

S. I. A. 60.

REPORT

OF THE

SIXTY-FIRST MEETING

OF THE

BRITISH ASSOCIATION

FOR THE

ADVANCEMENT OF SCIENCE

HELD AT

CARDIFF IN AUGUST 1891.



LONDON:

JOHN MURRAY, ALBEMARLE STREET.

1892.

OFFICE OF THE ASSOCIATION: BURLINGTON HOUSE, LONDON, W.

PRINTED BY
SPOTTISWOODE AND CO., NEW-STREET SQUARE
LONDON

CONTENTS.

	Page
OBJECTS and Rules of the Association	xxiv
Places and Times of Meeting and Officers from commencement	xxxiv
Presidents and Secretaries of the Sections of the Association from commencement	xliii
List of Evening Lectures.....	lx
Lectures to the Operative Classes	lxiii
Officers of Sectional Committees present at the Cardiff Meeting.....	lxiv
Treasurer's Account	lxvi
Table showing the Attendance and Receipts at the Annual Meetings	lxviii
Officers and Council, 1891-92	lxx
Report of the Council to the General Committee	lxxi
Committees appointed by the General Committee at the Cardiff Meeting in August 1891	lxxvi
Other Resolutions adopted by the General Committee	lxxxiv
Resolutions referred to the Council for consideration, and action if desirable	lxxxiv
Synopsis of Grants of Money	lxxxv
Places of Meeting in 1892 and 1893	lxxxvi
General Statement of Sums which have been paid on account of Grants for Scientific Purposes	lxxxvii
General Meetings	c

Address by the President, WILLIAM HUGGINS, Esq., D.C.L., LL.D., Ph.D.,
F.R.S., F.R.A.S., Hon.F.R.S.E., &c. 3

REPORTS ON THE STATE OF SCIENCE.

	Page
Report of the Corresponding Societies Committee, consisting of Mr. FRANCIS GALTON (Chairman), Professor A. W. WILLIAMSON, Sir DOUGLAS GALTON, Professor BOYD DAWKINS, Sir RAWSON RAWSON, Dr. J. G. GARSON, Dr. JOHN EVANS, Mr. J. HOPKINSON, Professor R. MELDOLA (Secretary), Professor T. G. BONNEY, Mr. W. WHITAKER, Mr. G. J. SYMONS, General PITTRIVERS, and Mr. W. TOPLEY.....	41
Report of a Committee, consisting of Messrs. J. LARMOR and G. H. BRYAN, appointed to draw up a Report on the present state of our knowledge of Thermodynamics, specially with regard to the Second Law	85
Sixth Report of the Committee, consisting of Professors FITZGERALD (Chairman), ARMSTRONG, and G. J. LODGE (Secretaries), Sir WILLIAM THOMSON, Lord RAYLEIGH, J. J. THOMSON, SCHUSTER, POYNTING, CRUM BROWN, RAMSAY, FRANKLAND, TILDEN, HARTLEY, S. P. THOMPSON, McLEOD, ROBERTS-AUSTEN, RÜCKER, REINOLD, CAREY FOSTER, and H. B. DIXON, Captain ABNEY, Drs. GLADSTONE, HOPKINSON, and FLEMING, and Messrs. CROOKES, SHELFORD BIDWELL, W. N. SHAW, J. LARMOR, J. T. BOTTOMLEY, R. T. GLAZEBROOK, J. BROWN, and JOHN M. THOMSON, appointed for the purpose of considering the subject of Electrolysis in its Physical and Chemical Bearings	122
Eleventh Report of the Committee, consisting of Sir WILLIAM THOMSON, Mr. R. ETHERIDGE, Professor JOHN PERRY, Dr. HENRY WOODWARD, Professor THOMAS GRAY, and Professor JOHN MILNE (Secretary), appointed for the purpose of investigating the Earthquake and Volcanic Phenomena of Japan. (Drawn up by the Secretary).....	123
Second Report of the Committee, consisting of Lord RAYLEIGH, Sir WILLIAM THOMSON, Professor CAYLEY, Professor B. PRICE, Dr. J. W. L. GLAISHER, Professor A. G. GREENHILL, Professor W. M. HICKS, and Professor A. LODGE (Secretary), appointed for the purpose of calculating Tables of certain Mathematical Functions, and, if necessary, of taking steps to carry out the Calculations, and to publish the results in an accessible form	129
First Report of the Committee, consisting of Mr. G. J. SYMONS (Chairman), Professor R. MELDOLA, Mr. J. HOPKINSON, and Mr. A. W. CLAYDEN (Secretary), appointed to consider the application of Photography to the Elucidation of Meteorological Phenomena. (Drawn up by the Secretary)	130
Report of the Committee, consisting of Professor O. J. LODGE, Professor CAREY FOSTER, and Mr. A. P. CHATTOCK (Secretary), appointed to investigate the Discharge of Electricity from Points	139
Report of the Committee, consisting of Lord McLAREN (Chairman), Professor CRUM BROWN (Secretary), Mr. MILNE-HOME, Dr. JOHN MURRAY, Dr. BUCHAN, and the Hon. RALPH ABERCROMBY, appointed for the purpose of co-operating with the Scottish Meteorological Society in making Meteorological Observations on Ben Nevis	140
Third (Interim) Report of the Committee, consisting of Professor FITZGERALD, Dr. JOHN HOPKINSON, Mr. R. A. HADFIELD, Mr. TROUTON, Professor ROBERTS-AUSTEN, Mr. H. F. NEWALL, and Professor BARRETT (Secretary), on the various Phenomena connected with the Recalescent Points in Iron and other Metals.....	147

	Page
Second (Interim) Report of the Committee, consisting of Dr. JOHN KERR, Sir WILLIAM THOMSON, Professor RÜCKER, and Mr. R. T. GLAZEBROOK (Secretary), appointed to co-operate with Dr. KERR in his researches on Electro-optics	147
Report of the Committee, consisting of Professor LIVEING, Dr. C. PIAZZI SMYTH (Secretary), and Professors DEWAR and SCHUSTER, appointed to co-operate with Dr. C. PIAZZI SMYTH in his researches on the Ultra-violet Rays of the Solar Spectrum	147
Report of the Committee, consisting of Professor W. GRYLLS ADAMS (Chairman and Secretary), Sir WILLIAM THOMSON, Professor G. H. DARWIN, Professor G. CHRYSAL, Professor A. SCHUSTER, Professor RÜCKER, Mr. C. H. CARPMAEL, Commander CREAK, the ASTRONOMER ROYAL, Mr. WILLIAM ELLIS, and Mr. G. M. WHIPPLE, appointed for the purpose of considering the best means of Comparing and Reducing Magnetic Observations.....	149
Report of the Committee, consisting of Professor G. CAREY FOSTER, Sir WILLIAM THOMSON, Professor AYRTON, Professor J. PERRY, Professor W. G. ADAMS, Lord RAYLEIGH, Dr. O. J. LODGE, Dr. JOHN HOPKINSON, Dr. A. MUIRHEAD, Mr. W. H. PREECE, Mr. HERBERT TAYLOR, Professor EVERETT, Professor SCHUSTER, Dr. J. A. FLEMING, Professor G. F. FITZGERALD, Mr. R. T. GLAZEBROOK (Secretary), Professor CHRYSAL, Mr. H. TOMLINSON, Professor W. GARNETT, Professor J. J. THOMSON, Mr. W. N. SHAW, Mr. J. T. BOTTOMLEY, and Mr. T. GRAY, appointed for the purpose of constructing and issuing Practical Standards for use in Electrical Measurements	152
Interim Report of the Committee, consisting of Professor CAYLEY, Professor SYLVESTER, Mr. A. R. FORSYTH, and Professor A. LODGE (Secretary), appointed for the purpose of carrying on the Tables connected with the Pellian Equation from the point where the work was left by Degen in 1817	160
Seventh Report of the Committee, consisting of Sir G. G. STOKES (Chairman), Professor SCHUSTER, Mr. G. JOHNSTONE STONEY, Sir H. E. ROSCOE, Captain ABNEY, Mr. WHIPPLE, Professor McLEOD, and Mr. G. J. SYMONS (Secretary), appointed for the purpose of considering the best methods of recording the direct Intensity of Solar Radiation	160
Report of the Committee, consisting of Sir H. E. ROSCOE, Mr. J. N. LOCKYER, Professors DEWAR, WOLCOTT GIBBS, LIVEING, SCHUSTER, and W. N. HARTLEY, Captain ABNEY, and Dr. MARSHALL WATTS (Secretary), appointed to prepare a new series of Wave-length Tables of the Spectra of the Elements and Compounds	161
Interim Report of the Committee, consisting of Professor THORPE, Professor HUMMEL (Secretary), Dr. PERKIN, Professor RUSSELL, Captain ABNEY, and Professor STROUD, on the Action of Light upon Dyed Colours. (Drawn up by the Secretary)	263
Report (provisional) of a Committee, consisting of Professors McLEOD and W. RAMSAY and Mr. W. A. SHENSTONE (Secretary), appointed to investigate the Influence of the Silent Discharge of Electricity on Oxygen and other Gases	264
Third Report of the Committee, consisting of Professors H. McLEOD (Chairman), ROBERTS-AUSTEN (Secretary), and REINOLD and Mr. H. G. MADAN, appointed for the Continuation of the Bibliography of Spectroscopy	264
Fifth Report of the Committee, consisting of Professor TILDEN and Professor ARMSTRONG (Secretary), appointed for the purpose of investigating Isomeric Naphthalene Derivatives. (Drawn up by Professor ARMSTRONG).....	265
Fifth Report of the Committee, consisting of Professors TILDEN, McLEOD, PICKERING, RAMSAY, and YOUNG and Drs. A. R. LEEDS and NICOL	

	Page
(Secretary), appointed for the purpose of reporting on the Bibliography of Solution	273
Fifth Report of the Committee, consisting of Professors TILDEN and RAMSAY and Dr. NICOL (Secretary), appointed for the purpose of investigating the Properties of Solutions	273
Third Report of the Committee, consisting of Professor ROBERTS-AUSTEN (Chairman), Sir F. ABEL, Messrs. E. RILEY and J. SPILLER, Professor J. W. LANGLEY, Mr. G. J. SNELUS, Professor TILDEN, and Mr. THOMAS TURNER (Secretary), appointed to consider the best method of establishing an International Standard for the Analysis of Iron and Steel. (Drawn up by the Secretary)	273
Report (provisional) of a Committee, consisting of Professors H. E. ARMSTRONG and W. R. DUNSTAN and Messrs. C. H. BOTHAMLEY and W. A. SHENSTONE (Secretary), appointed to investigate the direct formation of Haloid Compounds from pure materials	274
Provisional Report of the Committee, consisting of General FESTING, Captain ABNEY, and Professor H. E. ARMSTRONG (Secretary), on the Absorption Spectra of Pure Compounds	275
Nineteenth Report of the Committee, consisting of Professor PRESTWICH, Dr. H. W. CROSSKEY, Professors W. BOYD DAWKINS, T. MCKENNY HUGHES, and T. G. BONNEY, and Messrs. C. E. DE RANCE, W. PENGELLY, J. PLANT, and R. H. TIDDEMAN, appointed for the purpose of recording the Position, Height above the Sea, Lithological Characters, Size, and Origin of the Erratic Blocks of England, Wales, and Ireland, reporting other matters of interest connected with the same, and taking measures for their preservation. (Drawn up by Dr. CROSSKEY, Secretary).....	276
Second Report of the Committee, consisting of Dr. H. WOODWARD (Chairman), Rev. G. F. WHIDBORNE, Messrs. R. ETHERIDGE, R. KIDSTON, J. E. MARR, C. D. SHERBORN, and A. S. WOODWARD (Secretary), for the Registration of all the Type Specimens of British Fossils	299
Seventeenth Report of the Committee, consisting of Drs. E. HULL and H. W. CROSSKEY, Sir DOUGLAS GALTON, Professor G. A. LEBOUR, and Messrs. JAMES GLAISHER, E. B. MARTEN, G. H. MORTON, J. PARKER, W. PENGELLY, JAMES PLANT, J. PRESTWICH, I. ROBERTS, C. FOX-STRANGWAYS, T. S. STOOKE, G. J. SYMONS, W. TOPLEY, TYLDEN-WRIGHT, E. WETHERED, W. WHITAKER, and C. E. DE RANCE (Secretary), appointed for the purpose of investigating the Circulation of Underground Waters in the Permeable Formations of England and Wales, and the Quantity and Character of the Water supplied to various Towns and Districts from these Formations. (Drawn up by C. E. DE RANCE, Reporter)	300
Report of the Committee, consisting of Messrs. H. BAUERMAN, F. W. RUDLER, and J. J. H. TEALL and Dr. JOHNSTON-LAVIS, appointed for the investigation of the Volcanic Phenomena of Vesuvius and its neighbourhood. (Drawn up by Dr. JOHNSTON-LAVIS)	312
Second Report of the Committee, consisting of Professor JAMES GEIKIE (Chairman), Dr. TEMPEST ANDERSON, Dr. VALENTINE BALL, Mr. JAMES E. BEDFORD, Professor T. G. BONNEY, Professor W. BOYD DAWKINS, Mr. JAMES W. DAVIS, Mr. WILLIAM GRAY, Mr. ROBERT KIDSTON, Mr. ARTHUR S. REID, Mr. R. H. TIDDEMAN, Mr. W. W. WATTS, Mr. HORACE B. WOODWARD, and Mr. OSMUND W. JEFFS (Secretary), to arrange for the collection, preservation, and systematic registration of Photographs of Geological Interest in the United Kingdom. (Drawn up by the Secretary)	321
Report of the Committee, consisting of Mr. G. J. SYMONS, Mr. C. DAVISON (Secretary), Sir F. J. BRAMWELL, Mr. E. A. COWPER, Professor G. H. DARWIN, Professor EWING, Mr. ISAAC ROBERTS, Mr. THOMAS GRAY, Dr. JOHN	

	Page
EVANS, Professors PRESTWICH, HULL, LEBOUR, MELDOLA, and JUDD, Mr. M. WALTON BROWN, and Mr. J. GLAISHER, appointed to consider the advisability and possibility of establishing in other parts of the country Observations upon the Prevalence of Earth Tremors similar to those now being made in Durham in connection with coal-mine explosions	333
Report of the Committee, consisting of Dr. H. WOODWARD (Chairman), Messrs. W. D. CRICK, T. G. GEORGE, WM. HULL, E. A. WALFORD, E. WILSON, H. B. WOODWARD, and BEEBY THOMPSON (Secretary), to work the very Fossiliferous Transition Bed between the Middle and Upper Lias in Northamptonshire, in order to obtain a more clear idea of its fauna, and to fix the position of certain species of fossil fish, and more fully investigate the horizon on which they occur. (Drawn up by the Secretary)	334
Report of the Committee, consisting of Mr. J. W. DAVIS (Chairman), Rev. E. JONES (Secretary), Drs. J. EVANS and J. G. GARSON, and Messrs. W. PENGELLY, R. H. TIDDEMAN, and J. J. WILKINSON, to complete the investigation of the Cavè at Elbolton, near Skipton, in order to ascertain whether Remains of Palæolithic Man occur in the Lower Cave Earth	351
Report of the Committee, consisting of Dr. JOHN EVANS (Chairman), Mr. B. HARRISON (Secretary), and Professors J. PRESTWICH and H. G. SEELEY, appointed to carry on excavations at Oldbury Hill, near Ightham, in order to ascertain the existence or otherwise of Rock-shelters at this spot. (Drawn up by Mr. B. HARRISON)	353
Fourth Report of the Committee, consisting of Professor FLOWER (Chairman), Mr. D. MORRIS (Secretary), Mr. CARRUTHERS, Dr. SCLATER, Mr. THISELTON-DYER, Dr. SHARP, Mr. F. DU CANE GODMAN, Professor NEWTON, Dr. GÜNTHER, and Colonel FEILDEN, appointed for the purpose of reporting on the present state of our knowledge of the Zoology and Botany of the West India Islands, and taking steps to investigate ascertained deficiencies in the Fauna and Flora	354
Draft of Report of the Committee, consisting of Professor FLOWER (Chairman), Mr. D. SHARP (Secretary), Dr. BLANFORD, Dr. HICKSON, Professor NEWTON, Professor RILEY, Mr. O. SALVIN, and Dr. SCLATER, appointed to report on the present state of our knowledge of the Zoology of the Sandwich Islands, and to take steps to investigate ascertained deficiencies in the Fauna	357
Fifth Report of the Committee, consisting of Professor FOSTER, Professor BAYLEY BALFOUR, Mr. THISELTON-DYER, Dr. TRIMEN, Professor MARSHALL WARD, Mr. CARRUTHERS, Professor HARTOG, Mr. WALTER GARDINER, and Professor BOWER (Secretary), appointed for the purpose of taking steps for the establishment of a Botanical Laboratory at Peradeniya, Ceylon	358
Fourth Report of the Committee, consisting of Mr. A. W. WILLS (Chairman), Mr. E. W. BADGER, Mr. G. CLARIDGE DRUCE, and Professor HILLHOUSE, for the purpose of collecting information as to the Disappearance of Native Plants from their Local Habitats. (Drawn up by Professor HILLHOUSE, Secretary)	359
Report of a Committee, consisting of Professor NEWTON, Mr. JOHN CORDEAUX (Secretary), Messrs. JOHN A. HARVIE-BROWN, R. M. BARRINGTON, W. EAGLE CLARKE, and the Rev. E. P. KNUBLEY, appointed at Leeds to make a digest of the observations on the Migration of Birds at Lighthouses and Light-vessels, which have been carried on by the Migration Committee of the British Association, and to report on the same at Cardiff	363
Report of the Committee, consisting of Professor FLOWER (Chairman), Professor M. FOSTER, Professor RAY LANKESTER, Professor VINES, and Mr. S. F. HARMER (Secretary), appointed for the purpose of arranging for the occupa-	

	Page
tion of a Table at the Laboratory of the Marine Biological Association at Plymouth	364
Report of the Committee, consisting of Dr. P. L. SCLATER, Professor RAY LANKESTER, Professor COSSAR EWART, Professor M. FOSTER, Mr. A. SEDGWICK, Professor A. M. MARSHALL, and Mr. PERCY SLADEN (Secretary), nominated for the purpose of arranging for the occupation of a Table at the Zoological Station at Naples	365
Report of the Committee, consisting of Professor A. C. HADDON, Professor W. A. HERDMAN, and Mr. W. E. HOYLE (Secretary), appointed for improving and experimenting with a Deep-sea Tow-net, for opening and closing under water	382
Report of the Committee, consisting of Dr. J. H. GLADSTONE (Chairman), Professor H. E. ARMSTRONG (Secretary), Mr. S. BOURNE, Dr. CROSSKEY, Mr. G. GLADSTONE, Mr. J. HEYWOOD, Sir JOHN LUBBOCK, Sir PHILIP MAGNUS, Professor N. STORY MASKELYNE, Sir H. E. ROSCOE, Sir R. TEMPLE, and Professor S. P. THOMPSON, appointed for the purpose of continuing the inquiries relating to the teaching of Science in Elementary Schools	383
Third Report of the Committee, consisting of Sir J. N. DOUGLASS, Professor OSBORNE REYNOLDS, Professor W. C. UNWIN, and Messrs. W. TOPLEY, E. LEADER WILLIAMS, W. SHELFORD, G. F. DEACON, A. R. HUNT, W. H. WHEELER, W. ANDERSON, and H. BAMFORD, appointed to investigate the Action of Waves and Currents on the Beds and Foreshores of Estuaries by means of Working Models.....	386
Report of the Committee, consisting of Professor FLOWER (Chairman), Dr. GARSON (Secretary), Dr. BEDDOE, General PIT-RIVEES, Mr. FRANCIS GALTON, and Dr. E. B. TYLOR, appointed for the purpose of editing a new Edition of 'Anthropological Notes and Queries'	404
Report of the Committee, consisting of Professor FLOWER (Chairman), Dr. GARSON (Secretary), Mr. BLOXAM, and Dr. WILBERFORCE SMITH, for the purpose of carrying on the work of the Anthropometric Laboratory	405
Seventh Report of the Committee, consisting of Dr. E. B. TYLOR, Mr. G. W. BLOXAM, Sir DANIEL WILSON, Dr. G. M. DAWSON, and Mr. R. G. HALIBURTON, appointed to investigate the physical characters, languages, and industrial and social condition of the North-Western Tribes of the Dominion of Canada	407
Fifth Report of the Committee, consisting of Sir JOHN LUBBOCK, Dr. JOHN EVANS, Professor W. BOYD DAWKINS, Dr. R. MUNRO, Mr. W. PENGELLY, Dr. HENRY HICKS, Professor MELDOLA, Dr. MUIRHEAD, and Mr. JAMES W. DAVIS, appointed for the purpose of ascertaining and recording the localities in the British Islands in which evidences of the existence of Prehistoric Inhabitants of the country are found. (Drawn up by Mr. JAMES W. DAVIS)	440
Fourth and Final Report of the Committee, consisting of the Hon. RALPH ABERCROMBY, Dr. A. BUCHAN, Mr. J. Y. BUCHANAN, Mr. J. WILLIS BUND, Professor CHRYSAL, Mr. D. CUNNINGHAM, Professor FITZGERALD, Dr. H. R. MILL (Secretary), Dr. JOHN MURRAY (Chairman), Mr. ISAAC ROBERTS, Dr. H. C. SORBY, and the Rev. C. J. STEWARD, appointed to arrange an investigation of the Seasonal Variations of Temperature in Lakes, Rivers, and Estuaries in various parts of the United Kingdom in co-operation with the local societies represented on the Association. (Drawn up by Dr. H. R. MILL)	454
On the Capture of Comets by Planets, especially their Capture by Jupiter. By Professor H. A. NEWTON.....	511
The Recent Progress of Agriculture in India. By C. L. TUPPER	532

TRANSACTIONS OF THE SECTIONS.

SECTION A.—MATHEMATICAL AND PHYSICAL SCIENCE.

THURSDAY, AUGUST 20.

	Page
Address by Professor OLIVER J. LODGE, D.Sc., LL.D., F.R.S., President of the Section	547
1. Interim Report of the Committee on Phenomena connected with Recalescence	557
2. On the Action of a Planet upon small Bodies passing near the Planet, with special reference to the Action of Jupiter upon such Bodies. By Professor H. A. NEWTON	557
3. On the Absorption of Heat in the Solar Atmosphere. By W. E. WILSON, M.R.I.A., F.R.A.S.	557
4. The Ultra-Violet Spectrum of the Solar Prominences. By Professor GEORGE E. HALE, Director of the Kenwood Physical Observatory, Chicago	557
5. Report on Researches relative to the Second Law of Thermodynamics. By Dr. J. LARMOR and G. H. BRYAN	558
6. Note on a Simple Mechanical Representation of Carnot's Reversible Cycle. By G. H. BRYAN	558

FRIDAY, AUGUST 21.

1. Interim Report of the Committee on Researches in Electro-optics	558
2. Note on the Electromagnetic Theory of the Rotation of the Plane of Polarised Light. By Professor A. GRAY, M.A., F.R.S.E.	558
3. On an Experiment on the Velocity of Light in the neighbourhood of rapidly-moving Matter. By Professor OLIVER J. LODGE, F.R.S.	560
4. The Action of Electrical Radiators, with a Mechanical Analogy. By J. LARMOR	560
5. On the Measurement of Stationary Hertzian Oscillations along Wires, and the Damping of Electric Waves. By Professor D. E. JONES, B.Sc.	561
6. On the Propagation of Electromagnetic Waves in Wires. By WALTER THORP	562
7. On Reflection near the Polarising Angle from the Clean Surfaces of Liquids. By LORD RAYLEIGH, Sec.R.S.	563

SATURDAY, AUGUST 22.

DEPARTMENT I.—PHYSICS.

1. Sixth Report of the Committee on Electrolysis	564
2. Interim Report on the present state of our Knowledge in Electrolysis and Electro-Chemistry	564

	Page
3. Electrolytic Problems. By ROBERT L. MOND	564
4. On Clausius' Theory of Electrolytic Conduction, and on some Secret Evidence for the Dissociation Theory of Electrolysis. By J. BROWN ...	564
5. Report of the Committee on the Phenomena accompanying the Discharge of Electricity from Points	565
6. On the Electrification of Needle Points in Air. By A. P. CHATTOCK.....	565
7. On the Measurement of Liquid Resistances. By J. SWINBURNE	565
8. The Surface-Tension of Ether and Alcohol at Different Temperatures. By Professor WILLIAM RAMSAY, Ph.D., F.R.S.....	565

DEPARTMENT II.—MATHEMATICS.

1. Interim Report of the Committee on Mathematical Functions.....	566
2. Interim Report of the Committee on the Pellian Equation Tables	566
3. On Periodic Motion of a Finite Conservative System. By Sir WILLIAM THOMSON, Pres.R.S.	566
4. On a Geometrical Illustration of a Dynamical Theorem. By Sir ROBERT BALL, F.R.S.	566
5. On the Transformation of a Differential Resolvent. By the Rev. ROBERT HARLEY, M.A., F.R.S.	566
6. On the Transformations used in connection with the Duality of Differential Equations. By E. B. ELLIOTT, F.R.S.	568
7. Note on a Method of Research for Invariants. By E. B. ELLIOTT, F.R.S.	568
8. On Liquid Jets under Gravity. By Rev. H. J. SHARPE, M.A.	568
9. The Geometry of Confocal Conics. By Professor T. C. LEWIS	570
10. Some Tangential Transformations, including Laguerre's Semi-Droites Réciproques. By Professor R. W. GENESE, M.A.	571
11. Note on the Normal to a Conic. By R. II. PINKERTON	572
12. On the Importance of the Conception of Direction in Natural Philosophy. By E. T. DIXON	572

MONDAY, AUGUST 24.

1. Report of the Committee on Researches on the Ultra-Violet Rays of the Solar Spectrum	573
2. Comparison of Eye and Hand Registration of Lines in the Violet and Ultra-Violet of the Solar Spectrum, against Photographic Records of the same, with the same Instrument, after a lapse of several years. By C. PIAZZA SMYTH, LL.D., F.R.S.E.	573
3. Note on Observing the Rotation of the Sun with the Spectroscope. By G. JOHNSTONE STONEY, M.A., D.Sc., F.R.S.	573
4. On the Cause of Double Lines in Spectra. By G. JOHNSTONE STONEY, M.A., D.Sc., F.R.S.	574
5. Seventh Report of the Committee on Solar Radiation	575
6. Report of the Committee on Meteorological Photography.....	575

Page

7. Report of the Committee on the Meteorological Observations on Ben Nevis	575
8. Report of the Committee on the Reduction of Magnetic Observations.....	575
9. Report of the Committee on the Seasonal Variations in the Temperature of Lakes, Rivers, and Estuaries	576
10. On the probable Nature of the Bright Streaks on the Moon. By Dr. RALPH COPELAND, F.R.A.S., F.R.S.E.	576

TUESDAY, AUGUST 25.

1. Report of the Committee on Electrical Standards	576
2. The Causes of Variation of Clark Standard Cells. By J. SWINBURNE ...	576
3. Joint Discussion with Section G on Units and their Nomenclature, opened by Professor OLIVER J. LODGE, F.R.S., followed by W. H. PREECE, F.R.S.	577
Some Revolutionary Suggestions on the Nomenclature of Electrical and Mechanical Units. By Professor W. STROUD	577
On a Table to facilitate the Conversion of Electrostatic and Electromagnetic Measures into one another. By G. JOHNSTONE STONEY, M.A., D.Sc., F.R.S.	577
Absolute Units of Measurement. By W. MOON	580

WEDNESDAY, AUGUST 26.

1. On the Measurement of Lenses. By Professor SILVANUS P. THOMPSON, F.R.S.	580
2. On a new Polariser. By Professor SILVANUS P. THOMPSON, F.R.S.	580
3. Some Experiments on a new Method for the Determination of 'v.' By A. G. WEBSTER	580
4. On the Magnetic Field in the neighbourhood of the South London Electrical Railway. By Professor W. E. AYRTON, F.R.S., and Professor RÜCKER, F.R.S.	581
5. On the Periodic Time of Tuning-Forks maintained in Vibration Electrically. By Professor J. VIRIAMU JONES and T. HARRISON	581
6. Magnetic Experiments made in connection with the Determination of the Rate of Propagation of Magnetisation in Iron. By F. T. TROUTON	581
7. On the Connection between the Crystal Form and the Chemical Composition of Bodies. The Symmetry of Crystals accounted for by the Application of Boscovich's Theory of Atoms to the Atoms of the Chemist. By WILLIAM BARLOW, F.G.S.	581
8. Report of the Committee on the Volcanic and Seismological Phenomena of Japan	583
9. On Phenomena which might be Observable if the Hypothesis that Earthquakes are connected with Electrical Phenomena be entertained. By Professor JOHN MILNE, F.R.S.	583
10. Experimental Study of a Curious Movement of Ovoids and Ellipsoids. By Professor LECONTE	583

	Page
11. On Vowel Sounds. By Dr. R. J. LLOYD	583
12. A Latent Characteristic of Aluminium. By Dr. A. SPRINGER ...	533

SECTION B.—CHEMICAL SCIENCE.

THURSDAY, AUGUST 20.

Address by Professor W. C. ROBERTS-AUSTEN, C.B., F.R.S., President of the Section	584
1. Report of the Committee on International Standards for the Analysis of Iron and Steel.....	601
2. Report on the Action of Light upon Dyed Colours	601
3. Report on the Influence of the Silent Discharge of Electricity on Oxygen and other Gases	601
4. Report on the Bibliography of Solution	602
5. Report on the Properties of Solutions	602
6. Report on the Bibliography of Spectroscopy	602

FRIDAY, AUGUST 21.

1. Report of the Committee on the Formation of Haloids	602
2. The Spontaneous Ignition of Coal. By Professor VIVIAN B. LEWES.....	602
3. On Nickel Carbon Oxide and its application in Arts and Manufactures. By LUDWIG MOND, F.R.S.	602
4. On the Electrical Evaporation of Metals and Alloys. By W. CROOKES, F.R.S.	607
5. On the Cause of Imperfections in the Surface of Rolled Copper Alloys. By T. TURNER, A.R.S.M.	607

MONDAY, AUGUST 24.

1. Certain Pyrometric Measurements and Methods of Recording them. By Professor W. C. ROBERTS-AUSTEN, C.B., F.R.S.	607
2. On the Existence of a Compound in Alloys of Gold and Tin. By A. P. LAURIE, M.A.	607
3. On the Relation between the Composition of a Double Salt and the Composition and Temperature of the Solution in which it is formed. By A. VERNON HARCOURT, F.R.S., and F. W. HUMPHERY	608
4. Some Experiments on the Molecular Refraction of Dissolved Electrolytes. By Dr. J. H. GLADSTONE, F.R.S., and W. HIBBERT.....	609
5. The Action of Heat on Alkaline Hypochlorites. By Professor H. McLEOD, F.R.S.	609
6. A simple Apparatus for Storing Dry Gases. By W. SYMONS, F.C.S.....	609

TUESDAY, AUGUST 25.

	Page
1. Report on Isomeric Naphthalene Derivatives	610
2. Report on Wave-length Tables of the Spectra of the Elements	610
3. Report on the Absorption Spectra of Pure Compounds	610
4. On the Specific Heat of Basalt. By W. C. ROBERTS-AUSTEN, C.B., F.R.S., and A. W. RÜCKER, F.R.S.	610
5. An Apparatus for Testing Safety Lamps. By Professor F. CLOWES, F.C.S.	611
6. On Didymium from different Sources. By Professor C. M. THOMPSON, F.C.S.	611
7. On the Nature of Solution. By Professor W. RAMSAY, F.R.S.	612
8. The Interpretation of certain Chemical Reactions. By C. H. BOTHAMLEY, F.C.S.	612
9. Action of Nitrosyl Chloride on Unsaturated Carbon Compounds. By J. J. SUDBOROUGH, B.Sc., A.I.C., F.C.S.	612
10. On the Formation of Peaty Colouring Matters in Sewage by the Action of Micro-organisms. By W. E. ADENEY, F.I.C., Assoc.R.C.Sc.I.	612
11. On a new Method of Disposal of Sewage, with some references to Schemes now in use. By C. G. MOOR, B.A.	612
12. The Reaction of Glycerides with Alcoholic Potash. By A. H. ALLEN, F.C.S.	613
13. Note on the Electrolysis of Alloys. By HENRY C. JENKINS, Assoc.M. Inst.C.E., F.C.S.	613

SECTION C.—GEOLOGY.

THURSDAY, AUGUST 20.

Address by Professor T. RUPERT JONES, F.R.S., F.G.S., President of the Section	614
1. Discovery of the <i>Olenellus</i> -zone in the North-west Highlands. By Sir ARCHIBALD GEIKIE, F.R.S., Director-General of the Geological Survey...	633
2. On some recent Work of the Geological Survey in the Archæan Gneiss of the North-west Highlands. By Sir ARCHIBALD GEIKIE, F.R.S., Director- General of the Survey	634
3. Report of the Committee on the Registration of Type Specimens	634
4. Remarks on the Lower Tertiary Fish Fauna of Sardinia. By A. SMITH WOODWARD, F.G.S.	634
5. Evidence of the Occurrence of Pterosaurian and Plesiosaurian Reptiles in the Cretaceous Strata of Brazil. By A. SMITH WOODWARD, F.G.S.	635
6. The Cause of Monoclinial Flexure. By A. J. JUKES-BROWNE, F.G.S. ...	635
7. Note on an Undescribed Area of Lower Greensand, or Vectian, in Dorset- shire. By A. J. JUKES-BROWNE, F.G.S.	635

	Page
8. On the Continuity of the Kellaways Beds over extended areas near Bedford, and on the Extension of the Fuller's Earth Works at Woburn. By A. C. G. CAMERON	636

FRIDAY, AUGUST 21.

1. On the Discovery of the South-Eastern Coal-field. By Professor W. BOYD DAWKINS, F.R.S.....	637
2. The Geology of Petroleum and Natural Gas. By W. TOPLEY, F.R.S., Assoc.Inst.C.E.	637
3. The Origin of Petroleum. By O. C. D. ROSS	639
4. A Comparison between the Rocks of South Pembrokeshire and those of North Devon. By HENRY HICKS, M.D., F.R.S., Sec. Geol. Soc.	641
5. Vulcanicity in Lower Devonian Rocks. The Prawle Problem. By W. A. E. USSIER, F.G.S.	642
6. On the Occurrence of Detrital Tourmaline in a Quartz-schist west of Start Point, South Devon. By A. R. HUNT, M.A., F.G.S.	643

SATURDAY, AUGUST 22.

1. Report of the Committee on the Circulation of Underground Waters ...	644
2. Note on the Discovery of <i>Estheria Minuta</i> (var. <i>Brodieana</i>) in the New Red Sandstone. By C. E. DE RANCE, F.G.S.	644
3. Report of the Committee on Geological Photographs	644
4. Notes upon <i>Colobodus</i> , a Genus of Mesozoic Fossil Fishes. By MONTAGU BROWNE, F.Z.S., F.G.S.	644
5. Report of the Committee on Earth Tremors	645
6. Report of the Committee on the Volcanic Phenomena of Vesuvius.....	645

MONDAY, AUGUST 24.

1. The Cause of an Ice Age. By Sir ROBERT BALL, F.R.S.	645
2. Report of the Committee on Erratic Blocks	647
3. Notes on the Glacial Geology of Norway. By H. W. CROSSKEY, LL.D., F.G.S.	647
4. Recent Discoveries concerning the Relation of the Glacial Period in North America to the Antiquity of Man. By Professor G. FREDERICK WRIGHT, LL.D., F.G.S.A.....	647
5. On the Evidences of Glacial Action in Pembrokeshire, and the Direction of Ice-flow. By HENRY HICKS, M.D., F.R.S., Sec. Geol. Soc.	649
6. Note on Boulders at Darley, near Matlock, Derbyshire. By HERBERT BOLTON.....	650
7. Notes of a Section of Drift at Levenshulme, Manchester. By PERCY F. KENDALL, F.G.S.	650

	Page
8. The Lava Beds of California and Idaho, and their relation to the Antiquity of Man. By Professor G. FREDERICK WRIGHT, LL.D., F.G.S.A.	651
9. Report of the Committee on Excavations at Oldbury Hill	651
10. Preliminary Notes on the Excavations at Oldbury Hill. By JOSEPH PRESTWICH, D.C.L., F.R.S.	651
11. Report of the Committee on Elbolton Cave, near Skipton.....	652

TUESDAY, AUGUST 25.

1. On the Occurrence of <i>Pachythea</i> and a Species of <i>Nematophycus</i> in the Silurian Beds at Tymawr Quarry, Rummy. By J. STORRIE.....	652
2. Report of the Committee on the Lias of Northamptonshire	654
3. The Mastodon and Mammoth in Ontario, Canada. By Professor J. HOYES PANTON, M.A., F.G.S.	654
4. Note on the occurrence of <i>Ammonites jurensis</i> in the Ironstone of the Northampton Sands, in the neighbourhood of Northampton. By E. T. NEWTON, F.G.S., F.Z.S.	655
5. On certain <i>Ammonite</i> -zones of Dorset and Somerset. By S. S. BUCKMAN, F.G.S., Hon. Memb. Yorks. Phil. Soc.....	655
6. Notes on the <i>Polyzoa</i> (<i>Bryozoa</i>) of the Zones of the Upper Chalk. By GEORGE ROBERT VINE	656

SECTION D.—BIOLOGY.

THURSDAY, AUGUST 20.

Address by FRANCIS DARWIN, M.A., M.B., F.R.S., President of the Section	660
1. Fourth Report of the Committee appointed for the purpose of reporting on the present state of our knowledge of the Zoology and Botany of the West India Islands, and taking steps to investigate ascertained deficiencies in the Flora and Fauna	678
2. Report of the Committee appointed to report on the present state of our knowledge of the Zoology of the Sandwich Islands, and to take steps to investigate ascertained deficiencies in the Fauna	678
3. Fifth Report of the Committee appointed for the purpose of taking steps for the establishment of a Botanical Laboratory at Paradeniya, Ceylon...	678
4. Report of a Committee appointed to make a digest of the observations on the Migration of Birds at Lighthouses and Light-vessels which have been carried on by the Migration Committee of the British Association.....	678
5. Fourth Report of the Committee for the purpose of collecting information as to the Disappearance of Native Plants from their Local Habitats	678
6. Report of the Committee appointed for the purpose of arranging for the occupation of a Table at the Laboratory of the Marine Biological Association at Plymouth	678

	Page
7. Report of the Committee appointed for Improving and Experimenting with a Deep-Sea Tow-Net.....	678
8. Non-sexual Formation of Spores in the Desmidiaceæ. By A. W. BENNETT	678
9. On a simple Apparatus for the Cultivation of small organisms in Hanging Drops, and in various Gases, under the Microscope. By Professor MARSHALL WARD, F.R.S.	678
10. On some simple Models illustrating the Vascular System of Vertebrates. By Professor W. N. PARKER	679
11. On the Progress of the Investigation of the Natural History of the Friendly Islands. By J. J. LISTER.....	679

FRIDAY, AUGUST 21.

1. Report of the Committee nominated for the purpose of arranging for the occupation of a Table at the Zoological Station at Naples	680
2. On some Species of Diatoms with Pseudopodia. By J. G. GRENFELL, F.G.S., F.R.M.S.	680
3. On Nuclear Structure in the Bacteria. By HAROLD WAGER	681
4. Discussion on the Systematic Position of certain Organisms that are regarded by some Naturalists as Animals, and by others as Plants	682

SATURDAY, AUGUST 22.

1. On Anatomical Nomenclature. By Professor W. KRAUSE	682
2. On Fertilisation and Conjugation Processes as allied Modes of Protoplasmic Rejuvenescence. By Professor MARCUS HARTOG, M.A., D.Sc., F.L.S.	683
3. A Preliminary Classification of Sexual and allied Modes of Protoplasmic Rejuvenescence, &c. By Professor MARCUS HARTOG, M.A., D.Sc., F.L.S.	683
4. On recent Investigations of the Marine Biological Association (Fishery and Physical). By W. L. CALDERWOOD, Director.....	685
5. On the Growth of Food-fishes and their Distribution at different ages. By J. T. CUNNINGHAM, M.A.	685
6. The Reproduction of the Pilchard. By J. T. CUNNINGHAM, M.A.	686
7. Observations on the Larvæ of <i>Palinurus vulgaris</i> . By J. T. CUNNINGHAM, M.A.	687
8. Distribution of <i>Crystallogobius Nilssonii</i> , Gill. By J. T. CUNNINGHAM, M.A.	687

MONDAY, AUGUST 24.

1. Facts regarding Prothalli and the Propagation of Ferns. By E. J. LOWE, F.R.S., F.L.S.	687
2. On Ferns and their Multiple Parents. By E. J. LOWE, F.R.S., F.L.S. ...	688
3. The Ciliated Organs of the Leeches. By Professor GILSON.....	690

	Page
4. Some Points in the Early Development of <i>Mus musculus</i> and <i>Mus decumanus</i> : the Relation of the Yolk Sac to the Decidua and the Placenta. By ARTHUR ROBINSON, M.D.	690
5. Observations upon the Development of the Spinal Cord in <i>Mus musculus</i> and <i>Mus decumanus</i> : the Formation of the Septa and the Fissures. By ARTHUR ROBINSON, M.D.	691
6. On the Innervation of the Epipodial Processes of some Nudibranchiate Mollusca. By Professor W. A. HERDMAN, D.Sc., and J. A. CLUBB	692
7. Exhibition of a new Apparatus for opening and closing a Tow-Net by Electricity. By W. E. HOYLE and L. F. MASSEY	693
8. Exhibition of, and Remarks upon, some Young Specimens of <i>Echidna aculeata</i> . By Professor W. N. PARKER, Ph.D.	693
9. Experiments on Respiration in Tadpoles of the Common Frog (<i>Rana temporaria</i>). By Professor W. N. PARKER, Ph.D.	694
10. On the Arrangement of the Living Fishes, as based upon the Study of their Reproductive System. By Professor G. B. HOWES, F.L.S., F.Z.S. ...	694
11. On the Recent Visitation of <i>Plutella Crucifera</i> . By W. FREAM.....	695

TUESDAY, AUGUST 25.

1. On the Artificial Production of Rhythm in Plants. By FRANCIS DARWIN and DOROTHEA F. M. PERTZ.....	695
2. On Floating Leaves. By Professor MIALL, F.L.S.	695
3. Notes on Internal Phloëm in the Dicotyledons. By D. H. SCOTT, M.A., Ph.D., F.L.S.	696
4. On the Occurrence of Diastase in Pollen. By Professor J. R. GREEN, M.A., B.Sc.	696
5. The Presence of a Diastatic Ferment in Green Leaves. By Professor S. H. VINES, M.A., F.R.S.	697
6. On the Nuclei of the Hymenomycetes. By HAROLD WAGER	700
7. New Form of Appendicularian 'Haus.' By Geo. SWAINSON, F.L.S.	701
8. On the Customary Methods of describing the Gills of Fishes. By Professor G. B. HOWES, F.L.S., F.Z.S.	702
9. Exhibition of a very small Parrot from the Solomon Islands. By Canon TRISTRAM, F.R.S.	702

SECTION E.—GEOGRAPHY.

THURSDAY, AUGUST 20.

Address by E. G. RAVENSTEIN, F.R.G.S., F.S.S., President of the Section ...	703
1. The Art of Observing. By JOHN COLES, F.R.A.S.	714
2. Recent Geographical Progress in Great Britain. By J. SCOTT KELTIE ...	714
3. Trees and Prairies. By MILLER CHRISTY	715

	Page
4. The Homology of Continents. By Dr. HUGH R. MILL, F.R.S.E.	715
5. On the Comparative Value of African Lands. By ARTHUR SILVA WHITE, F.R.S.E., Sec.R.Scot.G.S.....	715

FRIDAY, AUGUST 21.

1. On Acclimatisation. By ROBERT W. FELKIN, M.D.....	715
2. Changes in Coast Lines. By Dr. J. S. PHENÉ	716
3. Morocco as a Field for Geographers. By J. E. BUDGETT MEAKIN	716
4. On the Aborigines of Western Australia. By Miss E. M. CLERKE.....	716
5. The Application of Indian Geographical Survey Methods to Africa. By Lieut.-Colonel T. H. HOLDICH, R.E.	717
6. Bar-Subtense Survey. By Colonel HENRY TANNER	718

SATURDAY, AUGUST 22.

1. Suggestions for the Revision and Improvement of the Large Scale Maps of the Ordnance Survey. By HENRY T. CROOK, C.E.	718
2. Mr. RAVENSTEIN explained a Series of Maps illustrating his Presidential Address to the Section	718
3. A Local Collection of Maps was described by the Librarian of the Public Library	718

MONDAY, AUGUST 24.

1. Antarctic Exploration. By E. DELMAR MORGAN	719
2. Photography applied to Exploration. By JAMES THOMSON	719
3. Journeys to the Lake Ngami Region. By HARRY D. BUCKLE.....	719
4. A Visit to Kilimanjaro and Lake Chala. By Mrs. FRENCH SHELDON ...	719
5. The Geography of South-West Africa. By Dr. HENRY SCHLICHTER.....	719

TUESDAY, AUGUST 25.

1. The Siam Border. By Lord LAMINGTON	720
2. Colorado. By Dr. BELL	720
3. The Physical and Industrial Geography of Florida. By ARTHUR MONTEFIORE, F.G.S., F.R.G.S.....	720
4. The Volta River. By G. DOBSON	722
5. The Bakhtiari Country and the Karun River. By Mrs. BISHOP	722
6. Physical Aspects of the Himalayas, and Notes on the Inhabitants. By Colonel HENRY TANNER	722
7. On the proposed Formation of a Topographical Society in Cardiff. By E. G. RAVENSTEIN, F.R.G.S.	722

SECTION F.—ECONOMIC SCIENCE AND STATISTICS.

THURSDAY, AUGUST 20.

Page

Address by Professor W. CUNNINGHAM, D.D., D.Sc., F.S.S., President of the Section	723
1. Labour and Capital: their Differences and how to reconcile them. By C. H. PERKINS	735
2. On the Coal Question. By T. FORSTER BROWN, M.Inst.C.E.	736

FRIDAY, AUGUST 21.

1. 'Miners' Thrift and Employers' Liability: a Remarkable Experience.' By GEORGE L. CAMPBELL	737
2. State Provision against Sickness and Old Age, and the German Invalidity and Superannuation Law. By LOUIS TYLOR.....	739
3. On some Economic Aspects of Life Assurance. By JOHN M. McCANDLISH, F.R.S.E.	739
4. The Survival of Domestic Industries. By Professor GONNER.....	740
5. Free Travel. By S. M. BURROUGHS.....	740

SATURDAY, AUGUST 22.

1. The alleged Differences in the Wages paid to Men and to Women for Similar Work. By SIDNEY WEBB, LL.B.....	742
2. The Taxation of Inventors. By LEWIS EDMUNDS, D.Sc.....	743

MONDAY, AUGUST 24.

1. On recent Progress in Indian Agriculture. By C. L. TUPPER, Chief Secretary to the Punjab Government.....	744
2. Railway Communications of India. By W. C. FURNIVALL, M.Inst.C.E.	744
3. Report on the Teaching of Science in Elementary Schools.....	745
4. On the Upbringing of Destitute and Pauper Children. By the Rev. J. O. BEVAN, M.A.	745

TUESDAY, AUGUST 25.

1. On the Data available for determining the best Limit (physically) for Hours of Labour. By J. T. ARLIDGE, M.D.....	746
2. The Cure of Consumption in its Economic Aspect. By G. W. HAMBLETON	747
3. The Increase of Food and Population. By W. E. A. AXON.....	747
4. Le Play's method of Systematic Observation. By F. AUBURTIN.....	747
5. Recent Changes in the Distribution of Population in England and Wales. By EDWIN CANNAN	747

SECTION G.—MECHANICAL SCIENCE.

THURSDAY, AUGUST 20.

	Page
Address by T. FORSTER BROWN, M.Inst.C.E., President of the Section	749
1. Report of the Estuaries Committee	757
2. The Ystradyfodwg and Pontypridd Main Sewerage. By G. CHATTERTON	757
3. The River Usk, and the Harbour of Newport. By L. F. VERNON-HAR- COURT, M.A., M.Inst.C.E., Engineer to the Newport Harbour Commission	757
4. On Mechanical Ventilation and Heating of Buildings. By W. KEY	758

FRIDAY, AUGUST 21.

1. On the Channel Tubular Railway. By SIR EDWARD REED, K.C.B., M.P., F.R.S.	758
2. Petroleum Oil-engines. By Professor WILLIAM ROBINSON, M.E., Assoc. M.Inst.C.E.	759
3. On the Revolving Purifier for the Treatment of Water by Metallic Iron. By W. ANDERSON, D.C.L., F.R.S., M.Inst.C.E.	762
4. A Steady Platform for Guns, &c., at Sea. By BEAUCHAMP TOWER	763
5. Description of Lewis and Hunter's System of Coaling Ships. By C. HUNTER	763
6. On some of the Peculiarities to be observed in Portland Cements, and on the most advanced methods for determining their Constructive Value. By HENRY FAIJA, M.Inst.C.E.	764
7. On the Compound Principle in the Transmission of Power by Compressed Air. By Professor A. C. ELLIOTT, D.Sc.(Edin.)	765
8. Sinking Wells and Shafts. By HENRY DAVEY, M.Inst.C.E.	766

MONDAY, AUGUST 24.

1. The London-Paris Telephone. By W. H. PREECE, F.R.S.	767
2. On the Telephoning of Great Cities. By A. R. BENNETT, M.I.E.E.	769
3. Recent Progress in the Use of Electric Motors. By Professor G. FORBES, F.R.S.	771
4. On Electric Firedamp Indicators. By N. WATTS	773
5. The Lighting of Railway Trains Electrically. By I. A. TIMMIS.....	773

TUESDAY, AUGUST 25.

1. An Electrical Parcel Exchange System. By A. R. BENNETT, M.I.E.E....	774
2. The Bénier Hot-Air Engine. By M. BÉNIER.....	775
3. On the Internal and External Work of Evaporation. By W. WORBY BEAUMONT, M.Inst.C.E.....	777
4. On a new System of Screw Propulsion with non-reversible Engines. By W. WORBY BEAUMONT, M.Inst.C.E.	779
5. Action of Screw Propellers. By Major R. DE VILLAMIL, R.E.	780

	Page
6. On the Comparative Values of various Substances used as Non-conducting Coverings for Steam Boilers and Pipes. By W. HEPWORTH COLLINS, F.C.S., F.G.S., F.R.M.S.	780
7. Joint Discussion with Section A upon Units and their Nomenclature.....	781

SECTION H.—ANTHROPOLOGY.

THURSDAY, AUGUST 20.

Address by Professor F. MAX MÜLLER, M.A., Foreign Member of the French Institute, President of the Section	782
1. The Social and Religious Ideas of the Chinese, as illustrated in the Ideographic Characters of the Language. By Professor R. K. DOUGLAS	796
2. On recent Progress in the Analysis of Vowel-sounds. By R. J. LLOYD, D.Lit., M.A.	796
3. Family Life of the Haidas (Queen Charlotte Islands). By the Rev. CHARLES HARRISON	797
4. Report of the North-Western Tribes of Canada Committee	798
5. On the Work of Major J. W. Powell, Director of the U.S. Ethnological Bureau. By Professor MAX MÜLLER, M.A.	798

FRIDAY, AUGUST 21.

1. On the Ancient Language of the Natives of Tenerife. By the MARQUESS OF BUTE, K.T.....	799
2. On the Limits of Savage Religion. By EDWARD B. TYLOR, D.C.L., F.R.S.	800
3. 'Couvade.' By H. LING ROTH	800
4. On the 'Morong' and other Customs of the Natives of Assam. By S. E. PEAL.....	801
5. Burial Customs of New Britain. By the Rev. B. DANKS	802

MONDAY, AUGUST 24.

1. Barbaric Elements in Ancient Greece and Italy. By Professor G. HARTWELL-JONES, M.A.....	803
2. The Morocco Berbers. By J. E. BUDGETT MEAKIN	804
3. On the Worship of Meteorites. By Professor H. A. NEWTON	805
4. On Human Remains from the Duggleby 'Howe,' Yorkshire. By J. G. GARSON, M.D.	806
5. On Comparison of Ancient Welsh Customs, Devices, and Commerce with those of Contemporary Nations. By Dr. PHENÉ, F.S.A.....	807
6. The First Sea-Wanderings of the English Race. By W. M. ADAMS	808
7. Points of Contact between Old-world Myths and Customs and the Navajo Myth entitled 'The Mountain Chant.' By Miss A. W. BUCKLAND	808
8. East Central African Customs. By the Rev. JAMES MACDONALD	809
9. Report of the Prehistoric Inhabitants Committee	811
10. Report of the Elbolton Cave Committee	811

TUESDAY, AUGUST 25.

	Page
1. The Formation of a Record of the Prehistoric and Ancient Remains of Glamorganshire. By EDWIN SEWARD	811
2. Instinctive Criminality: its true Character and National Treatment. By S. A. K. STRAHAN, M.D.	811
3. The Anthropometric Method of Identifying Criminals. By J. G. GARSON, M.D.....	813
4. Recent Hittite Discoveries. By Dr. PHENÉ, F.S.A.	814
5. Account of the Similkameen Indians of British Columbia. By Mrs. S. S. ALLISON	815
6. Nicobar Pottery. By E. H. MAN.....	815
7. Report of the Anthropometric Laboratory Committee	816
8. Report of the ' Anthropological Notes and Queries Committee '.....	816
9. Report of the Indian Committee	816
 INDEX	 817
 TABLES 3, 5, 6, and 9 of North-Western Tribes of Canada	 <i>to face page 436</i>

LIST OF PLATES.

PLATE I.

Illustrating the Report of the Committee appointed to investigate the Volcanic Phenomena of Vesuvius and its Neighbourhood.

PLATES II.—XIV.

Illustrating the Report of the Committee appointed to investigate the Action of Waves and Currents on the Beds and Foreshores of Estuaries by means of Working Models.

PLATE XV.

Illustrating the Fourth and Final Report of the Committee appointed to investigate the Seasonal Variations of Temperature in Lakes, Rivers, and Estuaries in various parts of the United Kingdom in co-operation with the local Societies represented on the Association.

OBJECTS AND RULES

OF

THE ASSOCIATION.



OBJECTS.

THE ASSOCIATION contemplates no interference with the ground occupied by other institutions. Its objects are:—To give a stronger impulse and a more systematic direction to scientific inquiry,—to promote the intercourse of those who cultivate Science in different parts of the British Empire, with one another and with foreign philosophers,—to obtain a more general attention to the objects of Science, and a removal of any disadvantages of a public kind which impede its progress.

RULES.

Admission of Members and Associates.

All persons who have attended the first Meeting shall be entitled to become Members of the Association, upon subscribing an obligation to conform to its Rules.

The Fellows and Members of Chartered Literary and Philosophical Societies publishing Transactions, in the British Empire, shall be entitled, in like manner, to become Members of the Association.

The Officers and Members of the Councils, or Managing Committees, of Philosophical Institutions shall be entitled, in like manner, to become Members of the Association.

All Members of a Philosophical Institution recommended by its Council or Managing Committee shall be entitled, in like manner, to become Members of the Association.

Persons not belonging to such Institutions shall be elected by the General Committee or Council, to become Life Members of the Association, Annual Subscribers, or Associates for the year, subject to the approval of a General Meeting.

Compositions, Subscriptions, and Privileges.

LIFE MEMBERS shall pay, on admission, the sum of Ten Pounds. They shall receive *gratuitously* the Reports of the Association which may be published after the date of such payment. They are eligible to all the offices of the Association.

ANNUAL SUBSCRIBERS shall pay, on admission, the sum of Two Pounds, and in each following year the sum of One Pound. They shall receive

gratuitously the Reports of the Association for the year of their admission and for the years in which they continue to pay *without intermission* their Annual Subscription. By omitting to pay this subscription in any particular year, Members of this class (Annual Subscribers) *lose for that and all future years* the privilege of receiving the volumes of the Association *gratis*; but they may resume their Membership and other privileges at any subsequent Meeting of the Association, paying on each such occasion the sum of One Pound. They are eligible to all the Offices of the Association.

ASSOCIATES for the year shall pay on admission the sum of One Pound. They shall not receive *gratuitously* the Reports of the Association, nor be eligible to serve on Committees, or to hold any office.

The Association consists of the following classes:—

1. Life Members admitted from 1831 to 1845 inclusive, who have paid on admission Five Pounds as a composition.
2. Life Members who in 1846, or in subsequent years, have paid on admission Ten Pounds as a composition.
3. Annual Members admitted from 1831 to 1839 inclusive, subject to the payment of One Pound annually. [May resume their Membership after intermission of Annual Payment.]
4. Annual Members admitted in any year since 1839, subject to the payment of Two Pounds for the first year, and One Pound in each following year. [May resume their Membership after intermission of Annual Payment.]
5. Associates for the year, subject to the payment of One Pound.
6. Corresponding Members nominated by the Council.

And the Members and Associates will be entitled to receive the annual volume of Reports, *gratis*, or to *purchase* it at reduced (or Members') price, according to the following specification, viz.:—

1. *Gratis*.—Old Life Members who have paid Five Pounds as a composition for Annual Payments, and previous to 1845 a further sum of Two Pounds as a Book Subscription, or, since 1845, a further sum of Five Pounds.

New Life Members who have paid Ten Pounds as a composition.
Annual Members *who have not intermitted* their Annual Subscription.

2. *At reduced or Members' Price*, viz., two-thirds of the Publication Price.
—Old Life Members who have paid Five Pounds as a composition for Annual Payments, but no further sum as a Book Subscription.

Annual Members who have intermitted their Annual Subscription.
Associates for the year. [Privilege confined to the volume for that year only.]

3. Members may purchase (for the purpose of completing their sets) any of the volumes of the Reports of the Association up to 1874, of which more than 15 copies remain, at 2s. 6d. per volume.¹

Application to be made at the Office of the Association.

Volumes not claimed within two years of the date of publication can only be issued by direction of the Council.

Subscriptions shall be received by the Treasurer or Secretaries.

¹ A few complete sets, 1831 to 1874, are on sale, at £10 the set.

Meetings.

The Association shall meet annually, for one week, or longer. The place of each Meeting shall be appointed by the General Committee two years in advance; and the arrangements for it shall be entrusted to the Officers of the Association.

General Committee.

The General Committee shall sit during the week of the Meeting, or longer, to transact the business of the Association. It shall consist of the following persons:—

CLASS A. PERMANENT MEMBERS.

1. Members of the Council, Presidents of the Association, and Presidents of Sections for the present and preceding years, with Authors of Reports in the Transactions of the Association.

2. Members who by the publication of Works or Papers have furthered the advancement of those subjects which are taken into consideration at the Sectional Meetings of the Association. *With a view of submitting new claims under this Rule to the decision of the Council, they must be sent to the Secretary at least one month before the Meeting of the Association. The decision of the Council on the claims of any Member of the Association to be placed on the list of the General Committee to be final.*

CLASS B. TEMPORARY MEMBERS.¹

1. Delegates nominated by the Corresponding Societies under the conditions hereinafter explained. *Claims under this Rule to be sent to the Secretary before the opening of the Meeting.*

2. Office-bearers for the time being, or delegates, altogether not exceeding three, from Scientific Institutions established in the place of Meeting. *Claims under this Rule to be approved by the Local Secretaries before the opening of the Meeting.*

3. Foreigners and other individuals whose assistance is desired, and who are specially nominated in writing, for the Meeting of the year, by the President and General Secretaries.

4. Vice-Presidents and Secretaries of Sections.

Organising Sectional Committees.²

The Presidents, Vice-Presidents, and Secretaries of the several Sections are nominated by the Council, and have power to act until their names are submitted to the General Committee for election.

From the time of their nomination they constitute Organising Committees for the purpose of obtaining information upon the Memoirs and Reports likely to be submitted to the Sections,³ and of preparing Reports

¹ Revised by the General Committee, 1884.

² Passed by the General Committee, Edinburgh, 1871.

³ *Notice to Contributors of Memoirs.*—Authors are reminded that, under an arrangement dating from 1871, the acceptance of Memoirs, and the days on which they are to be read, are now as far as possible determined by Organising Committees for the several Sections *before the beginning of the Meeting.* It has therefore become

thereon, and on the order in which it is desirable that they should be read, to be presented to the Committees of the Sections at their first meeting. The Sectional Presidents of former years are *ex officio* members of the Organising Sectional Committees.¹

An Organising Committee may also hold such preliminary meetings as the President of the Committee thinks expedient, but shall, under any circumstances, meet on the first Wednesday of the Annual Meeting, at 11 A.M., to nominate the first members of the Sectional Committee, if they shall consider it expedient to do so, and to settle the terms of their report to the General Committee, after which their functions as an Organising Committee shall cease.²

*Constitution of the Sectional Committees.*³

On the first day of the Annual Meeting, the President, Vice-Presidents, and Secretaries of each Section having been appointed by the General Committee, these Officers, and those previous Presidents and Vice-Presidents of the Section who may desire to attend, are to meet, at 2 P.M., in their Committee Rooms, and enlarge the Sectional Committees by selecting individuals from among the Members (not Associates) present at the Meeting whose assistance they may particularly desire. The Sectional Committees thus constituted shall have power to add to their number from day to day.

The List thus formed is to be entered daily in the Sectional Minute-Book, and a copy forwarded without delay to the Printer, who is charged with publishing the same before 8 A.M. on the next day in the Journal of the Sectional Proceedings.

Business of the Sectional Committees.

Committee Meetings are to be held on the Wednesday at 2 P.M., on the following Thursday, Friday, Saturday,⁴ Monday, and Tuesday, from 10 to 11 A.M., punctually, for the objects stated in the Rules of the Association, and specified below. [The arrangements for sectional meetings, adopted at the Cardiff meeting, will be continued at Edinburgh in 1892, see p. lxxxiv.]

The business is to be conducted in the following manner:—

1. The President shall call on the Secretary to read the minutes of the previous Meeting of the Committee.
2. No paper shall be read until it has been formally accepted by the

necessary, in order to give an opportunity to the Committees of doing justice to the several Communications, that each author should prepare an Abstract of his Memoir of a length suitable for insertion in the published Transactions of the Association, and that he should send it, together with the original Memoir, by book-post, on or before....., addressed to the General Secretaries, at the office of the Association. 'For Section.....' If it should be inconvenient to the Author that his paper should be read on any particular days, he is requested to send information thereof to the Secretaries in a separate note. Authors who send in their MSS. three complete weeks before the Meeting, and whose papers are accepted, will be furnished, before the Meeting, with printed copies of their Reports and abstracts. No Report, Paper, or Abstract can be inserted in the Annual Volume unless it is handed either to the Recorder of the Section or to the Secretary, *before the conclusion of the Meeting.*

¹ Sheffield, 1879.

² Swansea, 1880.

³ Edinburgh, 1871.

⁴ The meeting on Saturday is optional, Southport, 1883.

Committee of the Section, and entered on the minutes accordingly.

3. Papers which have been reported on unfavourably by the Organising Committees shall not be brought before the Sectional Committees.¹

At the first meeting, one of the Secretaries will read the Minutes of last year's proceedings, as recorded in the Minute-Book, and the Synopsis of Recommendations adopted at the last Meeting of the Association and printed in the last volume of the Report. He will next proceed to read the Report of the Organising Committee.² The list of Communications to be read on Thursday shall be then arranged, and the general distribution of business throughout the week shall be provisionally appointed. At the close of the Committee Meeting the Secretaries shall forward to the Printer a List of the Papers appointed to be read. The Printer is charged with publishing the same before 8 A.M. on Thursday in the Journal.

On the second day of the Annual Meeting, and the following days, the Secretaries are to correct, on a copy of the Journal, the list of papers which have been read on that day, to add to it a list of those appointed to be read on the next day, and to send this copy of the Journal as early in the day as possible to the Printer, who is charged with printing the same before 8 A.M. next morning in the Journal. It is necessary that one of the Secretaries of each Section (generally the Recorder) should call at the Printing Office and revise the proof each evening.

Minutes of the proceedings of every Committee are to be entered daily in the Minute-Book, which should be confirmed at the next meeting of the Committee.

Lists of the Reports and Memoirs read in the Sections are to be entered in the Minute-Book daily, which, with *all Memoirs and Copies or Abstracts of Memoirs furnished by Authors, are to be forwarded, at the close of the Sectional Meetings, to the Secretary.*

The Vice-Presidents and Secretaries of Sections become *ex officio* temporary Members of the General Committee (*vide p. xxvi*), and will receive, on application to the Treasurer in the Reception Room, Tickets entitling them to attend its Meetings.

The Committees will take into consideration any suggestions which may be offered by their Members for the advancement of Science. They are specially requested to review the recommendations adopted at preceding Meetings, as published in the volumes of the Association, and the communications made to the Sections at this Meeting, for the purposes of selecting definite points of research to which individual or combined exertion may be usefully directed, and branches of knowledge on the state and progress of which Reports are wanted; to name individuals or Committees for the execution of such Reports or researches; and to state whether, and to what degree, these objects may be usefully advanced by the appropriation of the funds of the Association, by application to Government, Philosophical Institutions, or Local Authorities.

In case of appointment of Committees for special objects of Science, it is expedient that *all Members of the Committee should be named, and*

¹ These rules were adopted by the General Committee, Plymouth, 1877.

² This and the following sentence were added by the General Committee, Edinburgh, 1871.

one of them appointed to act as Chairman, who shall have notified personally or in writing his willingness to accept the office, the Chairman to have the responsibility of receiving and disbursing the grant (if any has been made) and securing the presentation of the Report in due time; and further, it is expedient that one of the members should be appointed to act as Secretary, for ensuring attention to business.

That it is desirable that the number of Members appointed to serve on a Committee should be as small as is consistent with its efficient working.

That a tabular list of the Committees appointed on the recommendation of each Section should be sent each year to the Records of the several Sections, to enable them to fill in the statement whether the several Committees appointed on the recommendation of their respective Sections had presented their reports.

That on the proposal to recommend the appointment of a Committee for a special object of science having been adopted by the Sectional Committee, the number of Members of such Committee be then fixed, but that the Members to serve on such Committee be nominated and selected by the Sectional Committee at a subsequent meeting.¹

Committees have power to add to their number persons whose assistance they may require.

The recommendations adopted by the Committees of Sections are to be registered in the Forms furnished to their Secretaries, and one Copy of each is to be forwarded, without delay, to the Secretary for presentation to the Committee of Recommendations. *Unless this be done, the Recommendations cannot receive the sanction of the Association.*

N.B.—Recommendations which may originate in any one of the Sections must first be sanctioned by the Committee of that Section before they can be referred to the Committee of Recommendations or confirmed by the General Committee.

The Committees of the Sections shall ascertain whether a Report has been made by every Committee appointed at the previous Meeting to whom a sum of money has been granted, and shall report to the Committee of Recommendations in every case where no such Report has been received.²

Notices regarding Grants of Money.

Committees and individuals, to whom grants of money have been entrusted by the Association for the prosecution of particular researches in science, are required to present to each following Meeting of the Association a Report of the progress which has been made; and the Chairman of a Committee to whom a money grant has been made must forward to the General Officers, before July 1, a statement of the sums which have been expended, with vouchers, and the balance which remains disposable on each grant.

Grants of money sanctioned at any one Meeting of the Association expire on June 30 following; nor is the Treasurer authorised, after that date, to allow any claims on account of such grants, unless they be renewed in the original or a modified form by the General Committee.

No Committee shall raise money in the name or under the auspices of the British Association without special permission from the General

¹ Revised by the General Committee, Bath, 1888.

² Passed by the General Committee at Sheffield, 1879.

Committee to do so; and no money so raised shall be expended except in accordance with the rules of the Association.

In each Committee, the Chairman is the only person entitled to call on the Treasurer, Professor A. W. Rücker, F.R.S., Burlington House, London, W., for such portion of the sums granted as may from time to time be required.

In grants of money to Committees, the Association does not contemplate the payment of personal expenses to the members.

In all cases where additional grants of money are made for the continuation of Researches at the cost of the Association, the sum named is deemed to include, as a part of the amount, whatever balance may remain unpaid on the former grant for the same object.

All Instruments, Papers, Drawings, and other property of the Association are to be deposited at the Office of the Association, when not employed in carrying on scientific inquiries for the Association.

Business of the Sections.

The Meeting Room of each Section is opened for conversation from 10 to 11 daily. *The Section Rooms and approaches thereto can be used for no notices, exhibitions, or other purposes than those of the Association.*

At 11 precisely the Chair will be taken,¹ and the reading of communications, in the order previously made public, commenced. At 3 P.M. the Sections will close.

Sections may, by the desire of the Committees, divide themselves into Departments, as often as the number and nature of the communications delivered in may render such divisions desirable.

A Report presented to the Association, and read to the Section which originally called for it, may be read in another Section, at the request of the Officers of that Section, with the consent of the Author.

Duties of the Doorkeepers.

1. To remain constantly at the Doors of the Rooms to which they are appointed during the whole time for which they are engaged.
2. To require of every person desirous of entering the Rooms the exhibition of a Member's, Associate's, or Lady's Ticket, or Reporter's Ticket, signed by the Treasurer, or a Special Ticket signed by the Secretary.
3. Persons unprovided with any of these Tickets can only be admitted to any particular Room by order of the Secretary in that Room.

No person is exempt from these Rules, except those Officers of the Association whose names are printed in the programme, p. 1.

Duties of the Messengers.

To remain constantly at the Rooms to which they are appointed during the whole time for which they are engaged, except when employed on messages by one of the Officers directing these Rooms.

¹ The sectional meetings on Saturday and on Wednesday may begin at any time which may be fixed by the Committee, not earlier than 10 or later than 11. Passed by the General Committee at Bath, 1888.

Committee of Recommendations.

The General Committee shall appoint at each Meeting a Committee, which shall receive and consider the Recommendations of the Sectional Committees, and report to the General Committee the measures which they would advise to be adopted for the advancement of Science.

Presidents of the Association in former years are *ex officio* members of the Committee of Recommendations.¹

All Recommendations of Grants of Money, Requests for Special Researches, and Reports on Scientific Subjects shall be submitted to the Committee of Recommendations, and not taken into consideration by the General Committee unless previously recommended by the Committee of Recommendations.

All proposals for establishing new Sections, or altering the titles of Sections, or for any other change in the constitutional forms and fundamental rules of the Association, shall be referred to the Committee of Recommendations for a report.²

If the President of a Section is unable to attend a meeting of the Committee of Recommendations, the Sectional Committee shall be authorised to appoint a Vice-President, or, failing a Vice-President, some other member of the Committee, to attend in his place, due notice of the appointment being sent to the Assistant General Secretary.³

*Corresponding Societies.*⁴

1. Any Society is eligible to be placed on the List of Corresponding Societies of the Association which undertakes local scientific investigations, and publishes notices of the results.

2. Application may be made by any Society to be placed on the List of Corresponding Societies. Applications must be addressed to the Secretary on or before the 1st of June preceding the Annual Meeting at which it is intended they should be considered, and must be accompanied by specimens of the publications of the results of the local scientific investigations recently undertaken by the Society.

3. A Corresponding Societies Committee shall be annually nominated by the Council and appointed by the General Committee for the purpose of considering these applications, as well as for that of keeping themselves generally informed of the annual work of the Corresponding Societies, and of superintending the preparation of a list of the papers published by them. This Committee shall make an annual report to the General Committee, and shall suggest such additions or changes in the List of Corresponding Societies as they may think desirable.

4. Every Corresponding Society shall return each year, on or before the 1st of June, to the Secretary of the Association, a schedule, properly filled up, which will be issued by the Secretary of the Association, and which will contain a request for such particulars with regard to the Society as may be required for the information of the Corresponding Societies Committee.

5. There shall be inserted in the Annual Report of the Association

¹ Passed by the General Committee at Newcastle, 1863.

² Passed by the General Committee at Birmingham, 1865.

³ Passed by the General Committee at Leeds, 1890.

⁴ Passed by the General Committee, 1884.

a list, in an abbreviated form, of the papers published by the Corresponding Societies during the past twelve months which contain the results of the local scientific work conducted by them; those papers only being included which refer to subjects coming under the cognisance of one or other of the various Sections of the Association.

6. A Corresponding Society shall have the right to nominate any one of its members, who is also a Member of the Association, as its delegate to the Annual Meeting of the Association, who shall be for the time a Member of the General Committee.

Conference of Delegates of Corresponding Societies.

7. The Conference of Delegates of Corresponding Societies is empowered to send recommendations to the Committee of Recommendations for their consideration, and for report to the General Committee.

8. The Delegates of the various Corresponding Societies shall constitute a Conference, of which the Chairman, Vice-Chairmen, and Secretaries shall be annually nominated by the Council, and appointed by the General Committee, and of which the members of the Corresponding Societies Committee shall be *ex officio* members.

9. The Conference of Delegates shall be summoned by the Secretaries to hold one or more meetings during each Annual Meeting of the Association, and shall be empowered to invite any Member or Associate to take part in the meetings.

10. The Secretaries of each Section shall be instructed to transmit to the Secretaries of the Conference of Delegates copies of any recommendations forwarded by the Presidents of Sections to the Committee of Recommendations bearing upon matters in which the co-operation of Corresponding Societies is desired; and the Secretaries of the Conference of Delegates shall invite the authors of these recommendations to attend the meetings of the Conference and give verbal explanations of their objects and of the precise way in which they would desire to have them carried into effect.

11. It will be the duty of the Delegates to make themselves familiar with the purport of the several recommendations brought before the Conference, in order that they and others who take part in the meetings may be able to bring those recommendations clearly and favourably before their respective Societies. The Conference may also discuss propositions bearing on the promotion of more systematic observation and plans of operation, and of greater uniformity in the mode of publishing results.

Local Committees.

Local Committees shall be formed by the Officers of the Association to assist in making arrangements for the Meetings.

Local Committees shall have the power of adding to their numbers those Members of the Association whose assistance they may desire.

Officers.

A President, two or more Vice-Presidents, one or more Secretaries, and a Treasurer shall be annually appointed by the General Committee.

Council.

In the intervals of the Meetings, the affairs of the Association shall be managed by a Council appointed by the General Committee. The Council may also assemble for the despatch of business during the week of the Meeting.

- (1) The Council shall consist of¹
 1. The Trustees.
 2. The past Presidents.
 3. The President and Vice-Presidents for the time being.
 4. The President and Vice-Presidents elect.
 5. The past and present General Treasurers, General and Assistant General Secretaries.
 6. The Local Treasurer and Secretaries for the ensuing Meeting.
 7. Ordinary Members.
- (2) The Ordinary Members shall be elected annually from the General Committee.
- (3) There shall be not more than twenty-five Ordinary Members, of whom not more than twenty shall have served on the Council, as Ordinary Members, in the previous year.
- (4) In order to carry out the foregoing rule, the following Ordinary Members of the outgoing Council shall at each annual election be ineligible for nomination:—1st, those who have served on the Council for the greatest number of consecutive years; and, 2nd, those who, being resident in or near London, have attended the fewest number of Meetings during the year—observing (as nearly as possible) the proportion of three by seniority to two by least attendance.
- (5) The Council shall submit to the General Committee in their Annual Report the names of the Members of General Committee whom they recommend for election as Members of Council.
- (6) The Election shall take place at the same time as that of the Officers of the Association.

Papers and Communications.

The Author of any paper or communication shall be at liberty to reserve his right of property therein.

Accounts.

The Accounts of the Association shall be audited annually, by Auditors appointed by the General Committee.

¹ Passed by the General Committee, Belfast, 1874.

Table showing the Places and Times of Meeting of the British Association, with Presidents, Vice-Presidents, and Local Secretaries, from its Commencement.

PRESIDENTS.	VICE-PRESIDENTS.	LOCAL SECRETARIES.
The EARL FITZWILLIAM, D.C.L., F.R.S., F.G.S., &c. York, September 27, 1831.	{ Rev. W. Vernon Harcourt, M.A., F.R.S., F.G.S.	{ William Gray, jun., Esq., F.G.S. Professor Phillips, M.A., F.R.S., F.G.S.
The REV. W. BUCKLAND, D.D., F.R.S., F.G.S., &c. Oxford, June 19, 1832.	{ Sir David Brewster, F.R.S. L. & E. &c. { Rev. W. Whewell, F.R.S., Pres. Geol. Soc.	{ Professor Daubeny, M.D., F.R.S., &c. Rev. Professor Powell, M.A., F.R.S., &c.
The REV. ADAM SEDGWICK, M.A., V.P.R.S., V.P.G.S. Cambridge, June 25, 1833.	{ G. B. Airy, Esq., F.R.S., Astronomer Royal, &c. { John Dalton, Esq., D.C.L., F.R.S.	{ Rev. Professor Henslow, M.A., F.L.S., F.G.S. Rev. W. Whewell, F.R.S.
SIR T. MACDOUGALL BRISBANE, K.C.B., D.C.L., F.R.S. L. & E. Edinburgh, September 8, 1834.	{ Sir David Brewster, F.R.S., &c. Rev. T. R. Robinson, D.D.	{ Professor Forbes, F.R.S. L. & E., &c. Sir John Robinson, Sec. R.S.E.
The REV. PROYOST LLOYD, LL.D. Dublin, August 10, 1835.	{ Viscount Oxmantown, F.R.S., F.R.A.S. Rev. W. Whewell, F.R.S., &c.	{ Sir W. R. Hamilton, Astron. Royal of Ireland, &c. Rev. Professor Lloyd, F.R.S.
The MARQUIS OF LANSDOWNE, D.C.L., F.R.S. Bristol, August 22, 1836.	{ The Marquis of Northampton, F.R.S. Rev. W. D. Conybeare, F.R.S., F.G.S., J. C. Pritchard, Esq., M.D., F.R.S.	{ Professor Daubeny, M.D., F.R.S., &c. V. F. Hovenden, Esq.
The EARL OF BURLINGTON, F.R.S., F.G.S., Chan- cellor of the University of London Liverpool, September 11, 1837.	{ The Bishop of Norwich, P.L.S., F.G.S., John Dalton, Esq., D.C.L., F.R.S. Sir Philip de Grey Egerton, Bart., F.R.S., F.G.S. Rev. W. Whewell, F.R.S.	{ Professor Traill, M.D. Wm. Wallace Currie, Esq., Joseph N. Walker, Esq., Pres. Royal Institution, Liverpool.
The DUKE OF NORTHUMBERLAND, F.R.S., F.G.S., &c. Newcastle-on-Tyne, August 20, 1838.	{ The Bishop of Durham, F.R.S., F.S.A. The Rev. W. Vernon Harcourt, F.R.S., &c. Prideaux John Selby, Esq., F.R.S.E.	{ John Adamson, Esq., F.L.S., &c. Wm. Hutton, Esq., F.G.S. Professor Johnston, M.A., F.R.S.
The REV. W. VERNON HARCOURT, M.A., F.R.S., &c. Birmingham, August 26, 1839.	{ The Marquis of Northampton. The Rev. T. R. Robinson, D.D. The Very Rev. Principal Macfarlane	{ George Barker, Esq., F.R.S. Peyton Bakistoun, Esq., M.D. Joseph Hodgson, Esq., F.R.S.
The MARQUIS OF BREADALBANE, F.R.S. Glasgow, September 17, 1840.	{ Major-General Lord Greenock, F.R.S.E. Sir David Brewster, F.R.S. Sir T. M. Brisbane, Bart., F.R.S. The Earl of Mount-Edgumbe	{ Andrew Liddell, Esq. Rev. J. P. Nicol, LL.D. John Strang, Esq.
The REV. PROFESSOR WHEWELL, F.R.S., &c. Plymouth, July 29, 1841.	{ The Earl of Morley. Lord Eliot, M.P. Sir C. Lemon, Bart. Sir T. D. Acland, Bart.	{ W. Snow Harris, Esq., F.R.S. Col. Hamilton Smith, F.L.S. Robert Vere Fox, Esq. Richard Taylor jun., Esq.
The LORD FRANCIS EGERTON, F.G.S. Manchester, June 23, 1842.	{ John Dalton, Esq., D.C.L., F.R.S. Hon. and Rev. W. Herbert, F.L.S., &c. Rev. A. Sedgwick, M.A., F.R.S. W. C. Henry, Esq., M.D., F.R.S. Sir Benjamin Heywood, Bart.	{ Peter Clare, Esq., F.R.A.S. W. Fleming, Esq., M.D. James Heywood, Esq., F.R.S.
The EARL OF ROSSE, F.R.S. Cork, August 17, 1843.	{ The Earl of Listowel. Viscount Adare. Sir W. R. Hamilton, Pres. R.I.A. Rev. T. R. Robinson, D.D.	{ Professor John Stevelly, M.A. Rev. Jos. Carson, F.T.C. Dublin. William Keleher, Esq. Wm. Clear, Esq.
The REV. G. PEACOCK, D.D. (Dean of Ely), F.R.S. York, September 26, 1844.	{ Earl Fitzwilliam, F.R.S. Viscount Morpeth, F.G.S. The Hon. John Stuart Wortley, M.P. Sir David Brewster, K.H., F.R.S. Michael Faraday, Esq., D.C.L., F.R.S. Rev. W. V. Harcourt, F.R.S.	{ William Hatfield, Esq., F.G.S. Thomas Meynell, Esq., F.L.S. Rev. W. Scoresby, LL.D., F.R.S. William West, Esq.

SIR JOHN F. W. HERSHEL, Bart., F.R.S., &c.
 CAMBRIDGE, June 19, 1846.
 The Earl of Hardwicke. The Bishop of Norwich
 Rev. J. Graham, D.D. Rev. G. Ainslie, D.D.
 G. B. Airy, Esq., M.A., D.C.L., F.R.S.
 The Rev. Professor Sedgwick, M.A., F.R.S.

SIR RODERICK IMPEY MURCHISON, G.C.St.S., F.R.S.
 SOUTHAMPTON, September 10, 1846.
 The Marquis of Winchester. The Earl of Yarborough, D.C.L.
 Lord Ashburton, D.C.L. Viscount Palmerston, M.P.
 Right Hon. Charles Shaw Letevre, M.P.
 Sir George T. Staunton, Bart., M.P., D.C.L., F.R.S.
 The Lord Bishop of Oxford, F.R.S.
 Professor Owen, M.D., F.R.S.
 The Rev. Professor Powell, F.R.S.

SIR ROBERT HARRY INGLIS, Bart., D.C.L., F.R.S.,
 M.P. for the University of Oxford.
 OXFORD, June 23, 1847.
 The Earl of Rosse, F.R.S. The Lord Bishop of Oxford, F.R.S.
 The Vice-Chancellor of the University
 Thomas G. Bucknall Escount, Esq., D.C.L., M.P. for the University of
 Oxford. The Very Rev. the Dean of Westminster, D.D., F.R.S.
 Professor Daubeny, M.D., F.R.S. The Rev. Prof. Powell, M.A., F.R.S.

The MARQUIS OF NORTHAMPTON, President of the
 Royal Society, &c.
 SWANSEA, August 9, 1848.
 The Marquis of Bute, K.T. Viscount Adare, F.R.S.
 Sir H. T. De la Beche, F.R.S., Pres. G.S.
 The Very Rev. the Dean of Llandaf, F.R.S.
 Lewis W. Dillwyn, Esq., F.R.S. W. R. Grove, Esq., F.R.S.
 J. H. Vivian, Esq., M.P., F.R.S. The Lord Bishop of St. David's

The REV. T. R. ROBINSON, D.D., M.R.I.A., F.R.A.S.
 BIRMINGHAM, September 12, 1849.
 The Earl of Harrowby. The Lord Wrottesley, F.R.S.
 The Right Hon. Sir Robert Peel, Bart., M.P., D.C.L., F.R.S.
 Charles Darwin, Esq., M.A., F.R.S., Sec. G.S.
 Professor Faraday, D.C.L., F.R.S.
 Sir David Brewster, K.H., LL.D., F.R.S. Rev. Prof. Willis, M.A., F.R.S.

SIR DAVID BREWSTER, K.H., LL.D., F.R.S. L. & E.,
 Principal of the United College of St. Salvador and St.
 Leonard, St. Andrews.
 EDINBURGH, July 21, 1850.
 The Right Hon. the Lord Provost of Edinburgh
 The Earl of Cathcart, K.C.B., F.R.S.E.
 The Earl of Rosebery, K.T., D.C.L., F.R.S.
 The Right Hon. David Boyle (Lord Justice-General), F.R.S.E.
 General Sir Thomas M. Brisbane, Bart., D.C.L., F.R.S., Pres. R.S.E.
 The Very Rev. John Lee, D.D., V.P.R.S.E., Principal of the University
 of Edinburgh. Professor W. P. Alison, M.D., V.P.R.S.E.
 Professor J. D. Forbes, F.R.S., Sec. R.S.E.

GEORGE BIDDELL AIRY, Esq., D.C.L., F.R.S., Astro-
 nomer Royal.
 IPSWICH, July 2, 1851.
 The Lord Rendlesham, M.P. The Lord Bishop of Norwich
 Rev. Professor Sedgwick, M.A., F.R.S.
 Rev. Professor Henslow, M.A., F.L.S.
 Sir John P. Boileau, Bart., F.R.S. Sir William F. F. Middleton, Bart.
 J. C. Cobbold, Esq., M.P. T. B. Western, Esq.

COLONEL EDWARD SABINE, Royal Artillery, Treas. &
 V.P. of the Royal Society
 BELFAST, September 1, 1852.
 The Earl of Enniskillen, D.C.L., F.R.S.
 The Earl of Rosse, Pres. R.S., M.R.I.A.
 Sir Henry T. De la Beche, F.R.S.
 Rev. Edward Hincks, D.D., M.R.I.A.
 Rev. P. S. Henry, D.D., Pres. Queen's College, Belfast
 Rev. T. R. Robinson, D.D., Pres. R.I.A., F.R.A.S.
 Professor G. G. Stokes, F.R.S. Professor Stevelly, LL.D.

William Hopkins, Esq., M.A., F.R.S.
Professor Ansted, M.A., F.R.S.
Henry Clark, Esq., M.D.
T. H. C. Moody, Esq.
Rev. Robert Walker, M.A., F.R.S.
H. Wentworth Acland, Esq., B.M.
Matthew Moggridge, Esq.
D. Nicol, Esq., M.D.
Captain Tindal, R.N.
William Willis, Esq.
Bell Fletcher, Esq., M.D.
James Chance, Esq.
Rev. Professor Kelland, M.A., F.R.S. L. & E.
Professor Balfour, M.D., F.R.S.E., F.L.S.
James Tod, Esq., F.R.S.E.
Charles May, Esq., F.R.A.S.
Dillwyn Sims, Esq.
George Arthur Bidell, Esq.
George Ransome, Esq., F.L.S.
W. J. C. Allen, Esq.
William McGee, Esq., M.D.
Professor W. P. Wilson.

LOCAL SECRETARIES.

Henry Cooper, Esq., M.D., V.P. Hull Lit. & Phil. Society.
Bethel Jacobs, Esq., Pres. Hull Mechanics' Inst.

Joseph Dickinson, Esq., M.D., F.R.S.
Thomas Inman, Esq., M.D.

John Strang, Esq., LL.D.
Professor Thomas Anderson, M.D.
William Gourlie, Esq.

Capt. Robinson, R.A.
Richard Beamish, Esq., F.R.S.
John West Huggell, Esq.

Lundy E. Foote, Esq.
Rev. Professor Jellett, F.T.C.D.
W. Neilson Hancock, Esq., LL.D.

Rev. Thomas Hincks, B.A.
W. Sykes Ward, Esq., F.C.S.
Thomas Wilson, Esq., M.A.

Professor J. Nicol, F.R.S.E., F.G.S.
Professor Fuller, M.A.
John F. White, Esq.

VICE-PRESIDENTS.

The Earl of Carlisle, F.R.S. Lord Londesborough, F.R.S.
Professor Faraday, D.C.L., F.R.S. Rev. Prof. Sedgwick, M.A., F.R.S.
Charles Frost, Esq., F.S.A., Pres. of the Hull Lit. and Phil. Society
William Spence, Esq., F.R.S. Lieut.-Col. Sykes, F.R.S.
Professor Wheatstone, F.R.S.

The Lord Wrottesley, M.A., F.R.S., F.R.A.S.
Sir Philip de Malpas Grey Egerton, Bart., M.P., F.R.S., F.G.S.
Professor Owen, M.D., LL.D., F.R.S., F.L.S., F.G.S.
Rev. Professor Whewell, D.D., F.R.S., Hon. M.R.I.A., F.G.S., Master of Trinity College, Cambridge
William Lessell, Esq., F.R.S., L. & E., F.R.A.S.
Joseph Brooks Yates, Esq., F.S.A., F.R.G.S.

The Very Rev. Principal Macfarlane, D.D.
Sir William Jardine, Bart., F.R.S.E.
Sir Charles Lyell, M.A., LL.D., F.R.S.
James Smith, Esq., F.R.S., L. & E. Walter Crum, Esq., F.R.S.
Thomas Graham, Esq., M.A., F.R.S., Master of the Royal Mint.
Professor William Thomson, M.A., F.R.S.

The Earl of Ducie, F.R.S., F.G.S.
The Lord Bishop of Gloucester and Bristol
Sir Roderick I. Murchison, G.C.St.S., D.C.L., F.R.S.
Thomas Barwick Lloyd Baker, Esq. The Rev. Francis Closc, M.A.

The Right Hon. the Lord Mayor of Dublin
The Provost of Trinity College, Dublin Lord Talbot de Malahide
The Marquis of Kildare
The Lord Chancellor of Ireland
The Lord Chief Baron, Dublin
Sir William R. Hamilton, LL.D., F.R.A.S., Astronomer Royal of Ireland
Lieut.-Colonel Larcom, R.E., LL.D., F.R.S.
Richard Griffith, Esq., LL.D., M.R.I.A., F.R.S.E., F.G.S.

The Lord Monteaigle, F.R.S.
The Lord Viscount Goderich, M.P., F.R.G.S.
The Right Hon. M. T. Baines, M.A., M.P.
Sir Philip de Malpas Grey Egerton, Bart., M.P., F.R.S., F.G.S.
The Rev. W. Whewell, D.D., F.R.S., Hon. M.R.I.A., F.G.S., F.R.A.S., Master of Trinity College, Cambridge
James Garth Marshall, Esq., M.A., F.G.S.
R. Monckton Mines, Esq., D.C.L., M.P., F.R.G.S.

The Duke of Richmond, K.G., F.R.S.
The Earl of Aberdeen, LL.D., K.G., K.T., F.R.S.
The Lord Provost of the City of Aberdeen
Sir John F. W. Herschel, Bart., M.A., D.C.L., F.R.S.
Sir David Brewster, K.H., D.C.L., F.R.S.
Sir Roderick I. Murchison, G.O.St.S., D.C.L., F.R.S.
The Rev. W. V. Harcourt, M.A., F.R.S.
The Rev. T. R. Robinson, D.D., F.R.S.
A. Thomson, Esq., LL.D., F.R.S., Convener of the County of Aberdeen

PRESIDENTS.

WILLIAM HOPKINS, Esq., M.A., V.P.R.S., F.G.S.,
Pres. Camb. Phil. Society
HULL, September 7, 1853.

The EARL OF HARROWBY, F.R.S.,
LIVERPOOL, September 20, 1854.

The DUKE OF ARGYLL, F.R.S., F.G.S.,
GLASGOW, September 12, 1855.

CHARLES G. B. DAUBENY, Esq., M.D., LL.D., F.R.S.,
Professor of Botany in the University of Oxford,
CHELTENHAM, August 6, 1856.

The REV. HUMPHREY LLOYD, D.D., D.C.L., F.R.S.,
L. & E., V.P.R.I.A.,
DUBLIN, August 26, 1857.

RICHARD OWEN, Esq., M.D., D.C.L., V.P.R.S., F.L.S.,
F.G.S., Superintendent of the Natural History Department
of the British Museum,
LEEDS, September 22, 1858.

HIS ROYAL HIGHNESS THE PRINCE CONSORT,
ABERDEEN, September 14, 1859.

The LORD WROTTESELEY, M.A., V.P.R.S., F.R.A.S.,
OXFORD, June 27, 1860.

The Earl of Derby, K.G., P.O., D.C.L., Chancellor of the Univ. of Oxford
The Rev. F. Jenne, D.C.L., Vice-Chancellor of the University of Oxford
The Duke of Marlborough, D.C.L., F.G.S., Lord Lieutenant of Oxfordshire
The Earl of Rosse, K.P., M.A., F.R.S., F.R.A.S.
The Lord Bishop of Oxford, D.D., F.R.S.
The Very Rev. H. G. Liddell, D.D., Dean of Christ Church, Oxford
Professor Daubeny, M.D., LL.D., F.R.S., F.L.S., F.G.S.
Professor Acland, M.D., F.R.S. Professor Donkin, M.A., F.R.S., F.R.A.S.

George Rolleston, Esq., M.D., F.L.S.
H. J. S. Smith, Esq., M.A., F.C.S.
George Griffith, Esq., M.A., F.C.S.

WILLIAM FAIRBAIRN, Esq., LL.D., C.E., F.R.S.
MANCHESTER, September 4, 1861.

The Earl of Ellesmere, F.R.G.S.
The Lord Stanley, M.P., D.C.L., F.R.G.S.
The Lord Bishop of Manchester, D.D., F.R.S., F.G.S.
Sir Philip de Malpas Grey Egerton, Bart., M.P., F.R.S., F.G.S.
Sir Benjamin Heywood, Bart., F.R.S.
Thomas Bazley, Esq., M.P.
James Aspinall Turner, Esq., M.P.
James Prescott Joule, Esq., LL.D., F.R.S., Pres. Lit. & Phil. Soc. Manchester
Professor E. Hodgkinson, F.R.S., M.R.I.A., M.Inst.C.E.
Joseph Whitworth, Esq., F.R.S., M.Inst.C.E.

R. D. Darbshire, Esq., B.A., F.G.S.
Alfred Nield, Esq.
Arthur Ransome, Esq., M.A.
Professor H. E. Roscoe, B.A.

The REV. P. WILLIS, M.A., F.R.S., Jacksonian Professor
of Natural and Experimental Philosophy in the University of Cambridge
CAMBRIDGE, October 1, 1862.

The Rev. the Vice-Chancellor of the University of Cambridge
The Very Rev. Harvey Goodwin, D.D., Dean of Ely
The Rev. W. Whewell, D.D., F.R.S., Master of Trinity College, Cambridge
The Rev. Professor Sedgwick, M.A., D.C.L., F.R.S.
The Rev. J. Challis, M.A., F.R.S.
G. B. Airy, Esq., M.A., D.C.L., F.R.S., Astronomer Royal
Professor G. G. Stokes, M.A., D.C.L., Sec. R.S.
Professor J. C. Adams, M.A., D.C.L., F.R.S., Pres. C.P.S.

Professor C. C. Babington, M.A., F.R.S., F.L.S.
Professor G. D. Liveing, M.A.
The Rev. N. M. Ferrers, M.A.

SIR W. ARMSTRONG, C.B., LL.D., F.R.S.
NEWCASTLE-ON-TYNE, August 26, 1863.

Sir Walter C. Trevelyan, Bart., M.A.
Sir Charles Lyell, LL.D., D.C.L., F.R.S., F.G.S.
Hugh Taylor, Esq., Chairman of the Coal Trade
Isaac Lowthian Bell, Esq., Mayor of Newcastle
Nicholas Wood, Esq., President of the Northern Institute of Mining Engineers
Rev. Temple Chevallier, B.D., F.R.A.S.
William Fairbairn, Esq., LL.D., F.R.S.

A. Noble, Esq.
Augustus H. Hunt, Esq.
R. C. Clapham, Esq.

SIR CHARLES LYELL, Bart., M.A., D.C.L., F.R.S.
BATH, September 14, 1864.

The Right Hon. the Earl of Cork and Orrery, Lord-Lieutenant of Somersetshire
The Most Noble the Marquis of Bath
The Right Hon. Earl Nelson
The Right Hon. Lord Portman
The Very Rev. the Dean of Hereford
The Venerable the Archdeacon of Bath
W. Tite, Esq., M.P., F.R.S., F.G.S., F.S.A.
A. E. Way, Esq., M.P.
W. Sanders, Esq., F.R.S., F.G.S.

C. Moore, Esq., F.G.S.
C. E. Davis, Esq.
The Rev. H. H. Winwood, M.A.

LOCAL SECRETARIES.

VICE-PRESIDENTS.

PRESIDENTS.

JOHN PHILLIPS, Esq., M.A., LL.D., F.R.S., F.G.S.,
 Professor of Geology in the University of Oxford
 BIRMINGHAM, September 6, 1866.

The Right Hon. the Earl of Lichfield, Lord-Lieutenant of Staffordshire
 The Right Hon. the Earl of Dudley
 The Right Hon. Lord Leigh, Lord-Lieutenant of Warwickshire
 The Right Hon. Lord Lyttelton, Lord-Lieutenant of Worcestershire
 The Right Hon. Lord Wrottesley, M.A., D.C.L., F.R.S., F.I.A.S.
 The Right Rev. the Lord Bishop of Worcester
 The Right Hon. C. B. Adelerley, M.P.
 William Scholefield, Esq., M.P. F. Oeier, Esq., F.R.S.
 J. T. Chance, Esq. The Rev. Charles Evans, M.A.

William Mathews, jun., Esq., M.A., F.G.S.
 John Henry Chamberlain, Esq.
 The Rev. G. D. Boyle, M.A.

WILLIAM R. GROVE, Esq., Q.C., M.A., F.R.S.,
 NOTTINGHAM, August 22, 1866.

His Grace the Duke of Devonshire, Lord-Lieutenant of Derbyshire
 His Grace the Duke of Rutland, Lord-Lieutenant of Leicestershire
 The Right Hon. Lord Selkirk, Lord-Lieutenant of Nottinghamshire
 The Right Hon. J. E. Denison, M.P.
 J. C. Webb, Esq., High-Sheriff of Nottinghamshire
 Thomas Graham, Esq., F.R.S., Master of the Mint.
 Joseph Hooker, Esq., M.D., F.R.S., F.I.S.
 John Russell Hind, Esq., F.R.S., F.R.A.S. T. Close, Esq.

Dr. Robertson.
 Edward J. Lowe, Esq., F.R.A.S., F.I.S.
 The Rev. J. F. McCallan, M.A.

HIS GRACE THE DUKE OF BUCCLEUCH, K.G.,
 D.C.L., F.R.S.
 DUNDEE, September 4, 1867.

The Right Hon. the Earl of Arkle, K.T.
 The Right Hon. the Lord Kinnaird, K.T.
 Sir John Ogilvy, Bart., M.P.
 Sir Roderick I. Murchison, Bart., K.C.B., LL.D., F.R.S., F.G.S., &c.
 Sir David Baxter, Bart.
 Sir David Brewster, D.C.L., F.R.S., Principal of the University of Edinburgh
 James D. Forbes, Esq., LL.D., F.R.S., Principal of the United College
 of St. Salvador and St. Leonard, University of St. Andrews.

J. Henderson, jun., Esq.
 John Austin Lake (Gloag), Esq.
 Patrick Anderson, Esq.

JOSEPH DALTON HOOKER, Esq., M.D., D.C.L., F.R.S.,
 F.L.S.
 NORWICH, August 19, 1868.

The Right Hon. the Earl of Leicester, Lord-Lieutenant of Norfolk
 Sir John Peter Boleau, Bart., F.R.S.
 The Rev. Adam Sedgwick, M.A., LL.D., F.R.S., F.G.S., &c., Wood-
 warden Professor of Geology in the University of Cambridge
 Sir John Lubbock, Bart., F.R.S., F.L.S., F.G.S.
 John Couch Adams, Esq., M.A., D.C.L., F.R.S., F.R.A.S., Lowndean
 Professor of Astronomy and Geometry in the University of Cam-
 bridge.
 Thomas Brightwell, Esq.

Dr. Donald Dalrymple.
 Rev. Joseph Crompton, M.A.
 Rev. Canon Hinds Howell.

PROFESSOR GEORGE G. STOKES, D.C.L., F.R.S.,
 EXETER, August 18, 1869.

The Right Hon. the Earl of Devon
 The Right Hon. Sir Stafford H. Northcote, Bart., C.B., M.P., &c.
 Sir John Bowring, LL.D., F.R.S.
 William B. Carpenter, Esq., M.D., F.R.S., F.L.S.
 Robert Wren Fox, Esq., F.R.S.
 W. H. Fox Talbot, Esq., M.A., LL.D., F.R.S., F.L.S.

Henry S. Ellis, Esq., F.R.A.S.
 John C. Bowring, Esq.
 The Rev. R. Kirwan.

PROFESSOR T. H. HUXLEY, LL.D., F.R.S., F.G.S.,
 LIVERPOOL, September 14, 1870.

The Right Hon. the Earl of Derby, LL.D., F.R.S.
 Sir Philip de Malpas Grey Egerton, Bart., M.P.
 The Right Hon. W. E. Gladstone, D.C.L., M.P.
 S. R. Graves, Esq., M.P.
 Sir Joseph Whitworth, Bart., LL.D., D.C.L., F.R.S.
 James P. Joule, Esq., LL.D., D.C.L., F.R.S.
 Joseph Mayer, Esq., F.R.S., F.R.G.S.

Rev. W. Banister.
 Reginald Harrison, Esq.
 Rev. Henry H. Higgins, M.A.
 Rev. Dr. A. Hume, F.S.A.

PROFESSOR SIR WILLIAM THOMSON, M.A., LL.D., F.R.S. L. & E......
 EDINBURGH, August 2, 1871.

His Grace the Duke of Buccleuch, K.G., D.C.L., F.R.S.
 The Right Hon. the Lord Provost of Edinburgh.....
 The Right Hon. John Inglis, LL.D., Lord Justice-General of Scotland...
 Sir Alexander Grant, Bart., M.A., Principal of the University of Edinburgh.....
 Sir Roderick I. Murchison, Bart., K.C.B., G.C.Sk.S., D.C.L., F.R.S.....
 Sir Charles Lyell, Bart., D.C.L., F.R.S., F.G.S.....
 Dr. Lyon Playfair, C.B., M.P., F.R.S.....
 Professor Christison, M.D., D.C.L., Pres. R.S.E.....
 Professor Balfour, F.R.S. L. & E.....

W. B. CARPENTER, Esq., M.D., LL.D., F.R.S., F.L.S......
 BRIGHTON, August 14, 1872.

The Right Hon. the Earl of Chichester, Lord-Lieutenant of the County of Sussex.....
 His Grace the Duke of Norfolk.....
 His Grace the Duke of Richmond, K.G., P.C., D.C.L.....
 His Grace the Duke of Devonshire, K.G., D.C.L., F.G.S.....
 Sir John Lubbock, Bart., M.P., F.R.S., F.L.S., F.G.S.....
 Dr. Sharpey, LL.D., Sec. R.S., F.L.S.....
 Joseph Prestwich, Esq., F.R.S., Pres. F.L.S.....

PROFESSOR ALEXANDER W. WILLIAMSON, Ph.D., F.R.S., F.C.S......
 BRADFORD, September 17, 1873.

The Right Hon. the Earl of Rosse, F.R.S., F.R.A.S.....
 The Right Hon. Lord Houghton, D.C.L., F.R.S.....
 The Right Hon. W. E. Forster, M.P.....
 The Mayor of Bradford.....
 J. P. Gassiot, Esq., D.C.L., F.R.S. Professor Phillips, D.C.L., F.R.S.....

PROFESSOR J. TYNDALL, D.C.L., LL.D., F.R.S......
 BELFAST, August 13, 1874.

The Right Hon. the Earl of Enniskillen, D.C.L., F.R.S.....
 The Right Hon. the Earl of Rosse, F.R.S.....
 Sir Richard Wallace, Bart., M.P.....
 The Rev. Dr. Henry.....
 Dr. Andrews, F.R.S.....
 Professor Stokes, D.C.L., F.R.S.....

SIR JOHN HAWKSHAW, M.Inst.C.E., F.R.S., F.G.S. ..
 BRESTOL, August 25, 1875.

The Right Hon. the Earl of Ducie, F.R.S., F.G.S.....
 The Right Hon. Sir Stafford H. Northcote, Bart., C.B., M.P., F.R.S.....
 The Mayor of Bristol.....
 Major-General Sir Henry C. Rawlinson, K.C.B., LL.D., F.R.S., F.R.G.S.....
 Dr. W. B. Carpenter, LL.D., F.R.S., F.L.S., F.G.S.....
 W. Sanders, Esq., F.R.S., F.G.S.....

PROFESSOR THOMAS ANDREWS, M.D., LL.D., F.R.S., Hon. F.R.S.E......
 GLASGOW, September 6, 1876.

His Grace the Duke of Argyll, K.T., LL.D., F.R.S. L. & E., F.G.S.....
 The Hon. the Lord Provost of Glasgow.....
 Sir William Stirling Maxwell, Bart., M.A., M.P.....
 Professor Sir William Thomson, M.A., LL.D., D.C.L., F.R.S. L. & E.....
 Professor Allen Thomson, M.D., LL.D., F.R.S. L. & E.....
 Professor A. C. Ramsay, LL.D., F.R.S., F.G.S.....
 James Young, Esq., F.R.S., F.C.S.....

PROFESSOR ALLEN THOMSON, M.D., LL.D., F.R.S. L. & E......
 PLYMOUTH, August 15 1877.

The Right Hon. the Earl of Mount-Edgumbe.....
 The Right Hon. Lord Blackford, K.C.M.G.....
 William Spotswood, Esq., M.A., LL.D., F.R.S., F.R.A.S., F.R.G.S.....
 William Froude, Esq., M.A., C.E., F.R.S.....
 Charles Spence Bate, Esq., F.R.S., F.L.S.....

Professor A. Crum Brown, M.D., F.R.S.E.
 J. D. Marwick, Esq., F.R.S.E.

Charles Carpenter, Esq.
 The Rev. Dr. Griffith.
 Henry Willett, Esq.

The Rev. J. R. Campbell, D.D.
 Richard Goddard, Esq.
 Peile Thompson, Esq.

W. Quartus Ewart, Esq.
 Professor G. Fuller, C.B.
 T. Sinclair, Esq.

W. Lant Carpenter, Esq., B.A., B.Sc., F.C.S.
 John H. Clarke, Esq.

Dr. W. G. Blackie, F.R.G.S.
 James Grahame, Esq.
 J. D. Marwick, Esq.

William Adams, Esq.
 William Square, Esq.
 Hamilton Whiteford, Esq.

PRESIDENTS.

WILLIAM SPOTTISWOODE, Esq., M.A., D.C.L., LL.D., F.R.S., F.R.A.S., F.R.G.S.
DUBLIN, August 14, 1878.

PROFESSOR G. J. ALLMAN, M.D., LL.D., F.R.S.L. & E., M.R.I.A., Pres. L.S.
SHEFFIELD, August 20, 1879.

ANDREW CROMBIE RAMSAY, Esq., LL.D., F.R.S., V.P.G.S., Director-General of the Geological Survey of the United Kingdom, and of the Museum of Practical Geology.
SWANSEA, August 25, 1880.

SIR JOHN LUBBOCK, Bart., M.P., D.C.L., LL.D., F.R.S., Pres. L.S., F.G.S.
YORK, August 31, 1881.

O. W. SIEMENS, Esq., D.C.L., LL.D., F.R.S., F.C.S., M.Inst.C.E.
SOUTHAMPTON, August 23, 1882.

ARTHUR CAYLEY, Esq., M.A., D.C.L., LL.D., F.R.S., V.P.R.A.S., Sadlerian Professor of Pure Mathematics in the University of Cambridge
SOUTHPORT, September 19, 1883.

VICE-PRESIDENTS.

{ The Right Hon. the Lord Mayor of Dublin
The Provost of Trinity College, Dublin
His Grace the Duke of Abercorn, K.G.
The Right Hon. the Earl of Enniskillen, D.C.L., F.R.S., F.G.S.
The Right Hon. the Earl of Rosse, B.A., D.C.L., F.R.S., F.R.A.S., M.R.I.A.
The Right Hon. Lord O'Hagan, M.R.I.A.
Professor G. G. Stokes, M.A., D.C.L., LL.D., Sec. R.S. }

{ His Grace the Duke of Devonshire, K.G., M.A., LL.D., F.R.S., F.R.G.S.
The Right Hon. the Earl Fitzwilliam, K.G., F.R.G.S.
The Right Hon. the Earl of Wharfedale, F.R.G.S.
W. H. Brittain, Esq. (Master Cutler)
Professor T. H. Huxley, Ph.D., LL.D., Sec. R.S., F.L.S., F.G.S.
Professor W. Odling, M.B., F.R.S., F.C.S. }

{ The Right Hon. the Earl of Jersey
The Mayor of Swansea
The Hon. Sir W. R. Grove, M.A., D.C.L., F.R.S.
H. Hussey Vivian, Esq., M.P., F.G.S.
L. L. Dillwyn, Esq., M.P., F.L.S., F.G.S.
J. Gwyn Jeffreys, Esq., LL.D., F.R.S., F.L.S., Treas. G.S., F.R.G.S. }

{ His Grace the Archbishop of York, D.D., F.R.S.
The Right Hon. the Lord Mayor of York
The Right Hon. Lord Houghton, D.C.L., F.R.S., F.R.G.S.
The Venerable Archdeacon Creyke, M.A.
The Hon. Sir W. R. Grove, M.A., D.C.L., F.R.S.
Professor G. G. Stokes, M.A., D.C.L., LL.D., Sec. R.S.
Sir John Hawkshaw, M.Inst.C.E., F.R.S., F.G.S., F.R.C.S.
Allen Thomson, Esq., M.D., LL.D., F.R.S.L. & E.
Professor Alliman, M.D., LL.D., F.R.S.L. & E., F.L.S. }

{ Captain Sir F. J. Evans, K.C.B., F.R.S., F.R.A.S., F.R.G.S., Hydrographer to the Admiralty
F. A. Abel, Esq., C.B., F.R.S., V.P.C.S., Director of the Chemical Establishment of the War Department
Professor De Chaumont, M.D., F.R.S.
Major-General A. C. Cooke, R.E., C.B., F.R.G.S., Director-General of the Ordnance Survey
Professor Prestwich, M.A., F.R.S., F.G.S., F.C.S.
Philip Lutley Sclater, Esq., M.A., Ph.D., F.R.S., F.L.S., F.G.S. }

{ The Right Hon. the Earl of Derby, M.A., LL.D., F.R.S., F.R.G.S.
The Right Hon. the Earl of Crawford and Balcarres, LL.D., F.R.S., F.R.A.S.
The Right Hon. the Earl of Lathom.
Principal J. W. Dawson C.M.G., M.A., LL.D., F.R.S., F.G.S.
J. G. Greenwood, Esq., LL.D., Vice-Chancellor of the Victoria University
Professor H. E. Roscoe, Ph.D., LL.D., F.R.S., F.C.S. }

LOCAL SECRETARIES.

Professor R. S. Ball, M.A., F.R.S.
James Goff, Esq.
John Norwood, Esq., LL.D.
Professor G. Sigerson, M.D.

H. Clifton Sorby, Esq., LL.D., F.R.S., F.G.S.
J. F. Moss, Esq.

W. Morgan Esq., Ph.D., F.C.S.
James Strick, Esq.

Rev. Thomas Adams, M.A.
Tempest Anderson, Esq., M.D., B.Sc.

C. W. A. Jellicoe, Esq.
John E. Le Feuvre, Esq.
Morris Milnes, Esq.

J. H. Ellis, Esq.
Dr. Vernon.
T. W. Willis, Esq.

The RIGHT HON. LORD RAYLEIGH, M.A., D.C.L., LL.D., F.R.S., F.R.A.S., F.R.C.S., Professor of Experimental Physics in the University of Cambridge.
MONTREAL, August 27, 1884.

The RIGHT HON. SIR LYON PLAYFAIR, K.C.B. M.P., Ph.D., LL.D., F.R.S. L. & E., F.C.S.
ABERDEEN, September 9, 1885.

SIR J. WILLIAM DAWSON, C.M.G., M.A., LL.D., F.R.S., F.G.S., Principal and Vice-Chancellor of McGill University, Montreal, Canada
BIRMINGHAM, September 1, 1886.

SIR H. E. ROSCOE, M.P., D.C.L., LL.D., Ph.D., F.R.S., V.P.O.S.
MANCHESTER, August 31, 1887.

The Right Hon. Sir John Alexander Macdonald, K.C.B., D.O.L., LL.D. & E., F.C.S.

The Right Hon. Sir Lyon Playfair, K.C.B., M.P., Ph.D., LL.D., F.R.S.L. & E., F.C.S.
The Hon. Sir Alexander Tilloch Galt, G.C.M.G.
The Hon. Sir Charles Tupper, K.C.M.G.
Chief Justice Sir A. A. Dorton, C.M.G.
Principal Sir William Dawson, C.M.G., M.A., LL.D., F.R.S., F.G.S.
The Hon. Dr. Chauveau
Professor Edward Frankland, M.D., D.C.L., Ph.D., LL.D., F.R.S., F.C.S.
W. H. Hingston, Esq., M.D., D.C.L., L.R.C.S.E.
Thomas Sterry Hunt, Esq., M.A., D.Sc., LL.D., F.R.S.

His Grace the Duke of Richmond and Gordon, K.G., D.C.L., Chancellor of the University of Aberdeen

The Right Hon. the Earl of Aberdeen, LL.D., Lord-Lieutenant of the Aberdeenshire
The Right Hon. the Earl of Crawford and Balcarres, M.A., LL.D., F.R.S., F.R.A.S.

James Matthews, Esq., Lord Provost of the City of Aberdeen
Professor Sir William Thomson, M.A., LL.D., F.R.S. L. & E., F.R.A.S.
Alexander Bain, Esq., M.A., LL.D., Rector of the University of Aberdeen

The Very Rev. Principal Pirie, D.D., Vice-Chancellor of the University of Aberdeen
Professor W. H. Flower, LL.D., F.R.S., F.L.S., Pres. Z.S., F.G.S., Director of the Natural History Museum, London
Professor John Struthers, M.D., LL.D.

The Right Hon. the Earl of Bradford, Lord-Lieutenant of Shropshire

The Right Hon. Lord Leigh, D.C.L., Lord-Lieutenant of Warwickshire
The Right Hon. Lord Norton, K.O.M.G.
The Right Hon. Lord Wrottesley, Lord-Lieutenant of Staffordshire
The Right Rev. the Lord Bishop of Worcester, D.D.
Thomas Martineau, Esq., Mayor of Birmingham
Professor G. G. Stokes, M.A., D.O.L., LL.D., Pres. R.S.
Professor W. A. Tilden, D.Sc., F.R.S., F.O.S.
Rev. A. R. Vardy, M.A.
Rev. H. W. Watson, D.Sc., F.R.S.

His Grace the Duke of Devonshire, K.G., M.A., LL.D., F.R.S., F.G.S., F.R.G.S.

The Right Hon. the Earl of Derby, K.G., M.A., LL.D., F.M.S., F.R.G.S.
The Right Rev. the Lord Bishop of Manchester, D.D.
The Right Rev. the Bishop of Salford
The Right Worshipful the Mayor of Manchester
The Right Worshipful the Mayor of Salford
The Vice-Chancellor of the Victoria University
The Principal of the Owens College
Sir William Roberts, B.A., M.D., F.R.S.
Thomas Ashton, Esq., J.P., D.L.
Oliver Heywood, Esq., J.P., D.L.
James Prescott Joule, Esq., D.O.L., LL.D., F.R.S., F.R.S.E., F.C.S.

S. E. Dawson, Esq.
R. A. Ramsay, Esq.
S. Rivard, Esq.
S. C. Stevenson, Esq.
Thos. White, Esq., M.P.

J. W. Crombie, Esq., M.A.
Angus Fraser, Esq., M.A., M.D., F.C.S.
Professor G. Pirie, M.A.

J. Barham Oarslake, Esq.
Rev. H. W. Crosskey, LL.D., F.G.S.
Charles J. Hart, Esq.

F. J. Faraday, Esq., F.L.S., F.F.S.
Charles Hopkinson, Esq., B.Sc.
Professor A. Milnes Marshall, M.A., M.D., D.Sc., F.R.S.
Professor A. H. Young, M.B., F.R.C.S.

PRESIDENTS.

SIR FREDERICK J. BRAMWELL, D.C.L., F.R.S.,
M.Inst.C.E......
 BATH, September 5, 1888.

PROFESSOR WILLIAM HENRY FLOWER, C.B., LL.D.,
F.R.S., F.R.C.S., Pres. Z.S., F.L.S., F.G.S., Director of
 the Natural History Departments of the British
 Museum
 NEWCASTLE-UPON-TYNE, September 11, 1889.

SIR FREDERICK AUGUSTUS ABEL, C.B., D.C.L., D.Sc.,
F.R.S., P.P.C.S., Hon. M.Inst.C.E......
 LEEDS, September 3, 1890.

WILLIAM HUGGINS, Esq., D.C.L., LL.D., Ph.D., F.R.S.,
F.R.A.S., Hon. F.R.S.E......
 CARDIFF, August 19, 1891.

VICE-PRESIDENTS.

The Right Hon. the Earl of Cork and Orrey, Lord Lieutenant of Somerset
 set
 The Most Hon. the Marquis of Bath
 The Right Hon. and Right Rev. the Lord Bishop of Bath and Wells, D.D.
 The Right Rev. the Bishop of Clifton, D.D.
 The Right Worshipful the Mayor of Bath
 The Right Worshipful the Mayor of Bristol
SIR F. A. ABEL, C.B., D.C.L., F.R.S. V.P.C.S......
 The Venerable the Archdeacon of Bath, M.A.
 The Rev. Leonard Blomefield, M.A., F.L.S., F.G.S.
Professor Michael Foster, M.A., M.D., LL.D., Sec. R.S., F.L.S., F.C.S.
W. S. Gore-Langton, Esq., J.P., D.L.
Colonel R. P. Laurie, C.B., M.P......
H. D. Skrine, Esq., J.P., D.L.
E. R. Wodehouse, Esq., M.P.
Jerom Murch, Esq., J.P., D.L......

His Grace the Duke of Northumberland, K.G., D.C.L., LL.D., Lord
 Lieutenant of Northumberland.....
 The Right Hon. the Earl of Durham, Lord Lieutenant of Durham
 The Right Hon. the Earl of Ravensworth
 The Right Rev. the Lord Bishop of Newcastle, D.D.
 The Right Hon. Lord Armstrong, C.B., D.C.L., LL.D., F.R.S.
 The Right Hon. John Morley, M.P., LL.D.
 The Very Rev. the Warden of the University of Durham, D.D.
 The Right Worshipful the Mayor of Newcastle
 The Worshipful the Mayor of Gateshead
SIR L. Lowthian Bell, Bart., D.C.L., F.R.S., F.C.S., M.Inst.C.E......
Sir Charles Mark Palmer, Bart., M.P......

His Grace the Duke of Devonshire, K.G., M.A., LL.D., F.R.S., F.G.S.,
 F.R.G.S.
 The Most Hon. the Marquess of Ripon, K.G., G.C.S.I., C.I.E., D.C.L.,
 F.R.S., F.L.S., F.R.G.S.
 The Right Hon. the Earl Fitzwilliam, K.G., F.R.G.S.
 The Right Rev. the Lord Bishop of Ripon, D.D.
 The Right Hon. Sir Lyon Playfair, K.C.B., Ph.D., LL.D., M.P., F.R.S.,
 F.C.S.
 The Right Hon. W. L. Jackson, M.P., F.S.S.
 The Right Worshipful the Mayor of Leeds
Sir James Kitson, Bart., M.Inst.C.E., F.R.G.S......
Sir Andrew Fairbairn, M.A......

The Right Hon. Lord Windsor, Lord Lieutenant of Glamorganshire
 The Most Hon. the Marquess of Bute, K.T.
 The Right Hon. Lord Rayleigh, M.A., D.C.L., LL.D., Sec.R.S., F.R.A.S.,
 F.R.G.S.
 The Right Hon. Lord Tredegar
 The Right Hon. Lord Aberdare, G.C.B., F.R.S., F.R.G.S.
Sir J. T. D. Llewelyn, Bart., F.Z.S......
Sir Archibald Geikie, LL.D., D.Sc., For.Sec.R.S., F.R.S.E., Pres.G.S.,
Director-General of the Geological Survey of the United Kingdom

LOCAL SECRETARIES.

W. Pumphrey, Esq.
J. L. Stothert, Esq., M.Inst.C.E.
B. H. Watts, Esq.

Professor P. Phillips Bedson, D.Sc., F.C.S.
Professor J. Herman Merivale, M.A.

J. Rawlinson Ford, Esq.
Sydney Lupton, Esq., M.A., F.C.S.
Professor L. C. Miall, F.L.S., F.G.S.
Professor A. Smitthells, B.Sc., F.C.S.

R. W. Atkinson, Esq., B.Sc., F.C.S., F.I.C.
Professor H. W. Lloyd Tanner, M.A., F.R.A.S.

Presidents and Secretaries of the Sections of the Association.

Date and Place	Presidents	Secretaries
MATHEMATICAL AND PHYSICAL SCIENCES.		
COMMITTEE OF SCIENCES, I.—MATHEMATICS AND GENERAL PHYSICS.		
1832. Oxford	Davies Gilbert, D.C.L., F.R.S.	Rev. H. Coddington.
1833. Cambridge	Sir D. Brewster, F.R.S.	Prof. Forbes.
1834. Edinburgh	Rev. W. Whewell, F.R.S.	Prof. Forbes, Prof. Lloyd.
SECTION A.—MATHEMATICS AND PHYSICS.		
1835. Dublin	Rev. Dr. Robinson	Prof. Sir W. R. Hamilton, Prof. Wheatstone.
1836. Bristol	Rev. William Whewell, F.R.S.	Prof. Forbes, W. S. Harris, F. W. Jerrard.
1837. Liverpool..	Sir D. Brewster, F.R.S.	W. S. Harris, Rev. Prof. Powell, Prof. Stevelly.
1838. Newcastle	Sir J. F. W. Herschel, Bart., F.R.S.	Rev. Prof. Chevallier, Major Sabine, Prof. Stevelly.
1839. Birmingham	Rev. Prof. Whewell, F.R.S....	J. D. Chance, W. Snow Harris, Prof. Stevelly.
1840. Glasgow ...	Prof. Forbes, F.R.S.....	Rev. Dr. Forbes, Prof. Stevelly, Arch. Smith.
1841. Plymouth	Rev. Prof. Lloyd, F.R.S.	Prof. Stevelly.
1842. Manchester	Very Rev. G. Peacock, D.D., F.R.S.	Prof. M'Culloch, Prof. Stevelly, Rev. W. Scoresby.
1843. Cork	Prof. M'Culloch, M.R.I.A. ...	J. Nott, Prof. Stevelly.
1844. York.....	The Earl of Rosse, F.R.S. ...	Rev. Wm. Hey, Prof. Stevelly.
1845. Cambridge	The Very Rev. the Dean of Ely.	Rev. H. Goodwin, Prof. Stevelly, G. G. Stokes.
1846. Southamp- ton.	Sir John F. W. Herschel, Bart., F.R.S.	John Drew, Dr. Stevelly, G. G. Stokes.
1847. Oxford.....	Rev. Prof. Powell, M.A., F.R.S.	Rev. H. Price, Prof. Stevelly, G. G. Stokes.
1848. Swansea ...	Lord Wrottesley, F.R.S.	Dr. Stevelly, G. G. Stokes.
1849. Birmingham	William Hopkins, F.R.S.....	Prof. Stevelly, G. G. Stokes, W. Ridout Wills.
1850. Edinburgh	Prof. J. D. Forbes, F.R.S., Sec. R.S.E.	W. J. Macquorn Rankine, Prof. Smyth, Prof. Stevelly, Prof. G. G. Stokes.
1851. Ipswich ...	Rev. W. Whewell, D.D., F.R.S.	S. Jackson, W. J. Macquorn Rankine, Prof. Stevelly, Prof. G. G. Stokes.
1852. Belfast.....	Prof. W. Thomson, M.A., F.R.S. L. & E.	Prof. Dixon, W. J. Macquorn Rankine, Prof. Stevelly, J. Tyndall.
1853. Hull	The Very Rev. the Dean of Ely, F.R.S.	B. Blaydes Haworth, J. D. Sollitt, Prof. Stevelly, J. Welsh.

Date and Place	Presidents	Secretaries
1854. Liverpool...	Prof. G. G. Stokes, M.A., Sec. R.S.	J. Hartnup, H. G. Puckle, Prof. Stevelly, J. Tyndall, J. Welsh.
1855. Glasgow ...	Rev. Prof. Kelland, M.A., F.R.S. L. & E.	Rev. Dr. Forbes, Prof. D. Gray, Prof. Tyndall.
1856. Cheltenham	Rev. R. Walker, M.A., F.R.S.	C. Brooke, Rev. T. A. Southwood, Prof. Stevelly, Rev. J. C. Turnbull.
1857. Dublin.....	Rev. T. R. Robinson, D.D., F.R.S., M.R.I.A.	Prof. Curtis, Prof. Hennessy, P. A. Ninnis, W. J. Macquorn Rankine, Prof. Stevelly.
1858. Leeds	Rev. W. Whewell, D.D., V.P.R.S.	Rev. S. Earnshaw, J. P. Hennessy, Prof. Stevelly, H. J. S. Smith, Prof. Tyndall.
1859. Aberdeen...	The Earl of Rosse, M.A., K.P., F.R.S.	J. P. Hennessy, Prof. Maxwell, H. J. S. Smith, Prof. Stevelly.
1860. Oxford.....	Rev. B. Price, M.A., F.R.S....	Rev. G. C. Bell, Rev. T. Rennison, Prof. Stevelly.
1861. Manchester	G. B. Airy, M.A., D.C.L., F.R.S.	Prof. R. B. Clifton, Prof. H. J. S. Smith, Prof. Stevelly.
1862. Cambridge	Prof. G. G. Stokes, M.A., F.R.S.	Prof. R. B. Clifton, Prof. H. J. S. Smith, Prof. Stevelly.
1863. Newcastle	Prof. W. J. Macquorn Rankine, C.E., F.R.S.	Rev. N. Ferrers, Prof. Fuller, F. Jenkin, Prof. Stevelly, Rev. C. T. Whitley.
1864. Bath.....	Prof. Cayley, M.A., F.R.S., F.R.A.S.	Prof. Fuller, F. Jenkin, Rev. G. Buckle, Prof. Stevelly.
1865. Birmingham	W. Spottiswoode, M.A., F.R.S., F.R.A.S.	Rev. T. N. Hutchinson, F. Jenkin, G. S. Mathews, Prof. H. J. S. Smith, J. M. Wilson.
1866. Nottingham	Prof. Wheatstone, D.C.L., F.R.S.	Fleeming Jenkin, Prof. H. J. S. Smith, Rev. S. N. Swann.
1867. Dundee ...	Prof. Sir W. Thomson, D.C.L., F.R.S.	Rev. G. Buckle, Prof. G. C. Foster, Prof. Fuller, Prof. Swan.
1868. Norwich ...	Prof. J. Tyndall, LL.D., F.R.S.	Prof. G. C. Foster, Rev. R. Harley, R. B. Hayward.
1869. Exeter	Prof. J. J. Sylvester, LL.D., F.R.S.	Prof. G. C. Foster, R. B. Hayward, W. K. Clifford.
1870. Liverpool...	J. Clerk Maxwell, M.A., LL.D., F.R.S.	Prof. W. G. Adams, W. K. Clifford, Prof. G. C. Foster, Rev. W. Allen Whitworth.
1871. Edinburgh	Prof. P. G. Tait, F.R.S.E. ...	Prof. W. G. Adams, J. T. Bottomley, Prof. W. K. Clifford, Prof. J. D. Everett, Rev. R. Harley.
1872. Brighton ...	W. De La Rue, D.C.L., F.R.S.	Prof. W. K. Clifford, J. W. L. Glaisher, Prof. A. S. Herschel, G. F. Rodwell.
1873. Bradford ...	Prof. H. J. S. Smith, F.R.S.	Prof. W. K. Clifford, Prof. Forbes, J. W. L. Glaisher, Prof. A. S. Herschel.
1874. Belfast.....	Rev. Prof. J. H. Jellett, M.A., M.R.I.A.	J. W. L. Glaisher, Prof. Herschel, Randal Nixon, J. Perry, G. F. Rodwell.
1875. Bristol	Prof. Balfour Stewart, M.A., LL.D., F.R.S.	Prof. W. F. Barrett, J. W. L. Glaisher, C. T. Hudson, G. F. Rodwell.
1876. Glasgow ...	Prof. Sir W. Thomson, M.A., D.C.L., F.R.S.	Prof. W. F. Barrett, J. T. Bottomley, Prof. G. Forbes, J. W. L. Glaisher, T. Muir.
1877. Plymouth...	Prof. G. C. Foster, B.A., F.R.S., Pres. Physical Soc.	Prof. W. F. Barrett, J. T. Bottomley, J. W. L. Glaisher, F. G. Landon.
1878. Dublin.....	Rev. Prof. Salmon, D.D., D.C.L., F.R.S.	Prof. J. Casey, G. F. Fitzgerald, J. W. L. Glaisher, Dr. O. J. Lodge.
1879. Sheffield ...	George Johnstone Stoney, M.A., F.R.S.	A. H. Allen, J. W. L. Glaisher, Dr. O. J. Lodge, D. MacAlister.

Date and Place	Presidents	Secretaries
1880. Swansea ...	Prof. W. Grylls Adams, M.A., F.R.S.	W. E. Ayrton, J. W. L. Glaisher, Dr. O. J. Lodge, D. MacAlister.
1881. York.....	Prof. Sir W. Thomson, M.A., LL.D., D.C.L., F.R.S.	Prof. W. E. Ayrton, Prof. O. J. Lodge, D. MacAlister, Rev. W. Routh.
1882. Southamp- ton.	Rt. Hon. Prof. Lord Rayleigh, M.A., F.R.S.	W. M. Hicks, Prof. O. J. Lodge, D. MacAlister, Rev. G. Richard- son.
1883. Southport	Prof. O. Henrici, Ph.D., F.R.S.	W. M. Hicks, Prof. O. J. Lodge, D. MacAlister, Prof. R. C. Rowe.
1884. Montreal ...	Prof. Sir W. Thomson, M.A., LL.D., D.C.L., F.R.S.	C. Carpmael, W. M. Hicks, Prof. A. Johnson, Prof. O. J. Lodge, Dr. D. MacAlister.
1885. Aberdeen...	Prof. G. Chrystal, M.A., F.R.S.E.	R. E. Baynes, R. T. Glazebrook, Prof. W. M. Hicks, Prof. W. Ingram.
1886. Birmingham	Prof. G. H. Darwin, M.A., LL.D., F.R.S.	R. E. Baynes, R. T. Glazebrook, Prof. J. H. Poynting, W. N. Shaw.
1887. Manchester	Prof. Sir R. S. Ball, M.A., LL.D., F.R.S.	R. E. Baynes, R. T. Glazebrook, Prof. H. Lamb, W. N. Shaw.
1888. Bath.....	Prof. G. F. Fitzgerald, M.A., F.R.S.	R. E. Baynes, R. T. Glazebrook, A. Lodge, W. N. Shaw.
1889. Newcastle- upon-Tyne	Capt. W. de W. Abney, C.B., R.E., F.R.S.	R. E. Baynes, R. T. Glazebrook, Prof. A. Lodge, W. N. Shaw, Prof. H. Stroud.
1890. Leeds	J. W. L. Glaisher, Sc.D., F.R.S., V.P.R.A.S.	R. T. Glazebrook, Prof. A. Lodge, W. N. Shaw, Prof. W. Stroud.
1891. Cardiff	Prof. O. J. Lodge, D.Sc., LL.D., F.R.S.	R. E. Baynes, J. Larmor, Prof. A. Lodge, Prof. A. L. Selby.

CHEMICAL SCIENCE.

COMMITTEE OF SCIENCES, II.—CHEMISTRY, MINERALOGY.

1832. Oxford.....	John Dalton, D.C.L., F.R.S.	James F. W. Johnston.
1833. Cambridge	John Dalton, D.C.L., F.R.S.	Prof. Miller.
1834. Edinburgh	Dr. Hope.....	Mr. Johnston, Dr. Christison.

SECTION B.—CHEMISTRY AND MINERALOGY.

1835. Dublin.....	Dr. T. Thomson, F.R.S.	Dr. Apjohn, Prof. Johnston.
1836. Bristol.....	Rev. Prof. Cumming	Dr. Apjohn, Dr. C. Henry, W. Hera- path.
1837. Liverpool...	Michael Faraday, F.R.S.....	Prof. Johnston, Prof. Miller, Dr. Reynolds.
1838. Newcastle	Rev. William Whewell, F.R.S.	Prof. Miller, H. L. Pattinson, Thomas Richardson.
1839. Birmingham	Prof. T. Graham, F.R.S.	Dr. Golding Bird, Dr. J. B. Melson.
1840. Glasgow ...	Dr. Thomas Thomson, F.R.S.	Dr. R. D. Thomson, Dr. T. Clark, Dr. L. Playfair.
1841. Plymouth...	Dr. Daubeny, F.R.S.	J. Prideaux, Robert Hunt, W. M. Tweedy.
1842. Manchester	John Dalton, D.C.L., F.R.S.	Dr. L. Playfair, R. Hunt, J. Graham.
1843. Cork.....	Prof. Apjohn, M.R.I.A.....	R. Hunt, Dr. Sweeny.
1844. York.....	Prof. T. Graham, F.R.S.	Dr. L. Playfair, E. Solly, T. H. Barker.
1845. Cambridge	Rev. Prof. Cumming	R. Hunt, J. P. Joule, Prof. Miller, E. Solly.
1846. Southamp- ton.	Michael Faraday, D.C.L., F.R.S.	Dr. Miller, R. Hunt, W. Randall.

Date and Place	Presidents	Secretaries
1847. Oxford.....	Rev. W. V. Harcourt, M.A., F.R.S.	B. C. Brodie, R. Hunt, Prof. Solly.
1848. Swansea ...	Richard Phillips, F.R.S.	T. H. Henry, R. Hunt, T. Williams.
1849. Birmingham	John Percy, M.D., F.R.S.....	R. Hunt, G. Shaw.
1850. Edinburgh	Dr. Christison, V.P.R.S.E.	Dr. Anderson, R. Hunt, Dr. Wilson.
1851. Ipswich ...	Prof. Thomas Graham, F.R.S.	T. J. Pearsall, W. S. Ward.
1852. Belfast.....	Thomas Andrews, M.D., F.R.S.	Dr. Gladstone, Prof. Hodges, Prof. Ronalds.
1853. Hull	Prof. J. F. W. Johnston, M.A., F.R.S.	H. S. Blundell, Prof. R. Hunt, T. J. Pearsall.
1854. Liverpool	Prof. W. A. Miller, M.D., F.R.S.	Dr. Edwards, Dr. Gladstone, Dr. Price.
1855. Glasgow ...	Dr. Lyon Playfair, C.B., F.R.S.	Prof. Frankland, Dr. H. E. Roscoe.
1856. Cheltenham	Prof. B. C. Brodie, F.R.S. ...	J. Horsley, P. J. Worsley, Prof. Voelcker.
1857. Dublin	Prof. Apjohn, M.D., F.R.S., M.R.I.A.	Dr. Davy, Dr. Gladstone, Prof. Sul- livan.
1858. Leeds	Sir J. F. W. Herschel, Bart., D.C.L.	Dr. Gladstone, W. Odling, R. Rey- nolds.
1859. Aberdeen...	Dr. Lyon Playfair, C.B., F.R.S.	J. S. Brazier, Dr. Gladstone, G. D. Liveing, Dr. Odling.
1860. Oxford.....	Prof. B. C. Brodie, F.R.S.....	A. Vernon Harcourt, G. D. Liveing, A. B. Northcote.
1861. Manchester	Prof. W. A. Miller, M.D., F.R.S.	A. Vernon Harcourt, G. D. Liveing.
1862. Cambridge	Prof. W. A. Miller, M.D., F.R.S.	H. W. Elphinstone, W. Odling, Prof. Roscoe.
1863. Newcastle	Dr. Alex. W. Williamson, F.R.S.	Prof. Liveing, H. L. Pattinson, J. C. Stevenson.
1864. Bath.....	W. Odling, M.B., F.R.S., F.C.S.	A. V. Harcourt, Prof. Liveing, R. Biggs.
1865. Birmingham	Prof. W. A. Miller, M.D., V.P.R.S.	A. V. Harcourt, H. Adkins, Prof. Wanklyn, A. Winkler Wills.
1866. Nottingham	H. Bence Jones, M.D., F.R.S.	J. H. Atherton, Prof. Liveing, W. J. Russell, J. White.
1867. Dundee ...	Prof. T. Anderson, M.D., F.R.S.E.	A. Crum Brown, Prof. G. D. Liveing, W. J. Russell.
1868. Norwich ...	Prof. E. Frankland, F.R.S., F.C.S.	Dr. A. Crum Brown, Dr. W. J. Rus- sell, F. Sutton.
1869. Exeter	Dr. H. Debus, F.R.S., F.C.S.	Prof. A. Crum Brown, Dr. W. J. Russell, Dr. Atkinson.
1870. Liverpool...	Prof. H. E. Roscoe, B.A., F.R.S., F.C.S.	Prof. A. Crum Brown, A. E. Fletcher, Dr. W. J. Russell.
1871. Edinburgh	Prof. T. Andrews, M.D., F.R.S.	J. T. Buchanan, W. N. Hartley, T. E. Thorpe.
1872. Brighton ...	Dr. J. H. Gladstone, F.R.S....	Dr. Mills, W. Chandler Roberts, Dr. W. J. Russell, Dr. T. Wood.
1873. Bradford ...	Prof. W. J. Russell, F.R.S. ...	Dr. Armstrong, Dr. Mills, W. Chan- dler Roberts, Dr. Thorpe.
1874. Belfast.....	Prof. A. Crum Brown, M.D., F.R.S.E., F.C.S.	Dr. T. Cranstoun Charles, W. Chan- dler Roberts, Prof. Thorpe.
1875. Bristol	A. G. Vernon Harcourt, M.A., F.R.S., F.C.S.	Dr. H. E. Armstrong, W. Chandler Roberts, W. A. Tilden.
1876. Glasgow ...	W. H. Perkin, F.R.S.	W. Dittmar, W. Chandler Roberts, J. M. Thomson, W. A. Tilden.
1877. Plymouth...	F. A. Abel, F.R.S., F.C.S. ...	Dr. Oxland, W. Chandler Roberts, J. M. Thomson.
1878. Dublin	Prof. Maxwell Simpson, M.D., F.R.S., F.C.S.	W. Chandler Roberts, J. M. Thom- son, Dr. C. R. Tichborne, T. Wills.
1879. Sheffield ...	Prof. Dewar, M.A., F.R.S.	H. S. Bell, W. Chandler Roberts, J. M. Thomson.

Date and Place	Presidents	Secretaries
1880. Swansea ...	Joseph Henry Gilbert, Ph.D., F.R.S.	P. Phillips Bedson, H. B. Dixon, Dr. W. R. Eaton Hodgkinson, J. M. Thomson.
1881. York.....	Prof. A. W. Williamson, Ph.D., F.R.S.	P. Phillips Bedson, H. B. Dixon, T. Gough.
1882. Southamp- ton.	Prof. G. D. Liveing, M.A., F.R.S.	P. Phillips Bedson, H. B. Dixon, J. L. Notter.
1883. Southport	Dr. J. H. Gladstone, F.R.S...	Prof. P. Phillips Bedson, H. B. Dixon, H. Forster Morley.
1884. Montreal ...	Prof. Sir H. E. Roscoe, Ph.D., LL.D., F.R.S.	Prof. P. Phillips Bedson, H. B. Dixon, T. McFarlane, Prof. W. H. Pike.
1885. Aberdeen...	Prof. H. E. Armstrong, Ph.D., F.R.S., Sec. C.S.	Prof. P. Phillips Bedson, H. B. Dixon, H. Forster Morley, Dr. W. J. Simpson.
1886. Birmingham	W. Crookes, F.R.S., V.P.C.S.	Prof. P. Phillips Bedson, H. B. Dixon, H. Forster Morley, W. W. J. Nicol, C. J. Woodward.
1887. Manchester	Dr. E. Schunck, F.R.S., F.C.S.	Prof. P. Phillips Bedson, H. Forster Morley, W. Thomson.
1888. Bath.....	Prof. W. A. Tilden, D.Sc., F.R.S., V.P.C.S.	Prof. H. B. Dixon, Dr. H. Forster Morley, R. E. Moyle, Dr. W. W. J. Nicol.
1889. Newcastle- upon-Tyne	Sir I. Lowthian Bell, Bart., D.C.L., F.R.S., F.C.S.	Dr. H. Forster Morley, D. H. Nagel, Dr. W. W. J. Nicol, H. L. Pattin- son, jun.
1890. Leeds	Prof. T. E. Thorpe, B.Sc., Ph.D., F.R.S., Treas. C.S.	C. H. Bothamley, Dr. H. Forster Morley, D. H. Nagel, Dr. W. W. J. Nicol.
1891. Cardiff	Prof. W. C. Roberts-Austen, C.B., F.R.S., F.C.S.	C. H. Bothamley, Dr. H. Forster Morley, Dr. W. W. J. Nicol, Dr. G. S. Turpin.

GEOLOGICAL (AND, UNTIL 1851, GEOGRAPHICAL) SCIENCE.

COMMITTEE OF SCIENCES, III.—GEOLOGY AND GEOGRAPHY.

1832. Oxford	R. I. Murchison, F.R.S.	John Taylor.
1833. Cambridge.	G. B. Greenough, F.R.S.	W. Lonsdale, John Phillips.
1834. Edinburgh.	Prof. Jameson	Prof. Phillips, T. Jameson Torrie, Rev. J. Yates.

SECTION C.—GEOLOGY AND GEOGRAPHY.

1835. Dublin	R. J. Griffith	Captain Portlock, T. J. Torrie.
1836. Bristol	Rev. Dr. Buckland, F.R.S.— <i>Geography</i> , R. I. Murchison, F.R.S.	William Sanders, S. Stutchbury, T. J. Torrie.
1837. Liverpool...	Rev. Prof. Sedgwick, F.R.S.— <i>Geography</i> , G. B. Greenough, F.R.S.	Captain Portlock, R. Hunter.— <i>Geo- graphy</i> , Captain H. M. Denham R.N.
1838. Newcastle..	C. Lyell, F.R.S., V.P.G.S.— <i>Geography</i> , Lord Prudhoe.	W. C. Trevelyan, Capt. Portlock.— <i>Geography</i> , Capt. Washington.
1839. Birmingham	Rev. Dr. Buckland, F.R.S.— <i>Geography</i> , G. B. Greenough, F.R.S.	George Lloyd, M.D., H. E. Strick- land, Charles Darwin.
1840. Glasgow ...	Charles Lyell, F.R.S.— <i>Geo- graphy</i> , G. B. Greenough, F.R.S.	W. J. Hamilton, D. Milne, Hugh Murray, H. E. Strickland, John Scouler, M.D.
1841. Plymouth...	H. T. De la Beche, F.R.S. ...	W. J. Hamilton, Edward Moor, M.D., R. Hutton.

Date and Place	Presidents	Secretaries
1842. Manchester	R. I. Murchison, F.R.S.	E. W. Binney, R. Hutton, Dr. R. Lloyd, H. E. Strickland.
1843. Cork.....	Richard E. Griffith, F.R.S., M.R.I.A.	Francis M. Jennings, H. E. Strickland.
1844. York.....	Henry Warburton, M.P., Pres. Geol. Soc.	Prof. Ansted, E. H. Bunbury.
1845. Cambridge.	Rev. Prof. Sedgwick, M.A., F.R.S.	Rev. J. C. Cumming, A. C. Ramsay, Rev. W. Thorp.
1846. Southamp- ton.	Leonard Horner, F.R.S.— <i>Geography</i> , G. B. Greenough, F.R.S.	Robert A. Austen, Dr. J. H. Norton, Prof. Oldham.— <i>Geography</i> , Dr. C. T. Beke.
1847. Oxford.....	Very Rev. Dr. Buckland, F.R.S.	Prof. Ansted, Prof. Oldham, A. C. Ramsay, J. Ruskin.
1848. Swansea ...	Sir H. T. De la Beche, C.B., F.R.S.	Starling Benson, Prof. Oldham, Prof. Ramsay.
1849. Birmingham	Sir Charles Lyell, F.R.S., F.G.S.	J. Beete Jukes, Prof. Oldham, Prof. A. C. Ramsay.
1850. Edinburgh ¹	Sir Roderick I. Murchison, F.R.S.	A. Keith Johnston, Hugh Miller, Prof. Nicol.

SECTION C (*continued*).—GEOLOGY.

1851. Ipswich ...	William Hopkins, M.A., F.R.S.	C. J. F. Bunbury, G. W. Ormerod, Searles Wood.
1852. Belfast.....	Lieut.-Col. Portlock, R.E., F.R.S.	James Bryce, James MacAdam, Prof. M'Coy, Prof. Nicol.
1853. Hull	Prof. Sedgwick, F.R.S.....	Prof. Harkness, William Lawton.
1854. Liverpool ..	Prof. Edward Forbes, F.R.S.	John Cunningham, Prof. Harkness, G. W. Ormerod, J. W. Woodall.
1855. Glasgow ...	Sir R. I. Murchison, F.R.S....	James Bryce, Prof. Harkness, Prof. Nicol.
1856. Cheltenham	Prof. A. C. Ramsay, F.R.S....	Rev. P. B. Brodie, Rev. R. Hepworth, Edward Hull, J. Scougall, T. Wright.
1857. Dublin	The Lord Talbot de Malahide	Prof. Harkness, Gilbert Sanders, Robert H. Scott.
1858. Leeds	William Hopkins, M.A., LL.D., F.R.S.	Prof. Nicol, H. C. Sorby, E. W. Shaw.
1859. Aberdeen...	Sir Charles Lyell, LL.D., D.C.L., F.R.S.	Prof. Harkness, Rev. J. Longmuir, H. C. Sorby.
1860. Oxford	Rev. Prof. Sedgwick, LL.D., F.R.S., F.G.S.	Prof. Harkness, Edward Hull, Capt. D. C. L. Woodall.
1861. Manchester	Sir R. I. Murchison, D.C.L., LL.D., F.R.S.	Prof. Harkness, Edward Hull, T. Rupert Jones, G. W. Ormerod.
1862. Cambridge	J. Beete Jukes, M.A., F.R.S.	Lucas Barrett, Prof. T. Rupert Jones, H. C. Sorby.
1863. Newcastle	Prof. Warington W. Smyth, F.R.S., F.G.S.	E. F. Boyd, John Daglish, H. C. Sorby, Thomas Sopwith.
1864. Bath.....	Prof. J. Phillips, LL.D., F.R.S., F.G.S.	W. B. Dawkins, J. Johnston, H. C. Sorby, W. Pengelly.
1865. Birmingham	Sir R. I. Murchison, Bart., K.C.B.	Rev. P. B. Brodie, J. Jones, Rev. E. Myers, H. C. Sorby, W. Pengelly.
1866. Nottingham	Prof. A. C. Ramsay, LL.D., F.R.S.	R. Etheridge, W. Pengelly, T. Wilson, G. H. Wright.

¹ At a meeting of the General Committee held in 1850, it was resolved 'That the subject of Geography be separated from Geology and combined with Ethnology, to constitute a separate Section, under the title of the "Geographical and Ethnological Section,"' for Presidents and Secretaries of which see page liv.

Date and Place	Presidents	Secretaries
1867. Dundee ...	Archibald Geikie, F.R.S., F.G.S.	Edward Hull, W. Pengelly, Henry Woodward.
1868. Norwich ...	R. A. C. Godwin-Austen, F.R.S., F.G.S.	Rev. O. Fisher, Rev. J. Gunn, W. Pengelly, Rev. H. H. Winwood.
1869. Exeter	Prof. R. Harkness, F.R.S., F.G.S.	W. Pengelly, W. Boyd Dawkins, Rev. H. H. Winwood.
1870. Liverpool...	Sir Philip de M. Grey Egerton, Bart., M.P., F.R.S.	W. Pengelly, Rev. H. H. Winwood, W. Boyd Dawkins, G. H. Morton.
1871. Edinburgh	Prof. A. Geikie, F.R.S., F.G.S.	R. Etheridge, J. Geikie, T. McKenny Hughes, L. C. Miall.
1872. Brighton ...	R. A. C. Godwin-Austen, F.R.S., F.G.S.	L. C. Miall, George Scott, William Topley, Henry Woodward.
1873. Bradford ...	Prof. J. Phillips, D.C.L., F.R.S., F.G.S.	L. C. Miall, R. H. Tiddeman, W. Topley.
1874. Belfast.....	Prof. Hull, M.A., F.R.S., F.G.S.	F. Drew, L. C. Miall, R. G. Symes, R. H. Tiddeman.
1875. Bristol	Dr. Thomas Wright, F.R.S.E., F.G.S.	L. C. Miall, E. B. Tawney, W. Topley.
1876. Glasgow ...	Prof. John Young, M.D.	J. Armstrong, F. W. Rudler, W. Topley.
1877. Plymouth...	W. Pengelly, F.R.S., F.G.S.	Dr. Le Neve Foster, R. H. Tiddeman, W. Topley.
1878. Dublin.....	John Evans, D.C.L., F.R.S., F.S.A., F.G.S.	E. T. Hardman, Prof. J. O'Reilly, R. H. Tiddeman.
1879. Sheffield ...	Prof. P. Martin Duncan, M.B., F.R.S., F.G.S.	W. Topley, G. Blake Walker.
1880. Swansea ...	H. C. Sorby, LL.D., F.R.S., F.G.S.	W. Topley, W. Whitaker.
1881. York.....	A. C. Ramsay, LL.D., F.R.S., F.G.S.	J. E. Clark, W. Keeping, W. Topley, W. Whitaker.
1882. Southamp- ton.	R. Etheridge, F.R.S., F.G.S.	T. W. Shore, W. Topley, E. Westlake, W. Whitaker.
1883. Southport	Prof. W. C. Williamson, LL.D., F.R.S.	R. Betley, C. E. De Rance, W. Topley, W. Whitaker.
1884. Montreal ...	W. T. Blanford, F.R.S., Sec. G.S.	F. Adams, Prof. E. W. Claypole, W. Topley, W. Whitaker.
1885. Aberdeen ...	Prof. J. W. Judd, F.R.S., Sec. G.S.	C. E. De Rance, J. Horne, J. J. H. Teall, W. Topley.
1886. Birmingham	Prof. T. G. Bonney, D.Sc., LL.D., F.R.S., F.G.S.	W. J. Harrison, J. J. H. Teall, W. Topley, W. W. Watts.
1887. Manchester	Henry Woodward, LL.D., F.R.S., F.G.S.	J. E. Marr, J. H. Teall, W. Topley, W. W. Watts.
1888. Bath.....	Prof. W. Boyd Dawkins, M.A., F.R.S., F.G.S.	Prof. G. A. Lebour, W. Topley, W. W. Watts, H. B. Woodward.
1889. Newcastle- upon-Tyne	Prof. J. Geikie, LL.D., D.C.L., F.R.S., F.G.S.	Prof. G. A. Lebour, J. E. Marr, W. W. Watts, H. B. Woodward.
1890. Leeds	Prof. A. H. Green, M.A., F.R.S., F.G.S.	J. E. Bedford, Dr. F. H. Hatch, J. E. Marr, W. W. Watts.
1891. Cardiff	Prof. T. Rupert Jones, F.R.S., F.G.S.	W. Galloway, J. E. Marr, Clement Reid, W. W. Watts.

BIOLOGICAL SCIENCES.

COMMITTEE OF SCIENCES, IV.—ZOOLOGY, BOTANY, PHYSIOLOGY, ANATOMY.

1832. Oxford.....	Rev. P. B. Duncan, F.G.S. ...	Rev. Prof. J. S. Henslow.
1833. Cambridge ¹	Rev. W. L. P. Garnons, F.L.S.	C. C. Babington, D. Don.
1834. Edinburgh.	Prof. Graham.....	W. Yarrell, Prof. Burnett.

¹ At this Meeting Physiology and Anatomy were made a separate Committee, for Presidents and Secretaries of which see p. liii.

Date and Place	Presidents	Secretaries
SECTION D.—ZOOLOGY AND BOTANY.		
1835. Dublin.....	Dr. Allman.....	J. Curtis, Dr. Litton.
1836. Bristol.....	Rev. Prof. Henslow	J. Curtis, Prof. Don, Dr. Riley, S. Rootsey.
1837. Liverpool...	W. S. MacLeay.....	C. C. Babington, Rev. L. Jenyns, W. Swainson.
1838. Newcastle	Sir W. Jardine, Bart.	J. E. Gray, Prof. Jones, R. Owen, Dr. Richardson.
1839. Birmingham	Prof. Owen, F.R.S.	E. Forbes, W. Ick, R. Patterson.
1840. Glasgow ...	Sir W. J. Hooker, LL.D.....	Prof. W. Couper, E. Forbes, R. Patterson.
1841. Plymouth...	John Richardson, M.D., F.R.S.	J. Couch, Dr. Lankester, R. Patterson.
1842. Manchester	Hon. and Very Rev. W. Herbert, LL.D., F.L.S.	Dr. Lankester, R. Patterson, J. A. Turner.
1843. Cork.....	William Thompson, F.L.S. ...	G. J. Allman, Dr. Lankester, R. Patterson.
1844. York.....	Very Rev. the Dean of Manchester.	Prof. Allman, H. Goodsir, Dr. King, Dr. Lankester.
1845. Cambridge	Rev. Prof. Henslow, F.L.S....	Dr. Lankester, T. V. Wollaston.
1846. Southampton,	Sir J. Richardson, M.D., F.R.S.	Dr. Lankester, T. V. Wollaston, H. Wooldridge.
1847. Oxford.....	H. E. Strickland, M.A., F.R.S.	Dr. Lankester, Dr. Melville, T. V. Wollaston.

SECTION D (*continued*).—ZOOLOGY AND BOTANY, INCLUDING PHYSIOLOGY.

[For the Presidents and Secretaries of the Anatomical and Physiological Subsections and the temporary Section E of Anatomy and Medicine, see p. liii.]

1848. Swansea ...	L. W. Dillwyn, F.R.S.....	Dr. R. Wilbraham Falconer, A. Henfrey, Dr. Lankester.
1849. Birmingham	William Spence, F.R.S.	Dr. Lankester, Dr. Russell.
1850. Edinburgh	Prof. Goodsir, F.R.S. L. & E.	Prof. J. H. Bennett, M.D., Dr. Lankester, Dr. Douglas MacLagan.
1851. Ipswich ...	Rev. Prof. Henslow, M.A., F.R.S.	Prof. Allman, F. W. Johnston, Dr. E. Lankester.
1852. Belfast.....	W. Ogilby	Dr. Dickie, George C. Hyndman, Dr. Edwin Lankester.
1853. Hull	C. C. Babington, M.A., F.R.S.	Robert Harrison, Dr. E. Lankester.
1854. Liverpool...	Prof. Balfour, M.D., F.R.S....	Isaac Byerley, Dr. E. Lankester.
1855. Glasgow ...	Rev. Dr. Fleeming, F.R.S.E.	William Keddie, Dr. Lankester.
1856. Cheltenham	Thomas Bell, F.R.S., Pres.L.S.	Dr. J. Abercrombie, Prof. Buckman, Dr. Lankester.
1857. Dublin.....	Prof. W. H. Harvey, M.D., F.R.S.	Prof. J. R. Kinahan, Dr. E. Lankester, Robert Patterson, Dr. W. E. Steele.
1858. Leeds	C. C. Babington, M.A., F.R.S.	Henry Denny, Dr. Heaton, Dr. E. Lankester, Dr. E. Perceval Wright.
1859. Aberdeen...	Sir W. Jardine, Bart., F.R.S.E.	Prof. Dickie, M.D., Dr. E. Lankester, Dr. Ogilvy.
1860. Oxford.....	Rev. Prof. Henslow, F.L.S....	W. S. Church, Dr. E. Lankester, P. L. Slater, Dr. E. Perceval Wright.
1861. Manchester	Prof. C. C. Babington, F.R.S.	Dr. T. Alcock, Dr. E. Lankester, Dr. P. L. Slater, Dr. E. P. Wright.
1862. Cambridge	Prof. Huxley, F.R.S.	Alfred Newton, Dr. E. P. Wright.
1863. Newcastle	Prof. Balfour, M.D., F.R.S....	Dr. E. Charlton, A. Newton, Rev. H. B. Tristram, Dr. E. P. Wright.

Date and Place	Presidents	Secretaries
1864. Bath	Dr. John E. Gray, F.R.S. ...	H. B. Brady, C. E. Broom, H. T. Stainton, Dr. E. P. Wright.
1865. Birmingham	T. Thomson, M.D., F.R.S. ...	Dr. J. Anthony, Rev. C. Clarke, Rev. H. B. Tristram, Dr. E. P. Wright.

SECTION D (*continued*).—BIOLOGY.¹

1866. Nottingham	Prof. Huxley, LL.D., F.R.S.— <i>Physiological Dep.</i> , Prof. Humphry, M.D., F.R.S.— <i>Anthropological Dep.</i> , Alf. R. Wallace, F.R.G.S.	Dr. J. Beddard, W. Felkin, Rev. H. B. Tristram, W. Turner, E. B. Tylor, Dr. E. P. Wright.
1867. Dundee ...	Prof. Sharpey, M.D., Sec. R.S.— <i>Dep. of Zool. and Bot.</i> , George Busk, M.D., F.R.S.	C. Spence Bate, Dr. S. Cobbold, Dr. M. Foster, H. T. Stainton, Rev. H. B. Tristram, Prof. W. Turner.
1868. Norwich ...	Rev. M. J. Berkeley, F.L.S.— <i>Dep. of Physiology</i> , W. H. Flower, F.R.S.	Dr. T. S. Cobbold, G. W. Firth, Dr. M. Foster, Prof. Lawson, H. T. Stainton, Rev. Dr. H. B. Tristram, Dr. E. P. Wright.
1869. Exeter	George Busk, F.R.S., F.L.S.— <i>Dep. of Bot. and Zool.</i> , C. Spence Bate, F.R.S.— <i>Dep. of Ethno.</i> , E. B. Tylor.	Dr. T. S. Cobbold, Prof. M. Foster, E. Ray Lankester, Prof. Lawson, H. T. Stainton, Rev. H. B. Tristram.
1870. Liverpool...	Prof. G. Rolleston, M.A., M.D., F.R.S., F.L.S.— <i>Dep. of Anat. and Physiol.</i> , Prof. M. Foster, M.D., F.L.S.— <i>Dep. of Ethno.</i> , J. Evans, F.R.S.	Dr. T. S. Cobbold, Sebastian Evans, Prof. Lawson, Thos. J. Moore, H. T. Stainton, Rev. H. B. Tristram, C. Staniland Wake, E. Ray Lankester.
1871. Edinburgh.	Prof. Allen Thomson, M.D., F.R.S.— <i>Dep. of Bot. and Zool.</i> , Prof. Wyville Thomson, F.R.S.— <i>Dep. of Anthropol.</i> , Prof. W. Turner, M.D.	Dr. T. R. Fraser, Dr. Arthur Gamgee, E. Ray Lankester, Prof. Lawson, H. T. Stainton, C. Staniland Wake, Dr. W. Rutherford, Dr. Kelburne King.
1872. Brighton ...	Sir J. Lubbock, Bart., F.R.S.— <i>Dep. of Anat. and Physiol.</i> , Dr. Burdon Sanderson, F.R.S.— <i>Dep. of Anthropol.</i> , Col. A. Lane Fox, F.G.S.	Prof. Thiselton-Dyer, H. T. Stainton, Prof. Lawson, F. W. Rudler, J. H. Lamprey, Dr. Gamgee, E. Ray Lankester, Dr. Pye-Smith.
1873. Bradford ...	Prof. Allman, F.R.S.— <i>Dep. of Anat. and Physiol.</i> , Prof. Rutherford, M.D.— <i>Dep. of Anthropol.</i> , Dr. Beddoe, F.R.S.	Prof. Thiselton-Dyer, Prof. Lawson, R. M'Lachlan, Dr. Pye-Smith, E. Ray Lankester, F. W. Rudler, J. H. Lamprey.
1874. Belfast	Prof. Redfern, M.D.— <i>Dep. of Zool. and Bot.</i> , Dr. Hooker, C.B., Pres.R.S.— <i>Dep. of Anthropol.</i> , Sir W.R. Wilde, M.D.	W. T. Thiselton-Dyer, R. O. Cunningham, Dr. J. J. Charles, Dr. P. H. Pye-Smith, J. J. Murphy, F. W. Rudler.
1875. Bristol	P. L. Sclater, F.R.S.— <i>Dep. of Anat. and Physiol.</i> , Prof. Cleland, M.D., F.R.S.— <i>Dep. of Anthropol.</i> , Prof. Rolleston, M.D., F.R.S.	E. R. Alston, Dr. McKendrick, Prof. W. R. M'Nab, Dr. Martyn, F. W. Rudler, Dr. P. H. Pye-Smith, Dr. W. Spencer.

¹ At a meeting of the General Committee in 1865, it was resolved:—'That the title of Section D be changed to Biology;' and 'That for the word "Subsection," in the rules for conducting the business of the Sections, the word "Department" be substituted.'

Date and Place	Presidents	Secretaries
1876. Glasgow ...	A. Russel Wallace, F.R.G.S., F.L.S.— <i>Dep. of Zool. and Bot.</i> , Prof. A. Newton, M.A., F.R.S.— <i>Dep. of Anat. and Physiol.</i> , Dr. J. G. McKendrick, F.R.S.E.	E. R. Alston, Hyde Clarke, Dr. Knox, Prof. W. R. M'Nab, Dr. Muirhead, Prof. Morrison Watson.
1877. Plymouth...	J. Gwyn Jeffreys, LL.D., F.R.S., F.L.S.— <i>Dep. of Anat. and Physiol.</i> , Prof. Macalister, M.D.— <i>Dep. of Anthropol.</i> , Francis Galton, M.A., F.R.S.	E. R. Alston, F. Brent, Dr. D. J. Cunningham, Dr. C. A. Hingston, Prof. W. R. M'Nab, J. B. Rowe, F. W. Rudler.
1878. Dublin	Prof. W. H. Flower, F.R.S.— <i>Dep. of Anthropol.</i> , Prof. Huxley, Sec. R.S.— <i>Dep. of Anat. and Physiol.</i> , R. McDonnell, M.D., F.R.S.	Dr. R. J. Harvey, Dr. T. Hayden, Prof. W. R. M'Nab, Prof. J. M. Purser, J. B. Rowe, F. W. Rudler.
1879. Sheffield ...	Prof. St. George Mivart, F.R.S.— <i>Dep. of Anthropol.</i> , E. B. Tylor, D.C.L., F.R.S.— <i>Dep. of Anat. and Physiol.</i> , Dr. Pye-Smith.	Arthur Jackson, Prof. W. R. M'Nab, J. B. Rowe, F. W. Rudler, Prof. Schäfer.
1880. Swansea ...	A. C. L. Günther, M.D., F.R.S.— <i>Dep. of Anat. and Physiol.</i> , F. M. Balfour, M.A., F.R.S.— <i>Dep. of Anthropol.</i> , F. W. Rudler, F.G.S.	G. W. Bloxam, John Priestley, Howard Saunders, Adam Sedgwick.
1881. York.....	Richard Owen, C.B., M.D., F.R.S.— <i>Dep. of Anthropol.</i> , Prof. W. H. Flower, LL.D., F.R.S.— <i>Dep. of Anat. and Physiol.</i> , Prof. J. S. Burdon Sanderson, M.D., F.R.S.	G. W. Bloxam, W. A. Forbes, Rev. W. C. Hey, Prof. W. R. M'Nab, W. North, John Priestley, Howard Saunders, H. E. Spencer.
1882. Southampton.	Prof. A. Gamgee, M.D., F.R.S.— <i>Dep. of Zool. and Bot.</i> , Prof. M. A. Lawson, M.A., F.L.S.— <i>Dep. of Anthropol.</i> , Prof. W. Boyd Dawkins, M.A., F.R.S.	G. W. Bloxam, W. Heape, J. B. Nias, Howard Saunders, A. Sedgwick, T. W. Shore, jun.
1883. Southport ¹	Prof. E. Ray Lankester, M.A., F.R.S.— <i>Dep. of Anthropol.</i> , W. Pengelly, F.R.S.	G. W. Bloxam, Dr. G. J. Haslam, W. Heape, W. Hurst, Prof. A. M. Marshall, Howard Saunders, Dr. G. A. Woods.
1884. Montreal ² ...	Prof. H. N. Moseley, M.A., F.R.S.	Prof. W. Osler, Howard Saunders, A. Sedgwick, Prof. R. R. Wright.
1885. Aberdeen ...	Prof. W. C. McIntosh, M.D., LL.D., F.R.S. F.R.S.E.	W. Heape, J. McGregor-Robertson, J. Duncan Matthews, Howard Saunders, H. Marshall Ward.
1886. Birmingham	W. Carruthers, Pres. L.S., F.R.S., F.G.S.	Prof. T. W. Bridge, W. Heape, Prof. W. Hillhouse, W. L. Sclater, Prof. H. Marshall Ward.
1887. Manchester	Prof. A. Newton, M.A., F.R.S., F.L.S., V.P.Z.S.	C. Bailey, F. E. Beddard, S. F. Harmer, W. Heape, W. L. Sclater, Prof. H. Marshall Ward.

¹ By direction of the General Committee at Southampton (1882) the Departments of Zoology and Botany and of Anatomy and Physiology were amalgamated.

² By authority of the General Committee, Anthropology was made a separate Section, for Presidents and Secretaries of which see p. lix.

Date and Place	Presidents	Secretaries
1888. Bath.....	W. T. Thiselton-Dyer, C.M.G., F.R.S., F.L.S.	F. E. Beddard, S. F. Harmer, Prof. H. Marshall Ward, W. Gardiner, Prof. W. D. Halliburton.
1889. Newcastle- upon-Tyne	Prof. J. S. Burdon Sanderson, M.A., M.D., F.R.S.	C. Bailey, F. E. Beddard, S. F. Har- mer, Prof. T. Oliver, Prof. H. Mar- shall Ward.
1890. Leeds	Prof. A. Milnes Marshall, M.A., M.D., D.Sc., F.R.S.	S. F. Harmer, Prof. W. A. Herdman, Dr. S. J. Hickson, Prof. F. W. Oliver, H. Wager, Prof. H. Mar- shall Ward.
1891. Cardiff	Francis Darwin, M.A., M.B., F.R.S., F.L.S.	F. E. Beddard, Prof. W. A. Herdman, Dr. S. J. Hickson, G. Murray, Prof. W. N. Parker, H. Wager.

ANATOMICAL AND PHYSIOLOGICAL SCIENCES.

COMMITTEE OF SCIENCES, V.—ANATOMY AND PHYSIOLOGY.

1833. Cambridge	Dr. Haviland.....	Dr. Bond, Mr. Paget.
1834. Edinburgh	Dr. Abercrombie	Dr. Roget, Dr. William Thomson.

SECTION E (UNTIL 1847).—ANATOMY AND MEDICINE.

1835. Dublin	Dr. Pritchard.....	Dr. Harrison, Dr. Hart.
1836. Bristol.....	Dr. Roget, F.R.S.	Dr. Symonds.
1837. Liverpool...	Prof. W. Clark, M.D.	Dr. J. Carson, jun., James Long, Dr. J. R. W. Vose.
1838. Newcastle	T. E. Headlam, M.D.	T. M. Greenhow, Dr. J. R. W. Vose.
1839. Birmingham	John Yelloly, M.D., F.R.S....	Dr. G. O. Rees, F. Ryland.
1840. Glasgow ...	James Watson, M.D.	Dr. J. Brown, Prof. Couper, Prof. Reid.

SECTION E.—PHYSIOLOGY.

1841. Plymouth...	P. M. Roget, M.D., Sec. R.S.	Dr. J. Butter, J. Fuge, Dr. R. S. Sargent.
1842. Manchester	Edward Holme, M.D., F.L.S.	Dr. Chaytor, Dr. R. S. Sargent.
1843. Cork	Sir James Pitcairn, M.D. ...	Dr. John Popham, Dr. R. S. Sargent.
1844. York	J. C. Pritchard, M.D.	I. Erichsen, Dr. R. S. Sargent.
1845. Cambridge	Prof. J. Haviland, M.D.	Dr. R. S. Sargent, Dr. Webster.
1846. Southamp- ton.	Prof. Owen, M.D., F.R.S. ...	C. P. Keele, Dr. Laycock, Dr. Sar- gent.
1847. Oxford ¹ ...	Prof. Ogle, M.D., F.R.S.	Dr. Thomas K. Chambers, W. P. Ormerod.

PHYSIOLOGICAL SUBSECTIONS OF SECTION D.

1850. Edinburgh	Prof. Bennett, M.D., F.R.S.E.	
1855. Glasgow ...	Prof. Allen Thomson, F.R.S.	Prof. J. H. Corbett, Dr. J. Struthers.
1857. Dublin.....	Prof. R. Harrison, M.D.	Dr. R. D. Lyons, Prof. Redfern.
1858. Leeds	Sir Benjamin Brodie, Bart., F.R.S.	C. G. Wheelhouse.

¹ By direction of the General Committee at Oxford, Sections D and E were incorporated under the name of 'Section D—Zoology and Botany, including Physiology' (see p. 1). Section E, being then vacant, was assigned in 1851 to Geology.

Date and Place	Presidents	Secretaries
1859. Aberdeen...	Prof. Sharpey, M.D., Sec.R.S.	Prof. Bennett, Prof. Redfern.
1860. Oxford.....	Prof.G.Rolleston, M.D., F.L.S.	Dr. R. M'Donnell, Dr. Edward Smith.
1861. Manchester	Dr. John Davy, F.R.S. L. & E.	Dr. W. Roberts, Dr. Edward Smith.
1862. Cambridge	G. E. Paget, M.D.....	G. F. Helm, Dr. Edward Smith.
1863. Newcastle	Prof. Rolleston, M.D., F.R.S.	Dr. D. Embleton, Dr. W. Turner.
1864. Bath.....	Dr. Edward Smith, LL.D., F.R.S.	J. S. Bartrum, Dr. W. Turner.
1865. Birmingham. ¹	Prof. Acland, M.D., LL.D., F.R.S.	Dr. A. Fleming, Dr. P. Heslop, Oliver Pembleton, Dr. W. Turner.

GEOGRAPHICAL AND ETHNOLOGICAL SCIENCES.

[For Presidents and Secretaries for Geography previous to 1851, see Section C p. xlvii.]

ETHNOLOGICAL SUBSECTIONS OF SECTION D.

1846. Southampton	Dr. Pritchard.....	Dr. King.
1847. Oxford.....	Prof. H. H. Wilson, M.A. ...	Prof. Buckley.
1848. Swansea	G. Grant Francis.
1849. Birmingham	Dr. R. G. Latham.
1850. Edinburgh	Vice-Admiral Sir A. Malcolm	Daniel Wilson.

SECTION E.—GEOGRAPHY AND ETHNOLOGY.

1851. Ipswich ...	Sir R. I. Murchison, F.R.S., Pres. R.G.S.	R. Cull, Rev. J. W. Donaldson, Dr. Norton Shaw.
1852. Belfast.....	Col. Chesney, R.A., D.C.L., F.R.S.	R. Cull, R. MacAdam, Dr. Norton Shaw.
1853. Hull.....	R. G. Latham, M.D., F.R.S.	R. Cull, Rev. H. W. Kemp, Dr. Norton Shaw.
1854. Liverpool...	Sir R. I. Murchison, D.C.L., F.R.S.	Richard Cull, Rev. H. Higgins, Dr. Ihne, Dr. Norton Shaw.
1855. Glasgow ...	Sir J. Richardson, M.D., F.R.S.	Dr. W. G. Blackie, R. Cull, Dr. Norton Shaw.
1856. Cheltenham	Col. Sir H. C. Rawlinson, K.C.B.	R. Cull, F. D. Hartland, W. H. Rumsey, Dr. Norton Shaw.
1857. Dublin.....	Rev. Dr. J. Henthorn Todd, Pres. R.I.A.	R. Cull, S. Ferguson, Dr. R. R. Madden, Dr. Norton Shaw.
1858. Leeds.....	Sir R. I. Murchison, G.C.St.S., F.R.S.	R. Cull, Francis Galton, P. O'Cal- laghan, Dr. Norton Shaw, Thomas Wright.
1859. Aberdeen...	Rear - Admiral Sir James Clerk Ross, D.C.L., F.R.S.	Richard Cull, Prof. Geddes, Dr. Nor- ton Shaw.
1860. Oxford.....	Sir R. I. Murchison, D.C.L., F.R.S.	Capt. Burrows, Dr. J. Hunt, Dr. C. Lemprière, Dr. Norton Shaw.
1861. Manchester	John Crawford, F.R.S.....	Dr. J. Hunt, J. Kingsley, Dr. Nor- ton Shaw, W. Spottiswoode.
1862. Cambridge	Francis Galton, F.R.S.....	J.W. Clarke, Rev. J. Glover, Dr. Hunt, Dr. Norton Shaw, T. Wright.
1863. Newcastle	Sir R. I. Murchison, K.C.B., F.R.S.	C. Carter Blake, Hume Greenfield, C. R. Markham, R. S. Watson.
1864. Bath.....	Sir R. I. Murchison, K.C.B., F.R.S.	H. W. Bates, C. R. Markham, Capt. R. M. Murchison, T. Wright.
1865. Birmingham	Major-General Sir H. Raw- linson, M.P., K.C.B., F.R.S.	H. W. Bates, S. Evans, G. Jabet, C. R. Markham, Thomas Wright.

¹ Vide note on page li.

Date and Place	Presidents	Secretaries
1866. Nottingham	Sir Charles Nicholson, Bart., LL.D.	H. W. Bates, Rev. E. T. Cusins, R. H. Major, Clements R. Markham, D. W. Nash, T. Wright.
1867. Dundee ...	Sir Samuel Baker, F.R.G.S.	H. W. Bates, Cyril Graham, Clements R. Markham, S. J. Mackie, R. Sturrock.
1868. Norwich ...	Capt. G. H. Richards, R.N., F.R.S.	T. Baines, H. W. Bates, Clements R. Markham, T. Wright.

SECTION E (*continued*).—GEOGRAPHY.

1869. Exeter	Sir Bartle Frere, K.C.B., LL.D., F.R.G.S.	H. W. Bates, Clements R. Markham, J. H. Thomas.
1870. Liverpool...	Sir R. I. Murchison, Bt., K.C.B., LL.D., D.C.L., F.R.S., F.G.S.	H. W. Bates, David Buxton, Albert J. Mott, Clements R. Markham.
1871. Edinburgh	Colonel Yule, C.B., F.R.G.S.	A. Buchan, A. Keith Johnston, Clements R. Markham, J. H. Thomas.
1872. Brighton ...	Francis Galton, F.R.S.....	H. W. Bates, A. Keith Johnston, Rev. J. Newton, J. H. Thomas.
1873. Bradford ...	Sir Rutherford Alcock, K.C.B.	H. W. Bates, A. Keith Johnston, Clements R. Markham.
1874. Belfast.....	Major Wilson, R.E., F.R.S., F.R.G.S.	E. G. Ravenstein, E. C. Rye, J. H. Thomas.
1875. Bristol	Lieut. - General Strachey, R.E., C.S.I., F.R.S., F.R.G.S., F.L.S., F.G.S.	H. W. Bates, E. C. Rye, F. F. Tuckett.
1876. Glasgow ...	Capt. Evans, C.B., F.R.S.....	H. W. Bates, E. C. Rye, R. Oliphant Wood.
1877. Plymouth...	Adm. Sir E. Ommanney, C.B., F.R.S., F.R.G.S., F.R.A.S.	H. W. Bates, F. E. Fox, E. C. Rye.
1878. Dublin	Prof. Sir C. Wyville Thomson, LL.D., F.R.S. L&E	John Coles, E. C. Rye.
1879. Sheffield ...	Clements R. Markham, C.B., F.R.S., Sec. R.G.S.	H. W. Bates, C. E. D. Black, E. C. Rye.
1880. Swansea ...	Lieut.-Gen. Sir J. H. Lefroy, C.B., K.C.M.G., R.A., F.R.S., F.R.G.S.	H. W. Bates, E. C. Rye.
1881. York.....	Sir J. D. Hooker, K.C.S.I., C.B., F.R.S.	J. W. Barry, H. W. Bates.
1882. Southampton.	Sir R. Temple, Bart., G.C.S.I., F.R.G.S.	E. G. Ravenstein, E. C. Rye.
1883. Southport	Lieut.-Col. H. H. Godwin-Austen, F.R.S.	John Coles, E. G. Ravenstein, E. C. Rye.
1884. Montreal ...	Gen. Sir J. H. Lefroy, C.B., K.C.M.G., F.R.S., V.P.R.G.S.	Rev. Abbé Laflamme, J. S. O'Halloran, E. G. Ravenstein, J. F. Torrance.
1885. Aberdeen...	Gen. J. T. Walker, C.B., R.E., LL.D., F.R.S.	J. S. Keltie, J. S. O'Halloran, E. G. Ravenstein, Rev. G. A. Smith.
1886. Birmingham	Maj.-Gen. Sir F. J. Goldsmid, K.C.S.I., C.B., F.R.G.S.	F. T. S. Houghton, J. S. Keltie, E. G. Ravenstein.
1887. Manchester	Col. Sir C. Warren, R.E., G.C.M.G., F.R.S., F.R.G.S.	Rev. L. C. Casartelli, J. S. Keltie, H. J. Mackinder, E. G. Ravenstein.
1888. Bath	Col. Sir C. W. Wilson, R.E., K.C.B., F.R.S., F.R.G.S.	J. S. Keltie, H. J. Mackinder, E. G. Ravenstein.
1889. Newcastle-upon-Tyne	Col. Sir F. de Winton, K.C.M.G., C.B., F.R.G.S.	J. S. Keltie, H. J. Mackinder, R. Sullivan, A. Silva White.
1890. Leeds	Lieut.-Col. Sir R. Lambert Playfair, K.C.M.G., F.R.G.S.	A. Barker, John Coles, J. S. Keltie, A. Silva White.
1891. Cardiff	E. G. Ravenstein, F.R.G.S., F.S.S.	John Coles, J. S. Keltie, H. J. Mackinder, A. Silva White, Dr. Yeats.

Date and Place	Presidents	Secretaries
----------------	------------	-------------

STATISTICAL SCIENCE.

COMMITTEE OF SCIENCES, VI.—STATISTICS.

1833. Cambridge	Prof. Babbage, F.R.S.	J. E. Drinkwater.
1834. Edinburgh	Sir Charles Lemon, Bart.....	Dr. Cleland, C. Hope Maclean.

SECTION F.—STATISTICS.

1835. Dublin	Charles Babbage, F.R.S.	W. Greg, Prof. Longfield.
1836. Bristol	Sir Chas. Lemon, Bart., F.R.S.	Rev. J. E. Bromby, C. B. Fripp, James Heywood.
1837. Liverpool...	Rt. Hon. Lord Sandon	W. R. Greg, W. Langton, Dr. W. C. Tayler.
1838. Newcastle	Colonel Sykes, F.R.S.	W. Cargill, J. Heywood, W. R. Wood.
1839. Birmingham	Henry Hallam, F.R.S.	F. Clarke, R. W. Rawson, Dr. W. C. Tayler.
1840. Glasgow ...	Rt. Hon. Lord Sandon, M.P., F.R.S.	C. R. Baird, Prof. Ramsay, R. W. Rawson.
1841. Plymouth...	Lieut.-Col. Sykes, F.R.S.....	Rev. Dr. Byrth, Rev. R. Luney, R. W. Rawson.
1842. Manchester	G. W. Wood, M.P., F.L.S. ...	Rev. R. Luney, G. W. Ormerod, Dr. W. C. Tayler.
1843. Cork	Sir C. Lemon, Bart., M.P. ...	Dr. D. Bullen, Dr. W. Cooke Tayler.
1844. York.....	Lieut. - Col. Sykes, F.R.S., F.L.S.	J. Fletcher, J. Heywood, Dr. Lay- cock.
1845. Cambridge	Rt. Hon. the Earl Fitzwilliam	J. Fletcher, Dr. W. Cooke Tayler.
1846. Southamp- ton.	G. R. Porter, F.R.S.	J. Fletcher, F. G. P. Neison, Dr. W. C. Tayler, Rev. T. L. Shapcott.
1847. Oxford	Travers Twiss, D.C.L., F.R.S.	Rev. W. H. Cox, J. J. Danson, F. G. P. Neison.
1848. Swansea ...	J. H. Vivian, M.P., F.R.S. ...	J. Fletcher, Capt. R. Shortrede.
1849. Birmingham	Rt. Hon. Lord Lyttelton.....	Dr. Finch, Prof. Hancock, F. G. P. Neison.
1850. Edinburgh	Very Rev. Dr. John Lee, V.P.R.S.E.	Prof. Hancock, J. Fletcher, Dr. J. Stark.
1851. Ipswich ...	Sir John P. Boileau, Bart. ...	J. Fletcher, Prof. Hancock.
1852. Belfast.....	His Grace the Archbishop of Dublin.	Prof. Hancock, Prof. Ingram, James MacAdam, jun.
1853. Hull	James Heywood, M.P., F.R.S.	Edward Cheshire, W. Newmarch.
1854. Liverpool...	Thomas Tooke, F.R.S.	E. Cheshire, J. T. Danson, Dr. W. H. Duncan, W. Newmarch.
1855. Glasgow ...	R. Monckton Milnes, M.P. ...	J. A. Campbell, E. Cheshire, W. New- march, Prof. R. H. Walsh.

SECTION F (*continued*).—ECONOMIC SCIENCE AND STATISTICS.

1856. Cheltenham	Rt. Hon. Lord Stanley, M.P.	Rev. C. H. Bromby, E. Cheshire, Dr. W. N. Hancock, W. Newmarch, W. M. Tartt.
1857. Dublin.....	His Grace the Archbishop of Dublin, M.R.I.A.	Prof. Cairns, Dr. H. D. Hutton, W. Newmarch.
1858. Leeds	Edward Baines	T. B. Baines, Prof. Cairns, S. Brown Capt. Fishbourne, Dr. J. Strang.

Date and Place	Presidents	Secretaries
1859. Aberdeen...	Col. Sykes, M.P., F.R.S.	Prof. Cairns, Edmund Macrory, A. M. Smith, Dr. John Strang.
1860. Oxford	Nassau W. Senior, M.A.	Edmund Macrory, W. Newmarch, Rev. Prof. J. E. T. Rogers.
1861. Manchester	William Newmarch, F.R.S....	David Chadwick, Prof. R. C. Christie, E. Macrory, Rev. Prof. J. E. T. Rogers
1862. Cambridge	Edwin Chadwick, C.B.	H. D. Macleod, Edmund Macrory.
1863. Newcastle .	William Tite, M.P., F.R.S. ...	T. Doubleday, Edmund Macrory, Frederick Purdy, James Potts.
1864. Bath	William Farr, M.D., D.C.L., F.R.S.	E. Macrory, E. T. Payne, F. Purdy.
1865. Birmingham	Rt. Hon. Lord Stanley, LL.D., M.P.	G. J. D. Goodman, G. J. Johnston, E. Macrory.
1866. Nottingham	Prof. J. E. T. Rogers.....	R. Birkin, jun., Prof. Leone Levi, E. Macrory.
1867. Dundee	M. E. Grant-Duff, M.P.	Prof. Leone Levi, E. Macrory, A. J. Warden.
1868. Norwich	Samuel Brown, Pres. Instit. Actuaries.	Rev. W. C. Davie, Prof. Leone Levi.
1869. Exeter	Rt. Hon. Sir Stafford H. Northcote, Bart., C.B., M.P.	E. Macrory, F. Purdy, C. T. D. Acland.
1870. Liverpool...	Prof. W. Stanley Jevons, M.A.	Chas. R. Dudley Baxter, E. Macrory, J. Miles Moss.
1871. Edinburgh	Rt. Hon. Lord Neaves	J. G. Fitch, James Meikle.
1872. Brighton ...	Prof. Henry Fawcett, M.P. ...	J. G. Fitch, Barclay Phillips.
1873. Bradford ...	Rt. Hon. W. E. Forster, M.P.	J. G. Fitch, Swire Smith.
1874. Belfast.....	Lord O'Hagan	Prof. Donnell, F. P. Fellows, Hans MacMordie.
1875. Bristol	James Heywood, M.A., F.R.S., Pres. S.S.	F. P. Fellows, T. G. P. Hallett, E. Macrory.
1876. Glasgow ...	Sir George Campbell, K.C.S.I., M.P.	A. M. Neel Caird, T. G. P. Hallett, Dr. W. Neilson Hancock, Dr. W. Jack.
1877. Plymouth...	Rt. Hon. the Earl Fortescue	W. F. Collier, P. Hallett, J. T. Pim.
1878. Dublin	Prof. J. K. Ingram, LL.D., M.R.I.A.	W. J. Hancock, C. Molloy, J. T. Pim.
1879. Sheffield ...	G. Shaw Lefevre, M.P., Pres. S.S.	Prof. Adamson, R. E. Leader, C. Molloy.
1880. Swansea ...	G. W. Hastings, M.P.	N. A. Humphreys, C. Molloy.
1881. York.....	Rt. Hon. M. E. Grant-Duff, M.A., F.R.S.	C. Molloy, W. W. Morrell, J. F. Moss.
1882. Southamp- ton.	Rt. Hon. G. Sclater-Booth, M.P., F.R.S.	G. Baden-Powell, Prof. H. S. Foxwell, A. Milnes, C. Molloy.
1883. Southport	R. H. Inglis Palgrave, F.R.S.	Rev. W. Cunningham, Prof. H. S. Foxwell, J. N. Keynes, C. Molloy.
1884. Montreal ...	Sir Richard Temple, Bart., G.C.S.I., C.I.E., F.R.G.S.	Prof. H. S. Foxwell, J. S. McLennan, Prof. J. Watson.
1885. Aberdeen...	Prof. H. Sidgwick, LL.D., Litt.D.	Rev. W. Cunningham, Prof. H. S. Foxwell, C. McCombie, J. F. Moss.
1886. Birmingham	J. B. Martin, M.A., F.S.S.	F. F. Barham, Rev. W. Cunningham, Prof. H. S. Foxwell, J. F. Moss.
1887. Manchester	Robert Giffen, LL.D., V.P.S.S.	Rev. W. Cunningham, F. Y. Edgeworth, T. H. Elliott, C. Hughes, Prof. J. E. C. Munro, G. H. Sargant.
1888. Bath	Rt. Hon. Lord Bramwell, LL.D., F.R.S.	Prof. F. Y. Edgeworth, T. H. Elliott, Prof. H. S. Foxwell, L. L. F. R. Price.
1889. Newcastle- upon-Tyne	Prof. F. Y. Edgeworth, M.A., F.S.S.	Rev. Dr. Cunningham, T. H. Elliott, F. B. Jevons, L. L. F. R. Price.

Date and Place	Presidents	Secretaries
1890. Leeds	Prof. A. Marshall, M.A., F.S.S.	W. A. Brigg, Rev. Dr. Cunningham, T. H. Elliott, Prof. J. E. C. Munro, L. L. F. R. Price.
1891. Cardiff	Prof. W. Cunningham, D.D., D.Sc., F.S.S.	Prof. J. Brough, E. Cannan, Prof. E. C. K. Gonner, H. Ll. Smith, Prof. W. R. Sorley.

MECHANICAL SCIENCE.

SECTION G.—MECHANICAL SCIENCE.

1836. Bristol	Davies Gilbert, D.C.L., F.R.S.	T. G. Bunt, G. T. Clark, W. West.
1837. Liverpool...	Rev. Dr. Robinson	Charles Vignoles, Thomas Webster.
1838. Newcastle	Charles Babbage, F.R.S.	R. Hawthorn, C. Vignoles, T. Webster.
1839. Birmingham	Prof. Willis, F.R.S., and Robt. Stephenson.	W. Carpmacel, William Hawkes, T. Webster.
1840. Glasgow	Sir John Robinson	J. Scott Russell, J. Thomson, J. Tod, C. Vignoles.
1841. Plymouth	John Taylor, F.R.S.	Henry Chatfield, Thomas Webster.
1842. Manchester	Rev. Prof. Willis, F.R.S.	J. F. Bateman, J. Scott Russell, J. Thomson, Charles Vignoles.
1843. Cork	Prof. J. Macneill, M.R.I.A. ...	James Thomson, Robert Mallet.
1844. York	John Taylor, F.R.S.	Charles Vignoles, Thomas Webster.
1845. Cambridge	George Rennie, F.R.S.	Rev. W. T. Kingsley.
1846. Southampton	Rev. Prof. Willis, M.A., F.R.S.	William Betts, jun., Charles Manby.
1847. Oxford	Rev. Prof. Walker, M.A., F.R.S.	J. Glynn, R. A. Le Mesurier.
1848. Swansea ...	Rev. Prof. Walker, M.A., F.R.S.	R. A. Le Mesurier, W. P. Struvé.
1849. Birmingham	Robt. Stephenson, M.P., F.R.S.	Charles Manby, W. P. Marshall.
1850. Edinburgh	Rev. R. Robinson	Dr. Lees, David Stephenson.
1851. Ipswich	William Cubitt, F.R.S.	John Head, Charles Manby.
1852. Belfast	John Walker, C.E., LL.D., F.R.S.	John F. Bateman, C. B. Hancock, Charles Manby, James Thomson.
1853. Hull	William Fairbairn, C.E., F.R.S.	James Oldham, J. Thomson, W. Sykes Ward.
1854. Liverpool...	John Scott Russell, F.R.S. ...	John Grantham, J. Oldham, J. Thomson.
1855. Glasgow ...	W. J. Macquorn Rankine, C.E., F.R.S.	L. Hill, jun., William Ramsay, J. Thomson.
1856. Cheltenham	George Rennie, F.R.S.	C. Atherton, B. Jones, jun., H. M. Jeffery.
1857. Dublin	Rt. Hon. the Earl of Rosse, F.R.S.	Prof. Downing, W.T. Doyne, A. Tate, James Thomson, Henry Wright.
1858. Leeds	William Fairbairn, F.R.S. ...	J. C. Dennis, J. Dixon, H. Wright.
1859. Aberdeen ...	Rev. Prof. Willis, M.A., F.R.S.	R. Abernethy, P. Le Neve Foster, H. Wright.
1860. Oxford	Prof. W. J. Macquorn Rankine, LL.D., F.R.S.	P. Le Neve Foster, Rev. F. Harrison, Henry Wright.
1861. Manchester	J. F. Bateman, C.E., F.R.S.	P. Le Neve Foster, John Robinson, H. Wright.
1862. Cambridge	Wm. Fairbairn, LL.D., F.R.S.	W. M. Fawcett, P. Le Neve Foster.
1863. Newcastle	Rev. Prof. Willis, M.A., F.R.S.	P. Le Neve Foster, P. Westmacott, J. F. Spencer.
1864. Bath	J. Hawksley, F.R.S.	P. Le Neve Foster, Robert Pitt.
1865. Birmingham	Sir W. G. Armstrong, LL.D., F.R.S.	P. Le Neve Foster, Henry Lea, W. P. Marshall, Walter May.
1866. Nottingham	Thomas Hawksley, V.P.Inst. C.E., F.G.S.	P. Le Neve Foster, J. F. Iselin, M. O. Tarbotton.
1867. Dundee	Prof. W. J. Macquorn Rankine, LL.D., F.R.S.	P. Le Neve Foster, John P. Smith, W. W. Urquhart.

Date and Place	Presidents	Secretaries
1868. Norwich ...	G. P. Bidder, C.E., F.R.G.S.	P. Le Neve Foster, J. F. Iselin, C. Manby, W. Smith.
1869. Exeter	C. W. Siemens, F.R.S.	P. Le Neve Foster, H. Bauerman.
1870. Liverpool...	Chas. B. Vignoles, C.E., F.R.S.	H. Bauerman, P. Le Neve Foster, T. King, J. N. Shoolbred.
1871. Edinburgh	Prof. Fleeming Jenkin, F.R.S.	H. Bauerman, Alexander Leslie, J. P. Smith.
1872. Brighton ...	F. J. Bramwell, C.E.	H. M. Brunel, P. Le Neve Foster, J. G. Gamble, J. N. Shoolbred.
1873. Bradford ...	W. H. Barlow, F.R.S.	Crawford Barlow, H. Bauerman, E. H. Carbutt, J. C. Hawkshaw, J. N. Shoolbred.
1874. Belfast	Prof. James Thomson, LL.D., C.E., F.R.S.E.	A. T. Atchison, J. N. Shoolbred, John Smyth, jun.
1875. Bristol	W. Froude, C.E., M.A., F.R.S.	W. R. Browne, H. M. Brunel, J. G. Gamble, J. N. Shoolbred.
1876. Glasgow ...	C. W. Merrifield, F.R.S.	W. Bottomley, jun., W. J. Millar, J. N. Shoolbred, J. P. Smith.
1877. Plymouth...	Edward Woods, C.E.	A. T. Atchison, Dr. Merrifield, J. N. Shoolbred.
1878. Dublin	Edward Easton, C.E.	A. T. Atchison, R. G. Symes, H. T. Wood.
1879. Sheffield ...	J. Robinson, Pres. Inst. Mech. Eng.	A. T. Atchison, Emerson Bainbridge, H. T. Wood.
1880. Swansea ...	James Abernethy, V.P. Inst. C.E., F.R.S.E.	A. T. Atchison, H. T. Wood.
1881. York.....	Sir W. G. Armstrong, C.B., LL.D., D.C.L., F.R.S.	A. T. Atchison, J. F. Stephenson, H. T. Wood.
1882. Southamp- ton.	John Fowler, C.E., F.G.S. ...	A. T. Atchison, F. Churton, H. T. Wood.
1883. Southport	James Brunlees, F.R.S.E., Pres.Inst.C.E.	A. T. Atchison, E. Rigg, H. T. Wood.
1884. Montreal ...	Sir F. J. Bramwell, F.R.S., V.P.Inst.C.E.	A. T. Atchison, W. B. Dawson, J. Kennedy, H. T. Wood.
1885. Aberdeen...	B. Baker, M.Inst.C.E.	A. T. Atchison, F. G. Ogilvie, E. Rigg, J. N. Shoolbred.
1886. Birmingham	Sir J. N. Douglass, M.Inst. C.E.	C. W. Cooke, J. Kenward, W. B. Marshall, E. Rigg.
1887. Manchester	Prof. Osborne Reynolds, M.A., LL.D., F.R.S.	C. F. Budenberg, W. B. Marshall, E. Rigg.
1888. Bath.....	W. H. Preece, F.R.S., M.Inst.C.E.	C. W. Cooke, W. B. Marshall, E. Rigg, P. K. Stothert.
1889. Newcastle- upon-Tyne	W. Anderson, M.Inst.C.E. ...	C. W. Cooke, W. B. Marshall, Hon. C. A. Parsons, E. Rigg.
1890. Leeds	Capt. A. Noble, C.B., F.R.S., F.R.A.S.	E. K. Clark, C. W. Cooke, W. B. Marshall, E. Rigg.
1891. Cardiff	T. Forster Brown, M.Inst.C.E.	C. W. Cooke, Prof. A. C. Elliott, W. B. Marshall, E. Rigg.

ANTHROPOLOGICAL SCIENCE.

SECTION H.—ANTHROPOLOGY.

1884. Montreal ...	E. B. Tylor, D.C.L., F.R.S. ...	G. W. Bloxam, W. Hurst.
1885. Aberdeen...	Francis Galton, M.A., F.R.S.	G. W. Bloxam, Dr. J. G. Garson, W. Hurst, Dr. A. Macgregor.
1886. Birmingham	Sir G. Campbell, K.C.S.I., M.P., D.C.L., F.R.G.S.	G. W. Bloxam, Dr. J. G. Garson, W. Hurst, Dr. R. Saundby.

Date and Place	Presidents	Secretaries
1887. Manchester	Prof. A. H. Sayce, M.A.	G. W. Bloxam, Dr. J. G. Garson, Dr. A. M. Paterson.
1888. Bath.....	Lieut.-General Pitt-Rivers, D.C.L., F.R.S.	G. W. Bloxam, Dr. J. G. Garson, J. Harris Stone.
1889. Newcastle-upon-Tyne	Prof. Sir W. Turner, M.B., LL.D., F.R.S.	G. W. Bloxam, Dr. J. G. Garson, Dr. R. Morison, Dr. R. Howden.
1890. Leeds	Dr. J. Evans, Treas.R.S., F.S.A., F.L.S., F.G.S.	G. W. Bloxam, Dr. C. M. Chadwick, Dr. J. G. Garson.
1891. Cardiff	Prof. F. Max Müller, M.A. ...	G. W. Bloxam, Prof. R. Howden, H. Ling Roth, E. Seward.

LIST OF EVENING LECTURES.

Date and Place	Lecturer	Subject of Discourse
1842. Manchester	Charles Vignoles, F.R.S.....	The Principles and Construction of Atmospheric Railways.
	Sir M. I. Brunel	The Thames Tunnel.
	R. I. Murchison.....	The Geology of Russia.
1843. Cork	Prof. Owen, M.D., F.R.S.....	The Dinornis of New Zealand.
	Prof. E. Forbes, F.R.S.....	The Distribution of Animal Life in the Ægean Sea.
	Dr. Robinson.....	The Earl of Rosse's Telescope.
1844. York	Charles Lyell, F.R.S.	Geology of North America.
	Dr. Falconer, F.R.S.....	The Gigantic Tortoise of the Siwalik Hills in India.
1845. Cambridge	G. B. Airy, F.R.S., Astron. Royal	Progress of Terrestrial Magnetism.
	R. I. Murchison, F.R.S.	Geology of Russia.
1846. Southamp- ton.	Prof. Owen, M.D., F.R.S. ...	Fossil Mammalia of the British Isles.
	Charles Lyell, F.R.S.	Valley and Delta of the Mississippi.
	W. R. Grove, F.R.S.....	Properties of the Explosive substance discovered by Dr. Schönbein; also some Researches of his own on the Decomposition of Water by Heat.
1847. Oxford.....	Rev. Prof. B. Powell, F.R.S.	Shooting Stars.
	Prof. M. Faraday, F.R.S.....	Magnetic and Diamagnetic Phenomena.
	Hugh E. Strickland, F.G.S....	The Dodo (<i>Didus ineptus</i>).
1848. Swansea ...	John Percy, M.D., F.R.S.....	Metallurgical Operations of Swansea and its Neighbourhood.
	W. Carpenter, M.D., F.R.S....	Recent Microscopical Discoveries.
1849. Birmingham	Dr. Faraday, F.R.S.	Mr. Gassiot's Battery.
	Rev. Prof. Willis, M.A., F.R.S.	Transit of different Weights with varying Velocities on Railways.
1850. Edinburgh	Prof. J. H. Bennett, M.D., F.R.S.E.	Passage of the Blood through the minute vessels of Animals in connection with Nutrition.
	Dr. Mantell, F.R.S.	Extinct Birds of New Zealand.
1851. Ipswich ...	Prof. R. Owen, M.D., F.R.S.	Distinction between Plants and Animals, and their changes of Form.
	G. B. Airy, F.R.S., Astron. Royal	Total Solar Eclipse of July 28, 1851.
1852. Belfast.....	Prof. G. G. Stokes, D.C.L., F.R.S.	Recent Discoveries in the properties of Light.
	Colonel Portlock, R.E., F.R.S.	Recent Discovery of Rock-salt at Carrickfergus, and geological and practical considerations connected with it.

Date and Place	Lecturer	Subject of Discourse
1853. Hull	Prof. J. Phillips, LL.D., F.R.S., F.G.S.	Some peculiar Phenomena in the Geology and Physical Geography of Yorkshire.
1854. Liverpool...	Robert Hunt, F.R.S..... Prof. R. Owen, M.D., F.R.S. Col. E. Sabine, V.P.R.S.	The present state of Photography. Anthropomorphous Apes. Progress of Researches in Terrestrial Magnetism.
1855. Glasgow ...	Dr. W. B. Carpenter, F.R.S. Lieut.-Col. H. Rawlinson ...	Characters of Species. Assyrian and Babylonian Antiquities and Ethnology.
1856. Cheltenham	Col. Sir H. Rawlinson	Recent Discoveries in Assyria and Babylonia, with the results of Cuneiform research up to the present time.
1857. Dublin	W. R. Grove, F.R.S..... Prof. W. Thomson, F.R.S. ...	Correlation of Physical Forces. The Atlantic Telegraph.
1858. Leeds	Rev. Dr. Livingstone, D.C.L.	Recent Discoveries in Africa.
1858. Leeds	Prof. J. Phillips, LL.D., F.R.S.	The Ironstones of Yorkshire.
1859. Aberdeen...	Prof. R. Owen, M.D., F.R.S.	The Fossil Mammalia of Australia.
1859. Aberdeen...	Sir R. I. Murchison, D.C.L....	Geology of the Northern Highlands.
1859. Aberdeen...	Rev. Dr. Robinson, F.R.S. ...	Electrical Discharges in highly rarefied Media.
1860. Oxford.....	Rev. Prof. Walker, F.R.S. ...	Physical Constitution of the Sun.
1860. Oxford.....	Captain Sherard Osborn, R.N.	Arctic Discovery.
1861. Manchester	Prof. W. A. Miller, M.A., F.R.S.	Spectrum Analysis.
1861. Manchester	G. B. Airy, F.R.S., Astron. Royal.	The late Eclipse of the Sun.
1862. Cambridge	Prof. Tyndall, LL.D., F.R.S.	The Forms and Action of Water.
1862. Cambridge	Prof. Odling, F.R.S.....	Organic Chemistry.
1863. Newcastle	Prof. Williamson, F.R.S.....	The Chemistry of the Galvanic Bat- tery considered in relation to Dynamics.
1863. Newcastle	James Glaisher, F.R.S.....	The Balloon Ascents made for the British Association.
1864. Bath.....	Prof. Roscoe, F.R.S.....	The Chemical Action of Light.
1864. Bath.....	Dr. Livingstone, F.R.S.	Recent Travels in Africa.
1865. Birmingham	J. Beete Jukes, F.R.S.....	Probabilities as to the position and extent of the Coal-measures be- neath the red rocks of the Mid- land Counties.
1865. Birmingham	William Huggins, F.R.S. ...	The results of Spectrum Analysis applied to Heavenly Bodies.
1866. Nottingham	Dr. J. D. Hooker, F.R.S.....	Insular Floras.
1867. Dundee.....	Archibald Geikie, F.R.S.....	The Geological Origin of the present Scenery of Scotland.
1867. Dundee.....	Alexander Herschel, F.R.A.S.	The present state of Knowledge re- garding Meteors and Meteorites.
1868. Norwich ...	J. Fergusson, F.R.S.....	Archæology of the early Buddhist Monuments.
1868. Norwich ...	Dr. W. Odling, F.R.S.	Reverse Chemical Actions.
1869. Exeter	Prof. J. Phillips, LL.D., F.R.S.	Vesuvius.
1869. Exeter	J. Norman Lockyer F.R.S. ...	The Physical Constitution of the Stars and Nebulæ.
1870. Liverpool...	Prof. J. Tyndall, LL.D., F.R.S.	The Scientific Use of the Imagination.
1870. Liverpool...	Prof. W. J. Macquorn Rankine, LL.D., F.R.S.	Stream-lines and Waves, in connec- tion with Naval Architecture.
1871. Edinburgh	F. A. Abel, F.R.S.....	Some recent Investigations and Ap- plications of Explosive Agents.
1871. Edinburgh	E. B. Tylor, F.R.S. ...	The Relation of Primitive to Modern Civilisation.

Date and Place	Lecturer	Subject of Discourse
1872. Brighton ...	Prof. P. Martin Duncan, M.B., F.R.S. Prof. W. K. Clifford	Insect Metamorphosis. The Aims and Instruments of Scientific Thought.
1873. Bradford ...	Prof. W. C. Williamson, F.R.S. Prof. Clerk Maxwell, F.R.S.	Coal and Coal Plants. Molecules.
1874. Belfast	Sir John Lubbock, Bart., M.P., F.R.S. Prof. Huxley, F.R.S.	Common Wild Flowers considered in relation to Insects. The Hypothesis that Animals are Automata, and its History.
1875. Bristol	W. Spottiswoode, LL.D., F.R.S. F. J. Bramwell, F.R.S.	The Colours of Polarised Light. Railway Safety Appliances.
1876. Glasgow ...	Prof. Tait, F.R.S.E. Sir Wyville Thomson, F.R.S.	Force. The <i>Challenger</i> Expedition.
1877. Plymouth ...	W. Warington Smyth, M.A., F.R.S. Prof. Odling, F.R.S.	The Physical Phenomena connected with the Mines of Cornwall and Devon. The new Element, Gallium.
1878. Dublin	G. J. Romanes, F.L.S. Prof. Dewar, F.R.S.	Animal Intelligence. Dissociation, or Modern Ideas of Chemical Action.
1879. Sheffield ...	W. Crookes, F.R.S. Prof. E. Ray Lankester, F.R.S.	Radiant Matter. Degeneration.
1880. Swansea ...	Prof. W. Boyd Dawkins, F.R.S. Francis Galton, F.R.S.	Primeval Man. Mental Imagery.
1881. York.....	Prof. Huxley, Sec. R.S. W. Spottiswoode, Pres. R.S.	The Rise and Progress of Palæontology. The Electric Discharge, its Forms and its Functions.
1882. Southamp- ton.	Prof. Sir Wm. Thomson, F.R.S. Prof. H. N. Moseley, F.R.S.	Tides. Pelagic Life.
1883. Southport	Prof. R. S. Ball, F.R.S. Prof. J. G. McKendrick, F.R.S.E.	Recent Researches on the Distance of the Sun. Galvanic and Animal Electricity.
1884. Montreal ...	Prof. O. J. Lodge, D.Sc. Rev. W. H. Dallinger, F.R.S.	Dust. The Modern Microscope in Researches on the Least and Lowest Forms of Life.
1885. Aberdeen...	Prof. W. G. Adams, F.R.S. ... John Murray, F.R.S.E.	The Electric Light and Atmospheric Absorption. The Great Ocean Basins.
1886. Birmingham	A. W. Rücker, M.A., F.R.S. Prof. W. Rutherford, M.D. ...	Soap Bubbles. The Sense of Hearing.
1887. Manchester	Prof. H. B. Dixon, F.R.S. ... Col. Sir F. de Winton, K.C.M.G.	The Rate of Explosions in Gases. Explorations in Central Africa.
1888. Bath.....	Prof. W. E. Ayrton, F.R.S. ... Prof. T. G. Bonney, D.Sc., F.R.S.	The Electrical Transmission of Power. The Foundation Stones of the Earth's Crust.
1889. Newcastle- upon-Tyne	Prof. W. C. Roberts-Austen, F.R.S. Walter Gardiner, M.A.	The Hardening and Tempering of Steel. How Plants maintain themselves in the Struggle for Existence.
1890. Leeds	E. B. Poulton, M.A., F.R.S. ... Prof. C. Vernon Boys, F.R.S.	Mimicry. Quartz Fibres and their Applications.
1891. Cardiff	Prof. L. C. Miall, F.L.S., F.G.S. Prof. A. W. Rücker, M.A., F.R.S.	Some Difficulties in the Life of Aquatic Insects. Electrical Stress.

LECTURES TO THE OPERATIVE CLASSES.

Date and Place	Lecturer	Subject of Discourse
1867. Dundee.....	Prof. J. Tyndall, LL.D., F.R.S.	Matter and Force.
1868. Norwich ...	Prof. Huxley, LL.D., F.R.S.	A Piece of Chalk.
1869. Exeter	Prof. Miller, M.D., F.R.S. ...	Experimental Illustrations of the modes of detecting the Composition of the Sun and other Heavenly Bodies by the Spectrum.
1870. Liverpool...	Sir John Lubbock, Bart., M.P., F.R.S.	Savages.
1872. Brighton ...	W. Spottiswoode, LL.D., F.R.S.	Sunshine, Sea, and Sky.
1873. Bradford ...	C. W. Siemens, D.C.L., F.R.S.	Fuel.
1874. Belfast	Prof. Odling, F.R.S.....	The Discovery of Oxygen.
1875. Bristol	Dr. W. B. Carpenter, F.R.S.	A Piece of Limestone.
1876. Glasgow ...	Commander Cameron, C.B., R.N.	A Journey through Africa.
1877. Plymouth ...	W. H. Preece	Telegraphy and the Telephone.
1879. Sheffield ...	W. E. Ayrton	Electricity as a Motive Power.
1880. Swansea ...	H. Seebohm, F.Z.S.	The North-East Passage.
1881. York	Prof. Osborne Reynolds, F.R.S.	Raindrops, Hailstones, and Snowflakes.
1882. Southamp- ton.	John Evans, D.C.L., Treas. R.S.	Unwritten History, and how to read it.
1883. Southport	Sir F. J. Bramwell, F.R.S. ...	Talking by Electricity—Telephones.
1884. Montreal ...	Prof. R. S. Ball, F.R.S.....	Comets.
1885. Aberdeen ...	H. B. Dixon, M.A.	The Nature of Explosions.
1886. Birmingham	Prof. W. C. Roberts-Austen, F.R.S.	The Colours of Metals and their Alloys.
1887. Manchester	Prof. G. Forbes, F.R.S.	Electric Lighting.
1888. Bath	Sir John Lubbock, Bart., M.P., F.R.S.	The Customs of Savage Races.
1889. Newcastle- upon-Tyne	B. Baker, M.Inst.C.E.	The Forth Bridge.
1890. Leeds	Prof. J. Perry, D.Sc., F.R.S.	Spinning Tops.
1891. Cardiff	Prof. S. P. Thompson, F.R.S.	Electricity in Mining.

OFFICERS OF SECTIONAL COMMITTEES PRESENT AT THE CARDIFF MEETING.

SECTION A.—MATHEMATICAL AND PHYSICAL SCIENCE.

President.—Professor Oliver J. Lodge, D.Sc., LL.D., F.R.S.

Vice-Presidents.—Sir Robert Ball, F.R.S.; W. Crookes, F.R.S.; Professor G. Carey Foster, F.R.S.; Rev. Robert Harley, F.R.S.; Professor J. Viriamu Jones, M.A.; Professor H. Lamb, F.R.S.; Professor H. A. Newton; Professor A. W. Rücker, F.R.S.

Secretaries.—R. E. Baynes, M.A. (*Recorder*); J. Larmor, M.A.; Professor A. Lodge, M.A.; Professor A. L. Selby, M.A.

SECTION B.—CHEMISTRY AND MINERALOGY.

President.—Professor W. Chandler Roberts-Austen, C.B., F.R.S., F.C.S.

Vice-Presidents.—Sir F. A. Abel, K.C.B., F.R.S.; W. Crookes, F.R.S.; Dr. J. H. Gladstone, F.R.S.; Professor G. D. Liveing, F.R.S.; Professor H. McLeod, F.R.S.; Professor R. Meldola, F.R.S.; Ludwig Mond, F.R.S.; Professor C. M. Thompson, M.A.

Secretaries.—C. H. Bothamley, F.C.S.; H. Forster Morley, D.Sc. (*Recorder*); W. W. J. Nicol, M.A.; G. S. Turpin, M.A.

SECTION C.—GEOLOGY.

President.—Professor T. Rupert Jones, F.R.S., F.G.S.

Vice-Presidents.—Sir Archibald Geikie, For.Sec.R.S.; Dr. H. Hicks, F.R.S.; Professor C. Lapworth, F.R.S.; Professor W. J. Sollas, F.R.S.; Rev. H. H. Winwood, M.A.; Professor G. Frederick Wright; Professor F. Zirkel, Ph.D.

Secretaries.—W. Galloway; J. E. Marr, F.R.S.; Clement Reid; W. W. Watts, M.A. (*Recorder*).

SECTION D.—BIOLOGY.

President.—Francis Darwin, M.A., M.B., F.R.S., F.L.S.

Vice-Presidents.—D. H. Scott, M.A.; Professor W. Stirling, M.D.; Dr. R. H. Traquair, F.R.S.; Professor H. Marshall Ward, F.R.S.

Secretaries.—F. E. Beddard, M.A.; Professor W. A. Herdman, D.Sc.; Sydney J. Hickson, D.Sc. (*Recorder*); George Murray, F.L.S.; Professor W. Newton Parker, Ph.D.; Harold Wager.

SECTION E.—GEOGRAPHY.

President.—E. G. Ravenstein, F.R.G.S., F.S.S., F.R.S.G.S.

Vice-Presidents.—Colonel Sir Francis de Winton, K.C.M.G., C.B. ; H. Seebohm, Hon. Sec. R.G.S.

Secretaries.—John Coles, F.R.G.S. ; J. Scott Keltie, F.R.G.S. (*Recorder*) ; A. Silva White, F.R.S.E. ; Dr. Yeats.

SECTION F.—ECONOMIC SCIENCE AND STATISTICS.

President.—Professor Cunningham, D.D., D.Sc., F.S.S.

Vice-Presidents.—Professor C. F. Bastable, F.S.S. ; Professor F. Y. Edgeworth, F.S.S. ; Hon. Sir Charles W. Fremantle, K.C.B. ; J. B. Martin, F.S.S.

Secretaries.—Professor J. Brough, LL.D. ; Professor E. C. K. Gonner, F.S.S. (*Recorder*) ; Professor W. R. Sorley, M.A.

SECTION G.—MECHANICAL SCIENCE.

President.—T. Foster Brown, M.Inst.C.E.

Vice-Presidents.—James Abernethy, M.Inst.C.E. ; Sir Benjamin Baker, K.C.M.G., F.R.S. ; J. Wolfe Barry, M.Inst.C.E. ; G. Chatterton, M.Inst.C.E. ; Professor Osborne Reynolds, F.R.S. ; T. Hurry Riches, M.Inst.C.E.

Secretaries.—Conrad W. Cooke ; Professor A. C. Elliott, D.Sc. ; W. Bayley Marshall, M.Inst.C.E. ; E. Rigg, M.A. (*Recorder*).

SECTION H.—ANTHROPOLOGY.

President.—Professor F. Max Müller, M.A.

Vice-Presidents.—The Marquess of Bute, K.T. ; E. W. Brabrook, F.S.A. ; J. G. Garson, M.D. ; Dr. E. B. Tylor, F.R.S.

Secretaries.—G. W. Bloxam, M.A. (*Recorder*) ; H. Ling Roth ; Edwin Seward.

THE BRITISH ASSOCIATION FOR

Dr.

THE GENERAL

From the commencement of the Leeds Meeting, 1890, and not

1890-91.

RECEIPTS.

	£	s.	d.
By Balance brought forward	298	16	0
„ New Life Compositions at Leeds Meeting and since.....	250	0	0
„ New Annual Members „ „	194	0	0
„ Annual Subscriptions „ „	598	0	0
„ Associates' Tickets at Leeds Meeting	678	0	0
„ Ladies' Tickets „ „	334	0	0
„ Sale of Publications	47	17	6
„ Rent received from Mathematical Society, for year ended September 29, 1890.....	12	15	0
„ Interest on Exchequer Bills	16	9	1
„ Dividends on Consols	227	18	4
„ Dividends on India 3 per cents.	105	6	0
„ Amount received from Mr. Sclater on account of Grant ' Zoology and Botany of West India Islands '	100	0	0
„ Amount received from Dr. H. Woodward, being unexpended balance of Grant for ' Lias Beds in Northamptonshire ' ...	16	12	0
„ Amount received from Professor G. F. Fitzgerald, being un- expended balance of Grant made for ' Electrolysis '.....	2	2	6
„ Amount received from Professor M. Foster, being the un- expended balance of Grant made for ' Botanical Station at Peradeniya '	2	0	0

£2883 16 5

Investments Account : July 31, 1891.

	£	s.	d.
New Consols.....	8500	0	0
India 3 per cents.	3600	0	0
Exchequer Bills	500	0	0

THE ADVANCEMENT OF SCIENCE.

TREASURER'S ACCOUNT

Cr.

including receipts on account of the Cardiff Meeting, 1891.

1890-91.

PAYMENTS.

	£	s.	d.
To Expenses of Leeds Meeting, including Printing and Advertising, purchase of Banners, and payments in respect of New Offices	362	10	3
„ Salaries, one year (1890-91).....	528	15	0
„ Rent of Office, 22 Albemarle Street, W. (1890-91)	117	0	0

GRANTS.

	£	s.	d.
Anthropometric Committee	10	0	0
Improving Deep-sea Tow-net	40	0	0
Discharge of Electricity from Points	10	0	0
Isomeric Naphthalene Derivatives	25	0	0
Botanical Station at Peradeniya	50	0	0
Variations of Temperature in Lakes	20	0	0
Photographs of Meteorological Phenomena	5	0	0
Corresponding Societies	25	0	0
Investigation of Caves at Elbolton	25	0	0
North-Western Tribes of Canada	200	0	0
Lias Beds of Northamptonshire	25	0	0
Meteorological Observations on Ben Nevis	50	0	0
Seismological Phenomena of Japan	10	0	0
Geological Record	100	0	0
Anthropological Notes and Queries	50	0	0
Electrolysis	5	0	0
Action of Light on Dyes	17	10	0
Analysis of Iron and Steel	10	0	0
Ultra-violet Rays of Solar Spectrum	50	0	0
Action of Waves and Currents in Estuaries	125	0	0
Fossil Phyllopora	10	0	0
Photographs of Geological Interest	9	5	0
Formation of Haloid Salts	25	0	0
Disappearance of Native Plants	5	0	0
Volcanic Phenomena of Vesuvius	10	0	0
Registration of Type-specimens of British Fossils	5	5	0
Electrical Standards	100	0	0
Marine Biological Association at Plymouth	12	10	0
	1029	10	0

By Balance at Bank of England, Western Branch, 900 13 11
 Less Cheques issued, but not presented to date 57 15 0

842 18 11

In hands of Assistant to General Treasurer ... 3 2 3

846 1 2

£2883 16 5

J. H. GLADSTONE, }
 HERBERT MCLEOD, } *Auditors.*

July 31, 1891.

Table showing the Attendance and Receipts

Date of Meeting	Where held	Presidents		
			Old Life Members	New Life Members
1831, Sept. 27 ...	York	The Earl Fitzwilliam, D.C.L.
1832, June 19 ...	Oxford	The Rev. W. Buckland, F.R.S.
1833, June 25 ...	Cambridge	The Rev. A. Sedgwick, F.R.S.
1834, Sept. 8 ...	Edinburgh	Sir T. M. Brisbane, D.C.L.....
1835, Aug. 10 ...	Dublin	The Rev. Provost Lloyd, LL.D.
1836, Aug. 22 ...	Bristol	The Marquis of Lansdowne
1837, Sept. 11 ...	Liverpool	The Earl of Burlington, F.R.S.
1838, Aug. 10 ...	Newcastle-on-Tyne	The Duke of Northumberland
1839, Aug. 26 ...	Birmingham.....	The Rev. W. Vernon Harcourt
1840, Sept. 17 ...	Glasgow	The Marquis of Breadalbane...
1841, July 20 ...	Plymouth	The Rev. W. Whewell, F.R.S.	169	65
1842, June 23 ...	Manchester	The Lord Francis Egerton.....	303	169
1843, Aug. 17 ...	Cork	The Earl of Rosse, F.R.S.	109	28
1844, Sept. 26 ...	York	The Rev. G. Peacock, D.D. ...	226	150
1845, June 19 ...	Cambridge	Sir John F. W. Herschel, Bart.	313	36
1846, Sept. 10 ...	Southampton	Sir Roderick I. Murchison, Bart.	241	10
1847, June 23 ...	Oxford	Sir Robert H. Inglis, Bart.....	314	18
1848, Aug. 9 ...	Swansea	The Marquis of Northampton	149	3
1849, Sept. 12 ...	Birmingham.....	The Rev. T. R. Robinson, D.D.	227	12
1850, July 21 ...	Edinburgh	Sir David Brewster, K.H.	235	9
1851, July 2 ...	Ipswich	G. B. Airy, Astronomer Royal	172	8
1852, Sept. 1 ...	Belfast	Lieut.-General Sabine, F.R.S.	164	10
1853, Sept. 3 ...	Hull	William Hopkins, F.R.S.	141	13
1854, Sept. 20 ...	Liverpool	The Earl of Harrowby, F.R.S. ...	238	23
1855, Sept. 12 ...	Glasgow	The Duke of Argyll, F.R.S. ...	194	33
1856, Aug. 6 ...	Cheltenham	Prof. C. G. B. Daubeny, M.D.	182	14
1857, Aug. 26 ...	Dublin	The Rev. Humphrey Lloyd, D.D.	236	15
1858, Sept. 22 ...	Leeds.....	Richard Owen, M.D., D.C.L.....	222	42
1859, Sept. 14 ...	Aberdeen	H.R.H. the Prince Consort ...	184	27
1860, June 27 ...	Oxford	The Lord Wrottesley, M.A. ...	286	21
1861, Sept. 4 ...	Manchester	William Fairbairn, LL.D., F.R.S.	321	113
1862, Oct. 1 ...	Cambridge	The Rev. Professor Willis, M.A.	239	15
1863, Aug. 26 ...	Newcastle-on-Tyne	Sir William G. Armstrong, C.B.	203	36
1864, Sept. 13 ...	Bath	Sir Charles Lyell, Bart., M.A.	287	40
1865, Sept. 6 ...	Birmingham.....	Prof. J. Phillips, M.A., LL.D.	292	44
1866, Aug. 22 ...	Nottingham.....	William R. Grove, Q.C., F.R.S.	207	31
1867, Sept. 4 ...	Dundee	The Duke of Buccleuch, K.C.B.	167	25
1868, Aug. 19 ...	Norwich	Dr. Joseph D. Hooker, F.R.S.	196	18
1869, Aug. 18 ...	Exeter	Prof. G. G. Stokes, D.C.L.	204	21
1870, Sept. 14 ...	Liverpool	Prof. T. H. Huxley, LL.D.....	314	39
1871, Aug. 2 ...	Edinburgh	Prof. Sir W. Thomson, LL.D.	246	28
1872, Aug. 14 ...	Brighton	Dr. W. B. Carpenter, F.R.S. ...	245	36
1873, Sept. 17 ...	Bradford	Prof. A. W. Williamson, F.R.S.	212	27
1874, Aug. 19 ...	Belfast	Prof. J. Tyndall, LL.D., F.R.S.	162	13
1875, Aug. 25 ...	Bristol	Sir John Hawkshaw, C.E., F.R.S.	239	36
1876, Sept. 6 ...	Glasgow	Prof. T. Andrews, M.D., F.R.S.	221	35
1877, Aug. 15 ...	Plymouth	Prof. A. Thomson, M.D., F.R.S.	173	19
1878, Aug. 14 ...	Dublin	W. Spottiswoode, M.A., F.R.S.	201	18
1879, Aug. 20 ...	Sheffield	Prof. G. J. Allman, M.D., F.R.S.	184	16
1880, Aug. 25 ...	Swansea	A. C. Ramsay, LL.D., F.R.S....	144	11
1881, Aug. 31 ...	York	Sir John Lubbock, Bart., F.R.S.	272	28
1882, Aug. 23 ...	Southampton	Dr. C. W. Siemens, F.R.S.....	178	17
1883, Sept. 19 ...	Southport	Prof. A. Cayley, D.C.L., F.R.S.	203	60
1884, Aug. 27 ...	Montreal	Prof. Lord Rayleigh, F.R.S. ...	235	20
1885, Sept. 9 ...	Aberdeen	Sir Lyon Playfair, K.C.B., F.R.S.	225	18
1886, Sept. 1 ...	Birmingham.....	Sir J.W. Dawson, C.M.G., F.R.S.	314	25
1887, Aug. 31 ...	Manchester	Sir H. E. Roscoe, D.C.L., F.R.S.	428	86
1888, Sept. 5 ...	Bath	Sir F. J. Bramwell, F.R.S.....	266	36
1889, Sept. 11 ...	Newcastle-on-Tyne	Prof. W. H. Flower, C.B., F.R.S.	277	20
1890, Sept. 3 ...	Leeds.....	Sir F. A. Abel, C.B., F.R.S. ...	259	21
1891, Aug. 19 ...	Cardiff	Dr. W. Huggins, F.R.S.	189	24

* Ladies were not admitted by purchased Tickets until 1843.

† Tickets of Admission to Sections of

at Annual Meetings of the Association.

Attended by						Amount received during the Meeting	Sums paid on Account of Grants for Scientific Purposes	Year	
Old Annual Members	New Annual Members	Associates	Ladies	Foreigners	Total				
...	353	1831	
...	1832	
...	900	1833	
...	1298	£20 0 0	1834	
...	167 0 0	1835	
...	1350	435 0 0	1836	
...	1840	922 12 6	1837	
...	1100*	...	2400	932 2 2	1838	
...	34	1438	1595 11 0	1839	
...	40	1353	1546 16 4	1840	
46	317	...	60*	...	891	1235 10 11	1841	
75	376	33†	331*	28	1315	1449 17 8	1842	
71	185	...	160	1565 10 2	1843	
45	190	9†	260	981 12 8	1844	
94	22	407	172	35	1079	831 9 9	1845	
65	39	270	196	36	857	685 16 0	1846	
197	40	495	203	53	1320	208 5 4	1847	
54	25	376	197	15	819	£707 0 0	275 1 8	1848	
93	33	447	237	22	1071	963 0 0	159 19 6	1849	
128	42	510	273	44	1241	1085 0 0	345 18 0	1850	
61	47	244	141	37	710	620 0 0	391 9 7	1851	
63	60	510	292	9	1108	1085 0 0	304 6 7	1852	
56	57	367	236	6	876	903 0 0	205 0 0	1853	
121	121	765	524	10	1802	1882 0 0	380 19 7	1854	
142	101	1094	543	26	2133	2311 0 0	480 16 4	1855	
104	48	412	346	9	1115	1098 0 0	734 13 9	1856	
156	120	900	569	26	2022	2015 0 0	507 15 4	1857	
111	91	710	509	13	1698	1931 0 0	618 18 2	1858	
125	179	1206	821	22	2564	2782 0 0	684 11 1	1859	
177	59	636	463	47	1689	1604 0 0	766 19 6	1860	
184	125	1589	791	15	3138	3944 0 0	1111 5 10	1861	
150	57	433	242	25	1161	1089 0 0	1293 16 6	1862	
154	209	1704	1004	25	3335	3640 0 0	1608 3 10	1863	
182	103	1119	1058	13	2802	2965 0 0	1289 15 8	1864	
215	149	766	508	23	1997	2227 0 0	1591 7 10	1865	
218	105	960	771	11	2303	2469 0 0	1750 13 4	1866	
193	118	1163	771	7	2444	2613 0 0	1739 4 0	1867	
226	117	720	682	45†	2004	2042 0 0	1940 0 0	1868	
229	107	678	600	17	1856	1931 0 0	1622 0 0	1869	
303	195	1103	910	14	2878	3096 0 0	1572 0 0	1870	
311	127	976	754	21	2463	2575 0 0	1472 2 6	1871	
280	80	937	912	43	2533	2649 0 0	1285 0 0	1872	
237	99	796	601	11	1983	2120 0 0	1685 0 0	1873	
232	85	817	630	12	1951	1979 0 0	1151 16 0	1874	
307	93	884	672	17	2248	2397 0 0	960 0 0	1875	
331	185	1265	712	25	2774	3023 0 0	1092 4 2	1876	
238	59	446	283	11	1229	1268 0 0	1128 9 7	1877	
290	93	1285	674	17	2578	2615 0 0	725 16 6	1878	
239	74	529	349	13	1404	1425 0 0	1080 11 11	1879	
171	41	389	147	12	915	899 0 0	731 7 7	1880	
313	176	1230	514	24	2557	2689 0 0	476 3 1	1881	
253	79	516	189	21	1253	1286 0 0	1126 1 11	1882	
330	323	952	841	5	2714	3369 0 0	1083 3 3	1883	
317	219	826	74	26 & 60 H. §		1777	1538 0 0	1173 4 0	1884
332	122	1053	447	6	2203	2256 0 0	1385 0 0	1885	
428	179	1067	429	11	2453	2532 0 0	995 0 6	1886	
510	244	1985	493	92	3838	4336 0 0	1186 18 0	1887	
399	100	639	509	35	1984	2107 0 0	1511 0 5	1888	
412	113	1024	579	12	2137	2441 0 0	1417 0 11	1889	
368	92	680	334	21	1775	1776 0 0	789 16 8	1890	
341	152	672	107	12	1497	1664 0 0	1029 10 0	1891	

† Including Ladies.

§ Fellows of the American Association were admitted as Hon. Members for this Meeting.

OFFICERS AND COUNCIL, 1892.

PRESIDENT.

WILLIAM HUGGINS, Esq., D.C.L., LL.D., F.R.S., Hon. FR.S.E., F.R.A.S.

VICE-PRESIDENTS.

<p>The Right Hon. LORD WINDSOR, Lord-Lieutenant of Glamorganshire.</p> <p>The Most Hon. the MARQUESS OF BUTE, K.T.</p> <p>The Right Hon. LORD RAYLEIGH, M.A., D.C.L., LL.D., Sec. R.S., F.R.A.S., F.R.G.S.</p> <p>The Right Hon. LORD TREDEGAR.</p> <p>The Right Hon. LORD ABERDAKE, G.C.B., F.R.S., F.R.G.S.</p>	<p>Sir J. T. D. LLEWELYN, Bart., F.Z.S.</p> <p>Sir ARCHIBALD GEIKIE, LL.D., D.Sc., For. Sec. R.S., F.R.S.E., Pres. G.S., Director-General of the Geological Survey of the United Kingdom.</p> <p>Sir ROBERT BALL, F.R.S., Royal Astronomer of Ireland.</p>
--	---

PRESIDENT ELECT.

Sir **ARCHIBALD GEIKIE, LL.D., D.Sc., For. Sec. R.S., F.R.S.E., Pres. G.S.**, Director-General of the Geological Survey of the United Kingdom.

VICE-PRESIDENTS ELECT.

<p>The Right Hon. the LORD PROVOST OF EDINBURGH.</p> <p>The Most Hon. the MARQUESS OF LOTHIAN, K.T.</p> <p>The Right Hon. the EARL OF ROSEBERY, LL.D., F.R.S., F.R.S.E.</p> <p>The Right Hon. LORD KINGSBURGH, C.B., LL.D., F.R.S., F.R.S.E.</p>	<p>Principal Sir WILLIAM MUIR, K.C.S.I.</p> <p>Professor Sir DOUGLAS MACLAGAN, M.D., Pres. R.S.E.</p> <p>Professor Sir WILLIAM TURNER, F.R.S., F.R.S.E.</p> <p>Professor P. G. TAIT, M.A., F.R.S.E.</p> <p>Professor A. CRUM BROWN, M.D., F.R.S., F.R.S.E., Pres. C.S.</p>
--	---

GENERAL SECRETARIES.

Capt. Sir **DOUGLAS GALTON, K.C.B., D.C.L., LL.D., F.R.S., F.G.S.**, 12 Chester Street, London, S.W.
A. G. VERNON HARCOURT, Esq., M.A., LL.D., F.R.S., F.C.S., Cowley Grange, Oxford.

ASSISTANT GENERAL SECRETARY.

G. GRIFFITH, Esq., M.A., F.C.S., Harrow.

GENERAL TREASURER.

Professor **ARTHUR W. RÜCKER, M.A., F.R.S.**, Burlington House, London, W.

LOCAL SECRETARIES FOR THE MEETING AT EDINBURGH.

<p>Professor G. F. ARMSTRONG, M.A., C.E., F.R.S.E., F.G.S.</p>	<p>F. GRANT OGILVIE, Esq., M.A., B.Sc., F.R.S.E.</p> <p>JOHN HARRISON, Esq.</p>
---	---

LOCAL TREASURER FOR THE MEETING AT EDINBURGH.

ADAM GILLIES SMITH, Esq., C.A.

ORDINARY MEMBERS OF THE COUNCIL.

<p>ANDERSON, Dr. W., F.R.S.</p> <p>AYRTON, Professor W. E., F.R.S.</p> <p>BAKER, Sir B., K.C.M.G., F.R.S.</p> <p>BATES, H. W., Esq., F.R.S.</p> <p>DARWIN, Professor G. H., F.R.S.</p> <p>DOUGLASS, Sir J. N., F.R.S.</p> <p>EDGEWORTH, Professor F. Y., M.A.</p> <p>EVANS, Dr. J., F.R.S.</p> <p>FITZGERALD, Professor G. F., F.R.S.</p> <p>GLAZEBROOK, R. T., Esq., F.R.S.</p> <p>JUDD, Professor J. W., F.R.S.</p> <p>LIVEING, Professor G. D., F.R.S.</p> <p>LODGE, Professor OLIVER J., F.R.S.</p>	<p>PREECE, W. H., Esq., F.R.S.</p> <p>RAMSAY, Professor W., F.R.S.</p> <p>REINOLD, Professor A. W., F.R.S.</p> <p>ROBERTS-AUSTEN, Professor W.C., C.B., F.R.S.</p> <p>SCHÄFER, Professor E. A., F.R.S.</p> <p>SCHUSTER, Professor A., F.R.S.</p> <p>SIDGWICK, Professor H., M.A.</p> <p>SYMONS, G. J., Esq., F.R.S.</p> <p>THORPE, Professor T. E., F.R.S.</p> <p>WARD, Professor MARSHALL, F.R.S.</p> <p>WHITAKER, W., Esq., F.R.S.</p> <p>WOODWARD, Dr. H., F.R.S.</p>
--	--

EX-OFFICIO MEMBERS OF THE COUNCIL.

The Trustees, the President and President Elect, the Presidents of former years, the Vice-Presidents and Vice-Presidents Elect, the General and Assistant General Secretaries for the present and former years, the Secretary, the General Treasurers for the present and former years, and the Local Treasurers and Secretaries for the ensuing Meeting.

TRUSTEES (PERMANENT).

The Right Hon. Sir **JOHN LUBBOCK, Bart., M.P., D.C.L., LL.D., F.R.S., F.L.S.**
 The Right Hon. **LORD RAYLEIGH, M.A., D.C.L., LL.D., Sec. R.S., F.R.A.S.**
 The Right Hon. Sir **LYON PLAYFAIR, K.C.B., M.P., Ph.D., LL.D., F.R.S.**

PRESIDENTS OF FORMER YEARS.

<p>Sir G. B. Airy, K.C.B., F.R.S.</p> <p>The Duke of Argyll, K.G., K.T.</p> <p>Sir Richard Owen, K.C.B., F.R.S.</p> <p>Lord Armstrong, C.B., LL.D.</p> <p>Sir William R. Grove, F.R.S.</p> <p>Sir Joseph D. Hooker, K.C.S.I.</p> <p>Sir G. G. Stokes, Bart., F.R.S.</p>	<p>Prof. Huxley, LL.D., F.R.S.</p> <p>Prof. Sir Wm. Thomson, Pres. R.S.</p> <p>Prof. Williamson, Ph.D., F.R.S.</p> <p>Prof. Tyndall, D.C.L., F.R.S.</p> <p>Prof. Allman, M.D., F.R.S.</p> <p>Sir John Lubbock, Bart., F.R.S.</p> <p>Prof. Cayley, LL.D., F.R.S.</p>	<p>Lord Rayleigh, D.C.L., Sec. R.S.</p> <p>Sir Lyon Playfair, K.C.B., F.R.S.</p> <p>Sir Wm. Dawson, C.M.G., F.R.S.</p> <p>Sir H. E. Roscoe, D.C.L., F.R.S.</p> <p>Sir F. J. Bramwell, Bart., F.R.S.</p> <p>Prof. W. H. Flower, C.B., F.R.S.</p> <p>Sir Frederick Abel, K.C.B., F.R.S.</p>
--	--	--

GENERAL OFFICERS OF FORMER YEARS.

<p>F. Galton, Esq., F.R.S.</p> <p>Dr. T. A. Hirst, F.R.S.</p>	<p>Prof. Michael Foster, Sec. R.S.</p> <p>George Griffith, Esq., M.A., F.C.S.</p> <p>Prof. Williamson, Ph.D., F.R.S.</p>	<p>P. L. Sclater, Esq., Ph.D., F.R.S.</p> <p>Prof. Donney, D.Sc., F.R.S.</p>
---	---	--

AUDITORS.

<p>Dr. Gladstone, F.R.S.</p>	<p>Prof. H. McLeod, F.R.S.</p>	<p>J. B. Martin, Esq., M.A., F.S.S.</p>
-------------------------------------	---------------------------------------	--

REPORT OF THE COUNCIL.

Report of the Council for the year 1890-91, presented to the General Committee at Cardiff, on Wednesday, August 19, 1891.

The Council have received the usual Financial Reports from the General Treasurer, during the past year, and his account for the year 1890-91, which was audited on the 31st July will be presented to the General Committee

The Council were informed by Dr. Williamson in the early part of the year that he would be unable to allow himself to be nominated to the office of General Treasurer at the present meeting of the Association, and that, as he would not be able to attend the meeting at Cardiff, he wished to continue in office only until the commencement of that meeting.

Dr. Williamson was appointed to succeed Mr. Spottiswoode in the year 1874, and during this long period of seventeen years his wise and calm judgment has afforded the Council, on all occasions of difficulty, most valuable assistance.

The Council recommend that, in accordance with the wish expressed by Dr. Williamson, a successor to his office be appointed at this meeting, and they have much pleasure in recommending to the General Committee that Professor Arthur W. Rücker, M.A., F.R.S., be elected General Treasurer, and that he be requested to enter at once upon the duties of the office.

Lord Rayleigh, one of the Vice-Presidents elect, will not be able to attend the meeting. The Council recommend that Sir Robert Ball, Royal Astronomer of Ireland, be elected Vice-President.

The Council received a letter from the Board of Trade requesting them to appoint one or two members of a committee about to be formed for considering the standards for the measurement of the ohm, the ampère, and the volt. The Council appointed Professor G. Carey Foster and Mr. R. T. Glazebrook members of this committee.

The Council have elected the following Foreign Men of Science, who attended the last Meeting of the Association, Corresponding Members:—

Prof. Brentano, Munich.
 Prof. V. Dwelshauvers-Dery, Liège.
 Prof. Mascart, Paris.
 Prof. W. Ostwald, Leipzig.
 Signor Maffeo Pantaleoni, Bari.

Dr. Otto Pettersson, Stockholm.
 Mr. A. Lawrence Rotch, Readville,
 Mass., U.S.A.
 Prof. J. H. van't Hoff, Amsterdam.

An invitation to hold the Annual Meeting of the Association at Nottingham in the year 1893 has been received, and will be presented to the General Committee on Monday.

Resolutions referred to the Council for consideration and action if desirable :—

(A) 'That the Council consider and report whether grants should be made from the funds of the Association for other than specific researches by specified individuals.'

The Council consider that grants should not be made to any single institution, or in support of a single object, for many years in succession. It must be distinctly understood that the aid given by the Association to any particular scientific institution or investigator must necessarily be limited and intermittent.

The Council are of opinion that grants in aid of research should not be made, except for specified subjects, and under such circumstances that satisfactory assurances can be given to the General Committee as to the person or persons by whom the research is to be carried out.

(B) 'That it is desirable that the question of publishing the papers more fully and expeditiously, and of adding reports of discussions, be considered by the Council.'

The Council are informed that steps have been taken to insure a more expeditious publication of the Annual Report.

They do not recommend that papers should be published more fully; nor do they recommend that discussions should be published, excepting in special cases when this is strongly advocated by Sectional Committees, and approved of by the General Committee. They recommend that, in every such case, an arrangement be made by the General Officers for the proper editing of the discussion.

(C) 'That in the arrangement of the Journal it is desirable, in the interests of clearness and of ease of reference, to return to the old practice of printing first the papers to be read in the various Sections, then the papers read on the previous day in those Sections, and lastly the list of Sectional Officers and of the Committees.'

The Council recommend that the papers to be read in the various Sections be printed first, then the lists of the Committees, and lastly the papers read on the previous day, and that each page should have a suitable heading.

(D) 'That the Council be requested, if possible, to fix the date of each meeting two years before it is held, and to bear in mind that the middle or latter part of September is the time most convenient to many members of the Association.'

The Council considered that it is not practicable to fix the date of the Annual Meeting two years before it is held. They recommend that information be obtained at as early a date as possible as to the times which are convenient to the town where a meeting is to be held, and that the authorities in such town be informed that the last fortnight in September is most generally convenient to academical and other important Sections of the members of the Association.

(E) 'That the hours at which the Sections and Committees meet be again considered by the Council.'

The Council have requested the Organising Committees to propose to the Council times for the meetings of their respective Committees and Sections, and recommend that these proposals be adopted for the Cardiff Meeting as an experimental measure.

(F) 'That a general Index to the Reports of the Committees of the Association, and of all papers ordered to be printed *in extenso*, be published, and that the Council be authorised to spend such sums as may be necessary for the purpose.'

The Council resolved that the Index to the Annual Reports of the Association be continued from the year 1861 to 1890 inclusive, and that it consist of one part only. References to Abstracts of Papers will be printed in italics.

(G) 'That the Council urge upon the Government to take steps to hasten the completion of the Ordnance Survey, and to afford greater facilities for the purchase of the Survey Maps.'

The Council having ascertained that the maps of the Ordnance Survey are neither known to nor used by the public nearly to the extent they should be, considering their value and the vast sums of money which have been expended on their production, and that this neglect arises from various causes, chief among which are the very defective arrangements made for the sale of the maps to the public, the obsolete topography of a large portion of the Survey, and the want of legal authority for the boundaries shown by the maps, resolved to make to the Government the following suggestions, with a view to the removal of the present obstacles to the usefulness of the maps:—

(1) That some modification be made in the present character of arrangements for the sale of the maps of the Ordnance Survey, whereby the maps may become more accessible to the public.

(2) That such additions be made to the Parliamentary grant for the Ordnance Survey as will enable the revision to be made more complete, and the arrears to be brought up to date within a reasonable time.

(3) That the boundaries and areas of the Ordnance Survey maps be made legal boundaries and areas in England and Scotland, as they already are in Ireland, so that they may form a basis for all valuation for local or imperial assessments.

This memorandum was communicated to the President of the Board of Agriculture, together with the following letter from the President of the Association:—

BRITISH ASSOCIATION FOR THE ADVANCEMENT OF SCIENCE.

22 Albemarle Street, London, W.,
March 11, 1891.

Sir,—I have the honour to invite your consideration of the accompanying memorandum, conveying the conclusions of the Council of the British Association for the Advancement of Science, on the subject of representations made to them in the form of a resolution passed at the last Annual Meeting of the British Association, held at Leeds in 1890, relating to some points of importance connected with the Ordnance Survey and its value to Her Majesty's dominions generally.

I have to express the hope that you will feel disposed to invite the favourable consideration of Her Majesty's Government to the recommendations included in the memorandum in question, and to state that, should you desire any further information upon the subjects to which these recommendations relate, the Council of the British Association will be happy to arrange for a deputation to wait upon you for the purpose of affording you such additional information.

I have the honour to be, Sir, your obedient Servant,

(Signed) F. A. ABEL, President.

The Right Hon. HENRY CHAPLIN, M.P.,
President of the Board of Agriculture.

The following reply from the Board of Agriculture has been received :—

Board of Agriculture, March 14, 1891.

Sir,—I am directed by Mr. Chaplin to acknowledge the receipt of your letter of the 11th inst., forwarding a memorandum on the Ordnance Survey, and to say that the subject will have due consideration.

To Sir F. ABEL, C.B., F.R.S., &c., &c.

I am, yours faithfully,
(Signed) P. H. BAGENAL.

(H) 'That the Council be requested to consider the question of watching the operation of Acts relating to Scientific and Technical Education, and to take such steps as may seem desirable for furthering the objects of those Acts.'

The Council considered this Resolution, and are of opinion that there is no necessity at the present time for them to take any action.

(I) 'That the Council be requested to consider whether it is not desirable to make special provision for the comprehensive consideration by the Association of questions relating to Scientific and Technical Education.'

With regard to this Resolution, the Council understand that the chief object of the Sectional Committee which originated it was to have general discussions on scientific and technical questions organised, in which members of the various Sections who have a special knowledge of these questions should take part.

The Council consider that the Sectional Committees have sufficient powers to deal with this proposal severally and jointly.

(J) 'That the paper by Mr. J. F. Green on "Steam Life-boats" be printed *in extenso*, with the necessary drawings.'

The Council decided that an abstract only of this paper should be printed.

The report of the Corresponding Societies Committee has been received, and will be presented to the General Committee.

The Corresponding Societies Committee, consisting of Mr. Francis Galton, Professor R. Meldola (Secretary), Professor A. W. Williamson, Sir Douglas Galton, Professor Boyd Dawkins, Sir Rawson Rawson, Dr. J. G. Garson, Dr. J. Evans, Mr. J. Hopkinson, Mr. W. Whitaker, Mr. G. J. Symons, General Pitt-Rivers, Mr. W. Topley, and Professor T. G. Bonney, is hereby nominated for reappointment by the General Committee, together with Mr. T. V. Holmes, F.G.S.

The Council nominate Mr. G. J. Symons, F.R.S., Chairman, Dr. J. G. Garson, F.Z.S., Vice-Chairman, and Professor R. Meldola, F.R.S., Secretary to the Conference of Delegates of Corresponding Societies to be held during the Meeting at Cardiff.

In accordance with the regulations the retiring Members of the Council, exclusive of Professor Rücker (who is recommended for the office of Treasurer), will be :—

Mr. Blanford.
Mr. Crookes.

Mr. J. B. Martin.
Capt. Wharton.

The Council recommend the re-election of the other ordinary Members of Council, with the addition of the gentlemen whose names are distinguished by an asterisk in the following list :—

*Anderson, Dr. W., F.R.S.
 Ayrton, Prof. W. E., F.R.S.
 Baker, Sir B., K.C.M.G., F.R.S.
 *Bates, H. W., Esq., F.R.S.
 Darwin, Prof. G. H., F.R.S.
 Douglass, Sir J. N., F.R.S.
 *Edgeworth Prof. F. Y., M.A.
 Evans, Dr. J., F.R.S.
 Fitzgerald, Prof. G. F., F.R.S.
 Glazebrook, R. T., Esq., F.R.S.
 Judd, Prof. J. W., F.R.S.
 Liveing, Prof. G. D., F.R.S.
 *Lodge, Prof. Oliver J., F.R.S.

Preece, W. H., Esq., F.R.S.
 *Ramsay, Prof. W., F.R.S.
 Reinold, Prof. A. W., F.R.S.
 Roberts-Austen, Prof. W. C., C.B., F.R.S.
 Schäfer, Prof. E. A., F.R.S.
 Schuster, Prof. A., F.R.S.
 Sidgwick, Prof. H., M.A.
 *Symons, G. J., Esq., F.R.S.
 Thorpe, Prof. T. E., F.R.S.
 Ward, Prof. Marshall, F.R.S.
 Whitaker, W., Esq., F.R.S.
 Woodward, Dr. H., F.R.S.

COMMITTEES APPOINTED BY THE GENERAL COMMITTEE AT THE
CARDIFF MEETING IN AUGUST 1891.

1. *Receiving Grants of Money.*

Subject for Investigation or Purpose	Members of the Committee	Grants
<p>Making Experiments for improving the Construction of Practical Standards for use in Electrical Measurements.</p> <p>[This grant includes 17l. 4s. 6d., the unexpended balance of last year's grant.]</p>	<p><i>Chairman.</i> — Professor Carey Foster.</p> <p><i>Secretary.</i>—Mr. R. T. Glazebrook.</p> <p>Sir William Thomson, Professors Ayrton, J. Perry, W. G. Adams, and Lord Rayleigh, Drs. O. J. Lodge, John Hopkinson, and A. Muirhead, Messrs. W. H. Preece and Herbert Taylor, Professors Everett and Schuster, Dr. J. A. Fleming, Professors G. F. Fitzgerald, Chrystal, and J. J. Thomson, Messrs. W. N. Shaw, J. T. Bottomley, and T. C. Fitzpatrick, Professor J. Viriamu Jones, Dr. G. Johnstone Stoney, and Professor S. P. Thompson.</p>	<p>£ s. d. 27 4 6</p>
<p>Co-operating with the Scottish Meteorological Society in making Meteorological Observations on Ben Nevis.</p>	<p><i>Chairman.</i>—Lord McLaren.</p> <p><i>Secretary.</i>—Professor Crum Brown.</p> <p>Messrs. John Murray and Buchan, Professor R. Copeland, and Hon. R. Abercromby.</p>	<p>50 0 0</p>
<p>The Application of Photography to the Elucidation of Meteorological Phenomena.</p>	<p><i>Chairman.</i>—Mr. G. J. Symons.</p> <p><i>Secretary.</i>—Mr. Clayden.</p> <p>Professor Meldola and Mr. John Hopkinson.</p>	<p>15 0 0</p>
<p>For Calculating Tables of certain Mathematical Functions, and, if necessary, for taking steps to carry out the Calculations, and to publish the results in an accessible form.</p>	<p><i>Chairman.</i>—Lord Rayleigh.</p> <p><i>Secretary.</i>—Professor A. Lodge.</p> <p>Sir William Thomson, Professor Cayley, Professor B. Price, and Messrs. J. W. L. Glaisher, A. G. Greenhill, and W. M. Hicks.</p>	<p>15 0 0</p>
<p>Carrying on the Tables connected with the Pellian Equation from the point where the work was left by Degen in 1817.</p> <p>[This grant includes 5l., the unexpended balance of a previous grant.]</p>	<p><i>Chairman.</i>—Professor Cayley.</p> <p><i>Secretary.</i>—Professor A. Lodge.</p> <p>Professor Sylvester and Mr. A. R. Forsyth.</p>	<p>15 0 0</p>

1. *Receiving Grants of Money*—continued.

Subject for Investigation or Purpose	Members of the Committee	Grants
Considering the subject of Electrolysis in its Physical and Chemical Bearings.	<i>Chairman.</i> —Professor Fitzgerald. <i>Secretaries.</i> — Professors H. E. Armstrong and O. J. Lodge. Professors Sir William Thomson, Lord Rayleigh, J. J. Thomson, Schuster, Poynting, Crum Brown, Ramsay, Frankland, Tilden, Hartley, S. P. Thompson, Roberts-Austen, Rücker, Reinold, Carey Foster, and H. B. Dixon, Captain Abney, Drs. Gladstone, Hopkinson, and Fleming, and Messrs. Crookes, Shelford Bidwell, W. N. Shaw, J. Larmor, J. T. Bottomley, R. T. Glazebrook, J. Brown, E. J. Love, and John M. Thomson.	£ s. d. 5 0 0
To investigate the Phenomena accompanying the Discharge of Electricity from Points.	<i>Chairman.</i> —Professor O. J. Lodge. <i>Secretary.</i> —Mr. A. P. Chattock. Professor Carey Foster.	50 0 0
The Volcanic and Seismological Phenomena of Japan.	<i>Chairman.</i> —Sir Wm. Thomson. <i>Secretary.</i> —Professor J. Milne. Professor W. G. Adams, Mr. J. T. Bottomley, and Professor A. H. Green.	10 0 0
To consider the best Method of establishing an International Standard for the Analysis of Iron and Steel. [This grant is the unexpended balance of last year's grant.]	<i>Chairman.</i> — Professor Roberts-Austen. <i>Secretary.</i> —Mr. Thomas Turner. Sir F. Abel, Messrs. E. Riley and J. Spiller, Professor J. W. Langley, Mr. G. J. Snelus, and Professor Tilden.	8 16 0
The Investigation of the direct Formation of Haloids from pure Materials. [This grant includes 5l. 5s., the unexpended balance of last year's grant.]	<i>Chairman.</i> —Professor H. E. Armstrong. <i>Secretary.</i> —Mr. W. A. Shenstone. Professor W. R. Dunstan and Mr. C. H. Bothamley.	25 5 0
The Properties of Solutions . . .	<i>Chairman.</i> —Professor W. A. Tilden. <i>Secretary.</i> —Dr. W. W. J. Nicol. Professor Ramsay.	10 0 0
The Action of Light upon Dyed Colours.	<i>Chairman.</i> —Professor Thorpe. <i>Secretary.</i> —Professor J. J. Hummel. Dr. Perkin, Professor Russell, Captain Abney, and Professor Stroud.	10 0 0

1. *Receiving Grants of Money*—continued.

Subject for Investigation or Purpose	Members of the Committee	Grants
<p>Recording the Position, Height above the Sea, Lithological Characters, Size, and Origin of the Erratic Blocks of England, Wales, and Ireland, reporting other matters of interest connected with the same, and taking measures for their preservation.</p> <p>[This grant includes 10<i>l.</i> granted last year but not drawn.]</p>	<p><i>Chairman.</i>—Professor J. Prestwich.</p> <p><i>Secretary.</i>—Dr. H. W. Crosskey, Professors W. Boyd Dawkins, T. McK. Hughes, and T. G. Bonney and Messrs. C. E. De Rance, P. F. Kendall, W. Pengelly, J. Plant, and R. H. Tiddeman.</p>	<p>£ s. d. 15 0 0</p>
<p>The Description and Illustration of the Fossil Phyllopora of the Palæozoic Rocks.</p> <p>[This grant was drawn last year, but was not spent.]</p>	<p><i>Chairman.</i>—Rev. Prof. T. Wiltshire.</p> <p><i>Secretary.</i>—Professor T. R. Jones. Dr. H. Woodward.</p>	<p>10 0 0</p>
<p>The Collection, Preservation, and Systematic Registration of Photographs of Geological interest.</p>	<p><i>Chairman.</i>—Professor J. Geikie.</p> <p><i>Secretary.</i>—Mr. O. W. Jeffs.</p> <p>Professors Bonney and Boyd Dawkins, Drs. V. Ball and T. Anderson, and Messrs. A. S. Reid, E. J. Garwood, W. Gray, H. B. Woodward, J. E. Bedford, R. Kidston, W. W. Watts, J. W. Davis, and R. H. Tiddeman.</p>	<p>20 0 0</p>
<p>To consider the best Methods for the Registration of all Type Specimens of Fossils in the British Isles, and to report on the same.</p>	<p><i>Chairman.</i>—Dr. H. Woodward.</p> <p><i>Secretary.</i>—Mr. A. Smith Woodward.</p> <p>Rev. G. F. Whidborne and Messrs. R. Kidston and J. E. Marr.</p>	<p>5 0 0</p>
<p>The Circulation of the Underground Waters in the Permeable Formations of England, and the Quality and Quantity of the Waters supplied to various Towns and Districts from these Formations.</p>	<p><i>Chairman.</i>—Professor E. Hull.</p> <p><i>Secretary.</i>—Mr. C. E. De Rance.</p> <p>Dr. H. W. Crosskey, Sir D. Galton, Professor J. Prestwich, and Messrs. J. Glaisher, P. Kendall, E. B. Marten, G. H. Morton, W. Pengelly, J. Plant, I. Roberts, T. S. Stooke, G. J. Symons, W. Topley, Tylden - Wright, E. Wethered, and W. Whitaker.</p>	<p>10 0 0</p>
<p>To complete the Investigation of the Cave at Elbolton, near Skipton, in order to ascertain whether the remains of Palæolithic Man occur in the Lower Cave Earth.</p>	<p><i>Chairman.</i>—Mr. J. W. Davis.</p> <p><i>Secretary.</i>—Rev. E. Jones.</p> <p>Drs. J. Evans and J. G. Garson and Messrs. W. Pengelly, R. H. Tiddeman, and J. J. Wilkinson.</p>	<p>25 0 0</p>
<p>To investigate the Extent and the Faunal Contents of the <i>Sowerbyi</i> Zone, and its Relationship to the <i>concauum</i> and <i>Sauzei</i> Zones.</p>	<p><i>Chairman.</i>—Professor T. Rupert Jones.</p> <p><i>Secretary.</i>—Mr. S. S. Buckman.</p> <p>Rev. Professor T. Wiltshire.</p>	<p>10 0 0</p>

1. *Receiving Grants of Money*—continued.

Subject for Investigation or Purpose	Members of the Committee	Grants
To carry on Excavations at Oldbury Hill, near Ightham, in order to ascertain the existence or otherwise of Rock Shelters at that spot.	<i>Chairman.</i> —Dr. J. Evans. <i>Secretary.</i> —Mr. B. Harrison. Professors Prestwich and H. G. Seeley.	£ s. d. 25 0 0
Completion of a Report on the Cretaceous Polyzoa.	<i>Chairman.</i> —Dr. H. Woodward. <i>Secretary.</i> —Mr. G. R. Vine. Professor T. Rupert Jones and Dr. H. C. Sorby.	10 0 0
To appoint Mr. Willey to investigate the Morphology of the Ascidians at the Zoological Station at Naples, or, failing this, to appoint some other competent investigator to carry on a definite piece of work at the Zoological Station at Naples approved by the Council.	<i>Chairman.</i> —Dr. P. L. Sclater. <i>Secretary.</i> —Mr. Percy Sladen. Professors Ray Lankester, Cossar Ewart, M. Foster, and A. Milnes Marshall and Mr. Sedgwick.	100 0 0
To arrange for the Occupation of a Table at the Laboratory of the Marine Biological Association, Plymouth.	<i>Chairman.</i> —Professor E. Ray Lankester. <i>Secretary.</i> —Mr. S. F. Harmer. Professors M. Foster and S. H. Vines.	17 10 0
For improving and experimenting with a Deep-sea Tow-net for opening and closing under water. [This includes 27 <i>l.</i> 14 <i>s.</i> 6 <i>d.</i> granted last year but not drawn.]	<i>Chairman.</i> —Professor A. C. Haddon. <i>Secretary.</i> —Mr. W. E. Hoyle. Professor W. A. Herdman.	40 0 0
To report on the present state of our Knowledge of the Zoology of the Sandwich Islands, and to take steps to investigate ascertained deficiencies in the Fauna, with power to co-operate with the Committee appointed for the purpose by the Royal Society, and to avail themselves of such assistance in their investigations as may be offered by the Hawaiian Government. [100 <i>l.</i> granted last year but not drawn.]	<i>Chairman.</i> —Professor Newton. <i>Secretary.</i> —Dr. David Sharp. Dr. Blanford, Dr. Hickson, Professor Riley, Mr. Salvin, Dr. Sclater, and Mr. Edgar A. Smith.	100 0 0
To report on the present state of our Knowledge of the Zoology and Botany of the West India Islands, and to take steps to investigate ascertained deficiencies in the Fauna and Flora. [100 <i>l.</i> granted last year but not drawn.]	<i>Chairman.</i> —Dr. P. L. Sclater. <i>Secretary.</i> —Mr. G. Murray. Mr. Carruthers, Drs. Günther and Sharp, Mr. F. Du Cane Godman, Professor Newton, and Dr. D. H. Scott.	100 0 0

1. *Receiving Grants of Money*—continued.

Subject of Investigation or Purpose	Members of the Committee	Grants
Climatological and Hydrographical Conditions of Tropical Africa.	<i>Chairman.</i> —Mr. E. G. Ravenstein. <i>Secretary.</i> —Mr. G. J. Symons. Mr. Baldwin Latham.	£ s. d. 75 0 0
For carrying on the Work of the Anthropometric Laboratory.	<i>Chairman.</i> —Professor Flower. <i>Secretary.</i> —Dr. Garson. Mr. Bloxam and Dr. Wilberforce Smith.	5 0 0
Exploration of Prehistoric Remains in Mashonaland.	<i>Chairman.</i> —Dr. J. G. Garson. <i>Secretary.</i> —Mr. J. Theodore Bent. Mr. Rudler, Mr. Brabrook, and Mr. Bloxam.	50 0 0
The Physical Characters, Languages, and Industrial and Social Condition of the North-Western Tribes of the Dominion of Canada.	<i>Chairman.</i> —Dr. E. B. Tylor. <i>Secretary.</i> —Mr. Bloxam. Sir Daniel Wilson, Dr. G. M. Dawson, Mr. R. G. Haliburton, and Mr. H. Hale.	100 0 0
The Habits, Customs, Physical Characteristics, and Religions of the Natives of India.	<i>Chairman.</i> —Sir William Turner. <i>Secretary.</i> —Mr. Bloxam. Professor Flower, Drs. Garson and E. B. Tylor, and Mr. H. H. Risley.	10 0 0
Editing a new Edition of 'Anthropological Notes and Queries.'	<i>Chairman.</i> —Professor Flower. <i>Secretary.</i> —Dr. Garson, Dr. Beddoe, General Pitt-Rivers, Mr. Francis Galton, Dr. E. B. Tylor, and Mr. Brabrook.	20 0 0
Corresponding Societies' Committee.	<i>Chairman.</i> —Mr. G. J. Symons. <i>Secretary.</i> —Professor R. Meldola. Mr. Francis Galton, Professor A. W. Williamson, Sir Douglas Galton, Professor Boyd Dawkins, Sir Rawson Rawson, Dr. J. G. Garson, Dr. John Evans, Mr. J. Hopkinson, Professor Bonney, Mr. W. Whitaker, General Pitt-Rivers, Mr. W. Topley, and Mr. T. V. Holmes.	25 0 0

2. *Not receiving Grants of Money.*

Subject for Investigation or Purpose	Members of the Committee
To co-operate with Dr. Piazzi Smyth in his Researches on the Ultra Violet Rays of the Solar Spectrum.	<i>Chairman.</i> —Professor Liveing. <i>Secretary.</i> —Dr. Piazzi Smyth. Professors Dewar and Schuster.

2. Not receiving Grants of Money—continued.

Subject for Investigation or Purpose	Members of the Committee
The Collection and Identification of Meteoric Dust.	<p><i>Chairman.</i>—Mr. John Murray. <i>Secretary.</i>—Mr. John Murray. Professor Schuster, Sir William Thomson, the Abbé Renard, Mr. A. Buchan, the Hon. R. Abercromby, and Dr. M. Grabham.</p>
The Rate of Increase of Underground Temperature downwards in various Localities of dry Land and under Water.	<p><i>Chairman.</i>—Professor Everett. <i>Secretary.</i>—Professor Everett. Professor Sir William Thomson, Mr. G. J. Symons, Sir A. C. Ramsay, Sir A. Geikie, Mr. J. Glaisher, Mr. Pengelly, Professor Edward Hull, Professor Prestwich, Dr. C. Le Neve Foster, Professor A. S. Herschel, Professor G. A. Lebour, Mr. A. B. Wynne, Mr. Gallo way, Mr. Joseph Dickinson, Mr. G. F. Deacon, Mr. E. Wethered, Mr. A. Strahan, and Professor Michie Smith.</p>
Comparing and Reducing Magnetic Observations.	<p><i>Chairman.</i>—Professor W. G. Adams. <i>Secretary.</i>—Professor W. G. Adams. Sir W. Thomson, Professors G. H. Darwin and G. Chrystal, Mr. C. H. Carpmael, Professor Schuster, Mr. G. M. Whipple, Captain Creak, the Astronomer Royal, Mr. William Ellis, and Professor A. W. Rücker.</p>
Considering the best Methods of Recording the Direct Intensity of Solar Radiation.	<p><i>Chairman.</i>—Sir G. G. Stokes. <i>Secretary.</i>—Mr. G. J. Symons. Professor Schuster, Mr. G. Johnstone Stoney, Sir H. E. Roscoe, Captain Abney, Mr. Whipple, and Professor M^rLeod.</p>
To co-operate with Dr. Kerr in his researches on Electro-optics.	<p><i>Chairman.</i>—Dr. John Kerr. <i>Secretary.</i>—Mr. R. T. Glazebrook. Sir W. Thomson and Professor Rücker.</p>
The various Phenomena connected with the recalescent Points in Iron and other Metals.	<p><i>Chairman.</i>—Professor Fitzgerald. <i>Secretary.</i>—Professor Barrett. Dr. John Hopkinson, Mr. R. A. Hadfield, Mr. Trouton, Professor Roberts-Austen, and Mr. H. F. Newall.</p>
To consider the establishment of a National Physical Laboratory for the more accurate determination of Physical Constants, and for other Quantitative Research, and to confer with the Council of the Association.	<p><i>Chairman.</i>—Professor Oliver J. Lodge. <i>Secretary.</i>—Mr. R. T. Glazebrook. Sir William Thomson, Lord Rayleigh, Professors J. J. Thomson, Rücker, Clifton, Fitzgerald, Carey Foster, and J. Viriamu Jones.</p>
Modes of measuring the Optical Constants of Microscopic, Photographic, and other Lenses, and of specifying and enumerating the Properties of their Combinations.	<p><i>Chairman.</i>—Professor G. C. Foster. <i>Secretary.</i>—Professor S. P. Thompson. Mr. R. T. Glazebrook, J. Walker, Sir Howard Grubb, Mr. Whipple, and Captain Abney.</p>

2. *Not receiving Grants of Money*—continued.

Subject for Investigation or Purpose	Members of the Committee
To examine and report how greater uniformity may be introduced into the Record of Spectroscopic Work.	<i>Chairman.</i> —Dr. Johnstone Stoney. <i>Secretary.</i> —Dr. Johnstone Stoney. Dr. Huggins and Professor Liveing.
Reporting on the Bibliography of Solution.	<i>Chairman.</i> —Professor W. A. Tilden. <i>Secretary.</i> —Dr. W. W. J. Nicol. Professors M'Leod, Pickering, Ramsay, and Young and Dr. A. R. Leeds.
To report on recent Inquiries into the History of Chemistry.	<i>Chairman.</i> —Professor H. E. Armstrong. <i>Secretary.</i> —Professor John Ferguson.
The Continuation of the Bibliography of Spectroscopy.	<i>Chairman.</i> —Professor H. M'Leod. <i>Secretary.</i> —Professor Roberts-Austen. Professor Reinold and Mr. H. G. Madan.
Preparing a new Series of Wave-length Tables of the Spectra of the Elements.	<i>Chairman.</i> —Sir H. E. Roscoe. <i>Secretary.</i> —Dr. Marshall Watts. Mr. Lockyer, Professors Dewar, Liveing, Schuster, W. N. Hartley, and Wolcott Gibbs, and Captain Abney.
The Influence of the Silent Discharge of Electricity on Oxygen and other Gases.	<i>Chairman.</i> —Professor H. M'Leod. <i>Secretary.</i> —Mr. W. A. Shenstone. Professor Ramsay and Mr. J. T. Cundall.
The Action of Light on the Hydracids of the Halogens in presence of Oxygen.	<i>Chairman.</i> —Dr. Russell. <i>Secretary.</i> —Dr. A. Richardson. Captain Abney and Professors Noel Hartley and W. Ramsay.
Isomeric Naphthalene Derivatives	<i>Chairman.</i> —Professor W. A. Tilden. <i>Secretary.</i> —Professor H. E. Armstrong.
Absorption Spectra of Pure Compounds.	<i>Chairman.</i> —General Festing. <i>Secretary.</i> —Dr. H. E. Armstrong. Captain Abney.
To inquire into the Proximate Chemical Constituents of the various kinds of Coal.	<i>Chairman.</i> —Sir I. Lowthian Bell. <i>Secretary.</i> —Professor P. Phillips Bedson. Mr. Ludwig Mond, Professors Vivian B. Lewes and E. Hull, and Messrs. J. W. Thomas and H. Bauerman.
The Rate of Erosion of the Sea-coasts of England and Wales, and the Influence of the Artificial Abstraction of Shingle or other material in that action.	<i>Chairman.</i> —Mr. R. B. Grantham. <i>Secretaries.</i> —Messrs. C. E. De Rance and W. Topley. Messrs. J. B. Redman, W. Whitaker, and J. W. Woodall, Maj.-Gen. Sir A. Clarke, Admiral Sir E. Ommanney, Sir J. N. Douglass, Capt. Sir G. Nares, Capt. J. Parsons, Capt. W. J. L. Wharton, Professor J. Prestwich, and Messrs. E. Easton, J. S. Valentine, and L. F. Vernon Harcourt.

2. *Not receiving Grants of Money*—continued.

Subject for Investigation or Purpose	Members of the Committee
To undertake the Investigation of the Sources of the River Aire, and also to test the value of Uranin and other Dyes in investigating the Courses of Underground Streams.	<i>Chairman.</i> —Professor R. Meldola. <i>Secretary.</i> —Professor Silvanus P. Thompson. Mr. J. Birbeck, Mr. Walter Morrison, M.P., Rev. G. Style, and Mr. Thomas Tate.
The Volcanic Phenomena of Vesuvius and its neighbourhood.	<i>Chairman.</i> —Mr. H. Bauerman. <i>Secretary.</i> —Dr. H. J. Johnston-Lavis. Messrs. F. W. Rudler and J. J. H. Teall.
Considering the advisability and possibility of establishing in other parts of the country Observations upon the Prevalence of Earth Tremors similar to those now being made in Durham in connection with coal-mine explosions.	<i>Chairman.</i> —Mr. G. J. Symons. <i>Secretary.</i> —Mr. C. Davison. Sir F. J. Bramwell, Mr. E. A. Cowper, Professor G. H. Darwin, Professor Ewing, Mr. Isaac Roberts, Mr. Thomas Gray, Dr. John Evans, Professors Prestwich, Hull, Lebour, Meldola, and Judd, Mr. M. Walton Brown, and Mr. J. Glaisher.
To consider a project for investigating the Structure of a Coral Reef by Boring and Sounding.	<i>Chairman.</i> —Professor T. G. Bonney. <i>Secretary.</i> —Professor W. J. Sollas. Sir Archibald Geikie, Professors A. H. Green, J. W. Judd, and C. Lapworth, Captain Wharton, Drs. H. Hicks and J. Murray, and Mr. F. Darwin.
Disappearance of Native Plants from their Local Habitats.	<i>Chairman.</i> —Mr. A. W. Wills. <i>Secretary.</i> —Professor W. Hillhouse. Messrs. E. W. Badger and George Claridge Druce.
To make a Digest of the Observations on the Migration of Birds at Lighthouses and Light-vessels.	<i>Chairman.</i> —Professor Newton. <i>Secretary.</i> —Mr. John Cordeaux. Messrs. John A. Harvie-Brown, R. M. Barrington, and W. E. Clarke and the Rev. E. P. Knubley.
For taking steps to establish a Botanical Laboratory at Peradeniya, Ceylon.	<i>Chairman.</i> —Professor M. Foster. <i>Secretary.</i> —Professor F. O. Bower. Professor Bayley Balfour, Mr. Thiselton-Dyer, Dr. Trimen, Professor Marshall Ward, Mr. Carruthers, Professor Hartog, and Mr. W. Gardiner.
To consider proposals for the Legislative Protection of Wild Birds' Eggs.	<i>Chairman.</i> —Mr. Thomas Henry Thomas. <i>Secretary.</i> —Dr. C. T. Vachell. Professors W. N. Parker, Newton, and Leipner, Mr. Poulton, and Canon Tristram.
The Teaching of Science in Elementary Schools.	<i>Chairman.</i> —Dr. J. H. Gladstone. <i>Secretary.</i> —Professor H. E. Armstrong. Mr. S. Bourne, Dr. Crosskey, Mr. George Gladstone, Mr. J. Heywood, Sir J. Lubbock, Sir Philip Magnus, Professor N. Story Maskelyne, Sir H. E. Roscoe, Sir R. Temple, and Professor Silvanus P. Thompson.

2. *Not receiving Grants of Money*—continued.

Subject for Investigation or Purpose	Members of the Committee
Intermarriage between widely dissimilar Peoples inhabiting the same Country.	<i>Chairman.</i> —Professor F. Max Müller. <i>Secretary.</i> —Mr. H. Ling Roth. Dr. E. B. Tylor.
The Prehistoric and Ancient Remains of Glamorganshire.	<i>Chairman.</i> —Lord Aberdare. <i>Secretary.</i> —Mr. E. Seward. Lord Bute, Messrs. G. T. Clark, R. W. Atkinson, Franklen G. Evans, C. Tanfield Vachell, James Bell, and T. H. Thomas, and Dr. Garson.

Other Resolutions adopted by the General Committee.

That Mr. W. N. Shaw be requested to continue his Report on the present state of our Knowledge in Electrolysis and Electro-chemistry.

That the Report on Thermodynamics presented by Dr. J. Larmor and Mr. G. H. Bryan be printed among the Reports.

That Dr. J. Larmor and Mr. G. H. Bryan be requested to continue their Report on the present state of our knowledge in Thermodynamics, specially with regard to the Second Law.

That Professor H. A. Newton's paper on 'The Action of a Planet upon Small Bodies passing near the Planet, with special reference to the Action of Jupiter upon such Bodies,' be printed *in extenso* in the Report of the Association.

That the Report presented by the Committee appointed to arrange for the occupation of a Table at the Zoological Station at Naples be printed in full in the Reports.

That the arrangements for Sectional Meetings adopted at the present Annual Meeting be continued next year at Edinburgh.

Resolutions referred to the Council for consideration, and action if desirable.

A Resolution relating to the Times of Meeting of the General Committee and the Committee of Recommendations.

Resolutions referring to the Ordnance Survey, viz.:

(1) That the publication of the one-inch and six-inch Ordnance Survey Maps is, in the interests of Science, urgently required at the earliest possible date, no less than in the interests of Industry, Manufacture, and Technical Education.

(2) That steps be taken and provision made for keeping the Ordnance Maps up to date.

(3) That the Maps should be made more accessible to the public, and should be sold at a lower price, as is the case in nearly all other official publications, such as Admiralty Charts, Blue Books, &c.

That the following papers be printed in full: 'Recent Progress in Indian Agriculture,' by C. L. Tupper; 'Recent Progress in Indian Railways,' by W. C. Furnivall.

Synopsis of Grants of Money appropriated to Scientific Purposes by the General Committee at the Cardiff Meeting, in August 1891. The Names of the Members entitled to call on the General Treasurer for the respective Grants are prefixed.

Mathematics and Physics.

	£	s.	d.
*Foster, Professor Carey.—Electrical Standards (partly renewed).....	27	4	6
*McLaren, Lord.—Meteorological Observations on Ben Nevis	50	0	0
Symons, Mr. G. J.—Photographs of Meteorological Phenomena	15	0	0
*Cayley, Professor.—Pellian Equation Tables (partly renewed)	15	0	0
*Rayleigh, Lord—Tables of Mathematical Functions	15	0	0
*Fitzgerald, Professor.—Electrolysis	5	0	0
*Lodge, Professor O. J.—Discharge of Electricity from Points	50	0	0
*Thomson, Sir W.—Seismological Phenomena of Japan	10	0	0

Chemistry and Mineralogy.

*Roberts-Austen, Professor.—Analysis of Iron and Steel (renewed).....	8	16	0
Armstrong, Professor H. E.—Formation of Haloids from Pure Materials (partly renewed)	25	5	0
*Tilden, Professor W. A.—Properties of Solutions	10	0	0
*Thorpe, Professor—Action of Light upon Dyed Colours (partly renewed).....	10	0	0

Geology.

*Prestwich, Professor.—Erratic Blocks (partly renewed) ...	15	0	0
*Wiltshire, Rev. T.—Fossil Phyllopora (renewed)	10	0	0
*Geikie, Professor J.—Photographs of Geological Interest ...	20	0	0
*Woodward, Dr. H.—Registration of Type Specimens of British Fossils (renewed)	5	0	0
*Hull, Professor E.—Underground Waters.....	10	0	0
*Davis, Mr. J. W.—Investigation of Elbolton Cave	25	0	0
Jones, Professor T. B.—Faunal contents of <i>Sowerbyi</i> Zone ...	10	0	0
*Evans, Dr. J.—Excavations at Oldbury Hill.....	25	0	0
*Woodward, Dr. H.—Cretaceous Polyzoa	10	0	0

Carried forward..... £371 5 6

* Reappointed.

	£	s.	d.
Brought forward.....	371	5	6

Biology.

*Sclater, Dr. P. L.—Table at the Naples Zoological Station	100	0	0
*Lankester, Professor E. R.—Table at Plymouth Biological Laboratory (renewed)	17	10	0
*Haddon, Professor A. C.—Improving a Deep sea Tow-net (partly renewed).....	40	0	0
*Newton, Professor—Fauna of Sandwich Islands (renewed)	100	0	0
*Sclater, Dr. P. L.—Zoology and Botany of the West India Islands (renewed) ..	100	0	0

Geography.

Ravenstein, Mr. E. G.—Climatology and Hydrography of Tropical Africa	75	0	0
--	----	---	---

Anthropology.

*Flower, Professor.—Anthropometric Laboratory	5	0	0
*Garson, Dr. J. G.—Prehistoric Remains in Mashonaland ...	50	0	0
*Tylor, Dr. E. B.—North-Western Tribes of Canada.....	100	0	0
*Turner, Sir W.—Habits, Customs, &c., of Natives of India (renewed)	10	0	0
*Flower, Professor.—New Edition of Anthropological Notes and Queries	20	0	0
*Symons, Mr. G. J.—Corresponding Societies Committee ...	25	0	0
	<u>£1,013 15 6</u>		

* Reappointed.

The Annual Meeting in 1892.

The Meeting at Edinburgh will commence on Wednesday, August 3:

Place of Meeting in 1893.

The Annual Meeting of the Association will be held at Nottingham.

General Statement of Sums which have been paid on account of Grants for Scientific Purposes.

	£	s.	d.		£	s.	d.
1834.				Mechanism of Waves	144	2	0
Tide Discussions	20	0	0	Bristol Tides	35	18	6
1835.				Meteorology and Subterra- nean Temperature.....	21	11	0
Tide Discussions	62	0	0	Vitrification Experiments ...	9	4	7
British Fossil Ichthyology ...	105	0	0	Cast-iron Experiments.....	103	0	0
	<u>£167</u>	<u>0</u>	<u>0</u>	Railway Constants	28	7	2
1836.				Land and Sea Level	274	1	4
Tide Discussions	163	0	0	Steam-vessels' Engines	100	0	0
British Fossil Ichthyology ...	105	0	0	Stars in Histoire Céleste	171	18	6
Thermometric Observations, &c.	50	0	0	Stars in Lacaille	11	0	0
Experiments on long-con- tinued Heat	17	1	0	Stars in R.A.S. Catalogue ...	166	16	6
Rain-gauges	9	13	0	Animal Secretions	10	10	0
Refraction Experiments	15	0	0	Steam Engines in Cornwall... ..	50	0	0
Lunar Nutation.....	60	0	0	Atmospheric Air	16	1	0
Thermometers	15	6	0	Cast and Wrought Iron	40	0	0
	<u>£435</u>	<u>0</u>	<u>0</u>	Heat on Organic Bodies	3	0	0
1837.				Gases on Solar Spectrum.....	22	0	0
Tide Discussions	284	1	0	Hourly Meteorological Ob- servations, Inverness and Kingussie	49	7	8
Chemical Constants	24	13	6	Fossil Reptiles	118	2	9
Lunar Nutation.....	70	0	0	Mining Statistics	50	0	0
Observations on Waves	100	12	0		<u>£1595</u>	<u>11</u>	<u>0</u>
Tides at Bristol	150	0	0	1840.			
Meteorology and Subterra- nean Temperature.....	93	3	0	Bristol Tides	100	0	0
Vitrification Experiments ...	150	0	0	Subterranean Temperature ...	13	13	6
Heart Experiments	8	4	6	Heart Experiments	18	19	0
Barometric Observations	30	0	0	Lungs Experiments	8	13	0
Barometers.....	11	18	6	Tide Discussions	50	0	0
	<u>£922</u>	<u>12</u>	<u>6</u>	Land and Sea Level	6	11	1
1838.				Stars (Histoire Céleste)	242	10	0
Tide Discussions	29	0	0	Stars (Lacaille)	4	15	0
British Fossil Fishes.....	100	0	0	Stars (Catalogue)	264	0	0
Meteorological Observations and Anemometer (construc- tion)	100	0	0	Atmospheric Air	15	15	0
Cast Iron (Strength of)	60	0	0	Water on Iron	10	0	0
Animal and Vegetable Sub- stances (Preservation of) ...	19	1	10	Heat on Organic Bodies	7	0	0
Railway Constants	41	12	10	Meteorological Observations .	52	17	6
Bristol Tides	50	0	0	Foreign Scientific Memoirs... ..	112	1	6
Growth of Plants	75	0	0	Working Population	100	0	0
Mud in Rivers	3	6	6	School Statistics	50	0	0
Education Committee	50	0	0	Forms of Vessels	184	7	0
Heart Experiments	5	3	0	Chemical and Electrical Phe- nomena	40	0	0
Land and Sea Level	267	8	7	Meteorological Observations at Plymouth	80	0	0
Steam-vessels.....	100	0	0	Magnetical Observations.....	185	13	9
Meteorological Committee ...	31	9	5		<u>£1546</u>	<u>16</u>	<u>4</u>
	<u>£932</u>	<u>2</u>	<u>2</u>	1841.			
1839.				Observations on Waves	30	0	0
Fossil Ichthyology	110	0	0	Meteorology and Subterra- nean Temperature.....	8	8	0
Meteorological Observations at Plymouth, &c.	63	10	0	Actinometers	10	0	0
				Earthquake Shocks	17	7	0
				Acrid Poisons.....	6	0	0
				Veins and Absorbents	3	0	0
				Mud in Rivers	5	0	0

	£	s.	d.		£	s.	d.
Marine Zoology	15	12	8	Reduction of Stars, British Association Catalogue	25	0	0
Skeleton Maps	20	0	0	Anomalous Tides, Frith of Forth	120	0	0
Mountain Barometers	6	18	6	Hourly Meteorological Observations at Kingussie and Inverness	77	12	8
Stars (Histoire Céleste)	185	0	0	Meteorological Observations at Plymouth	55	0	0
Stars (Lacaille).....	79	5	0	Whewell's Meteorological Anemometer at Plymouth	10	0	0
Stars (Nomenclature of).....	17	19	6	Meteorological Observations, Osler's Anemometer at Plymouth	20	0	0
Stars (Catalogue of).....	40	0	0	Reduction of Meteorological Observations	30	0	0
Water on Iron	50	0	0	Meteorological Instruments and Gratuities	39	6	0
Meteorological Observations at Inverness	20	0	0	Construction of Anemometer at Inverness	56	12	2
Meteorological Observations (reduction of)	25	0	0	Magnetic Co-operation.....	10	8	10
Fossil Reptiles	50	0	0	Meteorological Recorder for Kew Observatory	50	0	0
Foreign Memoirs	62	0	6	Action of Gases on Light.....	18	16	1
Railway Sections	38	1	0	Establishment at Kew Observatory, Wages, Repairs, Furniture, and Sundries	133	4	7
Forms of Vessels	193	12	0	Experiments by Captive Balloons	81	8	0
Meteorological Observations at Plymouth	55	0	0	Oxidation of the Rails of Railways.....	20	0	0
Magnetical Observations	61	18	8	Publication of Report on Fossil Reptiles	40	0	0
Fishes of the Old Red Sandstone	100	0	0	Coloured Drawings of Railway Sections	147	18	3
Tides at Leith	50	0	0	Registration of Earthquake Shocks	30	0	0
Anemometer at Edinburgh	69	1	10	Report on Zoological Nomenclature.....	10	0	0
Tabulating Observations	9	6	3	Uncovering Lower Red Sandstone near Manchester	4	4	6
Races of Men.....	5	0	0	Vegetative Power of Seeds ...	5	3	8
Radiate Animals	2	0	0	Marine Testacea (Habits of)	10	0	0
	<u>£1235</u>	<u>10</u>	<u>11</u>	Marine Zoology	10	0	0
				Marine Zoology	2	14	11
1842.				Preparation of Report on British Fossil Mammalia	100	0	0
Dynamometric Instruments	113	11	2	Physiological Operations of Medicinal Agents	20	0	0
Anoplura Britannicæ	52	12	0	Vital Statistics	36	5	8
Tides at Bristol	59	8	0	Additional Experiments on the Forms of Vessels	70	0	0
Gases on Light	30	14	7	Additional Experiments on the forms of Vessels	100	0	0
Chronometers	26	17	6	Reduction of Experiments on the Forms of Vessels	100	0	0
Marine Zoology.....	1	5	0	Morin's Instrument and Constant Indicator	69	14	10
British Fossil Mammalia	100	0	0	Experiments on the Strength of Materials	60	0	0
Statistics of Education.....	20	0	0		<u>£1565</u>	<u>10</u>	<u>2</u>
Marine Steam-vessels' Engines	28	0	0				
Stars (Histoire Céleste)	59	0	0				
Stars (Brit. Assoc. Cat. of)	110	0	0				
Railway Sections	161	10	0				
British Belemnites	50	0	0				
Fossil Reptiles (publication of Report)	210	0	0				
Forms of Vessels	180	0	0				
Galvanic Experiments on Rocks	5	8	6				
Meteorological Experiments at Plymouth	68	0	0				
Constant Indicator and Dynamometric Instruments	90	0	0				
Force of Wind	10	0	0				
Light on Growth of Seeds	8	0	0				
Vital Statistics	50	0	0				
Vegetative Power of Seeds	8	1	11				
Questions on Human Race	7	9	0				
	<u>£1449</u>	<u>17</u>	<u>8</u>				
1843.							
Revision of the Nomenclature of Stars	2	0	0				

	£	s.	d.
1844.			
Meteorological Observations at Kingussie and Inverness	12	0	0
Completing Observations at Plymouth	35	0	0
Magnetic and Meteorological Co-operation	25	8	4
Publication of the British Association Catalogue of Stars	35	0	0
Observations on Tides on the East Coast of Scotland	100	0	0
Revision of the Nomenclature of Stars	2	9	6
Maintaining the Establishment at Kew Observatory	117	17	3
Instruments for Kew Observatory	56	7	3
Influence of Light on Plants	10	0	0
Subterraneous Temperature in Ireland	5	0	0
Coloured Drawings of Railway Sections	15	17	6
Investigation of Fossil Fishes of the Lower Tertiary Strata	100	0	0
Registering the Shocks of Earthquakes	23	11	10
Structure of Fossil Shells	20	0	0
Radiata and Mollusca of the Ægean and Red Seas	100	0	0
Geographical Distributions of Marine Zoology	0	10	0
Marine Zoology of Devon and Cornwall	10	0	0
Marine Zoology of Corfu	10	0	0
Experiments on the Vitality of Seeds	9	0	0
Experiments on the Vitality of Seeds	8	7	3
Exotic Anoplura	15	0	0
Strength of Materials	100	0	0
Completing Experiments on the Forms of Ships	100	0	0
Inquiries into Asphyxia	10	0	0
Investigations on the Internal Constitution of Metals	50	0	0
Constant Indicator and Morin's Instrument	10	0	0
	<u>£981</u>	<u>12</u>	<u>8</u>

1845.			
Publication of the British Association Catalogue of Stars	351	14	6
Meteorological Observations at Inverness	30	18	11
Magnetic and Meteorological Co-operation	16	16	8
Meteorological Instruments at Edinburgh	18	11	9
Reduction of Anemometrical Observations at Plymouth	25	0	0

	£	s.	d.
Electrical Experiments at Kew Observatory	43	17	8
Maintaining the Establishment at Kew Observatory	149	15	0
For Kreil's Barometrograph	25	0	0
Gases from Iron Furnaces	50	0	0
The Actinograph	15	0	0
Microscopic Structure of Shells	20	0	0
Exotic Anoplura	10	0	0
Vitality of Seeds	2	0	7
Vitality of Seeds	7	0	0
Marine Zoology of Cornwall	10	0	0
Physiological Action of Medicines	20	0	0
Statistics of Sickness and Mortality in York	20	0	0
Earthquake Shocks	15	14	8
	<u>£831</u>	<u>9</u>	<u>9</u>

1846.			
British Association Catalogue of Stars	211	15	0
Fossil Fishes of the London Clay	100	0	0
Computation of the Gaussian Constants for 1829	5	0	0
Maintaining the Establishment at Kew Observatory	146	16	7
Strength of Materials	60	0	0
Researches in Asphyxia	6	16	2
Examination of Fossil Shells	10	0	0
Vitality of Seeds	2	15	10
Vitality of Seeds	7	12	3
Marine Zoology of Cornwall	10	0	0
Marine Zoology of Britain	10	0	0
Exotic Anoplura	25	0	0
Expenses attending Anemometers	11	7	6
Anemometers' Repairs	2	3	6
Atmospheric Waves	3	3	3
Captive Balloons	8	19	8
Varieties of the Human Race	7	6	3
Statistics of Sickness and Mortality in York	12	0	0
	<u>£685</u>	<u>16</u>	<u>0</u>

1847.			
Computation of the Gaussian Constants for 1829	50	0	0
Habits of Marine Animals	10	0	0
Physiological Action of Medicines	20	0	0
Marine Zoology of Cornwall	10	0	0
Atmospheric Waves	6	9	3
Vitality of Seeds	4	7	7
Maintaining the Establishment at Kew Observatory	107	8	6
	<u>£208</u>	<u>5</u>	<u>4</u>

	£	s.	d.
1848.			
Maintaining the Establishment at Kew Observatory	171	15	11
Atmospheric Waves	3	10	9
Vitality of Seeds	9	15	0
Completion of Catalogue of Stars	70	0	0
On Colouring Matters	5	0	0
On Growth of Plants	15	0	0
	<u>£275</u>	<u>1</u>	<u>8</u>

1849.			
Electrical Observations at Kew Observatory	50	0	0
Maintaining the Establishment at ditto.....	76	2	5
Vitality of Seeds	5	8	1
On Growth of Plants	5	0	0
Registration of Periodical Phenomena.....	10	0	0
Bill on Account of Anemometrical Observations	13	9	0
	<u>£159</u>	<u>19</u>	<u>6</u>

1850.			
Maintaining the Establishment at Kew Observatory	255	18	0
Transit of Earthquake Waves	50	0	0
Periodical Phenomena	15	0	0
Meteorological Instruments, Azores	25	0	0
	<u>£345</u>	<u>18</u>	<u>0</u>

1851.			
Maintaining the Establishment at Kew Observatory (includes part of grant in 1849)	309	2	2
Theory of Heat	20	1	1
Periodical Phenomena of Animals and Plants.....	5	0	0
Vitality of Seeds	5	6	4
Influence of Solar Radiation	30	0	0
Ethnological Inquiries.....	12	0	0
Researches on Annelida	10	0	0
	<u>£391</u>	<u>9</u>	<u>7</u>

1852.			
Maintaining the Establishment at Kew Observatory (including balance of grant for 1850).....	233	17	8
Experiments on the Conduction of Heat	5	2	9
Influence of Solar Radiations	20	0	0
Geological Map of Ireland ...	15	0	0
Researches on the British Annelida	10	0	0
Vitality of Seeds	10	6	2
Strength of Boiler Plates.....	10	0	0
	<u>£304</u>	<u>6</u>	<u>7</u>

	£	s.	d.
1853.			
Maintaining the Establishment at Kew Observatory	165	0	0
Experiments on the Influence of Solar Radiation	15	0	0
Researches on the British Annelida.....	10	0	0
Dredging on the East Coast of Scotland.....	10	0	0
Ethnological Queries	5	0	0
	<u>£205</u>	<u>0</u>	<u>0</u>

1854.			
Maintaining the Establishment at Kew Observatory (including balance of former grant).....	330	15	4
Investigations on Flax.....	11	0	0
Effects of Temperature on Wrought Iron.....	10	0	0
Registration of Periodical Phenomena.....	10	0	0
British Annelida	10	0	0
Vitality of Seeds	5	2	3
Conduction of Heat	4	2	0
	<u>£380</u>	<u>19</u>	<u>7</u>

1855.			
Maintaining the Establishment at Kew Observatory	425	0	0
Earthquake Movements	10	0	0
Physical Aspect of the Moon	11	8	5
Vitality of Seeds	10	7	11
Map of the World.....	15	0	0
Ethnological Queries	5	0	0
Dredging near Belfast.....	4	0	0
	<u>£480</u>	<u>16</u>	<u>4</u>

1856.			
Maintaining the Establishment at Kew Observatory:—			
1854.....	£ 75	0	0
1855.....	£500	0	0
}	575	0	0
Strickland's Ornithological Synonyms	100	0	0
Dredging and Dredging Forms	9	13	0
Chemical Action of Light ...	20	0	0
Strength of Iron Plates	10	0	0
Registration of Periodical Phenomena.....	10	0	0
Propagation of Salmon.....	10	0	0
	<u>£734</u>	<u>13</u>	<u>9</u>

1857.			
Maintaining the Establishment at Kew Observatory	350	0	0
Earthquake Wave Experiments	40	0	0
Dredging near Belfast.....	10	0	0
Dredging on the West Coast of Scotland.....	10	0	0

	£	s.	d.
Investigations into the Mol- lusca of California	10	0	0
Experiments on Flax	5	0	0
Natural History of Mada- gascar	20	0	0
Researches on British Anne- lida	25	0	0
Report on Natural Products imported into Liverpool ...	10	0	0
Artificial Propagation of Sal- mon	10	0	0
Temperature of Mines.....	7	8	0
Thermometers for Subterra- nean Observations.....	5	7	4
Life-boats	5	0	0
	<u>£507</u>	<u>15</u>	<u>4</u>

1858.

Maintaining the Establish- ment at Kew Observatory	500	0	0
Earthquake Wave Experi- ments	25	0	0
Dredging on the West Coast of Scotland.....	10	0	0
Dredging near Dublin.....	5	0	0
Vitality of Seeds	5	5	0
Dredging near Belfast.....	18	13	2
Report on the British Anne- lida	25	0	0
Experiments on the produc- tion of Heat by Motion in Fluids.....	20	0	0
Report on the Natural Pro- ducts imported into Scot- land.....	10	0	0
	<u>£618</u>	<u>18</u>	<u>2</u>

1859.

Maintaining the Establish- ment at Kew Observatory	500	0	0
Dredging near Dublin.....	15	0	0
Osteology of Birds	50	0	0
Irish Tunicata	5	0	0
Manure Experiments	20	0	0
British Medusidæ	5	0	0
Dredging Committee	5	0	0
Steam-vessels' Performance...	5	0	0
Marine Fauna of South and West of Ireland.....	10	0	0
Photographic Chemistry	10	0	0
Lanarkshire Fossils	20	0	1
Balloon Ascents.....	39	11	0
	<u>£684</u>	<u>11</u>	<u>1</u>

1860.

Maintaining the Establish- ment at Kew Observatory	500	0	0
Dredging near Belfast.....	16	6	0
Dredging in Dublin Bay.....	15	0	0
Inquiry into the Performance of Steam-vessels	124	0	0
Explorations in the Yellow Sandstone of Dura Den ...	20	0	0

	£	s.	d.
Chemico-mechanical Analysis of Rocks and Minerals.....	25	0	0
Researches on the Growth of Plants	10	0	0
Researches on the Solubility of Salts	30	0	0
Researches on the Constituents of Manures	25	0	0
Balance of Captive Balloon Accounts.....	1	13	6
	<u>£766</u>	<u>19</u>	<u>6</u>

1861.

Maintaining the Establish- ment at Kew Observatory..	500	0	0
Earthquake Experiments.....	25	0	0
Dredging North and East Coasts of Scotland	23	0	0
Dredging Committee :—			
1860.....£50 0 0	}	72	0 0
1861.....£22 0 0			
Excavations at Dura Den.....	20	0	0
Solubility of Salts	20	0	0
Steam-vessel Performance ...	150	0	0
Fossils of Lesmahagow	15	0	0
Explorations at Uriconium ...	20	0	0
Chemical Alloys	20	0	0
Classified Index to the Trans- actions.....	100	0	0
Dredging in the Mersey and Dee	5	0	0
Dip Circle	30	0	0
Photoheliographic Observa- tions	50	0	0
Prison Diet.....	20	0	0
Gauging of Water.....	10	0	0
Alpine Ascents	6	5	10
Constituents of Manures	25	0	0
	<u>£1111</u>	<u>5</u>	<u>10</u>

1862.

Maintaining the Establish- ment at Kew Observatory	500	0	0
Patent Laws	21	6	0
Mollusca of N.-W. of America	10	0	0
Natural History by Mercantile Marine	5	0	0
Tidal Observations	25	0	0
Photoheliometer at Kew	40	0	0
Photographic Pictures of the Sun	150	0	0
Rocks of Donegal.....	25	0	0
Dredging Durham and North- umberland	25	0	0
Connection of Storms	20	0	0
Dredging North-east Coast of Scotland	6	9	
Ravages of Teredo	3	11	
Standards of Electrical Re- sistance	50	0	
Railway Accidents	10	0	
Balloon Committee	200	0	
Dredging Dublin Bay	10	0	

	£	s.	d.
Dredging the Mersey	5	0	0
Prison Diet	20	0	0
Gauging of Water	12	10	0
Steamships' Performance.....	150	0	0
Thermo-electric Currents ...	5	0	0
	<u>£1293</u>	<u>16</u>	<u>6</u>

1863.

Maintaining the Establish- ment at Kew Observatory... 600	0	0	
Balloon Committee deficiency	70	0	
Balloon Ascents (other ex- penses)	25	0	
Entozoa	25	0	
Coal Fossils	20	0	
Herrings	20	0	
Granites of Donegal.....	5	0	
Prison Diet	20	0	
Vertical Atmospheric Move- ments	13	0	
Dredging Shetland	50	0	
Dredging North-east Coast of Scotland	25	0	
Dredging Northumberland and Durham	17	3	
Dredging Committee superin- tendence	10	0	
Steamship Performance	100	0	
Balloon Committee	200	0	
Carbon under pressure	10	0	
Volcanic Temperature	100	0	
Bromide of Ammonium	8	0	
Electrical Standards.....	100	0	
Electrical Construction and Distribution	40	0	
Luminous Meteors	17	0	
Kew Additional Buildings for Photoheliograph	100	0	
Thermo-electricity	15	0	
Analysis of Rocks	8	0	
Hydroida.....	10	0	
	<u>£1608</u>	<u>3</u>	<u>10</u>

1864.

Maintaining the Establish- ment at Kew Observatory.. 600	0	0
Coal Fossils	20	0
Vertical Atmospheric Move- ments	20	0
Dredging Shetland	75	0
Dredging Northumberland...	25	0
Balloon Committee	200	0
Carbon under pressure	10	0
Standards of Electric Re- sistance	100	0
Analysis of Rocks	10	0
Hydroida	10	0
Askham's Gift	50	0
Nitrite of Amyle	10	0
Nomenclature Committee ...	5	0
Rain-gauges	19	15
Cast-iron Investigation	20	0

£ s. d.

Tidal Observations in the Humber	50	0	0
Spectral Rays.....	45	0	0
Luminous Meteors	20	0	0
	<u>£1289</u>	<u>15</u>	<u>8</u>

1865.

Maintaining the Establish- ment at Kew Observatory.. 600	0	0	
Balloon Committee	100	0	
Hydroida.....	13	0	
Rain-gauges	30	0	
Tidal Observations in the Humber	6	8	
Hexylic Compounds	20	0	
Amyl Compounds	20	0	
Irish Flora	25	0	
American Mollusca	3	9	
Organic Acids	20	0	
Lingula Flags Excavation ...	10	0	
Eurypterus	50	0	
Electrical Standards.....	100	0	
Malta Caves Researches	30	0	
Oyster Breeding	25	0	
Gibraltar Caves Researches...	150	0	
Kent's Hole Excavations.....	100	0	
Moore's Surface Observations	35	0	
Marine Fauna	25	0	
Dredging Aberdeenshire	25	0	
Dredging Channel Islands ...	50	0	
Zoological Nomenclature.....	5	0	
Resistance of Floating Bodies in Water.....	100	0	
Bath Waters Analysis	8	10	
Luminous Meteors	40	0	
	<u>£1591</u>	<u>7</u>	<u>10</u>

1866.

Maintaining the Establish- ment at Kew Observatory.. 600	0	0
Lunar Committee.....	64	13
Balloon Committee	50	0
Metrical Committee.....	50	0
British Rainfall.....	50	0
Kilkenny Coal Fields	16	0
Alum Bay Fossil Leaf-Bed ...	15	0
Luminous Meteors	50	0
Lingula Flags Excavation ...	20	0
Chemical Constitution of Cast Iron	50	0
Amyl Compounds	25	0
Electrical Standards.....	100	0
Malta Caves Exploration	30	0
Kent's Hole Exploration	200	0
Marine Fauna, &c., Devon and Cornwall	25	0
Dredging Aberdeenshire Coast	25	0
Dredging Hebrides Coast ...	50	0
Dredging the Mersey	5	0
Resistance of Floating Bodies in Water.....	50	0
Polycyanides of Organic Radi- cals	29	0

	£	s.	d.
Rigor Mortis	10	0	0
Irish Annelida	15	0	0
Catalogue of Crania.....	50	0	0
Didine Birds of Mascarene Islands	50	0	0
Typical Crania Researches ...	30	0	0
Palestine Exploration Fund... 100	0	0	0
	<u>£1750</u>	<u>13</u>	<u>4</u>

1867.

Maintaining the Establish- ment at Kew Observatory..	600	0	0
Meteorological Instruments, Palestine	50	0	0
Lunar Committee	120	0	0
Metrical Committee	30	0	0
Kent's Hole Explorations ...	100	0	0
Palestine Explorations	50	0	0
Insect Fauna, Palestine	30	0	0
British Rainfall.....	50	0	0
Kilkenny Coal Fields	25	0	0
Alum Bay Fossil Leaf-bed ...	25	0	0
Luminous Meteors	50	0	0
Bournemouth, &c., Leaf-beds	30	0	0
Dredging Shetland	75	0	0
Steamship Reports Condensa- tion	100	0	0
Electrical Standards.....	100	0	0
Ethyl and Methyl series	25	0	0
Fossil Crustacea	25	0	0
Sound under Water	24	4	0
North Greenland Fauna	75	0	0
Do. Plant Beds	100	0	0
Iron and Steel Manufacture... 25	0	0	0
Patent Laws	30	0	0
	<u>£1739</u>	<u>4</u>	<u>0</u>

1868.

Maintaining the Establish- ment at Kew Observatory..	600	0	0
Lunar Committee	120	0	0
Metrical Committee	50	0	0
Zoological Record.....	100	0	0
Kent's Hole Explorations ...	150	0	0
Steamship Performances	100	0	0
British Rainfall.....	50	0	0
Luminous Meteors.....	50	0	0
Organic Acids	60	0	0
Fossil Crustacea	25	0	0
Methyl Series.....	25	0	0
Mercury and Bile	25	0	0
Organic Remains in Lime- stone Rocks	25	0	0
Scottish Earthquakes	20	0	0
Fauna, Devon and Cornwall..	30	0	0
British Fossil Corals	50	0	0
Bagshot Leaf-beds	50	0	0
Greenland Explorations	100	0	0
Fossil Flora	25	0	0
Tidal Observations	100	0	0
Underground Temperature... 50	0	0	0
Spectroscopic Investigations of Animal Substances	5	0	0

	£	s.	d.
Secondary Reptiles, &c.	30	0	0
British Marine Invertebrate Fauna	100	0	0
	<u>£1940</u>	<u>0</u>	<u>0</u>

1869.

Maintaining the Establish- ment at Kew Observatory..	600	0	0
Lunar Committee.....	50	0	0
Metrical Committee.....	25	0	0
Zoological Record	100	0	0
Committee on Gases in Deep- well Water	25	0	0
British Rainfall.....	50	0	0
Thermal Conductivity of Iron, &c.....	30	0	0
Kent's Hole Explorations.....	150	0	0
Steamship Performances	30	0	0
Chemical Constitution of Cast Iron.....	80	0	0
Iron and Steel Manufacture	100	0	0
Methyl Series.....	30	0	0
Organic Remains in Lime- stone Rocks.....	10	0	0
Earthquakes in Scotland	10	0	0
British Fossil Corals	50	0	0
Bagshot Leaf-beds	30	0	0
Fossil Flora	25	0	0
Tidal Observations	100	0	0
Underground Temperature ...	30	0	0
Spectroscopic Investigations of Animal Substances	5	0	0
Organic Acids	12	0	0
Kiltorcan Fossils	20	0	0
Chemical Constitution and Physiological Action Rela- tions	15	0	0
Mountain Limestone Fossils	25	0	0
Utilisation of Sewage	10	0	0
Products of Digestion	10	0	0
	<u>£1622</u>	<u>0</u>	<u>0</u>

1870.

Maintaining the Establish- ment at Kew Observatory	600	0	0
Metrical Committee.....	25	0	0
Zoological Record.....	100	0	0
Committee on Marine Fauna	20	0	0
Ears in Fishes	10	0	0
Chemical Nature of Cast Iron	80	0	0
Luminous Meteors	30	0	0
Heat in the Blood.....	15	0	0
British Rainfall.....	100	0	0
Thermal Conductivity of Iron, &c.	20	0	0
British Fossil Corals.....	50	0	0
Kent's Hole Explorations ...	150	0	0
Scottish Earthquakes	4	0	0
Bagshot Leaf-beds	15	0	0
Fossil Flora	25	0	0
Tidal Observations	100	0	0
Underground Temperature ...	50	0	0
Kiltorcan Quarries Fossils ...	20	0	0

	£	s.	d.
Mountain Limestone Fossils	25	0	0
Utilisation of Sewage	50	0	0
Organic Chemical Compounds	30	0	0
Onny River Sediment	3	0	0
Mechanical Equivalent of Heat	50	0	0
	£1572	0	0

1871.

Maintaining the Establishment at Kew Observatory	600	0	0
Monthly Reports of Progress in Chemistry	100	0	0
Metrical Committee	25	0	0
Zoological Record	100	0	0
Thermal Equivalents of the Oxides of Chlorine	10	0	0
Tidal Observations	100	0	0
Fossil Flora	25	0	0
Luminous Meteors	30	0	0
British Fossil Corals	25	0	0
Heat in the Blood	7	2	6
British Rainfall	50	0	0
Kent's Hole Explorations	150	0	0
Fossil Crustacea	25	0	0
Methyl Compounds	25	0	0
Lunar Objects	20	0	0
Fossil Coral Sections, for Photographing	20	0	0
Bagshot Leaf-beds	20	0	0
Moab Explorations	100	0	0
Gaussian Constants	40	0	0
	£1472	2	6

1872.

Maintaining the Establishment at Kew Observatory	300	0	0
Metrical Committee	75	0	0
Zoological Record	100	0	0
Tidal Committee	200	0	0
Carboniferous Corals	25	0	0
Organic Chemical Compounds	25	0	0
Exploration of Moab	100	0	0
Terato-embryological Inquiries	10	0	0
Kent's Cavern Exploration	100	0	0
Luminous Meteors	20	0	0
Heat in the Blood	15	0	0
Fossil Crustacea	25	0	0
Fossil Elephants of Malta	25	0	0
Lunar Objects	20	0	0
Inverse Wave-lengths	20	0	0
British Rainfall	100	0	0
Poisonous Substances Antagonism	10	0	0
Essential Oils, Chemical Constitution, &c.	40	0	0
Mathematical Tables	50	0	0
Thermal Conductivity of Metals	25	0	0
	£1285	0	0

1873.

	£	s.	d.
Zoological Record	100	0	0
Chemistry Record	200	0	0
Tidal Committee	400	0	0
Sewage Committee	100	0	0
Kent's Cavern Exploration	150	0	0
Carboniferous Corals	25	0	0
Fossil Elephants	25	0	0
Wave-lengths	150	0	0
British Rainfall	100	0	0
Essential Oils	30	0	0
Mathematical Tables	100	0	0
Gaussian Constants	10	0	0
Sub-Wealden Explorations	25	0	0
Underground Temperature	150	0	0
Settle Cave Exploration	50	0	0
Fossil Flora, Ireland	20	0	0
Timber Denudation and Rainfall	20	0	0
Luminous Meteors	30	0	0
	£1685	0	0

1874.

Zoological Record	100	0	0
Chemistry Record	100	0	0
Mathematical Tables	100	0	0
Elliptic Functions	100	0	0
Lightning Conductors	10	0	0
Thermal Conductivity of Rocks	10	0	0
Anthropological Instructions, &c.	50	0	0
Kent's Cavern Exploration	150	0	0
Luminous Meteors	30	0	0
Intestinal Secretions	15	0	0
British Rainfall	100	0	0
Essential Oils	10	0	0
Sub-Wealden Explorations	25	0	0
Settle Cave Exploration	50	0	0
Mauritius Meteorological Research	100	0	0
Magnetisation of Iron	20	0	0
Marine Organisms	30	0	0
Fossils, North-West of Scotland	2	10	0
Physiological Action of Light	20	0	0
Trades Unions	25	0	0
Mountain Limestone-corals	25	0	0
Erratic Blocks	10	0	0
Dredging, Durham and Yorkshire Coasts	28	5	0
High Temperature of Bodies	30	0	0
Siemens's Pyrometer	3	6	0
Labyrinthodonts of Coal-measures	7	15	0
	£1151	16	0

1875.

Elliptic Functions	100	0	0
Magnetisation of Iron	20	0	0
British Rainfall	120	0	0
Luminous Meteors	30	0	0
Chemistry Record	100	0	0

GENERAL STATEMENT.

xcv

	£	s.	d.
Specific Volume of Liquids...	25	0	0
Estimation of Potash and Phosphoric Acid.....	10	0	0
Isometric Cresols	20	0	0
Sub-Wealden Explorations ...	100	0	0
Kent's Cavern Exploration...	100	0	0
Settle Cave Exploration	50	0	0
Earthquakes in Scotland.....	15	0	0
Underground Waters	10	0	0
Development of Myxinoid Fishes	20	0	0
Zoological Record.....	100	0	0
Instructions for Travellers ...	20	0	0
Intestinal Secretions	20	0	0
Palestine Exploration	100	0	0
	<u>£960</u>	<u>0</u>	<u>0</u>

1876.

Printing Mathematical Tables	159	4	2
British Rainfall.....	100	0	0
Ohm's Law.....	9	15	0
Tide Calculating Machine ...	200	0	0
Specific Volume of Liquids...	25	0	0
Isomeric Cresols	10	0	0
Action of Ethyl Bromobutyrate on Ethyl Sodacetate.....	5	0	0
Estimation of Potash and Phosphoric Acid.....	13	0	0
Exploration of Victoria Cave, Settle	100	0	0
Geological Record.....	100	0	0
Kent's Cavern Exploration...	100	0	0
Thermal Conductivities of Rocks	10	0	0
Underground Waters	10	0	0
Earthquakes in Scotland.....	1	10	0
Zoological Record.....	100	0	0
Close Time	5	0	0
Physiological Action of Sound	25	0	0
Zoological Station.....	75	0	0
Intestinal Secretions	15	0	0
Physical Characters of Inhabitants of British Isles.....	13	15	0
Measuring Speed of Ships ...	10	0	0
Effect of Propeller on turning of Steam-vessels	5	0	0
	<u>£1092</u>	<u>4</u>	<u>2</u>

1877.

Liquid Carbonic Acids in Minerals	20	0	0
Elliptic Functions	250	0	0
Thermal Conductivity of Rocks	9	11	7
Zoological Record.....	100	0	0
Kent's Cavern	100	0	0
Zoological Station at Naples	75	0	0
Luminous Meteors	30	0	0
Elasticity of Wires	100	0	0
Dipterocarpeæ, Report on	20	0	0

	£	s.	d.
Mechanical Equivalent of Heat.....	35	0	0
Double Compounds of Cobalt and Nickel	8	0	0
Underground Temperatures	50	0	0
Settle Cave Exploration	100	0	0
Underground Waters in New Red Sandstone	10	0	0
Action of Ethyl Bromobutyrate on Ethyl Sodacetate	10	0	0
British Earthworks	25	0	0
Atmospheric Elasticity in India	15	0	0
Development of Light from Coal-gas	20	0	0
Estimation of Potash and Phosphoric Acid.....	1	18	0
Geological Record.....	100	0	0
Anthropometric Committee	34	0	0
Physiological Action of Phosphoric Acid, &c.....	15	0	0
	<u>£1128</u>	<u>9</u>	<u>7</u>

1878.

Exploration of Settle Caves	100	0	0
Geological Record.....	100	0	0
Investigation of Pulse Phenomena by means of Syphon Recorder	10	0	0
Zoological Station at Naples	75	0	0
Investigation of Underground Waters.....	15	0	0
Transmission of Electrical Impulses through Nerve Structure.....	30	0	0
Calculation of Factor Table for 4th Million	100	0	0
Anthropometric Committee...	66	0	0
Chemical Composition and Structure of less-known Alkaloids.....	25	0	0
Exploration of Kent's Cavern	50	0	0
Zoological Record.....	100	0	0
Fermanagh Caves Exploration	15	0	0
Thermal Conductivity of Rocks	4	16	6
Luminous Meteors.....	10	0	0
Ancient Earthworks	25	0	0
	<u>£725</u>	<u>16</u>	<u>6</u>

1879.

Table at the Zoological Station, Naples	75	0	0
Miocene Flora of the Basalt of the North of Ireland ...	20	0	0
Illustrations for a Monograph on the Mammoth	17	0	0
Record of Zoological Literature	100	0	0
Composition and Structure of less-known Alkaloids	25	0	0

	£	s.	d.
Exploration of Caves in Borneo	50	0	0
Kent's Cavern Exploration ...	100	0	0
Record of the Progress of Geology	100	0	0
Fermanagh Caves Exploration	5	0	0
Electrolysis of Metallic Solutions and Solutions of Compound Salts.....	25	0	0
Anthropometric Committee...	50	0	0
Natural History of Socotra ...	100	0	0
Calculation of Factor Tables for 5th and 6th Millions ...	150	0	0
Circulation of Underground Waters.....	10	0	0
Steering of Screw Steamers...	10	0	0
Improvements in Astronomical Clocks	30	0	0
Marine Zoology of South Devon	20	0	0
Determination of Mechanical Equivalent of Heat	12	15	6
Specific Inductive Capacity of Sprengel Vacuum.....	40	0	0
Tables of Sun-heat Coefficients	30	0	0
Datum Level of the Ordnance Survey	10	0	0
Tables of Fundamental Invariants of Algebraic Forms	36	14	9
Atmospheric Electricity Observations in Madeira	15	0	0
Instrument for Detecting Fire-damp in Mines	22	0	0
Instruments for Measuring the Speed of Ships	17	1	8
Tidal Observations in the English Channel	10	0	0
	<u>£1080</u>	<u>11</u>	<u>11</u>

1880.

New Form of High Insulation Key	10	0	0
Underground Temperature ...	10	0	0
Determination of the Mechanical Equivalent of Heat	8	5	0
Elasticity of Wires	50	0	0
Luminous Meteors	30	0	0
Lunar Disturbance of Gravity	30	0	0
Fundamental Invariants	8	5	0
Laws of Water Friction	20	0	0
Specific Inductive Capacity of Sprengel Vacuum.....	20	0	0
Completion of Tables of Sun-heat Coefficients	50	0	0
Instrument for Detection of Fire-damp in Mines	10	0	0
Inductive Capacity of Crystals and Paraffines	4	17	7
Report on Carboniferous Polyzoa	10	0	0

	£	s.	d.
Caves of South Ireland	10	0	0
Viviparous Nature of Ichthyosaurus	10	0	0
Kent's Cavern Exploration...	50	0	0
Geological Record.....	100	0	0
Miocene Flora of the Basalt of North Ireland	15	0	0
Underground Waters of Permian Formations	5	0	0
Record of Zoological Literature	100	0	0
Table at Zoological Station at Naples	75	0	0
Investigation of the Geology and Zoology of Mexico.....	50	0	0
Anthropometry	50	0	0
Patent Laws	5	0	0
	<u>£731</u>	<u>7</u>	<u>7</u>

1881.

Lunar Disturbance of Gravity	30	0	0
Underground Temperature ...	20	0	0
Electrical Standards	25	0	0
High Insulation Key.....	5	0	0
Tidal Observations	10	0	0
Specific Refractions	7	3	1
Fossil Polyzoa	10	0	0
Underground Waters	10	0	0
Earthquakes in Japan	25	0	0
Tertiary Flora	20	0	0
Scottish Zoological Station ...	50	0	0
Naples Zoological Station ...	75	0	0
Natural History of Socotra ...	50	0	0
Anthropological Notes and Queries	9	0	0
Zoological Record.....	100	0	0
Weights and Heights of Human Beings	30	0	0
	<u>£476</u>	<u>3</u>	<u>1</u>

1882.

Exploration of Central Africa	100	0	0
Fundamental Invariants of Algebraical Forms	76	1	11
Standards for Electrical Measurements	100	0	0
Calibration of Mercurial Thermometers	20	0	0
Wave-length Tables of Spectra of Elements.....	50	0	0
Photographing Ultra-violet Spark Spectra	25	0	0
Geological Record.....	100	0	0
Earthquake Phenomena of Japan	25	0	0
Conversion of Sedimentary Materials into Metamorphic Rocks	10	0	0
Fossil Plants of Halifax	15	0	0
Geological Map of Europe ...	25	0	0
Circulation of Underground Waters.....	15	0	0

	£	s.	d.
Tertiary Flora of North of Ireland	20	0	0
British Polyzoa	10	0	0
Exploration of Caves of South of Ireland	10	0	0
Exploration of Raygill Fissure	20	0	0
Naples Zoological Station ...	80	0	0
Albuminoid Substances of Serum	10	0	0
Elimination of Nitrogen by Bodily Exercise.....	50	0	0
Migration of Birds	15	0	0
Natural History of Socotra...	100	0	0
Natural History of Timor-laut	100	0	0
Record of Zoological Literature	100	0	0
Anthropometric Committee...	50	0	0
	<u>£1126</u>	<u>1</u>	<u>11</u>

1883.

Meteorological Observations on Ben Nevis	50	0	0
Isomeric Naphthalene Derivatives.....	15	0	0
Earthquake Phenomena of Japan	50	0	0
Fossil Plants of Halifax	20	0	0
British Fossil Polyzoa	10	0	0
Fossil Phyllopora of Palæozoic Rocks	25	0	0
Erosion of Sea-coast of England and Wales	10	0	0
Circulation of Underground Waters.....	15	0	0
Geological Record.....	50	0	0
Exploration of Caves in South of Ireland	10	0	0
Zoological Literature Record	100	0	0
Migration of Birds	20	0	0
Zoological Station at Naples	80	0	0
Scottish Zoological Station...	25	0	0
Elimination of Nitrogen by Bodily Exercise.....	38	3	3
Exploration of Mount Kilima-njaro.....	500	0	0
Investigation of Loughton Camp	10	0	0
Natural History of Timor-laut	50	0	0
Screw Gauges.....	5	0	0
	<u>£1083</u>	<u>3</u>	<u>3</u>

1884.

Meteorological Observations on Ben Nevis	50	0	0
Collecting and Investigating Meteoric Dust.....	20	0	0
Meteorological Observatory at Chepstow.....	25	0	0
Tidal Observations.....	10	0	0
Ultra-Violet Spark Spectra ...	8	4	0

1891.

	£	s.	d.
Earthquake Phenomena of Japan	75	0	0
Fossil Plants of Halifax	15	0	0
Fossil Polyzoa.....	10	0	0
Erratic Blocks of England ...	10	0	0
Fossil Phyllopora of Palæozoic Rocks	15	0	0
Circulation of Underground Waters.....	5	0	0
International Geological Map	20	0	0
Bibliography of Groups of Invertebrata	50	0	0
Natural History of Timor-laut	50	0	0
Naples Zoological Station ...	80	0	0
Exploration of Mount Kilima-njaro, East Africa	500	0	0
Migration of Birds.....	20	0	0
Coagulation of Blood.....	100	0	0
Zoological Literature Record	100	0	0
Anthropometric Committee...	10	0	0
	<u>£1173</u>	<u>4</u>	<u>0</u>

1885.

Synoptic Chart of Indian Ocean	50	0	0
Reduction of Tidal Observations.....	10	0	0
Calculating Tables in Theory of Numbers.....	100	0	0
Meteorological Observations on Ben Nevis	50	0	0
Meteoric Dust	70	0	0
Vapour Pressures, &c., of Salt Solutions.....	25	0	0
Physical Constants of Solutions.....	20	0	0
Volcanic Phenomena of Vesuvius	25	0	0
Raygill Fissure	15	0	0
Earthquake Phenomena of Japan	70	0	0
Fossil Phyllopora of Palæozoic Rocks	25	0	0
Fossil Plants of British Tertiary and Secondary Beds .	50	0	0
Geological Record	50	0	0
Circulation of Underground Waters.....	10	0	0
Naples Zoological Station ...	100	0	0
Zoological Literature Record.	100	0	0
Migration of Birds	30	0	0
Exploration of Mount Kilima-njaro	25	0	0
Recent Polyzoa	10	0	0
Marine Biological Station at Granton	100	0	0
Biological Stations on Coasts of United Kingdom	150	0	0
Exploration of New Guinea...	200	0	0
Exploration of Mount Roraima	100	0	0
	<u>£1385</u>	<u>0</u>	<u>0</u>

	£	s.	d.		£	s.	d.
1886.				Microscopic Structure of the			
Electrical Standards.....	40	0	0	Rocks of Anglesey.....	10	0	0
Solar Radiation.....	9	10	6	Exploration of the Eocene			
Tidal Observations	50	0	0	Beds of the Isle of Wight...	20	0	0
Magnetic Observations.....	10	10	0	Circulation of Underground			
Meteorological Observations				Waters.....	5	0	0
on Ben Nevis	100	0	0	'Manure' Gravels of Wexford	10	0	0
Physical and Chemical Bear-				Provincial Museum Reports	5	0	0
ings of Electrolysis	20	0	0	Investigation of Lymphatic			
Chemical Nomenclature	5	0	0	System.....	25	0	0
Fossil Plants of British Ter-				Naples Biological Station ...	100	0	0
tiary and Secondary Beds...	20	0	0	Plymouth Biological Station	50	0	0
Exploration of Caves in North				Granton Biological Station...	75	0	0
Wales	25	0	0	Zoological Record	100	0	0
Volcanic Phenomena of Vesu-				Flora of China	75	0	0
vius	30	0	0	Flora and Fauna of the			
Geological Record.....	100	0	0	Cameroons	75	0	0
Fossil Phyllozoa of Palæozoic				Migration of Birds	30	0	0
Rocks	15	0	0	Bathy-hypsographical Map of			
Zoological Literature Record.	100	0	0	British Isles	7	6	0
Marine Biological Station at				Regulation of Wages	10	0	0
Granton	75	0	0	Prehistoric Race of Greek			
Naples Zoological Station....	50	0	0	Islands.....	20	0	0
Researches in Food-Fishes and				Racial Photographs, Egyptian	20	0	0
Invertebrata at St. Andrews	75	0	0				
Migration of Birds	30	0	0				
Secretion of Urine.....	10	0	0				
Exploration of New Guinea...	150	0	0				
Regulation of Wages under							
Sliding Scales	10	0	0				
Prehistoric Race in Greek							
Islands.....	20	0	0				
North-Western Tribes of Can-							
nada.....	50	0	0				
	£995	0	6	1888.			
1887.				Ben Nevis Observatory.....	150	0	0
Solar Radiation	18	10	0	Electrical Standards.....	2	6	4
Electrolysis.....	30	0	0	Magnetic Observations.....	15	0	0
Ben Nevis Observatory.....	75	0	0	Standards of Light	79	2	3
Standards of Light (1886				Electrolysis	30	0	0
grant).....	20	0	0	Uniform Nomenclature in			
Standards of Light (1887				Mechanics	10	0	0
grant)	10	0	0	Silent Discharge of Elec-			
Harmonic Analysis of Tidal				tricity	9	11	10
Observations	15	0	0	Properties of Solutions	25	0	0
Magnetic Observations.....	26	2	0	Influence of Silicon on Steel	20	0	0
Electrical Standards	50	0	0	Methods of Teaching Chemis-			
Silent Discharge of Electricity	20	0	0	try	10	0	0
Absorption Spectra	40	0	0	Isomeric Naphthalene Deriva-			
Nature of Solution	20	0	0	tives.....	25	0	0
Influence of Silicon on Steel	30	0	0	Action of Light on Hydracids	20	0	0
Volcanic Phenomena of Vesu-				Sea Beach near Bridlington...	20	0	0
vius	20	0	0	Geological Record	50	0	0
Volcanic Phenomena of Japan				Manure Gravels of Wexford...	10	0	0
(1886 grant)	50	0	0	Erosion of Sea Coasts	10	0	0
Volcanic Phenomena of Japan				Circulation of Underground			
(1887 grant)	50	0	0	Waters	5	0	0
Exploration of Cae Gwyn				Palæontographical Society ...	50	0	0
Cave, North Wales	20	0	0	Pliocene Fauna of St. Erth...	50	0	0
Erratic Blocks	10	0	0	Carboniferous Flora of Lan-			
Fossil Phyllozoa	20	0	0	cashire and West Yorkshire	25	0	0
Coal Plants of Halifax.....	25	0	0	Volcanic Phenomena of Vesu-			
				vius	20	0	0
				Zoology and Botany of West			
				Indies	100	0	0
				Flora of Bahamas	100	0	0
				Development of Fishes—St.			
				Andrews	50	0	0
				Marine Laboratory, Plymouth	100	0	0
				Migration of Birds	30	0	0
				Flora of China	75	0	0

	£	s.	d.
Naples Zoological Station ...	100	0	0
Lymphatic System	25	0	0
Biological Station at Granton	50	0	0
Peradeniya Botanical Station	50	0	0
Development of Teleostei ...	15	0	0
Depth of Frozen Soil in Polar Regions	5	0	0
Precious Metals in Circulation	20	0	0
Value of Monetary Standard	10	0	0
Effect of Occupations on Physical Development.....	25	0	0
North-Western Tribes of Canada	100	0	0
Prehistoric Race in Greek Islands.....	20	0	0
	<u>£1511</u>	<u>0</u>	<u>5</u>

1889.

Ben Nevis Observatory.....	50	0	0
Electrical Standards.....	75	0	0
Electrolysis.....	20	0	0
Observations on Surface Water Temperature	30	0	0
Silent Discharge of Electricity on Oxygen	6	4	8
Methods of teaching Chemistry	10	0	0
Action of Light on Hydracids	10	0	0
Geological Record.....	80	0	0
Volcanic Phenomena of Japan	25	0	0
Volcanic Phenomena of Vesuvius	20	0	0
Fossil Phyllopora of Palæozoic Rocks	20	0	0
Higher Eocene Beds of Isle of Wight	15	0	0
West Indian Explorations ...	100	0	0
Flora of China	25	0	0
Naples Zoological Station ...	100	0	0
Physiology of Lymphatic System	25	0	0
Experiments with a Tow-net	5	16	3
Natural History of Friendly Islands.....	100	0	0
Geology and Geography of Atlas Range...	100	0	0
Action of Waves and Currents in Estuaries by means of Working Models	100	0	0
North-Western Tribes of Canada.....	150	0	0
Characteristics of Nomad Tribes of Asia Minor.....	30	0	0
Corresponding Societies	20	0	0
Marine Biological Association	200	0	0
Bath 'Baths Committee' for further Researches	100	0	0
	<u>£1417</u>	<u>0</u>	<u>11</u>

1890.

	£	s.	d.
Electrical Standards.....	12	17	0
Electrolysis	5	0	0
Electro-optics.....	50	0	0
Calculating Mathematical Tables	25	0	0
Volcanic and Seismological Phenomena of Japan	75	0	0
Pellian Equation Tables	15	0	0
Properties of Solutions	10	0	0
International Standard for the Analysis of Iron and Steel	10	0	0
Influence of the Silent Discharge of Electricity on Oxygen	5	0	0
Methods of teaching Chemistry	10	0	0
Recording Results of Water Analysis	4	1	0
Oxidation of Hydracids in Sunlight	15	0	0
Volcanic Phenomena of Vesuvius	20	0	0
Fossil Phyllopora of the Palæozoic Rocks.....	10	0	0
Circulation of Underground Waters.....	5	0	0
Excavations at Oldbury Hill	15	0	0
Cretaceous Polyzoa	10	0	0
Geological Photographs	7	14	11
Lias Beds of Northamptonshire	25	0	0
Botanical Station at Peradeniya	25	0	0
Experiments with a Tow-net	4	3	9
Naples Zoological Station ...	100	0	0
Zoology and Botany of the West India Islands	100	0	0
Marine Biological Association	30	0	0
Action of Waves and Currents in Estuaries	150	0	0
Graphic Methods in Mechanical Science	11	0	0
Anthropometric Calculations	5	0	0
Nomad Tribes of Asia Minor	25	0	0
Corresponding Societies	20	0	0
	<u>£799</u>	<u>16</u>	<u>8</u>

1891.

Ben Nevis Observatory.....	50	0	0
Electrical Standards.....	100	0	0
Electrolysis.....	5	0	0
Seismological Phenomena of Japan	10	0	0
Variations of Temperature in Lakes	20	0	0
Photographs of Meteorological Phenomena.....	5	0	0
Discharge of Electricity from Points	10	0	0
Ultra Violet Rays of Solar Spectrum	50	0	0

	£	s.	d.		£	s.	d.
International Standard for the Analysis of Iron and Steel.....	10	0	0	Botanical Station at Peradeniya	50	0	0
Isomeric Naphthalene Derivatives	25	0	0	Experiments with a Tow-Net Marine Biological Association at Plymouth	40	0	0
Formation of Haloids	25	0	0	Disappearance of Native Plants	12	10	0
Action of Light on Dyes	17	10	0	Action of Waves and Currents in Estuaries	5	0	0
Geological Record	100	0	0	Anthropometric Calculations	125	0	0
Volcanic Phenomena of Vesuvius	10	0	0	New Edition of 'Anthropological Notes and Queries'	10	0	0
Fossil Phyllopora	10	0	0	North - Western Tribes of Canada	50	0	0
Photographs of Geological Interest	9	5	0	Corresponding Societies	200	0	0
Lias Beds of Northamptonshire.....	25	0	0		25	0	0
Registration of Type-Specimens of British Fossils.....	5	5	0				
Investigation of Elbolton Cave.....	25	0	0				
					<u>£1,029</u>	<u>10</u>	<u>0</u>

General Meetings.

On Wednesday, August 19, at 8 p.m., in the Park Hall, Sir Frederick Abel, C.B., D.C.L., D.Sc., F.R.S., V.P.C.S., resigned the office of President to Dr. W. Huggins, F.R.S., Hon. F.R.S.E., F.R.A.S., who took the Chair, and delivered an Address, for which see page 1.

On Thursday, August 20, at 8 p.m., a Soirée took place in the Park Hall.

On Friday, August 21, at 8.30 p.m., in the Park Hall, Professor L. C. Miall, F.L.S., F.G.S., delivered a discourse on 'Some difficulties in the life of Aquatic Insects.'

On Monday, August 24, at 8.30 p.m., in the Park Hall, Professor A. W. Rücker, M.A., F.R.S., delivered a discourse on 'Electrical Stress.'

On Tuesday, August 25, at 8 p.m., a Soirée took place in the Park Hall.

On Wednesday, August 26, at 2.30 p.m., in the Dumfries Proprietary School, the concluding General Meeting took place, when the Proceedings of the General Committee and the Grants of Money for Scientific Purposes were explained to the Members.

The Meeting was then adjourned to Edinburgh. [The Meeting is appointed to commence on Wednesday, August 3, 1892.]

PRESIDENT'S ADDRESS.

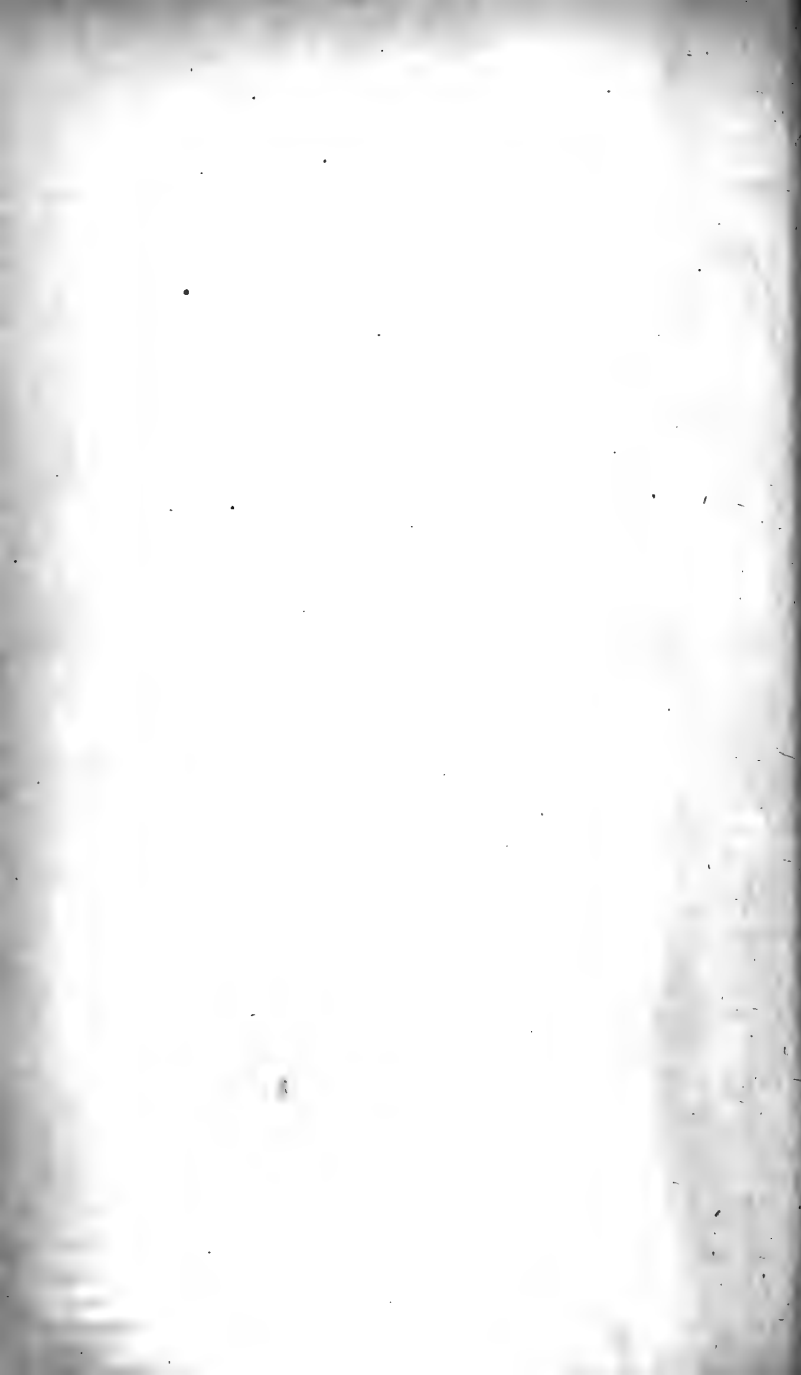

ADDRESS

BY

WILLIAM HUGGINS, ESQ.

D.C.L. (Oxon.), LL.D. (Cantab., Edin., et Dubl.), PH.D. (Lugd. Bat.),
F.R.S., F.R.A.S., Hon. F.R.S.E., &c., Correspondant
de l'Institut de France,

PRESIDENT.

It is now many years since this Association has done honour to the science of Astronomy in the selection of its President.

Since Sir George Airy occupied the chair in 1851, and the late Lord Wrottesley nine years later in 1860, other sciences have been represented by the distinguished men who have presided over your meetings.

The very remarkable discoveries in our knowledge of the heavens which have taken place during this period of thirty years—one of amazing and ever-increasing activity in all branches of science—have not passed unnoticed in the addresses of your successive Presidents; still it seems to me fitting that I should speak to you to-night chiefly of those newer methods of astronomical research which have led to those discoveries, and which have become possible by the introduction since 1860 into the observatory of the spectroscope and the modern photographic plate.

In 1866 I had the honour of bringing before this Association, at one of the evening lectures, an account of the first-fruits of the novel and unexpected advances in our knowledge of the celestial bodies which followed rapidly upon Kirchoff's original work on the solar spectrum and the interpretation of its lines.

Since that time a great harvest has been gathered in the same field by many reapers. Spectroscopic astronomy has become a distinct and acknowledged branch of the science, possessing a large literature of its own and observatories specially devoted to it. The more recent discovery of the gelatine dry plate has given a further great impetus to this modern side of astronomy, and has opened a pathway into the unknown of which even an enthusiast thirty years ago would scarcely have dared to dream.

In no science, perhaps, does the sober statement of the results which have been achieved appeal so strongly to the imagination, and make so evident the almost boundless powers of the mind of man. By means of its light alone to analyse the chemical nature of a far distant body; to be able to reason about its present state in relation to the past and future; to measure within an English mile or less per second the otherwise invisible motion which it may have towards or from us; to do more, to make even that which is darkness to our eyes light, and from vibrations which our organs of sight are powerless to perceive to evolve a revelation in which we see mirrored some of the stages through which the stars may pass in their slow evolutionary progress—surely the record of such achievements, however poor the form of words in which they may be described, is worthy to be regarded as the scientific epic of the present century.

I do not purpose to attempt a survey of the progress of spectroscopic astronomy from its birth at Heidelberg in 1859, but to point out what we do know at present, as distinguished from what we do not know, of a few only of its more important problems, giving a prominent place, in accordance with the traditions of this chair, to the work of the last year or two.

In the spectroscope itself advances have been made by Lord Rayleigh by his discussion of the theory of the instrument, and by Professor Rowland in the construction of concave gratings.

Lord Rayleigh has shown that there is not the necessary connection, sometimes supposed, between dispersion and resolving power, as besides the prism or grating other details of construction and of adjustment of a spectroscope must be taken into account.

The resolving power of the prismatic spectroscope is proportional to the length of path in the dispersive medium. For the heavy flint glass used in Lord Rayleigh's experiments the thickness necessary to resolve the sodium lines came out 1.02 cm. If this be taken as a unit, the resolving power of a prism of similar glass will be in the neighbourhood of the sodium lines equal to the number of centimètres of its thickness. In other parts of the spectrum the resolving power will vary inversely as the third power of the wave-length, so that it will be eight times as great in the violet as in the red. The resolving power of a spectroscope is therefore proportional to the total thickness of the dispersive material in use, irrespective of the number, the angles, or the setting of the separate prisms into which, for the sake of convenience, it may be distributed.

The resolving power of a grating depends upon the total number of lines on its surface, and the order of spectrum in use; about 1,000 lines being necessary to resolve the sodium lines in the first spectrum.

As it is often of importance in the record of observations to state the efficiency of the spectroscope with which they were made, Professor

Schuster has proposed the use of a unit of purity as well as of resolving power, for the full resolving power of a spectroscope is realised in practice only when a sufficiently narrow slit is used. The unit of purity also is to stand for the separation of two lines differing by one-thousandth of their own wave-length; about the separation of the sodium pair at D.

A further limitation may come in from the physiological fact that, as Lord Rayleigh has pointed out, the eye when its full aperture is used is not a perfect instrument. If we wish to realise the full resolving power of a spectroscope, therefore, the emergent beam must not be larger than about one-third of the opening of the pupil.

Up to the present time the standard of reference for nearly all spectroscopic work continues to be Ångström's map of the solar spectrum, and his scale based upon his original determinations of absolute wave-length. It is well known, as was pointed out by Thalén in his work on the spectrum of iron in 1884, that Ångström's figures are slightly too small, in consequence of an error existing in a standard mètre used by him. The corrections for this have been introduced into the tables of the wave-lengths of terrestrial spectra collected and revised by a Committee of this Association from 1885 to 1887. Last year the Committee added a table of corrections to Rowland's scale.

The inconvenience caused by a change of standard scale is, for a time at least, considerable; but there is little doubt that in the near future Rowland's photographic map of the solar spectrum, and his scale based on the determinations of absolute wave-length by Pierce and Bell, or the Potsdam scale based on original determinations by Müller and Kempf, which differs very slightly from it, will come to be exclusively adopted.

The great accuracy of Rowland's photographic map is due chiefly to the introduction by him of concave gratings, and of a method for their use, by which the problem of the determination of relative wave-lengths is simplified to measures of near coincidences of the lines in different spectra by a micrometer.

The concave grating and its peculiar mounting, in which no lenses or telescope are needed, and in which all the spectra are in focus together, formed a new departure of great importance in the measurement of spectral lines. The valuable method of photographic sensitizers for different parts of the spectrum has enabled Professor Rowland to include in his map the whole visible solar spectrum, as well as the ultra-violet portion as far as it can get through our atmosphere. Some recent photographs of the solar spectrum, which include A, by Mr. George Higgs, are of great technical beauty.

During the past year the results of three independent researches have appeared, in which the special object of the observers has been to distinguish the lines which are due to our atmosphere from those which are truly solar—the maps of M. Thollon, which, owing to his lamented death

just before their final completion, have assumed the character of a memorial of him; maps by Dr. Becker; and sets of photographs of a high and a low sun by Mr. McClean.

At the meeting of this Association in Bath, M. Janssen gave an account of his own researches on the terrestrial lines of the solar spectrum, which owe their origin to the oxygen of our atmosphere. He discovered the remarkable fact that while the intensity of one class of bands varies as the density of the gas, other diffuse bands vary as the square of the density. These observations are in accordance with the work of Egoroff and of Olszewski, and of Liveing and Dewar on condensed oxygen. In some recent experiments Olszewski, with a layer of liquid oxygen thirty millimètres thick, saw, as well as four other bands, the band coincident with Fraunhofer's A; a remarkable instance of the persistence of absorption through a great range of temperature. The light which passed through the liquid oxygen had a light blue colour resembling that of the sky.

Of not less interest are the experiments of Knut Ångström, which show that the carbonic acid and aqueous vapour of the atmosphere reveal their presence by dark bands in the invisible infra-red region, at the positions of bands of emission of these substances.

It is now some thirty years since the spectroscope gave us for the first time certain knowledge of the nature of the heavenly bodies, and revealed the fundamental fact that terrestrial matter is not peculiar to the solar system, but is common to all the stars which are visible to us.

In the case of a star such as Capella, which has a spectrum almost identical with that of the sun, we feel justified in concluding that the matter of which it is built up is similar, and that its temperature is also high, and not very different from the solar temperature. The task of analysing the stars and nebulae becomes, however, one of very great difficulty when we have to do with spectra differing from the solar type. We are thrown back upon the laboratory for the information necessary to enable us to interpret the indications of the spectroscope as to the chemical nature, the density and pressure, and the temperature of the celestial masses.

What the spectroscope immediately reveals to us are the waves which were set up in the ether filling all interstellar space, years or hundreds of years ago, by the motions of the molecules of the celestial substances. As a rule it is only when a body is gaseous and sufficiently hot that the motions within its molecules can produce bright lines and a corresponding absorption. The spectra of the heavenly bodies are indeed to a great extent absorption spectra, but we have usually to study them through the corresponding emission spectra of bodies brought into the gaseous form and rendered luminous by means of flames or of electric dis-

charges. In both cases, unfortunately, as has been shown recently by Professors Liveing and Dewar, Wüllner, E. Wiedemann, and others, there appears to be no certain direct relation between the luminous radiation as shown in the spectroscope and the temperature of the flame, or of the gaseous contents of the vacuum tube, that is, in the usual sense of the term as applied to the mean motion of all the molecules. In both cases, the vibratory motions within the molecules to which their luminosity is due are almost always much greater than would be produced by encounters of molecules having motions of translation no greater than the average motions which characterise the temperature of the gases as a whole. The temperature of a vacuum tube through which an electric discharge is taking place may be low, as shown thermometrically, quite apart from the consideration of the extreme smallness of the mass of gas, but the vibrations of the luminous molecules must be violent in whatever way we suppose them to be set up by the discharge; if we take Schuster's view that comparatively few molecules are carrying the discharge, and that it is to the fierce encounters of these alone that the luminosity is due, then if all the molecules had similar motions, the temperature of the gas would be very high.

So in flames where chemical changes are in progress, the vibratory motions of the molecules which are luminous may be, in connection with the energy set free in these changes, very different from those corresponding to the mean temperature of the flame.

Under the ordinary conditions of terrestrial experiments, therefore, the temperature or the mean vis viva of the molecules may have no direct relation to the total radiation, which, on the other hand, is the sum of the radiation due to each luminous molecule.

These phenomena have recently been discussed by Ebert from the standpoint of the electro-magnetic theory of light.

Very great caution is therefore called for when we attempt to reason by the aid of laboratory experiments to the temperature of the heavenly bodies from their radiation, especially on the reasonable assumption that in them the luminosity is not ordinarily associated with chemical changes or with electrical discharges, but is due to a simple glowing from the ultimate conversion into molecular motion of the gravitational energy of shrinkage.

In a recent paper Stas maintains that electric spectra are to be regarded as distinct from flame spectra, and, from researches of his own, that the pairs of lines of the sodium spectrum other than D are produced only by disruptive electric discharges. As these pairs of lines are found reversed in the solar spectrum, he concludes that the sun's radiation is due mainly to electric discharges. But Wolf and Diacon, and later, Watts, observed the other pairs of lines of the sodium spectrum when the vapour was raised above the ordinary temperature of the Bunsen flame. Recently, Liveing and Dewar saw easily, besides D the citron and green pairs and

sometimes the blue pair and the orange pair, when hydrogen charged with sodium vapour was burning at different pressures in oxygen. In the case of sodium vapour, therefore, and presumably in all other vapours and gases, it is a matter of indifference whether the necessary vibratory motion of the molecules is produced by electric discharges or by flames. The presence of lines in the solar spectrum which we can only produce electrically is an indication, however, as Stas points out, of the high temperature of the sun.

We must not forget that the light from the heavenly bodies may consist of the combined radiations of different layers of gas at different temperatures, and possibly be further complicated to an unknown extent by the absorption of cooler portions of gas outside.

Not less caution is needed if we endeavour to argue from the broadening of lines and the coming in of a continuous spectrum as to the relative pressure of the gas in the celestial atmospheres. On the one hand, it cannot be gainsaid that in the laboratory the widening of the lines in a Plücker's tube follows upon increasing the density of the residue of hydrogen in the tube, when the vibrations are more frequently disturbed by fresh encounters; and that a broadening of the sodium lines in a flame at ordinary pressure is produced by an increase of the quantity of sodium in the flame; but it is doubtful if pressure, as distinguished from quantity, does produce an increase of the breadth of the lines. An individual molecule of sodium will be sensibly in the same condition, considering the relatively enormous number of the molecules of the other gases, whether the flame is scantily or copiously fed with the sodium salt. With a small quantity of sodium vapour the intensity will be feeble except near the maximum of the lines; when, however, the quantity is increased the comparative transparency on the sides of the maximum will allow the light from the additional molecules met with in the path of the visual ray to strengthen the radiation of the molecules farther back, and so increase the breadth of the lines.

In a gaseous mixture it is found, as a rule, that at the same pressure or temperature, as the encounters with similar molecules become fewer, the spectral lines will be affected as if the body were observed under conditions of reduced quantity or temperature.

In their recent investigation of the spectroscopic behaviour of flames under various pressures up to forty atmospheres, Professors Liveing and Dewar have come to the conclusion that though the prominent feature of the light emitted by flames at high pressure appears to be a strong continuous spectrum, there is not the slightest indication that this continuous spectrum is produced by the broadening of the lines of the same gases at low pressure. On the contrary, photometric observations of the brightness of the continuous spectrum, as the pressure is varied, show that it is mainly produced by the mutual action of the molecules of a gas. Experiments on the sodium spectrum were carried up to a pressure of

forty atmospheres without producing any definite effect on the width of the lines which could be ascribed to the pressure. In a similar way the lines of the spectrum of water showed no signs of expansion up to twelve atmospheres; though more intense than at ordinary pressure, they remained narrow and clearly defined.

It follows, therefore, that a continuous spectrum cannot be considered, when taken alone, as a sure indication of matter in the liquid or the solid state. Not only, as in the experiments already mentioned, such a spectrum may be due to gas when under pressure, but, as Maxwell pointed out, if the thickness of a medium, such as sodium vapour, which radiates and absorbs different kinds of light, be very great, and the temperature high, the light emitted will be of exactly the same composition as that emitted by lamp-black at the same temperature, for the radiations which are feebly emitted will be also feebly absorbed, and can reach the surface from immense depths. Schuster has shown that oxygen, even in a partially exhausted tube, can give a continuous spectrum when excited by a feeble electric discharge.

Compound bodies are usually distinguished by a banded spectrum; but on the other hand such a spectrum does not necessarily show the presence of compounds, that is, of molecules containing different kinds of atoms, but simply of a more complex molecule, which may be made up of similar atoms, and be therefore an allotropic condition of the same body. In some cases, for example, in the diffuse bands of the absorption spectrum of oxygen, the bands may have an intensity proportional to the square of the density of the gas, and may be due either to the formation of more complex molecules of the gas with increase of pressure, or it may be to the constraint to which the molecules are subject during their encounters with one another.

It may be thought that at least in the coincidences of bright lines we are on the solid ground of certainty, since the length of the waves set up in the ether by a molecule, say of hydrogen, is the most fixed and absolutely permanent quantity in nature, and is so of physical necessity, for with any alteration the molecule would cease to be hydrogen.

Such would be the case if the coincidence were certain; but an absolute coincidence can be only a matter of greater or less probability, depending on the resolving power employed, on the number of the lines which correspond and on their characters. When the coincidences are very numerous, as in the case of iron and the solar spectrum, or the lines are characteristically grouped, as in the case of hydrogen and the solar spectrum, we may regard the coincidence as certain; but the progress of science has been greatly retarded by resting important conclusions upon the apparent coincidence of single lines, in spectroscopes of very small resolving power. In such cases, unless other reasons supporting the coincidence are present, the probability of a real coincidence is almost too small to be of any importance, especially in the case of a heavenly

body which may have a motion of approach or of recession of unknown amount.

But even here we are met by the confusion introduced by multiple spectra, corresponding to different molecular groupings of the same substance; and, further, to the influence of substances in vapour upon each other; for when several gases are present together, the phenomena of radiation and reversal by absorption are by no means the same as if the gases were free from each other's influence, and especially is this the case when they are illuminated by an electric discharge.

I have said as much as time will permit, and I think indeed sufficient, to show that it is only by the laborious and slow process of most cautious observation that the foundations of the science of celestial physics can be surely laid. We are at present in a time of transition when the earlier, and, in the nature of things, less precise observations are giving place to work of an order of accuracy much greater than was formerly considered attainable with objects of such small brightness as the stars.

The accuracy of the earlier determinations of the spectra of the terrestrial elements is in most cases insufficient for modern work on the stars as well as on the sun. They fall much below the scale adopted in Rowland's map of the sun, as well as below the degree of accuracy attained at Potsdam by photography in a part of the spectrum for the brighter stars. Increase of resolving power very frequently breaks up into groups, in the spectra of the sun and stars, the lines which had been regarded as single, and their supposed coincidences with terrestrial lines fall to the ground. For this reason many of the early conclusions, based on observations as good as it was possible to make at the time with the less powerful spectroscopes then in use, may not be found to be maintained under the much greater resolving power of modern instruments.

The spectroscope has failed as yet to interpret for us the remarkable spectrum of the Aurora Borealis. Undoubtedly in this phenomenon portions of our atmosphere are lighted up by electric discharges; we should expect, therefore, to recognise the spectra of the gases known to be present in it. As yet we have not been able to obtain similar spectra from these gases artificially, and especially we do not know the origin of the principal line in the green, which often appears alone, and may have therefore an origin independent of that of the other lines. Recently the suggestion has been made that the Aurora is a phenomenon produced by the dust of meteors and falling stars, and that near positions of certain auroral lines to lines or flutings of manganese, lead, barium, thallium, iron, &c., are sufficient to justify us in regarding meteoric dust in the atmosphere as the origin of the auroral spectrum. Liveing and Dewar have made a conclusive research on this point, by availing themselves of the dust of excessive minuteness thrown off from the surface of electrodes of various

metals and meteorites by a disruptive discharge, and carried forward into the tube of observation by a more or less rapid current of air or other gas. These experiments prove that metallic dust, however fine, suspended in a gas will not act like gaseous matter in becoming luminous with its characteristic spectrum in an electric discharge, similar to that of the Aurora. Professor Schuster has suggested that the principal line may be due to some very light gas which is present in too small a proportion to be detected by chemical analysis or even by the spectroscope in the presence of the other gases near the earth, but which at the height of the auroral discharges is in a sufficiently greater relative proportion to give a spectrum. Lemström, indeed, states that he saw this line in the silent discharge of a Holtz machine on a mountain in Lapland. The lines may not have been obtained in our laboratories from the atmospheric gases, on account of the difficulty of reproducing in tubes with sufficient nearness the conditions under which the auroral discharges take place.

In the spectra of comets the spectroscope has shown the presence of carbon presumably in combination with hydrogen, and also sometimes with nitrogen; and in the case of comets approaching very near the sun, the lines of sodium, and other lines which have been supposed to belong to iron. Though the researches of Professor H. A. Newton and of Professor Schiaparelli leave no doubt of the close connection of comets with corresponding periodic meteor swarms, and therefore of the probable identity of cometary matter with that of meteorites, with which the spectroscopic evidence agrees, it would be perhaps unwise at present to attempt to define too precisely the exact condition of the matter which forms the nucleus of the comet. In any case the part of the light of the comet which is not reflected solar light can scarcely be attributed to a high temperature produced by the clashing of separate meteoric stones set up within the nucleus by the sun's disturbing force. We must look rather to disruptive electric discharges produced probably by processes of evaporation due to increased solar heat, which would be amply sufficient to set free portions of the occluded gases into the vacuum of space. May it be that these discharges are assisted, and indeed possibly increased, by the recently discovered action of the ultra-violet part of the sun's light? Hertz has shown that ultra-violet light can produce a discharge from a negatively electrified piece of metal, while Hallwachs and Righi have shown further that ultra-violet light can even charge positively an unelectrified piece of metal; phenomena which Lenard and Wolf associate with the disengagement from the metallic surfaces of very minute particles. Similar actions on cometary matter, unscreened as it is by an absorptive atmosphere, at least of any noticeable extent, may well be powerful when a comet approaches the sun, and help to explain an electrified condition of the evaporated matter which would possibly bring it under the sun's repulsive action. We shall have to return to this point in speaking of the solar corona.

A very great advance has been made in our knowledge of the constitution of the sun by the recent work at the Johns Hopkins University by means of photography and concave gratings, in comparing the solar spectrum, under great resolving power, directly with the spectra of the terrestrial elements. Professor Rowland has shown that the lines of thirty-six terrestrial elements at least are certainly present in the solar spectrum, while eight others are doubtful. Fifteen elements, including nitrogen as it shows itself under an electric discharge in a vacuum tube, have not been found in the solar spectrum. Some ten other elements, inclusive of oxygen, have not yet been compared with the sun's spectrum.

Rowland remarks that of the fifteen elements named as not found in the sun, many are so classed because they have few strong lines, or none at all, in the limit of the solar spectrum as compared by him with the arc. Boron has only two strong lines. The lines of bismuth are compound and too diffuse. Therefore even in the case of these fifteen elements there is little evidence that they are really absent from the sun.

It follows that if the whole earth were heated to the temperature of the sun, its spectrum would resemble very closely the solar spectrum.

Rowland has not found any lines common to several elements, and in the case of some accidental coincidences, more accurate investigation reveals some slight difference of wave-length or a common impurity. Further, the relative strength of the lines in the solar spectrum is generally, with a few exceptions, the same as that in the electric arc, so that Rowland considers that his experiments show 'very little evidence' of the breaking up of the terrestrial elements in the sun.

Stas in a recent paper gives the final results of eleven years of research on the chemical elements in a state of purity, and on the possibility of decomposing them by the physical and chemical forces at our disposal. His experiments on calcium, strontium, lithium, magnesium, silver, sodium and thallium, show that these substances retain their individuality under all conditions, and are unalterable by any forces that we can bring to bear upon them.

Professor Rowland looks to the solar lines which are unaccounted for as a means of enabling him to discover such new terrestrial elements as still lurk in rare minerals and earths, by confronting their spectra directly with that of the sun. He has already resolved yttrium spectroscopically into three components, and actually into two. The comparison of the results of this independent analytical method with the remarkable but different conclusions to which M. Lecoq de Boisbaudran and Mr. Crookes have been led respectively, from spectroscopic observation of these bodies when glowing under molecular bombardment in a vacuum tube, will be awaited with much interest. It is worthy of remark that as our knowledge of the spectrum of hydrogen in its complete form came to us from the stars, it is now from the sun that chemistry is probably about to be enriched by the discovery of new elements.

In a discussion in the Bakerian lecture for 1885 of what we knew up to that time of the sun's corona, I was led to the conclusion that the corona is essentially a phenomenon similar in the cause of its formation to the tails of comets, namely, that it consists for the most part probably of matter going from the sun under the action of a force, possibly electrical, which varies as the surface, and can therefore in the case of highly attenuated matter easily master the force of gravity even near the sun. Though many of the coronal particles may return to the sun, those which form the long rays or streamers do not return; they separate and soon become too diffused to be any longer visible, and may well go to furnish the matter of the zodiacal light, which otherwise has not received a satisfactory explanation. And further, if such a force exist at the sun, the changes of terrestrial magnetism may be due to direct electric action, as the earth moves through lines of inductive force.

These conclusions appear to be in accordance broadly with the lines along which thought has been directed by the results of subsequent eclipses. Professor Schuster takes an essentially similar view, and suggests that there may be a direct electric connection between the sun and the planets. He asks further whether the sun may not act like a magnet in consequence of its revolution about its axis. Professor Bigelow has recently treated the coronal forms by the theory of spherical harmonics, on the supposition that we see phenomena similar to those of free electricity, the rays being lines of force, and the coronal matter discharged from the sun, or at least arranged or controlled by these forces. At the extremities of the streams for some reasons the repulsive power may be lost, and gravitation set in, bringing the matter back to the sun. The matter which does leave the sun is persistently transported to the equatorial plane of the corona; in fact, the zodiacal light may be the accumulation at great distances from the sun along this equator of such like material. Photographs on a larger scale will be desirable for the full development of the conclusions which may follow from this study of the curved forms of the coronal structure. Professor Schaeberle, however, considers that the coronal phenomena may be satisfactorily accounted for on the supposition that the corona is formed of streams of matter ejected mainly from the spot zones with great initial velocities, but smaller than 382 miles a second. Further that the different types of the corona are due to the effects of perspective on the streams from the earth's place at the time relatively to the plane of the solar equator.

Of the physical and the chemical nature of the coronal matter we know very little. Schuster concludes, from an examination of the eclipses of 1882, 1883, and 1886, that the continuous spectrum of the corona has the maximum of actinic intensity displaced considerably towards the red when compared with the spectrum of the sun, which shows that it can only be due in small part to solar light scattered by small particles. The lines of calcium and of hydrogen do not appear to form part of the normal spectrum

of the corona. The green coronal line has no known representative in terrestrial substances, nor has Schuster been able to recognise any of our elements in the other lines of the corona.

The spectra of the stars are almost infinitely diversified, yet they can be arranged with some exceptions in a series in which the adjacent spectra, especially in the photographic region, are scarcely distinguishable, passing from the bluish-white stars like Sirius, through stars more or less solar in character, to stars with banded spectra, which divide themselves into two apparently independent groups, according as the stronger edge of the bands is towards the red or the blue. In such an arrangement the sun's place is towards the middle of the series.

At present a difference of opinion exists as to the direction in the series in which evolution is proceeding, whether by further condensation white stars pass into the orange and red stages, or whether these more coloured stars are younger and will become white by increasing age. The latter view was suggested by Johnstone Stoney in 1867.

About ten years ago Ritter, in a series of papers, discussed the behaviour of gaseous masses during condensation, and the probable resulting constitution of the heavenly bodies. According to him, a star passes through the orange and red stages twice, first during a comparatively short period of increasing temperature which culminates in the white stage, and a second time during a more prolonged stage of gradual cooling. He suggested that the two groups of banded stars may correspond to these different periods: the young stars being those in which the stronger edge of the dark band is towards the blue, the other banded stars, which are relatively less luminous and few in number, being those which are approaching extinction through age.

Recently a similar evolutionary order has been suggested, which is based upon the hypothesis that the nebulae and stars consist of colliding meteoric stones in different stages of condensation.

More recently the view has been put forward that the diversified spectra of the stars do not represent the stages of an evolutionary progress, but are due for the most part to differences of original constitution.

The few minutes which can be given to this part of the address are insufficient for a discussion of these different views. I purpose, therefore, to state briefly, and with reserve as the subject is obscure, some of the considerations from the characters of their spectra which appeared to me to be in favour of the evolutionary order in which I arranged the stars from their photographic spectra in 1879. This order is essentially the same as Vogel had previously proposed in his classification of the stars in 1874, in which the white stars, which are most numerous, represent the early adult and most persistent stage of stellar life, the solar condition that of full maturity and of commencing age; while in the orange and red stars with banded spectra we see the setting in and advance of old age.

But this statement must be taken broadly, and not as asserting that all stars, however different in mass and possibly to some small extent in original constitution, exhibit one invariable succession of spectra.

In the spectra of the white stars the dark metallic lines are relatively inconspicuous, and occasionally absent, at the same time that the dark lines of hydrogen are usually strong, and more or less broad, upon a continuous spectrum, which is remarkable for its brilliancy at the blue end. In some of these stars the hydrogen and some other lines are bright, and sometimes variable.

As the greater or less prominence of the hydrogen lines, dark or bright, is characteristic of the white stars as a class, and diminishes gradually with the incoming and increase in strength of the other lines, we are probably justified in regarding it as due to some conditions which occur naturally during the progress of stellar life, and not to a peculiarity of original constitution.

To produce a strong absorption-spectrum a substance must be at the particular temperature at which it is notably absorptive; and, further, this temperature must be sufficiently below that of the region behind from which the light comes for the gas to appear, so far as its special rays are concerned, as darkness upon it. Considering the high temperature to which hydrogen must be raised before it can show its characteristic emission and absorption, we shall probably be right in attributing the relative feebleness or absence of the other lines, not to the paucity of the metallic vapours, but rather to their being so hot relatively to the substances behind them as to show feebly, if at all, by reversion. Such a state of things would more probably be found, it seems to me, in conditions anterior to the solar stage. A considerable cooling of the sun would probably give rise to banded spectra due to compounds, or to more complex molecules; which might form near the condensing points of the vapours.

The sun and stars are generally regarded as consisting of glowing vapours surrounded by a photosphere where condensation is taking place, the temperature of the photospheric layer from which the greater part of the radiation comes being constantly renewed from the hotter matter within.

At the surface the convection currents would be strong, producing a considerable commotion, by which the different gases would be mixed and not allowed to retain the inequality of proportions at different levels due to their vapour densities.

Now the conditions of the radiating photosphere and those of the gases above it, on which the character of the spectrum of a star depends, will be determined, not alone by temperature, but also by the force of gravity in these regions; this force will be fixed by the star's mass and its stage of condensation, and will become greater as the star continues to condense.

In the case of the sun the force of gravity has already become so

great at the surface that the decrease of the density of the gases must be extremely rapid passing in the space of a few miles, from atmospheric pressure to a density infinitesimally small; consequently the temperature-gradient at the surface, if determined solely by expansion, must be extremely rapid. The gases here, however, are exposed to the fierce radiation of the sun, and unless wholly transparent would take up heat, especially if any solid or liquid particles were present from condensation or convection currents.

From these causes, within a very small extent of space at the surface of the sun, all bodies with which we are acquainted should fall to a condition in which the extremely tenuous gas could no longer give a visible spectrum. The insignificance of the angle subtended by this space as seen from the earth should cause the boundary of the solar atmosphere to appear defined. If the boundary which we see be that of the sun proper, the matter above it will have to be regarded as in an essentially dynamical condition—an assemblage, so to speak, of gaseous projectiles for the most part falling back upon the sun after a greater or less range of flight. But in any case it is within a space of relatively small extent in the sun and probably in the other solar stars, that the reversion which is manifested by dark lines is to be regarded as taking place.

Passing backward in the star's life, we should find a gradual weakening of gravity at the surface, a reduction of the temperature-gradient so far as it was determined by expansion, and convection currents of less violence producing less interference with the proportional quantities of gases due to their vapour densities, while the effects of eruptions would be more extensive.

At last we might come to a state of things in which, if the star were hot enough, only hydrogen might be sufficiently cool relatively to the radiation behind to produce a strong absorption. The lower vapours would be protected, and might continue to be relatively too hot for their lines to appear very dark upon the continuous spectrum; besides, their lines might be possibly to some extent effaced by the coming in under such conditions in the vapours themselves of a continuous spectrum.

In such a star the light radiated towards the upper part of the atmosphere may have come from portions lower down of the atmosphere itself, or at least from parts not greatly hotter. There may be no such great difference of temperature of the low and less low portions of the star's atmosphere as to make the darkening effect of absorption of the protected metallic vapours to prevail over the illuminating effect of their emission.

It is only by a vibratory motion corresponding to a very high temperature that the bright lines of the first spectrum of hydrogen can be brought out, and by the equivalence of absorbing and emitting power that the corresponding spectrum of absorption should be produced; yet for a strong absorption to show itself, the hydrogen must be cool relatively to the source of radiation behind it, whether this be condensed particles

or gas. Such conditions, it seems to me, should occur in the earlier rather than in the more advanced stages of condensation.

The subject is obscure, and we may go wrong in our mode of conceiving of the probable progress of events, but there can be no doubt that in one remarkable instance the white-star spectrum is associated with an early stage of condensation.

Sirius is one of the most conspicuous examples of one type of this class of stars. Photometric observations combined with its ascertained parallax show that this star emits from forty to sixty times the light of our sun, even to the eye, which is insensible to ultra-violet light, in which Sirius is very rich, while we learn from the motion of its companion that its mass is not much more than double that of our sun. It follows that unless we attribute to this star an improbably great emissive power, it must be of immense size, and in a much more diffuse and therefore an earlier condition than our sun; though probably at a later stage than those white stars in which the hydrogen lines are bright.

A direct determination of the relative temperature of the photospheres of the stars might possibly be obtained in some cases from the relative position of maximum radiation of their continuous spectra. Langley has shown that through the whole range of temperature on which we can experiment, and presumably at temperatures beyond, the maximum of radiation-power in solid bodies gradually shifts upwards in the spectrum from the infra-red through the red and orange, and that in the sun it has reached the blue.

The defined character as a rule of the stellar lines of absorption suggests that the vapours producing them do not at the same time exert any strong power of general absorption. Consequently we should probably not go far wrong, when the photosphere consists of liquid or solid particles, if we could compare select parts of the continuous spectrum between the stronger lines or where they are fewest. It is obvious that if extended portions of different stellar spectra were compared, their true relation would be obscured by the line-absorption.

The increase of temperature, as shown by the rise in the spectrum of the maximum of radiation, may not always be accompanied by a corresponding greater brightness of a star as estimated by the eye, which is an extremely imperfect photometric instrument. Not only is the eye blind to large regions of radiation, but even for the small range of light that we can see the visual effect varies enormously with its colour. According to Professor Langley, the same amount of energy which just enables us to perceive light in the crimson at A would in the green produce a visual effect 100,000 times greater. In the violet the proportional effect would be 1,600, in the blue 62,000, in the yellow 28,000, in the orange 14,000, and in the red 1,200. Captain Abney's recent experiments make the sensitiveness of the eye for the green near F to be 750 times greater than for red about C. It is for this reason, at least in part, that I suggested

1891.

in 1864, and have since shown by direct observation, that the spectrum of the nebula in Andromeda, and presumably of similar nebulae, is in appearance only wanting in the red.

The stage at which the maximum radiation is in the green, corresponding to the eye's greatest sensitiveness, would be that in which it could be most favourably measured by eye-photometry. As the maximum rose into the violet and beyond, the star would increase in visual brightness, but not in proportion to the increase of energy radiated by it.

The brightness of a star would be affected by the nature of the substance by which the light was chiefly emitted. In the laboratory solid carbon exhibits the highest emissive power. A stellar stage in which radiation comes, to a large extent, from a photosphere of the solid particles of this substance, would be favourable for great brilliancy. Though the stars are built up of matter essentially similar to that of the sun, it does not follow that the proportion of the different elements is everywhere the same. It may be that the substances condensed in the photospheres of different stars may differ in their emissive powers, but probably not to a great extent.

All the heavenly bodies are seen by us through the tinted medium of our atmosphere. According to Langley, the solar stage of stars is not really yellow, but, even as gauged by our imperfect eyes, would appear bluish-white if we could free ourselves from the deceptive influences of our surroundings.

From these considerations it follows that we can scarcely infer the evolutionary stages of the stars from a simple comparison of their eye-magnitudes. We should expect the white stars to be, as a class, less dense than the stars in the solar stage. As great mass might bring in the solar type of spectrum at a relatively earlier time, some of the brightest of these stars may be very massive and brighter than the sun—for example, the brilliant star Arcturus. For these reasons the solar stars should not only be denser than the white stars, but perhaps, as a class, surpass them in mass and eye-brightness.

It has been shown by Lane that, so long as a condensing gaseous mass remains subject to the laws of a purely gaseous body, its temperature will continue to rise.

The greater or less breadth of the lines of absorption of hydrogen in the white-stars may be due to variations of the depth of the hydrogen in the line of sight, arising from the causes which have been discussed. At the sides of the lines the absorption and emission are feebler than in the middle, and would come out more strongly with a greater thickness of gas.

The diversities among the white stars are nearly as numerous as the individuals of the class. Time does not permit me to do more than to record that in addition to the three sub-classes into which they have been divided by Vogel, Scheiner has recently investigated minor differences as suggested by the character of the third line of hydrogen near G. He

has pointed out too that so far as his observations go the white stars in the constellation of Orion stand alone, with the exception of Algol, in possessing a dark line in the blue which has apparently the same position as a bright line in the great nebula of the same constellation; and Pickering finds in his photographs of the spectra of these stars dark lines corresponding to the principal lines of the bright-line stars, and the planetary nebulæ with the exception of the chief nebular line. The association of white stars with nebular matter in Orion, in the Pleiades, in the region of the Milky Way, and in other parts of the heavens, may be regarded as falling in with the view that I have taken.

In the stars possibly further removed from the white class than our sun, belonging to the first division of Vogel's third class, which are distinguished by absorption bands with their stronger edge towards the blue, the hydrogen lines are narrower than in the solar spectrum. In these stars the density-gradient is probably still more rapid, the depth of hydrogen may be less, and possibly the hydrogen molecules may be affected by a larger number of encounters with dissimilar molecules. In some red stars with dark hydrocarbon bands the hydrogen lines have not been certainly observed; if they are really absent, it may be because the temperature has fallen below the point at which hydrogen can exert its characteristic absorption; besides, some hydrogen will have united with the carbon. The coming in of the hydrocarbon bands may indicate a later evolutionary stage, but the temperature may still be high, as acetylene can exist in the electric arc.

A number of small stars more or less similar to those which are known by the names of their discoverers, Wolf and Rayet, have been found by Pickering in his photographs. These are remarkable for several brilliant groups of bright lines, including frequently the hydrogen lines and the line D_3 , upon a continuous spectrum strong in blue and violet rays, in which are also dark lines of absorption. As some of the bright groups appear in his photographs to agree in position with corresponding bright lines in the planetary nebulæ, Pickering suggests that these stars should be placed in one class with them, although the brightest nebular line is absent from these stars. The simplest conception of their nature would be that each star is surrounded by a nebula, the bright groups being due to the gaseous matter outside the star. Mr. Roberts, however, has not been able to bring out any indication of nebulosity by prolonged exposure. The remarkable star η Argus may belong to this class of the heavenly bodies.

In the nebulæ, the elder Herschel saw portions of the fiery mist or 'shining fluid' out of which the heavens and the earth had been slowly fashioned. For a time this view of the nebulæ gave place to that which regarded them as external galaxies, cosmical 'sandheaps,' too remote to be resolved into separate stars; though indeed in 1858 Mr. Herbert

Spencer showed that the observations of nebulae up to that time were really in favour of an evolutionary progress.

In 1864 I brought the spectroscope to bear upon them; the bright lines which flashed upon the eye showed the source of the light of a number of them to be glowing gas, and so restored these bodies to what is probably their true place, as an early stage of sidereal life.

At that early time our knowledge of stellar spectra was small. For this reason partly, and probably also under the undue influence of theological opinions then widely prevalent, I unwisely wrote in my original paper in 1864, 'that in these objects we no longer have to do with a special modification of our own type of sun, but find ourselves in presence of objects possessing a distinct and peculiar plan of structure.' Two years later, however, in a lecture before this Association, I took a truer position. 'Our views of the universe,' I said, 'are undergoing important changes; let us wait for more facts with minds unfettered by any dogmatic theory, and therefore free to receive the teaching, whatever it may be, of new observations.'

Let us turn aside for a moment from the nebulae in the sky to the conclusions to which philosophers had been irresistibly led by a consideration of the features of the solar system. We have before us in the sun and planets obviously not a haphazard aggregation of bodies, but a system resting upon a multitude of relations pointing to a common physical cause. From these considerations Kant and Laplace formulated the nebular hypothesis, resting it on gravitation alone, for at that time the science of the conservation of energy was practically unknown. These philosophers showed how, on the supposition that the space now occupied by the solar system was once filled by a vaporous mass, the formation of the sun and planets could be reasonably accounted for.

By a totally different method of reasoning, modern science traces the solar system backward step by step to a similar state of things at the beginning. According to Helmholtz the sun's heat is maintained by the contraction of his mass, at the rate of about 220 feet a year. Whether at the present time the sun is getting hotter or colder we do not certainly know. We can reason back to the time when the sun was sufficiently expanded to fill the whole space occupied by the solar system, and was reduced to a great glowing nebula. Though man's life, the life of the race perhaps, is too short to give us direct evidence of any distinct stages of so august a process, still the probability is great that the nebular hypothesis, especially in the more precise form given to it by Roche, does represent broadly, notwithstanding some difficulties, the succession of events through which the sun and planets have passed.

The nebular hypothesis of Laplace requires a rotating mass of fluid which at successive epochs became unstable from excess of motion, and left behind rings, or more probably perhaps lumps, of matter from the equatorial regions.

The difficulties to which I have referred have suggested to some thinkers a different view of things, according to which it is not necessary to suppose that one part of the system gravitationally supports another. The whole may consist of a congeries of discrete bodies even if these bodies be the ultimate molecules of matter. The planets may have been formed by the gradual accretion of such discrete bodies. On the view that the material of the condensing solar system consisted of separate particles or masses, we have no longer the fluid pressure which is an essential part of Laplace's theory. Faye, in his theory of evolution from meteorites, has to throw over this fundamental idea of the nebular hypothesis, and he formulates instead a different succession of events in which the outer planets were formed last; a theory which has difficulties of its own.

Professor George Darwin has recently shown, from an investigation of the mechanical conditions of a swarm of meteorites, that on certain assumptions a meteoric swarm might behave as a coarse gas, and in this way bring back the fluid pressure exercised by one part of the system on the other, which is required by Laplace's theory. One chief assumption consists in supposing that such inelastic bodies as meteoric stones might attain the effective elasticity of a high order which is necessary to the theory through the sudden volatilisation of a part of their mass at an encounter, by which what is virtually a violent explosive is introduced between the two colliding stones. Professor Darwin is careful to point out that it must necessarily be obscure as to how a small mass of solid matter can take up a very large amount of energy in a small fraction of a second.

Any direct indications from the heavens themselves, however slight, are of so great value, that I should perhaps in this connection call attention to a recent remarkable photograph by Mr. Roberts of the great nebula in Andromeda. On this plate we seem to have presented to us some stage of cosmical evolution on a gigantic scale. The photograph shows a sort of whirlpool disturbance of the luminous matter which is distributed in a plane inclined to the line of sight, in which a series of rings of bright matter separated by dark spaces, greatly foreshortened by perspective, surround a large undefined central mass. The parallax of this nebula has not been ascertained, but there can be little doubt that we are looking upon a system very remote, and therefore of a magnitude great beyond our power of adequate comprehension. The matter of this nebula, in whatever state it may be, appears to be distributed, as in so many other nebulae, in rings or spiral streams, and to suggest a stage in a succession of evolutionary events not inconsistent with that which the nebular hypothesis requires. To liken this object more directly to any particular stage in the formation of the solar system would be 'to compare things great with small,' and might be indeed to introduce a false analogy; but on the other hand, we should err through an excess of caution if we did

not accept the remarkable features brought to light by this photograph as a presumptive indication of a progress of events in cosmical history following broadly upon the lines of Laplace's theory.

The old view of the original matter of the nebulæ, that it consisted of a 'fiery mist,'

'a tumultuous cloud
Instinct with fire and nitre,'

fell at once with the rise of the science of thermodynamics. In 1854 Helmholtz showed that the supposition of an original fiery condition of the nebulous stuff was unnecessary, since in the mutual gravitation of widely separated matter we have a store of potential energy sufficient to generate the high temperature of the sun and stars. We can scarcely go wrong in attributing the light of the nebulæ to the conversion of the gravitational energy of shrinkage into molecular motion.

The idea that the light of comets and of nebulæ may be due to a succession of ignited flashes of gas from the encounters of meteoric stones was suggested by Professor Tait, and was brought to the notice of this Association in 1871 by Sir William Thomson in his Presidential Address.

The spectrum of the bright-line nebulæ is certainly not such a spectrum as we should expect from the flashing by collisions of meteorites similar to those which have been analysed in our laboratories. The strongest lines of the substances which in the case of such meteorites would first show themselves, iron, sodium, magnesium, nickel, &c., are not those which distinguish the nebular spectrum. On the contrary, this spectrum is chiefly remarkable for a few brilliant lines, very narrow and defined, upon a background of a faint continuous spectrum, which contains numerous bright lines, and probably some lines of absorption.

The two most conspicuous lines have not been interpreted; for though the second line falls near, it is not coincident with a strong double line of iron. It is hardly necessary to say that though the near position of the brightest line to the bright double line of nitrogen, as seen in a small spectroscope in 1864, naturally suggested at that early time the possibility of the presence of this element in the nebulæ, I have been careful to point out, to prevent misapprehension, that in more recent years the nitrogen line and subsequently a lead line have been employed by me solely as fiducial points of reference in the spectrum.

The third line we know to be the second line of the first spectrum of hydrogen. Mr. Keeler has seen the first hydrogen line in the red, and photographs show that this hydrogen spectrum is probably present in its complete form, or nearly so, as we first learnt to know it in the absorption spectrum of the white stars.

We are not surprised to find associated with it the line D_3 , near the position of the absent sodium lines, probably due to the atom of some unknown gas, which in the sun can only show itself in the outbursts of

highest temperature, and for this reason does not reveal itself by absorption in the solar spectrum.

It is not unreasonable to assume that the two brightest lines, which are of the same order as the third line, are produced by substances of a similar nature, in which a vibratory motion corresponding to a very high temperature is also necessary. These substances, as well as that represented by the line D_3 , may be possibly some of the unknown elements which are wanting in our terrestrial chemistry between hydrogen and lithium, unless indeed D_3 be on the lighter side of hydrogen.

In the laboratory we must have recourse to the electric discharge to bring out the spectrum of hydrogen; but in a vacuum-tube, though the radiation may be great, from the relative fewness of the luminous atoms or molecules or from some other cause, the temperature of the gas as a whole may be low.

On account of the large extent of the nebulæ, a comparatively small number of luminous molecules or atoms would probably be sufficient to make the nebulæ as bright as they appear to us. On such an assumption the average temperature may be low, but the individual particles, which by their encounters are luminous, must have motions corresponding to a very high temperature, and in this sense be extremely hot.

In such diffuse masses, from the great mean length of free path, the encounters would be rare but correspondingly violent, and tend to bring about vibrations of comparatively short period, as appears to be the case if we may judge by the great relative brightness of the more refrangible lines of the nebular spectrum.

Such a view may perhaps reconcile the high temperature which the nebular spectrum undoubtedly suggests with the much lower mean temperature of the gaseous mass, which we should expect at so early a stage of condensation, unless we assume a very enormous mass; or that the matter coming together had previously considerable motion, or considerable molecular agitation.

If the hydrogen shown by the spectroscope in the nebulæ and in the atmospheres of the stars is retained by these bodies, we should be able to assign approximately an inferior limit for the force of gravity at their surfaces; provided that we assume that the gas is in the uncombined state, and always exists in some greater proportion than in the free space about them.

The inquisitiveness of the human mind does not allow us to remain content with the interpretation of the present state of the cosmical masses, but suggests the question—

‘What see'st thou else

In the dark backward and abysm of time?’

What was the original state of things? how has it come about that by the side of ageing worlds we have nebulæ in a relatively younger stage? Have any of them received their birth from dark suns, which have col-

lided into new life, and so belong to a second or later generation of the heavenly bodies?

During the short historic period, indeed, there is no record of such an event; still it would seem to be only through the collision of dark suns, of which the number must be increasing, that a temporary rejuvenescence of the heavens is possible, and by such ebbings and flowings of stellar life that the inevitable end to which evolution in its apparently uncompensated progress is carrying us can, even for a little, be delayed.

We cannot refuse to admit as possible such an origin for nebulae.

In considering, however, the formation of the existing nebulae we must bear in mind that, in the part of the heavens within our ken, the stars still in the early and middle stages of evolution exceed greatly in number those which appear to be in an advanced condition of condensation. Indeed, we find some stars which may be regarded as not far advanced beyond the nebular condition.

It may be that the cosmical bodies which are still nebulous owe the lateness of their development to some conditions of the part of space where they occur, such as conceivably a greater original homogeneity, in consequence of which condensation began less early. In other parts of space condensation may have been still further delayed, or even have not yet begun. It is worthy of remark that these nebulae group themselves about the Milky Way, where we find a preponderance of the white-star type of stars, and almost exclusively the bright-line stars which Pickering associates with the planetary nebulae. Further, Dr. Gill concludes, from the rapidity with which they impress themselves upon the plate, that the fainter stars of the Milky Way also, to a large extent, belong to this early type of stars. At the same time other types of stars occur also over this region, and the red hydrocarbon stars are found in certain parts; but possibly these stars may be before or behind the Milky Way, and not physically connected with it.

If light matter be suggested by the spectrum of these nebulae, it may be asked further, as a pure speculation, whether in them we are witnessing possibly a later condensation of the light matter which had been left behind, at least in a relatively greater proportion, after the first growth of worlds into which the heavier matter condensed, though not without some entanglement of the lighter substances. The wide extent and great diffuseness of this bright-line nebulosity over a large part of the constellation of Orion may be regarded perhaps as pointing in this direction. The diffuse nebulous matter streaming round the Pleiades may possibly be another instance, though the character of its spectrum has not yet been ascertained.

In the planetary nebulae, as a rule, there is a sensible increase of the faint continuous spectrum, as well as a slight thickening of the bright lines towards the centre of the nebula, appearances which are in favour of the view that these bodies are condensing gaseous masses.

Professor G. Darwin, in his investigation of the equilibrium of a rotating mass of fluid, found, in accordance with the independent researches of Poincaré, that when a portion of the central body becomes detached through increasing angular velocity, the portion should bear a far larger ratio to the remainder than is observed in the planets and satellites of the solar system, even taking into account heterogeneity from the condensation of the parent mass.

Now this state of things, in which the masses though not equal are of the same order, does seem to prevail in many nebulae, and to have given birth to a large class of binary stars. Mr. See has recently investigated the evolution of bodies of this class, and points out their radical differences from the solar system in the relatively large mass-ratios of the component bodies, as well as in the high eccentricities of their orbits brought about by tidal friction, which would play a more important part in the evolution of such systems.

Considering the large number of these bodies, he suggests that the solar system should perhaps no longer be regarded as representing celestial evolution in its normal form—

‘ A goodly Paterne to whose perfect mould
He fashioned them . . . ’

but rather as modified by conditions which are exceptional.

It may well be that in the very early stages condensing masses are subject to very different conditions, and that condensation may not always begin at one or two centres, but sometimes set in at a large number of points, and proceed in the different cases along very different lines of evolution.

Besides its more direct use in the chemical analysis of the heavenly bodies, the spectroscope has given to us a great and unexpected power of advance along the lines of the older astronomy. In the future a higher value may, indeed, be placed upon this indirect use of the spectroscope than upon its chemical revelations.

By no direct astronomical methods could motions of approach or of recession of the stars be even detected, much less could they be measured. A body coming directly towards us or going directly from us appears to stand still. In the case of the stars we can receive no assistance from change of size or of brightness. The stars show no true discs in our instruments, and the nearest of them is so far off that if it were approaching us at the rate of a hundred miles in a second of time, a whole century of such rapid approach would not do more than increase its brightness by the one-fortieth part.

Still it was only too clear that, so long as we were unable to ascertain directly those components of the stars' motions which lie in the line of sight, the speed and direction of the solar motion in space, and many of

the great problems of the constitution of the heavens, must remain more or less imperfectly known. Now the spectroscope has placed in our hands this power, which, though so essential, appeared almost in the nature of things to lie for ever beyond our grasp; it enables us to measure directly, and under favourable circumstances to within a mile per second, or even less, the speed of approach or of recession of a heavenly body. This method of observation has the great advantage for the astronomer of being independent of the distance of the moving body, and is therefore as applicable and as certain in the case of a body on the extreme confines of the visible universe, so long as it is bright enough, as in the case of a neighbouring planet.

Doppler had suggested as far back as 1841 that the same principle, on which he had shown that a sound should become sharper or flatter if there were an approach or a recession between the ear and the source of the sound, would apply equally to light; and he went on to say that the difference of colour of some of the binary stars might be produced in this way by their motions. Doppler was right in that the principle is true in the case of light, but he was wrong in the particular conclusion which he drew from it. Even if we suppose a star to be moving with a sufficiently enormous velocity to alter sensibly its colour to the eye, no such change would actually be seen, for the reason that the store of invisible light beyond both limits of the visible spectrum, the blue and the red, would be drawn upon, and light-waves invisible to us would be exalted or degraded so as to take the place of those raised or lowered in the visible region, and the colour of the star would remain unchanged. About eight years later Fizeau pointed out the importance of considering the individual wave-lengths of which white light is composed. It is, indeed, Doppler's principle which underlies the early determination of the velocity of light by Roemer; but this method, in its converse form, can scarcely be regarded as of practical value for the motions in the line of sight of binary stars. As soon, however, as we had learned to recognise the lines of known substances in the spectra of the heavenly bodies, Doppler's principle became applicable as the basis of a new and most fruitful method of investigation. The measurement of the small shift of the celestial lines from their true positions, as shown by the same lines in the spectrum of a terrestrial substance, gives to us the means of ascertaining directly in miles per second the speed of approach or of recession of the heavenly body from which the light has come.

An account of the first application of this method of research to the stars, which was made in my observatory in 1868, was given by Sir Gabriel Stokes from this chair at the meeting at Exeter in 1869. The stellar motions determined by me were shortly after confirmed by Professor Vogel in the case of Sirius, and in the case of other stars by Mr. Christie, now Astronomer Royal, at Greenwich; but, necessarily, in con-

sequence of the inadequacy of the instruments then in use for so delicate an inquiry, the amounts of these motions were but approximate.

The method was shortly afterwards taken up systematically at Greenwich and at the Rugby Observatory. It is to be greatly regretted that, for some reasons, the results have not been sufficiently accordant and accurate for a research of such exceptional delicacy. On this account probably, as well as that the spectroscope at that early time had scarcely become a familiar instrument in the observatory, astronomers were slow in availing themselves of this new and remarkable power of investigation. That this comparative neglect of so truly wonderful a method of ascertaining what was otherwise outside our powers of observation has greatly retarded the progress of astronomy during the last fifteen years, is but too clearly shown by the brilliant results which within the last couple of years have followed fast upon the recent masterly application of this method by photography at Potsdam, and by eye with the needful accuracy at the Lick Observatory. At last this use of the spectroscope has taken its true place as one of the most potent methods of astronomical research. It gives us the motions of approach and of recession, not in angular measures, which depend for their translation into actual velocities upon separate determinations of parallactic displacements, but at once in terrestrial units of distance.

This method of work will doubtless be very prominent in the astronomy of the near future, and to it probably we shall have to look for the more important discoveries in sidereal astronomy which will be made during the coming century.

In his recent application of photography to this method of determining celestial motions, Professor Vogel, assisted by Dr. Scheiner, considering the importance of obtaining the spectrum of as many stars as possible on an extended scale without an exposure inconveniently long, wisely determined to limit the part of the spectrum on the plate to the region for which the ordinary silver-bromide gelatine plates are most sensitive, namely, to a small distance on each side of G, and to employ as the line of comparison the hydrogen line near G, and recently also certain lines of iron. The most minute and complete mechanical arrangements were provided for the purpose of securing the absolute rigidity of the comparison spectrum relatively to that of the star, and for permitting temperature adjustments and other necessary ones to be made.

The perfection of these spectra is shown by the large number of lines, no fewer than 250 in the case of Capella, within the small region of the spectrum on the plate. Already the motions of about fifty stars have been measured with an accuracy, in the case of the larger number of them, of about an English mile per second.

At the Lick Observatory it has been shown that observations can be made directly by eye with an accuracy equally great. Mr. Keeler's brilliant success has followed in great measure from the use of the third

and fourth spectra of a grating with 14,438 lines to the inch. The marvellous accuracy attainable in his hands on a suitable star is shown by observations on three nights of the star Arcturus, the largest divergence of his measures being not greater than six-tenths of a mile per second, while the mean of the three nights' work agreed with the mean of five photographic determinations of the same star at Potsdam to within one-tenth of an English mile. These are determinations of the motions of a sun so stupendously remote that even the method of parallax practically fails to fathom the depth of intervening space, and by means of light-waves which have been, according to Elkin's nominal parallax, nearly 200 years upon their journey.

Mr. Keeler with his magnificent means has accomplished a task which I attempted in vain in 1874, with the comparatively poor appliances at my disposal, of measuring the motions in the line of sight of some of the planetary nebulae. As the stars have considerable motions in space it was to be expected that nebulae should possess similar motions, for the stellar motions must have belonged to the nebulae out of which they have been evolved. My instrumental means, limiting my power of detection to motions greater than twenty-five miles per second, were insufficient. Mr. Keeler has found in the examination of ten nebulae motions varying from two miles to twenty-seven miles, with one exceptional motion of nearly forty miles.

For the nebula of Orion, Mr. Keeler finds a motion of recession of about ten miles a second. Now this motion agrees closely with what it should appear to have from the drift of the solar system itself, so far as it has been possible at present to ascertain the probable velocity of the sun in space. This grand nebula, of vast extent and of extreme tenuity, is probably more nearly at rest relatively to the stars of our system than any other celestial object we know; still it would seem more likely that even here we have some motion, small though it may be, than that the motions of the matter of which it is formed were so absolutely balanced as to leave this nebula in the unique position of absolute immobility in the midst of whirling and drifting suns and systems of suns.

The spectroscopic method of determining celestial motions in the line of sight has recently become fruitful in a new but not altogether unforeseen direction, for it has, so to speak, given us a separating power far beyond that of any telescope the glass-maker and the optician could construct, and so enabled us to penetrate into mysteries hidden in stars apparently single, and altogether unsuspected of being binary systems. The spectroscope has not simply added to the list of the known binary stars, but has given to us for the first time a knowledge of a new class of stellar systems, in which the components are in some cases of nearly equal magnitude, and in close proximity, and are revolving with velocities greatly exceeding the planetary velocities of our system.

The K line in the photographs of Mizar, taken at the Harvard College Observatory, was found to be double at intervals of fifty-two days. The spectrum was therefore not due to a single source of light, but to the combined effect of two stars moving periodically in opposite directions in the line of sight. It is obvious that if two stars revolve round their common centre of gravity in a plane not perpendicular to the line of sight, all the lines in a spectrum common to the two stars will appear alternately single or double.

In the case of Mizar and the other stars to be mentioned, the spectroscopic observations are not as yet extended enough to furnish more than an approximate determination of the elements of their orbits.

Mizar especially, on account of its relatively long period, about 105 days, needs further observations. The two stars are moving each with a velocity of about fifty miles a second, probably in elliptical orbits, and are about 143 millions of miles apart. The stars of about equal brightness have together a mass about forty times as great as that of our sun.

A similar doubling of the lines showed itself in the Harvard photographs of β Aurigæ at the remarkably close interval of almost exactly two days, indicating a period of revolution of about four days. According to Vogel's later observations, each star has a velocity of nearly seventy miles a second, the distance between the stars being little more than seven and a half millions of miles, and the mass of the system 4.7 times that of the sun. The system is approaching us at the speed of about sixteen miles a second.

The telescope could never have revealed to us double stars of this order. In the case of β Aurigæ, combining Vogel's distance with Pritchard's recent determination of the star's parallax, the greatest angular separation of the stars as seen from the earth would be 1-200th part of a second of arc, and therefore very far too small for detection by the largest telescopes. If we take the relation of aperture to separating power usually accepted, an object glass of about eighty feet in diameter would be needed to resolve this binary star. The spectroscope, which takes no note of distance, magnifies, so to speak, this minute angular separation 4,000 times; in other words, the doubling of the lines, which is the phenomenon that we have to observe, amounts to the easily measurable quantity of twenty seconds of arc.

There were known, indeed, variable stars of short period, which it had been suggested might be explained on the hypothesis of a dark body revolving about a bright sun in a few days, but this theory was met by the objection that no such systems of closely revolving suns were known to exist.

The Harvard photographs of which we have been speaking were taken with a slitless form of spectroscope, the prisms being placed, as originally by Fraunhofer, before the object glass of the telescope. This method, though it possesses some advantages, has the serious drawback

of not permitting a direct comparison of the star's spectrum with terrestrial spectra. It is obviously unsuited to a variable star like Algol, where one star only is bright, for in such a case there would be no doubling of the lines, but only a small shift to and fro in the spectrum of the lines of the bright star as it moved in its orbit alternately towards and from our system, which would need for its detection the fiducial positions of terrestrial lines compared directly with them.

For such observations the Potsdam spectrograph was well adapted. Professor Vogel found that the bright star of Algol did pulsate backwards and forwards in the visual direction in a period corresponding to the known variation of its light. The explanation which had been suggested for the star's variability, that it was partially eclipsed at regular intervals of 68.8 hours by a dark companion large enough to cut off nearly five-sixths of its light, was therefore the true one. The dark companion, no longer able to hide itself by its obscureness, was brought out into the light of direct observation by means of its gravitational effects.

Seventeen hours before minimum Algol is receding at the rate of about $24\frac{1}{2}$ miles a second, while seventeen hours after minimum it is found to be approaching with a speed of about $28\frac{1}{2}$ miles. From these data, together with those of the variation of its light, Vogel found, on the assumption that both stars have the same density, that the companion, nearly as large as the sun, but with about one-fourth his mass, revolves with a velocity of about fifty-five miles a second. The bright star of about twice the size and mass moves about the common centre of gravity with the speed of about twenty-six miles a second. The system of the two stars, which are about $3\frac{1}{4}$ millions of miles apart, considered as a whole, is approaching us with a velocity of 2.4 miles a second. The great difference in luminosity of the two stars, not less than fifty times, suggests rather that they are in different stages of condensation, and dissimilar in density.

It is obvious that if the orbit of a star with an obscure companion is sufficiently inclined to the line of sight, the companion will pass above or below the bright star and produce no variation of its light. Such systems may be numerous in the heavens. In Vogel's photographs, Spica, which is not variable, by a small shifting of its lines reveals a backward and forward periodical pulsation due to orbital motion. As the pair whirl round their common centre of gravity, the bright star is sometimes advancing, at others receding. They revolve in about four days, each star moving with a velocity of about fifty-six miles a second in an orbit probably nearly circular, and possess a combined mass of rather more than $2\frac{1}{2}$ times that of the sun. Taking the most probable value for the star's parallax, the greatest angular separation of the stars would be far too small to be detected with the most powerful telescopes.

If in a close double star the fainter companion is of the white-star

type, while the bright star is solar in character, the composite spectrum would be solar with the hydrogen lines unusually strong. Such a spectrum would in itself afford some probability of a double origin, and suggest the existence of a companion star.

In the case of a true binary star the orbital motions of the pair would reveal themselves in a small periodical swaying of the hydrogen lines relatively to the solar ones.

Professor Pickering considers that his photographs show ten stars with composite spectra; of these, five are known to be double. The others are: τ Persei, ζ Aurigæ, δ Sagittarii, 31 Ceti, and β Capricorni. Perhaps β Lyræ should be added to this list.

In his recent classical work on the rotation of the sun, Dunér has not only determined the solar rotation for the equator but for different parallels of latitude up to 75° . The close accordance of his results shows that these observations are sufficiently accurate to be discussed with the variation of the solar rotation for different latitudes, which had been determined by the older astronomical methods from the observations of the solar spots.

Though I have already spoken incidentally of the invaluable aid which is furnished by photography in some of the applications of the spectroscope to the heavenly bodies, the new power which modern photography has put into the hands of the astronomer is so great, and has led already, within the last few years, to new acquisitions of knowledge of such vast importance, that it is fitting that a few sentences should be specially devoted to this subject.

Photography is no new discovery, being about half a century old; it may excite surprise, and indeed possibly suggest some apathy on the part of astronomers, that though the suggestion of the application of photography to the heavenly bodies dates from the memorable occasion when, in 1839, Arago, announcing to the Académie des Sciences the great discovery of Niepce and Daguerre, spoke of the possibility of taking pictures of the sun and moon by the new process, yet that it is only within a few years that notable advances in astronomical methods and discovery have been made by its aid.

The explanation is to be found in the comparative unsuitability of the earlier photographic methods for use in the observatory. In justice to the early workers in astronomical photography, among whom Bond, De la Rue, J. W. Draper, Rutherford, Gould, hold a foremost place, it is needful to state clearly that the recent great successes in astronomical photography are not due to greater skill, nor, to any great extent, to superior instruments, but to the very great advantages which the modern gelatine dry plate possesses for use in the observatory over the methods of Daguerre, and even over the wet collodion film on glass which, though a great advance on the silver plate, went but a little way towards putting

into the hands of the astronomer a photographic surface adapted fully to his wants.

The modern silver-bromide gelatine plate, except for its grained texture, meets the needs of the astronomer at all points. It possesses extreme sensitiveness; it is always ready for use; it can be placed in any position; it can be exposed for hours; lastly, it does not need immediate development, and for this reason can be exposed again to the same object on succeeding nights, so as to make up by several instalments, as the weather may permit, the total time of exposure which is deemed necessary.

Without the assistance of photography, however greatly the resources of genius might overcome the optical and mechanical difficulties of constructing large telescopes, the astronomer would have to depend in the last resource upon his eye. Now we cannot by the force of continued looking bring into view an object too feebly luminous to be seen at the first and keenest moment of vision. But the feeblest light which falls upon the plate is not lost, but is taken in and stored up continuously. Each hour the plate gathers up 3,600 times the light-energy which it received during the first second. It is by this power of accumulation that the photographic plate may be said to increase, almost without limit, though not in separating power, the optical means at the disposal of the astronomer for the discovery or the observation of faint objects.

Two principal directions may be pointed out in which photography is of great service to the astronomer. It enables him within the comparatively short time of a single exposure to secure permanently with great exactness the relative positions of hundreds or even of thousands of stars, or the minute features of nebulae or other objects, or the phenomena of a passing eclipse, tasks which by means of the eye and hand could only be accomplished, if at all, after a very great expenditure of time and labour. Photography puts it in the power of the astronomer to accomplish in the short span of his own life, and so enter into their fruition, great works which otherwise must have been passed on by him as an heritage of labour to succeeding generations.

The second great service which photography renders is not simply an aid to the powers the astronomer already possesses. On the contrary, the plate, by recording light-waves which are both too small and too large to excite vision in the eye, brings him into new regions of knowledge, such as the infra-red and the ultra-violet parts of the spectrum, which must have remained for ever unknown but for artificial help.

The present year will be memorable in astronomical history for the practical beginning of the Photographic Chart and Catalogue of the Heavens, which took their origin in an International Conference which met in Paris in 1887, by the invitation of M. l'Amiral Mouchez, Director of the Paris Observatory.

The richness in stars down to the ninth magnitude of the photographs

of the comet of 1882 taken at the Cape Observatory under the superintendence of Dr. Gill, and the remarkable star charts of the Brothers Henry which followed two years later, astonished the astronomical world. The great excellence of these photographs, which was due mainly to the superiority of the gelatine plate, suggested to these astronomers a complete map of the sky, and a little later gave birth in the minds of the Paris astronomers to the grand enterprise of an International Chart of the Heavens. The actual beginning of the work this year is in no small degree due to the great energy and tact with which the Director of the Paris Observatory has conducted the initial steps, through the many delicate and difficult questions which have unavoidably presented themselves in an undertaking which depends upon the harmonious working in common of many nationalities, and of no fewer than eighteen observatories in all parts of the world. The three years since 1887 have not been too long for the detailed organisation of this work, which has called for several elaborate preliminary investigations on special points in which our knowledge was insufficient, and which have been ably carried out by Professors Vogel and Bakhuyzen, Dr. Trépied, Dr. Scheiner, Dr. Gill, the Astronomer Royal, and others. Time also was required for the construction of the new and special instruments.

The decisions of the Conference in their final form provide for the construction of a great photographic chart of the heavens with exposures corresponding to forty minutes' exposure at Paris, which it is expected will reach down to stars of about the fourteenth magnitude. As each plate is to be limited to four square degrees, and as each star, to avoid possible errors, is to appear on two plates, over 22,000 photographs will be required. For the more accurate determination of the positions of the stars, a *réseau* with lines at distances of 5 mm. apart is to be previously impressed by a faint light upon the plate, so that the image of the *réseau* will appear together with the images of the stars when the plate is developed. This great work will be divided, according to their latitudes, among eighteen observatories provided with similar instruments, though not necessarily constructed by the same maker. Those in the British dominions and at Tacubaya have been constructed by Sir Howard Grubb.

Besides the plates to form the great chart, a second set of plates for a catalogue is to be taken, with a shorter exposure, which will give stars to the eleventh magnitude only. These plates, by a recent decision of the Permanent Committee, are to be pushed on as actively as possible, though as far as may be practicable plates for the chart are to be taken concurrently. Photographing the plates for the catalogue is but the first step in this work, and only supplies the data for the elaborate measurements which have to be made, which are, however, less laborious than would be required for a similar catalogue without the aid of photography.

Already Dr. Gill has nearly brought to conclusion, with the assistance
1891.

of Professor Kapteyn, a preliminary photographic survey of the Southern heavens.

With an exposure sufficiently long for the faintest stars to impress themselves upon the plate, the accumulating action still goes on for the brighter stars, producing a great enlargement of their images from optical and photographic causes. The question has occupied the attention of many astronomers whether it is possible to find a law connecting the diameters of these more or less over-exposed images with the relative brightness of the stars themselves. The answer will come out undoubtedly in the affirmative, though at present the empirical formulæ which have been suggested for this purpose differ from each other. Captain Abney proposes to measure the total photographic action, including density as well as size, by the obstruction which the stellar image offers to light.

A further question follows as to the relation which the photographic magnitudes of stars bear to those determined by eye. Visual magnitudes are the physiological expression of the eye's integration of that part of the star's light which extends from the red to the blue. Photographic magnitudes represent the plate's integration of another part of the star's light—namely, from a little below where the power of the eye leaves off in the blue, to where the light is cut off by the glass, or is greatly reduced by want of proper corrections when a refracting telescope is used. It is obvious that the two records are taken by different methods in dissimilar units of different parts of the star's light. In the case of certain coloured stars the photographic brightness is very different from the visual brightness; but in all stars changes, especially of a temporary character, may occur in the photographic or the visual region, unaccompanied by similar changes in the other part of the spectrum. For these reasons it would seem desirable that the two sets of magnitudes should be tabulated independently, and be regarded as supplementary of each other.

The determination of the distances of the fixed stars from the small apparent shift of their positions when viewed from widely separated positions of the earth in its orbit is one of the most refined operations of the observatory. The great precision with which this minute angular quantity, a fraction of a second of arc only, has to be measured, is so delicate an operation with the ordinary micrometer, though, indeed, it was with this instrument that the classical observations of Sir Robert Ball were made, that a special instrument, in which the measures are made by moving the two halves of a divided object glass, known as a heliometer, has been pressed into this service, and quite recently, in the skilful hands of Dr. Gill and Dr. Elkin, has largely increased our knowledge in this direction.

It is obvious that photography might be here of great service, if we could rely upon measurements of photographs of the same stars taken at suitable intervals of time. Professor Pritchard, to whom is due the

honour of having opened this new path, aided by his assistants, has proved by elaborate investigations that measures for parallax may be safely made upon photographic plates, with, of course, the advantages of leisure and repetition; and he has already by this method determined the parallax for twenty-one stars with an accuracy not inferior to that of values previously obtained by purely astronomical methods.

The remarkable successes of astronomical photography, which depend upon the plate's power of accumulation of a very feeble light acting continuously through an exposure of several hours, are worthy to be regarded as a new revelation. The first chapter opened when, in 1880, Dr. Henry Draper obtained a picture of the nebula of Orion; but a more important advance was made in 1883, when Dr. Common, by his photographs, brought to our knowledge details and extensions of this nebula hitherto unknown. A further disclosure took place in 1885, when the Brothers Henry showed for the first time in great detail the spiral nebulosity issuing from the bright star Maia of the Pleiades, and shortly afterwards nebulous streams about the other stars of this group. In 1886 Mr. Roberts, by means of a photograph to which three hours' exposure had been given, showed the whole background of this group to be nebulous. In the following year Mr. Roberts more than doubled for us the great extension of the nebular region which surrounds the trapezium in the constellation of Orion. By his photographs of the great nebula in Andromeda, he has shown the true significance of the dark canals which had been seen by the eye. They are in reality spaces between successive rings of bright matter, which appeared nearly straight owing to the inclination in which they lie relatively to us. These bright rings surround an undefined central luminous mass. I have already spoken of this photograph.

Some recent photographs by Mr. Russell show that the great rift in the Milky Way in Argus, which to the eye is void of stars, is in reality uniformly covered with them. Also quite recently Mr. George Hale has photographed the solar prominences by means of a grating, making use of the lines H and K.

The heavens are richly but very irregularly inwrought with stars. The brighter stars cluster into well-known groups upon a background formed of an enlacement of streams and convoluted windings and intertwined spirals of fainter stars, which becomes richer and more intricate in the irregularly rifted zone of the Milky Way.

We, who form part of the emblazonry, can only see the design distorted and confused; here crowded, there scattered, at another place superposed. The groupings due to our position are mixed up with those which are real.

Can we suppose that each luminous point has no other relation to those near it than the accidental neighbourhood of grains of sand upon

the shore, or of particles of the wind-blown dust of the desert? Surely every star from Sirius and Vega down to each grain of the light-dust of the Milky Way has its present place in the heavenly pattern from the slow evolving of its past. We see a system of systems, for the broad features of clusters and streams and spiral windings which mark the general design are reproduced in every part. The whole is in motion, each point shifting its position by miles every second, though from the august magnitude of their distances from us and from each other, it is only by the accumulated movements of years or of generations that some small changes of relative position reveal themselves.

The deciphering of this wonderfully intricate constitution of the heavens will be undoubtedly one of the chief astronomical works of the coming century. The primary task of the sun's motion in space together with the motions of the brighter stars has been already put well within our reach by the spectroscopic method of the measurement of star-motions in the line of sight.

From other directions information is accumulating: from photographs of clusters and parts of the Milky Way, by Roberts in this country, Barnard at the Lick Observatory, and Russell at Sydney; from the counting of stars, and the detection of their configurations, by Holden and by Backhouse; from the mapping of the Milky Way by eye, at Parsonstown; from photographs of the spectra of stars, by Pickering at Harvard and in Peru; and from the exact portraiture of the heavens in the great international star chart which begins this year.

I have but touched some only of the problems of the newer side of astronomy. Of the many others which would claim our attention if time permitted I may name the following. The researches of the Earl of Rosse on lunar radiation, and the work on the same subject and on the sun, by Langley. Observations of lunar heat with an instrument of his own invention by Mr. Boys; and observations of the variation of the moon's heat with its phase by Mr. Frank Very. The discovery of the ultra-violet part of the hydrogen spectrum, not in the laboratory, but from the stars. The confirmation of this spectrum by terrestrial hydrogen in part by H. W. Vogel, and in its all but complete form by Cornu, who found similar series in the ultra-violet spectra of aluminium and thallium. The discovery of a simple formula for the hydrogen series by Balmer. The important question as to the numerical spectral relationship of different substances, especially in connection with their chemical properties; and the further question as to the origin of the harmonic and other relations between the lines and the groupings of lines of spectra; on these points contributions during the past year have been made by Rudolf v. Kövessligethy, Ames, Hartley, Deslandres, Rydberg, Grünwald, Kayser and Runge, Johnstone Stoney, and others. The remarkable employment of interference phenomena by Professor Michelson for the determination of the size, and distribution of light within them, of the images of objects

which when viewed in a telescope subtend an angle less than that subtended by the light-wave at a distance equal to the diameter of the objective. A method applicable not alone to celestial objects, but also to spectral lines, and other questions of molecular physics.

Along the older lines there has not been less activity; by newer methods, by the aid of larger or more accurately constructed instruments, by greater refinement of analysis, knowledge has been increased, especially in precision and minute exactness.

Astronomy, the oldest of the sciences, has more than renewed her youth. At no time in the past has she been so bright with unbounded aspirations and hopes. Never were her temples so numerous, nor the crowd of her votaries so great. The British Astronomical Association formed within the year numbers already about 600 members. Happy is the lot of those who are still on the eastern side of life's meridian!

Already, alas! the original founders of the newer methods are falling out—Kirchhoff, Ångström, D'Arrest, Secchi, Draper, Becquerel; but their places are more than filled; the pace of the race is gaining, but the goal is not and never will be in sight.

Since the time of Newton our knowledge of the phenomena of Nature has wonderfully increased, but man asks, perhaps more earnestly now than then, what is the ultimate reality behind the reality of the perceptions? Are they only the pebbles of the beach with which we have been playing? Does not the ocean of ultimate reality and truth lie beyond?

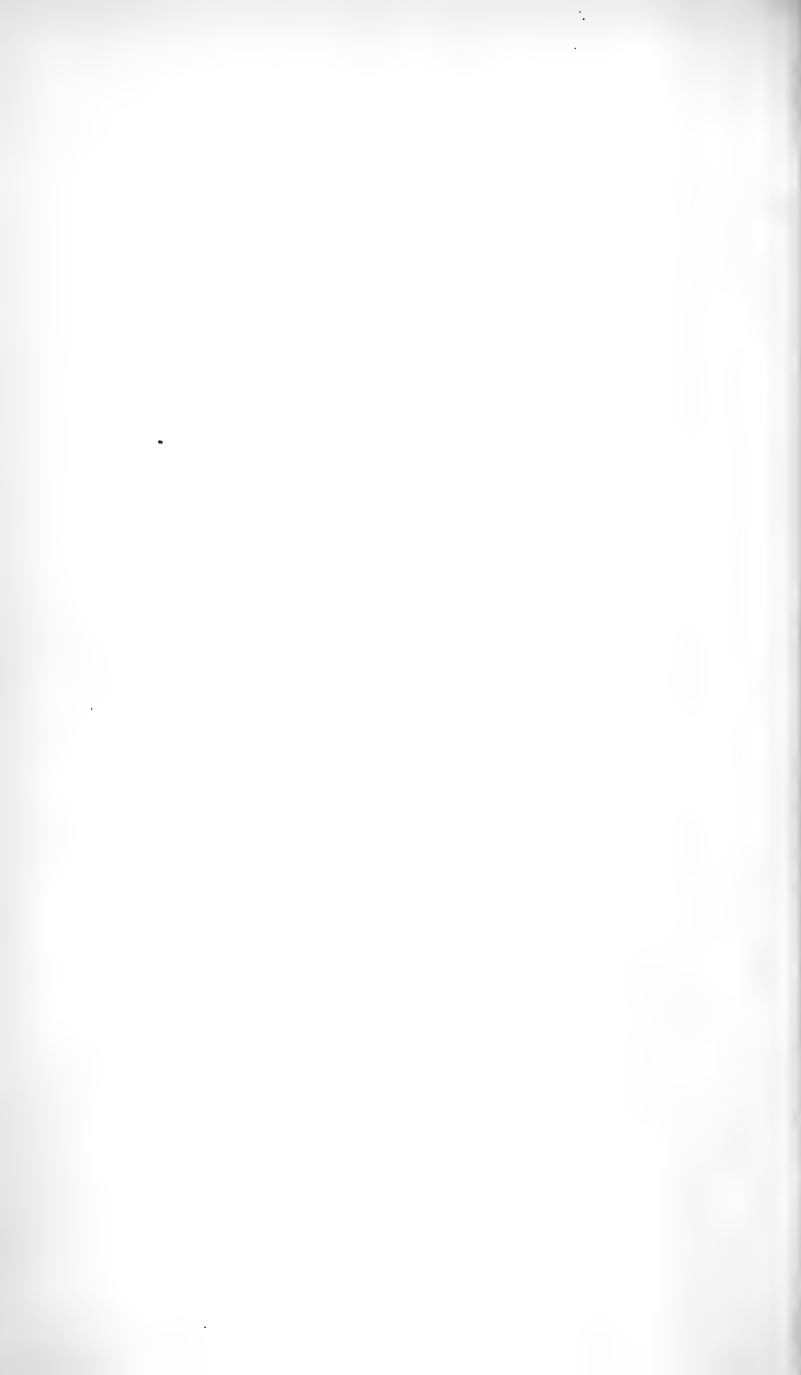

REPORTS
ON THE
STATE OF SCIENCE.

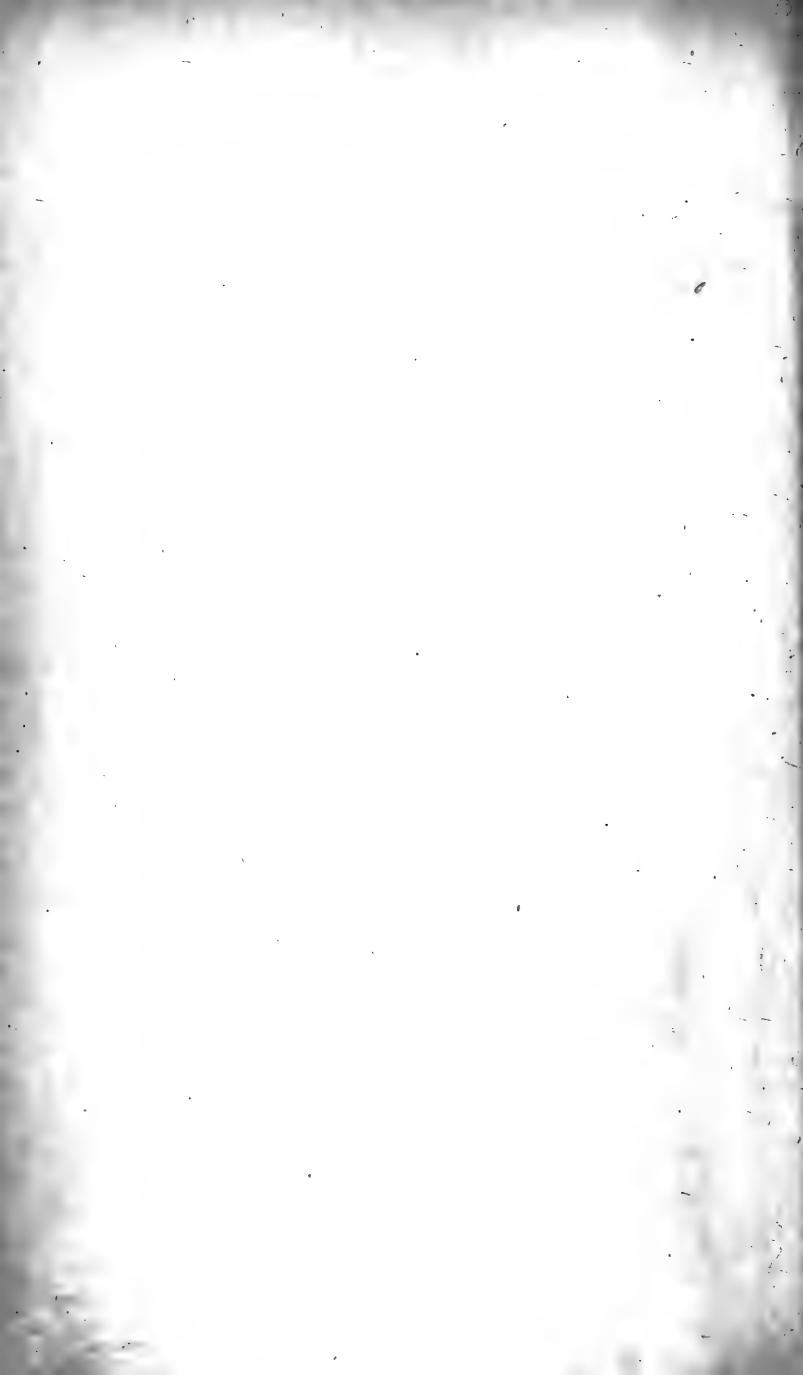

REPORTS

ON THE

STATE OF SCIENCE.

Report of the Corresponding Societies Committee, consisting of Mr. FRANCIS GALTON (Chairman), Professor A. W. WILLIAMSON, Sir DOUGLAS GALTON, Professor BOYD DAWKINS, Sir RAWSON RAWSON, Dr. J. G. GARSON, Dr. JOHN EVANS, Mr. J. HOPKINSON, Professor R. MELDOLA (Secretary), Professor T. G. BONNEY, Mr. W. WHITAKER, Mr. G. J. SYMONS, General PITT-RIVERS, and Mr. W. TOPLEY.

THE Corresponding Societies Committee of the British Association begs to submit to the General Committee the following Report of the proceedings of the Conference held at Leeds.

The Council nominated Mr. G. J. Symons, F.R.S., Chairman, Professor T. G. Bonney, F.R.S., Vice-Chairman, and Professor R. Meldola, F.R.S., Secretary to the Conference. The meetings were held on Thursday, September 4, and Tuesday, September 9, at 3.30 P.M., in the Philosophical Hall. The Delegates (numbering 36) nominated by the Corresponding Societies to attend the Leeds Meeting were:—

Mr. A. Tate, C.E.	Belfast Natural History and Philosophical Society.
Mr. Wm. Gray, M.R.I.A.	Belfast Naturalists' Field Club.
Mr. Charles Pumphrey	Birmingham Natural History and Microscopical Society.
Mr. J. Kenward, F.S.A.	Birmingham Philosophical Society.
Mr. R. W. Atkinson, F.C.S.	Cardiff Naturalists' Society.
Mr. M. H. Mills	Chesterfield and Midland Counties Institution of Engineers.
Mr. T. Cushing, F.R.A.S.	Croydon Microscopical and Natural History Club.
Mr. W. Healey	Cumberland and Westmorland Association for the Advancement of Literature and Science.
Mr. A. S. Reid, M.A., F.G.S.	East Kent Natural History Society.
Mr. Robert Brown, R.N.	{ East of Scotland Union of Naturalists' Societies.
Prof. R. Meldola, F.R.S.	{ Perthshire Society of Natural Science.
		Essex Field Club.

Mr. D. Corse Glen, F.G.S.	.	.	} Geological Society of Glasgow. Natural History Society of Glasgow.
Mr. J. Hopkinson, F.L.S.	.	.	
Provost Ross	.	.	Hertfordshire Natural History Society and Field Club.
His Honour Deemster Gill	.	.	Inverness Scientific Society and Field Club.
Mr. J. E. Bedford, F.G.S.	.	.	Isle of Man Natural History and Antiquarian Society.
Mr. J. Stubbins, F.G.S.	.	.	Leeds Geological Association.
Mr. F. T. Mott, F.R.G.S.	.	.	Leeds Naturalists' Club and Scientific Association.
Mr. G. H. Morton, F.G.S.	.	.	Leicester Literary and Philosophical Society.
Mr. M. B. Slater, F.L.S.	.	.	Liverpool Geological Society.
Mr. Eli Sowerbutts, F.R.G.S.	.	.	Malton Field Naturalists' and Scientific Society.
Mr. W. Watts, F.G.S.	.	.	Manchester Geographical Society.
Prof. J. E. C. Munro, LL.D.	.	.	Manchester Geological Society.
Prof. W. Hillhouse, F.L.S.	.	.	Manchester Statistical Society.
Dr. J. T. Arlidge, M.A.	.	.	Midland Union of Natural History Societies.
Mr. C. A. Markham, F.S.A.	.	.	North Staffordshire Naturalists' Field Club and Archæological Society.
Mr. C. Hawley Torr	.	.	Northamptonshire Natural History Society and Field Club.
Prof. G. A. Lebour, M.A., F.G.S.	.	.	Nottingham Naturalists' Society.
Mr. J. Reginald Ashworth	.	.	North of England Institute of Mining and Mechanical Engineers.
Mr. A. Silva White, F.R.S.E.	.	.	Rochdale Literary and Scientific Society.
Mr. W. Andrews, F.G.S.	.	.	Royal Scottish Geographical Society.
Rev. J. O. Bevan, M.A.	.	.	Warwickshire Naturalists' and Archæologists' Field Club.
Mr. J. W. Davis, F.G.S.	.	.	Woolhope Naturalists' Field Club.
Mr. W. Cash, F.L.S.	.	.	Yorkshire Geological and Polytechnic Society.
Mr. C. P. Hobkirk, F.L.S.	.	.	} Yorkshire Naturalists' Union. ¹
Rev. E. P. Knubley, M.A.	.	.	

FIRST CONFERENCE, SEPTEMBER 4.

The chair was taken by Mr. G. J. Symons, F.R.S., the Corresponding Societies Committee being also represented by Professor T. G. Bonney, F.R.S., Mr. W. Topley, F.R.S., Mr. J. Hopkinson, F.L.S., and Professor R. Meldola, F.R.S. (Secretary).

The Chairman proposed that the report of the Corresponding Societies Committee to the General Committee, printed copies of which had been distributed among the Delegates, should be taken as read. This was put to the meeting and carried unanimously. The subjects dealt with in the report were then taken in order.

SECTION A.

Temperature Variation in Lakes, Rivers, and Estuaries.—The Chairman stated that in connection with the work of this Committee, of which Dr. H. R. Mill was the Secretary, a large number of thermometers had

¹ Three Delegates appointed under the rule which empowers a Society having its head-quarters in the place of meeting to send up this number of representatives.

been distributed throughout the country, and a good deal of information had been collected during the year. It was proposed to ask for the reappointment of the Committee with a grant to enable the observations to be tabulated.

Mr. William Watts stated that he had been conducting temperature observations in two large reservoirs belonging to the Oldham Corporation during the last eighteen months. These results were included in the report of the Committee. Mr. Watts added that there was some probability of the observations having to be discontinued for want of funds, although on his own part he was perfectly willing to carry on the work for another year.

Mr. Cushing presented a record of weekly temperature observations taken in the River Wandle in Surrey. The temperatures were taken between 3 and 3.30 P.M. on Sunday afternoons, and extended from October 1888 to February 1890. The observations were taken at ten different stations, five of which are on the Carshalton and five on the Croydon branch of the river. The tabulated records were accompanied by a statement of the mean weekly shade temperature and the rainfall for the previous week, both being made up to 9 P.M. on the Saturday. The tables were also accompanied by a sketch of the district traced from the 25-inch Ordnance map, showing the positions of all the stations, which were numbered from 1 to 10, and which corresponded with the positions in the temperature tables as read from left to right. The river is very shallow, but the tables showed some rather large mean differences of temperature. While stations 1, 8, and 9 showed respectively the mean differences of 15.8, 16.2, and 17.7° F.; station No. 5, where the water is only 18 inches deep, shows a mean yearly variation of only 0.7° F., while the mean variation of shade temperature during the same period was 38.7° F. These temperatures were taken at from 12 to 18 inches below the surface with a thermometer graduated on the stem and verified at Kew. The observations had been taken by Mr. F. C. Bayard, an active Fellow of the Royal Meteorological Society and Secretary to the Croydon Microscopical and Natural History Club, which Society was represented by Mr. Cushing at the Conference. Mr. Bayard had expressed his willingness to continue the observations.

The Secretary suggested that the results presented by Mr. Cushing should be handed to Dr. Mill, the Secretary of the Committee.

The Chairman, having commented on the value of Mr. Bayard's observations, proceeded to state that he had recently been reducing experiments with respect to evaporation, which had been made during several years at Strathfield Turgiss in Hampshire, in which the ordinary small evaporators had been compared with a galvanised iron tank 6 feet square and 2 feet deep. The rough result was that the evaporation from the tank averaged about 15 inches per annum, while the smaller ones (owing to the high temperature of the water) indicated an evaporation considerably in excess of the truth.

Meteorological Photography—Mr. Hopkinson alluded to the success which had been achieved by the Committee on Geological Photography, of which Mr. Jeffs was Secretary, and pointed out the growing importance of photography as an aid in other branches of scientific research. He suggested that the idea might be extended to meteorological photography, and that a Committee should be formed for carrying out this object. Photography could be advantageously applied to the investiga-

tion of meteorological phenomena such as the forms of clouds, lightning flashes, the effects of storms, &c. It would be the function of such a Committee to collect the photographs and keep a register of them, which would be added to from year to year. The study of the forms of clouds would be more satisfactory if undertaken by a comparison of photographs than by drawings. Mr. Hopkinson referred to the practical difficulty of photographing light clouds in a blue sky, and suggested that it might form part of the work of the Committee to investigate methods for effecting this object. With respect to lightning flashes he stated that numerous photographs had been taken, some of which were very valuable, but others were useless owing to the failure on the part of the photographer to indicate the position of the plate in the camera. The advisability of interesting the Corresponding Societies in the work was pointed out to the Delegates by Mr. Hopkinson, who also urged the special necessity of securing as soon as possible photographs showing the after-effects of storms. It was proposed that a Committee of the Association with a small grant should be formed through Section A. If this Committee were sanctioned Mr. Symons and Professor Meldola would consent to serve on it, and Mr. A. W. Clayden, who had made a special study of the photography of clouds and lightning flashes, would be willing to act as Secretary.

After some discussion as to the mode of procedure it was decided that application should be made through the Committee of Section A for the formation of a Committee on Meteorological Photography, and that the application should be also supported by a recommendation from the Conference of Delegates to the Committee of Recommendations.

SECTION C.

Sea Coast Erosion.—Mr. Topley stated that the Committee appointed for this purpose would be glad to receive any assistance. Some of the Corresponding Societies had applied for forms, but nothing had as yet been done. Three years ago the Isle of Man Society had proposed to take the matter in hand and form a Committee. He believed some of the Yorkshire Societies were doing good work, but they had not yet received the results.

Erratic Blocks.—The Rev. E. P. Knubley stated, with reference to the work of this Committee, that the Yorkshire Naturalists' Union had been carrying on the records satisfactorily, and that about twenty-five reports had been presented during the year. These had been sent to Dr. Crosskey, the Secretary of the Committee.

Geological Photography.—Mr. O. W. Jeffs stated that, through the action of the Conference of Delegates at previous meetings of the British Association, a Committee had been appointed for collecting and reporting on geological photographs. Very material assistance had been rendered to the work of this Committee by various Delegates from the several Corresponding Societies, many of which had sent photographs or lists of those that had been taken. All that had been done thus far was of a preliminary character, and had consisted in arranging the photographs which had been taken in order to select those which illustrated well-defined strata or sections. The work was by no means complete, and the report, which would shortly be presented, showed that a very large

proportion of the counties of England and Wales were as yet unrepresented. Mr. Jeffs asked those Delegates who had not yet done so to bring the matter before their Societies, and to interest their photographic members in the work. The object of the Committee was to secure by systematic action in the various districts a series of photographs illustrating the features which geologists thought most worthy of being recorded in their respective localities. The only portion of England where the scheme had been carried out to any extent was Yorkshire. The Yorkshire Naturalists' Union had adopted the photographic method, and had taken over 100 negatives. Mr. Hopkinson had brought the subject before the Hertfordshire Natural History Society, and he hoped to receive photographs from them shortly. A large number of the photographs which had been received would be exhibited in the room of Section C, and Mr. Jeffs invited the Delegates to inspect them. He added that the Committee would be glad to receive any suggestions from the Delegates. The counties from which photographs had been received were:—Dorsetshire, Cornwall (very few), Devonshire (very few), Isle of Man (several), Kent, Lancashire, Montgomeryshire, Nottingham, a few from North Wales, Suffolk, and Shropshire, a large number from Yorkshire, and some from Scotland and Ireland. The list was manifestly very incomplete, and he hoped that by next year's Report it would be considerably extended. Copies of the circular of instructions issued by the Committee were circulated among the Delegates.

Professor Lebour asked if any steps had been taken with respect to the keeping of the photographs.

Mr. Jeffs said that this matter had not yet been discussed by their Committee. They intended to keep the photographs until the collection had assumed a more complete form. A suggestion had been made to render some of the best examples more available to the Delegates and to the public, and more especially to those requiring them for educational purposes, by issuing them in the form of a publication, but the matter had not yet been properly discussed.

Professor Bonney said that, as a member of the Committee on geological photography, he was enabled to state that the work had hitherto been necessarily of a preliminary nature, and had been carried out by the zeal and energy of Mr. Jeffs. The question of publication would come before the Committee later on, and, speaking on his own behalf, he considered it of great importance that some step in this direction should be taken. He expressed the opinion that the best destination of the photographs would be to lodge them with the Geological Society if they would receive them. If an enlarged photograph were required for educational purposes, the negative could then be borrowed for the purpose. It would, of course, be a year or two before the photographs would be accessible. When a large collection had been accumulated, it would be most useful to select some thirty or forty of the more typical examples of geological phenomena and to have them enlarged for publication. Professor Bonney expressed the opinion that, for the purposes of teaching, enlarged photographs would be better than photographs taken on a large scale.

The discussion was continued by Mr. W. Watts and Mr. Eli Sowerbutts. The suggestions put forward by Professor Bonney were approved of, and it was pointed out that it would be desirable that the Corresponding Societies should have a list of the photographs already sent in to the Committee, in order to know which were wanted and which were not.

Many members of the Manchester Geographical Society had been taking photographs, and in time a large number of negatives would be collected, which the owners would, no doubt, be willing to place at the disposal of the Committee if it were known that they would be safely deposited in some accessible place, and a record giving the source and locality of each negative also kept.

Mr. Jeffs stated in reply that a list of the views which had been received would be kept, and also a register for entering the name of the person responsible for borrowing a negative. He suggested that the Committee might make arrangements with some photographer for preparing lantern slides from the photographs at a fixed charge, for the purpose of lecture illustration. With respect to the photographs taken by the members of the Manchester Geographical Society, Mr. Jeffs said that their Committee would be very pleased to receive them whenever they were sent.

Mr. William Gray stated that he was interested in the subject of geological photography in the North of Ireland, and he approved of the scheme put forward by the Committee, of which Mr. Jeffs was the Secretary. He had succeeded in securing a few photographs, which were sufficient to show the value of the method both as applied to this subject and to the erosion of the sea-coast. He expressed the opinion that it would be an advantage if each Delegate were appointed as the local representative of the Committee in his own district, and authorised to collect the photographs. There were many members of his society (Belfast Naturalists' Field Club) who had done a great deal of photographic work, but there was some amount of hesitation in forwarding negatives to the British Association Committee, which he thought would be got over if there were some person in the society directly authorised to collect the photographs. Mr. Gray expressed his willingness to act in this capacity for the North of Ireland. He alluded also to the advantage of being able to get the photographs reproduced in the form of lantern slides, and stated that, if such slides were required for illustrating the physical features of the North of Ireland, he would be able to see that they were supplied at a reasonable price. Mr. A. Tate, on behalf of the Belfast Natural History and Philosophical Society, expressed similar views.

Professor Meldola pointed out that, in taking photographs of geological sections, in which differences in the strata were often indicated only by small differences in colour, it would be an advantage to use orthochromatic plates. The colour differences were sometimes so slight, that the differentiation of strata would be imperceptible in an ordinary photograph, and he therefore expressed the hope that the Committee in their schedule of instructions would see their way to recommend the adoption of these plates, which, although somewhat more costly than ordinary plates, would give such superior results as to warrant their use.

A further discussion took place respecting the desirability of adopting some means by which members of the British Association, and those who assisted in the work, would be enabled to procure copies of the photographs either as lantern slides, prints, or enlargements. Mr. Symons suggested that the best plan would be for those members requiring copies to be allowed the temporary loan of the negative itself, while lantern slides should be prepared by some recognised person under the immediate direction of the Secretary of the Committee. In reply to a question by Mr. M. H. Mills as to whether any underground photographs had been

taken, and if so, whether they had proved to be of any value, Mr. Jeffs stated that no photographs of underground sections had yet been received.

SECTION D.

Disappearance of Native Plants.—Professor Hillhouse distributed among the Delegates copies of the third report of the Committee on this subject. He stated that the report had this year been confined to the North of England, the Isle of Man, and to a few records from the southern counties of Wales. The bulk of the material had been obtained directly by correspondence with the local Natural History Societies. The Committee were especially indebted to the Yorkshire Naturalists' Union, which had formed a committee of their own, the labours of this committee having largely contributed to the satisfactory results which had been obtained. There was still a certain amount of difficulty in inducing the representatives of the societies, to which circulars had been sent, to take steps in the matter, and he expressed a hope that the Delegates would do their best to promote the objects of the Committee. Although the Committee had not yet come to any definite decision, he thought that next year's report would probably deal with the whole of Wales, and possibly adjoining counties, and with the south-western counties of England, and Delegates from these districts were asked to bear this in mind.

Professor Hillhouse then gave a *résumé* of the report which had been presented, stating that it contained an account of the more or less complete disappearance from the localities mentioned therein of about seventy species. In some cases the disappearance had been due to natural causes—*e.g.*, the encroachments of the sea on the Cumberland coast and elsewhere had brought about the disappearance of several littoral plants; but in the great majority the handiwork of man had been recognisable. Disappearance through human agency he classified under two heads—personal and impersonal. Impersonal action he illustrated by the results of building works, agricultural operations, drainage, &c., which cause constant changes in local floras. Thus the Isle of Man *Brassica* (*B. monensis*), first found by the famous botanist John Ray at the Moiragh, Ramsey, in 1670, is in danger of extirpation there, and has already been extirpated at Douglas by building operations; and the commonest of the scarlet poppies (*Papaver rhœas*) is greatly diminishing in the county of Cumberland through the gradual abandonment of cereal tillage. It is only incidentally, however, that these impersonal changes affect plants of special interest, while the personal actions of man—that is, his actions directed intentionally at some particular plant—have naturally their chief influence upon plants of peculiar interest or beauty. Here again, as in previous reports, it is the 'collecting dealer' whose ravages form the main burden of complaint. The Ladies' Slipper orchid (*Cypripedium Calceolus*), once not uncommon in Yorkshire, Durham, and Westmoreland, has well-nigh succumbed, and the hillsides, banks, and hedgerows are being rapidly stripped of their once abundant ferns. As an example of the systematic way in which this is done, Professor Hillhouse instanced the case of the Maiden Hair (*Adiantum Capillus-veneris*), which in the Isle of Man is regularly hunted for by men with boats and ladders, and sold to 'trippers' in the Douglas market. He thought that the local Natural

History Societies might do a great deal towards persuading holiday makers and tourists that it is far better, far safer, and, in the long run, far cheaper, to buy these plants from nurserymen who grow them, than to incur the trouble, expense, and risk of removing them at a time when the conditions are so unfavourable as they are during practically the holiday season, and that they might do something towards restraining the robbers themselves.

Mr. Hopkinson stated that nearly the whole of the ferns in his district (St. Albans) had disappeared within the last twenty years. He attributed the extermination to the London collectors and dealers, and added that there was a danger of such a common plant as the primrose becoming exterminated in time from the London district, as they were taken to the metropolis by cartloads every year.

Mr. Sowerbutts called attention to the inefficacy of the law of trespass in such cases, as no penalty can be inflicted unless damage is proved. He considered the worst depredator to be the botanical fanatic.

Mr. Gray did not think that the true botanist would be guilty of such wilful destruction. They had a special rule among their Society that no rare plant should be damaged or removed. One class of offenders to be dealt with were the persons who, without any knowledge of the habits of a rare species, liked to see it growing about their premises, and for this reason had it removed. If these persons were taught that it is often impossible for such plants to live away from their natural conditions their depredations might perhaps be checked.

Mr. M. B. Slater said that he had known many lovers of plants in his district (Malton) who would tramp many miles in search of a rare species. Although in a sense these men were botanical fanatics he did not think that they were the depredators. It was the young beginner in the study of botany who, in his opinion, should be cautioned against exterminating any rare plant in his anxiety to procure specimens. He suggested that the best plan would be to endeavour to procure at the proper time a little ripe seed from the plant in its native habitat, and then to try and raise it. This would be the means of saving from destruction some of our greatest rarities. Mr. Slater had adopted this plan himself, and had growing under cultivation some of the rarer and most interesting of British plants. He believed the extension of agriculture to have been one great cause of the disappearance of local species, and by obtaining seeds, or even in extreme cases the plants themselves, some species might be saved from destruction. Although some practical difficulties might be encountered, he thought that with perseverance these would be overcome, and the student would certainly derive great advantage from trying to cultivate his plants. If successful he would thus attain a far better knowledge of their life histories, as he would be enabled to watch the plants through their various stages of growth.

Investigation of the Invertebrate Fauna and Cryptogamic Flora of the British Isles.—The Rev. E. P. Knubley stated that no formal report of the work of this Committee had been presented to the Section, but that the Yorkshire Naturalists' Union had been steadily carrying on the work during the past year.

SECTION E.

Mr. Sowerbutts made some remarks with respect to the scope of Geography, and suggested that detached papers on the geology, zoology, meteorology, botany, &c., of some particular region could be regarded as coming under this science, and might with advantage be read together in a common Section-room. The discussion was continued by Professor Bonney, who considered the suggestion worthy of consideration, but likely to meet with great practical difficulties.

SECTION G.

Flameless Explosives for use in Coal Mines.—Professor Lebour stated that the North of England Institute of Mining and Mechanical Engineers were about to make experiments on this subject. They had recently obtained a grant of 300*l.* for the experiments, but more would be required. He appealed to other engineering societies represented at the Conference to co-operate in the investigation, which was of such general importance in mining districts.

Mr. Mills said that the Chesterfield and Midland Counties Institute had not taken the matter up through their Council, but several individual members had been working at it, and the results would shortly be published.

SECTION H.

Catalogue of Prehistoric Remains.—Mr. Kenward said that the Birmingham Philosophical Society was fully alive to the importance of recording the few ancient remains in their district. He had done a great deal of work in this direction himself, and had induced others to promote the suggestions discussed at the Conferences at Bath and Newcastle, as well as to assist in carrying out the Archæological survey proposed by the Society of Antiquaries.¹

Mr. Gray stated that the Belfast Naturalists' Field Club had taken the matter up in a systematic way, and would continue their co-operation.

At the conclusion of the Conference the Chairman remarked upon the advantage of being able to have at hand for reference the publications of the local Societies as collected by the Corresponding Societies Committee for the purpose of preparing the catalogue of papers which formed part of their annual report. He also called attention to the fact that a few of the older and well-known local Societies had not yet become enrolled as Corresponding Societies.

Professor Meldola pointed out that this matter had already been discussed at a previous conference (Bath, 1888) as well as by their Committee in London. He thought that the work of the Conference of

¹ The objects and mode of carrying out this survey were explained by Dr. John Evans, President of the Society of Antiquaries, at the Bath Conference in 1888. *Report Brit. Assoc.* 1889, p. 188. (Secretary Corresponding Societies Committee.)

Delegates was now sufficiently well known, and that, although there were a few societies whose co-operation it would be extremely desirable to secure, no further approach could be made on the part of the Committee. It rested rather with the Delegates themselves to assist in securing the Societies in their own districts.

SECOND CONFERENCE, SEPTEMBER 9.

The chair was taken by Mr. G. J. Symons, F.R.S., the Corresponding Societies Committee being also represented by Sir Rawson Rawson, Dr. Garson, Mr. Hopkinson, and Professor R. Meldola, F.R.S. (Secretary).

SECTION A.

Phenological Observations.—Mr. Symons made the following communication:—

‘Phenological observations, which may perhaps be said to have originated with Gilbert White, although studied with care in Austria, received little attention in England until 1874, when the Royal Meteorological Society invited and obtained the assistance of Delegates from the Royal Agricultural Society, Royal Horticultural Society, Royal Botanic Society, Royal Dublin Society, and Marlborough College Natural History Society, who held several meetings, and eventually drew up an elaborate report, which, curiously enough, upon re-examining after the lapse of sixteen years, seems to show that practically few of the Delegates approved of it, although from motives of politeness they allowed it to pass. Flowering plants, insects, and birds were referred respectively to the Rev. T. A. Preston, Mr. McLachlan, and Professor Newton. Of plants the large number of seventy-one were recommended for observation, of insects only eight, and of birds seventeen. Mr. McLachlan, Professor Newton, Mr. Bell of Selborne, and Professor Thiselton Dyer all expressed the opinion that the list should be kept as short as possible, and although Mr. Preston’s long list of plants was retained, it was resolved that special attention should be called to fifteen out of the seventy-one, by printing their names in capitals.

‘The Royal Meteorological Society undertook the cost and trouble of preparing and issuing the necessary forms, and from 1875 to 1888, both inclusive, the Rev. T. A. Preston prepared and the Society printed annual reports embodying the results obtained. Mr. Preston found it impossible to continue the work, and Mr. E. Mawley took it up and prepared the report for 1889. He has, however, arrived at the same conclusion as the authorities already quoted, and his recommendation to reduce and simplify the observations has been accepted by the Council of the Royal Meteorological Society, which now desires to enlist as many observers as possible, all of whom are to work according to the form, of which copies are submitted for consideration.

‘With this view the Council of the Royal Meteorological Society has endeavoured to obtain the assistance of the Corresponding Societies on the British Association list, and it is with the same object that I have asked permission to bring these few words before this Conference.’

Mr. Cushing said that the British Association had reported on this subject at the Cambridge Meeting in 1845, and it was then abandoned until the Royal Meteorological Society took it up. As Mr. Symons had said, the list in 1874 comprised seventy-one plants, eight insects, and seventeen birds. In 1883 the Society published a new schedule, which included seventy-nine plants, eleven insects, and twenty-one birds. After some years the list was reduced to thirteen plants, five insects, and five birds, and he asked why this reduction had been sanctioned.

Professor Lebour raised the question why, among the plants, two species had been included which were among the most variable of British species?

The Rev. E. P. Knubley, with reference to the list of birds, said that the swallow had been included, but a large number of persons did not know the difference between a swallow, a swift, and a martin. It occurred to him that it would be better to insert the sand-martin in its place, because it was likely to arrive the first of the three. The nightingale, also included in the list, for all practical purposes ceased in the south of Yorkshire. The only places it had appeared so far north were in the neighbourhood of Doncaster, Leeds, and Harrogate. It had occurred at Scarborough once, and it might perhaps be heard near Harrogate every three or four years. He suggested whether for this bird it would not be better to substitute the chiff-chaff, the willow wren, or the redstart, which arrive about the same time and are of the same class. This remark applied also to the West of England, where the nightingale is unknown, and he thought that it would be better to have a bird which extended all over the country.

Mr. Symons said that the nightingale was not included in the first schedule, but there was a strong feeling that the list of British birds would be incomplete without it, and it was therefore eventually inserted. He saw no reason why it should not stand, because he understood that the list represented only the minimum, and not the maximum, of species which might be recorded.

After some remarks by Sir Rawson Rawson and Mr. Corse Glen,

Professor Hillhouse called attention to the list of plants. He said there was a manifest objection to the free use of hedge plants, because the body of the hedge was often so protective that there might be two observers in close proximity watching the same species and yet quite different dates might be entered, because of the prevailing direction of the wind at the season. In the next place, with regard to *Crataegus oxyacantha*, they would not unfrequently find those plants which grew near or in the hedge flowering ten days before the normal period. He knew of two plants which were two forms of this species which grew side by side with interlacing branches, the periods of flowering differing by from seven to fourteen days. These were growing at the back of Trinity College, Cambridge. With respect to *Rosa canina*, he was not sure which of the eighteen to fifty forms could be identified with this name, but their flowering period extended over something like seven weeks. The records for this plant would, therefore, be very conflicting. Professor Hillhouse further suggested the advisability of omitting from the schedule the words: 'If, unfortunately, the first flowering be missed for a day or two, the observer is requested to give the estimated date of first flowering and to place an asterisk against the entry.' He was of

opinion that botanists would like to see this clause omitted, and that only actual observations should be recorded.

Mr. Symons, in concluding the discussion, stated that he had brought the matter forward on behalf of the Royal Meteorological Society, and as a meteorologist rather than as a naturalist. At the same time, the subject was one of equal importance to naturalists and meteorologists, and he expressed his thanks to those who had given hints and made remarks with the object of getting the observations made in the best possible way. He expressed a hope that the Societies represented at the Conference would be induced to assist in carrying on the work.¹

Temperature Variation in Lakes, Rivers, and Estuaries.—Professor Meldola read the following communication from Dr. H. R. Mill, the Secretary of the above Committee:—

‘The Committee has to thank the following local Societies for their assistance in obtaining observations, and to state that the work of Society observers is, as a rule, more regular and more accurate than that of isolated volunteers:—

‘Manchester Geological Society, Grantham Scientific Society, Rochdale Literary and Scientific Society, Bristol Naturalists’ Society, Cardiff Naturalists’ Society, Burton-on-Trent Natural History Society, East Kent Natural History Society, Marlborough College Natural History Society, Northampton Natural History Society, Dumfries and Galloway Natural History Society.

‘Several other Societies applied for information, and would have taken part in the work had there been a suitable river or lake in their neighbourhood.

‘It is desirable that the Societies already engaged in observations should continue to make them for another year with as much regularity as possible. Those which have not already taken it up will not be urged to do so, as a sufficiency of data for the purposes of the Committee is now in course of being secured.’

Meteorological Photography.—Mr. Hopkinson reported that the formation of a Committee for this purpose had been sanctioned by the Committee of Section A, and the form had been forwarded to the Committee of Recommendations.²

SECTION C.

Professor Lebour stated that he had been asked to represent the Committee of this Section and to bring under the notice of the Delegates the following list of Committees recommended for appointment:—

1. *Erratic Blocks.*—The work of this Committee had been explained at former Conferences, and the co-operation of those Corresponding Societies which had not yet taken part in the observations was invited.

2. *The ‘Geological Record.’*—The continuation of this work had been recommended and a grant had been asked for to assist in carrying on its publication.

¹ Mr. Symons distributed copies of the schedule at the meeting. They can be had on application to Edward Mawley, Esq., Rosebank, Berkhamstead, Herts.

² The Committee, consisting of Mr. G. J. Symons (Chairman), Mr. A. W. Clayden (Secretary), Professor Meldola, and Mr. J. Hopkinson, has been appointed with a grant of 5*l.* for preliminary expenses. (Secretary Corresponding Societies Committee.)

3. *Underground Waters*.—The work of this Committee had also been several times brought before the Delegates, and the Secretary, Mr. De Rance, was present to give any further explanations.

4. *Exploration of Oldbury Hill*.—The exploration of this ancient earthwork, near Ightham, in Kent, had been recommended, with the special object of examining the supposed 'rock-shelters.' A committee had been formed for the purpose of carrying on excavations.

5. *Geological Photography*.—This Committee, of which Mr. Jeffs was secretary, and the work of which had been discussed at the last meeting, had been recommended for reappointment with the addition of two names.

6. *Northamptonshire Lias*.—A committee for collecting and registering the fossils of this formation had been recommended for appointment, and excavations had already been commenced.

7. *Sea-coast Erosion*.—This Committee, the objects of which had been explained to the Delegates on former occasions, and of which Mr. Topley was Secretary, had been recommended for reappointment.

8. *Registration of Type Specimens*.—A recommendation had also been sent in for the appointment of a committee for reporting on type specimens in museums, an important subject, in which great assistance might be rendered by the local Societies.

9. *Earth-Tremors*.—This Committee, which had been referred to at former Conferences, had been recommended for reappointment, with Mr. Davison as Secretary. Professor Lebour explained that his occupations left him no leisure for acting any longer as Secretary to this Committee.

10. *Exploration of Elbolton Cave*.—A committee had been formed for the excavation of this cave, which was near Skipton, and in which relics of human occupation had already been found. Some of the local Societies in Yorkshire might assist in the investigation.

11. *Source of the River Aire*.—The object of the Committee appointed for the purpose of investigating this subject was to ascertain, if possible, by means of the coal-tar colouring matter, fluorescein, whether the water which flows out of Malham Tarn and disappears down a 'water sink' to the south of the Tarn is the stream which emerges at Malham Cove or Aire Head, or at both these places. The use of the dye for this purpose had been suggested by Professor Meldola to Professor S. P. Thompson, and the latter had brought the subject before Section C in the form of a paper with the object of having a committee appointed for the purpose of carrying out the experiments. It had been suggested that the method might be found generally useful for investigating the course of underground waters, as a very small trace of the dye produced an intense green fluorescence, and had not the slightest injurious effect upon the water.

Mr. C. E. De Rance, who had also been requested to act as a representative of Section C, made some remarks with respect to the work of the Underground Water Committee. The latter had been appointed in 1874 and had just presented their sixteenth report. The objects of the Committee were to inquire into the subject of underground water with a view to supply from wells or springs. A form of inquiry had been prepared in which questions were asked respecting the quality, quantity, and level of the water. They were particularly anxious to secure records of the water level extending over long periods of time; they had reason

to believe that many sets of observations of the level in wells and springs had been made daily or weekly during past times, and the Committee thought it highly important to secure these old records if possible.

The work of the Coast Erosion Committee, which was appointed in 1882, had been carried on with important results, and much information had been derived from a study of old charts to which the Committee had been enabled to get access. The Committee on Erratic Blocks, of which Dr. Crosskey, of Birmingham, was the Secretary, was appointed in 1871 with the object of recording the exact positions of the more important boulders and, if possible, of entering these positions on the Ordnance map. Copies of these maps should be kept by the Societies taking part in the work, and copies should also be sent to the British Association Committee. It was important also to have a microscopical examination of sections of chips from the boulders made by competent geologists, so that the probable sources of the boulders might be ascertained. Another point in connection with this subject, in which the Corresponding Societies might exert their local influence, was that the boulders where they occurred should not be left to the mercy of the stone-breaker, but should be preserved. This applied especially to public parks or gardens, where the local Societies might well use their influence with the Corporations to induce them to have the boulders preserved and even placed in prominent positions, where they might be readily accessible and at the same time secure from danger of demolition.

With reference to the publication of the 'Geological Record,' Mr. De Rance had been requested by Mr. Topley to bring the subject prominently before the Delegates. The work was instituted, as was well known, by Mr. Whitaker in 1874, and entailed a large amount of unremunerated labour. The number of copies sold was insufficient to meet the cost of publication, notwithstanding the grant made by the British Association, and unless more subscribers could be secured the publication would have to cease. The 'Geological Record' Committee took the opportunity of appealing to the Delegates, and Mr. De Rance on behalf of the Committee asked them to make known the character and scope of the work in order to increase the list of subscribers. Circulars for this purpose were distributed among the Delegates.

Professor Meldola made some remarks with reference to the proposed method for investigating the source of the Aire, after which he stated that he had been requested by Dr. Crosskey to render the thanks of the Erratic Blocks Committee to the Corresponding Societies for the aid which they had already given, and to express a hope that their assistance would be continued. Dr. Crosskey had forwarded for inspection a copy of a paper on the boulders of the Midland district, by Mr. F. W. Martin, F.G.S., read before and published by the Birmingham Philosophical Society. This paper was accompanied by a map of the Midland District on the scale of two miles to the inch, and was considered by the Erratic Blocks Committee to be an example of the method of investigation which would yield the best results in this inquiry. In this paper attention had been paid to distribution of the erratics, their grouping and various levels, their mixture with or freedom from local blocks, as well as to the importance of discriminating between erratics distributed without regard to local hills and those that are gathered together in the valleys at present existing. A copy of the last report of the Committee will be forwarded

on application to any address sent to Dr. Crosskey, and a few copies of the map are also to be had by those Societies taking part in the work.¹

Mr. J. W. Davis stated, with respect to the work of the Committee for investigating the source of the Aire, that some five or six years ago Mr. Walter Morrison, M.P., and several members of the Yorkshire Naturalists' Union, tried a number of experiments with aniline dyes, similar to that proposed by Professor S. P. Thompson, but they had all failed.

Mr. Gray made some remarks with reference to the method of inducing the Corresponding Societies to take up the work of the various Committees. He thought that much force would be given to the representations made by the Delegates to their Societies if the Committees which required the co-operation of the local Societies would send copies of their reports to and communicate directly with those Societies, pointing out that the work suggested by the Delegate was of real use and likely to be valuable to the Committee in carrying out the objects of the British Association. The Belfast Naturalists' Field Club, for example, had no Committees on Erratic Blocks or on Coast Erosion, but if these Association Committees sent their reports and a request for assistance he felt sure that many members of their Society would be glad to take these matters up.

The Chairman, Mr. De Rance, Mr. Hopkinson, and Mr. Corse Glen spoke in favour of Mr. Gray's suggestion.

SECTION D.

Professor Hillhouse stated that no new committees had been appointed this year by their Section which had any bearing on the work of the Corresponding Societies.

SECTION E.

Teaching of Geography in Primary Schools.—Mr. Sowerbutts said that the Committee of this Section had had under consideration the teaching of geography in primary schools. He had undertaken to draw up a report on this subject with reference to the action of the local authorities, and especially so far as concerned his own district in Lancashire. The object of the report would be to make known how far the Government grant apportioned for technical education or allied purposes was made use of for the teaching of geography. His own experience went to show that the subject was much neglected, and he invited Delegates from other parts of the country to give information by sending in School Board reports or reports of municipal authorities dealing with educational matters, so that he might be able to present a fairly complete report to the Committee next year. He hoped by this means that pressure might be brought to bear upon the Government in order to have justice done to a subject of such importance.

¹ The paper referred to appears in the *Proceedings of the Birmingham Philosophical Society*, vol. vii., Part I., 1890. Dr. Crosskey's address is 117 Gough Road, Birmingham.

SECTION H.

Committee of Aid for Anthropological Excavations.—Dr. Garson called attention to the existence of a Committee of Aid formed by the Anthropological Institute, and the purpose of which had been explained at last year's Conference of Delegates. He stated that every year there were many people who were desirous of carrying on, and who did sometimes carry on, investigations of this kind, but unfortunately discretion was not sufficiently mingled with the zeal displayed. This was, no doubt, due to an imperfect knowledge of the method of conducting such investigations. Owing to this want of knowledge a large amount of valuable material was often destroyed. For the purpose of aiding by direction or otherwise the exploration of ancient remains, a committee had been appointed in 1888 by the Anthropological Institute, the chairman of this committee being General Pitt-Rivers, the Inspector of Ancient Monuments. Local Societies would find it to their advantage if they would report to the committee of the Anthropological Institute when they were desirous of undertaking explorations. Due attention would be given to their applications, and, if thought desirable, the matter would be placed in the hands of some expert member of the Committee, every member of the latter being in some way a specialist; so that local exploring committees could have any assistance they required in the way of skilled advice in opening up barrows, earthworks, camps, &c.

Prehistoric Remains Committee.—Mr. J. W. Davis said that this Committee, of which he was the Secretary, was appointed in 1887. Since then four reports had been presented, which varied much in length, but of which the interest and importance had been well kept up. He expressed his conviction that if the various Corresponding Societies would take up the work the subject would become of the very greatest importance to the country generally. What was wanted was a record of everything that had reference to prehistoric man, his dwellings, implements, pottery, &c. A goodly number of reports had been promised, but it appeared that in many instances their compilation took a considerable amount of time. He hoped that next year they would present a much longer list than that which had been presented to the Section this year. Dr. Munro had promised a list of the lake dwellings of the British Isles; and, amongst others, Mr. Gray, who represented the Belfast Society, had promised to send a one-inch map with the ancient remains in Ireland marked upon it. If they could get a complete map of the whole country similarly marked, this map, which would be the property of the British Association, would be of the very highest value, and the Committee would have accomplished most important work. He trusted the Delegates would inform their Societies what had already been done and what still remained to be done, so that they might be able to enlist the services of others who were interested in Archæological research.

At the conclusion of the business a discussion took place with reference to the best method for imparting to the Corresponding Societies through the respective Delegates a knowledge of what had taken place at the Conferences. Mr. Hopkinson suggested that each Delegate should read a paper before his Society, giving an account of the line of work taken

up by the various Committees, and that this paper should be published in the Society's Transactions or Reports as soon as possible. He distributed among the Delegates a paper of this kind which he had brought before the Hertfordshire Natural History Society.¹

Another question raised was the advisability of in some way bringing into relationship with the British Association those Societies which did not come up to the standard of excellence for enrolment as Corresponding Societies. It was stated that there were a large number of smaller Societies doing good work, but which were not in a position to publish the results of original investigations or to issue a publication. It was felt that much good would be done to these Societies if they could be affiliated by some means, and allowed to take part in the meetings of the Conference, perhaps without having the privilege of sending a Delegate to the General Committee or of receiving gratuitously a copy of the annual volume of Reports. The matter was referred to the Corresponding Societies Committee for their consideration.

On the motion of Professor Lebour, seconded by Mr. J. W. Davis, a vote of thanks was passed to the Chairman, Mr. Symons, and to Professor Meldola, the Secretary of the Conference.

With reference to the last point raised at the Leeds Conference, the Corresponding Societies Committee has to report that, after considering the question referred to, it is recommended that the attendance at the Conferences of representatives of local Societies which are not Corresponding Societies should be sanctioned on the understanding that these representatives are not actually enrolled among, and do not receive the privileges of, authorised Delegates. The Committee has also authorised its Secretary to supply any local Society which may apply for them with copies of the reports of the Conferences, the lists of Committees, and other information likely to be of use in furthering local scientific investigation.

The Committee has received application from all the Societies now enrolled, and recommends their retention. It is further recommended to the General Committee that:—

1. The Somersetshire Archæological and Natural History Society,
2. The South London Microscopical and Natural History Society,
3. The Tyneside Geographical Society,
4. The Yorkshire Philosophical Society,

should be enrolled as Corresponding Societies of the British Association.

¹ This plan has been adopted in former years by the Delegates of the Manchester Geographical Society, the Isle of Man Natural History Society, the Essex Field Club, and the Yorkshire Naturalists' Union (Secretary Corresponding Societies Committee).

The Corresponding Societies of the British Association for 1890-91.

Full Title and Date of Foundation	Abbreviated Title	Head-quarters or Name and Address of Secretary	No. of Members	Entrance Fee	Annual Subscription	Title and Frequency of Issue of Publications
Barnsley Naturalists' and Scientific Society, 1867	Barnsley Nat. Sci. Soc.	Henry Wade, 10 Pitt Street	61	None	6s. and 10s. 6d.	Transactions, occasionally.
Bath Natural History and Antiquarian Field Club, 1855	Bath N. H. A. F. C.	Rev. H. H. Winwood, Royal Literary and Scientific Institution, Bath	90	5s.	10s.	Proceedings, annually.
Bedfordshire Archaeological and Natural History Society, 1887	Bed. A. N. H. Soc.	F. A. Blaydes and F. B. W. Phillips, M.A., Harpur Place, Bedford	60	None	7s. 6d.	Transactions, occasionally.
Belfast Natural History and Philo- sophical Society, 1821	Belfast N. H. Phil. Soc.	Museum, College Square. R. M. Young, B.A.	264	None	1l. 1s.	Report and Proceedings, annually.
Belfast Naturalists' Field Club, 1863	Belfast Nat. F. C.	Museum, College Square. R. Lloyd Praeger, B.E., M.R.I.A.	282	None	5s.	Report and Proceedings, annually.
Birmingham Natural History and Microscopical Society, 1864	Birm. N. H. M. Soc.	William F. Marshall, Mason College, Birmingham	204	None	1l. 1s. and 10s. 6d.	'Midland Naturalist,' monthly.
Birmingham Philosophical Society.	Birm. Phil. Soc.	C. Davison and T. W. Bridge, Medical Institute, Edmund Street, Birmingham	119	None	1l. 1s.	Proceedings, annually.
Bristol Naturalists' Society, 1862	Bristol Nat. Soc.	University College, Bristol. Professor Adolph Leiper, 47 Hampton Park, Redland, Bristol	220	5s.	10s.	Proceedings, annually.
Burton-on-Trent Natural History and Archaeological Society, 1876	Burt. N. H. Arch. Soc.	46 High Street, G. Harris Morris, Ph.D., F.I.C., 121 Alexandra Road, Burton-on-Trent	210	None	5s.	Annual Report. Transactions occasionally.
Cardiff Naturalists' Society, 1867	Cardiff Nat. Soc.	R. W. Atkinson, B.Sc., F.I.C., 44 Loudon Square, Cardiff	400	None	10s. 6d.	Report and Transactions, half-yearly
Chester Society of Natural Science and Literature, 1871	Chester Soc. Nat. Sci.	Grosvenor Museum, Chester. G. R. Griffith	610	None	5s.	Annual Report. Proceedings every three or four years.
Chesterfield and Midland Counties Institution of Engineers, 1871	Chesterf. Mid. Count. Inst.	Stephenson Memorial Hall, W. F. Howard, 13 Cavendish Street, Chesterfield	253	1l. 1s.	Members 31s. 6d.; Subscribers 21s.; Associates and Students 20s. Minimum, 10s. 6d.	Transactions quarterly.
Cornwall Mining Association and Institute of, 1859	Cornw. Min. Assoc. Inst.	William Thomas, C.E., F.G.S., Penzance, Camborne	350	None	10s. 6d. and 1l. 1s.	Transactions, annually.
Cornwall Royal Geological Society of, 1814	Cornw. R. Geol. Soc.	G. B. Millett, Penzance	100	None	None	Report and Transactions, annually.
Croydon Microscopical and Natural History Club, 1870	Croydon M. N. H. C.	Public Hall, Croydon. F. O. Bayard, Manor Road, Wallington	297	None	10s.	Proceedings and Transactions, annually.
Cumberland and Westmorland Association for the Advancement of Literature and Science, 1876	Cumb. West. Assoc.	J. B. Bailey, 28 Eaglesfield Street, Maryport	1,007	None	6s.	Transactions, annually.
Dorset Natural History and Antiquarian Field Club, 1875	Dorset N. H. A. F. C.	M. G. Stuart, New University Club, St. James's Street, London, S.W.	270	None	10s.	Proceedings, annually.
Dumfriesshire and Galloway Natural History and Antiquarian Society, 1862	Dum. Gal. N. H. A. Soc.	Grey Friars, Dumfries, Dr. E. J. Chinnock, Fern Bank, Dumfries	192	2s. 6d.	5s.	Transactions and Journal of Proceedings, annually.

	assessment of 4d.	Transactions, annually.
East of Scotland Union of Naturalists Societies, 1861	12s. 6d.	Transactions, annually.
Edinburgh Geological Society, 1834	15s.	'Essex Naturalist,' monthly; Special Memoirs, occasionally. Transactions, annually.
Essex Field Club, 1880	10s.	Transactions, annually.
Glasgow, Geological Society of, 1858	7s. 6d.	Proceedings and Transactions, annually.
Glasgow, Natural History Society of, 1851	11. 1s.	Proceedings, annually; occasional papers.
Glasgow, Philosophical Society of, 1802	7s. 6d.	Proceedings, annually.
Hampshire Field Club, 1885	10s.	Transactions, quarterly.
Hertfordshire Natural History Society and Field Club, 1875	10s.	Proceedings, usually every two years.
Holmesdale Natural History Club, 1867	5s.	Transactions, occasionally.
Inverness Scientific Society and Field Club, 1875	11. 1s.	Journal, generally annually.
Ireland, Royal Geological Society of, 1831	11.	Journal, annually.
Ireland, Statistical and Social Inquiry Society of, 1847	5s.	Transactions, annually.
Leeds Geological Association, 1874	6s.	Transactions, occasionally.
Leeds Naturalists' Club and Scientific Association, 1878	Members 11. 1s.; Associates 10s. 6d.	Transactions, quarterly.
Leicester Literary and Philosophical Society, 1835	Residents 11. 1s. Non-Res. 10s. 6d.	Transactions, annually.
Liverpool Engineering Society, 1875	10s. 6d.	Journal.
Liverpool Geological Society, 1858	None	Report, every two years.
Liverpool, Literary and Philosophical Society of, 1812	None	Yn Lloar Manninagh, quarterly Journal, quarterly.
Liverpool Microscopical Society, 1869	None	Transactions, about nine parts per annum.
Malton Field Naturalists' and Scientific Society, 1879	10s. 6d.	Transactions, annually.
Man, Isle of, Natural History and Antiquarian Society, 1879	None	Proceedings, annually.
Manchester Geographical Society, 1885	11. 1s.	Proceedings, annually.
Manchester Geological Society, 1838	10s. 6d.	Journal.
Manchester Statistical Society, 1833	None	Report, every two years.
Marlborough College Natural History Society, 1864	None	Gentlemen 6s. Ladies 3s. Ordinary 11. 1s. Associates 10s. 6d.
	None	Transactions, about nine parts per annum.
	10s. 6d.	Transactions, annually.
	1s. 6d.	Report, annually.
William Cole, 12 Townsend Crescent, Kirkcaldy, N.B.	892 Members, 232	
H. M. Cadell, 5 St. Andrew Square, Edinburgh	450	
William Cole, 7 Knighton Villas, Buckhurst Hill, Essex	230	
J. B. Murdoch, Capelrig, Mearns, Glasgow	350	
D. A. Boyd and J. Steel, 207 Bath Street, Glasgow	680	
John Mayer, 207 Bath Street, Glasgow	250	
Hartley Institution, Southampton. W. Dale	250	
Dr. J. Morrison, F.G.S., St. Albans, and F. A. Hawks, Hertford	73	
A. J. Crossfield, Carr End, Keigate	184	
Thomas Wallace, High School, Inverness	140	
Prof. W. J. Sollas, F.R.S., Trinity College, Dublin	150	
J. Pim, B.L., 35 Molesworth Street, Dublin	135	
Wm. Lower Carter, F.G.S., Meenwood, Leeds	251	
80 Municipal Buildings, Victoria Square, Leeds	330 (including Associates)	
C. J. Billson, M.A., St. John's Lodge, Clarendon Park Road, Leicester	200	
Royal Institution. J. H. T. Turner, 3 Cook Street, Liverpool	56	
Royal Institution. H. C. Beasley	271	
Royal Institution. John Rutherford, L.L.B., Wason Chambers, 4 Harrington Street, Liverpool	134	
Royal Institution. Wm. Oelriclus	94	
Thomas J. Blanche, Malton, Yorkshire	135	
P. M. C. Kermode, Hillside, Ramsey, Isle of Man	850	
Eli Sowerbutts, F.R.G.S., 44 Brown Street, Manchester	228	
Mark Sturup, F.G.S., 36 George Street, Manchester	192	
25 Booth Street, Manchester. Francis E. M. Beardsall and G. H. Pownall	315	
Marlborough College. E. Meyrick.		

SELECTED LIST OF SOCIETIES, &c. (continued).

Full Title and Date of Foundation	Abbreviated Title	Head-quarters or Name and Address of Secretary	No. of Members	Entrance Fee	Annual Subscription	Title and Frequency of Issue of Publications
Midland Union of Natural History Societies, 1877	Mid. Union . . .	W. K. Parkes, 61 Cavendish Road, cent, Birmingham	2,000	—	—	'Midland Naturalist,' monthly.
North of England Institute of Mining and Mechanical Engineers, 1852	N. Eng. Inst. . .	M. Walton Brown, Neville Hall, Newcastle-upon-Tyne	670	None	21s. and 42s.	Transactions, about every two months.
North Staffordshire Naturalists' Field Club and Archeological Society, 1865	N. Staff. N. F. C. A. Soc.	Rev. T. W. Daltry, M.A., Madeley Vicarage, Newcastle, Staffs.	363	5s.	5s.	Report and Transactions, annually.
Northamptonshire Natural History Society and Field Club, 1885	N'ton. N. H. Soc. .	The Museum, Guildhall Road, Northampton. H. N. Dixon	200	None	10s.	Journal, quarterly.
Nottingham Naturalists' Society, 1892	Nott. Nat. Soc. .	Nottingham Institute, 3 Shakespeare Street. F. R. Jackson	153	None	5s.	Transactions and Report, annually.
Paisley Philosophical Institution, 1808	Paisley Phil. Inst. .	J. Gardner, 3 County Place, Paisley	378	5s.	7s. 6d.	Report, annually.
Penzance Natural History and Antiquarian Society, 1889	Penz. N. H. A. Soc. .	G. F. Tregelles, 3 Market Place, Penzance	90	None	10s. 6d.	Report and Transactions, annually.
Perthshire Society of Natural Science, 1867	Perths. Soc. N. Sci. .	Perthshire Natural History Museum, Ray Street, Perth. S. T. Ellison	314	2s. 6d.	5s. 6d.	Transactions and Proceedings, annually.
Rochdale Literary and Scientific Society, 1878	Rochdale Lit. Sci. Soc.	J. Reginald Ashworth, 20 King Street South, Rochdale	243	None	6s.	Transactions, occasionally.
Rochester Naturalists' Club, 1878	Rochester N. C. . .	John Hepworth, Union Street, Rochester	141	None	3s. 6d., 5s., and 10s.	'Rochester Naturalist,' quarterly.
Royal Scottish Geographical Society, 1884	R. Scot. Geog. Soc. .	National Portrait Gallery, Edinburgh. A. Silva White	1,574	1l. 1s.	1l. 1s.	'Scottish Geographical Magazine,' monthly.
Somersetshire Archeological and Natural History Society, 1849	Som'setsh. A. N. H. Soc.	The Castle, Taunton. F. T. Elworthy	589	10s. 6d.	10s. 6d.	Proceedings, annually.
South African Philosophical Society, 1877	S. African Phil. Soc. .	W. H. Finlay, Royal Observatory, Cape Town	78	None	2l.	Transactions, annually.
South London Microscopical and Natural History Society, 1871	S. London M. N. H. Soc.	Brixton Hall, Acre Lane, Brixton. H. Groves	123	None	10s.	Report, annually.
Tyneside Geographical Society, 1887	Tyneside Geog. Soc. .	Geographical Institute, Barras Bridge, Newcastle-on-Tyne. G. E. T. Smithson	980	None	10s.	Journal, half yearly.
Warwickshire Naturalists' and Archeologists' Field Club, 1854	Warw. N. A. F. C. .	W. G. Fretton, F.S.A., Hearsall Terrace, Chapel Fields, Coventry	75	2s. 6d.	5s.	Proceedings, annually.
Woolhope Naturalists' Field Club, 1851	Woolhope N. F. C. .	Woolhope Club Room, Free Library, Hereford. H. Cecil Moore	185	10s.	10s.	Transactions, annually or biennially.
Yorkshire Geographical and Polytechnic Society, 1887	Yorks. Geol. Poly. Soc.	James W. Davis, F.G.S., Chevin-edge, Halifax	260	None	13s.	Proceedings, annually.
Yorkshire Naturalists' Union, 1861	Yorks. Nat. Union .	W. Denison Roebuck, F.L.S., Sunny Bank, Leeds; Rev. E. P. Knibley, M.A., Staveley Rectory, Leeds; and Edgar B. Waite, F.L.S., The Museum, Leeds	430 and 2,580 Associates	None	10s. 6d.	Transactions, annually; 'The Naturalist,' monthly.
Yorkshire Philosophical Society, 1822	Yorks. Phil. Soc. . .	Museum, York. T. S. Noble	450	None	2l.	Report, annually.

Index of the more important Papers, and especially those referring to Local Scientific Investigations, published by the above-named Societies during the year ending June 1, 1891.

** This catalogue contains only the titles of papers published in the volumes or parts of the publications of the Corresponding Societies sent to the Secretary of the Committee in accordance with Rule 2.

Section A.—MATHEMATICAL AND PHYSICAL SCIENCE.

Name of Author	Title of Paper	Abbreviated Title of Society	Title of Publication	Volume or Part	Page	Published
Abbe, Prof. C.	The Modern Weather Bureau	S. African Phil. Soc.	<i>Trans.</i>	VI.	17	1890
Abel, W. J.	The Microscope	Nott. Nat. Soc.	<i>Trans. and Rep.</i>	For 1890	12	1891
Allan, G. E.	Alteration of the Index of Refraction of Water with Temperature	Glasgow Phil. Soc.	<i>Proc.</i>	XXI.	126	1890
Anderson, Rev. W.	Meteorology of Dumfries	Dum. Gal. N. H. A. Soc.	<i>Trans.</i>	6	28, 107, 203	"
"	Temperature of the River Nith	"	"	"	248	"
Ashworth, J. R.	Thermometric Observations of Air and Water at Cowm and Spring Mill Reservoirs	Rochdale Lit. Sci. Soc.	"	II.	103	"
Brown, J.	Notes on the Musical Sand of Eigg	Belfast N. H. Phil. Soc.	<i>Report and Proc.</i>	For 1890	23	"
Burder, Dr. G. F.	Rainfall at Clifton in 1889	Bristol Nat. Soc.	<i>Proc.</i>	VI.	195	"
Casartelli, Rev. L. C.	Notes on Manchester Rainfall during the Twelve Years 1878 to 1889	Manch. Geog. Soc.	<i>Journal</i>	6	177	1891
Clark, J. E.	The Windrush at York, March 8, 1890	Yorks. Phil. Soc.	<i>Report.</i>	For 1890	43	"
Comber, T.	Photo-micrography	Liv'pool Mic. Soc.	<i>Journal</i>	1	94	"
Crosfield, J. B.	Lunar Rainbow at Reigate	Holmesdale N. H. C.	<i>Proc.</i>	1	46	1890
Dixon, H. N.	Phenological Observations	N'ton. N. H. Soc.	<i>Journal</i>	VI.	50	"
Fordham, H. G.	A Record of Water-level in a deep Chalk Well at Odsey Grange, Royston, 1878-1888	Herts N. H. Soc.	<i>Trans.</i>	VI.	31	"
Gardner, D. R.	The Conversion of Ordinary Gas Shades into Regenerative Lamps	Glasgow Phil. Soc.	<i>Proc.</i>	XXI.	92	"
Gore, Dr. G.	Relative Amounts of available Voltaic Energy of Aqueous Solutions	Birm. Phil. Soc.	"	VII.	43	"
Hopkinson, J.	Meteorological Observations taken at St. Albans during the year 1889	Herts. N. H. Soc.	<i>Trans.</i>	VI.	25	"
"	Report on the Rainfall in Hertfordshire in 1889	"	"	"	65	"
"	Temperature and Rainfall at Hitchin, 1850-89	"	"	"	72	"
"	Climatological Observations taken in Hertfordshire in 1889	"	"	"	77	"

Section A.—MATHEMATICAL AND PHYSICAL SCIENCE (continued).

Name of Author	Title of Paper	Abbreviated Title of Society	Title of Publication	Volume or Part	Page	Published
Hopkinson, J.	Half a Century's Rainfall in Hertfordshire	Herts. N. H. Soc.	<i>Trans.</i>	VI.	81	1890
Horsley, Col.	Temperature of the River Stour at Canterbury.	E. Kent N. H. Soc.	<i>S. Eastern Nat'l list</i>	I.	5	"
Lang, W., jun.	Cyanotype Reproductions of Seaweeds	Glasgow Phil. Soc.	<i>Proc.</i>	XXI.	155	"
Lodge, Prof. O. J.	Electrical Oscillations	"	"	"	216	"
Maclean, M., and M. Goto	Electrification of Air by Combustion	"	"	"	22	"
Markham, C. A.	Meteorological Reports	N'ton. N. H. Soc.	<i>Journal</i>	VI.	35, 60, 104, 133	"
"	Parhelia or Mock Suns	"	"	"	19	"
Mavor, H. A.	Public Lighting by Electricity	Glasgow Phil. Soc.	<i>Proc.</i>	XXI.	142	"
Morris, T.	Some Causes of the Crystallisation of Iron (Discussion)	Liv'pool E. Soc.	<i>Trans.</i>	XI.	18	"
Muirhead, Dr. H.	The Relationships which the Perihelia of Comets bear to the Sun's Line of Flight in Space	Glasgow Phil. Soc.	<i>Proc.</i>	XXI.	33	"
Nevins, A.	Weather Forecasting	N. Staff. N. F. C. A. Soc.	<i>Report and Trans.</i>	For 1890	57	1891
Newman, T. P.	Fog	Holmesdale N. H. C.	<i>Proc.</i>	1	4	1890
Rintoul, D.	Observations of Temperature at Clifton, 1889	Bristol Nat. Soc.	"	VI.	198	"
Robson, R.	Strange Atmospheric Appearance	Dum. Gal. N. H. A. Soc.	<i>Trans.</i>	6	15	"
Shaw, Dr. C.	Modern Photography	Belfast N. H. Phil. Soc.	<i>Report and Proc.</i>	For 1890	45	"
Society, The.	Meteorological Observations	Paisley Phil. Inst.	<i>Report.</i>	—	—	"
Thompson, J. T.	Optical Illusions	Cardiff Nat. Soc.	<i>Report and Trans.</i>	XXII.	1	1891
Thompson, Prof. S. P.	William Gilbert, of Colchester, Founder of the Science of Electricity	Essex F. C.	<i>Essex Naturalist.</i>	V.	50	"
Thresh, Dr. J. C.	Notes on the recent prolonged Frost, 1890-91	"	"	"	64	"
Tyndall, W. H.	Meteorology of Redhill for the year 1887.	Holmesdale N. H. C.	<i>Proc.</i>	1	1	1890
"	Notes on Meteorology of Redhill for 1888	"	"	"	37	"
Watts, W.	Thermometrical Observations of Atmospheric Air and Water at Pictborne and Denshaw	Manch. Geol. Soc.	<i>Trans.</i>	XX.	580	"
Wells, J. G.	The Weather of 1889	Burt. N. H. Arch. Soc.	<i>Report.</i>	14th	17	"

Section B.—CHEMICAL SCIENCE.

Brierley, J.	New Forest Water	Hants. F. C.	<i>Proc.</i>	IV.	71	1890
Brown, Dr. A. C.	The Basicity of Acids	Glasgow Phil. Soc.	"	XXI.	69	"
Brown, M. W.	Experiments with Explosives used in Mines	N. Eng. Inst.	<i>Trans. of Inst. Inst.</i>	9	40	1891

Author	Title	Society	Publication	Year
BROWN, M. W., and W. Foggie	Experiments with Chlorine	Cardiff Nat. Soc.	Report and Trans.	1891
Cundall, Dr. J. T.	The Production of Ozone by Flames.	Nott. Nat. Soc.	Trans. and Report.	1890
Francis, E.	Potable Water	Birm. Phil. Soc.	Proc.	1890
Gore, Dr. G.	Examples of Solution Compounds	Rochdale Lit. Sci. Soc.	Trans.	1890
Stenhouse, T.	A curious Coal-pit Water	Manch. Geol. Soc.	"	1890
Watts, W.	On Nitrogen Gas in Strinesdale Tunnel	"	"	1890
"	On the Carbonite Syndicate Explosives	"	"	1890
Section O.—GEOLOGY.				
Andrews, W.	On the Discovery of Blue Slate in North Warwickshire	Warw. N. A. F. C.	Proc.	1891
Barclay, R.	The Geology of the Highlands, from Mount Battock, Kincardineshire, to the Village of Edzell, and thence to the Sea at St. Cyrus	E. Scot. Union	"	1890
Barker, F.	Geological Report	N. Staff. N. F. C. A. Soc.	Report and Trans.	1891
Beasley, H. C.	Presidential Address—The Life of the English Trias	Liv'pool Geol. Soc.	Proc.	1890
Bedford, J. E.	Report of Yorkshire Geological Photograph Committee	Yorks. Nat. Union	The Naturalist	1891
Bell, D.	Phenomena of the Glacial Epoch: II. The Great Submergence	Glasgow Geol. Soc.	Trans.	1890
Bell, T.	On the Middlesbrough Salt Works and the recent Borings on the Lackenby Foreshore Estate	Manch. Geol. Soc.	"	1890
Bennett, F. J.	The Influence of Geology on Settlement	Marlb. Coll. N. H. Soc.	Report.	1891
Bennie, J.	On Things New and Old from the Ancient Lake of Cowdenglen, Renfrewshire	Glasgow Geol. Soc.	Trans.	1891
Black, Dr. W. G.	A Collection of Metallic Ores from Damaraland, South Africa	Manch. Geol. Soc.	XX.	1890
Blair, M.	The Surface Geology of Paisley	Glasgow Geol. Soc.	IX.	1891
Brodie, Rev. P. B.	On Fossil and recent Extinct Birds, with an account of the Formations in which they occur, and the circumstances of their preservation	Warw. N. A. F. C.	Proc.	1891
Buckman, S. S.	On the Jurensis Zone	N'ton N. H. Soc.	Journal	1890
Bulman, G. W.	On a Coal Seam in the Bernician Series of Northumberland, and its Bearing on the Theory of the Formation of Coal	Yorks. Nat. Union	The Naturalist	1890

Section C.—GEOLOGY (continued).

Name of Author	Title of Paper	Abbreviated Title of Society	Title of Publication	Volume or Part	Page	Published
Bulman, G. W.	On the Origin of the Upper Drift Sands and Gravels of Northumberland	Yorks. Nat. Union.	<i>The Naturalist</i>	For 1891	43	1891
Burns, D.	The Bending of Beds near Veins	N. Eug. Inst.	<i>Trans. of Fed. Inst.</i>	2	64	1890
Cadell, H. M.	Notes on the Coal Question	Edinb. Geol. Soc.	"	VI.	86	1890
Campbell, W. Y.	Mines and Minerals in South Africa.	Tyneside Geog. Soc.	<i>Journal</i>	Vol I., No. 3	8	"
Cash, W., and J. Lomax	On <i>Lepidophlois</i> and <i>Lepidodendron</i>	Yorks. Geol. Poly. Soc.	<i>Proc.</i>	XI.	478	1891
Clarke, J. F. M.	The Geology of the Bridgwater Railway; a brief account of Lias Cuttings through the Polden Hills in Somersetshire	Bath N. H. A. F. C.	"	VII.	127	"
Coates, H.	The Index Collection of Rock Specimens.	Perths. Soc. N. Sci.	<i>Trans.</i>	I.	143	1890
Cole, Rev. E. M.	Peat Deposit at Filey	Yorks. Nat. Union.	<i>The Naturalist</i>	For 1891	17	1891
Colenutt, G. W.	The Fossil Chelonians of the Oligocene of the Isle of Wight	Hants. F. C.	<i>Proc.</i>	IV.	57	1890
Craig, R.	Notes upon a Cutting in the New Kilbirnie Branch of the Lanarkshire and Ayrshire Railway on the Farm of Gurdy, Beith; with List of Fossils	Glasgow Geol. Soc.	<i>Trans.</i>	IX.	64	1891
Cumming, L.	Note on Glacial Moraines	Liv'pool Geol. Soc.	<i>Proc.</i>	VI.	174	1890
Dakyns, J. R.	On the Changes of the Lower Carboniferous Rocks in Yorkshire, from South to North	Yorks. Geol. Poly. Soc.	"	XI.	353	1891
Dalton, W. H.	Notes of Geological Rambles in the Braintree District	Essex F. C.	<i>Essex Naturalist</i>	IV.	79	1890
"	Note on the Upminster Brickyard, 1890	"	"	"	186	"
"	The Undulations of the Chalk in Essex	"	"	V.	113	1891
Davison, C.	On the Study of Earthquakes in Great Britain.	Birm. Phil. Soc.	<i>Proc.</i>	VII.	68	1890
Deane, Rev. G.	On the Effects of a reputed Waterspout at Batcombe and Chetnole, Dorsetshire	"	"	"	26	"
De Rance, C. E.	Notes on Borings for Water and Salt in the County of York	Yorks. Geol. Poly. Soc.	"	XI.	424	1891
Dickson, E., and P. Holland	On the Examination of Water and Sediment from the River Arveiron near Argentière	Liv'pool Geol. Soc.	"	VI.	194	1890
"	On the Examination of some Anglesea Rocks	"	"	"	206	"
Dow, R.	A Geological Sketch of East Fife	Perths. Soc. N. Sci.	<i>Trans.</i>	I.	139	"
Dowker, G.	Beds between the Chalk and London Clay	E. Kent N. H. Soc.	<i>S. Eastern Nat'list</i>	I.	12	"
Dudgeon, P.	The Minerals of Dumfries and Galloway	Dumf. Geol. N. H. A. Soc.	"	"	"	"

1891.	Eve, A. S.	On a Waterfall in Norway	Marb. Coll. N. H. Soc.	Report.	XXXIX.	84	1891
	Fox, H.	On the Micaceous Schists of the Penolver District (the Lizard)	Cornw. R. Geol. Soc.	Report and Trans.	XI.	327	"
	"	The Carouga Boulder	"	"	"	334	"
	"	Picotite in Serpentine	"	"	"	336	"
	Garforth, W. E.	Deep Mining	Yorks. Geol. Poly. Soc.	Proc.	"	469	"
	Gasking, Rev. S.	On the Geology of the South of the Isle of Man	I. of Man N. H. A. Soc.	Yn Lloar Manninagh	I.	119	1890
	"	The so-called Old Red Sandstone of the Isle of Man	"	"	"	135	1891
	Geinitz, Dr. H. B.	On the Red and Variegated Marls of the Upper Dyas near Manchester	Manch. Geol. Soc.	Trans.	XX.	537	1890
	George, J. E.	Microscopical Examination of Two Glacial Boulders	Liv'pool Geol. Soc.	Proc.	VI.	197	"
	Goodchild, J. G.	Notes on Faults	Edinb. Geol. Soc.	Trans.	VI.	71	"
	"	Some Abnormal Deposits of Limestone	"	"	"	75	"
	"	Dolomitic Limestones	"	"	"	96	"
	"	Some Irregular Forms of Stratification	"	"	"	116	"
	"	An Outline of the Geological History of Upper Swaledale	Yorks. Nat. Union	The Naturalist	"	243	"
	Gregory, J. W.	A Catalogue of the Pliocene Echinoidea in the Reed Collection in the Museum of the Yorkshire Philosophical Society	Yorks. Phil. Soc.	Report.	For 1890	7	1891
	Grestley, W. S.	North American Geological Notes	Manch. Geol. Soc.	Trans.	XXI.	69	1890
	Halse, E.	Some 'Basket' Deposits of the Gold Coast, West Africa	N. Eng. Inst.	Trans. of Fed. Inst.	2	69	1891
	Harker, A.	Petrological Notes on some of the larger Boulders on the Beach South of Flambro' Head	Yorks. Geol. Poly. Soc.	Proc.	XI.	409	"
	"	Notes on North of England Rocks: II., III.	Yorks. Nat. Union	The Naturalist	For 1890	237, 300	1890
	"	Bibliography: Geology and Palaeontology, 1889	"	"	For 1891	339	"
	"	The Ancient Lavas of the English Lake District	"	"	For 1891	145	1891
	Harrison, Rev. S. N.	Boulders around the Maughold Coast	I. of Man N. H. A. Soc.	Yn Lloar Manninagh	I.	208	"
	Heddle, Dr. M. F.	On new Localities for Zeolites	Glasgow Geol. Soc.	Trans.	IX.	72	"
	Hind, Dr. W.	The Geology of Whitmore	N. Staff. N. F. C. A. Soc.	Report and Trans.	For 1891	40	"
	"	Notes on a Pre-Glacial River Bed at Stoke Road	"	"	"	53	"
	Hobson, B.	On some Opicalcite Erratics at Barton-upon-Irwell	Manch. Geol. Soc.	Trans.	XXI.	84	"
	Holgate, B.	Some Physical Properties of Coal	Yorks. Geol. Poly. Soc.	Proc.	XI.	460	"

Section C.—GEOLOGY (continued).

Name of Author	Title of Paper	Abbreviated Title of Society	Title of Publication	Volume or Part	Page	Published
Hollingsworth, G. H.	On a Tree Branch found in the Drift	Manch. Geol. Soc.	<i>Trans.</i>	XX.	566	1890
Holmes, T. V.	The Chelmsford Water Supply	Essex F. C.	<i>Essex Naturalist</i> .	IV.	82	"
"	On some Sections between West Thurrock and Stifford, on the Grays and Upminster Railway	"	"	"	143	"
Hopkinson, J.	On Local Scientific Investigation in connection with Committees of the British Association	Herts. N. H. Soc.	<i>Trans.</i>	VI.	37	"
"	On Geological Photography in Hertfordshire	"	"	"	49	"
Howden, Dr. J. C.	The Early History of Montrose and the Geology of the Montrose District	E. Scot. Union	<i>Proc.</i>	For 1890	8	1891
Hull, Prof. E.	Our Coal Resources	Edinb. Geol. Soc.	"	VI.	76	1890
Johnstone, A.	The Rock Dolomite	"	"	"	99	"
"	Devitrification of Igneous Rocks	"	"	"	106	"
Jones, Prof. T. Rupert	On some <i>Estheria</i> and <i>Estheria</i> -like Shells from the Carboniferous Shales of Western Scotland	Glasgow Geol. Soc.	"	IX.	79	1891
Jones, Prof. T. Rupert, and J. W. Kirby	On the Ostracoda found in the Shales of the Upper Coal Measures at Slade Lane, near Manchester	Manch. Geol. Soc.	"	XXI.	137	"
Kidston, R.	On the Fructification and Internal Structure of Carboniferous Ferns in their relation to those of existing Genera, with special reference to British Paleozoic Species	Glasgow Geol. Soc.	"	IX.	1	"
"	The Yorkshire Carboniferous Flora	Yorks. Nat. Union	"	14	1	1890
Lamplugh, G. W.	On the larger Boulders of Flamborough Head, and other parts of the Yorkshire Coast, Part IV.	Yorks. Geol. Poly. Soc.	<i>Proc.</i>	XI.	397	1891
"	The Neocomian Clay at Knapton	Yorks. Nat. Union	<i>The Naturalist</i>	For 1890	336	1890
Landon, J.	The Barr Beacon Beds	Birm. Phil. Soc.	<i>Proc.</i>	VII.	113	"
"	Note on a new Drift Section at Northfield	"	"	"	127	"
Lewis, G.	A Geological Sketch of the Town and District of Nottingham	Chesterf. Mid. Count. Inst.	<i>Trans.</i>	II.	22	"
McLennan, J. S.	The Geology of the Inghton Valley	Glasgow Geol. Soc.	"	IX.	91	1891
Macnair, P.	The Index Collection of Minerals	Perthas. Soc. N. Sci.	<i>Trans.</i>	I.	145	1890

Mansel-Pleydell, J. C.	Memor upon a new Ichthyopterigian from the Kimmeridge Clay of Gillingham, Dorset (<i>Ophthalosaurus Pleydellii</i>)	Dorset N. H. A. F. C.	Proc.	XI.	7	"
"	<i>Histonotus singularis</i>	"	"	"	91	"
Marley, J.	Sketch of the Rise and Progress of the Clerocean South Durham Salt Industry	N. Eng. Inst.	Trans. of Fed. Inst.	I.	339	1891
Martin, F. W.	The Boulders of the Midland District (Second Paper)	Birm. Phil. Soc.	Proc.	VII.	85	1890
Mayou, R.	A Lump of Coal.	Rochester N. C.	Roch. Naturalist.	I.	480	"
Millar, W. J.	Notes on the Excursion to the New Reservoir for Bowling Water Supply on March 23, 1889	Glasgow Geol. Soc.	Trans.	IX.	203	1891
Mills, M. H.	A few Notes on the Ironstone Deposits of Leicestershire	Chesterf. Mid.Count. Inst.	"	II.	28	1890
Monckton, H. W.	On the Boulder Clay in Essex.	Essex F. C.	Essex Naturalist.	IV.	199	"
Morgan, Prof. C. I. I.	The Brislington Cutting.	Bristol Nat. Soc.	Proc.	VI.	165	"
"	Mendip Notes.	"	"	"	169	"
"	The Geology of the Wick Rocks Valley	"	"	"	183	"
Murdoch, J. B.	Journal of a Bore put down for Water at Thornliebank, Renfrewshire; with Notes on the Strata	Glasgow Geol. Soc.	Trans.	IX.	207	1891
Murray, Dr. J.	The Maltese Islands, with special reference to their Geological Structure	R. Scot. Geog. Soc.	Magazine	VI.	449	1890
Pearce, H.	Personal Observations of Glacial Action among British Mountains	Birm. N. H. M. Soc.	Mid. Naturalist	XIV.	77	1891
Platnauer, H. M.	List of Figured Specimens in the Museum of the Yorkshire Philosophical Society	Yorks. Phil. Soc.	Report.	For 1890	56	"
Platt, S. S.	Notes on the Paving Stones used at Rochdale.	Rochdale Lit. Sci. Soc.	Trans.	II.	4	1890
Postlethwaite, J.	The Deposits of Metallic and other Minerals surrounding the Skiddaw Granite	Cumb. West. Assoc.	"	XV.	75	1891
Reade, T. M.	Geological Notes on the Excursion to Anglesea	Liv'pool Geol. Soc.	Proc.	VI.	166	1890
"	Note on a Boulder met with in driving a Sewer Heading in Addison Street, Liverpool	"	"	"	188	"
"	Notes on some Mammalian Bones found in the Blue Clay below the Peat Forest Bed at Alt- month	"	"	"	213	"
Richardson, R.	The Geology of a part of the Puy de Dôme District of France	Edinb. Geol. Soc.	Trans.	VI.	89	"
"	Obituary Notice of D. Milne-Home, Esq.	"	"	"	119	"
Ricketts, Dr. C.	Remarks on the Contorted Schists of Anglesea	Liv'pool Geol. Soc.	Proc.	VI.	190	"
Rippon, J.	Notes on Sulphur Springs, North End of Formosa	Manch. Geog. Soc.	Journal	6	41	"

Section C.—GEOLOGY (continued).

Name of Author	Title of Paper	Abbreviated Title of Society	Title of Publication	Volume or Part	Page	Published
Roeder, C.	On some newly discovered Species in the Upper Permian Deposits of Manchester	Manch. Geol. Soc.	<i>Trans.</i>	XX.	535	1890
"	Notes on the Upper Permians at Fallowfield, Manchester	"	"	"	615	"
"	Description of Fossils found in the Upper Permians at Fallowfield	"	"	XXI.	13	"
"	Notes on the Permians and Superficial Beds at Fallowfield	"	"	"	104	1891
"	Notes on the Upper Coal Measures at Slade Lane, near Manchester	"	"	"	114	"
"	Further Notes on the Upper Coal Measures at Slade Lane, Manchester	"	"	"	199	"
Seeley, Prof.	Some Scientific Results of a Mission to South Africa	S. African Phil. Soc.	"	VI.	1	1890
Seward, A. C.	Fossil Climates	Yorks. Nat. Union	<i>The Naturalist</i>	For 1891	149	1891
Seward, E.	Notes on a Slab of Fossiliferous Marble found at Marston Magna, Somerset	Cardiff Nat. Soc.	<i>Report and Trans.</i>	XXII.	8	"
Sherwood, W.	The Glaciation of Greenland	Birm. Phil. Soc.	<i>Proc.</i>	VII.	68	1890
Shore, T. W.	The Clays of Hants and their Economic Uses	Hants. F. C.	"	IV.	23	"
Smith, J.	The Great Ice Age in the Garnock Valley	Glasgow Geol. Soc.	<i>Trans.</i>	IX.	151	1891
"	Note on the Occurrence of Footprints in the Calciferous Sandstone between West Kilbride and Fairlie, Ayrshire	"	"	"	201	"
"	English Upper Silurian Ostracoda	Glasgow N. H. Soc.	<i>Proc. and Trans.</i>	III.	134	1890
Solly, Rev. H. S.	The Geology of Bridport	Dorset N. H. A. F. C.	<i>Proc.</i>	XI.	109	"
"	Note on a Fault in the Cliff West of Bridport Harbour	"	"	"	118	"
Stirrup, M.	On a Cheshire Boulder	Manch. Geol. Soc.	<i>Trans.</i>	XXI.	83	1891
"	Notes on the Carboniferous Insects found at the Commeny Mines (Allier), France	"	"	"	93	"
"	Note on a Boulder from the Coal of Aldwarke Main Colliery, near Rotherham, Yorkshire	"	"	"	170	"
"	On a Granite Pebble from the Sand Rock Mine, Bacup, Lancashire	"	"	"	172	"
Stock, H.	The 'Sitting-up' of the River Roden	Essex F. C.	<i>Essex Naturalist</i>	IV.	94	1890
Tate, T.	On the so-called Inclusion Granite	Yorks. Geol. Poly. Soc.	<i>Proc.</i>	XI.	480	1891

Author	Title	Society	Journal	Year	Page
Thompson, B.	The Blethley Boring	N'ton. N. H. Soc.	"	"	96
"	The Jurensis Zone in Northamptonshire	"	"	"	126
"	Fossil Fishes of the Lower Oolites	"	"	"	482
Tiddeman, R. H.	Physical History of the Carboniferous Rocks in Upper Airedale	Yorks. Geol. Poly. Soc.	Proc.	XI.	1891
Ussher, W. A. E.	The Devonian Rocks as described by De la Beche, interpreted in accordance with recent researches	Cornw. R. Geol. Soc.	Report and Trans.	XI.	273
"	The Triassic Rocks of West Somerset and the Devonian Rocks on their Borders	Som'setsh. A. N. H. Soc.	Proc.	XXXV.	1890
Vine, G. R.	Notes on the Polyzoa of the Red Chalk of Yorkshire and Norfolk	Yorks. Geol. Poly. Soc.	"	XI.	1891
Watt, J.	Theories of the Ice Age	Dum. Gal. N. H. A. Soc.	Trans.	—	85
Watts, W.	Delegate's Report, British Association Meeting at Leeds	Manch. Geol. Soc.	"	XXI.	63
Whitaker, W.	Some Hertfordshire Well-sections.—Second Paper	Herts. N. H. Soc.	"	VI.	53-64
White, J.	Notes on Gairloch, Ross-shire	Glasgow Geol. Soc.	"	IX.	1891
Williamson, Prof. W. C.	Our present Knowledge of the Vegetation of the Carboniferous Age and the further Advancement of the Study of the Subject	Manch. Geol. Soc.	"	XXI.	156
Wilson, J.	Birkhill Fossils at Inverleithen	Edinb. Geol. Soc.	"	VI.	1890
Wire, A. P.	Memoir of John Brown, F.G.S., of Stanway	Essex F. C.	Essex Naturalist.	IV.	158
Woodward, H. A.	Notes on the Finding of Natural Grease in the Carmel Mine at the Newtown Collieries	Manch. Geol. Soc.	Trans.	XXI.	175
Worth, R. N.	Additional Notes on the Cornish Trias	Cornw. R. Geol. Soc.	Report and Trans.	XI.	338
Young, J.	On the Internal Structure of the Carboniferous Corals forming the Genus <i>Chetetes</i> of Fischer	Glasgow Geol. Soc.	Trans.	IX.	57
"	On a Peculiar Structure—Spines within Spines—in Carboniferous Species of the Productidæ	"	"	"	86
Young, Prof. J.	On Mammalian Remains from Cresswell Crag Bone Caves	"	"	"	210
Young, R.	Some Notes on the Upper Boulder Clay near Belfast	Belfast N. H. Phil. Soc.	Report and Proc.	For 1890	57
Archer, H. T.	Obituary: John Hancock	Yorks. Nat. Union.	The Naturalist	For 1890	357
Armistead, J. J.	Fish Culture	Dum. Gal. N. H. A. Soc.	Trans.	6	141
"	The Balance of Nature in regard to Fisheries	"	"	"	216

Section D.—BIOLOGY.

Section D.—BIOLOGY (continued).

Name of Author	Title of Paper	Abbreviated Title of Society	Title of Publication	Volume or Part	Page	Published
Backhouse, J. jun.	Eastern Turtle Dove in Yorkshire	Yorks. Nat. Union.	<i>The Naturalist</i>	For 1890	258	1890
"	Yorkshire Notes on the Tree Sparrow	"	"	"	355	"
"	In Memoriam: Nicholas Wearmouth	"	"	For 1891	148	1891
Baker, J. G.	North Yorkshire: Second Edition	"	<i>Trans.</i>	15	273	1890
Banks, E. R.	Purbeck Wild Flowers in December.	Dorset N. H. A. F. C.	<i>Proc.</i>	XI.	82	"
Barclay, W.	The Flora of the Right Bank of the Tay between Perth and the Mouth of the Earn	Perths. Soc. N. Sci.	<i>Trans.</i>	I.	123	"
Barnes, R.	Some Additional Localities and New Records for the Mosses of North Yorkshire and South Durham	Yorks. Nat. Union.	<i>The Naturalist</i>	For 1890	211	"
"	<i>Lajourea rosettiana</i> in North-west Yorkshire	"	"	"	236	"
Beaumont, C. R.	A Ramble round Daisy Nook	Rochdale Lit. Sci. Soc.	<i>Trans.</i>	II.	60	"
Blagg, E. W. H.	Varieties of Eggs of Birds which nest in North Staffordshire	N. Staff. N. F. C. A. Soc.	<i>Report and Trans.</i>	For 1891	59	1891
Booth, H. B.	Bird Notes from the Malham District	Yorks. Nat. Union.	<i>The Naturalist</i>	For 1890	259	1890
Botanical Section.	Phenological Observations, 1889	Burt. N. H. Arch. Soc.	<i>Report</i>	14th	13	"
Boulger, Prof. G. S.	John Ray, the Naturalist	Essex F. C.	<i>Essex Naturalist</i>	IV.	119	"
Bouskell, F., and C. B. Headly	Ezekiel George Varenne, of Kelvedon	"	<i>Trans.</i>	V.	42	1891
Bower, Prof. F. O.	A List of the Macro-Lepidoptera of Leicestershire	" Lit. Phil. Soc.	"	II.	311	"
Bridge, T. W.	Club Mosses Past and Present	Glasgow Phil. Soc.	<i>Proc.</i>	XXI.	158	1890
"	The Structure and Function of the Air-bladder in certain Fishes	Birm. Phil. Soc.	"	VII.	144	"
Broom, R.	On the Structure of the Root-sheath in Hedgehog-Spines	Glasgow N. H. Soc.	<i>Proc. and Trans.</i>	III.	127	"
Brown, R.	Report of Delegate to the British Association	E. Scot. Union	<i>Proc.</i>	For 1890	65	1891
Browne, M.	Revision of a Genus of Fossil Fishes, <i>Dapedius</i>	Leicester Lit. Phil. Soc.	<i>Trans.</i>	II.	196	1890
Brunetti, E.	Collecting Diptera, with Notes on the Diptera of Epping Forest	Essex F. C.	<i>Essex Naturalist</i>	IV.	85	"
Bucknall, C.	The Fungi of the Bristol District: Part XII.	Bristol Nat. Soc.	<i>Proc.</i>	VI.	189	"
Cambridge, Rev. O. P.	Notes on some Habits of the Squirrel	Dorset N. H. A. F. C.	"	XI.	27	"
"	The British Species of <i>Phalangidæ</i> or Harvest Men	"	"	"	163	"
"	A White Street at Huddesdon	Herts N. H. Soc.	<i>Trans.</i>	VI.	76	"

Author	Title	Society	Journal	Page	Year
Christy, M.	The Birds of Essex, a Contribution to the Natural History of the County	Essex F. C.			"
Clarendon, Earl of	Anniversary Address: The Horse	Herts N. H. Soc.	<i>Trans.</i>	103	1891
Clarke, H. S.	The Larvæ of the Eyed Hawk Moth.	I. of Man N. H. A. Soc.	<i>Yn Lloer Man-ninagh</i>	92	1890
Collage, W. E.	Report of the Entomological Section	"	<i>The Naturalist</i>	142	1891
Corbett, H. H.	The Burrowing Habits of certain Land and Freshwater Mollusca	Yorks. Nat. Union	"	75	"
Cordeaux, J.	Additions to the Yorkshire List of Lepidoptera for the Doncaster District	"	"	1	"
Corrie, J.	Ornithological Notes from the Humber District	"	"	199, 21	'90-91
Courtenay, Rev. Dr.	The Ornithology of Glencairn	Dum. Gal. N. H. A. Soc.	<i>Trans.</i>	68, 215	1890
Crawshaw, Rev. C.	Notes on the Domestic Cat and its Ancient Home	Penz. N. H. A. Soc.	<i>Report and Trans.</i>	257	1891
Crosfield, J. B.	The Money Cowry on the Coast of Cumberland	Yorks. Nat. Union	<i>The Naturalist</i>	324	1890
Crosfield, Gough, and Salmon, Messrs.	Report of Excursions, 1888	Holmesdale N. H. C.	<i>Proc.</i>	12	"
Crouch, W.	Plants in Flower during December	"	"	33	"
Dale, C. W.	Fungi new to West Yorkshire	Yorks. Nat. Union	<i>The Naturalist</i>	356	"
Daltry, Rev. T. W.	More Fungi new to West Yorkshire	"	"	20	1891
Davidson, Dr. A.	On the Mollusca of the Becontree Hundred, Essex	Essex F. C.	<i>Essex Naturalist</i>	202	1890
Davis, H.	Diptera of West Cornwall	Penz. N. H. A. Soc.	<i>Report and Trans.</i>	262	1891
Davis, W.	Orthoptera of West Cornwall	"	"	267	"
Davy, J. B.	Entomological Report	N. Staff. N. F. C. A. Soc.	<i>Rep. and Trans.</i>	14	"
Dixon, H. N.	The Birds of Upper Nithsdale	Dum. Gal. N. H. A. Soc.	<i>Trans.</i>	76	1890
Dodd, Miss	A Chat about Lichens	Belfast Nat. F. C.	<i>Rep. and Proc.</i>	297	1891
Donnan, W. D.	Aquarium Tank and Pond	Cardiff Nat. Soc.	<i>Rep. and Trans.</i>	55	"
Dowker, G.	Notes on the Rev. W. Fowler's List of Lincolnshire Limestone Plants	Yorks. Nat. Union	<i>The Naturalist</i>	39	"
Druce, G. C.	Additions to the Flora of the Alford District of North Lincolnshire during 1890	"	"	65	"
	Northampton Mosses	N'ton. N. H. Soc.	<i>Journal</i>	54	1890
	Wild Flowers of Mona	I. of Man N. H. A. Soc.	<i>Yn Lloer Man-ninagh</i>	97	"
	The Primrose and its Allies	Belfast Nat. F. C.	<i>Rep. and Proc.</i>	287	1891
	Notes on the Great Pipe Fish	E. Kent N. H. Soc.	<i>S. Eastern Nat'list</i>	19	1890
	A Tour through Spain, with special reference to the Flora	Birm. N. H. M. Soc.	<i>Mid. Naturalist</i>	157	"

Section D.—BIOLOGY (continued).

Name of Author	Title of Paper	Abbreviated Title of Society	Title of Publication	Volume or Part	Page	Published
Druce, G. C.	The Flora of Northamptonshire	N'ton. N. H. Soc.	<i>Journal</i>	VI.	7, 56, 65, 100	1890
Elliot, G. F. Scott	Parasitic Fungi	Dum. Gal. N. H. A. Soc.	<i>Trans.</i>	6	14	"
"	The Flora of Madagascar	"	"	"	236	"
"	Report on the Dumfriesshire Herbarium	"	"	"	275	"
Ewing, P.	Second Contribution to the Topographical Botany of the West of Scotland	Glasgow N. H. Soc.	<i>Proc. and Trans.</i>	III.	159	"
"	Third Contribution to the Topographical Botany of the West of Scotland	"	"	"	161	"
"	On <i>Juncus tenuis</i> , Willdenow, as a Scottish Plant	"	"	"	166	"
Fawcett, J. W.	The Tree Sparrow in the County of Durham	Yorks. Nat. Union	<i>The Naturalist</i>	For 1890	277, 353	"
Fielding, Rev. C. H.	General Wild Flowers	Rochester N. C.	<i>Roch. Naturalist</i>	I.	482	"
"	Kentish Birds	"	"	II.	17	1891
"	Botanical Notes	Dum. Gal. N. H. A. Soc.	<i>Trans.</i>	6	35	1890
Fitch, E. A.	Rats and Mice in Essex	Essex F. C.	<i>Essex Naturalist</i>	IV.	121	"
"	<i>Acidalia marginepunctata</i> in Essex	"	"	"	190	"
"	Benjamin Allen, of Braintree	"	"	"	192	"
"	The Lepidoptera of Essex: Part I. Butterflies	"	"	V.	74	1891
Fortune, R.	Notes on the Starling	Yorks. Nat. Union	<i>The Naturalist</i>	For 1890	167	1890
Fowler, Rev. W.	Lincolnshire Limestone Plants	"	"	"	169	"
Francis, H. A.	Some British Wild Bees	Bristol Nat. Soc.	<i>Proc.</i>	VI.	213	"
French, J.	On the Occurrence of <i>Cyclostoma elegans</i> in a living state at Felstead	Essex F. C.	<i>Essex Naturalist</i>	IV.	92	"
"	Notes on the prolonged Frost, 1890-91	"	"	V.	66	1891
"	On the Range of the Primrose (<i>Primula vulgaris</i>) and the Bardfield Oxlip (<i>P. elatior</i>) in North-Western Essex	"	"	"	120	"
Friend, Rev. H.	Earthworms of the North of England	Yorks. Nat. Union	<i>The Naturalist</i>	For 1891	13	"
"	Some Annulosa from Cumberland and Yorkshire	"	"	"	62	"
Gasking, Rev. S.	The Arachnida of the Isle of Man	I. of Man N. H. A. Soc.	<i>Yn Lloer Manninagh Trans.</i>	I.	93	1890
Gibbs, A. E.	Seeds and Fruits; their Structure and Migrations	Herts N. H. Soc.	"	VI.	16	"
Goodchild, J. G.	Some of the Birds observed in Upper Swaledale	Yorks. Nat. Union	<i>The Naturalist</i>	For 1890	248	"

Gough, B. B.	Report of Excursions, 1889	Holmesdale N. H. C.	<i>Proc.</i>	1	50
Gray, P.	Succession of Plant Life	Dum. Gal. N. H. A. Soc.	<i>Trans.</i>	6	218
Griffith, A. F.	<i>Orrisia fagivora</i> in Hertfordshire	Herts N. H. Soc.	"	6	75
"	Notes on <i>Tineina</i> and other Lepidoptera observed in the Neighbourhood of Sandridge, Herts	"	"	"	1891
Grimshaw, P. H.	Notes on the Flora of West Cumberland	Yorks. Nat. Union.	<i>The Naturalist</i>	For 1890	325
Hastings, W.	Natural History Notes	Dum. Gal. N. H. A. Soc.	<i>Trans.</i>	6	7, 127
Hay, Col. H. M. D.	Remarks on the Black Throated Thrush and its occurrence in Scotland	Perth. Soc. N. Sci.	"	I.	135
Haydon, W. T.	Leaf Fungi in 1889, in the Neighbourhood of Dover	E. Kent N. H. Soc.	<i>S. Eastern Naturalist</i>	I.	22
Heathcote, E. D.	Hampshire Mosses	Hants F. C.	<i>Proc.</i>	IV.	78
Hobkirk, C. P.	Disappearance of Native Plants in Yorkshire	Yorks. Nat. Union.	<i>The Naturalist</i>	For 1891	1891
and P. F. Lee					
Hodgson, W.	Disappearance of Native Plants in Cumberland	"	"	"	7
Hood, J.	List of Rotifera found within a Radius of Twenty Miles round Dundee	E. Scot. Union	<i>Proc.</i>	For 1890	44
"	The Haunts and Habits of Rotifers	"	"	"	59
Hopkinson, J.	Hertfordshire Plant Records, 1886-89	Herts N. H. Soc.	<i>Trans.</i>	VI.	1890
"	Report on Phenological Phenomena observed in Hertfordshire during the years 1889-90	"	"	"	1891
Hottinger, Miss	On the Teaching of Botany	Leicester Lit. Phil. Soc.	"	II.	183
Hunt, Dr. T.	A Note on the Evolution of Cruciferous Flowers	Rochdale Lit. Sci. Soc.	"	ii.	1
Ingold, E. G.	Mollusca of the Neighbourhood of Bishop's Stortford	Essex F. C.	<i>Essex Naturalist</i>	IV.	215
Isabell, Rev. J.	The Great Water Beetle	Penz. N. H. A. Soc.	<i>Report and Trans.</i>	III.	1891
"	Additions to Coleoptera of Land's End District	"	"	"	247
Kelsall, J. E.	Hampshire Birds	Hants F. C.	<i>Proc.</i>	IV.	1890
Kermode, P. M. C.	Introduction to the Study of Lichens in the Isle of Man	I. of Man N. H. A. Soc.	<i>In Liooar Manninagh</i>	I.	85
Kew, H. W.	The Faculty of Homing in Gastropods	Yorks. Nat. Union.	<i>The Naturalist</i>	For 1890	307
Lefevre, M. E.	Description of new Species of South African Eumolpidæ	S. African Phil. Soc.	<i>Trans.</i>	VI.	39
Leonard, H. P.	Observations on a Pair of Blackbirds	Bristol Nat. Soc.	<i>Proc.</i>	VI.	202
Lett, Rev. H. W.	Notes on some Rare Hepatics and Mosses found in Ulster	Belfast Nat. F. C.	<i>Report and Proc.</i>	III.	1891
Lilford, Lord	Notes on the Birds of Northamptonshire and Neighbourhood	N'ton. N. H. Soc.	<i>Journal</i>	VI.	1, 41,
"	Notes on Birds in the Lilford Aviaries	"	"	"	69, 116
"		"	"	"	80

Section D.—BROLOGY (continued).

Name of Author	Title of Paper	Abbreviated Title of Society	Title of Publication	Volume or Part	Page	Published
McAldowie, Dr. A. M.	Annual Address: Observations on the Geography of North Staffordshire	N. Staff. N. F. C. A. Soc.	<i>Report and Trans.</i>	For 1891	67	1891
McAndrew, J.	The Flora of Wigtownshire	Dum. Gal. N. H. A. Soc.	<i>Trans.</i>	6	17, 193	1890
"	Botanical Notes	"	"	"	88	"
"	Lists of Mosses and Hepaticæ	"	"	"	89	"
"	Additional Notes on the Flora of Wigtownshire, with Notes on Moffat and Kirkcudbrightshire Plants	Glasgow N. H. Soc.	<i>Proc. and Trans.</i>	III.	131	"
Macdonald, Dr. T. F.	Hydrostatic Arrangements in the Horse's Foot	Glasgow Phil. Soc.	<i>Proc.</i>	XXI.	138	"
McGregor, T. M.	Additional Aculeate Hymenoptera for 1889	Perths. Soc. N. Sci.	<i>Trans.</i>	I.	152	"
McLellan, D.	Horticulture, Village Gardening, &c.	Glasgow Phil. Soc.	<i>Proc.</i>	XXI.	128	"
Macpherson, A. H.	Nests and Eggs of Birds	Marlb. Coll. N. H. Soc.	<i>Report.</i>	XXXIX.	31	1891
Macpherson, Rev. H. A.	The Lapland Bunting, an Addition to the Avifauna of Essex	Essex F. C.	<i>Essex Naturalist.</i>	IV.	118	1890
"	An Essex Curlew Sandpiper	"	"	"	140	"
"	Notes on Birds from Lancashire	Yorks. Nat. Union	<i>The Naturalist.</i>	For 1890	234	"
"	Eagles in the North of England	"	"	"	323	"
"	White Grouse and White Partridges in Yorkshire	"	"	"	115	1891
Marlock, Dr. R.	Some Adaptations of South African Plants to the Climate	S. African Phil. Soc.	<i>Trans.</i>	VI.	31	1890
Marquand, E. D.	The Cryptogamic Flora of Kelvedon and its Neighbourhood; compiled from the Herbarium and Notes made by the late E. G. Varenne	Essex F. C.	<i>Essex Naturalist.</i>	V.	1	1891
"	In Memoriam: John Ralfe	Penz. N. H. A. Soc.	<i>Report and Trans.</i>	III.	225	"
A. M.	Animal Pedigrees	Birm. N. H. M. Soc.	<i>Mid. Naturalist.</i>	XIV.	97	"
Martindale, C. E.	<i>Hieracium orarium</i> in Durham and West Yorkshire	Yorks. Nat. Union.	<i>The Naturalist.</i>	For 1891	134	"
Martindale, J. A.	The Study of Lichens, with special reference to those of the Lake District	Cumb. West. Assoc.	<i>Trans.</i>	XV.	1	"
"	The Lichens of Westmorland	Yorks. Nat. Union.	<i>The Naturalist.</i>	For 1890	161	1890
"	Zoological Report	N. Staff. N. F. C. A. Soc.	<i>Report and Trans.</i>	For 1891	22	1891

Author	Work	Society	Year	Page	Volume
Mawley, E.	A simple Method of taking Phenological Observations	BETS N. H. SOC.	1890	147	I.
Meldrum, R. H.	Some new Localities for rare Mosses	Perths. Soc. N. Sci.	1891	95	XXXIX.
Meyrick, E.	Types of Structure in the Lepidoptera	Marlb. Coll. N. H. Soc.	"	138	"
"	Notes on Lepidoptera	"	1890	56	6
Miller, F.	The Oak and other Trees	Dum. Gal. N. H. A. Soc.	1891	302	II.
Mott, F. T.	Weeds	Leicester Lit. Phil. Soc.	"	116	For 1891
Nelson, T. H.	In Memoriam: Robert Calvert	Yorks. Nat. Union.	"	119	"
"	Ornithological Notes from Redcar for 1890-91.	"	"	38	XXII.
Paterson, Dr. D. R.	Recent Researches into the Action of Micro-organisms	Cardiff Nat. Soc.	"	298	III.
Patterson, R.	The Birds of the Bog Meadows	Belfast Nat. F. C.	1890	42	For 1890
Patterson, B., and R. Ll. Praeger	The Vertebrate Fauna of Ulster	Belfast N. H. Phil. Soc.	"	135	IV.
Paulson, R.	Notes on the Carices of the Epping Forest Area	Essex F. C.	"	57	For 1890
Pearce, H.	Notes on a Collection of Butterflies	Belfast N. H. Phil. Soc.	"	xvii.	VI.
Péringuey, L.	Parasitic Bees and Wasps, and their own Parasites	S. African Phil. Soc.	1891	290	III.
Phillips, W. H.	Strange Pets I have had	Belfast Nat. F. C.	"	256	II.
Pope, F. M.	Micro-organisms in their Relations to the Higher Animals	Leicester Lit. Phil. Soc.	"	15	For 1891
Porrirt, G. T.	A Comparison of the Lepidopterous Fauna of Yorkshire and Lancashire and Cheshire	Yorks. Nat. Union.	"	288	III.
Praeger, R. Ll.	Some new or rare North of Ireland Plants	Belfast Nat. F. C.	1890	188	II.
Preston, Rev. T. A.	On Vernation and Æstivation	Leicester Lit. Phil. Soc.	1891	251	"
"	A few Notes on the Kew Herbarium	"	"	307	"
"	Notes on the Genus <i>Gentiana</i> , Linn.	"	"	126	I.
Quine, Rev. J.	The Study of Natural History in the Isle of Man	I. of Man N. H. A. Soc.	1890	118	For 1891
Redman, C.	<i>Miscodera arctica</i> and <i>Pterostichus æthiops</i> in Lancashire	Yorks. Nat. Union.	"	7	I.
Reid, J.	The Life History of the Giant Hogweed	E. Kent N. H. Soc.	"	46	XI.
Richardson, N. M.	Chief Peculiarities of the Lepidopterous Fauna of Portland	Dorset N. H. A. F. C.	"	64	"
"	A Case of apparent Substitution of a Wing for a Leg in a Moth (<i>Zygena filipendula</i>)	"	"	74	"
"	Description of Two Species of Lepidoptera (<i>Gelochia portlandicella</i> and <i>Nepticula auro-marginella</i>) from Dorset, new to Science	"	"	177	For 1890
Roebuck, W. D.	Bibliography: Birds, 1888	Yorks. Nat. Union.	"		

Section D.—BIOLOGY (continued).

Name of Author	Title of Paper	Abbreviated Title of Society	Title of Publication	Volume or Part	Page	Published
Roebuck, W. D.	Conchological Field Notes from Upper Swaledale, N.-W. Yorkshire	Yorks. Nat. Union.	<i>The Naturalist</i>	For 1891	229	1890
"	The Conchology of Malham	"	"	"	263	"
"	The Yorkshire Naturalists' Union at Kildale-in-Cleveland	"	"	"	269	"
"	Bibliography: Lepidoptera, 1888	"	"	"	279	"
"	"	"	"	For 1891	157	1891
"	Bibliography: Phanerogamic Botany, 1886	"	"	For 1890	359	1890
"	"	"	"	For 1891	125	1891
"	"	"	"	"	27	"
"	Bibliography: Fishes, 1886, 1887, and 1888	"	"	VI.	89	1890
Rooper, G.	Notes on Birds observed in Hertfordshire during the year 1889	Herts. N. H. Soc.	<i>Trans.</i>	"	"	"
"	Notes on Birds observed in Hertfordshire during the year 1890 and the early part of 1891	"	"	"	123	1891
Rutherford, J.	The Anatomy of <i>Arion hortensis</i>	Dum. Gal. N. H. A. Soc.	"	6	182	1890
Schönland, Dr. S.	Notes on <i>Cyphia volubilis</i> , Willd.	S. African Phil. Soc.	"	VI.	44	"
Schunck, J. E.	The Planting of Trees in Towns	Rochdale Lit. Sci. Soc.	"	II.	37	"
Scott, T.	Notes on some Fresh-water, Brackish-water, and Marine Entomostraca new to the Fauna of Orkney	Glasgow N. H. Soc.	<i>Proc. and Trans.</i>	III.	91	"
"	On the Land and Fresh-water Mollusca of Bute	"	"	"	170	"
Shackleton, A.	Disappearance of Yorkshire Plants	Yorks. Nat. Union.	<i>The Naturalist</i>	For 1891	79	1891
Shenstone, J. C.	Suggestions for the Formation of a County Herbarium	Essex F. C.	<i>Essex Naturalist</i>	IV.	71	1890
Shuffley, Rev. W. A.	The Flowering Plants and Ferns of Littondale	Yorks. Nat. Union.	<i>The Naturalist</i>	For 1891	51	1891
Slater, Rev. H. H.	Are Starlings Double-brooded?	"	"	"	143	"
Smith, E. A.	Note on <i>Hydrobia jenkinsi</i>	Essex F. C.	<i>Essex Naturalist</i>	IV.	212	1890
Snodgrass, Dr. W.	Note on Nerve Cells	Glasgow Phil. Soc.	<i>Proc.</i>	XXI.	30	"
Stone, J. B.	Plant Marches	Birm. N. H. M. Soc.	<i>Mid. Naturalist</i>	XIII.	249	"
Storrie, J.	Notes on Fish Parasites	Cardiff Nat. Soc.	<i>Report and Trans.</i>	XXII.	54	1891
"	Notes on the Blood-rain	"	"	"	"	"
Stuart, M. G.	Report on Returns of Rainfall and Observations of Flowering of Plants and Appearances of Birds and Insects during 1889	Dorset N. H. A. F. C.	<i>Proc.</i>	XI.	217	1890
Tannahill, T. F.	The Battle of the Microbes	Rochester N. C.	<i>Roch. Naturalist</i>	II.	1	1891

Thompson, J. T.	the Crustacea	Cardiff Nat. Soc.	Report and Trans.	47	1891
Thornewill, Rev. C.	The <i>Trichinaspiralis</i> and its relation to Trichinosis	Burt. N. H. Arch. Soc.	Report.	21	1890
F. Trail, Prof. J. W.	Report for 1890 on the Fungi of the East of Scotland	E. Scot. Union	Proc.	39	1891
H. Underhill, H. M. J.	Painting Lantern Slides direct from the Microscope	Birm. N. H. M. Soc.	<i>Mid. Naturalist</i>	224	1890
Waite, E. R.	The Yorkshire Naturalists' Union at Lowthorpe and Driffeld	Yorks. Nat. Union	<i>The Naturalist</i>	203	"
"	The Yorkshire Naturalists' Union at Bretton Park	"	"	223	"
"	Vertebrates of the Western Ainsty	"	"	81	1891
Waterfall, C.	Discovery of <i>Carex montana</i> , &c., in Derbyshire	"	"	50	"
Watt, L.	Notes on the rarer Plants of the Parish of Old Kilpatrick	Glasgow N. H. Soc.	<i>Proc. and Trans.</i>	182	1890
Webb, S.	On the Otoliths of Fishes	E. Kent N. H. Soc.	<i>S. Eastern Nat'list</i>	26	"
White, Dr. F. B.	The Willows of the District of the North-East of Scotland	E. Scot. Union	<i>Proc.</i>	31	1891
"	Catalogue of Perthshire Willows in the Museum	Perths. Soc. Nat. Sci.	<i>Trans.</i>	155	1890
"	Herbarium	"	<i>Proc.</i>	lv.	"
"	Opening Address	"	"	lxviii.	"
"	Annual Address	"	"	173	"
Whiteside, R.	How to Improve the Breed of Trout in the Isle of Man	Isle of Man N. H. A. Soc.	<i>In Lioar Manninagh</i>		
Whitlock, F. B.	Notes on the Tree Sparrow	Yorks. Nat. Union	<i>The Naturalist</i>	319	"
"	Pine Grosbeak in Notts	"	"	38	1891
"	Ornithological Notes from Notts, Autumn and Winter, 1890-91	"	"	46	"
Whitwell, W.	An additional Station for <i>Arenaria gothica</i> in West Yorkshire	"	"	257	1890
"	Flowering Plants and Ferns of Upper Swaledale	N. Staff. N. F. C. A. Soc.	<i>Report and Trans.</i>	305	"
Wilkins, T. S.	Microscopical Report	Glasgow N. H. Soc.	<i>Proc. and Trans.</i>	21	1891
Wilson, Rev. A. S.	The Dispersion of Seeds and Spores: Part II.	Dum. Gal. N. H. A. Soc.	<i>Trans.</i>	101	1890
Wilson, J.	Sea-weeds	Yorks. Nat. Union	<i>The Naturalist</i>	252	"
Woodd, C. H. B.	Vertebrate Fauna of Langstrothdale	"	"	135	1891
"	The Fungi of Langstrothdale	"	"	140	"
Wright, J.	On Foraminifera which Construct their Tests of Sponge-Spicules	Belfast Nat. F. C.	<i>Report and Proc.</i>	286	"
Yates, J.	Botanical Report	N. Staff. N. F. C. A. Soc.	<i>Rep. and Trans.</i>	11	"

Section E.—GEOGRAPHY.

Name of Author	Title of Paper	Abbreviated Title of Society	Title of Publication	Volume or Part	Page	Published
Annenkoff, Lieut.-Gen.	The Physical Conditions of Central Asia in relation to Russian Colonisation	R. Scot. Geog. Soc.	<i>Magazine</i>	VII.	75	1891
Bartholomew, J. G.	The Mapping of the World: Part I. Europe.	"	"	VI.	293	1890
"	"	"	"	VII.	575	"
"	"	"	"	"	124	1891
Black, W. G.	"	"	"	6	206	"
Blackie, T. M.	Rhins of Galloway: a Colonial Comparison	Manch. Geog. Soc.	<i>Journal</i>	IV.	114	1890
Blyth, J.	Concerning certain Essex Rivers	Essex F. C.	<i>Essex Naturalist</i>	XXI.	37	"
Browne, E. E.	Fiji: Past and Present	Glasgow Phil. Soc.	<i>Proc.</i>	Vol. I. No. 4	21	1891
Campbell, W. Y.	Persia and the Persians	Tyneside Geog. Soc.	<i>Journal</i>	6	85	1890
	The Transvaal: its History, Geography, Mineral Wealth, and Progress	Manch. Geog. Soc.	"	"	"	"
Colenso, Miss H. E.	Zululand: Past and Present	"	"	"	157	1891
Cook, A.	Notes on the recent Development, Explorations, and Commercial Geography of British North Borneo	"	"	"	63	1890
Colomb, Sir J.	Britannic Confederation: I. A Survey of existing Conditions	R. Scot. Geog. Soc.	<i>Magazine</i>	VII.	233	1891
Crook, H. T.	On the present State of the Ordnance Survey, and the paramount Necessity for a thorough Revision	{ Manch. Geog. Soc. R. Scot. Geog. Soc.	<i>Journal</i> <i>Magazine</i>	6 VI.	228 510	" 1890
Cross, Rev. D. K.	Geographical Notes of the Country between Lakes Nyassa, Rukwa, and Tanganyika	"	"	"	281	"
Dickson, Dr. W. G.	A Voyage Inland from Canton	"	"	"	354, 393	"
Dingelstedt, V.	Russian Laplanders	"	"	"	407	"
Douglas, Prof. R. K.	Our Commercial Relations with China	"	"	VII.	11	1891
Education Committee	Report on the present Condition of Geographical Education in Manchester and District	Manch. Geog. Soc.	<i>Journal</i>	6	325	"
Freshfield, D. W.	The Forests of Abkhasia	"	"	"	17	1890
Fretton, W. G.	The Warwickshire Feldon, a Sketch of its Hills and Valleys, Waters, Famous Trees, and other Physical Features	Warw. N. A. F. C.	<i>Proc.</i>	35	23	1891
Geikie, Prof. J.	On the Scientific Results of Dr. Nansen's Expedition	R. Scot. Geog. Soc.	<i>Magazine</i>	VII.	79	"

Goldsmid, Major-Gen. Sir F.	A Railway through Southern Persia.	"	"	"	VI.	617	1890
Harding, J.	Local Geography (Preston)	Manch. Geog. Soc. ; Som'setsh. A. N. H. Soc.	Journal	6	6	76	"
Howes, Rev. J. G.	Notes on Exford	Manch. Geog. Soc.	Proc.	6	XXV.	37	"
Jacoby, G.	British Trade with Algeria, Tunis, and the Sahara	Manch. Geog. Soc.	Journal	6	6	269	1891
King, F. D.	Description of a Contour Map of Huddersfield and District	"	"	"	"	82	1890
Krogh, F. von.	The Negotiations of Duke Frederick III. of Holstein-Gottorp with Russia and Persia concerning the Scheme for bringing the Persian Trade through Holstein-Gottorp (1633-1640 A.D.)	"	"	"	"	30	"
Lynch, H. F. B.	New Trade Routes into Persia.	"	"	"	"	223	1891
Mackinder, H. J.	On the Necessity of Thorough Teaching in General Geography as a Preliminary to the Teaching of Commercial Geography	"	"	"	"	1	1890
Manchester, Bishop of, Archdeacon Maples, Rev. D. K. Cross, and J. W. Moir	Nyasaland and African Exploration.	"	"	"	"	287	1891
Marshall, W. P.	Notes on a Trip to the Orkney and Shetland Isles, and on some singular Water-worn Rocks in Orkney	Birm. N. H. M. Soc.	Mid. Naturalist	XIV.	XIV.	8	"
Maud, E. A.	Our new Colony, Zambesia	Tyneside Geog. Soc.	Journal	Vol. I., No. 4	Vol. I., No. 4	45	"
Mellor, E. W.	Normandy	Manch. Geog. Soc.	"	6	6	304	"
Mill, Dr. H. R.	On the Teaching of Geography in Russia.	R. Scot. Geog. Soc.	"	"	"	239	"
"	Statistical Oceanography: A Review	Glasgow Phil. Soc.	Magazine	VII.	VII.	260	"
Muir, Dr. T.	The Territorial Expansion of the British Empire during the last Ten years	Tyneside Geog. Soc.	Proc.	XXI.	XXI.	98	1890
Parke, Dr. T. H.	Incidents connected with the Relief of Emin Pasha	Tyneside Geog. Soc.	Journal	Vol. I., No. 3	Vol. I., No. 3	10	"
Peters, Dr. C.	From the Mouth of the Tana to the Source-Region of the Nile	R. Scot. Geog. Soc.	Magazine	VII.	VII.	113	1891
Pitcher, W.	Spanish Honduras	Manch. Geog. Soc.	"	VI.	VI.	633	1890
Pitcairn, W. D.	British New Guinea: its Geography and the Manners and Customs of the Natives	Manch. Geog. Soc.	Journal	6	6	49	"

Section E.—GEOGRAPHY (continued).

Name of Author	Title of Paper	Abbreviated Title of Society	Title of Publication	Volume or Part	Page	Published
Playfair, Lt.-Col.	The Mediterranean, Physical and Historical	Manch. Geog. Soc.	<i>Journal</i>	6	244	1891
Sir R. L. Pumphrey, C., and W. P. Marshall	A Visit to the North Cape and Norway	Birm. N. H. M. Soc.	<i>Mid. Naturalist</i>	XIV.	29	"
Ravenstein, E. G.	Anniversary Address: Rivers, Plains, and Mountains	R. Scot. Geog. Soc.	<i>Magazine</i>	VII.	1	"
Reed, J. H.	The Lakes of Eastern Central Africa	Manch. Geog. Soc.	<i>Journal</i>	6	208	"
Rippon, J.	The Island of San Thomé and the West Coast of Africa	"	"	"	43	1890
Sowerbutts, E.	Report of Delegate to the British Association at Leeds in 1890	"	"	"	261	1891
Sparkes, Rev. A. L.	Notes on the Great Salina	Leicester Lit. Phil. Soc.	<i>Trans.</i>	II.	160	1890
Stanley, H. M.	His recent Journey through Africa	Manch. Geog. Soc.	<i>Journal</i>	6	113	1891
"	The Emin Pasha Relief Expedition	{ R. Scot. Geog. Soc. Tyneside Geog. Soc.	<i>Magazine</i>	VI.	337	1890
Steinthal, Rev. S. A.	Annual Address.	Manch. Geog. Soc.	"	6	102	"
Stewart, Rev. J.	Southern Africa, Past and Present	R. Scot. Geog. Soc.	<i>Magazine</i>	VII.	177	1891
Sturup, M.	Unknown France	Manch. Geog. Soc.	<i>Journal</i>	6	12	1890
Taylor, W. A.	Map Projections	R. Scot. Geog. Soc.	<i>Magazine</i>	VI.	306	"
Thomas, T. H.	A Visit to the Lipari Isles and Etna	Cardiff Nat. Soc.	<i>Report and Trans.</i>	XXII.	11	1891
Thompson, I. W.	Los Angeles and Southern California: Retrospect	Manch. Geog. Soc.	<i>Journal</i>	6	297	"
Thomson, B.	Rossel Island (a Cannibal Island)	"	"	"	7	1890
Thomson, J. P.	Sir William Macgregor's Ascent of Mount Victoria, and Explorations of the Owen Stanley Range, British New Guinea.	"	"	"	184	1891
"	The Island of Kadavu	"	"	"	194	"
Wells, J. W.	The Physical Features of Brazil in their relation to the Commercial and Industrial Development of the Country	R. Scot. Geog. Soc.	<i>Magazine</i>	VI.	505	1890
White, A. Silva	The Partition of Africa	"	"	"	561	"
"	On the Comparative Value of African Lands	"	"	VII.	91	1891
Wilson, Col. Sir C.	Methods and Processes of the Ordnance Survey	"	"	"	248	"
Yate, Capt. A. C.	A Journey to Tashkent	"	"	"	57	"

		Stat. Soc. Ireland	Journal	X.	468	1890
Bailey, W. F.	The Woods, Forests, Turf Bogs, and Foreshores of Ireland: Opportunity for, and Advisability of establishing Government Management and Protection	"	"	"	477	"
"	The Prussian Agrarian Reforms of the present Century, their Method and Extent	Rochester N. C.	<i>Roch. Naturalist</i>	"	473	"
Bird, C.	Rochester Water and Kentish Coal	Manch. Geol. Soc.	<i>Trans.</i>	I.	48	"
Burrows, J. S.	Notes on Coal Mining	Belfast N. H. Phil. Soc.	<i>Report and Proc.</i>	XXI.	47	"
Brown, J.	Thoughts on Education and Schools	Essex F. C.	<i>Essex Naturalist</i>	IV.	259	"
Cole, W.	Technical Education Scheme for Essex	Manch. Geol. Soc.	<i>Trans.</i>	XXI.	206	1891
Crankshaw, J.	On the Water Supply at Horwich	Stat. Soc. Ireland	<i>Journal</i>	X.	483	1890
Finlay, Rev. T.	German Socialism	"	"	"	439	"
Grimshaw, Dr. T. W.	President's Address	Manch. Geol. Soc.	<i>Trans.</i>	XXI.	222	1891
Hall, H.	Statistics as to Falls of Roof and Coal	Birm. Phil. Soc.	<i>Proc.</i>	VII.	132	1890
Hill, E.	Bimetallism: How its Benefits (and other Public Advantages) may be obtained and its Evils avoided	"	"	"	113	1891
Langdon, A. M. L.	The Future Unit of Local Government	Manch. Stat. Soc.	<i>Trans.</i>	For 1890-91	461	1890
Lawson, Dr. W.	Local Registration of Title	Stat. Soc. Ireland	<i>Journal</i>	X.	47	"
Letts, Prof. E. A.	Sanitation	Belfast N. H. Phil. Soc.	<i>Report and Proc.</i>	For 1890	155	"
Mott, F. T.	On the Development of Museums as Public Educators	Leicester Lit. Phil. Soc.	<i>Trans.</i>	II.	29	1891
Moxon, T. B.	Our Bank-note System and its Effects upon Commerce	Manch. Stat. Soc.	"	For 1890-91	119	1890
Munro, Prof. J. E. C.	Sliding Scales in the Coal and Iron Industries, 1885-89	"	"	For 1889-90	1	1891
"	The Local Taxation of Chief Rents	Stat. Soc. Ireland	<i>Journal</i>	X.	448	1890
O'Brien, Murrough	A Description of Registration and Transfer of Land Titles and Securities in the Canton Vaud	"	"	"	61	1891
Rhodes, Dr. J. M.	Pauperism Past and Present	Manch. Stat. Soc.	<i>Trans.</i>	For 1890-91	1	1890
Russell, Dr. J. B.	Sanitation and Social Economics	Glasgow Phil. Soc.	<i>Proc.</i>	XXI.	133	1891
Rylett, Rev. H.	The Taxation of Land Values	Manch. Stat. Soc.	<i>Trans.</i>	For 1890-91	5	"
Temperley, W. A., jun.	Sheep-farming in Australia	Tyneside Geog. Soc.	<i>Journal</i>	Vol. I., No. 4	97	1890
Thresh, Dr. J. C.	The Sanitary Condition of Essex	Essex F. C.	<i>Essex Naturalist</i>	IV.	47	1891
"	Vital Statistics of the County of Essex	"	"	V.	180	"
Tonge, J.	Coal Mining in 1860 and 1890: a few Contrasts	Manch. Geol. Soc.	<i>Trans.</i>	XXI.		

Section F.—ECONOMIC SCIENCE AND STATISTICS (continued).

Name of Author	Title of Paper	Abbreviated Title of Society	Title of Publication	Volume or Part.	Page	Published
Tonge, J. Trail, Prof. J. W. H.	On Accidents in Mines The British Association in its relation to Local Natural History Museums The Salt Industry of Cheshire	Manch. Geol. Soc. E. Scot. Union Liverpool E. Soc.	<i>Trans.</i> <i>Proc.</i> <i>Trans.</i>	XXI. For 1890 XI.	220 21 55	1891 " 1890
<i>Section G.—MECHANICAL SCIENCE.</i>						
Bannister, M. C.	Notes on Mechanical Refrigeration and Ice- making Machinery	Liv'pool E. Soc.	<i>Trans.</i>	XI.	68, 112	1890
Beloe, C. H.	The Purification of Water and Sewage by the Magnetic Spongy Carbon Process (Discussion)	"	"	"	24	"
Brown, M. W. Corlett, G. S.	The Waddle Patent (1890) Fan On a new Form of Bell for Signalling in Col- lieries, on Railways, &c.	N. Eng. Inst. Manch. Geol. Soc.	<i>Trans. Fed. Inst.</i> <i>Trans.</i>	2 XX.	173 567	1891 1890
Cotterell, A. P. I.	On the Reconstruction of Viaducts on the Cornwall Railway	Bristol Nat. Soc.	<i>Proc.</i>	VI.	217	"
Crankshaw, J.	On Irrigation and Water Storage in the West- ern States of America	Manch. Geol. Soc.	<i>Trans.</i>	XX.	519	"
Deacon, M.	Comparative Experiments upon a Capell and a Schiele Fan working under similar con- ditions	Chesterf. Mid. Count. Inst.	"	I.	287	"
Farren, G. Fitzgerald, Prof. M. Frew, A.	The Stability of Earthen and Masonry Dams The Theory of the Screw Propeller The Reclamation of Waste Lands in the Clyde Estuary	Liv'pool E. Soc. Belfast N. H. Phil. Soc. Glasgow Phil. Soc.	" <i>Report and Proc.</i> <i>Proc.</i>	XI. For 1890 XXI.	28, 54 56 173	" " "
Greenhill, J. H. Griffiths, T. Grundy, J.	Work Cymmer Colliery A Note on Bickford's Patent Colliery Fuze and Safety Lighter	Belfast N. H. Phil. Soc. Cornw. Min. Assoc. Inst. Manch. Geol. Soc.	<i>Report and Proc.</i> <i>Trans.</i> "	For 1890 III. XXI.	19 3 143	" " 1891
Harvey, J. W. J.	Investigation of the Board of Trade Formulæ for Strength of Firebox Girder Stays Presidential Address	Bristol Nat. Soc.	<i>Proc.</i>	VI.	232	1890
Jackson, J.	Submerged Bridges between Ireland	Chesterf. Mid. Count. Inst. Belfast N. H. Phil. Soc.	<i>Trans.</i> <i>Report and Proc.</i>	I. For 1890	277 58	" "

Smith, G. E.	"	"	"	43	"
Soar, C.	"	"	"	18	"
Stevenson, A. L.	"	"	"	38	"
	"	"	"	35	"
Taylor, J.	"	Trans. Fed. Inst.	"	191	1891
Thomas, W.	"	Trans.	"	183	1890
Walters, H.	"	"	"	21	"
West, H. H.	"	"	"	31	"
Yeaman, C. H.	"	"	"	1	"
	"	"	"	94, 114	"

Section H.—ANTHROPOLOGY.						
Agar, Rev. W.	The Value of the Poetic Spirit to the Scientific Worker	Leicester Lit. Phil. Soc.	Trans.	II.	294	1891
Bent, J. T.	Notes on the Armenians in Asia Minor	Manch. Geog. Soc.	Journal	6	220	"
Black, G. F.	Dumfriesshire Antiquities in Edinburgh Museum	Dum. Gal. N. H. A. Soc.	Trans.	6	207	1890
Brown, J. W.	Flints from West Craig, Andreas, Isle of Man	I. of Man N. H. A. Soc.	In Lioar Manninagh Proc.	I.	174	1891
Callan, Rev. H.	Some Considerations of Asia Minor and its Ethnology	Glasgow Phil. Soc.	"	XXI.	51	1890
Callander, Dr. J.	Roman Camp at Springfield	Dum. Gal. N. H. A. Soc.	Trans.	6	5	"
Chinnock, Dr. E. J.	Antiquarian Discoveries at Kirkcubright	"	"	VI.	263	"
Clarendon, Earl of	Anniversary Address—Field Sports and their Bearing on the National Character	Herts. N. H. Soc.	"	I.	1	"
Cole, Rev. E. M.	The Duggetty 'Howe'	Yorks. Geol. Poly. Soc.	Proc.	XI.	441	1891
Coles, F. R.	Tumulus at Caulside	Dum. Gal. N. H. A. Soc.	Trans.	6	83	1890
Cornish, J. B.	The Grave at Conchistown	"	"	"	152	"
Dennett, R. E.	The Fjort: the Manners and Customs of the Native Congo People	Penz. N. H. A. Soc.	Report and Trans.	III.	251	1891
Dugan, C. W.	The Gold Antiquities of Ireland	Manch. Geog. Soc.	Journal	6	26	1890
Fiedler, Prof. G.	Glimpes into Teutonic Antiquity	Belfast Nat. F. C.	Report and Proc.	III.	304	1891
		Glasgow Phil. Soc.	Proc.	XXI.	189	1890

Section H.—ANTHROPOLOGY (continued).

Name of Author	Title of Paper	Abbreviated Title of Society	Title of Publication	Volume or Part	Page	Published
Fitzpatrick, J. J.	Recent Discovery of a Bone Cave at Deep Dale, near Buxton	Liv'pool Geol. Soc.	<i>Proc.</i>	VI.	200	1890
Green, E.	Thoughts on Bath as a Roman City	Bath N. H. A. F. C.	"	VII.	114	1891
Haydon, W. T.	A Neolithic 'Find' near Dover	E. Kent N. H. Soc.	<i>N. Eastern Nat'list</i>	I.	33	1890
Hoffman, Dr. W. J.	The Origin of the Shoshoni Indians	I. of Man N. H. A. Soc.	<i>Yn Lloar Manni-nagh</i>	I.	103	"
Kermode, P. M. C.	The Burial Mound known as Cronk Aust, Lezayre, Isle of Man	"	"	"	88	"
"	The Antiquities of the Parish of Bride	"	"	"	182	1891
Lewis, T. H.	Stone Monuments in North-Western Iowa and South-Western Minnesota	Manch. Geog. Soc.	<i>Journal</i>	"	216	"
McAldowie, R.	Notes on a Staffordshire Witch Brooch	N. Staff. N. F. C. A. Soc.	<i>Report and Trans.</i>	For 1891	54	"
Mansel - Pleydell, J. C.	Winterbourne Kingston Roman Well	Dorset N. H. A. F. C.	<i>Proc.</i>	XI.	1	1890
March, Dr. H. C.	How the Need of Art is increased by the Advancement of Science	Rochdale Lit. Sci. Soc.	<i>Trans.</i>	II.	43	"
Meyrick, E.	Anthropometrical Statistics	Marlb. Coll. N. H. Soc.	<i>Report.</i>	XXXIX.	193	1891
Milligan, S. F.	The Ancient Irish Hot-air Bath	Belfast N. H. Phil. Soc.	<i>Report and Proc.</i>	For 1890	25	1890
Moore, A. P.	The Study of Philology	Leicester Lit. Phil. Soc.	<i>Trans.</i>	II.	286	1891
Mortimer, J. R.	Pre-history of the Village of Fimber: Part II. Supposed Roman Camp at Octon	Yorks. Geol. Poly. Soc.	<i>Proc.</i>	XI.	445	"
Mott, F. T.	On Culture	"	"	II.	457	"
Patterson, W. H.	A Notice of some Ancient Grave Slabs found near Dunderald, Co. Down	Leicester Lit. Phil. Soc.	<i>Trans.</i>	II.	223	"
Reader, F. W.	Note on Punctured Pottery found at Fryerning	Belfast Nat. F. C.	<i>Report and Proc.</i>	III.	285	"
Shaw, J.	Folk Lore in Tynron	Essex F. C.	<i>Essex Naturalist</i>	IV.	133	1890
Smart, Dr. W.	Budbury Rings	Dum. Gal. N. H. A. Soc.	<i>Trans.</i>	6	9	"
Spurrell, F. C. J.	Danbury Camp, Essex	Dorset N. H. A. F. C.	<i>Proc.</i>	XI.	16	"
"	Hæsten's Camps at Shoeburyness and Benfleet, Essex	Essex F. C.	<i>Essex Naturalist</i>	IV.	138	"
Vachell, Dr. C. T.	An Ancient Custom observed at Cossey, Norfolk	"	"	"	150	"
Walkey, R. H.	The Neolithic Settlement on the Brooghs, Ramsey	Cardiff Nat. Soc.	<i>Report and Trans.</i>	XXII.	4	1891
Wilson, J. R.	Stone Implements	I. of Man N. H. A. Soc.	<i>Yn Lloar Manni-nagh</i>	I.	212	"
		Dum. Gal. N. H. A. Soc.	<i>Trans.</i>	6	129	1890

Report of a Committee, consisting of Messrs. J. LARMOR and G. H. BRYAN, on the present state of our knowledge of Thermodynamics, specially with regard to the Second Law.

[Ordered by the General Committee to be printed among the Reports.]

PART I.—RESEARCHES RELATING TO THE CONNECTION OF THE SECOND LAW WITH DYNAMICAL PRINCIPLES. DRAWN UP BY G. H. BRYAN.

Introduction.

1. The present report treats exclusively of the attempts that have been made to deduce the Second Law of Thermodynamics from purely mechanical principles.

Before considering the several methods in detail it may be well to summarise the meaning of the various terms which enter into the mathematical expressions of the laws of thermodynamics, with a view of showing more fully what conditions must be kept in view in establishing the dynamical analogues. This has been done more or less fully by several authors of papers on the subject, but more especially by von Helmholtz in his paper on the 'Statics of Monocyclic Systems.'¹ The substance of this paper will be dealt with more fully later on in the present Report, but we will now mention the principal points touched on in the introduction.

2. *Meaning of the Second Law.*—Let a quantity dQ of work in the form of heat be communicated to a body whose absolute temperature is θ . Let E be the internal energy of the body, dW the work done against external forces by the change in the configuration of the body which takes place during the addition of dQ . It is not assumed that the external forces are conservative.

Then the First and Second Laws are expressed by the equations

$$dQ = dE + dW \quad . \quad . \quad . \quad . \quad . \quad (1)$$

$$dQ = \theta dS \quad . \quad . \quad . \quad . \quad . \quad (2)$$

where dS is a perfect differential of a quantity S , called the *entropy*, whose value depends only on the state of the body at the instant considered.

The essential principle involved in the Second Law does not lie solely in the fact that dQ has an integrating divisor θ . In fact, if we assume that the state of a body is completely defined by *two* variables x and y , it must always be possible to put dQ in the form

$$dQ = Mdx + Ndy,$$

where M , N are functions of x and y only. And it is always possible to find an integrating factor for an expression of this form.

Moreover, if one integrating factor can be found for dQ , an infinite number of such factors can be found. For in equation (2) let s be any arbitrary function of S ; then we may write the equation in the form

$$dQ = \theta \frac{dS}{ds} ds.$$

¹ Crelle, *Journal*, vol. xcvi.

Hence if

$$\eta = \theta \frac{dS}{ds} \quad \dots \quad (3)$$

we have

$$dQ = \eta ds \quad \dots \quad (4)$$

so that η as well as θ is the reciprocal of an integrating factor of dQ , or, as we may call it, an 'integrating divisor' of dQ . Since dS/ds may be regarded as a function of S , we see that the product of the temperature into any arbitrary function of the entropy of a body is an integrating divisor of dQ , and therefore possesses properties analogous to θ in equation (2).

Hence the absolute temperature θ is not fully defined by equation (2), and the Second Law of Thermodynamics is not, therefore, completely proved by the establishment of an equation of this form.

3. It is, therefore, necessary to take into account the other property by which temperature is characterised, namely, that *heat always tends to pass from a body of higher to one of lower temperature, and in particular that if two bodies in contact have the same temperature there will be no transference of heat between them.*

The Second Law of Thermodynamics consists in the fact that among the integrating factors of dQ there is one whose reciprocal, θ , possesses the properties of temperature just mentioned.

4. But, nevertheless, without considering the properties of thermal equilibrium between different bodies we derive one very important inference from equation (2)—namely, that the thermal condition of a system whose parts are in thermal equilibrium can be completely defined by a single coordinate, or, in other words, that the consideration of thermal phenomena only adds *one* to the total number of coordinates otherwise required to fix the state of a dynamical system.

5. *Impossibility of a Perfectly General Mechanical Proof.*—To reduce the First Law of Thermodynamics to the principle of Conservation of Energy it is only necessary to assume that heat is some form of energy; no hypothesis is required as to what particular form this energy takes. It was natural, therefore, that physicists should at a very early date endeavour to reduce the Second Law in like manner to a purely dynamical principle, and the principle of Least Action naturally suggested itself as the probable analogue of Carnot's principle. But here a limitation at once arises from the necessity of giving a dynamical meaning to dQ , the energy communicated to the system in the form of heat, and of separating dQ from $-dW$, the energy communicated in the form of mechanical work.

6. This limitation requires that some special assumption shall be made regarding the nature of heat, and the natural and almost inevitable assumption is that every finite portion of matter is built up of a very large number of elementary portions, called molecules, and that the form of energy known as Heat is due to the relative motion of the molecules among themselves.

But, further, these molecules must be characterised by some peculiar property, such as their (practically) infinitely large number whereby their dynamical properties differ in some manner from those of a finite number of particles or rigid bodies. For without such a distinction it would be impossible to deduce any dynamical equations involving dQ ,

the work performed on the system through the coordinates defining the positions of the molecules and not involving $-dW$, the work performed through the coordinates determining the external configuration of the system. The two portions of the work could only enter together into the equations in the form dE .

In other words, it is impossible to deduce the Second Law of Thermodynamics from purely mechanical principles without making some axiomatic assumption regarding the nature of the molecules whose motion produces the phenomenon of heat.

7. The question now arises as to what dynamical quantity represents temperature. We have good reasons for believing that, in gases at least, the absolute temperature is proportional, either to the total mean kinetic energy, or to the mean kinetic energy of translation of the molecules. But if this or indeed any other hypothesis be adopted it will be necessary, before the mechanical theory of heat is complete, to prove that (1) the molecular kinetic energy is an integrating divisor of dQ ; (2) it determines the thermal state of a body in relation to other bodies.

Most of the earlier writings are concerned only with the first property. But a complete mechanical proof of the Second Law would involve a mechanical definition of temperature applicable to all kinds and states of matter, together with an explanation on dynamical or statistical laws of the principle of degradation of energy in non-reversible processes; and we are still far from arriving at a satisfactory solution of either of these problems.

8. It will be convenient to classify the methods by which the problem has been attacked as follows, under three headings corresponding to the three different fundamental hypotheses which underlie them:—

I. The Hypothesis of 'Stationary' or 'Quasi-Periodic' Motions as adopted by Clausius and Szily.

II. The Hypothesis of 'Monocyclic Systems' of von Helmholtz, and similar hypotheses.

III. The Statistical Hypothesis of Boltzmann, Clerk Maxwell, and other writers on the Kinetic Theory of Gases.

9. Rankine seems to have been the first who attempted to deduce the Second Law from dynamical principles. As early as 1855 he published a paper 'On the Hypothesis of Molecular Vortices,'¹ in which he obtained equations analogous to those of thermodynamics; and in a paper read at the British Association in 1865² he explained the Second Law on the hypothesis that 'heat consists in any kind of steady molecular motion within limited space,' such as that due to circulating streams. Both of Rankine's hypotheses are special cases of Helmholtz's 'Monocyclic Systems.'

Boltzmann seems to have been the next to take up the subject, but his claim to priority has been disputed by Clausius, whose investigations appeared about five years later. Boltzmann was undoubtedly the first to regard the subject from a statistical point of view.

Szily laid claim to the discovery of the connection of the Second Law with Hamilton's Principle of Least Action, and he may fairly be entitled to the credit of having propounded this connection. But most of his early investigations are not only wanting in rigour, but in many cases so inaccurate that they do not *prove* the connection at all.

¹ *Phil. Mag.* 1855, pp. 354, 411.

² *Ibid.* 1865, p. 241.

Clerk Maxwell's theorem, named after its discoverer, was the first attempt at a kinetic analogue of thermic equilibrium. It was generalised by Boltzmann, and afterwards further generalised by Maxwell himself; but the latter extensions are probably incorrect, as we shall see hereafter.

Having thus briefly mentioned the earliest researches on the present subject, let us turn to a consideration of the papers themselves, beginning with the writings of Clausius and Szily.

SECTION I.—*The Hypothesis of Stationary or Quasi-Periodic Motions.*

10. *Clausius and Szily.*—In 1870 Clausius showed that when a system of particles is in stationary motion, the mean *vis viva* of the system is equal to its virial.¹ About a year later he gave a proof of the Second Law, based on the laws of motion, in a paper entitled 'On the Second Axiom in the Mechanical Theory of Heat.'² The methods of proof employed by Clausius in this paper are very laborious and complicated, while his arguments are artificial and, in places, not very intelligible.

Soon after Clausius' paper had appeared, Szily endeavoured to show that 'what in the mechanical theory of heat is called the Second Law is nothing other than Hamilton's Principle of Least Action.'³ The proofs which Szily gave are, in many places, quite at variance, not only with the principles of dynamics, but also even with the laws of Thermodynamics themselves. Thus he repeatedly mistook dE for dQ , and tried to show that dE/T is a complete differential (a result not in general true); moreover, in endeavouring to account for the principle of degradation of energy in a non-reversible cycle, he altogether ignored the First Law, and supposed some of the molecular energy of the system to be actually lost or annihilated by friction, viscosity, or imperfect elasticity of the molecules, or by other similar resistances. In consequence he had to employ methods of proof that were far from rigorous, and even, in many instances, illogical.

Szily's papers seem, however, to have had one good effect—namely, that of stimulating Clausius to remodel his investigations in a simpler and more intelligible form. Those who care to examine the original papers of these writers will find them translated in the volumes of the 'Philosophical Magazine' from 1871 to about 1876. Among them is a paper by Szily,⁴ in which he claimed to have deduced the Second Law from the First 'without any further hypothesis whatever.' Yet Szily based this investigation on two hypotheses which are hardly more axiomatic than Carnot's principle.

11. *Clausius' Methods.*—It would be useless to enter into further criticism. We now proceed to give a proof of the Second Law based on the methods of Clausius, with the object of bringing into prominence the more salient features of his investigations, and of presenting them in a concise form.

The assumptions which form the basis of Clausius' proof may be stated as follows:—

(i.) In the steady or undisturbed state of the system the motion of the molecules shall be *stationary* or *quasi-periodic*; in other words, the potential and kinetic energies of the molecules shall fluctuate *rapidly*

¹ *Phil. Mag.* vol. xl. (1870), p. 122.

² *Ibid.* vol. xlii. (1871) (September).

³ *Ibid.* vol. xliii. (1872), p. 339.

⁴ *Ibid.* V. series, vol. i. (1876), p. 22.

about their mean values, and there shall be one or more 'quasi-periods,' i , satisfying the definition which will be given in the course of the proof (equation 13, *infra*).

(ii.) When the state of the system is changed (as by the communication of heat or by changes in the volume or external configuration of a body), such changes shall be capable of being treated as small variations of the motion from the state of steady motion.

Helmholtz, in his paper on Monocyclic Systems, makes a similar assumption—namely, that the changes in the state of the system shall take place so very slowly that the motion of the system at any instant differs infinitesimally little from a possible state of steady motion. This is the exact equivalent of the assumption always made in treating the Second Law from a physical point of view—namely, that heat is communicated to or taken from the working substance so slowly that at every instant of the process the temperature of the body is sensibly uniform throughout.

12. With these assumptions, let the positions of the molecules be determined in the first instance by the Cartesian coordinates (x, y, z) of the particles (m) forming them.

Suppose that the state of the system also depends on the values of certain other coordinates, $p_1, p_2, \&c.$, which, as suggested by J. J. Thomson,¹ we shall call the 'controllable coordinates' of the system; to this class belong the volume of the body, the charge of electricity present on it, or any coordinates which can be acted on directly from without. The values of these latter coordinates will enter into the expression for the potential energy of the system.

$$\begin{aligned} \text{Let } T &= \text{kinetic energy of system} = \frac{1}{2} \sum m(\dot{x}^2 + \dot{y}^2 + \dot{z}^2). \\ V &= \text{potential energy.} \\ E &= \text{total energy} = T + V. \end{aligned}$$

In Thomson and Tait's 'Natural Philosophy,' part i. § 327, it is shown that

$$\delta \int_{t_1}^{t_2} 2T dt = \left[\sum m(\dot{x} \delta x + \dot{y} \delta y + \dot{z} \delta z) \right]_{t=t_1}^{t=t_2} + \int_{t_1}^{t_2} \left\{ \delta T - \sum m(\ddot{x} \delta x + \ddot{y} \delta y + \ddot{z} \delta z) \right\} dt \quad (5)$$

But by D'Alembert's Principle we always have for the motion of the system

$$\sum \left\{ \left(m\ddot{x} + \frac{\partial V}{\partial x} \right) \delta x + \left(m\ddot{y} + \frac{\partial V}{\partial y} \right) \delta y + \left(m\ddot{z} + \frac{\partial V}{\partial z} \right) \delta z \right\} = 0,$$

whence

$$\sum m(\ddot{x} \delta x + \ddot{y} \delta y + \ddot{z} \delta z) = - \sum \left(\frac{\partial V}{\partial x} \delta x + \frac{\partial V}{\partial y} \delta y + \frac{\partial V}{\partial z} \delta z \right) \quad . \quad . \quad (6)$$

Now, V is a function not only of the molecular coordinates (x, y, z) but also of the controllable coordinates p_1, p_2, \dots and these latter are also liable to variation. Hence for the complete variation of V we have

$$\delta V = \sum \left(\frac{\partial V}{\partial x} \delta x + \frac{\partial V}{\partial y} \delta y + \frac{\partial V}{\partial z} \delta z \right) + \sum \frac{\partial V}{\partial p} \delta p \quad . \quad . \quad (7)$$

¹ *Applications of Dynamics to Physics and Chemistry*, p. 94.

Here the terms

$$\sum \frac{\partial V}{\partial p} \delta p$$

represent the work done on the system by variation of the controllable coordinates—*i.e.*, the external work performed on the system. Hence, if δW denote the external work performed by the system, as in § 2, we have

$$\sum \frac{\partial V}{\partial p} \delta p = -\delta W. \quad . \quad . \quad . \quad (8)$$

Substituting in equation (5) from (6), (7), (8), in succession, we have

$$\delta \int_{t_1}^{t_2} 2T dt = \left[\sum m(\dot{x}\delta x + \dot{y}\delta y + \dot{z}\delta z) \right]_{t_1}^{t_2} + \int_{t_1}^{t_2} (\delta T + \delta V + \delta W) dt \quad . \quad (9)$$

But if δQ represents the variation of energy communicated through the molecular or *uncontrollable* coordinates, we have, by the Principle of Conservation of Energy¹ (equation 1),

$$\delta Q = \delta E + \delta W = \delta T + \delta V + \delta W.$$

Therefore (9) gives

$$\delta \int_{t_1}^{t_2} 2T dt = \left[\sum m(\dot{x}\delta x + \dot{y}\delta y + \dot{z}\delta z) \right]_{t_1}^{t_2} + \int_{t_1}^{t_2} \delta Q dt \quad . \quad (10)$$

Let $t_2 - t_1 = i$, and let mean values with respect to the time be indicated in the usual way by a vinculum drawn over them, then the last equation (10) may be written

$$\delta(2i\bar{T}) = \left[\sum m(\dot{x}\delta x + \dot{y}\delta y + \dot{z}\delta z) \right]_{t_1}^{t_1+i} + i \cdot \delta\bar{Q} \quad . \quad (11)$$

whence

$$\frac{\delta\bar{Q}}{\bar{T}} = \frac{\delta(2i\bar{T})}{i\bar{T}} - \frac{\left[\sum m(\dot{x}\delta x + \dot{y}\delta y + \dot{z}\delta z) \right]_{t_1}^{t_1+i}}{i\bar{T}} \quad . \quad (12)$$

Hence, if we assume the quasi-period i to be defined, as postulated (assumption 1), by the relation

$$\left[\sum m(\dot{x}\delta x + \dot{y}\delta y + \dot{z}\delta z) \right]_{t_1}^{t_1+i} = 0. \quad . \quad . \quad (13)$$

we shall have

$$\frac{\delta\bar{Q}}{\bar{T}} = \frac{\delta(2i\bar{T})}{i\bar{T}} = \delta \log (i\bar{T}) = \delta \log (i\bar{T})^2 \quad . \quad (14)$$

13. Equation (14) is analogous to the thermodynamical equation (2) when written in the form

$$\frac{dQ}{\theta} = dS;$$

the mean kinetic energy of the molecules \bar{T} taking the place of the absolute temperature θ .

Thus Carnot's principle is proved for reversible transformations, pro-

¹ This step was omitted by Szily, who fell into several errors in consequence, and it is not explicitly mentioned in Clausius' writings.

vided that the absolute temperature of a body is proportional to the mean kinetic energy of its molecules taken over a quasi-period of their motion. But to complete the proof it would still be necessary to show that a quantity proportional to the mean kinetic energy of the molecules fulfils the properties of temperature stated in § 3. The investigations on this point will be considered in Section III.

The hypothesis that the quasi-period i is very short compared with the time required to communicate a finite quantity of energy through the molecules is tacitly involved in our regarding $\delta\bar{Q}$ as a small variation. On this hypothesis the value of \bar{T} will vary very slowly, and \bar{T} may therefore be regarded as a continuously varying function. Hence, in considering what takes place over a considerable number of quasi-periods, we may replace the sign of summation by that of integration, and thus obtain

$$\int_1^2 \frac{dQ}{T} = \sum \frac{\delta\bar{Q}}{\bar{T}} = 2 \log \frac{i_2 T_2}{i_1 T_1}$$

the suffixes 1, 2 referring to the initial and final state of the body.

14. The hypotheses involved in the definition of the quasi-period i by means of equation (13) call for some comment. In his paper 'On a New Mechanical Theorem relating to Stationary Motions,'¹ Clausius gives a rather more general form of the theorem, in which he supposes that there may be different quantities i corresponding to different molecular coordinates; but in this case it seems to be necessary, according to him, that in the varied motion all the i 's shall be altered in the same ratio. If such is assumed to be the case, $\delta \log i$ will be the same for all. Hence we shall obtain for the portion whose quasi-period is i

$$\delta\bar{Q} = 2\bar{T} \delta \log i + 2\delta\bar{T},$$

and, therefore, for the whole body

$$\Sigma \delta\bar{Q} = 2\Sigma\bar{T} \cdot \delta \log i + 2\delta\Sigma\bar{T};$$

or, if we remove the signs of summation and let the quantities refer to the entire system,

$$\delta\bar{Q} = 2\bar{T} \delta \log i + 2\delta\bar{T},$$

whence

$$\frac{\delta\bar{Q}}{\bar{T}} = 2\delta (\log i\bar{T}). \quad \cdot \quad \cdot \quad \cdot \quad \cdot \quad \cdot \quad (14)$$

as before.

If we assume that each molecular coordinate (x , for example) always fluctuates in the same periodic time i , so that the corresponding velocity \dot{x} vanishes at the times $t_1, t_1 + i, t_1 + 2i, \&c.$, then the relation defining the corresponding i ,

$$\left[m\dot{x}\delta x \right]_{t=t_1}^{t=t_1+i} = 0,$$

will be satisfied identically, and there will be no difficulty about the matter. When, however, the molecular motions do not possess even this amount of periodicity, Clausius gets over the difficulty by arguments of the following general nature:—If we are dealing with a body of finite

¹ *Phil. Mag.* vol. xlvi. (1873), p. 236.

dimensions, the molecular coordinates (x, y, z) must fluctuate between certain finite limits, and hence $\delta x, \delta y, \delta z$, cannot increase indefinitely with the time. Hence by taking the time i sufficiently large we must have ultimately

$$\int_{i=\infty}^t \frac{\left[\sum m(\dot{x}\delta x + \dot{y}\delta y + \dot{z}\delta z) \right]_{t=t_1}^{t=t_1+i}}{i} = 0 \quad . \quad . \quad (15)$$

since the numerator does not increase indefinitely with i .

Now, it appears to me that the statements printed in italics are open to objection. There is no reason why $\delta x, \delta y, \delta z$ should not increase continually with the time until they can no longer be regarded as *small variations*, and it seems highly probable that this will happen under certain circumstances. Take, for example, the case of a gas formed of a number of hard spherical molecules colliding with one another, the lengths of the mean free paths being great compared with the radius of each sphere. If the direction of motion of one of these spheres be varied very slightly, then at the next impact there will be a considerable alteration in the direction of the line of centres.¹ After the impact, therefore, the variation in the direction of motion will be very greatly increased, and a similar increase will take place at each impact, until at last the molecule will no longer collide with the same molecules as in the original motion, but will come into collision with quite a different set. By this time there will not be the slightest connection between the original and the varied motion.

15. I would therefore suggest that the existence of a 'quasi-period' i , as defined by (13), can be better explained by arguments of a statistical nature based on the immensely large number of the molecules present in a body of finite dimensions. In the steady or stationary motion of such a body, it is reasonable to assume (as in the kinetic theory of gases) that the velocities of the molecules are on the whole equally distributed as regards direction. Thus, for example, the average number of molecules for which \dot{x} is positive and lies between u and $u+du$ is equal to the average number for which \dot{x} is negative and lies between $-u$ and $-(u+du)$.

Moreover, in the disturbed motion the displacements $(\delta x, \delta y, \delta z)$ of any molecule cannot depend in any manner on its velocity components $(\dot{x}, \dot{y}, \dot{z})$. It is of course quite possible to conceive a disturbance of the motion in which some fixed relation exists between the displacements and the velocity components of the molecules—indeed, we might choose the relation to be any we please—but a disturbance of this kind would only be possible if the molecules were individually *controllable*; in other words, the displacements could only be brought about by means of Clerk Maxwell's 'demons,' and it would then be reasonable to suppose that the Second Law would fail altogether.

Hence in any physically possible variation of the motion the terms involving positive and negative velocity components in the expression

$$\sum m(\dot{x}\delta x + \dot{y}\delta y + \dot{z}\delta z)$$

will on the whole cancel one another, and therefore the average value of the expression will be zero. This proves Clausius' Theorem.

¹ This is easily exemplified by means of billiard-balls.

It should be noted that Clausius introduces the conception of a 'phase' in dealing with stationary motions, but this is not an essential feature of the proof, and it only modifies the form of the equations. I have therefore dispensed with it.

16. *Connection with Hamilton's Principle.*—Although Thomson and Tait have based their proof of the Principle of Least Action on equation (5), the above investigations do not show more than a very indirect connection between that principle and the equation (14) which corresponds to the Second Law of Thermodynamics. Had we used generalised coordinates to represent the positions of the molecules, equation (6) would have been replaced by Lagrange's generalised equations of motion, and the connection would hardly have been any closer, depending only, as it would have done, on the fact that Lagrange's equations could be deduced from the Principle of Least Action, and that equation (14) would have been deduced from Lagrange's equations.

Clausius recognised at the very outset of his researches the fact that Hamilton's principle could not be applied directly to the case of a system of molecules in which the variation of the motion was accompanied by the performance of external work through the controllable coordinates of the system. For, as he puts it, Hamilton's principle only holds good when, in the varied motion, the Ergal has the same form as a function of the coordinates as in the original motion.¹ By the coordinates Clausius here means the molecular coordinates only, for he considers the controllable coordinates as variable parameters which enter into and affect the form of the potential energy or 'Ergal.' In consequence of this fact Clausius claimed that his equations involved a new principle which was of more general application than Hamilton's principle. We shall, however, show (i.) that, by means of a certain assumption as to the form taken by the external work, a system can be formed to which Hamilton's principle is directly applicable; (ii.) that the principle leads immediately to the analogue of the Second Law in the form of equation (14); and (iii.) that the assumption made does not really interfere with the generality of the proof.

17. Our assumption is that the external forces, acting on the controllable coordinates of the body, belong to a conservative system. This system we may, for convenience, call the 'external system.' When the body performs external work δW , the potential energy of the external system increases by δW . Hence we may denote this potential energy by W . The external system and the original body, when taken together, form a complete dynamical system, to which Hamilton's principle *can* be applied; for the potential energy of the complete system is a function only of the generalised coordinates of the system.

Moreover, in the complete system the increment of the total energy is $=\delta E + \delta W = \delta Q$ by (1). Hence the total energy may be denoted by Q where

$$Q = E + W = T + V + W,$$

the total potential energy being U where

$$U = V + W = Q - T.$$

Let $p_1, p_2 \dots$ denote the generalised coordinates of the complete system, $q_1, q_2 \dots$ the corresponding velocities, so that $q_n = \dot{p}_n$; and let

¹ *Phil. Mag.* vol. xlv. (1872), p. 365.

s_1, s_2, \dots be the corresponding generalised momenta. Let p_a be taken as a type of the controllable coordinates which define the configuration of the external system, p_b as a type of the uncontrollable coordinates which define the positions of the molecules in the body. Since the energy of the external system is assumed to be wholly potential,

$$\therefore s_a = \frac{\partial T}{\partial q_a} = 0 \quad . \quad . \quad . \quad . \quad . \quad (16)$$

With the present notation the two general forms of the equation expressing Hamilton's principle are

$$\delta \int_0^i (T - U) dt = \left[\sum s \delta p \right]_0^i - Q \delta i \quad . \quad . \quad . \quad (17a)$$

and

$$\delta \int_0^i 2T dt = \left[\sum s \delta p \right]_0^i + i \delta Q \quad . \quad . \quad . \quad (17b)$$

Of these the latter form must be used. Assume i to be so chosen as to satisfy the relation

$$\left[\sum s \delta p \right]_0^i = 0,$$

which, since $s_a = 0$, may also be written

$$\left[\sum s_b \delta p_b \right]_0^i = 0; \quad . \quad . \quad . \quad . \quad (18)$$

a relation identical with that assumed in equation (13) and justifiable in a similar manner.

Equation (17b) now becomes, on introducing mean values,

$$\delta(2i\bar{T}) = i\delta Q,$$

giving, as before, equation (14),

$$\frac{\delta Q}{\bar{T}} = \delta 2 \log(i\bar{T}).$$

It might at first sight appear as if the assumption as to the conservative nature of the external forces imposed a serious limitation on the generality of the theorem, and, in fact, prevented its application to cyclical processes. But this is really not the case. To remove the limitation it is only necessary to suppose that the external system contains certain connections by which periodic motion of the body is converted into progressive motion of some of the external coordinates, as exemplified in the crank of a steam-engine. In other words, the external energy W must be a multiple valued function of the controllable coordinates of the body. From equation (18), i depends only on the state of the body, not on that of the external system, and evidently \bar{T} depends only on the state of the body. Hence, if the initial and final states of the body be the same, although the initial and final states of the external system may be different, we must have

$$\int \frac{\delta Q}{\bar{T}} = 0 \quad . \quad . \quad . \quad . \quad . \quad (19)$$

Since the external system of conservative forces may be chosen to be any we please, equation (19) must be true for any cyclical process whatever, whether or not accompanied by the production or absorption of external work.

This, then, is the closest connection which exists between Hamilton's principle and the kinetic analogue of the Second Law of Thermodynamics.

We might avoid the necessity of constructing a different multiply connected field of external force to suit each cyclic process by adopting a generalisation of the principle of Least Action, but this generalisation would no longer belong to the forms given by Hamilton. Thus we might suppose W , and therefore Q , to be a function of the time. This would not affect the form of (17a), but in (17b) $i\delta Q$ would be replaced by

$$\int_0^i \delta Q dt \text{—i.e., } i\delta \bar{Q}.$$

A slightly different method adopted by Helmholtz in his papers on 'Least Action' (Crelle, 'Journal,' vol. c.) leads to the same result. He supposed the generalised external force components P_a to be functions of the time only; in this case we must write $\Sigma(P_a p_a)$ instead of W , and, therefore, $E + \Sigma(P_a p_a) = Q$.

18. Under the present section of this Report must be mentioned Prof. J. J. Thomson's theorem that 'when a system consisting of a very great number of molecules is in a steady state, the mean value of the Lagrangian function has a stationary value so long as the velocities of the controllable coordinates are not altered.'¹

This 'theorem' is nothing more or less than Hamilton's Principle of Least Action, which is enunciated in a form identical with the above by von Helmholtz in his paper on Least Action.² In fact, if in equation (18) we write

$$H = U - T,$$

and assume the variation to be so chosen that

$$\delta i = 0, \quad \left[\sum s_b \delta p_b \right]_0^i = 0 \quad . \quad . \quad . \quad (19)$$

we have at once

$$\delta \int_0^i H dt = 0,$$

whence

$$\delta(i\bar{H}) = 0,$$

or by (19)

$$\delta\bar{H} = 0;$$

so that \bar{H} has a stationary value.

The function H , which is merely the Lagrangian function with its sign changed, has been termed by Helmholtz the *Kinetic Potential*.

The mean value of this function is the dynamical analogue of the quantity in the theory of heat which is called the *Thermodynamical Potential* by Duhem and Massieu, the *Force Function of Constant Temperature* by J. Willard Gibbs, and the *Free Energy* by Helmholtz himself.

The fact that, for a system which undergoes reversible transformations

¹ *Applications of Dynamics to Physics and Chemistry*, p. 142.

² Crelle, *Journal*, vol. c. p. 139.

only, the thermodynamic potential is a *minimum*, is thus identical with the principle of *minimum* action. For non-reversible processes the thermodynamic potential tends to a minimum, and this fact expresses the principle of degradation of energy involved in the Second Law, though as yet the corresponding dynamical property has not been worked out.

J. J. Thomson's applications of his 'theorem' have no bearing on the subject of this Report, as they do not depend to any extent on the dynamical aspect of the question.

SECTION II.—*Hypotheses based on the Properties of Monocyclic Systems.*

19. The peculiarity of the theories to be discussed in this section is that they are not in themselves statistical. They do not therefore postulate the existence of an infinitely large number of molecules the motion of which, taken individually, is uncontrollable. Instead of this, the fundamental hypotheses on which they are based have reference to the forms of the kinetic and potential energy as functions of the coordinates of the system. Thus the equations of motion of any finite system of rigid bodies fulfilling the necessary qualifications will give rise to equations analogous in form to those which represent the laws of Thermodynamics.

Under the present category may be classed Rankine's very early theories, already mentioned, Helmholtz's papers on the statics of Monocyclic Systems,¹ and the proof of the Second Law given by J. J. Thomson in his 'Applications of Dynamics to Physics and Chemistry.' Boltzmann has endeavoured to show how a system satisfying the properties of a monocyclic system may be derived from statistical considerations, but this investigation naturally falls under Section III. of this Report.

Rankine's hypotheses call for no comment, being only very special cases of those of Helmholtz.

20. *H. L. F. von Helmholtz on the Principles of Statics of Monocyclic Systems.*—As no account of these papers has hitherto been given in English, we shall now consider them somewhat fully. The introductory portion has already been noticed in §§ 2, 3.

Helmholtz defines a *polycyclic system* as a dynamical system containing one or more periodic or circulating motions. If there is only one such motion, or if, owing to the existence of certain relations between the velocities of the different parts of the system, the circulating motions can all be defined by a single coordinate, the system is called *monocyclic*.

As in other investigations the coordinates of the system fall under two classes—those which, following the suggestion of J. J. Thomson, we have called '*controllable*' coordinates, and those defining the internal or circulating motions within the system, which that writer calls '*unconstrainable*' coordinates. In applying the results to Thermodynamics, the latter coordinates are those which fix the positions of the molecules, and thus define the thermal state of the body; they may, therefore, be called '*molecular*' coordinates.

A polycyclic or monocyclic system is assumed to possess the following properties:—

(i.) The kinetic and potential energies of the system do not involve the actual values of the molecular coordinates which define the circulating motions, but only depend on their generalised velocities or rates of change.

¹ 'Principien der Statik monocyclischer Systeme,' Crelle, *Journal*, xcvi. pp. 111, 317.

These coordinates are therefore *gyrostatic* or, as J. J. Thomson calls them, 'speed' coordinates. The present hypothesis seems to assume that the molecules exert no mutual forces except those due to impact or unyielding constraints. At any rate, if there be any other molecular forces they can only depend on the controllable coordinates of the system.

(ii.) When the state of the system is changed the changes take place very slowly, so that the velocities of the controllable coordinates are small, and so also are the accelerations of the molecular or gyrostatic coordinates. (This corresponds to the second assumption in § 11.)

21. Let the generalised coordinates of a polycyclic system be denoted by p , the generalised velocities by q , the generalised momenta by s , and the generalised force components exerted by the system, in the direction of p increasing, by P ; also, let the suffix a refer in each case to the controllable coordinates, and b to the molecular coordinates of the system. Let T =kinetic energy, V =potential energy, $H=V-T$, so that H is the Lagrangian function with its sign changed.

The general equations of motion give

$$\left. \begin{aligned} q &= \frac{dp}{dt}, \quad s = -\frac{\partial H}{\partial q} = \frac{\partial T}{\partial q} \\ P &= \frac{d}{dt} \left(\frac{\partial H}{\partial q} \right) - \frac{\partial H}{\partial p} \end{aligned} \right\} \dots \dots \dots (20)$$

In consequence, however, of the assumptions (i.) and (ii.) we have

$$\frac{\partial H}{\partial p_b} = 0, \quad q_a = 0, \quad s_a = \frac{\partial H}{\partial q_a} = 0 \dots \dots (21)$$

whence the generalised equations for the polycyclic system become

$$\left. \begin{aligned} P_a &= -\frac{\partial H}{\partial p_a} \\ P_b &= -\frac{ds_b}{dt} = \frac{d}{dt} \left[\frac{\partial H}{\partial q_b} \right] \end{aligned} \right\} \dots \dots \dots (22)$$

Hence if dQ is the total energy communicated through the gyrostatic coordinates q_b in time dt , we have

$$dQ = -\sum P_a q_a dt = +\sum q_b \frac{ds_b}{dt} dt = \sum q_b ds_b \dots \dots (23)$$

Also, if the Lagrangian function has not been modified, or if, in other words, no gyrostatic coordinates have been ignored, T is a homogeneous quadratic function of the quantities q_b , and hence in this case

$$2T = \sum q_b s_b \dots \dots \dots (24)$$

22. The simplest form of *monocyclic system* is that containing only one gyrostatic coordinate q_b ; here

$$dQ = q_b ds_b \dots \dots \dots (25)$$

Thus q_b is an integrating divisor of dQ , and by § 2 the product of q_b with any function of s_b is also an integrating divisor of dQ . In particular

$$2T = q_b s_b \dots \dots \dots (26)$$

$$\therefore \frac{dQ}{T} = 2d(\log s_b) \dots \dots \dots (27)$$

Moreover, if $E=T+V$ is the total energy of the system,

$$dQ=dE+\sum(P_a dp_a) \quad . \quad . \quad . \quad (28)$$

so that dQ is the analogue of the quantity of heat communicated to a body.

Hence equation (27) is analogous to the Second Law of Thermodynamics as given by equation (2), on the assumption that the kinetic energy T takes the place of the temperature.

If S is the quantity corresponding to entropy in (27), we have on integration

$$S=2(\log s_b - \log A), \text{ where } A \text{ is a constant.}$$

This may also be put in the form

$$S=\log T + \log \left(\frac{s_b}{A^2 q_b} \right) \quad . \quad . \quad . \quad (29)$$

Here s_b/q_b is of no dimensions in time; hence s_b/q_b is a function of length only, and the expression for S is exactly analogous to the corresponding formula for a perfect gas—

$$S=c_v \log \theta + (c_p - c_v) \log v + C \quad . \quad . \quad . \quad (30)$$

If q_b is of the nature of angular velocity, so that $q_b t$ is of no dimensions in length, $s_b t$ will be of dimensions $[L]^2$, and therefore s_b/q_b will be of dimensions $[L]^2$. But v is of dimensions $[L]^3$, hence by comparing the dimensions of the quantities in (29), (30), we must have $(c_p - c_v)/c_v = \frac{2}{3}$, $\therefore c_p = \frac{5}{3}c_v$, and this is the relation between the specific heats of a mono-atomic gas.

23. Helmholtz next considers the more general case in which there are several velocity coordinates q_b , and he investigates the relations connecting them on the assumption that dQ has an integrating divisor. Writing

$$dQ = \sum q_b ds_b = \lambda d\sigma \quad . \quad . \quad . \quad (31)$$

it is evident that the required conditions will be satisfied by assuming that the equation

$$dQ=0 \quad . \quad . \quad . \quad (32)$$

has an integral of the form

$$F(s_b) = \sigma = \text{constant} \quad . \quad . \quad . \quad (33)$$

and that

$$q_b = \lambda \frac{\partial F}{\partial s_b} \quad . \quad . \quad . \quad (34)$$

The conditions that the kinetic energy should be an integrating divisor are also found. If the Lagrangian function has not been modified, Helmholtz finds that the kinetic energy is in every case an integrating divisor of dQ , provided that the geometrical relations between the motions of the various coordinates are *purely kinematical*, or such as could exist in nature.

24. It has, however, been pointed out by Boltzmann, in his remarks on Helmholtz's paper,¹ that Helmholtz's proof of this theorem is based on

¹ Boltzmann, 'Ueber die Eigenschaften monocyclischer Systeme,' Crelle, *Journal*, xcvi. p. 86 *et seq.*

the assumption that dQ has an integrating divisor; or, in other words, that the solution of the equation

$$dQ=0$$

can be expressed in the form of a single primitive. Under such circumstances, the proof shows that the kinetic energy of the system must necessarily be one of the integrating divisors of dQ . But, on the other hand, there may be cases in which the equation $dQ=0$ does not possess a solution in the form of a single primitive, and Helmholtz's investigations are not applicable to such cases.

In fact the theory of differential equations shows that the equation (32)

$$dQ \equiv \sum q_b ds_b = 0$$

does not in general lead to a single primitive of the form (33)

$$F(s_b) = \text{constant.}$$

In order to obtain an integral of (32) it is therefore in general necessary to assume certain functional relations between the variables. In other words, we must assume the existence of certain geometrical equations connecting the different parts of the system, and this is equivalent to imposing certain constraints whereby the number of degrees of freedom of the system is reduced. Helmholtz finds that the kinetic energy T will be an integrating divisor of dQ , provided that the assumed geometrical equations are purely kinematical, and in this category are included all forms of constraint which are possible in a perfectly conservative dynamical system.

There are, however, as Helmholtz has shown, certain cases in which (32) has for its integral a single primitive of the form (33), and in these cases it is not necessary to assume the existence of geometrical equations representing constraints on the system. Such a polycyclic system possesses properties identical with those of a monocyclic system, and, although the gyrostatic coordinates are independent, the kinetic energy is always an integrating divisor of dQ .

It is probable that Helmholtz's geometrical equations can be interpreted thermodynamically as the conditions that the different parts of the body may be all at the same temperature. Unless this condition is satisfied we know from purely physical considerations that dQ has not in general an integrating divisor.

25. The limitations, as well as the meaning of 'purely kinematical' geometrical conditions, are, however, more clearly shown in Helmholtz's second paper,¹ in which he deduces the analogue of the Second Law by means of an application of the principle of similitude, as follows: The geometrical conditions are considered purely kinematical when they allow the rate at which the system is moving to be varied without varying the relations between the coordinates of the various parts. Thus corresponding to any state of motion of the system we may obtain another possible state of motion of the system by supposing all the velocities of the system increased n fold, provided that proportional alterations be made in the external forces (P) of the system. In the new motion the

¹ Crelle, *Journal*, vol. xcvi. pp. 317-322.

same changes will take place in a less time; hence, if we use accented letters for the original motion, we shall have generally

$$\left. \begin{aligned} t &= \frac{1}{n} t' \\ p &= p' \\ q &= nq' \\ T &= n^2 T' \\ s &= ns' \end{aligned} \right\} \dots \dots \dots (35)$$

The effect of communicating a quantity of energy dQ through the speed coordinates of such a system will be to increase the rate of working of the system, and therefore to increase n .

Now we have

$$\begin{aligned} dQ &= \sum (q_v ds_v) = \sum \{(nq'_v) d(ns'_v)\} \\ &= n^2 \sum (q'_v ds'_v) + ndn \sum (q'_v s'_v) \dots \dots \dots (36) \end{aligned}$$

But when the rate is constant, $dn=0$; $dQ=0$;

$$\therefore \sum (q'_v ds'_v) = 0 \dots \dots \dots (37)$$

which defines the monocycle.

$$\therefore dQ = ndn \sum (q'_v s'_v) \dots \dots \dots (38)$$

But

$$2T = 2n^2 T' = 2n^2 \sum (q'_v s'_v);$$

$$\therefore \frac{dQ}{T} = \frac{2dn}{n} = 2d(\log n) \dots \dots \dots (39)$$

The quantity corresponding to entropy—viz., $2 \{\log n - \log(\text{constant})\}$ differs from that given by the method of Clausius, but the two investigations are easily reconciled. For writing (36) in the form

$$dQ = ndn \sum (q'_v s'_v) + n^2 \{d \sum (q'_v s'_v) - \sum (s'_v dq'_v)\} = 0 \dots (40)$$

the assumption made in Clausius' method is that

$$\sum (s'_v dq'_v) = 0 \dots \dots \dots (41)$$

and under such circumstances

$$dQ = ndn 2T' + n^2 d 2T' \dots \dots \dots (42)$$

$$\begin{aligned} \therefore \frac{dQ}{T} &= \frac{dQ}{n^2 T'} = \frac{2dn}{n} + \frac{2dT'}{T'} \\ &= 2d(\log n T') = 2d \log (T/n) \dots \dots \dots (43) \end{aligned}$$

which agrees with (14).

26. By far the most interesting part of Helmholtz's papers is that in which he has investigated the dynamical analogue of thermal equilibrium between two or more bodies of equal temperature. Of this portion we will now give a brief sketch.

If two bodies of equal temperature are placed in contact, the state of either body will be unaffected, and the system, taken as a whole, will be subject to the two laws of thermodynamics.

The dynamical analogue to be investigated is that of two monocyclic systems coupled together by means of geometrical connections between

their molecular coordinates only (*not* between their controllable coordinates) in such a manner that the motions of the two systems are individually unaffected by the coupling, but that the coupled system forms a single monocyclic system. Corresponding to equality of temperature we must have equality between two integrating divisors of dQ for the two monocyclic systems, and these integrating divisors must always remain equal so long as the two systems are coupled together.

Such being the conditions imposed upon the problem from thermal considerations, Helmholtz investigates the general form of the integrating divisors for two monocyclic systems in order that this condition may be fulfilled—*i.e.*, that equality of these divisors may be the criterion of the possibility of coupling the systems. This kind of coupling he calls ‘*isomorous*.’ As simple instances of such coupled dynamical systems the following are mentioned:—

(i.) Two revolving wheels may be coupled together by joining their axles if their angular velocities are equal. If either wheel carries a Watt’s governor or centrifugal regulator in which the distance of the revolving balls from the axis is controllable, the angular velocities of the two wheels can thus be equalised just as two bodies may be brought to the same temperature by applying suitable pressures.

(ii.) Two circulating streams of liquid in annular vessels can be combined into a single stream wherever their linear velocities are identical, and the necessary conditions may be secured by suitably varying the form and dimensions of the containing vessels.

The principle of limited availability when heat is converted into work by reversible processes depends on the impossibility of controlling the individual molecules of a body: all that we can do is to communicate heat to the body by placing it in contact with another body, which must be at the same temperature if the process is to be reversible. Corresponding to this property we must make the hypothesis that in a monocyclic system it is impossible to operate directly on the gyrostatic coordinates by means of external forces, but that work can only be communicated through these coordinates by coupling the system with another monocyclic system, and that the coupling must be ‘*isomorous*.’ If this assumption be made, the monocyclic system will evidently possess properties corresponding to the principle of limited availability.

27. Let η_1 and η_2 be the required integrating divisors for the two systems, so that whenever $\eta_1 = \eta$ and $\eta_2 = \eta$ the systems can be coupled together. Let the corresponding entropies be σ_1 and σ_2 ; then for such a coupled system we must have

$$\left. \begin{aligned} dQ_1 &= \eta d\sigma_1 \\ dQ_2 &= \eta d\sigma_2 \\ \therefore dQ &= dQ_1 + dQ_2 = \eta d(\sigma_1 + \sigma_2) \end{aligned} \right\} \dots \dots (44)$$

therefore η is an integrating divisor of dQ for the entire coupled system.

Any other integrating divisor will be the product of η with an arbitrary function of the corresponding entropy (§ 2). But the kinetic energies T_1 , T_2 , $T_1 + T_2$ are integrating divisors of dQ_1 , dQ_2 , and dQ (since the coupled system is supposed to be monocyclic). Therefore

$$\left. \begin{aligned} T_1 &= \eta_1 \phi(\sigma_1) \\ T_2 &= \eta_2 \psi(\sigma_2) \\ T_1 + T_2 &= \eta \chi(\sigma_1 + \sigma_2) \end{aligned} \right\} \dots \dots (45)$$

whence

$$\chi(\sigma_1 + \sigma_2) = \phi(\sigma_1) + \psi(\sigma_2) \quad . \quad . \quad . \quad (46)$$

giving, on differentiating first with regard to σ_1 and then with regard to σ_2 ,

$$\chi'' = 0.$$

Therefore on integration

$$\left. \begin{aligned} \chi &= a + b + c(\sigma_1 + \sigma_2) \\ \phi &= a + c\sigma_1 \\ \psi &= b + c\sigma_2 \end{aligned} \right\} . \quad . \quad . \quad . \quad (47)$$

But if s_1, s_2 be the generalised momenta corresponding to the gyrostatic coordinates of the two systems, we have

$$\left. \begin{aligned} dQ_1 &= 2T_1 d \log s_1 = \eta_1 ds_1 \\ dQ_2 &= 2T_2 d \log s_2 = \eta_2 ds_2 \end{aligned} \right\} . \quad . \quad . \quad . \quad (48)$$

From (45), (47), and (48)

$$\left. \begin{aligned} 2d \log s_1 &= \frac{d\sigma_1}{a + c\sigma_1} \\ 2d \log s_2 &= \frac{d\sigma_2}{b + c\sigma_2} \end{aligned} \right\} . \quad . \quad . \quad . \quad (49)$$

$$\therefore \text{ by integration, } \left. \begin{aligned} \phi(\sigma_1) &= a + c\sigma_1 = (s_1/\alpha)^{2c} \\ \psi(\sigma_2) &= b + c\sigma_2 = (s_2/\beta)^{2c} \end{aligned} \right\} . \quad . \quad . \quad (50)$$

where α, β are constants. Substituting in (45) we find

$$\left. \begin{aligned} \eta_1 &= T_1 \left(\frac{\alpha}{s_1} \right)^{2c} \\ \eta_2 &= T_2 \left(\frac{\beta}{s_1} \right)^{2c} \end{aligned} \right\} . \quad . \quad . \quad . \quad (51)$$

These, then, are the most general forms of η_1, η_2 possessing the two qualifications by which temperature is characterised—namely, (i.) Carnot's principle and (ii.) the property of defining the state of a body in relation to its thermal equilibrium with another body.

28. There is still another condition to be satisfied in finding a kinetic analogue of temperature—namely, the property that if two bodies, A and B, are in thermal equilibrium, and if A and C are also in thermal equilibrium, then B and C will be in thermal equilibrium.

This imposes on our monocyclic systems the condition that whenever a system (1) can be coupled with either of two systems (2) and (3), the systems (2) and (3) can also be coupled together. The examples already given of wheels revolving with equal angular velocity and of circulating streams are instances of the fulfilment of this condition.

In all such cases the geometrical equations connecting the coordinates of the coupled bodies must be of the form

$$\phi_1 = \psi_2 = \chi_3 \quad . \quad . \quad . \quad (52)$$

where ϕ_1 only involves the coordinates of the first body, ψ_2 those of the second, and χ_3 those of the third.

Applying § 23, we see that if $F(s_1, s_2)$ denote the entropy of the

system formed by coupling (1) and (2), the geometrical equation (34) gives

$$\frac{q_1}{\partial F} = \frac{q_2}{\partial F} \quad \cdot \quad \cdot \quad \cdot \quad \cdot \quad \cdot \quad (53)$$

$$\frac{\partial F}{\partial s_1} = \frac{\partial F}{\partial s_2}$$

and this must be reducible, after dividing out by a common factor, to the form (52)

$$\phi_1 = \psi_2.$$

Therefore

$$\frac{q_1}{\Phi'(s_1)} = \frac{q_2}{\Psi'(s_2)} \quad \cdot \quad \cdot \quad \cdot \quad \cdot \quad \cdot \quad (54)$$

where $\Phi'(s_1)$ is a function of s_1 alone and $\Psi'(s_2)$ is a function of s_2 alone. Therefore, comparing (53) and (54), we must have

$$\frac{\partial F}{\Phi'(s_1) ds_1} = \frac{\partial F}{\Psi'(s_2) ds_2} \quad \cdot \quad \cdot \quad \cdot \quad \cdot \quad \cdot \quad (55)$$

Putting

$$\Phi(s_1) = \int \Phi'(s_1) ds_1, \quad \Psi(s_2) = \int \Psi'(s_2) ds_2 \quad \cdot \quad \cdot \quad (56)$$

(55) gives

$$\frac{\partial F}{\partial \Phi} = \frac{\partial F}{\partial \Psi} \quad \cdot \quad \cdot \quad \cdot \quad \cdot \quad \cdot \quad (57)$$

The integral of this can be written in the form

$$X(F(s_1, s_2)) = X(\sigma) = \Phi(s_1) + \Psi(s_2) + C \quad \cdot \quad \cdot \quad (58)$$

where X denotes any arbitrary function of F or σ .

Equation (58) determines the general form of the quantity corresponding to entropy in the system formed by coupling the two monocyclic systems (1) and (2) in a manner satisfying the conditions of the present problem.

Moreover, in the individual systems we have by (56)

$$\left. \begin{aligned} dQ_1 &= q_1 ds_1 = \frac{q_1}{\Phi'(s_1)} d\Phi(s_1) \\ dQ_2 &= q_2 ds_2 = \frac{q_2}{\Psi'(s_2)} d\Psi(s_2) \end{aligned} \right\} \quad \cdot \quad \cdot \quad \cdot \quad \cdot \quad (59)$$

so that the quantities $q_1/\Phi'(s_1)$ and $q_2/\Psi'(s_2)$, which are equated when the systems are coupled, are integrating divisors of dQ_1 and dQ_2 . This kind of coupling is therefore 'isomorous,' and is analogous to the thermal contact of bodies at the same temperature.

29. Thus Helmholtz has shown that all the thermodynamical properties of matter can be represented dynamically by means of monocyclic systems which are capable of being coupled together. In coupling such systems it has been assumed that—

(i.) The forces acting on the controllable coordinates are unaffected, so that only the motions of the molecular or gyrostatic coordinates are connected together, and the coupled system is monocyclic.

(ii.) The geometrical equations connecting the two systems can be put in the form $\phi_1 = \psi_2$, so that ϕ_1 and ψ_2 possess the same properties which

characterise temperature as the criterion of thermal equilibrium between two or more bodies.

It has also been deduced that ϕ_1 and ψ_2 are integrating divisors for the two respective systems, so that they satisfy the definition given by Carnot's laws.

The only other property of heat—namely, the principle of limited availability—follows at once on the hypothesis of § 26 as to the unconstrainable nature of the gyrostatic coordinates of the system, and the analogue is therefore complete.

30. Helmholtz is almost the only writer who has made any attempt at a *complete* mechanical theory of heat. The other writers have simply endeavoured to show that an equation of the form (2) can be deduced from dynamical considerations by assuming that the kinetic energy due to the uncontrollable motion of the system takes the place of temperature. This assumption is not necessary in Helmholtz's investigations—a great advantage considering our uncertainty as to the nature of temperature.

Although the properties of temperature are *explained* by means of monocyclic systems, it cannot be said that they are *proved* on these hypotheses. Thus, it would be very easy to couple a monocyclic system with two other systems in such a manner that the two latter could not also be coupled together—as, for example, in the case of revolving wheels connected together by cogs. What Helmholtz has done is to show the possibility of dynamical analogues and the conditions they must satisfy, rather than to establish an analogy between *all* dynamical systems and heated bodies.

The omission of the work done by intermolecular forces also introduces certain restrictions on the generality of the proof. In the vortex atom theory of matter no difficulty of any kind presents itself, because the vortex atoms are essentially monocyclic in character; but on Boscovich's hypotheses there will be difficulties, although these difficulties do not appear insuperable. There seems, for example, no reason why the molecular *potential* energy should not be controllable, in which case the work done by the intermolecular forces would be of the nature of available energy—available, that is, through the controllable coordinates of the body. Thus, for example, if we suppose a number of molecules enclosed in an envelope at rest under their mutual repulsions, and if we imagine the envelope to expand so that the distances between the molecules are increased, the intermolecular forces do work in expanding the envelope, and the whole of this work will be available. Thus there is nothing impossible in such an hypothesis. But it cannot be regarded as axiomatic, and can only be justified if it is found to accord with observed phenomena, among which must be included the Second Law itself. In fact, it must not be forgotten that the object of all such investigations is to discover theories which will account for facts, and not to prove facts by means of theories.

31. *Professor J. J. Thomson's Proof of the Second Law.*—The investigation now to be considered is one which in its principle and fundamental hypotheses is intimately related to Helmholtz's researches, although the method of proof is somewhat different. I refer to the proof of the Second Law given by Prof. J. J. Thomson in his 'Applications of Dynamics to Physics and Chemistry,' chap. vi. §§ 46–49. It is in connection with this investigation that the author introduces the terms *unconstrainable* and *controllable*, which he uses to distinguish coordinates defining the

states of the molecules of a body individually from those which define the state of the molecules in the aggregate.

It was stated in § 24 that, under certain circumstances, a polycyclic system may possess exactly the same properties as a monocyclic system, even though the coordinates defining the circulating motions of the system are all independent. The system considered by J. J. Thomson belongs to this class, for the necessary conditions are secured by the assumption which the author makes in the following statement concerning the kinetic energy due to the molecular or 'unconstrainable' coordinates u of the system: ¹—If the term

$$\frac{1}{2} \{ (uu) \dot{u}^2 + \dots \}$$

involves any 'controllable' coordinate ϕ , then it is evident that this coordinate ϕ must enter as a factor into all the terms in the form expressed by the equation

$$\frac{1}{2} \{ (uu) \dot{u}^2 + \dots \} = \frac{1}{2} f(\phi) \{ (uu)' \dot{u}^2 + \dots \} \quad (60)$$

where the coefficients $(uu)'$ do not involve ϕ , otherwise the phenomenon would be influenced more by the motion of some particular molecule than by that of others.² In other words, the investigation is limited in its application to the thermal properties of a single body, for in the case of a system of more than one body it is evident that the phenomena would be differently influenced by the motion of the molecules in different bodies. In such a case the molecular kinetic energy of each individual body would contain a common factor $f(\phi)$, which might be different for different bodies. Even in the case of a single body the assumption, though plausible, can hardly be regarded as axiomatic.

The other assumptions involved in J. J. Thomson's work are similar to those of Helmholtz, but they impose fewer restrictions on the generality of the proof. While Helmholtz assumes that the changes in the state of the system take place so slowly that the velocities of the controllable coordinates (q_a or ϕ) do not enter into the energy of the system, Thomson merely assumes that the portions of the kinetic energy due to the controllable and molecular coordinates are distinct, so that the whole kinetic energy is of the form

$$T = T_c + T_u \quad (61)$$

where the part T_u alone is to be taken as the dynamical analogue of temperature, the part T_c denoting the kinetic energy due to motions of the body as a whole and other *controllable* motions.

Moreover, Thomson only assumes that the *potential* energy of the system is a function of the controllable and not of the molecular coordinates, so that

$$\delta V = \sum \frac{\partial V}{\partial \phi} \delta \phi \quad (62)$$

and

$$\sum \frac{\partial V}{\partial u} \delta u = 0 \quad (63)$$

¹ *Applications of Dynamics*, pp. 94, 95.

² In comparing J. J. Thomson's proof with that of Helmholtz we must write $p_a = \phi, p_b = u, q_b = \dot{u}$.

while Helmholtz's investigations involve the assumptions of (21), namely, that

$$\frac{\partial H}{\partial p_u} \equiv \frac{\partial H}{\partial u} \equiv \frac{\partial V}{\partial u} - \frac{\partial T}{\partial u} = 0 \quad . \quad . \quad . \quad (64)$$

assumptions which characterise the molecular coordinates as gyrostatic or speed coordinates.

With the above assumptions it is shown that

$$\frac{\delta Q}{T_u} = \sum \delta \log f(\phi) + \delta \log T_u \quad . \quad . \quad . \quad (65)$$

an equation analogous to the Second Law (2). Also

$$\left(\frac{\partial Q}{\partial \phi}\right)_{T_u \text{ constant}} = -T_u \left(\frac{\partial \Phi}{\partial T_u}\right)_{\phi \text{ constant}} \quad . \quad . \quad . \quad (66)$$

where Φ is the generalised component of external force corresponding to the coordinate ϕ . This relation is analogous to the well-known thermodynamical relation

$$\left(\frac{\partial Q}{\partial v}\right)_{\theta \text{ constant}} = \theta \left(\frac{\partial p}{\partial \theta}\right)_{v \text{ constant}} \quad . \quad . \quad . \quad (67)$$

32. J. J. Thomson also mentions the case in which V , the potential energy of the system, is a function of the molecular as well as of the controllable coordinates. But here he tacitly assumes that the molecular coordinates only enter into V in the form of the *temperature*, an assumption quite unjustifiable from dynamical considerations, for no dynamical meaning can be attached to temperature until the Second Law has been *completely* (*vide* §§ 2, 3) established by dynamical principles.

On the hypothesis that T_u is the quantity which is analogous to temperature in the dynamical system, the assumption takes the form

$$\sum \frac{\partial V}{\partial u} \delta u = \frac{\partial V}{\partial T_u} \delta T_u \quad . \quad . \quad . \quad (68)$$

and unless this condition is satisfied the relation (66) will *not* be true, as J. J. Thomson asserts, when the potential energy is a function of the molecular as well as of the controllable coordinates.

Concerning the *physical* aspect of equation (68) Mr. C. V. Burton has suggested to me the following argument:—If we consider a vessel of unalterable volume containing ice, water, and steam at the triple point it is evident that heat may be communicated to the system isothermally, the effect being to decrease the quantity of ice and to increase the quantity of water and of steam without altering the pressure or volume. In this case the molecular potential energy would in all probability be increased without any concomitant change in the temperature or in the potential energy of the controllable coordinates.

33. *H. Poincaré on the Applicability of Monocyclic Systems to Irreversible Processes.*—The question whether Helmholtz's monocyclic systems can be employed to illustrate irreversible processes has been considered by Mons. H. Poincaré,¹ and answered by him in the negative; but his investigation is far from satisfactory.

In the first place, he points out that an irreversible process is only

¹ *Comptes Rendus*, cviii. (1889), p. 550.

dynamically possible when the Lagrangian function contains odd powers of the generalised velocities, and that this is the case when it has been modified so that some of the velocities have been ignored owing to the corresponding generalised momenta being constant. But this simply means that the ignored velocities are not to be reversed when the motion of the system is reversed. It is easy to see that in a dynamical system it is not in general possible to reverse some of the motions without reversing them all.

Poincaré now considers, as a test case, that in which the system is acted on by no external forces, and he considers, more particularly, what happens when the entropy is approaching its maximum, his object being to discover whether there is any dynamical way of proving the fundamental thermodynamic property that the entropy of a system is continually increasing. If such is the case, then, taking S as the entropy, dS/dt must always be positive. Now, taking E as the energy and adopting the notation of Helmholtz, the Hamiltonian equations give

$$\frac{dp}{dt} = \frac{\partial E}{\partial s}, \quad \frac{ds}{dt} = -\frac{\partial E}{\partial p};$$

whence

$$\frac{dS}{dt} = \sum \left(\frac{\partial S}{\partial p} \frac{\partial E}{\partial s} - \frac{\partial S}{\partial s} \frac{\partial E}{\partial p} \right) \dots \dots \dots (69)$$

In the subsequent investigation Poincaré assumes that when the entropy is a maximum the system must be in stable equilibrium, so that in this condition of the system we have not only

$$\frac{\partial S}{\partial p} = 0 \quad \text{and} \quad \frac{\partial S}{\partial s} = 0,$$

but also

$$\frac{ds}{dt} = \frac{\partial E}{\partial p} = 0 \quad \text{and} \quad \frac{dp}{dt} = \frac{dE}{dS} = 0.$$

Such a step appears to me to be quite unjustifiable, for it amounts to nothing less than assuming that the system under investigation is at the absolute zero of temperature, and the entropy in such a case will of course be infinite.

If we have any number of bodies enclosed in an adiathermanous envelope it is known from physical, not dynamical, considerations that the entropy of the system will tend to a maximum as the temperatures of the various bodies become equalised, and yet when all the bodies are at the same temperature the molecules are still in a lively state of motion, not at rest, as in Poincaré's investigation.

It is also to be noted that Poincaré nowhere makes use of the fact that S is the entropy of the system.

Hence it is difficult to see how Poincaré's result can have any direct bearing on the principle of degradation of energy or even how it can have a thermodynamical interpretation at all.

34. At the same time, there are many considerations which render it *primâ facie* unlikely that the monocyclic method should be capable of accounting for the principle of degradation of energy.

A system which is irreversible will certainly not be monocyclic according to the definition of Helmholtz, and hence we cannot assume

that the geometrical equations which that author has investigated will any longer hold good; the same may also be said with regard to the alternative hypothesis underlying J. J. Thomson's investigation. Moreover, even if the latter hypothesis be assumed to hold good for an unequally heated body, the function which plays the part of temperature will be the whole molecular kinetic energy, so that instead of the entropy we shall obtain an expression which does not alter in value as the temperatures of the various parts become equalised. Another hypothesis, which does not seem to me to be unreasonable, is that possibly irreversible changes may take place when any portion of the potential energy of the system depends partly on the molecular as well as on the controllable coordinates of the system, so that this portion of potential energy, as well as the kinetic, is uncontrollable. But then there appear to be no grounds, except from statistical considerations, for supposing that this energy will all be rendered kinetic by the action of the intermolecular forces. Such would certainly not be the case in a system possessing only one or two degrees of freedom.

The consideration of dissipative forces, such as friction, is of course precluded by the conditions of the problem, for their presence would be a violation of the principle of Conservation of Energy. And as we are thus left with a dynamical system which is perfectly reversible (provided that the system is complete and all the velocities are reversed), it seems necessary to accept the principle of degradation of energy as a statistical property and not as a dynamical principle. We shall consider the matter more fully in the third section of this Report.

35. *Dr. Ludwig Boltzmann on the Mechanical Representation of Monocycles.*—In his paper on the properties of monocyclic systems, already referred to,¹ Dr. Boltzmann discussed at great length a mechanical model illustrative of a system in which it appeared not only that dQ/T was not a perfect differential, but that dQ did not possess any integrating factor whatever.

In a volume only just published² Boltzmann has again taken up the representation of monocyclic systems by means of mechanical models, and has slightly elaborated ideas suggested in Helmholtz's papers. On account of their greater simplicity we will consider the latter representations before the former.

As a simple example of a monocyclic system Boltzmann takes a vertical revolving shaft having attached to it a horizontal spoke along which a bead can slide without friction. A string, which is attached to the bead, passes over a small pulley close to the shaft, and hangs freely, carrying a scale-pan, on which varying weights can be placed. The arrangement may be illustrated by the shaft C D and the spoke carrying the mass E in the figure of § 38.

If we suppose the shaft and spoke to be without mass, and if m be the mass of the bead, r its distance from the shaft, ω the angular velocity, T the kinetic energy of the system, and dQ the amount of work performed by turning a handle attached to the shaft, we have

$$\frac{dQ}{T} = d \log (r^4 \omega^2) \quad . \quad . \quad . \quad (70)$$

¹ Crelle, *Journal*, xxviii. p. 88.

² *Vorlesungen über Maxwell's Theorie der Electricität und des Lichtes*, I. Theil (Leipzig: Johann Ambrosius Barth, 1891), pp. 8–23.

The right-hand side is equal to $d \log (s^2)$, where s is the angular momentum, thus agreeing with Helmholtz's result (§ 21, equation 27).

Boltzmann shows how such a machine may be made to undergo a series of transformations analogous to Carnot's cycle. In an isothermal transformation the angular velocity and the distance of the bead from the shaft are varied in such a manner that the kinetic energy of rotation remains constant; in an adiabatic transformation no work is performed on the shaft, and therefore the angular momentum, $mr^2\omega$, as also the corresponding entropy, remains constant.

The author gives other models of monocycles in which several movable rods and beads are attached to the same shaft. A Watt's governor is another simple example of a monocycle. Other examples of 'kinetic engines' were given by Professor Osborne Reynolds in a lecture delivered on November 15, 1883.¹

36. An attempt is also made by Boltzmann to extend the dynamical analogy to irreversible processes, by showing that for a cycle of changes which do not take place infinitely slowly we must have $\int dQ/T < 0$. Unfortunately, however, this generalisation does not hold good if the system is frictionless, and, as already remarked, the introduction of friction is not allowable in forming a purely dynamic analogue of the properties of heat. Boltzmann assumes that *when the bead is sliding outwards along the spoke, the tension in the string is always slightly less than the centrifugal force, and that when the bead is sliding inwards the tension is always slightly greater than the centrifugal force*; for otherwise (he says) the bead and suspended weights would never start moving. Thus if p denote the tension in the string, we may put

$$p = mr\omega^2 - e,$$

where e always has the same sign as dr .

But the statements in italics are not true if the spoke is frictionless, for the equation of motion of the bead is

$$m \frac{d^2r}{dt^2} = mr\omega^2 - p,$$

so that

$$e = m \frac{d^2r}{dt^2}.$$

If the bead be allowed to slide outwards, starting at distance r_1 and stopping at distance r_2 , then d^2r/dt^2 must be at first positive and afterwards negative, for otherwise the outward velocity dr/dt would continually increase. Hence e cannot always have the same sign as dr , and Boltzmann's argument fails.

37. Boltzmann's mechanical representation of a system in which dQ has no integrating divisor consists of two parallel revolving vertical shafts, which we will call A, B, each similar to that described in § 35 and figured in § 38, each provided with a horizontal revolving spoke, along which a bead is capable of being made to slide. The motions of the two shafts are connected together through the following mechanism:—The motion of A is transmitted by means of bevelled cog-wheels to a horizontal shaft C, carrying at its other end a rough disc G, which of course revolves in a vertical plane. Attached to the vertical shaft B is a

¹ *Nature*, vol. xxix. p. 113.

horizontal disc H, the *edge* of which is in contact with the *face* of the disc G. The motion of the horizontal shaft is transmitted to the vertical shaft B by means of the friction at the point of contact of the two discs G, H. The disc H is capable of being raised or lowered on the shaft B, and in this way the ratio of the angular velocities of the two shafts A and B can be varied. Lastly, the system is set in motion by turning a handle attached to the shaft A.

Let m, μ be the masses of the beads on the spokes attached to the shafts A, B; let r, ρ be their distances from the axes, w, ω the angular velocities of the shafts, a the adjustable height of the horizontal disc H above the axis of the horizontal shaft C. Boltzmann assumes the disc H to be of unit radius, and the radii of the bevelled cog-wheels connecting A, C to be equal, so that the angular velocities of the shafts A, B are connected by the relation

$$\omega = aw.$$

If, with Boltzmann, we neglect the inertia of everything except the sliding beads, and supposing that r, ρ, a only vary very slowly, the kinetic energy is evidently

$$T = \frac{1}{2} (mr^2w^2 + \mu\rho^2\omega^2) = \frac{1}{2} (mr^2 + \mu\rho^2a^2) w^2.$$

The system has four generalised coordinates, namely, r, ρ, a , and the angular coordinate corresponding to the angular velocity w . The latter is the only speed coordinate of the system, for the kinetic energy does not involve the rates of change of the other coordinates.

Hence if we follow Helmholtz's assumptions (i.), (ii.) of § 20, the coordinates r, ρ, a must be regarded as controllable, and the system is monocyclic. We have, in fact,

$$s = \frac{\partial T}{\partial w} = (mr^2 + \mu\rho^2a^2)w, \quad T = \frac{1}{2}ws,$$

and

$$dQ = wds = Td(2 \log s),$$

so that T is an integrating divisor of dQ .

This result is quite at variance with that found by Boltzmann. The reason is that he has not regarded r, ρ, a as controllable, but has included in dQ the work brought into the system through these coordinates. This work properly belongs to $-dW$ of equation (i.), § 2, and not to dQ .

In varying the height a there would, in the natural course of events, be a loss of energy through friction, as the edge of the horizontal disc H would have to slip up or down in contact with the face of the vertical disc G. This slipping may be avoided by shifting the vertical shaft B slightly to one side or the other of the vertical plane through the horizontal shaft C. The friction between the rotating discs will then cause H slowly to rise or fall (as the case may be) automatically and without slipping.

This simple device obviates a difficulty which in Boltzmann's original paper requires several pages of explanation.

38. *Simple Mechanical Model of Carnot's Reversible Heat-Engine.*—The following model appears to be new. It may be of interest as furnishing a mechanical representation of the properties of the source and refrigerator of a perfect heat engine, although to do this it is necessary

to take the angular velocity instead of the kinetic energy to represent temperature. In this respect the model resembles the example (i.) given in § 27, and the angular momentum takes the place of entropy.

As in Boltzmann's models, I suppose the working substance represented by a hollow vertical revolving shaft C D, carrying a spoke on which the mass E is free to slide. This shaft is terminated by circular discs C, D; while the source and refrigerator of the engine are represented by discs A, B, made to revolve with constant but unequal angular velocities, ω_1, ω_2 . The discs C and A or D and B may be rigidly connected together only when their angular velocities are equal, just as, in Carnot's engine, the working substance and the source or refrigerator are only placed in contact when their temperatures are equal.

The string S passes down the interior of the shaft, and, instead of hanging down freely, it may be passed over a fixed pulley R, its pull being adjusted in any convenient manner. A frictionless swivel I prevents torsion accumulating in the string.

The four operations of Carnot's cycle will now be represented as follows:—

(i.) The angular velocity of the shaft C D being initially ω_2 , work is done on the system by pulling out the string S (and thus bringing the mass E nearer to the axis of rotation) until the angular velocity has been increased to ω_1 . Since the angular momentum meanwhile remains constant, this operation is isentropic.

(ii.) The discs C and A may now be rigidly connected together, so that during this operation the angular velocity must remain equal to ω_1 ,

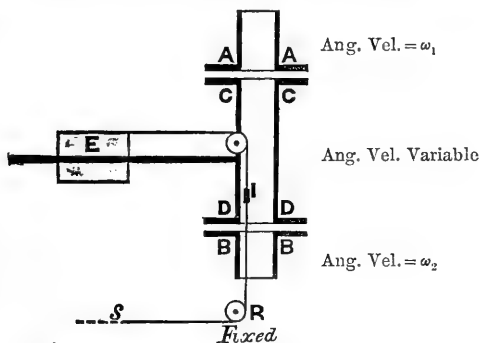

the change being isothermal. The mass E is then allowed to slide further out, doing work on whatever contrivance maintains the pull in the string.

(iii.) The discs C and A are disconnected, and, the angular momentum remaining constant, the mass E is allowed to slide still further out, again doing work by means of the string. This operation must continue until the angular velocity is reduced to ω_2 .

(iv.) The discs D and B are now rigidly connected, and work is done on the system by pulling out the string until the mass E has regained its original distance from the axis of rotation.

The cycle is now complete, and is obviously reversible. If Q_1 is the

energy acquired by the system from A, and Q_2 the energy given out to B, it is easy enough to show that

$$\frac{Q_1}{\omega_1} = \frac{Q_2}{\omega_2} \quad . \quad . \quad . \quad . \quad . \quad (71)$$

corresponding to the well-known thermodynamic equation. At the same time the external work performed by the string is $Q_1 - Q_2$.

If s_1 and s_2 be the angular momenta of the shaft and spoke during the operations (i.) and (iii.) respectively, either member of (71) is equal to $s_2 - s_1$.

If two discs were brought into contact when their angular velocities were unequal, there would be a loss of energy by friction, so that the analogy with an *irreversible* cycle would not be complete.

SECTION III. *Statistical Hypotheses.*

39. The investigations now to be considered depend on the existence of a certain law of average distribution of speed, which holds whenever an enormously large number of molecules is in a state of steady or stationary motion. This remark applies to the Kinetic Theory of Gases, and the methods are only applicable when the nature of the molecules is such that the law of distribution in question is capable of investigation.

Among the more recent researches bearing on the subject may be particularly mentioned Professor Tait's papers 'On the Foundations of the Kinetic Theory of Gases,'¹ Dr. Boltzmann's papers on the 'Analogies of the Second Law'² and on the 'Properties of Monocyclic and other Related Systems,'³ and Sir William Thomson's recent communication to the Royal Society 'On some Test Cases for the Maxwell-Boltzmann Doctrine regarding Distribution of Energy.'⁴

40. *The Boltzmann-Maxwell Doctrine.*—The law of distribution of speed is variously known as Boltzmann's Theorem and Clerk Maxwell's Theorem, being due in part to one writer and in part to the other. It seems to have been first discovered by Clerk Maxwell for the case of a number of perfectly elastic smooth colliding spheres of two or more different magnitudes, or, if preferred, a number of simple particles which repel one another when at a certain distance apart, after the manner of perfectly elastic spheres.⁵ The theorem was subsequently generalised by Boltzmann⁶ for the case of a system of particles repelling one another according to any law, and was finally generalised still further by Maxwell⁷ for a number of molecules, each consisting of a dynamical system

¹ *Trans. R.S. Edinburgh*, 1886-91.

² 'Analogien des zweiten Hauptsatzes der Thermodynamik,' *Crelle, Journal*, c. p. 213.

³ 'Ueber die Eigenschaften monocyclischer und anderer damit verwandter Systeme,' *Crelle, Journal*, xcvi. p. 68.

⁴ *Nature*, August 13, 1891.

⁵ 'On the Collisions of Elastic Spheres,' *Phil. Mag.* 1860; 'On the Dynamical Theory of Gases,' *Phil. Trans. R.S.* May 1866.

⁶ 'Ueber die mech. Bedeut. des 2^{ten} Haupts. d. mech. Wärmelehre,' *Wiener Sitzb.* Bd. 53, pp. 195-220. 'Studien über das Gleichgew. d. leb. Kraft zwischen beweg. mater. Punkten,' *ibidem*, Bd. 58 (1868). 'Ueber das Gleichgew. zwischen mehratom. Gasmolekülen'; 'Analyt. Beweis des 2^{ten} Haupts. d. mech. Wärmetheorie aus d. Sätzen für den Gleichgew. d. leb. Kraft'; 'Einige allgem. Sätze über Wärme-Gleichgewicht,' *Wiener Sitzb. Mathem. Naturw. Klasse*, Band 63.

⁷ 'On Boltzmann's Theorem,' &c., *Trans. Camb. Phil. Soc.* 1878.

defined by means of any generalised coordinates whatever. The case when the molecules are in a field of force due to external influence while the only intermolecular forces are those due to impact is considered by Dr. Watson in his 'Kinetic Theory of Gases.'

Clerk Maxwell's theorem in its most general form states that when a system of molecules has attained the 'special' or stationary state the time-average of the kinetic energy is equally distributed over the different degrees of freedom of the system.

It now remains to examine how far the successive generalisations have since been proved or disproved; accordingly we shall consider them in the following order:—

- (i.) Colliding elastic spheres under no forces.
- (ii.) Colliding elastic spheres in a field of force.
- (iii.) Simple particles or smooth spheres under molecular forces.
- (iv.) Molecules of a perfectly general character.

41. The first case, that of colliding spheres under no forces, has been considered by Tait in his important papers 'On the Foundations of the Kinetic Theory of Gases.'¹ Tait finds that the theorem *does* hold good provided that the following assumptions be made:—

- (a) That the particles of the two gases are thoroughly mixed.
- (b) That the particles of each gas acquire the error-law of speed.
- (c) That there are free collisions between particles of the same as well as of different kinds, and that one kind does not preponderate overwhelmingly over the other.

42. The second case also has been verified by Tait in the same contribution. He considers the case in which the field of force is uniform, like that due to gravity. A limitation is thus imposed on the generality of the proof, for the investigation does not hold good when the external force varies so rapidly from point to point that the change from molecule to molecule is appreciable. On the contrary, it must be possible to divide up the mass of gas into elements which are so small that the force over any such element may be considered uniform, and nevertheless each element must contain such a large number of molecules that the distribution of energy in it can be investigated by Tait's method.

This limitation is not assumed in the proof given by Watson,² but it seems doubtful whether the theorem is valid except under some such restriction. One of the 'test cases' considered by Sir William Thomson in his recent paper³ may possibly throw some light on this question; I refer to the case of a system of particles moving in two dimensions in a field of force whose potential is of the form

$$V = \frac{1}{2} (\alpha^2 x^2 + \beta^2 y^2 + cx^2 y^2).$$

Thomson concludes that the portions of average kinetic energy due to the two velocity components \dot{x} and \dot{y} are probably not in general equal to one another. The author considers a system in which no collisions occur. The existence of collisions would, of course, materially affect the

¹ *Trans. R.S.E.*, vol. xxxiii. part 1 (1886), p. 77.

² *Kinetic Theory of Gases*, Prop. IV.

³ Read to the Royal Society, June 11, 1891, *Nature*, August 13, 1891, § 13.

distribution of energy between the two velocity components of the particles, and it seems reasonable to draw the following inferences regarding the more general case:—

(i.) If the molecules are very few and far between, impacts will seldom occur, and the distribution will approximate to what it would be if there were no impacts, as in the case considered by Thomson.

(ii.) If the molecules are densely distributed, impacts will be numerous, so that the distribution of speed will depend mainly on these impacts, and will approximate to that investigated by Tait for a uniform field.

(iii.) In intermediate cases the distribution of speed will be determined partly by the impacts and partly by the variations in the field. It will, therefore, be *intermediate* between those investigated by the method of Thomson and that of Tait. A complete investigation of such a case would probably be one of great difficulty.

43. The third case—namely, that in which the intermolecular forces are other than those due to impact—presents a new feature of difficulty: it now becomes necessary to take account of the possibility that three or more particles may be simultaneously within mutual influence of one another; for the probability of this is no longer infinitely small, as it is in the case of simple impacts.

In his recent paper already alluded to, Thomson considers this point, more especially with reference to a system composed of double molecules or 'doublets.' A compound gas is an example of such a system. Here a complete collision may consist of a large number of impacts, and the author remarks that 'it seems exceedingly difficult to find how to calculate true statistics of these chattering collisions and arrive at sound conclusions as to the ultimate distribution of energy in any of the very simplest cases other than Maxwell's original case of 1860.'¹

It seems, however, unnecessary to consider multiple collisions if either of the following conditions is satisfied:—

(a) If the range of molecular action lies between narrow limits, so that the collision is approximately of the nature of a simple impact.

(b) If the intermolecular force only acts when the particles are at a considerable distance apart. The 'radius of encounter,' as it may be called, being thus very great, we may safely assume that the aggregate effect on any molecule of such a system of distant molecules is constant, and therefore equivalent to that of a field of external force. Unfortunately, however, this case is of little interest.

A difficulty of a different kind has been indicated by Tait²—namely, that of giving a satisfactory answer to the question, 'What is to be taken as the measure of the temperature?' According to the views of Clausius, Van der Waals, and others, the whole average kinetic energy per molecule measures the temperature; but Tait gives reasons for believing that the temperature depends on the mean square speed of the *free* paths of the molecules, and is therefore measured by the value of the average kinetic energy when (with the same mean square speed of free path) the volume is infinite. In other words, Tait supposes the temperature measured by the average kinetic energy per *free* molecule. If the mean square speed be kept constant, the whole kinetic energy will vary with the volume of the gas, and thus on the hypothesis of Clausius

¹ *Nature*, August 13, 1891, § 8.

² 'On the Virial Equation for Molecular Forces, being Part IV. of a paper on the Foundations of the Kinetic Theory of Gases,' *Proc. R.S.E.* 1890.

the temperature would vary instead of, as it should, remaining constant. Moreover, in the case of a liquid in contact with its vapour at the same temperature, the whole kinetic energy per molecule should be equal in the two portions, and this again appears improbable.

44. The last and most general case of all is that investigated by Maxwell in 1878,¹ where the molecules consist of dynamical systems determined by means of generalised coordinates. It has now been proved beyond doubt that the theorem is *not* valid in this general form. As a test case, Burnside² has considered a system of colliding elastic spheres, in which the centre of mass does not coincide with the centre of figure, but is at a small distance, c , from it. He finds that the average energies of rotation of any sphere about each of the three principal axes through the centre of inertia are equal, and that the whole average energy of rotation is *twice* the whole average energy of translation. Had Maxwell's theorem been true, the whole average energies of rotation and translation would have been equal.

Maxwell's proof is defective in several respects. One of the chief fallacies lies in his assumption that the kinetic energy of a dynamical system can always be expressed as a sum of squares of generalised velocity components. At the same time, he assumes that the Lagrangian or Hamiltonian equations of motion can be applied to the corresponding generalised coordinates of the system. This is not in general true; thus, for example, it is not true in the simple case of a single rigid body. Here the kinetic energy due to rotation can be expressed as a sum of squares of the angular velocities about the three principal axes, but these angular velocities are not the rates of change of generalised coordinates which determine the position of the body at any instant.³ Thus the want of agreement between Maxwell's theorem and Burnside's result is only what might have been expected.

In the paper already referred to Thomson says, 'But, conceding Maxwell's fundamental assumption, I do not see in the mathematical workings of his paper any proof of his conclusion "that the average kinetic energy corresponding to any one of the variables is the same for every one of the variables of the system." Indeed, as a general proposition, its meaning is not explained, and seems to me inexplicable. The reduction of the kinetic energy to a sum of squares leaves the several parts of the whole with no correspondence to any defined or definable set of independent variables. What, for example, can the meaning of the conclusion be for the case of a jointed pendulum (a system of two rigid bodies, one supported on a fixed horizontal axis, and the other on a parallel axis fixed relatively to the first body, and both acted on only by gravity)? The conclusion is quite intelligible, however (but is it true?), when the kinetic energy is expressible as a sum of squares of rates of change of single coordinates each multiplied by a function of all, or of some, of the coordinates.'⁴

45. Many physicists have objected to the Boltzmann-Maxwell theorem on account of 'the supposition that the mean energy of any kind of vibration in any atom must be equal to that of translation in any

¹ *Trans. Camb. Phil. Soc.* 1878.

² 'On the Partition of Energy between the Translatory and Rotatory Motions of a Set of non-homogeneous Elastic Spheres,' *Trans. R.S.E.* vol. xxiii. Part II.

³ Compare Routh, *Rigid Dynamics*, vol. i. § 406, Ex. 1.

⁴ *Nature*, August 13, 1891, § 10.

direction, and therefore capable of unlimited increase.'¹ According to Thomson, however,² 'what has hitherto by Maxwell, and Clausius, and others after them, been called an "elastic sphere" is not an elastic solid capable of rotation and of elastic deformation, and therefore capable of an infinite number of modes of steady vibration, of finer and finer degrees of nodal subdivision, and shorter and shorter periods, into which all translational energy would, if the Boltzmann-Maxwell generalised proposition were true, be ultimately transformed. The smooth "elastic spheres" are really Boscovich point-atoms with their translational inertia, and with for law of force zero force at every distance between two points exceeding the sum of the radii of the two balls, and infinite repulsion at exactly this distance.'

It may also be observed that a sphere in which vibratory energy is set up on impact cannot be regarded as a 'perfectly elastic sphere' with coefficient of restitution equal to unity. The necessity of adopting Thomson's representation by Boscovich point-atoms is otherwise apparent when we remember that as long as the portions of matter with which we are dealing are capable of subdivision, so long will the energy contained in them be capable of subdivision. Unless, therefore, we suppose each molecule to consist of one or a finite number of indivisible atoms, it would be unreasonable to expect that heat would entirely take the form of atomic motion.

46. *Applications to the Second Law.*—The simplest proof of the Second Law of Thermodynamics based on the hypothesis of the Boltzmann-Maxwell law of distribution of speed is that due to Mr. S. H. Burbury.³ The proof is too well known to need description here. It leads to the same form for the entropy as Boltzmann's original investigation for the case of a system of point-atoms.⁴ Although Watson and Burbury take the temperature as represented by the average kinetic energy of translation of the molecules, the fact that the average energy is assumed to be distributed equally among the coordinates shows that the proof would be equally valid if the whole average kinetic energy were taken to represent the temperature. Hence the proposition (when valid) does not afford any evidence as to what part of the molecular energy plays the part of temperature.

Another proof has been given by R. C. Nichols,⁵ and is based on the virial equation of Clausius,

$$pv = \frac{2}{3} (T - \sum \sum (\frac{1}{2} Rr)).$$

Here T is the *total mean vis viva* of the system, so that if Nichols' proof be valid, it does not seem possible to reconcile the views of Tait (§ 43) regarding the nature of temperature with the definition afforded by the Second Law.

A general proof of the Second Law, based on Maxwell's generalisation of Boltzmann's theorem, has been given by Boltzmann in 1885.⁶ The

¹ Prof. W. M. Hicks, *B.A. Report*, 1885.

² *Nature*, August 13, 1891, § 3. I have slightly rearranged the original wording, so as to make the sentence more intelligible.

³ *Phil. Mag.* January 1876, p. 61; Watson's *Kinetic Theory of Gases*, Prop. XIII.

⁴ 'Analyt. Beweis des 2^{ten} Haupts,' *Wien. Sitzb.* Bd. 63, II. Abth.

⁵ 'On the Proof of the Second Law of Thermodynamics,' *Phil. Mag.* 1876 (1), p. 369.

⁶ Crelle, *Journal*, c. p. 213.

author employs the method of reduction to sums of squares and subsequent use of Lagrange's equations—in short, most of the steps that are erroneous in Maxwell's work; the proof is therefore invalid except in certain special cases. One result is, however, interesting; for the case of a system whose configuration is determined by a single coordinate, and whose period of oscillation is t , Boltzmann finds

$$\delta Q = 2T\delta \log_e (Tt) \quad . \quad . \quad . \quad (72)$$

thus giving for the entropy the expression found by Clausius, and described in the first section of this Report (§ 12, equation (14)).

47. *Statistical Construction of Monocyclic Systems.*—A very interesting and suggestive paper has been published by Boltzmann,¹ who has shown how systems possessing monocyclic properties can be built up by combining a large number of systems which are similar to one another, but not individually monocyclic. This is the paper to which reference has been made in § 37.

A single particle moving in an elliptic orbit about a centre of force in the focus is not monocyclic in itself, but a monocyclic system may be built up by taking a very large number of such particles, thus forming a stream or a kind of Saturn's ring, whose density at any point of the orbit is independent of the time. Here, if the attraction at distance r be a/r^2 , Boltzmann finds

$$dQ = Td \log \frac{a^2}{T} = qds,$$

where

$$q = \frac{2T^{\frac{3}{2}}}{a}, \quad s = \frac{a}{T^{\frac{1}{2}}}.$$

Moreover, if μ is the total flux across any section up to the time t , and m the mass of the ring, we have

$$q = \sqrt{\frac{2\pi}{m}} \frac{d\mu}{dt},$$

and, therefore, $\int qdt$ may be taken as a generalised coordinate of the system.

Another example is afforded by a stream of particles of total mass m performing rectilinear oscillations under a conservative system of forces. In this case Boltzmann finds

$$dQ = 2Td \log_e iT. \quad . \quad . \quad . \quad (73)$$

which agrees with Clausius' result (equations 14, 72). Here we may take for the generalised velocity and momentum of the system respectively,

$$q = m/i, \quad s = 2T/q = 2iT/m. \quad . \quad . \quad (74)$$

A particular case is that of a stream of particles reflected backwards and forwards between two fixed perfectly elastic parallel walls at a distance a apart. If $\frac{1}{2}m$ is the mass of the stream going in either direction, v the velocity, and H the kinetic potential, we have

$$dQ = mvdv + mv^2 \frac{da}{a} = qds \quad . \quad . \quad . \quad (75)$$

¹ Crelle, *Journal*, xcvi. p. 68.

where

$$q = \frac{mv}{2a}, \quad H = -T = -2 \frac{a^2 q^2}{m}, \quad s = -\frac{\partial H}{\partial q} = -\frac{4a^2 q}{m} = 2av \quad . \quad (76)$$

and $-\partial H/\partial a$ is the pressure on either wall.

This system is strictly monocyclic.

Boltzmann modifies this example slightly by considering the case of a mass m formed of minute particles contained in a rectangular box, whose sides are a, b, c , the directions of motion being parallel to the face (ab) and inclined to the edges a at an angle $=D$. Taking a, b , and v as variable, we have

$$-H = T = \frac{mv^2}{2}, \quad dQ = mv dv + mv^2 \left(\sin^2 D \frac{da}{a} + \cos^2 D \frac{db}{b} \right) \quad (77)$$

and to put the last equation into Helmholtz's form we must assume

$$q = \frac{v}{a^{\sin^2 D} b^{\cos^2 D}}, \quad s = -\frac{\partial H}{\partial q} \quad . \quad . \quad . \quad (78)$$

But the kinetic energy is no longer an integrating divisor of dQ if we suppose the angle D variable. It is not hard to explain why this case differs from the others considered by Boltzmann. The angle D cannot be considered as a controllable coordinate of the system, for it can only be varied by acting on all the molecules individually. Moreover, it is not a speed-coordinate, so that Helmholtz's methods are no longer applicable. The effect of slightly rotating the box would be not merely to produce an alteration in the angle of incidence D , but to alter the character of the motion entirely, for the particles which are about to impinge on the face ac would be differently affected from those about to impinge on the face bc .

Boltzmann follows up these simple examples by a perfectly general investigation based on Maxwell's theorem, from which it appears that any system which conforms to the Boltzmann-Maxwell doctrine possesses monocyclic properties analogous to those found by Helmholtz. The results obtained by Boltzmann do not hold good, except in the particular cases when Maxwell's theorem is valid. Two cases are considered—that in which all coordinates of the system are independent, and that in which certain coordinates are connected by invariable relations. The arguments employed by Boltzmann in discussing the latter case appear wanting in rigour, thus rendering the result liable to further objections. The remainder of the paper is chiefly taken up with a discussion of the models referred to in our second section.

48. *Application of Statistical Methods to Irreversible Phenomena.*—In a recent note¹ Mr. E. P. Culverwell has called attention to the principal difficulties attending the explanation of irreversibility on the hypotheses of the kinetic theory of gases. The general purport of his remarks may be summarised as follows:—

(i.) Although the distribution of energy when a gas has assumed the Boltzmann configuration (or, as Tait calls it, the 'special state') has been investigated, it has never been proved that a gas does actually tend towards this 'special state.'

¹ 'Note on Boltzmann's Kinetic Theory of Gases, and on Sir W. Thomson's Address to Section A (1884),' *Phil. Mag.* 1890, vol. xxx. p. 95.

(ii.) Such a tendency cannot be independent of the law of force between the molecules, for if we take the case of a system of particles attracting one another with forces varying directly as the distance, the motion will be strictly periodic, and there will be no tendency towards equalisation of energy.

(iii.) The tendency cannot be independent of initial circumstances, for if the motion of every point were reversed we should have a configuration which would tend further and further away from the 'special state.'

(iv.) It therefore appears probable that in estimating the tendency to equalisation of energy among the molecules, account must be taken of the effects of the luminiferous æther. The molecules cannot be considered as forming a complete dynamical system in themselves. It seems, then, impossible to overcome the difficulties of the kinetic theory; all that can be done is to shift these difficulties from the molecules on to the æther, and they then reappear in another form.

We will now examine how far these difficulties have been met by the researches of those who take a less gloomy view of the question.

It is no doubt impossible, from the inherent difficulty of the problem, to investigate any *general* property of non-reversible processes in a body composed of an infinitely large number of molecules; for, when even the 'Problem of Three Bodies' has not been fully solved, how can we expect to fully solve the problem of an infinite number of bodies?

But without doing this it is possible to investigate certain irreversible phenomena by the methods of the kinetic theory, and thus to account for the degradation of available energy under circumstances in which the problem is soluble.

49. Thus Tait¹ has worked out the rate of equalisation of average energy in a mixture of two kinds of spheres. He has, moreover, applied his formulæ to the case of a mixture of equal parts of oxygen and nitrogen on the supposition that the aggregate masses are equal, that the number of molecules per cubic inch = $\frac{3}{2} \times 10^{20}$, and that the sum of the radii of the molecules = 3×10^{-8} of an inch. He finds that the difference of the average energies of the two systems of molecules will fall to .01 of its original value in $\frac{1}{3} \times 10^{-9}$ of a second. This result surely affords very strong evidence in favour of a general tendency towards the 'special state.'

Moreover, the kinetic theory has been applied to explain the phenomena of heat-conduction, viscosity, diffusion of a mixture of gases, and other irreversible processes. These have all been worked out by Tait in the same series of papers. One very great merit of his work is that he has in every instance clearly set forth the assumptions on which his proofs are based. The investigations are, therefore, not liable to objection, as is so often the case with the work of writers who have implicitly made similar assumptions without explicitly stating them.

With regard to the second point, Sir W. Thomson has pointed out² that the law of the direct distance possesses unique properties distinct from those of any other law. It is, in fact, the only law of force under which the whole motion is strictly periodic and the equations of motion are completely integrable—a fact sufficiently well known to manufacturers of Senate House problems. But as there is still some uncertainty

¹ 'On the Foundations of the Kinetic Theory of Gases,' *Trans. R.S.E.* 1886, Section V.

² *On Some Test Cases*, &c. § 10.

respecting the *permanent* distribution of energy in a system of material points under intermolecular forces, it would be premature to form conclusions regarding the tendency towards the equalisation of energy, except in those cases where the only reactions between the points are those due to impact.

50. If we regard the whole matter as one of probabilities, the argument derived from reversing the system may be met without an appeal to the luminiferous æther. Although a conservative dynamical system is always reversible, the reversed motion may not unfrequently be dynamically unstable in the highest degree. One of the best illustrations in point is afforded by the impossibility of riding a bicycle backwards (*i.e.* with the steering wheel behind); here the forward motion is stable, but the reversed motion is highly unstable.

Take, then, a system of material points or colliding spheres all tending towards the 'special state.' If the motion is slightly disturbed they will still tend towards the 'special state,' and the effect of the disturbance in modifying the character of the motion will diminish without limit. But if we suppose at any stage of the process that the motion of every point is exactly reversed, then the difference between the disturbed and undisturbed reversed motions will increase without limit, and the disturbed reversed motion will tend towards a very different state from that from which we started. In a very short time we shall have entirely different series of collisions taking place in the disturbed and undisturbed reversed motions. When, therefore, we consider the immense number of molecules present in any body of finite size, it is not hard to understand that the probability of the energy tending towards an unequal distribution is infinitesimally small, for just the same reason that if any two different substances in a minute state of subdivision have become thoroughly mixed it is impossible to separate them again by simply stirring them up. There is nothing inconceivable about such a separation, but the chances are so overwhelmingly against it that we may with absolute certainty declare the separation impossible. In this manner there is no difficulty in understanding how on statistical grounds alone we may be able to state with absolute certainty that 'heat cannot pass of itself from a cold body to a hot body.'

Of course evidence of this kind is speculative, and, moreover, only affords a possible explanation, and not a proof, of the principle of degradation of energy.

But, as it has been necessary to suppose space furnished throughout with an æther in order to account for electrical and optical phenomena, allowance must be made for the fact that this æther will in all probability play a prominent part in thermal phenomena, more especially as it is the medium by which radiant heat is propagated. The great velocity of light shows that the æther can have but a very small capacity for radiant energy, and, therefore, that its presence will not materially affect the results of investigations relating to reversible thermodynamic processes, while it will certainly facilitate the dissipation of energy. It must not, however, be thought that researches relating to heat are worthless because they do not take account of the æther; for do not such researches fulfil what should be the highest object of scientific enquiry—namely, of helping us to 'judge the unknown from the known'?

Conclusion.

51. Although many of the researches mentioned in this report are not unfrequently called dynamical proofs of the Second Law, yet to prove the Second Law, about which we know something, by means of molecules, about which we know much less, would not be in consonance with the sentiments expressed at the end of the last paragraph. The most conclusive evidence for regarding Carnot's principle as a theorem in molecular dynamics lies in the remarkable agreement between the results obtained by the methods described in the three different sections of this report, all of which are based on different fundamental hypotheses. It is worthy of note that the method of Clausius alone is independent of any assumptions regarding the nature of the intermolecular forces.

It has been proved, on each of the various hypotheses, that when a system of molecules undergoes transformations analogous to reversible processes in thermodynamics the molecular kinetic energy T is an integrating divisor of the work dQ communicated to the system through the molecular coordinates. Thus any quantity proportioned to T satisfies the definition of temperature afforded by (2), § 2. The evidence that such a quantity possesses the properties mentioned in § 3 is far less conclusive. These properties have never been investigated by the methods of the first section, while, if the statistical method be adopted, the evidence is confined to the very limited cases in which Maxwell's theorem is valid. The methods of the kinetic theory of gases do not afford a direct proof of any relation between the molecular kinetic energies of two substances which are in thermal contact, but which do not mingle.

In the volume already alluded to in this Report, Prof. J. J. Thomson claims to have deduced certain thermal properties of matter from the generalised equations of dynamics without the use of the Second Law of Thermodynamics, and he further claims that the results thus obtained afford evidence of the connection between the Second Law and the Hamiltonian principle. It would seem, however, that the novelty of this point of view is not fundamentally very great, for the molecular assumptions involved in the proofs are identical with those required in order to deduce the Second Law from dynamical principles. And, moreover, properties of temperature are assumed which, as we have just seen, have *not* hitherto been satisfactorily deduced from dynamical principles.

If, on the other hand, we decide, for the present at any rate, to regard Carnot's Principle (like Newton's Laws of Motion) as an axiom based on experience, the researches which we have considered show how this principle may be reduced to a theorem in molecular dynamics by making suitable assumptions as to the nature and motion of molecules. In this way the reversible thermal properties of matter may be represented by means of monocyclic or other dynamical systems, and the fundamental equations of thermodynamics may be replaced by particular cases of the ordinary dynamical equations. This is the point of view adopted by Helmholtz in his valuable paper on the physical meaning of the Principle of Least Action.¹

In conclusion we may reasonably hope that future researches in the domain of molecular science will still further strengthen the bond of

¹ Crelle, *Journal*, c.

connection which we suppose to exist between the Second Law of Thermodynamics and Newton's Laws of Motion.

My thanks are due to Mr. Larmor for references to many important papers on the present subject and to Mr. C. V. Burton for his most invaluable assistance in revising both the manuscript and proofs and in furnishing many useful suggestions.

Sixth Report of the Committee, consisting of Professors FITZGERALD (Chairman), ARMSTRONG, and O. J. LODGE (Secretaries), Sir WILLIAM THOMSON, Lord RAYLEIGH, J. J. THOMSON, SCHUSTER, POYNTING, CRUM BROWN, RAMSAY, FRANKLAND, TILDEN, HARTLEY, S. P. THOMPSON, MCLEOD, ROBERTS-AUSTEN, RÜCKER, REINOLD, CAREY FOSTER, and H. B. DIXON, Captain ABNEY, Drs. GLADSTONE, HOPKINSON, and FLEMING, and Messrs. CROOKES, SHELFORD BIDWELL, W. N. SHAW, J. LARMOR, J. T. BOTTOMLEY, R. T. GLAZEBROOK, J. BROWN, and JOHN M. THOMSON, appointed for the purpose of considering the subject of Electrolysis in its Physical and Chemical Bearings.

DURING the past year the completed portion of Mr. Shaw's report on our knowledge of electrolysis has been printed and circulated among the members, and has appeared in the annual volume of the Association. So also has the report of the discussion with Professors van t'Hoff and Ostwald and others at Leeds, which was edited by Professor Thorpe.

Papers received from Mr. J. Brown on the subject of the electrification of the spray thrown up from a vessel in which chemical reaction with effervescence was occurring, to which attention has been directed by Mr. Enright, and on the electrolysis of solutions of the chlorides of iodine and bromine, were communicated to the 'Philosophical Magazine.'

The valuable theoretical and experimental work of Professor J. J. Thomson, which has been described in the 'Philosophical Magazine' and in the 'Proceedings of the Royal Society,' on the discharge of electricity through vacuum tubes, has a distinct electrolytic significance; and some researches of Mr. A. P. Chattock on the discharge of electricity from points, which are to be described at the present meeting, are tending in very much the same direction; and showing that all convective passage of electricity, whether in liquids or gases or in partial vacua, are essentially electrolytic, taking place probably by means of a series of Grotthuss chains, and with atomic charges of the same order of magnitude as those concerned in electrolysis proper.

Other interesting work is going on, and a document entailing a great amount of labour which has been drawn up by the Rev. T. C. Fitzpatrick, one of the members of the Committee on Electrical Standards, is nearly complete; it will be published next year.

The Committee suggest that they should be reappointed, and with a grant of 5*l.* to cover printing and postage.

Eleventh Report of the Committee, consisting of Sir WILLIAM THOMSON, Mr. R. ETHERIDGE, Professor JOHN PERRY, Dr. HENRY WOODWARD, Professor THOMAS GRAY, and Professor JOHN MILNE (Secretary), appointed for the purpose of investigating the Earthquake and Volcanic Phenomena of Japan. (Drawn up by the Secretary.)

THE GRAY-MILNE SEISMOGRAPH.

THE first of the above seismographs, constructed in 1883, partly at the expense of the British Association, still continues to be used as the standard instrument. The earthquakes which it has recorded since April 27 of last year are given in the following list.

Catalogue of Earthquakes recorded at the Meteorological Observatory, Tokio, between May 1, 1890, and April 30, 1891, by the Gray-Milne Seismograph.

No.	Month	Date	Time	Duration	Direction	Horizontal motion		Vertical motion	
						secs.	mm.	secs.	mm.
1890.									
			H. M. S.	M. S.					
1,026	V.	1	3 56 25 A.M.	—	—		slight	—	—
1,027	"	"	8 38 50 A.M.	—	—		slight	—	—
1,028	"	"	7 40 10 P.M.	—	—		very slight	—	—
1,029	"	"	9 59 21 P.M.	—	—		slight	—	—
1,030	"	4	2 29 17 P.M.	1 45	S.-N.	1'4	0'2	—	—
1,031	"	7	10 4 38 A.M.	0 20	E.-W.		slight	—	—
1,032	"	8	8 35 56 A.M.	1 0	S.W.-N.E.	0'8	0'3	—	—
1,033	"	10	6 49 23 A.M.	0 10	E.-W.		slight	—	—
1,034	"	15	2 36 9 P.M.	5 30	N.W.-S.E.	2'2	0'9	—	—
1,035	"	21	0 9 54 P.M.	0 35	E.-W.	0'4	0'2	—	—
1,036	"	24	1 39 33 P.M.	1 30	N.W.-S.E.	0'5	0'3	—	—
1,037	"	25	8 54 45 A.M.	—	—		slight	—	—
1,038	"	27	6 49 40 P.M.	—	—		slight	—	—
1,039	"	31	8 42 25 P.M.	—	—		slight	—	—
1,040	VI.	7	11 29 53 A.M.	—	—		slight	—	—
1,041	"	15	4 30 15 P.M.	0 12	E.-W.		slight	—	—
1,042	"	18	1 45 22 P.M.	3 0	N.W.-S.E.	1'3	0'6	slight	—
1,043	"	26	9 3 13 A.M.	—	—		slight	—	—
1,044	"	28	5 10 40 A.M.	0 50	S.E.-N.W.	0'7	0'7	—	—
1,045	VII.	2	2 15 9 A.M.	—	—		slight	—	—
1,046	"	3	11 5 55 P.M.	—	—		very slight	—	—
1,047	"	8	2 50 30 P.M.	0 20	N.E.-S.W.	0'9	0'3	—	—
1,048	"	9	9 53 1 P.M.	1 0	W.N.W.-E.S.E.	1'5	0'3	—	—
1,049	"	11	9 51 5 A.M.	—	—		very slight	—	—
1,050	"	14	4 10 49 P.M.	0 50	S.-N.		slight	—	—
1,051	"	16	8 15 51 P.M.	0 20	E.-W.	0'3	0'3	—	—
1,052	"	18	0 35 46 A.M.	0 10	E.-W.		slight	—	—
1,053	"	19	4 18 50 P.M.	0 50	W.N.W.-E.S.E.	0'4	0'2	slight	—
1,054	"	20	9 15 45 P.M.	—	—		very slight	—	—
1,055	"	26	3 51 13 A.M.	—	—		slight	—	—
1,056	"	28	2 57 25 P.M.	—	—		very slight	—	—
1,057	VIII.	2	11 6 35 P.M.	1 8	S.-N.	1'2	0'2	—	—
1,058	"	4	9 38 14 A.M.	—	—		very slight	—	—
1,059	"	5	1 46 21 P.M.	2 14	S.E.-N.W.	1'5	0'3	—	—
1,060	"	7	7 27 13 A.M.	—	—		very slight	—	—
1,061	"	11	1 43 45 P.M.	—	—		slight	—	—
1,062	"	21	6 5 16 P.M.	—	—		very slight	—	—
1,063	"	29	11 34 31 A.M.	—	—		very slight	—	—
1,064	IX.	5	7 57 19 P.M.	3 0	S.-N.	2'4	0'8	—	—
1,065	"	6	0 11 55 A.M.	1 40	S.S.W.-N.N.E.	1'0	0'6	—	—
1,066	"	17	6 20 57 P.M.	0 55	S.W.-N.E.	0'6	0'2	—	—
1,067	"	30	7 24 54 P.M.	2 0	S.-N.	1'0	0'2	—	—

CATALOGUE OF EARTHQUAKES—*continued.*

No.	Month	Date	Time	Duration	Direction	Horizontal motion		Vertical motion	
						secs.	mm.	secs.	mm.
			H. M. S.	M. S.					
1,068	X.	6	4 36 50 P.M.	2 45	E.N.E.-W.S.W.	1.4	0.7	—	—
1,069	"	10	9 33 30 A.M.	—	S.-N.	very slight	—	—	—
1,070	"	12	9 45 30 A.M.	—	S.-N.	very slight	—	—	—
1,071	"	16	4 5 47 A.M.	0 30	—	slight	—	—	—
1,072	"	17	8 38 18 P.M.	0 36	E.-W.	slight	—	—	—
1,073	"	19	2 33 45 P.M.	0 30	E.-W.	0.2	0.3	—	—
1,074	"	19	8 34 14 P.M.	—	—	very slight	—	—	—
1,075	"	29	10 36 51 P.M.	0 15	E.-W.	slight	—	—	—
1,076	XI.	2	9 30 30 A.M.	—	—	slight	—	—	—
1,077	"	5	0 44 29 A.M.	0 30	E.-W.	slight	—	—	—
1,078	"	14	2 21 17 A.M.	1 6	S.E.-N.W.	0.6	0.3	—	—
1,079	"	16	3 8 6 P.M.	0 30	E.-W.	slight	—	—	—
1,080	"	17	9 31 38 A.M.	0 50	E.-W.	slight	—	—	—
1,081	"	22	10 50 31 P.M.	—	—	very slight	—	—	—
1,082	"	25	7 1 0 P.M.	1 0	S.W.-N.E.	0.2	0.2	—	—
1,083	"	27	0 24 39 A.M.	0 15	S.E.-N.W.	slight	—	—	—
1,084	"	27	7 33 48 P.M.	—	—	very slight	—	—	—
1,085	"	29	7 30 40 P.M.	—	—	feeble	—	—	—
1,086	XII.	11	5 34 53 P.M.	0 30	S.E.-N.W.	0.3	0.2	—	—
1,087	"	24	7 22 27 A.M.	—	—	very slight	—	—	—
1891.									
1,088	I.	29	6 20 30 P.M.	—	—	very slight	—	—	—
1,089	II.	13	6 30 0 A.M.	2 50	S.S.E.-N.N.W.	1.4	0.5	—	slight
1,090	"	13	6 56 20 A.M.	2 0	S.S.E.-N.N.W.	1.1	0.5	—	—
1,091	"	14	10 10 34 A.M.	1 15	E.S.E.-W.N.W.	0.2	0.4	—	—
1,092	"	20	2 17 16 P.M.	—	—	slight	—	—	—
1,093	III.	1	4 17 43 P.M.	2 20	S.W.-N.E.	0.3	0.5	0.3	0.3
1,094	"	2	7 17 40 A.M.	—	—	slight	—	—	—
1,095	"	20	8 39 38 A.M.	—	E.-W.	slight	—	—	—
1,096	"	24	10 22 31 P.M.	—	—	slight	—	—	—
1,097	"	25	5 11 0 A.M.	1 0	E.-W.	0.6	0.3	—	—
1,098	"	28	3 28 7 P.M.	—	—	very slight	—	—	—
1,099	IV.	6	4 8 10 P.M.	—	—	slight	—	—	—
1,100	"	7	9 49 46 A.M.	6 0	S.S.W.-N.N.E.	1.5	0.8	—	slight
1,101	"	15	2 59 16 P.M.	0 10	E.-W.	slight	—	—	—
1,102	"	18	0 5 6 P.M.	—	—	very slight	—	—	—
1,103	"	21	10 49 7 A.M.	3 0	W.N.W.-E.S.E.	1.1	1.9	—	slight
1,104	"	28	16 24 23 P.M.	—	—	slight	—	—	—
1,105	"	30	11 54 3 A.M.	—	—	very slight	—	—	—

In the above list eighty earthquakes are recorded, a number comparable with the number of disturbances recorded in previous years. The intensity of these disturbances has, however, been unusually feeble, and without the aid of instruments it is likely that not more than thirty of them would have been noted. Although one earthquake lasted six minutes, the duration has generally been small, whilst only on one occasion did the full range of motion exceed one millimetre.

Notwithstanding the fact that the list of records is as extensive as in previous years, the opportunities for many kinds of observation have been unusually small—so small, in fact, that it is thought better to withhold the results of a certain class of experiments until they have been amplified by the observations of another year.

OBSERVATIONS IN A PIT.

In the 'Transactions of the Seismological Society,' Vol. X., the present writer, in a paper entitled 'On a Seismic Survey,' gave examples of observations made in a pit 10 feet in depth. For certain large earth-

quakes it appeared that the motion at the bottom of the pit was very much less than that observed on the surface, while for small disturbances the difference between the surface and pit records was too small to be measurable. In 1886 a pit 18 feet in depth was sunk through dry compact earth at the Imperial University in Tokio, at the bottom of which seismometers were established on a brick pavement. These seismometers and others in the Seismological Laboratory a few yards distant when placed side by side gave records which were identical. The work was commenced by Professor S. Sekiya, and continued by myself, and the records obtained have now been subjected to a careful analysis by Mr. F. Ōmori, a graduate of the University, who has taken from ten to thirty waves in thirty different earthquakes and for each of these waves calculated its amplitude, period, maximum velocity, and maximum acceleration. Of these thirty disturbances, for each of which diagrams were obtained on the surface and in the pit, three were strong and twenty-seven were feeble. For each set of calculations referring to a particular earthquake average values were obtained, and the average for these average values was as follows:—

1. Ratio of Quantities Observed on the Surface to those Observed in the Pit.

(a) FEEBLE DISTURBANCES.

		Average
1. Ratio of amplitudes . . .	{ E.W. component . . . 1.0 N.S. component . . . 1.3 }	1.2.
2. Ratio of Periods . . .	{ E.W. component . . . 0.9 N.S. component . . . 1.1 }	1.0.
3. Ratios of maximum velocities . . .	{ E.W. component . . . 1.2 N.S. component . . . 1.3 }	1.3.
4. Ratios of maximum accelerations	{ E.W. component . . . 1.4 N.S. component . . . 2.0 }	1.7.

From the above it appears that for small disturbances the motion on the surface is *slightly* greater than it is in the pit; further, from an inspection of the diagrams, it is seen that those from the pit are always smoother than those from the surface. In severe earthquakes Mr. Ōmori points out that this latter character is strongly marked.

(b) STRONG DISTURBANCES.

		Average
1. Ratio of amplitudes . . .	{ E.W. component . . . 1.6 N.S. component . . . 1.2 }	1.4.
2. Ratio of periods . . .	{ E.W. component . . . 1.1 N.S. component . . . 1.1 }	1.1.
3. Ratio of maximum velocities . . .	{ E.W. component . . . 1.4 N.S. component . . . 1.2 }	1.3.
4. Ratio of maximum accelerations	{ E.W. component . . . 1.4 N.S. component . . . 1.1 }	1.3.

(c) RIPPLES SUPERIMPOSED ON WAVES OF STRONG DISTURBANCES.

		Average
1. Ratio of amplitudes . . .	{ E.W. component . . . 2.0 N.S. component . . . 2.3 }	2.2.
2. Ratio of periods . . .	{ E.W. component . . . 0.8 N.S. component . . . 0.8 }	0.8.
3. Ratio of maximum velocities . . .	{ E.W. component . . . 3.0 N.S. component . . . 2.6 }	2.8.
4. Ratio of maximum accelerations	{ E.W. component . . . 5.8 N.S. component . . . 3.5 }	4.7.

The ripples referred to appear amongst the waves in the early part of a disturbance, and, as Mr. Omori suggests, may be the continuation of the minute motions which are sometimes recorded in diagrams before the true earthquake itself has commenced.

A conclusion of some importance, which is confirmed by the above observations, is that buildings which rise from a basement or which are surrounded by an open area receive less motion than those which rise from the surface.

Observations on the vertical component of motion are now being made in the pit.

THE OVERTURNING AND FRACTURING OF BRICK AND OTHER COLUMNS.

During the past year a long series of experiments was carried out to determine the accelerations necessary to overturn or fracture columns of various descriptions. The columns were placed or fixed upon a truck which could be moved back and forth through a range and with a period comparable with what might occur in a severe earthquake. Each back and forth motion was recorded on a band of paper running at a uniform speed in a direction at right angles to the direction of motion of the truck. At the instant the column overturned or was fractured a mark was made on the paper, so that the particular wave which was being drawn when overthrow or fracture occurred could be identified.

On the assumption of simple harmonic motion, calling the period of this wave T and its amplitude a , which were quantities measurable on the diagram, the maximum velocity V , or $\frac{2\pi a}{T}$, and the maximum acceleration, or $\frac{V^2}{a}$, could be calculated. These quantities were compared

with quantities dependent on the dimensions, density, and strength of the columns experimented upon. The object of the experiments was to furnish those who have to build in earthquake countries with data respecting the quantity of motion which certain forms of structure might be expected to withstand.

On October 15, 1884, we recorded in Tokio a maximum acceleration of 210 mm. per sec. per sec., whilst on February 22, 1880, when Yokohama was considerably damaged, such records as were obtained apparently indicated 360 mm. per sec. per sec. A maximum range of motion of 100 mm. and a period of 2 seconds implies a maximum acceleration of 450 mm. per sec. per sec. As it is possible that this quantity might be exceeded, structures in earthquake countries ought at least to be able to withstand three times as much.

For various reasons, of which the following are important, it seems impossible to absolutely determine the quantity of motion necessary to overturn a body of given dimensions.

1. The body may be set in motion and be rocking with a definite period and amplitude when it receives the final impulse which determines its overthrow.
2. Bodies, like columns, standing on end have a period of oscillation varying with the arc through which they rock.
3. An earthquake seldom, if ever, consists of a single sudden move-

ment, but of a series of movements, which continually vary in amplitude and period.

4. A series of earthquake waves is often accompanied by a series of superimposed waves.

OVERTURNING.

The theoretical investigation of the overturning of a body like a column, which, although incomplete, has yielded results comparable with those obtained from experiment, is due to my colleague, Professor C. D. West. The result may be expressed as follows:—

Let f = the acceleration in feet per sec. per sec. which may cause overturning,

y = the height of the centre of gravity of the column,

x = the horizontal distance of the centre of gravity of the column from the edge about which it may turn,

g = the acceleration due to gravity.

Then $f = g \frac{x}{y}$.

Experiments showed that the quantity f , which may be calculated from the dimensions of a body, is closely related to the maximum acceleration, or $\frac{V^2}{a}$, which the body experienced at the time of overturning.

When the period of motion is short f and $\frac{V^2}{a}$ closely approximate, but when the period is great (say two seconds) f may be 30 per cent. greater than $\frac{V^2}{a}$.

FRACTURING.

A theoretically-derived formula, which showed a close relationship with the results of experiment, was

$$a = \frac{1}{6} \frac{g F^\circ A \beta}{f W},$$

where a = the acceleration necessary to produce fracture;

F° = the force of cohesion, or force per unit surface, which, when gradually applied, is sufficient to produce fracture;

A = area of base fractured;

β = thickness of the column;

f = height of centre of gravity above the fractured base;

W = weight of the portion broken off.

Values for F° varying between 4.1 and 14.8 lbs. per square inch were determined by pulling portions of the brick and mortar columns asunder in a testing machine.

Corresponding to these different values of F° different values of a were obtained.

Out of fourteen columns which were broken, in twelve cases the values obtained for a , when $F^\circ = 14.8$ lbs., were fairly comparable with the quan-

tity V^2/a . In two cases where fracture may have occurred at a bad joint the quantity V^2/a was more near to a when $F=4.1$ lbs.

As an illustration of the practical application of the above investigation, let us assume that the greatest maximum acceleration to be expected is 1,000 mm. per sec. per sec., which is a quantity four times greater than anything yet recorded in Tokio, and then determine the height to which a brick column 2 feet square may be built above its foundations and be able to withstand this motion.

If x is the height required and w the weight of one cubic inch of brickwork = .0608 lbs., then by substitution we derive from the above formula

$$x = \sqrt{\frac{F\beta g}{3aw}}$$

When $F=5$ lbs. then $x=6$ ft. 8 in.

When $F=15$ lbs. then $x=11$ ft. 7 in.

A detailed account of the relationship of this formula to the formula previously employed, together with an account of the experiments, is being offered by myself and Mr. F. Ōmori, a graduate of the Imperial University, to the Institution of Civil Engineers.

For assistance in carrying out the experiments my thanks are due to Mr. D. Larrien, who provided the truck and rails on which the experiments were made; Mr. K. Tatsuno, Professor of Architecture, who designed and built the walls and columns; the authorities of the University, who provided the workshop and workmen, to Mr. Y. Yamagawa, who superintended the electrical appliances; and, finally, to my colleagues, who from time to time rendered valuable assistance.

EARTHQUAKES IN CONNECTION WITH ELECTRIC AND MAGNETIC PHENOMENA.

1. *Magnetic Phenomena.*

The conclusion to be derived from the notes relating to magnetic phenomena and earthquakes published in the Report for last year was that, for Tokio at least, the records of the Magnetic Observatory, which is continually being shaken by earthquakes, only show disturbances which may be the result of mechanically-produced movements. Since then I have read an account of the experiment of M. Mourreaux, chief of the Magnetic Observatory of Parc Saint-Maur, near Paris. Having had his instruments disturbed at the time of earthquakes, M. Mourreaux suspended on the same stand as the magnetograph a copper bar having the same form as the magnetic one. The bifilar suspension for the copper bar was made identical with that used for the magnet, and the movements of each were recorded photographically.

With three earthquakes the records for the magnet were disturbed, whilst the records for the copper bar were not disturbed. This experiment has been discussed by G. Agamemnone ('Atti della Reale Accademia dei Lincei,' vol. vi., January 5, 1890), who points out that for various reasons the period of the copper bar and the magnet must be different, and, therefore, by a given movement one might be caused to move whilst the other remained at rest—a conclusion with which the present writer concurs.

Near an active volcano, where masses of magnetic matter may be

shifted or altered in temperature, changes in magnetic elements may possibly be observed, but, so far as observation and experiment have hitherto gone, we are inclined to the opinion that ordinary earthquakes are in no way connected with magnetic phenomena.

2. *Electric Phenomena.*

In the Report for last year I gave the results of a comparison of the records of several hundreds of earthquakes, and the photographic records of atmospheric electricity from a Mascart electrometer. The observations were made at the Meteorological Observatory in Tokio. A result arrived at was that at the time of many earthquakes, especially when Tokio was near the *epicentrum*, the air often became electro-negative. In a detailed paper on this same subject ('Trans. Seis. Soc.,' vol. xv. p. 160) it is stated that these results 'must only be regarded as tentative,' and as during the past year I have discovered a source of error in Mascart's instrument, this remark must not be overlooked. Sometimes, even in exceedingly dry weather, the instrument rapidly loses its sensitiveness, and, if the mirror be displaced, it does not quickly return to zero. The reason does not appear to reside in the fibre nor always in the acid, for, if the wire dipping in the acid and attached to the needle and mirror be taken out and washed, the sensitiveness is regained. Now the acid is being changed weekly and the wire washed. The results which have already been recorded having an explanation in mechanical movements must still be regarded as tentative.

Second Report of the Committee, consisting of LORD RAYLEIGH, Sir WILLIAM THOMSON, Professor CAYLEY, Professor B. PRICE, Dr. J. W. L. GLAISHER, Professor A. G. GREENHILL, Professor W. M. HICKS, and Professor A. LODGE (Secretary), appointed for the purpose of calculating Tables of certain Mathematical Functions, and, if necessary, of taking steps to carry out the Calculations, and to publish the results in an accessible form.

THE first Report was in 1889. Since then values of $I_0(x)$ have been calculated from $x=0$ to $x=6\cdot10$ at intervals of $\cdot01$, and considerable progress has been made in still further expanding this table, making the interval $\cdot001$. This will enable values of $I_0(x)$ for intermediate values of x to be read off by the help of first differences only.

Progress has been made towards the calculations of $I_1(x)$ for values of x differing by the interval $\cdot01$, or, if desired, $\cdot001$. The method adopted is that of calculating the successive differential coefficients of $I_1(x)$ for the values of x given in the 1889 Report by means of the formula

$$2 \frac{d}{dx} (I_n(x)) = I_{n-1}(x) + I_{n+1}(x)$$

and its derivatives, and interpolating by means of Taylor's Theorem.

The Committee have asked for a grant of 15*l.*, to enable them to employ a professional calculator to help in the continuation of the work.

First Report of the Committee, consisting of Mr. G. J. SYMONS (Chairman), Professor R. MELDOLA, Mr. J. HOPKINSON, and Mr. A. W. CLAYDEN (Secretary), appointed to consider the application of Photography to the Elucidation of Meteorological Phenomena. (Drawn up by the Secretary.)

IN commencing operations in the autumn of last year your Committee considered that the first step was to make their existence and aim as widely known as possible. Hence the chief work of the year has been the issue of circulars inviting the co-operation of others, and the taking of such other steps as seemed likely to help in that main object.

The following circular was first drawn up and issued to the secretaries of a large number of photographic societies, field clubs, and other associations throughout the world. Letters to a similar effect were widely distributed through the medium of the press, and personal efforts were made to solicit aid wherever it seemed obtainable.

CIRCULAR A.]

‘WARLEIGH,’ PALACE ROAD, TULSE HILL PARK,
LONDON, S.W.: November, 1890.

SIR,—At the Leeds Meeting of the British Association in September last the above-named committee was formed in order to ‘report upon the application of photography to the elucidation of meteorological phenomena, and to collect and register photographs of such phenomena.’

The success with which these instructions can be carried out necessarily depends in a great measure upon the voluntary co-operation of others.

Will you therefore lend us your valuable aid by making the matter known among the members of the society you represent, and by giving us the names of any persons resident in your neighbourhood who might be willing to further the work in hand?

We shall be glad to receive copies of any photographs illustrating meteorological phenomena, or their effects, but we should especially welcome offers of future assistance in the shape of photographs taken in accordance with simple instructions which will be supplied on application.

Photographs received will be numbered and registered and exhibited at the next meeting of the British Association.

The Committee wish it to be understood that, *in the absence of any intimation to the contrary*, contributions to their collection will be regarded as their own property, with liberty of reproduction at their discretion.

Hoping that you will co-operate in the work,

I am, your obedient Servant,
ARTHUR W. CLAYDEN, *Secretary.*

It was, however, felt that a photograph of a meteorological phenomenon possessed comparatively little value for scientific purposes unless some information could be gained as to the circumstances under which it was taken. Again, photographers generally, and amateurs in particular, seem to find great difficulty in securing good photographs of such things as clouds; therefore it seemed desirable to endeavour to ascertain whether any brand of plate, make of lens, or special device deserved particular recommendation. The following form was therefore printed and issued, with a modified version of Circular A, and distributed wherever there seemed any probability of active co-operation.

FORM.]

Name of Observer _____

Address _____

Place of Observation ¹ _____Description of Lens ² _____ Focal length _____Make of Plate employed ³ _____

Please state also whether the Picture was taken by direct exposure, through yellow glass, by reflection from black glass, or by any other special device _____

Any other information _____

No. of Print																				
Date.																				
Time of Day																				
Direction ⁴																				
Stop ⁵																				
Exposure ⁶																				
Developer ⁷																				

¹ If more than one place is used, take a separate Form for each.² Name of maker and his description, such as 'rapid rectilinear.'³ Maker's description, unless a special emulsion is used, in which case the Committee would be glad of the full formula.⁴ Insert point of compass towards which the camera was pointed. State whether true or magnetic.⁵ $\frac{f}{F}$, $\frac{f}{T}$, $\frac{f}{V}$, or whatever the ratio may be.⁶ Great exactness is not required.⁷ Insert P. for Pyro, P.S. for Pyro and Sulphite, E. for Eikonogen, F.O. for Ferrous Oxalate, Q. for Hydroquinone. The Committee will be obliged for the full formula.

N.B.—It is highly desirable that all prints should show some fixed object, such as a tree or chimney. In the absence of any such point of reference the print should be marked to show the north and the zenith.

At the same time, since effective help might be looked for among the great mass of enthusiastic amateurs who possess little or no knowledge of meteorology, and from meteorologists who know little of photography, a short paper of elementary instructions was also distributed.

INSTRUCTIONS.]

Photographs are desired of clouds, lightning, hoar-frost, remarkable hailstones, snow-wreaths, avalanches, glaciers, storm-waves, waterspouts, tornadoes, dust-whirls, halos, parhelia, or any other meteorological phenomena or their consequences.

General Instructions.

1. As soon as possible after exposing a plate, number it and fill in the details relative to it on one of the forms supplied. The more completely these are filled in the more valuable will the photograph be.

2. The size of the plate is immaterial provided that the focus is sharp. Use a magnifier when focussing, and for objects like clouds focus upon a distant tree or building.

3. Use a lens which does not distort the image.

4. Do not touch up either negative or print.

5. When photographing any object which is moving or changing, a series of views taken at short intervals, so as to show the progress of the phenomenon, will be of especial value.

6. Whenever possible, a figure or other object of known dimensions should be introduced, in order to serve as an approximate scale.

Cloud Photography.

For heavy clouds no special apparatus is required, but exposure must be shorter than for ordinary landscape work. For very thin clouds exposure must be extremely short and development very cautious. Fair results may then be occasionally obtained without special means.

In order to obtain better and more certain results three methods have been adopted:—

(a) Using a slow plate and rapid lens, with short exposure.

(b) Using an ordinary plate and lens, but with a sheet of pale yellow glass in front of the lens.

(c) Using an ordinary plate and lens, but placing a plane mirror of black glass in front of the lens, so that its surface makes an angle of about 33° with the axis of the lens. The image reflected in the mirror is fairly easy to photograph.

The Committee hope to receive examples of each of these processes, as well as examples and descriptions of any other special devices which may be adopted by observers.

Lightning Photography.

When a thunderstorm occurs at night it is very easy to photograph the flashes of lightning.

Fix the camera rigidly (do not hold it in the hand) and expose it to a part of the sky where flashes are frequent.

As soon as one flash has crossed the field of view change the plate.

Whenever possible, count the number of seconds between seeing the flash and hearing the beginning of the thunder. Note this time on the print or form.

If you have two cameras some useful results may be attained by using one as described above and holding another in the hand, pointing in about the same direction, but kept in constant oscillation. It is hoped that two photographs of the same flash may be thus secured.

Another desirable experiment is to fix both cameras in the same direction, change the plates in one after each flash, but leave the plate exposed in the second until six or eight flashes have crossed the field of view.

If the camera is placed in a window this must be open, as the interposition of a window pane may give rise to multiple images.

Be particularly careful to note the exact time and direction of each flash photographed.

A rapid lens, with a stop $f/8$ or thereabouts, should be used for lightning.

Prints, which may be mounted or unmounted, should be sent as early as possible to the Secretary at

‘WARLEIGH,’ TULSE HILL PARK, LONDON, S.W.

This work of distribution has been greatly aided by the courtesy of the Council of the Royal Meteorological Society. But in spite of their assistance the time available for the purposes of the Committee has been mainly devoted to carrying out this introductory labour and conducting the correspondence it has involved.

The secretary to your committee has also personally appealed to various societies on behalf of the work in hand by the exhibition of lantern slides in explanation of the Committee's object.

In all cases promises of future help (in the shape of photographs taken under recorded circumstances) have been solicited, rather than the gift of prints from old negatives.

The result is that some progress has been made in the organisation of a system of observers who will be on the look-out for interesting phenomena. Such offers already number between forty and fifty, and new names are slowly coming in. Indeed, many of the circulars inviting such aid have been sent to such distant places that replies could hardly be expected yet. However, as it is, the promises in hand include some from Tasmania, Mauritius, Java, Sweden, America, and the Continent, while those from the United Kingdom come from all parts of the country.

Your committee view this result with some satisfaction, because a wide distribution and large number of observers multiply the chances of securing records of rare phenomena. It is a case of sowing seed over a large area, and it is only the earlier parts which have yet had time to yield much harvest.

PHOTOGRAPHS COLLECTED.

The number of prints actually received up to the time of closing this report (July 20, 1891) is not large. The total number, 153, includes 95 of clouds, 11 of lightning, 6 of damage by lightning, 2 damage by hail, 3 of the positions of meteorological instruments, 6 of glacier structure, 3 of fog shadows, 8 of hoar-frost, 2 of snow-crystals, and some others. But these can only be regarded as a first instalment of the results of the year's work, and your committee look forward with confidence to a considerable increase in their collection during the next few months.

The details of the collection already made can be best judged by reference to the appended list:—

First List of Photographs.

CLASS A.—CLOUDS.

- | | | |
|------|---------|--|
| Nos. | 1-6. | From the Kew Committee of the Royal Society. |
| „ | 7-23. | From Rear-Admiral Maclear. |
| „ | 24-26. | From Mr. A. E. Western. |
| „ | 27-32. | From Mr. Arthur Nicols. |
| „ | 33-100. | From Mr. A. W. Clayden (secretary). |

A considerable number of negatives are also available from which prints have not yet been taken.

CLASS B.—LIGHTNING.

- | | | | |
|-----|-----|--|--------------|
| No. | 1. | Taken on moving plate, from Dr. H. H. Hoffert. | |
| „ | 2. | Reversed flash, from Mr. A. W. Clayden. | |
| „ | 3. | Branched | „ „ „ |
| „ | 4. | Multiple | „ „ „ |
| „ | 5. | „ | „ „ „ |
| „ | 6. | Reversed | „ „ „ |
| „ | 7. | Simple and multiple flashes, from Mr. A. W. Clayden. | |
| „ | 8. | Narrow ribbon, from Mr. J. H. Bateman. | |
| „ | 9. | — from Mr. Ernest Brown. | |
| „ | 10. | — | „ „ „ |
| „ | 11. | — | „ Mr. Avery. |

CLASS C.—DAMAGE BY LIGHTNING.

- Nos. 1-4. Rear-Admiral Maclear.
 „ 5-6. Señor Don Augusto Arcimis.
 „ 7-10. Mr. J. Hopkinson.

CLASS D.—DAMAGE BY STORMS.

- Nos. 1 and 2. Effect of hailstorms of August 2 and 3, 1879, from Mr. G. W. Whipple.

CLASS E.—ELECTRIC SPARKS.

- Nos. 1-10. Illustrating forms of discharge, from Mr. A. W. Clayden.
 „ 11-18. Explaining dark flashes, from Mr. A. W. Clayden.

CLASS F.—SNOWFALL, &C.

- Nos. 1 and 2. Snow-crystals, from Mr. A. W. Clayden.
 „ 3 and 4. Drifts, March 11, 1891, from Mr. R. G. Durrant.

CLASS G.—GLACIERS.

- No. 1. Ice-cliffs of the empty Meerjensee, 1889, from Mr. Greenwood Pim.
 Nos. 2-7. Various glaciers from Mr. Greenwood Pim.

CLASS H.—HOAR-FROST.

- Nos. 1-8. From Mr. A. W. Clayden.

CLASS M.—MISCELLANEOUS.

- Nos. 1-3. Shadows of a camera on fog, from Mr. A. W. Clayden.

REGISTRATION OF PHOTOGRAPHS IN OTHER COLLECTIONS.

This section of the work has hardly been commenced. Several prominent firms of professional photographers have been approached with a view to tabulating the pictures they possess, but they have not offered any special facilities. This is to be regretted in some ways, but there seems reason to hope that another year something of the kind might be done.

The fine collection in the possession of the Royal Meteorological Society has been examined. It contains a large number of very beautiful cloud studies by Dr. Riggenbach and M. Paul Garnier, but information as to the methods adopted by these observers and as to the conditions under which the pictures were taken is at present wanting. Nevertheless the work of registering these photographs would have been taken in hand had it not been all but impossible to describe them properly. The chaotic condition of cloud nomenclature seems to render it impossible to describe the minute differences of structure so admirably shown in the pictures in terms which would be generally intelligible. Many cloud forms, especially among the thinner types, are intimately related to one another, some being only transitional phenomena during the passage of one stable form into another. Your committee have therefore laid special stress in their instructions to observers upon the importance of securing series of cloud pictures at short intervals delineating cloud changes and showing, as far as possible, the relations between various forms. Until some satisfactory system of nomenclature has been devised, or until your

committee can form a comprehensive collection, it seems that the accurate registration of cloud photographs must be left in abeyance. Perhaps by this time next year, if they are permitted to continue their work, something of the kind may be found practicable by referring other photographs to types in their own collection.

Another important collection is in the possession of the chairman of your committee. An early opportunity will be taken for the tabulation and registration of its contents.

METHODS OF CLOUD PHOTOGRAPHY.

Specimens of cloud photographs have been received illustrating several methods.

1. By the courtesy of the Kew Committee of the Royal Society six specimens of the photographs taken under their direction have been placed at the disposal of your committee. These have been taken in a special form of camera provided with a rotating shutter, the opening of which can be varied at pleasure. The exposure given is a fraction of a second, and the plates are of the rapid gelatine bromide type. So far as definition is concerned, these pictures leave little to be desired.

2. Mr. A. E. Western sends one print from a negative taken on Edwards' medium isochromatic plate, and two taken with Carbutt's orthochromatic celluloid films, in all cases after placing a sheet of pale yellow glass in front of the lens. The definition in all three is good, but the type of cloud is one which is easy to photograph, and it does not yet appear whether the method is of very much value for thin cirrus clouds.

3. The secretary to your committee has made a careful trial of two other methods.

The first consists in placing a plane mirror of black glass in front of the lens, so that the plane of its surface makes an angle of about 33° with the axis of the lens. This method has been theoretically described by Dr. Riggensbach in a paper read before the Royal Meteorological Society on November 21, 1888. It is supposed to depend on the extinction of the polarised component of the light from the blue sky. But in practice it is found that the mirror is of great advantage, altogether apart from any polarisation. It diminishes the brilliancy of the whole illumination, so that it becomes easy to time the exposure correctly. By this means it is found perfectly simple to get good negatives of even very delicate cirrus clouds on any of the ordinary brands of dry plates. The negatives frequently require intensification in order to bring out all possible detail, and it seems that transparencies on glass or prints on bromide paper are to be preferred to ordinary silver prints.

The second device which has been tested is the employment of slow plates. Very satisfactory results have been obtained by exposing in the camera some of the plates prepared for transparency work by Mawson and Swan. This method has not been tried so thoroughly as the other, but enough has been done to show that it may be recommended.

The lens used in both cases was an Optimus rapid rectilinear with a stop $\frac{f}{11}$. With ordinary plates and the black mirror the exposure varied from about a tenth to half of a second, and with the transparency plate about twice or three times as long.

The experiments will be continued throughout the summer, and your

committee hope that they will soon be in a position to decide which method is on the whole most suitable for the purpose. The black glass method has the one great advantage that it works well with the ordinary plates, and as the mirror may be easily removed and replaced a few cloud pictures may be taken during any photographic excursion without the necessity of carrying slides charged with plates of little use for other purposes.

PHOTOGRAPHS OF LIGHTNING.

The registration of photographs of lightning is beset with difficulty, just such as interfered with the description of clouds. A provisional classification has been issued under the authority of the Thunderstorm Committee of the Royal Meteorological Society. This, however, was premature, and cannot be regarded as satisfactory. Hence your committee have turned their attention rather to the study of lightning than to recording pictures of it.

The phenomena accompanying electric discharges do not seem to have been very perfectly studied, but certain facts are known, and photographs of lightning and of electric sparks point to others. It seems, therefore, that no classification can be generally accepted which ignores existing knowledge of the connection between the electrical conditions and the character of the discharge.

The so-called black flashes have of course been disposed of. The experiments described two years ago by the Secretary to your committee showed that the appearance is due to reversal produced by some form of diffused light having fallen upon the plate. This conclusion has been subsequently confirmed by Mr. Shelford Bidwell, F.R.S., and again by Mr. Clayden in the photograph numbered 2B. This was taken at Bath in the early morning hours of June 25. After the flash had passed, the plate was left exposed for a few minutes in the hope that a second flash might illuminate the same part of the sky. This happened, the lower part of the field of view being brightly lit up by a flash which was itself hidden in the clouds. Where the consequent glare crossed the undeveloped image of the flash reversal has occurred, while no reversal can be detected in the other portion.

It will be noticed that this flash, like many others, shows a distinct ribbon-like structure. The repeated occurrence of this phenomenon has already given rise to considerable discussion, and Mr. W. Marriott and Mr. Cowper Ranyard have attributed it to a movement of the camera during the existence of the flash. Certainly many such photographs have been taken in cameras held in the hand or on no very firm base. Moreover, Dr. Hoffert's photograph, No. 1B, shows this structure well in the successive bright flashes. Nevertheless, it must be noted that in this last case the camera was in rapid motion, and yet the ribbon-like structure is hardly more pronounced than it is in other pictures where any accidental movement was presumably much less. Moreover, the photographs Nos. 2B and 3B show this structure very plainly, though the camera was standing on a steady support, and movement during the flash was quite out of the question.

Alternative hypotheses are that the appearance is due to reflection from the back of the plate or in the lens. If either view were true the brighter parts of the flash should show the ribbon form the best, whereas

the contrary seems often to be the case. Again, if the former hypothesis were true, the position occupied by the reflected light could be ascertained by considering the direction of the incident light. Fact here disagrees with theory.

The evidence at present obtainable therefore points to the conclusion that a bright lightning flash may often take the form of a long sinuous ribbon, whose sectional thickness is very different in two directions normal to each other. Some of the appearances noticed also indicate that the greater thickness throughout all the parts of a given flash lies in one and the same direction, and the variations in its apparent direction are merely an effect of perspective.

This structure must be carefully distinguished from another, in which several distinct flashes follow precisely similar paths side by side. Sometimes the bright flashes (which may or may not show the ribbon shape proper) are connected by a less brilliant luminosity, which converts the whole phenomenon into a very broad ribbon. Photographs of this class are exemplified by Nos. 4 B, 5 B. The flash represented in Dr. Hoffert's photograph is evidently one of the same order, and the curious smudges which cross the plate must doubtless be due to the above-mentioned fainter light. Clearly we have here to deal with intermittent discharges, a number of discharges following each other along the same or closely contiguous paths. In some cases photographs of this kind show reduplicated images of buildings corresponding fairly well with the images of the component parts of the discharge. In such a case there seems little room for doubt that the flashes followed the same path or paths only a very short distance apart.

The secretary to your committee, however, secured the photograph No. 4 B on June 25. In this case the camera was certainly not moved. The flash, like many others, appeared multiple to the naked eye, but as the motion of the eyeball might have produced that effect, although the flashes formed the same path, little weight can be laid on that argument. Indeed, the fact that the camera was standing still and quite untouched is sufficient to prove that flashes of such a nature do occur. It is really a rapid and almost simultaneous volley of flashes connected partly by a less vivid discharge which obliquely links the brighter lines. There is also evident a sort of half-twist of one part of the flash around another part.

In order to elucidate the unexpected facts brought to light in the numerous photographs belonging to the Royal Meteorological Society a number of experiments have been made by your secretary upon electric sparks obtained from an induction machine. As these tend to throw some light upon the questions in hand, a brief account of them may not be out of place.

First remove the small Leyden jars from a Voss or Wimshurst machine. The discharge is then pink in colour, of slight brilliancy, and strongly resembles the brush discharge. If the knobs are brought near each other the discharge passes along several lines, which arrange themselves side by side in a plane at right angles to the direction of discharge.

If now the condensers are introduced in the ordinary position, the spark at once becomes more brilliant, and the pink tinge disappears. This spark obtained from the ordinary size of condenser appears to be precisely the same as the commoner varieties of lightning. If larger

condensers are substituted the spark becomes thicker and brighter, and its minor irregularities frequently disappear.

Next remove the condensers from the machine, and connect their inner coatings with the prime conductors, while the outer coatings are imperfectly insulated, as, for instance, by placing them on a wooden table. If the jars are near each other, as each spark passes between the discharging knobs another will pass between the outer coatings.

Gradually increase the distance between the jars. The spark between the outer coatings will become more irregular as it grows longer, and at a certain distance it will suddenly cease. At this moment the discharge between the knobs entirely alters its character. If the striking distance is short, the form assumed is that of a bright pink band, generally brighter at its margins than elsewhere, and showing a beautiful fluted structure. Its duration is short, but it is nevertheless easy to see that it is a really intermittent.

Again increase the striking distance step by step. The discharge is still intermittent, but thin, brilliant white sparks make their appearance. At first the pink discharge can be recognised passing obliquely between these bright sparks, but as the distance increases the pink light disappears, and the discharge becomes a rapid volley of bright sparks.

The photographs from No. 1 E to No. 9 E show these phenomena.

Again, if the discharging knobs are placed some distance from the machine, so that the field due to their charge is but little affected by the movements of the machine or operator, it may often be noticed that with ordinary bright sparks their form is repeatedly the same. No. 10 E shows a series of sparks taken under such conditions at intervals of about one second.

Now, it is probable that all these forms of discharge have their analogues in lightning. The bright sparks with small condensers are the counterpart of the commoner type of lightning. Those from the large Leyden jars and between the outer coatings correspond to more powerful flashes, the latter being the 'impulsive discharge' described by Professor O. Lodge. The volleys of bright sparks are also the type of many observed multiple flashes. There remain only the pink discharges, and surely these are the counterpart of the flashes which yield photographs like No. 4 B.

Moreover there seems to be no *primâ facie* absurdity in supposing that a short series of flashes may occur during a brief time along parallel paths. Such a phenomenon is conceivably explicable—

(a) by an identity of conditions over the whole area traversed by the flashes;

(b) by the movement of the charged cloud causing the conditions which held in one place at a given moment to hold a short distance away at another;

(c) by the movement of the air sweeping along the disturbance caused by the first spark, so that a path of least resistance resulting from that disturbance occupies different positions. Your committee would draw attention to the similarity between the appearance of the bright pink discharge and that through rarefied air. Some of the discharges, Nos. 3 E to 7 E, look as if the passage of the bright sparks caused a partial vacuum between them, and the pink sparks then struck through this lessened resistance along the paths of the bright sparks and across the low resisting interval between them, the slope of these transverse

sparks being possibly determined by the difference of potential required to break through what resistance there was.

Possibly it may be found that the ribbon structure is also due to some such phenomenon. The passage of the first flash will produce for a short time a highly rarefied column of air, through which a stream of less luminous sparks may pass until the displaced air surges back. Resistance will then be abnormally high exactly along the track of the first spark, and this column of extra dense air will be surrounded by a tube (so to say) of lower resistance. Indeed, the paths of subsequent discharges in a series may conceivably be determined either by the outward movement of the wave of rarefaction or by the alternate compression and rarefaction along the original path. In either case the movement of the air may easily suffice to carry the position of least resistance along with it. That subsequent discharges do sometimes follow what may be called the trough of the atmospheric wave is indicated by the tendency sometimes exhibited for one spark or flash to twist partly round another.

However, your committee do not wish it to be understood that they put forward these suggestions as definite hypotheses. They merely state them in order to indicate various lines along which further research is desirable. They hope, if they are permitted to continue their task for another year, to add considerably to the experimental and observational facts at present available, and possibly to reach more definite conclusions than existing material allows.

Before ending their report your committee feel that a passing reference is due to the important paper read before the Royal Society in which the Kew Committee described some of their results, and also to the work which has been carried on at Berlin and elsewhere in the photography of the so-called luminous night-clouds and of clouds invisible to the naked eye.

They wish to express their thanks to the Kew Committee, to the numerous persons who have volunteered their assistance, and especially to the Council of the Royal Meteorological Society.

In conclusion they ask to be reappointed, with a grant of 15*l.*, in order that they may have an opportunity of following up the beginning that has been made.

Report of the Committee, consisting of Professor O. J. LODGE, Professor CAREY FOSTER, and Mr. A. P. CHATTOCK (Secretary), appointed to investigate the Discharge of Electricity from Points.

MEASUREMENTS have been made of the strength of field necessary to start discharge at points of radius of curvature varying from 0.7×10^{-3} to 58×10^{-3} cm. The results show that the field strength increases rapidly as the radius of curvature diminishes. They also point to the gas surrounding the point as the seat of resistance to discharge, rather than to the surface of the metal; and, upon the assumption that discharge means the breaking down of Grothuss chains in the gas, extrapolation indicates an atomic charge of dimensions approximating to those of the ionic charge of electrolytic ions.

The variations of the field strength with pressure of the gas seem to agree with the Grotthuss chain hypothesis as far as the measurements go.

Upon the assumption that the passage of electricity from a point to a plate is a one-way flow, it is possible to obtain a value of the ratio of mass moving to electricity carried by it (i.e., the electro-chemical equivalent of the discharged matter) in terms of the slopes of potential and pressure brought about by the discharge, and the density of the current passing. Experiments are now in progress to determine this ratio, if possible. So far they point to a number far in excess of the electrolytic value. This may be due to error in the measurements, or, possibly, to the presence of metal dust in the discharge.

Measurements, also still in progress, have been made on the mechanical forces which act on a point during discharge. They point to interesting differences between + and - electricity, and it is hoped that useful information may be obtained as to the manner in which the two electricities leave the point by further work in this direction.

Your Committee asks for reappointment with a grant of 50*l.*

Report of the Committee, consisting of Lord McLAREN (Chairman), Professor CRUM BROWN (Secretary), Mr. MILNE HOME, Dr. JOHN MURRAY, Dr. BUCHAN, and the Hon. RALPH ABERCROMBY, appointed for the purpose of co-operating with the Scottish Meteorological Society in making Meteorological Observations on Ben Nevis.

DURING 1890 the hourly observations by night and by day at the Ben Nevis Observatory have been carried on uninterruptedly by Mr. Omond and the assistants, and as heretofore the five daily observations at Fort William have been made with great regularity by Mr. Livingston. As intimated in last report, a vitally important advance was made in the system of observations on Ben Nevis by the opening of the low-level observatory in Fort William on July 14, 1890, for regular continuous observations. This observatory has been equipped by the Meteorological Council with a complete set of self-recording instruments, such as are in use at the first-class observatories of the Council. The directors have thus now at their disposal the best information available for extending the scientific and practical inquiries they have undertaken through the unique facilities offered by these well-equipped observatories. A beginning has also been made with an elaborate discussion of this double series of hourly observations of which some account will be given in this report.

The directors were again able to give relief to the various members of the observing staff by the courtesy of the following gentlemen, who have given their services as observers for periods varying from four to eight weeks:—Messrs. R. C. Mossman, James McDonald, M.A., and Alexander Drysdale, M.A., B.Sc.; and Messrs. P. Gillies and C. Stewart, from Professor Tait's Laboratory, are now (August, 1891) assisting in the work of observing.

For the year 1890 the following were the monthly mean pressures and temperatures, hours of sunshine, amounts of rainfall, and number of fair

days, or days of less than 0·01 inch of rain, at the observatory, the mean pressures at the Ben Nevis Observatory being reduced to 32° only, while those at Fort William are reduced to 32° and sea-level:—

1890	Jan.	Feb.	March	April	May	June	July	Aug.	Sept.	Oct.	Nov.	Dec.	Year
<i>Mean Pressure in Inches.</i>													
Ben Nevis Observatory	24·983	25·543	25·079	25·226	25·316	25·349	25·297	25·312	25·482	25·395	25·147	25·409	25·295
Fort William	29·548	30·221	29·674	29·820	29·845	29·878	29·802	29·799	29·964	29·955	29·732	30·084	29·860
Difference	4·565	4·678	4·595	4·594	4·529	4·529	4·505	4·487	4·482	4·560	4·585	4·675	4·565
<i>Mean Temperatures.</i>													
Ben Nevis Observatory	26·9	24·8	25·4	26·4	35·3	36·4	37·1	38·6	41·9	33·6	27·4	22·2	31·3
Fort William	42·1	39·6	42·3	44·4	53·2	54·2	55·0	55·9	56·6	49·6	42·0	37·2	47·7
Difference	15·2	14·8	16·9	18·0	17·9	17·8	17·9	17·3	14·7	16·0	14·6	15·0	16·4
<i>Extremes of Temperature.</i>													
Ben Nevis Observatory:													
Maxima	27·3	46·1	36·8	37·1	52·4	45·6	51·7	53·7	58·9	44·9	41·0	39·0	58·9
Minima	16·8	12·7	10·1	16·9	22·1	27·1	28·8	27·7	27·5	16·0	13·2	9·0	9·0
Difference	20·5	33·4	26·7	20·2	30·3	18·5	22·9	26·0	31·4	28·9	27·8	30·0	49·9
<i>Rainfall in Inches.</i>													
Ben Nevis Observatory	29·42	4·57	27·31	8·09	6·01	14·67	13·22	14·33	20·71	37·30	18·96	3·75	198·34
No. of Days of no Rain	0	17	5	15	10	3	4	4	6	2	2	15	83
No. of days 1 in. or more fell	11	2	8	2	2	3	4	6	6	15	6	1	66
Fort William	19·67	1·66	11·13	3·10	2·67	7·68	7·69	6·22	7·85	13·85	10·31	1·29	93·12
<i>Hours of Sunshine.</i>													
Ben Nevis Observatory	4	68	36	78	126	24	42	46	83	35	27	22	591
Fort William	—	—	—	—	—	—	—	117	102	52	34	26	—

At Fort William the mean temperature of the year was 47°·7, being 0°·5 above the mean. The exceptional departures from the monthly means were: January 2°·8, May 3°·2, September 3°·1, and October 2°·0 above, and July 2°·3, August 3°·1, and December 2°·4 under, the means. The mean annual temperature at the top of the Ben was 31°·3, or 0°·4 above the mean, and as contrasted with Fort William the departures from the means were in July 2°·8 and in August 1°·0 under and in September 4°·0 above it. In anticyclonic weather, such as largely prevailed in September, the excess of temperature at the top of the Ben is always relatively higher than at sea-level adjoining.

The minimum temperature for the year was 9°·0 on December 19, being about the point to which the temperature has fallen each year since the observatory was opened. The maximum was 58°·9 on September 7. This is about the lowest annual maximum temperature hitherto observed, and it is otherwise remarkable as having occurred so late in the season. Indeed, low temperatures ruled during the summer in an unusual degree, the highest in June being 45°·6, July 51°·7, and August 53°·7. Thus the extreme range of temperature for the year was 49°·9; in the previous year it was 55°·4.

The registration of the sunshine-recorder showed only 591 hours out of a possible 4,470 hours. Excepting 1886, when the number was 576,

this is the lowest since the observations began. In January only 4 hours were registered, being the lowest monthly amount yet observed, but in December the number of hours was 22, being considerably in excess of the hours registered at stations generally over the United Kingdom during this exceptional month.

The rainfall was the heaviest yet recorded in any year, being 198·34 inches, and if the amount were calculated for the meteorological year beginning with December, 1889, the annual amount would be 213·63 inches. The rainfall for October, 37·30 inches, is the highest yet recorded in any month; and 29·42 inches were recorded in January and 27·31 inches in March. On October 3 the rainfall was 7·29 inches, but for the 24 hours from 9 P.M. of the 2nd to 9 P.M. of the 3rd the extraordinary quantity of 8·07 inches was collected. In four months the rainfall was the highest yet recorded for these months.

The number of days on which the rainfall was *nil*, or less than the hundredth of an inch, was 83, being the fewest number of fair days of any year since the observatory was opened. There were 17 fair days in February, 15 in April and December, but none in January. There were 66 days on which one inch or upwards fell. In October there were 15 such days and 11 in January.

The rainfall of 1890 in the eastern part of Scotland to the south of the Grampians was nearly everywhere under the average, the deficiency being a sixth in the Border Counties. On the other hand, in north-western districts it was about a fifth above the average. The annual average at the observatory since 1885 is 134·50 inches, and hence the rainfall of 1890 was 63·84 inches, or 48 per cent., above the average—an excess nowhere approached at any observing station in Scotland.

Atmospheric pressure at Fort William was 29·860 inches, or 0·032 inch above the mean pressure. The monthly extremes were the minimum in January and the maximum in February, these being respectively 0·229 inch below and 0·295 inch above the means of these months.

The following shows the departures from the means of the pressure and rainfall of the four months of heaviest rainfall at the Ben Nevis Observatory:—

Differences from the Means.

	Pressure Inch	Rainfall Inches
January	-0·194	+12·55
March	-0·143	+15·39
September	+0·088	+8·96
October	+0·086	+22·44

It will be observed that during the two last months, when the rainfall was greatly above the average, pressure also was above the average. On the top of the Ben it repeatedly occurs that high pressures are accompanied with very heavy and long-continued rains.

Considerable progress has been made during the year with the discussion of the Ben Nevis observations.

An exhaustive examination of the 'Winds of Ben Nevis,' by Messrs. Omond and Rankin, has been recently completed and the results communicated in a paper read before the Royal Society of Edinburgh. The authors show that while the sea-level winds in this part of Scotland are, with respect to the distribution of pressure, in accordance with Buys Ballot's Law of the Winds, the Ben Nevis winds do not at all fit in with

such a distribution of pressure, but that on the contrary they point to a widely different distribution of pressure at the height of the observatory, 4,407 feet above the sea. In large storms, with a deep barometric depression in the centre, the Ben Nevis winds are practically the same as at lower levels; but with smaller storms great differences are presented. In these cases it is remarkable that with a cyclone covering Scotland, the North Sea, and Southern Norway the winds frequently blow, not in accordance with the sea-level isobars, but in an entirely opposite direction, suggesting an outflow from the cyclone towards the anticyclone near at the time on the other side. It is further remarkable that this outflowing seldom or never occurs when the centre of the storm is to the south or west, but only when it lies to the north or east. If the wind on the hill-top is not at a right, or greater, angle from the sea-level wind, it is usually nearly the same as it; the supposed veering of the wind at great heights required by the theory that a cyclone is a whirling column, drawing the air in spirally below and pouring it out spirally above, is so seldom observed as to be the exception, and not the rule. This important result and the analogous observation that frequently in great storms of winds prostrated trees lie practically in one direction over wide regions show impressively how much observation has yet to contribute before any satisfactory theory of storms can be propounded.

The winds of other high-level European observatories, which may all be regarded as situated in anticyclonic regions, have been examined, and it is found that they show the closest agreement with the winds at low levels in the same regions. This result separates the Ben Nevis Observatory from other observatories, so as to form a class by itself, the differentiating cause being the circumstance that Ben Nevis alone lies in the central track of the European cyclones. This consideration emphasises the value of the Ben Nevis observations in all discussions of weather. It may be added that, with respect to the relation of the winds to the low-level isobars, Ben Nevis Observatory is more pronouncedly a high-level observatory in winter than in summer, or, more generally, in cold than in warm weather.

Mr. Rankin has communicated to the directors a paper on the results of the dust-counting observations of the past year. The highest number observed was 14,400 per cubic centimetre in April last, whilst the lowest, 0, was observed in July, 1890, and again in March, 1891; and here it must be noted that each observation is really the mean of ten observations taken at the time. The greatest amount of dust is observed when the wind is E., S.E., or S., both at sea-level and the top of the Ben; but when the winds at the top diverge most from those at sea-level then the lowest dust values are obtained. We have here, broadly indicated, another contribution to weather prognosis afforded by the dust observations, since they point to quite different phases of weather.

True fogs and wet mists exhibit marked differences. In fog there is usually a considerable amount of dust; in mist, or wet mist, usually very little. It is observed when the number of dust particles noted is extremely small, or even 0, that the air is surcharged with aqueous vapour, if such a condition be supposed possible, and that then, there being no dust particles to serve as nuclei on which the vapour might condense, it simply condenses on all exposed objects direct from the air. This has been found to be the most wetting condition of the air, a few minutes only being sufficient to give the observer a thorough soaking. Every

post and rope seem running over with water, though, looking out at the weather, one has no idea it is nearly so wet.

Sufficient observations have been made to show a well-marked diurnal variation in the numbers of dust particles. The following are the tri-hourly results for March, April, and May, 1891 :—

	Means		Means
1 A.M.	736	1 P.M.	950
4 "	526	4 "	1,438
7 "	570	7 "	1,035
10 "	526	10 "	1,029
Mean			854

The daily minimum thus occurs when the daily strength of the wind is greatest, and also the descending current, down the mountain, and the maximum when the wind is least strong and the ascending current up the mountain strongest.

Mr. R. C. Mossman has communicated a paper to the Scottish Meteorological Society on the cases of silver thaw at the Observatory, which will appear in next issue of the Society's Journal. From 1885 to 1890 there occurred 198 cases, lasting in all 873 hours—that is, cases in which rain froze as it fell. The maximum frequency is from November to March. It occasions, as may well be supposed, much inconvenience and discomfort to the observers.

The chief point established by Mr. Mossman is that the distribution of pressure over Western Europe is at the time always substantially the same. The daily weather charts show that on these 198 days the distribution of pressure was for the Ben cyclonic on 137 and anticyclonic on 61 days. In anticyclonic cases a cyclone is off the north-west coast of Norway, while the anticyclone stretches away over the south of England and Ireland. In cyclonic cases Ben Nevis is clearly within the area of low pressure, the centre of which again is off the north-west coast of Norway, while the anticyclone is removed farther to southward over the Peninsula. Hence the value of this phenomenon in forecasting weather. The average duration is 6 hours in winter and 3 in summer. The longest continued was 41 hours on January 3-4, 1889. The lowest temperature at which it has occurred was 18°·0, but nearly in all cases the occurrence takes place shortly before a thaw.

During the past year the unremitting attention of Dr. Buchan has been given to the examination and discussion of the hourly observations of the two observatories. The discussion includes the ten months ending May, 1891.

In entering on the discussion it quickly became apparent that the influence of high winds on the barometer was the first inquiry calling for serious attention. The depression of the barometer during high winds was plainly so serious as to render the examination of many questions all but a hopeless task until some approximation was made to the values of these depressions for different wind velocities.

Fortunately the two observatories present the conditions favourable for this investigation. They are so near to each other as to form virtually but one observatory, the barometer at the top being in a building exposed to winds of all velocities up to at least 150 miles an hour, whereas the other barometer is in a sheltered building, where light winds prevail

generally, so that this barometer may be regarded as recording the true pressure of the atmosphere. This was more exactly secured in making comparisons of the two barometers by selecting only those cases when winds at the Fort William Observatory were light. As stated by the Committee in previous reports, the observations of the force of the wind are estimations on a scale of 0 to 12, the equivalent of each figure of the scale in miles per hour having been carefully determined by Mr. Omond by means of Chrystal's anemometer. The barometric observations at the two observatories were reduced to sea-level hour by hour, and the differences plus or minus were entered in columns representing the different wind forces at the higher observatory. The following is the result of the comparison :—

Wind Force	Eq. miles per hour	Bar. Depression Inch
0	2	—0·001
1	7	—0·004
2	13	—0·005
3	21	—0·010
4	29	—0·014
5	38	—0·026
6	47	—0·035
7	57	—0·050
8	67	—0·070
9	77	—0·104
10	88	—0·122
11	99	—0·150

Thus in calm weather the two reduced barometers are practically the same, but with every increase of wind which sweeps past the higher observatory, the depression of the barometer inside steadily augments. It is not till a velocity of more than 20 miles an hour is reached that the depression amounts to one-hundredth of an inch. At 57 miles it is 0·050 inch, at 77 miles 0·104 inch, and at 99 miles 0·150 inch. In forecasting weather it will be necessary to keep this effect of high winds on the barometer constantly in mind, with the view of arriving at a better approximation to the geographical distribution of pressure at the time the forecasts are being framed.

These results are for all winds grouped together irrespective of their direction. The next inquiry grouped the winds according to their direction to sixteen points of the compass. During the time under examination, all the very high winds were from E.S.E. or S.E., these being the directions in which the wind blows freely along the slopes of the mountain to the observatory. In 11 cases the wind from these directions attained a velocity of 100 miles an hour or more, and the reduced barometer of the high-level station read about one-sixth of an inch lower than the barometer of the low-level observatory. In no other of the 16 directions was there, during the ten months, a higher velocity than 62 miles an hour observed, and indeed in the directions E., E.N.E., N.E., N., N.W., and W. the observed velocity was never greater than 29 miles an hour. With these northerly winds the observations at the top of the mountain indicate a much lower speed than that which, from the drift of the clouds, is seen to be reached at a comparatively small height above the top of the Ben. The cause of this comparatively calm state of the air immediately on the top is the impact of the air on the face of the tremendous cliff, close to the top of which the observatory is built, by which the stream

lines are suddenly deflected upwards. Now in such cases the depression of the barometer is about three times as great as that which occurs with an equally strong wind from other directions, and indicates clearly the formation of a restricted region of low pressure around and outside the observatory. Another curious and highly interesting result observed with other directions of the wind is that the reduced high-level barometer exceeds the reduced low-level barometer when the wind blows at the rate of about 5 miles an hour. This increased pressure accompanying wind rising up the slope of the hill may perhaps explain the small clear space immediately on the top of a hill, otherwise cloud-topped, and the very different force of wind on the two sides of a ridge lying about a right angle to the direction of the wind.

An examination has also been made of the relations of differences of temperature at the two observatories to differences of the sea-level pressures at the same hours. During the ten months examined the temperature differences have ranged from the high-level observatory showing a temperature 26° lower to a temperature 6° higher than the temperature at Fort William at the time. A comparison has been made by sorting the differences into two-degrees amounts, and instituting a comparison only on those cases when the strength of the wind at either of the observatories did not exceed 26 miles an hour.

The following show for each two-degrees difference of temperature the difference between the reduced barometer of the top and the barometer at Fort William, the plus sign indicating that the top barometer was the higher, and the minus sign that it was the lower of the two:—

Difference of Temperature	Difference of Pressure Inch	Difference of Temperature	Difference of Pressure Inch
+ 6° to + 4°	+ 0.047	- 10° to - 12°	+ 0.006
+ 4 " + 2	+ 0.044	- 12 " - 14	+ 0.001
+ 2 " + 0	+ 0.041	- 14 " - 16	- 0.005
- 0 " - 2	+ 0.031	- 16 " - 18	- 0.010
- 2 " - 4	+ 0.020	- 18 " - 20	- 0.018
- 4 " - 6	+ 0.008	- 20 " - 22	- 0.023
- 6 " - 8	+ 0.009	- 22 " - 24	- 0.029
- 8 " - 10	+ 0.007	- 24 " - 26	- 0.033

The broad result is this, and it is clear and explicit, when the higher observatory has the higher temperature, and when the differences of temperature are small, then the reduced pressure at the top of the mountain is the greater of the two; but when the differences of temperature are large then the reduced pressure at the top is the less of the two. The regular progression of these figures show that what is substantially a true average has been obtained. The result, which is altogether unexpected, raises questions of the greatest importance, affecting the theory of storms, the effect of vertical movements of great masses of air on the barometric pressure which accompanies cyclones and anticyclones, and the necessity there is for some accurate knowledge of the absolute amounts of aqueous vapour at different heights in the atmosphere under different weather conditions. Ben Nevis, with its two observatories, one at the top, the other at the foot of the mountain, would, with a third halfway up the hill, afford unique facilities for the prosecution of this all-important hygrometric inquiry, which would, however, require considerable additions, for the time it is carried on, to the observatories' present appliances and staff.

Third (Interim) Report of the Committee, consisting of Professor FITZGERALD, Dr. JOHN HOPKINSON, Mr. R. A. HADFIELD, Mr. TROUTON, Professor ROBERTS-AUSTEN, Mr. H. F. NEWALL, and Professor BARRETT (Secretary), on the various Phenomena connected with the Recalescent Points in Iron and other Metals.

THE Committee reported at some length last year, and wish to postpone a further report till next year. They desire, therefore, to be reappointed without a grant.

Second (Interim) Report of the Committee, consisting of Dr. JOHN KERR, Sir WILLIAM THOMSON, Professor RÜCKER, and Mr. R. T. GLAZEBROOK (Secretary), appointed to co-operate with Dr. KERR in his researches on Electro-optics.

THE Committee report that Dr. Kerr is continuing his experiments on Electro-optics, and hopes to be able to get some definite results for the meeting next year. They wish to be reappointed.

Report of the Committee, consisting of Professor LIVEING, Dr. C. PIAZZI SMYTH (Secretary), and Professors DEWAR and SCHUSTER, appointed to co-operate with Dr. C. PIAZZI SMYTH in his researches on the Ultra-violet Rays of the Solar Spectrum.

THE first proceeding of this committee after authorisation was to inquire into all that their Secretary was proposing to do in the way of observation and record in the ultra-violet of the solar spectrum and the sufficiency or otherwise of the apparatus he had already collected for the purpose. Much correspondence followed through the autumn and in the winter of 1890-91, and it soon became evident that only a small part of what was scientifically necessary could be procured with the amount voted.

In February, 1891, however, a most agreeable surprise occurred, in the shape of a resuscitation of a still earlier application on the same general lines, but on a wider basis, by Dr. C. Piazzi Smyth to the Royal Society's Government Grant Committee in July, 1890, and which he erroneously imagined, from their silence after receiving it, had not been approved by that body. But it had been simply kept in abeyance, and was finally pronounced favourably upon and granted in 1891. This measure happily relieved the British Association Committee from attempting to do altogether too much for its small means, though still requiring the utmost economy in their disposition, as well as their limitation to the exact line pointed out in the resolution passed by the General Committee at Leeds, viz., 'to co-operate with their Secretary in his researches on the Ultra-violet Rays of the Solar Spectrum.'

Now this part of the spectrum being absolutely invisible to the eye, though otherwise known to be in the field of the Secretary's Grating spectroscope at the time, while the *focus* of the inspecting or photograph-

ing telescope thereof varied rapidly with the smallest angular change of its direction in spectrum place, there arose a necessity for a considerable improvement of the focussing arrangement over and above what is usually supplied for the visible parts of the spectrum, or had been furnished in the present instance for all parts. But this improvement has now been accomplished by Messrs. T. Cooke & Sons, of York, according to a design by the Secretary, enabling the focus to be set distinctly and solidly to the thousandth of an inch without reference to anything but numerical tables prepared beforehand and tested by photographic record.

Again, however, in some of the most interesting of those ultra-violet regions of solar spectrum light a further and more intricate difficulty of a physical nature was found when photographing in the second order of the Grating's spectra. For, though that operation was performed under double shields of the darkest blue glass procurable, yet the red region of the first order of spectrum would insist on breaking in through all obstacles, and showing itself even brilliantly by means of the anomalous ultra-red ray transmitted by the supposed most pure and densely blue, or violet, glass known! One possible method of getting rid of this difficulty immediately seemed to be by photographing only in the first order of the Grating's spectrums, throughout whose violet fields there is no red band of any other order to come in—blue glass in place or not. But could sufficient spectrum separation of lines be thereby obtained, and without any other drawback?

To meet this essential problem Messrs. T. Cooke & Sons, of York, were again applied to, and they constructed within the grant made to the Committee an extra-large Barlow photo-achrom-concave lens, which magnified the previous image of the inspecting telescope's object-glass by 2·3 times, or rather more than the first order of the Grating's spectrums is magnified, in separation only, by the second order. And if by the Barlow concave the magnifying is both in separation and in height of lines (and therefore weakening to the intensity of the image), it was hoped that longer exposures could be freely given. So that then, with them, would come the final trial, which has still to be made—whether the exquisite definition of the first order of spectrum cannot be *lenticularly* magnified to the required degree, with less loss of that still more valuable feature, *definition*, than what takes place when it is *diffractionally* magnified (at least in the Secretary's Grating spectroscop) by resorting to *its* second order of spectrum?

This is the main point, then, up to which the Secretary's research has just arrived by aid of the British Association's grant of 1890. For while the whole of that sum has now been expended on the above-mentioned *major* subjects and a number of *minor* improvements and working particulars bearing on the same ends, and nothing further in the way of grant is now being asked for, it leaves sufficient material in Dr. C. Piazzi Smyth's hands for much work in the months to come. In earnest whereof he begs to send some of his accomplished work during the last nine months, in the shape of two album cases, each containing twenty-six of his separately mounted and scaled but continuous solar spectrum magnified photographs of lines in the violet and ultra-violet, besides a third and thinner album case of previously taken eye-and-hand-made drawings at the same instrument, but of the easier half only of the same subjects, for inter-comparison of the two methods which are past, and in preparation for the third, which is to come.

Report of the Committee, consisting of Professor W. GRYLLS ADAMS (Chairman and Secretary), Sir WILLIAM THOMSON, Professor G. H. DARWIN, Professor G. CHRYSAL, Professor A. SCHUSTER, Professor RÜCKER, Mr. C. H. CARPMAEL, Commander CREAK, the ASTRONOMER ROYAL, Mr. WILLIAM ELLIS, and Mr. G. M. WHIPPLE, appointed for the purpose of considering the best means of Comparing and Reducing Magnetic Observations.

IN accordance with the arrangements made last year for determining the mean diurnal range from the observations taken on five days in each month, the following list of quiet days during the year 1890 has been selected by the Astronomer Royal as suitable for the determination of the magnetic diurnal variations:—

Quiet Days in 1890.

January	5, 7, 12, 30, 31.
February	2, 7, 10, 23, 25.
March	2, 3, 9, 29, 30.
April	3, 9, 18, 25, 28.
May	1, 13, 16, 22, 29.
June	6, 10, 15, 24, 30.
July	3, 9, 14, 28, 29.
August	4, 12, 13, 28, 30.
September	8, 9, 23, 27, 28.
October	4, 7, 21, 28, 29.
November	3, 6, 11, 24, 29.
December	3, 7, 12, 14, 26.

During the past year the magnetic survey of the United Kingdom, now in progress under the superintendence of Professors Rücker and Thorpe, has advanced rapidly. Messrs. Gray, A.R.C.Sc., and Watson, B.Sc., A.R.C.Sc., are at present working in Ireland and Scotland respectively. A body of computers has been organised at South Kensington, so that the reductions are proceeding *pari passu* with the observations, and by the end of this summer complete observations will have been made at more than 600 stations in the British Isles.

On June 18 last, in a paper read before the Royal Society on the 'Comparison of Simultaneous Magnetic Disturbances at several Observatories, and Determination of the Value of the Gaussian Coefficients for those Observatories,' the Chairman pointed out the importance of adopting the same scale-values for similar instruments at different observatories, especially at new observatories which have been recently established, and discussed special magnetic disturbances, especially the disturbances of a great magnetic storm which occurred on June 24 and 25, 1885, for which photographic records have been obtained from seventeen different observatories: eleven in Europe, one in Canada, one in India, one in China, one in Java, one at Mauritius, and one at Melbourne.

In this paper the records are discussed and compared, tables are formed of the simultaneous disturbances, and the traces are reduced to Greenwich mean time and brought together on the same plates arranged on the same time-scale. Plates I. and II. show the remarkable agreement between the disturbances at the different observatories, and the tables show that the amount of disturbance, especially of horizontal magnetic force, is nearly the same at widely distant stations.

An attempt has also been made to apply the Gaussian analysis to sudden magnetic disturbances, and, with a view to their application in future work, the values of the Gaussian coefficients have been obtained for twenty different observatories, and the numerical equations formed for the elements of magnetic force in three directions mutually at right angles, and also the equation for the magnetic potential in terms of the Gaussian constants to the fourth order. The observatories of Washington and Los Angeles in the United States of America are included in this list.

During the past year a very interesting volume has been published, giving the magnetic observations at the United States Naval Observatory at Washington for 1888 and 1889. In accordance with the recommendation made at the International Conference held at Washington in 1884 the hours adopted in these American tables are for the seventy-fifth meridian (west of Greenwich), mean time.

The results of the Washington observations are contained in ten tables, as follows:—

TABLE I.—Mean hourly values of declination for 1888–89.

TABLE II.—Mean hourly declination for each month of 1888–89, taken from monthly composite curves.

TABLE III.—Mean hourly values of horizontal force for each month of 1889 in c.g.s. units (dynes).

TABLE IV.—Mean hourly values of vertical force for each month of 1889 in c.g.s. units (dynes).

TABLES V., VI., and VII.—Hourly values of declination, horizontal force, and vertical force respectively.

TABLE VIII.—Summary of disturbances in declination during 1888–89, determined from the composite curve.

TABLES IX. and X.—Observations for 1888–89 for horizontal force and dip respectively.

In addition to the tables there are fourteen plates as follows:—

PLATE I.—Examples of the daily photographic traces of declination, horizontal and vertical force.

PLATE II.—Mean diurnal variation of the magnetic elements for 1889.

PLATES III., IV., V., VI.—Monthly composite curves of declination for 1888 and 1889, each plate for six months.

PLATES VII. to XIV.—Comparisons of disturbed days of declination at Washington, Los Angeles, Toronto (Canada), and Pawlowsk (St. Petersburg).

The traces are all placed for the same time, and are reduced to the same length of base line. In the horizontal-force trace increase of ordinate denotes increase of force, and in the vertical-force trace increase of ordinate denotes decreasing force, and the scale-value adopted for both horizontal and vertical force instruments is very nearly the scale-value recommended in the third report of this committee to the British Association (1887), viz., 1 centimetre of ordinate = .0005 c.g.s. units.

The Committee entertain hopes that another of their recommendations, to which attention was first drawn in their third report (1887), and to which attention was again drawn in their fifth and sixth reports, viz., the establishment of a Magnetic Observatory at the Cape of Good Hope, is about to be carried out. At a meeting of the Committee held on June 2, 1891, at which the Chairman, Sir William Thomson, Professor Rücker, Commander Creak, Mr. Ellis, and Mr. Whipple were present, and at which Mr. Gill also attended at the request of the Committee, a statement was drawn up with regard to the requirements for a Magnetic Observatory at the Cape of Good Hope, and a rough estimate of cost and maintenance

was supplied by Mr. Whipple at the request of the Committee. It was resolved to ask the First Lord of the Admiralty to consider a statement of these requirements and to receive a deputation of the Committee and other scientific men interested in the progress of terrestrial magnetism to urge the establishment of a Magnetic Observatory at the Cape of Good Hope, to be placed under the direction of Mr. Gill, the Director of the Cape Royal Astronomical Observatory. In answer to Sir William Thomson's application to the first Lord of the Admiralty, asking him to receive a deputation on the subject, the First Lord requested that before receiving a deputation he might have a statement of the requirements with regard to the proposed magnetic observatory at the Cape to be asked for by the deputation.

At the request of Sir William Thomson a statement was laid by the Chairman of the Committee before the first Lord of the Admiralty, pointing out the importance of establishing a magnetic observatory at the Cape of Good Hope and submitting a rough estimate of the cost of observatory and apparatus and the necessary requirements.

In a circular issued by the International Meteorological Committee, which will meet in Munich in September next, the following questions bearing on terrestrial magnetism are proposed for consideration:—

QUESTION 8.—Is it not necessary in the introduction to the publication of magnetic observations to give the absolute values of the normal readings of differential instruments?

QUESTION 31.—Would it not be useful to come to an agreement as to the values of the coordinates of magnetic curves registered by magnetographs?

To these questions, according to the opinion of this Committee, as expressed in their reports, especially in their third report (1887), there can be but one answer. The absolute values of the normal readings of all magnetic instruments and their scale-values should be given in the publication of magnetic records, and it would be convenient that the same scale-values should be adopted at all Observatories for similar instruments. The value recommended by this Committee for changes of horizontal and vertical force is $\cdot 0005$ c.g.s. units for 1 centimetre of the scale.

The Committee recommend that for self-registering magnetographs the scale values for declination, horizontal force, and vertical force should be arranged so that equal changes of ordinate correspond to equal increments of absolute force in three directions at right angles to one another, δx , δy , and δz being the changes in the horizontal force in the magnetic meridian, the horizontal force *perpendicular* to the magnetic meridian and the vertical force respectively.

The Committee also recommend that as far as possible the same time-scale should be adopted for the registering magnetographs at different Observatories, and that this scale should be 15 millimetres to the hour.

Professor Lemström, of Helsingfors, also suggests the following questions for consideration:—

QUESTION 29.—What method should be employed for the study of earth-currents?

QUESTION 30.—What is the extent of our knowledge of atmospheric electricity, and how should we measure it quantitatively so as to get better results?





QUESTION 32.—What instrument is best for studying the variations of vertical intensity of terrestrial magnetism?

With regard to Question 32 the Committee are of opinion that Lloyd's vertical-force magnetometer is a very satisfactory instrument for studying the changes in the vertical magnetic force.









Report of the Committee, consisting of Professor G. CAREY FOSTER, Sir WILLIAM THOMSON, Professor AYRTON, Professor J. PERRY, Professor W. G. ADAMS, Lord RAYLEIGH, Dr. O. J. LODGE, Dr. JOHN HOPKINSON, Dr. A. MUIRHEAD, Mr. W. H. PREECE, Mr. HERBERT TAYLOR, Professor EVERETT, Professor SCHUSTER, Dr. J. A. FLEMING, Professor G. F. FITZGERALD, Mr. R. T. GLAZEBROOK (Secretary), Professor CHRYSAL, Mr. H. TOMLINSON, Professor W. GARNETT, Professor J. J. THOMSON, Mr. W. N. SHAW, Mr. J. T. BOTTOMLEY, and Mr. T. GRAY, appointed for the purpose of constructing and issuing Practical Standards for use in Electrical Measurements.

THE work of testing resistance coils at the Cavendish Laboratory has been continued. A table of values found for the coils is appended:—



B.A. Units.

No. of Coil	Resistance in B.A. Units	Temperature
Elliott, 245  No. 74	·99954	11°·9
Elliott, 246  No. 75	·99949	12°·15
Elliott, 248  No. 76	·99988	13°·9
B.A., No. 38  No. 77	1·00023	15°·7
Elliott, 257  No. 78	1·00046	15°·6

Legal Ohms.

No. of Coil	Resistance in Legal Ohms	Temperature
McWhirter, L.O. . . .  No. 200	·99836	13°·9
Elliott, 244  No. 202	·99871	11°·75
Elliott, 250  No. 203	·99924	13°·9
Nalder, 3081  No. 204	·99868	15°·2
Elliott, 258  No. 205	·99985	15°·4
Elliott, 259  No. 206	·99975	15°·5
Elliott, 260  No. 207	10·0019	15°·6
Nalder, 2018  No. 208	10·0066	17°·8
Nalder, 2020  No. 209	100·056	17°·7

Ohm Coils.

No. of Coil		Resistance in Ohms	Temperature
Elliott, 243	 No. 201	·99948	11°·85
Elliott, 267	 No. 325	1·00040	16°·0
Nalder, 3059	 No. 326	1·00005	16°·8

Among these the coil B.A. No. 38  No. 77 has a special interest; it is an original platinum silver coil which formerly belonged to Professor Balfour Stewart, and is now in the possession of Professor Schuster at the Owens College. According to the label on it, it was right at 16°·5. According to the Secretary's observations, its value is one mean B.A. Unit at 14·9. This coil, therefore, would appear to have risen in value since about 1867 by ·0006 B.A.U., and this result is not in accordance with the conclusions deduced in 1888 from the observations on the other platinum silver coils then examined.

Some further experiments have been made with satisfactory results on the air-condensers of the Association. A megohm resistance box has been purchased for use in comparisons of capacity.

With a view to testing the permanence of the resistance standards it was thought desirable to compare them again with the mercury standards. This was done in December and January by the Secretary. The coil Flat was compared with two mercury tubes constructed in 1884 by Mr. J. R. Benoit, which had been filled at Cambridge early in the year 1885, and had remained full since. An account of the comparison was read before the Physical Society May 9, 1891, and appears in the 'Philosophical Magazine,' July, 1891.

The tubes were compared with the B.A. standards. If we take, as was done in 1885, for the resistance in B.A. units of a column of mercury 100 cm. long 1 sq.-mm. in section, the value ·95412 B.A.U., we have the following results for the resistance of the tubes in Legal Ohms.

No.	Value in 1885 found by RTG	Value in 1891 found by RTG
37	·99990	·99986
39	·99917	·99913

The differences are only ·00004 Legal Ohms, which is too small to feel really certain about. If we accept for the resistance of mercury the value ·95352 B.A.U., which (B.A. Report, 1890) appears the best value, then we have:

No.	Value given by Benoit 1885	Value found by RTG in 1891
37	1·00045	1·00033
39	·99954	·99959

These comparisons were made with Flat, and lead to the conclusion that it has remained unchanged.

In November, 1890, the Association was invited by the President of the Board of Trade to nominate two members to represent the Association on a Committee 'On Standards for the Measurement of Electricity for use in Trade.' A meeting of the Electrical Standards Committee was held on December 2, and it was agreed to suggest to the Council of the Association the names of Professor Carey Foster and Mr. R. T. Glazebrook as representatives. These gentlemen were appointed by the Board of Trade together with Mr. Courtenay Boyle, C.B., Major Carden, Mr. E. Graves, Mr. W. H. Preece, Sir Wm. Thomson, Lord Rayleigh, Dr. Jno. Hopkinson, and Professor Ayrton.

This Committee after various meetings drew up a report, a copy of which is printed as Appendix I. to this report.

The standards of resistance constructed in accordance with Resolution 6 of the report are now in the hands of the Secretary, and are being compared with the standards of the Association.

Numerous experiments on the methods of constructing Clark's cells, and on the electromotive force of such cells, have been made at the Cavendish Laboratory by Mr. Wilberforce, Mr. Skinner, and the Secretary. These are still incomplete, but the experiments so far as they have been finished lead to the value 1.434 volts at 15° for the E.M.F. of the cell. The value found by Lord Rayleigh was 1.435 at the same temperature.

Mr. Fitzpatrick has continued his experiments on the resistance of silver, and an account of these will be given in a future Report.

The Committee ask for reappointment with omission of the names of Principal Garnett and Mr. H. Tomlinson, and addition of those of Dr. G. Johnstone Stoney and Professor S. P. Thompson. They recommend that Professor Carey Foster be Chairman, and Mr. R. T. Glazebrook Secretary. They further ask to be allowed to retain an unexpended balance of last year's grant, amounting to 17l. 4s. 6d., as well as for a new grant of 10l.

APPENDIX I.

REPORT OF THE ELECTRICAL STANDARDS COMMITTEE APPOINTED BY THE BOARD OF TRADE.

To the Right Honourable Sir Michael Hicks-Beach, Bart., M.P., President of the Board of Trade.

In compliance with the instructions contained in your Minute of the 16th December last, that we should consider and report whether any, and, if so, what action should be taken by the Board of Trade under section 6 of the Weights and Measures Act, 1889, with a view to causing new denominations of standards for the measurement of electricity for use for trade to be made and duly verified, we have the honour to submit the following report:

1. Before coming to a decision as to the points referred to us, we were anxious to obtain evidence as to the wishes and views of those practically interested in the question, as well as of Local Authorities who are concerned in the administration of the Weights and Measures Acts.

2. With this view we prepared draft resolutions embodying the proposals which, subject to further consideration, appeared to us desirable, and forwarded copies to the representatives of various interests for criticism. Copies were also forwarded to the Press. We also invited the following bodies to nominate witnesses to give evidence before us :

The Association of Chambers of Commerce of the United Kingdom.

The Association of Municipal Corporations.

The London County Council.

The London Chamber of Commerce.

3. In response to this invitation the following gentlemen attended and gave evidence :

On behalf of the Association of Chambers of Commerce, Mr. Thomas Parker and Mr. Hugh Erat Harrison.

On behalf of the London Council, Professor Silvanus Thompson.

On behalf of the London Chamber of Commerce, Mr. R. E. Crompton.

The Association of Municipal Corporations did not consider it necessary to offer any oral evidence, but the following resolution passed by the Law Committee of that body, was adopted by the Council of the Association :

‘The Committee are of opinion that, assuming that the science of electricity has advanced so far that it is now possible properly to define the three units referred to in the Board of Trade letter,’ (*i.e.*, the ohm, ampère, and volt) ‘and to construct an instrument for the purpose of standard measurement, the time has arrived for the Board of Trade to take action thereon.’

4. In addition to the witnesses above referred to the following gentlemen were invited to give evidence, and we are indebted to them for valuable information and assistance.

Dr. J. A. Fleming.

Dr. Alexander Muirhead.

5. We also had the advantage of the experience and advice of Mr. H. J. Chaney, Superintendent of Weights and Measures, who, at the request of our Chairman, was present at our meetings.

6. After a careful consideration of the questions submitted to us, and the evidence given by the various witnesses, we have agreed to the following resolutions :

Resolutions.

1. That it is desirable that new denominations of standards for the measurement of electricity should be made and approved by Her Majesty in Council as Board of Trade standards.
2. That the magnitudes of these standards should be determined on the electro-magnetic system of measurement with reference to the centimetre as unit of length, the gramme as unit of mass, and the second as unit of time, and that by the terms centimetre and gramme are meant the standards of those denominations deposited with the Board of Trade.

3. That the standard of electrical resistance should be denominated the ohm, and should have the value 1,000,000,000 in terms of the centimetre and second.
4. That the resistance offered to an unvarying electric current by a column of mercury of a constant cross sectional area of one square millimetre, and of a length of 106·3 centimetres at the temperature of melting ice may be adopted as one ohm.
5. That the value of the standard of resistance constructed by a committee of the British Association for the Advancement of Science in the years 1863 and 1864, and known as the British Association unit, may be taken as ·9866 of the ohm.
6. That a material standard, constructed in solid metal, and verified by comparison with the British Association unit, should be adopted as the standard ohm.
7. That for the purpose of replacing the standard, if lost, destroyed, or damaged, and for ordinary use, a limited number of copies should be constructed, which should be periodically compared with the standard ohm and with the British Association unit.
8. That resistances constructed in solid metal should be adopted as Board of Trade standards for multiples and submultiples of the ohm.
9. That the standard of electrical current should be denominated the ampère, and should have the value one-tenth (0·1) in terms of the centimetre, gramme, and second.
10. That an unvarying current which, when passed through a solution of nitrate of silver in water, in accordance with the specification attached to this report, deposits silver at the rate of 0·001118 of a gramme per second, may be taken as a current of one ampère.
11. That an alternating current of one ampère shall mean a current such that the square root of the time average of the square of its strength at each instant in ampères is unity.
12. That instruments constructed on the principle of the balance, in which by the proper disposition of the conductors, forces of attraction and repulsion are produced, which depend upon the amount of current passing, and are balanced by known weights, should be adopted as the Board of Trade standards for the measurement of current whether unvarying or alternating.
13. That the standard of electrical pressure should be denominated the volt, being the pressure which, if steadily applied to a conductor whose resistance is one ohm, will produce a current of one ampère.
14. That the electrical pressure at a temperature of 62° F. between the poles or electrodes of the voltaic cell known as Clark's cell, may be taken as not differing from 1·433 volts by more than an amount which will be determined by a sub-committee appointed to investigate the question, who will prepare a specification for the construction and use of the cell.
15. That an alternating pressure of one volt shall mean a pressure such that the square root of the time-average of the square of its value at each instant in volts is unity.

16. That instruments constructed on the principle of Sir W. Thomson's Quadrant Electrometer used idiostatically, and for high pressures instruments on the principle of the balance, electrostatic forces being balanced against a known weight, should be adopted as Board of Trade standards for the measurement of pressure, whether unvarying or alternating.

7. We have adopted the system of electrical units originally defined by the British Association for the Advancement of Science; and we have found in its recent researches, as well as in the deliberations of the International Congress on Electrical Units, held in Paris, valuable guidance for determining the exact magnitude of the several units of electrical measurement, as well as for the verification of the material standards.

8. We have stated the relation between the proposed standard ohm and the unit of resistance originally determined by the British Association, and have also stated its relation to the mercurial standard adopted by the International Conference.

9. We find that considerations of practical importance make it undesirable to adopt a mercurial standard, we have, therefore, preferred to adopt a material standard constructed in solid metal.

10. It appears to us to be necessary that in transactions between buyer and seller a legal character should henceforth be assigned to the units of electrical measurement now suggested, and with this view, that the issue of an Order in Council should be recommended, under the Weights and Measures Act, in the form annexed to this report.

SPECIFICATION REFERRED TO IN RESOLUTION 10.

In the following specification the term silver voltameter means the arrangement of apparatus by means of which an electric current is passed through a solution of nitrate of silver in water. The silver voltameter measures the total electrical quantity which has passed during the time of the experiment, and by noting this time the time-average of the current, or, if the current has remained constant, the current itself can be deduced.

In employing the silver voltameter to measure currents of about 1 ampère the following arrangements should be adopted. The kathode on which the silver is to be deposited should take the form of a platinum bowl not less than 10 cm. in diameter, and from 4 to 5 cm. in depth.

The anode should be a plate of pure silver some 30 square cm. in area and 2 or 3 millimetres in thickness.

This is supported horizontally in the liquid near the top of the solution by a platinum wire passed through holes in the plate at opposite corners. To prevent the disintegrated silver which is formed on the anode from falling on to the kathode, the anode should be wrapped round with pure filter paper, secured at the back with sealing wax.

The liquid should consist of a neutral solution of pure silver nitrate, containing about 15 parts by weight of salt to 85 parts of water.

The resistance of the voltameter changes somewhat as the current passes. To prevent these changes having too great an effect on the current, some resistance besides that of the voltameter should be inserted in the circuit. The total metallic resistance of the circuit should not be less than 10 ohms.

Method of Making a Measurement.

The platinum bowl is washed with nitric acid and distilled water, dried by heat, and then left to cool in a desiccator. When thoroughly dry it is weighed carefully.

It is nearly filled with the solution, and connected to the rest of the circuit by being placed on a clean copper support, to which a binding screw is attached. This copper support must be insulated.

The anode is then immersed in the solution so as to be well covered by it and supported in that position; the connexions to the rest of the circuit are made.

Contact is made at the key noting the time of contact. The current is allowed to pass for not less than half an hour, and the time at which contact is broken is observed. Care must be taken that the clock used is keeping correct time during this interval.

The solution is now removed from the bowl and the deposit is washed with distilled water and left to soak for at least six hours. It is then rinsed successively with distilled water and alcohol and dried in a hot-air bath at a temperature of about 160° C. After cooling in a desiccator it is weighed again. The gain in weight gives the silver deposited.

To find the current in ampères this weight, expressed in grammes, must be divided by the number of seconds during which the current has been passed, and by $\cdot 001118$.

The result will be the time average of the current, if during the interval the current has varied.

In determining by this method the constant of an instrument, the current should be kept as nearly constant as possible, and the readings of the instrument taken at frequent observed intervals of time. These observations give a curve from which the reading corresponding to the mean current (time average of the current) can be found. The current, as calculated by the voltmeter, corresponds to this reading.

PROVISIONAL MEMORANDUM ON THE PREPARATION OF THE CLARK'S
STANDARD CELL.

Definition of the Cell.

The cell consists of zinc and mercury in a saturated solution of zinc sulphate and mercurous sulphate in water, prepared with mercurous sulphate in excess, and is conveniently contained in a cylindrical glass vessel.

Preparation of the Materials.

1. *The Mercury.*—To secure purity it should be first treated with acid in the usual manner, and subsequently distilled in vacuo.

2. *The Zinc.*—Take a portion of a rod of pure zinc, solder to one end a piece of copper wire, clean the whole with glass paper, carefully removing any loose pieces of the zinc. Just before making up the cell dip the zinc into dilute sulphuric acid, wash with distilled water, and dry with a clean cloth or filter paper.

3. *The Zinc Sulphate Solution.*—Prepare a saturated solution of pure ('pure re-crystallised') zinc sulphate by mixing in a flask distilled water with nearly twice its weight of crystals of pure zinc sulphate, and adding

a little zinc carbonate to neutralise any free acid. The whole of the crystals should be dissolved with the aid of gentle heat, *i.e.* not exceeding a temperature of 30° C., and the solution filtered, while still warm, into a stock bottle. Crystals should form as it cools.

4. *The Mercurous Sulphate.*—Take mercurous sulphate, purchased as pure, and wash it thoroughly with cold distilled water by agitation in a bottle; drain off the water, and repeat the process at least twice. After the last washing drain off as much of the water as possible.

Mix the washed mercurous sulphate with the zinc sulphate solution, adding sufficient crystals of zinc sulphate from the stock bottle to ensure saturation, and a small quantity of pure mercury. Shake these up well together to form a paste of the consistence of cream. Heat the paste sufficiently to dissolve the crystals, but not above a temperature of 30° . Keep the paste for an hour at this temperature, agitating it from time to time, then allow it to cool. Crystals of zinc sulphate should then be distinctly visible throughout the mass; if this is not the case, add more crystals from the stock bottle, and repeat the process.

This method insures the formation of a saturated solution of zinc and mercurous sulphates in water.

The presence of the free mercury throughout the paste preserves the basicity of the salt, and is of the utmost importance.

Contact is made with the mercury by means of a platinum wire about No. 22 gauge. This is protected from contact with the other materials of the cell by being sealed into a glass tube. The ends of the wire project from the ends of the tube; one end forms the terminal, the other end and a portion of the glass tube dip into the mercury.

To set up the Cell.

The cell may conveniently be set up in a small test tube of about 2 cm. diameter, and 6 or 7 cm. deep. Place the mercury in the bottom of this tube, filling it to a depth of, say, 1.5 cm. Cut a cork about .5 cm. thick to fit the tube; at one side of the cork bore a hole through which the zinc rod can pass tightly; at the other side bore another hole for the glass tube which covers the platinum wire; at the edge of the cork cut a nick through which the air can pass when the cork is pushed into the tube. Pass the zinc rod about 1 cm. through the cork.

Clean the glass tube and platinum wire carefully, then heat the exposed end of the platinum red hot, and insert it in the mercury in the test tube, taking care that the whole of the exposed platinum is covered.

Shake up the paste and introduce it without contact with the upper part of the walls of the test tube, filling the tube above the mercury to a depth of rather more than 2 cm.

Then insert the cork and zinc rod, passing the glass tube through the hole prepared for it. Push the cork gently down until its lower surface is nearly in contact with the liquid. The air will thus be nearly all expelled, and the cell should be left in this condition for at least twenty-four hours before sealing, which should be done as follows:—

Melt some marine glue until it is fluid enough to pour by its own weight, and pour it into the test tube above the cork, using sufficient to cover completely the zinc and soldering. The glass tube should project above the top of the marine glue.

The cell thus set up may be mounted in any desirable manner. It is convenient to arrange the mounting so that the cell may be immersed in a water bath up to the level of, say, the upper surface of the cork. Its temperature can then be determined more accurately than is possible when the cell is in air.

Interim Report of the Committee, consisting of Professor CAYLEY, Professor SYLVESTER, Mr. A. R. FORSYTH, and Professor A. LODGE (Secretary), appointed for the purpose of carrying on the Tables connected with the Pellian Equation from the point where the work was left by Degen in 1817.

A LARGE part but not the whole of the work has been completed, but the Committee hope to have it completed in time for next year's meeting of the Association.

10*l.* of the grant of 15*l.* has been expended.

Seventh Report of the Committee, consisting of Sir G. G. STOKES (Chairman), Professor SCHUSTER, Mr. G. JOHNSTONE STONEY, Sir H. E. ROSCOE, Captain ABNEY, Mr. WHIPPLE, Professor McLEOD, and Mr. G. J. SYMONS (Secretary), appointed for the purpose of considering the best methods of recording the direct Intensity of Solar Radiation.

YOUR Committee have to report that, after considerable search, Professor Schuster found the thermometers constructed for Professor Balfour Stewart for use with the apparatus designed by and constructed for him, and that the apparatus and a mass of correspondence relating thereto had been placed in Professor McLeod's hands. He reports that he has tested all the thermometers, and made observations with the instrument when opportunity has offered. He has found it desirable to provide a screen to prevent the action of the sun on the outside of the instrument affecting too much, or too unequally, the reading of the internal thermometers. It was always contemplated that the action of the sun on the case of the instrument would affect the embedded thermometers; but as care was taken that the central thermometer should be prompt in responding to changes of temperature, while the embedded thermometers, in consequence of the way in which they were protected, should change but slowly, it was expected that the *difference* between the temperatures marked by the central thermometer and by the embedded thermometer respectively would be sensibly proportional to the intensity of solar radiation, notwithstanding the changes of temperature of the outer case. This anticipation, the correctness of which is of vital importance to the success of the instrument, has not, however, as yet been tested experimentally, and the trials would require to be made under specially favourable atmospheric conditions. The Committee hope to report definitely in the course of another year as to the utility of the apparatus and desire reappointment without any grant.

Report of the Committee, consisting of Sir H. E. ROSCOE, Mr. J. N. LOCKYER, Professors DEWAR, WOLCOTT GIBBS, LIVEING, SCHUSTER, and W. N. HARTLEY, Captain ABNEY, and Dr. MARSHALL WATTS (Secretary), appointed to prepare a new series of Wave-length Tables of the Spectra of the Elements and Compounds.

 IRON (ARC SPECTRUM).¹

(† denotes one of Rowland's 'normal' lines, or one of Müller and Kempf '300' lines, as the case may be).

Kayser and Runge (Rowland)	Thalén		Intensity and Character	Müller and Kempf	Difference Rowland - Ångström	Reduction to Vacuum		Oscillation Frequency in Vacuo
	Ångström	Fievez				$\lambda +$	$\frac{1}{\lambda} -$	
6750·36	48·6		2		1·76	1·97	4·3	14809·7
6708·04			2			1·96	4·4	14903·1
†6678·14	76·9		8	†6678·36	1·24			14969·8
6668·18	66·6		1		1·58			14992·2
6665·58			1					14998·0
†6663·60	62·3		6	†6663·74	1·30	1·96		15002·5
6654·30	52·8		1		1·50	1·95		15023·5
6647·69	45·7		1		1·99			15038·4
6644·85			1					15044·8
6640·13	38·4		4		1·73			15055·5
†6633·90	32·7		6n	†6634·14	1·20			15069·7
6627·77	26·5		4		1·27	1·95		15083·6
6614·05			1n.			1·94		15114·9
6611·94			1					15119·8
†6609·25	08·7		6	†6609·50	0·55			15125·9
6608·06			1				4·4	15128·6
6605·34	04·2		1		1·14		4·5	15134·8
6597·93	96·8		4n		1·13			15151·8
6594·00	94·3		6		-0·3			15160·8
†6593·07	92·2		10	†6593·61	0·87			15162·9
6591·79			1			1·94		15165·9
6586·14			1			1·93		15178·9
6584·80			2					15182·0
6581·45	80·3		2		1·15			15189·7
6577·83			1					15198·1
6575·19	74·0		6	†6575·27	1·19			15204·2
6572·87			1					15209·5
6571·33			1					15213·1
6569·36	68·2		8n		1·16			15217·7
6556·92	55·6		1		1·32	1·93		15246·6
†6546·40	45·1		10	†6546·66	1·30	1·92		15271·1
6544·14			1					15276·3
6538·77			1					15288·9
6534·07	33·0		2n	†6534·30	1·07			15299·9
6528·81	27·7		1		1·11			15312·2
6523·59			1			1·92		15324·5
6518·51	17·3		6		1·21	1·91		15336·4
6515·95			1					15342·4
6510·15	08·3		1		1·85			15356·1
6507·43			1					15363·4

¹ Kayser and Runge (Berlin, 1888); Thalén (Upsala, 1884); Müller and Kempf (Potsdam, 1886).

IRON (ARC SPECTRUM)—continued.

Kayser and Runge (Rowland)	Thalén		Intensity and Character	Müller and Kemptf.	Difference Rowland — Ångström	Reduction to Vacuum		Oscillation Frequency in Vacuo
	Ångström	Fievez				$\lambda +$	$\frac{1}{\lambda} -$	
6504.38	03.3		2		1.08			15369.7
6501.77	00.7		2		1.07			15375.9
6499.13	98.3		2		0.83			15382.2
6496.68	96.1		2		0.58			15388.0
6495.13	94.2		10		0.93			15391.6
6494.09			1					15394.1
6492.81			1					15397.1
6490.60			1					15402.4
6488.39			2					15407.6
6486.08			2			1.91		15413.1
6483.93			1			1.90		15418.2
6481.97	81.0		4		0.97			15422.9
6475.73	74.8		4	†6475.91	0.93			15437.8
6471.58			1					15447.7
6469.10	68.5		4		0.90			15452.9
†6462.76	61.7		4	†6462.95	1.06			15468.8
6457.19			1					15482.1
6456.51	55.2		1		1.31			15483.7
6450.08			1	†6450.18		1.90		15499.2
6439.24			1	†6439.38		1.89		15525.3
6436.79			1					15531.2
6433.42			1					15539.3
6432.85			1					15540.7
†6430.99	30.1		8	†6431.12	0.89			15545.2
6426.75			1					15555.5
6421.52	20.6		8	†6421.72	0.92			15568.1
6420.23	19.2		6n		1.03			15571.3
6417.24			1					15578.5
6414.23			1			1.89		15585.8
6411.83	10.9		8	†6411.98	0.93	1.88		15591.7
6411.18			1				4.5	15593.2
6408.25	07.1		6	†6408.35	1.15		4.6	15600.3
6404.98			1					15608.2
6402.74			1					15613.7
6400.13	99.1		10	†6400.35	1.03			15620.1
6399.68			1					15621.2
6398.30			1					15624.5
6396.22			1					15629.6
6393.83			1	†6393.92				15635.5
6393.63	92.6		8		1.03			15636.0
6392.96			1					15637.6
6391.50			1					15641.2
6389.51			1					15646.0
6387.44			1					15651.1
6386.28			1n					15654.0
6385.00			2					15657.1
6383.57			1					15660.6
6382.37			1					15663.6
†6380.89	79.7	79.5	6	†6381.13	1.19			15667.2
6379.32			1			1.88		15671.1
6378.16			1			1.87		15673.9
6376.09	75.0	73.5	1		1.09			15679.0
6373.89			1					15684.4
6371.60			1					15690.0
6369.79			1					15694.5

IRON (ARC SPECTRUM)—*continued.*

Kayser and Runge (Rowland)	Thalén		Intensity and Character	Müller and Kempf	Difference Rowland - Ångström	Reduction to Vacuum		Oscillation Frequency in Vacuo
	Ångström	Fievez				$\lambda +$	$\frac{1}{\lambda} -$	
6367.53			1					15700.1
6364.69	63.5	62.7	2n		1.19			15707.1
6363.01	61.2	60.6	2		1.81			15711.2
6361.90			1					15714.0
6361.01			1					15716.2
6360.20			1					15718.2
†6358.83	57.7	57.3	4	†6358.99	1.13			15721.6
6357.61			1					15724.6
6356.39			1					15727.6
6355.16	54.0	54.0	4	†6355.46	1.16	1.87		15730.6
6354.86			1			1.86		15743.7
6344.28	43.2	44.0	4	†6344.50	1.08			15747.6
6341.73	41.0		1		0.73			15764.0
6339.17	38.0	38.0	2n	†6339.33	1.17			15770.3
†6336.97	35.9	36.0	10		1.07			15775.8
6335.43	34.3	34.3	8	†6335.72	1.13			15779.6
6334.62			1					15781.7
6333.49			1					15784.5
6331.04	30.5	29.0	2n		0.54			15790.6
6328.93			2n					15795.8
6326.84			2n					15801.1
6324.60			1					15806.7
†6322.83	21.6	21.6	6	†6323.06	1.23			15811.1
6321.78			1					15813.7
6320.42			1					15817.1
†6318.16	16.9	17.4	10	6318.41	1.26			15822.8
6317.27			1					15825.0
6315.92			2					15828.4
6315.42	13.9	13.4	4	†6315.46	1.52			15829.7
6311.62	11.0		2		0.62			15839.2
6310.59	09.5	09.1	1		1.09			15841.8
6309.53			1			1.86		15844.4
	06.0	05.7				1.85		
6302.65	01.6	02.0	6	†6302.84	1.05			15861.7
6301.61	00.7	00.5	10		0.91			15864.4
6300.60			1					15866.9
6299.31			1					15870.2
6297.90	96.9	97.0	6	†6298.24	1.00			15873.7
6296.67			1					15876.8
6293.94	93.0		2		0.94			15883.7
6292.88	92.0		1		0.88			15886.4
6291.10	90.2		6n	†6291.33	0.90			15890.9
6288.67	88.0		1		0.67			15897.0
6285.23	84.5		2n		0.73			15905.7
6283.17	81.6		2n		1.57			15910.9
6280.74	79.6		4		1.14			15917.1
6280.06			1					15918.8
6277.61	76.6		1n	†6277.95	1.01			15925.0
6274.10			1n			1.85		15933.9
6271.49	69.9		2		1.59	1.84		15940.6
6270.39	69.1	69.2	6		1.29			15943.4
6269.26			1				4.6	15946.2
6267.97			1				4.7	15949.4
†6265.27	64.1	64.0	8	†6265.48	1.17			15956.3
6264.28			1					15958.8

IRON (ARC SPECTRUM)—*continued.*

Kayser and Runge (Rowland)	Thalén		Intensity and Character	Müller and Kempf	Difference Rowland — Ångström	Reduction to Vacuum		Oscillation Frequency in Vacuo
	Ångström	Fievez				$\lambda +$	$\frac{1}{\lambda} -$	
6263.31			1n					15961.3
6261.26			2n					15966.5
6258.87			2n					15972.6
6256.52	55.3	55.1	6	†6256.66	1.22			15978.6
6254.40	53.2	53.0	6		1.20			15984.0
†6252.71	51.5	51.2	10	†6253.00	1.21			15988.4
6251.90			1					15990.4
6250.56			1n					15993.9
6248.85			1n					15998.2
6247.68			1					16001.2
6246.48	45.4	45.4	8	†6246.72	1.08			16004.3
6245.69			1					16006.3
6244.20			1n					16010.2
6243.06			1n					16013.1
6241.73			1					16016.5
6240.77	39.2	39.0	4	†6240.93	1.57			16019.0
6240.47			1					16019.7
6239.54			1			1.84		16022.1
6238.53			1			1.83		16024.7
6237.44			1n					16027.5
6235.26			1					16033.1
6232.83	31.5	31.5	6		1.33			16039.4
6231.76			1					16042.1
†6230.88	29.7	29.5	10	†6231.14	1.18			16044.4
6230.16			1					16046.2
6229.34			1					16048.4
6228.72			1					16050.0
6227.78			1					16052.4
6226.95	25.4	25.3	2		1.55			16054.5
6224.42			1n					16061.1
6222.31			1n					16066.5
6221.57			1					16068.4
6220.93	19.7	20.0	1		1.23			16070.1
†6219.42	18.3	18.2	8	†6219.61	1.12			16074.0
6218.51			1					16076.3
6217.81			1					16078.1
6216.49			1n					16081.5
6215.29	14.1	15.0	6		1.19			16084.6
†6213.57	12.3	12.4	8	†6213.78	1.27			16089.1
6211.25			1n					16095.1
6209.11			1n					16100.7
6206.98			1n					16106.2
6204.98			1n			1.83		16111.4
6202.59			1			1.82		16117.6
†6200.46	99.6	99.2	6	†6200.71	0.86			16123.1
6199.61			1					16125.3
6196.24			1					16134.1
6193.89			1					16140.2
6191.70	90.5	90.7	10	†6191.84	1.20			16145.9
6190.84			1					16148.2
6190.35			1				4.7	16149.5
6189.54			1				4.8	16151.6
6188.25	87.1	86.9	4		1.15			16155.0
6187.42			1					16157.1
6185.90	85.3	85.6	2		0.60			16161.1

IRON (ARC SPECTRUM)—*continued*.

Kayser and Runge (Rowland)	Thalén		Intensity and Character	Müller and Kempf	Difference Rowland - Ångström	Reduction to Vacuum		Oscillation Frequency in Vacuo
	Ångström	Fizevz				$\lambda +$	$\frac{1}{\lambda} -$	
6183·15	83·0		2		0·15			16168·3
†6180·34	79·3	79·2	6	†6180·56	1·04			16175·6
6178·80			1					16179·7
6173·48	72·3	72·3	4		1·18			16193·6
6172·60			1					16195·9
6170·62	69·4	69·8	6m	†6170·85	1·22			16201·1
6169·77			1			1·82		16203·4
6168·18			1			1·81		16207·5
6166·80			1					16211·1
6165·51	63·8	63·3	4		1·71			16214·5
6163·70	62·3		2		1·40			16219·2
6163·23			1					16220·4
6162·40			2	†6162·53				16222·6
6160·95			1					16226·5
6159·47			1n					16230·4
6157·87	56·7	56·7	6		1·17			16234·6
6157·29			1					16236·1
6154·86			1					16242·5
6153·75			1					16245·4
6151·78	50·5	50·5	4		1·28			16250·7
6150·47			1					16254·1
6149·24			1					16257·4
6147·96	48·1	46·6	4	†6148·10	-0·14			16260·8
6147·43			1					16262·2
6146·46			1					16264·7
6145·38			1					16267·6
6144·26			1					16270·5
6143·17			1					16273·4
†6141·88			6	†6142·04				16276·9
6141·13			1					16278·8
6140·12			1					16281·5
6139·00			1					16284·5
6137·84	36·6	36·8	10		1·24			16287·6
6137·06			1					16289·6
6136·76	35·6	35·5	10	6137·03	1·16			16290·4
6135·89			1					16292·7
6134·73			1			1·81		16295·8
6133·67			1			1·80		16298·6
6132·63			1					16301·4
6131·59		30·3	2					16304·2
6130·48			1					16307·1
6129·22			1					16310·5
6128·04	26·8	26·7	6		1·24			16313·6
6127·32			1					16315·5
6126·16			1					16318·6
6125·16			1					16321·3
6123·81	22·0	22·0	2		1·81			16324·9
6122·42			2					16328·6
6119·67			1					16335·9
6118·67			1					16338·6
6117·49			1					16341·8
†6116·34	15·3	15·1	4		1·04			16344·8
6115·50			1					16347·1
6113·01		12·0	2					16353·7
6111·82			1					16356·9

IRON (ARC SPECTRUM)—*continued.*

Kayser and Runge (Rowland)	Thalén		Intensity and Character	Müller and Kempf	Difference Rowland — Ångström	Reduction to Vacuum		Oscillation Frequency in Vacuo
	Ångström	Fievez				$\lambda +$	$\frac{1}{\lambda} -$	
6110.81			1					16359.6
6109.44		07.0	2					16363.3
6107.22			1					16369.3
6105.51			1					16373.8
†6103.35	02.0	01.8	8n		1.35			16379.6
6102.30	01.2	00.8	8n		1.10			16382.5
6100.42			1			1.80		16387.5
6098.61	97.4	97.0	4		1.21	1.79		16392.4
6096.89	95.7	95.1	2n		1.19			16397.0
6095.88			1					16399.7
6094.50	93.3	92.8	1		1.20			16403.4
6093.84	92.7	92.1	4n		1.14			16405.2
6092.02			1n					16410.1
6090.38			2					16414.5
6089.68		88.1	4					16416.4
6088.49			1n					16419.6
6087.00			1					16423.6
6085.42		84.0	1					16427.9
6082.81		81.3	1					16434.9
6081.77		80.0	1					16437.8
6079.29			2					16444.5
†6078.64	77.6	77.2	6n	†6078.83	1.04			16446.2
6076.66			1n				4.8	16451.6
6074.21			2				4.9	16458.1
6072.12			2				4.9	16463.8
6070.10			2					16469.3
6067.88			2					16475.3
†6065.64	64.5	64.5	10	†6065.81	1.14			16481.4
6064.92			1			1.79		16483.4
6063.54			1			1.78		16487.1
6062.98		61.4	2					16488.6
6061.41			1					16492.9
6059.43			1					16498.3
6057.34			1					16504.0
†6056.15	55.1	55.0	6n	†6056.35	1.05			16507.2
6054.20	53.1		2		1.10			16512.6
6044.57			1					16538.9
6043.86			1					16540.8
†6042.24	41.2	41.1	6	†6042.46	1.04			16545.2
6040.00			1					16551.4
6035.63	35.0	35.0	2		0.63			16563.4
6034.27	33.0	33.0	2		1.27			16567.1
6032.70			2					16571.4
6031.43			1					16574.9
6030.49		29.0	1			1.78		16577.5
6028.56			1			1.77		16582.8
6027.22	26.0	26.0	6		1.22			16586.5
6026.47			1					16588.6
†6024.21	23.0	23.0	10n	†6024.38	1.21			16594.8
6022.02			4					16600.8
†6020.28	19.1	19.2	6n		1.18			16605.6
6018.20			1					16611.4
6016.87			4					16615.0
6015.85			1					16617.8
†6013.68			4	†6013.83				16623.8

IRON (ARC SPECTRUM)—*continued.*

Kayser and Runge (Rowland)	Thalén		Intensity and Character	Müller and Kempf	Difference Rowland - Ångström	Reduction to Vacuum		Oscillation Frequency in Vacuo
	Ångström	Fizeev				$\lambda +$	$\frac{1}{\lambda}$	
6012·50	11·2	11·5	1		1·30			16628·1
6008·80	07·5	07·3	8		1·30			16637·3
6008·14		06·7	4n					16639·2
6006·74	05·0		1		1·74			16643·1
6005·70		03·9	2					16645·9
†6003·17	02·1		6	†6003·33	1·07			16653 0
6001·36		98·6	1					16658·0
5999·45			1					16663·3
5998·05	96·9	97·0	4n		1·15			16667·2
5997·04			1					16670·0
5995·12			1			1·77		16675·3
5993·37			1			1·76		16680·2
5991·42			1					16685·6
5990 04			1					16689 5
5988·67			1					16693·3
5987·21	86·2	86·2	6n	†5987·40	1·01			16697·4
5984·98	84·2	84·2	8n		0·78			16703·6
5983·91	82·8	82·7	6n		1·11			16706·6
5978·97			1					16720·4
†5976·93	76·0	76·0	8	†5977·11	0·93			16726·1
†5975·51	74·6	74·3	6		0·91			16730·1
5974·65			1					16732·5
5973·36			1					16736·1
5972·22			1					16739·3
5969·92			1					16745·7
5969·28			1					16747·5
5968·10		66·5	1					16750·8
5966·88			1					16751·3
5964·87			1					16759·9
5963·82		61·3	1					16762·9
5962·28		59·5	2					16767·2
5960·04			1			1·76		16773·5
†5958·38	57·1	57·4	4	†5958·55	1·28	1·75		16778·2
5956·85	55·0	56·0	6		1·85			16782·5
5955·86			1					16785·3
5954·65			1					16788·7
5952·94	51·6	51·6	8		1·34			16793·5
5949·55	48·5	48·7	4n		1·05			16803·1
5947·77			1				4·9	16808·1
5942·61		41·6	2				5·0	16822·6
5941·24		40·0	4					16826·5
5939·34			1					16831·9
5938·85			1					16833·3
†5934·81	33·9	33·0	8	†5934·99	0·91			16844·7
5931·21			1					16846·4
5930 25	29·3	28·7	10		0·95			16857·7
5928·00	27·2	26·2	4		0·80			16864·1
5926·95			1			1·75		16867·1
5924·83			1			1·74		16873·1
5923·66			1					16876·5
5922·67			1					16879·3
5921·69			1					16882·1
5920·62			1					16885·1
5919·11			1					16889·4
5918·18			1					16892·1

IRON (ARC SPECTRUM)—*continued.*

Kayser and Runge (Rowland)	Thalén		Intensity and Character	Müller and Kempf	Difference Rowland — Ångström	Reduction to Vacuum		Oscillation Frequency in Vacuo
	Ångström	Fievez				λ +	$\frac{1}{\lambda}$ -	
5917·32			1					16894·5
†5916·41	15·7	15·6	6		0·71			16897·1
5915·65			1					16899·3
†5914·32	13·2	13·4	10n	†5914·47	1·12			16903·1
5912·37			2					16908·7
5910·16	09·4	09·0	4		0·76			16915·0
5908·14		06·7	1					16920·8
†5905·82	04·4	04·3	6		1·42			16927·4
5905·13			1					16929·4
5902·64	01·3	01·3	2		1·34			16936·6
5901·87		00·3	1					16938·8
5900·41			1					16943·0
5899·40		98·0	1					16945·9
†5898·33	97·0	97·0	2		1·33			16948·9
5895·16			1					16958·1
5894·49			1					16960·0
5892·88	92·0	92·0	2		0·88			16964·6
5892·04	90·6	90·6	1		1·44			16967·0
5891·23		89·9	1					16969·4
5889·22			1			1·74		16975·2
5888·10		84·4	1			1·73		16978·4
5884·05	83·0	82·5	4	†5884·19	1·05			16990·1
5882·52			1					16994·5
5881·60		80·6	1					16997·2
5880·27			1					17001·0
5879·80		78·2	4					17002·4
5878·01		78·0	1					17007·6
5876·71	77·0	76·0	1		-0·29			17011·3
5875·76			1					17014·1
5874·82			1					17016·8
5873·44	74·0	72·0	2		-0·56			17020·8
5871·72			1					17025·8
5871·28			1					17027·1
5864·38			1					17047·1
†5862·51	61·5	61·4	10	†5862·66	1·01			17052·5
5859·83	58·4	58·5	8		1·43			17060·3
5857·71			1	†5857·80				17066·5
5856·24	55·5	55·2	2		0·74			17070·8
5855·30		54·2	1					17073·5
5854·01			1			1·73		17077·3
5853·38		52·2	1			1·72		17079·1
5852·35	51·3	51·0	2n		1·05			17082·1
5849·80	48·5	48·5	1		1·30			17089·6
5849·07			1					17091·7
5848·25	47·4	47·2	2n	†5848·52	0·85			17094·1
5845·93			1					17100·9
5845·13			1					17103·3
5838·64	37·0	35·8	2		1·64			17122·3
5837·88		35·1	2n				5·0	17124·5
5836·00			1				5·1	17129·9
5835·52	32·5	33·5	2		3·02			17131·3
5834·22			ln					17135·1
5830·80	27·5	27·5	1		3·30			17145·2
5827·83		25·0	1			1·72		17153·9
†5816·50	15·5	15·5	6	†5816·68	1·00	1·71		17187·4

IRON (ARC SPECTRUM)—*continued.*

Kayser and Runge (Rowland)	Thalén		Intensity and Character	Müller and Kempf	Difference Rowland — Ångström	Reduction to Vacuum		Oscillation Frequency in Vacuo
	Ångström	Fizevz				$\lambda +$	$\frac{1}{\lambda} -$	
5815.54			1					17190.2
5815.02	14.0	13.6	2		1.02			17191.7
5811.99	11.0	10.5	1		0.99			17200.7
5809.39	08.3	08.0	2		1.09			17208.4
5808.10		06.7	1					17212.2
5806.83	05.8	05.8	2	†5807.05	1.03			17216.0
5805.83			1					17219.0
5804.63	03.5	03.2	1		1.13			17222.5
5804.22		02.8	1					17223.7
5800.21		00.0	1					17235.7
5798.38	97.3	97.3	2		1.08			17241.1
5794.09	93.0	92.2	2		1.09			17253.9
5791.82			1					17260.6
†5791.14	90.2	90.1	4	†5791.30	0.94			17262.6
5790.55		89.8	1					17264.4
5788.45			1					17270.7
5785.50		84.5	1					17279.5
5784.78		84.2	1					17281.6
5784.00		83.4	1			1.71		17284.0
†5782.28	81.3	81.6	8		0.98	1.70		17289.1
5780.84	77.5	78.5	2		3.34			17293.4
5778.58	76.0		1		2.58			17300.2
†5775.24	74.1	74.0	6	†5775.36	1.14			17310.2
5774.49			1					17312.4
5771.28		69.7	1					17322.1
5769.37			1					17327.8
5765.34			1					17339.9
†5763.15	61.9	62.0	10	†5763.23	1.25			17346.5
5762.58			1					17348.2
5761.70			ln					17350.9
5761.39		59.9	1					17351.8
5760.51			2					17354.5
5759.73			ln					17356.8
5759.37		58.2	1					17357.9
5756.85		56.0	ln					17365.5
5755.24			1					17370.4
5754.44		53.9	ln					17372.8
†5753.28	52.0	52.0	8		1.28			17376.3
5752.11	51.0	51.0	2n		1.11			17379.8
5748.01	46.7	46.5	2n	†5748.19	1.31	1.70		17392.2
5745.34			1			1.69		17400.3
5743.04		41.8	1					17407.3
5742.02	40.9	40.9	2		1.12			17410.4
5740.10		39.5	1					17416.2
5738.43			1					17421.3
5737.11		36.8	1					17425.3
5733.97			1					17434.8
†5731.91	30.5	30.5	6	†5732.07	1.41	5.1		17441.1
5727.86	27.0	28.0	1		0.86	5.2		17453.3
5727.20			1					17455.3
5724.52			1					17463.5
5723.82	23.0	22.5	1		0.82			17465.6
5722.00			1					17471.2
5720.95	20.0	19.8	ln		0.95			17474.4
5718.03	16.8	16.5	6	†5718.13	1.23			17483.3

IRON (ARC SPECTRUM)—*continued.*

Kayser and Runge (Rowland)	Thalén		Intensity and Character	Müller and Kempf	Difference Rowland - Ångström	Reduction to Vacuum		Oscillation Frequency in Vacuo
	Ångström	Fizez				$\lambda +$	$\frac{1}{\lambda} -$	
5716.20	15.2		1		1.00			17488.9
†5715.24	13.8	14.0	4		1.44			17491.9
5714.34	13.3	13.3	2		1.04			17494.6
5713.54			1					17497.1
5712.30		11.0	2					17500.9
5712.02	10.8	10.7	2		1.22	1.69		17501.7
†5709.56	08.3	08.5	8	†5709.75	1.26	1.68		17509.3
5708.25	07.1	07.1	2		1.15			17513.3
5707.15	06.0	06.0	2		1.15			17516.7
5706.14	05.0	05.0	4		1.14			17519.8
5705.65			2					17521.3
5704.87			1					17523.7
5703.66			1					17527.4
5702.50			1					17531.0
†5701.71	00.4	00.5	6		1.31			17533.4
5700.37			4					17537.5
5699.62			1	5698.70				17539.8
5698.55	97.2	97.5	2		1.35			17543.1
5698.23			1					17544.1
5696.02		95.5	1					17550.9
5695.21			1					17553.4
5693.77	92.8	93.0	2		0.97			17557.9
5691.64	90.6	90.8	2		1.04			17564.4
5690.76			1					17567.1
5688.52			1					17574.1
5686.60	85.5	85.3	6		1.10			17580.0
5684.84			1					17585.4
5683.25		82.2	1					17590.4
5680.42	79.0	79.2	1		1.42			17599.1
†5679.18	77.9	78.0	4		1.28	1.68		17603.0
5672.32	71.0	70.5	1		1.32	1.67		17624.3
5668.65		69.1	1					17635.7
5667.67	66.0	66.6	4		1.67			17638.7
5666.95			1					17641.0
5664.85			1					17647.5
5663.94		63.0	1					17650.4
†5662.68	61.6	61.5	8		1.08			17654.3
5661.50		60.3	1					17658.0
5660.95		59.7	1					17659.7
5658.93	57.6	57.9	10		1.33			17666.0
5657.90			1					17669.2
5656.84			1					17672.5
†5655.64	54.4	54.6	4		1.24			17676.3
5655.40			2					17677.0
5654.21			ln					17680.7
5652.51	51.6	52.5	2		0.91			17686.0
5651.53		50.4	1					17689.1
5650.96		49.5	1					17690.9
5650.24		48.8	1					17693.2
5649.90	48.0	48.0	ln		1.90			17694.3
5646.84		47.5	1					17703.8
5646.20			ln					17705.8
5645.95		44.0	1					17706.6
5644.15	43.0	42.7	2	†5644.27	1.15			17712.3
5642.99		42.0	1					17715.9

IRON (ARC SPECTRUM)—*continued.*

Kavser and Range (Rowland)	Thalén		Intensity and Character	Müller and Kempf	Difference Rowland — Ångström	Reduction to Vacuum		Oscillation Frequency in Vacuo
	Ångström	Fievez				$\lambda +$	$\frac{1}{\lambda} -$	
5642.76			1					17716.6
†5641.60	40.2	40.5	4		1.40	1.67		17720.3
5640.60		39.5	1n			1.66		17723.4
5638.45	37.2	37.3	6	†5638.58	1.25			17730.2
5637.53		36.0	1					17733.1
5637.29			1					17733.8
5636.84		35.2	1					17735.2
5636.08		34.0	1					17737.6
5634.16	32.7	32.5	4		1.46			17743.7
5632.54		31.0	1					17748.8
5631.84			2					17751.0
5630.70			1					17754.6
5629.33			1					17758.9
5628.68			1					17760.9
5627.72			2					17764.0
5626.87			1					17766.7
5625.95	24.4	24.1	1		1.55			17769.6
†5624.70	23.2	23.5	8		1.50			17773.5
5623.95			1					17775.9
5623.61			1					17777.0
5621.72			1				5.2	17782.9
5620.70	19.3	19.4	2		1.40		5.3	17786.1
5619.70		18.5	1					17789.2
5618.81	18.0	17.7	2		0.81			17792.1
5617.90			1					17794.9
5617.39	16.1	16.0	1		1.29			17796.6
†5615.81	14.5	14.6	10	5615.85	1.31			17801.6
5614.09			1					17807.0
5612.11		11.0	1					17813.3
5610.05		09.2	2					17819.8
5609.12		07.8	1					17822.8
5607.90		05.8	2					17826.7
5606.30			1			1.66		17831.8
5605.12			1			1.65		17835.5
5603.14	01.7	01.5	8		1.44			17841.8
5601.77			1					17846.2
5600.39	98.9	98.6	2		1.49			17850.6
5598.37	97.2	97.2	4		1.17			17857.0
5596.48			1n					17863.1
5594.73	93.4	93.3	2	†5594.82	1.33			17868.7
5592.64		90.8	1					17875.3
5591.16			1					17880.1
5590.30		88.7	1					17882.8
5588.92			1					17887.2
5586.92	85.6	85.4	10	†5587.04	1.32			17893.6
5585.00		83.3	2					17890.8
5583.13			1n					17905.8
5580.99			1n					17912.7
5579.21		78.0	1n					17918.4
†5576.22	74.9	74.4	8		1.32			17928.0
5574.99			2					17931.9
5573.05	71.7	71.3	10		1.35			17938.2
5571.51			1			1.65		17943.2
†5569.77	68.5	68.5	10		1.27	1.64		17948.8
5568.89			1					17951.6

IRON (ARC SPECTRUM)—*continue*d.

Kayser and Runge (Rowland)	Thalén		Intensity and Character	Müller and Kempf	Difference Rowland — Ångström	Reduction to Vacuum		Oscillation Frequency in Vacuo
	Ångström	Fievez				$\lambda +$	$\frac{1}{\lambda} -$	
5567.50	66.4	66.0	4		1.10			17956.1
5565.76	64.6	64.2	6n	†5565.99	1.16			17961.7
5563.73	62.7	62.5	4		1.03			17968.2
5562.78	61.8	61.4	2n		0.98			17971.3
5560.36	59.3	59.0	2n		1.06			17979.1
5558.00	57.1	56.7	2n		0.90			17986.8
5554.96	53.9	54.0	6n	†5555.17	1.06			17996.6
5553.70	52.7	52.4	1		1.00			18000.7
5550.00	49.0	49.0	2n		1.00			18012.7
5547.12		45.7	2					18022.1
5546.60	45.5	45.3	2		1.10			18023.8
†5544.07	42.7	43.0	4		1.37			18032.0
5543.24	42.0	42.0	4	†5543.44	1.24			18034.7
5542.09			1					18038.4
5541.14		40.0	1n					18041.5
5540.93			1					18042.2
5539.91			1					18045.5
5539.40		37.7	1					18047.2
5538.68	36.3	37.2	2		2.38			18049.5
5537.86			1					18052.2
5536.63			1					18056.2
5535.52			4			1.64		18059.8
5534.87			1			1.63		18062.0
5533.10	31.5	31.8	2		1.60			18067.7
5532.87			1					18068.5
5532.13			1					18070.9
5531.16			1					18074.1
5530.71		29.7	1					18075.6
5529.26		28.4	2					18080.3
5525.70	24.7	24.4	4		1.00			18091.9
5524.40		23.0	1n					18096.2
5522.60	21.5	21.5	2		1.10			18102.1
5521.26	20.0	20.2	1		1.26		5.3	18106.5
5519.69			2				5.4	18111.6
5517.25			1n					18119.6
5516.80	15.6	16.5	1		1.20			18121.0
5514.71			1					18127.9
5512.47	11.4	11.2	2		1.07			18135.3
5510.70	09.5	09.2	1n		1.20			18141.1
5508.53	07.6	07.2	1n		0.93			18148.3
†5506.92	05.9	05.9	8		1.02			18153.6
5506.06			1					18156.4
5504.51		03.3	1					18161.5
5503.32	01.9	02.0	2n		1.42			18165.4
†5501.61	00.5	00.5	8	†5501.82	1.11			18171.1
5500.87			1					18173.5
5499.60			1n					18177.7
5497.96			1			1.63		18183.2
5497.73			1	†5497.83		1.62		18183.9
5497.52	96.6	96.4	6		0.92			18184.6
5496.92			1					18186.6
5495.75			1					18190.5
5494.62	93.5	93.7	2		1.12			18194.2
5493.70	92.5	93.0	4		1.20			18197.3
		92.5						

IRON (ARC SPECTRUM)—continued.

Kayser and Runge (Rowland)	Thalén		Intensity and Character	Müller and Kempf	Difference Rowland - Ångström	Reduction to Vacuum		Oscillation Frequency in Vacuo
	Ångström	Fievez				$\lambda +$	$\frac{1}{\lambda -}$	
5491.98	91.0	90.8	2		0.98			18203.0
5490.10	89.0	89.3	1		1.10			18209.2
5488.04	86.8	86.6	4n		1.24			18216.0
5486.00	85.0	84.0	1		1.00			18222.8
5483.28	82.4	81.8	4		0.88			18231.9
5481.62	80.2	80.2	4		1.42			18237.4
5481.06	79.9	79.6	4		1.16			18239.2
5478.60	77.4	78.0	2		1.20			18247.4
5476.82	75.9	75.8	8	†5476.97	0.92			18253.4
5476.43		75.3	4					18254.7
5474.08	73.3	73.6	6		0.78			18262.5
5472.88	72.0	72.1	2		0.88			18266.5
5470.79		69.7	2					18273.5
5470.36	69.0	69.1	1		1.36			18274.9
5469.11			1n					18278.1
5467.15		66.2	2					18285.7
5466.52	65.6	65.7	4		0.92			18287.8
5465.20			1					18292.2
5464.46	63.2	63.4	2		1.26	1.62		18294.7
		62.6						
†5463.41	62.3	62.3	8n		1.11	1.61		18298.2
5463.19			1					18298.9
5461.68			1n					18304.0
5459.69			1n					18310.7
5457.72			2					18317.3
5455.80	54.7	54.7	10		1.10			18323.7
5454.53			1					18328.0
5452.96		51.5	1					18333.3
5452.10			1					18336.1
5451.00			1					18339.9
5449.95			1					18343.4
5449.16			1					18346.0
5448.52		47.3	1					18348.2
†5447.05	45.9	46.0	10	†5447.20	1.15			18353.2
5445.21	44.2	44.3	8n		1.01			18359.4
5443.33			1					18365.7
5442.42			1					18368.8
5441.56	40.0	40.7	1		1.56			18371.7
5440.41			1					18375.6
5439.48		38.0	2					18378.7
5438.51			1					18382.0
5437.50		36.0	1					18385.4
5436.74	35.4	35.5	2		1.34			18388.0
†5434.66	33.0	33.0	8	†5434.81	1.66			18395.0
5433.15			2n					18400.1
5431.82			1					18404.6
5429.74	28.8	28.0	10		0.94			18411.7
5429.10			1			1.61		18413.9
5428.03			1			1.60		18417.5
5427.13			1					18420.5
5426.14			1					18423.9
†5424.20	23.6	23.4	10n		0.60			18430.5
5422.16			1					18437.4
5420.52		19.2	1					18443.0
5418.66			1				5.4	18449.3

IRON (ARC SPECTRUM)—*continued.*

Kavser and Runge (Rowland)	Thalén		Intensity and Character	Müller and Kempf	Difference Rowland — Ångström	Reduction to Vacuum		Oscillation Frequency in Vacuo
	Ångström	Fievez				λ+	$\frac{1}{\lambda}$ -	
5417·15	16·0	16·2	1		1·15		5·5	18454·4
5415·43	14·5	14·6	10n	†5415·52	0·93			18460·2
5413·30			1					18467·5
5411·13	10·0	10·0	8n		1·13			18474·9
5409·75	08·5	08·2	1		1·25			18479·6
5409·30			1					18481·2
5407·73		06·5	1					18486·5
†5405·91	04·8	04·9	10	†5406·06	1·11			18492·8
5404·35	03·1	03·3	8n		1·25			18498·1
5402·91			1					18503·0
5401·97			1					18506·3
	Vogel							
5400·60	99·6	99·6	6n	†5400·83	1·00			18511·0
5399·65			1					18514·2
5398·34	97·3	97·0	2n	5398·63	1·04			18518·7
†5397·27	96·2	96·0	10	†5397·45	1·07	1·60		18522·4
5395·42			1n			1·59		18528·7
5394·74			1					18531·1
†5393·30	92·1	92·3	8	†5393·57	1·2			18536·0
5391·75	90·4	90·3	4	5391·73	1·35			18541·3
5389·71	88·4	88·8	4n	5389·76	1·31			18548·4
5387·80	86·6	86·0	1n	5387·87	1·20			18554·9
5386·63	85·5	85·0	1	5386·76	1·13			18559·0
5385·63			1					18562·4
†5383·50	82·5	82·4	10n	†5383·68	1·00			18569·8
†5379·70	78·5	78·0	4	†5379·83	1·20			18583·9
5379·01			1					18585·3
5377·88	76·5	76·2	2		1·38			18589·2
5377·08	75·7	75·2	2	5377·75	1·38			18591·9
5375·57			1	5376·96				18597·2
5373·85	72·6	72·5	4	5373·85	1·25			18603·1
5372·01			1					18609·5
†5371·62	70·5	70·6	10	†5371·74	1·12			18610·9
5370·09	69·0	69·0	8n	5370·24	1·09			18616·2
†5367·60	66·4	66·6	8n	†5367·79	1·20			18624·8
5365·62	64·4	64·3	4	5365·67	1·12			18631·7
5365·02	63·9	63·6	6n	5365·19	1·32			18633·8
5362·90	61·9	61·8	2	5363·21	1·00			18641·1
5361·80	60·8	60·6	1	5362·06	1·00			18645·0
5359·97			1			1·59	5·5	18651·3
5358·16	57·3	57·3	1	5358·65	0·86	1·58	5·6	18657·5
5356·28		55·0	1					18664·1
†5353·53	52·5	52·5	6	5353·71	1·03			18673·7
5349·83	48·8	48·7	4n	5349·91	1·03			18686·6
5348·58			1					18690·9
5347·62			1					18694·3
5346·62			1					18697·8
5245·75			1					18700·8
5344·64			1					18704·7
5343·62	42·7	42·4	4n	5343·82	0·92			18708·3
5341·49			1					18715·8
5341·15	40·3	40·0	8	†5341·36	0·85			18717·0
5340·10	39·2	38·9	8	5340·34	0·90			18720·6
5337·37			1n					18730·2

IRON (ARC SPECTRUM)—continued.

Kayser and Runge (Rowland)	Thalén		Intensity and Character	Müller and Kempf	Difference Rowland—Ångström	Reduction to Vacuum		Oscillation Frequency in Vacuo
	Vogel	Fievez				$\lambda+$	$\frac{1}{\lambda}-$	
5335·47			1					18736·9
5335·25			1					18737·7
†5333·04	32·1	32·0	6	†5333·16	0·94			18745·4
5330·15	29·0	29·1	4	5330·07	1·15			18755·6
5328·94			1					18759·9
5328·50	27·3	27·6	8	†5328·51	1·20			18761·4
5328·15	27·0	27·0	10	5328·20	1·15			18762·6
5326·32		25·2	1					18769·1
5324·31	23·2	23·5	10	†5324·48	1·11	1·58		18776·2
5323·70			1			1·57		18778·3
5322·30	21·4	21·3	2	5322·45	0·90			18783·3
5321·36	20·4	20·3	1	5321·51	0·96			18786·6
5320·28	19·3	19·2	1	5320·39	0·98			18790·4
5319·24	18·5	18·0	1		0·74			18794·1
5316·85	16·1	16·0	2	†5317·01	0·75			18802·5
5315·19	14·6	14·5	1	5315·73	0·59			18808·4
5313·44			1					18814·6
5311·61			1					18821·1
5309·89			1					18827·2
†5307·48	06·5	06·6	6	†5307·66	0·98			18835·7
5306·31			1					18839·9
5304·22			1					18847·3
5302·46	01·5	01·4	10	†5302·60	0·96			18853·6
5300·25	99·4	99·0	1	5300·51	0·85			18861·4
5298·91	98·1	98·2	2	5399·19	0·81			18866·2
5296·82	94·9	95·0	1		0·92			18873·6
5295·41		94·3	1					18878·7
5294·63	93·7	93·9	1	5294·70	0·93			18881·5
5294·05	92·7		2		1·55			18883·5
5292·78		92·0	2					18888·1
5291·07			1					18894·2
5289·22			1					18900·8
†5288·64	87·6	87·6	4	†5288·85	1·04	1·57		18902·8
5287·48			1			1·56		18907·0
5285·76	84·2	84·2	1	5285·33	1·56			18913·2
5284·63	83·4	83·8	1	5284·66	1·23			18917·2
5283·75	82·7	82·6	10	†5283·93	1·05			18920·3
5281·91	80·9	80·8	8	†5282·15	1·01			18926·9
5280·53	79·7	79·0	2	5280·68	0·83			18931·9
5278·95			1					18937·6
5277·80			1					18941·7
5276·19	75·2	75·0	1	†5276·26	0·99			18947·5
5275·12	74·5	74·0	ln	5275·68	0·75			18951·3
5273·55	72·5	72·3	6	5273·81	1·05			18957·0
5273·32			4					18957·8
5272·28			1					18961·5
5271·37			1					18964·8
†5270·43	69·2	69·5	10	†5270·55	1·23			18968·2
†5269·65	68·5	68·6	10n	†5279·90	1·15			18971·0
5268·73			1					18974·3
5266·72	65·3	65·5	10	5266·80	1·42			18981·5
5264·00			1					18991·4
5263·42	62·3	62·0	6	5263·67	1·12			18993·4
5257·77	56·8	56·6	1	5258·16	0·97			19013·9
5255·44	54·7	54·7	1	5256·03	0·74			19022·3

IRON (ARC SPECTRUM)—*continued.*

Kayser and Runge (Rowland)	Thalén		Intensity and Character	Müller and Kempf	Difference Rowland - Angström	Reduction to Vacuum		Oscillation Frequency in Vacuo
	Vogel	Fievez				$\lambda +$	$\frac{1}{\lambda -}$	
5255·08	53·9	54·0	2	†5255·32	1·88			19023·6
†5253·56	52·4	52·6	4	5253·68	1·16	1·56		19029·1
5252·08	50·8	51·0	2	5252·07	1·28	1·55		19034·5
†5250·76	49·4	49·8	6	†5250·85	1·36			19038·3
†5250·33			1					19040·8
5249·17	48·0	47·9	1n	5249·33	1·17			19045·0
5247·20	46·2	45·7	2	5247·37	1·00			19052·2
	44·7	44·0		5245·98				
5243·95	43·0	42·8	2n	5244·24	0·95			19064·0
5242·58	41·8	41·1	6	†5242·75	0·78			19069·0
5242·00			1				5·6	19071·1
5236·33	35·4	35·5	1	5236·46	0·93		5·7	19091·6
5235·50	34·4	34·7	4	5235·60	1·10			19094·7
5234·77	33·6	33·8	1	5234·77	1·17			19097·3
†5233·05	32·1	32·1	10	†5233·21	0·95			19103·6
5232·48			1					19105·7
5231·49			1					19109·3
5229·95	29·0	29·0	6	5230·28	0·95			19114·9
5228·53	27·4	27·6	1	5228·39	1·13			19121·1
5227·85			1					19122·6
5227·33	26·2	26·4	10	5227·47	1·13			19123·5
5227·00		26·1	10					19125·7
5226·63			1					19127·1
5226·25			1					19128·5
5225·60	24·5	24·8	2	5225·66	1·10			19130·9
5224·40			1n					19135·3
5223·28	22·3	22·0	1	5223·44	1·18			19139·3
5222·63	21·5	21·4	1	5222·79	1·13			19141·7
5221·89		20·8	1					19144·4
5221·09	20·2	20·0	1		0·89			19147·4
5219·76	18·7		1	5220·07	1·06			19152·3
5218·28		17·7	2					19157·7
5218·03			2			1·55		19158·6
†5217·49	16·7	16·7	4	5217·93	0·79	1·54		19160·6
5216·37	15·6	15·5	6	5216·38	0·77			19164·7
†5215·28	14·5	14·5	4	†5215·56	0·78			19168·7
5212·85		11·0	1					19177·7
	09·5	09·5		5210·72				
5208·72	07·6	07·8	6	†5208·77	1·12			19192·9
5208·11			1					19195·1
5207·95			1					19195·7
5206·13		05·3	2					19202·4
5205·17			1					19206·0
†5204·65	03·8	03·3	4	5204·85	0·85			19207·9
†5202·42	01·7	01·4	8	†5202·61	1·72			19216·1
5201·22			1					19220·6
5199·70			1					19226·2
†5198·82	98·2	98·2	4	5199·15	0·62			19229·4
5198·09			1					19232·1
5197·68			1					19233·6
5196·69			1					19237·3
5196·20	95·3	95·6	1	5196·46	0·90			19239·1
5195·59	94·6	94·7	4	5195·73	0·99			19241·4
5195·03	94·0	94·2	8	5195·15	1·03			19243·5
5194·20			1					19246·3

IRON (ARC SPECTRUM)—continued.

Kayser and Runge (Rowland)	Thalén		Intensity and Character	Müller and Kempf	Difference Rowland—Ångström	Reduction to Vacuum		Oscillation Frequency in Vacuo
	Vogel	Fievez				$\lambda +$	$\frac{1}{\lambda} -$	
5193·10			1					19250·6
5192·47	91·4	91·8	10	†5192·67	1·07			19253·0
5192·10			1					19254·3
5191·56	90·6	90·6	10	†5191·76	0·96			19256·3
5188·90			1					19266·2
5188·00	87·2	87·2	2	5188·16	0·80			19269·5
5186·65			1					19274·6
5184·42	83·3	83·8	4n	5184·46	1·12	1·54		19282·9
5181·90			1			1·53		19292·2
5181·40	80·8	80·7	1	5181·81	0·60			19294·1
5180·14	79·4	79·4	2	5180·29	0·74			19298·8
5178·89	77·8	78·2	1n	5178·87	1·08			19303·5
5177·40	76·3	76·5	1	5177·23	1·10			19309·0
5173·85			1					19322·3
5171·71	71·1	70·9	8	5171·89	0·61			19330·3
5171·15			1					19332·4
5170·86			1					19333·4
5170·08			1					19336·4
5169·09	68·4	68·9	6	5169·33	0·69			19340·1
†5167·50	67·0	67·1	10	†5167·67	0·50			19346·0
5166·36	65·8	65·7	4	5166·70	0·58			19350·3
†5165·52	64·8	65·0	4n		0·72			19353·4
5164·65	63·8	64·2	1	5164·87	0·85			19356·7
†5162·49	61·6	61·5	6n	†5162·60	0·89			19364·8
5160·39	59·6		1n	5160·57	0·79			19372·7
5159·09	58·3		4n	†5159·40	0·79		5·7	19377·6
5157·18	56·6		1	5157·69	0·58		5·8	19384·6
	56·0			5157·18				
	54·7			5155·87				
	53·7			5154·77				
5153·28	52·8		6	5154·04	0·48			19399·3
5152·00	51·5		4	5152·64	0·50			19404·1
†5150·96	50·6		6	5151·66	0·36			19408·1
5149·43			1			1·53		19413·8
5148·36	47·8		6n	5148·84	0·56	1·52		19417·9
5148·15	46·4		2	5147·64	1·75			19418·6
5146·57	45·3		1	5146·56	1·27			19424·6
5145·17	44·3		1	5145·78	0·87			19429·9
5144·17	42·8		1	5143·98	1·37			19433·7
†5142·99	41·9		4	5143·09	1·09			19438·1
5142·63	41·6		4	5142·71	1·03			19439·5
†5141·85	40·8		4	5141·95	1·05			19442·5
5139·58	38·5		10	†5139·72	1·08			19451·0
5139·34			10					19451·9
5138·12			1					19456·6
5137·50	36·3		6n	5137·46	1·20			19458·9
5136·12	35·4		1	5136·50	0·72			19464·1
5133·64	33·0		8	†5134·00	0·64			19473·5
5131·51	30·8		4	5131·98	0·71			19481·6
5129·73	28·8		1	5129·92	0·93			19488·4
5128·15			1					19494·4
5127·44	26·4		4	5127·55	1·04			19497·1
5126·70			1					19499·9
5126·31	25·3		1	5126·42	1·01			19501·4
5125·27	24·4		8n	†5125·48	0·87			19505·4

IRON (ARC SPECTRUM)—*continued.*

Kayser and Kunge (Rowland)	Thalén		Intensity and Character	Müller and Kempf	Difference Rowland—Angström	Reduction to Vacuum		Oscillation Frequency in Vacuo
	Vogel	Fievez				$\lambda +$	$\frac{1}{\lambda -}$	
5124.18			1					19509.5
5123.82	23.1		6	5124.31	0.71			19510.9
5121.71	20.9		2n	5121.93	0.81			19518.9
5120.32			1					19524.2
5119.77			1					19526.3
5117.98			1					19533.2
5115.87	14.6		1	†5115.79	1.27	1.52		19541.2
5114.45	13.6		1	5114.52	0.85	1.51		19546.6
5111.21			1					19559.0
†5110.50	09.2		6	5110.03	1.30			19561.7
5109.75			1					19564.6
5107.76	07.2		6	†5107.85	0.56			19572.2
5107.53			4					19573.1
5106.57			1					19576.8
†5105.66	05.2		8	5105.83	0.46			19580.3
5104.45	04.0		1	5104.75	0.45			19584.9
5104.25	03.7		1	5104.35	0.55			19585.7
5104.07			ln					19586.4
5103.37			1					19589.1
5102.28			1					19593.3
5100.00			1					19602.0
5099.17			1					19605.2
5098.77	98.2		6	†5098.91	0.57			19606.8
†5097.07	96.6		4n	5097.36	0.47			19613.3
†5090.90	90.3		4n	†5091.12	0.60			19637.1
5088.15	87.7		1	5088.48	0.45			19647.7
5087.16	85.7		1	5086.52	0.46			19651.5
5084.26	83.8		1	†5084.39	0.46			19662.7
†5083.46	82.8		6	5083.66	0.66			19665.8
5083.14			1					19667.1
5080.78	80.6		1	5081.74	0.18			19676.2
5080.37	80.2		1	5081.11	0.17	1.51		19677.8
5079.85	79.4		6	5080.41	0.45	1.50		19679.8
5079.36	78.8		6n	5079.77	0.56			19681.7
5079.00			1					19683.1
5076.43	75.7		2	†5076.62	0.73			19693.1
5074.80	74.0		4	5075.03	0.80			19699.4
5072.82	72.0		1	5072.94	0.82			19707.1
5072.04	71.3		1	5072.34	0.74			19710.1
†5068.88	68.2		8	5069.10	0.68			19722.4
5067.22	66.6		1	5067.50	0.62			19728.9
5065.09	64.5		6n	†5065.21	0.59		5.8	19737.2
5060.11	59.2		1	5060.11	0.91		5.9	19756.5
	57.5							
	56.5			5057.44				
	55.8			5056.80				
	55.3			5056.11				
5054.71	53.9		1	5054.76	0.81			19777.6
5053.65	52.8		1	5053.77	0.85			19781.8
	52.2			5053.07				
5051.72	51.0		6	†5051.85	0.62			19789.3
5050.98			1					19792.2
5050.58			1					19793.8
†5049.94	49.4		8	†5050.05	0.54			19796.3
5048.57	48.1		2	5048.75	0.47			19801.7

IRON (ARC SPECTRUM)—*continued.*

Kavser and Runge (Rowland)	Thalén		Intensity and Character	Müller and Kempf	Difference Rowland Angström	Reduction to Vacuum		Oscillation Frequency in Vacuo
	Vogel	Fievez				$\lambda +$	$\frac{1}{\lambda} -$	
5047·85			1			1·50		19804·5
5044·38	43·6		2	5044·50	0·78	1·49		19818·1
5041·85	41·0		8	†5041·96	0·85			19828·1
5041·17	40·3		4	†5041·24	0·87			19830·8
5039·38	38·5		2	5039·51	0·88			19837·8
5036·90	36·2		1	5037·25	0·70			19847·6
5036·40	35·7		1	5036·75	0·70			19849·5
5031·95	31·3		1	5032·39	0·65			19867·1
5030·99	30·4		1	5031·45	0·59			19870·9
	30·3							
5029·73	29·1		1	5030·16	0·82			19875·9
5028·25	27·4		4	5028·46	0·85			19881·7
5027·28	26·4		4n	†5027·51	0·80			19885·6
5025·60	24·8		1	5025·77	0·80			19892·2
	24·0			5024·97				
5023·53	22·7		1		0·83			19900·4
5022·35	21·5		4	5022·45	0·85			19905·1
5021·61	20·8		1	5021·84	0·81			19908·0
5020·90	20·0		1	5021·03	0·90			19910·8
5019·89	19·4		1	5020·30	0·89			19914·9
5019·11			1					19917·9
5018·53	17·7		4	†5018·65	0·83			19920·3
5017·81			1					19923·1
5017·02	16·3		1	†5017·22	0·72			19926·2
5016·40			1					19928·7
5015·40			1					19932·7
5015·09	14·4		6	5015·26	0·69			19933·9
5014·42			1					19936·6
5014·10			1					19937·9
5013·48			1					19940·3
5012·86			1					19942·8
5012·50	11·7		1	5012·72	0·80			19944·2
5012·15	11·3		6	5012·19	0·85			19945·6
5011·42			1			1·49		19949·4
5007·50	06·6		2n	†5007·58	0·90	1·48		19944·1
†5006·24	0·55		8	†5006·28	0·75			19969·2
†5005·84	05·0		6	5005·84	0·84			19976·8
5004·92	04·0		1		0·92			19974·4
5004·14	03·2		1	5004·34	0·94			19977·5
5002·95	02·2		2	5003·12	0·75			19982·3
5002·02	01·1		8	5002·16	0·92			19986·0
4999·23	98·3		1	4999·38	0·93			19997·2
4997·00	95·6		1		0·40			20006·1
4995·81	94·8		1	4995·89	1·01			20010·9
4994·63			1					20015·6
†4994·25	93·6		4	4994·58	0·65			20017·1
4991·43	90·5		2n	†4991·44	0·93			20028·4
4990·56	89·9		1	4990·94	0·66			20031·9
4989·10	88·3		2n	4989·29	0·80			20037·8
4986·37	85·9		1	4986·99	0·47			20048·8
4985·68	85·3		4	4986·36	0·38			20051·5
4985·35	84·7		4	†4985·74	0·65			20052·9
4983·97	84·4		4	4985·43	0·57			20058·1
4983·41	83·0		2	4984·16	0·11			20060·7
4983·00	82·4		1	4983·45	0·60			20062·3

IRON (ARC SPECTRUM)—*continued.*

Kayser and Runge (Rowland)	Thalén		Intensity and Character	Müller and Kempf	Difference Rowland — Angström	Reduction to Vacuum		Oscillation Frequency in Vacuo
	Vogel	Fievez				$\lambda +$	$\frac{1}{\lambda} -$	
4982·67	81·8		6	4982·81	0·87			20063·7
4981·73	79·7		1		2·03			20067·4
4979·66	78·8		1	4979·69	0·86			20075·8
†4978·71	78·1		4	4979·09	0·61			20079·6
4977·79	77·0		1	4978·72	0·79	1·48		20083·3
4976·03			1			1·47		20090·4
4975·60	74·7		1	4975·81	0·97			20092·2
4974·40			1					20097·0
†4973·29	72·4		4	†4973·40	0·89			20101·5
4972·36			1				5·9	20105·3
4970·58	69·5		1		1·08		6·0	20112·4
4970·07	69·2		1	4970·06	0·87			20114·4
4968·79	67·7		1	4968·69	1·09			20119·6
4967·97	67·1		1	4968·05	0·87			20122·9
4966·96			1					20127·0
4966·23	65·3		6	†4966·36	0·93			20130·0
4964·65	63·4		1	4964·50	1·25			20136·4
4962·63	62·0		1	4963·02	0·63			20144·6
4962·03	61·3		1	4962·37	0·73			20147·0
4961·15	60·3		1	4961·46	0·85			20150·6
4959·61			1					20156·9
4957·80	56·8		8	4957·90	1·00			20164·2
4957·43	56·6		6	4957·53	0·83			20165·7
4956·11			1					20171·1
4955·73			1					20172·7
4954·90			1					20176·0
4954·60	53·7		1	4954·83	0·90			20177·3
4952·64	51·8		1	4952·81	0·84			20185·2
4950·25	49·4		2	†4950·43	0·84			20195·0
4948·38			In					20202·6
4946·54	45·7		4	4946·74	0·84			20210·1
4945·80	44·9		1	4945·99	0·90			20213·2
4943·80	43·7		1	4944·70	0·10			20221·4
4942·51	41·7		1	4942·75	0·81	1·47		20226·6
4941·32			1			1·46		20231·5
4939·78	38·8		4	4939·80	0·98			20237·8
	38·3			4939·43				
4938·93	37·8		6	4938·93	1·13			20241·3
4938·30	37·3		2	4938·31	1·00			20243·9
4937·44	36·3		1	4937·34	1·14			20247·4
4934·08			1					20261·2
4933·44	32·6		1	4933·67	0·84			20263·8
	31·3			4932·40				
4930·43	29·7		1	4930·76	0·73			20276·2
4927·93	27·3		1	4928·40	0·63			20286·7
4927·46	26·7		1	4927·93	0·76			20288·4
	24·6							
†4924·89	24·1		2	4925·19	0·79			20299·0
4924·00	23·2		1	†4924·25	1·80			20302·7
4923·26			1					20305·7
4921·11			1					20314·6
†4920·63	19·5		10	†4920·79	1·13			20316·6
†4919·11	18·1		8	†4919·20	1·01			20322·9
4918·15	17·0		1	4918·27	1·15			20326·8
4917·41	16·4		1	4917·59	1·01			20329·9

IRON (ARC SPECTRUM)—*continued.*

Kayser and Runge (Rowland)	Thalén		Intensity and Character	Müller and Kempf	Difference from Angström	Reduction to Vacuum		Oscillation Frequency in Vacuo
	Vogel	Fievez				$\lambda +$	$\frac{1}{\lambda} -$	
4913.76			1					20345.0
4911.93	11.2		1	4912.38	0.73			20352.6
4910.60	10.0		2	4911.15	0.60			20358.1
4910.15	09.5		4	4910.58	0.65			20360.0
4909.53	08.7		2	4909.81	0.83			20362.5
4907.86	06.8		1	4907.97	1.06	1.46		20369.5
4906.68			1			1.45		20374.4
4905.30	04.3		1	4905.33	1.00			20380.1
†4903.41	02.4			†4903.63	1.01			20388.0
	00.1			4901.30				
	97.8			4898.98				
	96.8			4897.91				
4896.56	95.9		1	4897.01	0.66		6.0	20416.5
4893.02	92.2		1	4893.12	1.02		6.1	20431.2
4891.62	90.8		10	†4891.78	0.82			20437.0
4890.89	90.2		8	†4891.10	0.69			20440.1
4889.95			1					20444.0
4889.14	88.4		2	4889.32	0.74			20447.4
4888.71	87.9		1	4888.87	0.81			20449.2
4887.39	86.3		1	4887.36	1.09			20454.7
4886.43	85.6		1	4886.59	0.83			20458.7
4885.55	84.6		2	4885.63	0.95			20462.4
4882.27	81.4		1	4882.47	0.87			20476.2
4881.80	80.8		1	4881.95	1.00			20478.1
4878.33	77.4		6	4878.49	0.93			20492.7
4876.00	75.3		1	4876.67	0.70			20502.5
	74.3			4875.68				
	73.7			4875.15				
	73.0			4874.21		1.45		
4872.25	71.3		8	4872.45	0.95	1.44		20518.3
4871.43	70.6		8	†4871.60	0.83			20521.7
4870.14			1					20527.2
4869.71	68.7		1	4869.87	1.01			20529.0
	67.6			4868.76				
	66.6							
4863.78	62.8		1		0.98			20554.0
	61.7							
4862.07	61.2		1	4862.17	0.87			20561.3
4860.92	60.3		1 _n		0.72			20566.1
†4859.86	58.8		8	4860.01	1.06			20570.6
4859.20			1					20573.4
4857.40	56.6		1	4857.64	0.80			20581.0
4855.80	54.7		1	†4855.89	1.10			20587.8
4855.00	54.1		1	4855.11	0.90			20591.2
4852.09	51.2		1	4852.39	0.89			20603.6
4849.02	48.8		1	†4849.05	0.22			20616.6
4848.57	48.1		1	4848.77	0.47			20618.5
4845.76	44.7		1	4845.67	1.06			20630.5
4844.13	43.3		1	4844.35	0.83			20637.4
4843.31	42.3		2	4843.48	1.01			20640.9
4841.92	41.1		1	4842.12	0.82			20646.9
4840.42	39.4		1	4840.62	1.02			20653.3
4839.66	38.8		2	4839.94	0.86			20656.5
4838.66	37.7		1	†4838.90	0.96			20660.8
4836.04	35.0		1	4836.31	1.04	1.43		20672.0

IRON (ARC SPECTRUM)—*continued.*

Kaiser and Runge (Rowland)	Thalén		Intensity and Character	Müller and Kempf	Difference Rowland — Angström	Reduction to Vacuum		Oscillation Frequency in Vacuo
	Vogel	Fievez				$\lambda +$	$\frac{1}{\lambda} -$	
4834.64	33.8		1	4834.96	0.84			20678.0
4832.84	31.8		2	4833.17	1.04			20685.7
4827.57	26.7		1		0.87			20708.2
4825.44	24.6		1		0.84			20717.4
4824.27			1					20722.4
†4823.63	23.3		4	†4824.04	0.33		6.1	20725.2
4817.90	17.2		1	†4818.24	0.70		6.2	20749.7
4815.42	15.3		1		1.12			20760.4
4813.33	12.3		1	4813.68	1.03			20769.4
4811.22	10.3		1	4811.67	0.92			20778.5
4810.06	09.3		1	†4810.81	0.76			20783.6
4809.65			1					20785.3
4809.36	08.6		1		0.76			20786.6
4808.87	08.0		1	†4809.05	0.87			20788.7
4808.25	07.5		1		0.75			20791.4
4807.86	07.1		1		0.76			20793.1
4804.71	03.8		1	4804.89	0.91			20806.7
4803.00	02.1		4	4803.12	.90	1.43		20814.1
4801.26			1			1.42		20821.7
4800.76	99.8		2		0.96			20823.8
4799.98	99.2		1		0.78			20827.2
4799.50	98.6		1		0.90			20829.3
4798.90			1					20831.9
4798.38	97.7		1	†4798.75	0.58			20834.2
	97.3			4798.58				
4794.15	93.5		1	4794.73	0.65			20852.6
4792.62	92.1		1	4793.21	0.52			20859.2
4791.33	90.3		1	4791.51	1.03			20864.8
4790.54			1					20868.3
4789.74	88.8		6	4790.02	0.94			20871.8
4788.86	87.8		2	4789.10	1.06			20875.6
4787.98	86.8		ln	4788.18	1.18			20879.4
4786.91	85.9		4		1.01			20884.1
4786.04	84.9		1	4786.17	1.14			20887.9
4783.56	79.8		4	†4783.73	3.76			20898.7
4779.55	78.5		1	4779.80	1.05			20916.3
4776.17	75.3		1		0.87			20931.1
4772.95	71.8		2	†4773.24	1.15			20945.2
4771.81	70.7		1	4771.95	1.11			20950.2
4768.46	67.3		2	4768.70	1.16			20964.9
4767.13			1					20970.8
4766.56	65.8		2	4767.18	0.76	1.42		20973.3
4765.98	65.3		1	4766.74	0.68	1.41		20975.8
	64.4			4765.82				
4762.48			1	†4762.83				20991.3
4761.66	58.8		1	4760.21	0.86			20994.9
4757.70	56.7		2	4757.91	1.00			21012.4
4756.20	55.3		1	4756.45	0.90			21019.0
†4754.16	54.7		4	†4754.40	0.46			21028.0
4752.50	51.6		1	4752.77	0.90			21035.3
	50.2			4751.47				
4750.13	49.2		1	4750.29	0.93			21045.8
4749.77			1				6.2	21047.4
4747.49	47.2		1	†4748.40	0.29		6.3	21057.5
4745.92	45.0		2	4746.16	0.92			21064.4

IRON (ARC SPECTRUM)—continued.

Kayser and Runge (Rowland)	Thalén		Intensity and Character	Müller and Kempf	Difference Rowland—Angström	Reduction to Vacuum		Oscillation Frequency in Vacuo
	Vogel	Fievez				$\lambda +$	$\frac{1}{\lambda} -$	
	43·6			4744·75				
4741·65	40·7		2	4741·84	0·95			21083·4
4741·27	39·6		1	4740·69	1·67			21085·1
4740·48			1					21088·6
4739·26			1					21094·0
4737·75	37·1		1	4738·05	0·65			21100·8
4736·91	36·2		10	†4737·15	0·71			21104·5
4735·96	35·2		4	4736·16	0·76			21108·7
4734·25	33·3		4	4734·38	0·95			21116·4
4733·71	32·7		4	4733·90	1·01			21118·8
4731·60	30·7		1	4731·81	0·90	1·41		21128·2
4730·41			1			1·40		21133·5
4729·84	28·9		1	4730·02	0·94			21136·1
4729·13	28·3		1	4729·41	0·83			21139·2
4728·67	27·9		4	4728·90	0·77			21141·3
†4727·56			4	†4727·72				21146·3
4726·38	25·4		1	4726·45	0·98			21151·5
4722·27			1					21170·0
4721·11	20·3		1		0·81			21175·2
4714·31	13·7		1	†4714·75	0·61			21205·7
4712·21	11·4		1	4712·46	0·81			21215·2
4711·56	10·7		1	4711·83	0·86			21218·1
4710·37	09·5		4	4710·62	0·87			21223·4
4709·83			1					21225·9
4709·18	08·3		4	4709·41	0·88			21228·8
4707·45	06·6		8	4707·69	0·85			21236·6
4705·53	04·7		1	4705·83	0·83			21245·3
4705·10	04·2		2	4705·30	0·90			21247·2
4701·10			ln					21265·3
4700·49	99·4		ln	4700·48	1·09			21268·1
4698·50	97·7		1	4698·78	0·80	1·40		21277·1
4694·97	94·3		1	4695·41	0·67	1·39		21293·1
4691·52	90·6		6	†4691·78	0·92			21308·7
4690·26	89·3		2	4690·37	0·96			21314·5
4689·62	88·6		1	4689·64	1·02			21317·4
4688·39	87·3		ln	4688·39	1·09			21323·0
4687·49	86·5		1	4687·56	0·99			21327·1
4685·27	83·7		1	4684·79	1·57			21337·2
†4683·68	82·7		2	4683·76	0·98			21344·4
4682·74			1					21348·7
4682·18	81·3		1	4682·46	0·88			21351·3
4681·58	80·6		1	4681·60	0·98			21354·0
4680·49	79·7		1	4680·63	0·79			21359·0
†4678·97	77·9		8	†4679·23	1·07			21365·9
4675·23			1				6·3	21383·0
4674·78			1				6·4	21385·0
4674·37			1					21386·8
4673·29	72·2		4	†4673·37	1·09			21391·8
4669·30	68·3		4	4679·28	1·00			21410·1
†4668·23	67·2		6	4678·20	1·03			21415·0
4667·56	65·5		6	†4667·81	1·06			21418·1
4666·08	64·9		ln	4666·08	1·18			21424·9
4664·46			1					21432·3
4663·25	62·3		1	4663·49	0·95			21437·9
4662·09	61·2		2		0·89			21443·2

IRON (ARC SPECTRUM)—*continued.*

Kayser and Runge (Rowland)	Thalén		Intensity and Character	Müller and Kempf	Difference Rowland — Angström	Reduction to Vacuum		Oscillation Frequency in Vacuo
	Vogel	Fievez				$\lambda +$	$\frac{1}{\lambda} -$	
4661.61	60.7		1	4661.71	0.91	1.39		21445.4
4658.77			1			1.38		21458.5
4658.42	57.5		1	4658.52	0.92			21460.1
4657.71	56.7		1	4657.82	1.01			21463.4
4654.70	53.7		10	†4654.89	1.00			21477.3
4652.21			1					21488.8
4651.27	50.4		4	4651.55	0.87			21493.1
4649.95	49.2		1	4650.37	0.75			21499.2
4647.54	46.7		8	4647.70	0.84			21510.4
4646.34			1n	†4646.52				21515.9
4644.94			1n					21522.4
†4643.58	42.7		4	4643.76	0.88			21528.7
4641.12	40.0		1n	4641.21	1.12			21540.1
4640.45			1					21543.2
4638.13	37.3		6	4638.32	0.83			21554.0
4637.66	36.7		6	4637.83	0.96			21556.2
4635.95	35.0		2	4636.19	0.95			21564.1
4634.92	33.9		1n	4635.04	1.02			21568.9
4633.87	33.0		1	4634.06	0.87			21573.8
4633.02	32.1		4	†4633.24	0.92			21577.8
4631.61			1					21584.4
4630.91			1					21587.6
4630.22	29.3		4	4630.45	0.92			21590.8
4629.44			1					21594.5
4627.65	26.6		1	4627.79	1.05			21602.8
4626.65			1			1.33		21607.5
4625.19	24.3		6	†4625.35	0.89	1.37		21614.3
4619.40	18.6		6	4619.66	0.80			21641.4
4618.88	18.1		2	4619.14	0.78			21643.9
4615.73	14.8		1	4615.92	0.93			21658.6
4614.29	13.3		1	4614.53	0.99			21665.4
4613.35	12.5		4	†4613.59	0.85			21669.8
†4611.38	10.5		8	4611.60	0.88		6.4	21679.1
4607.79	07.0		6	†4607.88	1.09		6.5	21695.9
4606.34			1					21702.7
4605.52			1n					21706.6
4604.84			1n					21709.8
4604.01	03.7		1	4604.90	0.41			21713.7
4603.03	02.3		8	4603.30	0.73			21718.3
†4602.11	01.3		4	4602.35	0.81			21722.7
4601.08	00.2		1	4601.35	0.88			21727.5
4600.09			1n					21732.2
4598.26	97.4		6	4598.48	0.86			21740.9
4597.50			1					21744.4
4596.64			1					21748.5
4596.13	93.3		2n	4596.38	0.83			21750.9
4595.48	94.7		4	4595.71	0.78			21754.0
4594.25			1					21759.8
4593.64			1					21762.7
4592.75	91.9		8	†4592.88	0.85			21766.9
4591.52	90.1		1n	4591.10	1.42	1.37		21772.8
4587.23	86.4		4	4597.45	0.83	1.36		21793.1
4586.46			1					21796.8
4584.89	84.2		2	4595.11	0.69			21804.3
4583.93	83.3		2	4594.17	0.63			21808.8

IRON (ARC SPECTRUM)—*continued.*

Kayser and Runge (Rowland)	Thalén		Intensity and Character	Müller and Kempf	Difference Rowland & Angström	Reduction to Vacuum		Oscillation Frequency in Vacuo
	Vogel	Fievez				$\lambda +$	$\frac{1}{\lambda} -$	
4583·04			1					21813·1
4582·51			1					21815·6
4581·66	80·8		4	†4581·72	0·86			21819·6
4580·67	79·8		2		0·87			21824·4
4580·04	79·4		1	4580·38	0·64			21827·4
4579·93			1					21827·9
4579·30			1					21830·9
4575·87			1					21847·3
4574·84	74·2		4	4575·07	0·64			21852·2
4574·34			1					21854·6
4573·05	72·2		1	4573·16	0·85			21860·7
4571·62	71·1		1	4572·00	0·52			21867·6
4568·93	68·2		4	4569·10	0·73			21880·5
4567·10	66·3		1	4567·20	0·80			21889·2
4566·62	65·8		2	4566·82	0·82			21891·5
4565·81	65·0		2	4565·87	0·81			21895·4
4565·44			1					21897·2
4564·87	64·2		2	4565·04	0·67			21899·9
4561·84			1					21914·5
4561·09	60·7		1	4561·71	0·39			21918·1
4560·26	59·4		2	4560·38	0·86			21922·1
4558·18	57·3		1	4558·36	0·88			21932·1
4557·46			1n					21935·5
4557·04			1					21937·6
4556·22	55·4		8	4556·33	0·82	1·36		21941·5
4554·63			1			1·35		21949·2
4554·16			1	†4554·35				21951·4
4552·66	51·8		4	4552·81	0·86			21958·7
4551·76			1n					21963·0
4551·10	50·1		1n	4551·07	1·00			21966·2
4549·57	48·9		4	†4549·86	0·67			21973·2
4548·88			1					21976·9
4547·95	47·3		8	4548·16	0·65			21981·4
4547·14	46·3		4	4547·28	0·84			21985·3
4546·61			1					21987·9
4546·13	44·0		1	4544·95	2·13			21990·2
4542·84			1n					21996·2
4542·53	41·8		2	4542·80	0·73			22007·7
4542·07			1					22009·9
4541·43			1					22013·0
4540·77			1				6·5	22016·2
4539·87			1				6·6	22020·5
4538·96	38·0		2	4539·07	0·96			22024·9
4537·74			1					22030·8
4536·58			1					22036·4
4536·10			1					22038·8
4535·65			1					22041·0
4534·94			1n					22043·4
4534·13			1					22048·3
4533·35	32·5		2	4533·47	0·85			22052·1
4532·47			1					22056·4
4531·75	30·8		4	4531·93	0·95			22059·9
4531·25	30·4		8	4531·40	0·85			22062·4
4530·51			1					22066·0
4529·75	28·8		4	4529·86	0·95			22069·7

IRON (ARC SPECTRUM)—*continued.*

Kayser and Runge (Rowland)	Thalén		Intensity and Character	Müller and Kempf	Difference Rowland - Angström	Reduction to Vacuum		Oscillation Frequency in Vacuo
	Vogel	Fievez				$\lambda +$	$\frac{1}{\lambda -}$	
4528.78	28.0		10	†4529.02	0.78			22074.4
4527.99			1					22078.3
4527.36			1					22081.3
4526.66	25.7		4	4526.75	0.96			22084.7
4525.99			1					22088.0
4525.27	24.4		6	4525.42	0.87			22091.5
4524.91			2					22093.3
4523.47	22.6		1	4523.65	0.87			22100.3
4522.72	22.0		1	†4523.60	0.72			22104.0
4520.35	19.5		1	†4520.46	0.85	1.35		22115.6
4518.62	17.6		1	4518.67	1.02	1.34		22124.0
4517.64	16.8		4	4517.83	0.84			22130.8
4515.36	14.7		1	4515.63	0.66			22140.0
4514.29	13.4		2		0.89			22144.3
4509.95	08.9		1	4509.98	1.05			22166.6
4509.41			1					22169.2
4508.40	07.6		1	†4508.48	0.80			22174.2
	06.5							
4504.93	04.2		1	4505.07	0.73			22191.3
4502.76	01.8		1	4502.86	0.96			22202.0
4502.31			1					22204.2
4499.03	98.4		1	4499.35	0.63			22220.4
4497.86	96.2		1	4497.13	0.66			22226.2
4496.20			2					22234.4
4495.51			1					22237.8
†4494.67	93.8		8	†4494.71	0.87			22242.0
4493.95			1					22245.5
4493.42			1					22248.2
4492.84	92.0		1	4492.90	0.84			22251.0
4491.53			1					22257.5
4490.88	90.2		2	4491.02	0.68			22260.7
4490.19	89.3		4	4490.35	0.89			22264.2
4489.84	88.8		4		1.04			22265.9
4489.08	88.3		1	4489.37	0.78			22269.7
4488.26	87.5		2	4488.47	0.76			22273.7
4485.77	84.8		4	†4485.98	0.97			22286.1
4484.36	83.5		6	4484.47	0.86	1.34		22293.1
4483.32			1			1.33		22298.3
4482.86	82.0		1	4482.99	0.86			22300.6
4482.35	81.6		8	4482.37	0.75			22303.1
4481.72	81.0		1	4481.77	0.72			22306.3
4481.03			1					22309.7
4480.26	79.4		2	4480.30	0.86			22313.5
4479.73	78.8		2	4479.81	0.93			22316.2
4478.18			1					22323.9
4477.71			1					22326.2
4477.37			1					22327.9
4476.98			1					22329.9
4476.20	75.4		10	†4476.29	0.80			22333.8
4475.41			1					22337.6
4474.87			1					22340.4
4474.13			1					22344.1
4472.84			2	†4473.10			6.6	22350.6
4471.94			1				6.7	22355.0
4471.31			1					22358.1

IRON (ARC SPECTRUM)—*continued.*

Kayser and Runge (Rowland)	Thalén		Intensity and Character	Müller and Kempf	Difference Rowland - Ångström	Reduction to Vacuum		Oscillation Frequency in Vacuo
	Vogel	Fievez				$\lambda +$	$\frac{1}{\lambda} -$	
4470.23			1					22363.5
4469.53	68.7		8	4469.64	0.83			22367.0
4468.44			1					22372.5
4467.96			1					22375.9
4467.55			1					22376.9
4466.70	66.0		8	†4466.97	0.70			22381.2
4465.96			1					22384.9
4465.39			1					22387.8
4464.88			4				6.7	22390.3
4463.66			1					22396.4
4463.33			1					22398.1
4462.11			4					22404.2
4461.75	61.2		6	4461.98	0.55			22406.0
4461.40			1					22407.8
4460.48			1					22412.4
4459.88			1					22415.4
4459.24	58.6		8	†4459.44	0.64			22418.6
4458.35			2					22423.1
4457.68			1					22426.5
4457.18			1					22429.0
4456.46	55.7		2	4456.69	0.76			22432.6
4455.85			1					22435.7
4455.20			In					22439.0
4454.50	53.8		6	4454.76	0.70			22442.5
4453.53	52.8		1	4453.71	0.73			22447.4
4453.16			1					22449.3
4452.22			1					22454.0
4451.71			2					22456.6
4450.44	49.8		2	4450.81	0.64			22463.0
4448.66			1			1.33		22472.0
4447.85	47.2		8	4448.12	0.65	1.32		22476.1
4447.23			2					22479.2
4446.95	46.3		2	4447.21	0.65			22480.6
4446.47			1					22483.0
4446.16			1					22484.6
4445.61	45.0		1	4445.85	0.61			22487.4
4445.15			1					22489.7
4444.79			1					22491.5
4444.15			1					22494.8
4443.30	42.7		8	4443.57	0.60			22499.1
4442.97			1					22500.8
4442.46	41.7		8	4442.70	0.76			22503.3
4441.80			1					22506.7
4441.10	40.3		1	4441.32	0.80			22510.2
4440.56	39.9		1	4440.76	0.66			22513.0
4439.96	39.3		2	4440.22	0.66			22516.0
4439.40			1					22518.9
4438.50	37.8		2	4438.69	0.70			22523.4
4437.88			1					22526.6
4437.04	36.3		2	4437.29	0.74			22530.8
4436.50			1					22533.6
4435.27			4	†4435.42				22539.8
4433.98	33.2		2	4434.11	0.78			22546.4
4433.32	32.6		6	4433.53	0.62			22549.8
4432.68	32.0		2	4432.86	0.68			22553.0

IRON (ARC SPECTRUM)—*continued.*

Kayser and Runge (Rowland)	Thalén		Intensity and Character	Müller and Kempf	Difference Rowland—Angström	Reduction to Vacuum		Oscillation Frequency in Vacuo
	Vogel	Fievez				$\lambda +$	$\frac{1}{\lambda -}$	
4432.06			1					22556.2
4431.43			1					22559.4
4430.74	30.2		8		0.54			22563.9
4430.32	29.6		2	4430.89	0.72			22565.0
4429.44			1	4430.30				22569.5
4428.74			1					22573.1
4428.17			1					22576.0
4427.44	26.7		8	4427.46	0.74			22579.7
4426.74			1					22583.3
4426.08			1					22586.6
4425.79			1	†4425.77				22587.1
4424.26			1					22595.9
4424.01	23.3		1		0.71			22596.2
4423.29	22.5		1	4423.32	0.79			22600.9
4422.67	21.8		8		0.87			22604.1
4422.02			1					22607.4
4421.37			1					22610.7
4418.43			ln					22625.8
4417.13			1					22632.4
4416.85			1					22633.9
4416.56			1					22635.4
4416.10			1					22637.7
4415.27	14.3		10	†4415.34	0.97			22642.0
4414.56			1					22645.6
4413.99			1					22648.5
4413.35			1			1.32		22651.8
4412.15			2			1.31		22658.0
4411.12			1					22663.3
4409.25			1					22672.9
4408.54	07.8		6	4408.37	0.74			22676.5
†4407.80	07.2		6	4407.85	0.60			22680.4
4406.74			1					22685.8
4406.07			1					22689.3
4404.88	04.3		10	†4405.00	0.58		6.7	22695.3
4403.60			1				6.8	22701.9
4402.95			1					22705.2
4401.46	00.7		6		0.76			22712.9
4400.72			1					22716.7
4400.02			1					22720.4
4398.84			1					22726.5
4396.76			1					22737.2
4395.39	94.5		2	†4395.45	0.89			22744.3
4392.66	92.2		1	4392.92	0.46			22758.4
4391.95			1					22762.1
4391.68			1					22763.5
†4391.09	90.5		6	4391.34	0.59			22766.6
4390.59	90.2		1	4390.88	0.39			22769.2
4390.10			2					22771.7
4389.35	88.8		2	4389.61	0.55			22775.6
4388.57	87.9		6	4388.80	0.67			22779.7
4388.01	87.4		4	4388.29	0.61			22782.6
4386.70			ln					22789.4
4385.40	84.9		1	4385.76	0.50			22796.1
4384.82	84.3		2	4385.12	0.52			22799.2
4384.38			1					22801.4

IRON (ARC SPECTRUM)—*continued.*

Kayser and Runge (Rowland)	Thalén		Intensity and Character	Müller and Kempf	Difference Rowland — Angström	Reduction to Vacuum		Oscillation Frequency in Vacuo
	Vogel	Fievez				$\lambda +$	$\frac{1}{\lambda} -$	
4383.70	83.0		10	†4383.70	0.70			22805.0
4382.88			2					22809.2
4380.60			ln					22821.1
4379.36			2					22827.6
4377.94			1			1.31		22835.0
4377.46	76.9		1	4377.69	0.56	1.30		22837.5
4376.89	76.4		2	4377.23	0.49			22840.5
†4376.04	75.6		8	4376.38	0.44			22844.9
4375.06	74.2		1	4374.92	0.86			22850.0
4374.59			1					22852.5
4373.67	73.3		2	4374.01	0.37			22857.3
4373.10	72.4		1	4373.23	0.80			22860.3
4371.51			1					22868.6
4371.09			1					22870.8
4370.59			1					22873.4
†4369.89	69.3		8		0.59			22877.1
4369.18			1					22880.8
4368.67			1					22883.5
4368.00	67.6		2	4368.36	0.40			22887.0
4367.68	67.2		6	†4368.07	0.48			22888.6
4366.89			1					22892.8
4366.02	65.5		1	4366.34	0.72			22897.3
4362.47	62.5		1	4363.21				22916.0
4360.91	60.5		1	4361.21	0.41			22924.2
4358.62	58.1		4	4358.91	0.52			22936.2
4356.94			1				6.8	22945.1
4353.60			1				6.9	22962.6
†4352.86	52.3		8	4353.12	0.56			22966.5
4352.57			1					22968.0
4351.67	51.0		4	4351.66	0.67			22972.8
4351.11			1					22975.7
4350.43			ln					22979.3
4349.87			1					22982.3
4349.07	48.6		2	4349.30	0.47			22986.5
4348.57			ln					22989.2
4347.99	47.4		2	4348.18	0.59			22992.2
4347.34			1					22995.7
4346.66	46.2		4	4346.88	0.46			22999.3
4345.17	44.2		1	4344.79	0.97			23007.2
4344.62			1					23010.1
4343.81	43.3		2	4343.96	0.51			23014.4
4343.39	42.7		2	4343.49	0.69	1.30		23016.6
4340.65	40.0		1	†4340.71	0.65	1.29		23031.1
4340.21			1					23033.5
4338.38	37.8		2	4338.55	0.58			23043.2
4338.05			1					23044.9
4337.71			1					23046.7
4337.14	36.6		10	4337.35	0.54			23049.8
4335.96			1					23056.0
4333.88	32.0		1	4332.72	1.88			23067.1
4331.89			1					23077.7
4331.02	30.6		1	4331.44	0.42			23082.3
4328.91			1					23093.6
4328.02	27.3		2	5328.34	0.72			23098.3
4327.22	26.6		4	4327.51	0.62			23102.6

IRON (ABC SPECTRUM)—*continued*,

Kaysers and Kunze (Rowland)	Thalén		Intensity and Character	Müller and Kempf	Difference Rowland — Angström	Reduction to Vacuum		Oscillation Frequency in Vacuo
	Vogel	Fievez				$\lambda +$	$\frac{1}{\lambda} -$	
4326·86	26·3		1	4327·20	0·56			23104·5
†4325·92	25·3		10	†4325·98	0·62			23109·6
4325·19			1					23113·5
4324·66			1					23116·3
4322·93			1					23125·5
4321·90	21·4		2	4322·20	0·50			23131·1
4320·89	20·2		1	4321·23	0·69			23136·5
4319·88			1					23141·9
4318·78			1					23147·8
4318·22			1					23150·8
4317·10			1					23156·8
4316·21			ln					23161·6
4315·83			1					23163·6
4315·21	14·6		10	4315·56	0·61			23166·9
4314·43			1					23171·1
4313·91			1					23173·9
4312·28			1					23182·7
4311·12			1					23188·9
4310·52	10·0		1	4310·98	0·52			23192·2
4309·50	09·2		6	4309·20	0·30			23197·6
4309·14			2					23199·6
G4307·96†	07·3		10	†4308·25	0·63			23205·9
4306·80			1					23212·2
4306·11			1					23215·9
4305·58	04·7		6	4305·71	0·88			23218·8
4305·32			1			1·29		23220·2
4304·66	04·0		1	4305·05	0·26	1·28		23223·7
4303·87			1					23226·0
4303·25			1					23231·3
4302·68			1					23234·4
4302·31	01·7		2	4302·75	0·61			23236·4
4301·16			1					23242·6
4300·86			1					23244·3
4300·29			1					23247·3
4299·42	98·8		10	4399·77	0·62			23252·0
4298·16	97·6		4	4398·58	0·56			23258·9
4297·46			1					23262·7
4296·56			1					23267·5
4296·13			1					23269·9
4295·83			1					23271·5
4295·45			1					23273·5
4295·08			1					23275·6
4294·26	93·7		10	4294·64	0·56			23280·0
4293·61			1					23283·5
4293·07			ln					23286·4
4292·49			1					23289·6
4292·36	91·7		2	4292·61	0·66			23290·3
4291·69	91·2		4	4292·02	0·49		6·9	23293·9
4290·99	90·5		1	4291·45	0·49		7·0	23297·6
4290·50	89·9		2	4290·77	0·60			23300·3
4290·04			1					23302·8
4289·84			2	†4289·87				23303·9
4289·08	88·7		2	4289·54	0·38			23308·0
4288·25	87·7		4	4288·63	0·55			23312·5
4287·05	86·7		2	4287·44	0·35			23319·2

IRON (ARC SPECTRUM)—*continued.*

Kavser and Runge (Rowland)	Thalén		Intensity and Character	Müller and Kempf	Difference Rowland — Ångström	Reduction to Vacuum		Oscillation Frequency in Vacuo
	Vogel	Fievez				$\lambda +$	$\frac{1}{\lambda} -$	
4286.58	86.2		1	4286.99	0.38			23321.6
4286.22			1					23323.6
4286.02			1					23324.7
4285.57	85.2		6	4285.92	0.37			23327.1
4285.20			1					23329.1
4284.90			1					23330.8
4284.55			ln					23332.7
4284.20			ln					23334.6
4283.73			1					23337.1
4283.35			1					23339.2
4283.20			1					23340.0
4282.58	82.1		10	4282.87	0.48			23343.4
4281.86			1					23347.3
4281.24			1					23350.7
4280.68	80.0		1	4280.87	0.68			23353.8
4279.99	79.4		1	4280.20	0.59			23357.5
4279.59	79.2		1	4279.94	0.39			23359.7
4279.01			1					23362.9
4278.35	77.9		2	4278.66	0.45			23366.5
4277.80	77.3		1	4278.02	0.50			23369.5
4277.34			1					23372.0
4276.80	76.4		2	4277.10	0.40			23375.0
4275.79	75.3		1	4275.91	0.49			23380.5
4275.27			1					23383.3
4274.87	73.7		2	4274.25	1.17			23385.5
4273.99			1					23390.3
4273.16			1					23394.9
4272.61			1					23397.9
4271.93	71.6		10	4272.17	0.33			23401.6
4271.30	71.0		10	4271.54	0.30			23405.1
4270.65			1					23408.6
4270.13			1					23411.5
4269.89			1					23412.8
4269.50			1			1.28		23414.9
4268.87	68.6		4	4269.12	0.27	1.27		23418.4
†4267.97	67.6		6	4268.14	0.17			23423.3
4267.08	66.7		4	4267.35	0.38			23428.2
4266.69			1					23430.4
4266.09			1					23433.7
4265.37	65.2		2	4265.65	0.17			23437.6
4264.88			1					23440.3
4264.37	64.1		2	4264.63	0.27			23443.1
4261.48			2					23459.0
4260.64	60.2		10	†4260.73	0.44			23463.6
4260.21			1					23466.0
4259.63			1					23469.2
4259.39			1					23470.5
4259.06			2					23472.4
4258.75	58.4		2	4259.00	0.35			23474.1
4258.43	58.0		2	4258.60	0.43			23475.8
4257.80			ln					23479.3
4257.18			ln					23482.7
4256.82			1					23484.7
4256.32			1					23487.5
4256.00			1					23489.2

IRON (ARC SPECTRUM)—*continued.*

Kayser and Runge (Rowland)	Thalén		Intensity and Character	Müller and Kempf	Difference Rowland — Angström	Reduction to Vacuum		Oscillation Frequency in Vacuo
	Vogel	Fievez				$\lambda +$	$\frac{1}{\lambda} -$	
4255·64	55·3		2	4255·92	0·14			23491·2
4255·08			1					23494·3
†4254·45	54·6		2	4255·28				23497·8
4254·13	53·6		1	4254·22	0·53			23499·6
4253·89			1					23500·9
4253·25			1					23504·4
4252·27			1					23509·8
4250·93	50·5		10	4251·13	0·43			23517·3
4250·28	49·8		10	4250·45	0·48			23520·9
4249·07			1					23527·6
4248·77			1					23529·2
4248·35	47·9		4	4248·60	0·45			23531·5
4247·60	47·1		8	4247·72	0·50			23535·7
4246·60			1					23541·2
4246·18	45·7		4	4246·36	0·48			23543·6
4245·39	44·9		6	4245·59	0·49			23548·0
4244·38			1					23553·6
4243·89	43·4		1	4244·13	0·49			23556·3
4243·44	43·0		2	4243·67	0·44			23558·8
4242·85	42·3		2	4242·98	0·55			23562·1
4242·44			1					23564·3
4241·90			1					23567·3
4241·20	40·7		1	4241·41	0·50			23571·2
4240·79			1					23573·5
4240·50			2					23575·1
4239·90	39·4		6	4240·11	0·50			23578·5
4238·98	38·5		8	4249·10	0·48			23583·6
4238·14	37·7		4	4248·32	0·44			23588·3
4237·26	36·8		2	4237·45	0·46			23593·1
4236·84			ln					23595·5
4236·09	35·6		10	†4236·21	0·49			23599·7
4235·41			2					23603·5
4235·01			1					23605·7
4234·51			1			1·27		23608·5
4233·76	33·3		10	4233·87	0·46	1·26		23612·7
4233·25			1					23615·5
4232·93			1					23617·3
4232·57			1					23619·3
4231·32			1					23626·3
4230·75			1					23629·5
4230·36			ln					23631·6
4229·86			1					23634·4
4229·61	29·0		2	4229·72	0·61			23635·8
4228·98			ln					23639·4
4227·60	27·0		10	4227·67	0·60		7·0	23647·1
4226·84			4				7·1	23651·2
4226·52	25·9		4	4226·65	0·62			23653·0
4226·08	25·5		4	4226·25	0·58			23655·5
4225·61	25·0		6	4225·69	0·61			23658·1
4224·63	24·1		2	4224·76	0·53			23663·6
4224·27	23·7		6	4224·43	0·57			23665·6
4223·40			1					23670·5
4222·32	21·8		8	4222·45	0·52			23676·6
4221·36			1					23681·9
4220·44	19·8		4	4220·59	0·64			23687·1

IRON (ARC SPECTRUM)—*continued.*

Kayser and Runge (Rowland)	Thalén		Intensity and Character	Müller and Kempf	Difference Rowland - Angström	Reduction to Vacuum		Oscillation Frequency in Vacuo
	Vogel	Fievez				$\lambda +$	$\lambda -$	
4219.99			1					23689.6
4219.47	18.8		8	4219.59	0.67			23692.6
4218.48			1					23698.1
4217.69	17.2		6	4217.80	0.49			23702.6
4216.28	15.7		6	4216.45	0.58			23710.5
4216.08			1					23711.6
4215.52			4					23714.8
4213.75	13.2		4	4213.85	0.55			23724.7
4213.38			1					23726.8
4212.61			1					23731.2
4210.48	09.8		8	4210.59	0.68			23743.2
4208.71	08.2		4	4208.83	0.51			23753.1
4207.93			1					23757.5
4207.22	06.7		4	4207.38	0.52			23761.6
4206.78	06.3		2	4206.90	0.48			23764.0
4205.63	05.0		2	4205.73	0.63			23770.5
4205.12			1					23773.4
4204.07	03.5		6	4204.21	0.57			23779.4
4203.63			ln					23781.9
4203.27			1					23783.9
4202.85			2					23786.3
4202.15	01.6		10	†4202.33	0.55			23790.2
4201.31			1					23795.0
4201.01	00.3		4	4200.98	0.71			23796.7
4200.01			1					23802.4
†4199.19	98.7		10	4199.33	0.49			23807.0
4198.75			2					23808.5
4198.42	97.7		10	4198.46	0.72	1.26		23811.4
4197.32			ln			1.25		23817.6
4196.66			2					23821.4
4196.31	95.7		6	4196.46	0.61			23823.4
4195.71	95.3		2		0.41			23826.8
4195.46			6					23828.2
4194.56			2					23833.3
4193.70			1					23838.2
4193.35			1					23840.2
4192.62			1					23844.3
4192.22			1					23846.6
4191.72			1					23849.4
4191.57	90.9		10	4191.65	0.67			23850.3
4190.89			1					23854.2
4190.48			1					23856.5
4190.07			1					23858.8
4189.67			2					23861.1
4188.99			1					23865.0
4188.66			1					23866.9
4187.92	87.3		10	4188.32	0.62			23871.1
4187.17	86.6		10	4187.31	0.57			23875.4
4186.20			1					23880.9
4185.72			1					23883.6
†4184.99	84.4		8	4185.12	0.59			23887.8
4184.31			1					23891.7
4183.11			1					23898.6
4182.85			1					23900.0
4182.46	81.8		6	4182.58	0.66			23902.3

IRON (ARC SPECTRUM)—continued.

Kayser and Runge (Rowland)	Thalén		Intensity and Character	Müller and Kempf	Difference Rowland—Angström	Reduction to Vacuum		Oscillation Frequency in Vacuo
	Vogel	Fievez				$\lambda +$	$\frac{1}{\lambda -}$	
4181·85	81·3		8	4182·00	0·55			23905·8
4181·16			1					23909·7
4180·60			1					23912·9
4179·93			1					23916·7
4179·46			1					23919·4
4178·95			1					23922·4
4178·64			1					23924·1
4178·11			1					23927·2
4177·66	77·2		6	†4178·07	0·46			23929·7
4177·16			1					23932·6
4176·62	76·0		6	4176·80	0·62			23935·7
4175·71	75·2		8	4175·85	0·51			23940·9
4174·98	74·3		6	4175·10	0·68			23945·1
4174·47			1					23948·0
4174·00	73·4		4	4174·20	0·60			23950·7
4173·52			1					23953·5
4173·39	72·8		4	4173·66	0·59			23954·2
4172·81	72·2		6	4172·88	0·61			23957·6
4172·66			1					23958·4
4172·20	71·5		8	4172·26	0·70			23961·1
4171·99			1					23962·3
4171·79			2					23963·4
4170·99	70·4		8	4171·21	0·59			23968·0
4170·42			1					23971·3
4169·90			1					23974·3
4169·03	68·4		2	4169·20	0·63			23979·3
4168·71			1					23981·1
4168·33			1					23983·3
4167·96	67·3		1	4168·16	0·66			23985·4
4167·38			1					23987·8
4165·51	64·8		2	4165·71	0·71			23999·6
4164·89			1				7·1	24003·1
4163·74	63·0		2	4163·88	0·74		7·2	24009·7
4162·63			1					24016·1
4162·19			1					24018·6
4161·57	60·9		2	4161·75	0·67			24022·2
4161·13			2					24024·7
4160·59			1					24027·8
4160·31			1					24029·5
4159·36			1			1·25		24035·0
†4158·89	58·2		6	4159·04	0·69	1·24		24037·7
4157·91	57·2		6	4158·03	0·71			24043·3
4157·46			1					24045·9
4156·88	56·2		8	4157·02	0·68			24049·3
4156·13			1					24053·6
4154·95	54·2		6	4155·05	0·75			24060·5
4154·57	53·8		6	4154·74	0·77			24062·7
4154·04	53·2		6	4154·15	0·84			24065·7
4153·47			1					24069·0
4152·78			1					24073·1
4152·25	51·4		4	†4152·34	0·85			24076·1
4152·04			2					24077·3
4151·34			1					24081·4
4150·42	49·7		4	4150·56	0·72			24086·7
4149·44	48·6		6	4149·56	0·84			24092·4

IRON (ARC SPECTRUM)—*continued.*

Kayser and Runge (Rowland)	Thalén		Intensity and Character	Müller and Kempf	Difference Rowland - Angström	Reduction to Vacuum		Oscillation Frequency in Vacuo
	Vogel	Fievez				$\lambda +$	$\frac{1}{\lambda} -$	
4147.74	47.0		8	4147.93	0.74			24102.3
4146.70			1n					24108.4
4146.12	45.4		4	4146.32	0.72			24111.7
4145.29			1					24116.6
4144.72			1					24119.9
4143.96	43.2		10	4144.14	0.76			24124.3
4143.50	42.7		10	4143.71	0.80			24127.0
4142.74			2					24131.4
4142.31			1					24133.9
4141.94	41.2		2	4142.11	0.74			24136.1
4141.51			1					24138.6
4141.11			1					24140.9
4140.54			2					24144.2
4139.96	39.2		2	4140.20	0.76			24147.6
4138.99			1					24153.3
4138.15			1					24158.2
4137.66			1					24161.2
4137.06	36.3		8	4137.25	0.76			24164.6
4136.58			1					24167.4
4135.98			1n					24170.9
4135.43			1					24174.1
4134.77	34.0		10	4134.92	0.77			24177.9
4134.50			2					24179.5
4133.96	33.2		4	4134.12	0.76			24182.7
4133.67			1					24184.4
4132.96	32.2		8	4133.17	0.76			24188.5
4132.15	31.3		10	†4132.43	0.85			24193.3
4131.14			1					24199.2
4130.58			1					24202.5
4130.08			1 ^a					24205.4
4129.71			1					24207.6
4129.28			1					24210.1
4128.91			1					24212.3
4127.86			2					24218.4
4127.68	26.9		6	4127.95	0.78			24219.5
4126.95			1			1.24		24223.8
4126.25	25.5		4	4126.45	0.75	1.23		24227.9
4125.94			2					24228.7
4125.71			2					24231.0
4125.17			1					24234.2
4124.76			1					24236.6
4124.35			1					24239.0
4123.81	23.2		4	4124.04	0.61			24242.2
4123.16			1					24246.0
4122.59	21.8		6	4122.85	0.79			24249.4
4121.88	21.1		6	4122.07	0.78			24253.6
4121.48			1					24255.9
4120.59			1					24261.2
4120.28	19.5		6	4120.49	0.78			24263.0
4119.84			1					24265.6
4119.45			2					24267.9
4119.00			2					24270.5
4118.62	17.8		10	†4119.02	0.82		7.2	24272.7
4118.00			2				7.3	24276.3
4117.75			1					24277.8

IRON (ARC SPECTRUM)—*continued.*

Kayser and Runge (Rowland)	Thalén		Intensity and Character	Müller and Kempf	Difference Rowland, Angström	Reduction to Vacuum		Oscillation Frequency in Vacuo
	Vogel	Fievez				$\lambda +$	$\frac{1}{\lambda} -$	
4117.41			1					24279.8
4116.86			1					24283.1
4116.22			1					24286.8
4115.78			1					24289.4
4115.34			2					24292.0
4114.98			2					24294.2
†4114.53	13.7		6	4114.74	0.83			24296.8
4113.89			1					24300.6
4113.52			1					24302.8
4113.08	12.3		4	4113.24	0.78			24305.4
4112.47			2					24309.0
4111.85			2					24312.7
4111.17			1					24316.7
4110.41			1					24321.2
4109.88	09.2		8	4110.09	0.68			24324.3
4109.23			4					24328.2
4108.23			1					24334.1
†4107.58	06.8		8	4107.76	0.78			24337.9
4106.55			4					24344.0
4106.37	05.7		4	4106.63	0.67			24345.1
4105.28			2					24351.6
4105.04			1					24353.0
4104.70			1					24355.0
4104.20	03.5		6	4104.40	0.70			24358.0
4103.44			1					24362.5
4102.50			1					24368.1
4101.76			2	†4101.98				24372.5
4101.37			4					24374.8
4100.82	00.2		6	4101.00	0.62			24378.1
4100.26			4					24381.4
4099.87			2					24383.7
4099.04			1					24388.6
4098.26	97.6		8	4098.41	0.66			24393.3
4097.19			1					23399.7
4096.67			1n					24402.8
4096.06	95.6		8	4096.29	0.46			24406.4
4095.35			1					24410.6
4094.57			1					24415.3
4093.28			1					24423.0
4092.60			4	4092.83				24427.0
4092.43			4					24428.1
4092.11			1					24430.0
4091.66			4					24432.7
4091.34			1					24434.6
4091.12			4			1.23		24436.1
4090.17			1			1.22		24441.6
4089.28			4					24446.9
4088.65			1					24450.6
4087.95			1					24454.8
4087.50			1					24457.5
4087.16	86.5		2	4087.35	0.66			24459.6
4086.54			1					24463.3
4086.06			1					24466.2
4085.38	84.7		6	4085.53	0.68			24470.2
4085.07	84.4		6	4085.27	0.67			24472.1

IRON (ARC SPECTRUM)—*continued.*

Kayser and Runge (Rowland)	Thalén		Intensity and Character	Müller and Kempf	Difference Rowland - Angström	Reduction to Vacuum		Oscillation Frequency in Vacuo
	Vogel	Fievez				$\lambda +$	$\frac{1}{\lambda} -$	
4084.59	83.9		8	4084.75	0.69			24475.0
4083.90			4					24479.1
4083.70			4					24480.3
4083.03			4					24484.3
4082.55			2					24487.2
4082.20			2					24489.3
4081.67			1					24492.5
4081.35			1					24494.4
4080.96			2					24496.7
4080.30	79.7		4	4080.47	0.60			24500.7
4079.91	79.3		6	4080.09	0.61			24503.0
4079.50			2					24505.5
4079.32			2					24506.6
4078.83			1					24509.5
4078.41	77.8		6	4078.65	0.61			24512.1
4077.74			1					24516.1
4077.36			1	†4077.48				24518.4
4076.72	76.0		8	4076.93	0.72			24522.2
4076.32			1					24524.6
4076.05			1					24526.3
4074.87	74.2		6	4075.01	0.67			24533.4
4074.49			1				7.3	24535.7
†4073.84	73.2		4	4074.03	0.64		7.4	24539.5
4073.35			1					24542.4
4072.62			2					24546.8
4071.79	71.0		10	†4071.86	0.79			24551.8
4070.85	69.7		6	4070.50	1.15			24557.5
4069.08			1					24568.2
4068.07	67.3		8	4068.21	0.77			24574.3
4067.36	66.7		6	4067.21	0.66			24578.6
4067.04	66.3		6		0.74			24580.5
4066.66			4					24582.8
4066.29			1					24585.0
4065.87			1					24587.6
4065.48			4					24589.9
4064.55			2					24595.6
4063.63	63.0		10	†4063.94	0.63			24601.1
4063.40			4					24602.5
4062.94			1					24605.3
4062.51	61.8		8	4062.73	0.71			24607.9
4062.00			1					24611.0
4061.24			1					24615.6
4060.88			1					24617.8
4059.80	59.2		4	4060.03	0.60			24624.3
4058.99			1n					24629.3
4058.86	58.2		4	4059.16	0.66			24630.1
4058.30			4					24633.8
4057.91	57.6		6		0.31			24635.8
4057.43	56.7		4n	4057.77	0.73			24638.7
4056.61			1					24643.7
4056.04			1					24647.2
†4055.63			4			1.22		24649.7
4055.12			2			1.21		24652.8
4054.94	54.2		2	4055.18	0.74			24653.9
4054.25			1					24658.1

IRON (ARC SPECTRUM)—*continued.*

Käyser and Runge (Rowland)	Thalén		Intensity and Character	Müller and Kempf	Difference Rowland — Ångström	Reduction to Vacuum		Oscillation Frequency in Vacuo
	Vogel	Fievez				$\lambda +$	$\lambda -$	
4053·87			1					24660·4
4053·31			1					24663·8
4052·75			2					24667·2
4052·56	51·7		1	4052·77	0·86			24668·4
4052·43			1					24669·1
4052·03			1					24671·6
4051·40			1					24675·4
4050·83			1					24678·9
4049·92			1					24684·4
4049·40			1					24687·6
†4048·82	48·2		2	4049·12	0·62			24691·2
4047·40			1					24699·8
4045·90	45·3		10	†4046·00	0·60			24709·0
4044·69	44·0		4	4044·94	0·69			24716·4
4044·00	43·3		4	4044·27	0·70			24720·6
4041·44	40·5		4		0·94			24736·3
4040·74	39·5		4		1·24			24740·5
4040·12			1					24744·3
4038·83			In					24752·2
†4035·76			2					24771·1
4034·59	33·9		6	4034·86	0·69			24778·3
4033·16	32·4		6	4033·47	0·76			24787·1
4032·72	32·0		2	4032·97	0·72			24789·8
4032·54			1					24790·9
4032·06	31·3		4	4032·38	0·76			24793·8
4031·33			1					24798·3
4030·84	30·0		6	†4030·85	0·84			24801·3
4030·60			4					24802·8
4030·26			1				7·4	24804·9
4029·72			2				7·5	24808·1
4027·63			1					24821·0
4025·93			1					24831·5
4024·86	24·0		4	4025·05	0·86			24838·1
4024·20			1					24842·2
4023·51			1					24846·4
4022·80			1					24850·8
4022·25			1					24854·2
4021·96	21·3		6	4022·27	0·66			24856·0
4021·69			1					24857·7
4020·54			1				1·21	24864·8
4019·75			1				1·20	24869·7
4019·13			1					24873·5
4018·79			1					24875·6
4018·36	17·5		2	4018·54	0·86			24878·3
4018·21			1					24879·2
4017·23	16·4		4	4017·53	0·83			24885·3
4016·55			1					24889·5
4015·40			1					24896·6
4014·63	13·6		6	4014·68	1·03			24901·4
4014·41			1					24902·8
4013·91	13·0		4	4014·22	0·91			24905·9
4013·75			1					24906·9
4011·81			1					24918·9
4011·49			1					24920·9
4011·05			1					24923·6

IRON (ARC SPECTRUM)—*continued.*

Kayser and Runge (Rowland)	Thalén		Intensity and Character	Müller and Kempf	Difference Rowland - Angström	Reduction to Vacuum		Oscillation Frequency in Vacuo
	Vogel	Fievez				$\lambda +$	$\lambda -$	
4009.80	09.0		6	4010.08	0.80			24931.4
4008.97			1					24936.6
4007.36	06.6		4	4007.68	0.76			24946.6
4006.71			2					24950.6
4006.39	05.5		2	4006.67	0.89			24952.6
4005.33	04.3	04.3	8	†4005.46	1.03			24959.2
4005.07			1					24960.8
4004.96			1					24961.5
4003.88			2					24968.3
4002.77			1					24975.2
4001.77	00.9		4	4002.05	0.87			24981.4
4000.57	99.5		2	4000.59	1.07			24988.9
4000.36			1					24990.2
3998.76			1					25000.2
3998.16	97.2		6	3998.33	0.97			25004.0
3997.49	96.7	96.7	6	3997.77	0.79			25008.2
3997.25			1					25009.7
3997.06			2					25010.9
3996.42			1					25014.9
3996.08			4					25017.0
3995.34			1					25021.7
3994.22			4					25028.7
3990.48			4					25052.1
3989.94			2				7.5	25055.5
3986.27			6	†3987.04			7.6	25078.5
3985.46			4					25083.6
†3984.08			6	3984.23		1.20		25092.3
3983.47			1			1.19		25096.1
3981.87			6					25106.2
3981.21			1					25110.4
3979.73			1					25119.7
3978.91			1					25124.9
3978.55			1					25127.2
3977.83			8					25131.7
3977.66			1					25132.8
3976.95			1					25137.3
3976.71			2					25138.8
3976.47			1					25140.3
3976.00			1					25143.3
3975.33			1					25147.5
3974.81			1					25150.8
3974.46			1					25153.0
3974.10			1 _n					25155.3
3973.75			4					25157.5
3973.00			1					25162.1
3971.41			6					25172.4
3970.51			4					25178.1
3970.35			1					25179.1
3969.72			1					25182.1
3969.34		66.7	8	3969.52				25185.5
3968.55			4	†3968.79				25190.5
3968.05			2					25193.7
3967.51			4					25197.1
3966.70			4					25202.3
3966.16			4					25205.7

IRON (ARC SPECTRUM)—*continued.*

Kaysers and Runge (Rowland)	Cornu	Intensity and Character	Müller and Kempf	Difference Rowland—Ångström	Reduction to Vacuum		Oscillation Frequency in Vacuo
					$\lambda +$	$\frac{1}{\lambda} -$	
3965·62		1					25209·1
3964·61		2					25215·6
3963·24		4	3963·61				25224·3
3962·80		1					25227·1
3962·42		1	3962·57				25229·5
3961·63		2					25234·5
3961·24		1					25237·0
3960·38		2	3960·46				25242·5
3958·48		1					25254·6
3958·29		1					25255·8
3957·80		1	3958·10				25259·0
3957·17		2					25263·0
3956·77	55·9	6		0·87			25265·5
3956·54		4					25267·0
3956·05		4	3956·12				25270·1
3955·50		2					25273·6
3954·78		1					25278·3
3953·93		1					25283·7
3953·25		4	3953·65				25288·0
3952·71		6	†3953·00				25291·5
3951·25		6					25300·8
3950·05		6	3949·27		1·19		25308·5
3949·25		1			1·18		25313·7
3948·87		6					25316·1
3948·23		4					25320·2
3947·64		4	3947·87				25324·0
3947·11		2	3947·48				25327·4
3945·22		2	3945·47				25339·5
3945·00		2	3945·28				25340·9
3944·82		1					25342·1
3944·11		2					25346·7
3943·43		2					25351·0
†3942·54		6	3942·92				25356·8
3941·40		2					25364·1
3940·98		6	3941·36				25366·8
3940·14		1					25372·2
3938·59		1					25382·2
3938·16		1					25385·0
3937·42		4					25389·7
3935·92		6	3936·00				25399·4
3935·40		2					25402·8
3934·81		1					25406·6
3934·47		1					25408·8
3933·75	32·9	6	3933·79	0·85			25413·4
3933·01		1					25418·2
3932·71		2					25420·3
3931·22		2					25429·8
3930·37	29·8	8	3930·44	0·57			25435·3
3929·24		2	3939·31				25444·6
3928·17		1					22449·5
3928·05	27·3	8	3938·27	0·75		7·6	25450·3
3926·05		4				7·7	25463·2
3925·74		4					25465·2
3925·31		1					25468·0
3923·00	22·0	8	3923·04	1·00			25483·0

IRON (ARC SPECTRUM)—*continued.*

Kayser and Runge (Rowland)	Cornu	Intensity and Character	Müller and Kempf	Difference Rowland—Angström	Reduction to Vacuum		Oscillation Frequency in Vacuo
					$\lambda +$	$\frac{1}{\lambda} -$	
3921.34		1					25493.8
3920.93		1					55496.4
3920.36	18.4	6	3920.41	1.96			25500.2
3919.18		2	3919.28				25507.8
3918.74		4	3918.82				25510.7
3918.49	17.8	4		0.69			25512.3
3917.29		6	3917.36				25520.1
†3916.82		6	3916.92				25523.2
3914.35		1	3914.55				25539.3
3913.74		4	3913.87		1.18		25543.3
3910.95		2			1.17		25561.5
3909.95		4	3910.14				25568.1
3909.78		1	3909.89				25569.2
3909.40		1	3909.50				25571.7
3908.02		4	3908.20				25580.7
3907.58		1	3907.75				25583.6
3906.84		2	3907.02				25588.4
3906.58	05.9	6	3906.74	0.68			25590.1
3905.64		1	†3905.87				25596.3
3904.00		6	3904.16				25607.0
3903.06	01.9	8	3903.24	1.16			25613.2
3902.43		1	3902.60				25617.4
3900.64		2	3900.86				25629.1
3899.80	98.4	6	3900.04	1.40			25634.6
3899.13		2					25639.0
3898.73		1					25641.7
3898.05	97.0	6	3898.32	1.05			25646.1
†3897.54		2	3897.82				25649.5
3895.75	94.7	6	†3895.78	1.05			25661.3
3894.56		1					25669.1
3894.09		2					25672.2
3893.47	92.6	4		0.87			25676.3
3893.00		1					25679.4
3892.54		1					25682.5
3892.02		4					25685.9
3890.94		4					25693.0
3890.49		1					25696.0
3890.02		1					25699.1
3888.92	88.0	4		0.92			25706.4
3888.63	87.4	6		1.23			25708.3
3887.17	86.4	6		0.77			25717.9
3886.38	86.0	6		0.38			25723.2
3885.61	84.7	4		0.91			25728.3
3885.25		1					25730.7
3884.46		4					25735.9
3883.39		4					25743.0
3882.11		1					25751.5
3878.82	80.3	8		-1.48			25773.3
3878.63		2					25774.6
3878.12	77.4	8		0.72	1.17		25778.0
3876.81		1			1.16		25786.7
3876.14		4					25791.2
3874.95		1					25799.1
3874.55		1					25801.7
3874.18		1					25804.2

IRON (ARC SPECTRUM)—*continued.*

Kayser and Hunge (Rowland)	Cornu	Intensity and Character	Müller and Kempf	Difference Rowland —Ångström	Reduction to Vacuum		Oscillation Frequency in Vacuo
					$\lambda +$	$\frac{1}{\lambda} -$	
3873-88		6					25806-2
3873-69		1					25807-5
3873-04		1					25811-8
3872-61	71-3	8		1-31			25814-7
3871-86	70-6	4		1-26			25819-7
3871-36		1					25823-0
3869-69		4				7-7	25834-2
3868-71		1				7-8	25840-6
3868-37		1					25842-9
3868-03	65-5	2		2-53			25845-1
3867-33	65-2	6		2-13			25849-8
3865-65	64-8	8		0-85			25861-1
3864-42		1					25869-3
3864-16		1					25871-0
3863-87		4					25873-0
3861-69		1					25887-6
3861-46	60-6	4		0-86			25889-1
3860-03	59-3	10		0-73			25898-7
3859-34		6					25903-4
3856-49	55-7	8		0-79			25922-5
3856-00		1					25925-8
3855-45		1					25929-5
3854-51	53-7	2		0-81			25935-8
3853-60	52-7	1		0-90			25942-0
3852-71	51-8	6		0-91			25947-9
3850-96	50-0	6		0-96			25959-7
3850-11	49-7	8		0-41			25965-5
3848-42		1					25976-9
3846-96	45-9	6		1-06			25986-7
3846-55		2					25989-5
3846-18		1					25992-0
3845-84		1					25994-3
3845-58		1					25996-1
3845-30	44-6	4		0-70			25998-0
3844-08		1					26006-2
3843-40	41-9	6		1-50	1-16		26010-8
3843-04		1					26013-3
3841-19	40-5	8		0-69	1-15		26025-8
3840-58	40-1	8		0-48			26029-9
3839-78		1					26035-4
3839-38	38-5	6		0-88			26038-1
3838-87		1					26041-9
3837-27		2					26052-4
3836-48		6					26057-8
3834-37	33-6	8		0-77			26072-1
3833-44		4					26078-4
3830-95		2					26095-5
3830-54		1					26098-2
3830-29		1					26099-9
3829-86		2					26102-8
3829-59		1					26104-7
3829-30		1					26106-6
3829-02		1					26108-5
3828-65		1					26111-1
3827-96	27-7	8		0-26			26115-8

IRON (ARC SPECTRUM)—*continued.*

Kayser and Runge (Rowland)	Cornu	Intensity and Character	Müller and Kempf	Difference Rowland — Ångström	Reduction to Vacuum		Oscillation Frequency in Vacuo
					$\lambda +$	$\lambda -$	
3827·72		2				7·8	26117·4
3826·99		1				7·9	26122·3
3826·04	25·3	8		0·74			26128·8
3825·54		1					26132·2
3824·58	24·1	8		0·48			26138·8
3824·24		1					26141·1
3823·66		1					26145·1
3822·39		1					26153·7
3821·98		2					26156·5
3821·71		1					26158·4
3821·32		4					26161·1
L 3820·56	19·7	8		0·86			26166·3
3819·75	19·2	1		0·55			26171·8
3818·77		1					26178·5
3818·43		1					26180·9
3817·84		1					26184·9
3817·11		1					26189·9
3816·48	16·9	4		-0·42			26194·3
3815·97	15·3	8		0·67			26197·9
3814·94		1					26204·8
3814·66	14·0	4		0·66			26206·8
3814·03		2					26211·1
3813·77		2					26212·9
3813·12	12·6	8		0·52			26217·3
3812·03		4					26224·8
3811·19		1					26230·6
3810·89		4					26232·7
3809·70		2					26240·9
3809·20		1					26244·3
3808·86		4					26246·7
3808·43		1					26249·6
3807·68		4					26254·8
3807·39		1					26256·8
3806·84		6					26260·6
3806·36		2					26263·9
3806·12		1					26265·6
3805·82		1					26267·6
3805·47	05·0	6		0·47	1·15		26270·1
3804·15		1			1·14		26279·2
3802·41		2					26291·2
3801·92		1					26294·6
3801·81	02·0	4		-0·19			26295·3
3801·54		1					26297·2
3801·15		2					26299·9
3799·68	99·4	6		0·28			26310·1
3798·65	98·7	6		-0·05			26317·2
3798·09		1					26321·1
3797·65	96·8	6		0·85			26324·2
3797·04		1					26328·4
3796·67		1					26331·0
3796·12		1					26334·8
3795·66		1					26338·0
3795·13	94·9	8		0·23			26341·7
3794·46	93·3	4		1·16			26346·3
3793·99		1					26349·6

IRON (ARC SPECTRUM)—*continued.*

Kayser and Runge (Rowland)	Cornu	Intensity and Character	Müller and Kempf	Difference Rowland — Ångström	Reduction to Vacuum		Oscillation Frequency in Vacuo
					$\lambda +$	$\frac{1}{\lambda} -$	
3793.60		1					26352.3
3793.48		1					26353.1
3792.96		1					26356.7
3792.62	92.7	1		-0.08			26359.1
3792.28	92.2	2		0.08			26361.5
3791.89		1					26364.2
3791.65		1					26365.8
3791.28		1 _n					26368.4
3790.88		1					26371.2
3790.22	90.5	6		-0.28			26375.8
3789.31	89.8	4		-0.49			26382.1
3788.01	87.1	6		0.91			26391.2
3787.30		1					26396.1
3786.81	86.2	4		0.62		7.9	26399.5
3786.30		4				8.0	26403.0
3786.07	85.4	4		0.67			26404.6
3785.83		1					26406.3
3782.74		2					26427.9
3782.56		2					26429.1
3782.23		1					26431.4
3782.05		2					26432.7
3781.31		4					26437.9
3779.58		6					26449.9
3779.32		1					26451.8
3778.82		1					26454.6
3778.63		4					26456.6
3778.45		1					26457.9
3777.56		2					26464.1
3777.20		1					26466.6
3776.58		4					26471.0
3775.93		1					26475.5
3774.95		4					26482.4
3773.84		2					26490.2
3773.51		1					26492.5
3770.43		2					26514.2
3770.12		2				1.14	26516.3
3768.15		2				1.13	26530.2
3767.31	66.8	8		0.51			26536.1
3766.74		1					26540.1
3766.19		1					26544.0
3765.66	65.0	8		0.66			26547.8
3763.90	63.4	8		0.50			26560.2
3762.30		1					26571.5
3761.52		1					26577.0
3760.66		4					26583.1
3760.17		4					26586.5
3759.30		1					26592.7
3758.36	57.7	8		0.66			26599.3
3757.60		1					26604.7
3757.06		2					26608.5
3756.17		1					26614.9
3754.63		1					26625.8
3753.74	53.4	4		0.34			26632.1
3753.27		1					26635.4
3752.57		1					26640.4

IRON (ARC SPECTRUM)—*continued.*

Kaiser and Runge (Rowland)	Cornu	Intensity and Character	Müller and Kempf	Difference Rowland, — Ångström	Reduction to Vacuum		Oscillation Frequency in Vacuo
					$\lambda +$	$\frac{1}{\lambda}$	
3751-97		1					26644.7
3749-61	49.5	8		0.11			26661.4
3749-06		2					26665.3
3748-39	48.2	6		0.19			26670.1
†3747-09		4					26679.4
3746-56		1				8.0	26683.1
3745-95		6				8.1	26687.4
3745-67	45.5	8		0.17			26689.4
3744-21		2					26699.8
3743-58		4					26704.3
3743-45	42.9	6		0.55			26705.2
3742-77		2					26710.1
3740-44		2					26726.7
3740-22		1					26728.3
3739-73		2					26731.8
3739-45		1					26733.8
3739-22		1					26735.4
3738-44		6					26741.0
3737-27	36.5	8		0.77			26749.4
3735-45		6					26762.4
3735-00	34.4	8		0.60			26765.7
3733-46	33.2	4		0.26			26776.7
3732-54	32.4	6		0.14	1.13		26783.3
3731-51		2			1.12		26790.9
3731-07		2					26793.9
3730-53		4					26797.7
3728-81		1					26810.1
3727-78	27.0	6		0.78			26817.5
3727-13	26.7	4		0.43			26822.2
3725-62		1					26833.1
3724-51	24.1	6		0.41			26841.1
3722-69	21.9	6		0.79			26854.2
3722-07		1					26858.7
3721-69		2					26861.4
3721-57		1					26862.3
3721-41		1					26863.4
3720-07	19.7	10		0.37			26873.1
3718-55		4					26884.1
3716-59	16.4	6		0.19			26898.3
3716-04	15.5	4		0.54			26902.3
3711-54		1					26934.9
3711-35		2					26936.3
3709-79		1					26947.6
3709-66		1					26948.5
3709-37	09.0	6		0.37			26950.7
3708-72		1					26955.4
3708-03	07.8	6		0.23			26960.4
3707-73		1					26962.6
3707-60		1					26963.5
3707-18	07.5	4		-0.32		8.1	26966.5
3705-70	05.5	4		0.20		8.2	26977.2
3704-59	03.7	6		0.89			26985.3
3703-96		2					26989.9
3703-83		1					26990.9
3703-68	03.2	4		0.48			26992.0

IRON (ARC SPECTRUM)—*continued.*

Kayser and Runge (Rowland)	Cornu	Intensity and Character	Müller and Kempf	Difference Rowland—Ångström	Reduction to Vacuum		Oscillation Frequency in Vacuo
					$\lambda +$	$\frac{1}{\lambda} -$	
3702.63		1					26999.6
3702.16		2					27003.1
3701.20	00.8	6		0.40			27010.1
3699.23		1					27024.4
3698.73		2					27028.1
3698.17		1					27032.2
3697.58		4			1.12		27036.5
3695.68		1			1.11		27050.4
3695.18		4					27054.1
3694.13	93.7	6		0.43			27061.8
3693.16		1					27068.9
3692.79		1					27071.6
3691.49		1					27081.1
3691.19		1					27083.3
3690.86		2					27085.8
3690.60		1					27087.7
3690.23		1					27090.4
3689.98		1					27092.2
3689.58		4					27095.2
3688.65		1					27102.0
3687.77	87.2	6		0.57			27108.5
3687.58		6					27109.9
3687.21		1					27112.6
3686.65		1					27116.7
3686.40		1					27118.5
3686.10	85.8	6		0.30			27120.7
3684.24	85.0	4		0.76			27134.4
3683.77	83.9	2		0.13			27137.9
3683.18		1					27142.2
3682.35	81.7	6		0.65			27148.4
3681.79		1					27152.5
3681.35		1					27155.7
3680.90		2					27159.1
3680.03	80.3	4		-0.27			27165.5
3679.49		1					27169.5
3679.13		1					27172.1
3678.99		2					27173.2
3677.76	77.6	4		0.16			27182.3
3677.60		1					27183.4
3677.42		2					27184.8
3677.03		1					27187.7
3676.44		4					27192.0
3675.29		1					27200.5
3674.89		1					27203.5
3674.55		1					27206.0
3674.12		1					27209.2
3673.19		1					27216.1
3672.85		1					27218.6
3671.80		1					27226.4
3671.64		1					27227.6
3670.95		1					27232.7
3670.20		4					27238.3
3669.65	69.3	6		0.35			27242.4
3669.29		2					27245.0
3669.01		1					27246.9

IRON (ARC SPECTRUM)—*continued.*

Kayser and Runge (Rowland)	Cornu	Intensity and Character	Müller and Kempf	Difference Rowland - Angström	Reduction to Vacuum		Oscillation Frequency in Vacuo
					$\lambda +$	$\frac{1}{\lambda} -$	
3668·82		1					27248·5
3668·68		1					27249·6
3668·35		1					27252·0
3668·11		2				8·2	27253·8
3667·45		2				8·3	27258·6
3666·99		1					27262·0
3666·41		1					27266·3
3665·90		1					27270·1
3665·33		1					27274·4
3664·74		2					27278·8
3664·10		1					27283·5
3663·60		1					27287·3
3663·41	62·4	1		1·01			27288·7
3663·04	62·0	1		1·04			27291·4
3661·52		1					27302·8
3661·08		1					27306·0
3660·53		1			1·11		27310·1
3659·65	56·2	6		3·45	1·10		27316·7
3658·68		1					27324·0
3658·07		1					27328·5
3657·66		1					27331·6
3657·27		1					27334·5
3656·37		1					27341·2
3655·93		1					27344·5
3655·60		4					27347·0
3655·12		1					27350·6
3654·83		1					27352·7
3654·11		1					27358·1
3653·90		1					27359·7
3651·61	51·7	6		-0·09			27376·9
3650·64		1					27384·2
3650·42	49·4	4		1·02			27385·8
3650·14		2					27387·9
3649·65	48·6	4		1·05			27391·6
3649·44		1					27393·2
3647·99	46·9	8		1·09			27404·0
3647·57		1					27407·2
3645·96		4					27419·3
3645·63		1					27421·8
3645·22		1					27424·9
3644·97		1					27426·8
3644·73		1					27428·6
3643·80		4					27435·6
3640·53		6					27460·2
3638·44	37·7	4		0·74			27476·0
3637·98		1					27479·5
3637·39		1					27483·9
3637·16		1n					27485·7
3636·73		1n					27488·9
3636·32		2					27492·0
3635·39		1n					27499·1
3634·80		1					27503·5
3634·48	33·8	4		0·68			27506·0
3633·98		1					27409·7
3633·16		2					27515·9

IRON (ARC SPECTRUM)—*continued.*

Kavser and Runge (Rowland)	Cornu	Intensity and Character	Müller and Kempf	Difference Rowland—Angström	Reduction to Vacuum		Oscillation Frequency in Vacuo
					$\lambda +$	$\frac{1}{\lambda} -$	
3632·71		1					27519·4
3632·20		4					27523·2
3631·62	30·9	6n		0·72			27527·6
3631·23		4					27530·6
3630·50		4				8·3	27536·1
3628·97		1				8·4	27547·6
3628·22		1					27553·3
3627·91		1					27555·7
3827·19		1					27561·2
3626·64		1					27565·3
3626·31		1					27567·8
3625·30	23·7	4		1·60			27575·5
3624·95		1					27578·2
3624·46		1					27581·9
3623·94		1					27585·9
3623·58		1					27588·6
3623·33	22·7	6		0·63	1·10		27590·5
3622·15	21·0	6		1·15	1·09		27599·5
3621·87		1					27601·6
3621·61	20·6	6		1·01			27603·6
3621·24		1					27606·4
3620·62		1					27611·2
3620·37		1					27613·1
3619·89		1					27616·7
3619·54		1					27619·4
3618·92	17·8	8		1·12			27624·1
3618·54		2					27627·0
3617·94	16·9	6		1·04			27631·6
3617·47		1					27635·2
3617·23		1					27637·1
3616·76		1					27640·7
3616·46		1					27642·9
3616·29		1					27644·2
3615·80		1					27648·0
3615·41		1					27651·0
3614·78		1					27655·8
3614·26		1					27659·8
3613·75		1					27663·7
3613·58		1					27665·0
3613·26		1					27667·4
3613·10		1					27668·7
3612·25		2					27675·2
3610·86		1					27685·8
3610·29	09·7	6		0·59			27690·2
3608·99	08·3	8		0·69			27700·2
3608·33		1					27705·3
3607·72		1					27709·9
3606·83	06·0	6		0·83			27716·8
3606·05		1					27722·8
3605·62	04·6	6		1·02			27726·1
3604·88		1					27731·8
3604·54		1					27734·4
3604·29		1					27736·3
3603·98		1					27738·7
3603·83		1					27739·9

IRON (ARC SPECTRUM)—*continued.*

Kayser and Runge (Rowland)	Cornu	Intensity and Character	Müller and Kempf	Difference Rowland—Ångström	Reduction to Vacuum		Oscillation Frequency in Vacuo
					$\lambda +$	$\frac{1}{\lambda} -$	
3603·71		1					27740·8
3603·59		1					27741·7
3603·34	02·1	4		1·24			27743·6
3602·64	01·8	2		0·84			27749·0
3602·23		1					27752·2
3599·77		2					27771·3
3599·30		1					27774·8
3599·12		1					27776·2
3598·85		1					27778·3
3597·84		1					27786·2
3597·22		2					27790·8
3596·35		2					27797·6
3596·03		1					27800·0
3595·78		1					27802·0
3595·43		1					27804·7
3594·71	94·0	6		0·71			27810·2
3593·62		1					27818·7
3593·46		1					27819·9
3592·97		1					27823·7
3592·83		1					27824·8
3592·61		1					27826·5
3592·13		1				8·4	27830·2
3591·48		1				8·5	27835·2
3591·13		1					27837·9
3590·80		1					27840·4
3590·21		1					27845·0
3589·73		1					27848·7
3589·58		2					27849·9
3589·25		4					27852·5
3589·05		1					27854·0
3588·75		2					27856·3
3587·87		2					27863·2
3587·55		2					27865·7
3587·34		1					27867·3
3587·10	86·2	8		0·90			27869·2
3586·62		1				1·09	27872·9
3586·24		6				1·08	27875·8
3585·84		4					27879·0
3585·43	84·9	4		0·53			27882·1
3585·33		2					27882·9
3585·08		4					27884·9
3584·78	84·1	6		0·68			27887·2
3583·74		1					27895·3
3583·45		2					27897·6
3582·76		1					27902·9
3582·32		4					27906·4
3581·94		1					27909·3
3581·73		1					27911·0
N 3581·32	80·6	10		0·72			27914·2
3578·80		2					27933·8
3578·49		1					27936·2
3578·03		2					27939·8
3576·89		2					27948·7
3576·11		1					27954·8
3575·49		4					27959·7

IRON (ARC SPECTRUM)—*continued.*

Kayser and Runge (Rowland)	Cornu	Intensity and Character	Müller and Kempf	Difference Rowland—Ångström	Reduction to Vacuum		Oscillation Frequency in Vacuo
					$\lambda +$	$\frac{1}{\lambda}$	
3575-37		1					27960.6
3575-22		1					27961.8
3574-00		6					27971.3
3573-52		2					27975.1
3272-79		1					27980.8
3572-12		6					27986.1
3571-34		2					27992.2
3570-45		4					27999.2
3570-23	68.9	10		1.33			28000.9
3569-60		1					28005.8
3569-09		2					28009.8
3568-94		1					28011.0
3568-53		1					28014.2
3567-52		1					28022.2
3567-15		2					28025.1
3566-70		1					28028.6
3566-46		2					28030.5
3565-72		4					28036.3
3565-50	64.1	10		1.40			28038.0
3564-61		1					28045.1
3564-22		1					28048.1
3560-81		2					28075.0
3559-62		2					28084.4
3559-39		1					28086.2
3559-18		1					28087.9
3558-62	58.1	8		0.52			28092.3
3556-99	56.0	8		0.99			28105.2
3555-04	54.0	10		1.04			28120.6
3554-62		1					28123.9
3554-24		4				8.5	28126.9
3553-84		4				8.6	28130.0
3553-58		1					28132.0
3553-29		1					28134.3
3552-95		4					28137.0
3552-58		1					28140.1
3552-24		2				1.08	28142.6
†3549-97		2				1.07	28160.6
3548-13		2					28175.3
3547-89		2					28177.2
3547-31		2					28181.8
3546-29		1					28189.9
3545-95		1					28192.6
3545-74		6					28194.3
3544-74		2					28202.2
3543-78		2					28209.8
3543-53		1					28211.8
3542-37		2					28221.1
3542-20	41.5	6		0.70			28222.4
3541-22	40.1	6		1.12			28230.3
3540-82	39.2	2		1.62			28233.4
†3540-24		2					28238.1
3538-87		1					28249.0
3538-68		1					28250.5
3538-48		1					28252.1
3538-01		4					28255.9

IRON (ARC SPECTRUM)—continued.

Kayser and Runge (Rowland)	Cornu	Intensity and Character	Müller and Kempf	Difference Rowland — Ångström	Reduction to Vacuum		Oscillation Frequency in Vacuo
					$\lambda +$	$\frac{1}{\lambda} -$	
3537·84		4					28257·2
3537·60		2					28259·2
3536·65	35·4	6		1·25			28266·7
3535·01		1					28279·9
3534·63		1					28282·9
3533·30		6					28293·6
3533·08		4					28295·3
3532·71		1					28298·3
3532·17		1					28302·6
3531·90		1					28304·8
3531·56		1					28307·5
3530·48		2					28316·2
3529·90		4					28320·8
3529·63		1					28323·0
3529·44		1					28324·5
3527·90	27·0	6		0·90			28336·9
3526·76		4					28346·0
3526·51	25·7	6		0·81			28348·0
3526·25		6					28350·1
3526·08		2					28351·5
3525·97		1					28352·4
3524·62		2					28363·2
3524·34		2					28365·5
3524·15		2					28367·0
3523·38		1					28373·2
3522·97		1					28376·5
3522·37		2					28381·4
3521·93		2					28384·9
3521·36	20·6	8		0·76			28389·5
3520·95		1					28392·8
3520·14		1					28399·4
3518·96		2					28408·9
3518·80		1					28410·2
3517·19		1				8·6	28423·2
3516·66		1				8·7	28427·4
3516·50		2					28428·7
3515·39		1					28437·6
3515·15		2					28439·6
3514·72		1					28443·1
3513·91	13·7	8		0·21	1·07		28449·6
3513·15		1			1·06		28455·8
3513·05		1					28456·6
3512·78		1					28458·8
3512·30		1					28462·7
3511·80		1					28466·7
3511·49		1					28469·2
3510·76		1					28475·2
3510·52		4					28477·1
3510·43		1					28477·8
3509·95		2					28481·7
3509·23		1					28487·6
3508·58		4					28492·9
3507·23		1					28503·8
3506·59	05·8	4		0·79			28509·0
3506·39		1					28510·7

IRON (ARC SPECTRUM)—*continued.*

Kayser and Runge (Rowland)	Cornu	Intensity and Character	Müller and Kempf	Difference Rowland—Ångström	Reduction to Vacuum		Oscillation Frequency in Vacuo
					$\lambda +$	$\frac{1}{\lambda} -$	
3505.15		2					28520.7
3504.95		2					28522.4
3504.52		1					28525.9
3502.35		1					28543.6
3500.64	01.8	4		-1.16			28557.5
3498.84		1					28572.2
3497.92	96.8	6		1.12			28578.7
3497.20	95.9	6		1.30			28585.6
3496.27		1					28593.2
3495.96		1					28595.7
3495.37	94.5	4		0.87			28600.6
3494.76		1					28605.6
3494.24		1					28609.8
3493.78		2					28613.6
3493.37		1					28617.0
3493.04		2					28619.7
3492.68		1					28622.6
3490.65	91.9	8		-1.25			28639.3
3489.74	89.8	6		-0.06			28646.7
3489.49	88.9	1		0.59			28648.8
3486.63	88.0	1		-1.37			28672.3
3485.42	85.4	4		0.02			28682.2
3485.06		1					28685.2
3484.92		1					28686.4
3483.91		1					28694.7
3483.09		2					28701.4
3482.23		1					28708.5
3481.87		1					28711.5
3481.64		1				8.7	28713.4
3480.45		1				8.8	28723.1
3479.73		1					28729.1
3478.69		2					28737.6
3477.93		2			1.06		28743.9
3477.09		1			1.05		28750.8
3476.93		4					28752.2
3476.75	76.1	8		0.65			28753.7
3476.39		1					28756.7
3476.17		1					28758.5
3475.95		1					28760.3
3475.72		4					28762.2
3475.52	74.9	8		0.62			28763.9
3474.51		2					28772.2
3474.14		1					28775.3
3473.78		1					28778.3
3473.59		1					28779.9
3473.39		1					28781.5
3472.61		1					28788.0
3472.29		1n					28790.6
3472.06		1n					28792.5
3471.40	70.4	8		1.00			28798.0
3470.78		1					28803.2
3469.91		4					28810.4
3469.70		1					28812.1
3469.49		1					28813.9
3469.09		2					28817.2

IRON (ARC SPECTRUM)—*continued.*

Kayser and Runge (Rowland)	Cornu	Intensity and Character	Müller and Kempf	Difference Rowland — Ångström	Reduction to Vacuum		Oscillation Frequency in Vacuo
					$\lambda +$	$\frac{1}{\lambda} -$	
3468.92		4					28818.6
3466.98		2					28834.7
3466.57		4					28838.2
3465.95	65.5	10		0.45			28843.3
3464.98		1					28851.4
3464.16		1n					28858.2
3463.39		1					28864.6
3462.87		1					28869.0
3462.43		2					28872.6
3461.73		2					28878.5
3461.15		1n					28883.3
3460.40		1					28889.6
3460.02	61.5	6		-1.48			28892.8
3459.83		1					28894.3
3459.51		2					28897.0
3458.55		2					28905.0
3458.39	57.8	4		0.59			28906.4
3457.53		1					28913.6
3457.15		1n					28916.8
3456.32		1n					28923.7
3455.41		1n					28931.3
3454.26		1					28941.0
3453.60		1					28946.5
3453.10	53.2	4		-0.1			28950.7
3452.35		6					28957.0
3451.99		6					28960.0
3451.71		2					28962.3
3450.41		6					28973.3
3447.37	45.7	6		1.67			28998.8
3447.00		1					29001.9
3446.86		1					29003.1
3446.34		2					29007.5
3445.87		1n					29011.4
3445.22	44.4	8		0.82		8.8	29016.9
3443.96	43.0	10		0.96		8.9	29027.4
3443.30		1n					29033.0
3443.03		1n					29035.3
3442.75		2					29037.6
3442.44	40.8	4		1.64			29040.3
3442.07		1					29043.4
3441.07	39.9	10		1.17	1.05		29051.8
3440.69	39.6	10		1.09	1.04		29055.0
3439.93		2n					29061.5
3439.09		1n					29068.6
3438.36		1n					29074.7
3438.02		2					29077.6
3437.68		1n					29080.5
3437.37		1n					29083.1
3437.11		2n					29085.3
3436.06		1n					29094.2
3433.64		4					29114.7
3433.09		1					29119.4
3431.90		4					29129.5
3428.81		1n					29155.7
3428.26		6					29160.4

IRON (ARC SPECTRUM)—*continued.*

Kayser and Runge (Rowland)	Cornu	Intensity and Character	Müller and Kempf	Difference Rowland—Ångström	Reduction to Vacuum		Oscillation Frequency in Vacuo
					$\lambda +$	$\frac{1}{\lambda}$	
3427·21	26·7	8		0·51			29169·3
3426·71		6					29173·6
3426·44	25·4	6		1·04			29175·9
3425·08	24·8	6		0·28			29187·5
3424·36	22·8	10		1·56			29193·7
3423·79		1					29198·5
3422·69	20·9	10		1·79			29207·9
3419·76		4					29232·9
3419·25		1					29237·3
3418·91		1					29240·2
3418·58	16·0	8		2·58			29243·0
3418·28		1					29245·6
3417·92	15·5	8		2·42			29248·7
3417·30		1					29254·0
3416·65		1					29259·5
3416·30		1					29262·5
3415·61		6					29268·4
3414·83		4					29275·1
3413·22	11·8	10		1·42			29288·9
3412·43		1					29295·7
3411·43		4					29304·3
3411·22		1					29306·1
3410·98		1					29308·2
3410·26		6					29314·4
3409·22		2				8·9	29323·3
3408·52		1				9·0	29329·2
3407·55	06·1	10		1·45			29337·6
3406·88		6					29343·4
†3406·50		2					29346·6
3405·89		2					29351·9
3405·65		1					29354·0
3405·45		1					29355·7
3405·24		1					29357·5
3404·75		1					29361·7
3404·41	03·1	10		1·31	1·04		29364·7
3403·39		2			1·03		29373·5
3402·33		6					29382·6
3401·60		6					29388·9
3400·50		1					29398·4
3399·39	97·6	10		1·79			29408·0
3398·29		1					29417·6
3397·68		2					29422·8
3397·05		4					29428·3
3396·13		1					29436·3
3394·65		6					59449·1
3394·13		2					29453·6
3393·72		1					29457·2
3393·46		1					59459·4
3393·07		1					29462·8
3392·74	91·0	8		1·74			29465·7
3392·37		4					29468·9
3392·12		2					29471·1
3391·21		1					29479·0
3390·61		1					29484·2
3389·83		2					29491·0

IRON (ARC SPECTRUM)—*continued.*

Kayser and Runge (Rowland)	Cornu	Intensity and Character	Müller and Kempf	Difference Rowland—Angström	Reduction to Vacuum		Oscillation Frequency in Vacuum
					$\lambda +$	$\frac{1}{\lambda} -$	
3389.01		1					29498.1
3388.84		1					29499.6
3387.48		4					29511.5
3385.58		2					29528.0
3385.02		1					29532.9
3384.05		8					29541.4
3383.80		4					29543.6
3382.48		4					29555.1
3381.42		2					29564.4
3380.62		2					29571.4
3380.17		8					29575.3
3379.11		6					29584.6
3378.77		6					29587.6
3378.06		1					29593.8
3376.58		2					29606.8
3375.64		1					29615.0
3374.58		1					29624.3
3374.01		1				9.0	29629.3
3372.90		1				9.1	29639.0
3372.18		4					29645.3
3370.87		10					29656.8
3369.62		8					29667.8
3368.16		1			1.03		29680.7
3366.88		6			1.02		29692.0
3364.66		1					29711.6
3364.34		1					29714.4
3363.77		1					29719.4
3363.63		1					29720.7
3362.37		1					29731.8
3362.09		1					29734.3
3361.03		1					29743.7
3359.84		1					29754.2
3359.55		1					29756.8
3358.41		1					29766.9
3356.44		4					29784.4
3355.27		6					29794.8
3354.16		4					29804.6
3353.42		1					29811.2
3353.10		1					29814.0
3351.85		4					29825.2
3351.65		2					29826.9
3350.45		1					29837.6
3348.03		6					29859.2
3347.03		2					29868.1
3346.12		1					29885.2
3343.83		1					29896.7
3343.29		1					29901.6
3342.35		6					29910.0
3342.01		4					29913.0
3341.01		1					29922.0
3340.64		6					29925.3
3339.70		2					29933.7
3339.24		2				9.1	29937.8
3338.76		2				9.2	29942.0
3337.73		6					29951.3

IRON (ARC SPECTRUM)—*continued.*

Kayser and Runge (Rowland)	Cornu	Intensity and Character	Müller and Kempf	Difference Rowland—Ångström	Reduction to Vacuum		Oscillation Frequency in Vacuo
					$\lambda +$	$\frac{1}{\lambda}$	
3336-30		2					29964.1
3335-85		4					29968.2
3334-31		2			1.02		29982.0
3331-74		4			1.01		30005.1
3330-37		1					30017.5
3329-64		2					30024.1
3329-00		8					30029.8
3327-60		1					30042.5
3325-56		4					30060.9
3324-62		4					30069.4
3323-84		6					30076.5
3322-65		2					30087.3
3320-86		2					30103.5
3320-36		1					30108.0
3319-35		4					30117.2
3317-24		4					30136.3
3316-60		1					30142.2
3315-75		1					30149.9
3314-86		8					30158.0
3314-60		1					30160.3
3314-25		1					30163.5
3313-98		1					30166.0
3312-82		1					30176.6
3312-40		1					30180.4
3311-23		1					30191.1
3310-53		6					30197.4
3308-89		1					30212.4
3307-87		1					30221.7
3307-33	04.7	6		2.63			30226.7
3307-16		1					30228.2
3306-50	04.1	10		2.40			30234.3
3306-09	03.7	10		2.39			30238.0
3305-28		1					30245.4
3304-45		1				9.2	30253.0
3303-69		1				9.3	30259.9
3302-87		1					30267.4
3302-02		1					30275.2
3301-35		1					30281.3
3300-69		1					30287.4
3299-61		1					30297.3
3299-14		1					30301.6
3298-77		1					30305.0
3298-25	96.0	8		2.25			30309.8
3296-91		1					30322.1
3296-56		1					30325.3
3295-94		1					30331.1
3295-12		1			1.01		30338.6
3293-17		1			1.00		30356.6
3292-70	90.8	8		1.90			30360.9
3292-13	90.0	8		2.13			30366.2
3291-10	89.3	6		1.80			30375.7
3290-86		1					30377.9
3290-03		1					30385.6
3289-51		1					30390.4
3289-04		1					30394.7

IRON (ARC SPECTRUM)—continued.

Kaysers and Runge (Rowland)	Cornu	Intensity and Character	Müller and Kempf	Difference Rowland—Ångström	Reduction to Vacuum		Oscillation Frequency in Vacuo
					$\lambda +$	$\frac{1}{\lambda} -$	
3288.77		1					30397.2
3288.14		1					30403.0
3287.09		2					30412.7
Q 3286.87	84.8	10		2.07			30414.8
3286.11	84.6	1		1.51			30421.8
3285.50		2					30427.5
3285.33		1					30429.0
3284.71	83.4	4		1.31			30436.2
3283.64		1					30444.7
3283.00	82.7	4		0.30			30450.6
3282.40		1					30456.2
3281.95		1					30460.4
3281.40		1					30465.5
3280.37		8					30475.1
3279.87		1					30479.7
3278.83		2					30489.4
3277.42		1					30502.5
3276.55		2					30510.6
3275.84		1					30517.2
3274.53		1					30529.4
3274.05	72.2	8		1.85			30533.9
3272.75		1					30546.0
3271.75		2					30555.4
3271.58		2					30557.0
3271.12	69.3	8		1.82		9.3	30561.3
3270.08		1				9.4	30570.9
3269.40		1					30577.2
3268.33		4					30587.3
3265.73	63.9	8		1.83			30611.6
3265.15		4					30617.1
3264.80		1n					30620.3
3264.60		4					30622.2
3263.46		2					30632.9
3263.05		1					30636.8
3262.40		2					30642.9
3262.10		1					30645.7
3261.41		2					30652.2
3260.32		2					30662.4
3260.09		4					30664.6
3259.15		1				1.00	30673.4
3258.50		1				0.99	30679.6
3257.69		6					30687.2
3257.33		2					30690.6
3256.80		1					30695.6
3256.20		1					30701.2
3255.97		1					30703.4
3254.79		1					30714.5
3254.47	52.4	8		2.67			30717.6
3254.03		1					30721.7
3253.70		2					30724.8
3253.00		2					30731.4
3252.55		2					30735.7
3251.31		6					30747.4
3250.75		2					30752.7
3250.50		1					30755.1

IRON (ARC SPECTRUM)—*continued.*

Kayser and Runge (Rowland)	Cornu	Intensity and Character	Müller and Kempf	Difference Rowland—Ångström	Reduction to Vacuum		Oscillation Frequency in Vacuo
					$\lambda +$	$\frac{1}{\lambda}$	
3249-94		1					30760-4
3249-27		1					30766-7
3248-53		1					30773-8
3248-31	46-8	6		1-51			30775-8
3247-70	46-1	4		1-60			30781-6
3247-39		4					30784-6
3247-08		2					30787-5
3246-55		1					30792-5
3246-09		4					30796-9
3245-59		1					30801-6
3245-35		1					30803-9
3244-97		1					30807-5
3244-27	42-8	8		1-47			30814-2
3243-94		1					30817-3
3243-50		1					30821-5
3243-22		1					30824-2
3242-35		1					30832-4
3241-54		1					30840-1
3240-59		1					30849-2
3239-53	38-9	8		0-63			30859-3
	38-7						
	37-8	1		1-27			30863-7
3239-07		1					30868-1
3238-60		1					30874-6
3237-92		1					30879-3
3237-43		1					30884-5
3236-88		2				9-4	30889-9
3236-31	34-3	4		2-01		9-5	30896-1
3235-66		1					30905-2
3234-71		2					30911-3
3234-07	32-3	6		1-77			30920-2
3233-14		4					30927-1
3232-42		1					30933-8
3231-72		1					30940-2
3231-05		6					30942-6
3230-80		1					30947-5
3230-29		4					30950-1
3230-01		2					30953-7
3229-64		1					30958-0
3229-19		2					30960-1
3228-97		2					30963-3
3228-64		1					30966-0
3228-36		4					30968-4
3228-11		2				0-99	30970-6
3227-88	26-5	6		1-38		0-98	30977-4
3227-17		2					30980-4
3226-86		1					30989-6
3225-90	24-4	10		1-50			30998-4
3224-98		1					31005-3
3224-27		1					31008-9
3223-89		1					31014-5
3223-31		1					31026-0
3222-12	21-0	10		1-12			31047-2
3219-92	18-7	8		1-22			31049-6
3219-67		8					31059-9
3218-60		1					

IRON (ARC SPECTRUM)—*continued.*

Kaysers and Runge (Rowland)	Cornu	Intensity and Character	Müller and Kempf	Difference Rowland—Ångström	Reduction to Vacuum		Oscillation Frequency in Vacuo
					$\lambda+$	$\frac{1}{\lambda}-$	
3217.49		8					31070.6
3216.03		8					31084.7
3215.49		1					31090.0
3214.48		2					31099.7
3214.14	12.2	8		1.94			31103.0
3213.43		1					31109.9
3212.08	10.8	6		1.28			31123.0
3211.77	10.5	2		1.27			31126.0
3211.63		2					31127.3
3210.92	09.8	4		1.12			31134.2
3210.35	09.3	4		1.05			31139.7
3209.45		4					31148.5
3208.60		4					31156.7
3207.22		2					31170.1
3205.45	04.3	8		1.15			31187.4
3204.15		1					31190.0
3203.14		1				9.5	31209.9
3202.65		2				9.6	31214.5
3201.52		1					31225.6
3200.81		1					31232.5
3200.58	99.7	8		0.88			31234.7
3199.62	98.8	8		0.82			31244.1
3198.38		1n					31256.2
3197.67		1n					31263.2
3197.04	96.3	8		0.74	0.98		31269.3
3196.24		2			0.97		31277.2
3195.35		1					31285.9
3194.73		1					31291.9
3194.52		1					31294.0
3193.92		1					31299.9
3193.37	92.7	6		0.67			31305.3
3192.93	92.3	6		0.63			31309.6
3192.66		1					31312.2
3191.77		6					31321.0
3191.22		1					31326.4
3190.80		1					31330.5
3190.13		1					31337.1
3188.96		4					31348.6
3188.67		4					31351.4
3188.14		2					31356.6
3187.70		1					31361.0
3187.35		2n					31364.4
3186.83		2					31369.5
3185.72		1					31380.5
3185.34		1					31384.2
3185.00		4					31387.6
3184.73		1					31390.2
3184.24		1					31395.1
3183.67		1					31400.7
3183.11		4					31406.2
3182.13		2					31415.9
3181.97		4					31417.5
3181.60		4					31421.1
3180.85		4					31428.5
R 3180.30	79.8	10		0.50			31434.0

IRON (ARC SPECTRUM)—*continued.*

Kayser and Runge (Rowland)	Cornu	Intensity and Character	Müller and Kempf	Difference Rowland—Ångström	Reduction to Vacuum		Oscillation Frequency in Vacuo
					$\lambda +$	$\lambda -$	
3179.61		2					31440.8
3179.06		1					31446.2
3178.64		1					31450.4
3178.08		6					31455.9
3177.64		1					31460.3
3177.09		1					31465.7
3176.44		2					31472.2
3176.09		1					31475.7
3175.53		8					31481.2
3175.18		1					31484.7
3173.75		4					31498.9
3173.53		1					31501.1
3172.14		2					31514.9
3171.73		1					31518.9
3171.44		6				9.6	31521.8
3170.43		2				9.7	31531.8
3168.94		4					31546.6
3168.15		1					31554.5
3167.97		4					31556.3
3166.55		6					31570.4
3165.97		6					31576.2
3165.11		4					31584.8
3164.40		1					31591.9
3163.95		2					31596.4
3162.45		2					31611.3
3162.04	60.9	6		1.14			31615.4
3161.44		2					31621.5
3160.74		8					31628.5
3160.37		4				0.97	31632.2
3159.20		1				0.96	31643.9
3159.08		2					31645.1
3158.48		1					31651.1
3157.99	57.4	6		0.59			31656.0
3157.15	56.7	8		0.45			31664.4
3156.35		4					31672.5
3155.89		1					31677.1
3155.37		2					31682.3
3154.61		2					31689.9
3154.29		1					31693.1
3153.85		1					31697.6
3153.31		6					31703.0
3151.95		1					31716.7
3151.42		8					31722.0
3150.35		2					31732.8
3149.64		1					31740.0
3148.47		2					31751.8
3148.31		1					31753.4
3147.84		2					31758.1
3147.70		2					31759.5
3147.40		2					31762.5
3146.52		1					31771.4
3145.13		2					31785.5
3144.61	44.4	4		0.21			31790.7
3144.06	44.2	6		-0.14			31796.3
3143.33		1					31803.7

IRON (ARC SPECTRUM)—*continued.*

Kayser and Runge (Rowland)	Cornu	Intensity and Character	Müller and Kempf	Difference Rowland—Ångström	Reduction to Vacuum		Oscillation Frequency in Vacuo
					$\lambda +$	$\frac{1}{\lambda}$	
3142.97	43.3	4		-0.33			31807.3
3142.54	42.6	6		-0.06			31811.7
3140.47		4					31832.7
3140.00		4					31837.4
3139.76		1					31839.9
3138.62		2					31851.4
3137.84		1				9.7	31859.4
3136.89		1				9.8	31868.9
3136.59		4					31872.0
3135.76		1					31880.4
3135.51		2					31882.9
3134.21		8					31896.2
3132.61		6					31912.5
3129.45		4					31944.7
3129.20		2					31947.2
3129.05		2					31948.8
3126.89		1					31970.8
3126.25		6					31977.4
3125.77		8					31982.3
3125.00		1					31990.2
3124.16		1					31998.8
3123.43		1			0.96		32006.3
3122.41		2			0.95		32016.7
3121.83		1					32022.7
3120.95		4					32031.7
3120.54		4					32035.9
3120.41		1					32037.3
3119.58		6					32045.8
3117.69		2					32065.2
3116.73		8					32075.1
3116.47		1					32077.8
3115.86		1					32084.1
3113.70		2					32106.3
3112.16		4					32122.2
3111.90		2					32124.9
3111.81		2					32125.8
3110.97		2					32134.5
3110.37		4					32140.7
3109.73		1					32147.3
3109.07		1					32154.2
3108.07		2					32164.5
3107.46		1					32170.8
3106.59		1				9.8	32179.8
3105.69		1				9.9	32189.1
3104.34		1					32203.1
3103.95		1					32207.1
3102.96		4					32217.4
3102.76		6					32219.5
3102.23		1					32225.0
3101.96		1					32227.8
3101.63		4					32231.2
3101.10		1					32236.7
3100.97		2					32238.1
3100.77	99.8	8		0.97			32240.1
s ₂ 3100.38	99.5	6		0.88			32244.2

IRON (ARC SPECTRUM)—*continued.*

Kavser and Runge (Rowland)	Cornu	Intensity and Character	Müller and Kempf	Difference Rowland—Ångström	Reduction to Vacuum		Oscillation Frequency in Vacuo
					$\lambda +$	$\frac{1}{\lambda}$	
3100.04	99.2	10		0.84			32247.7
3099.11		1					32257.4
3098.25		6					32266.4
3097.70		1					32272.1
3097.00		1					32279.4
3096.12		1					32288.6
3095.37		2					32296.4
3095.03		1					32300.0
3093.92		6					32311.6
3093.45		2					32316.5
3092.87		1					32322.5
3091.67	90.4	8		1.27			32335.1
3091.25		1					32339.5
3090.31		1					32349.3
3089.64		1					32356.3
3088.93		1			0.95		32363.8
3088.25		1			0.94		32370.9
3087.49		1					32378.9
3086.85		ln					32385.6
3085.78		ln					32396.8
3083.81		10					32417.5
3083.22		1					32423.7
3082.75		1					32428.7
3082.27		1					32433.7
3081.97		1					32436.9
3081.26		1					32444.3
3081.09		1					32446.1
3080.11	79.3	4		0.81			32456.5
3079.81		1					32459.6
3078.50		4					32473.5
3078.10		4					32477.7
3077.77		2					32481.2
3077.32		1					32485.9
3076.60		1					32493.5
3075.80		10					32502.0
3074.53		2					32515.4
3074.24		2					32518.5
3074.08		2				9.9	32520.1
3073.28		1				10.0	32528.5
3072.28		ln					32539.1
3071.54		ln					32547.0
3070.33		1					32559.8
3069.56		ln					32568.0
3068.89		1					32575.1
3068.25		4					32581.9
3068.06		1					32583.9
3067.30	65.5	10		1.80			32594.8
3066.55		4					32599.9
3066.13		1					32604.4
3065.40		1					32612.2
3064.82		1					32618.3
3064.01		2					32627.0
3063.28		1					32634.7
3062.96		1					32638.2
3062.47		1					32643.4

IRON (ARC SPECTRUM)—*continued.*

Kayser and Runge (Rowland)	Cornu	Intensity and Character	Müller and Kempf	Difference Rowland—Ångström	Reduction to Vacuum		Oscillation Frequency in Vacuo
					$\lambda +$	$\frac{1}{\lambda} -$	
3062·29		1					32645·3
3061·89		1					32649·6
3061·08		4					32658·2
3060·63		2					32663·0
3059·19	57·3	10		1·89			32678·4
3057·55		10					32695·9
3056·39		2					32708·6
3055·82		1					32714·4
3055·35		6					32719·5
3054·45		2					32729·1
3053·95		1					32734·5
5053·53		2n					32739·0
3053·15		6					32743·1
3051·84		1					32757·1
3050·90		4					32767·2
3049·53		2n					32781·9
3048·61		2n			0·93		32791·7
s 3047·71	46·5	10		1·21			32801·5
3047·15		4n					32807·5
3047·02		1					32808·9
3045·70		2					32823·2
3045·16		6					32829·0
3044·68		2					32834·2
3043·36		1					32848·4
3042·75	41·5	8		1·25			32855·0
3042·13	40·7	6		1·43		10·0	32861·7
3041·83	40·3	8		1·53		10·1	32864·8
3041·08		1					32872·9
3040·54	39·2	8		1·34			32878·8
3040·07		1					32883·9
3039·44		2					32890·7
3039·19		1n					32893·4
3038·47		1					32901·2
3037·80		2					32908·5
3037·54	36·2	6		1·34			32911·3
3037·37		6					32913·1
3035·86		2n					32929·5
3034·63		2n					32942·8
3034·26		2					32946·9
3033·45		1					32955·7
3033·20		2					32958·4
3031·74		6					32974·3
3031·31	29·8	6		1·51			32978·9
3030·75		1					32985·0
3030·24	28·7	8		1·54			32990·6
3029·33		4					33000·5
3026·57	25·3	8		1·27			33030·6
3026·00		4					33036·8
3025·75	24·6	6		1·15			33039·6
3025·39		2					33043·5
3024·13	22·7	8		1·43			33057·3
3022·89		1					33070·8
3021·15	19·9	8		1·25			33089·9
3020·70	19·4	10		1·30			33094·8
3019·31		2					33110·0

IRON (ARC SPECTRUM)—*continued.*

Kayser and Runge (Rowland)	Cornu	Intensity and Character	Müller and Kempf	Difference Rowland - Ångström	Reduction to Vacuum		Oscillation Frequency in Vacuo
					$\lambda +$	$\frac{1}{\lambda}$	
3019.08	17.7	8		1.38		10.1	33112.6
3018.23		1				10.2	33121.8
3017.72	16.5	8		1.22			33127.4
3016.29	15.0	6		1.29			33143.1
3016.04		4					33145.9
3015.01		1					33157.2
3014.27		2					33165.3
3012.59		2			0.93		33183.8
3012.07		1			0.92		33189.6
3011.57		6					33195.1
3010.28		1					33209.3
3009.66	08.4	10		1.26			33216.1
3009.18		4					33221.4
3008.23	07.3	10		0.93			33230.9
3007.30	06.3	10		1.00			33242.2
3005.40		4					33263.2
3004.73		1					33270.7
3004.20		2					33276.5
3003.74		1					33281.6
3003.14	02.7	6		0.44			33288.3
3002.74	02.4	4		0.34			33292.7
3002.58		1					33294.5
3002.18		1					33298.9
3001.80		1					33303.1
3001.05	00.2	8		0.85			33311.5
3000.56		6					33316.9
2999.61	99.0	10n		0.61			33327.5
2998.61		1					33338.6
2997.51		1					33350.8
2996.49		6				10.2	33362.2
2995.96		1				10.3	33368.0
2995.41		1					33374.1
t 2994.54	94.4	10		0.14			33383.8
2992.63		1					33405.1
2992.34		1					33408.4
2991.78		6n					33414.6
2990.48		6					33429.1
2989.43		1					33440.9
2989.00		1					33445.7
2988.58		2					33450.4
2987.82		1					33458.9
2987.40	87.1	8		0.30			33463.6
2986.72		1					33471.2
2986.54		2					33473.3
2985.65		6					33483.2
2984.92	84.1	8		0.82			33491.4
2983.68	82.0	10		1.68			33505.4
2982.94		1					33513.7
2982.78		1					33515.5
2982.31		1					33520.8
2981.95		6					33524.8
2981.54	79.7	8		1.84			33529.4
2980.62		6					33539.8
2979.98		1					33547.0
2979.44		1					33553.1

IRON (ARC SPECTRUM)—*continued.*

Kayser and Runge (Rowland)	Cornu	Intensity and Character	Müller and Kempf	Difference Rowland — Ångström	Reduction to Vacuum		Oscillation Frequency in Vacuo
					$\lambda +$	$\frac{1}{\lambda}$	
2978.16		1					33567.5
2976.91		1					33581.6
2976.66		1					33584.4
2976.22	76.8	6		-0.58	0.92		33589.4
2974.86		1			0.91		33604.7
2973.41	73.8	8		-0.39		10.3	33621.1
2973.17		8				10.4	33623.7
2972.36		4					33632.9
2971.89		1					33638.2
2970.60		4					33652.8
2970.20	70.7	10		-0.5			33657.4
2969.52	70.0	10		-0.48			33665.1
2968.95		1					33671.5
2968.58		4					33675.7
2966.99	67.4	10		-0.41			33693.8
2966.31		2					33701.5
2965.92		4					33705.9
2965.35	65.6	8		-0.25			33712.4
2965.12		4					33715.0
2964.72		2					33719.6
2964.30		2					33724.4
2963.77		ln					33730.4
2962.67		1					33742.9
2962.20		2					33748.3
2961.74		1					33753.5
2961.30		4					33758.5
2960.75		2					33764.8
2960.64		1					33766.1
2960.39		4					33768.9
2960.07	60.5	8		-0.43			33772.6
2959.76		2					33776.1
2959.44		1					33779.8
2958.55		1					33789.9
2958.04		ln					33795.8
2957.57		6					33801.1
2957.48	57.4	6		0.08			33802.2
2957.38		6					33803.3
2956.94		2n					33808.3
2955.76		1					33821.8
2954.39		ln					33837.5
2954.13		6					33840.5
2953.99		4					33841.9
2953.86	53.8	6		0.06			33843.6
2953.59		6					33846.7
2952.65		ln					33857.5
2951.69		ln				10.4	33868.5
2950.34	50.5	8n		-0.16		10.5	33883.9
2949.83		1					33889.8
2949.28		6					33896.1
2949.07		1					33898.5
2948.79		2					33901.7
2948.52		6					33904.8
U 2948.00	47.8	8		0.20			33910.8
2947.77		8					33913.4
2947.45		4					33917.1

IRON (ARC SPECTRUM)—*continued.*

Kayser and Runge (Rowland)	Liveing and Dewar	Intensity and Character	Müller and Kempf	Difference Rowland—Ångström	Reduction to Vacuum		Oscillation Frequency in Vacuo
					$\lambda +$	$\frac{1}{\lambda} -$	
2947.26		1					33919.3
2946.54		1					33927.6
2945.79		2n					33936.2
2945.20	44.6	4n		0.60			33943.0
2944.49	44.0	6		0.49			33951.2
2943.73	43.1	2		0.63			33960.0
2942.79		1					33970.8
2941.93		1					33980.8
2941.42	40.8	8		0.62			33986.7
2940.68	39.9	4n		0.78			33995.2
2939.39	38.7	4		0.69			34010.2
2939.15		2					34012.9
2937.90	37.3	8n		0.60			34027.4
2936.99	36.4	10		0.59			34038.0
2936.18		4					34047.4
2934.45		1					34067.4
2934.04		1			0.91		34072.2
2933.14	32.4	4		0.74	0.90		34082.6
2932.06		1					34095.2
2931.92	*31.1	1		0.82			34096.8
2931.55		2					34101.1
2931.18		1					34105.4
2930.72		1					34110.8
2930.49		1					34113.5
2929.67		4					34123.0
2929.20	28.3	8		0.90			34128.5
2929.04		2				10.5	34130.4
2928.83		4				10.6	34132.7
2928.20		2					34140.1
2928.02		1					34142.2
2927.66		4					34146.4
2927.08		1					34153.1
2926.65	26.0	8		0.65			34158.2
2925.96	25.2	6		0.76			34166.2
2925.43	24.7	6		0.73			34172.4
2924.66		ln					34181.4
2923.94	23.2	6		0.74			34189.8
2923.39	22.8	8n		0.59			34196.3
2922.81		ln					34203.0
2922.46	*21.5	2		0.96			34207.1
2921.86		1					34214.2
2921.19		ln					34222.0
2920.76	20.0	6		0.76			34227.1
2920.41		1					34231.2
2919.95		4					34236.6
2919.31		1					34244.1
2919.11		1					34246.4
2918.42		4					34254.5
2918.11	17.4	8		0.71			34258.2
2917.58		1					34264.4
2916.20		ln					34280.6
2914.34	13.6	6		0.74			34302.5
2913.70		ln					34310.0

* Those marked with an asterisk (*) were observed only in the Spark-spectrum.

IRON (ARC SPECTRUM)—*continued.*

Kayser and Runge (Rowland)	Living and Dewar	Intensity and Character	Müller and Kempf	Difference Rowland - Ångström	Reduction to Vacuum		Oscillation Frequency in Vacuo
					$\lambda +$	$\frac{1}{\lambda} -$	
2912.26	11.5	10		0.76			34327.0
2911.01	*10.5	4		0.51			34341.7
2909.91		1					34354.7
2909.57	08.9	6		0.67			34358.7
2909.38		1					34361.0
2908.97	08.2	6		0.77			34365.8
2907.94		1					34378.0
2907.59	07.1	6		0.49		10.6	34382.1
2906.70		1				10.7	34392.6
2906.53	05.8	4		0.73			34394.6
2906.23		1					34398.1
2905.60		1					34405.6
2905.46		2					34407.3
2904.66		1					34416.7
2904.22	03.5	4n		0.72			34421.9
2903.52		1					34430.2
2902.55		1					34441.8
2902.02	01.3	8n		0.72			34448.0
2901.46	00.8	6		0.66			34454.7
2899.49	98.9	8		0.59			34478.1
2898.93		2					34484.8
2898.74		1					34487.0
2898.52	97.8	6n		0.72			34489.7
2897.69		1					34499.5
2897.33	*96.7	1		0.63			34503.8
2897.14		1					34506.1
2896.63		1					34512.2
2895.11	94.5	8		0.61			34530.3
2894.59	94.0	8		0.59			34536.5
2893.97	93.2	4		0.77			34543.9
2893.86		2					34545.2
2893.47		1					34549.9
2893.17		1					34553.5
2892.89		1					34556.8
2892.56	92.0	6		0.56	0.90		34560.7
2891.98	91.2	2		0.78	0.89		34567.7
2891.82		2					34569.6
2891.49		1					34573.5
2890.99		2					34579.3
2890.53		1n					34585.0
2890.12		2					34589.9
2889.96	89.2	4		0.76			34591.9
2889.66		1					34595.4
2888.01	*87.6	1		0.41			34615.2
2887.88	87.3	6		0.58			34616.8
2887.43		1					34622.2
2887.22		1					34624.7
2886.38	85.8	6		0.58			34634.8
2885.46		2					34645.8
2884.45		1n					34657.9
2883.80	83.3	6		0.50			34665.8
2882.99		1					34675.5
2881.65		10					34691.6
2880.84	80.4	6		0.44			34701.4
2880.67		2					34703.4

IRON (ARC SPECTRUM)—*continued.*

Kayser and Runge (Rowland)	Living and Dewar	Intensity and Character	Müller and Kempf	Difference Rowland—Ångström	Reduction to Vacuum		Oscillation Frequency in Vacuo
					$\lambda +$	$\frac{1}{\lambda} -$	
2879.60		1					34716.3
2879.01		1					34723.5
2878.84	78.2	4		0.64			34725.5
2878.75		1					34726.6
2877.95		1					34736.2
2877.37	76.8	8		0.57		10.7	34743.3
2876.80	76.4	2		0.40		10.8	34750.0
2876.24		1n					34756.8
2875.78		1					34762.4
2875.35	74.9	2		0.45			34767.6
2874.98		4					34772.0
2874.24	73.6	8		0.64			34781.0
2873.74	73.0	2		0.74			34787.1
2873.48		2					34790.2
2872.93		1					34796.9
2872.54		1					34801.6
2872.38	72.0	8		0.38			34803.5
2871.83		1					34809.6
2871.39	*70.7	1		0.69			34815.5
2871.16		1					34818.3
2870.37		1					34827.9
2869.93		2					34833.3
2869.38	69.0	8		0.38			34839.9
2868.94		2					34845.3
2868.50	68.0	4		0.50			34850.6
2868.33		2n					34852.7
2867.94		1					34857.4
2867.63	67.1	4		0.53			34861.2
2867.37		4					34864.4
2867.09	*66.5	1		0.59			34867.8
2866.68	66.2	8		0.48			34872.8
2865.90		1					34882.3
2865.43	*64.7	1n		0.73			34888.0
2863.92	63.6	8		0.32			34906.4
2863.46	63.1	10		0.36			34912.0
2962.56	62.4	6		0.16			34923.0
2862.00		1					34929.8
2861.48	*60.9	1		0.58			34936.1
2861.29		1					34938.5
2860.50		4					34948.1
2859.48		1					34960.6
2858.96	58.3	6		0.66			34966.9
2858.41	*57.9	4		0.51			34973.7
2858.13		2					34977.1
2857.88		2					34980.2
2857.29	*56.7	1		0.59			34987.4
2857.09		1					34989.8
2856.19		1				0.89	35000.9
2855.75	*55.3	2		0.45		-0.88	35006.3
2853.81		10					35030.1
2853.02		1					35039.8
2852.19		6					35050.0
2851.85		10					35054.1
2851.58		2					35057.5
2850.69		6					35068.4

IRON (ARC SPECTRUM)—*continued.*

Kayser and Runge (Rowland)	Living and Dewar	Intensity and Character	Müller and Kempf	Difference Rowland, —Ångström	Reduction to Vacuum		Oscillation Frequency in Vacuo
					$\lambda +$	$\frac{1}{\lambda} -$	
2849·91	*49·3	1		0·61			35078·0
2849·67		1					35081·0
2848·77	48·2	8		0·57			35092·1
2848·13	48·0	2		0·13		10·8	35100·0
2847·72		1n				10·9	35104·9
2846·87	46·5	6		0·37			35115·4
2845·75		2					35129·2
2845·63	45·3	8		0·33			35130·7
2844·04	43·6	10		0·44			35150·3
2843·69	43·1	8		0·59			35154·7
2843·30		2					35159·5
2842·96		2					35163·7
2842·46		1					35169·9
2842·06		1n					35174·8
2841·72		1n					35179·1
2841·32		1n					35184·0
2840·99		4					35188·1
2840·73		2					35191·3
2840·50	40·3	6		0·20			35194·2
2840·06	39·6	10		0·46			35199·6
2839·66		1					35204·6
2838·51		2n					35218·8
2838·19	37·7	8		0·49			35222·8
2836·45		1n					35244·4
2836·02		4					35249·8
2835·76		2					35253·0
2835·51	*35·2	6		0·31			35256·1
2834·81		4					35264·8
2834·48		1					35268·9
2834·22		1					35272·2
2834·07		1					35274·0
2833·95	32·8	1n		1·15			35275·5
2833·47	32·4	2		1·07			35281·5
2832·47	31·8	10		0·67			35294·0
2831·04		4					35311·8
2830·85		1					35314·2
2830·55		1n					35317·9
2829·58		1n					35330·0
2828·87	28·3	6		0·57			35338·9
2828·70		1					35341·0
2828·44		1n					35344·3
2827·98	27·3	4		0·68			35350·0
2827·68	*27·0	2n		0·68			35353·8
2827·20		1n					35359·8
2826·88		1n				10·9	35363·8
2826·56		4				11·0	35367·7
2826·07		2					35373·8
2825·75		6					35377·8
2825·60	25·1	8		0·50			35379·7
2824·73		2					35390·6
2824·42	23·9	6		0·52			35394·5
2823·32	22·9	8		0·42			35408·3
2821·95		1					35425·5
2821·69		1					35428·7
2821·33		1					35433·3

IRON (ARC SPECTRUM)—*continued.*

Kavser and Runge (Rowland)	Liveing and Dewar	Intensity and Character	Müller and Kempf	Difference Rowland—Ångström	Reduction to Vacuum		Oscillation Frequency in Vacuo
					$\lambda +$	$\frac{1}{\lambda} -$	
2821.09		1					35436.3
2820.86	20.4	2		0.46			35439.2
2820.35		ln			0.88		35445.6
2819.51		2			0.87		35456.1
2819.35	19.0	6		0.35			35458.2
2818.28		1					35471.6
2817.98		1					35475.4
2817.55	17.0	8		0.55			35480.8
2816.74		ln					35491.0
2815.58	15.1	6		0.48			35505.7
2815.14		2					35511.2
2813.67	*13.4	2		0.27			35529.8
2813.36	12.8	10		0.56			35533.7
2812.60	*12.2	1		0.40			35543.3
2812.36		1					35546.3
2812.09	11.7	4		0.39			35549.7
2811.23	*10.9	ln		0.33			35560.6
2810.94		ln					35564.3
2810.37	09.7	ln		0.67			35571.5
2808.73		1					35592.3
2808.37	07.9	6		0.47			35596.8
2808.03		1					35601.2
2807.32		2					35610.2
2807.03	06.7	10		0.33			35613.8
2806.53		ln					35620.2
2806.13		2				11.0	35625.3
2805.87	*05.4	2		0.47		11.1	35628.5
2804.92		4					35640.5
2804.56	04.2	10		0.36			35645.1
2804.13	*03.8	ln		0.33			35650.6
2803.68	03.2	6		0.48			35656.3
2803.20		2					35662.4
2802.76	01.8	4		0.96			35668.0
2801.15	00.8	8		0.35			35688.5
2800.73	00.1	ln		0.63			35693.9
2800.31	99.4	1		0.91			35699.2
2799.87		1					35704.8
2799.34		1					35711.6
2799.21	98.8	4		0.41			35713.3
2798.64		1					25720.5
2798.31	97.9	8		0.41			35724.7
2797.82	97.4	8		0.42			35731.0
2796.91	*96.3	2		0.61			35742.6
2796.38		ln					35749.4
2795.90		1					35755.6
2795.58		8					35759.7
2795.00	94.5	10		0.50			35767.1
2794.77		6					35770.0
2794.21		1					35777.2
2793.97	*93.3	2		0.67			35780.3
2792.89		1					35794.1
2792.44	92.2	6		0.24			35799.9
2791.84	91.5	6		0.34			35807.6
2791.51		6					35811.8
2791.00	*90.3	1		0.70			35818.3

IRON (ARC SPECTRUM)—*continued.*

Kayser and Runge (Rowland)	Liveing and Dewar	Intensity and Character	Müller and Kempf	Difference Rowland - Ångström	Reduction to Vacuum		Oscillation Frequency in Vacuo
					$\lambda +$	$\frac{1}{\lambda} -$	
2789·87	89·5	8		0·37		11·1	35832·9
2789·54		4				11·2	35837·0
2788·19	} 88·0	10		0·12			35854·4
2788·05		10					35856·2
2787·16		1					35867·6
2786·84		4					35871·7
2786·26		1					35879·2
2785·25		1					35892·2
2785·11		1					35894·0
2784·40	84·2	4		0·20			35903·2
2784·07		2			0·87		35907·4
2783·75	*83·4	8		0·35	0·86		35911·6
2782·12		1					35932·6
2781·89	81·6	8		0·29			35935·6
2780·93		1					35948·0
2780·77		4					35950·1
2780·61		1					35952·1
2780·28		4					35956·4
2779·85		4 _n					35962·0
2779·34	78·9	6		0·44			35968·6
2778·89	78·3	6		0·59			35974·4
2778·64		1					35977·6
2778·29	77·9	8		0·39			35981·2
2778·15	*77·7	6		0·45			35984·0
2776·86	*76·1	1		0·76			36000·7
2776·47		2 _n					36005·7
2775·92		1					36012·9
2775·11		1					36023·4
2774·76	74·5	8		0·26			36028·0
2774·47		1					36031·7
2774·21		1					36035·1
2773·96		2					36038·3
2773·28	73·1	8		0·18			36047·2
2772·89		2					36052·3
2772·56		4					36056·5
2772·40		2					36058·6
2772·15	71·9	8		0·25			36061·9
2771·94		1					36064·6
2771·30	71·1	1		0·20			36072·9
2770·75	70·3	4		0·45			36080·1
2770·57		1					36082·4
2770·06		1					36089·1
2769·73	69·4	4		0·33			36093·4
2769·37	69·1	6		0·27			36098·1
2768·98	68·8	4		0·18			36103·2
2768·52		2 _n					36109·2
2768·19		2 _n					36113·5
2767·56	67·2	10		0·36			36121·7
2766·99	66·8	6		0·19			36129·1
2766·75		2					36132·3
2766·45		1					36136·2
2766·07		1					36141·2
2765·73	*65·3	1		0·43			36145·6
2765·30	*64·7	1		0·60			36151·2
2765·13		1				11·2	36153·5

IRON (ARC SPECTRUM)—*continued.*

Kayser and Runge (Rowland)	Liveing and Dewar	Intensity and Character	Müller and Kempf	Difference Rowland - Ångström	Reduction to Vacuum		Oscillation Frequency in Vacuo
					$\lambda +$	$\frac{1}{\lambda} -$	
2764·80		1				11·3	36157·7
2764·41	64·0	8		0·41			36162·8
2763·17	63·0	6		0·17			36179·0
2762·82	*62·4	6		0·42			36183·6
2762·52		1					36187·5
2762·12	61·9	8		0·22			36192·8
2761·83	61·7	8		0·13			36196·6
2761·57		1					36200·0
2761·30		1					36203·5
2760·96		6					36208·0
2760·71		1					36211·3
2760·42		1					36215·1
2760·20		1					36218·0
2759·86	59·7	8		0·16			36222·4
2759·42		1					36228·2
2759·02		1					36233·6
2758·20		1					36244·2
2757·91		6					36248·0
2757·38	57·2	8		0·18			36255·0
2757·09	*56·9	1		0·19			36258·8
2756·85		1					36262·0
2756·36	56·2	8		0·16			36268·4
2755·77	55·5	10		0·27			36276·2
2755·25		4					36283·0
2755·01		2					36286·2
2754·72		1					36290·0
2754·48	54·3	6		0·18			36293·2
2754·09	53·9	6		0·19			36298·3
2753·74	53·5	6		0·24			36302·9
2753·37	53·0	6		0·37			36307·8
2753·19		2					36310·2
2752·20		1					36323·3
2752·89		4					36327·4
2751·44	*50·8	2		0·64			36333·3
2751·20		1					36336·5
2750·95	50·6	8		0·35			36339·8
2750·82		1					36341·5
2750·21	49·8	10		0·41			36349·6
2749·58		6					36357·9
2749·42	49·0	6		0·42			36360·0
2749·23		6					36362·5
2748·49		1					36372·3
2748·25		1					36375·5
2747·64		6					36383·6
2747·03	46·6	10		0·43			36391·6
2746·54	46·1	10		0·44			36398·1
2745·87		2			0·86		36407·0
2745·52		1			0·85		36411·7
2745·13		6					36416·8
2744·60	44·2	8		0·40		11·3	36423·9
2744·12	43·7	8		0·42		11·4	36430·3
2743·63	43·3	6		0·33			36436·7
2743·21	42·8	10		0·43			36442·0
2742·45	42·0	10		0·45			36452·3
2742·11		4					36456·9

IRON (ARC SPECTRUM)—*continued.*

Kayser and Runge (Rowland)	Liveing and Dewar	Intensity and Character	Müller and Kempf	Difference Rowland — Ångström	Reduction to Vacuum		Oscillation Frequency in Vacuo
					$\lambda +$	$\frac{1}{\lambda} -$	
2741·65	*41·1	2		0·55			36463·0
2741·48		1					36465·2
2741·20		4					36469·0
2740·42		1n					36479·4
2739·59	39·1	10		0·49			36490·4
2738·92		1					36499·3
2738·55		2					36504·3
2738·28		4					36507·9
2737·93		4					36512·5
2737·72		2					36515·3
2737·37	36·9	8		0·47			36520·0
2737·02	36·5	8		0·52			36524·6
2736·61		1					36530·2
2736·31		1					36534·2
2735·71		6					36542·2
2735·61		6					36543·5
2735·51	35·0	6		0·51			36544·9
2734·98		2					36551·9
2734·70		2					36555·7
2734·39	33·9	8		0·49			36559·8
2734·07	33·7	4		0·37			36564·1
2733·65	33·1	10		0·55			36569·7
2732·88	*32·5	1		0·38			36580·0
2732·53		1					36584·7
2731·93	*31·5	1n		0·43			36592·8
2731·37		2					36600·3
2731·04		4					36604·7
2730·79	30·2	8		0·59			36608·0
2730·16		1					36616·5
2729·45	*29·1	1		0·35			36626·0
2729·02		1					36631·8
2728·90	28·3	6		0·60			36633·4
2728·45		1					36639·4
2728·11	27·5	6		0·61			36644·0
2727·61	27·1	8		0·51			36650·7
2727·48		1					36652·5
2726·90		1n					36660·3
2726·20	25·5	10		0·70			36669·7
2725·92		1					36673·5
2725·68		2					36676·7
2725·37		4					36680·9
2724·97	24·3	8		0·67			36686·2
2724·78		2					36688·8
2724·42		1					36693·7
2723·66	23·1	10		0·56			36703·9
2723·08		1				11·4	36711·7
2722·10		2				11·5	36724·8
2720·99	20·3	10		0·69			36739·8
2720·28	19·7	6		0·58			36749·4
2719·51		6					36759·8
2719·11	18·5	10		0·61			36765·2
2718·51	18·0	8		0·51			36773·4
2717·84	17·4	4		0·44			36782·4
2717·43		2					36788·0
2716·52		1					36800·3

IRON (ARC SPECTRUM)—*continued.*

Kayser and Runge (Rowland)	Liveing and Dewar	Intensity and Character	Müller and Kempf	Difference Rowland—Ångström	Reduction to Vacuum		Oscillation Frequency in Vacuo
					$\lambda +$	$\frac{1}{\lambda} -$	
2716·31	15·7	4n		0·61			36803·1
2715·38	14·9	1n		0·48			36815·8
2715·24		1					36817·7
2714·93	14·4	4		0·53			36821·9
2714·48	13·8	10		0·68			36828·0
2714·15	13·5	4		0·65			36832·4
2713·64		1					36839·4
2712·42	*11·9	2		0·52			36855·9
2711·92	*11·5	2		0·42			36862·7
2711·71	11·2	6		0·51			36865·6
2711·02		1					36875·0
2710·61	10·1	6		0·51			36880·6
2710·08	09·7	2n		0·38			36887·8
2709·74		1					36892·4
2709·47		1					36896·1
2709·13	*08·7	2		0·43			36900·7
2708·64	08·1	10		0·54	0·84		36907·4
2708·00		1			0·83		36916·1
2707·57	06·7	2		0·87			36922·0
2707·13		1					36928·0
2706·63	06·0	8		0·63			36934·8
2706·07	05·6	6		0·47			36942·5
2705·61		1					36948·7
2705·30		1n					36953·0
2704·80		1n					36959·8
2704·06	*03·6	6		0·46			36969·9
2702·83	02·6	1n		0·23			36986·8
2702·52		4					36991·0
2701·99	01·2	4		0·79			36998·3
2701·08		1n				11·5	37010·7
2699·93		1n				11·6	37026·4
2699·18	98·6	8		0·58			37036·7
2698·68		1					37043·5
2698·23	97·7	1n		0·53			37049·7
2697·58	*97·0	1		0·58			37058·7
2697·08	96·6	8		0·48			37065·5
2696·41	95·9	8n		0·51			37074·7
2696·12	95·6	6n		0·52			37078·7
2695·64	95·0	4n		0·64			37085·3
2695·12	94·4	4		0·72			37092·5
2694·63	94·0	4n		0·63			37099·2
2694·37	*93·4	1		0·97			37102·8
2692·91		2					37122·9
2692·71	92·1	4		0·61			37125·7
2692·31	91·7	2		0·61			37131·2
2691·80	*91·2	1		0·60			37138·3
2691·46	90·9	1		0·56			37143·0
2690·80		1n					37152·1
2690·12	89·5	6		0·62			37161·5
2689·92	89·3	6		0·62			37164·2
2689·71		4n					37167·1
2689·28	88·8	8		0·48			37173·1
2687·91	87·3	2n		0·61			37192·0
2687·59	86·8	1n		0·79			37196·5
2686·82	86·0	2n		0·82			37207·1

IRON (ARC SPECTRUM)—*continued.*

Kayser and Runge (Rowland)	Living and Dewar	Intensity and Character	Müller and Kempf	Difference Rowland—Ångström	Reduction to Vacuum		Oscillation Frequency in Vacuo
					$\lambda +$	$\frac{1}{\lambda} -$	
2685·77		1n					37221·7
2685·19		1					37229·7
2684·86	84·2	4		0·66			37234·3
2684·10	83·5	4n		0·60			37244·8
2682·28	81·5	2n		0·78			37270·1
2681·62	80·8	4n		0·82			37279·3
2680·99	*80·4	1		0·59			37288·1
2680·53	79·9	6		0·63			37294·5
2680·26		2					37298·2
2679·97		1				11·6	37302·2
2679·14	78·5	10		0·64		11·7	37313·7
2678·25	77·2	1n		1·05			37326·1
2677·30		1					37339·4
2676·97	*76·1	2		0·87			37344·0
2676·56		1					37349·7
2676·21	75·1	1n		1·11			37354·6
2675·37	74·6	4n		0·77			37366·3
2674·74		2					37375·1
2674·32		1			0·84		37381·0
2673·28	72·4	6		0·88	0·83		37395·5
2672·30	71·8	1n		0·50			37409·2
2671·49	*70·8	1		0·69			37420·6
2670·86		1					37429·4
2670·59	69·9	1		0·69			37433·2
2670·00	*69·2	1		0·80			37441·5
2669·55	68·7	8		0·85			37447·8
2669·00	*68·5	1		0·50			37455·5
2668·84		1n					37457·8
2668·30		1					37465·3
2667·97	67·2	6		0·77			37470·0
2667·72		1					37473·5
2667·36		1					37478·5
2667·05		6					37482·9
2666·94	66·1	8		0·84			37484·4
2666·72		4					37487·5
2666·43	65·7	8		0·73			37491·6
2665·87	64·2	1		0·67			37499·5
2665·15	64·0	1		1·15			37509·6
2664·74	63·5	8		1·24			37515·4
2664·16		4n					37523·6
2663·28	*62·2	1n		1·08			37536·0
2662·42		2					37548·1
2662·13	61·6	8		0·53			37552·2
2661·57		1					37560·1
2661·31	60·8	8		0·51			37563·8
2660·48		6					37575·5
2659·26		1n					37592·7
2658·48	57·8	2		0·68		11·7	37603·8
2656·85	56·4	6		0·45		11·8	37626·7
2656·22	55·7	8		0·52			37635·7
2655·17	*54·4	1		0·77			37650·6
2653·40		2					37661·5
2653·87	*53·3	1		0·57			37669·0
2652·53	*52·2	1		0·33			37688·1
2651·78	50·9	6		0·88			37698·7

IRON (ARC SPECTRUM)—*continued.*

Kayser and Runge (Rowland)	Liveing and Dewar	Intensity and Character	Müller and Kempf	Difference Rowland - Ångström	Reduction to Vacuum		Oscillation Frequency in Vacuo
					$\lambda +$	$\frac{1}{\lambda} -$	
2651.27	50.4	4		0.87			37706.0
2648.57		4					37744.4
2648.29		1					37748.4
2647.64	47.3	8		0.34			37757.7
2646.40	45.2	1		1.20			37775.4
2645.52	44.9	6		0.62			37787.9
2644.07	43.8	10		0.27			37808.7
2641.74	41.4	8		0.34			37842.0
2641.13	*40.7	2		0.43			37850.8
2640.35		1					37862.0
2639.60	*39.2	1		0.40		11.8	37872.7
2637.69	36.6	1		1.09	0.83	11.9	37900.1
2636.54	36.1	4		0.44	0.82		37916.6
2635.87	35.5	8		0.37			37926.2
2635.00		ln					37938.8
2633.68	*32.9	1		0.78			37957.8
2633.09		1					37966.3
2632.66	32.3	2		0.36			27972.5
2632.30	32.0	4		0.30			37977.7
2631.72		2					37986.1
2631.37	31.0	10		0.37			37991.1
2631.07	30.7	10		0.37			37995.4
2630.13	29.7	2		0.43			38009.0
2629.66	29.2	1		0.46			38015.8
2629.28		1					38021.3
2628.35	27.9	10		0.45			38034.8
2627.18	26.8	2		0.38			38051.7
2626.52	26.2	1		0.32			38061.3
2625.72	25.2	10		0.52			38072.9
2624.84		1					38085.7
2624.21	23.6	2		0.61			38094.8
2623.58	23.1	10		0.48			38104.0
2622.00		1					38126.9
2621.72	21.2	8		0.52			38131.0
2620.73	*20.4	1		0.33			38145.4
2620.47	19.9	6		0.57		11.9	38149.2
2619.06	*18.6	1		0.46		12.0	38169.6
2618.78	18.3	4		0.48			38173.7
2618.47		1					38178.2
2618.10	17.6	4		0.50			38183.6
2617.71	17.2	6		0.51			38189.3
2617.25		2					38196.0
2616.50		1					38207.0
2615.94		1					38215.2
2615.50	15.0	6		0.50			38221.6
2614.62	14.0	4		0.62			38234.5
2614.27		1					38239.6
2613.91	13.3	8		0.61			38244.9
2613.33		2					38253.4
2612.96	12.3	4		0.66			38258.8
2611.94	11.4	10		0.54			38273.7
2611.16	10.7	2		0.46			38285.1
2610.87	10.3	1		0.57			38289.4
2609.79	09.1	ln		0.69			38305.3
2609.30	08.7	1		0.60			38312.5

IRON (ARC SPECTRUM)—*continued.*

Kayser and Runge (Rowland)	Liveing and Dewar	Intensity and Character	Müller and Kempf	Difference Rowland — Ångström	Reduction to Vacuum		Oscillation Frequency in Vacuo
					$\lambda +$	$\frac{1}{\lambda} -$	
2608.65	08.2	4n		0.45			38322.0
2607.16	06.7	8		0.46			38343.9
2606.92	06.5	4		0.42			38347.4
2606.36	*06.1	2		0.26			38355.7
2605.77	05.3	8		0.47			38364.4
2604.90	04.4	6		0.50			38377.2
2603.71	03.5	4		0.21		12.0	38394.7
2600.25	99.7	4		0.55	0.82	12.1	38445.7
2599.53	98.9	10		0.63	0.81		38456.4
2598.95		1					38465.0
2598.44	97.8	10		0.64			38472.5
2596.60	96.0	2n		0.60			38499.8
2595.41	95.2	1		0.21			38517.5
2594.20	93.5	6		0.70			38535.4
2593.75	93.1	6		0.65			38542.1
2592.90	*92.2	4		0.70			38554.8
2592.35	91.7	2		0.65			38562.9
2591.65	91.0	8		0.65			38573.4
2591.34		4					38578.0
2590.65	*90.0	1		0.65			38588.3
2588.96	*88.2	1		0.76			38613.4
2588.11	87.5	10		0.61			38626.1
2586.56		1					38649.3
2585.93	85.4	10		0.53			38658.7
2584.59	84.0	8		0.59			38678.8
2582.50	82.0	10		0.50		12.1	38710.1
	81.7					12.2	
2581.57	80.9	2		0.67			38723.9
2581.05	80.3	1		0.75			38731.7
2580.52	79.9	2		0.62			38739.7
2579.92	79.5	6		0.42			38748.7
	79.3						
2579.35	78.7	4		0.65			38757.3
2578.86	78.3	1		0.56			38764.6
2578.01	77.4	10		0.61			38777.4
2577.41	*76.5	1		0.91			38786.4
2576.76	76.2	8		0.56			38796.2
2576.20	75.7	6		0.50			38804.7
2575.83	75.3	10		0.53			38810.2
	74.8						
2574.43	74.0	6		0.43			38831.3
2573.84		1					38840.3
2573.23	*72.8	1		0.43			38849.5
2572.82	72.5	6		0.32			38855.7
2571.67	*71.2	4		0.47			38873.0
2570.92	*70.6	1		0.32			38884.4
2570.56	70.1	8		0.46			38889.8
2569.73	69.4	6		0.33			38902.4
2568.97	68.6	4		0.37			38913.9
2568.49	*68.1	2		0.39			38921.2
2567.93		4					38929.7
2566.99	66.7	8		0.29			38933.9
2566.55	65.1	2		0.45			38965.8
2564.63	64.2	4		0.43	0.81		38979.8
2563.99		1			0.80		38989.5

IRON (ARC SPECTRUM)—*continued.*

Kayser and Runge (Rowland)	Livinge and Dewar	Intensity and Character	Müller and Kempf	Difference Rowland—Ångström	Reduction to Vacuum		Oscillation Frequency in Vacuo
					$\lambda +$	$\frac{1}{\lambda} -$	
2563·53	63·2	10		0·33		12·2	38996·5
2562·63	62·3	10		0·33		12·3	39010·1
2562·35	61·9	4		0·45			39014·4
2561·87	61·5	4		0·37			39021·7
2561·33	60·9	4		0·43			39029·9
2560·65	60·3	6		0·35			39040·3
2560·43	60·0	4		0·43			39043·6
2559·91	*59·6	2		0·31			39051·6
2559·25	*58·9	1		0·35			39061·6
2558·60	58·3	4		0·30			39071·6
2557·42	*57·2	1		0·22			39090·4
2556·92	56·6	6		0·32			39097·2
2556·38	56·0	6		0·38			39105·5
2555·59	*55·2	4		0·39			39117·6
2555·37	54·9	4		0·47			39121·0
2555·04	*54·8	4		0·24			39126·0
2554·00	*53·4	1		0·60			39142·0
2553·32	52·8	8		0·52			39152·4
2552·74	52·3	4		0·44			39161·3
2551·19	50·8	8		0·39			39185·1
2550·75	50·3	2n		0·45			39191·8
2550·07	49·7	2n		0·37			39202·3
2549·63	49·2	8		0·43			39209·1
2548·76	*48·4	6		0·36			39222·5
2548·17	47·8	2		0·37			39231·5
2547·06	46·6	8		0·46			39248·6
2546·26	45·8	8		0·46			39261·0
2545·95	*44·9	2		1·05		12·3	39265·8
2544·83	44·5	8n		0·33		12·4	39283·0
2544·02	43·7	6		0·32			39295·5
2543·47	43·0	4		0·47			39304·0
2542·85	*42·4	1		0·45			39313·5
2542·20	41·7	8		0·50			39323·6
2541·18	40·8	6		0·38			39339·4
2540·90	*40·4	4		0·50			39343·7
2540·00		1					39357·7
2539·48	39·1	2		0·38			39365·7
2538·98	38·6	10		0·38			39373·5
2537·21	36·9	10		0·31			39401·0
2536·90	36·6	8		0·30			39405·8
2535·67	35·2	6		0·47			39424·9
2535·25		4					39431·4
2534·52	34·2	4		0·32			39442·8
2533·86	33·4	10		0·46			39453·1
2533·26	32·6	2		0·66			39462·4
2532·98	32·4	1		0·58			39466·8
2532·37	32·0	6		0·37			39476·3
2531·62	31·1	1		0·52			39488·0
2530·79	30·4	8		0·37			39500·9
2530·03	29·6	4		0·43			39512·8
2529·65	*29·2	4		0·45			39518·8
2529·40	28·9	8n		0·50			39522·7
2529·03		4					39528·4
2528·57	28·1	6		0·47			39535·6
	27·9						

IRON (ARC SPECTRUM)—*continued.*

Kayser and Runge (Rowland)	Living and Dewar	Intensity and Character	Müller and Kempf	Difference Rowland—Ångström	Reduction to Vacuum		Oscillation Frequency in Vacuo
					$\lambda +$	$\frac{1}{\lambda} -$	
2527·67	27·1	8		0·57			39549·7
2527·30	*26·7	8		0·60	0·80	12·4	39555·5
2526·30	26·0	8		0·30	0·79	12·5	39571·1
2525·48	25·1	6		0·38			39583·9
2525·11	24·7	6		0·41			39589·7
2524·52	23·9	2		0·62			39599·0
2524·32		6					39602·1
2523 76	23·3	6		0·46			39610·9
2523·19		8					39619·9
2522·93		1					39623·9
2522·67	22·5	6		0·17			39628·0
2521·97	21·5	6		0·47			39639·0
2521·09	20·8	6		0·29			39652·9
2519·71	19·3	4		0·41			39674·6
2519·30	18·8	4		0·50			39681·1
2518·93	18·5	2		0·43			39686·9
2518·25	17·8	10		0·45			39697·6
2517·76	17·4	6		0·36			39705·3
2517·25	16·8	6		0·45			39713·4
2516·65	16·3	2		0·35			39722·9
2516·19	15·8	8		0·39			39730·1
2514·84	14·3	2		0·54			39751·5
2514·38	14·1	6		0·28			39758·7
2513·94		2					39765·7
2513·33	13·2	2 _n		0·13			39775·4
2512·38	12·2	6		0·18			39790·4
	12·0						
2511·84	11·6	4		0·24			39799·0
2511·41	11·4	2		0·01			39805·8
2511·05	10·6	8		0·36			39811·5
2510·87							39814·3
2509·43	*08·8	1 _n		0·63		12·5	39837·2
2508·78	08·5	6		0·28		12·6	39847·4
2507·99	07·6	6		0·39			39860·0
2507·49		2					39867·9
2506·98	06·6	6		0·38			39876·0
2506·70	06·2	4		0·50			39880·5
2506·25	*05·8	2		0·45			39887·6
2505·64	05·2	8		0·44			39897·4
2505·09	04·9	4		0·19			39906·1
2503·89	*03·6	2		0·29			39925·3
2503·50	03·0	8		0·50			39931·5
2502·53	02·1	8		0·43			39947·0
2501·87	01·4	8		0·47			39957·5
2501·00	00·9	8		0·10			39971·4
2498·96	98·7	10		0·26			40004·0
2498·37		2					40013·5
2497·88	97·5	6		0·38			40021·3
2497·15		6					40033·0
2496·60	96·3	6		0·30			40041·9
2496·01	95·6	8		0·41			40051·3
2495·35		1					40061·9
2494·30	93·9	1		0·40			40078·8
2494·10	93·7	4		0·40			40082·0
2493·34	92·9	10		0·44			40094·2

IRON (ARC SPECTRUM)—*continued.*

Kayser and Runge (Rowland)	Liveing and Dewar	Intensity and Character	Müller and Kempf	Difference Rowland—Ångström	Reduction to Vacuum		Oscillation Frequency in Vacuo
					$\lambda +$	$\frac{1}{\lambda} -$	
2492.72		1					40104.2
2492.12	92.0	4		0.12			40113.9
2491.50	91.0	6		0.50			40123.9
2490.98	90.5	6		0.48			40132.2
2490.50		4			0.70	12.6	40139.9
2490.01	89.5	4		0.51	0.78	12.7	40147.8
2489.63	*89.2	4		0.43			40153.9
2489.04	88.7	6		0.34			40163.4
2488.23	87.7	10		0.53			40176.5
2487.44	87.1	1		0.34			40189.3
2487.18	86.8	2		0.38			40193.5
2486.77	86.4	2		0.37			40200.1
2486.42	86.1	2		0.32			40205.8
2486.04	85.7	2		0.34			40211.9
2485.47		1					40221.1
2485.21	84.7	1		0.51			40225.3
2484.35	83.7	8		0.65			40239.3
2483.34	82.9	10		0.44			40255.6
2482.16	81.8	4		0.36			40274.8
2481.11	*80.7	1		0.41			40291.8
2480.25	80.0	6		0.25			40305.8
2480.01		6					40309.7
2479.64	79.5	10		0.14			40315.7
	79.2						
2478.67	78.3	2		0.37			40331.5
2478.22	*77.9	1		0.32			40338.8
2477.41	*77.1	1		0.31			40352.0
2476.77	76.5	8		0.27			40362.5
2476.40	75.8	1		0.60			40368.5
2474.88	74.5	8		0.38			40393.3
2473.30	*72.9	1		0.40			40419.1
2473.15	72.7	6		0.45		12.7	40421.6
2472.83	72.4	6		0.43		12.8	40426.7
2472.40	71.9	6		0.50			40433.7
2471.05	70.5	4		0.55			40455.8
2470.78	*70.3	4		0.48			40460.2
2470.01		1					40472.9
2469.60	*69.0	1		0.60			40479.6
2468.97	68.4	8		0.57			40489.9
2468.41	*67.8	1		0.61			40499.1
2467.80	67.2	6n		0.60			40509.1
2466.81	66.4	6n		0.41			40525.4
2466.02	*65.4	2		0.62			40538.4
2465.23	64.7	8		0.53			40551.4
2465.05	*64.5	1		0.55			40554.3
2464.09	*63.7	1		0.39			40570.1
2463.86	63.4	4		0.46			40573.9
2463.39	62.8	2		0.59			40581.7
2462.81	62.3	6		0.51			40591.2
2462.60		4					40594.7
2462.30	61.9	4		0.40			40599.6
2461.89	*61.4	4		0.49			40606.4
2461.28	61.0	8		0.28			40616.5
	60.8						
2460.37	60.2	6		0.17			40631.5

IRON (ARC SPECTRUM)—*continued.*

Kayser and Runge (Rowland)	Living and Dewar	Intensity and Character	Müller and Kempf	Difference Rowland - Ångström	Reduction to Vacuum		Oscillation Frequency in Vacuo
					$\lambda +$	$\frac{1}{\lambda} -$	
2459.53		1					40645.4
2458.78	58.5	8		0.28			40657.8
	58.2						
2457.68	57.4	8		0.28			40676.0
2456.67	*56.4	2n		0.27			40692.7
2456.14	56.0	2		0.14		12.8	40701.5
2455.66	55.3	4n		0.36		12.9	40709.3
2454.55	*54.3	2n		0.25	0.78		40727.8
2453.57	53.2	8		0.37	0.77		40744.0
2452.67	52.3	2n		0.37			40759.0
2452.29	51.8	1		0.49			40765.3
2451.80	51.3	2		0.50			40773.5
2451.55	51.0	2		0.55			40777.6
2451.28	50.7	2		0.58			40782.1
2450.56	50.0	2		0.56			40794.1
2449.93	*49.6	1		0.33			40804.6
2448.88	48.5	1n		0.38			40822.1
2448.50	48.1	2		0.40			40828.4
2447.81	47.5	8		0.31			40839.9
2447.25	*47.1	1		0.15			40849.3
2446.53	46.3	2		0.23			40861.3
2446.30	*45.9	1		0.40			40865.2
2445.68	45.4	4		0.28			40875.5
2445.23	44.9	2		0.33			40883.0
2444.58	44.3	6		0.28			40893.9
2443.94	43.7	6		0.24			40904.6
2442.68	42.3	10		0.38			40925.7
2441.73	41.5	2		0.23			40941.7
2440.25	39.8	8		0.45			40966.5
2439.82	39.4	8		0.42			40973.7
2439.36	*39.0	6		0.36		12.9	40981.5
2438.27	37.9	6		0.37		13.0	40999.7
2437.33	*36.9	1n		0.43			41015.5
2436.45	36.0	8		0.45			41030.3
2435.93	35.6	4		0.33			41039.1
2435.04	34.7	6		0.34			41054.1
2434.86	34.3	4		0.56			41057.1
	33.9						
2433.54	*33.2	1		0.34			41079.4
2432.97	*32.5	2		0.47			41089.0
2432.34	31.8	4		0.54			41099.7
2431.38	30.7	4		0.68			41115.9
2431.08	30.5	8		0.58			41121.0
2430.16	29.7	6		0.46			41136.5
2429.53	29.0	8		0.53		13.0	41147.2
2429.00	28.5	1		0.50		13.1	41156.1
2428.41	*27.9	4		0.51			41166.1
2427.11	*27.0	1		0.11			41188.2
2426.46	25.4	1n		0.06			41199.2
2425.68	25.0	1n		0.68			41212.5
2425.04	*24.3	1		0.74			41223.3
2424.22	23.8	8		0.42			41237.3
2423.25	22.9	2		0.35			41253.8
2422.73	22.4	1		0.33			41262.6
2421.79	21.3	8		0.49			41278.7

IRON (ARC SPECTRUM)—*continued.*

Kayser and Runge (Rowland)	Livinge and Dewar	Intensity and Character	Müller and Kempf	Difference Rowland—Ångström	Reduction to Vacuum		Oscillation Frequency in Vacuo
					$\lambda +$	$\frac{1}{\lambda} -$	
2421·02	20·7	1		0·32			41291·8
2420·39	20·0	1		0·39			41302·6
2419·80	19·4	1		0·40			41312·6
2419·49	18·9	4n		0·59			41317·9
2419·17	18·2	4		0·97			41323·4
2417·94	17·5	4n		0·44			41344·4
2417·58	17·1	2		0·48	0·77		41350·6
2416·68	16·3	1		0·38	0·76		41366·0
2416·00	15·4	2n		0·60			41377·6
2415·29	14·8	1		0·49		13·1	41389·8
2414·50	13·8	1		0·70		13·2	41403·2
2413·37	13·0	10		0·37			41422·6
2412·45		1					41438·3
2411·79	11·4	1n		0·39			41449·8
2411·16	10·7	10		0·46			41460·6
2410·56	10·2	10		0·36			41470·9
2408·13	07·6	2		0·53			41512·8
2407·66	07·3	2n		0·36			41520·9
	06·9						
2406·72	06·3	10		0·42			41537·1
2405·02	04·5	10		0·52			41566·5
2404·48	04·2	8		0·28			41575·8
2402·67	02·3	4		0·37			41607·2
2402·23	01·9	1		0·33			41614·8
2401·60	01·4	2		0·20			41625·7
2401·25	01·0	1		0·25			41631·8
2400·39	00·0	2		0·39			41646·7
2399·31	99·0	10		0·31			41665·4
2398·29	98·0	1		0·29			41683·2
2395·62	95·4	10		0·22		13·2	41729·6
	95·2						
2394·33	94·1	1		0·23		13·3	41752·0
	92·8						
2392·70	92·4	1		0·30			41780·5
2391·53	91·3	6		0·23			41800·9
2390·03	89·9	4		0·13			41822·4
2388·71	88·4	8		0·31			41850·3
2388·42	*88·0	1n		0·42			41855·4
	87·2						
2386·03	85·8	1		0·23			41897·3
2385·07	84·8	4		0·27			41914·2
2384·48	84·2	6		0·28			41924·6
2383·24	83·0	8		0·24			41946·4
	82·7						
2382·15	81·7	10		0·45			41965·6
2380·82	80·5	6		0·32	0·76		41989·0
2379·38	79·0	8		0·38	0·75	13·3	42014·5
2378·03	77·6	2		0·43		13·4	42038·2
2377·33	76·9	2		0·43			42050·6
2376·54	76·2	1		0·34			42064·6
2375·90		1					42075·9
2375·30	74·9	8		0·40			42086·5
2374·59	74·1	2		0·49			42099·1
2373·79	73·4	10		0·39			42113·3
2372·65	72·7	1		0·05			42133·6

IRON (ARC SPECTRUM)—*continued.*

Kavser and Runge (Rowland)	Living and Dewar	Intensity and Character	Müller and Kempf	Difference Rowland — Ångström	Reduction to Vacuum		Oscillation Frequency in Vacuo
					$\lambda +$	$\frac{1}{\lambda}$	
2371.51	71.1	4		0.41			42153.8
2370.56	70.1	6		0.46			42170.7
2369.55	69.1	2		0.45			42188.7
2368.66	68.2	8		0.46			42204.6
2366.66	66.2	6		0.46			42240.2
2365.61	65.1	1		0.51			42259.0
2364.88	64.4	10		0.48			42272.0
2363.81	63.5	1		0.31		13.4	42291.2
2362.11	*61.6	8		0.51		13.5	42321.5
	60.3						
2360.37	59.9	8		0.47			42352.7
2360.06	59.7	8		0.36			42358.3
	59.2						
2359.16	58.7	6		0.46			42374.5
	55.6						
2355.37	55.1	1		0.27			42442.7
2354.93	53.6	6		0.33			42450.6
	54.1						
	51.5						
2351.22	50.9	2		0.32			42517.6
2350.50	49.9	1		0.60			42530.6
2349.91	49.5	4		0.41		13.5	42541.3
2348.28	48.0	10		0.28		13.6	42570.8
	47.8						
	45.9						
2345.29	44.7	2		0.59			42625.0
2344.37	43.9	6		0.47			32641.8
2344.09	43.6	6		0.49	0.75		42646.9
2343.52	43.1	6		0.42	0.74		42657.3
2341.69	41.2	1n		0.49			42690.6
2340.30	40.0	2n		0.30			42716.0
2339.62	39.3	2n		0.32			42728.4
	39.0						
2338.08	37.7	8		0.38			42756.5
	34.8						
2334.83	34.5	4		0.33		13.6	42816.1
	34.2						
	33.1					13.7	
2332.87	32.5	10		0.37			42852.0
2331.38	30.9	8		0.48			42879.3
2329.67	29.3	1n		0.37			42910.8
2327.40	26.9	8		0.50			42952.7
2321.48		1					43062.3
2320.42	19.9	6		0.52			43081.9
	19.6						
	19.2					13.7	
2318.23	17.7	4		0.53		13.8	43122.6
	17.5						
2317.32	16.7	4		0.62			43139.5
2314.10	13.6	1		0.50			43199.5
2313.17	12.7	6		0.47			43216.9
2312.40	12.0	1		0.40			43231.3
	11.6						
	11.0						
	10.6						

IRON ARC SPECTRUM—(continued).

Kayser and Runge (Rowland)	Livinge and Dewar	Intensity and Character	Müller and Kemp	Difference Rowland — Ångström	Reduction to Vacuum		Oscillation Frequency in Vacuo
					$\lambda +$	$\frac{1}{\lambda} -$	
	09·3						
2309·05	08·6	6		0·45	0·74		43294·0
2306·35	06·0	4		0·35	0·73		43344·7
	05·8						
2304·82	04·4	2		0·42		13·8	43373·5
	03·4					13·9	
2303·52	03·2	6		0·32			43397·9
2301·75	01·4	4		0·35			43431·3
	01·0						
2300·70	00·4	1		0·30			43451·1
2300·20	00·0	2		0·20			43460·6
	99·2						
2299·30	99·0	4		0·30			43477·6
	98·6						
2298·24	98·0	6		·24			43497·7
2297·85	97·6	6		0·25			43505·0
2297·04	96·8	4		0·24			43520·4
2296·23		1					43535·7
2294·45	94·2	2		0·25			43569·5
2293·90	93·6	6		0·30			43580·0
2292·56	92·3	2		0·26			43605·5
	91·4						
2291·18	90·9	6		0·28			43631·7
	90·6						
2290·61	90·3	4		0·31			43642·6
2290·05	89·9	1		0·15			43653·3
2289·05	88·8	8		0·25			43672·3
2288·19	87·9	2		0·29			43688·8
2287·70	87·4			0·30		13·9	43698·1
2287·37	87·1			0·27			43704·3
2284·12	84·0			0·12		14·0	43766·5
	83·6						
	83·2						
2283·15	83·0	n		0·15			43785·1
	82·8						
2282·17	81·8			0·37			43803·9
	80·0						
2280·05	79·7			0·35			43844·7
2277·73	77·5			0·23			43889·4
2277·12	76·9			0·22			43901·1
2276·07	75·7	n		0·37			43921·4
	75·2						
	74·9						
2274·09	73·8			0·29			43959·6
2272·83	72·5			0·33			43984·0
	71·8						
2271·84	71·5			0·34		14·0	44003·2
2270·87	70·5			0·37	0·73	14·1	44021·9
2270·47					0·72		44029·6
2268·96	68·8			0·16			44059·0
2267·51	67·2			0·31			44087·1
2267·06	66·8			0·26			44095·9
	66·6						
2266·37	65·7			0·67			44109·3
2265·05	64·7			0·35			44135·0

IRON ARC SPECTRUM—(continued).

Kayser and Runge (Rowland)	Liveing and Dewar	Intensity and Character	Müller and Kempf	Difference Rowland — Ångström	Reduction to Vacuum		Oscillation Frequency in Vacuo
					$\lambda +$	$\frac{1}{\lambda}$	
2264·51	64·2			0·31			44145·6
2263·37	63·2			0·17			44167·8
	62·8						
	62·4						
	60·7						
2260·83	60·4			0·43			44217·4
2260·15	59·8			0·35			44230·7
2259·50	59·2			0·30			44243·5
2255·94	55·4			0·54	14·1		14313·3
2253·15	52·8			0·35			44368·1
	51·6					14·2	
	51·2						
	50·6						
2250·82	50·5			0·32			44414·0
2248·97	48·8			0·17	0·72		44450·6
2230·01	29·7			0·31	0·71		44828·6
	&c.			&c.			

 THE TELLURIC LINES OF THE SOLAR SPECTRUM.¹

Becker (Rowland)	Intensity		Oscillation Frequency	Reduction to Vacuum	Oscillation Frequency in Vacuo	
	Horizon	Medium Altitude			Rowland	Ångström ²
6020·33	10?	9	16610·4	4·9	16605·5	
6019·25	7	2	16613·4		16608·5	
6016·56	6?	—	16620·8		16613·9	
6016·06	8	2	16622·2		16617·3	
6015·88	9	3	16622·7		16617·8	
6015·48	8?	1	16622·8		16618·9	
6015·22	6	1	16624·5		16619·6	
6014·64	4	2	16626·1		16621·2	
6014·03	4	1	16627·8		16621·9	
6012·93	6	2	16630·8		16625·9	
6012·17	5	—	16632·9		16628·0	
6011·83	5	—	16633·9		16629·0	
6011·58	5	2	16634·5		16629·6	
6011·18	5	2	16635·7		16630·8	
6010·09	4	2	16638·7		16633·8	
6009·53	9	2	16640·2		16635·3	
6009·43	5	1	16640·5		16635·6	
6008·50	5?	—	16643·1		16638·2	
6007·20	5	1	16646·7		16641·8	
6006·81	4?	2	16647·8		16642·9	
6006·08	5	1	16649·8		16644·9	
6005·03	5	1	16652·7		16647·8	
6004·82	8	2	16653·3		16648·4	
6004·33	4	—	16654·6		16649·7	
6003·96	8	2	16655·7		16650·8	
6002·78	8	3	16659·0		16654·1	

¹ Becker, *Trans. Roy. Soc. Edin.* xxxvi. I. 1890.

² Cornu, Piazzì-Smyth, and Fizev.

THE TELLURIC LINES OF THE SOLAR SPECTRUM—*continued.*

Becker (Rowland)	Intensity		Oscillation Frequency	Reduc- tion to Vacuum	Oscillation Frequency in Vacuo	
	Horizon	Medium Altitude			Rowland	Ångström
6002-22	7	2	16660.5	4.9	16655.6	
6001.68	6	1	16662.0		16657.1	
6001.39	5	2	16662.8		16657.9	
6000.34	7	2	16665.7		16660.8	
5999.83	11	4	16667.1		16662.2	
5998.73	3?	2	16670.2		16665.3	
5998.37	6d	2	16671.2		16666.3	
5997.43	10	4	16673.8		16668.9	
5996.67	5	—	16675.9		16671.0	
5996.53	5	—	16676.3		16671.4	
5995.39	5	1	16679.5		16674.6	
5994.74	11	4	16681.3		16676.4	
5994.08	6	2	16683.1		16678.2	
5993.81	5	2	16683.9		16679.0	
5993.27	8d	3	16685.5		16680.6	
5993.17						
5992.17	11d	{ 4	16688.4		16683.5	
5992.01			{ 4		16688.9	
5991.03	11	4	16691.6		16686.7	
5990.74	10	3	16692.4		16687.5	
5990.50	6	1	16693.1		16638.2	
5989.44	11	4	16696.1		16691.2	
5989.06	4	1	16697.1		16692.2	
5988.75	10d	4	16698.1		16693.2	
5988.67						
5988.27	8	2	16699.3		16694.4	
5987.20	11?	8	16702.3		16697.4	
5986.25	4	2	16705.0		16700.1	
5985.86	5	2	16706.0		16701.1	
5985.37	10	4	16707.4		16702.5	
5985.00	8	—	16708.4		16703.5	
5984.41	7	3	16710.1		16705.2	
5984.24	6	2	16710.6		16705.7	
5983.55	7	2	16712.5		16707.6	
5983.00	6	2	16714.0		16709.1	
5982.47	5	2	16715.5		16710.6	
5982.15	8	2	16716.4		16711.5	
5981.89	7	2	16717.1		16712.2	
5981.40	9	3	16718.5		16713.6	
5980.96	4	1	16719.7		16714.8	
5980.70	6	1	16720.4		16715.5	
5980.31	8	3	16721.5		16716.6	
5979.93	4?	—	16722.6		16717.7	
5979.33	5	—	16724.3		16719.4	
5979.08	6	2	16725.0		16720.1	
5978.18	6	1	16727.5		16722.0	
5977.94	12	4	16728.2		16723.3	
5977.55	8	3	16729.3		16724.4	
5977.14	12	5	16730.4		16725.5	
5976.94	10?	7	16731.0		16726.1	
5976.66	8	3	16731.8		16726.9	
5976.04	7	2	16733.5		16728.6	
5975.27	12	5	16735.6		16730.7	
5974.40	8	3	16738.1		16732.2	
5973.72	4	2	16740.0		16735.1	
5972.95	6	1	16742.1		16737.2	

THE TELLURIC LINES OF THE SOLAR SPECTRUM—*continued*.

Becker (Rowland)	Intensity		Oscillation Frequency	Reduc- tion to Vacuum	Oscillation Frequency in Vacuo	
	Horizon	Medium Altitude			Rowland	Ångström
5972.77	3?	—	16742.6	4.9	16737.7	
5972.71	5	2	16742.8		16737.9	
5971.53	11	5	16746.1		16741.2	
5970.87	5	2	16748.0		16743.1	
5970.70			2	16748.5		16743.6
5970.24	10	5	16749.7		16744.8	
5969.24	10	4	16752.5		16747.6	
5968.64	4?	—	16754.2		16749.3	
5968.49	12	3	16754.7		16749.8	16752
5967.87	11	5	16756.4		16751.5	16754
5967.66	10	4	16757.0		16752.1	16755
5967.39	7	3	16757.8		16752.9	
5967.18	3?	—	16758.3		16753.4	
5966.81	10	5	16759.4		16754.5	
5966.42	10d	3	16760.6		16755.7	16759
5966.33						
5965.40	4	2	16763.3		16758.4	16761
5965.05	8	3	16764.3		16759.4	16762
5963.98	4	1	16767.3		16762.4	
5963.71	5	2	16768.1		16763.2	
5963.30	4	2	16769.2		16764.3	
5962.65	10	4	16771.1		16766.2	
5962.35	6	1	16771.9		16767.0	
5961.89	5	1	16773.2		16768.3	
5961.59	8	3	16774.0		16769.1	
5960.82	3?	2	16776.2		16771.3	
5960.38	2?	—	16777.4		16772.5	
5960.13	9	3	16778.2		16773.3	
5959.84	5	2	16779.0		16774.1	
5959.39	6	2	16780.2		16775.3	
5959.14	6	2	16780.9		16776.0	
5958.98	8	—	16781.4		16776.5	
5958.85	12	5	16781.8		16776.9	16779
5958.48	12	5d	16782.9		16778.0	16781
5958.42						
5958.02	12	5	16784.1		16779.2	16782
5957.95	4?	—	16784.3		16779.4	
5957.37	5	2	16785.9		16781.0	
5957.27			2	16786.2		16781.3
5956.76	8?	—	16787.6		16782.7	16785
5956.50	9	4	16788.4		16783.5	16786
5955.90	6	2	16790.1		16785.2	
5955.10	11	5	16792.3		16787.4	16790
5954.61	6	2	16793.7		16788.8	
5953.88	3?	—	16795.8		16790.9	
5953.61	8	2	16796.5		16791.6	16795
5952.81	8	—	16798.8		16793.9	16797
5951.68	10	5	16802.0		16797.1	
5951.50	8	2	16802.5		16797.6	
5951.05	9	3	16803.7		16798.8	16801
5950.91	4?	—	16804.2		16799.3	
5950.49	10	4	16805.3		16800.4	16803
5950.35	8	2	16805.7		16800.8	
5949.92	11	4	16807.0		16802.1	16804
5949.80	7	1	16807.3		16802.4	16805
5949.69	5	—	16807.6		16802.7	

THE TELLURIC LINES OF THE SOLAR SPECTRUM—*continued.*

Becker (Rowland)	Intensity		Oscillation Frequency	Reduction to Vacuum	Oscillation Frequency in Vacuo	
	Horizon	Medium Altitude			Rowland	Ångström
5949.42	10	6	16808.4	4.9	16803.5	16807
5949.25	11	6	16808.8		16803.9	
5949.18	2?	—	16809.0	5.0	16804.1	16808
5948.96	8	3	16809.7		16804.8	
5948.78	4?	—	16810.2		16805.3	
5948.35	10	2	16811.4		16806.5	
5947.54	8	3	16813.7		16808.7	16811
5947.24	12	6	16814.5		16809.5	
5947.02	11	5	16815.1		16810.1	16813
5946.73	4	—	16816.0		16811.0	
5946.18	(5?)	—	16817.5		16812.5	16816
5946.14	12	6	16817.6		16812.6	
5945.81	10	4	16818.6	16813.6	16817	
5945.39	10	4	16819.8	16814.8		
5944.84	10	4	16821.3	16816.3	16819	
5944.42	10d	5	16822.5	16817.5		
5943.58	3?	2	16824.9	16819.9	16822	
5943.22	3?	2	16825.9	16820.9		
5942.73	12	6	16827.3	16822.3	16826	
5942.57	12	6	16827.7	16822.7		
5942.35	8	—	16828.4	16823.4	16827	
5941.73	10	5	16830.1	16825.1		
5941.19	11	5	16831.6	16826.6	16828	
5941.01	8	4	16832.2	16827.2		
5940.54	9	4	16833.5	16828.5	16832	
5940.27	4	—	16834.2	16829.2		
5940.03	8	3	16834.9	16829.9	16833	
5938.72	7	2	16838.6	16833.6		
5938.41	4	—	16839.5	16834.5	16837	
5938.21	9	4	16840.1	16835.1		
5938.01	8	3	16840.6	16835.6	16847	
5937.58	8	2	16841.9	16836.9		
5937.37	6	1	16842.5	16837.5	16849	
5937.22	2	—	16842.9	16837.9		
5936.85	4	2	16844.0	16839.0	16851	
5936.42	4	2	16845.2	16840.2		
5935.96	10	4	16846.5	16841.5	16846	
5935.66	2	—	16847.3	16842.3		
5935.38	7	2	16848.1	16843.1	16847	
5934.32	9	2	16851.1	16846.1		
5934.14	4	—	16851.6	16846.6	16849	
5933.91	7	3	16852.3	16847.3		
5933.16	5	1	16854.4	16849.4	16851	
5932.96	11	5	16855.0	16850.0		
5932.51	3	1	16856.3	16851.3	16855	
5932.28	12	6	16856.9	16851.9		
5932.13	3	1	16857.4	16852.4	16857	
5931.17	8	3	16860.1	16855.1		
5930.77	8	2	16861.2	16856.2	16862	
5929.57	6	1	16864.6	16859.6		
5929.25	9	2	16865.5	16860.5	16862	
5928.99	9	3	16866.3	16861.3		
5928.69	4	—	16867.1	16862.1	16863	
5928.53	11d	5	16867.7	16862.7		
5928.43						
5927.86	6	—	16869.5	16864.5	16868	

THE TELLURIC LINES OF THE SOLAR SPECTRUM—*continued.*

Becker (Rowland)	Intensity		Oscillation Frequency	Reduction to Vacuum	Oscillation Frequency in Vacuo	
	Horizon	Medium Altitude			Rowland	Ångström
5926·94	5	2	16872·1	5·0	16867·1	16869
5926·74	8	2	16872·7		16867·7	
5926·29	4	1	16874·0		16869·0	
5925·82	4	1	16875·3		16870·3	
5925·19	12	5	16877·1		16872·1	
5924·96	6	1	16877·7		16872·7	
5924·49	12	6	16879·1		16874·1	16877
5923·98	11	5	16880·5		16875·5	
5923·82	11	5	16881·0		16876·0	
5923·39	7	3	16882·2		16877·2	16881
5922·87	9	3	16883·7		16878·7	
5922·66	10	4	16884·3		16879·3	16882
5922·54	8	4	16884·7		16879·7	
5921·83	7	3	16886·7		16881·7	16885
5921·39	6d	3	16888·1		16883·1	16886
5921·25						
5920·73	10	4	16889·8		16884·8	16888
5920·29	6	2	16891·1		16886·1	
5919·83	12	6	16892·4		16887·4	
5919·22	12	5	16894·1		16889·1	16893
5918·62	12	4	16895·8		16890·8	16894
5918·08	7	2	16897·4		16892·4	16896
5917·53	8	3	16898·9		16893·9	
5917·29	5	—	16899·6		16894·6	
5916·93	6	2	16900·6		16895·6	
5916·77	7	2	16901·1		16896·1	16900
5916·21	6	2	16902·7		16897·7	16901
5915·77	9	4	16904·0		16899·0	16902
5915·52	9	4	16904·7		16899·7	
5915·06	9	4	16906·0		16901·0	16903
5914·64	4	1	16907·2		16902·2	
5913·92	4	1	16909·3		16904·3	16906
5913·15	10	4	16911·5		16906·5	16909
5912·82	8	3	16912·4		16907·4	
5912·70	8	3	16912·7		16907·7	
5912·15	7	2	16914·3		16909·3	
5911·99	7	2	16914·8		16909·8	
5911·56	5	2	16916·0		16911·0	
5911·33	5	—	16916·7		16911·7	
5911·05	3?	—	16917·5		16912·5	
5910·95	11d	{ 4	16917·8		16912·8	16916
5910·87			{ 3	16918·0		
5910·79	4	—	16918·2		16913·2	
5910·32	3?	—	16919·6		16914·6	
5910·25	11d	4	16919·8		16914·8	16918
5909·57	7	3d	16921·7		16916·7	16919
5909·14	10	5	16922·9		16917·9	
5908·85	3	1	16923·8		16918·8	
5908·36	9	4	16925·2		16920·2	16923
5907·98	9	5	16926·2		16921·2	16923
5907·58	8	3	16927·4		16922·4	16925
5907·42	8	4	16927·9		16922·9	
5907·16	6	—	16928·6		16923·6	16927
5906·53	6	2	16930·4		16925·4	
5906·38	6	2	16930·8		16925·8	16928
5905·68	5	—	16932·8		16927·8	

THE TELLURIC LINES OF THE SOLAR SPECTRUM—*continued.*

Becker (Rowland)	Intensity		Oscillation Frequency	Reduc- tion to Vacuum	Oscillation Frequency in Vacuo	
	Horizon	Medium Altitude			Rowland	Ångström
5905·46	9	3	16933·5	5·0	16928·5	16932
5905·25	7	1	16934·1		16929·1	16932
5904·97	5	3	16934·9		16929·9	
5904·53	5	3	16936·2		16931·2	
5904·16	8	3	16937·2		16932·2	
5904·04	8	3	16937·6		16932·6	
5903·87	7	4	16938·0		16933·0	16937
5903·64	9	2	16938·7		16933·7	
5903·34	(4?)	3	16939·6		16934·6	16938
5902·90	5	2	16940·8		16935·8	
5902·73	4	—	16941·3		16936·3	
5902·53	5	4	16941·9		16936·9	
5902·25	10	3	16942·7		16937·7	16941
5902·13	8	3	16943·0		16938·0	
5901·62	12	7	16944·5		16939·5	
5901·43	9	3	16945·0		16940·0	16944
5901·07	8	3	16946·1		16941·1	
5900·60	7	2	16947·4		16942·4	16945
5900·22	11	6	16948·5		16943·5	16947
5900·06	10	5	16949·0		16944·0	16948
5899·17	10	4	16951·5	16946·5	16949	
5898·94	6	1	16952·2	16947·2	16950	
5898·56	6	2	16953·3	16948·3	16951	
5898·33	11	7	16954·0	16949·0	16953	
5898·10	6	2	16954·6	16949·6		
5897·90	6	—	16955·2	16950·2		
5897·58	9	4	16956·1	16951·1	16954	
5897·22	6	—	16957·1	16952·1	16955	
5896·97	10	4	16957·8	16952·8	16956	
5896·72	4b	—	16958·6	16953·6		
5896·58	11	4	16959·0	16954·0	16957	
5896·37	5b	—	16959·6	16954·6		
5895·89	5	2	16961·0	16956·0		
5895·64	1b	—	16961·7	16956·7		
5895·26	10	3	16962·8	16957·8	16960	
5895·11	10	3	16963·2	16958·2	16962	
5894·71	5	1	16964·4	16959·4	16963	
5894·51	9	4	16964·9	16959·9		
5893·88	4?	—	16966·8	16961·8		
5893·72	10	4	16967·2	16962·2	16965	
5893·52	4	1	16967·8	16962·8		
5893·24	9	4	16968·6	16963·6	16966	
5892·88	6	4	16969·6	16964·6	16967	
5892·59	10	5	16970·5	16965·5	16968	
5892·40	(3?)	1	16971·0	16966·0		
5892·09	4?	2	16971·9	16966·9		
5891·87	11	5	16972·5	16967·5	16970	
5891·73	10	4	16972·9	16967·9	16971	
5891·37	8	5	16974·0	16969·0	16972	
5891·11	6	1	16974·7	16969·7		
5890·92	7	1	16975·3	16970·3	16973	
5890·42	7	1	16976·7	16971·7		
5890·34	14	—	16977·0	16972·0		
5889·78	11	5	16978·6	16973·6	16977	
5889·23	5	2	16980·2	16975·2		
5888·86	9	4	16981·2	16976·2	16980	

THE TELLURIC LINES OF THE SOLAR SPECTRUM—*continued.*

Becker (Rowland)	Intensity		Oscillation Frequency	Reduc- tion to Vacuum	Oscillation Frequency in Vacuo	
	Horizon	Medium Altitude			Rowland	Ångström
5888-01	7	3	16983-7	5-0	16978-7	
5887-82	9	5	16984-2		16979-2	16982
5887-60	4b	1	16984-8		16979-8	
5887-36	10	5	16985-5		16980-5	16984
5887-10	3	1	16986-3		16981-3	
5886-84	6	1	16987-0		16982-0	
5886-55	9	4d	16987-9		16982-9	16985
5886-51						
5886-34	3b	—	16988-5		16983-5	
5886-12	10d	5	16989-1		16984-1	16987
5885-77	6	2	16990-1		16985-1	16988
5885-68	6	2	16990-4		16985-4	16989
5885-02	3?	2	16992-3		16987-3	
5884-68	4?	2	16993-3		16988-3	
5884-34	8	2	16994-3		16989-3	
5884-04	11	7	16995-1		16990-1	16994
5883-52	4	1	16996-6		16991-6	16995
5883-12	8	2	16997-8		16992-8	
5882-92	8	3	16998-4		16993-4	
5882-58	6	—	16999-4		16994-4	16997
5882-51	6	—	16999-6		16994-6	16998
5882-02	8	3	17001-0		16996-0	
5881-91	8	3	17001-3		16996-3	
5881-79	6	—	17001-6		16996-6	17000
5881-53	(5?)	4d	17002-5		16997-5	
5881-45						
5881-21	8	3	17003-3		16998-3	
5881-03	8	3	17003-8		16998-8	
5880-84	8	2	17004-4		16999-4	
5880-65	6d	3	17005-0		17000-0	17003
5880-59						
5879-98	6	4	17006-9		17001-9	17004
5879-77	9	4	17007-5		17002-5	
5879-64	9	4	17007-8		17002-8	17007
5879-24	7	1	17009-0		17004-0	17008
5877-66	6	1	17013-6		17008-6	
5877-43	6	2	17014-2		17009-2	17012
5877-21	4	1	17014-9		17009-9	
5877-04	3	—	17015-4		17010-4	17013
5876-44	9	3	17017-1		17012-1	17015
5876-22	9	3	17017-7		17012-7	
5875-71	9	3	17019-2		17014-2	
5875-55	5	1	17019-7		17014-7	
5875-24	5	3	17020-6		17015-6	17019
5874-77	4d	2	17022-1		17017-1	17020
5874-68						
5874-37	4	1	17023-1		17018-1	
5874-02	5	2	17024-1		17019-1	
5873-71	7	2	17025-0		17020-0	
5873-37	6	5	17026-0		17021-0	
5872-37	5	1d	17028-9		17023-9	
5872-09	4	1	17029-7		17024-7	
5871-85	4	1	17030-4		17025-4	
5871-38	9	3	17031-8		17026-8	
5871-26	5	—	17032-1		17027-1	
5870-73	9	3	17033-7		17028-7	

THE TELLURIC LINES OF THE SOLAR SPECTRUM—*continued.*

Becker (Rowland)	Intensity		Oscillation Frequency	Reduc- tion to Vacuum	Oscillation Frequency in Vacuo	
	Horizon	Medium Altitude			Rowland	Ångström
5869.94	6	3	17036.0	5.0	17031.0	
5869.82	6	3	17036.3		17031.3	
5868.89	7	2	17039.0		17034.0	
5867.71	9	5	17042.4		17037.4	
5866.31	4	2	17046.5		17041.5	
5865.90	7	2	17047.7		17042.7	
5865.66	7	2	17048.4		17043.4	
5864.90	4	1	17050.6		17045.6	
5864.38	6	3	17052.1		17047.1	
5863.37	4	1	17055.0		17050.0	
5863.18	4	—	17055.6		17050.6	
5861.86	5	2	17059.4		17054.6	
5861.77	6	2	17059.7		17054.7	
5859.73	10	8	17065.6		17060.6	
5859.04	3	—	17067.6		17062.6	
5857.13	4?	2	17073.2		17068.2	
5854.97	5	2	17079.5		17074.5	
5854.52	4	2	17080.8		17075.8	
5853.43	(4?)	3	17084.0		17079.0	
5853.29	(4?)	2	17084.4		17079.4	
5851.52	8	3	17089.6		17084.6	
5851.34	3	—	17090.1		17085.1	
5851.05 } 5850.97 }	8	1d	17091.1		17086.1	
5849.89	5	3	17094.3		17089.3	
5848.82	5	1	17097.5		17092.5	
5846.09	(4?)	2	17105.4		17100.4	
5845.76	8	1	17106.4		17101.4	
5845.15	(4?)	2	17108.2		17103.2	
5844.00	3	2	17111.6		17106.6	
5842.87	6	2	17114.9		17109.9	
5842.63	5	2	17115.6		17110.6	
5842.29	3?	2	17116.6		17111.6	
5841.33	4	1	17119.4		17114.4	
5841.02	6	1	17120.3		17115.3	
5839.84	4	2	17123.8		17118.8	
5839.61	5	2	17124.4		17119.4	
5838.90	4	3	17126.5		17121.5	
5838.64	6	3	17127.3		17122.3	
5838.44	4	2	17127.9		17122.9	
5837.46	4	1	17130.7		17125.7	
5836.62	4	1	17133.2	5.0	17128.2	
5835.80	5	3	17135.6	5.1	17130.5	
5834.78	4?	2	17138.6		17133.5	
5834.20	8	4	17140.3		17135.2	
5833.51	4	1	17142.4		17137.3	
5832.64	4d	2	17144.9		17139.8	
5832.07	4	1	17146.6		17141.5	
5831.55	4	—	17148.1		17143.0	
5831.14	4d	2	17149.3		17144.2	
5830.28	5	2	17151.8		17146.7	
5830.06	4	2	17152.5		17147.4	
5829.56	4	2	17154.0		17148.0	
5828.90	4	2	17155.9		17150.9	
5828.49	5	1	17157.1		17152.0	
5827.89	7	1	17158.9		17153.8	

THE TELLURIC LINES OF THE SOLAR SPECTRUM—*continued.*

Becker (Rowland)	Intensity		Oscillation Frequency	Reduction to Vacuum	Oscillation Frequency in Vacuo	
	Horizon	Medium Altitude			Rowland	Ångström
5827.13	(3?)	2	17161.1	5.1	17156.0	
5826.47	(3?)	2	17163.0		17157.9	
5825.32	4?	2	17166.4		17161.3	
5824.90	4	—	17167.7		17162.6	
5824.61	4	2	17168.5		17163.4	
5823.82	4	2	17170.9		17165.8	
5823.53	5	—	17171.7		17166.6	
5823.36	(3?)	2	17172.2		17167.1	
5823.13	(3?)	2	17172.9		17167.8	
5822.56	} 4	{ 3	17174.6		17169.5	
5822.50			17174.8		17169.7	
5822.27	4?	—	17175.4		17170.3	
5822.10	4	3	17175.9		17170.9	
5821.51	3	2	17177.7		17172.6	
5821.23	3?	—	17178.5		17173.4	
5821.12	3?	—	17178.8		17173.7	
5820.98	3	1	17179.2		17174.1	
5820.62	4	1	17180.3		17175.2	
5820.13	4?	2	17181.7		17176.6	
5819.51	3	2	17183.6		17178.5	
5819.07	4	—	17184.9		17179.8	
5818.76	4	2	17185.8		17180.7	
5818.34	6	2	17187.0		17181.9	
5818.18	(3?)	2	17187.5		17182.4	
5817.79	4	1	17188.7		17183.6	
5817.59	4	1	17189.2		17184.2	
5817.00	4	2	17191.0		17185.9	
5815.80	4	2	17194.5		17189.4	
5815.30	(5?)	4	17196.0		17190.9	
5814.96	} (5?)	5d	17197.2		17192.1	
5814.87						
5813.74	4	2	17200.6		17195.5	
5813.13	4	2	17202.5		17197.4	
5812.75	3	2	17203.6		17198.5	
5811.61	3	1	17207.0		17201.0	
5811.35	2?	—	17207.7		17202.6	
5809.94	3	—	17211.9		17206.8	
5809.70	4	1	17212.6		17207.5	
5809.07	4	2	17214.5		17209.4	
5808.84	3	—	17215.2		17210.1	
5807.86	4	2	17218.0		17212.9	
5806.79	4?	—	17221.2		17216.1	
5806.44	4	1	17222.3		17217.3	
5806.14	3	1	17223.2		17218.1	
5805.14	3	2	17226.1		17221.0	
5804.07	3?	—	17229.3		17224.2	
5803.57	5	1	17230.8		17225.7	
5803.16	3	1	17232.0		17226.9	
5802.91	4	1	17232.7		17227.6	
5802.74	4	1	17233.2		17228.1	
5802.53	3?	2	17233.9		17228.8	
5802.40	3	1	17234.3		17229.2	
5802.03	3?	2	17235.4		17230.4	
5801.39	4	2	17237.3		17232.1	
5801.04	5	2	17238.3		17233.3	
5800.78	5	1	17239.1		17234.0	

THE TELLURIC LINES OF THE SOLAR SPECTRUM—*continued.*

Becker (Rowland)	Intensity		Oscillation Frequency	Reduc- tion to Vacuum	Oscillation Frequency in Vacuo	
	Horizon	Medium Altitude			Rowland	Ångström
5800-17	3	—	17240-9	5-1	17235-8	
5800-01	4	2	17241-4		17236-3	
5799-49	5	1	17242-9		17237-8	
5799-25	(3?)	2	17243-6		17238 5	
5798-66 } 5798-61 }	4d	1	17245-4		17240-3	
5798-36	9	6	17246-3		17241-2	
5798-24	4	—	17246-6		17241-5	
5798-03	9	6	17247-2		17242-1	
5797-77	4	2	17248-0		17242-9	
5797-53	3	—	17248-7		17243-6	
5797-32	2	1	17249-3		17244-2	
5796-99	4	2	17250-3		17245-2	
5796-65	4	—	17251-3		17246-2	
5796-42 } 5796-28 }	(4?)	4d	17252-2		17247-1	
5796-10	4	1	17253-0		17247-9	
5795-77	3	1	17254-0		17248-9	
5795-51	2	1	17254-7		17249-6	
5795-31	3	2	17255-3		17250-3	
5794-93	2	1	17256-5		17251-4	
5794-71	2	—	17257-1		17252-0	
5794-51	4	2	17257-7		17252-6	
5794-02	5	—	17259-2		17254-1	
5793-67	4	1	17260-2		17255-1	
5793-06	3	—	17262-0		17256-9	
5792-30 } 5792-15 }	4d	2	17264-5		17259-4	
5791-84	4	2	17265-7		17260-6	
5791-48	3	1	17266-7		17261-6	
5791-01	4	—	17268-1		17263-0	
5790-33	5	3	17270-2		17265-1	
5790-05	4	2	17271-0		17265-9	
5789-80	2	—	17271-8		17266-7	
5789-35	5	—	17273-1		17268-0	
5789-03	5	2	17274-1		17269-0	
5788-87 } 5788-76 }	4d	2	17274-7		17266-6	
5788-31	4	1	17276-2		17271-1	
5787-63	2?	1	17278-2		17273-2	
5787-41	6	2	17278-9		17273-8	
5787-19	5	3	17279-5		17273-4	
5786-91 } 5786-76 }	3d	1	17280-6		17275-1	
5782-67	4	1	17293-1		17288-1	
5782-05	4	—	17294-9		17289-8	
5780-34	5.	1	17300-0		17294-9	
5779-50	4	2	17302-5		17297-4	
5778-11	3	1	17306-7		17301-6	
5777-83	3	1	17307-5		17302-4	
5776-56	6	—	17311-3		17306-2	
5776-31	4	2	17312-1		17307-0	
5776-19	6	—	17312-4		17307-3	
5775-82	3	1	17313-6		17308-5	
5775-60	3	—	17314-2		17309-1	
5774-65	4	2	17317-1		17312-0	

THE TELLURIC LINES OF THE SOLAR SPECTRUM—*continued*.

Becker (Rowland)	Intensity		Oscillation Frequency	Reduc- tion to Vacuum	Oscillation Frequency in Vacuo	
	Horizon	Medium Altitude			Rowland	Ångström
5774·38	4?	3	17317·9	5·1	17312·8	
5774·15	4?	3	17318·6		17313·5	
5773·79	3	2	17319·6		17314·5	
5773·34	7	2	17321·0		17315·9	
5773·16	7	2	17321·5		17316·4	
5772·88	4?	—	17322·4		17317·3	
5772·77	8	2	17322·7		17317·6	
5771·81	7	2	17325·6		17320·5	
5771·70	5	—	17325·9		17320·8	
5771·53	6	2	17326·4		17321·3	
5770·89	2	1	17328·3		17323·2	
5770·41	7	1	17329·8		17324·7	
5770·31	4	1	17330·1		17325·0	
5769·60	7	1	17332·2		17327·1	
5769·38	6	2	17332·9		17328·8	
5768·71	3	—	17334·9		17329·8	
5768·55	5	2	17335·4		17330·3	
5767·84	3	1	17337·5		17332·4	
5767·32	8	2	17339·1		17334·0	
5767·13	3	—	17339·6		17334·5	
5766·47	6	2	17341·6		17336·5	
5766·08	3	1	17342·8		17337·7	
5765·88	2?	—	17343·4		17338·3	
5765·70	2	1	17343·9		17338·8	
5765·14	2	1	17345·6		17340·5	
5764·84	2	1	17346·5		17341·4	
5764·48	4	1	17347·6		17342·5	
5764·15	(3?)	2	17348·6		17343·5	
5763·64	8	2	17350·1		17345·0	
5763·55	7	2	17350·4		17345·3	
5762·76	3	1	17352·8		17347·7	
5761·75	8	3	17355·8		17350·7	
5761·36	3	2	17357·0		17351·9	
5759·72	(4?)	3	17362·0		17356·9	
5759·39	5	1	17363·0		17357·9	
5759·04	5	2	17364·0		17358·9	
5758·59	4	2	17365·4		17360·3	
5758·08	3	2	17366·9		17361·8	
5757·65	3?	2	17368·2		17363·1	
5757·41	3	—	17368·9		17363·8	
5757·16	5	1	17369·7		17364·6	
5756·68	3	1	17371·1		17366·0	
5755·91	5	1	17373·5		17368·4	
5755·64	5	2	17374·3		17369·2	
5754·37	9	2	17378·1		17373·0	
5754·13	5	2	17378·8		17373·7	
5753·55	3	1	17380·6		17375·5	
5753·13	8	3	17381·8		17376·7	
5752·68	3	2	17383·2		17378·1	
5751·99	6	2	17385·3		17380·2	
5750·74	4	2	17389·1		17384·0	
5750·56	3?	—	17389·6		17384·5	
5749·49	4d	2	17392·9		17387·8	
5748·12	7	5	17397·0		17391·9	
5747·83	7	5	17397·9		17392·8	
5747·45	3	1	17399·0		17393·9	

THE TELLURIC LINES OF THE SOLAR SPECTRUM—*continued.*

Becker (Rowland)	Intensity		Oscillation Frequency	Reduction to Vacuum	Oscillation Frequency in Vacuo	
	Horizon	Medium Altitude			Rowland	Ångström
5747.02	3	1	17400.3	5.1	17395.2	
5746.67	3	1	17401.4		17396.3	
5745.92	10	2	17403.7		17398.6	
5745.44	4	1	17405.1		17410.0	
5745.05	9	1	17406.3		17401.2	
5744.37	3	1	17408.3		17403.2	
5744.11	2?	—	17409.1		17404.0	
5743.94	5	2	17409.7		17404.6	
5743.58	6d	2	17410.8		17405.3	
5742.72	4	1	17413.4		17408.3	
5742.30	10	1	17414.6		17409.5	
5741.49	4?	2	17417.1		17412.0	
5741.10	4	2	17418.3		17413.2	
5740.19	4	2	17421.0		17415.9	
5739.59	4?	3	17422.8		17417.7	
5739.14	4	1	17424.2		17419.1	
5738.57	4	3	17426.0		17420.9	
5738.30	5	2	17426.8		17421.7	
5737.82	11	2	17428.2		17423.1	
5737.53	5	2d	17429.3		17424.2	
5737.38						
5737.16	5	2	17430.2		17425.1	
5736.49	4	1	17432.3		17427.2	
5735.96	3	—	17433.9		17428.8	
5735.74	9	2d	17434.6		17429.5	
5735.20	4	2	17436.2		17431.1	
5734.66	4	1	17437.8		17432.7	
5733.80	7	1	17440.4		17435.3	
5733.27	8	2d	17442.3	5.1	17437.2	
5733.11						
5732.77	4	1	17443.6	5.2	17438.4	
5731.46	4	2	17447.6		17442.4	
5731.02	4	2	17448.9		17443.7	
5730.27	5	1	17451.2		17446.0	
5729.95	9	2	17452.2		17447.0	
5729.78	9	2	17452.7		17447.5	
5729.30	4?	2	17454.1		17448.9	
5728.92	7	2	17455.3		17450.1	
5728.58	7	2	17456.3		17451.1	
5727.95	3	1	17458.2		17453.0	
5727.76	(4?)	3	17458.8		17453.6	
5727.18	10	7	17460.6		17455.4	
5726.98	9	3	17461.2		17456.0	
5726.79	6	—	17461.8		17456.6	
5726.16	3	1	17463.7		17458.5	
5726.00	3	1	17464.2		17459.0	
5724.70	3	1	17468.2		17463.2	
5724.54	(4?)	3	17468.7		17463.5	
5724.12	9	1	17469.9		17464.7	
5723.74	4	1	17471.1		17466.9	
5722.98	2?	—	17473.4		17468.2	
5722.34	6	2	17475.4		17470.2	
5722.07	10	2	17476.2		17471.0	
5721.92	4	1	17476.6		17471.4	
5721.05	5	3	17479.3		17472.1	
5720.51	8	2	17481.0		17478.8	

THE TELLURIC LINES OF THE SOLAR SPECTRUM—*continued.*

Becker (Rowland)	Intensity		Oscillation Frequency	Reduction to Vacuum	Oscillation Frequency in Vacuo	
	Horizon	Medium Altitude			Rowland	Ångström
5719·94	5	2	17482·7	5·2	17477·2	
5719·75	11	2	17483·3		17478·1	
5719·15	8	2	17485·1		17479·9	
5718·51	4	2	17487·1		17481·9	
5717·65	9	2	17489·7		17484·2	
5717·13	4	2	17491·3		17486·1	
5716·16	(3?)	2	17494·3		17489·2	
5715·87	3	1	17495·2		17490·0	
5714·27 } 5714·21 }	8	4d	17500·1		17494·9	
5712·76	4	2	17504·7		17499·5	
5711·69	5	1	17507·9		17502·8	
5711·50	8	1	17508·5		17503·4	
5710·97	5	1	17510·2		17505·0	
5710·07	4	2	17512·9		17507·8	
5709·18	3	2	17515·6		17510·4	
5707·26	7	—	17521·5		17517·3	
5706·69	4	1	17523·3		17518·1	
5705·24	(3?)	2	17527·7		17521·9	
5704·67	4	—	17529·5		17524·4	
5704·42	7	2	17530·3		17525·1	
5704·05	3	—	17531·4		17526·2	
5703·44	6	1	17533·3		17528·1	
5702·95	5	3	17534·8		17529·6	
5702·12	3	1	17537·3		17532·1	
5700·90	9	2	17541·1		17535·9	
5700·78	3?	—	17541·5		17536·3	
5700·17	2?	1	17543·3		17538·1	
5699·52	10	4	17545·3		17540·1	
5699·14	3	1	17546·5		17541·3	
5698·93	6	—	17547·1		17541·9	
5698·75 } 5698·60 }	(5?)	5	17547·7		17542·5	
5698·31	10	2	17548·2		17543·0	
5697·92 } 5697·79 }	4d	—	17549·1		17543·9	
5697·51	4	1	17549·5		17544·3	
5697·31	(3?)	2	17550·4		17545·2	
5696·96	8	1	17551·5		17546·3	
5696·58	4	1	17552·1		17546·9	
5696·06	8d	3	17553·2		17548·0	
5695·65	3	1	17554·4		17549·2	
5694·34	6	1	17556·0		17550·8	
5693·76	8	1	17557·2		17552·2	
5693·38	4	2	17561·3		17556·1	
5692·91	8	2	17565·1		17557·9	
5692·57	10	2	17564·3		17559·1	
5692·35	4	1	17565·7		17560·5	
5690·81	4	—	17566·8		17561·6	
5690·62	10	6	17567·4		17562·2	
5690·42	8	—	17572·2		17567·0	
5690·07	5	—	17572·8		17567·6	
5689·74	9	3	17573·4		17568·2	
5689·20	4	1	17574·5		17569·3	
5688·74	6	2	17575·5		17570·3	
5687·80	5	2	17577·2		17572·0	
			17578·6		17573·4	
			17581·5		17576·3	

THE TELLURIC LINES OF THE SOLAR SPECTRUM—*continued.*

Becker (Rowland)	Intensity		Oscillation Frequency	Reduction to Vacuum	Oscillation Frequency in Vacuo	
	Horizon	Medium Altitude			Rowland	Ångström
5687-66	10	3	17581-9	5-2	17576-7	
5686-49	5	3	17585-5		17580-3	
5686-38	(5?)	4	17585-9		17580-7	
5685-97	5	1	17587-1		17581-9	
5685-61	8	2	17588-3		17583-1	
5685-55	4?	—	17588-5		17583-3	
5685-28	5	2	17589-3		17584-1	
5684-05	9	3	17593-1		17587-9	
5682-98	6	—	17596-4		17591-2	
5681-97	8	2	17599-5		17594-3	
5681-74	3	—	17600-2		17595-0	
5680-98	5	1	17602-6		17597-4	
5680-10	5	2	17605-3		17600-1	
5679-79	5	2	17606-3		17601-1	
5676-94	8	2	17615-1		17609-9	
5674-79	4	1	17621-8		17616-6	
5674-49	4	—	17622-7		17617-5	
5674-42	4	1	17622-9		17617-7	
5674-15	5	1	17623-8		17618-6	
5672-07	4	—	17630-2		17625-0	
5671-58	4	2	17631-8		17626-6	
5670-50	5	2	17635-1		17629-9	
5668-70	3	—	17640-7		17635-5	
5667-94	3	1	17643-1		17637-9	
5666-03	4	2	17649-0		17643-8	
5652-01	(3?)	2	17692-8		17687-6	
5634-37	(2?)	2	17748-2		17743-0	
5633-23	(2?)	2	17751-8		17746-6	
5631-02	(2?)	2	17758-8	5-2	17753-6	
5575-53	3	—	17935-5	5-3	17930-2	
5548-72	3	2	18022-2		18016-9	
5529-92	3?	2	18083-4		18078-1	
5523-03	3	1	18106-1	5-3	18100-8	
5520-23	3	1	18115-2	5-4	18109-8	
5519-95	(3?)	2	18116-1		18110-7	
5519-41	4	1	18117-9		18112-5	
5516-49	3	2	18127-5		18122-1	
5516-09	3	1	18128-8		18123-4	
5515-52	4	1	18130-7		18125-3	
5513-91	4	2	18136-0		18130-6	
5511-37	5	2	18144-3		18138-9	
5509-64	4	2	18150-0		18144-6	
5509-11	2	—	18151-7		18146-3	
5507-67	(3?)	2	18156-5		18151-1	
5506-57	(3?)	2	18160-1		18154-7	
5505-37	4	2	18164-1		18158-7	
5502-00	3?	—	18175-2		18169-8	
5500-44	3	2	18180-4		18175-0	
5499-70	3	1	18182-8		18177-1	
5499-39	3	—	18183-8		18178-1	
5499-05	4	2	18185-0		18179-6	
5498-56	3	—	18186-6		18181-2	
5496-98	5	2	18191-8		18186-4	
5496-33	3	—	18194-0		18188-6	
5495-65	4	—	18196-2		18190-8	
5491-70	3	2	18209-3		18203-9	

THE TELLURIC LINES OF THE SOLAR SPECTRUM—*continued.*

Becker (Rowland)	Intensity		Oscillation Frequency	Reduction to Vacuum	Oscillation Frequency in Vacuo	
	Horizon	Medium Altitude			Rowland	Ångström
5491·22	4	2	18210·9	5·4	18205·5	
5491·04	(4?)	—	18211·5		18206·1	
5485·20	3	2	18230·9		18225·5	
5484·28	3	1	18233·9		18228·5	
5482·76	4	2	18239·0		18233·6	
5482·09	6d	4d	18241·2		18235·8	
5480·52	(4?)	—	18246·4		18241·0	
5479·51	3	2	18249·8		18244·4	
5478·93	4	2	18251·7		18246·3	
5478·32	7	2	18253·8		18248·4	
5475·41	2	—	18263·5		18258·1	
5473·54	5	3	18269·7		18264·3	
5470·35	8	2	18280·4		18275·0	
5466·90	6	2	18291·9		18286·5	
5466·17	3	2	18294·4		18289·0	
5465·47	5	2	18296·7		18291·3	
5465·21	6	3	18297·6		18292·2	
5464·84	(3?)	2	18298·8		18293·4	
5462·59	(7?)	7	18306·3		18300·9	
5462·18	5	2	18307·7		18302·2	
5459·54	7	—	18316·6		18311·2	
5459·05	(3?)	2	18318·2		18312·8	
5458·65	5	2	18319·5		18316·1	
5457·62	7	4	18323·0		18317·6	
5457·34	4	2	18323·9		18318·5	
5456·58	8	4	18326·5		18321·1	
5455·28	4	2	18330·9		18325·5	
5452·54	3	1	18340·1		18334·7	
5451·26	4	2	18344·4		18339·0	
5450·43	4	1	18347·2		18341·8	
5449·57	5	1	18350·1		18344·7	
5449·16	4	2	18351·5		18348·1	
5449·07	4	2	18351·8		18348·4	
5448·22	6	2	18354·6		18349·2	
5446·25	3	1	18361·3		18355·9	
5444·23	4	2	18368·1		18362·7	
5442·51	7	4	18373·9		18368·5	
5439·91	3	1	18382·7		18377·3	
5439·06	5d	2	18385·6		18380·2	
5438·99						
5438·43	4	2	18387·7		18382·3	
5438·16	4	2	18388·6		18383·2	
5437·36	6	4	18391·3		18385·9	
5437·23	6	4	18391·7		18386·3	
5435·76	7	2	18396·7		18391·3	
5435·49	3?	—	18397·6		18392·2	
5434·92	6	1	18399·5		18394·1	
5434·04	4	2	18402·5		18397·1	
5431·82	5	3	18410·0		18404·6	
5431·60	5	3	18410·8		18405·4	
5431·25	3	1	18412·0		18406·6	
5430·46	4	3	18414·7		18409·3	
5428·88	7d	3	18420·0		18414·6	
5428·78						
5428·09	5d	3	18422·7		18417·3	
5427·89						
		3	18423·4		18418·0	

THE TELLURIC LINES OF THE SOLAR SPECTRUM—*continued.*

Becker (Rowland)	Intensity		Oscillation Frequency	Reduction to Vacuum	Oscillation Frequency in Vacuo	
	Horizon	Medium Altitude			Rowland	Ångström
5427-17	5d	2	18425.8	5.4	18420.4	
5426-85	(3?)	3	18426.9		18421.5	
5426-42	(3?)	3	18428.4		18423.0	
5425-96	3	2	18429.9		18424.5	
5425-09	4	1	18432.9		18427.5	
5423-66	3	—	18437.7		18432.3	
5423-06	9d	3	18439.9		18434.5	
5422-98						
5421-31	7d	5	18445.7		18440.3	
5420-71	7	2	18447.8		18442.5	
5420-49	(8?)	6	18448.5		18443.1	
5420-41			18448.8		18443.4	
5419-49	8	3	18451.9		18447.5	
5418-43	5	2	18455.5	5.4	18450.1	
5418-07	5	3	18456.8	5.5	18451.3	
5417-39	5	1	18459.1		18453.6	
5416-68	4	2	18461.5		18456.0	
5416-47	4	—	18462.2		18456.7	
5416-25	6	2	18463.0		18457.5	
5415-66	4	1	18465.0		18459.5	
5415-18	4	—	18466.6		18461.1	
5414-86	4	1	18467.7		18462.2	
5414-50	8	3	18468.9		18463.4	
5414-23	7	5	18469.8		18464.3	
5413-30	8d	4	18473.0		18467.5	
5413-00	7	4	18474.0		18468.5	
5412-34	7	2	18476.3		18470.8	
5411-92	5	1	18477.7		18472.2	
5410-61	(3?)	3	18482.2		18476.7	
5409-80	5	3	18485.0		18479.5	
5408-98	5	—	18487.8		18482.3	
5408-40	6	2	18489.8		18484.3	
5408-20	6	2	18490.4		18484.9	
5407-25	4	1	18493.7		18487.2	
5402-43	4	2	18510.2		18504.7	
5400-07	3	1	18518.3		18512.8	
5398-66	4	—	18523.1		18517.6	
5398-12	7	1	18525.0		18519.5	
5391-31	(3?)	2	18548.4		18542.9	
5390-93	(3?)	2	18549.7		18544.2	
5386-02	5	1	18566.6		18561.1	
5383-01	(3?)	3	18577.0		18571.5	
5367-85	(3?)	3	18629.4		18523.9	
5366-95	(3?)	2	18632.6		18527.1	
5364-09	(3?)	2	18642.5		18537.0	
5362-32	4	3	18648.6		18543.1	
5361-08	3	2	18653.0		18547.5	
5360-51	2?	—	18654.9	5.5	18549.4	
5359-95	2?	—	18656.9	5.6	18651.3	
5354-10	3d	2	18677.3		18671.7	
5353-07	(3?)	2	18680.9		18675.3	
5351-82	3	1	18685.2		18679.6	
5351-28	4	—	18687.1		18681.5	
5350-52	4?	3	18689.8		18684.2	
5349-23	4	1	18694.3		18688.7	
5348-93	4?	3	18695.3		18689.7	

THE TELLURIC LINES OF THE SOLAR SPECTRUM—*continued*.

Becker (Rowland)	Intensity		Oscillation Frequency	Reduction to Vacuum	Oscillation Frequency in Vacuo	
	Horizon	Medium Altitude			Rowland	Ångström
5347.62	3?	2	18699.9	5.6	18694.3	
5342.21	3?	3	18718.8		18713.2	
5340.42	3?	2	18725.1		18719.5	
5322.64	(3?)	2	18787.7		18782.1	
5316.19	3?	1	18810.5		18804.9	
5314.02	3?	1	18818.2		18812.6	
5290.52	4	2	18901.7		18896.1	
5288.00	5	3	18910.7		18905.1	
5283.58	(7?)	5	18926.6		18921.0	
5277.19	3	1	18949.5		18943.9	
5275.40	(7?)	6	18955.9		18950.3	
5275.11	(7?)	6	18957.0		18951.4	
5251.66	4?	2	19041.6		19036.0	
5251.52	3	1	19042.1	5.6	19036.5	
5205.40	4	2	19210.8	5.7	19205.1	
5205.12	4	2	19211.9	5.7	19206.2	
5143.94	5d	—	19440.4	5.8	19434.6	
5142.10	(2?)	2	19447.3		19441.5	
5132.25	(3?)	2	19484.6		19478.8	
5125.20	(10?)	8	19511.4		19505.6	
5117.02	(5?)	4	19542.6		10536.8	
5116.72	(5?)	4b	19543.8		19538.0	
5111.16	4	1	19565.0		19559.2	
5110.20	3	1	19568.7		19562.9	
5105.07	4d	1	19588.4		19582.6	
5103.86	(3?)	2d	19593.2		19587.4	
5103.77					19592.2	
5102.57	8	3	19598.0			
5101.90	6	2	19600.5		19594.7	
5097.40	5	3	19617.8		19612.0	
5096.23	5	1	19622.4		19616.6	
5095.95	7	2	19623.4		19617.6	
5094.52	8	5	19628.9		19623.1	
5094.20	6	—	19630.2		19624.4	
5094.04	6	2	19630.8		19625.0	
5093.78	2	—	19631.8		19626.0	
5092.58	8	4	19636.4		19630.6	
5092.37	7	5	19637.2		19631.4	
5091.32	4	2	19641.3		19635.5	
5090.39	4d	2	19645.1		19639.3	
5090.25						
5089.92	4	2	19646.7		19640.9	
5089.36	(4?)	4	19648.8		19643.0	
5089.23	(4?)	3	19649.3		19643.5	
5086.75	6	2	19658.9		19653.1	
5086.21	6	—	19661.0		19655.2	
5085.39	4	2	19664.2		19658.4	
5085.11	3	—	19665.3		19659.5	
5084.64	5	2	19667.1		19661.3	
5083.91	7	2	19669.9		19664.1	
5083.12	5	2	19673.0		19667.2	
5080.53	8	5	19683.0		19677.2	
5079.76	7	1	19686.2		19680.4	
5078.57	6	3	19690.6		19684.8	
5078.18	3	1	19692.1		19686.3	
5077.57	7	3	19694.5		19688.7	

THE TELLURIC LINES OF THE SOLAR SPECTRUM—*continued.*

Becker (Rowland)	Intensity		Oscillation Frequency	Reduc- tion to Vacuum	Oscillation Frequency in Vacuo	
	Horizon	Medium Altitude			Rowland	Ångström
5076.65	9	2	19698.0	5.8	19692.2	
5075.98	5	2	19700.6		19694.8	
5074.43	3?	1	19706.6		19700.8	
5073.89	4?	3	19708.7		19702.9	
5073.09	7	6	19711.8		19706.0	
5072.06	4	—	19715.8		19710.0	
5071.40	5	1	19718.4		19712.6	
5071.21	5	2	19719.2		19713.4	
5070.35	5	—	19722.5		19716.7	
5070.04	5	3	19723.7		19717.9	
5069.53	4	3	19725.3		19719.5	
5069.26	5	7	19726.7		19720.9	
5068.88	11?	9	19728.2		19722.4	
5068.45	5	4	19729.9		19723.1	
5067.29	11	8	19734.4		19728.6	
5066.49	6	3	19737.5		19731.7	
5066.04	9	6	19739.3		19733.5	
5065.85	(3?)	3	19740.0		19734.2	
5063.74	4	1	19748.2	5.8	19742.4	
5062.44	(3?)	2	19753.3	5.9	19747.4	
5061.18	6	2	19758.2		19752.3	
5060.56	5	2	19760.7		19754.8	
5060.19	10	8	19762.1		19756.2	
5059.58	3	1	19764.5		19758.6	
5058.32	6	2	19769.4		19763.5	
5057.69	9	—	19771.9		19766.0	
5056.95	5	5	19774.8		19768.9	
5056.58	10	3	19776.2		19770.3	
5056.44	5	2	19776.8		19770.9	
5055.28	4	2	19781.3		19776.4	
5054.52	4	—	19784.3		19778.4	
5053.92	6	3	19786.6		19780.7	
5053.64	5d	3	19787.7		19781.8	
5052.52	6	1	19792.1		19786.2	
5052.31	6?	3	19792.9		19787.0	
5050.49	4	2	19800.1		19794.2	
5049.72	5	1	19803.1		19797.2	
5047.56	(4?)	3	19811.5		19805.6	
5047.14	(4?)	3b	19813.2		19807.3	
5046.65	3	—	19815.1		19809.2	
5046.35	3	2	19816.3		19810.4	
5045.76	4	—	19818.6		19812.7	
5044.73	3	2	19822.7		19816.8	
5044.08	8	3	19825.2		19819.3	
5043.13	8	3	19829.0		19823.1	
5042.97	8	3	19829.6		19823.7	
5042.62	3	2	19831.0		19825.1	
5041.46	8	4	19835.5		19829.6	
5040.67	4	3	19838.6		19832.7	
5040.39	5	3	19839.7		19833.8	
5039.86	7	2	19841.8		19835.9	
5039.03	5	—	19845.1		19839.2	
5038.91	5	2	19845.6		19839.7	
5038.42	9	7	19847.5		19841.6	
5038.23	(5?)	—	19848.3		19842.4	
5038.00	5	2	19849.1		19843.2	

THE TELLURIC LINES OF THE SOLAR SPECTRUM—*continued.*

Becker (Rowland)	Intensity		Oscillation Frequency	Reduc- tion to Vacuum	Oscillation Frequency in Vacuo	
	Horizon	Medium Altitude			Rowland	Ångström
5037·82	9	4	19849·9	5·9	19844·0	
5037·43	8	3	19851·4		19845·5	
5035·83	8	2	19857·7		19851·8	
5035·19	5	—	19860·2		19854·3	
5034·80	8	1	19861·8		19855·9	
5034·69	7	—	19862·2		19856·3	
5034·45	5	2	19863·1		19857·2	
5034·23	5	2	19864·0		19858·1	
5033·17	5	2	19868·2		19862·3	
5031·34	6	2	19875·4		19869·5	
5030·52	4	1	19878·7		19872·8	
5029·82	8	—	19881·4		19875·5	
5028·98	6	2	19884·7		19878·8	
5028·72	6	1	19885·8		19879·9	
5026·26	6	—	19895·5		19889·6	
5025·94	6	3	19896·8		19890·9	
5024·81	6	2	19901·3		18895·4	
5024·39	6	3	19902·9		19897·0	
5019·49	4	—	19922·4		19916·5	
5019·26	4	3	19923·3		19917·4	
5018·65	5?	—	19925·7		19919·8	
5018·55	11	9	19226·1		19920·2	
5018·00	5	1	19928·3		19922·4	
5017·23	5	2	19931·3		19925·4	
5016·07	5	1	19935·9		19930·0	
5015·33	4	2	19938·9		19933·0	
5006·90	4	2	19972·4		19966·5	
5004·48	5	3	19982·1		19976·2	
5002·75	4	2d	19989·0		19983·1	
4998·14	5	3	20007·4		20001·5	
4996·13	3	1	20015·5		20009·6	
4988·50	(3?)	2	20046·1		20040·2	
4984·91	4	1	20060·5		20054·6	
4983·69	4	1	20065·5		20059·6	
4981·48	6	2	20074·4		20068·5	
4975·95	3?	2	20096·7	5·9	20090·8	
4969·61	(3?)	2	20122·3	6·0	20116·3	
4969·41	(3?)	2	20123·1		20127·1	
4964·80	(4?)	2	20141·8		20135·8	
4913·10	2	—	20353·7		20147·7	
4902·52	4?	3	20397·7		20191·7	
4902·21	4?	3	20399·0		20193·0	

Interim Report of the Committee consisting of Professor THORPE, Professor HUMMEL (Secretary), Dr. PERKIN, Professor RUSSELL, Captain ABNEY, and Professor STROUD, on the Action of Light upon Dyed Colours. Drawn up by the Secretary.

THE primary object of the work of this Committee is to determine accurately the relative fastness to light of all the various colours at present employed by the dyer of textile fabrics. This is to be attained

by exposing to direct sunlight and the ordinary atmospheric influences, patterns of silks, wool, and cotton, specially dyed with the various natural and artificial colouring matters.

The work of purifying these colouring matters, dyeing the patterns, recording the dyed and faded colours of each pattern, &c., &c., must necessarily require much time. Moreover, owing to the very large number of colours to be examined, the long exposure needed to give useful results (one year at least), and the limited capacity of the exposing frame employed, the work will naturally proceed but slowly, and will extend over a period of some years.

During the past year the Secretary of the Committee has been engaged in collecting samples of the colouring matters required for the investigation, and in making preliminary exposure experiments with the view of determining the best method of procedure to be adopted.

Having decided to expose the patterns in groups according to colour, the work of purifying and dyeing with the *red* colouring matters has been begun, and is now in progress in accordance with a scheme in the hands of members of the Committee.

Of the 20*l.* originally granted to the Committee at the last meeting of the Association in Leeds, the sum of 17*l.* 10*s.* has been expended in the purchase of the necessary silk, wool, and cotton material, also an exposing frame, which has been erected at Adel in the neighbourhood of Leeds.

Particulars of this expenditure have been forwarded by the Chairman of the Committee to the General Treasurer.

Report (provisional) of a Committee, consisting of Professors M'LEOD and W. RAMSAY, and Mr. W. A. SHENSTONE (Secretary), appointed to investigate the Influence of the Silent Discharge of Electricity on Oxygen and other Gases.

THE Committee regrets to state that, owing to various circumstances, very little further progress has been made during the past year. The necessary means for securing assistance in part of the work have, however, lately been secured, and its continued progress may therefore now be looked for; and it is recommended that the Committee be reappointed.

No grant is asked for, as the necessary apparatus is at the command of the Committee.

Third Report of the Committee, consisting of Professors H. M'LEOD (Chairman), ROBERTS-AUSTEN (Secretary), and REINOLD, and Mr. H. G. MADAN, appointed for the Continuation of the Bibliography of Spectroscopy.

THE collection and verification of the titles of papers on spectroscopy have been continued during the past year, but there is not yet sufficient matter for publication.

The Committee desire to be reappointed.

Fifth Report of the Committee, consisting of Professor TILDEN and Professor ARMSTRONG (Secretary), appointed for the purpose of investigating Isomeric Naphthalene Derivatives. (Drawn up by Professor ARMSTRONG.)

The isomeric dichloronaphthalenes.—Since the publication of the previous report Mr. Wynne and the writer have completed their examination of the dichloronaphthalenes. As mentioned in the third report, no fewer than twelve isomerides were reputed to exist; one of these, however—strange to say, the α -modification, the oldest member of the set—has proved to be non-existent as a distinct isomeride, being a mixture of two others inseparable by the ordinary methods of crystallisation; while another has been shown to have been improperly ranked as a dichloro-derivative, being a trichloronaphthalene. The remaining ten have been characterised and their constitution determined by logical and consistent arguments, which leave no doubt that they actually are the ten dichloronaphthalenes which, according to theory, can exist if the simple double hexagon formula for naphthalene be adopted.

The formulæ of the ten dichloronaphthalenes are given in the table below, those of the acids into which they are converted on sulphonation being given in the second column of the table, and those of the corresponding trichloronaphthalenes in the third. In this table S is printed for SO_3H ; the melting points of the chloride and amide of the acid are indicated below the symbol of the acid.¹

$\alpha\alpha$ -Dichloronaphthalenes.

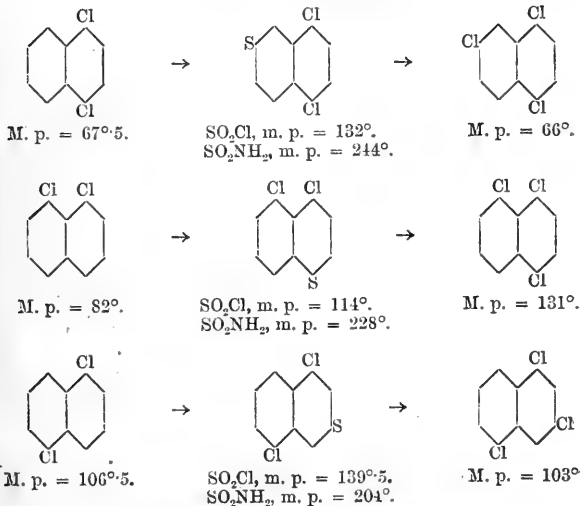

¹ Cf. *Chem. Soc. Proceedings*, 1890, pp. 77-84.

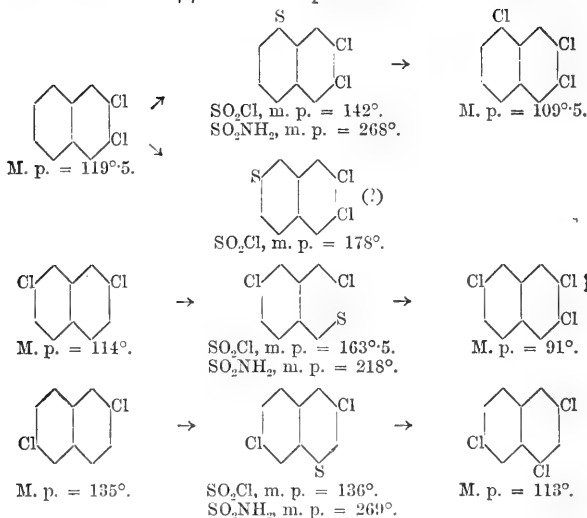
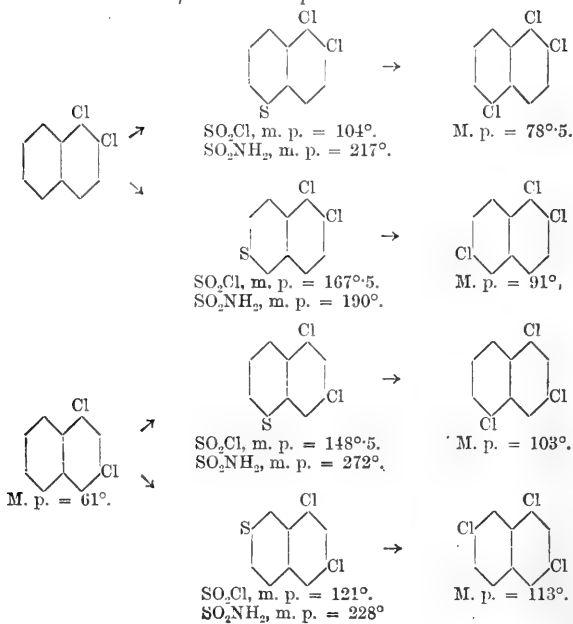
ββ-Dichloronaphthalenes.*αβ-Dichloronaphthalenes.*

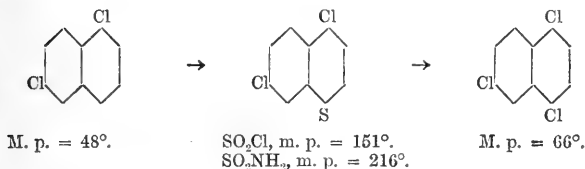
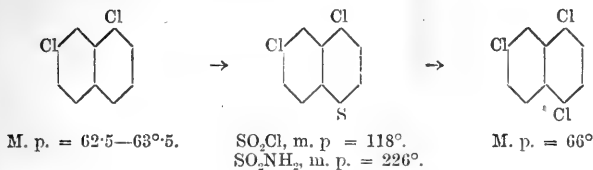

The establishment of the existence of such a series of ten isomerides formed by the introduction of but two atoms of chlorine into a hydrocarbon is in itself remarkable; it is still more remarkable when the diversity of properties which the isomerides manifest is taken into consideration; moreover the identification of ten isomerides and the recognition of their constitution afford striking testimony to the completeness of modern methods of inquiry and the truth of our theory of constitution: however much our symbols may differ from actuality, there cannot be a doubt that they afford a most accurate presentment of intramolecular relationship.

It may be added that the facts now established place it beyond question that the hydrocarbon naphthalene has a symmetrical structure such as is indicated by the conventional double hexagon formula; it remains to solve the far more difficult problem involved in the determination of its exact inner structure.

The opportunity afforded by a series of ten isomerides for the comparative study of physical properties in their relation to constitution is obviously very great, and it is intended ere long to enter on this branch of the inquiry.

The isomeric dibromonaphthalenes.—With the object of securing the data necessary for the exact comparison of the chloro- and bromo-derivatives of naphthalene, and especially the behaviour of naphthalene towards chlorine and bromine, much time has been devoted by the writer and Mr. Rossiter to the study of the dibromonaphthalenes. The results are not yet sufficiently complete to render their publication desirable.

The isomeric trichloronaphthalenes.—Theoretically fourteen isomeric trichloronaphthalenes can exist. As the determination of the constitution of a large number of naphthalene derivatives—including many of technical importance—is dependent on a knowledge of the trichloronaphthalenes, Mr. Wynne and the writer have paid much attention to their study; besides the seven already known, they have succeeded in preparing six others, and are at present endeavouring to prepare the only modification which remains to be discovered. The melting points of the thirteen known trichloronaphthalenes and their probable constitution are indicated in the following table, in which also are given the letters by which they have been distinguished.

—	Constitution	Melting Point	—	Constitution	Melting Point
[α]	1 : 2 : 3	81°	[η]	1 : 3 : 2'	113°
—	1 : 2 : 4	92°	[θ]	1 : 3 : 3'	80°
—	1 : 2 : 1'	unknown	[γ]	1 : 3 : 4'	103°
—	1 : 2 : 2'	84°	[δ]	1 : 4 : 1'	131°
—	1 : 2 : 3'	92°·5	[ϵ and ζ]	1 : 4 : 2'	66°
—	1 : 2 : 4'	78°·5	—	2 : 3 : 1'	109°·5
? [β]	1 : 3 : 1'	90°	—	2 : 3 : 2'	91°

It will be noticed that three modifications melt at about 80°, and four near to 90°; hence it is important to ascertain the distinctive properties of the several modifications, so that their identification may be rendered easy and certain. This difficult and wearisome task will, it is hoped, be completed during the coming year.

Naphthalenedisulphonic acids.—By eliminating the NH_2 group from beta-naphthylaminedisulphonic acid 'G', Mr. Wynne and the writer, since the publication of the last report, have succeeded in preparing naphthalene 1 : 3 or *meta*-disulphonic acid; the same acid has been independently prepared in this manner in the laboratory of the Badische Anilin und Soda Fabrik. It is noteworthy that although in a measure the analogue of benzenemetadisulphonic acid, which readily yields resorcinol on fusion with alkali, naphthalene 1 : 3 disulphonic acid is converted by fusion with alkali with remarkable facility into a trihydroxynaphthalene. Five of the ten possible disulphonic acids are therefore now known. Their properties are summarised in a table in the 'Chemical Society's Proceedings,' 1890, p. 14.

Naphthylamine-, naphthol- and chloronaphthalene-disulphonic acids.—A large number of disulphonic acids of the naphthylamines and naphthols are now in technical use,¹ and both on this account and in order to obtain the material for a discussion of the comparative influence of NH_2 and OH , the constitution of these acids has been determined by Mr. Wynne and the writer, and they have also prepared disulphonic acids by sulphonating the chloronaphthalenesulphonic acids in order to compare the influence of what may be regarded as a neutral radicle with that of the alkylic NH_2 and acidic OH ; the results have been recorded during the past two years in nine communications to the Chemical Society, and appear in the 'Proceedings.' One interesting result of the examination of the disulphonic acids, to which attention may be called, is that apparently there is an 'invincible objection' on the part of two SO_3H groups to remain in either contiguous or para- or peri-positions. The expression 'remain in' is used advisedly, as it appears probable that initially such positions are not infrequently taken up by sulphonic groups.

The formation of beta-derivatives.—In previous reports emphasis has over and over again been laid on the fact that in the majority of cases naphthalene gives rise to *alpha*-derivatives, *beta*-derivatives being formed only when a group is present which determines the entry of the new group into the contiguous beta-position or owing to the occurrence of secondary change. Attention must now be called to certain important exceptions to this rule.

¹ A very complete description of the various naphthalene derivatives which are used technically will be found in the art. Naphthalene by Mr. Wynne in the recently-published vol. ii. of Thorpe's *Dictionary of Applied Chemistry* (Longmans).

One of these exceptions is that afforded by the formation from naphthalene 1 : 3' disulphonic acid on nitration of a nitro-acid of the formula

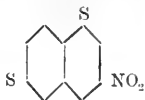

(cf. 'Chem. Soc. Proceedings,' 1891, p. 27); this acid, however, is but a subsidiary product, the main product being an acid of the formula

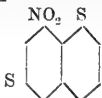

It has long been known that when the 1 : 4' disulphonic acid is nitrated, it yields an α -nitro-acid; recently Mr. Wynne and the writer have found that the product also contains the isomeric β -nitro-acid.

Other exceptions are afforded by the production of beta-chloro- and bromo-naphthalene on chlorination and bromination of naphthalene;¹ and by the presence of a certain proportion of beta-naphthylamine in commercial alpha-naphthylamine—a proof that naphthalene yields some beta-nitronaphthalene on nitration; the writer's attention has been called to this last fact both by Dr. H. Caro and by Professor Noeltling.

Lastly Mr. Rossiter and the writer have found that beta-naphthol when brominated yields a dibromo-derivative of the formula

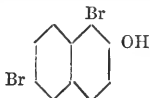

and in this case there appears to be no alpha-compound formed, so that the departure from the alpha-law is complete.

But the explanation of these results is not difficult. In no case probably is the substitution derivative the direct product of change; but its formation is preceded by that of an addition compound. This is generally admitted in the case of chloro- and bromo-derivatives, but evidence of the formation of addition compounds has not hitherto been forthcoming in other cases. Mr. Rossiter and the writer, however, have recently given proof that a compound with nitric acid is initially formed in the process of nitration.² Obviously, in the case of a symmetrical molecule such as that of bromine, either an alpha- or a beta-derivative will result, according as either the beta- or the alpha-atom of bromine becomes eliminated from the bromide, thus:—

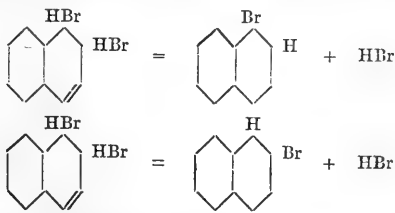

¹ Cf. *Chem. Soc. Proceedings*, 1890, p. 85.

² *Ibid.*, 1891, p. 89.

The alpha-law in this case is expressed by saying that in the main the tendency is for the beta-bromine atom to be removed.

In the case of a dissymmetrical molecule, such as that of nitric acid, the formation of the one or the other derivative will depend on the nature of the addition compound—*i.e.*, on the distribution of the radicles of the acid—assuming them to be 'distributed' when addition takes place, thus:—

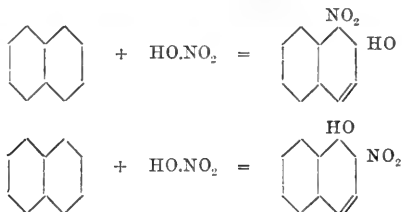

In this case the alpha-law is expressed in the statement that in the main the tendency is for the acid radicle to assume an alpha-position in the addition compound first formed.

This question has already been discussed by Mr. Wynne and the writer with reference to the tetra-chlorides of naphthalene and of its derivatives, naphthalene tetrachloride affording the three possible dichloronaphthalenes, but the 1:3 compound in largest and the 1:2 in least proportion, thus:—

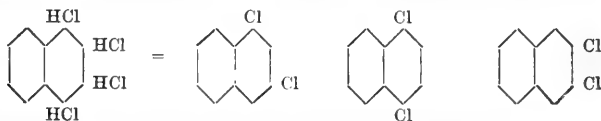

The behaviour of the substituted chlorides is as follows:—

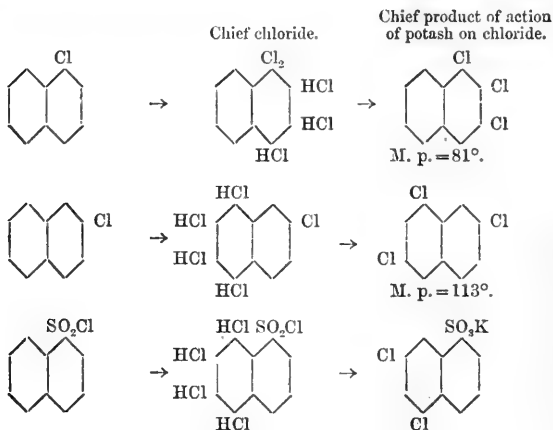

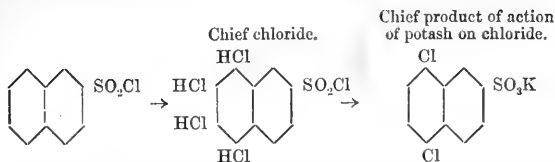

The influence of the substituent both as affecting the addition of chlorine and the elimination of hydrogen chloride is especially noteworthy. It will be seen that the sulphochlorides behave alike, but the two chloronaphthalenes dissimilarly towards chlorine, and that each compound decomposes in a manner peculiar to itself on treatment with alcoholic potash.

As yet no evidence has been obtained that a *beta*-bromo-, chloro-, or nitro-derivative may result by isomeric change from a previously formed *alpha*-derivative.

With regard to the *sulphonic acids*, on reference to the previous table in which the constitution of the acids formed on sulphonating the ten dichloronaphthalenes is indicated, it will be observed that in some cases an *alpha*- and in some cases a *beta*-sulphonic acid is formed, or a mixture of both. Mr. Wynne and the writer have expressed the opinion that the *alpha*-acid is always initially produced, and that in some cases this is so unstable that it spontaneously passes over into the *beta*-isomeride and escapes observation, while in others it is partially preserved. They base this conclusion on the fact that in all cases hitherto studied in which both acids are formed it is possible to convert the *alpha*- into the *beta*-acid by heating. Thus 1 : 2-dichloronaphthalene affords about two-thirds *alpha*- and one-third *beta*-acid; but when the product is heated the latter is practically the sole product. In like manner the initial product of sulphonation from 1 : 3-dichloronaphthalene contains about one-fifth *beta*-acid; but if it be heated at 160° during eighteen hours complete conversion into the *beta*-isomeride is effected.

Should this conclusion with reference to the manner in which *beta*-sulphonic acids are formed be ultimately established it would follow that, unlike nitric acid, sulphonating agents regularly act in one way, and that the formation of the addition compound takes place in such a manner that the sulphonic radicle always attaches itself in an *alpha*-position.

Isomeric change in the case of sulphonic acids.—The problems which this subject presents are of extreme interest; some idea of their character is afforded by the following example. When heated at about 150–160° 1 : 4 *alpha*-chloronaphthalene sulphonic acid undergoes a change into the more symmetrical *alpha*-isomeride, while 2 : 1'-*beta*-chloronaphthalenesulphonic acid is converted in a similar manner into the more symmetrical *beta*-isomeride—results which may be regarded as indicative of a tendency to a final state of symmetry, thus :—

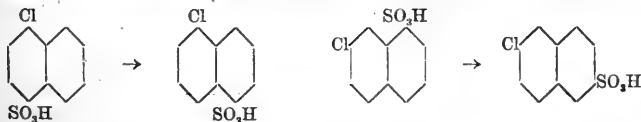

In the case of the dichlorosulphonic acids it is noteworthy that the

position ultimately taken up by the SO_3H radicle appears to be determined by the beta-chlorine-atom, perhaps because the β -sulphonic acids are the most 'degraded' products, thus:—

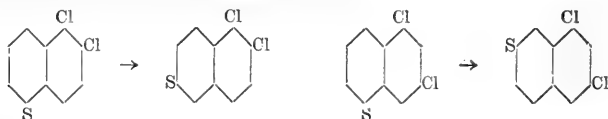

With reference to these examples it may be pointed out that the apparent passage of the sulphonic radicle in the one case from one nucleus into the other, in another from an alpha- into the contiguous beta-, and in a third from an alpha- into the more distant beta-position, are remarkable variations of the phenomenon of intramolecular mobility.

There is a striking difference in the behaviour of the 1 : 4, 1 : 4', and 1 : 2 *aa*-dichloronaphthalenes, to which attention may be directed, the non-formation of the acid containing a chlorine atom and the sulphonic radicle in the 1 : 1' position being noteworthy, thus:—

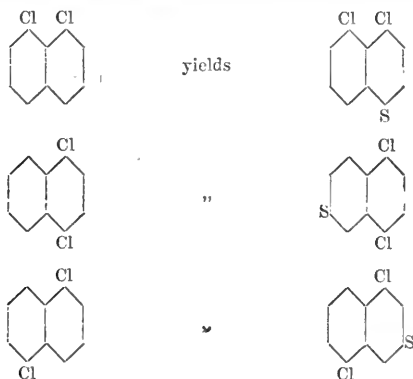

In the case of the 1 : 4 and 1 : 4' compounds the sulphonyl radicle is obviously influenced in two directions, and may be said to take up a mean position.

A case of isomeric change which at present appears altogether paradoxical is that which is said to occur on heating sodium naphthionate ($\text{NH}_2 : \text{SO}_3\text{Na} = 1 : 4$) at $200\text{--}250^\circ$, whereby it is converted into the isomeric 1 : 2-compound.

The foregoing brief reference to the work of the Committee will suffice to show that the study of naphthalene derivatives is fraught with interest, more especially as it is to be anticipated that results of general application will be obtained in the course of the inquiry.

Fifth Report of the Committee, consisting of Professors TILDEN, MCLEOD, PICKERING, RAMSAY, and YOUNG and Drs. A. R. LEEDS and NICOL (Secretary), appointed for the purpose of reporting on the Bibliography of Solution.

DURING the past year no progress has been made with the work of cataloguing the papers on Solution in the few remaining selected journals.

The Committee invite the co-operation of members who have access to large scientific libraries and are willing to take an active part in the work.

Fifth Report of the Committee, consisting of Professors TILDEN and RAMSAY and Dr. NICOL (Secretary), appointed for the purpose of investigating the Properties of Solutions.

THE Committee have to report that, owing to the pressure of other work, but little progress has been made with experiments on the atomic volumes of carbon, hydrogen, and oxygen when substances containing these elements are dissolved in water or other solvents. A preliminary research on the volume of oxygen in the oxy-acids of chlorine, bromine, and iodine has been completed with somewhat startling results, which lead the Committee to hope that valuable data will be obtained when the work is complete.

Third Report of the Committee, consisting of Professor ROBERTS-AUSTEN (Chairman), Sir F. ABEL, Messrs. E. RILEY and J. SPILLER, Professor J. W. LANGLEY, Mr. G. J. SNELUS, Professor TILDEN, and Mr. THOMAS TURNER (Secretary), appointed to consider the best method of establishing an International Standard for the Analysis of Iron and Steel. (Drawn up by the Secretary.)

IN the two previous reports of this Committee the objects of the Committee were defined, and an account was given of the preparation and distribution by the American Committee of four out of the five international steel standards which Professor Langley had been requested and had kindly undertaken to prepare. A year ago it was hoped that a final report would be presented at the Cardiff meeting, but, unfortunately, this hope has not been realised, and the completion of the work has been deferred. In the second report mention was made of the fact that the American Committee had entered upon an investigation of the relative accuracy of different methods of analysis, particularly in connection with the estimation of carbon in steel. This work was not considered within the province of the British Association Committee when its objects were

defined in accordance with the discussion which took place at Bath and with subsequent correspondence with Professor Langley.

The British Association Committee have during the past year carefully considered the course of action taken by the American Committee and the position of British analysts now that the scope of the inquiry entered into by the former has been thus enlarged, and it has been considered advisable to publish the results of the determinations of the British analysts as soon as their work is completed. This view was communicated to Professor Langley, who in a letter received on August 7, 1891, endorses the proposed publication of the results hitherto obtained by the British Association Committee.

Owing to the very short time which has elapsed since the receipt of Professor Langley's letter and the fact that two of the British analysts have not yet forwarded their reports to the Committee, it has not yet been possible to institute a comparison of results obtained, but no time will be lost in completing the examination of the four standards at present in hand and in then preparing a report on the English results. Dr. Wedding has informed Professor Langley that the work of the German Committee is now nearly completed.

The fifth standard has not yet been prepared, some difficulty having been met with in obtaining so large a quantity of mild steel of perfectly uniform composition. It was originally proposed to make the standard of basic steel, but it was urged that greater uniformity could be obtained with crucible metal. Professor Langley states that he has made several attempts to make crucible steel sufficiently low in carbon, but finds it impossible to do so in the plumbago crucibles used in the United States. This matter is now under consideration, and it is hoped the fifth standard will be prepared shortly.

Report (provisional) of a Committee, consisting of Professors H. E. ARMSTRONG and W. R. DUNSTAN and Messrs. C. H. BOTHAMLEY and W. A. SHENSTONE (Secretary), appointed to investigate the direct formation of Haloid Compounds from pure materials.

HAVING confirmed Wanklyn's early observation that carefully dried chlorine was practically without action on sodium, R. Cowper in 1883 ('Chem. Soc. Journ.' 1883, pp. 153-155) made a number of experiments on the behaviour of dried chlorine towards other metals, and in several cases found that if dried by contact with freshly-fused calcium chloride it was without action. Thus Dutch metal was apparently still unacted on after three months' exposure in the dried gas; and zinc, in the form of foil, and magnesium wire were also unattacked. Silver and bismuth, however, were slightly acted on, and tin, antimony, and arsenic were rapidly attacked; mercury appeared to be acted on as rapidly by dried chlorine as by the moist gas.

Pringsheim has since shown that, even in the case of hydrogen and chlorine, the interaction is affected by the presence of moisture.

These, and similar observations by H. B. Dixon and others with reference to the formation of oxides from dry materials, render it desirable to more fully elucidate the conditions which determine the formation of

metallic and other chlorides and analogous compounds; and it is in this direction that the Committee are working.

Mr. Shenstone has already obtained results which are both interesting and suggestive. Chlorine prepared in the ordinary manner dried by exposure in contact with phosphoric oxide during several months was found to very readily attack mercury—a result in accordance with Cowper's observation. Nevertheless chlorine prepared in another manner was found to behave differently. With the object of testing the quality of chlorine prepared by heating platinous chloride in vacuo, tubes of such chlorine, dried by contact during several hours with phosphoric oxide, were opened under highly-purified recently-heated mercury: although the surface of the mercury in contact with the gas was very quickly tarnished, no sensible absorption occurred during many hours in daylight, but afterwards absorption took place, at first gradually, and subsequently with tolerable rapidity. Several such experiments were made with chlorine prepared from different specimens of platinous chloride, and in every case a colourless gaseous residue, not exceeding 5 per cent., was obtained, which proved to be partly soluble in water, partly in alkaline pyrogallate, and partly insoluble. (? Nitrogen.) The fact that absorption at first took place with exceeding slowness, and subsequently proceeded at a more and more rapid rate, is apparently a significant indication that the interaction of chlorine and mercury is conditioned by the presence of some third substance, and the importance of continuing the enquiry is unquestionable.

It is probable that the impurities in the gas from platinous chloride are derived from a basic compound. Mr. Shenstone finds that platinous chloride is to a slight extent volatile—a fact which is ordinarily overlooked, although it has been noticed by Mr. G. Matthey; hence the analysis of the substance by the ordinary method of ignition is liable to afford fallacious results.

Nearly 20*l.* has already been expended, chiefly in the purchase of platinum and platinum apparatus. The Committee desire to be re-appointed, with a grant of 30*l.*, as the experiments are now being extended to a number of other compounds.

Provisional Report of the Committee, consisting of General FESTING, Captain ABNEY, and Professor H. E. ARMSTRONG (Secretary), on the Absorption Spectra of Pure Compounds.

THE determination of the spectra of the compounds which the Committee have fixed upon as essential has been continued, and several have been measured and classified. The work is very laborious and can only progress slowly owing to the difficulty of obtaining absolutely pure compounds, and other difficulties in the photographic method employed have also arisen. The Committee wish for reappointment to continue the investigation.

Nineteenth Report of the Committee, consisting of Professor PRESTWICH, Dr. H. W. CROSSKEY, Professors W. BOYD DAWKINS, T. MCKENNY HUGHES, and T. G. BONNEY and Messrs. C. E. DE RANCE, W. PENGELLY, J. PLANT, and R. H. TIDDEMAN, appointed for the purpose of recording the Position, Height above the Sea, Lithological Characters, Size, and Origin of the Erratic Blocks of England, Wales, and Ireland, reporting other matters of interest connected with the same, and taking measures for their preservation. (Drawn up by Dr. CROSSKEY, Secretary.)

IN their last report the Committee gave some of the general results of their survey of the erratic blocks in the Midland district of England; they are unable, however, this year still further to address themselves to the task of giving a scientific arrangement to the vast number of facts that have been collected in consequence of the number of new facts which have been reported to them, and which it is necessary to record before any more systematic generalisations can be attempted.

The destruction of erratics, moreover, is going on so rapidly that already many of those described in the reports of this Committee have disappeared, and in a few years these reports will be the chief evidence of the very existence of a large series of phenomena of great importance in glacial geology.

During the past year a N.W. of England Boulder Committee has been formed, with Mr. C. E. De Rance, F.G.S., as President and Mr. Percy F. Kendall, F.G.S., as Secretary, which has already done valuable work, and promises to accomplish a survey of the erratics of the district it has undertaken to explore, so thorough, as ultimately to render a scientific arrangement of the facts possible and enable their meaning to be understood.

The Committee have to thank the N.W. of England Boulder Committee for the following communications, which contain several features of especial interest:—

(1) The group of boulders reported from Hest Bank (Lancashire) is of importance. The stones are exclusively such as might have been derived from the country at present draining into the internal angle of Morecambe Bay. Account must be taken of this fact in any attempt to explain their origin.

(2) The area occupied by drift containing Lake District erratics is extended and help given towards defining the area of their distribution on the western slopes of the Pennine chain.

(3) The remarkable sporadic grouping of large boulders is shown; for example, in the group in the river Tame when taken in connection with the records of Cheshire groups.

(4) Evidence is given of the transport and glaciation of local blocks; e.g., by the discovery of a large angular block of Ardwick limestone at Haughton Green, the nearest known outcrop of the rock being about three miles to the N.W., as well as many other angular blocks of the same limestone.

(5) The mode of transport of some erratics and their behaviour

towards the solid rocks over which they have been carried are illustrated, the account given of the Levenshulme group furnishing evidence of ice in motion.

Many noteworthy boulders and groups of boulders are also described.

LANCASHIRE.

Reported by Mr. THOMAS RANSOME.

Bolton-le-Sands.—On eastern shore of Morecambe Bay, 1 mile north of Hest Bank Railway Station; 12 ft. 6 in. × 8 ft. × 8 ft.; oblong; moved; mountain limestone; fallen from boulder clay to the sea beach.

Group.

This is a series of specimens representing all the varieties met with in an examination of the boulder clay exposed in the cliffs at Hest Bank. The determinations are by Mr. P. F. Kendall, F.G.S.—

1. Shap granite.
2. Breccia; red base with large fragments; ? Brockram.
3. Grit; greenish grey; very fine and micaceous; ? Silurian.
4. Limestone; red base with many white encrinite stems; Carboniferous.
5. " black with lithostrotion; Carboniferous.
6. " pale buff with ochreous markings; Carboniferous.
7. " pale buff with encrinite stems; Carboniferous.
8. " earthy buff with mollusca; Carboniferous.
9. " dark buff with dendrites; Carboniferous.
10. " earthy red with *Spirifera glabra*; Carboniferous.
11. Chert with many microzoa; Carboniferous.
12. " black with cuboidal jointing; Carboniferous.
13. Grit; very coarse, dark red, with quartz and other pebbles the size of a pea; ? origin.
14. Sandstone, buff, speckled with brown; Carboniferous.
15. " dark brick red; micaceous; ? Carboniferous.
16. Grit; coarse quartzose with felspar; ? Millstone grit.
17. Breccia; andesitic with rhyolitic fragments; ? Yewdale breccia.
18. 'Hällefinta'; buff greenish; Borrowdale.
19. Rhyolite; liver-coloured; flinty with few felspars and no quartz; Borrowdale.
20. ? Volcanic rock, stained with copper; ? Borrowdale.
21. Breccia; andesitic with rhyolitic fragments; Yewdale.
22. Ash; greenish to purple; Borrowdale.
23. Mica trap. Cf. those of Sedbergh and Kendal.
24. Granite; a small fragment grey, with a portion of felspar crystals containing inclusions of quartz; ? Shap.

[All these rocks appear to have been derived from the area immediately to the northward.—P. F. K.]

Reported by the Rev. C. R. BARKER, S.J., B.A.

A group of boulders from Stonyhurst College, near Whalley, Lancashire. Stonyhurst lies four miles to the west of Whalley Station, at a height of 360 feet above O.D., on the gentle south-eastern slope of Longridge Fell. The whole district is made up of Yoredale limestones and shales beautifully exposed on the banks of the river Hodder to the north-east, and of the Yoredale grits which form the Longridge Fell and all the neighbouring hills; and up to a considerable height the country is covered with a uniform coat of boulder clay, from which (except when

otherwise specified) the erratics in question have been extracted. Glacial striæ may be seen on the mountain limestone at various points some five to six miles to the north-east, near Clitheroe: these striæ, as shown by the geological survey map, point a few degrees west of south.

The two rocks which seem to be most abundantly represented among the erratics found near Stonyhurst are—first, a compact, deep, purplish red Permian marl, which is slightly exposed four miles to the north-east, near Clitheroe; secondly, a compact yellow sandstone, very persistently characterised by speckles of brown iron-oxide. I have coupled this rock with the one first mentioned because I think it likely that it, too, is Permian or Triassic. The erratics composed of these two rocks all seem to be of quite small size.

Almost as numerous as the above mentioned, and far exceeding them in size, are boulders composed of various andesitic rocks, showing a strong family likeness, perfectly fresh and hard, of a grey colour, slightly varied in different specimens by greenish and bluish tints. Many of these measure a full cubic foot or more, and show well all the characters of ice-borne boulders. Most of them are certainly identical with rocks in Borrowdale (andesites of the well-known Borrowdale series).

Next, perhaps, in frequency of occurrence come small rounded or flattened boulders of a fine-grained rose-coloured rock of syenitic aspect.

Of another rock, also of syenitic aspect, but much larger grained, I procured a single boulder, the size of an infant's head, from a field-drain close to the college.

[Mr. Kendall is of opinion that both of these are varieties of the Buttermere granophyre.]

A single piece of a compact, homogeneous pink rhyolite, picked up within a mile or two of Stonyhurst.

This specimen seems to me certainly identical with a similar pink rhyolite, composing a remarkable group of large boulders a mile or two west of Dungeon Ghyll Hotel, near Grasmere, by the side of a broad path or cart-track leading up the valley to the west from the back of the hotel. Some of the boulders measured two or three cubic feet.

A few hundred feet above the college, on the slope of Longridge Fell, boulders of other than local rocks become very rare; at a height of 1,100 feet, or so, all drift has disappeared, while on the top, at a height of some 1,300 feet, I have often walked for miles, examining ground, walls, and cairn, and have never been able to find a single worn pebble or boulder—nothing but angular fragments of the local sandstone. On Fairsnape Fell, to the north, at about the same height, I have noticed the same fact.

Reported by Mr. G. J. C. BROOM, F.G.S.

Group.

St. Helen's.—New Street, on east side of borough between Lancaster Street and Coburg Street. Largest, 2 ft. × 1 ft. 6 in. × —; Smallest, 6 in. diam.; the majority were of small size; all water-worn. [? Rounded.—P. F. K.] They occurred in boulder clay about 10–20 ft. beneath the surface in a trench 600 ft. long and 6 ft. wide. About two cartloads were found. One specimen examined was of Buttermere granophyre. [P. F. K.] 6 in. × 4½ in. × 2 in.; flat; egg-shaped; water-worn [? Rounded.—P. F. K.]; finely scratched and grooved upon two faces;

grey sandstone or grit. [? L. Silurian of Lake District or Galloway.—P. F. K.]

Tontine Street, Central Ward. 1 ft. 4 in. × 10 in. × 7 in.; angular; scratched obscurely on the top side, which is flat; grey granite. [Galloway.—P. F. K.]

Water Street, Central Ward. 2 ft. × 1 ft. 10 in. × —; water-worn; grey granite.

Oxford Street, South Windle Ward. 7 ft. × 2 ft. × —; lying at present north and south, widest end north; andesite, L.D.¹; 160 ft. O.D.; ? if it has been moved by man.

Norman's Road, Sutton. 3 ft. × 2 ft. × 1 ft.; long axis north and south; water-worn; red granite [? Eskdale]; embedded in boulder clay at about 12 ft. deep.

Group.

St. Helen's, between Vincent Street and Charles Street, Hardshaw Ward.—This group consists of red granite and blue (trap) rock varying in size from 3 in. diam., egg-shaped, to about 27 in. diam. and 10 in. to 20 in. deep. They occur in the space of every 20 yards square, in about equal proportions as to rock; if anything the blue predominates. But few show scratches and all are water-worn [? rounded]. [The specimens, eleven in number, accompanying this report comprised the following:—

Andesites (L.D.)	6
Buttermere granophyre	1
Eskdale granite?	1
Galloway granites	3

11

—P. F. K.]

The following list was of the larger sizes taken at random:—

- (a) 2 ft. 3 in. × 2 ft. 3 in. × 1 ft. 8 in.; angular; flat on top; red granite.
- (b) 1 ft. 8 in. × 1 ft. 9 in. × 10 in.; angular; flat on top; well-defined scratches, though not deep; blue [? andesite].
- (c) 1 ft. 8 in. × 1 ft. 3 in. × 9 in.; angular; blue [? andesite].
- (d) 2 ft. 11 in. × 3 ft. × —; angular; blue [? andesite]; *in situ*.
- (e) 2 ft. × 1 ft. 6 in. × 9 in.; angular; blue [? andesite].

These cover an area of about an acre. The smaller sizes are given as about 50 cartloads to about 70–100 square yards superficial.

- (f) Three boulders, each about 1 ft. 6 in. × 1 ft. 2 in. × 8 in.; angular; red granite.
- (g) 2 ft. 1 in. × 1 ft. 6 in. × 1 ft.; angular; coarse-grained grey granite [? Galloway].
- (h) Three others of like size, but not accessible.

Reported by Mr. S. S. PLATT, Assoc. Mem. Inst. O.E.

All the following are from the neighbourhood of Rochdale:—

Facit.—At top of incline in H. Heys & Co.'s quarry—

- (1) 2 ft. 10 in. × 1 ft. 10 in. × 2 ft.; subangular; striated at top; granophyre, Buttermere.
- (2) 1 ft. 2 in. × 1 ft. × 10 in.; rounded; weathered.

¹ L.D. = Lake District.

- (3) $8\frac{1}{2}$ in. \times 6 in. \times $7\frac{1}{3}$ in.; rounded; granophyre, Buttermere.
 (4) 8 in. diam.; rounded.
 (4A) 5 in. \times 5 in. \times 5 in.; rounded.

Mean Hey Quarry—

- (5) 5 in. \times 4 in. \times 4 in.; angular; rhyolite; L.D. [= Lake District, and below].
 (6) $1\frac{1}{2}$ in.; pebble; quartzite. (Found near Nos. 5 and 7 in drift under peat.)
 (7) 3 in. \times 3 in. \times 3 in.; angular; andesite; L.D.
 (8) $5\frac{1}{2}$ in. \times $3\frac{1}{4}$ in. \times $3\frac{1}{2}$ in.; subangular; andesite; L.D.
 (9) 9 in. \times 6 in. \times 7 in.; rounded; granite.

Near Butterworth and Brooks' office in quarry—

- (10) 10 in. \times 6 in. \times 4 in.; subangular; faintly scratched in direction of long axis; ? Needle's Eye; syenite.

[I think it probable that this and other specimens so named may be abnormal varieties of the Buttermere granophyre.—P. F. K.]

- (11) About same dimensions as 12; andesite; L.D.
 (12) 1 ft. 3 in. \times 1 ft. 6 in. \times 1 ft.; weathered; andesite; L.D.
 (13) 2 ft. 4 in. \times 1 ft. 11 in. \times 1 ft. 8 in.; subangular; polished on top but not scratched. (This lay just under the peat, which is here 8 ft. thick.)
 (14) 4 in. \times 4 in. \times 2 in.; flat; quartz.
 (14A) 1 ft. $\frac{1}{2}$ in. \times 9 in. \times 6 in.; slightly scratched in direction of long axis; granophyre, Buttermere.
 (15) 9 in. \times $4\frac{1}{2}$ in. \times 4 in.; flattened; polished; granophyre, Buttermere.
 (15A) 9 in. \times $7\frac{1}{2}$ in. \times $5\frac{1}{2}$ in.; subangular; polished; granophyre, Buttermere.

Hall Cowm Quarry—

- (16) 1 ft. 8 in. \times 1 ft. \times 9 in.; scratched in direction of long axis; marks $\frac{1}{16}$ in. deep; chert.
 (17) $6\frac{1}{2}$ in. \times 4 in. \times $2\frac{1}{2}$ in.; subangular; scratched in direction of long axis.
 (18) $10\frac{1}{2}$ in. \times 7 in. \times 5 in.; subangular.

Ditto, on Cowm side—

- (19) 12 in. \times 9 in. \times 6 in.; rounded; porphyritic andesite; L.D.
 (20) 8 in. \times 6 in. \times 4 in.; rounded; granophyre, Buttermere.

Ditto, above Cowm—

- (21) 8 in. \times 6 in. \times 5 in.; slightly scratched in direction of long axis; andesite; L.D.

Group.

Heywood.—Hopwood brickworks, about 1 mile south of the centre of Heywood. The section shows a bed of purple boulder clay 7 feet thick, covered by drift-sand about 6–7 feet thick. Where unspecified the boulders are from the clay. About 460 feet above O.D.

- (58) 8 in. \times 4 in. \times 5 in.; angular; Carboniferous limestone.
 (59) 1 ft. 6 in. \times 1 ft. 6 in. \times 9 in.; subangular; weathered; ? variety of Creetown granite; from drift sand.
 (60) 7 in. \times 6 in. \times 3 in.; subangular; longitudinally scratched; porphyrite; L.D.
 (61) 10 in. \times 9 in. \times 8 in.; rounded; granite; Eskdale.
 (62) 9 in. \times 6 in. \times 6 in.; rounded; andesitic agglomerate; L.D.
 (63) 8 in. \times 5 in. \times 3 in.; angular; andesite; L.D.
 (64) 9 in. \times 6 in. \times 5 in.; flattened; slightly scratched at ends; granophyre, Buttermere.
 (65) 1 ft. \times 9 in. \times 8 in.; rounded; andesite; L.D.
 (66) 1 ft. \times 9 in. \times 8 in. (in two pieces); andesite; L.D.

- (67) 10 in. × 7 in. × 6 in.; subangular; crossed scratches on flat face; andesite; L.D.
 (68) 1 ft. × 1 ft. × 8 in.; ellipsoidal; scratched longitudinally; quartzose rock.
 (69) 8 in. × 10 in. × 8 in.; rounded with one flat face; a little scratched near ends; variety of granophyre, Buttermere.
 (70) 1 ft. × 10 in. × 7 in.; rounded with flattened faces; scratched on faces; quartzose rock.
 (71) 1 ft. 3 in. × 9 in. × 5 in.; subangular; well scratched longitudinally and some cross scratches; quartzose rock.
 (72) 1 ft. 2 in. × 10 in. × 9 in.; rounded; granite, Eskdale.
 (73) 10 in. × 8 in. × 5 in.; subangular; scratched on flat side; quartzose rock.
 (74) 10 in. × 8 in. × 5 in.; subangular; much striated; quartzose rock.
 (75) 6 in. × 5 in. × 4 in.; angular; rhyolitic ash; L.D.
 (76) 1 ft. 6 in. × 1 ft. 1 in. × 9 in.; longitudinally scratched; red-brown gritstone.
 (77) 6 in. diameter; rhyolite; L.D.
 (78) 8 in. × 6 in. × 5 in.; purple gritstone.
 (79) 1 ft. × 9 in. × 9 in.; subangular; scratched; andesite with epidote; L.D.
 (80) 9 in. × 6 in. × 4 in.; subangular; quartz porphyry.
 (81) 6 in. × 8 in.; quartz porphyry.

With these are many limestones and andesites 3 in.–6 in. in diameter. Many of them are scratched.

Heywood.—In hedge on west side of road—

- (82) 1 ft. 5 in. × 1 ft. 4 in. × 10 in.; subangular; flattened; granophyre, Buttermere.
 (83) 1 ft. 6 in. × 1 ft. × 1 ft.; subangular; granite.
 (83A) 1 ft. × 10 in. × 10 in.; subangular; andesite; L.D.

Near Heber's toll-gate—

- (84) 1 ft. 6 in. diameter; andesite; L.D.

Rochdale.—King Street South, Grove Street—

- (97) 9 in. diameter; granite. Cf. Dalry, New Galloway. O.D. 470 feet; out of gravel about 6 feet below surface.
 (98) — × 5 in. × 4 in.; granite, Galloway.

Between Burn Edge and Knot Booth, $2\frac{1}{4}$ miles south-east of centre of Rochdale, above side of road—

- (99) 4 ft. × 2 ft. × 1 ft. 9 in.; subangular; sandstone or grit.

Near Haugh Hey, in field above Wood Mill—

- (100) 2 ft. 6 in. × 2 ft. 6 in. × 2 ft.; very much rounded with hummocky ends; andesitic agglomerate; L.D.
 (101) 1 ft. 2 in. × 11 in. × 10 in.; subangular; granophyre, Buttermere.
 (102) 2 ft. 3 in. × 1 ft. 9 in. × 1 ft. 3 in.; subangular with flattened sides; scratched longitudinally; quartz felsite with epidote.

Group.

Sparth Bottoms, Norman Road, half a mile S.W. of Town Hall, Rochdale. The section (which is for brick clay) shows above 16 ft. of strong purple boulder clay surmounted by 9 ft. of drift sand and gravel. The gravel is at the top, and is about 4 ft. thick. The bottom of the cutting is at about 400 feet O.D.

- (105) 8 in. × 6 in. × 4 in.; subangular; granite, Galloway.
 (106) 8 in. × 6 in. × 6 in.; subangular; andesite; L.D.
 (107) 9 in. × 8 in. × 4 in.; flattened; scratched longitudinally; grit.

- (108) 2 ft. 4 in. × 1 ft. 9 in. × 1 ft.; subangular; scratched longitudinally; Clitheroe grey limestone. [? Locality.—P. F. K.]
 (109) 6 in. × 4 in. × —; rounded; granite, Galloway.
 (110) 7 in. × 5 in. × 4 in.; rounded; granite ? Cairnsmore of Fleet.
 (111) 2 ft. 6 in. × 1 ft. 8 in. × 1 ft.; rectangular; scratched longitudinally, and on one side diagonally; sandstone grit.

There are many like this about 3 ft. × 2 ft., and many andesitic and breccias or agglomerates about 3 in.—4 in. diameter.

- (111A) 2 ft. 6 in. × 1 ft. 8 in. × 1 ft. 4 in.; 'cank.'
 (112) 6 in. × 4 in. (broken); granite with red felspar; Galloway.
 (113) 7 in. × 6 in. × 5 in.; scratched longitudinally and at rounded corners; limestone.
 (114) 5 ft. × 2 ft. × 1 ft. 9 in.; long and angular; well scratched and grooved longitudinally; 'cank.'
 (115) 1 ft. 2 in. diam.; nearly spherical; subangular; sandstone grit.
 (116) 3 in. × 2 in. × —; granite ? var. of Eskdale.
 (117) 3 in. × 2 in. × —; granite, Eskdale.
 (118) 1 ft. 7 in. × 1 ft. 2 in. × 7 in.; subangular to round; much scratched longitudinally and diagonally; flag-rock.
 (119) 4½ in. × 3 in. × 3 in.; oval; purple quartzite.
 (120) 10 in. × 7 in. × 6 in.; rounded; rectangular; granite ? var. of Eskdale.
 (121) 7 in. × 5 in. × —; subangular; granite, Galloway.
 (122) 7 in. × 7 in. × 4 in.; andesite; L.D.
 (123) 7 in. × 6 in. × 4 in.; subangular; ? var. of granophyre, Buttermere.
 (124) 4 in. × 3 in. × —; subangular; rhyolite; L.D.
 (125) 3½ in. × 2½ in. × 2½ in.; subangular; granite ? Cairnsmore of Fleet.
 (126) 5 in. × 4 in. × —; rounded; grey granite ? var. of Creetown.
 (127) 1½ diam.; subangular; scratched; hematite. [There were several of these.]
 (127A) 4 in. × 2 in.; triangular; hornblende-andesite; L.D.
 (127B) —; well scratched; red variety of Carboniferous limestone. [This much resembles the rocks exposed in the bed of the Ribble, near Mytton Bridge.—P. F. K.]

Group.

Greenbooth, Naden Valley, two miles N.W. of the centre of Rochdale—

- (128) 2 ft. × 1 ft. 6 in. × 1 ft. 6 in.; subangular; granophyre, Buttermere.
 (129) 2 ft. × 1 ft. 6 in. × 1 ft.; subangular; broken; granophyre, Buttermere.
 (130) 1 ft. 6 in. × 1 ft. × 1 ft.; subangular; quartz porphyry.
 (131) 2 ft. 6 in. × 2 ft. × 1 ft. 6 in.; rectangular with rounded corners; under side flattened and scratched longitudinally; granophyre, Buttermere.
 (132) 3 in. × 2 in. × —; rectangular; quartzite.
 (133) About 1 in. cube; hematite.
 (134) 1 ft. 4 in. × 9 in. × 8 in.; subangular; granite, Eskdale.
 (135) 1 ft. 6 in. × 1 ft. × 8 in.; subangular; smoothed; ? syenite, Needle's Eye, Colvend [see No. 10].
 (136) 1 ft. 6 in. × 8 in. × 4 in.; flat; angles very little rounded; quartz felsite with epidote.
 (137) 1 ft. 4 in. × 1 ft. 1 in. × 7 in.; subangular; granophyre, Buttermere.
 (138) 1 ft. 8 in. × 1 ft. 3 in. × 10 in.; rectangular; bedded ash; ? Borrowdale; L.D.
 (139) 1 ft. 2 in. × 9 in. × 7 in.; subangular; hornblende-andesite; L.D.
 (140) 1 ft. 3 in. × 9 in. × 10 in.; irregular; rhyolite; L.D.

Group.

Heywood Waterworks Reservoir, 675 ft. O.D., near by-wash of lowest reservoir near Meter House; many andesites and syenites, about 2 ft. diameter and upwards.

Heywood Waterworks Reservoir, in bottom of lowest reservoir near iron-pipe outlet—

- (141) 2 ft. × 2 ft. × 1 ft.; subangular; scratched at sides; granophyre, Buttermere.
 (142) 5 in. × 3 in. × —; oval; quartz vein-stuff; L.D.
 (143) 2 ft. × 1 ft. 6 in. × 1 ft.; subangular; sides smoothed; granophyre, Buttermere.
 (144) 2 ft. × 1 ft. 4 in. × 1 ft. 2 in.; irregular; subangular; smoothed and weathered; ? syenite, Needle's Eye, Colvend [see No. 10].
 (145) 3 ft. × 2 ft. × —; smoothed; weathered; granophyre, Buttermere.
 (146) 1 ft. × 9 in. × 6 in.; granophyre, Buttermere.
 (147) 1 ft. 6 in. × 1 ft. 6 in. × —; volcanic ash; L.D.
 (148) 2 ft. × 2 ft. × 1 ft. 2 in.; rounded; granophyre, Buttermere.

At foot of by-wash to middle reservoir.

- (149) 6 in. × 6 in. × 1½ in.; flattened; quartzose grit.
 (150) 2 ft. 3 in. × 2 ft. 3 in. × 1 ft. 2 in.; subangular; rounded ends; scratched longitudinally; ? syenite, Needle's Eye, Colvend [see No. 10].
 (151) 1 ft. 10 in. × 1 ft. 10 in. × 1 ft.; angular to subangular; flattened and rounded; ? syenite, with marked crystals of epidote [see No. 10].
 (152) 2 ft. 6 in. × 2 ft. 6 in. × 1 ft.; subangular; smoothed; ? syenite, with marked crystals of epidote [see No. 10].
 (153) 3 ft. × 2 ft. × 1 ft. 6 in.; irregular; subangular; smoothed and weathered; ? syenite, with marked crystals of epidote [see No. 10].

Near Moorside, west side Spring Mill Reservoir, Rochdale Waterworks, about 850 O.D.—

- (158) 4 ft. × 1 ft. 9 in. × 1 ft. 9 in.
 (159) 1 ft. 6 in. × 10 in. × 5 in.; subangular; quartzose grit, with slaty fragments. [Cf. 'Haggis Rock, Queensberry grits.—P. F. K.]
 (160) 2 ft. × 1 ft. 3 in. × 1 ft.; subangular, with rounded corners; ? var. of granophyre, Buttermere.

Near Hill Top Farm, Castleton, 1½ mile S. of centre of Rochdale, 500–550 ft. O.D.—

- (169) 2 ft. × 1 ft. 3 in. × 1 ft.; irregular; subangular; flattened on one side; volcanic ash, L.D.
 (170) 11 in. × 10 in. × 7 in.; angular, with flattened sides and ends; corners rounded; weathered; granophyre, Buttermere.
 (171) 1 ft. 1 in. × 10 in. × 8 in.; tetrahedral; three sides polished and grooved; granite, Galloway.
 (172) 2 ft. 3 in. × 1 ft. 10 in. × 10 in.; subangular; weathered; millstone grit.
 (173) 8 in. × 7 in. × 6 in.; subangular, with rounded ends and flattened sides; andesitic breccia, L.D.
 (174) 8 in. × 5½ in. × 3½ in.; subangular; weathered; volcanic ash; L.D.
 (174A) 10 in. × 7 in. × 5 in.; volcanic ash; L.D.
 (175) 9 in. × 8 in. × 5 in.; rounded, weathered; granophyre, Buttermere.
 (176) 5 in. × 4 in. × 4 in.; rounded, and very much weathered; granite, Eskdale.
 (177) 11 in. × 8 in. × 4 in.; irregular; flattened side; scratched diagonally; 'cank.' (There are many grits and canks not enumerated.)
 (178) 5 in. × 3½ in. × 2 in.; oval; rhyolitic ash; L.D.
 (179) 1 ft. 3 in. × 10 in. × 6 in.; flattened, with rounded corners; grooved a little on flattened sides; andesite; L.D.
 (180) 2 ft. 3 in. (+) × 2 ft. × 1 ft. 6 in.; subangular; a little grooved at rounded corner; Gannister, fine siliceous rock.
 (181) 2 ft. × 1 ft. 3 in. × 1 ft. 3 in.; subangular, with rounded corners; red-brown grit, like those ending N.W. of Rochdale.
 (182) 1 ft. 4 in. × 10 in. × 3 in. (+); flat side up.
 (183) 1 ft. 3 in. × 11 in. × 4 in.; oval; two sides, flattened and scratched longitudinally; andesitic breccia; L.D.

- (184) 1 ft. 2 in. × 9 in. × 6 in.; subangular; quartz felsite with epidote.
 (185) — subangular; hornblende andesite.
 (186) 6 in. × 5½ in. × 4 in.; rounded; porphyritic andesite; L.D.
 (187) 5 in. × 4 in. × 3 in.; rectangular; red devitrified rhyolite; L.D.
 (188) 9 in. × 7 in. × 5 in.; subangular; porphyritic andesite; L.D.
 (189) 8 in. × 5 in. × 4 in.; subangular; ? silurian grit.
 (190) 8 in. × 5 in. × 5 in.; rounded; andesite; L.D.
 (191) 6½ in. × 4 in. × 3 in.; subangular; andesite, containing garnets (? Keswick).
 (192) 1 ft. 2 in. × 1 ft. × 8 in.; subangular; irregular; granophyre, Buttermere.

Facit Cemetery, in front of mortuary chapels—

- (193) 7 ft. × 4 ft. × 2 ft. 9 in.; oblong; angular with rounded corners; scratched diagonally to length; granophyre, Buttermere.

North end of mortuary chapels—

- (194) 6 ft. × 3 ft. 6 in. × 3 ft.; rounded; flattened; one side hummocky; granophyre, Buttermere.
 (195) 9 in. × 6 in. × 5 in.; ? syenite; Needle's Eye, Colvend [see No. 10].

Group.

Road from Hill Top by Grange Barn, Cowm Top, &c., to Hardy Bridge, about 1¾ miles south of centre of Rochdale. 550–600 ft. O.D.

- (196) 9 in. × 6 in. × —; rounded; grit.
 (197) 6 in. × 3 in. × 2 in.; flat; granite, Galloway.
 (198) 6 in. diam.; granite, Eskdale.
 (199) 9 in. × 6 in. × 4 in.; irregular; rhyolitic ash; L.D.
 (200) 6 in. × 4 in. × —; oval; granite, Galloway.
 (201) 4 in. × 3 in. × 2 in.; subangular; red rhyolite; L.D.
 (202) — quartzite.
 (203) 1 ft. 9 in. × 1 ft. 6 in. × 1 ft.; quartz porphyry or porphyritic rhyolite.
 (204) 8 in. × 6 in. × 4 in.; rounded; rhyolitic ash with well-marked crystals of hornblende.
 (205) 6 ft. 6 in. × 4 ft. 6 in. × 4 ft. 6 in.; subangular; two sides smoothed, flat and striated, one especially so, with long grooves lengthwise. Also on rounded edge near the same. Above this on the top (as lying at present), the striations are at an angle of about 60° divergence from the last, and here it is rounded and polished. Flag rock. This is a very well-marked local glacial boulder, and from authentic information I learn that it was discovered about 1870 in driftsand about 4 ft. beneath the surface, 400 ft. O.D., and 25 yds. south of the river Roch.

Reported by Mr. P. F. KENDALL, F.G.S.

First field north of Peel Moat, Heaton Chapel, near Stockport—

- 3 ft. 2 in. × 2 ft. 7 in. × 2 ft. 6 in.; subangular; moved grey Coal-measure sandstone, weathering in a bright buff; source not determinable; the at present upper surface is striated longitudinally, *i.e.*, in direction of long axis; adjacent hills are covered with glacial sand, but this stone was found in the underlying clay; boulder clay.

Group.

The specimens were from a heap in the brickyard. They had been obtained from very fine sticky clay containing very few stones and occasional shells in fair preservation. The clay exhibits very complicated folds and contortions. It is overlain by sands, and rests upon red

sandstone rock. This group is very noteworthy, as it contains so many varieties of basic rocks (dolerites, &c.) of a type either absent or very rare in other localities.

Heaton Mersey, near Stockport, Bailey's brickyard—

Largest about 1 cub. ft., smallest about 3 cub. in.; some in each condition; all moved; several are well scratched longitudinally, especially the limestones; Dalbeattie, Criffel, Eskdale (Cumberland), Buttermere; ? Cairnsmore of Fleet (Galloway).

	Specimens
Eskdale granite	3
Buttermere granophyre	2
Yewdale breccia	2
Bright pink micaceous porphyry	1
Criffel granite	1
Dark green rock with augite	1
Fine hornblende syenite	1
Granite ? Cairnsmore of Fleet	1
Yellowish quartz porphyry	1
Rhyolite	2
Andesite	3
Dalbeattie granite	1
Dalbeattie granite ?	1
Dolerite (fresh)	3
Dolerite (coarse)	1
Dolerite	1
Peridotite (much decomposed) ?	1
Andesitic ash	3
Millstone grit	3
Coal-measure sandstone	4
Coal-measure sandstone (red)	1
Gannister	1
Carboniferous limestone	3
Silurian grit	3
New Red sandstone	3

—
47

Manchester.—Stretford Road, opposite No. 530—

4 ft. x 4 ft. x 3 ft.; scratched on all visible faces, mostly parallel to long axis; scratches on one flat surface are parallel to but in opposite direction to those on the other; Coal-measure sandstone; in boulder clay, about 30 ft. from the surface; boulder clay.

Stretford Road, junction with Chester Road. About three tons of broken-up Coal-measure sandstone—relics of a great boulder found in a sewer-heading. It was finely striated, but no direction could be assigned.

Barton-upon-Irwell.—Manchester Ship Canal, 200 yards west of Barton Hospital—

3 ft. 10 in. x 3 ft. 8 in. x 1 ft. 6 in.; subangular; well scratched on visible face; grey Coal-measure sandstone. 2 ft. 6 in. x 2 ft. x 1 ft. 6 in.; rounded, triangular in section; longitudinally scratched; granite, Eskdale.

50 yards from east end of Sticking's Island—

3 ft. 6 in. x 3 ft. x 2 ft. 6 in.; river-worn; andesite; L.D.
2 ft. 9 in. x 2 ft. 4 in. x 1 ft. 2 in.; river-worn; andesitic ash; L.D.

Irlam, in Railway Goods-Yard—

2 ft. 3 in. x 2 ft. 3 in. x 1 ft.; subangular; Coal-measure sandstone.

Reported by Mr. J. W. GRAY, F.G.S.

Group.

Levenshulme.—New railway cutting about 200 yards east of Slade Lane. A large boulder of Coal-measure sandstone is to be seen having a group of smaller stones packed in front of it, the whole resting on the soft purple shales associated with the Ardwick limestone. The large stone was separated from the underlying Coal-measures by a thin layer of brownish boulder clay, and (immediately in contact with the boulder) a film about 3 in. thick of worked-up shale, which was also massed in front (*i.e.*, to eastward) of it, and formed the nidus of the smallest stones before mentioned. In this case the evidence was held to be conclusive as showing the direction of movement. The packed shale and fragments of stone were on the easterly side of the large boulder, and the largest subangular fragment, 2 ft. × 1 ft. 8 in. × 1 ft. 2 in., consisted of Ardwick limestone of a kind which cropped out 50 yards to the westward. The dimensions of the sandstone boulder are 5 ft. × 4 ft. 3 in. × 2 ft. 4 in. Long axis about N. 50° W. magnetic. It is scratched upon all visible faces. The principal scratches upon the upper surface are from N. 50° W., *i.e.*, in the direction of the long axis. They clearly originate at the north-westerly end, and finish at the south-easterly end.

[A boulder of igneous rock, resembling rocks from the Lake District, weighing 2½ tons, found in Coronation Street, Reddish, has been described by Mr. Gray in the 'Annual Report of the Stockport Society of Naturalists,' 1889. It has been removed for preservation to the Vernon Park.]

Reported by Mr. THOMAS AXON.

In river Tame on Lancashire side, about 100 yds. below Arden Paper Mills, near Woodley, Cheshire—

8 ft. 3 in. × 7 ft. 8 in. × 6 ft. 6 in.; subangular; has fallen out of some glacial deposit; no distinct striations; volcanic rock, probably rhyolitic, and from the Borrowdale series of the Lake District; about 10 yds. to northwards of boundary between Lancashire and Cheshire; isolated from any glacial deposit; river silt.

Haughton Green, about 200 yds. below the river Tame from Arden Paper Mills, near Woodley, Cheshire—

6 ft. 6 in. × 7 ft. 3 in. × 4 ft. 2 in. (visible). A great mass lies beside the stone which has been broken from it. This would make the length 9 ft. 6 in. instead of 6 ft. 6 in.; rounded; has fallen out of the river-bank; well scratched on the side which is now uppermost in direction of long axis; a rather coarse andesite, from Borrowdale series, L.D.; 5 yds. on Cheshire side of Lancashire and Cheshire boundary; isolated; on bed of river Tame.

5 ft. × 2 ft. 9 in. × 2 ft. 3 in.; none of these is full measurement, as the stone is partly under water; rounded; fallen out of river bank; probably andesite, Borrowdale series, L.D.; 5 yds. on Cheshire side of Lancashire and Cheshire boundary; isolated; bed of river Tame.

In the bank of the river Tame, under Arden Paper Mills, near Woodley, Cheshire—

4 ft. 6 in. × 3 ft. 6 in. × 2 ft. 6 in. (visible); rounded; has been moved; isolated; river silt.

Near Woodley, Cheshire, Mill Lane, Bredbury, at corner of lane leading down to the bridge and quarry—

2 ft. 5 in. × 2 ft. 2 in. × 8 in. (visible); rounded; moved; granite, Eskdale, Cumberland; isolated; doubtful, but probably boulder clay.

In river Tame on Lancashire side, 160 yds. below Arden Paper Mills, near Woodley, Cheshire—

3 ft. × 2 ft. 4 in. × 8 in.; rounded; granite, Eskdale, Cumberland.

Haughton Green, 20 yds. on Lancashire side of Gibraltar Bridge—

2 ft. 6 in. × 1 ft. 10 in. × 9 in.; rounded; flat; andesite; L.D.

Burrow's farmyard, opposite Conservative Club, *Haughton Green Road*—

2 ft. × 2 ft. × 1 ft. 6 in.; rounded; andesite; L.D.

1 ft. 8 in. × 1 ft. 3 in. × 1 ft. 3 in.; angular; Ardwick limestone. Both came out of the main sewer excavation.

Farmhouse, opposite Prospect Place, *Haughton Green Road*—

2 ft. 2 in. (visible) × 1 ft. 8 in. × 1 ft. (visible); well rounded; scratched longitudinally; andesite; L.D.

Vaudry Lane, corner of *Twotree Lane*—

2 ft. 8 in. × 2 ft. 4 in. × 1 ft. 9 in.; rounded; black-mica granite, Gallo-way.

Group.

Tib Street, corner of *Stockport Road*—

(1) 2 ft. 2 in. × 1 ft. 4 in. × 1 ft. 2 in.; rounded; andesite; L.D.

(2) 2 ft. 3 in. × 1 ft. 2 in. × 1 ft. 2 in. (visible); rounded; granite, Eskdale.

(3) 2 ft. 3 in. × 2 ft. × 10 in. (visible); subangular; granophyre, Buttermere.

(4) 1 ft. 4 in. × 1 ft. 2 in. × 2 ft. (visible); subangular; andesitic breccia.

(5) 1 ft. 10 in. × 1 ft. 2 in. × 1 ft. (visible); rounded; andesite; L.D.

Corner of *Clayton Street*—

2 ft. 6 in. × 1 ft. 8 in. × 1 ft. 6 in. (visible); rounded; andesite; L.D.

Corner of *Town Lane*—

2 ft. × 1 ft. × 11 in.; subangular; andesite or rhyolite; L.D.

Corner of *Acre Street* and *Town Lane*—

2 ft. 3 in. × 2 ft. × 11 in.; subangular; granophyre, Buttermere.

2 ft. 6 in. × 1 ft. 8 in. × 1 ft.; rounded; andesite; L.D.

Hyde Hall—

2 ft. × 1 ft. 6 in. × 1 ft. 2 in.; andesite; L.D.

2 ft. 4 in. × 1 ft. 6 in. × 1 ft. 1 in.; rhyolite; L.D.

100 yards west of *Hyde Hall*—

1 ft. 10 in. × 1 ft. 8 in. × 1 ft. 2 in.; subangular, cuboidal; granophyre, Buttermere.

CHESHIRE.

Hazel Grove, beside gate leading to Mill Hill, Norbury—

1 ft. 10 in. × 1 ft. 7 in. × 2 ft. 1 in. (visible); rounded; andesite; L.D.

Reported by Mr. THOMAS KAY, J.P.

Tabley House, near *Knutsford*.—At south-west side in Ryde Wood, east of Tabley Pool—

5 ft. × 4 ft. 6 in. × 2 ft.; scratched on side which is now towards east; grey granite [Galloway?—P. F. K.]. This stone is set on end.

3 ft. 6 in. × 3 ft. × 2 ft. 6 in.; rounded; red granite.

3 ft. 6 in. diam.; triangular; rounded.

These boulders, with a few smaller ones, were probably dug up when the lake was enlarged.

Reported by W. R. DAMBRILL-DAVIES, Surgeon-Major.

Wilmslow.—Lindow Common, in the centre of Common—

4 ft. × 3 ft. 2 in. × 1 ft. 6 in. (visible); angular; andesite; L.D.; the stone protrudes through peat which is underlain by glacial sand.

Near the old workhouse—

4 ft. 4 in. × 2 ft. × —; almond-shaped; andesite; L.D.; removed from the Common.

Mr. Henshall's field—

3 ft. × 1 ft. 6 in. × —; andesite; L.D.; removed from the Common.

Near W. Worth's pig-cote—

3 ft. 4 in. × 1 ft. 9 in. × 2 ft. 3 in.; rounded; granite, Eskdale; removed from the Common.

Potts's turf-field—

2 ft. 3 in. diam.; almost perfectly spherical; granite; has been moved.

Macclesfield.—Birtles-of-the-Hill on H. Bostock's farm—

Nearly 4 ft. in diam.; somewhat triangular; granite; has been moved.

Reported by Mr. W. BROCKBANK, F.L.S., F.G.S.

Northern Etchells.—Heyhead Farm, Woodhouse Lane—

12 ft. × 6 ft. 6 in. × 6 ft. (visible); very sharp and angular; bean-shaped; S. 80° E. geographical; andesitic rock from L.D.; 226 ft. O.D.; Dr. Ashworth, of Heaton Moor, Stockport, has photographed it; the boulder protruded through the turf for many years. It rests on reddish buttery boulder clay, containing L.D., Scottish, and other rocks and flint.

The stone has now been removed to the grounds of Sir Edward Watkin at Northenden.

Reported by Mr. P. F. KENDALL, F.G.S.

Heyhead Farm, Woodhouse Lane—

Two boulders of similar composition to the above, but weighing only about 2 cwt. each.

Woodhouse Lane, 50 yards east of above—

3 ft. × 2 ft. 10 in. × 1 ft. 6 in.; well rounded and weathered; moved; andesitic ash; L.D.; 226 ft.

1 ft. 10 in. × 1 ft. 2 in. × 1 ft.; well rounded and weathered; moved; andesitic ash; L.D.

Woodhouse Lane, half a mile south from Heyhead Farm—

1 ft. 6 in. × 1 ft. 6 in. × 10 in.; rounded; Eskdale granite, Cumberland.

1 ft. 6 in. × 1 ft. 2 in. × 10 in.; rounded; grey granite, Galloway.

1 ft. 6 in. × 1 ft. × 9 in.; rounded; rhyolite with much iron pyrites; L.D.

1 ft. 6 in. × 11 in. × 8 in.; subangular; vesicular andesite; L.D.

1 ft. 6 in. × 1 ft. 2 in. × 1 ft.; rounded; ? felsite; L.D.

1 ft. × 9 in. × 6 in.; rounded; andesitic ash; L.D.

1 ft. × 10 in. × 10 in.; rounded; dolerite.

1 ft. 3 in. × 1 ft. × 1 ft.; rounded and much weathered; grey granite with much black mica; Galloway.

2 ft. × 1 ft. 6 in. × 1 ft.; rounded; Buttermere granophyre.

1 ft. 2 in. × 1 ft. × 10 in.; subangular; grey granite, Galloway.

1 ft. 3 in. × 1 ft. × 10 in.; subangular; cherty felsite; L.D.

2 ft. × 1 ft. 6 in. × 1 ft. 2 in.; rounded; andesite; L.D.

2 ft. 6 in. × 2 ft. × 1 ft.; subangular; striated; andesite; L.D.

1 ft. 9 in. × 1 ft. 8 in. × 1 ft. 2 in.; rounded; andesite; L.D.

1 ft. × 1 ft. × 9 in.; rounded; andesite; L.D.

These have all been moved; they are lying by the roadside.

Styal.—Beside footpath, 300 yards west by north of 'Ship' Inn—

2 ft. 10 in. × 1 ft. 6 in. × 1 ft. 6 in.; rounded; probably moved; Eskdale granite; rests on boulder clay.

Group.

Macclesfield.—'Setter Dog' Inn, 3 miles on Buxton Road. Largest, 2 ft. × 1 ft. × ?; smallest, 6 in. × 6 in. × 6 in.; all rounded.

ANALYSIS.

Nature	Source	No. of Specimens
Granophyre	Buttermere	6
Granite	Dalbeattie ?	1
Andesite	L.D.	4
Agglomerate	"	1
Rhyolite with much biotite	" (?)	1
Quartz porphyry	" (?)	1
Brick-red porphyry	Dee above Tongland (?)	1
Granite	Criffel	2
Quartzite	—	1

18

The boulders have all been moved. Altitude about 1,400 feet above O.D.

100 yards east of 'Setter Dog' Inn—

3 ft. × 1 ft. 8 in. × 1 ft. 2 in.; subangular; andesite from L.D.; 1,400 ft.; has been moved.

Cheadle Village.—Just behind the church—

2 ft. 3 in. × 1 ft. 3 in. × 9 in.; rounded; striated obliquely across the visible face; andesitic ash; L.D.; 130 ft.; has been moved.

Woodley.—Back Lane—

2 ft. × 2 ft. × 1 ft. 1 in.; rounded; andesite; L.D.; has been moved.

2 ft. × 1 ft. 2 in. × 1 ft. 3 in.; rounded; Yewdale breccia, Cumberland; has been moved.

Group.

Behind Buckley's lower mill—

Largest, 2 ft. × 1 ft. 6 in. × 1 ft.; small, 6 in. cube; gannister?; granite, Eskdale; hornblendic granite, Galloway; granophyre, Buttermere; Coal-measure sandstone?; rhyolite, L.D.; Carboniferous limestone?

The boulders were embedded in soft buttery boulder clay resting on the shales of the middle Coal-measures. The Coal-measure sandstone.

Reported by Mr. P. F. KENDALL, F.G.S.

*Group.**Hyde.*—Clay-pit on bank of canal, near Apethorne Mill—

1 ft. 3 in. × 1 ft. 1 in. × 10 in.; cuboidal; scratched; andesite; L.D.

2 ft. 7 in. × 1 ft. 5 in. × 1 ft. 3 in.; triangular in section; well striated on two faces; andesitic agglomerate; L.D.

2 ft. × 1 ft. 6 in. × 1 ft. 1 in.; obscurely scratched; andesite; L.D.

1 ft. 5 in. × 1 ft. 3 in. × 1 ft.; cuboidal; well scratched, the scratches upon upper surface parallel to but originating at the opposite end to those on the lower surface; andesite; L.D.

2 ft. 6 in. × 2 ft. 4 in. × 1 ft. 3 in.; subangular; scratched; Coal-measure sandstone.

1 ft. 8 in. × 1 ft. 4 in. × 1 ft. 3 in.; well rounded; andesite; L.D.

2 ft. 6 in. × 2 ft. 2 in. × 1 ft. 11 in.; cuboidal and slightly rounded; andesite; L.D.

1 ft. 3 in. × 1 ft. × 1 ft.; angular; Ardwick limestone, South-east Lancashire.

10 in. × 8 in. × 8 in.; rounded; Carboniferous limestone.

1 ft. 6 in. × 11 in. × 8 in.; well rounded; granite, Eskdale.

1 ft. × 10 in. × 8 in.; Ardwick limestone, brecciated variety, South-east Lancashire.

1 ft. 4 in. × 1 ft. 2 in. × 9 in.; very well scratched in many directions; andesite; L.D.

2 ft. 2 in. × 1 ft. 4 in. × 8 in. (visible); rounded; andesite; L.D.

1 ft. 2 in. × 10 in. × 9 in.; not much rounded; scratched; granite.

9 in. × 8 in. × 8 in.; very coarse granite, Eskdale.

1 ft. × 10 in. × 9 in.; well rounded; granophyre, Buttermere.

1 ft. 4 in. × 1 ft. 4 in. × 1 ft. 2 in.; rounded; red black-mica granite, Galloway.

3 ft. × 2 ft. 10 in. × 2 ft. (visible); well scratched longitudinally; Carboniferous limestone.

1 ft. 8 in. × 1 ft. 4 in. × 1 ft. 2 in.; rounded; scratched; yellow quartz-porphry (? origin).

8 in. × 6 in. × 6 in.; angular; Ardwick limestone; South-east Lancashire.

11 in. × 10 in. × 6 in.; ? Permian limestone.

6 in. × 4 in. × 4 in.; ? Permian limestone.

1 ft. 2 in. × 9 in. × 9 in.; rounded; andesite; L.D.

1 ft. × 9 in. × 8 in.; much exfoliated; grey black-mica granite, Galloway.

1 ft. 2 in. × 8 in. × 8 in.; well scratched longitudinally; rhyolite; L.D.

7 in. × 5 in. × 5 in.; angular; Ardwick limestone, South-east Lancashire.

- 11 in. × 9 in. × 8 in.; rounded, but one end subangular; andesite; L.D.
 1 ft. 6 in. × 1 ft. 1 in. × 8 in. (visible); rounded; andesitic ash; L.D.
 1 ft. 2 in. × 10 in. × 10 in.; rounded; granophyre (coarse var.), Buttermere.
 1 ft. 2 in. × 10 in. × 8 in.; rounded; granophyre (fine var., drusy), Buttermere.
 1 ft. 3 in. × 1 ft. × 9 in.; rounded; granophyre, Buttermere.
 1 ft. × 1 ft. × 9 in.; dark grey porphyrite with tinge of red; L.D.
 1 ft. 3 in. × 10 in. × 9 in.; well rounded; longitudinally scratched; banded grey grit; ? silurian.

Reported by Mr. J. REEVES.

Hazel Grove, Brook House Farm—

- 2 ft. 3 in. × 1 ft. 10 in. × 1 ft.; rounded; moved; scratched longitudinally on two faces; andesite; L.D.

Corner of Dean Lane, Norbury Moor—

- 2 ft. 4 in. × 1 ft. 2 in. × 1 ft.; subangular; andesite; L.D.
 2 ft. × 1 ft. × 10 in.; subangular; granophyre, Buttermere.

Reported by Mr. J. W. GRAY, F.G.S.

Offerton, Stockport. Field in front of 'Woodlands'—

- 4 ft. 3 in. × 4 ft. 5 in. × 2 ft. 6 in.; subangular; granite, Eskdale; 286 feet O.D.; embedded in boulder clay.
 2 ft. 6 in. × 2 ft. × 1 ft. 5 in.; rounded; granite, Galloway; 286 feet O.D.; embedded in boulder clay.

These two stones were touched by the plough, and subsequently were dug out and removed to the entrance to the stables, where they now lie.

Daw Bank, Stockport—

- 4 ft. 8 in. × 2 ft. 6 in. × 2 ft.; subangular; andesite; L.D. (Has been washed out of some glacial deposit.)
 1 ft. 8 in. × 1 ft. × 1 ft. 3 in. (visible); rounded; granite, Eskdale. (Has been washed out of some glacial deposit.)

Cale Green, Stockport. In garden of house at corner of Beech Road—

- 3 ft. 5 in. × 2 ft. 10 in. × 1 ft. (visible); subangular; andesite; L.D.

Portwood, Stockport. In excavation for new gasholder—

- 4 ft. × 3 ft. × 1 ft.; waterworn; Yewdale breccia; L.D.; about 120 feet O.D.; embedded in river gravel, which extends below the present river level.

This stone has been placed at the entrance to the Vernon Park Museum.

Reported by Messrs. GEORGE SHAW and ALBERT TAYLOR.

Bramall.—50 yards E. of Bramall Gates—

- 3 ft. 3 in. × 2 ft. 2 in. × 1 ft. 6 in.; triangular section; coarse grey granite [? Eskdale].

Huxley's Tenements, Robin's Lane—

- 2 ft. 7 in. × 2 ft. 1 in. × 1 ft. 2 in.; upper and lower sides polished; rhyolitic breccia [L.D.].

Group.

Robin's Lane—

1 ft.—1 ft. 6 in. diam.; andesite, syenite [? granophyre], granite.

Pepper Street Farm—

2 ft. 6 in. × 2 ft. 1 in. × 1 ft. 4 in.; upper side scratched; granite, Eskdale.

Adswold.—Lady Bridge Farm—

2 ft. 6 in. × 1 ft. 8 in. × 1 ft. 5 in.; upper side scratched; white granite.

100 yards W. of above—

1 ft. 8 in. × 1 ft. 9 in. × 1 ft.; upper side scratched; fine red granite.

Offerton.—Bed of stream 250 yards below Toll Gate, at Dan Bank—

6 ft. × 4 ft. × 3 ft.; subangular; breccia [? L.D.].

In bed of brook below Dooley Lane—

5 ft. × 4 ft. × 2 ft. 6 in.; rather angular; shape irregular; white granite.

Offerton Lane, near Bleach Works—

1 ft. 6 in. diam.; granite, Eskdale.
3 ft. × 2 ft. 6 in. × 1 ft. 6 in.; andesite; L.D.
2 ft. × 1 ft. × 1 ft.; granite.

Stream at Wilson's Bleach Works—

2 ft × 1 ft. 6 in. × 1 ft. 6 in.; scratched; andesite; L.D.

Offerton Lane, about 50 yards W. of Wright's Arms—

2 ft. × 1 ft. 3 in. × 1 ft.; andesite; L.D.
1 ft. 10 in. × 1 ft. 3 in. × 1 ft.; andesite; L.D.

Bradley's Farm, Lisburne House, off Dial Stone Lane—

2 ft 9 in. × 2 ft. 2 in. × 1 ft. 8 in.; andesite; L.D.

Group.

Bradley's Farm, Lisburne House, off Dial Stone Lane—

1 ft. 3 in.—1 ft. 6 in. diam.; red granite; white granite and andesites.

Group.

Mile End Lane. Dug out of boulder clay while repairing the road—

2 ft. 2 in. × 1 ft. 4 in. × 1 ft. 4 in.; hornblendic granite [? Galloway].
1 ft. 10 in. × 1 ft. 2 in. × 9 in.; hornblende-andesite; L.D.
2 ft. 5 in. × 1 ft. 7 in. × 1 ft. 7 in.; andesite; L.D.
2 ft. 8 in. × 2 ft. 2 in. × 1 ft. 1 in.; andesitic breccia (sheared); L.D.
2 ft. 8 in. × 1 ft. 4 in. × 1 ft. 4 in. [granite-porphry?]
1 ft. 4 in. × 1 ft. 2 in. × 10 in.; white granite.
1 ft. 8 in. × 1 ft. 1 in. × 7 in.; Coal-measure sandstone.
2 ft. 8 in. × 2 ft. 5 in. × 1 ft. 7 in.; andesite; L.D.
2 ft. 2 in. × 1 ft. 7 in. × 1 ft. 1 in.; breccia?
1 ft. 1 in. × 10 in. × 10 in. [fine red rhyolite].
2 ft. 2 in. × 2 ft. 2 in. × 1 ft. 8 in. [granophyre, Buttermere].
2 ft. 2 in. × 1 ft. 6 in. × 1 ft. 1 in.; granite [? Eskdale].
1 ft. 7 in. × 1 ft. 1 in. × 1 ft. 1 in.; andesite; L.D.
1 ft. 7 in. × 1 ft. 7 in. × 1 ft. 1 in.; andesite; L.D.

Norbury.—Mill Lane—

- 2 ft. 6 in. × 1 ft. × 1 ft. ; white granite.
2 ft. × 1 ft. 6 in. × 2 ft. 6 in. ; andesite.

Group.

In bed of stream from mill to colliery ; 100 yards from bridge—

- (1) 1-2 ft. long ; andesites and granite.
(2) 2 ft. 2 in. × 1 ft. 6 in. × 1 ft. 6 in. ; white granite.

200 yards below colliery—

- 2 ft × 2 ft. × 1 ft. 6 in. ; scratched andesite ; L.D.

Hatherlow, near Romiley.—Bunker's Hill Road—

- 2 ft. 3 in. × 1 ft. 9 in. × 1 ft. 6 in. ; andesite ; L.D.
2 ft. × 1 ft. 5 in. × 1 ft. 4 in. ; andesite ; L.D.

Junction of Bunker's Hill Road and Chadkirk—

- 2 ft × 1 ft. 3 in. × 1 ft. 3 in. ; granite [Galloway ; ? Cairnsmore of Fleet].

Field opposite cottages, Chadkirk—

- 2 ft. 4 in. × 1 ft. 10 in. × 1 ft. 10 in. ; granite [Galloway ; ? Cairnsmore of Fleet].

Marple Aqueduct—

- 2 ft. 3 in. × 1 ft. 6 in. × 1 ft. 6 in. ; white granite.

Group.

Brabbin's Brow, Canal Bank—

- 1-2 ft. long ; breccias and andesites
2 ft. 3 in. × 1 ft. 4 in. × 1 ft. ; andesite ; L.D.

Conservative Club, Marple—

- 2 ft. 6 in. × 1 ft. 4 in. × 1 ft. 4 in. ; breccia ; L.D.
1 ft. 6 in. long ; red granite.

Marple Ridge.—100 yards south of Mount Pleasant Chapel—

- 2 ft. 6 in. × 1 ft. 10 in. × 1 ft. 3 in. ; fine buff granite with large quartz.

Longson's Farm, Marple Ridge—

- 2 ft. × 1 ft. 6 in. × 1 ft. 6 in. ; white granite.

Between Longson's and the Fold—

- 1 ft. 8 in. × 1 ft. 3 in. × 1 ft. ; andesite ; L.D.

Marple, near Corkwell Farm.—Lombray Lane—

- 3 ft. × 2 ft. × 1 ft. 6 in. ; ? andesite.

Windlehurst Lane—

- 1 ft 6 in. diam. ; bluish granite [? Galloway].
1 ft. 8 in. × 1 ft. 3 in. × 9 in. ; white granite [? Eskdale].

Horse Shoe Inn, High Lane—

- 3 ft. × 1 ft. 10 in. × 1 ft. 8 in. ; white granite.

Royal Oak, High Lane—

2 ft. 6 in. \times 1 ft. \times 9 in. ; andesite ; L.D.

Threaphurst Lane—

1 ft. 8 in. \times 1 ft. 6 in. \times 1 ft. 6 in. ; granite ?

1 ft. 6 in. \times 1 ft. 6 in. \times 1 ft. 6 in. ; white granite [? Cairnsmore of Fleet].

3 ft. \times 2 ft. 10 in. \times 1 ft. 8 in. ; andesite ; L.D.

Reported by Mr. J. H. GRUNDY.

Parish of Mottram.—Township and Manor of Stayley, in field on Shaw Moor Farm—

7 ft. 6 in. \times 3 ft. 11 in. \times — ; subangular ; very irregular in outline ; circumference of part exposed, 20 ft. 6 in. ; long axis about N.W. and S.E. ; andesite (or felsite), L.D. ; 1,000 ft. O.D. ; is partially covered by peat.

The stone is mutilated, a portion having been used to mend an adjacent wall. Two shot-holes can be seen.

In lane leading from Shaw Moor Farm to Roe Cross, opposite Round Hill Poultry Farm—

2 ft. 6 in. \times 1 ft. 4 in. \times 1 ft. 3 in. ; rounded.

Matley Township.—Matley Lane, near Wrigley Fold Farm. Counted over thirty boulders here ; varying in size, mostly over 2 ft. long.

DERBYSHIRE.

Reported by Mr. P. F. KENDALL, F.G.S.

Little Hayfield, corner of road to Park Hall—

1 ft. 8 in. \times 1 ft. 6 in. \times 8 in. ; rounded ; moved ; no striations ; granophyre, Buttermere ; 723 ft. 9 in. above O.D.

1 ft. 6 in. \times 1 ft. 6 in. \times 1 ft. (visible) ; rounded ; moved ; no striations ; granite, Eskdale ; 723 ft. 9 in. above O.D.

Reported by Messrs. J. W. GRAY, F.G.S., and P. F. KENDALL, F.G.S.

Bugsworth.—First house on high road E. of railway station—

2 ft. \times 2 ft. \times 1 ft. 3 in. ; rounded ; moved ; volcanic agglomerate ; L.D. ; 617 ft. 7 in. above O.D.

At the same place two smaller stones, one being Criffel granite and the other a Lake District andesite.

Group.

Bugsworth.—Ballast pit opposite signal post at N. end of tunnel on Midland Railway. The deposit is a gravel in which the largest stones do not exceed a 9-inch cube. The bedding is very high, and dips to the S. or S.W. Altitude above O.D., 600 ft. and upward. The 600 ft. contour passes across the floor of the pit.

Analysis of Stones.

The stones consist of about 98 per cent. or upward of the local millstone grit, inclusive perhaps of a small proportion of Coal-measure sandstone. Of the remaining 2 per cent., shales of local origin form part; and of undoubted foreigners there were:—

Borrowdale Series of Lake District.—Agglomerate, rhyolite, andesite, and vein-quartz.

Granites.—Buttermere, Eskdale, and Rig o' Burnfoot (or some other Galloway granite), flint, quartzite from Triassic Pebble Beds (F₂), Carboniferous limestone, chert, ochre, gannister.

STAFFORDSHIRE.

Reported by Mr. FRED BARKE, of Stoke-upon-Trent.

Madeley, Staff. In vicar's garden, Newcastle-under-Lyme—

4 ft. × 2 ft 6 in. × 2 ft. 6 in.; angular; 'trap.'

3 ft. × 2 ft 9 in. × 2 ft.; rounded; granite.

The vicar said these had been brought from a field at Stoney Low, a few hundred yards S.E. of its present site, out of boulder clay.

Little Madeley.—Gravel pit at point of bifurcation, close to 'e' in 'Little' (Madeley) on Ordnance map, Newcastle-under-Lyme, Staff. Small boulders of granite not exceeding 12 inches diameter.

The gravel pit is in grass land. Its extent not ascertained. Beds of sand and gravel alternate, and contain fragments of shells and chalk flints. Base of series not exposed.

YORKSHIRE.

The following reports of erratic blocks and groups of erratic blocks have been furnished by the Yorkshire Boulder Committee:—

A square block of whinstone. The length is 2 ft. 7 in. by 2 ft. 4 in. by 2 ft. 3 in. above ground. In the parish of Folkton, near Filey, on the estate of J. Woodall, Esq., Scarborough. The farm is called West Flotmanby Hall farm. Folkton is situated about five miles to the west of Filey. West Flotmanby Hall is east of Folkton about half a mile. No striations or marks of any kind, but upon the N.E. face of the boulder is the mark of the Government broad arrow. The nearest district from which it could have travelled is Kildale, in Cleveland, about forty miles west. About 150 ft. above the sea. It is situated nearly on the top of a ridge of gravel running N.E. by S.W., and rests upon gravel-sand and beds of clay.

In the parish of Folkton, on the estate of J. Woodall, Esq., Scarborough, round a spring head at the N.E. side of West Flotmanby Hall, near Filey, there are several boulders which have been collected from the Carrs; the largest is—

2 ft. 6 in. × 1 ft. 11 in. × 1 ft. 3 in.; Mountain limestone.

1 „ 7 „ × 1 „ 4 „ × 1 „ 1 „; Diorite.

1 „ 3 „ × 0 „ 11 „ × 0 „ 8 „; „

1 „ 1 „ × 0 „ 10 „ × 0 „ 8 „; Whinstone.

1 „ 0 „ × 0 „ 9 „ × 0 „ 8 „; Sandstone.

All are subangular to rounded. They have all been moved to their pro-

sent position. The whinstone and diorite may have come from the west and the sandstone from the north-west; probably about forty miles distant. Height, about 150 ft. above sea-level.

Group of boulders, $0^{\circ} 25' 15''$ W. longitude; $54^{\circ} 16' 30''$ N. latitude. Falsgrave, near Scarborough, where Stepney Road turns sharply to the right at Falsgrave. One 3 ft. 8 in. \times 2 ft. 6 in. \times 2 ft. 8 in. basalt; one 3 ft. 3 in. \times 1 ft. 6 in. \times 1 ft. 6 in. red granite. Two of nearly the same size of lias, and numerous others down to the smallest sizes. About 130 tons have been carted away for road metal. Generally rounded, but a few are subangular. All have been moved. Striations in larger boulders in all directions. They are from all directions and different distances, and represent different formations, but many are igneous or metamorphic. Say 27 per cent. various; 12 per cent. some twenty kinds of granite and syenites of different colours; 4 per cent. gneiss; 12 per cent. basalts, various; 8 per cent. quartzites; 2 per cent. greenstones; 4 per cent. volcanic ashes; 12 per cent. mountain limestone; 1 per cent. millstone grit; 6 per cent. lias; 5 per cent. oolite; 5 per cent. pisolite; 1 per cent. chert; 1 per cent. chalk flint. Height, 200 ft. above the sea and covering an area of 150 yards \times 20 yards. They are embedded in glacial drift, evidently slightly pervious. Some water must have percolated through the clay acting chemically on some of those most easily thus acted upon. In some cases the iron has been turned brown, but there has not been a free passage of water through. In levelling the road in question in no case have they gone more than 6 ft. deep; thus all were near the surface.

Boulder of Shap granite; measuring 2 ft. 11 in. long, 2 ft. 6 in. broad, 2 ft. 1 in. thick. In the parish of Ganton, near Scarborough, on the estate of Sir C. Legard, Ganton Hall, now forming the corner-stone on the premises belonging to the Greyhound Inn. Is a large Shap boulder. It is from subangular to rounded and is oblong in shape. There are no indications of any striæ or grooving. It has been a sort of trysting stone for generations. An old man remembers when he first came to the village sixty-two years ago; this stone was then at the junction or angle of the road, and from this position anyone could be seen approaching the village by the highway. It was removed across the road to its present position in 1853. It formerly stood at the north corner of the village lane joining the highway. Height, about 60 ft. above the sea. The formation on which the boulder rests is composed of beds of sand to a great depth; there is occasionally a band of rough angular flint intermixed, but generally speaking the whole district about here is a huge sand-bed.

At the west end of the same house are two boulders measuring—

2 ft. 6 in. \times 1 ft. 4 in. \times 1 ft. 3 in.; Whinstone.

1 ft. 3 in. \times 1 ft. 2 in. \times 1 ft. 0 in.; Oolitic sandstone.

The one composed of whinstone is angular, the Oolitic sandstone subangular. Both have been moved to their present position. The sandstone may have come across the valley about six miles north. Height above the sea, about 60 ft.

Boulder of grey granite; length, 3 ft. 8 in., 1 ft. 8 in. broad, 1 ft. 6 in. thick, occurs in the parish of Lund, at the north end of the village of Lund, near Beverley, East Riding of Yorkshire, and about 150 yards to the north of Lund Church. Subangular. There is no doubt but

that this boulder has been removed to its present position, although a long time ago. No striæ or markings. Probably the nearest source would be about 200 miles north. Height, about 150 ft. above the sea.

In the parish of Lund, at the north end of the village, principally in the village street, at the north side of the church, there are about 100 boulders, which are to be seen in the footpaths, foundations of old houses, banks of the road, &c.: these are composed of whinstone, diorite, hard compact sandstone, and granite, but the majority are whinstone. The largest is about 2 ft. long, 14 in. broad, and 9 in. thick; the smallest is about 9 in. thick, 8 in. broad, 7 in. deep. Besides these are several hundreds not more than 6 in. by 6 in. by 6 in., which have been used for paving footpaths. They are all rounded to subangular. The whole have been moved to their present position. The nearest rock of the same nature would be about Cleveland in the north; probably 100 miles north. Height, about 150 ft. above the sea. Boulders, more or less small, of all sorts of foreign rocks are being continually cleared off the land about here, and broken up for roads. There seems to be only a thin covering of boulder clay in some parts, and underneath a great thickness of rounded chalk gravel with flints, &c.

Boulder of Shap granite at Barton (Yorkshire, N.R.), between Darlington and Richmond; 1 ft. 8 in. \times 1 ft. 6 in. \times 2 ft.; rounded. About 250 ft. above the sea, and resting on Keuper sandstone.

Boulder of Shap granite in the village street of Sand-Hutton, near Thirsk; 3 ft. \times 1 ft. 10 in. \times 1 ft. 10 in.; subangular; direction of longest axis N.N.W. and S.S.E.; no striæ; about 98 ft. above the sea; isolated; resting on Keuper sandstone.

Boulder of millstone grit, at Rainton, near Thirsk; 2 ft. 6 in. \times 2 ft. 3 in. \times 1 ft. 10 in.; subangular; no striæ; a block of the same nature occurs fifteen miles (west); about 150 ft. above the sea; isolated, and resting on Keuper sandstone.

ISLE OF MAN.

Reported by the Rev. S. N. HARRISON.

Port Lewaigue Shore.—From Ballure to Gob-ny-Roina—

- (1) 3 ft. 6 in. \times 2 ft. 6 in. \times 1 ft. 6 in.; granite; subangular.
- (2) 3 ft. \times 2 ft. \times 1 ft. 6 in.; trap.
- (3) 1 ft. 8 in. \times 1 ft. 4 in. \times 10 in. granite; subangular.
- (4) 3 ft. \times 2 ft. \times 1 ft. 6 in.; granite; subangular.
- (5) 2 ft. \times 2 ft. \times 1 ft. 6 in.; round.
- (6) 2 ft. 8 in. \times (16 ft.?) \times 1 ft.; trap; oblong.
- (7) 3 ft. 8 in. \times 1 ft. 10 in. \times 1 ft.; granite; subangular.
- (8) 3 ft. \times 3 ft. \times 2 ft.; granite; subangular; square.
- (9) 3 ft. \times 3 ft. \times 2 ft.; granite; round.
- (10) 3 ft. 6 in. \times 2 ft. \times 2 ft.; granite; round.
- (11) 3 ft. 2 in. \times 3 ft. \times 3 ft.; subangular.
- (12) 3 ft. \times 2 ft. \times 2 ft.; grey granite; rounded.
- (13) 8 ft. \times 5 ft. \times 5 ft.; granite; rounded.
- (14) Several 2 ft. \times 2 ft.; granite; rounded.
- (15) 3 ft. \times 3 ft. \times 3 ft.; grey granite; rounded.

General direction of long axes, E. and W.

Port-e-Vullyn Gob-ny-Roina to Corna—

- (1) 2 ft. \times 2 ft. \times 1 ft. 6 in.; granite; subangular.
- (2) 1 ft. 6 in. \times 1 ft. 6 in. \times 1 ft.; granite; subangular.

- (3) 2 ft. 6 in. \times 2 ft. \times 1 ft. 8 in.; grey granite; rounded.
- (4) 4 ft. longest diam., 9 ft. circumference; round.
- (5) 4 ft. diam.; pitchstone; round.
- (6) 2 ft. \times 1 ft. 6 in. \times 1 ft.; granite; round.
- (7) 2 ft. \times 2 ft. \times 2 ft.; granite; subangular.
- (8) 2 ft. 8 in. \times 2 ft. \times 2 ft.; granite; subangular.
- (9) 3 ft. \times 2 ft. \times 1 ft. 6 in.; granite; rounded.
- (10) 3 ft. 6 in. \times 2 ft. \times 2 ft.; granite; subangular.

Traie-na-Feeinney—

- (11) 7 ft. \times 4 ft. \times 4 ft.; long axis N.E.; granite; angular.
- (12) Several small 1 ft. \times 1 ft. \times 1 ft.; granite; rounded.

Port Moar Shore—

- (1) 2 ft. 6 in. \times 2 ft. \times 1 ft. 4 in.; granite, coarse, grey; round.
- (2) 2 ft. 2 in. \times 2 ft. \times 1 ft. 2 in.; granite, coarse, grey; round.
- (3) 2 ft. \times 2 ft. \times 1 ft.; granite, red; subangular.
- (4) 2 ft. \times 1 ft. 2 in. \times 1 ft.; syenite; subangular.
- (5) 2 ft. \times 1 ft. 2 in. \times 1 ft.; syenite; subangular.
- (6) 2 ft. \times 1 ft. 2 in. \times 1 ft.; granite; round.
- (7) 8 ft. circumference; granite; round.
- (8) 8 ft. circumference; granite; round.
- (9) 9 ft. circumference; granite; round.
- (10) 5 ft. \times 3 ft. \times 4 ft. granite; subangular.
- (11) Near Cronk Scarron, a few 1 ft. \times 10 in. \times 10 in.

Port-e-Bloggan—

- (12) 2 ft. 4 in. \times 2 ft. \times 2 ft.; granite; round.
- (13) 5 ft. circumference; basalt (decomposed); round.
- (14) 5 ft. circumference; granite; round.
- (15) 2 ft. \times 2 ft. \times 1 ft.; granite; subangular.

Port Moar—

- (16) 3 ft. \times 2 ft. \times 1 ft. 4 in.; granite; subangular.
- (17) 2 ft. 6 in. \times 1 ft. 8 in. \times 1 ft.; granite; subangular.
- (18) 3 ft. \times 2 ft. \times 2 ft.; granite; subangular.
- (19) 3 ft. \times 2 ft. \times 10 in.
- (20) Several; granite.
- (21) 2 ft. \times 1 ft. 6 in. \times 1 ft. 4 in.; granite; subangular.
- (22) 3 ft. 4 in. \times 2 ft. \times 2 ft.; granite; round; broken in two.
- (23) 3 ft. \times 2 ft. \times 2 ft.; granite; round.
- (24) 2 ft. \times 1 ft. \times 1 ft.; granite; oval.
- (25) 3 ft. 6 in. \times 2 ft. 6 in. \times 1 ft.; granite; round.
- (26) 9 ft. circumference; granite.
- (27) 5 ft. circumference; granite; round.
- (28) 5 ft. circumference; granite; round.

NOTE.—During the past ten years about 800 tons of small boulders have been carted away.

Port Moa to Corna—

- (1) Various sizes; porphyry; subangular.
- (2) 3 ft. 6 in. \times 3 ft. \times 2 ft.; granite; subangular.
- (3) 2 ft. 5 in. \times 2 ft. 3 in. \times — ?; granite; round.
- (4) 1 ft. 2 in. \times 8 in. \times 8 in.; granite; subangular.
- (5) 1 ft. 3 in. \times 10 in. \times 8 in.; granite; subangular.

NOTE.—Quartz porphyry occurs *in situ* on the shore.

Traie Uanaique.—Nearly all porphyry, various sizes. Further south on to Traie-na-Halsal a few white limestone, porphyry, and quartzites.

On the Clay on Ballajora—

- (1) 1 ft. \times 10 in. \times 9 in.; granite; round.
- (2) 1 ft. \times 10 in. \times 8 in.; granite; round.

- (3) 1 ft. 2 in. × 1 ft. × 10 in.; granite; round.
- (4) 1 ft. × 10 in. × 10 in.; granite; round.
- (5) 1 ft. 3 in. × 1 ft. × 1 ft.; granite; subangular.
- (6) 1 ft. 4 in. × 1 ft. 2 in. × 10 in.; granite; round.
- (7) 1 ft. 2 in. × — × 10 in.; granite; round.
- (8) 2 ft. × 1 ft. 6 in. × 10 in.; granite; round.
- (9) 2 ft. × 2 ft. × 1 ft. 2 in.; granite; subangular.
- (10) 1 ft. 2 in. × 1 ft. × 10 in.; granite; rounded.
- (11) 2 ft. 6 in. × 2 ft. × 2 ft.; granite; rounded.
- (12) 1 ft. × 10 in. × 8 in.; granite; rounded.
- (13) 1 ft. × 10 in. × 8 in.; granite; rounded.
- (14) 1 ft. × 10 in. × 8 in.; granite; rounded.
- (15) 1 ft. × 10 in. × 8 in.; granite; rounded.
- (16) 2 ft. × 10 in. × 10 in.; granite; oval.
- (17) 2 ft. × 1 ft. 6 in. × 1 ft. 6 in.; granite; subangular.
- (18) 2 ft. × 1 ft. 6 in. × 1 ft. 4 in.; granite; round.

Ballafayle, above Gob Garvane—

- (1) 1 ft. 11 in. × 1 ft. × 10 in.; granite; subangular.
- (2) 1 ft. 10 in. × 10 in. × 8 in.; granite; round.
- (3) 1 ft. × 10 in. × 8 in.; granite; subangular.
- (4) 1 ft. × 8 in. × 8 in.; granite; subangular.
- (5) 1 ft. × 11 in. × 8 in.; in fence; granite; subangular.
- (6) 2 ft. × 10 in. × 10 in.; in fence; granite; round.
- (7) 1 ft. 4 in. × 1 ft. 2 in. × 1 ft.; in fence; granite; subangular.
- (8) 1 ft. 2 in. × 1 ft. × 10 in.; in fence; granite; subangular.
- (9) 1 ft. × 10 in. × 8 in.; granite; round.
- (10) 1 ft. 10 in. × 11 in. × 1 ft.; in fence; granite; rounded.
- (11) 2 ft. 6 in. × 1 ft. 8 in. × 1 ft.; red sandstone.
- (12) 1 ft. 6 in. × 1 ft. × 10 in.; granite.
- (13) 1 ft. 2 in. × 10 in. × 8 in.; granite.
- (14) 3 ft. × 2 ft. × 1 ft. 8 in.; granite; striated.
- (15) 1 ft. 4 in. × 1 ft. × 10 in.; granite; round.
- (16) 1 ft. 2 in. × 1 ft. × 1 ft.; granite; round.
- (17) 1 ft. × 10 in. × 10 in.; granite; round.
- (18) 1 ft. × 8 in. × 8 in.; granite; round.
- (19) 1 ft. × 8 in. × 8 in.; granite; round.
- (20) 1 ft. 2 in. × 1 ft. × 10 in.; granite; round.
- (21) 2 ft. × 1 ft. 6 in. × 1 ft. 8 in.; granite; round.
- (22) 1 ft. × 10 in. × 8 in.; granite; round.

Second Report of the Committee, consisting of Dr. H. WOODWARD (Chairman), Rev. G. F. WHIDBORNE, Messrs. R. ETHERIDGE, R. KIDSTON, J. E. MARR, C. D. SHERBORN, and A. S. WOODWARD (Secretary), for the Registration of all the Type Specimens of British Fossils.

THE Committee have to report that, after some preliminary delay, copies of the circular and letter mentioned last year have been issued to the majority of the British museums and owners of private geological collections, and several valuable lists have already been received. It is proposed to complete the distribution of the forms immediately, and there is thus some hope that the majority of the lists may be available for classification before the next meeting of the Association. In the opinion of the Committee it is inadvisable to attempt a detailed report until some such classification has been made; and it has been decided to append to

the list of types an enumeration of the principal specimens which have been described and figured.

Owing to the influence to some extent of members of the Committee, it is gratifying to be able to state that several of the larger museums have decided to publish separate lists of the type and figured specimens in their respective collections. Those of Bristol (by Mr. Edward Wilson) and York (by Mr. H. M. Platnauer) are already published; while those of Bath (by Rev. H. H. Winwood and Mr. E. Wilson) and Cambridge (by Mr. H. Woods) are nearly ready for issue. Separate lists are also promised for the Museums of Edinburgh, Newcastle-on-Tyne, and Brighton; and it is hoped that a catalogue of type specimens of fossil Invertebrata in the British Museum will shortly be prepared. So far as the British fossil Vertebrata are concerned, Messrs. Woodward and Sherborn's catalogue (London, 1890) contains a nearly complete enumeration of the types.

Seventeenth Report of the Committee, consisting of Drs. E. HULL and H. W. CROSSKEY, Sir DOUGLAS GALTON, Professor G. A. LEBOUR, and Messrs. JAMES GLAISHER, E. B. MARTEN, G. H. MORTON, J. PARKER, W. PENGELLY, JAMES PLANT, J. PRESTWICH, I. ROBERTS, C. FOX-STRANGWAYS, T. S. STOOKE, G. J. SYMONS, W. TOPLEY, TYLDEN-WRIGHT, E. WETHERED, W. WHITAKER, and C. E. DE RANCE (Secretary), appointed for the purpose of investigating the Circulation of Underground Waters in the Permeable Formations of England and Wales, and the Quantity and Character of the Water supplied to various Towns and Districts from these Formations. (Drawn up by C. E. DE RANCE, Reporter.)

EIGHTEEN years have elapsed since your Committee were appointed with their present Chairman and Secretary in their respective positions; since then your Committee have not only recorded the wells and borings already in existence, but they have annually given much information to engineers and contractors, which they believe have materially aided towns and districts being supplied with pure water. The value and importance of underground water, both from its purity and the absence of expensive law costs and compensation to riparian owners, are daily more and more realised, and with the utilisation of these stores comes the necessity of recording their character, quality, and local conditions. Your Committee, therefore, seek re-election.

Your Committee would again call the attention of the Delegates of the Corresponding Societies to the importance of local observers giving special attention to the date at which the springs of their neighbourhood diminish in yield and subsequently increase; the date at which any springs cease to flow, and that on which they recommence; the amount of flow of any springs either daily, weekly, or monthly; similar records of the heights of the water in wells and borings, whether for long or short periods. The value of such observations would be much enhanced if descriptions be given that will enable the locality to be identified on the one-inch map of the Ordnance Survey and the levels in regard to the Ordnance Datum line.

YORKSHIRE.

Boring at The Brewery, Skipton.

Information from Messrs. Scott and Robinson. Boring carried out by Diamond Boring Co., London, 1890.

Dark bituminous limestone with compact black shale bands Feet
500

A plentiful supply of water was met with, of a pure character, but unfortunately strongly impregnated with sulphuretted hydrogen gas, which was freely given off when the water was agitated. It is worthy of note that sulphur springs occur at various points along the anticlinal axis ranging through this boring; amongst them is the sulphur well or Craven Baths, at Skipton, on the opposite side of the valley, and the well-known sulphur springs of Harrogate to the east; while to the west of Clitheroe one occurs at Standen Brook, to which a bath-house is attached, also south of Worsaw, in Twist's Brook, in Holden Brook, and in the bed of the river Hodder, north of Longridge Fell. The Skipton boring commences 340 feet above the mean sea-level; the sulphur bath is at 420 feet above the same; the shale and thin bedded limestones there are vertical.

LINCOLNSHIRE.

The following is a list of the strata found on the surface, or proved in borings, in descending order; the strata printed in italics are of a pervious nature:—

			Ft.
Cretaceous	Chalk	<i>Middle chalk</i>	164
		Loam chalk	
		Red chalk 11 feet, Carstone 36 feet	47
	Tealby beds	<i>Tealby limestone</i>	15
		Tealby clay	50
		Claxby ironstone	10
Spilsby sandstone		30	
	Kimeridge and Oxford clays	800	
Oolitic	Upper	<i>Kellaway's rock</i>	10 (?)
		Basement clay	18 (?)
	Great oolite series	<i>Cornbrash</i>	5
		Great oolite clay	25
		<i>Great oolite limestone</i>	15
	Inferior oolite	Upper estuarian beds	35
		<i>Lincolnshire limestone</i>	60
	Basement beds (Northampton sands)	30	
Liassic	Lias	Upper lias	100
		Marlstone rock bed, represented by clay, not porous	20
		Middle lias clay	15 (?)
		Lower lias	814
		Rhætic	22
Triassic	Trias	Keuper marls	725
		<i>Keuper sandstone</i>	249
		Upper soft sandstone	206
		<i>Pebble beds</i>	113
		Lower soft sandstone	223
Permian	Permian	Upper marls	118
		Upper magnesian limestone	44
		Middle marls	140
		Lower magnesian limestone	26
		Marl slate	193
	Upper Coal-measures	10 (+)	

The following are the revised figures of the South Scarle (or Collingham boring), Nottinghamshire, on the border of the Lincoln county boundary, and nine miles to the south-west of that city :—

		Ft.	
	Deep deposits	21	} 753
	{ Lower lias	29	
	{ Rhætic	65	
Trias	{ Keuper marls	688	} 205 $\frac{1}{2}$
	{ Keuper sandstone and shale	
	{ Upper soft sandstone	} 205 $\frac{1}{4}$
	{ Blue shale	1	
	{ Reddish brown conglomerate	73	} 11
{ Quartzite conglomerate	39		
	Lower soft sandstones, marls in the first 79 feet	} 223
	Permian red marls	118 $\frac{1}{2}$	
Permian	{ Magnesian limestone, light yellowish	43 $\frac{1}{2}$	} 519
	{ Marl, red and blue gypsum, sandstone	150	
	{ Thin bedded grey shale dolomite, basement breccia	118	
Upper Coal-measures	{ Deep red indurated marls with hæmatite nodules 12	

Springs at 834 feet, flowed 11 gallons per minute; at 950 feet, 50 gallons per minute, and are said to have risen 52 feet above the surface. The temperature of the water was 69° F. at the base of the Keuper, and 73° at the top of the Permian. The beds have been studied by Dr. Hull, F.R.S., Mr. Wilson, F.G.S., and Mr. Dalton, F.G.S.; the information given above is drawn up from their united labours.

Information from Mr. H. TEAGUE, C.E., City Engineer, Lincoln.

A trial borehole at Bracebridge, Lincoln, by Messrs. Bass and Co. was discontinued at a depth of 320 feet, the base of the lower lias clay not being reached. The water obtained at that depth contained—

	Grains per gallon
Sodium chloride	549.00
Sodium bromide	11.00
Sodium carbonate	15.00
Calcium	12.50
Magnesium	4.58
Calcium sulphate	1.13
Silica35
Iron oxide, alumina, &c.21
Suspended matter04
	593.81

The discharge from springs in the Lincoln area has been taken by the City Engineer at various points at Tealby on the Wolds. The discharge on May 25, 1891, was 109,440 gallons per day. At Welton these springs yielded 2,800,000 gallons on June 22, 1891; in August 1878 they only yielded 105,000 gallons; and in June, 1887, 163,000 per 24 hours, proving the extreme variability of oolitic springs. The maximum discharge was after a rainfall of five inches in the previous five weeks. A borehole at Deneholme, 106 feet in depth, yielded 20,000 gallons per 24 hours; its height and quantity were affected by rainfall.

Information from Messrs. JUKES-BROWNE and DALTON, of the Geological Survey.

Scothern Grange Well.

	Feet.
Boulder clay	7
Gravel with water	(+)

Langworth Farm, $\frac{1}{4}$ mile S.W. of Station.

	Feet.
Boulder clay } sunk	30
Oxford clay }	30
Ditto, bored	(+)
60 Kellaway's rock	(+)

The water rises to the surface.

Sudbrook Holme. Boring by Messrs. LEGRAND and SUTCLIFF.

Water rises to level of top of the house; yield, 7,000 gallons per day of 10 hours.

	Ft. in.	Ft. in.	
Soil	2 0	2 0	
Kellaway's beds {	Stone	5 0	7 0
	Grey sand	13 0	20 0
	Blue clay	7 0	27 0
Cornbrash {	Stone	4 6	31 6
	Great Green clay	11 6	43 0
oolitic clay {	Dark clay	14 0	57 0
	Great oolite {	Stone	4 0
oolite {	Clay	1 0	62 0
	Shell rock	14 6	76 6
	Green clay	3 8	80 2
Upper estuarian {	Stone	5 4	85 6
	Clay	15 0	100 6
Lincolnshire limestone } Stone	5 6	107 0	

HORNCASTLE.

In the shafts and borings made at Kirkstead and Woodhall, near Horncastle, in 1819, in a futile search for coal, no water appears to have been met with, except the saline spring, now known as Woodhall Spa, which occurred at a depth of 530 feet, and is believed by Mr. Jukes-Browne, of the Geological Survey, to have issued from the inferior oolite. He thinks it probable that the beds passed through were as follows:—

Feet.		Feet.
10	Gravel and boulder clay	10
360	Kimeridge and Oxford clays	350
500	Kellaway rock, clays, cornbrash }	110
640	Great oolite, upper estuarines }	140
1020	Lincolnshire oolite and Northampton sands	380
	Bias (upper, middle and lower)	380

The temperature of the water in 1883 was 59.6 F., and the water contained, in 1863, in grains per gallon:—

Chloride of sodium	1215.17
Chloride of potassium	2.45
Chloride of magnesium	86.84
Chloride of calcium	105.00
Bromide of sodium	5.14
Iodide of sodium	2.73
Sulphate of soda	30.62
Bicarbonate of soda	45.76
Carbonate of lime	9.38
Carbonate of iron	0.27
Silicon	0.33
Organic matter	trace

At Stamford, the Marquis of Exeter had a futile boring for coal put down which commenced in the Kimeridge clay, and was discontinued at 500 feet still in the lias, as might have been anticipated.

NOTTINGHAMSHIRE.

OWTHORPE, *Quarter Sheet 71 S.E.*

Borings for coal, 1876-80. Information from Mr. Harrison:—

Ft.	in.		Ft.	in.
12	0	Lower lias	12	0
46	6	Rhætic beds	34	6
679	6	Keuper marls (gypsum)	633	0
			Ft.	in.
772	6	{ Red sandy marl and sandstone	15	0
		{ Red sandy marl	44	0
		{ Reddish and white gritty sandstone, with pebbles	34	0
804	6	{ Firm white micaceous sandstone	22	0
		{ White and pink gritty sandstone	10	0
941	6	Coarse-grained gritty sandstone, passing into quartzish conglomerate	137	0
		Red and white marl	2	0
		Sandstone and conglomerate	56	0
		Firm white micaceous, sometimes gritty sandstone	36	0
		Dark and coarse sandstone	16	0
1,068	6	Red and grey sand, and conglomerate	17	0
		Red, and banded grey and red marl and white clay	14	0
1,097	6	Red, grey, and white fine-grained micaceous sandstone	15	0
1,342	0	Coal-measures and coal seams	244	6

In abstract:—

Ft.	in.		Ft.	in.
46	6	Lias and Rhætic	46	6
679	6	Keuper marls	633	0
772	6	Keuper sandstone	93	0
804	6	Soft sandstone	32	0
1,068	6	Pebble beds (Bunter)	264	0
1,097	6	Permian marl, &c.	29	0
1,342	0	Coal-measures	244	6

Particulars of well-boring, given by Mr. HENRY MELLISH, of Hodsock Priory, Worksop, carried out at the same. [For questions see Appendix.]

1. Situated at Hodsock Priory, Worksop (Notts), on the formation marked f 1 on the map of the Geological Survey.

1a. Bored March, 1891.

2. 55 feet.

3. Six in. borehole; depth, 94 feet; no well.

4. Water stands about 3 feet from surface; permanent pump not yet fixed, but on completion of bore we tried it with a centrifugal pump, which we worked for the best part of a day and a half. It raised the water at a rate estimated at from 110,000 to nearly 150,000 gallons per 24 hours; when running at the higher rate it lowered the level in the bore from 3 feet to 18 feet below the surface; the level recovered in a few minutes on stopping the pump.

5. See 4.

6. No data.

7. Water in the bore stands about 1 foot higher than the water-level in the surrounding soil. A mill-dam a few yards has its level some 6 feet above water in the bore.

8. Copy of analysis enclosed.

9. About 6 feet of soil above the rock, the rest all in red sandstone, with a little marl in places, apparently in beds a few inches thick.

9a and **10.** Water throughout; stands about 4 feet from surface.

11. Surface water kept out by iron tubing to a depth of 55 feet.

12. Not to my knowledge.

13, 14, and 15. No.

Copy of Analysis.

	Grains per gallon.
Total solid residue	18.48
Containing—	
Oxidisable organic matter02
Chlorine (equal to chloride of sodium, 1.48)90
Nitric acid as nitrates	3.85
The water also contained—	
Free ammonia0005
Albuminoid ammonia001
Hardness according to Clark's scale	13

The water was bright and clear, and quite free from colour and deposit; it left on evaporation a residue which was white, and did not blacken at all on heating strongly.

The water has a mere trace of organic matter in solution, and hardly any ammonia, and it is a beautifully pure supply for drinking purposes. It not being excessively hard makes it also serviceable for general domestic purposes. (Signed) J. AUGUSTUS VOELCKER.

LANCASHIRE.

Borings at the Widnes Alkali Co.'s Works.

Information from Messrs. E. Timmins and Sons. Shaft, 45 feet deep; then boring.

Ft.	in.		Ft.	in.
7	0	Soil	7	0
14	0	Clay	7	0
26	6	Quicksand	12	6
46	0	Strong clay	19	6
51	6	Quicksand	5	6
147	0	Strong clay	95	6
152	0	Sand and gravel	5	0
600	0	Red sandstone (4 in. boring)	152	0

Yield, 114,300 gallons in 24 hours at bottom of the well. 1891.

Another boring gave—

Ft.	in.		Ft.	in.
10	0	Filled up material	10	0
20	0	Clay	10	0
27	0	Quicksand	7	0
32	0	Gravel and boulders	5	0 (?)
43	0	Strong clay with stones	11	0 (?)
75	0	Quicksand	32	0

Well at Willgreave Farm, opposite Thelwall, near Warrington, by Messrs. TIMMINS and SONS, Runcorn.

Ft.	in.		Ft.	in.
24	0	Sand	24	0
		Fine gravel, rusty	7	6
		Blue river clay	0	6
		Coarse gravel	2	6
		Strong clay	1	0
		Coarse gravel	6	6
		Clay	1	0
		Sand	4	0
		Clay	87	0
		Sand	1	0
		Clay	8	0
		Fine sand	8	0
		Clay	8	0
		Silky sand	5	0
		Clay	1	0
		Sand	5	0
		Clay	15	0
		Quicksand	25	0
		Clay	2	0
231	0	Sand	19	0

This boring discloses the greatest trough in the valley of the Mersey, the rock not having been reached at a depth of 231.

Boring on Lancashire shore of River Mersey at Vyrnwy Waterworks tunnel, west of Warrington, by Messrs. COCKRANE.

Ft.	in.		Ft.	in.
6	0	Soil and peat	6	0
15	0	Loam	9	0
25	0	Fine sand	10	0
52	0	Gravel	27	0
61	0	Sandy clay	9	0
75	0	Red sand	14	0
89	0	Silky clay	14	0
93	0	Sandy clay	4	0
98	0	Red sand	5	0
118	6	Sandy clay	20	6
132	0	Salt and clay	13	6
135	0	Red sand	3	0
		Red sandstone	(+)	

Borings were made at either end of the proposed Vyrnwy tunnel to convey the water-pipes under the Mersey from Cheshire into Lancashire on the margin of the river in those counties by Messrs. Timmins and Sons, Runcorn. Rock was reached, and artesian water at once rose with great violence to the surface and overflowed at a height of 20 feet above ordinary datum. The samples obtained are preserved in the Liverpool Corporation Water Department, but probably, from lenticular porous beds being then dry, they do not correspond to the subsequent shafts

sunk on their sites. The actual sections met with by the shafts are as follows; water had been admitted to the beds, between the completion of the borings and the execution of the shafts, by the withdrawal of the lining tubes of the bore-holes. The case is of great interest as showing the care that must be exercised in dealing with borings not to induce artificial conditions.

Lancashire Shaft.

Ft. in.		Ft. in.
2 0	Soil	2 0
12 0	Loam clay	10 0
13 0	Fine sand	1 0
32 0	Coarse sand	19 0
37 0	Blue loam	5 0
44 0	Silt sand and loam	7 0
47 6	Coarse gravel	3 6
49 0	Stiff red clay	1 6
50 0	Coarse sand	1 0
57 0	Stiff red clay	7 0
61 0	Red silt	4 0
62 0	Clay and sand	1 0
66 0	Brown clay	4 0
71 0	Red silt	5 0
80 0	Brown silt and clay	9 0
86 0	Running sand	6 0
97 0	Clay and sand	11 0
98 0	Sand and gravel	1 0
106 0	Marly clay	8 0

The red sandstone occurred at a depth of 133 feet 6 inches, sandy clays and loamy sands intervening.

CHESHIRE.

Cheshire Shaft.

Ft. in.		Ft. in.
1 0	Soil	1 0
10 0	Clay	9 0
20 0	Peat	10 0
25 0	Clay and loam	5 0
39 0	Running sand	14 0
43 0	Loam	4 0
49 6	Fine gravel	6 6
63 6	Running sand	14 0
66 0	Clay and sand	3 6
84 3	Stiff clay	18 3

In the boring the clay continued to 97 feet, marly sand to 105 feet, then red sandstone.

The following analyses are interesting, as showing the effect of natural springs of brine issuing at pressure, and mixing with the fresh-water in the Glacial Drift overlying the Keuper marls at Calveley, near Tarporley, Cheshire. The analyses were made by Mr. J. Carter Bell:—
1. Well in Mr. Jos. Jink's field, Calveley. 2. Brook in Mr. James Trickett's farm, Calveley. 3. Well at new kennels, Calveley. Stated in grains per gallon:—

—	1	2	3
Total solid at 212° F.	126·0	74·0	700·0
Mineral, ditto	88·5	42·5	650·0
Chlorine	11·62	1·82	207·55

Macclesfield County Asylum, 1873-5.

(Surface level 538 feet above Ordnance Datum.)

Ft. in.		WELL.	Ft. in.
36	0	Brick clay, three or four thin beds of quicksand .	36 0
BORING.			
63	0	Quicksands, shells, boulders	27 0
97	0	Soft brick clay	34 0
141	0	Very stiff brown and blue boulder clay	44 0
163	0	Brick clay	22 0
165	0	Brown sand, pebbles, shell fragments	2 0
166	0	Loam	1 0
180	0	Loose running sand	14 0
183	0	Hard stiff brown and blue boulder clay	3 0
184	0	Very sharp running sand	1 0
186	0	Stiff clay, brown boulder clay pebble	2 0
192	0	Loamy gravel	6 0
193	0	Very tough boulder clay	1 0
197	0	Sand and fine gravel, shells	4 0
216	0	Brown sand	19 0
220	0	Gravel, erratic and local rocks	4 0
344	0	Upper red mottled sandstone	124 0

Water level, 174 feet from the surface, or 364 feet above O.D. The rock-surface was 318 feet above O.D. The bottom of the pump-barrel is 207 feet below the surface.

Messrs. Henry Evans and Co., Star Brewery, Macclesfield.

Carried out by Messrs. Mather and Platt, Salford Ironworks.

Ft. in.		Ft. in.
134	0	Drift 134 0
203	0	Sandstone 169 0

Wrought-iron tubes to top of rock, 10 inches diameter.

Macclesfield Brewery.

Ft. in.		WELL.	Ft. in.
33	0	Sand and gravel	33 0
BORING.			
37	0	Sand, fine	4 0
		Brick clay	18 0
		Boulder clay	13 0
		Gravel (boulders and pebbles)	11 0
		Fine gravel, shell fragments	4 0
		Gravel and clay	5 0
		Fine sand	6 0
		Coarse gravel	2 0
		Clay and gravel	14 0
		Brick clay	7 0
		Sandy clay shells	4 0
		Boulder clay, large boulders	12 0
138	0	Gravelly clay	5 0
		Trias, red sandstone	(x)

Water plentiful.

Brewery near Railway Bridge, Sutton.

Ft. in.		Ft. in.
	Boulder clay	12 0
	Sand and gravel	8 0
	Boulder clay	10 0
75 0	Quicksand	45 0
180 0	Red sandstone	105 0

Water plentiful.

Brewery, Park Green, Macclesfield.

Ft. in.		Ft. in.
44 0	Details unknown	44 0
46 6	Very rough gravel	2 6
62 7	Compact boulder clay	16 1
65 7	Rough gravel, small pebbles	3 0
70 0	Tough boulder clay	4 5
72 6	Fine sand	2 6
74 7	Fine running sand	2 1
98 0	Coarse local gravel	23 5
147 7	Red and mottled sandstone	49 7

Bollington Church Rectory, near Macclesfield.

Boring close to churchyard, made by Messrs. E. Timmins and Sons, Bridgwater Foundry, Runcorn.

Ft. in.		Ft. in.
21 0	Red clay	21 0
27 0	Sand and gravel	6 0
28 0	Coarse clay	1 0
30 0	Strong clay	2 0
34 0	Coarse sand	4 0
40 0	Strong clay	6 0
45 6	Sandy gravel	5 6
50 0	Marly clay	4 6
65 0	Brown sandstone	15 0
84 0	Brown marl	19 0
87 0	Brown sandstone	3 0
133 0	Mottled marl	46 0

Surface level 600 feet above O.D. Water stands 15 feet from the surface. Total solids, 197 grains per gallon.

Lymm Waterworks.

Boring made by the Diamond Boring Company, under the superintendence of Mr. Easton, C.E. Surface level 60 feet above O.D.

The following notes are made by Mr. De Rance, from the cores preserved in the water-tower. The following occurred at:—

Ft.	
31	Rough hackly sandstone (Lower Keuper).
36	Fine hard-grained sandstone.
53	Hard marly micaceous partings.
56-63	Rough hackly sandstone.
63-68	Fine-grained micaceous sandstone.
78	Fine sandstone.
80	Very fine-grained sandstone.
82	Rough compact sandstone.
110-250	Purple fine-grained sandstone.
1000	Soft red sandstone.

Weak brine occurred at the bottom of the borehole which was plugged up.

Boring at Messrs. Battersby and Co.'s Offerton Hat Works, Stockport.

Carried out by the Executors of the late E. Timmins, Runcorn.
Communicated by Mr. Percy Kendall, F.G.S.

Ft.	in.		Ft.	in.
15	0	Sandy clay (well, 13 feet; rest bored)	15	0
17	0	Small gravel	2	0
36	0	Brown clay	19	0
51	0	Loamy sand	15	0
70	0	Brown loam	19	0
79	0	Brown clay, and mixed gravel (water level, 74 feet from the surface)	9	0
84	0	Mixed sand, gravel, and brown clay	5	0
91	0	Gravel (base of drift)	7	0
152	0	Permian sandstone (suction-pipe, 135 feet from surface)	61	0
152	9	Permian marl	0	9
154	9	Permian sandstone	2	0
156	9	Permian marl	2	0
177	6	Permian sandstone (perforated 10 in. tubes)	20	9
219	0	Permian marl (tubed out)	41	6
300	0	Permian sandstone (tubed, perforated to 229 feet; 8½ in. boring below 229, no tubes)	81	0

SHROPSHIRE.

Information from the Rev. COOPER WOOD, Clive Vicarage, Shrewsbury.

Well levels from which the town of Wem is supplied.

August 14, 1887. Fall off, 17 inches; time required for return, 40 minutes.

October 31, 1887. Fall off, 26 inches; time required for return, 70 minutes.

March 20, 1888. Fall off, 32 inches; time required for return, 92 minutes.

April 2, 1888. Fall off, 42 inches; time required for return, 150 minutes.

May 21, 1888. Fall off, 46 inches; time required for return, 360 minutes.

October 9, 1888. Fall off, 49 inches; time required for return, 720 minutes.

Total result of drought, 49 inches.

January 31, 1889. Return, 1 inch; time not observed.

February 28, 1889. Return, 2 inches; time not observed.

March 28, 1889. Return, 3 inches; time not observed.

April 5, 1889. Return, 5 inches; time not observed.

Total replacement to date, 5 inches.

Total depth of well, 67 feet.

Height to which water rose before August 1887, 31 feet 6 inches.

Pump will lower this by 13 feet 6 inches in 60 minutes, pumping at 28 strokes a minute.

WARWICKSHIRE.

In last year's Report the Coventry Waterworks borings were described as executed in the Permian sandstone, and delivering a very pure water at artesian pressure at the surface, without pumping. Since then a trial boring has been executed at Whitley, of which the following are the details:—

Ft.		Ft.	in.
10	Surface soil	10	0
	Lower Keupers sandstone	40	0
50	White with red streaks		
	Permian sandstone	150	0
200	Dark red		

Your Committee regret to note that the trial boring is only 1,130 yards

from the filter-beds of the Corporation Sewage Farm; it is not proposed to pump from the boring, but from a shaft about 100 feet nearer the farm; the dip of the very jointed and open Lower Keuper sandstone is about south-east or from the farm towards the shaft, which is, moreover, 16 feet below the filter-beds, which are 9 acres in extent, and receive no less than two million gallons per day of sewage.

GLAMORGANSHIRE.

*Information from Mr. J. STORRIE, The Museum, Cardiff.
Cogan Brickworks Boring, 1885.*

Ft.		Ft.
201	Red marl, grey bands	201
202	Green marls	1
312	Red marls	110
313	Green marl	1
338	Red marl	25
	Coarse grit	(+)

Water at 358 feet.

The Dumballs Boring, near Cardiff.

Ft.		Ft.	in.
456	Red marls	456	0
502	Conglomerate	46	0

Old Brewery, Cardiff.

331	Marls	331	0
	Conglomerates		(+)

Water 326 feet, stands at 40 feet from the surface before pumping, pump placed at 120 feet from the surface.

The Ely Brewery Co., near Cardiff Station, 2½ miles from Cardiff.

Ft.		Ft.	in.
186	Marls	186	0
190	Conglomerates		±(+)

Water at 181 feet.

APPENDIX.

List of Questions circulated.

1. *Position* of well or shafts with which you are acquainted.
- 1a. State *date* at which the well or shaft was originally sunk. Has it been deepened since by sinking or boring, and when?
2. Approximate *height* of the surface of the ground above Ordnance Datum (mean sea level)?
3. *Depth* from surface to bottom of shaft or well with diameter. *Depth* from surface to bottom of bore-hole, with diameter.
- 3a. *Depth* from the surface to the horizontal driftways, if any. What is their length and number?
4. *Height* below the surface at which water stands *before* and *after* pumping. Number of hours elapsing before ordinary level is restored after pumping.
- 4a: *Height* below the surface at which the water stood when the well was first sunk, and height at which it stands now when not pumped.
5. *Quantity* capable of being pumped in gallons per day of 24 hours. Average quantity daily pumped.

6. Does the *water level* vary at different seasons of the year, and to what extent? Has it diminished during the last ten years?
7. Is the ordinary *water level* ever affected by local rains, and, if so, in how short a time? And how does it stand in regard to the level of the water in the neighbouring streams, or sea?
8. *Analysis* of the water, if any. Does the water possess any marked *peculiarity*?
9. *Section* with nature of the rock passed through, including cover of Drift, if any, with *thickness*.
- 9a. In which of the above rocks were springs of water intercepted?
10. Does the cover of Drift over the rock contain *surface springs*?
11. If so, are these *land springs* kept entirely *out* of the well?
12. Are any large *faults* known to exist close to the well?
13. Were any *brine springs* passed through in making the well?
14. Are there any *salt springs* in the neighbourhood?
15. Have any wells or borings been discontinued in your neighbourhood in consequence of the water being more or less *brackish*? If so, please give section in reply to query No. 9.
16. Kindly give any further information you can.

Report of the Committee, consisting of Messrs. H. BAUERMAN, F. W. RUDLER, and J. J. H. TEALL and Dr. JOHNSTON-LAVIS, appointed for the investigation of the Volcanic Phenomena of Vesuvius and its Neighbourhood. (Drawn up by Dr. JOHNSTON-LAVIS.)

[PLATE I.]

THE reporter has, during the last year, carefully and continuously investigated all new sections of the rocks of the Neapolitan area. The great main sewer which is in course of construction, as mentioned in the last report, crosses the whole of the volcanic district to the west of Naples and terminates near the Monte di Cuma in the Gulf of Gaeta. This tunnel, of considerable section, is about 20 kilometres in length, and is being constructed from nineteen points of attack. In many places the materials traversed are of a very friable nature, and consequently the masonry lining progresses with the cutting. It will be therefore seen that most careful and constant attention and frequent visits are necessary for keeping a record of the geology. Most of this tunnel is through rocks at a high temperature, so that numerous thermometric observations were made. So far most of the different portions are not yet joined, and therefore any description would be very incomplete if given in this report; it is therefore proposed to postpone it till the next meeting of the British Association. Several observations, however, of considerable importance as bearing on this district as well as on vulcanological phenomena in general, have come to light.

For upwards of a year the remaining portion of the reporter's spare time has been spent in the compilation of the bibliography of Vesuvius and the Phlegroean fields, as well as of the other volcanoes of Southern Italy. In this he has had the able co-operation of his wife, Madame Antonia Lavis. This long, tedious, but very necessary work is now complete, and the reporter hopes to present a copy to the Association. To show the amount of toil necessary, it may be mentioned that the number of entries have been more than double those published in the Report of the International Geological Congress of 1881.





Illustration the Report of the Committee for Investigating the Volcanic Phenomena of Venezuela.

The reporter has much gratification in presenting to the Association the great geological map of Monte Somma and Vesuvius, which has been now published some months, and in the construction of which much substantial help, and above all moral encouragement, has been given by the British Association. The reporter hopes that his colleagues in the science of geology will be satisfied that he has done his utmost to win their confidence.

During the latter part of 1890 and the early part of 1891, the central activity of Vesuvius has very slightly varied, except about the new year, when it was considerably increased, rising to the third or fourth degree, simultaneously with the stoppage of the lateral outflow of lava that had been going on since August 7, 1890. Since then, up to the present outburst, the central activity has been generally at the first degree, and the cone of eruption has slowly grown in height (see Plate).

On June 1 there was a crater within the central cone of eruption, of about 50 m. in diameter, near the centre of which was the eruptive vent, surrounded by another embryonic eruptive cone. On that day, four small eruptive mouths opened around the embryonic cone in the bottom of the central crater, the smallest being to the east.

Thus the volcano remained till June 7, at 10 a.m., when activity stopped, only a small quantity of vapour escaping from central vents. At midday a radial cleft opened at the north toe of the cone of eruption (May 1889, June 1891), traversing towards its east end the little sickle-shaped ridge, the remnant of the 1885-86 crater, but, as yet, gave out little vapour. At 4 to 4.30 p.m., shocks of earthquake commenced, limited only to the upper slopes of Vesuvius, and simultaneous with the extension of the radial fissure down the side of the great Vesuvian cone for nearly half its way opposite the Punta del Nasone of Monte Somma, from which, at about 5.30 p.m., issued a little lava, whilst from the upper extremity of the fissure at the toe of the cone of eruption much vapour escaped, so that as seen from Naples the smoke-plume arose from this point. From 5.30 to 7 p.m. the fissure still extended lower, accompanied from time to time by local earthquakes, noises, and the elevation of columns of black dusty smoke. At a few minutes to 7 the floor of the Atrio del Cavallo was reached, and a remarkably black column of smoke had arisen.

My friend Dr. L. Sambon saw this column arise, and came to inform me immediately, as I had left off watching the mountain at 5.30. After photographing the mountain, we left Naples at 9 p.m., and spent some time in inquiries at Resina and near the Observatory. Everything was now dark, as the volcano had calmed down at 8 p.m. At 2 a.m., June 8, we were at the eastern extremity of the Observatory ridge, and commenced to wend our way across the lava surface towards Monte Somma. We were at the lowest part of the depression at the west end of the Atrio del Cavallo, where it joins the Fossa della Vetrana, and along which some of the largest lava-streams have flowed (1855, 1872, &c.), when suddenly on our right above us (2.23 a.m.) a vast quantity of bright red vapour arose from the new outpour of lava. We hastened our steps as much as the road and our lantern would allow us, so as to reach the escarpment of Monte Somma, the foot of which was followed till near the Punta del Nasone, and close to the theatre of eruption. Here we clambered up some distance above the level of the Atrio to watch events whilst we ate our late supper or early breakfast. Along

the slope of the great cone in the line of fissure were a few luminous points from some pieces of still uncooled lava of the little that had oozed forth from the lower half of the fissure. At about 60 or 80 yards from the foot of the great cone two or three fountains of lava were throwing up jets of molten rock for 2 or 3 m., and the lava was slowly spreading out on the almost horizontal plain of the Atrio in several tongues. The lava must have still been high in the main chimney, as the vapour that issued at the top of the fissure showed a slightly red illumination. So

FIG. 1.—Great cone of Vesuvius, as seen from a little W. of the Punta del Nasone of Monte Somma, showing the eruptive rift of June 7, 1891. (Photographed by the author.)

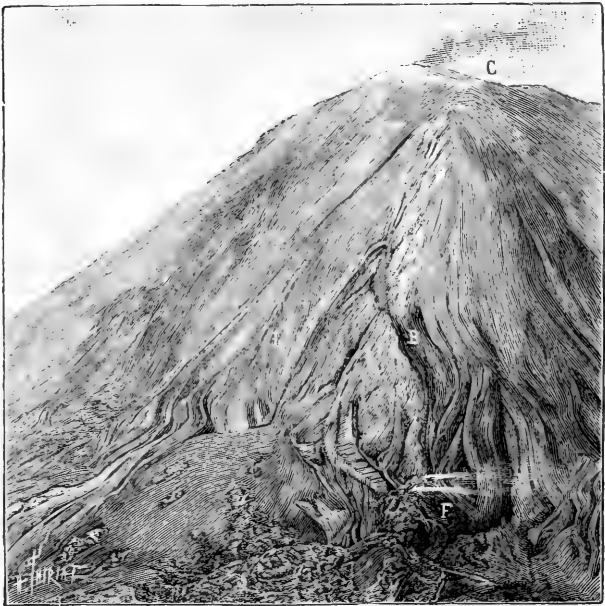

C, crater plain and cone of eruption; *B*, rift, marked half-way down by an irregular crateriform pit produced by the explosion at 5.30 P.M.; *L*, tongues of lava that issued from last-mentioned pit; *F*, main outpour of lava with fumaroles.

we remained till daylight, when we could see the fissure on the side of the cone. The mouth that formed at 5.30 the previous day was still smoking a little, whilst the fissure below it sent off several ramifications at an acute angle like the branches of an inverted tree, from several of which little streams of lava had been given out, where they had soon consolidated (see fig. 1). We now followed the base of the great cone to the lower railway station, where we found all the people up and dressed, frightened by strong shocks and noises at 2.23 a.m., coincident with the fresh outflow of lava that we had witnessed, but which shocks

we had not felt, although they were described as the most severe that had been felt.

Having ascended to the summit of Vesuvius, we found the central crater rapidly enlarging by the falling in of its edges. From the new fissure at its summit was issuing much vapour under pressure, and rich in sulphurous acid, which is, even in traces, intolerable; and the hot air coming from innumerable new fissures rendered approach very difficult. We did, in fact, once jump across part of the fissure, but returned much quicker on account of the hot irritant vapours. An approach from the opposite side was equally unsuccessful. At some old fumaroles on the 1872 crater plain I collected some crusts of boric acid and alum, both rare products at this volcano.

I then wrote that one of three terminations we may expect to these phenomena, which are very characteristic of a lateral disruption, so common at Vesuvius¹:—

1. Should the lava cool sufficiently to plug the radial dyke, no further phenomena will occur, and activity will be restored to the central vent.

2. If this plugging only partially takes place, lava may dribble forth for months, but probably the escape of vapour will soon be restored to the central vent.

3. If the rent should widen, considering how low it extends, we may expect a grand eruption which might rival that of 1872, which commenced near the same spot and much in the same way; the mechanism by which this occurs I have explained elsewhere.²

The suggestion that I published in several newspapers has been fully confirmed—namely, that the second alternative type of eruptive character would be pursued by the volcano. Now, for a period of nearly two months lava has continued to dribble forth, activity has returned to the central vent, and no great changes have occurred.

The throat of the volcano commenced to be cleared on June 9, the vapour forcing its way up from the crater bottom through the choke of loose materials, and rose above as a column carrying with it much dust; at the same time the powerful vapour blast issuing from the upper extremity of the lateral rift soon stopped. Each day I was kept informed of the state of the volcano by the kindness of Messrs. Ferber and Treiber, the director and engineer respectively of the Vesuvian Railway.

On June 15 I considered it right to again visit the mountain, and had the good fortune to be accompanied by Messrs. H. Elliot, A. Green, Linden, Newstead, and Treiber, several of whom are excellent photographers, so that with two of my own cameras we were able to make an extensive pictorial record of some very unique formations.

At the point of issue of the lava, at the junction of the foot of the great Vesuvian cone and the Atrio del Cavallo, the first lava had cooled sufficiently to walk over it, but beneath our feet could still be seen in a few holes the flowing lava. At the foot of the great cone, and extending for half-way across the Atrio, along the radius of the eruptive rent, as if this had continued so far, were a series of dribble cone fumaroles. We counted seven complete and well-formed examples, besides numerous

¹ *Nature*, vol. xlv. June 18, 1891, pp. 160–161; *Corriere di Napoli*, June 10; *L'Italie*, June 11; *The Mediterranean Naturalist* for July.

² H. J. J. L., 'The Relationship of the Structure of Igneous Rocks to the Conditions of their Formation,' *Scientific Proceedings Roy. Dublin Soc.*, vol. v., N.S., pp. 112–56.

abortive ones. Most were giving out intensely heated vapour, which was liberated from the lava flowing beneath, and which soon carbonised a piece of wood placed in it. Around the lips of the upper opening,

FIG. 2.—Fumaroles formed on the new lava at some distance from the base of the great cone in the Atrio, as seen on June 15, 1891. (Photographed by the author.)

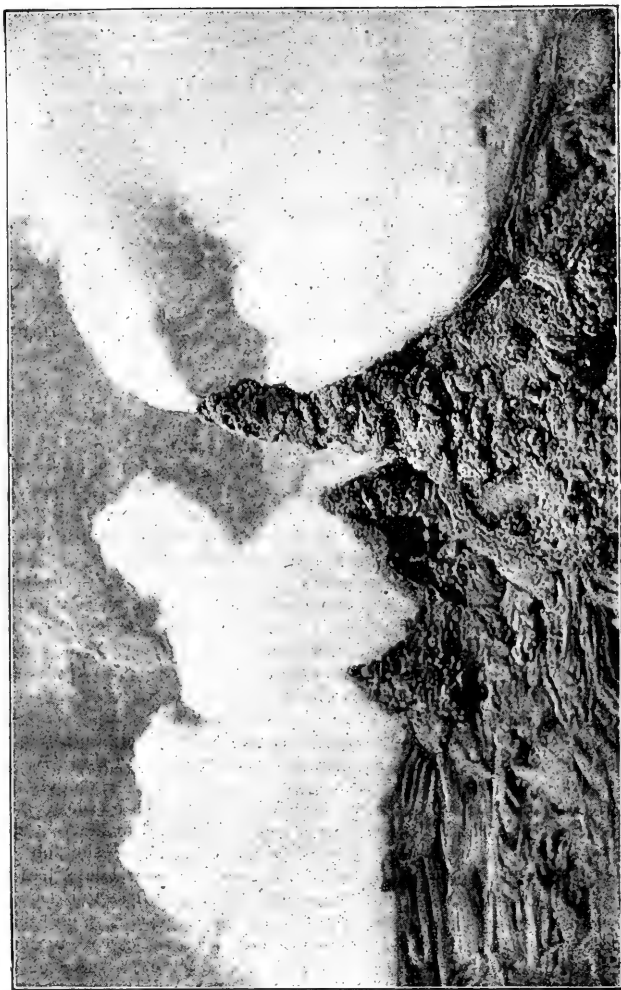

hæmatite with fused chlorides of potash, soda, iron, copper, &c., were being condensed from the vapour, and trickling down the outer surface of the fumarole, consolidated as curious vari-coloured stalactites of very deliquescent nature.

The lava had first flowed towards the escarpment of Monte Somma in a fan-like manner, so that the eastern extremity reached that great natural section just beneath the Punta del Nasone. Still following the natural inclination of the ground, it turned to the west, and on June 15 was opposite dyke 16 (as marked on my large geological map just published, and on the dykes themselves), advancing at a very slow rate.

The lava is a vitreous and coarse-grained rock, especially in regard to the included leucite as well as augite crystals, whilst the surface is, with one exceptional tongue, of the corded or 'pahoehoe' type. This is due to the magna being one that has been simmering since January in the chimney of the volcano, so that most of its dissolved water has been boiled off, and so allowing it to cool without the formation of scoriæ from the

FIG. 3.—Fumaroles formed on the new lava close to its exit at foot of great cone in the Atrio, as seen on June 15, 1891. (Photographed by the author.)

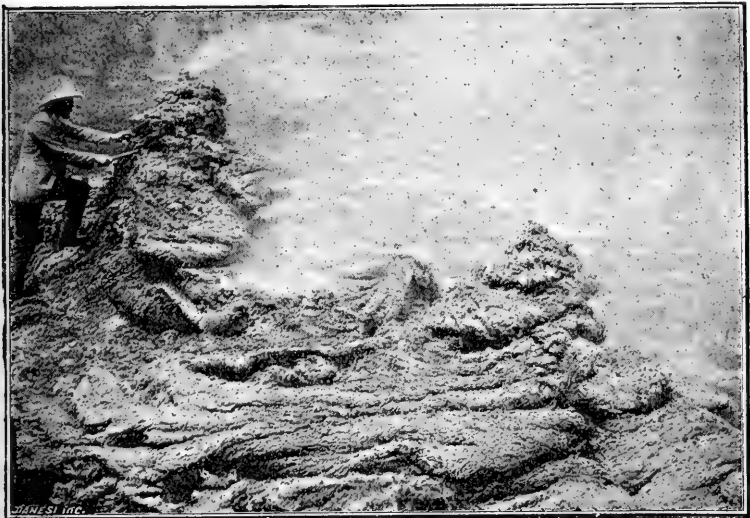

vapour that otherwise would escape after its exit. Leucite I have also demonstrated to be formed while the magma is simmering under low pressure with free escape for vapour in the upper part of the volcanic chimney.¹

At the summit of the great cone the crumbling in of the edges was constantly going on, but the upper extremity of the lateral rift at the foot of the cone of eruption and at the summit of the great Vesuvian cone had nearly ceased to give forth vapour. Along the line of rent on the mountain side no fumaroles or other signs of activity were visible except quite at the foot, where those of which I have spoken commence.

Up till June 26 there was an effort to clear the upper part of the

¹ See H. J. J. L., 'Geol. M. Somma and Vesuvius,' *Quart. Journ. Geol. Soc.* vol. xl.; and 'Relationship of the Structure of Igneous Rocks to the Conditions of their Formation,' *Scientific Proceedings Roy. Dublin Soc.* vol. v. N.S.

volcanic chimney of the impeding materials, which were constantly being added to by the slips from the crater's edge; but on that evening a dull red glow was visible in the crater bottom, showing that a fairly clear passage had been temporarily made for the continuous escape of vapour, and also that the lava was at no very great depth from the summit of the volcano. This of course indicates that the lateral opening was insufficient to drain off much of the lava which occupies the chimney above the level of the lateral outlet. Had such evacuation really taken place the eruption would have assumed enormous proportions, from the actual amount of lava above the tap, but more from frothing up of lava below that level, in consequence of the relief of pressure which in that case would occur. Of course, during all these days the ejection of dust with the smoke occurred, giving the latter its peculiar dark grey colour. Further destruction of the crater edge took place, so as to partly block the outlet, and it was not till our next visit that it again cleared.

On June 30 I again visited the crater, accompanied by my friend Mr. A. Green. All the summit of the great cone was covered by a thick coating of dust and sand, upon the surface of which were the usual white and yellowish-green chloride crusts seen on such occasions, so rich in copper as to plate with that metal the iron nails of our boots. The crater had considerably enlarged, the edges were in an extremely unstable state, with often considerable strips marked off by cracks parallel to the free edge, so that with a slight push by a stick it was possible to detach large masses of the materials which form the sides of the crater in the recent cone of eruption. So dangerous were the edges that it was but two places that my experience indicated as being safe to approach and look over, and that even with several precautions; so that the fatal accident to Señor Silva Jardim, who lost his life here but a few hours after our departure, is not to be wondered at.

On looking down some 45 to 50 m. beneath us, we could see the glow from a mouth some 2 or 3 m. in diameter. The walls of the crater were concave, so that, although overhanging at the top, yet a plumb-line let fall from the edge would strike the bottom of the cliff. The crater bottom was roughly plain, due to the combination of a talus all round, and an attempt at a cone encircling the main vent. It will be thus seen that the crater cavity was of the form of a convex-sided cylinder, or more simply barrel-shaped, with its upper diameter some 50 to 55 m.

With much difficulty we made our way around to the north side of the cone of eruption, which did not show its usual loose scoriæ surface, as it was buried beneath a thick coat of sand and dust, covered with a thin saline crust on its surface. The upper limit of the radial rift, which we were prevented from examining three weeks previously, on account of its giving out so much vapour as to constitute the temporary escape aperture of the volcano, had now become quiescent, so that we could fully examine it. Only a current of hot air was now issuing from it, but I was able to collect some fine masses of crystallised molysite and kremersite from its edges. Its average breadth was about 0.50 m. where it traversed old compact lava, but of course it disappeared as soon as it reached the looser materials. The real azimuth of its orientation, which we could now determine with greater accuracy than when we were walking over hot rock and enveloped in hot irritating vapours, proves to be, as it radiates away from the axis of Vesuvius, about 15° west of north. It curves then a little to the north, and near the foot of the

great cone it again assumes nearly the same azimuth as at starting, an arrangement which is quite evident when the Vesuvian cone is regarded from the Punta del Nasone. From that, the highest point of Somma, the lower extremity of the rift lies a little to the right or west, and faces that part of the Somma ridge which corresponds to the upper extremity of the Vallone Cancherone.

In the forenoon of June 30 much dust had fallen at the lower railway

FIG. 4.—Plan of the summit of the great cone of Vesuvius, July 31, 1891.

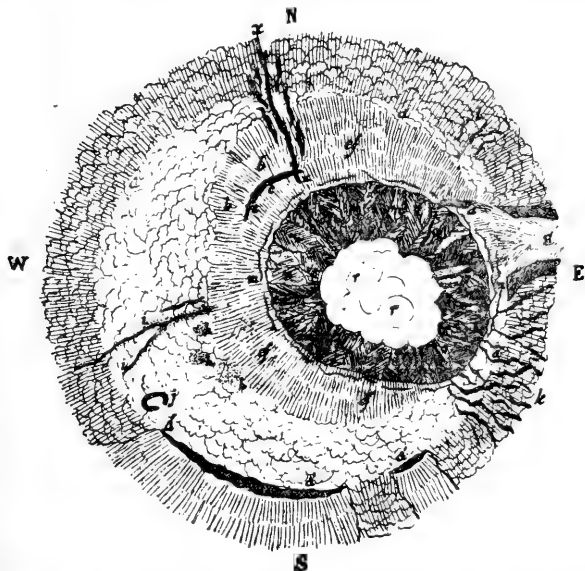

Limits of the crater of 1872; where overflowed by more recent lavas, *a*, and where still uncovered, *a'*; remains of cone of 1885–86, *b*; part of crater edge of May 1886, *c*; part of crater edge of May 1889, *d*; cone of eruption up to June 7, 1891, *ef*; fissure of May 1889, *g*; yellow patches of decomposed lava, scoriæ, and dust, *h*; fissures emitting hot vapour with HCl, *i*; guides' shelter, *j*; numerous fissures at the S.E. edge of the crater plain and great cone that the preceding days had increased in size and number, *k*; other fissures on the N.E. of great cone, *l*; fissures along the edges of the crater in process of formation, *m*; present crater, *n*; dykes seen in section, *o*; hollow dyke of the eruption of May, 1889–91, and of anterior ones, *p*; same of eruption of May 2, 1885, *q*; vapour column hiding bottom of crater, *r*; fissure of eruption of June 7, 1891, *x*.

station, of which we collected some bagfuls. It is the usual fine sandy material of these eruptions, and consists of the pulverised components of the cone of eruption.

Having passed the night at the lower railway station, the next day we crossed the Atrio, ascended to the western extremity of the ridge of Somma, and followed it along so as to get a general bird's-eye view of the whole scene of the eruption, and take photographs of the more important points. As one stands on the Punta del Nasone and embraces

that magnificent view of Vesuvius and the Atrio del Cavallo, one sees below the new lava-stream in the form of the letter **L**, the horizontal portion of which is still being prolonged down the Atrio towards the Fossa della Vetrana. In the middle of the ridge we found a thin coating of fine red dust which had reached thus far from the crater. Much of the Atrio was also covered by the same material. Scaling the cliff face just beyond the Cognulo di Ottajano to the Atrio del Cavallo, we again visited the lower point of the outburst. Most of the beautiful fumaroles were in a state of ruin, and lined by good-sized crystals of hæmatite and mixed chloride crusts. Here the lava was quite solid, though at one point was a hole, some 50 m. from the base of the great cone, where we could see the molten rock flowing lazily along about a metre beneath our feet. The lava at the end of the flow was making considerable progress to the westwards, and stood opposite dyke 13.

During the month of July few changes took place in the mountain; the crater still got larger, dust was thrown out, and the lava descended. These phenomena are capable of continuing for months if the drainage opening does not enlarge.

After an interval of a month, during which by the kindness of Messrs. Treiber and Ferber I was kept continuously informed of any change, I again visited the volcano. The crater had considerably enlarged, but chiefly in a south-easterly direction, in the line of the fissures that have existed for a long time at the edge of the crater plain and the top of the great cone. These fissures had also increased in size and number since my last visit, so that altogether this seems to be, at present, the most favoured direction for the next disruption of the great cone. The crater has therefore an irregular oval form, with the major axis directed N.W.—S.E. On this occasion I could not see the bottom of the crater, but on its walls were several dykes, which may be enumerated according to their orientation:—N.E.; N.; N.N.E., probably the dyke of the last eruption; N.W.; S.W., probably the upper part of the fissure *i* below which emits hydrochloric acid; the hollow dyke that has supplied the eastern rift; the hollow dyke that supplied the eruption of May 2, 1885; and a little solid dyke close to it. There may have been others, but the perilous nature of the crater edge requiring great care, even in the only two places one could approach, together with the abundant irritating vapour, prevented a careful examination.

The lava, which had at one time extended down to nearly opposite Messrs. Cook's gate-lodge in the Fossa Vetrana, was now flowing very slowly at the junction of the Fossa and the Atrio del Cavallo.

A few days previously four shocks of earthquake occurred, limited to the great cone and felt at the lower railway station. These, combined with the other phenomena above mentioned, show that the cone is in an extremely unstable state, and want of confidence must be felt until some time further has elapsed.

In conclusion, the reporter must thank Mr. G. M. Cook, of Messrs. Cook, Son & Co., for granting free passage over the Vesuvian Railway, thus greatly facilitating the investigation of the volcanic phenomena.

Second Report of the Committee, consisting of Professor JAMES GEIKIE (Chairman), Dr. TEMPEST ANDERSON, Dr. VALENTINE BALL, Mr. JAMES E. BEDFORD, Professor T. G. BONNEY, Professor W. BOYD DAWKINS, Mr. JAMES W. DAVIS, Mr. WILLIAM GRAY, Mr. ROBERT KIDSTON, Mr. ARTHUR S. REID, Mr. R. H. TIDDEMAN, Mr. W. W. WATTS, Mr. HORACE B. WOODWARD, and Mr. OSMUND W. JEFFS (Secretary), to arrange for the collection, preservation, and systematic registration of Photographs of Geological Interest in the United Kingdom. (Drawn up by the Secretary.)

YOUR Committee beg to report that during the past year the work of collecting photographs illustrating the geological features of our country has been continued, with the result that 313 additional photographs have been received and registered, making a total up to the month of August of 588. A detailed list of these additional photographs is appended herewith. At the Leeds meeting of the Association upwards of 200 photographs were arranged for exhibition in the room appointed for the use of Section C, many of which illustrated sections of strata and other geological features of considerable scientific interest. This collection attracted much attention, and it is proposed to continue the exhibition at Cardiff if convenient arrangements can be made. By this means the Committee hope to secure the aid of many photographers, who can thus form a better idea of the kind of subjects which it is desirable to include in the collection of geological views.

Special efforts have been made to induce the local societies in each county to organise systematic surveys for the furtherance of the work. This method has been pursued with great success in Yorkshire, the members of the Geological Photographic Committee of the Yorkshire Naturalists' Union having again contributed a large and valuable series of prints. Many of these subjects refer to sections which cannot be reproduced, as, for instance, fossil trees laid bare in quarrying and excavations for the foundations of buildings now covered over.

The Hertfordshire Natural History Society and the East Kent Natural History Society have also organised schemes for the photography of local geological features, and some views have been sent in from these sources, which, it is hoped, will be supplemented by a further series next year.

In the case of some local societies difficulties have arisen, which have delayed the completion of similar arrangements proposed to have been made. It is not always possible to obtain the services of a photographer when desired, and it has been found difficult to arouse the interest of many of the local photographic societies in geological work. Considering the number of amateur photographers now to be met with in every centre of scientific energy, it is hoped that a large number of photographers will be induced in the future to co-operate with the local scientific societies in the scheme instituted by the Committee. The numerous field-meetings and scientific excursions, now so popular a part of the work of such societies, would appear to afford convenient opportunities for aiding our scheme, if arrangements could be made for a photographer to accompany the party whenever the district to be visited offered suitable subjects for the

use of the camera. But it is very desirable that the work should be pursued systematically in every county. A list should be drawn up by the officers of the local societies, giving the localities of new sections opened, besides particulars of old sections and other features worthy of reproduction and permanent pictorial record. Several photographers have intimated their willingness to assist the Committee in this way, if they were informed of the localities of which photographs are desired. The Committee would be glad to receive from geologists generally such particulars, which would be duly noted, and endeavours would be made to secure photographs when opportunity offered.

For the information of photographers, the following lists of *desiderata* are given:—

Per Professor JAMES GEIKIE, Edinburgh.

Weathering of basalt-rock: old quarries, Salisbury Craigs, Edinburgh.

Volcanic agglomerate, penetrated by basalt-dykes: The Binn, Burntisland, Fifeshire.

White trap (intrusive sheet) in sandstone and shales: Old limestone quarry, near Oil Works, Burntisland.

Diagonally-bedded sandstone: Seafeld Tower, near Kirkcaldy.

Unconformity between Silurian and Old Red sandstone: Siccar Point, near Cockburnspath, Berwickshire.

Fault in carboniferous sandstones and shales: railway cutting, Craiglockhart Station, Edinburgh.

Per Mr. JOHN HOPKINSON, of St. Albans.

Chalk-pit at Boxmoor.

Chalk-pit between Rickmansworth and Harefield.

Chalk-pit on Reed Hill, near Royston (anticlinal), sections of Woolwich and Reading beds and London clay exposed in brickfields near Watford.

Series of views of the chalk escapement through north of Hertfordshire and adjoining counties.

Per Mr. D. CLAGUE, Liverpool.

Current bedded sandstones at Dingle Point on north bank of the Mersey.

Outcrop of coal seams at Doulton quarry, St. Helen's.

These lists are, of course, capable of being largely extended, and are inserted simply as examples of what is required.

While the actual number of new photographs sent in for registration during the year does not greatly exceed the number acknowledged in the last report, it is gratifying to state that, as a whole, the subjects have been selected with greater care to include the most typical views. It has not been wished to restrict too greatly the definition of what is a 'geological photograph.' Views illustrating types of landscape scenery are often extremely useful, though not perhaps enforcing any particular geological feature. These will be simply described as: 'Landscape—Silurian'; or, 'Landscape—Bunter Sandstone,' &c., as the case may be. But, as the collection grows in numbers, it will be more convenient to confine it to views which are especially typical and characteristic. For the guidance of amateur photographers and others who might not be able always to refer to a geological authority, the following explanatory paragraph was inserted in the circular of instructions issued by the Committee:—

Photographs are desired illustrative of characteristic rock-sections, especially those of a typical character or temporary nature; important boulders; localities

affected by denudation, or where marked physiographical changes are in operation; raised beaches; old sea cliffs and other conspicuous instances of marine erosion; characteristic river-valleys or escarpments, and the like; glacial phenomena, such as *roches moutonnées*, moraines, drums and kames, or any natural views of geological interest. Photographs of microscopical sections, and typical hand-specimens of rocks are also admissible.

Your Committee held a meeting at Leeds and discussed several details of the work, which has been principally carried out through the medium of correspondence.

Regarding the question of the disposal of the photographs, it was decided to defer any recommendation on the subject until the collection was in a more complete form.

Reference was made in the last report to a proposed publication of a series of the best photographs received by the Committee, reproduced by a permanent process. The suggestion has received the careful consideration of the Committee. It was decided, however, to defer the subject until the next meeting of the Association, when, if any arrangements with a publisher could be made, the Committee would probably be in a position to select a series of approved photographs for the purpose of authorising their reproduction, with the consent of the owners of the negatives.

A desire having been widely expressed for facilities by which lantern slides of the geological photographs included in the list issued could be procured, the Secretary was instructed to endeavour to make arrangements to effect this object. Owing to the fact of the negatives not being in the possession of the Committee, the privilege of supplying lantern slides remains in the hands of the various photographers. In the case of professional photographers, there is usually no difficulty in supplying these to teachers and others who may require them. Negatives taken by private persons are not unfrequently handed over to a professional photographer, who has authority to supply slides to the public. Applications for slides should, therefore, as in the case of ordinary prints, be made to the *photographer direct*, whose address is, whenever known, printed at the head of each local list, or else to the local society under whose auspices the photographs were taken. In order to meet the convenience of amateurs who do not make their own slides, but who would be willing to lend their negatives for the purpose of having slides made, the Secretary has effected an arrangement with an experienced photographer, who will undertake to supply lantern slides, at a fixed price, from negatives with which he may be temporarily entrusted. It is understood that this arrangement only applies to those cases in which the owner of the negative does not desire to supply them himself. Future lists will contain the needful particulars as to obtaining lantern slides; in the meantime persons desiring to avail themselves of the arrangement above mentioned may communicate with the Secretary.

Your Committee are pleased to observe the spread of geological photographic schemes in countries abroad. The Société Géologique de Belgique have, on the recommendation of M. G. Dewalque, adopted a form similar to that of form 'A' issued by your Committee for recording the details and registering the numbers of photographs contributed to their own collection, and a copy of this schedule is inserted in the 'Bulletin' of the Society for July, 1890.

The Geological Society of America have also appointed a Committee on Photographs, which has already made good progress, nearly 300

examples having been exhibited at the Washington meeting of this Society in December, 1890. The American Committee purpose preparing some lists for international exchange.

A paper by Mr. Arthur S. Reid, M.A., F.G.S., appeared in the 'Photographic Quarterly' for January, 1891, in which the author advocated the use of the hand camera in the field, and subsequent enlargements on bromide paper to whole plate size.

In order to proceed with the collection of geological photographs and bring the scheme to a more complete stage, your Committee respectfully request reappointment and a renewal of the grant.

SECOND LIST OF GEOLOGICAL PHOTOGRAPHS.

(TO AUGUST, 1891.)

NOTE.—This list contains the subjects of geological photographs, copies of which have been received by the Secretary of the Committee since the publication of the last report. Photographers are asked to affix the registered numbers, as given below, to their negatives, for convenience of future reference.

Copies of any photographs desired can, in most instances, be obtained either from the photographer direct or from the officers of the local society under whose auspices the views were taken.

The Committee in no case has assumed the copyright of photographs registered, which is presumed to be held by the photographer.

The price at which copies of photographs may be obtained depends upon the size of the print and local circumstances, over which the Committee has no control.

BERKSHIRE.

Per Rev. A. IRVING, D.Sc., F.G.S., Wellington College, Wokingham.
(Photographed by Rev. P. H. KEMPTHORNE.) Size 6 × 4 inches.

Regd. No.

280, 281 Nine Mile Ride, Old Windsor Forest, 1890 Contortions in laminated brick clays

Photographed by R. C. McCLINTOCK.

452 Nine Mile Ride, Old Windsor Forest, 1891 Section in clay diggings at Lawrence's Pits

CHESHIRE.

Photographed by CHARLES A. DEFIEUX, 25 Sandstone Road, Stoneycroft, Liverpool. Size 6 × 4 inches.

460, 461 Leasowe Shore, 1891. Blown sands, showing stratification and results of wind-erosion on sandhills
462 „ Dove Point Submarine forest-bed
463 „ „ „ „ (large tree stump 2 ft. diameter)
464-466 „ „ „ General views of forest-bed (3)
467 Hilbre Island Fault in (?) Keuper sandstone on west side of island

Photographed by J. BIRTLES, Northwich. Size 6 × 4 inches.

Regd. No.

- 544-546** Witton Hall Rock Salt Three views of interior of mine (photographed
Mine, Northwich, 1882 . by electric light)

CORNWALL.

*Per Yorkshire Naturalists' Union (Geol. Photo. Section). (Photographed
by HERBERT DENISON, 32 Clarendon Road, Leeds.) Size 6 × 4 inches.*

- 453, 459** Durgan, Helford River, Fal- Coast scenery, Devonian
mouth Harbour, 1890
454 Cave, East of Falmouth Marine denudation
Harbour
455-458 The Lizard (4 views) . Coast scenery

Photographed by J. J. COLE, F.R.A.S., 'Mayland,' Sutton, Surrey.

- 571** Norcot, Bude . . . Carboniferous strata
572 Long Island, Trevalga . Slates; volcanic ash
573 Boscastle Coast . . . „ quartz masses embedded

CUMBERLAND.

*Per Yorkshire Naturalists' Union (Geol. Photo. Section). (Photographed
by LAWRENCE RICHARDSON, Sedbergh School.) Size 4 × 3 inches.*

- 291** Head of Ennerdale Valley, Mounds of glacial débris
1890
292 Borrowdale . . . Glaciated rock surface

DERBYSHIRE.

Photographed by WILLIAM POTTER, Matlock. Size 10 × 8 inches.

- 276** Stevens' quarry, Matlock Carboniferous limestone, with lead vein
Dale, 1890

*Per Yorkshire Naturalists' Union (Geol. Photo. Section). (Photographed by
GODFREY BINGLEY, 15 Cardigan Road, Leeds.) Size 6 × 4 inches.*

- 468** Matlock Bath, Scarthin Nick Gorge in Carboniferous limestone
477 Matlock, High Tor . . Carboniferous limestone
469-474 Dove Dale . . . Carboniferous limestone, effects of erosion
480, 482-3 „ Pillar Rock . . . „ „ „
475 Miller's Dale, Chee Tor . . . „ „ „
476-478 Chee Dale . . . „ „ „
479 Monsal Dale . . . „ „ „
481 Ashwood Dale . . . „ „ „

*Per Professor JAMES GEIKIE, LL.D., F.R.S. (Photographed by HERBERT
BOLTON, Manchester Museum, Manchester.) Size 12 × 10 inches.*

- 542, 543** Darley, near Matlock, 1891 Cutting in boulder clay, with large boulders

Photographed by EVAN SMALL, M.A., B.Sc., University College, Nottingham.

- 570** Miller's Dale . . . Weathering of Carboniferous limestone

DEVONSHIRE.

Photographed by A. R. HUNT, M.A., F.G.S., Southwood, Torquay.
Sizes various.

Regd. No.			
417	Kent's Cavern, Torquay	Group of bone implements	
	(from)		
418	"	"	flint do.
419-421	"	"	Nodule tools (breccia)
422	"	"	Bones: beaver
423	"	"	Tooth: cave lion
424-429	Torbay, 'The Hope's Nose'	Raised beach	
430	Torquay	Natural arch: Middle Devonian limestone	

Photographed by J. J. COLE, F.R.A.S., 'Mayland,' Sutton, Surrey.

574	Dartmoor, Hounter Tor	Granite, fallen and shifted
575	" " " "	"
576	" Hey Tor	"
577	" Hey Clatter	Angular blocks of granite, fallen N. and W.
578	Blagberry, Hartland	Foldings in Carboniferous strata
579	Holcombe Head	New Red Conglomerate
580	Brent Tor Cliff	Volcanic ash; remains of cone of Carboniferous age

DORSETSHIRE.

Photographed by Miss M. K. ANDREWS, 12 College Gardens, Belfast.
Size $4\frac{1}{2} \times 3\frac{1}{2}$ inches.

296-299	Lulworth Cove	Chalk and Purbeck strata
----------------	-------------------------	--------------------------

Photographed by J. J. COLE, F.R.A.S., 'Mayland,' Sutton, Surrey.

581	Lulworth, Stare Cve	Greensand, Purbeck and Portland beds
582	" Stare Cliff	Contorted Purbeck beds
583	" Stare Hole	Portland stone
584	" Cove	Inclined Purbeck on 'Dirt beds'
585	Gad Cliff, near Kimmeridge	Portland stone on Kimmeridge clay

HAMPSHIRE.

Photographed by A. R. HUNT, M.A., F.G.S., Southwood, Torquay.
Size 6×4 inches.

431	Freshwater, I. of Wight	Natural arch in chalk
------------	-----------------------------------	-----------------------

Photographed by Miss M. K. ANDREWS, 12 College Gardens, Belfast.

300	Bournemouth	Bournemouth sands
------------	-----------------------	-------------------

HERTFORDSHIRE.

Photographed by JOHN HOPKINSON, F.G.S., The Grange, St. Albans.
Size 4×3 inches.

525	Watford Heath Kiln, 1891	London clay on Reading beds
526	" Bushey Kiln	" "

Regd. No.

- 527** Chalk pit north-west of Upper chalk, with flints
 Bushey Station, Watford
528 Do. north of Bushey Station, „ with ' pipe ' of gravel and sand
 Watford

ISLE OF MAN.

Per Yorkshire Naturalists' Union (Geol. Photo. Section). (Photographed by G. H. RODWELL, 44 Wade Lane, Leeds.) Size 4 x 3 inches.

- 301** Spanish Head and ' Sugar Clay slates ; sea ' stack '
 Loaf ' Rock, 1890
302 Douglas Head, 1890 . . Contorted clay slates

Photographed by F. N. EATON, 31 Highfield South, Rock Ferry, Cheshire. Size 4 x 3 inches.

- 303** Port Erin, 1891 . . Contorted clay slates
304 „ the Breakwater Effects of storm
305 Port St. Mary . . Cambrian beds on shore (with fault)
306 Peel Castle . . Quartz veins in slate
307-8 „ . . Contorted strata
309 Douglas Bay, Port Jack . Stratification and jointing of rock
310 „ Lighthouse . Contorted clay-slates
311 „ Port Skillion Vertical clay-slates

Per Chester Society of Natural Science (Photo. Section), (Photographed by Dr. HY. STOLTERFOTH, M.A., Chester.) Size 6 x 4 inches.

- 349** Langness, 1890 . . Junction of Old Red sandstone and clay
 slates
350 „ 1889 . . Old Red conglomerate
351 „ 1890 . . „ „
352 Scarlett Point . . Core of old volcano

KENT.

Photographed by ARTHUR S. REID, M.A., F.G.S., Trinity College, Glenalmond, N.B.

- 344-347** Lenham, 1891 . . Sand ' pipes ' in chalk

Per Yorkshire Naturalists' Union (Geol. Photo. Section). (Photographed by GODFREY BINGLEY, 15 Cardigan Road, Leeds). Size 8 x 6 inches.

- 507** Tunbridge Wells . . The ' Toad Rock '

Per Captain J. GORDON MCDAKIN, 15 Esplanade, Dover. Size 12 x 10 inches.

- 414** Dover, Shakespeare Cliff . Middle and lower chalk
415 „ East Cliff . Upper and middle chalk, showing coast
 erosion

LANCASHIRE.

Photographed by R. G. BROOK, St. Helens. Size 8 x 6 inches.

- 285-290** Ravenhead, 1890 . . Coal measures, with outcrop of ' fiery mine '
 seam exposed in clay pit

[The views form a connected series.]

SHROPSHIRE.

*Photographed by W. W. WATTS, M.A., F.G.S., Geol. Survey of Ireland,
14 Hume Street, Dublin. Size 8½ × 6½ inches.*

Regd. No.

- 435** Hope Rectory, near Minsterley, 1889 Contorted ash bed (Middle Arenig series)
- 436** Wenlock Edge, 1887. . Bedding and concretionary structure of Wenlock limestone
- 437** East Hope, 1886 . . Wenlock limestone
- 438** The Wrekin, from Benthall Edge, 1886 General view
- 439** Corbett's Dingle, near Broseley, 1886 Coal measure sandstone: weathering
- 440** Quarry near Walcot House, near Chirbury, 1886 Lower Wenlock beds

SOMERSET.

*Photographed by JAS. D. HARDY, 73 Clarence Road, Clapton, London.
Size 8 × 6 inches.*

- 277** Holwell, near Frome, 1890 Rhætic beds: *Microlestes* quarry

*Photographed by Miss M. K. ANDREWS, 12 College Gardens, Belfast.
Size 8 × 6 inches.*

- 278, 279** Newbridge, near Weston Station, Bath White lias

*Photographed by W. H. F. ALEXANDER, 14A Chorley Old Road, Bolton.
Size 6 × 4 inches.*

- 312** Cheddar Cliffs, 1890 . . Gorge in Carboniferous limestone

Bath Natural History and Antiquarian Field Club. Per Rev. W. H. WINWOOD, M.A., F.G.S., Secretary. (Photographed by G. F. POWELL, Bath.)

- 569** Midford Station (near), 1891 Inferior Oolite: *Trigonia* beds

STAFFORDSHIRE.

*Photographed by A. SOPWITH, C.E., Cannock Chase, near Walsall.
Size 6 × 4 inches.*

- 282-284** Cannock Chase Coal Mine Coal seams in interior of mine

WILTSHIRE.

Per J. LARDNER GREEN, F.R.Met.Soc., 'Tintinhull,' Milford Hill, Salisbury. (Photographed by W. BROOKS, High Street, Salisbury.) Size 10 × 8 inches.

- 416** Teffont Mill, near Dinton, 1863 Contorted Purbeck beds

*Photographed by R. G. DURRANT, M.A., The College, Marlborough.
Size 8 × 6 inches.*

- Regd. No.
547-548 Marlborough. 'The Devil's Group of Sarsen stones
 Den,' 1891
549 " Road to Cliffe Lower chalk
 Pypard

WORCESTERSHIRE.

*Photographed by C. J. WATSON, Acock's Green, Birmingham.
Size 8 × 6 inches.*

- 294** Bilberry Hill, The Lickey, Contorted Llandovery beds
 1884
295 Tewkesbury (banks of river Keuper marls
 Severn), 1889 (6 × 4 in.)

YORKSHIRE.

*Per J. E. CLARK, 9 Feversham Terrace, York. (Photographed by
 W. ESKETT, Lendal, York.) Size 8 × 6 inches.*

- 354-361** Foundations of Goods Sta- Boulder clay (8 sections)
 tion, York, 1876-7

*Per Yorkshire Naturalists' Union (Geol. Photo. Section). (Photographed
 by W. H. SAWDON, Ingleton.) Contributed by C. D. HARDCASTLE, 31
 Victoria Place, Leeds.*

- 362, 363** Ingleton Carboniferous limestone with band of coal
 and shale

Photographed by G. H. RODWELL, 44 Wade Lane, Leeds. Size 6 × 4 inches.

- 364, 365** Gordale Scar . . . Carboniferous limestone
366, 509 Buttertub Pass, Upper Landscape: " "
 Swaledale
367 Hardraw Scar, Wensleydale Gorge in Yoredale rocks
368 Middleton, High Force . River erosion; waterfall
510 Hell Gill, near Hawes . " "

Photographed by H. RICHARDSON, Sedbergh School. Size 6 × 4 inches.

- 369-372** Taith's Gill, Sedbergh . Anticlinal in Carboniferous limestone
373, 374 Crook of Lune . . . Bannisdale slates

Photographed by A. G. EDE, Sedbergh School. Size 6 × 4 inches.

- 375** Nor Gill, Sedbergh . . Carboniferous limestone
376, 377 Taith's Gill . . . " "
378 Garsdale . . . Silurian rock
379 River Rawthay . . . River valley: Silurian rocks

Photographed by H. H. COBB, Sedbergh School. Size 4 × 3 inches.

- 380** Uldale Force, Sedbergh . Horizontal beds of Carboniferous limestone;
 waterfall
381, 382 Hebblethwaite Gill . . Conglomerate bed
383 Rawthay Bridge . . Vertical beds of Carboniferous limestone

Photographed by A. LAMBERT, York Terrace, Harrogate. Size 4 × 3 inches.

Regd. No.		
384	Ripon Park; Banks of Ure	Contorted strata (? Yoredale)
385	Swaledale; Catrigg Force	River erosion (Carboniferous limestone)
386, 388	„ Kisdon Force	„ „
387	„ East Gill Beck	„ „
389	„ Mill Gill, near Askrigg	„ „

Photographed by GODFREY BINGLEY, 15 Cardigan Road, Leeds.

Size 6 × 4 inches.

484	Ingleton, Thornton Force	Carboniferous limestone resting on Silurian grits
485, 486	„ Baxendale Gorge	Channel in Silurian grits
487-498	Harrogate, Brimham Rocks	Millstone grit; weathered masses
499	„ Birk Crag	„ „
500	„ Plumpton Rocks	„ „
501-504	Meanwood, Leeds; Rowley's Quarry	Glacial débris lying on contorted Lower Carboniferous shales
505, 506	Pateley Bridge, High Stean	Gorge in Carboniferous limestone
508	Baldersby Park, near Thirsk	Large boulder of Carboniferous grit

Purchased by the Yorkshire Naturalists' Union (Geol. Photo. Section)—per J. E. BEDFORD, Secretary, 9 Cardigan Road, Leeds. Size 4 × 3 inches.

511	Ilkley; 'Cow and Calf' Rock	Blocks of Millstone grit
------------	-----------------------------	--------------------------

Photographed by A. E. NICHOLS, Borough Engineer's Office, Leeds.

Size 8 × 6 inches.

512	Winterburn Reservoir, near Gargrave	Brecciated limestone in Bowland shales
513	„ „	Striated boulder of limestone
514	Harrogate, Plumpton Rocks	Millstone grit
518-520	Hunslet, Leeds (Gould & Stevenson's brickyard and quarry), 1891	Lower coal measures
	[Showing the condition of the excavations photographed by Mr. F. W. BRANSON in 1885.]	
521	Leeds, Boyle's brickyard	Coal measures
522	Bradford, Cliff's clay pits	Glacial drift
515-517	Otley (Alm's Cliff)	Kinderscout grit
523, 524	Scarborough, Castle Hill	Calcareous grit (oolite) with 'doggers'

NORTH WALES.

Per Manchester Geographical Society, ELI SOWERBUTTS, F.R.G.S., Secretary. (Photographed by members.) Size 6 × 4 inches.

313	Swallow Falls, R. Llugwy	River erosion
314, 315	Fairy Glen, Bettws-y-Coed	„ „
316, 317	Conway Falls, „	„ „
318	Rapids, Conway River	„ „

Per Birmingham Natural History Society. Contributed by C. J. WATSON, Acock's Green, Birmingham. (Photographed by F. I. WILLIAMSON, Esher, Surrey, and G. W. WILLS, Wylde Green, near Birmingham.) Size 8 × 6 inches.

319-321	Llanberis	Perched blocks
322	Capel Curig	„ „

Regd. No.

- 323** Capel Curig (S.E.) . . . Roche moutonnée
324 Cwm Tryfaen (W. side) . . . Large perched block, lying on glaciated surface
325 Trefriew Glaciated rock-surface on W. side of road

Photographed by DR. HENRY STALTERFOTH, M.A., *Chester.*
Size 6 × 4 inches.

- 353** Tremerchion, Vale of Exterior of bone caves in limestone; Fynnon Clwyd, 1890 Beuno and Cae Gwyn

Photographed by W. W. WATTS, M.A., F.G.S., *Geol. Survey of Ireland,*
 14 *Hume Street, Dublin.* *Enlargements from ¼ plate.*

- 441** Welshpool, Quarry at . . . Dyke of columnar diabase
442 Arenig, Railway Cutting . . . Boulder clay, with boulders
443 Llyn-y-Gader, Cader Idris . . . Moraine dam
451 " " " " . . . Lake dammed by moraine
444 Llyn-y-Cae (from N. side), Cader Idris . . . Moraine dam
445 Llyn-y-Cae (from E. side) Cader Idris . . . Perched blocks
446 Llyn-y-Cae (east of), Cader Idris . . . Roche moutonnée
447, 448 Llyn-y-Cae, Cader Idris . . . " " and perched blocks
449 Y Foel Perfydd, Pen-y-Gwryd . . . Perched block (figured by Sir A. C. RAMSAY)
450 Pass of Llanberis, below mouth of Cwm Glas . . . Glacial moraines (described by Sir A. C. RAMSAY)

Per G. H. MORTON, F.G.S., 209 *Edge Lane, Liverpool.* (*Photographed by the late* W. H. WILSON, *of the Liverpool Geological Society.*) *Size 12 × 10 inches.*

- 550** Llangollen, Tan-y-Castell Ravine, Eglwyseg Rocks, 1876 . . . Carboniferous limestone
551 Llangollen, Craig-yr-ogof . . . " "
552 Llangollen, Ty-nant Ravine, facing Craig-yr-Ogof on the North (Panoramic view, 20 × 4½ inches) . . . Carboniferous limestone

[Showing the subdivisions of the Carboniferous limestone series, described by Mr. Morton in 'Proc. Liverpool Geol. Soc.,' Vol. III., 1876.]

Photographed by J. J. COLE, F.R.A.S., '*Mayland, Sutton, Surrey.*

- 586** Llanberis Pass Altered rhyolites, lavas and tuffs
587 Spur of Snowdon Ordovician slates, &c.
588 Cwm Glas, Snowdon Glaciated hollow; roche moutonnée

SCOTLAND.

Photographed by JOHN STEWART, 32 *Boyd Street, Largs, Ayrshire.*
Size 6 × 4 inches.

- 348, 349** Ness Glen, Doon Water River erosion (near Dalmellington), 1891
350 Loch Doon Glaciated surface (rock basin)

Regd. No.

- 351** Strathblane ' Balagan beds,' with fault in limestone
352 ' Spout of Balagan ' . . Valley erosion
353 Cumbræ, ' Lion Rock ' . . Trap dyke

Photographed by ARTHUR S. REID, Trinity College, Glenalmond, Perth.

- 408** Perth, 1891 Large glaciated boulder

*Photographed by WM. NORRIE, 28 Cross Street, Fraserburgh.
 Size 8 × 6 inches.*

- 390** Colonsay, W. Coast, 1888 . Wind-eroded rocks
391 S. Mull Feathered fracture in basalt
392 Island of Mhurie, 1887 . Basaltic peak
393 " Tiree, 1889 . . ' Ring and Cupped ' stone
394 " Rona, 1887 . . Wave tunnel
395 " " . . West horns of N. Rona
396 " Treshuist, 1889 . Summit of ' Dutchman's Cap '
397 " " . . Sea ' stack '
398 Whitenhead, 1889
399 " Contorted gneiss
400 " N. end of great fault
401 Island of Rum Stack of Mharagach
402 " Mingulay, 1888 . S.W. cliff
403 " " " . . Cliff on W. coast

*Per A. R. HUNT, F.G.S., Southwood, Torquay.
 (Photographed by Mr. A. J. CORRIE.)*

- 433** Ross Bay, Kirkcudbright- Roches moutonnées
 shire

(Photographed by A. R. HUNT.)

- 434** Rumbling Bridge, Dunkeld River valley, with pot-holes in bed of stream

IRELAND.

*Photographed by W. H. F. ALEXANDER, 14a Chorley Old Road, Bolton.
 Size 4 × 3 inches.*

- 341** Castle Connell, bank of Carboniferous limestone
 Shannon, 1890
342, 343 Kilkee Sea cliffs and stack
344-346 " Marine denudation; caves and headlands
347 Glengariff, Co. Cork . . Perched block on road to Berehaven

*Photographed by Miss M. K. ANDREWS, 12 College Gardens, Belfast.
 Size 6 × 4 inches.*

- 326-328** Carnmoney Hill, Co. An- Old Volcanic neck
 trim, 1891
329-334 " " " Sections in chalcedony quarry
337 Cushendun Old Red sandstone
338 Whitehead Trap dyke
339 The Corran, Lorne . . Gravel beds on boulder clay
530 Kinbane Head Chalk underlying basalt
531, 532 Ballycastle White chalk
533 " Colliery Bay . . Dyke in Carboniferous strata
534-537 Whitehouse, Macedon Pt. . Dykes in Bunter sandstone
335, 336 Corr's Quarries, Armagh . Trap dyke

Regd. No.		
340	Copeland Island, Co. Down	Lower Silurian
538	Hollywood Shore "	Lower Carboniferous shales
539, 540	" " "	Dyke in Lower Keuper
541	" " (near Marino), Co. Down	Marine erosion of coast line
529	Downhill, Co. Londonderry	Chalk underlying basalt

*Photographed by TEMPEST ANDERSON, M.D., 17 Stonegate, York.
(Enlargements from $\frac{1}{4}$ -plate negatives.)*

553, 554	Garron Point, 1891 . . .	Great fault
555	" " Quarry . . .	Junction, basalt and chalk
556	Carrick-a-Rede . . .	Old volcanic vent
557	" " " " . . .	Sea stacks
558	Kenbane Head . . .	Basalt on chalk; fault
559	Portnakillew . . .	Intrusive basalt
560	Portnaboe . . .	Dyke
561	Giant's Causeway . . .	Basalt; marine erosion
562, 563	" " and amphitheatre	Columnar basalt
564	Pleaskin . . .	" "
565	White Rocks, Dunluce . . .	Spheroidal basalt
566	" " " " . . .	Natural arch in chalk
567	Garron; 'White Lady' . . .	Weathering of chalk
568	Portmoon . . .	Marine denudation

Report of the Committee, consisting of Mr. G. J. SYMONS, Mr. C. DAVISON (Secretary), Sir F. J. BRAMWELL, Mr. E. A. COWPER, Professor G. H. DARWIN, Professor EWING, Mr. ISAAC ROBERTS, Mr. THOMAS GRAY, Dr. JOHN EVANS, Professors PRESTWICH, HULL, LEBOUR, MELDOLA, and JUDD, Mr. M. WALTON BROWN, and Mr. J. GLAISHER, appointed to consider the advisability and possibility of establishing in other parts of the country Observations upon the Prevalence of Earth Tremors similar to those now being made in Durham in connection with coal-mine explosions.

DURING the past year the Committee have examined a large number of instruments designed for the observation of earth tremors and other small movements of the earth's crust. They hope to be able, in their next report, to report upon them and to recommend instruments specially adapted for use in this country.

The Committee invite designs or suggestions for the construction of the following instruments: (1) a seismoscope for recording the time of occurrence of a tremor, either by stopping or preferably by not stopping a clock; (2) a self-registering instrument for determining the time of occurrence, the direction, amplitude, &c., of a tremor or series of tremors; and (3) a simple form of nadirane or other instrument for the observation of slight earth-tilts. Communications on this subject should be addressed to the Secretary (Mr. C. Davison, 38 Charlotte Road, Birmingham), who will be glad to answer any inquiries.

The Committee respectfully suggest that they be reappointed, but ask for no grant.

Report of the Committee, consisting of Dr. H. WOODWARD (Chairman), Messrs. W. D. CRICK, T. G. GEORGE, WM. HULL, E. A. WALFORD, E. WILSON, H. B. WOODWARD, and BEEBY THOMPSON (Secretary), to work the very Fossiliferous Transition Bed between the Middle and Upper Lias in Northamptonshire, in order to obtain a more clear idea of its fauna, and to fix the position of certain species of fossil fish, and more fully investigate the horizon on which they occur. (Drawn up by the Secretary.)

IN 1863 Mr. E. C. H. Day published in the 'Journal of the Geological Society' a paper entitled 'On the Middle and Upper Lias of the Dorsetshire Coast.' In this paper, page 293 of the Journal, Mr. Day describes 'The Marlstone with its Pleurotomaria Bed.' From this description it appears that the marlstone rock bed is capped by a remarkable bed of small thickness, abounding in gasteropods and other fossils, which indicate—particularly the ammonites—a passage bed between the Middle and Upper Lias. Mr. Day considers that the Fish bed of Ilminster and Dumbleton is absent.

In 1865-66 Mr. Charles Moore published, in the 'Proceedings of the Somersetshire Archæological and Natural History Society,' a long paper 'On the Middle and Upper Lias of the South-West of England,' in which he describes a zone situated between the Marlstone and Fish bed under the name of the *Leptæna beds*.

In 1872 Mr. Thos. Beesley read a paper before the Warwickshire Naturalists and Archæologists' Field Club entitled 'A Sketch of the Geology of the Neighbourhood of Banbury,' in which mention was made of a *passage bed* between the Middle and Upper Lias. This paper was published in the 'Proceedings' of the Society.

In 1876 Messrs. Tate and Blake published their 'Yorkshire Lias,' in which they described a zone of the Middle Lias, under the name of the *Zone of Ammonites Annulatus*, occupying the position of the Pleurotomaria bed of Day and the *Leptæna beds* of Moore.

Again, in 1879 Mr. Edwin A. Walford published in the 'Proceedings of the Warwickshire Naturalists and Archæologists' Field Club' a paper 'On Some Middle and Upper Lias Beds in the Neighbourhood of Banbury.' This paper describes a bed situated between the Marlstone rock bed and the Upper Lias Fish bed, in the south-western parts of Northamptonshire, under the name of the *Transition bed*.

Some few years ago two of the members of this committee—Messrs. Thompson and Crick—detected the same bed in a rather large number of widely separated parts of Northamptonshire, and as far north as Tilton, in Leicestershire.¹

As it seemed of considerable interest to more thoroughly investigate this bed and those immediately above and below it, and there was much difficulty in doing so owing to nearly all the Marlstone quarries being closed, the British Association kindly made a grant of money for the purpose. The present report gives the results of the investigation.

¹ Mr. E. Wilson had previously described the deposits at Tilton, but did not separate the Transition bed from the rock bed.

By the date of delivering the report, July 25, it has not been possible to thoroughly investigate all the material collected, but if anything further of interest is found a supplementary report will be presented in 1892.

We particularly desire to thank Mr. S. S. Buckman, F.G.S., for examining and reporting on the ammonites, and Mr. E. Wilson, F.G.S., the gasteropods.

SITUATION OF SECTIONS.

The sections that have been opened are situated respectively at Milton, about 3 miles S.S.W. of Northampton; at Bugbrook, about 4 miles almost due west from the last named; near to Arbury Hill, and at Catesby, about 8 miles further westward; and at Chipping Warden, about $6\frac{1}{2}$ miles S.S.W. of the Arbury Hill one.

The list of fossils contains some collected over a rather wider area and extending northwards as far as Watford (on the railway), $7\frac{1}{2}$ miles N.E. of Catesby.

It will be noticed, therefore, that the investigation embraces places situated 14 miles apart from N.E. to S.W., and about 12 miles at right angles to this.

GENERAL SECTION.

The section given below shows the sequence of the beds studied, in its most complete form.

		Ft. in.	
	Unfossiliferous clays of the Upper Lias	70 to 100 0	
‘Serpentinus’ zone.	‘Communis’ beds. {	A. Upper Cephalopoda bed	0 6
		B. Clay with numerous small planulate ammonites	3 to 6 0
	‘Serpentinus’ beds. {	C. Lower Cephalopoda bed	0 6 to 9
		D. Calcareous clay—few fossils	3 to 5 0
		E. Cephalopoda bed—not constant	0 4
	Fish beds. {	F. Shale—large ammonites and fish fragments	0 4
		G. Fish bed—nodular	0 2
		H. Paper shale	0 4
		I. Fish bed in large slabs	0 2
	Transition beds. {	J. Paper shale	0 5
		K. Red sand or sandy clay	} 1 0 greatest thickness.
		L. Grey marl	
	‘Spinatus’ zone.	M. Marlstone rock bed	6 0

In regard to the above section we may say that there is no exposure giving the full sequence, and that where the upper beds are shown the lower ones may differ somewhat from this, and *vice versa*.

With regard to E and F the evidence is about equally balanced as to whether they should go with the ‘Serpentinus’ beds or the Fish beds, and so we prefer at present to leave it undecided. They may be regarded as constituting a transitional zone.

The first section was opened in the spring of 1890 at Milton, about 3 miles S.S.W. of Northampton, but owing to the delay in procuring permission, and other difficulties experienced, that was the only one that could be opened that year. In some respects, however, this was the most interesting section examined. It has the advantage of being further eastward than any other section exposing the same beds, and, as has been pointed out elsewhere,¹ the beds seem to vary more at right angles to the line of strike than they do along it.

¹ *The Middle Lias of Northamptonshire*, by Beeby Thompson, F.C.S., F.G.S.

SECTION OF MIDDLE AND UPPER LIAS BEDS NEAR TO MILTON.

The letters A, B, C, &c., refer to the position of beds in general section.

	Ft.	in.
1. Soil passing into marly clay. The clay, which is nearly white, only occupies a few inches near the base. A few fragments of <i>Belemnites</i>	2	6
E.—2. CEPHALOPODA BED.—An argillaceous limestone, hard, nearly white, very fossiliferous, chiefly large ammonites of the falcifer group badly preserved.	0	4
<i>Ammonites serpentinus</i> (near to) <i>Aptychi</i> .		
,, <i>Strangwaysi</i> (common).		
,, <i>exaratus</i> .		
,, <i>cornucopia</i> .		
<i>Cerithium gradatum?</i>		
F.—3. A light-coloured, somewhat shaly bed, moderately hard, scarcely to be distinguished from No. 2 in appearance, and containing similar <i>Ammonites</i> of large size. Numerous <i>fish fragments</i> in lower portion	0	4
G.—4. FISH BED.—A light-coloured nodular limestone, not continuous, resting on or in thin shale. <i>Fish fragments</i> common, also <i>small Ammonites</i> and their <i>aptychi</i>	0	2
H.—5. PAPER SHALE.—A shale splitting into very thin laminae, of a colour almost exactly like No. 3. <i>Fish fragments</i> common	0	4
I.—6. FISH BED in large slabs, most of which split easily into two or three thinner ones. Fewer <i>fish fragments</i> and other fossils in this than in No. 4	0	2
J.—7. PAPER SHALE changing downwards into a more clayey layer, and then a more sandy one, altering to a reddish colour, and gradually losing its shaly character	0	5
8. Bluish shale or clay, somewhat sandy, very thin, but quite distinct and continuous throughout the section. Less regular in a horizontal direction than the other beds	0	0½
TRANSITION BEDS.		
K.—9. Red sandy layer with a few badly preserved fossils, chiefly <i>Belemnites</i>	0	5
L.—10. Grey marl, or limestone, not very distinctly separable from the sand above or the limestone below. A great many <i>Belemnites</i> , perhaps six or seven species, but much worn and often fragmentary. <i>Gasteropods</i> less abundant here than in most places where the same bed is found	0	7
<i>Ammonites acutus</i> (many) <i>Arcomya vetusta</i> (many).		
,, <i>Holandrei</i> (many) <i>Lima punctata</i> .		
,, <i>crassus</i> . <i>Astarte</i> (two species).		
,, <i>annulatus</i> . <i>Ilhynchonellæ</i> (many).		
<i>Gasteropods, &c.</i>		
M.—11. ROCK BED OF MIDDLE LIAS, very fissile at the top, upper surface very like, and has on it similar fossils to the Transition bed proper. Many small <i>flat pebbles</i> , probably quite local, and fair amount of crystallised carbonate of lime at the junction.		

With regard to this section it may be observed that in no other locality in the county have we found the Fish bed so distinctly separated into two layers.

SECTION AT BUGBROOK.

(Mr. Ward's farm, near the village, and south of the railway.)

	Ft.	in.
B.—1. Soil and blue clay, much disturbed, many little <i>planulate Ammonites</i> lying about on the weathered surface	3	0
C.—2. LOWER CEPHALOPODA BED.—An irregular layer of small water-worn stones of a ruddy yellow colour. Oolitic in places, the broken surface across these oolitic parts looking very like coral	0	6
<i>Ammonites communis?</i> <i>Nucula Hammeri.</i> <i>Nautilus, &c.</i>		
D.—3. Blue clay, rather darker colour than usually met with on this horizon, red and sandy at the top, also very ruddy and shaly towards the bottom. Few fossils	4	6
E and F.—4. CEPHALOPODA BED (INCONSTANT BED).—A hard bluish grey stone, weathering quite red at joints and exposed surfaces—called 'Pendle' by the workmen. Many <i>Ammonites</i> of the <i>falcifer</i> group and very few of the <i>planulate</i> , the former often crushed quite flat, as they are in the shales below	0	8
<i>Nautilus astacoides? large and small.</i> <i>Ammonites exaratus.</i> " <i>Strangwaysi, &c.</i>		
The fine ribbed variety of <i>A. Strangwaysi</i> seems most often crushed.		
H.—5. PAPER SHALE.—A grey, finely laminated shale, weathering to a much lighter colour, containing <i>fish fragments</i> and a good number of flattened <i>Ammonites</i> —chiefly the fine ribbed variety of <i>A. Strangwaysi</i>	0	4
I.—6. FISH BED.—A bluish-grey stone, laminated like the shales, and weathering quite white on the exterior. Comes out in large flat slabs—only nodular in one part, and that just over a large fissure in the rock bed below	0	2
<i>Fish fragments</i> fairly abundant, only <i>small Ammonites</i> , chiefly <i>A. latescens</i> . <i>Saurian remains</i> more abundant here than elsewhere in the same bed.		
J.—7. PAPER SHALE like No. 5, though fewer <i>Ammonites</i> probably		
L.—8. TRANSITION BED.—Not present as a distinct bed, and no red clay; nevertheless clearly shown by the altered character of the top of the rock bed, and by the presence in this of <i>Ammonites Holandrei</i> , <i>Cerithium ferreum</i> , <i>small Rhynchonellæ, &c.</i>		
Nearly as hard as the rock bed itself. No pebbles here.		

	Ft. in.
M.—9. ROCK BED OF MIDDLE LIAS.—An oolitic rock of a greenish-grey colour internally, red at joints. Masses of <i>Rhynchonella tetrahedra</i> , many rather small reported to be	5 0
<i>Belemnites paxillosus</i> and others.	
<i>Lima punctata</i> .	
<i>Pecten lunularis</i> (many).	
„ <i>dentatus</i> (fair number).	

The section just described was opened at what appeared to be the most convenient spot; it was the site of an old brickyard worked many years ago, and was left in a most convenient condition for reopening, but as the results were somewhat disappointing, the Rev. J. Harrison kindly gave us permission to make a section at the old Dryhurst pit, about a mile further eastward, where the very fine fish *Lepidotus gigas*, now in the British Museum, is said to have been obtained.¹ The depth of the Fish bed at this spot made it impossible to work it without considerable expense, as it exceeded 10 feet, and there was no open face to commence at. The section made, however, shows the development of some of the higher beds better than any other now to be seen in the district, and we were able to get at the lower beds nearer the surface some half-mile away. Thus the three sections in this neighbourhood enable us to get a very much better idea of the character and succession of the beds than we had before.

SECTION AT DRYHURST PIT, BUGBROOK.

	Ft. in.
1. Soil and clay	2 to 3 0
A.—2. UPPER CEPHALOPODA BED.—A hard rather shaly limestone, blue-hearted, not very homogeneous in character, very ferruginous in places, and many of the fossils bright red. Fossils very abundant, but badly preserved	0 6
<i>Ammonites bifrons</i> } About equally abundant.	
„ <i>Holandrei</i> } About equally abundant.	
„ <i>communis</i> } About equally abundant.	
„ <i>cornucopia</i> (very large).	
„ <i>subcarinatus</i> .	
<i>Nautilus</i> (large).	
<i>Belemnites</i> (long slender forms).	
<i>Lima</i> (2 sp. ; large).	
Coral.	
Very few specimens of <i>Harpoceras</i> besides <i>H. bifrons</i> .	
B.—3. Clay, dirty-looking, ferruginous, sandy, streaked with blue. Same fossils as in bed above apparently, but most fragmentary or small	4 6
No specimen of <i>A. bifrons</i> detected.	
C.—4. LOWER CEPHALOPODA BED.—A hard blue-hearted stone, much more argillaceous than No. 2, purple markings at fresh joints, ferruginous where weathered. Some very large <i>Ammonites</i> — <i>A. Strangwaysi</i> —but extremely difficult to extract	0 6

¹ Figured in Agassiz's *Recherches sur les Poissons fossiles*, vol. ii., p. 235; also in Baker's *Northamptonshire*, vol. i., p. 440.

	Ft. in.
D.—5. Dull grey clay or shale, blue towards bottom.	
Bottom not reached	3 0?

The continuation of this section is shown in a shallow opening some half-mile away, and is almost exactly like that at the bottom of the first section described (Mr. Ward's farm), except that the Transition bed is softer and more distinctly shown, and the Fish bed is more nodular, and apparently more fossiliferous. It does not appear necessary to give a separate section and list of fossils.

The next section opened was near to Arbury Hill, about 13 miles almost due east from Northampton. In this neighbourhood the rock bed is very near to the surface.

SECTION NEAR TO ARBURY HILL.

	Ft. in.
1. Soil	1 to 2 0
E to J?—2. FISH BED.—A yellowish, sometimes almost white limestone, very irregular in composition, not in the least like the Fish bed in the other sections described. Crowded with Ammonites	0 3
<i>Fish fragments (a few).</i>	
<i>Euomphalus minutus.</i>	
<i>Cerithium subliassicum (= Nerinea liassica).</i>	
<i>Cerithium gradatum?</i>	
<i>Ammonites cornucopia.</i>	<i>Ammonites similis.</i>
" <i>serpentinus?</i>	" <i>cæcilia.</i>
" <i>falcifer.</i>	" <i>exaratus.</i>
" <i>Strangwaysi.</i>	" <i>crassus.</i>
" <i>latescens.</i>	" <i>n. sp., &c.</i>
L.—3. TRANSITION BED.—A light grey marl, rather hard, hence difficult to extract fossils from whole	0 3
<i>Ammonites acutus</i>	<i>Hinnites velatus.</i>
" <i>crassus</i>	<i>Plicatula spinosa.</i>
" <i>Hollandrei</i>	<i>Pecten textorius.</i>
<i>Turbo linctus</i>	<i>Rhynchonella tetrahedra, &c.</i>
<i>Phasianella turbinata</i>	
<i>Actæoninia Ilminsterensis</i>	
<i>Amberlyæ Æolus</i>	
M.—4. Rock bed	4 0?

Fortunately a similar section was opened at Catesby about the same time, and worked for about a week for road metal. This gave us an opportunity of examining the rock bed of that district. The section itself above the rock bed is so similar to the one at Arbury Hill that it would be mere repetition to give it.

The rock bed is here calcareous, ferruginous, and very fissile. The fossils obtained or noted were—

- Pecten equivalvis (large form).*
- " *dentatus.*
- " *lunularis.*
- Lima sp.? (very large form).*
- Trigonia Lingonensis?*
- Rhynchonella tetrahedra (in masses).*
- Terebratula punctata.*
- Waldheimia resupinata, &c.*

It will be noticed that the last two sections, Arbury and Catesby, differ greatly from the more easterly ones. The Fish bed is totally different in appearance and composition, and has developed into a Cephalopoda bed. There are no Paper Shales, and no red sandy clay between the Transition bed and Fish bed. It is very probable that the Fish bed of this district embraces the fauna of all the beds from E to J of the general section. The fossils would seem to indicate this; indeed, we believe there is no fossil from the beds E and F that is not included in the Fish-bed list.

No crushed Ammonites, and no Aptychi, have been found in the Fish bed, where it has the abnormal characters just described.

The last section opened is situate about a mile north of Chipping Warden. The richly fossiliferous condition of the Transition bed here was made known by the investigations of Mr. E. A. Walford some years ago, when the quarry was in work. The Transition bed at Chipping Warden is softer and more easily worked than at any other place known to us. This may perhaps partially explain the reputed richness of the bed.

SECTION AT CHIPPING WARDEN.

	Ft.	in.
1. Soil	1	6
D.—2. Light-coloured calcareous clay. A few <i>Belemnites</i> and fragments of <i>Ammonites</i>	2	6
Some fragments of whitish limestone in the upper part are probably remnants of the Lower Cephalopoda bed.		
F? The lower portion is more shaly, and of a ruddy colour, dark purple coloration at joints.		
G, H, I.—3. FISH BED.—A limestone in two bands, upper part in small irregular pieces easily broken, lower in large slabs, none of it nodular, blue interior	0	6
<i>Ammonites Strangwaysi</i> (very large).		
" <i>Holandrei</i> .		
" <i>acutus?</i> (some small forms differing only a little from).		
<i>Fish remains</i> (a few).		
<i>Euomphalus minutus</i> , &c.		
K, L.—4. TRANSITION BED.—Clay and grey friable sandy marl, very red in places, the marl only fossiliferous apparently. Some small ironstone concretions and crystallised carbonate of lime in the lower part. Most of the fossils from the Transition bed in the list to follow have been at some time found at Chipping Warden (see list)	0	6
M.—5. Ferruginous limestone, similar to the rock bed, very fossiliferous, particularly in lower part, mostly broken shells. <i>Large Belemnites</i> , <i>Pecten lunularis</i> , <i>P. dentatus</i> , <i>Pentacrinus</i> , <i>Rhynchonella tetrahedra</i> , &c.	0	3
6. Sandy marl, much resembling the Transition bed, but the fossils larger, many crushed and broken shells, <i>Rhynchonella</i> mostly as separated valves, a few <i>gasteropods</i>	0	3
7. A ferruginous limestone, very red exterior, usual fos- sils, depth?		

The beds 5, 6, and 7 may collectively be regarded as the Marlstone rock bed.

LIST OF FOSSILS.

Name of Fossil	Rock Bed	Transition Bed	Fish Bed and Paper Shales	Serpentinus Beds	Communis Beds
Ichthyosaurus—vertebræ or teeth . . .	*		*	*	*
Pterodactylus ? (slender and apparently hollow bone).			*		
Lepidotus gigas (British Museum) . . .			*		
Pachycormus (Northampton Museum) . . .			*		
Leptolepis concentricus ? (abundant fragments).			*		
Amaltheus spinatus, Brug. (rare) . . .	*				
1. Stephanoceras commune, Sow.		*	*	*	*
2. " Holandrei, d'Orb		*	*	*	*
3. " crassum, Young and Bird		*	*		
" annulatum, Sow.		*			
4. " (.Eg.) Grenouillouxi (near to) }		*			
" ? foniculum, Simp.					
" Raquinianum, d'Orb.				*	*
" semicelatum, Simp. ?					*
" n. sp.		*			
Harpoceras acutum, Tate (abundant)		*			
5. " serpentinum, Rein. (near to)			*		
" Frautzi, Reynes ?			*		
" falciferum, Sow.			*		
6. " Strangwaysi, Sow. (coarse ribbed).			*	*	
" " (fine ribbed)			*	*	
7. " lythense, Y and B.			*		
8. " elegans, Sow.			*		
9. " simile, Simp. ?			*		
" cæcilia, Rein. (Tate and Blake)			*		
" boreale, Seeb.			*		
" exaratum, Y. and B.			*	*	
" latescens, Simp.			*		
" Levisoni, Simp.			*	* ?	*
10. " lympharum, Dumort. (near to).			*	*	
" primordiale, Schl. ?			*	*	
" subplanatum, Oppel			*	*	
" bifrons, Brug.			*		*
" n. sp. ? (2)			*		
Phylloceras subcarinatum, Y. and B.			*		*
Lytoceras cornucopia, Y. and B.			*		*
Aptychi (numerous, and of more than one species).			*		
Nautilus astacoides, Y. and B. ?				*	*
Belemnites paxillosus, Schl.	*				
" tripartitus, Schl.	*	*			*
" (numerous species, much worn).		*			
" apicicurvatus, Blain ?					*
" vulgaris, Y. and B.					*
" subtenuis, Simp.					*
" Ilminsterensis, Phillips ?			* ?		*
" quadricanaliculatus, Quenst.					*
Belotcuthis ?			*		
Dentalium elongatum, Münster. (= D. gracile, Moore).		*	*		

LIST OF FOSSILS—*continued.*

Name of Fossil	Rock Bed	Transition Bed	Fish Bed and Paper Shales	Serpentinus Beds	Communis Beds
Dentalium liassicum, Moore		*	*	*	
Neritina, sp. ?		*			
Neritopsis transversa, Moore (near to)			*		
" operculum = Peltarion unilobatum, Desl.			*		
Cryptænia rotelliformis, d'Orb.		*			
" consobrina, Tate ?	*	*			
" heliciformis, Desl.		*	*		
Pleurotomaria helicinoïdes, Röm. (= Trochus helicinoïdes)		*			
" rustica, Desl.		*	*		
" anglica, Def.	*	*	*		
" Hierlatzensis ? Stol.		*	*		
Alaria semicostulata, Piette and Eu. Desl.			* ?		
" unispinosa, Moore		*			
Monodonta Lindecolina, Wilson (near to)		*			
Euomphalus minutus, Schüb (abundant)			*		
Trochus Thetis, Münst.		*			
" Pethertonensis, Moore		*			
" rotulus, Stol.		*			
" Mysis (near to)		*			
" Œgion, d'Orb. (= T. Ariel, Dumort. and T. lineatus, Moore ?)		*			
" sagenatus, Wilson				*	
" duplicatus, Münst.					*
" Northamptonensis, Wilson					*
Amberlya Callipyge, Wilson		*			
" Gaudryana, d'Orb.		*			
" var.		*			
" Æolus, d'Orb. (= Trochus Emylius, d'Orb. ?)		*			
" capitanea, Münst.				*	
Bourguetia (Phasianella) turbinata, Stol.		*			
Turbo cyclostoma, Benz.		*			
" nudus, Moore		*			
" varians, Moore		*			
" bullatus, Moore		*			
" Theodori, Münst. ?		*		* ?	
" lineatus, Moore		*			
" sp. ?		*	*		
Pitonillus linctus, Moore		*			
Eucyclus conspersus, Tate		*			
Littorina sp. ?				*	
Cerithium liassicum, Moore		*			
" pyramidale, Moore		*			
" ferreum, Tate		*			
" coronatum, Moore		*		*	
" Ilminsterensis, Moore		*			
" gradatum, Moore ?		* ?	*		
" reticulatum, Desl. ?		*			
Cerithinella (Cerithium) confusum, Tate		*			
Chemnitzia semitecta, Tate ?		*			
" Blainvillei, Münster		*			
" foveolata, Tate		*			
Actæonina Ilminsterensis, Moore	*	*			

LIST OF FOSSILS—continued.

Name of Fossil	Rock Bed	Transition Bed	Fish Bed and Paper Shales	Serpentinus Beds	Communis Beds
<i>Actæonina</i> sp.?		*			
„ <i>marginata</i>				*	
<i>Cylindrites</i> Whitfieldi, Moore		*			
<i>Orthostoma fontis</i> , Dumort?		*			
<i>Turritella</i> Dunkeri, Terq.		*			
<i>Nerinea liassica</i> , Moore (so called) = <i>Cerithium subliassicum</i> , Huddleston & Wilson, MS.			*		
<i>Ostrea submargaritacea</i> , Brauns.	*	*?			
„ <i>sportella</i> , Dumort.	*	*			
„ <i>cymbium</i> , Lam. var. <i>obliquata</i>	*				
„ „ „ <i>depressa</i>	*				
<i>Anomia numismalis</i> , Quenst.		*			
<i>Pecten equivalvis</i> , Sow. (large form)	*	*			
„ <i>dentatus</i> , Sow. (a small var. of <i>equivalvis</i>)	*	*			
„ <i>lunularis</i> , Röm. = <i>P. liasinus</i> , Nyst.	*	*			
„ <i>priscus</i> , Schl.	*	*			
„ <i>calvus</i> , Goldf.	*	*			
„ <i>textorius</i> , Schl.	*	*	*		
„ <i>substriatus</i> , Röm.?	*	*	*		
„ <i>pumilus</i> , Lam.	*	*	*	*	*
„ <i>strionatis</i> , Quenst. (a form near to)	*	*	*		
<i>Hinnites tumidus</i> , Ziet. (= <i>H. velatus</i> , Goldf.)	*	*			
„ <i>Davæi</i>	*	*			
<i>Lima Hermanni</i> , Voltz.	*	*			
„ <i>punctata</i> , Sow.	*	*			
„ <i>eucharis</i> , d'Orb.	*	*			
„ sp. ? (very large)	*	*			
„ sp. ? (2)	*	*		*	*
<i>Limea acuticosta</i> , Dumort.	*	*			
<i>Plicatula spinosa</i> , Sow.	*	*	*		
„ sp. ? (large, and large spines)	*	*			
„ <i>catinus</i> , Desl.	*	*			*
<i>Monotis inaequivalvis</i> , Sow.	*	*			
„ sp. ?	*	*			
„ sp. ?	*	*		*	
<i>Inoceramus substriatus</i> , Münst.		*			*?
„ <i>cinctus</i> , Münst.		*			*?
„ <i>dubius</i> , Sow. (many)		*	*		
<i>Modiola subcancellata</i> , Buvig.	*	*			
<i>Macrodon Buckmanni</i> , Rich.	*	*			
„ <i>undatus</i> , Walford	*	*			
<i>Cucullæa Münsteri</i> , Ziet.	*	*			
<i>Arca liasina</i> , Röm.	*	*			
„ <i>interrupta</i> , Moore	*	*			
<i>Nucula Hammeri</i> , Def.		*?			*
„ <i>claviformis</i> , Sow.	*	*			*
<i>Leda galathea</i> , d'Orb.	*	*			
<i>Trigonia Lingonensis</i> , Dumort.?	*	*			
„ <i>pulchella</i>	*	*			*
<i>Astarte striato-sulcata</i> , Röm. = <i>A. amalthei</i> , Quenst.	*	*			
<i>Astarte Voltzii</i> , Goldf.	*	*			
„ <i>subcarinata</i> , Münst.	*	*			
„ <i>subtetragona</i> , Münst.	*	*			

LIST OF FOSSILS—continued.

Name of Fossil	Rock Bed	Transition Bed	Fish Bed and Paper Shales	Serpentinus Beds	Communis Beds
Astarte sp. ?	*		*	*	
Cardita multicostata, Phil.	*				
Cardinia concinna, Sow. = C. philea, d'Orb.	*	*		*?	
Myoconcha decorata, Münst.	*	*			
Protocardium truncatum, Sow.	*	*			
Lucina pumila, Münst.	*	*			
„ Bellona, d'Orb.	*			*	
Unicardium subglobosum, Tate	*	*			
Arcomya vetusta, Bean		*			
Goniomya sp. ? (many)			*		
Opis curvirostris, Moore				*	
Spiriferina rostrata, Schl.	*	*			
Terebratula punctata, Sow.	*	*			
„ „ var. Radstockensis, Dav.	*				
Terebratula subpunctata, Dav.	*				
„ Edwardsi, Dav.	*	*			
„ Walfordi, Dav.	*	*			
„ curviconcha, Oppel?				*	
„ sp. ?			*		
Waldheimia resupinata, Sow.	*				
„ indentata, Sow.	*				
„ Lycetti, Dav.				*?	
Rhynchonella tetrahedra, Sow.	*	*	*?		
„ „ var. Northamptonensis, Walker.	*	*			
Rhynchonella fodinalis, Tate	*	*?			
„ amalthei, Quenst.		*			
„ Bouchardi, Dav.		*	*	*	
Crustacean fragments	*				*
Serpula tetragona, Desl.		*			
„ quinquecostata, Münst.		*			
Ditrypa circinata, Tate		*			
„ etalensis, Piette		*			
Acrosalenia Banburiensis, Wright		*			
Millerocrinus Hausmanni, Röm.		*			
Pentacrinus Jurensis, Quenst.		*			
Diplocidarid Desori, Wright		*			
Thecoyathus tuberculatus, Tomes		*			
Nubecularia tibia, J. and P.			*	*	*
„ lucifugas				*	
Wood	*	*	*	*	*

NOTES ON THE AMMONITES. BY MR. S. S. BUCKMAN, F.G.S.

Referring to the Transition-bed Ammonites Mr. Buckman says:—The specimens of *Dactyloceras* are very good. They show one thing continuously, namely, that it will not do to apply the term *Commune* zone to the zone above the *Falciferum* zone, because, though no actual specimens of *commune* are present, *i.e.*, if one be strict in regard to identification, yet there are certain forms much too close. Your researches, therefore, have settled that point, and another name must be given to what is now called the *Commune* zone.

Another point these Ammonites show, at least so it seems to me, is that our Upper Lias species of *Dactyloceras* are migrants. Several of these species occurring at the bottom of the Upper Lias are so changed from what I imagine to be their parent forms—*Grenouillouxi* and *Pettos*, d'Orb.—that I think such changes must have commenced at least before they came to us.

For fossils to which the numbers refer see list.

1. Transition-bed form between *Communis* and *Annulatus*.
2. Transition-bed form differs somewhat from that found in higher beds.
3. Between *Crassus* and *Desplacei*.
4. *Dactyloceras* between *Crassus* and *Grenouillouxi*.
5. *Hildoceras* n. sp. (?), a form more or less of a passage between *Levisoni* and *Serpentinum*; some of the specimens may be *H. Frautzi*, *Reynes*.
6. The specimens of *Harpoceras Strangwaysi* are very variable in ribbing, some very coarsely ribbed, others very finely ribbed. It is a matter of opinion whether they should be all classed under one name; at any rate, there is no other name for them.
7. Mostly young forms, narrow centred, otherwise very like *H. simile*.
8. *Harpoceras elegans*, Sow., non Wright. Some forms between *exaratum* and *elegans*.
9. Vary between *simile* and *lythense*, wider centred than true *lythense*. Ribs not as coarse as in Blake's figure.
10. Very much like Dumortier's figure of *A. lympharum*, but the ribs appear a little less sigmoid.

SUMMARY OF OBSERVATIONS.

M. The Marlstone Rock Bed.—This is the most important bed of the Middle Lias in Northamptonshire, and throughout the country from an economical point of view. Its usual character in the area referred to in this report is that of a hard, calcareous, and ferruginous rock, varying in colour from a bluish-green, or grey, to a reddish-brown, according to the amount of weathering it has experienced. Where it comes near the surface, as at Arbury and Catesby, it is somewhat fissile, and so of little value except for road mending. Where dug from a considerable depth it may be obtained in large blocks suitable for building purposes, particularly if care be exercised in placing it in the building as it exists in the bed.

In no portion of the area investigated is it rich enough in iron to be used as an ore, though in the south-western portion of the county, at King's Sutton, it has been so used. The calcareous matter in it is considered an advantage, as the stone will flux itself.

Between Catesby and Chipping Warden the bed gets very sandy, and this character is particularly noticeable near to Byfield.

The thickness varies from 4 feet to 12 feet, the average being about 5 or 6 feet.

The dominant fossils are brachiopods.

Rhynchonella tetrahedra occurs in masses, and *Terebratula punctata*

more rarely in the same manner. Bands composed of *ossicles* and fragments of shells sometimes extend for a considerable distance. The characteristic ammonite, *A. spinatus*, is exceedingly rare.

K, L. *The Transition Beds*.—These beds in Northamptonshire usually consist of a rather thin band of grey friable marl passing upwards into a red sandy clay, though the latter is not unfrequently absent where the former may be distinctly identified.

The marl, in its most typical form, appears to consist of a highly porous, calcareous matrix containing numerous small rounded grains of the same composition, which latter may be plentiful enough to give it an oolitic character. It weathers reddish-brown on exposure. The lower portion sometimes passes into a hard compact limestone, but even then, apart from the fossils, it can usually be identified, though its exact junction with the rock bed may remain doubtful.

The thickness, including the red sandy clay, seldom exceeds 6 inches, but at Milton they together measure a foot.

The red sandy clay does not, as a rule, contain fossils, but at Milton it contained a good many casts of belemnites and evidences of other fossils.

The lower portion of the Transition beds may be described as a highly fossiliferous bed, both as regards individuals and species, though, as the fossils are mostly small, and require a good deal of patient searching for, it would not always give a stranger to it that impression, and of course it is not equally fossiliferous everywhere.

The most characteristic fossil is *Ammonites acutus*, and it is doubtful if this species has been found out of this particular zone, though some of the smaller specimens from beds above may be very close to it. The sudden appearance of this ammonite in *great numbers*, and its equally sudden disappearance or change are matters of considerable interest that require further investigation. The other ammonites, of the genus *Stephanoceras*, are nearly equally abundant, but some of these come fully developed, and also occur in higher beds.

The striking fossils here, however, are the gasteropods, as will be noticed by the list.

Another noticeable feature of the Transition beds is the generally small size of the fossils (gasteropods excepted), and particularly of the brachiopods and other survivors of the Middle Lias period. Small specimens of *Rhynchonella tetrahedra* are probably more abundant than any other fossil.

G, I. *The Fish Bed*.—The Fish bed proper is mostly a single band of argillaceous limestone or of flat limestone nodules, both of which split easily in a longitudinal direction after exposure to atmospheric influences for some time, and in doing so nearly always expose a number of fragmentary fish remains.

The nodules with us are never concretionary, and in all probability their particular condition has been brought about by water percolating through joints in the bed, because the upper surface is mostly more convex than the lower, and they all show the same horizontal stratification (compare description of Bugbrook section).

The stone has characters which enable a geologist to readily identify it when in its normal condition. It is yellowish or quite white on the exterior, and bluish-grey, light-brown, or yellowish inside, according to the amount of weathering undergone.

The stone, which has got coloured light-brown throughout, nearly always shows a large number of parallel, nearly microscopic veins, extending right across the stone. The veins look like, and probably are, minute cracks filled in with crystallised carbonate of lime, and on the weathered surface of such stones these veins stand out in relief. The same character was observed in the Fish bed of Alderton, Gloucestershire.

The above is a description of the bed as it occurs at Milton, Bugbrook, and some other parts of the county, but at Arbury Hill, Catesby, Byfield, Chipping Warden, &c., it is quite different. At these places it is very irregular in composition and difficult to describe; it weathers rather yellow than white, contains fewer fish remains and more ammonites. The Paper Shales have not been detected where there is an abundant ammonite fauna in the Fish bed, hence the suggestion that this is an attenuated zone representing in time and in fossil contents more than one of the beds given in the general section. Another reason may be found in the singular absence of ammonites of the genus *Stephanoceras* from the Fish beds of Milton and Bugbrook, although found above and below, and their great abundance in the Fish bed of Arbury Hill and Catesby, &c.

The most distinctive fossils found in the Fish bed, besides the *fish remains*, are the *Aptychi* of *Ammonites*, cephalopods allied to the *Loligo* and *Sepia*, *Cerithium gradatum?* *Euomphalus minutus*, *Inoceramus dubius* and a *Goniomya*.

H, J. *The Paper Shales* are finely laminated shales having a very regular and clean plane of division. When exposed to a dry atmosphere the thin layers often exhibit a tendency to spontaneous separation from each other, and even curl up at the edges.

The shales at any place are closely like the Fish bed at the same place in colour, &c., and there is no doubt that the Fish bed proper must only be regarded as a more indurated portion of the shales. This easily accounts for more than one hard layer at some places (*cf.* Milton).

So far as we can judge, the fossils in the shales and Fish bed are identically the same, only that in the shales the ammonites are mostly crushed quite flat. The crushing may perhaps be accounted for by an abundance of organic matter in those beds, which, as it decayed, permitted them to give way under the pressure of sediment above. *Ammonites esuratus* seems to have resisted compression better than the other ammonites.

The sudden appearance and decline of fish is a matter deserving of attention. Not a fragment of any kind appears to have been found in the Marlstone, and scarcely any in the beds just above the Fish bed.

The shales are better developed at Milton and Bugbrook than elsewhere in the county.

C, D. *The Serpentinus Beds*.—These beds form the upper portion only of what is usually called the 'Serpentinus' zone; the latter would include the Fish bed and shales. Mr. Buckman recommends that these beds be called the *Falcifer* beds and the zone the *Falciferum* zone, because, although many ammonites of the *falcifer* group occur, very few agree with the type of *A. serpentinus* itself; hence a more general term is desirable. This would agree with the Continental nomenclature.

This sub-zone rests upon the Fish beds, and usually consists of a bed of calcareous clay, capped by an argillaceous limestone containing some large ammonites of the 'Falcifer' group.

E, F.—This investigation has brought out the fact that there is a

distinct cephalopoda bed, or may be two beds, at the base of the clay, as well as at the top, in some places (Milton and Bugbrook).

This bed had been previously noticed at Milton, but as the fossils found in it are, on the whole, very similar to those found in what we have usually called the Lower Cephalopoda bed, it was thought to be that bed, and the usually intervening clay absent. This has been completely set at rest now by the finding of a full sequence of the beds at Bugbrook (see Bugbrook section).

It is at present doubtful whether this bed should be classed as the lowest of the 'Serpentinus' beds or the highest of the Fish beds. There is much reason for the latter course, as it contains many *flattened ammonites* at Bugbrook like those in the Paper Shales, also *Aptychi* at both Milton and Bugbrook, and these had never before been found out of the Fish zone. We prefer at present to leave it as a doubtful, or transitional zone.

D.—*The clay* may be dark blue when freshly exposed, but gets very light coloured on exposure, and when dry cracks into roughly cubical masses; the freshly exposed surfaces are often quite purple. In some places it contains numerous little white concretions, as does also the Cephalopoda bed above.

Thickness a few inches to 5 feet.

There are very few noticeable fossils in this clay, except just at the base, where the bed often gets shaly, or develops into a distinct hard bed (see sections at Milton and Bugbrook).

A small group of new forms of *Foraminifera* have been described by Dr. Rudolph Haeusler¹ from clays above the Fish bed at Byfield, collected by Mr. E. A. Walford, F.G.S.—*Ophthalmidium Walfordi*, *O. nubeculaniforme*, &c. An elaborate comparison is drawn between certain Jurassic Miliolidae of the Jura and those of the neighbourhood of Banbury, Oxon.

C. *Lower Cephalopoda Bed*.—The 'Serpentinus' beds are capped by an argillaceous limestone containing some very large specimens of *Ammonites Strangwaysi* and others of the falcifer group; hence the term Cephalopoda bed. It varies from dark blue to light yellow colour, according to nearness to the surface; but even the light-coloured pieces exhibit a bluish or violet-coloured interior if sufficiently thick. It often appears water-worn. Thickness about 6 inches.

The most characteristic fossils of this sub-zone appear to be *Ammonites subplanatus*, *Amberlya capitanea*, *Opis curvirostris?* and *Onustus spinosus*. All of them rather rare.

A. *B. Communis Beds*.—These also consist of a clay capped by a Cephalopoda bed.

B. *The clay* is very irregular in composition, varying much, apparently, in the amount of sand and calcareous matter. It generally contains a large number of small white concretions, as does also the hard bed above; also small argillo-calcareous nodules, like larger ones found commonly in higher beds, appear in this for the first time in the Upper Lias.

The clay is most easily identified by the presence in it of large numbers of small ammonites, chiefly *A. communis* and *A. Holandrei*, which are generally quite white.

Average thickness about 3 feet.

A. *The Upper Cephalopoda bed*, as the hard bed at the top is usually

¹ 'Bemerkungen über einige liasische Milioliden,' von Rudolph Haeusler, *N. Jahrbuch f. Mineralogie*, &c., Bd. I. 1887.

called locally, is very variable in character, but almost always fissile. The description of this bed at Bugbrook gives a fair idea of the bed over the area embraced by this report. At Bugbrook it is very fossiliferous, *Ammonites communis*, *A. Holandrei*, and *A. bifrons* largely predominating. Singularly, in this bed the fossils seem to lie anyhow; many of the specimens, particularly *A. bifrons*, stand quite upright in it, instead of lying on their sides as is usual.

The most characteristic fossils of this sub-zone, besides those mentioned above, are *Belemnites subtenuis*, and other long, slender forms; *Trochus duplicatus*, *T. Northamptonensis*, *Eucyclus acuminatus*, d'Orb., *Nucula claviformis*, and *Ammonites subcarinatus*.

CONCLUSIONS.

Maps.—It may be noted here that over most of the area embraced by these investigations there is a capping of Upper Lias, varying from a couple of feet to 10 or 12 feet, where the maps show only Marlstone.

The hard beds near the base of the Upper Lias seem to have protected the intervening clay beds from denudation, and these latter have largely protected the Marlstone rock bed itself, making it thus a more valuable stone than it would otherwise have been.

Horizon of Fossils.—The fact noted above may account for the incorrect determination of the horizon of a number of fossils collected many years ago by Miss Baker, now in the British Museum and other places. We would particularly call attention to the specimen of *Lepidotus gigas*, Agassiz, now in the British Museum, which is, or was, labelled as from the Marlstone of Bugbrook. This certainly came from the Fish bed of that district, as did also another specimen now in the Northampton Museum.

Of the other fossils, chiefly ammonites, labelled as from the Marlstone, there can be little doubt that they came from the inconstant hard bed just above the Paper Shales. It seems highly probable that all the beds from this Cephalopoda bed to the base of the rock bed, which constitute almost one continuous hard layer, were formerly regarded as Marlstone.

CORRELATION OF THE BEDS.

Rock Bed.—There is probably no zone of the Lias more distinctly marked, lithologically and palæontologically, than the Marlstone rock bed. Right across the country from Dorsetshire to Yorkshire it is scarcely ever absent, and it varies comparatively little.

The correlation of the beds above the rock bed is not quite so certain, but we would submit some evidences of the contemporaneity of the beds variously designated as below:—

Pleurotomaria Bed of Dorsetshire (DAY).¹

Leptaena Beds of Somersetshire and Gloucestershire (MOORE).

Transition Beds of Northamptonshire (WALFORD).

Annulatus Zone of Yorkshire (TATE and BLAKE).

1. The situation of each of these beds is the same, viz., just above the rock bed of the Middle Lias and below the Fish bed of the Upper Lias.

¹ Dr. Wright did not admit that the *Pleurotomaria* bed of Mr. Day was the equivalent of the *Transition* bed of the Midlands.—E. W.

2. With regard to the *Pleurotomaria bed*, it is characterised by the mixture of Upper and Middle Lias fossils, the ammonites in particular being Upper Lias forms and nearly identical with those found in Northamptonshire; also gasteropods are met with of many species. One of the lamellibranchs that Day particularly mentions as a rare form—*Sanguinolaria vetusta*—is abundant at Milton in the Transition bed, though not found elsewhere.

3. *The Leptæna Clays* of Moore agree in position with our Transition bed, but evidently include also the shales below the Fish bed, for Moore both speaks of the *Leptæna beds* as extending from the Marlstone to the Fish bed at Dumbleton, and also refers¹ to the flattened impressions of ammonites and their aptychi, and fish remains in the upper portion.

Not only does the description of the beds lead to the belief that they are the representatives of the Transition bed and part of the Paper Shales, but we have found between the typical localities of Ilminster and Dumbleton, viz., at Stinchcombe Hill, in Gloucestershire, a red sandy clay just above the rock bed with *Ammonites acutus* in it.

4. *The Annulatus Zone of Yorkshire*, of Tate and Blake, is so clearly a Transition zone from the Middle to the Upper Lias that the contemporaneity of this with the Transition bed of Northamptonshire need scarcely be insisted upon. It would appear that whilst there was a period of rest, or actual denudation of previously deposited matter, at the termination of the Middle Lias era in some parts of the Midland and South-western counties, in Yorkshire from the first, and some few other places after a time, a deposit was taking place.

Fish and Saurian Zone (MOORE).

Fish Bed and Paper Shales, or Fish beds.

Paper Shales with Fish and Insect Limestones—'Dumbleton' Series (JUDD).

'Animal' Dogger and Jet-rock Series (TATE and BLAKE).

Here, again, we have a set of beds differently named, but which can be distinctly recognised as the same, extending over an area from Somersetshire to Yorkshire, and very seldom entirely absent.

(1) It is exceedingly probable that the lower part of the Upper Lias limestone on the south coast is the representative of the Fish bed, for, according to Mr. Day's description, it contains *Ammonites serpentinus* in abundance, and does not differ more from the typical form than does the same bed only a few miles apart in Northamptonshire (compare Bugbrook and Catesby). The list of fossils given from the upper part is consistent with this view.

(2) *The Fish and Saurian Zone* is certainly the same as the Fish bed and Paper Shales of Northamptonshire, and this investigation shows that it would be a not inappropriate name.²

(3) *Fish and Insect Beds* would not be quite so suitable a description, as insects seem to be very local.

(4) *'Dumbleton' Series* does not seem a suitable term, considering

¹ *The Middle and Upper Lias of the South-West of England*, by Charles Moore, F.G.S., pp. 7 and 56, 57.

² Mr. Charles Moore expressed doubt as to the Fish bed of S.W. Northamptonshire, described by Mr. Walford, being the equivalent of that of Somerset and Gloucester.

that the beds have such a great lateral development, and can be appropriately named otherwise.

(5) 'Animal' Dogger and Jet-rock Series.—There can be little doubt from Messrs. Tate and Blake's description of these beds that they are the equivalents of the beds described in this paper as the Fish bed and Paper Shales. The points of similarity are these:—

- (a) The horizon is the same, viz., just above the 'Annulatus' beds.
- (b) Large numbers of fishes and reptiles occur, including of the former *Leptolepis*, *Lepidotus*, and *Pachycormus*.
- (c) *Aptychi* of ammonites are a peculiar feature of the series, being found in no other member of the Yorkshire Lias.
- (d) Cephalopods allied to the *Loligo* or the *Sepia* are only developed here.
- (e) The ammonites are similar, and compressed specimens of *A. complanatus* and *A. serpentinus* occur over all the beds.
- (f) *Euomphalus minutus* and *Inoceramus dubius* are common, the latter being the most characteristic fossil.
- (g) Wood is abundant.

We cannot with certainty carry the correlation further, but probably more complete investigations would show a similar correspondence until the sands of the South-western counties began to form. It may be that the 'Cheese' dogger at Saltwick Nab in Yorkshire represents one of our Cephalopoda beds.

The Committee desire to express their thanks to the British Association for giving them the opportunity of investigating a set of beds of great interest locally, and they hope of some interest to geologists generally.

Report of the Committee, consisting of Mr. J. W. DAVIS (Chairman), Rev. E. JONES (Secretary), Drs. J. EVANS and J. G. GARSON and Messrs. W. PENGELLY, R. H. TIDDEMAN, and J. J. WILKINSON to complete the investigation of the Cave at Elbolton, near Skipton, in order to ascertain whether Remains of Palæolithic Man occur in the Lower Cave Earth.

THE Elbolton Cave Exploration was continued under the direction of your Committee until the end of December 1890. The entrance to the cave is through a shaft or pot-hole 20 feet in depth situated at the foot of a small limestone scar on Elbolton 1,000 feet above sea-level. The chamber, before the exploration commenced, was 30 feet long, and varied from 7 to 13 feet in width. The floor was fairly level, with the exception of a heap of stones under the entrance. On the surface nothing was observed but a few sheep bones of recent origin. The upper stratum, which varied in thickness from 4 feet at the east to 17 feet at the west end of the chamber, is the only one wherein human remains have yet been found. It consisted of loose angular fragments of limestone interspersed with large quantities of bones of *Bos longifrons*, the horse, the boar, dog, red deer, sheep, &c. The bones of the larger animals were split and broken, and were evidently used as food. Burnt

bones and charcoal were found in three places. Three human skeletons were discovered buried 5 feet below the floor level, with the legs bent and the knees drawn up close to the skull. The other human bones were more or less scattered. Most of the skulls were shattered, though two, obtained from the east end, are fairly preserved, and are dolichocephalic, the index of one being 73.4. Two skeletons in very bad condition were also found at the other end of the chamber at a much lower level, 13 and 15 feet respectively below the floor (one lying but a few inches above the clay containing bones of the bear and reindeer). The latter specimens are more decayed than the others, and could not be measured. Associated with them was pottery of different character to that which was found in the other parts of the cave. It is thicker, ruder, and ornamented with triangular-shaped characters made with an angular tool. The pottery found near the other specimens at the higher level was marked with straight lines, which in some cases cut one another and form a diamond-shaped ornamentation, in others the lines go in and out without intersecting, and form a 'herring-bone' pattern; others had impressions made by some rounded bone tool. Both kinds of pottery were made from clay similar to that found in the cave, and both kinds were hand-fashioned without wheel, and charred and burned from the inside. No flints or metal of any kind have been found in the cave. The only objects obtained have been bone pins and a few other worked bones.

Nearly all of the upper stratum containing human remains had been cleared away before August 1890, and the next layer had been worked for some distance, especially in the second shaft at the west end of the chamber. So far this lower stratum was composed of stiff clay, with angular fragments of limestone and at times a thin bed of stalagmite. No human remains or any of the animals associated with them have been found. These are replaced mainly by bears, both *Ursus ferox* and *Ursus arctos*, and great numbers of Alpine hares and foxes. The bones in this layer show no evidence of having been gnawed by other animals; they either perished in the fissure or their bones were washed down through pot-holes into the cave. The bones from the lower layer are darker, much harder, and less porous than those from the upper one.

After the meeting of the Association at Leeds the efforts of your Committee were first directed to the careful examination of the lower clay bed in the centre of the chamber. A pot-hole, about 10 feet deep and 3 in width, was cleared out. This contained a few of the limb bones of a bear. A great part of the rock floor at the foot of the first ladder was blasted. It consisted apparently of a quantity of rock fallen from the roof and cemented by stalagmite. We were hopeful that underneath it we should find an old deposit. So far, however, it is solid. Further west the excavation was continued, the difficulty of working in the soft adhesive clay increasing. The percentage of bones was small, and in the next 6 feet not a single bone was found. The cave has now developed into a deep fissure, and is from 4 to 6 feet in width at a depth of about 45 feet from the original level of the cave floor. The attention of your Committee was next directed to find any possible entrance to the cave in addition to the present one: the floor was tested along the sides of the cave east of the first ladder, but the miners report that there the ground was all solid rock.

Between the barren clay section and the second ladder there is a quantity of unexplored material. Huge blocks of fallen rock are wedged

in the fissure, and it was found unsafe to remove them as they underpin an immense overhanging side of the cave 60 feet in height. The second ladder was then descended, and a level driven beneath the fallen blocks at a depth of 45 feet measured from the first floor. For the first 6 feet this level was as ossiferous as any of the material yet examined, and of similar character, containing bones of the bear and hare. Beneath was a barren clay, followed by beds of sharp quartz sand, until the level is barred by solid rock. In the descent two or three stalagmitic floors were pierced, but the material continued the same above and below the stalagmite. The new chambers that were opened last year are extensions of this fissure. The miners have put a steel rod 8 feet lower than present level, forcing it through another stalagmitic floor. While the east part of this level is sand, containing no bones, the western part and the passage up to the new chamber is a brecciated mass of bones and stalagmite.

At the further extremity of the new chambers, and about 60 yards from foot of second ladder, there was a deep pool into which the roof dipped. In the floor of the passage leading to the pool a hole 8 feet deep was dug. The material was comminuted limestone. Here also bones of young bears were found. They had evidently been washed down from the first chamber. By means of this excavation the pond was lowered 4 or 5 feet. A ladder was placed across it, and an entrance effected into a further passage leading to a large natural chamber.

So far the cave has been interesting. What may be entombed in the unexplored depths of the fissure is a matter of pure conjecture. Whether a repetition of the finds in the fissure at Ray Gill, and in the lower cave earth of the Victoria Cave, with the addition of palæolithic man, must be left for future exploration to determine.

Your Committee request reappointment, and that a grant of 25*l.* may be made to assist in the further exploration of the cave.

Report of the Committee, consisting of Dr. JOHN EVANS (Chairman) Mr. B. HARRISON (Secretary), and Professors J. PRESTWICH and H. G. SEELEY, appointed to carry on excavations at Oldbury Hill, near Ightham, in order to ascertain the existence or otherwise of Rock-shelters at this spot. Drawn up by Mr. B. HARRISON.

OWING to hindrances, the work could not be begun until August, 1890. The first excavation, immediately below the exposed rocks, was unproductive in a great measure. This was owing to huge trees being close by, the roots of which, forming a perfect network, offered serious obstacles, as, though permission had been granted by the owner to excavate, yet damage to the trees was strictly forbidden.

A section was first cut parallel with the face of the rock, but no true floor was reached, the rock itself being too near the surface, and forming merely a shoulder under the surface soil.

Many days at this being unsuccessful, another excavation was made on the slope of the hill just below, and a considerable area was trenched to a depth of about 3 feet.

1891.

Here, however, only Neolithic flakes were found; and great blocks, fallen from above, and deeply imbedded in the soil, presented obstacles not easy to surmount.

Later on work was commenced lower down still, at a spot where, in cultivating the ground in former years, relics of Palæolithic age had been found.

Two implements were secured, but the rocky conditions tried my labourers' strength; and to do the work thoroughly horse-power was needed, the blocks in many instances weighing more than half a ton.

A good large area, however, was here trenched to a depth varying from 3 to 5 feet.

The slope of the bold projecting spur below Mount Pleasant, lying about fifty yards south-east of the former digging, was next tried, and here success crowned our efforts, for very soon immense numbers of flakes were met with, and in such profusion that I was prompted to carry on the work thoroughly.

Leave was asked for and granted for an area of some 9 or 10 rods to be worked over, and ere long finely fashioned characteristic Palæolithic implements were found daily, as well as flakes, some of these so minute that it seemed as if the place of the actual workshop had been lighted on.

Altogether 49 well-finished implements, or portions of them, and 648 waste flakes, have been found at this spot, leading to the supposition either that this was the frontage of a rock-shelter, or that the material had slipped down from above. We think that it would be highly desirable to make further excavations in this and the adjacent area.

The greater portion of these flakes were found at depths varying from $2\frac{1}{2}$ to 3 feet; and, as a rule, they lay at the base of, or immediately overlying a gravelly wash. The implements are very similar to some of those found in the rock-shelters of central France.

Similar conditions to those of this spur appear on the north-west side of Oldbury Hill, near to an outcrop of rock; and at various times implements have been found near it.

Leave has been granted for work to be carried on here.

Fourth Report of the Committee, consisting of Professor FLOWER (Chairman), Mr. D. MORRIS (Secretary), Mr. CARRUTHERS, Dr. SCLATER, Mr. THISELTON-DYER, Dr. SHARP, Mr. F. DUCANE GODMAN, Professor NEWTON, Dr. GÜNTHER, and Colonel FEILDEN, appointed for the purpose of reporting on the present state of our knowledge of the Zoology and Botany of the West India Islands, and taking steps to investigate ascertained deficiencies in the Fauna and Flora.

THIS Committee was appointed in 1887, and it has been reappointed each year until the present time.

During the past year Mr. F. DuCane Godman, F.R.S., has continued to employ a collector in the island of St. Vincent, and owing to the valuable assistance thus afforded to the Committee it has been possible to complete the exploration of this island. The collections in zoology are

very extensive, and those in botany extend to the whole of the phanero-gams and the vascular cryptogams. No expense has been incurred by the Committee in regard to any of these collections in St. Vincent.

The services of Mr. R. V. Sherring, F.L.S., were accepted, as mentioned in the last report, to make botanical collections in the island of Grenada. He left this country in October last and returned after seven months' absence in June last. Mr. Sherring has forwarded to this country large collections, consisting for the most part of vascular cryptogams, and these are now in course of being determined at Kew. A detailed report on the various collections in zoology and botany received during the past year is given below.

At the present time Mr. Herbert H. Smith, the collector employed by Mr. Godman, is making collections in zoology in the island of Grenada. This is the most southerly of the chain of islands intended to be explored by the Committee. When this island is completed the Committee will have been engaged in investigating the fauna and flora of most of the islands in the Lesser Antilles lying between Martinique and Trinidad. The islands in which collections have so far been made consist of Dominica, St. Lucia, Barbados, St. Vincent, the Grenadines, and Grenada.

ZOOLOGY.

Since the last report collections have continued to be received from St. Vincent by Mr. Godman. The work of sorting and arranging these collections has been begun. The arthropods are already completed, and the larger part of the insects is mounted and prepared for despatch to the specialists who have been engaged to work them out.

For this purpose the Committee have been so fortunate as to obtain the assistance of the following naturalists: Herr Hofrath Brunner v. Wattenwyl for the Orthoptera; Professor Riley for the Rhynchota; Mr. Howard for the parasitic Hymenoptera; Professor S. W. Williston for the Diptera; Professor Aug. Forel for the Ants; Lord Walsingham for Lepidoptera, part; F. D. Godman and O. Salvin for Lepidoptera, part; D. Sharp for Coleoptera; M. Simon for Spiders generally; and G. W. Peckham for Attidæ. The Committee have undertaken to procure publication of the memoirs that may be received from these *savants*.

A small collection of specimens made by Dr. H. A. Alford Nicholls, F.L.S., local secretary to the Committee in the island of Dominica, was received in May last. This consisted of nine mammals, one lizard, one snake, five fishes, one *Ascalaphus*, twelve Longicornia, two Passalidæ, and five Lamellicornia. Besides these Dr. Nicholls sent from the island of Tobago four of the peculiar nests of the yellow-tailed bird of that island (*Cassicus cristatus*). These birds usually build their nests depending from isolated branches of the silk-cotton tree (*Eriodendron anfractuosum*), and they look like huge fruits waving in the wind.

A small collection of Lepidoptera was received in November last from Captain Hellard, R.E., local secretary to the Committee in the island of St. Lucia. The mounted specimens in this collection arrived in bad order owing to the pieces of camphor getting loose in the boxes and breaking the greater part of them, including almost the whole of the *Sphingidæ*.

Mr. John C. Wells, who has devoted attention to the ornithology of Grenada, has kindly consented to act as a local secretary for that island.

BOTANY.

Of the botanical collections received from St. Vincent the vascular cryptogams have been determined by Mr. J. G. Baker, F.R.S., and an account of them, with two plates, printed in the 'Annals of Botany,' vol. v. (April, 1891), pp. 163-172. Amongst the ferns the most striking novelty is a new species of *Asplenium*, named *A. Godmani*, Baker (pl. xi.), found in damp forests at the extreme top of Morne à Garou. Other new species are *Hymenophyllum vincentinum*, Baker (pl. x.), and *Acrostichum* (*Elaphoglossum*) *Smithii*, Baker. The total number of vascular cryptogams found recently in St. Vincent amounts to 168 species. Most of these are widely spread through tropical America and only four are endemic. In addition to the above a new species of *Hepaticæ*, also from St. Vincent (*Kantia vincentina*, C. H. Wright), was described in the 'Journal of Botany,' vol. xxix. (April, 1891), p. 107.

Of the phanerogams from St. Vincent and some of the Grenadines the work of determining these is being carried on as expeditiously as circumstances permit. The collection is a very large one, and the results so far attained are contained in the following memorandum prepared by Mr. R. A. Rolfe:—

The flowering plants have been determined as far as the end of Rutaceæ. Those from St. Vincent number slightly over a hundred species, of which about thirty, consisting for the most part of common West Indian plants, were not previously recorded from the island. The most interesting plant is a species of *Trigynia* (apparently new), a small tropical American genus of Anonaceæ not hitherto detected in the West Indies. A *Clusia* and a species of *Tetrapteryx*, which cannot be identified, may also prove new. The remainder have been fully determined. The three most interesting of these are *Norantea Jussæi*, Tr. and Pl., previously known only from Guadeloupe and Dominica; *Zanthoxylon microcarpum*, Griseb., from Dominica and Trinidad; and *Z. spinosum*, Sw., from Dominica, Jamaica, and Cuba. The composition of the flora of the Lesser Grenadines, situated between St. Vincent and Grenada, was previously almost unknown. The plants hitherto determined are as follows:—From the island of Bequia, 34 species; from Mustique, 18; from Canouan, 5; and from Union, the nearest to Grenada, 5. They are without exception common West Indian plants, and are all also natives of St. Vincent. From the results hitherto obtained it seems clear that the flora of the Lesser Antilles is tolerably uniform throughout, although the larger islands of Dominica, Martinique, St. Lucia, and possibly St. Vincent, appear to have each a very small endemic element.

The collections made by Mr. Sherring at Grenada consist of nearly 6,000 specimens of vascular cryptogams and about 1,000 specimens of phanerogams. The number of species of ferns is about 140, and of these two are new, viz., *Alsophila Elliottii*, Baker, and *Acrostichum Sherringii*, Baker. The phanerogams have not yet been worked out. Sixty species of ferns were previously known from Grenada from collections made by Mr. G. R. Murray, F.L.S., and Mr. W. R. Elliott. Mr. Sherring has increased this number to 140. The species of greatest interest, other than those known to be new, are *Asplenium Godmani*, Baker, recently found in St. Vincent; *Polypodium Hartii*, Jenman, first described in 1886 and known only in the mountains of Jamaica and Dominica; and

Acrostichum Aubertii, widely spread in continental America, but new to the West Indies. Other interesting plants collected by Mr. Sherring are *Schizæa fluminensis*, Miers, new to the West Indies, but believed to be only a shade variety of *S. dichotoma*, and *Dancea polymorpha*, Leprieur, a critical form of which but little is known.

An account of vascular cryptogams collected at Grenada is in course of being prepared for the 'Annals of Botany.'

Mr. Sherring has prepared an interesting report on the flora of Grenada, and this, with a valuable series of photographs, to be shown at the Cardiff meeting of the British Association, will prove of great interest to students of West Indian botany.

A collection of plants was received from Dr. Nicholls at the same time as the specimens in zoology already noticed. These consisted of fifty-six species of vascular cryptogams—all of them were, however, well-known West Indian plants—and a small number (175 numbers) of phanerogams. The latter have not yet been determined.

The Committee recommend their reappointment, with the following members: Dr. Sclater, Mr. Carruthers, Professor Newton, Mr. Godman, Dr. Günther, and Dr. Sharp. The Committee also recommend that the grant of 100*l.* placed at their disposal, but not expended during the current year, be renewed.

Draft of Report of the Committee, consisting of Professor FLOWER (Chairman), Mr. D. SHARP (Secretary), Dr. BLANFORD, Dr. HICKSON, Professor NEWTON, Professor RILEY, Mr. O. SALVIN, and Dr. SCLATER, appointed to report on the present state of our knowledge of the Zoology of the Sandwich Islands, and to take steps to investigate ascertained deficiencies in the Fauna.

THE Committee beg leave to state that the zoology of the Sandwich Islands has been only partially investigated. A very incomplete collection of insects was made there some years since by the Rev. T. Blackburn, and described by himself and others, showing that important results as to the origin, or origins, of the fauna of the archipelago may be expected from the study of this group. The land shells of the islands are very numerous, and are supposed to be fairly well known through the efforts of the Rev. J. T. Gulick and Mr. Pease; but it is the opinion of many zoologists that additional information as to the distribution of the mollusca in these islands would be very valuable. The birds have been within the last few years the main object of a visit made to the islands by Mr. Scott Wilson, who passed about eighteen months upon the islands without being able to complete a thorough investigation of their ornithology. Some departments of the zoology have not been investigated in any way, and there is strong evidence that the fauna is rapidly disappearing.

Under these circumstances the Committee have been desirous of sending a competent zoological collector to the islands; but the grant made by the Association being insufficient for that purpose the Committee decided to communicate with the Hawaiian Government to learn whether it would in any way assist in the research. A very favourable answer to the application of the Committee was made by the Foreign Minister of

his Majesty the late King of the Hawaiian Islands, stating his belief that additional funds would be forthcoming if a circular were drawn up explaining the objects of the Committee, and he offered to make such a circular known to those inhabitants who would be likely to co-operate, provided that a portion of the collections obtained should be ultimately placed in the Museum at Honolulu. As the rules of the British Association prohibit, however, this committee from issuing such a circular without the sanction of the General Committee, all operations have had to be stayed, and the grant of 100*l.* made to the Committee has not been drawn.

Meanwhile a committee has been appointed by the Royal Society, and 200*l.* from the Government grant placed at its disposal, for the same purpose as this committee, power being given to the former to act in concert with the latter, as was done with much advantage in the case of the West Indian Exploration Committee.

The Committee respectfully beg leave to recommend their reappointment, with power to act in concert with the committee appointed by the Royal Society, and to avail themselves of the help proffered by the Hawaiian Government on the terms above mentioned; and as the estimated cost of employing a proper zoological collector in the islands for about two years will amount to not less than 600*l.*, your committee solicit a grant of 200*l.*

Fifth Report of the Committee, consisting of Professor FOSTER, Professor BAYLEY BALFOUR, Mr. THISELTON-DYER, Dr. TRIMEN, Professor MARSHALL WARD, Mr. CARRUTHERS, Professor HARTOG, Mr. WALTER GARDINER, and Professor BOWER (Secretary), appointed for the purpose of taking steps for the establishment of a Botanical Laboratory at Peradeniya, Ceylon.

THE Committee desire first to acknowledge the continued co-operation of the Government of Ceylon, and of the Director of the Royal Gardens at Peradeniya, in giving facilities for study in the Royal Garden, and in assigning a room in the official Bungalow for use as a laboratory.

During the greater part of the year this room has been occupied by Mr. J. Bretland Farmer, of Magdalen College, Oxford, and at the date of writing the report he has not yet returned; it would therefore be premature as yet to ask him for a detailed account of his work. It may, however, be stated that his attention has been specially devoted to the study of the Bryophyta, and that a thorough investigation of these plants in a tropical country such as Ceylon may be expected to yield most valuable results.

The grant of 50*l.* voted at the last meeting has been for the most part expended on apparatus, which will remain permanently in the laboratory, the most important items being a photographic camera, a balance specially constructed for a tropical climate, and a dissecting microscope by Zeiss.

The Committee hope before the next meeting to receive a detailed report from Mr. Farmer, and also a list of apparatus now in the laboratory from Dr. Trimen. In the meanwhile, having full confidence in the value of the results obtained, the Committee request that they be reappointed, but do not at present ask for any further grant of money.

Fourth Report of the Committee, consisting of Mr. A. W. WILLS (Chairman), Mr. E. W. BADGER, Mr. G. CLARIDGE DRUCE, and Professor HILLHOUSE, for the purpose of collecting information as to the Disappearance of Native Plants from their Local Habitats. Drawn up by Professor HILLHOUSE, Secretary.

For the present report the Committee solicited details as to Wales, the border counties from Shropshire southwards, and the south-western counties of England. As no returns have been received from Welsh correspondents, and of the border counties only Shropshire is represented, the report must be considered as applying to the last-named county and the south-western counties of England. Some details as to South Wales will be found in the report for 1890. In drawing up the list the Committee have followed the same rules as in previous years, the numbering and nomenclature throughout being that of the 'London Catalogue,' ed. 8, corrected reprint for 1890.

Lists have been received from ten personal correspondents whose initials are appended, in addition to which the Bath branch of the Selborne Society appointed a Committee to provide returns as to the Bath district. The Committee feel compelled to refer to the admirable work of this young but strong and active Society in promoting the object which the Committee have in view, work which, of its kind, is beyond praise.

As will be seen, the diminution of our native ferns again plays an important part in the list, and the 'collector' and 'dealer' figure largely. It is a matter of common and everyday knowledge that ferns have (with the exception of the bracken) disappeared from the local *floras* of our large towns; but the ravages of the dealer are carried on so systematically, and with the aid of all the resources that money places at his disposal, that the most out-of-the-way places can be stripped quite as completely as those near at hand. All the Devonshire correspondents bear common witness to the results of his depredations in that ideal home of the fern.

One of our correspondents, reporting upon the area of the Bristol Coal-fields, writes:

Before coming to the few instances of partial or complete extinction upon which I am reporting, I should like to say that my experience as a field-botanist, familiar with most of the species native in the South and West of England, has led me to receive with caution and distrust reported disappearances of rare plants from their habitats in this part of the country. On investigation it has almost invariably turned out that such reported extinctions were not well founded, and had frequently been made by persons imperfectly acquainted either with the plants themselves or with the localities where they grow. Not long since a letter was published in the London 'Standard' which condemned the 'wantonness of botanists,' in that they had compassed the destruction of the *Euphorbia pilosa* near Bath, and the Cheddar Pink. My knowledge of both convinced me that the writer had entirely missed the station for the former plant, and that he could not have visited Cheddar when *D. casius* was in bloom. Some other supposed extinctions have proved to rest on the apparent disappearance of species (particularly annuals) in an unfavourable season, or succession of seasons. But these plants have been found to reappear when the depressing climatal influence has been withdrawn. As examples may be mentioned *Cicuta virosa* and *Rhynchospora fusca*, ancient

inhabitants of the peat-moors on the southern limit of this district. Both these plants continue to be observed at intervals of a few years; but so uncertain are they in appearance that I have never yet known anyone to go specially in search of them and be successful in his quest. But it would be an error to consider either to be in danger of extinction. A circumstance occurred only last week that strongly confirms my contention. About twelve years ago I found a large patch of *Crambe maritima* on the Dorsetshire coast. A year or two later the plant had entirely disappeared, and no trace of it could be found on several subsequent visits, the last two years ago. But on Wednesday last I was greatly pleased to see at least twenty five specimens growing upon the exact spot whence it had been absent for nine or ten years. Here, with some show of reason and yet in error, might have been reported a case of extinction of a rare species.

One of the best known of western botanists places his finger upon what the Committee cannot help feeling to be a source of danger to plants in the following extracts from his letter:—‘In early life—that is, before 1841—I botanised over the neighbourhood of —, and unfortunately, with the late — of —, drew up a list of the plants in that district, since which many ferns have disappeared from the localities that we gave, and I fear that —’s habit of giving them will lead to the extirpation of many other plants;’ and another correspondent (Devonshire), dealing with the same point, instances Leighton’s ‘Flora of Shropshire’ as one ‘by the aid of which a child might walk straight up to any plant in the county.’ It is a matter, no doubt, of very grave difficulty to determine to what extent it is desirable in a local flora to be precise in the description of localities, and the Committee do not feel that they are either competent or called upon to suggest laws upon the subject. They do not see, however, that exactitude in defining locations serves any really good purpose, and it certainly takes away somewhat from the zest of a search, and removes an incentive to patient perseverance. Two correspondents illustrate the opposite method to that complained of, inasmuch as one will not state a locality from which *Osmunda regalis* is disappearing, lest thereby he should spread the knowledge of its continued existence therein; and another writes:—‘A few days ago a very interesting discovery was made by a member of my family, viz. a large patch of *Maianthemum convallaria* (L. C., 1394) in a wild, out-of-the-world district; but such a dread I have of marauders that even in my communication with Kew I have not gone beyond naming the county in which the “find” occurred.’

More than one correspondent draws attention to the mischief very often done by field clubs, not merely in the reckless and often extensive removal of rare plants during their periodical forays, but that in the ‘Transactions,’ in the local press, and privately, the exact ‘finds’ and localities are indicated, so that further destruction becomes inevitable. So long as field clubs themselves are such hardened sinners in this respect, as many of them appear to be, it seems useless to invoke their assistance in their respective localities for the purpose of urging upon the public generally, and landowners particularly, the desirability of affording some protection to the rarer of their local plants in their struggle for existence, and of endeavouring rigidly to repress the loafers who gather the fern-roots and hawk them for sale.

The attention of the Committee is again drawn to the unsatisfactory condition of the law of trespass, and the consequent difficulty under which magistrates lie when called upon to act in the interests of wild plants.

While the Committee feel that the time is not yet ripe for even

taking into consideration the desirability of making any general appeal for Government protection, they are strongly of opinion that, in one case, at least, of special interest alike to South Wales and South-West England, such an appeal is urgently needed, and would probably be successful, in favour, namely, of *Paeonia corallina*, Retz (L. C., 47), threatened with extinction from its sole British habitat, the Steep Holmes. In this case the Committee think that there is a special reason for an appeal to Government, since they understand that the recent acquisition of the island as Government property, and the consequent removal of the regulations enforced by the previous proprietor, are the direct cause of the approaching extermination.

40, 41. *Helleborus viridis*, L., and *H. fatidus*, L. Nearly extinct in their stations near Bath, through the raids of dealers (S. S. B.).

43. *Aquilegia vulgaris*, L. Formerly plentiful in a field near Melksham, Wilts; disappeared through change of culture (B. S.).

47. *Paeonia corallina*, Retz. Steep Holmes; threatened with extinction from this, its only British habitat.

200. *Silene nutans*, L. Disappeared from its station at Hawkstone, Shropshire; probably being destroyed by rabbits (W. E. B.).

209. *Lychnis Githago*, Lam. Diminishing near Plymouth, from improved tillage (D. D. D.).

351. *Trifolium Bocconi*, Savi. 'The only British habitat of this plant is in Cornwall, at the Lizard, where it has become extremely scarce through the ravages of a local guide and dealer, who collects and sells the Lizard plants to all who apply for them. A wealthy lady member of the exchange clubs pays this man freely, and is responsible for much mischief' (J. W. W.).

495. *Potentilla Comarum*, Nestl. Banks of Tamar, near Plymouth; probably uprooted by steamboat trippers (D. D. D.).

612. *Eryngium campestre*, L. Nearly extinct in its station near Plymouth, where found by Ray in 1662, owing to the greater public use of its site (D. D. D.).

1003. *Lithospermum purpureo-cæruleum*, L. Nearly extinct on the sea-coast near Torquay (T. H. A.-H.).

1018. *Atropa Belladonna*, L. Near Box, Wilts; destroyed by a clergyman (R. C. A. P.). Near Plymouth; destroyed by excavations for a fort (D. D. D.).

1020. *Hyoscyamus niger*, L. Near Plymouth; disappearing from unknown causes; attempts to grow it for commerce have failed (D. D. D.). Wroxeter, Shropshire; 'when the excavations on the site of Uriconium began in 1858 or 1859, a very abundant crop of this plant appeared for several years, but it has dwindled away, and is rare there now.' It has also become rare about Much Wenlock, where it was formerly common (W. E. B.). [Compare the reports from Avoch, on the Moray Firth, recorded in Second Report of the Committee.]

1223. *Rumex maritimus*, L. Has disappeared from its Ellesmere station, Shropshire, probably being taken by a collector (W. P.).

1239. *Daphne Mezereum*, L. Nearly extinct in the Bath district; used for medicinal and other purposes (S. S. B.).

1240. *D. Laureola*, L. Is now dug up in the woods round Bath by dealers, and sold in Bath (S. S. B.).

1251. *Euphorbia pilosa*, L. Is still to be found in Bath station; collectors are its chief enemy (S. S. B.).

1339. *Cephalanthera paliensis*, Rich. Formerly plentiful near Bath, but now being rapidly eradicated by dealers (S. S. B.).

1358. *Ophrys apifera*, Huds. Plymouth; extinct since 1875, in its only local station, through railway extensions (D. D. D.).

1370. *Iris foetidissima*, L. Has disappeared from the vicinity of Plymouth through building operations (D. D. D.).

1380. *Narcissus Pseudo-narcissus*, L. Is greatly diminishing through the lanes and orchards of S. Devon, mainly through 'indiscriminate purchase by nurserymen and others from persons who advertise and sell them by the thousand' (T. H. A.-H.).

1383. *N. biflorus*, Curtis. Gradually diminishing in the orchards of S. Devon, from the same causes as 1380 (T. H. A.-H.).

1385. *Galanthus nivalis*, L. As 1380 (T. H. A.-H.).

1386. *Leucojum aestivum*, L. Until recently found on the banks of the Dart, S. Devon, but now apparently quite extinct (T. H. A.-H.).

1474. *Damasonium stellatum*, Pers. Has disappeared from its Ellesmere station, Shropshire, the site being covered by a garden (W. P. and W. E. B.).

1521. *Cyperus longus*, L. 'Weston-in-Gordano, North Somerset; the spot was anciently a fish-pond, but by gradual drainage it became a marsh, and within the last few years has been ditched, ploughed, and planted; the sedge still comes up amongst the crop, but does not flower, and probably will soon cease to exist' (J. W. W.).

1659. *Polygonum littoralis*, Sm. St. Philip's Marsh, Bristol; destroyed by brickmakers excavating the ground, and afterwards filling in the place with rubbish (J. W. W.).

1761. *Hymenophyllum Tunbridgense*, Smith. Disappearing from neighbourhood of Plymouth, through removal by people (D. D. D.).

1762. *H. unilaterale*, Borg. As in 1761 (D. D. D.).

1764. *Adiantum Capillus-Veneris*, L. Nearly extinct round Ilfracombe, through collectors (W. P. H.). Formerly plentiful on the S. Devon coast, but 'it has been wantonly plundered and is now nearly extinct' (T. H. A.-H.).

1766. *Cryptogramme crispa*, R. Br. Apparently extinct near Linton, N. Devon; exterminated by collectors (W. P. H.).

1769. *Asplenium lanceolatum*, Huds. A few years ago quite plentiful on the coast of S. Devon, but now nearly extinct through collectors and dealers (T. H. A.-H.). Has disappeared from Leycombe, Ashburton, through collectors (F. A.).

1770. *Asplenium Adiantum-nigrum*, L. Formerly not uncommon about Haighton Hill, Salop; now rare, no doubt through fern-gatherers (W. P.).

1771. *Asplenium marinum*, L. Trewornan, Wadebridge; much sought after, and large plants are now uncommon (D. S.). Becoming yearly more scarce on the coast of S. Devon, 'through the greed of collectors, and the thoughtlessness of those who ought to know better' (T. H. A.-H.).

1777. *Asplenium septentrionale*, Hull. Porlock; carried off by a Bristol dealer (R. C. A. P.). Apparently extinct round Lynton, N. Devon; exterminated by collectors (W. P. H.).

1778. *Athyrium Filix-femina*, Roth. East side of Longmynd, Shropshire; much reduced by visitors (W. P.).

1782. *Scolopendrium vulgare*, Symons. Formerly abundant in some stations near Bath, but being rapidly reduced by dealers (S. S. B.).

1789. *Polystichum lobatum*, Presl. Roadside between Yorton railway station and Clive, Salop; has disappeared (W. P.).

1790. *Polystichum angulare*, Presl. Disappearing from neighbourhood of Plymouth through action of fern-collectors and dealers, and of persons who transplant the roots into gardens (D. D. D.).

1792. *Lastræa Oreopteris*, Presl. Disappearing from east-end of Longmynd, near Church Stretton, Salop, through visitors (W. P.).

1793. *Lastræa Filix-mas*, Presl. Far less plentiful round Bath, mainly through dealers (S. S. B.).

1802. *Phegopteris Dryopteris*, Fée. Light-spout Valley, near Church Stretton, Salop; all but exterminated by visitors (W. P.).

1803. *Phegopteris Robertiana*, A. Br. (= *Polypodium calcareum*). Near Melksham, Wilts; disappeared through building operations (B. S.).

1804. *Phegopteris polypodioides*, Fée (= *Polypodium phegopteris*, L.). Has disappeared from banks of river Dart, S. Devon, through collectors (F. A.).

1806. *Osmunda regalis*, L. Disappearing from neighbourhood of Plymouth, from action of fern-collectors and dealers, and of persons who transplant the roots into gardens (D. D. D.). Now scarce in N. Devon, through collectors (W. P. H.). A few years ago most abundant both in N. and S. Devon, but now rapidly disappearing everywhere through collectors (T. H. A.-H.). In Shropshire much reduced by collectors (W. P.).

1825. *Lycopodium clavatum*, L. Formerly plentiful on the Longmynd Hills, Salop, but now scarce; 'I have seen it at the hotel at Church Stretton used to decorate the table' (W. P.). [The same decoration is very common at shooting-breakfasts in the Highlands.]

Report of a Committee, consisting of Professor NEWTON, Mr. JOHN CORDEAUX (Secretary), Messrs. JOHN A. HARVIE-BROWN, R. M. BARRINGTON, W. EAGLE CLARKE, and the Rev. E. P. KNUBLEY, appointed at Leeds to make a digest of the observations on the Migration of Birds at Lighthouses and Light-vessels, which have been carried on by the Migration Committee of the British Association, and to report on the same at Cardiff.

THE Committee have to report that, regarding the Migration Digest, very considerable progress has been made during the past year with the systematic tabulation of the facts collected during nine years by the Committee. These have been arranged under the head of species for a given month, and on a plan that shows at a glance the date and distribution, numbers, time of occurrence of each movement, on all coasts and subdivisions of coasts. Initiatory steps have been taken in the preparation and printing of a schedule on which these results will be finally tabulated and submitted to the Association as the chief portion of the Final Report; also a map showing the distribution on the British coasts for each species on migration. These schedules and maps will form the most bulky portion of the final digest, and when completed will show (for several species on each sheet) the results already mentioned, and permit of a ready comparison of all the movements in every aspect and over a given time.

Your Committee would respectfully solicit their reappointment as before; and, while engaging to bring the enquiry to a conclusion with the least possible delay, they find it impossible to pledge themselves to any fixed date for completing the work.

Report of the Committee, consisting of Professor FLOWER (Chairman), Professor M. FOSTER, Professor RAY LANKESTER, Professor VINES, and Mr. S. F. HARMER (Secretary), appointed for the purpose of arranging for the occupation of a Table at the Laboratory of the Marine Biological Association at Plymouth.

THE Committee have followed the precedent of the previous year in not employing the grant of 30*l.* entrusted to them in taking a table for a complete year; but they have made use of portions of the grant, from time to time, as the occasion arose.

They have nominated the following persons to the use of a table at Plymouth:—

Miss Florence Buchanan, for one month (July, 1891).

Mr. S. J. Hickson, M.A., D.Sc., Fellow of Downing College, Cambridge, for one month (from August 26, 1891).

Mr. A. Willey, for six weeks (from August 3, 1891).

No payment is made for one of these months, while the remaining period is paid for at the rate of 5*l.* per month. The Committee have therefore to report that they have only spent 12*l.* 10*s.*, leaving an unused balance of 17*l.* 10*s.*

The Committee are obviously unable to give any detailed information with regard to the results of their employment of the grant. Miss Buchanan is already working at Plymouth, and is engaged in the systematic study of the species of Polychæta occurring at Plymouth, with a view to preparing a list of the Polychæt fauna of that neighbourhood; she is also making observations on the regeneration of lost parts in *Nereis* and in *Nephtys*, and on the variation of *Nereis diversicolor*. Mr. Hickson proposes to investigate the development of *Alcyonium*; and, if time permits, to study certain points in its physiology and minute anatomy. Mr. Willey expresses his intention of investigating the group of the Tunicata.

The Committee believe that the nominations which they have made are a sufficient evidence of the utility of the grant in assisting well-qualified persons who are anxious to work at the Plymouth Laboratory; and they ask the Association to re-appoint them, and to place at their disposal 17*l.* 10*s.*, being the unused balance of the grant made to them at the Leeds Meeting.

Experience has shown that applications for nomination are likely to be made for the summer months only, as in the two preceding years. The Committee wish to point out that, if this is the case, they do not expect to be able to furnish at the ensuing meeting of the Association a detailed Report on the investigations undertaken with the assistance of the new grant; but they hope to be in a position, if re-appointed, to give a more complete account, in their next Report, of the results of the investigations which are in progress, or which are about to be made with the assistance of the grant which has just expired.

Report of the Committee, consisting of Dr. P. L. SCLATER, Professor RAY LANKESTER, Professor COSSAR EWART, Professor M. FOSTER, Mr. A. SEDGWICK, Professor A. M. MARSHALL, and Mr. PERCY SLADEN (Secretary), nominated for the purpose of arranging for the Occupation of a Table at the Zoological Station at Naples.

[Ordered to be printed among the Reports.]

THE Committee regret to report that at the last meeting of the Association held in Leeds the Committee of Recommendations did not sanction the grant approved by the Committee of Section D for the use of a table at the Naples Zoological Station. A communication, signed by the President of the Section, was addressed to the President of the Association, by whom it was read at the last meeting of the General Committee, expressing the disappointment felt by the Committee of Section D at the decision of the Committee of Recommendations, and pointing out that in their opinion the cessation of the grant would act as a serious discouragement to biological investigation, and would place British naturalists at a great disadvantage.

Fortunately the Committee have not been deprived of the privilege of nominating workers to occupy a table during the past year at the Naples Zoological Station, Captain Noble, the President of Section G, having generously given 100*l.* for the purpose of maintaining a table as in previous years, an offer which the General Committee authorised the Committee to take advantage of. The Committee desire to express their high appreciation of Captain Noble's singular liberality, and to place on record their indebtedness to him for rescuing British biologists from the unenviable position in which, but for his generosity, they would have been placed.

The Committee beg to direct the attention of the Association to the fact that three applications from competent workers for permission to use the table had been received by the Committee when they applied for the renewal of the grant at Leeds; and that for the last four years applications have always been in the possession of the Committee to justify their recommending the continuance of the grant, and they would, therefore, respectfully submit to the Association that the grant has in no case been applied for without a definite purpose, and to assist a specific object of research.

The Committee trust that the Association will sanction the payment of the grant of 100*l.*, as in previous years, for the hire of a table in the Zoological Station at Naples; and they strongly recommend the continuance of this grant as a means of affording to British naturalists advantages for prosecuting research which are unobtainable elsewhere.

The Committee have received an application for permission to use the table from Mr. Arthur Willey, who proposes to make a special series of investigations on the Ascidians, which will occupy him from the end of September, through the winter and spring of next year, and the Committee express the hope that the Association will enable them to sanction this application.

Two gentlemen have occupied the table during the past year, Mr. William R. Melly and Mr. Edward J. Bles, and their reports upon the nature of the work undertaken are appended. The Committee would

direct attention to the remarks made by Mr. Bles upon the special advantages to be derived from working at the Naples Zoological Station.

The Publications of the Station.—The progress of the various works undertaken by the Station is here summarised:—

1. Of the 'Fauna und Flora des Golfes von Neapel' no monograph has been published since the last report. The preparation of the monographs comprised in this series requires, on account of the complete and exhaustive manner in which the subjects are treated, a considerable length of time, which can only rarely be estimated beforehand. It becomes on this account very difficult to publish regularly a yearly set of monographs. The comparatively small number issued lately will, however, soon be balanced by the publication of an increased number of works, as the following monographs are now in hand, and the three or four first named will soon leave the press:—

Prof. Della Valle of Modena, on 'Gammarini.' Prof. Spengel of Giessen, on 'Balanoglossus.' Dr. Giesbrecht of Naples, on 'Pelagic Copepoda.' Dr. Jatta of Naples, on 'Cephalopoda.' Dr. Vosmaer of Utrecht, on 'Spongia.' Prof. Falkenberg of Rostock, on 'Rhodomeleæ.' Prof. Apáthy of Klausenburg, on 'Hirudinei.' Dr. Bürger of Giessen, on 'Nemertini.' Prof. Chun of Breslau, on 'Siphonophora.' Dr. v. Davidoff of Munich, on 'Appendicularia.' Dr. Müller of Greifswald, on 'Ostracoda.' Dr. Schiemenz of Naples, on 'Pteropoda.' Prof. v. Koch of Darmstadt, on 'Alcyonaria.'

2. Of the 'Mittheilungen aus der Zoologischen Station zu Neapel,' vol. ix., part iv. with 10 plates, has been published.

3. Of the 'Zoologischer Jahresbericht' the whole 'Bericht' for 1889 has been published.

4. Of the 'Guide to the Aquarium,' a new German and a new French edition (illustrated) have been published. A new English edition (illustrated) is being prepared.

Extracts from the General Report of the Zoological Station.—The officers of the Station have courteously furnished lists (1) of the naturalists who have occupied tables since the last report, (2) of the works published during 1890 by naturalists who have worked at the Zoological Station, (3) of the specimens sent out by the Station during the past year. These details, which will be found at the end of this Report, are the most convincing evidence of the growth and efficiency of the institution.

I. Report on the Occupation of the Table. By Mr. WILLIAM R. MELLY.

I arrived at Naples on October 28, and was most kindly received by Professor Dohrn.

I worked at the Station every day until December 7, when I was unfortunately taken ill with rheumatic fever, and remained so unwell for the rest of my stay in Naples that I was able to do very little work.

I left Naples on Saturday, January 3, as my doctor advised me to return to England.

Specimens of various sponges, chiefly *Esperia Lorenzii* containing *Spongicola*, were obtained for me almost every day during the first part of my stay. But as this animal lives in fairly deep water, it was unobtainable except in calm weather, and unfortunately during the last three weeks of my stay the weather was so bad that none were procured.

I kept my specimens in aquaria, through which a constant stream of

water flowed. At first they seemed to thrive exceedingly well, but later on they became very sluggish and hardly ever extended themselves. Whether this was owing to the time of year, or to the weather, which was exceptionally cold for Naples, or whether it was due to my having overcrowded my tanks, I am unable to say.

Spongiicola fistularis, F. E. Schulze, inhabits several of the silicious sponges, but most of my work has been on specimens inhabiting either *Esperia bauriana*, O.S., or *Esperia Lorenzii*, O.S. In these two species, so far as I can judge from the few specimens of each that I have as yet been able to make sections of, although the internal anatomy is the same, the form of growth is different.

In *E. bauriana* the chitinous tubes are straight, and do not generally project more than 1 mm. above the surface of the sponge, and are very long, tapering as they go deeper into the sponge, till they join each other, forming a network. In *E. Lorenzii*, on the other hand, the tubes are much shorter, that is, they form a network inside the sponge considerably sooner, and they project often 2 or 3 mm. or even more above the surface, and are generally curved. This may be due to their being different species inhabiting different sponges, or it may be due simply to the different form of sponges they inhabit. For whereas *E. bauriana* is solid all the way through, *E. Lorenzii* is hollow, and therefore of course the tubes would be obliged to become curved and to join each other nearer the surface. I myself incline to the latter view, and I am also far from sure that when the Monactinellid group of sponges are thoroughly worked through it will not be found that *E. bauriana* and *E. Lorenzii* are the same species living under different conditions.

I have not studied these forms very closely, but from sections I have of them (cut always for the purpose of obtaining sections of the enclosed *Spongiicola*) the anatomy of the two seems to me almost identical, as are also their spicules.

Coming next to my methods of examining and killing my specimens, the chief difficulty arose from the extreme shyness of these animals, as they will only extend themselves under the most favourable circumstances, and the slightest movement is sufficient to cause the whole colony to disappear again within their tubes. To examine them alive under anything like a high power is almost an impossibility. The slightest jar of the glass containing them, or of the table, almost invariably causes the instant disappearance of every tentacular crown in the colony.

I have often known them retract with nothing more than the jar caused by the lens entering the water in which they were lying.

When first taken from the aquaria in the morning, my specimens, which I placed in glass boxes about two inches in diameter and one in depth, full of water, would generally extend in from half an hour to an hour, but if they again retracted they usually took much longer, and frequently refused to extend themselves at all until they were again placed in running water.

The opacity of the sponge is another source of difficulty.

Owing also to the fact of the *Spongiicola* tentacles being white against the opaque and also light-coloured background of the sponge, it is almost impossible to make out even the number of the tentacles.

With regard to killing them extended, I had practically no success whatever. I have tried all the methods I could hear of, but with very poor results indeed.

The best results I got by pouring in very slowly, a drop at a time, about one every minute or so,

96 per cent. methyl alcohol (CH ₃ OH).	10 vols.
Salt water	90 vols.
Natrium chloride	0·6 vol.

After three-quarters of an hour or so, if they had not retracted, I poured on quickly a large quantity of hot sublimate; by this method I succeeded in getting some specimens half retracted.

For preserving specimens for sections I found the best results were obtained from specimens treated for two minutes in 1 per cent. osmic acid, then passed for two minutes through alcohol of 5, 10, 20, 30, 40 per cent. up to 90 per cent., hardened in absolute alcohol, and imbedded in paraffin. I found it best to leave the *Spongicola* in the sponge and dissect it out after having hardened the whole in absolute alcohol.

For staining I used mostly borax-carmin and hæmatoxalin, staining the *Spongicola* whole after having dissected it from the sponge. I did not obtain any good results from dissecting the *Spongicola* living, as it seems capable of withdrawing itself to almost any extent inside its tube, which in the interior of the sponge is very soft and easily torn.

HISTORY.—*Spongicola fistularis* was first discovered and named by Professor Allman in 1874 (*Stephanoscyphus mirabilis*, 'Nature,' July 30, 1874, 'Ann. and Mag. Nat. Hist.,' 4th series, vol. xiv., 1874, p. 237). He describes it as inhabiting horny sponges in shallow water on the south coast of France.

From the fact that he could discover no hypostome or proboscis he came to the conclusion it was not a true hydroid. He further made out what he believed to be four longitudinal canals extending from the base of the tentacle-crown some distance back and projecting into the interior of the body-cavity. These, he says, are connected with a 'circular canal' situated in the body-wall, 'which is wide, and easily admits a needle.' This, he says, is continuous and without septa, having a distinct endodermal lining.

He failed to find an endodermal lining to the longitudinal canals, though he thinks one probably exists.

He further states that the tentacles are placed in 'two closely approximated and alternating series of 18 each, forming a single circlet,' and that their structure is the same as that of a typical hydroid, that when retracted the terminal orifice is closed over them, and that the anterior part is thin-walled and very contractile, like a hydranth in its hydrotheca.

He divides the animal into a proximal and distal portion, and says that the mouth is probably situated where the two join, and that the proximal cavity is the true digestive cavity, while the distal cavity is homologous with the umbrella, and the tentacles with the marginal tentacles of a medusa.

He also states there is no endodermal lining to the distal cavity, while the axial cavity has a well-marked one.

Therefore, though the form and habit are those of a Hydroid Trophosome, its organisation is that of a medusa. So he says it is as far removed from Hydroida as from Siphonophora, and he proposes therefore

a new order—'Thecomedusæ'—'animals composed of composite zooids, medusiform with circular and radiating canals, included in a chitinous rooted perisarc, which forms the tube within which they are retractile.'
Genus *Stephanoscyphus*.

In 1877 Professor F. E. Schulze published an extensive paper on this animal ('Archiv für mikroskopische Anatomie,' vol. 13, 1877).

He failed to find either the circular or longitudinal canals described by Professor Allman.

He gives the structure as being ectoderm; then a layer of longitudinal muscular fibres, then a layer of supporting lamella, and then endoderm throughout. He describes four 'Längswälle,' which he says are made by the endoderm folding round longitudinal ridges of supporting lamella. There is also, he says, a hypostome which is simply a continuation of the body-wall bent at right angles, and the four 'Längswälle' continue along the under side of this membrane and end at its free edge.

He gives the number of tentacles as being variable, probably a multiple of four.

He further describes four nose-like projections from the chitinous tube into the interior, compressing the animal in the form of a Maltese cross.

The results he comes to are on the whole so very different from those of Professor Allman that he leaves it an open question as to whether the two animals are the same or not.

In 1886 Professor Metschnikoff in his 'Embryologischen Studien an Medusen,' Vienna, 1886, p. 87, suggests that this animal might be a stage in the life history of *Nausithoe*, partly on account of the fact that when the young *Nausithoe* reach the Scyphistoma stage they produce chitinous tubes, into which they retract with extreme quickness, and partly relying on a paper of Kowalewski's ('Untersuchungen über die Entwicklung der Coelenteraten' in Nachr. Ges. Fr. &c. Moskau, vol. 10, 2, Sep., p. 36) in which that author says that he has seen Strobilation and also Ephyrae given off by *Stephanoscyphus*.

Professor Fol ('Die erste Entwick. d. Geryoniden Eier.' Jen. Zeit., vii., p. 488) remarks that the larvæ of *Nausithoe* swim about for some weeks in his aquaria without changing, except that thread-cells appear in their ectoderm, after which they always die. This fact Metschnikoff also remarks, but without mentioning that such would probably be the case, as no doubt the young *Nausithoe* cannot develop without entering a sponge.

So far as I then knew, this was all the work that had been done on *Spongicola* when, in the spring of 1890, in Professor Schulze's laboratory in Berlin, I took up its further investigation.

The points that seemed to me to want clearing up were:—

1. Were *Stephanoscyphus mirabilis* and *Spongicola fistularis* one and the same animal, or different species of the same genus, or were they altogether different?
2. What was the exact position of this animal in the Zoological series?
3. What was the exact significance of, 1st, the 'Längswälle' of Schulze; 2nd, the chitinous projections into the interior of the animal?

I began my work on material which Professor Schulze very kindly procured for me from Trieste, which consisted entirely of specimens of *E. bauriana* well stocked with *Spongicola*. Unfortunately, although I 1891.

was enabled to make out some points with regard to the structure and anatomy of the animal, the material was in too bad a condition to give very good results.

Professor Schulze made several attempts to procure me living material from Trieste, but the specimens on every occasion arrived in a half-macerated condition. Finally, at the end of the summer, Professor Schulze advised my going to Naples. This, owing to the great kindness of the British Association in placing their table at my disposal, I was enabled to do.

When I arrived at Naples and stated the object of my visit, Professor Dohrn informed me that Professor Paul Mayer and Signor Lo Bianco had during the summer made a discovery regarding *Spongiicola*.

I was immediately introduced to Professor Mayer, who, with the greatest kindness, gave me full particulars of everything he had done, and to whom my most hearty thanks are due for much kind assistance and many valuable hints.

I also here wish to express my indebtedness to Dr. Eisig, Signor Salvatore Lo Bianco, and all the other assistants at the Station, for their extreme kindness to me during my stay in Naples.

While I was there in November, Dr. Mayer and Signor Lo Bianco published (in the 'Zoologischer Anzeiger,' No. 351, 1890) a short paper, '*Spongiicola* und *Nausithoe*,' completely answering my No. 2 query.

On June 20 they saw the Ephyrae being given off from the *Spongiicola*, which were nearly all in Strobila stages.

These larvæ were kept and fed until, at the end of four days, they reached, without doubt, the stage which Professor Claus has described and figured as a young *Nausithoe* ('Untersuchungen über die Organisation und Entwicklung der Medusen,' Prag und Leipzig, 1883, Pl. 7, Fig. 48), thus proving that *Spongiicola* is the Scyphistoma stage of *Nausithoe*.

From this, as Dr. Mayer pointed out to me, another question arose, namely, as to whether Professor Haeckel is right in his work on 'Medusæ' (1879, p. 486), in saying that all the three species of *Nausithoe* hitherto described, viz., *N. punctata*, Köll., *N. marginata*, Köll., and *N. albida*, Gegenbaur, are the same species.

It seemed to me that this might be settled with regard to whether there were more than one species of the Scyphistoma form. I therefore turned my attention to this subject, and found that, 1st, there was the difference in form already stated; 2nd, the tubes that grow in the solid sponges, and are straight, are much lighter in colour than the more curved ones in the hollow *Esperia*; 3rd, that the *Spongiicola* with the straight tubes have generally the yellow crystals in their tentacles (I saw none in the body-walls), described by Kölliker, in the walls of the bell of *N. punctata*. These I have never seen in the curved-tubed animals, but the difficulty of seeing them at all may account for this, as it is only when the animal is in a certain light that they are visible.

Dr. Mayer and Signor Lo Bianco found them always present in the Ephyrae.

On the whole I am inclined to think that the differences I observed are not sufficient to enable me to say with any certainty that there is more than one species. I was, unfortunately, unable to study this question from its other side, as only one specimen of *Nausithoe* was captured during my stay in Naples.

With regard to question No. 1, it seems to me probable that the animals described as '*Stephanoscyphus mirabilis*' by Allman, and '*Spongicola fistularis*' by Schulze, are one and the same.

I am enabled to endorse Professor Schulze in every statement he has made, and have very little indeed to add to his work.

The only points on which I can as yet extend his excellent paper are with regard to the way in which this animal retracts, and to the structure of the '*Längswälle*' or longitudinal ridges.

First, as to retraction. The entire body-wall for the first half mm., more or less, folds over inwards, like the finger of a glove when it is pulled inside out, bringing the tentacles into the interior of the animal; the membranous hypostome, which is so difficult to see that it might easily have been missed, even by such an excellent observer as Professor Allman, is pressed close against the sides of the body some way down, leaving apparently a canal lined with endoderm, which appears to be in the body-wall.

This I take to be what Professor Allman mistook for a circular canal. The tentacles are much retracted, and either lie pointing outwards, or can be again extended deep down into the interior of the animal, when no doubt particles of food entangled in the thread-cells, with which the tentacles are plentifully covered, are digested by the endoderm cells.

When a careful series of transverse sections are cut, first (as might be expected) there is a solid ring of ectoderm, then there appears endoderm in the middle between two circular layers of ectoderm, next a circular space is seen dividing the endoderm into two layers, which closely approximate to the two layers of ectoderm, forming an apparent circular canal lined with endoderm. The interior space lined with ectoderm is filled by transverse sections of tentacles. Still deeper sections are reached showing the tentacles given off from the internal layer of ectoderm with the approximated layer of endoderm running out into and forming the solid centre of each tentacle; below that, unless the tentacles have been projected downwards into the body of the animal, transverse sections of them cease, and the two layers of the endoderm again come to be closely approximated; a few sections further on the internal layer of ectoderm ceases, and only an external layer of ectoderm and a layer of endoderm, separated by a layer of supporting lamella, remain.

Between the ectoderm and endoderm there is always a layer of clear colourless supporting lamella, but in the upper parts it is very thin and in many cases hardly to be distinguished. But after the limit of invagination is reached, the layer of supporting lamella becomes much more distinctly seen; and here also two layers of longitudinal muscular fibres make their appearance, one on each side of it. These layers of muscular fibres, proceeding lower with the series of sections, join each other at four places, forming, as it were, four oblong pieces of supporting lamella surrounded by muscle fibres. These oblong pieces gradually become more circular and draw away from each other, and their centres are filled with peculiar long-shaped cells, which are apparently thread-cells in various stages of development. Round these the endoderm lining the whole of the internal cavity makes four folds which project inwards into the interior of the cavity, the space between the muscle fibres and themselves being filled with the clear colourless supporting lamella.

These in transverse and longitudinal sections look very like longi-

tudinal canals, and are probably what Professor Allman describes as such.

The exact significance of these endodermal folds and the manner of their attachment to the membrane forming the hypostome are points which I had hoped before now to have cleared up from the material which I preserved while in Naples, but, unfortunately, I have not yet been able to find time since quitting Naples to continue my work on *Spongicola*.

With regard to the longitudinal ridges formed of developing thread-cells and surrounded by a layer of longitudinal muscular fibres, I think, from my investigations, there can be little doubt that they are used, not to cause the crown of tentacles to invaginate in the manner described, as they are not continued high enough up for that purpose (which I believe to be effected in some way by the endodermal folds), but to retract the whole animal after it has invaginated itself into its tube.

The four chitinous nose-like projections, which are well described both by Schulze and Allman, project inwards in such a manner as to cause the four longitudinal ridges of developing thread-cells to become horse-shoe-shaped round them, and are, I think, without doubt present to enable the animal to use its muscles with greater effect.

Sometimes four smaller ones are present, placed between the four larger ones.

The longitudinal ridges probably enable the whole animal to rapidly expand again after contraction, owing to the extreme elasticity of their contents.

These are the chief results that I was enabled to obtain while at Naples, but I hope that in the future I may be able to continue my work on the material I collected while there, as there are still several points I should like to clear up.

In conclusion it is, I think, unnecessary on my part, after the articles that have lately appeared, to say more in regard to the Naples Station, but no praise could be too high for the excellent way in which everything is managed, and the great facilities given to students for original research of every description.

At the present moment I believe I am correct in saying that without having been allowed the use of the British Association table I could not possibly have obtained either the results I have obtained or those which I hope still to achieve by further study on the material I was enabled to preserve while there.

In conclusion I wish to express my deep obligation to the British Association for the use of their table, and to Professor Dohrn and his staff for all their kind assistance to me while at Naples.

II. *Report on the Occupation of the Table.* By Mr. EDWARD J. BLES.

Having been allowed, through the kindness of the Committee, to spend three months at the Naples Zoological Station, I left England towards the end of December 1890, and reached Naples on December 22. I found a well-appointed table in readiness, and on the following day living material began to arrive in more than abundance. My visit was unfortunately broken during the eighth week by an attack of influenza, immediately followed by complications which left me extremely weak.

The illness and period of convalescence lasted four weeks, and seriously interrupted the course of my work, as I only remained at the Station for little more than a fortnight after recovery. I left Naples on March 27.

It had been my intention to work at the development of the Polychæta, but the only suitable form available at that season of the year (a *Nereis*) was already appropriated by one of the workers at the Station. Eggs of *Spio fuliginosus* and of *Polymnia nebulosa* were easily obtained in quantity; in both cases, however, minuteness and opacity detract from their value for embryological research.

I was able to confirm Salensky's account of the segmentation stages in the egg of *S. fuliginosus*. I made unsuccessful attempts to fertilise artificially the eggs of *Arenicola marina*, *A. Grubei*, and *Lanice conchilega*; the sexual products appeared to be unripe. The first fortnight was occupied by these preliminary studies, and in examining the rich and varied proceeds of the daily dredgings and tow-nettings. A fresh supply of the wonderful pelagic life in the Bay was brought in every day with very few exceptions, and I had many opportunities of examining numerous forms of annelidan larvæ in the living condition, and of preserving a large quantity of material. Still there seemed to be little probability of obtaining a sufficient number of specimens in different stages of the development of any one form, and I therefore took up, at the kind suggestion of Professor Eisig, the study of the adult anatomy of the Chlorhæmidæ, a family of polychæt worms.

I received numerous specimens of *Siphonostoma diplochætos*, Otto, and of *Trophonia plumosa*, Clap.; further, specimens of *Stylarioides monilifer*, D. Ch., and of *Stylarioides Edwardsii* (= *Lophiocephala Edwardsii*, Costa). Sig. Lo Bianco kindly handed over to me a few specimens of a *Stylarioides* new to science, which were found associated with *Balanoglossus* on one occasion some years ago, and has not again been seen. I also received alive a single specimen of each of two hitherto unknown species of *Trophonia*.

I have given most attention to *S. diplochætos*, as this species is convenient for dissection, &c., and common. The worm is 6-7 cm. long, has 40-50 segments, and is about 1 cm. across the widest part of the body, a third of the total length from the anterior end. From this point backwards the animal tapers gradually to the hinder end; the anus is terminal. More than half of the width of the animal is taken up by the thick investment of a substance partly colloid and partly mucous. Through this and the transparent epidermis the brightly coloured viscera are sometimes very clearly visible. The soft sheath covers the whole of the body behind the first pairs of setæ. It is secreted by mucus-cells borne in the heads of clavate, filiform, epidermal papillæ. The swollen heads of the papillæ just reach the surface of the sheath, and a secretion from them replaces a thin mucous outer layer which is periodically cast. To this layer adheres a continuous coating of the ooze in which the animal lives. The fresh external deposits of mucus are soluble in a 5 to 10 per cent. solution of sodium carbonate, and are insoluble in acids. The older internal layers are not affected by the alkaline solution, and have probably undergone some chemical change. They are distinctly colloid. The papillæ are longer and more numerous on the dorsal than on the ventral surface, and there is a crowded group of long ones interspersed with each bundle of setæ. These appear to be sensory, and bear short sensory hairs at their tips. Below the mucous sheath lies a thin

cuticle, in contact with both the sheath and the epidermis. The epidermis is a single layer of squamous cells, and is devoid of mucus-cells, with the exception of those in the heads of the papillæ and those scattered in the ciliated region round the mouth, anterior to the first pairs of setæ. In this region the papillæ are absent. The setæ of the dorsal and ventral bundles of the first segment are more numerous and longer than those of posterior segments; they are directed forwards, and form a fan-shaped *chevaux-de-frise* on each side of the head. Their parapodia form a large continuous fold of the integument, within which the head can be retracted, the setæ then closing in and forming a sort of cage. The posterior parapodia are not well developed; the dorsal and ventral bundles of setæ are set on widely separated conical protuberances connected by a slight ridge. The ventral bundles are used for progression, the animal walking on the tips of the setæ, which are inclined forwards and then pulled back in succession from before backwards.

The alimentary canal, compared with that of other Polychæta (except *Pectinaria*), is abnormal in being bent on itself several times. The narrow œsophagus opens near the hinder end and on the dorsal surface of a large sac-like, thin-walled stomach, which is continued into an ω -shaped 'duodenal' part of the intestine. The stomach, the 'duodenum,' the hinder ends of the pair of nephridia, and the posterior ovaries in the female are enclosed in the septum between segments 9 and 10. This septum forms a complete partition between the 'thoracic' and abdominal portions of the cœlom. It is distended by the viscera named into a large sac, extending as far back as the 16th to 20th segment. It confines the genital products, when they become free, to the anterior part of the body-cavity. It is the only complete septum in the body; indeed, there is in *Siphonostoma* no septum anterior to it, but in *Trophonia* there is also one between the fifth and sixth segments. (I am throughout regarding the first setigerous segment as the first behind the head.) The musculature of the body-wall is slight; there are well-developed retractors of the head.

The vascular system has attracted attention on account of the dark green colour of the blood in all the species of this family. Lankester has shown that the colouring matter, which he calls *chlorocruorin*, is a body which, like hæmoglobin, is easily oxidised and, by suitable reagents, reduced; it also gives a characteristic banded absorption spectrum. Large quantities of blood are contained in the capacious lacunæ surrounding the stomach and intestine. The lacunæ have no proper cellular walls, but lie between the basement membrane of the gastric epithelium and a membrane below the peritoneal epithelium. Connected with the enormous lacunæ at the hinder end of the stomach and running forward dorsal to the œsophagus is a large contractile heart. It propels the blood forward to the branchiæ, dividing in a right and left afferent branchial vessel at the hinder border of the supra-œsophageal ganglion. Each branch runs downwards to the inner side of the branchiæ and sends an afferent vessel into each gill-filament. This afferent vessel is directly continuous with an efferent vessel at the tip of the filament, thus forming a single vascular loop in each. The efferent vessels all open into a single large efferent trunk running parallel to and outside the afferent trunk. The efferent trunks unite in the mid-ventral line some distance behind the mouth, to form the sub-intestinal vessel. The heart is to be regarded as a gastric blood-lacuna, which has become independent

of the alimentary canal, but whether this applies to the anterior branchial portion, as it does to the posterior portion, is doubtful.

The heart contains a cardiac body, similar to that present in the Cirratulidæ, Terebellidæ, Amphictenidæ, Ampharetidæ, and Hermellidæ, all families with coloured blood. I can confirm the observations of J. T. Cunningham on its anatomical relations and those of Jourdan on its histological features; but the latter has fallen into an old error by inferring from its colour, &c., that it is a gastral cæcum. In *Siphonostoma* there is no connection and not even contact with the gut. Its cells are, in hardened specimens, crowded with green granules, which also occur in the clotted blood, and the organ is probably concerned in the formation of the blood-pigment. The chloragogenic cells of other polychæt worms are peritoneal, and in *Siphonostoma* the manner in which different portions of the cardiac body are attached to the wall of the heart gives reason to believe that its cells are peritoneal in origin. At the hinder end of the heart there are indications of the cardiac body being paired.

The 'glandes en tubes,' 'glandes salivaires,' of earlier writers have been conjectured to be nephridia by Wirén, Cunningham, and Jourdan, but these investigators failed to discover the nephridial funnel. This is situated at the level of the hinder border of the supra-oesophageal ganglion. It resembles those nephrostomes in *Aphrodite* which serve as vasa deferentia, in its being very wide and extending from dorsal to ventral surface. The opening is directed forwards, inwards, and downwards, and is close to the anterior end of the cœlom. It is lined by a single layer of cells bearing long stout flagella. The funnel leads into a narrow tube with an intercellular lumen, whose wall is composed of a single layer of nephridial cells and an investing layer of peritoneum. This tube passes straight back as far as the 12th segment, there bends on itself and runs straight forward, becoming much dilated at the level of the oesophagus, in some cases filling almost the whole of the perivisceral space. The external aperture of the nephridium is anterior to the first bundles of setæ on a conical papilla, one on each side, close to the protuberance bearing the eyes and to the inner side of the branchial filaments. The two limbs of the V-tube formed by the nephridial duct are closely apposed along their entire length, and the investing peritoneum forms a simple sac, as though it had been pushed inwards by the nephridium as a whole; there is no peritoneum between the apposed surfaces of the two limbs. In their position and simplicity of structure the nephridia resemble the single pair of thoracal nephridia in the Serpulidæ. In the Chlorhæmidæ, however, abdominal nephridia do not occur. There are no blood-vessels in the nephridia. Ova have been seen in the nephridia of *Chlorhæma* by Williams, and he concluded that the segmental organs, as he calls them, were genital glands. Here, then, the same organ functions as an excretory organ and as a gonaduct.

I was eventually successful in experiments on feeding with carmine, and was able to keep the worms alive for a fortnight in filtered sea-water containing finely-powdered carmine in suspension, by passing a constant current of air through the water. As regards the nervous system and sense-organs and the reproductive organs, I can at present add nothing to the descriptions of Grube, Jourdan, and Jaquet.

The zoological position of the Chlorhæmidæ has often been altered. Grube, who is entitled to speak with authority, places them between the Errantia and the Tubicola, but I am inclined to believe that they will

prove to be modified *Tubicola*, which have secondarily acquired an errant habit. I am continuing my work on this group, and hope to collect some embryological material and complete the experiments on the excretion of carmine.

I should like to mention here my deep sense of gratitude to Professor Dohrn and the capable staff of the Stazione for all the kindness and attention they gave me during my stay with them.

Having experienced the benefits which accrue to visitors at the Naples Zoological Station, I feel very strongly the importance of the British Association continuing to participate in the many advantages afforded by this institution.

I will not dwell upon well-known advantages, such as the richness of the fauna and flora; such as the possession of a large and growing library, exceptionally complete in its acquisitions of current literature; such as the completeness and efficiency of the equipment, and the experience and matured advice of the staff; yet I venture to recall the fact of the existence of comfortable and modern physiological and bacteriological laboratories, which are well attended by foreign investigators. In Naples, moreover, referring now especially to morphology, so many masters have produced work which has become classical that specialists in almost every group of marine animals and plants have there all the conditions enabling them to follow in the concrete and control the results of researches with which books have made them familiar.

The frequent opportunities for intercourse with the leaders of Continental schools of the biological sciences, and with some of their most promising pupils, are of great importance. This applies more expressly to Englishmen who, unlike most Germans, have not been educated at two or more universities. In Naples there are brought to the student, in many cases by their originators, the ideas prevalent and the theories in course of development at a large number of foreign universities. One can see carried out, in the daily course of practice, methods in vogue abroad, and can at the same time observe the results of these methods, form an independent opinion on their value, and be incited to suggest improvements and new applications. Besides these mutual advantages there is the further one, continually increasing in importance, which consists in the obvious facilities for acquiring or improving a knowledge of almost every European language.

So large a gathering of men engaged in original investigation cannot fail to create what for their younger associates is a stimulating atmosphere of research. The companionship of representatives of all the various departments in biology, with necessarily different trainings, will and does cultivate broader views and materially forwards the desirable state of things in which one science aids in advancing another, and, like a symbiotic organism, derives equivalent benefits in return. In no other Marine Biological Station are all the above circumstances combined as they are in that directed by Professor Dohrn, and in no other is the endeavour to make the institution truly international in character so prominent a feature in the programme, and so successfully carried out. This endeavour it is surely incumbent on the greatest seafaring nation to support by all possible means, and an adequate amount of support ought surely to come from the British Association for the Advancement of Science.

III. A List of Naturalists who have worked at the Zoological Station from the end of June 1890 to the end of June 1891.

Number on List	Naturalist's Name	State or University whose Table was made use of	Duration of Occupancy	
			Arrival	Departure
559	Dr. J. Rioja y Martin	Spain	July 1, 1890	Nov. 22, 1890
560	Dr. A. Messea	Italy	" 2, "	Sept. 21, "
561	Dr. M. Verworn	Prussia	" 5, "	Dec. 25, "
562	Prof. A. Della Valle	Italy	" 7, "	Nov. 4, "
563	Dr. G. Valenti	"	" 25, "	Sept. 30, "
564	Dr. F. S. Monticelli	"	Aug. 1, "	—
565	Sig. G. Mazzarelli	"	" 1, "	—
566	Dr. B. Rawitz	Prussia	" 4, "	Oct. 15, "
567	Dr. C. Crety	Italy	" 10, "	Nov. 22, "
568	Ten. Borja de Goyeneche.	Spain	" 17, "	Feb. 7, 1891
569	Dr. V. Salvati	Italy	Sept. 1, "	June 1, "
570	Dr. J. C. Koningsberger.	Holland	" 1, "	Dec. 25, 1890
571	Dr. T. Pintner	Austria	" 4, "	Oct. 17, "
572	Dr. C. v. Wirtinghausen.	Prussia	" 13, "	Apr. 9, 1891
573	Dr. A. Looss	Saxony	" 15, "	Mar. 7, "
574	Mr. W. R. Melly	British Association	Oct. 29, "	Jan. 3, "
575	Dr. J. Loeb	Strasburg	" 31, "	Apr. 25, "
576	Dr. M. v. Davidoff	Zoological Station	Nov. 16, "	Feb. 28, "
577	Dr. G. Maurea	Italy	" 21, "	June 1, "
578	Ten. Anglada y Rava	Spain	" 24, "	—
579	Mr. G. Bidder	Zoological Station	" 24, "	—
580	Dr. P. Samassa	Austria	" 30, "	Mar. 27, "
581	Dr. N. Slunine	Russia (Navy).	Dec. 3, "	May 23, "
582	Dr. M. Cazwero	Spain	" 15, "	—
583	Sig. A. Russo	Italy	" 22, "	—
584	Mr. E. J. Bles	British Association	" 22, "	Mar. 27, "
585	Mr. Marmier	Zoological Station	Jan. 1, 1891	Feb. 4, "
586	Dr. G. Cano	Italy	" 1, "	—
587	Dr. S. Pansini	"	" 1, "	—
588	Dr. G. Jatta	"	" 1, "	—
589	Dr. F. Raffaele	"	" 1, "	—
590	Mr. A. Newstead	Cambridge	" 5, "	—
591	Dr. K. F. Wenckebach	Holland	" 9, "	June 18, "
592	Dr. D. Bergendal	Zoological Station	" 22, "	—
593	Dr. O. Bürger	Hesse	Feb. 3, "	—
594	Dr. C. Fiedler	Switzerland	" 11, "	Apr. 24, "
595	Prof. A. de Korotneff	Russia	" 15, "	Mar. 24, "
596	Mr. M. Kaloujsky	"	" 26, "	May 5, "
597	Dr. K. K. Schneider	Saxony	Mar. 5, "	—
598	Dr. G. Guaglianone	Italy	" 7, "	June 1, "
599	Stud. P. Schottländer	Prussia	" 7, "	Apr. 17, "
600	Prof. W. His	Saxony	" 11, "	" 8, "
601	Dr. W. His	"	" 11, "	" 8, "
602	Dr. F. v. Haberler	Austria	" 12, "	" 6, "
603	Prof. M. Holl	"	" 16, "	" 6, "
604	Dr. P. Kaufmann	Prussia	" 16, "	May 21, "
605	Dr. E. Ballowitz	Hamburg	" 20, "	Apr. 23, "
606	Mr. H. L. Russell	Amer. 'Davis' Table	" 20, "	—
607	Prof. J. Rückert	Bavaria	" 22, "	" 10, "
608	Mr. S. F. Harmer	Cambridge	" 26, "	" 18, "
609	Prof. A. Hansen	Hesse	" 27, "	—
610	Dr. E. Rohde	Prussia	" 30, "	—

III. A LIST OF NATURALISTS—*continued.*

Number on List	Naturalist's Name	State or University whose Table was made use of	Duration of Occupancy	
			Arrival	Departure
611	Dr. S. Kästner . .	Saxony	Apr. 2, 1891	Apr. 18, 1891
612	Prof. Hoppe-Seyler . .	Strasburg	" 3, "	" 20, "
613	Sr. S. Prado	Spain	" 4, "	—
614	Miss Julia B. Platt . .	Amer. 'Davis' Table	" 7, "	—
615	Dr. R. S. Bergh	Zoological Station . .	" 9, "	June 14, "
616	Dr. O. Maass	Prussia	" 30, "	—
617	Prof. W. Schimke- witsch.	Russia	May 4, "	" 10, "
618	Dr. A. Jaschtschenko	Russia	" 4, "	—
619	Mag. L. Kundsinn	"	" 14, "	June 12, "
620	Dr. A. Pasquale	Zoological Station . .	June 1, "	—
621	Mr. E. A. Minchin	Oxford	" 28, "	—

IV. *A List of Papers which have been published in the year 1890 by the Naturalists who have occupied Tables at the Zoological Station.*

- Prof. J. Steiner . . . Die Functionen des Centralnervensystems der wirbellosen Thiere. 'Sitz.-Ber. K. Preuss. Akad. Wiss.,' Berlin, 1890.
- Prof. C. Brandt . . . Neue Radiolarienstudien. 'Mitth. Verein Schleswig-Holst. Aerzte,' 1890.
- Dr. T. Boveri . . . Ein geschlechtlich erzeugter Organismus ohne mütterliche Eigenschaften. 'Sitz.-Ber. Ges. f. Morphologie u. Physiologie,' München, Bd. 4, 1890.
- " Zellen-Studien, Heft 3, Ueber das Verhalten der chromatischen Kernsubstanz, etc. 'Jena. Zeitschr. f. Naturw.' Bd. 24, 1890.
- " Ueber die Niere des Amphioxus. 'Münch. med. Wochenschr,' No. 26, 1890.
- Dr. F. A. F. C. Went . . Die Entstehung der Vacuolen in den Fortpflanzungszellen der Algen. 'Jahrb. f. wiss. Botanik,' Bd. 21, 1890.
- Dr. C. de Bruyne . . . Monadines et Chytridiacées Parasites des Algues du Golfe de Naples. 'Arch. de Biologie,' t. 10, 1890.
- Prof. S. Apáthy . . . Pseudobranchellion Margói (Nova familia Hirudinearum). 'Aerztl. naturw.' Bericht des ländl. Museumvereins in Siebenbürgen,' 1890.
- Dr. G. Cano . . . Specie nuove e poco conosciute di Crostacei decapodi del Golfo di Napoli. 'Boll. Soc. Nat. Napoli,' 1890.
- " Morfologia dell' apparecchio sessuale femminile, glandole del cemento e fecondazione nei Crostacei decapodi. 'Mitth. Zool. St. Neapol,' Bd. 9, 1890.
- T. Groom & D. J. Loeb . . Der Heliotropismus der Nauplien von Balanus perforatus u. die periodischen Tiefenwanderungen pelagischer Thiere. 'Biol. Centralblatt,' Bd. 10, 1890.
- Dr. F. Sanfelice . . . Contributo alla conoscenza di alcune forme nucleolari. 'Boll. Soc. Nat. Napoli,' 1890.
- " Contributo alla fisiopatologia del midollo delle ossa. *Ibid.*
- W. L. Calderwood . . On the swimming bladder and flying powers of Dactylopterus volitans. 'Proc. R. Soc. Edinburgh,' vol. xvii, 1889-90.
- Drs. Kruse, Pansini, and Pasquale . . . Influenzastudien. 'Centralbl. f. Bacteriologie u. Parasitenkunde,' Bd. 7, 1890.
- . P. Mingazzini . . . Contributo alla conoscenza delle gregarine. 'Rendic. Acc. Lincei,' (2) vol. 5, 1889.
- " " . . . Sullo sviluppo dei Myxosporidi. 'Boll. Soc. Nat. Napoli,' 1890.

- Dr. P. Mingazzini . . . La parentela dei Coccidi colle gregarine. *Ibid.*
 Dr. J. Loeb . . . Weitere Untersuchungen über den Heliotropismus der Thiere, etc. 'Arch. f. d. ges. Physiologie,' Bd. 47, 1890.
 " . . . Untersuchungen zur physiol. Morphologie der Thiere; I. Ueber Heteromorphose. Würzburg, 1890.
 Dr. F. Raffaele . . . Sullo spostamento postembrionale della cavità addominale nei Teleostei. 'Mitth. Zool. Station, Neapel,' Bd. 9, 1890.
 Prof. H. Ambronn . . . Cellulose-Reaction bis Arthropoden u. Mollusken. *Ibid.*
 " " . . . Ueber das Leuchten der Sapphirinen. *Ibid.*
 " " . . . Das optische Verhalten markhaltiger u. markloser Nervenfasern. 'Ber. Sächs. Ges. Wiss.' 1890.
 Dr. G. W. Müller . . . Ueber Halocypriden. 'Zool. Jahrb.' Bd. 5, 1890.
 " " . . . Neue Cypriniden. *Ibid.*
 Dr. W. v. Schröder . . . Ueber die Harnstoffbildung der Haifische. 'Zeitschr. f. physiol. Chemie.' Bd. 14, 1890.
 Prof. G. v. Koch . . . Die systematische Stellung von Sympodium coralloides. 'Zool. Jahrbücher,' Bd. 5, 1890.
 Dr. A. Pasquale . . . Ulteriori ricerche sugli Streptococchi delle Mucose, etc. 'Giorn. intern. Scienze Med.' anno 12, 1890.
 " . . . Sulla presenza di larve di Ditteri nell' Intestino di alcuni fabbricanti di Massana. *Ibid.*
 " . . . Le tenie dei polli di Massana. *Ibid.*
 Prof. N. Kastschenko . . . Ueber den Reifungsprocess des Selachiereies. 'Zeitschr. f. wiss. Zool.' Bd. 50, 1890.
 Dr. F. S. Monticelli . . . Di una forma teratologica di Bothriocephalus microcephalus, Rud. 'Boll. Soc. Nat. in Napoli,' 1890.
 " . . . Note elmintologiche. *Ibid.*
 F. E. Weiss . . . Excretory Tubules in Amphioxus lanceolatus. 'Quart. Journ. Micr. Science,' vol. 31, 1890.
 Dr. S. Pansini . . . Bacteriologische Studien über den Auswurf. 'Virchow's Archiv,' Bd. 122, 1890.
 Dr. M. v. Davidoff . . . Untersuchungen zur Entw. Gesch. der Distaplia magnilarva, etc. 'Mitth. Zool. St. Neapel,' Bd. 9, 1890.
 Dr. T. C. Cori . . . Untersuchungen über die Anatomie u. Histologie der Gattung Phoronis. 'Zeitschr. wiss. Zool.' Bd. 51, 1890.
 Dr. A. Messea . . . Contribuzione allo studio delle ciglia dei Batterii, etc. 'Rivista d'Igiene e Sanità Pubblica,' anno 1, 1890.

V. A List of Naturalists, &c., to whom Specimens have been sent from the end of June 1890 to the end of June 1891.

				Lire c.
1890.	July	1	Prof. Ch. Julin, Liège . . . Amphioxus . . .	13·30
	"	6	Physiol. Dep., University, Edinburgh. . . Various . . .	15·60
	"	"	Dr. P. Pelseneer, Ghent . . . Mollusca . . .	12·05
	"	"	Zool. Institute, Bâle . . . Embryos . . .	21·20
	"	"	University College, Dundee . . . Pantopoda . . .	13·
	"	"	Anatom. Institute, Strasburg . . . Embryos of Dog-fish . . .	20·40
	"	"	Dr. H. Fowler, Plymouth . . . Idothea . . .	9·05
	"	10	Laboratoire de Zoologie, Vimeux. . . Cymothea, Squilla . . .	7·80
	"	11	G. B. Paravia & Co., Rome . . . Collection . . .	204·85
	"	"	Musée Cantonal, Fribourg . . . Collection . . .	200·
	"	"	M. A. Eloffe, Paris . . . Cœlenterata . . .	39·45
	"	"	Anatom. Institute, Munich . . . Head of Heptanchus . . .	17·
	"	15	Museum, Darmstadt . . . Orthogoriscus Molæ . . .	34·95
	"	19	Mr. P. Jamieson, Dunbar . . . Amphioxus . . .	7·60
	"	25	Zool. Institute, Bonn . . . Collection . . .	600·
	"	"	M. A. Eloffe, Paris . . . Cirrhipedia . . .	20·55
	"	"	A. Dall' Eco, Florence . . . Antedon, Hyalæe . . .	4·15
	"	29	Prof. Ciaccio, Bologna . . . Embryos of Lophius . . .	26·15

					Lire c.
1890.	July	29	Mr. G. B. Ridewood, Plymouth	Engraulis	13-15
	"	31	Faculté des Sciences, Nancy	Asterias	6-95
	Aug.	5	Zool. Institute, Berlin	Eggs of Cephalopoda	6-15
	"	21	Natural History Museum, Ham- burg.	Collection	434-30
	"	"	Mr. H. Kreye, Hanover	Collection	232-05
	"	"	Dr. P. Casanova, Valencia	Amphioxus, & Embryos	6-65
	"	"	Polytechnikum, Zurich	Collection	757-90
	"	"	Zool. Laboratory, Zurich	Collection	416-95
	"	"	Veterinary School, Zurich	Collection	71-15
	"	"	Dr. Killian, Freiburg	Embryos of Torpedo	4-80
	"	26	Prof. R. Bergh, Copenhagen	Conus mediterr.	5-60
	Sept.	10	Mr. W. Schlüter, Halle	Collection	146-50
	"	"	National Museum, Melbourne	Collection	2124-50
	"	"	Morphological Laboratory, Cam- bridge.	Amphioxus	54-65
	"	12	Mr. F. Heydrich, Langenvalza	Algæ	7-10
	"	22	Zool. Instit., Berlin	Material for dissection	363-95
	"	27	Mr. E. Halkyard, Knutsford	Dredging material	50-
	Oct.	3	Eberbach & Son, Ann Arbor	Collection	577-65
	"	"	Mr. G. Tagliani, Stuttgart	Sargassum	5-55
	"	7	Museum of Vertebrates, Florence.	Pisces	94-20
	"	8	Mme. Vimont, Paris	Sepia	5-40
	"	14	Zoolog. Institute, Liège	Siphonophora, various	206-95
	"	15	Dr. H. Driesch, Zurich	Antennularia	15-25
	"	20	Prof. G. Vimercati, Florence	Collection	41-45
	"	"	Mr. R. Damon, Weymouth	Amphioxus	24-40
	"	"	Municipality, Berlin	Collection	62-15
	"	24	Oberrealschule Sechshaus, Vienna.	Collection	140-
	Nov.	4	Zool. Institute, Perugia	Embryos of Torpedo	10-65
	"	"	Emb. Laboratory University, Edinburgh.	Palythoa, Astroides	12-40
	"	5	Dr. Killian, Freiburg	Embryos of Torpedo	11-05
	"	8	Gymnasium, Görz	Collection	90-
	"	10	Veterinary School, Dresden	Cœlenterata	115-
	"	"	Indian Museum, Calcutta	Collection	12-50
	"	"	Dr. A. Hansen, Darmstadt	Corallines	6-50
	"	19	Zool. Institute, Bâle	Collection	265-05
	"	"	Dr. J. Kober, Bâle	Various	32-10
	"	"	Zool. Museum, Berlin	Collection	207-65
	"	22	Zootom. Institute, Charkoff	Various	72-70
	"	26	Mr. H. Ayers, Milwaukee	Amphioxus	102-75
	"	"	University College, London	Amphioxus	24-30
	"	"	A. Pichler's W ^{vo} & Son, Vienna.	Various	46-95
	"	"	Comp. Anat. Cab., Moscow	Balanoglossus	4-70
	"	"	Dr. J. Beard, Edinburgh	Embryo of Scyllium	15-10
	"	"	Lab. physiol. Jardin bot., Brus- sels.	Living Styptocaulon Scoparium	6-10
	"	27	Zool. Inst., Bonn	Echinodermata, Sepia	100-
	"	29	Mr. V. Frič, Prague	Corallium, var.	108-55
	"	"	Mr. W. Schlüter, Halle a/S.	Various	120-75
	Dec.	9	Morphological Laboratory, Cam- bridge.	Sipunculus	19-30
	"	"	Mr. G. Schlatter, Catania	Various	19-45
	"	"	Zool. Inst., Munich	Ciona, &c.	44-70
	"	11	Zool. Inst., Jena	Various	107-10
	"	18	Palæontol. Inst., Munich	Lithothamnion	10-
	"	"	Mr. R. Damon, Weymouth	Amphioxus	24-10
	"	"	Mr. V. Hess, Schloss Waldstein	Caulerpa	7-75
	"	"	Mr. V. Frič, Prague	Various	34-25

				Lire c.
1890.	Dec.	18	Rev. A. M. Norman, Burnmoor Rectory.	Collection 360·85
	"	20	Owens College, Manchester	Living Murex 25·
	"	22	Zool. Inst. Freiburg i/B.	Hydroid Polyyps, Copepods 53·05
	"	31	University College, London	Ciona 80·25
	"	"	Mr. L. Loeb, Zurich	Collection 200·
1891.	Jan.	5	Mr. A. Tiedemann, Kiel	Cerallium, &c. 72·75
	"	6	Zool. Inst., Greifswald	Crustacea 44·95
	"	"	Université Catholique, Louvain	Crustacea 15·80
	"	10	Morphological Laboratory, Cambridge.	Salpa 300·15
	"	"	Zool. Inst., Breslau	Mollusca 36·20
	"	"	Zootom. Cabinet, Warsaw	Embryos of Selachians 22·50
	"	12	Mr. J. Hornell, Egremont.	Annelida 13·10
	"	13	Mdme. E. Marie, Paris	Siphonophora 32·15
	"	14	M. Lesniewski, Geneva	Skins of Dog-fish. 2·75
	"	17	Ministry of Marine, Madrid	Collection 948·70
	"	21	Zool. Cabinet, Moscow	Collection 253·45
	"	"	Gymnasium, Hradec-Králové	Collection 34·65
	"	24	R. Holloway College, Egham	Collection 90·
	"	27	Prof. Ambronn, Leipzig	Bones of Sepia 15·
	"	31	Zool. Inst., Strasburg	Salmacina 4·05
	Feb.	3	Univ. College, Aberystwith	Various 24·30
	"	"	Sac. G. Bibbia, Palermo	Rhizostoma 10·
	"	5	Univ. Museum, Oxford	Amphioxus 41·95
	"	16	Mr. G. Schneider, Bâle	Various 59·85
	"	"	Dr. von Leudenberg, Innsbruck	Abyla ———
	"	20	Museo Municipal, Ponta Delgada.	Crustacea, Pisces 144·40
	"	28	Museo Civico, Milan	Pisces 55·65
	"	"	Prof. G. Berney, Château d'Aex	Collection 84·55
	"	"	Prof. Rabl. Rückhard	Brains of Turtles 28·15
	March	5	Univ. College, London	Collection 269·15
	"	"	Medical College, Madras	Various 197·95
	"	10	Zool. Museum, Naples	Collection 108·35
	"	"	Mr. G. Butler, Surbiton	Pristiurus 16·60
	"	"	Mr. F. H. Butler, London	Amphioxus 24·75
	"	11	Owens College, Manchester	Collection 251·55
	"	"	Dr. Nisse, Frankfurt a/M.	Torpedo, Amphioxus 10·45
	"	"	Baron de S. Joseph, Paris	Annelida 14·85
	"	15	Prof. A. de Korotneff, Kiev	Collection 50·
	"	16	Mr. A. Duncker, Hamburg	Lophius, Dactylopterus 7·45
	"	24	Lab. de Zoologie, Lyon	Collection 648·
	"	"	Dr. W. Felix, Leipzig	Amphioxus 17·35
	"	27	Zool. Inst., Strasburg	Salpa, Pyrosoma 7·05
	April	3	Prof. Trendelenburg, Bonn	Various 20·
	"	"	A. Pichler's W ^o e & Son, Vienna.	Pelagia 31·65
	"	"	Zool. Inst., Berlin	Collection 491·25
	"	14	British Museum, London	Collection 1000·
	"	"	Anat. Inst., Bonn	Lepas 11·85
	"	17	Anatom. Inst., Groningen	Amphioxus 12·75
	"	21	R. Ist. Tecnico, Rome	Collection 239·
	"	23	Anatom. Inst., Greifswald	Collection 1000·
	"	"	Physiolog. " "	Various 130·50
	"	24	Mr. V. Frič, Prague	Pelagia, Corallium 98·45
	"	30	Morphol. Labor., Cambridge	Sepia, Amphioxus, Pelagia 648·
	"	"	Botanical " "	Accetabularia 11·
	"	"	Mr. G. Berthel, Steinpleis	Collection 100·
	May	1	Zool. Inst., Strasburg	Ægineta, Æquorea 8·25
	"	2	Zool. Inst., Freiburg i/B.	Various 19·85
	"	"	Lab. de Zoologie, Lyon	Cucumaria, Petromyzon 29·

				Lire c.
1891	May	4	Marine Biol. Lab., Wood's Holl	Amphioxus 70·80
	"	7	Mr. A. Tiedemann, Kissingen .	Siphonophora, &c. 53·60
	"	"	Dr. W. Schwabe, Leipzig . .	Murex 29·
	"	"	Mr. W. Schlüter, Halle . . .	Various 152·85
	"	"	Lyceum, Graz	Various 55·70
	"	9	Zool. Inst., Tomsk, Siberia .	Various 97·25
	"	10	Prof. G. Sidler, Bern	Various 62·85
	"	11	Anatom. Inst., Groningen . .	Embryos of Pristiurus 43·25
	"	12	Mr. J. Tempère, Paris	Various 37·25
	"	"	University, Edinburgh	Various 35·30
	"	16	Kunstgewerbeschule, Karls- ruhe i/B.	Collection 112·45
	"	20	Zool. Inst., Moscow	Collection 160·90
	"	30	Zool. Sammlung, Polytechnic, Zurich.	Collection 1189·05
	"	"	Mr. M. Kaloujsky, Moscow . .	Collection 300·
	"	"	Zool. Inst., Göttingen	Arenicola 6·85
	June	1	Prof. G. Sidler, Bern	Collection 132·85
	"	"	A. Dall' Eco., Florence	Rhizostoma, Anemonia 12·30
	"	5	Mr. S. Brogi, Siena	Collection 106·95
	"	"	Mr. I. C. Thompson, Liverpool .	Collection 160·50
	"	6	Mr. J. Tempère, Paris	Various 60·25
	"	14	'Linnæa,' Nat. Hist. Inst., Berlin.	Collection 829·40
	"	"	Prof. H. E. Ziegler, Freiburg i/B	Embryos of Torpedo 13·80
	"	"	Lab. di Patal. Gen., Bologna . .	" Pristiurus and Lacerta 18·70
	"	16	Dr. Killian, Freiburg i/B	Embryos of Torpedo 13·95
	"	18	Veter. Inst., Dorpat	Collection 387·60
	"	"	A. Dall' Eco., Florence	Seyllium 5·70
	"	19	Dr. O. vom Rath, Freiburg i/B .	Cymothoa, Anilocra 6·20
	"	"	Palæontol. Institut., Munich . .	Ascetta 8·55
	"	21	Realschule, Nördlingen	Collection 110·
	"	23	University College, London . . .	Squilla, &c. 70·05
	"	27	Zool. Inst., Halle	Cephalopoda 101·25
	"	"	Prof. R. Bergh, Copenhagen . . .	Conus medit. 7·85
	"	30	Zool. Lab., Utrecht	Torpedo 13·25
	"	"	Anatom. Inst., Dorpat	Emb. of Pristiurus 39·90
				21809·30

Report of the Committee, consisting of Professor A. C. HADDON, Professor W. A. HERDMAN, and Mr. W. E. HOYLE (Secretary), appointed for improving and experimenting with a Deep-sea Tow-net, for opening and closing under water.

THE Committee have devised and had constructed an improved form of the apparatus for opening and closing the tow-net by an electric current, which will be exhibited at the forthcoming meeting of the Association. Their efforts to obtain an opportunity for experimenting in deep water have not been successful, and hence the money destined for the purchase of an electric cable of considerable length has not been expended. The Committee suggest that they should be reappointed, and a sum of 40*l.* (including an unspent balance of 27*l.* 14*s.* 6*d.*, which has been returned to the Treasurer) should be intrusted to them.

Report of the Committee, consisting of Dr. J. H. GLADSTONE (Chairman), Professor H. E. ARMSTRONG (Secretary), Mr. S. BOURNE, Dr. CROSSKEY, Mr. G. GLADSTONE, Mr. J. HEYWOOD, Sir JOHN LUBBOCK, Sir PHILIP MAGNUS, Professor N. STORY MASKELYNE, Sir H. E. ROSCOE, Sir R. TEMPLE, and Professor S. P. THOMPSON, appointed for the purpose of continuing the inquiries relating to the teaching of Science in Elementary Schools.

LAST year your Committee had to report very considerable changes in the code of regulations issued by the Education Department which bore upon instruction in scientific subjects in elementary schools, and also certain additions to the Science and Art directory consequent thereon. As these only began to take effect from September 1 last the returns of the Education Department, issued this year, which extend down to August 31, deal entirely with the results of examinations under the old code. They are therefore strictly comparable with those of the seven preceding years.

The following table gives the number of departments of schools in which the several class subjects have been examined by H.M. Inspector during each twelve months:—

Class Subjects.—Departments	1882-3	1883-4	1884-5	1885-6	1886-7	1887-8	1888-9	1889-90
English	18,363	19,080	19,431	19,608	19,917	20,041	20,153	20,304
Geography	12,823	12,775	12,336	12,055	12,035	12,058	12,171	12,367
Elementary Science	48	51	45	43	39	36	36	32
History	367	382	386	375	383	390	386	414
Drawing	—	—	—	249	505	—	—	—
Needlework	5,286	5,929	6,499	6,809	7,137	7,424	7,620	7,758

The number of scholars examined in the scientific specific subjects during the same period is as follows:—

Specific Subjects.—Children	1882-3	1883-4	1884-5	1885-6	1886-7	1887-8	1888-9	1889-90
Algebra	26,547	24,787	25,347	25,393	25,103	26,448	27,465	30,035
Euclid and Mensuration	1,942	2,010	1,269	1,247	995	1,006	928	977
Mechanics A	2,042	3,174	3,527	4,844	6,315	6,961	9,524	11,453
" B	—	206	239	128	33	331	127	209
Animal Physiology	22,759	22,857	20,869	18,523	17,338	16,940	15,893	15,842
Botany	3,280	2,604	2,415	1,592	1,589	1,598	1,944	1,830
Principles of Agriculture	1,357	1,859	1,481	1,351	1,137	1,151	1,199	1,228
Chemistry	1,183	1,047	1,095	1,158	1,488	1,808	1,531	2,007
Sound, Light, and Heat	630	1,253	1,231	1,334	1,158	978	1,076	1,183
Magnetism and Electricity	3,643	3,244	2,864	2,951	2,250	1,977	1,669	2,293
Domestic Economy	19,582	21,458	19,437	19,556	20,716	20,787	22,064	23,094
Total	82,965	84,499	79,774	78,477	78,122	79,985	83,420	90,151
Number of scholars in Standards V., VI., and VII. }	286,355	325,205	352,860	393,289	432,097	472,770	490,590	495,164

The first of these tables shows that, while during the year there were 151 more departments that took at least one class subject, there were 196

more in which geography was taught; while, on the other hand, there were only 32 in all that took up elementary science, the lowest record of any of the years under review.

On comparing the figures for the several specific subjects in the second table with the number of scholars qualified to take any two of them under the rules of the Code, it will be found that there has been an important increase over the previous year in the study of algebra, mechanics, chemistry, and magnetism and electricity; but if the comparison be made with the year 1885-6, or any of the preceding years, it will be found that this year's return still shows a relative, if not an absolute, falling off in the study of every one of the subjects, except mechanics and chemistry.

The general result shows that the slight turn in the tide as to the percentage of scholars taught these specific subjects as compared with the number that might have taken them, which was just remarked in last year's report, has been more than maintained. It will be apparent from the following table:—

In 1882-3	29·0 per cent.
„ 1883-4	26 0 „
„ 1884-5	22·6 „
„ 1885-6	19·9 „
„ 1886-7	18·1 „
„ 1887-8	16·9 „
„ 1888-9	17·0 „
„ 1889-90	18·4 „

This result is mainly due to the operations of the School Boards for London, Liverpool, Birmingham, and Nottingham, which have given much attention to the teaching of mechanics, in some cases under the peripatetic system and in others in special schools.

The code of regulations which has been issued this year by the Education Department contains only two alterations that call for notice.

The one consists of the following note to the work required under the head of Arithmetic in Standard IV. (Schedule I.):—‘The scholars in Standards V., VI., and VII. should know the principles of the metric system, and be able to explain the advantages to be gained from uniformity in the method of forming multiples and sub-multiples of the unit. As a preparation for this it will be useful to give in Standard IV. elementary lessons on the notation of decimal fractions.’ This reintroduces the study of the metric system which was dropped in the year 1874.

The other is the addition of another alternative course of elementary science (Schedule II., Course I.), called ‘lessons on common things.’ The course laid down for the several standards is as follows:—

‘Standards I. and II.—Thirty object lessons on the chief tribes of animals and their habits, and on common plants and their growth.

‘Standard III.—Common inorganic substances and their properties.

‘Standard IV.—Simple mechanical laws in their application to common life and industries. Pressure of liquids and gases.

‘Standard V.—Simple chemical laws in their application to common life and industries.

‘Standard VI.—Outlines of physiology in its bearing on health and work.

‘Standard VII.—Other simple physical laws, such as those of light, heat, &c.’

It is doubtful whether this will prove acceptable, as it involves a wider range of study than any of those going before, in which the same subject is carried onward from year to year. In so far, however, as the title is concerned, the institution of this Course marks an advance in views, and is a valuable recognition of the principle that in teaching science in elementary schools it is important to base the instruction on common objects generally.

Last year the National Association for the Promotion of Technical Education endeavoured to obtain some modifications of the alternate courses of elementary science in Schedule II., and your Committee also drew especial attention to certain points of which they disapproved. No alteration, however, has been made. They can only express the hope that this important schedule will be carefully revised for the code of next year; and it seems highly desirable that the revision should be carried out with the assistance of some of the teachers who have given special attention to methods of teaching science.

It is stated at pp. 28, 29 of the Code that 'it is intended that the instruction in elementary science shall be given mainly by experiment and illustration. If these subjects are taught by definition and verbal description, instead of making the children exercise their own powers of observation, they will be worthless as means of education.' It is here clearly implied that the object of instruction in elementary science is to lead the children to *exercise their powers of observation*; but it is much to be feared that the methods generally adopted in teaching the subject do not satisfy this requirement, and it is highly important that ampler instructions should be placed before teachers. Valuable and instructive as are class lessons, whether 'conversational object lessons' or lessons freely illustrated by experiment, experience shows that their effect is but too often ephemeral; and, above all, it is to be feared that they do little towards developing the power of independent observation, as in such lessons children do not learn to do things themselves, but gain their information from the teacher.

The Committee desire most strongly to urge that the time has now come when every effort should be made to introduce experimental lessons, especially measurement lessons, into schools; in other words, that the children should be set to do simple experimental exercises themselves, not merely to attend lessons, listening to and taking notes of what is said. It is now clearly recognised that even in the case of students of a far higher grade than those in the elementary schools practical instruction should always accompany lectures and demonstrations, and this must be all the more necessary in the case of young children. In the higher standards not only the observing faculties, but also the reasoning faculties, should be brought fully into play in the practical lessons. It may be added that in the course of the measurement lessons, even in the lower standards, opportunity would be given to the children to compare the English with the metric system, and thus the knowledge of this latter, which is now required of the higher standards, would be easily acquired.

If attention be once directed in the Code to the necessity for instruction of the kind suggested being given, there can be no doubt that suitable sets of practical exercises will soon be devised and carried into practice. The non-recognition of their importance is at present the chief bar to the introduction of such practical exercises.

Science demonstrators have recently been appointed by the School
1891.

Board for London, in addition to those referred to in former reports, who are endeavouring to initiate practical work by the scholars in a number of the schools under their charge. The results of their work are to be awaited with interest, as there can be no doubt that when it is once shown that children in elementary schools can be taught to experiment for themselves, and thereby acquire the habits of accurately observing and later on of reasoning from observation, no great delay will arise in introducing such teaching into schools generally.

There is little hope that any but specially trained teachers will be able satisfactorily to conduct experimental teaching with the object of inculcating scientific habits of mind. Hence, bearing in mind the probability that a revolution in methods of teaching is clearly foreshadowed, and that the action of the Government in providing funds for technical instruction is having a most important influence in encouraging applied science teaching, it would seem highly desirable that the teachers in training should be prepared to do what will be required of them. As it will be their object to teach *scientific method*, it is all-important that their own training in this direction should be as ample as possible, and that they should be led to recognise more clearly than is done at present what is the object to be gained in introducing elementary science into schools; that the *use* of facts—not mere facts—is to be taught.

Though the scholars of elementary schools who are working in the standards are excluded from participation in the grant out of the beer and spirit duties, the application of this fund will have an indirect influence upon elementary education, and your Committee note with satisfaction that throughout England and Wales only two counties have refused to apply any portion of the grant to technical education, and that all the rest, with the exception of eight, have applied the entire grant to that purpose. This extension of technical instruction among the ex-standard children, and the scholars in evening schools, will render the preparatory work in the elementary schools all the more important.

Third Report of the Committee, consisting of Sir J. N. DOUGLASS, Professor OSBORNE REYNOLDS, Professor W. C. UNWIN, and Messrs. W. TOPLEY, E. LEADER WILLIAMS, W. SHELFORD, G. F. DEACON, A. R. HUNT, W. H. WHEELER, W. ANDERSON, and H. BAMFORD, appointed to investigate the Action of Waves and Currents on the Beds and Foreshores of Estuaries by means of Working Models.

[PLATES II.—XIV.]

THE Committee held a meeting in the rooms of Mr. G. F. Deacon, 32 Victoria Street, Westminster (July 29, 1891), and considered the results obtained since the last report. Professor Reynolds reported that by the date of the meeting of the British Association the objects of the investigation would be accomplished, and suggested that it would not be necessary to continue the investigation beyond that date or to apply to the Association for reappointment. These suggestions were adopted, and it was resolved that the thanks of the Committee be communicat'ed to the

Council of the Owens College for the facilities afforded for conducting the experiments in the Whitworth Engineering Laboratory.

Having considered the disposal of the apparatus, which has no pecuniary value, the Committee resolved to recommend the Association to place it at the disposal of the Owens College.

At a second meeting held in the Committee room of Section G at Cardiff the report submitted by Professor Reynolds was adopted.

On Model Estuaries.

By Professor OSBORNE REYNOLDS, F.R.S., M.Inst.C.E.

§ I.—INTRODUCTION TO REPORT III.

1. In accordance with the suggestions in the Second Report, read at the Leeds meeting of the British Association, the investigation has been continued with a view—

(1) To obtain further information as to the final condition of equilibrium with long tidal rivers entering the head of a V-shaped estuary.

(2) To obtain a more complete verification of the value of the criterion of similarity.

(3) To investigate the effect of tides in the generator diverging from simple harmonic tides.

(4) To determine the comparative effect of tides varying from spring to neap.

Opportunity has also been taken:—

(5) To investigate the effect of prolonging the walls of the river into the estuary through the bar which was below low water, with prolongations reaching up to low water, and others reaching up to half-tide—this being done in both models, so that the similarity of the effects might be seen; and

(6) To investigate the effect of rendering the estuaries unsymmetrical by means of large groins, and so to test the laws of similarity obtained in the symmetrical estuaries as applied to unsymmetrical estuaries.

2. The two models have been continuously occupied in these investigations, when not stopped for surveying or arranging fresh experiments. In this way each of the models has run 600,000 tides, corresponding to 840 years. These tides have been distributed over six experiments in the large tank E, and four in the small tank F, in number from 50,000 to 250,000.

3. The experiments have all been conducted on the same system as described in the previous reports.

All the experiments but one have been made in tanks E and F, without further modification; and in all these land water to the extent of 0.5 per cent. of the tidal capacity per tide has been introduced at the top of the river.

Initially, the sand has been laid to the level of half-tide from Section 13 up the river to Section 26 down the estuary. The vertical sand gauges distributed along the middle line of the estuary have been read and recorded each day. Tide curves have been taken at frequent intervals. Contour surveys have been made, generally after 16,000 tides, and again

after 32,000; while in the longer experiments further surveys have been made. With the spring and neap tide, the rate of action being much the slower, intervals between the surveys have been longer. In all 26 complete surveys have been made, and 20 plans showing contours corresponding to every 6 feet reduced to a 30-foot tide, together with sections and tide curves Plate III., are given in this report.

The general conditions of each experiment, together with the general results obtained, are shown in the table, while a description of each experiment is given in § VI.

The Committee have been fortunate in retaining the services of Mr. Greenshields, who has carried out the experiments, observing and recording the results, besides executing such modifications as have been required, designing the compound harmonic gearing for the spring and neap tides, which has answered excellently.

Mr. Bamford has kindly continued his assistance in conducting the investigations and reducing the results.

§ II.—GENERAL RESULTS AND CONCLUSIONS.

4. *The conditions of equilibrium with a long tidal river entering at the top of a V-shaped estuary.*—The experiments in tanks C and E made last year led to the conclusion stated in Art. 11 of the Second Report: 'that the effect of a river 50 miles long, when reduced to a 30-foot tide, increasing gradually in width until it enters the top of a V-shaped estuary, is entirely to change the character of that estuary. The time occupied by the water in getting up the river and in returning causes this water to run down the estuary while the tide is low, and necessitates a certain depth at low water, which causes the channel to be much deeper at the head of the estuary. In its effects on the lower estuary the experiments with the tidal river are decisive, but as regards the action of silting up the river further investigation is required, both to establish similarity in the models, and to ascertain the ultimate condition of final equilibrium.'

From this year's experiments, III., IV., V., VI., and VII., in tank E, and V. and VI. in tank F, it appears that if the length of the tidal river, reduced to a 30-foot tide, is 50 miles; or taking R for the length of the tidal river in miles and h for the rise of tide at the mouth of the estuary in feet, if

$$R=8.5\sqrt{h}$$

the river will keep open so that the tide will rise to the top, the sand falling gradually from the top of the river to the level of about mean tide at the mouth.

That the depth of water in the river and at the top of the estuary increases rapidly with the length of the river, and when

$$R=12\sqrt{h}$$

the level of the sand at the mouth of the river will be more than h feet below the level of low water and the bottom will be below low water level for more than half the length of the river above its mouth.

5. *The similarity of the results in the tanks E and F.*—The experiments in the tanks E and F this year confirm those of last year in showing that during the early stages of forming the estuary from sand at the level of mean tide the action in the river is different in the small tank F from

what it is in the large tank E, although the value of the criterion of similarity h^3e ¹ may be but little below 0.09.

It was not found practicable to get the value of the criterion any greater in tank F, but it was found on diminishing the rise of tide in the large tank E until the criterion had a value 0.09, that the results were still similar, although the rate of action and the increase in the size of the ripple indicated that the limit was being approached. That the dissimilarity in tank F was only the result of a phase in the formation of the estuary was also definitely shown by the effects of dredging out the sand, which was above the initial level in the river during the early stages of the Experiments V. and VI., after which the action in tank F resumed the same course as that in E, and led to the same final condition of equilibrium, showing by the rate of action and size of ripple that the limit of similarity was approached.

It thus appears that with such arrangements as these tanks represent there are two possible conditions of final equilibrium.

The one is that which has uniformly been presented by tank E, and in Experiment V. in tank F after dredging; namely, the tide rising up to the top of the river and keeping the sand low in the estuary. The other, that which was presented in Experiments I., II., III., and IV., in tank F; namely, the sand at the top of the estuary rising to high water level, as it would do if there were no river, choking the mouth of the river except so far as necessary to allow the land water to pass, and so preventing any tidal action from the river.

Which of these two conditions the river will assume during the process of forming the estuary appears to be a critical matter, decided by whether the tidal action of the river in lowering the sand at the head of the estuary predominates over the tendency of the tide in the estuary to raise the sand at the mouth of the river.

There is a possible condition of instability between the river and the estuary. The emphatic difference in the action of the long tidal river and mere tidal capacity at the head of the estuary in keeping down the sand at the head of the estuary; and, further, the very great effect which an increase in the length of the river has on the depth of water in the estuary and in the river are clearly shown.² In Experiments III. and V. in tank E, an increase of from 50 to 70 miles in the length of the river in V. causing the depth of water to increase from by 40 to 30 feet all down the river and estuary, lowering the sand in the lower river and upper estuary from the level of half-tide to 28 feet below low water. In neither of these experiments was the condition of instability reached, but 50 miles was very near the limit.

In such a state any diminution of the upper tidal waters of the river, by shortening the river or by land reclamation, might well have caused the critical stage to be passed and caused the river to silt up—just as in the other way the increasing of the tidal capacity high up the river by dredging in Experiment V., tank F, caused the critical stage of silting up to be passed and the river to open out. The sand actually removed in this experiment by dredging was 8 per cent. of the tidal capacity,

¹ h is the actual rise in feet, e the vertical exaggeration as referred to a 30-foot tide.

² See Plate IV. in which the sections of the rivers and estuaries in tank C, Experiment II., and tank E, Experiments III. and IV. are plotted to the same vertical and horizontal scales.

or 400 million cubic yards, removed at the rate of 7 million cubic yards a year.

In most navigable rivers two processes have been going on—dredging and land reclamation—the first tending greatly to improve the rivers and estuaries, the second to deteriorate them so that any improvement has been a question of balance. Where the rivers have improved they will probably continue to improve so long as dredging goes on, but if the dredging should stop, for example in the Thames, there would in all probability be a gradual deterioration, possibly ending in the silting up of the tidal river.

6. *The effect of Tides deviating from the simple Harmonic Law.*—One attempt was made to study this question, when it was found that it would require such modifications in the gearing as were not practicable in the time, and so it was abandoned.

7. *The action of Tides varying from Spring to Neap.*—The rates of action and conditions of final equilibrium in rectangular tanks, in V-shaped estuaries with a long tidal river, and in each estuary rendered unsymmetrical by large groins, have been investigated with tides varying harmonically from spring to neap, and again to spring in 29 tides. The ratio of these at spring and neap being 3 to 2 as compared with uniform tides, having the same rise as the spring tides, also for uniform tides having the same rise as the mean of spring and neap, the results showing definitely:

(1) *That the condition of Final Equilibrium in all cases with spring and neap tides was the same as that with uniform tides having the same rise as springs, and much greater, essentially different, from that with a uniform tide having a rise equal to the mean rise of spring and neap tides.*

(2) *That the Rate of Action with the varying tide is much smaller than that of a uniform tide having the rise of the spring tide. The ratios being definite, about 2.5 to 1.*

(3) *That the limits of similarity obtained for all spring tides hold approximately for tides varying from spring to neap.*

8. *The effects of prolonging the rivers into the estuaries by walls below high water.* Experiments V. in tanks E and F having arrived at similar final conditions of equilibrium (in which the depth of the rivers for some distance above their mouths was reduced to a 30-foot tide, nearly 30 feet at low water, while the sand in the estuaries gradually rose from the mouths of the rivers until it reached to within 12 feet of low water at a distance of 14 miles below the mouth and then fell again, all the sand being below this level, there being passes which formed a crooked deep water channel), opportunity was taken to prolong the banks of the river by walls at first up to low water and extending through the bar to a distance of 44 miles from the mouths of the rivers. Then raising these walls to half-tide, and finally carrying the walls forward slowly in tank E at a rate of half a mile a year (700 tides), and in tank F dredging from between the walls at a rate of seven million cubic yards a year (700 tides).

This was done in the first place as a further test of the similarity of the action in the two tanks, and secondly as affording an interesting study as to the effect of vertical walls in the direction of the current in the bed of a tide-way. The effect of these walls at the level of low water and at half tide were precisely similar in both tanks; in neither case did they produce any sensible effect at all on the level of the sand between them. At the level of half-tide they caused in both tanks a slight silting

up outside the walls and also a slight silting up in the river above its mouth, which effects were very much increased when the walls were raised to half-tide. On the walls being removed in tank E and then gradually carried forward, the silting up behind the wall and deterioration of the river increased, but there was no improvement in navigable depth between the walls.

The dredging in tank F, so long as it was continued, added about 20 feet on a 30-foot tide or 10 feet on a 15-foot tide, to the navigable depth between the walls, but there was the same silting up behind the walls and the same deterioration in the river.

It thus appears that the similarity of the results in both tanks supports the conclusion *that vertical walls having the horizontal direction of the current in a straight tideway and terminating well below high water, produce but little effect on the distribution of the sand between them, so long as the passage is freely open at both ends, but that if the passage be blocked at one end they form a bay in which the sand rises at the head.*

9. *The effects of the tide in estuaries not symmetrical.*—Having so far, in accordance with the original scheme of this investigation (First Report, 1889, p. 5), simplified the circumstances which influence the distribution of sand by maintaining the lateral boundaries perfectly symmetrical, and as nearly rectilinear as practicable, and having found definite laws connecting the distributions of sand in the beds of the model estuaries with the period and rise of the tide and the length of the estuary, besides the laws connecting the period of the tide with the horizontal and vertical scales under which the models give similar results, there remained two questions :

(1) How far such discrepancies as appear between the general distributions of sand found in the models and those observed in actual estuaries are attributable to irregularities in the boundaries of the latter ?

(2) How far the influence of these boundaries is subject to the same laws of similarity as those already obtained ?

The original experiments of the author in models of the Mersey which led to the appointment of the Committee (B.A. Report, 1887) had to a great extent answered these questions, showing that similar irregularities in the lateral boundaries exercise similar and predominating influences on the lateral distributions of the sand in the models and in the estuaries.

It seemed, however, desirable, so far as time allowed, to confirm these results of the author's and make this investigation complete in itself by carrying out experiments in both models similar to those already carried out, except that the boundaries should be boldly irregular.

Such experiments also afforded opportunity for studying some general effects of great importance. The relation between the depths of water and the rise of tide had come out very definite in the symmetrical experiments, and it was desirable to see how far these relations would be disturbed by lateral irregularities. For instance : (1) Would bold irregularities in the boundaries of the estuary alter the depth of water in the river ? Bold irregularities in the boundaries, causing the water to take a sinuous course, would have the effect of virtually narrowing and increasing the length of the estuary, and by causing eddies would obstruct the passage of the water to some extent. Lengthening the estuary would tend to increase its depth at corresponding points, and obstructing the water would tend to diminish the tidal action in the river ; at all events, until the estuary had increased in depth.

(2) At the mouth of the estuary the flow of water had so far been straight up and down, and equal all across the estuary. By rendering the mouth unsymmetrical, circulation would be set up which would render the up-currents stronger at one part and the down-currents stronger at another, an effect which would correspond to some extent to that of tidal currents across the mouth of the estuary.

(3) The large tidal sand ripples below low water in the model estuaries, with the flood and ebb taking the same course, constitute a feature which it is impossible to overlook, yet the existence of corresponding ripples had been entirely overlooked in actual estuaries until they were found to exist when they were looked for, having been first seen in the models. The reason that they were overlooked before is, no doubt, explained by the fact that the bottom is not visible below low water in actual estuaries; but this is not all. In the estuaries these ripples, where found, have been confined to the bottoms and sides of the narrow channels between high sand banks, and they do not occur on the level sands below low water towards the mouths of estuaries to anything like the same extent as in the models. By rendering the estuary unsymmetrical and so causing the ebb and flood to take different courses, this effect, as explaining the greater prevalence of ripples with symmetrical estuaries, would be tested.

These considerations led to the repetition of Experiment V. in tank F, at first with a single groin extending from the right bank into the middle of the estuary at the mouth, and subsequently to the introduction of three more groins from alternate sides of the estuary to the middle, up the estuary, and then to the introduction of similar groins into tank E, during Experiment VII., with spring and neap tides.

The result of these experiments is to show conclusively:

(1) *That the laws of similarity found for symmetrical channels with uniform tides hold with sinuous channels for uniform or varying tides.*

(2) *That the greater uniformity of the depth of sand on cross sections of models with symmetrical boundaries than with actual estuaries, does not exist when the banks are equally irregular.*

(3) *That the circulation caused by the unequal flow of the tide in model estuaries tends greatly to take the sand out, and that the natural tendency in an estuary to scarp the boundaries so as to increase its sinuosities tends greatly to the deepening of the channels.*

(4) *That in the models with boldly irregular boundaries the tidal ripples are much less frequent than in the symmetrical models, being confined to places where there are no cross currents, as in actual estuaries.*

10. *Conclusion of the Investigation.*—It seems that the objects of this investigation have now been accomplished.

The investigation of the action of tides on the beds of model estuaries has been found perfectly practicable. Two tanks have been kept running night and day from June 22, 1889, to August 1891, and have each accomplished upwards of 1,200,000 tides, representing the experience of 2,000 years. Such difficulties as protecting the sand from extraneous disturbance and keeping it free from fouling, regulating the levels of the water, the tidal periods, the rise of tide, forms of the tide curve and the supply of land water, observing and recording the results, have all been fairly overcome, though none of the precautions taken could have been safely dispensed with.

The limits to the conditions under which the results will conform to the simple hydrokinetic law of similarity have been fairly established;

while above these limits the applicability of the simple hydrokinetic law to these experiments has been abundantly verified in models varying in scale from six inches to a mile to an inch and a half to the mile, and with vertical exaggerations, as compared with a 30-foot tide, ranging from 60 to 100.

The laws of the distribution of the sand in a tideway under circumstances of progressing complexity have been determined and have been verified, not only by repetitions of the same experiment but also by producing similar distributions under different circumstances, which circumstances, however, conformed to the laws of hydrokinetic similarity. Thus the distributions of sand in simple rectangular estuaries, V-shaped estuaries, and V-shaped estuaries with a long tidal river, have all been investigated and found to be definite.

Investigations have also been made with definite results of the separate effects of land water in moderate quantities, and of the length of the tidal river on the depth of water in the river and estuary, and of the effect of bold irregularities in the configuration of the lateral boundaries of the estuaries, also of training walls in deep water. And, lastly, the comparative rates and ultimate action of uniform tides and tide varying from spring to neap have been determined.

It thus appears that this system of investigation has been tested over a great portion of the ground it is likely to cover, and that most of the difficulties that are likely to occur have been met and the necessary precautions found.

It would seem, therefore, by carefully observing these precautions, the method may now be applied with confidence to practical problems.

§ III.—THE APPARATUS.

11. *General Working of the Apparatus.*—All the apparatus has worked well, although certain repairs have been rendered necessary by wear; thus, the motor has required new pins, not much, considering it has made over 200 million revolutions. The knife edges, on which the generator of the large tank rests, which are of cast-iron, and 2 inches long, and each carry about 1,000 lb., were found to have, after one million oscillations, worn down $\frac{1}{8}$ of an inch, until they had become so locked in the Vs as to stop the motor.

12. *The modifications in the Tanks* have this year been confined to the introduction of training walls and groins. These have been made of paper saturated with solid paraffin (which gradually became warped by the pressure), sheet zinc, and sheet lead or wood, as was most convenient. In the last experiment the large tank was modified by taking out the partition boards and stopping the opening at the end so as to reproduce the original rectangular tank A.

13. *Gearing for the Spring and Neap Tides, Plate II.*—This arrangement, designed by Mr. Greenshields, accomplished the result very neatly and effectually with a minimum of new appliances. It admits of any degree of adjustment in the *ratio* of maximum and minimum tides, and works easily and well.

On commencing the work with spring and neap tides it was found essential to have an indicator of the phase of the tide, which would be easily visible without having to examine the gearing. For this a counter, having twenty-nine teeth in the escapement wheel, which carried a long

finger over the face, was constructed by Mr. Greenshields, and worked well, proving a great convenience.

§ IV.—DESCRIPTION OF THE EXPERIMENTS ON THE MOVEMENT OF SAND IN A TIDEWAY, FROM SEPTEMBER 4, 1890, TO AUGUST 1891.

14. *Experiment III., Plan 1, Tanks E and F, Plate V.*—These experiments were intended as a repetition of Experiments I. (Second Report, p. 528), which were only continued to 36,000 tides. The only difference in the conditions being that, while in Experiment I. the sand was initially laid up to the top of the river, Section 38, in Experiment III. the sand was only laid up the river to Section 13. These experiments were carried on during the vacation, Mr. Foster kindly keeping the tanks running and reading the counters daily. In this way 47,000 tides were run in tank E, and 66,000 in F, when the surveys for Plan 1 were taken.

These surveys show a rather more advanced state than is shown in Plan 2, Experiment I., but they present exactly the same characters. In tank E the sand in the estuary is slightly lower in the longer experiment than in the shorter, but shows the same distribution. In both experiments in tank E the level of the sand at the mouth of the river is that of mean tide, and in both experiments the level of the sand reaches the H.W.L. in the generator at Section 11, or 13 miles up from the mouth, and in both the tide continued to rise to the top of the river.

In tank F, also, both experiments show the same general distribution of sand in the estuaries and river. In the estuary the phenomenon previously observed with a low value for the criterion, namely, the large ripple, is more pronounced in the longer experiment; but in both experiments the river has become barred at an early stage, showing that the conditions in F during the formation of the estuary have been below those essential for similarity.

The rise of tide observed at the end of the Experiment III. in both E and F is below those observed at the earlier stages. In tank E the rise of tide with the same rise in the generator has fallen to 0.125 foot at 47° tides, though it was 0.140 foot at 32,000, and 0.095 foot at 66,000 in F, against 0.096 foot at 32,000. This phenomenon, which becomes more pronounced in some of the later experiments, is accounted for by the improved tideway as the experiment gets older, allowing the estuary to empty itself more completely. It requires notice, since it renders estimates, such as the value of the criterion of similarity based upon the rise of tide, difficult. The same quantity of water passes up and down the estuary, but does not effect the same rise of tide at the generator, which falls as the experiment gets older, while the rise of tide up the estuary increases at the same time.

15. *Experiments on Increased Length of Tidal River. Experiments IV., E and F, with Land Water, Plates VI., X., and IV., October 22 to November 17, 1890.*—The sand laid 0.333 foot in E, and 0.187 in F from Section 13 up the river to Section 26 down the estuary. Mean rise of the tide, 0.310 in E, 0.197 in F. Rise of the generators the same as before, periods 33.47 in E, 22.21 in F.

The conditions were thus the same as in Experiment III., with the exception that the tidal periods were reduced in the ratio 1 to $\sqrt{2}$. As reduced to a 30-foot tide, this would have the effect of increasing the horizontal scales in the ratio $\sqrt{2}$ to 1. Thus, while in Experiment III.

the estuaries from generator to mouth of tidal river represented about 50 miles, and the rivers 54 miles; in Experiment IV. the estuaries were 70, and the rivers 76.

With the same tide at the mouth the elongation of the estuary would cause the tide to rise higher at the mouth of the river, but as there was only the same quantity of water from the generator the tides with the longer estuaries were smaller at the generators, which would again diminish the tides at the mouths of the rivers. The tides observed at the mouths of the rivers were somewhat higher than in Experiment III. And this fact must be allowed for in considering the results as representing the effect of increasing the lengths of the rivers on the distribution of sand.

In tank E the effect was very remarkable. For the first 5,000 tides the sand rose up the river as far as it was laid, the head of the sand gradually going forward, and the sand falling at the top of the estuary and in the mouth of the river. Somewhat the same appearances appeared in tank F, though it soon became apparent that the advance of the head of the sand was much slower in F, and also the lowering of the sand at the top of the estuary. Sand was going up the river, but it accumulated in the lower reaches.

In E at 9,000 tides there was an almost sudden change; the sand in the river was rapidly carried to the top, leaving the lower reaches empty. After 11,000 tides the bottom of the river was swept clean from the mouth to Section 15 (30 miles), and then a steady downward movement of the sand went on all down the estuary until there was deep water all the way down from 10 miles below the head of the river. The clearing of the bottom of the river of sand evidently increased the action of the river, increasing greatly the rise of tide.

In tank F the result was very different; instead of the sand shifting suddenly up the river, the sand reached Section 15, and then barred the river at Section 11, the river then gradually filling up. At 38,000 tides, when the second survey was made, the tide was still rising at the top of the river, and the head of the sand still proceeding forwards. The experiment was continued to 81,000 tides, and the head of the sand reached Section 19, the tide still rising at the head very slightly. This shows that the conditions of similarity were more nearly fulfilled in the river in tank F in this experiment than in III. The values of the criterion, however, given in the table are lower in IV. than in III. This is because these values are calculated from the rise in the generators which were in these experiments 0.110 in tank E and 0.081 in F, against 0.125 and 0.095 in Experiments III. With the same water going out of the generator there must have been higher tides at the mouths of the rivers in IV., and as the vertical exaggeration in Experiment IV. was $\sqrt{2}$ times larger than in I. and III., assuming the rise of tide in tanks E and F, Experiments III. and IV., to be as in Experiments I., the values of the criterion in Experiments IV. would be at least 0.261 and 0.103. This is in accordance with the observed results.

It seems therefore that in order to apply the criterion to the conditions of similarity at the top of a long estuary with a tidal river the actual rise of the tide at the mouth of the river should be taken in estimating the value of the criterion for similarity at these points. It appears however that in no case has the criterion estimated from the tides in the generator exceeded the value .09, but what the condi-

tions of similarity have been fulfilled, while in no case has it fallen decidedly below this value without decided symptoms of dissimilarity having appeared, so that this value for the criterion seems to be established as a good working rule for the formation of an estuary from sand at the level of half-tide.

If the bottom of the estuary is modelled the case is different, but the occurrence of large ripples, in experiments in tank F and in Experiment V. in tank E, when the value of the criterion fell as low as .08, shows that the similarity of the ripple depends on the same value of the criterion as the formation of the estuary.

16. *Experiments with Limiting Value of Criterion.—Experiment V. with Land Water, Tank E, Plates VII., VIII., and XI., from November 20 to December 24.*—The conditions of this experiment were designed to bring the value of the criterion, estimated from the rise of tide in the generator in the final condition of equilibrium, to 0.09, keeping the horizontal scale as nearly as possible the same as in IV., and diminishing the rise of tide so as to increase the proportional depth of sand in the river, and thus prevent the bottom being swept clean when the final condition was reached.

The length of the crank working the generator in IV. had been 4.437 inches; this was reduced to 3.77 inches in V., reducing the rise of the tide in the ratio 0.85. To keep the horizontal scale the same the period 33.3 seconds was increased to 36 seconds, leaving the product $p\sqrt{h}$ constant.

This reduced the vertical exaggeration e in the ratio 0.85. Thus the value of h^3e is reduced $(0.85)^4$ or 0.52.

Now the value of the criterion in Experiment IV. just before the bottom was swept with sand was greater than 0.18, which, multiplied by 0.52, gives 0.093.

As carried out at the final condition shown in Plan 3, Plate VIII., the period was 35.6 seconds, the rise of tide 0.107, and the value of the criterion 0.0912.

This low value of the criterion showed itself in the rate of progress of the experiment. It was 13,000 tides before the sand in the river reached Section 19, against 4,000 in Experiment IV., and 25,000 against 9,000 in IV. before reaching the head of the river. In the early stage of the experiment it seemed doubtful whether the sand was going to bar the river as in Experiment IV., tank F. Except in rate of action, however, the motion of the sand followed the same course as in Experiment IV., taking a sudden shift at about 20,000 tides, and then rapidly lowering the sand at the head of the estuary. At the mouth of the river the bottom of the tank was reached after 50,000 tides, but only between the ripple bars, so that it was not swept clean.

The ripples in this experiment were very much larger than anything before in tank E, showing that the criterion was approaching its critical value.

The final condition of the estuary, as shown in Plan 3, after 36,000 tides, shows conclusively the effect of the upper tidal water in a long river on the bed of the lower estuary. Below Section 19, 32 miles from the top of the river, there is no sand above the level of low water in the estuary, and from this the sand falls uniformly to the mouth of the river, where there is a depth of water, at low tide, of 30 feet. In the head of the estuary there is a bar the top of which is only 12 feet below low water; this is at Section 9, or 18 miles below the mouth of the river; below this point the sand gradually falls to the generator.

Comparing this with the results in Experiments I. and III., where the reduced length of the river is only some 50 miles, but in which the rise of tide at the mouth of the river was somewhat greater, the effect of the extra 20 miles length in the river is seen to have improved the general and navigable depth of the river and estuary from the top of the river to a distance of 40 miles down the estuary by from 40 to 30 feet.

17. *The effects of dredging in the river, Experiment V., in Tank F, from November 19 to December 23, 1890, Plan 3, Plate VIII.*—The initial conditions of this experiment were the same as those of Experiment IV. in tank F, except that the mean level of the tide was raised to 0·016 above the initial level of the sand, and the period was increased from 22 to 23·3 seconds. The experiment was undertaken with the intention of ascertaining (1) whether raising the mean level of the tide above the initial level of the sand without altering the rise of tide would prevent the river becoming barred; and, supposing this did not succeed, (2) to ascertain whether, if the bar which had hitherto formed in the river during the early stages of the experiments in tank F were kept down by dredging out the sand as it rose above the initial level, the later stages would follow the same course as in tank E.

The results were remarkable, and bring out the critical character of the conditions at the mouth of the river.

The experiment was allowed to run 30,000 tides, during which the progress of the sand was much more rapid than in IV., reaching Section 19 in 6,000 tides, as against 36,000 in Experiment IV. and 13,000 in Experiment E, V., and reaching Section 23 in 16,000. At this point it stuck, and the sand accumulated at the head of the estuary and in the river, which became barred at Section 19, on reaching 30,000 tides.

It thus appears that lowering the initial level of the sand produced an effect on the first action very nearly equal to increasing the rise of tide by double the amount, but that as the sand distributed itself this effect passed off.

At 30,000 tides the bar in the river was dredged down to the initial level of the sand, and this level was maintained by daily dredging till 70,000 tides had been run, 0·08 cubic foot of sand in all being removed.

At this stage the sand in the river suddenly shifted up to the top as in Experiments IV. and V., E. The sand at the mouth of the river and top of the estuary falling until the bottom appeared, dredging was discontinued. At 95,000 tides the final condition had been reached, which was almost identical over the whole estuary with that of Experiment V. E after 60,000 tides, as shown in Plan 3, Experiment V., E and F.

The instability of the condition which may prevail at the mouth of a river is thus clearly shown, as well as the useful effect of improving the tideway by dredging in the upper reaches in the river. In three experiments in tank F, I., III., and IV., the river became completely barred, and the estuary became a bay with a stream of land water entering at its top; in Experiment V. the bar again formed, but on being kept down by dredging to the level of half-tide till the sand had fallen at the head of the estuary, the river at length prevailed, and the sand was washed out till there was 30 feet of water at low tide.

The time and amount of sand removed in producing this effect were considerable. The tidal capacity of the river and estuary is 1 cubic foot; this reduced to a 30-foot tide is 21,700 million cubic yards, or on a 15-foot tide is 5,422 million. The amount of dredging, 0·08 cubic foot in

all, represents 1,743 million cubic yards on a 30-foot tide, or 437 million on a 15-foot tide. This was distributed over 40,000 tides, or sixty years, so that even with the 15-foot tide it would represent 7 million cubic yards a year.

After the dredging the rise of tide fell from .081 to .073 foot, which would result from the lowering the sand which was above low water.

18. *Experiments with Training Walls. Experiment V. (continued) with Training Walls, Tanks E and F, from January 7 to February 20, 1891. Plan 4, Plate XII.*—Having arrived at similar final conditions of equilibrium in tanks E and F, in which the sand was entirely below low water from Section—19 up the rivers (32 miles from the top of the river) to the generators, and in which there were bars in the estuary below the mouths of the rivers, reducing the depth of water at low tide from 28 feet in the river to a minimum of 12 on the top of the bars, it seemed an opportunity not to be lost for testing the similarity of the effect in the two tanks of prolonging the rivers by training walls through the bars.

With this view walls of thick paper saturated with paraffin pushed vertically into the sand and extending up to low water were run out from the end of the river, preserving the same divergence as the walls of the river to Section 22, or 40 miles on a 30-foot tide, the tanks being stopped for the purpose.

These walls produced no apparent effect whatever on the depth of sand between the walls, during 20,000 or 30,000 tides. They were then replaced at the upper end by walls of sheet zinc extending to half-tide, which did produce an apparent effect, inasmuch as the sand accumulated outside the walls, forming an apparent channel within; also the sand rose in the river, doing away with the appearance of a bar. These effects were similar in both models after 40,000 tides had been run.

The old walls were removed in both tanks and replaced by walls commencing at $\frac{3}{4}$ tide at the mouths of the rivers, and falling during the first 4 or 5 miles to half-tide, at which they were continued to Section 22.

In tank E the walls were advanced gradually from the mouth of the river at a rate of about half a mile in 700 tides (year). The result of this is shown in Plan 4, Plate XII., tank E. There is no improvement in the navigable depth of the river.

In tank F the walls were put in and then the tops of the ripple bars were daily dredged off between the walls. This was continued for 100,000 tides, during which 5 per cent. of the tidal capacity was removed, or about 1,000 million cubic yards on a 30-foot tide, or 250 millions on a 15-foot tide, which represents 7 millions annually on the 30-foot tide, or 1.8 millions on a 15-foot tide. The effect, as shown in Plan 4, tank F, Plate XII., is to add some 20 feet to the depth on a 30-foot tide, or 10 feet on a 15-foot tide.

The silting up behind the walls is the same as in tank E, and the detriment to the navigable depth of the river is also similar.

19. *Experiment V. (continued) with Tide deviating from the Simple Harmonic in Tank E, February 23 to March 12.*—This was meant as a preliminary experiment. The balance of the generator was altered to give a rise of tide in 17 seconds and a fall in 20. The experiment was run for about 40,000 tides, and a survey taken, which showed little or no effect. On carefully examining the tide curves it was found that they

showed very little inequality in the rise and fall. On attempting to increase this by further altering the balance, it was found that this could not be done. To continue this part of the investigation it would have been necessary to introduce complex gearing. Time did not suffice for this, and the study was not carried further.

20. *Experiments with Tides varying from Spring to Neap, Tank E, V., VI., VII., VIII., Tank A, XIII. Plates X., XI., XII., and XIV., March 20 to August, 1891.*—The gearing for tank E having been modified so as to cause a rise in the generator, varying to over an interval of 29 tides, the variation being harmonic and adjustable, so as to admit of any relation between the maximum and minimum rise.

These were adjusted so that the mean rise was the same as the rise in Experiment V., the spring and neap rises being in the ratio 3 to 2. A drain with an adjustable orifice was put in the bottom of the tank to drain off nearly all the fresh water, and the scummer adjusted so as to draw off the excess of land water at low spring tide level; this being adjusted by trial until when running the mean tide level was the same as before.

Experiment V. was then restarted without the sand having been disturbed to afford a preliminary trial of the *apparatus*, the period being that of Experiment V., 36 seconds. This was continued 18,000 tides, till the apparatus was completely in hand; then the sand was relaid for Experiment VI., Plan 2, Plate X., in which the conditions were the same as V., except the tide. The mean rise in the generator was the same in VI. as in V., and the ratio of the spring and neaps 3 to 2. This brought the rise in the generator at spring tides in VI. greater than that in Experiment IV., in the ratio of 1.1 to 1. The action on the sand was much more rapid than in Experiment V. with the uniform tide being nearly as quick as in IV. The sand reaching the top of the river in 13,000 tides, as against 10,000 in IV. and 25,000 in V., and the bottom of the river being swept as clean in 17,000 tides in VI., as in 14,000 in IV. In other respects the action in VI. very closely resembled that in IV. The rate of action was a little slower, but the action itself seemed rather stronger, as corresponding to a higher tide. Surveys were taken at 20,000 and 34,000 tides. The experiment was then stopped, in order to make the conditions comparable with those of Experiment V; it being quite clear that the action of spring and neap tides, having a mean rise equal to that of a uniform tide, was not only much more rapid, but led to a different state of final equilibrium.

Experiment VII., Plan 1, Plate XI.—In this the tide was adjusted until the rise of the generator at spring tide was the same as that for the uniform tide in V., the other conditions being all the same.

The character of the action now became identical with what it had been in Experiment V., but the rate was decidedly slower. Thus the sand moving up the river reaches:—

Section 19 after 13,000 in V. and 39,000 in VI.
 ,, 27 after 20,000 ,, ,, 51,000 in VI.

The survey taken after

18,000 tides in Experiment V, Tank E, and
 51,000 ,, ,, ,, VII., ,,

are almost identical, the latter being a little the forwardest.

It thus appears that spring and neap tides, having a ratio 3 to 2, produce the same result as *two-fifths* the same number of tides all springs.

So far neither of these estuaries had reached the condition of final equilibrium, but the similarity that the Plans 1, Experiments V. and VII. present seemed sufficient assurance that this would be the same.

It was intended to repeat Experiment V., tank A, as soon as the tank had been re-formed to its rectangular shape; in the meantime groins were introduced in tank E similar to those which had been used in Experiment VI. F, and Experiment VII. E was continued to ascertain how far similar effects would be produced by varying and uniform tides in estuaries with similar but boldly irregular outlines.

Experiment VII. E, Plan 4, Plate XIII. was continued with groins to 123,000 tides. Similar groins had affected the condition of the sand in the estuary and river in Experiment VI., tank F, so that further comparison between Experiments VII. and V. cannot be made.

Experiment XIII., Tank A, rectangular without land-water, spring and neap tides, Plan 3, Plate VIII, from July 10 to August 10, 1891.—In this experiment the rates of spring and neap tides were 3 to 2, and the rise of tide at spring tides was 0.176, the same as in Experiment V., tank A. The tank was reduced to its original rectangular form (Report I.), namely, 4 feet broad, and 12 feet from the generators to the top. The sand was laid as in Experiment V., tank A, at a depth of 2 in. from Section 18 to the top of the tank, and the mean tide was adjusted as in Experiment V., tank A. The period was 50 seconds, as in tank A. Thus the conditions of Experiment XIII. and V., tank A, were precisely the same, with the exception that while the tides in Experiment V. were all springs, those in Experiment XIII. varied from springs to neap; the object of Experiment XIII. being to compare the rate of action and final condition of equilibrium with varying tides with the very definite results obtained as to the slopes of the sand obtained in the rectangular tanks and recorded in Report I., B.A. Report, 1889.

These results are shown on Plate VIII. The period in Experiment XIII., tank A, being shorter than in V. The actual slope is greater but the slopes reduced to a 30-foot tide agree.

21. *Experiments on Estuaries not Symmetrical. Experiment VI., in Tank F, with large groins, Plans 1 and 4, Plates XII. and XIII., from April 8 to June 16.*—This experiment was started under conditions in all respects similar to those in Experiment V., tank F, with the exception of a vertical groin extending from the right bank to the middle of the estuary, with an inclination of 45° towards the generator, and rising from the bottom of the tank above high water. This groin, which appears in the charts to represent an artificial structure, is, in fact, out of all proportion to anything of that kind which has yet been attempted. As reduced to a 30-foot tide, it is 11 miles long, 100 feet high up to H.W.L., and half a mile broad. Thus it corresponds rather to such a natural feature as Spurn Head, at the mouth of the Humber, than to a break-water such as that at Harwich.

In starting the experiment, the end of the sand at Section 26 was 20 miles above the point of the groin at Section 36. The groin had deep water on both sides of it, so that its only effect was to deflect the flood on to the left bank of the estuary.

This effect was very decided, the strength of the flood on the right

carrying the sand up the estuary in spite of the effect of the ebb to bring it down. But this in itself was not so much; it was the large eddy caused by the groin which produced the greatest effect. The water entering on the left of the estuary crossed over to the right, and returned along the right bank. In other words, during flood the right side of the estuary for 30 miles from the generator was in back water. This back water also gave the ebb a start down the right bank which rendered the ebb stronger on this side.

The sand came down rapidly on the right side, and besides was carried over from the left to the right, and formed a bank along the right middle of the estuary, reaching the generator after a very few tides. Round this bank the water circulated, carrying the sand with it up on the left and down on the right, the bank growing all the time. The ripple round this bank was very striking, arranged with the ripple heads all down on the right side and up on the left. After about 3,000 tides the sand began to pass from the point of this bar in a fine stream across the open channel, dividing this point from the point of the groin, and commenced the formation of a bank in the generator corresponding to that in the tank. This bank had to be removed from the generator, and after 6,000 tides 4 lbs. of sand were so removed. In Experiment V. the first sand removed from the generator was after 120,000 tides had been run.

The sand also went more rapidly up the river in Experiment VI. than in Experiment V. But this was accounted for by dredging in the river having begun much earlier, after 20,000 tides as against 30,000.

In all 8 lbs. of sand were removed from the river in Experiment VI., against 10 lbs. in V., or about 0.004 of the tidal capacity in VI. against 0.08 in V. In both cases the dredging stopped when the sand began to shift up the river after 70,000 tides.

At 100,000 tides a condition of final equilibrium had been arrived at. The sand in the river was just the same as in V., Plan 3, Experiments V. and VI. in tank F. There is deep water in VI. up to Section 21, 30 miles from the generator, the levels of the sand being much the same from this point up as in V.

A similar groin was then introduced at Section 16, extending from the left bank to the middle of the estuary. This groin was $4\frac{1}{2}$ miles long and 100 feet high to H.W.L., and 50,000 more tides were run, the river all the time slightly improving. Thus having brought deep water up to Section 14, or about 44 miles from the generator, a groin extending from the right bank to mid-channel at Section 8, about 2.5 miles long and 70 feet high, and another from the left bank to mid-channel at Section 5, 2 miles long and 70 feet high, were put in.

The first effect of these groins was to raise the sand slightly in the mouth of the river; but this improved again, and after 50,000 more tides there was deep water extending from the mouth of the river to the generator, and the river was better than in Experiment V. with the training walls, though not quite so good as before these were put in.

In the meantime the banks had risen in the estuary below the groins, extending down from nearly H.W.L. to the point of the next groin, where there was a pass with water nearly to the bottom of the tank.

The sand carried down into the generator during the experiment amounted to 69 lbs., or 57 per cent. of the tidal capacity. In Experiment V. 24 lbs. were removed in like manner, or 20 per cent. of the tidal capacity.

and Results of Experiments.

Vertical exaggeration on a 30-foot tide <i>e</i>	Criterion of similarity		Height of initial sand in feet	Height of mean tide in feet	Excess of mean tide over initial sand in feet <i>d</i>	Number of tides from the start	Remarks
	$C = h^2$	$C' = (h + 2d)^2 e$					
62-00	0.121	—	0.333	0.322	—	47,183	Normal.
81-84	0.070	0.070	0.187	0.187	—	66,369	River blocked.
85-63	0.167	—	0.333	0.310	—	18,530	River cleaned.
104-57	0.057	—	0.187	0.182	0.005	21,135	River blocking.
80-98	0.108	—	0.333	0.308	—	37,755	River cleaned.
104-73	0.056	—	0.187	0.179	0.008	38,719	River nearly blocked.
79-53	0.144	—	0.333	0.336	—	17,923	Slow.
96-82	0.049	—	0.187	0.203	0.016	19,416	Quicker.
77-88	0.124	—	0.333	0.321	—	37,359	River cleaned.
98-32	0.050	0.165	0.187	0.203	0.016	37,181	Blocking—Dredged.
74-48	0.091	—	0.333	0.320	—	65,404	River clear.
93-49	0.035	—	0.187	0.207	0.020	95,558	River clear.
75-18	0.097	—	0.333	0.306	—	167,186	} Similar.
91-32	0.030	—	0.187	0.204	0.017	255,200	
73-08	0.080	—	0.333	0.335	—	208,264	Failure.
81-47	0.170	—	0.333	0.328	—	226,930	Preliminary.
84-46	0.2268	—	0.333	0.325	—	20,822	Quick.
79-33	0.1336	—	0.333	0.317	—	34,394	River clear.
81-00	0.1507	—	0.333	0.333	—	51,591	Normal.
76-60	0.1017	—	0.333	0.332	—	101,790	—
"	"	"	"	"	"	122,989	—
91-01	0.0299	—	0.187	0.192	0.005	18,972	—
93-60	0.0360	—	0.187	0.193	0.006	36,511	—
93-33	0.0284	—	0.187	0.193	0.006	99,558	—
91-66	0.0314	—	0.187	0.192	0.005	196,651	—
68-54	0.3084	—	0.250	—	—	51,240	} Similar.
69-16	0.3769	—	0	—	—	16,282	

city. 37 per cent. of the tidal capacity on a 30-foot tide would represent a mean increase of depth over the entire estuary of 11 feet; and as the increase was by no means over the whole estuary, the increase in the channels and lower estuary was much more than this, and although by this time the sand in the estuary had for the most part become quite yellow, sand was still being carried down into the generator.

In the meantime, as already stated, groins similar to those in Experiment VI. in tank F, had been introduced into experiment VII. in tank E, after 64,000 tides had been run with spring and neap tides. 60,000 more tides, which would be equivalent to about 27,000 spring tides, were run, the effect being that, notwithstanding the difference in the initial conditions, the state of the lower estuary was closely approximating to the state of VI. in F after 36,000 tides (Plan 2, Experiment VII., tank E; VI., tank F).

In the upper estuary in VII., tank E, the distribution of the sand is precisely similar to that in VI., tank F, but there is rather more of it, which is explained partly by the fact of the difference in the equivalent tides run, 30,000 in E as against 50,000 in F, after the upper groins were put in, and partly by the much greater amount of sand still left in the lower estuary in tank E. Had it been possible to run 250,000 more spring and neap tides in VII., tank E, there is every reason to suppose the final condition would have been precisely similar to that obtained in Experiment VI. in tank F.

Report of the Committee, consisting of Professor FLOWER (Chairman), Dr. GARSON (Secretary), Dr. BEDDOE, General PITT-RIVERS, Mr. FRANCIS GALTON, and Dr. E. B. TYLOR, appointed for the purpose of editing a new Edition of 'Anthropological Notes and Queries.'

THE Committee has to report that during the past year material progress has been made in the work of editing the new edition of 'Anthropological Notes and Queries.' The whole of the work is now in the press, and so far advanced that it has been possible to present an advanced copy to the Association along with this report.

The editors are of opinion that the value of the work would be enhanced by the addition of some additional illustrations to the first part—Anthropography.

The Committee considers the plate illustrating the colour of eyes, hair, and skin—also submitted to the Association—a decided advance upon anything that has been hitherto done in that way, and has every confidence that if a further sum is placed at the disposal of the editors for illustrations it will be spent to the best advantage.

The Committee request to be reappointed, and that a further sum of 20*l.* be placed at its disposal for illustrations.

The Committee in conclusion reports that best thanks are due to the Anthropological Institute of Great Britain and Ireland (under the auspices of which body the work is being edited) for undertaking

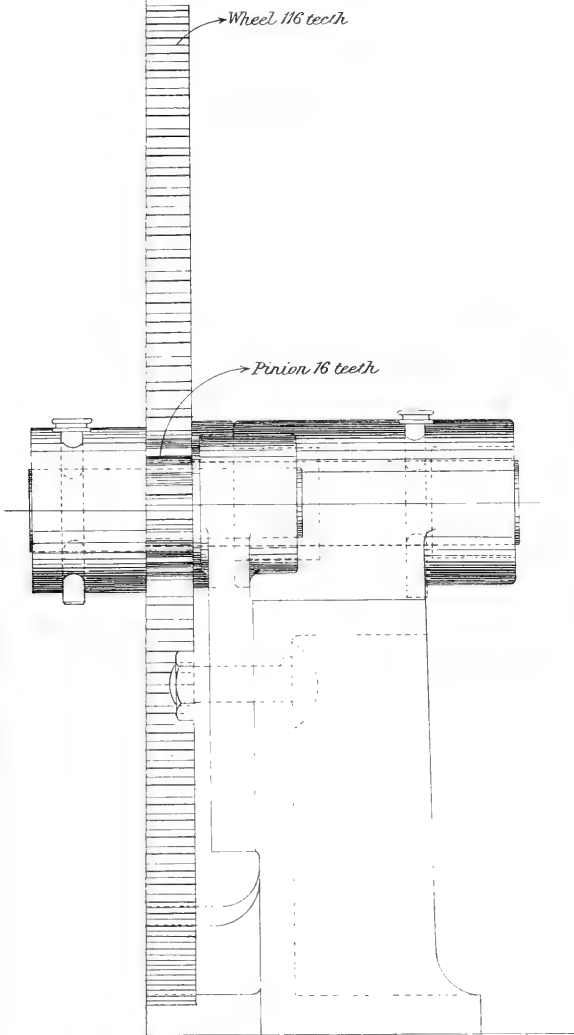

urrents on the



Illustrating the Report of the Committee for investigating the action of Waves and Currents on the Beds and Foreslopes of Estuaries by means of Working Models.

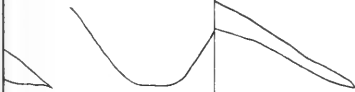

k E, Experiment VI

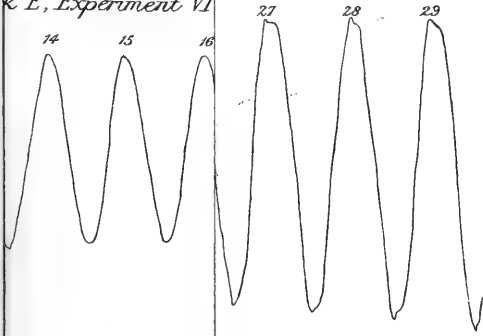

E, Experiment VII.

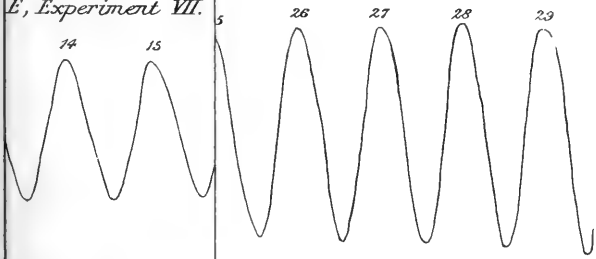

Tide Curves.
(aves and Currents a

would represent
feet; and as the
increase in the
and although by
it become quite

those in Exper-
ment VIII in the E.
m. 500,000 more
inches, were run,
the initial condi-
tion of the water in
tank VIII, tank

of the sand is
other more of it,
the equivalent
of the amount
of sand left in the
in 250,000 more
inches to suppose
that obtained in

Lower (Chas-
es) Pitt-Rivers,
ointed for the
ological Note

material progress
Anthropological
be press, and so
need copy to the

work would be
one to the first

out of eyes, hair,
distance eyes, hair,
every confidence
more for illustra-

a further sum of
are due to the
and under the
for end-raking

Fig. 1. Experiment I



Fig. 2. Experiment II



Fig. 3. Experiment III



Fig. 4. Experiment IV

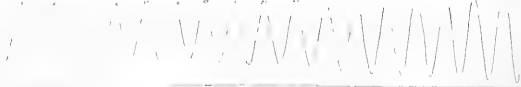

July Curves

Illustrating the Report of the Committee for investigating the action of Waves and Currents on the Beds and Foreshores of Estuaries by means of Working Models.

61st R.

54 Sec^s

The

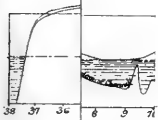
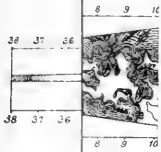

Sec^r

The fig^s

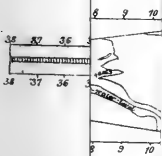

I.

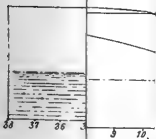

WITH LAND WATER
and Adjustment of Flow of the Bay at 24 H.



WITH LAND WATER

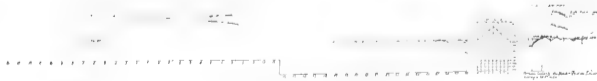

and Adjustment of Flow of the Bay at 24 H.

Illustrations the Report of the Committee for Investigating the action of Waves and Currents on the Beds and Foreshores of Estuaries by means of Working Models

The fig

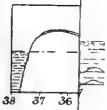
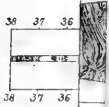

Sec

The

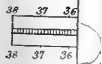

WITH LAND WATER

Table I. Experiment II. The effect of the tide on the water level.

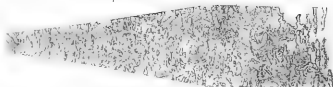

Table I. Experiment II. The effect of the tide on the water level.



When the tide is in the basin the water level is higher than when it is out.

WITH LAND WATER

Table I. Experiment II. The effect of the tide on the water level.

The effect of the tide on the water level in the basin.



Table I. Experiment II. The effect of the tide on the water level.



Low Water level

The effect of the tide on the water level in the basin.

The illustration shows the motion of Waves and Currents on the Beds and Foreborders of Estuaries by means of Working Models.

61st R. 24 31

1

2



3



24 31

The figure

4



5

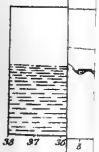

6



WITH LAND WATER

The U.S. Geological Survey, Washington, D.C.

U.S. GEOLOGICAL SURVEY, WATER RESOURCES DIVISION

PLATE I. MODEL OF AN ESTUARY



Fig. 1. Model of an estuary.

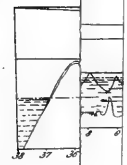
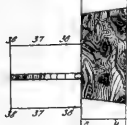

Fig. 2. Model of an estuary.

Illustrating the Report of the Committee for investigating the action of Waves and Currents on the Beds and Foreshores of Estuaries by means of Working Models.

Sec. 9

The



Sec. 10

The

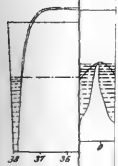
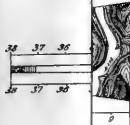

12

W. H. AND WATER

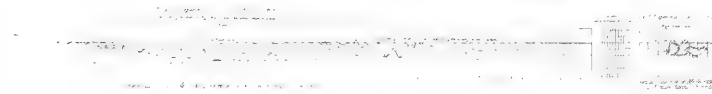

WITH LAND WATER

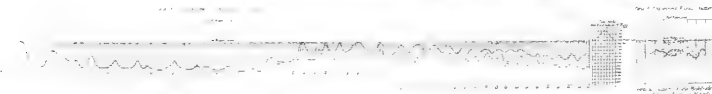

Illustrating the Report of the Committee for investigating the action of Waves and Currents on the Beds and Foreshores of Estuaries by means of Working Models.

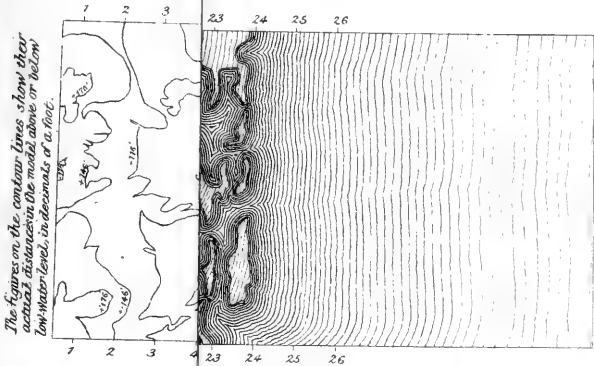

Tank Tank A Experiment V, Cross Section 1.

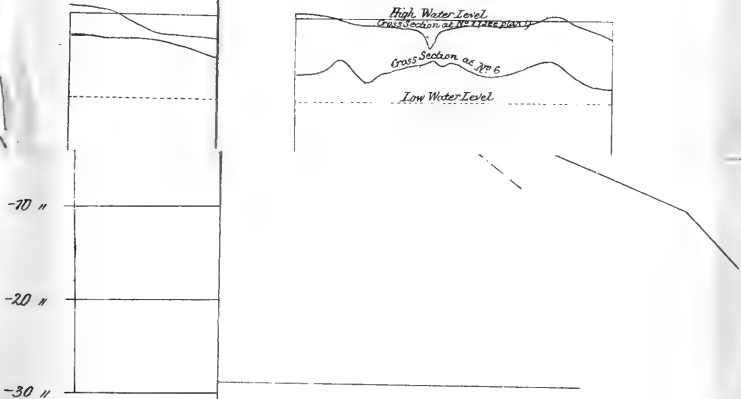

Illus and Currents on the Beds

dels.

at 49.3 Sec^s at 49.3 Sec^s

WITH UNIFORM TIDES

Tank A Experiment V Plan I After 1200' Ebb at 55' Sea + 5' Water to ...

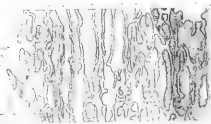

Tank A Experiment V, Longitudinal Section I

Tank A Experiment V, Cross Section I



Model - sides of an Estuary having a 30° side

Vertical Scale - 4" of Model = 1' of Estuary having a 30° side

WITH SPRING AND NEAP TIDES

Tank A Experiment XIII Plan III After 1200' Ebb at 55' Sea + 5' Water to ...



Tank A Experiment XIII, Longitudinal Section III

Tank A Experiment XIII, Cross Section III



Model - sides of an Estuary having a 30° side

Vertical Scale - 4" of Model = 1' of Estuary having a 30° side

Diagram of Actual Slopes with a vertical exaggeration of 20

Diagram of Actual Slopes with a vertical exaggeration of 20

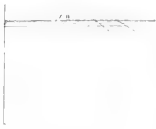
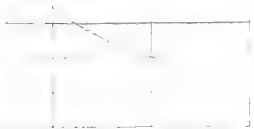

Tank A, Experiment V, Plan I
XIII, = III

Illustrating the Report of the Committee for investigating the action of Waves and Currents on the Beds and Foreshores of Estuaries by means of Working Models



Tab. 2 Experiment B. Plan of the distribution of the water

... ..

...



Tab. 3 Experiment B. Plan of the distribution of the water

Horizontal scale = 1/100000 feet

Tab. 4 Experiment B. Plan of the distribution of the water

Water level 0.075 feet above bottom of tank

Tab. 5 Experiment B. Plan of the distribution of the water

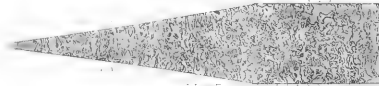

Horizontal scale = 1/100000 feet

Tab. 6 Experiment B. Plan of the distribution of the water



Illustrating the Report of the Committee for investigating the action of Waves and Currents on the Beds and Foreshores of Estuaries by means of Working Models.

61st

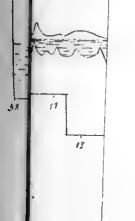
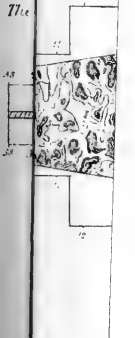



Fig. 1. Plan view of the model bed.

Illustrating the Report of the Committee for Investigating the action of Waves and Currents on the Beds and Foreshores of Estuaries by means of Working Models.

The figures on

12 13

11



37 36 35

37 36 35

11

12 13

wall



37 36 35

11

12 13

9

12 13

figures on

11



37 36 35

37 36 35

11

12 13



37 36 35

11

12 13

1/39700 of an



WITH LAND WATER

Test F Experiment 4, 1/2 to 1/4 Scale, 1/100 Scale at 1000



WITH LAND WATER

Test F Experiment 4, 1/2 to 1/4 Scale, 1/100 Scale at 2000



Test F Experiment 5, 1/2 to 1/4 Scale, 1/100 Scale

Test F Experiment 5, 1/2 to 1/4 Scale, 1/100 Scale

Vertical Scale, 1/2 to 1/4 Scale, 1/100 Scale at 1000

The figures on

37 36 35 34

37 36 35 34

37 36 35 34

37 36 35 34

The figures

37 36 35

37 36 35

37 36 35





Fig. 1. Cross-section of estuary bed and foreshore.



Fig. 2. Cross-section of estuary bed and foreshore.

Fig. 3. Cross-section of estuary bed and foreshore.

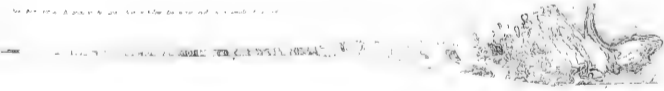

Fig. 4. Cross-section of estuary bed and foreshore.

Illustrating the Report of the Committee for investigating the action of Waves and Currents on the Beds and Foreshores of Estuaries by means of Working Models.

6.72 Secs

9 10

38 37 36



38 37 36

9 10



38 37 36

9 10

24.79 Secs

9 10

38 37 36



38 37 36

9 10



38 37 36



Part I Experiment II Plate B. 100-11, 100 fathoms of S. W. 100'



Ship, with 100 fms. of water, showing the hull.

WITH LAND WATER
Part I Experiment II Plate B. 100-11, 100 fms. of S. W. 100'



Part I Experiment II Longitudinal Section B



Horizontal Section of the Hull, with an Airway, showing a 100 fms.

62nd



Link C Experiment II Longitudinal Section II

Mark Water Level when in a Bay

See Water Level when in a Bay

Link E Experiment III Longitudinal Section I

Mark Water Level when in a Bay

See Water Level when in a Bay

Link E Experiment II Longitudinal Section II

Mark Water Level when in a Bay

Edal Bay

Illustrating the Report of the Committee for investigating the action of Waves and Currents on the Beds and Foreshores of Estuaries by means of Working Models.

the publication of the work and defraying the expenses thereof, which must be very considerably in excess of the contributions made by the Association.

Report of the Committee, consisting of Professor FLOWER (Chairman), Dr. GARSON (Secretary), Mr. BLOXAM, and Dr. WILBERFORCE SMITH, for the purpose of carrying on the work of the Anthropometric Laboratory. (Drawn up by Dr. GARSON, Secretary.)

THE Committee has to report that at the Leeds meeting of the Association last year excellent accommodation near the reception room was provided by the Local Committee for the anthropometric laboratory. The services of a clerk were, as previously, placed at the disposal of the officers of the Anthropological Section, under whose supervision the work of the laboratory was carried on. By the kind permission of Mr. Francis Galton, F.R.S., the services of the superintendent of his laboratory at South Kensington, Sergeant Randall, were again available to carry on the work of the Association laboratory.

The measurements and observations made in the laboratory were the same as last year, except that the length of the hand was substituted for that of the middle finger, and the form of the profile of the nose was added. They consisted of the age, sex, birthplace, colour of eyes, hair; profile of nose; height when sitting, kneeling, and standing; vertical distance from vertex to tragus, mouth, and chin; length and breadth of head; length and breadth of nose; length and breadth of face (nasio-mental and bizygomatic respectively); length of cubit and of hand; span of arms across the back; weight in ordinary clothing; strength of pull with each hand; vital capacity of lungs; strength of vision with each eye, and sense of colour; and in males the maximum and minimum circumference of the chest during inspiration and expiration. A duplicate form of these observations was handed to each person who was measured. The total number of persons measured was 135, of these 95 were males and 40 were females. The number of applicants for measurement was greatly in excess of those who could be measured, so that with a larger staff of assistants in the laboratory many more observations could have been obtained.

The Committee acknowledges with thanks the use of Stanley's new medical spirometer for testing the breathing capacity, which was kindly placed at its disposal by the manufacturer, Mr. H. T. Tallack, of 28 Hatton Garden, London. After some preliminary comparison of results obtained from Hutchinson and Lowne's spirometers and those of the new instrument, it was resolved to use the latter exclusively during the meeting. The experience gained from its use last year was so satisfactory that the Committee has arranged, by the kindness of the manufacturer, to use it again this year. The statistics of the observations made at the Leeds meeting have been worked up during the year after the manner adopted in the last two reports. The work of amalgamating the whole of the statistics of observations made at meetings of the Association is being proceeded with each year with a view, as soon as a sufficient number of

statistics have been obtained, to publishing the results in a more comprehensive form. It is also contemplated, when a sufficient number of cases have been obtained, to publish the proportions of the different parts of the body.

The measurements have hitherto been made as far as possible according to the metric system, that being by far the most convenient and universal form of measurement. As, however, many persons measured at the laboratory ask what the equivalent in English measurement is of these measurements a table has been drawn up which it is hoped will be of assistance to those who have not yet made themselves familiar with the more universal system of weights and measures.

Metrical Measurements and their equivalents in inches and half-inches.

mm.	inch	mm.	inch	mm.	inch	mm.	inch	mm.	inch
6	$\frac{1}{4}$	394	$15\frac{1}{2}$	800	$31\frac{1}{2}$	1,207	$47\frac{1}{2}$	1,613	$63\frac{1}{2}$
13	$\frac{1}{2}$	406	16	813	32	1,220	48	1,626	64
19	$\frac{3}{4}$	419	$16\frac{1}{2}$	826	$32\frac{1}{2}$	1,232	$48\frac{1}{2}$	1,639	$64\frac{1}{2}$
25	1	432	17	838	33	1,245	49	1,651	65
38	$1\frac{1}{2}$	444	$17\frac{1}{2}$	851	$33\frac{1}{2}$	1,258	$49\frac{1}{2}$	1,664	$65\frac{1}{2}$
51	2	457	18	864	34	1,270	50	1,677	66
64	$2\frac{1}{2}$	470	$18\frac{1}{2}$	877	$34\frac{1}{2}$	1,283	$50\frac{1}{2}$	1,690	$66\frac{1}{2}$
76	3	482	19	889	35	1,296	51	1,702	67
89	$3\frac{1}{2}$	495	$19\frac{1}{2}$	902	$35\frac{1}{2}$	1,309	$51\frac{1}{2}$	1,715	$67\frac{1}{2}$
101	4	508	20	915	36	1,321	52	1,728	68
114	$4\frac{1}{2}$	521	$20\frac{1}{2}$	927	$36\frac{1}{2}$	1,334	$52\frac{1}{2}$	1,740	$68\frac{1}{2}$
127	5	534	21	940	37	1,347	53	1,753	69
140	$5\frac{1}{2}$	546	$21\frac{1}{2}$	953	$37\frac{1}{2}$	1,359	$53\frac{1}{2}$	1,766	$69\frac{1}{2}$
152	6	559	22	966	38	1,372	54	1,778	70
165	$6\frac{1}{2}$	571	$22\frac{1}{2}$	978	$38\frac{1}{2}$	1,385	$54\frac{1}{2}$	1,791	$70\frac{1}{2}$
178	7	584	23	991	39	1,397	55	1,804	71
190	$7\frac{1}{2}$	597	$23\frac{1}{2}$	1,004	$39\frac{1}{2}$	1,410	$55\frac{1}{2}$	1,817	$71\frac{1}{2}$
203	8	610	24	1,016	40	1,423	56	1,829	72
216	$8\frac{1}{2}$	622	$24\frac{1}{2}$	1,029	$40\frac{1}{2}$	1,436	$56\frac{1}{2}$	1,842	$72\frac{1}{2}$
228	9	635	25	1,042	41	1,448	57	1,855	73
241	$9\frac{1}{2}$	648	$25\frac{1}{2}$	1,055	$41\frac{1}{2}$	1,461	$57\frac{1}{2}$	1,867	$73\frac{1}{2}$
254	10	661	26	1,067	42	1,474	58	1,880	74
267	$10\frac{1}{2}$	673	$26\frac{1}{2}$	1,080	$42\frac{1}{2}$	1,486	$58\frac{1}{2}$	1,893	$74\frac{1}{2}$
279	11	686	27	1,093	43	1,499	59	1,905	75
292	$11\frac{1}{2}$	699	$27\frac{1}{2}$	1,105	$43\frac{1}{2}$	1,512	$59\frac{1}{2}$	1,918	$75\frac{1}{2}$
305	12	711	28	1,118	44	1,524	60	1,931	76
318	$12\frac{1}{2}$	724	$28\frac{1}{2}$	1,131	$44\frac{1}{2}$	1,537	$60\frac{1}{2}$	1,943	$76\frac{1}{2}$
330	13	737	29	1,144	45	1,550	61	1,956	77
343	$13\frac{1}{2}$	750	$29\frac{1}{2}$	1,156	$45\frac{1}{2}$	1,562	$61\frac{1}{2}$	1,969	$77\frac{1}{2}$
356	14	762	30	1,169	46	1,575	62	1,981	78
368	$14\frac{1}{2}$	775	$30\frac{1}{2}$	1,181	$46\frac{1}{2}$	1,588	$62\frac{1}{2}$	1,994	$78\frac{1}{2}$
381	15	788	31	1,194	47	1,601	63	2,000	$78\frac{1}{2}$

Age.—The males examined varied in age from 18 to 75 years. Of these 2 were under 20 years, 24 between 20 and 30 years, 27 between 30 and 40 years, 13 between 40 and 50 years, 20 between 50 and 60 years, 7 between 60 and 70 years, and 2 from 70 years and upwards.

Birthplace and Residence.—The greatest number of both males and females from a single county were, as might naturally be expected, from Yorkshire, and particularly from Leeds; they number 38·9 per cent. of the whole number of males measured. Next in frequency come Lancashire and Middlesex, each with 8·4 per cent.; the Midland counties 7·3 per cent.; 3 per cent. from Scotland; 3 per cent. from Ireland; and the

remainder from various parts of England; except 6 per cent. who were from various parts of Europe. Of the females 42·5 per cent. were from Yorkshire. As regards residence 80 per cent. of the males lived in towns and 20 per cent. in the country. Of the females 75 per cent. lived in towns and 25 per cent. in the country the principal part of their lives. In the class of society to which the persons measured belong, the place of residence has perhaps less importance than among working classes living under less favourable conditions.

Occupation.—A considerable proportion of the males measured were engaged in commercial pursuits, the others were chiefly professional men.

Seventh Report of the Committee, consisting of Dr. E. B. TYLOR, Mr. G. W. BLOXAM, Sir DANIEL WILSON, Dr. G. M. DAWSON, and Mr. R. G. HALIBURTON, appointed to investigate the physical characters, languages, and industrial and social condition of the North-Western Tribes of the Dominion of Canada.

INTRODUCTION BY SIR DANIEL WILSON.

THE report here presented is again the result of the work of Dr. Franz Boas in the interesting ethnological field of British Columbia. It consists of two parts, the first being devoted to the Bilqula, a people inhabiting a limited tract in the vicinity of Dean Inlet and Bentinck Arms, the second dealing with the physical characteristics of the tribes of the North-west Coast region.

In connection with the Bilqula it is important to note that they, by reason of their position, have held the most important natural pass and trade route through the Coast Range, from the ocean to the interior, which exists between the Skeena River and the Fraser, a distance exceeding 400 miles. This circumstance has rendered their situation a peculiarly favourable one in some respects. It has induced them to engage in intertribal trade, and evidently also affords a clue to some of the peculiarities which Dr. Boas points out. From time immemorial, as the writer is informed by Dr. Dawson, who has geologically examined that part of the country, a route has been beaten out by way of the Bella Coola River, thence northward to the Salmon River, and then along the north side of the Blackwater River to the Upper Fraser. This is commonly known by the Tinneh of the interior as the 'Grease Trail,' from the fact that the chief article of value received from the coast in early times was the oil of the olachen or candle-fish, though dentalium shells and other things were also brought in. When trading vessels began to visit the coast, besides the natural products of the sea, iron and various kinds of manufactured goods found their way into the interior by the same route; while the fine furs of the inland region were carried back to the coast and sold to the vessels. It was by this same route, well known to the natives, that Sir Alexander Mackenzie was enabled to complete the first traverse of the North American continent from sea to sea and to reach

the shore of the Pacific in 1793. As a result of this intercommunication between the Bilqula and Tinneh it is found that houses essentially similar to those of the Coast Indians in mode of construction and ornamentation, though smaller and less skilfully built, occur far inland on the upper waters of the Salmon and Blackwater Rivers; while, on the other hand, the practical identity of some points in the mythology of the Bilqula with that of the Tinneh of the interior is a clear instance of reciprocal influence.

The second part of the report will be found to contain the most complete series thus far obtained of anthropological measurements relating to the tribes of the North-West Coast, with a discussion by the author of the data which these afford, in which several points of value are brought out and important suggestions are made for further inquiry. In this connection it must be mentioned that the committee are much indebted to the courteous and enlightened liberality of Major J. W. Powell, Director of the U.S. Bureau of Ethnology, who has permitted Dr. Boas to incorporate with the measurements obtained in British Columbia those made by him in Washington and Oregon under Major Powell's directions. It has thus been possible for Dr. Boas to give to his treatment of this subject a comprehensive character, which could not otherwise have been obtained, by enlarging the scope of his discussion so as to include the more or less intimately related tribes of the Pacific States with those of the Province of British Columbia itself.

Third Report on the Indians of British Columbia.

By Dr. FRANZ BOAS.

The following alphabet has been used in the report:—

The vowels have their continental sounds, namely: *a*, as in *father*; *e*, like *a* in *mate*; *i*, as in *machine*; *o*, as in *note*; *u*, as in *rule*.

In addition the following are used: *ä*, *ö*, as in German; *â*=*aw* in *law*; *ë*=*e* in *flower* (Lepsius's *e*).

Among the consonants the following additional letters have been used: *g*, a very guttural *g*, similar to *gr*; *k*, a very guttural *k*, similar to *kr*; *q*, the German *ch* in *bach*; *h*, the German *ch* in *ich*; *q*, between *q* and *h*; *c*=*sh* in *shore*; *ç*, as *th* in *thin*; *tl*, an explosive *l*; *dl*, a palatal *l*, pronounced with the back of the tongue (dorso-apical).

THE BILQULA.

The Bilqula, who are generally called Bella Coola, are the most northern tribe belonging to the Salish family. They are separated from the tribes speaking allied languages by the Chilcotin (of the Tinneh stock) in the interior, and on the coast by the Kwakiutl. Their language is—considered grammatically—more closely related to the dialects of the Coast Salish than to those of the tribes of the interior. A number of terms referring to the sea and sea-animals are the same in Bilqula and in the dialects of the Gulf of Georgia; so that we may safely assume that the two groups of tribes were at one time closely related, and that the Bilqula were differentiated from this group. They inhabit the coasts of Bentinck Arm and Dean Inlet, as shown on the map accompanying the sixth report of the committee, and extend far up Bella Coola River. Since the end of last century they

have dwindled down in numbers, and a few only of their once populous villages are still inhabited, namely, Sātsq, at the head of Dean Inlet; Nūtl'ē'l, at the mouth of Salmon River; Nuqa'lkH (which embraces five villages, at the mouth of Bella Coola River; Stū'ih, twenty-eight miles up Bella Coola River; and Tā'lio, at the head of South Bentinck Arm. The dialect of Nūtl'ē'l and Sātsq differs slightly from that of the other villages. The following is a list of their ancient villages, most of which are still inhabited at certain seasons, although not regularly:—

1. Sātsq.
2. Nūtl'ē'l. The tribe of this place is called SōtslemH.
3. Nuqa'lkH, embracing the villages K'ōmkō'tēs and Stskē'etl on the north side, Pē'isela and NutHē'ih̄tskōnē on the south side of the river.
4. Sēnqtl.
5. Tsōmō'otl.
6. Snū't'elē.
7. Nū'kH̄its.
8. Ase'nanē.
9. Nuk'ā'aqmats.
10. Tsqoaqk'ā'nē.
11. Nū'sk'elst.
12. Nūtlē'iq.
13. Stū'ih, twenty-eight miles from the sea.
14. Snū'tl'elatl. Nos. 4 to 14 are situated along Bella Coola River, and are given as they are met with in ascending the river.
15. Slā'aqtl, at the confluence of Bella Coola and Driver (?) Rivers.
16. Tā'liō, at the head of South Bentinck Arm, embracing K'oa'pQ, Tā'lio, Nū'ik', A'sēq.
17. K'oa'tlna, at the bay of that name in the southern entrance of Bentinck Arm. On the north entrance of Bentinck Arm were the Kiltē'itl, but it is doubtful whether they belonged to the Bilqula or to the Hē'iltuk. The latter call the people of Dean Inlet Kī'mkuitq.

Each of these tribes is subdivided into gentes, which appear to be arranged in exogamic groups. I learnt the names of the following gentes, which bear the names of their ancestors:—

Gentes of the Nuqa'lkH:

1. Tok'oa'is (=looking down on his family).
2. Spuqpuqō'lemQ; Qē'mtsiōa name: Mā'lakyilatl (see p. 415).
3. Siatlqēlā'aq.
4. Kē'ltāqk'aua.
5. Pō'tlas.

Gentes of the Nusk'ē'lstemH:

1. Tl'ak'aumō'ot.
2. K'ōoqōtlā'nē.
3. ?

Gentes of the Tālio'mH:

1. Ialo'stimōt (=making good fire); Qē'mtsiōa name; T'ā't'ēn-tsāit (=a cave protecting from rain).
2. Spatsā'tlt.
3. Tumqoa'akyas.
4. Ha'mtsit.

The evidence which I can present regarding the laws of intermarriage is the following: I inquired of Nusk'Elu'sta (=cold water in face), a member of the Ialo'stimōt gens, whether he might marry a Spatsā'tlt woman; this suggestion he rejected with the greatest indignation.

FIG. 1.—House-front of the gens Tōk'oā'is.

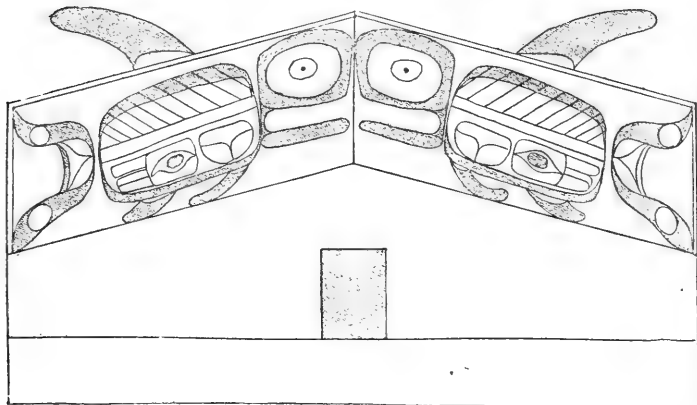

Members of the first two gentes, he explained later on, are not allowed to intermarry, neither are members of the last two gentes, while the first and second may marry among the third and fourth. He accounted for

FIG. 2.—House-front of the gens Tl'ak'aumō'ot, representing the moon.

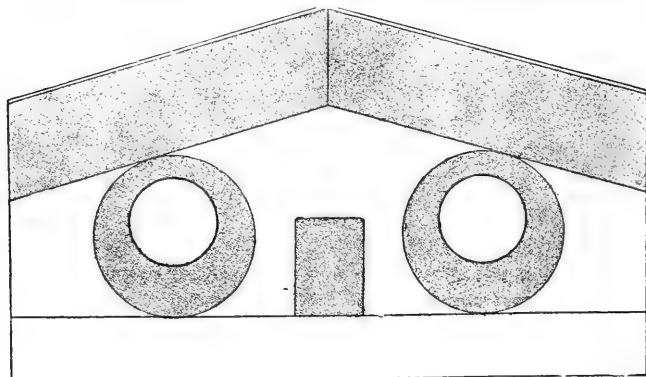

this by stating that Ialo'stimōt's son married Spatsā'tlt's daughter, and that consequently the two gentes were related to each other.

The gentes have crests similar to those of the neighbouring coast

tribes. The crest is represented in paintings on the house-front and on dancing implements.

The gens Tök'ōā'is has a killer-whale (*Delphinus orca*) painted on the house-front (fig. 1). The tradition says that the ancestor of this gens

FIG. 3.—Crest of the gens Smō'En, showing the mountain Suwā'kHH, with two clouds near its summit; above a mackerel sky.

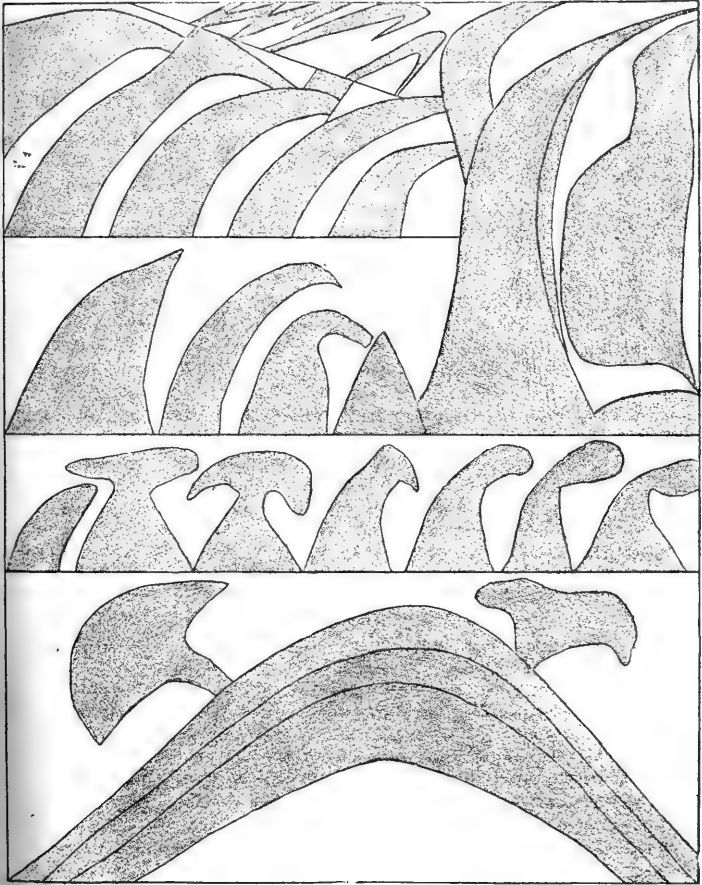

one day, when hunting in the mountains, found a house on which a killer was painted. The chief who lived in the house invited him and presented him with his crest for himself and for his descendants. The crest consists of the killer-whale, eagle, swan, and heron.

The crests of all gentes were obtained in like manner.

The gens Spatsā'tlt have breakers painted on the house-front, and use in dances the mask of a large kind of whale (*k'ents*), of the crow, and of the black bear.

The gens Tumqōā'akyas use the mask of Ōnestsitō'ma' (=the sleeper) and the eagle.

The gens Tl'ak'aumō'ot of the Nusk'E'lstēm use the moon (fig. 2).

The gens Ialo'stimōt of the Tālio'mē use the raven, robin (*aii'a'qonē*), eagle, whale, the bird *t'ēhtlala* (genus?), and *s'atlsā'ots*, the flood-tide. They have sun, moon, and stars painted on the house-front, and the *nusqē'mta* suspended from the beams of the roof (see p. 420):

The highest gens of Nūtl'E'l has the name Smō'ēn (=the north wind). He has the mountain Suwā'khh surmounted by a mackerel sky, and with clouds on its sides, painted on his house-front (fig. 3). Another object belonging to his crest represents waves.

The children belong to the gens of either father or mother, the decision being left to the choice of the parents.

SECRET SOCIETIES AND THE POTLATCH.

The social organisation, festivals, and secret societies of the Bilqula are still more closely interrelated than they are among the Kwakiutl, and must be considered in connection. We have to describe here the potlatch, the Sisau'kh, and the Kū'siūt. The Sisau'kh corresponds to the Tlōola'qa of the northern Kwakiutl tribes, the Kū'siūt to the Ts'ētsā'ēk'a. The Bilqula believe that the potlatch has been instituted by ten deities, nine brothers and one sister, the foremost among whom is Qē'mtsioa, to whose care the sunrise is intrusted. He resides with the others in a beautiful

FIG. 4.—Mask representing Qē'mtsioa.

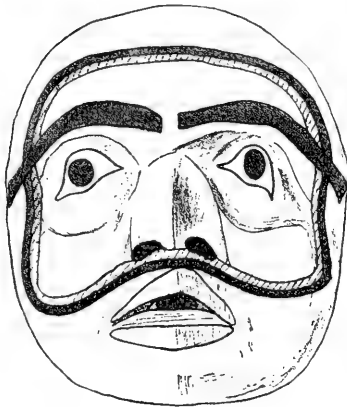

FIG. 5.—Mask representing Qēmqēmalā'otla.



house in the far east, and cries ō! ō! every morning when the sun rises. He has to take care that the sun rises properly. The first six of these deities

are grouped in pairs, and are believed to paint their faces with designs representing moon, stars, and rainbow. In the Kū'siūt these deities make their appearance, and are represented by masks which I have copied. Qē'mtsioa and Qēmqēmalá'otla wear the design of the full moon, indicated in the mask Qē'mtsioa (fig. 4) by a double curved line in red and black, the black outside, passing over forehead, cheeks, and upper lip. Qēmqēmalá'otla has a double curved line in red and black, the red outside, which passes over forehead, cheeks, and chin (fig. 5). Aiumkī'likya (fig. 6) and Aiumalá'otla (fig. 7) wear the design of the crescent, drawn

FIG. 6.—Mask representing Aiumkī'likya.

FIG. 7.—Mask representing Aiumalá'otla.



in red and black, with differences similar to those between the first and second. The fifth, K'ōmk'ōmkī'likya, and K'ō'mtsioa have designs representing stars (fig. 8), both wearing the same style of mask. The seventh is K'ula'qawa, whose face represents the blossom of a salmonberry bush (fig. 9). The next in order, Kulē'lias (=who wants to have blankets first), wears the design of the rainbow in black and blue (fig. 10). The ninth, At'amā'k wears on the head a mask representing a kingfisher, and is clothed in a birdskin blanket. The last of the series is a woman called Tl'ētsā'aplētlāna (=the eater), the sister of all the others. Her face is painted with a bladder filled with grease (fig. 11). She figures in several legends as stealing provisions and pursued by the people whom she has robbed.

The Sisau'kH, which is danced at potlatches and other festivals of gentes, is presided over by a being that lives in the sun. A man who had gone out hunting met the Sisau'kH, and was instructed by him in the secrets of the dance. When he returned he asked the people to clean their houses, and to strew them with clean sand, before he consented to enter. Then he danced the Sisau'kH, and told the people what he had seen. He said that the being had commanded them to perform this dance and to adorn themselves when dancing with carved headdresses with

trails of ermine skins, and to swing carved rattles. The man, later on, returned to the sun. Ever since that time the Bilqula dance the Sisau'kH. Besides this it is stated that the Raven gave each gens its secrets.

FIG. 8.—Mask representing
K'omk'omki'likya.

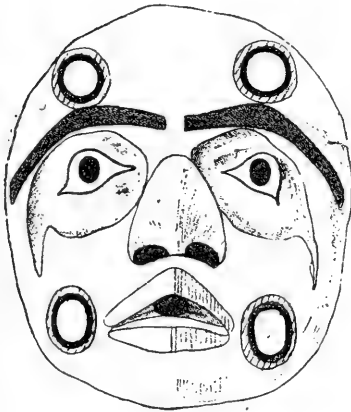

FIG. 9.—Mask representing
K'ula'qawa.



Each gens has its peculiar carvings, which are used in the Sisau'kH only, and are otherwise kept a deep secret, *i.e.*, they are the sacred posses-

FIG. 10.—Mask representing Kulé'lias.

FIG. 11.—Mask representing
Tl'etsa'aplélana.

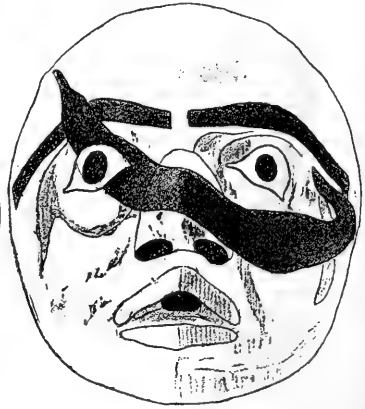

sions of each gens. All gentes, however, wear the beautiful carved headdresses and use the raven rattles, regardless of the carving they

represent. Every time the sacred objects of a gens are shown to the people a potlatch is given. The sacred objects, although the property of the various gentes, must nevertheless be acquired by each individual. That is to say, every free person has the right to acquire a certain group of carvings and names, according to the gens to which he or she belongs. Slaves and slaves' children, also illegitimate children, could not become Sisau'kH. A person cannot take a new carving, but must wait until it is given to him by his relatives—father, mother, or elder brother. Nusk'É-lu'sta, to whom I owe my information regarding the gentes, and who is a member of the gens Ialo'stimōt of the Talio'mH, stated that he had received the raven when he gave his first potlatch. At his second potlatch he received the eagle. He hopes that his mother will give him the whale at his next potlatch, and will at the same time divulge to him the secrets connected with it. In course of time, he said, he might get even others from his brother; but if the latter's children should prove to be very good, and develop very rapidly, his brother would probably give his secrets to his children. At festivals, when a person acquires a new secret, he changes his name. Each person has two names, a Kū'siūt name, which remains the same throughout life; and a Qē'mtsioa name, which is changed at these festivals. Thus, Nusk'Élu'sta's (which is his Kū'siūt name) present Qē'mtsioa name is At'litlēmne'lus'aiH, but at his next potlatch he intends to take the name of Kaliā'kis. These names are also the property of the various gentes, each gens having its own names. In the list of gentes given above, the names enumerated are the Kū'siūt names of the ancestors. In two cases only the Qē'mtsioa names have been ascertained (see p. 409). When a man possesses several Sisau'kH secrets he will distribute them among his children. When a girl marries, her father or mother may, after a child has been born to her, give one or several of their Sisau'kH secrets to her husband, as his children make him a member of the gens. When a person gets to be old he gives away all his Sisau'kH secrets. After any secret has been given away the giver must not use it any more. The crest and the Sisau'kH carvings must not be loaned to others, but each person must keep his own carvings. The only exceptions are the carved headdresses and the raven rattles, which are not the property of any particular gens.

The laws regarding the potlatch are similar to those of the Kwakiutl. The receiver of a present becomes the debtor of the person who gave the potlatch. If the latter should die the debts become due to his heirs. If the debtor should die his heirs become responsible for the debt. Property is also destroyed at potlatches. This is not returned, and serves only to enhance the social position of the individual who performed this act. It is not necessary that all the property given by a person in a potlatch should be owned by him. He may borrow part of it from his friends, and has to repay it with interest. I was told, for instance, that a man borrowed a large copper-plate and burnt it at a potlatch. When doing so he had to name the price which he was going to pay to the owner in its stead. Since that feast he died, and his heirs are now responsible for the amount named at the potlatch.

The Kū'siūt is presided over by a female spirit, called Anaūlikūtsai'H. Her abode is a cave in the woods, which she keeps shut from February till October, remaining all the while inside. In October she opens the door of her cave and sits in front of it. A woman is said to have been the first to find her. Anaūlikūtsai'H invited her into her cave and taught

her the secrets of the Kū'siūt. She wore ornaments of red cedar-bark around her head, wrists, and ankles; her face was blackened, her hair strewn with eagle-down. She commanded the woman to dance in the same way as she saw her dancing. The people should accompany her dance with songs, and, after she had finished, they should dance with masks. She said, 'Whenever a person sees me your people shall dance the Kū'siūt. If you do not do so I shall punish you with death and sickness. In summer, while I am in my house, you must not dance the Kū'siūt.'

Ever since that time the Bilqula dance the Kū'siūt. When a man has seen Anaulikūtsai'h sitting before her cave he will invite the people to a Kū'siūt. A ring made of red and white cedar-bark is hung up in his house, and the uninitiated are not allowed to enter it. Only in the evening, when dances are performed, they may look on, standing close to the door. As soon as the dances are over they must retire from the taboo house. Each Kū'siūt lasts three days.

The various dances performed by members of the Kū'siūt are also the property of the gentes, and the right of performing them is restricted to members of the gens. They must not be given to a daughter's husband, as is the case with the Sisau'kH dances (see above), but belong to the members of the gens alone. They may, however, be loaned and borrowed by members of the gens, who have a right to a particular dance, but who do not own it. Permission to use a mask or dance is obtained from the owner by payments. The owner may reclaim the dance or the borrower may return it at any time. Membership of the Kū'siūt is obtained through an initiation. At this time the novice is given his Kū'siūt name, which he retains throughout life. Each gens has its peculiar Kū'siūt names, which are inherited by young persons from their parents or from other relatives. Thus a young man who had the name of Pō'pō until he was about seventeen years old obtained at his initiation the name of Tl'akō'otl. I have not reached a very clear understanding of the details of the initiation; it seems that the dance is simply given to the novice in the same way as the Sisau'kH, this initiation being connected with a potlatch. But still it seems possible that he must 'dream' of the dance which he is to perform. Only the highest degrees of the Kū'siūt have to pass through a religious ceremony of some importance. The highest degrees are the Elaqō'tla (the Hā'mats'a of the Kwakiutl), the Ō'leq (the Nū'tlmatl of the Kwakiutl), and the Dā'tia (the Nō'ntsistatl of the Hé'iltuk). These grades are also hereditary. A Kū'siūt novice may acquire them at once at his first initiation.

When the Elaqō'tla is initiated he goes into the forest, where he encounters his guardian spirit. It is believed that he goes up to the sun, and formerly he had to take human flesh along for food. The chiefs held a council the night preceding the beginning of the ceremonies, and anyone who wanted to show his liberality offered one of his slaves to be killed, in order to serve as food for the Elaqō'tla. The offer was accepted and a payment of from ten to twenty blankets made for the slave. The latter was killed, and the members of the Elaqō'tla order devoured one-half of the body before the departure of the novice to the woods. There the latter is tied up and left to fast. He may stay there for twenty or thirty days until the spirit appears to him and takes him up to the sun, where he is initiated. Early one morning he returns, and is heard outside the houses. He has lost all his hair, which, it is believed, has been torn

out by the strong breeze blowing in the higher regions. He is quite naked, and bites everyone whom he can lay hold of. If he cannot catch anyone he will bite his own arm. It is believed that he has lost his soul, which fled from the body when the spirit came to him. Therefore the shamans must try for four days to recapture his soul. The night after they have recovered it the *Elaqō'tla* dances clothed in a bear-skin and wearing a large headring, heavy bracelets and anklets, all made of red and white cedar-bark. Some *Elaqō'tla* do not bite people, but merely devour raw salmon, or tear dogs to pieces and devour them. Those who bite people will also eat corpses. The *Elaqō'tla* has to observe a number of regulations. For four years after his initiation he must not gamble. He must stay away from his wife for one year, but this period is being reduced to one month. For two or three months he must not leave his house.

The *Ō'leq* (= the laugher) and the *Dā'tia* (= the thrower) do not go into the woods to be initiated, but both must fast three days before their first dance. The *Ō'leq* 'makes fun of everything' and scratches people with his nails. The *Dā'tia* carries stones and sticks, and breaks household goods and canoes. If he has destroyed some object during the day he pays for it at night when he dances. The *Ō'leq* and the *Dā'tia* must stay for one month, after they have danced, in their houses.

If a person transgresses the laws of the *Kū'siūt*, for instance when the *Elaqō'tla* gambles, or when a man performs a dance to which he has no right, also when a person derides the ceremonies or makes a mistake in dancing, his punishment is death. The chiefs assemble in council and the offender is called before the court. After his offence has been proved he is asked whether he is willing to suffer the penalty of death. If he is not willing, and one of his relatives is found willing to take the penalty on himself, the guilty party is spared, and the substitute is killed in his stead. The execution of the judgment is entrusted to the shaman, who bewitches the condemned person by throwing disease into him, or by poisoning him in some other (supernatural?) way. The object thrown by the shaman is a shell, bone, or finger-nail, around the middle of which objects a human hair is tied. If this object strikes the offender he will fall sick. Blood collects in his stomach, and if it so happens that he vomits this blood, and with it the disease-producing object, he will recover, and is not molested any further. The masks (not the whistles and other ornaments) used in the *Kū'siūt* are burnt immediately at the close of each dancing season. Novices must wear a necklet of red cedar-bark over their blankets for a whole year. The masks used in the dances represent mythical personages, and the dances are pantomimic representations of myths. Among others the thunder-bird and his servant *Atlqulā'tenum*, who wears a mask with red and blue stripes over the whole face from the right-hand upper side to the left-hand lower side, and a staff with red and blue spiral lines, appear in the dances. Prominent masks are also *Qē'mtsioa* and his brothers and his sister (see p. 412), *Masmasalā'niq* and his fellows, the raven and the *Nusqē'mta*, and many others.

CUSTOMS REGARDING BIRTH, PUBERTY, MARRIAGE, AND DEATH.

When the time of delivery approaches, the woman leaves the house and resorts to a small hut built for the purpose. She is assisted by pro-

fessional midwives. The child is washed in warm water. For ten days the mother must remain in this hut. Father and mother must not go near the room for a year (according to Nusk'Elu'sta, for ten days), else the salmon would take offence.

The child is soon given its first name. On this occasion the whole tribe is invited to a feast, the name is made public, and the guests receive small presents. The child retains this name until it becomes a member of the Kū'siūt, when it is given its Kū'siūt name. This ceremony takes place after puberty has been reached. About this period the young man gives his first potlatch and assumes the Q'ēmtsioa name.

When a girl reaches puberty she must stay in the shed which serves as her bedroom, where she has a separate fireplace. She is not allowed to descend to the main part of the house, and must not sit by the fire of the family. For four days she must remain motionless in a sitting posture. She fasts during the daytime, but is allowed a little food and drink at a very early hour in the morning. After this term she may leave her room, but only through a separate opening. She must not yet come to the main room. When leaving the house she wears a large hat, which protects her face against the rays of the sun. It is believed that if the sun should shine on her face her eyes would suffer. She may pick berries on the hills, but must not come near the river or sea for a whole year. She must not eat fresh salmon, else she would lose her senses, or her mouth would be transformed into a long beak. She must not chew gum or eat snow (see Fifth Report of Committee, 1889, p. 838).

If a young man wishes to marry a girl he goes, surrounded by his friends, to the house of the girl's father and states his intention. His friends carry food and presents, and if the father accepts the suit he sends out a young man, who receives the food and presents and carries them into the house. Sometimes the father does not accept the offer at once. In such cases the young man may repeat the same ceremony until he is finally rejected or accepted. After the time of the marriage has been agreed upon between the contracting parties, and the day preceding the marriage has arrived, the young man invites all the people to a feast, during which he states that he is to be married on the following day. He asks a number of men, generally from twenty to thirty, and four women to assist him. On the following forenoon they assemble, and accompany the bridegroom to the girl's house. They sing outside, and four of the men dance. All of them have their faces painted red. Finally they enter, and the bridegroom gives a large amount of property to the girl's father. Then the girl leaves her parents and goes to the bridegroom, bringing him also a large amount of property which has been given to her for this purpose by her parents and relatives. He in turn gives her blankets and other apparel of the best quality, and distributes presents among her relatives. This is repeated after some time. All he has given to his bride and her relatives is repaid to him with interest. A rich girl will repay twice or three times the amount given by the man. At the time of the marriage the bride's father may promise the groom to give him his Sisau'kH secrets as soon as the pair have their first child. The children may belong to the father's or mother's gens, as the parents may choose.

In case of a separation the wife refunds the amount of purchase-money. The children may stay with either parent, or part of them may

go with the mother and part with the father. The decision is left to the parents and children.

When a person has died the corpse is washed, the face painted red, the legs are doubled up, and the arms folded over the breast. The nose-ornament of the deceased is put into his nose; his shirt is put on, the back part covering the breast and the front part turned backward. The body is placed in a box and the latter is either fastened on the lower branches of a tree or placed in a little house, which is set on posts, above the level of the ground. The face of the deceased is turned eastward. Part of his property and gifts from his friends are deposited near the grave. The masks of the deceased are burnt. His crest is carved on a memorial column, which also shows how many canoes, coppers, head-dresses, and slaves he had given away at potlatches. These objects are painted or carved on the columns. Formerly slaves were killed at the burial of chiefs. The number of slaves killed was also indicated by so many human figures on the memorial column. After burial food for the use of the deceased is thrown into the fire. This is repeated frequently during a prolonged period after the death has occurred. Whenever the friends of the deceased partake of a meal a little food is thrown down at a place between the fire and the door, where the entrance to the lower world, the home of the dead, is believed to be.

The bed of a mourner must be protected against the ghost of the deceased. His male relatives stick a thorn-bush into the ground at each corner of their beds. After four days these are thrown into the water. Mourners must rise early and go into the woods, where they stick four thorn-bushes into the ground, at the corners of a square, in which they cleanse themselves by rubbing their bodies with cedar-branches. They also swim in ponds. After swimming they cleave four small trees and creep through the clefts, following the course of the sun. This they do on four subsequent mornings, cleaving new trees every day. Mourners cut their hair short. The hair that has been cut off is burnt. If they should not observe these regulations it is believed that they would dream of the deceased. Women when mourning scratch their cheeks with shells or stones.

The mourning regulations for a widower or a widow are especially strict. For four days he (or she) must fast, and must not speak a word, else the dead wife or husband would lay a hand on the mouth of the offender, who would then die. They must not go near water, and are forbidden to catch or eat salmon for a whole year. For the same length of time they must not eat fresh herring or olachen. Widow and widower cleanse themselves in the same way as other mourners. Their shadows are considered unlucky, and must not fall on any person.

Some time after the death of a rich or influential person his nearest relative invites the whole tribe to a potlatch. On this occasion he sings a mourning song for the deceased and gives away presents to his guests. It was explained to me that this ended the mourning, and that it was 'the same as giving away the bones of the deceased.'

RELIGION AND SHAMANISM.

The mythology of the Bilqula differs greatly from the mythologies of the other tribes of the North Pacific coast. It is impossible to say to

what cause this divergence is due. Mythology and religion are so closely connected that a few words on the former must be added here. The principal deity of the Bilqula is Snq, the sun-god (compare *sōng*, sun). The rays of the sun are his eyelashes. When prayed to he is called Tāat'au. In praying the Bilqula look heavenward. I obtained the following formulas: *AtlkHH itlō'tlsuq, Tāat'au*, 'Look on us where we are going, Tāat'au;' and *Tāat'au, atlkhaltnomdō'tlq*, 'Take care of us, Tāat'au.' Snq is pre-eminently the ruler of the world, and does not interfere with the actions and thoughts of men. These are given by Masmasalā'niq. According to the tradition of the Bilqula, before the liberation of the sun, and before the world was made as it is nowadays, four deities lived on the earth: Masmasalā'niq, Yula'timot, Matlapē'eqoek, and Itl'itlu'lak. The raven wished to obtain the sun, but he was unable to liberate it. Then he went to these deities and asked their help. They ascended to the sky, and tore the curtain, which up to that time had been expanded between heaven and earth, hiding the heavenly orbs. The sun appeared, but he shone dimly, as though darkened by clouds. The raven ascended to heaven through the rift made by Masmasalā'niq, and found there a beautiful prairie country in which all the birds lived. Masmasalā'niq and his brothers painted them beautifully and sent them down to earth, giving each his song and his arts. The raven was not content with the sun, and resolved to try and find a better one. He flew to the house of a great chief, who kept the *nusqē'mta* (*nu-ta*=place of, *sqēm*=the day is dawning). The *nusqē'mta* was a small round receptacle closed all around like an egg. The chief guarded it jealously, and kept it suspended from one of the rafters of his house. The raven knew that he could not obtain it by sheer force, and resorted to a ruse. He assumed the shape of the leaf of a spruce tree, and let himself drop into the pond from which the chief's daughter used to take water. The girl drank from the pond, swallowed the leaf, and thus became with child. She gave birth to a boy, who was the raven himself. The old chief loved the boy dearly, and allowed him to play with the *nusqē'mta*. This was what he desired. He ran out of the house, broke it, and flew away in the shape of a raven.

After the sun had thus been obtained Masmasalā'niq said: 'Let us make man.' He made the image of a man out of wood, but he was unable to endow it with breath. Matlapē'eqoek and Itl'itlu'lak tried likewise to carve human figures and to give them life, but they failed. Finally, Yula'timot carved the figure of a man and endowed it with life. He made a man and a woman in each country, and they became the ancestors of all the numerous tribes. Then Masmasalā'niq gave them their arts. He taught them to build canoes, to catch salmon, to build houses. He made rivers everywhere, that man should have water to drink, and that the fish might go up the rivers to be caught by man.

The Bilqula believe that Masmasalā'niq and his brothers still continue to give new ideas to man. They say that any new design of painting or carving, or any other new invention made by a member of their tribe, has been given to him by Masmasalā'niq.

The religious side of the potlatch and of the secret societies has been referred to above.

The soul is believed to dwell in the nape. It is similar in shape to a bird inclosed in an egg. If the shell of the egg breaks and the soul flies away its owner must die. Shamans are able to see and to recover souls.

By laying their hands on the nape of a person they are able to tell whether his soul is present or whether it has left the body. If the soul should become weak they are able to restore it to its former vigour. If a person swoons it is believed that his soul has flown away without breaking its shell. The shaman hears its buzzing wings, which give a sound like those of a mosquito. He may catch and replace it in the nape of its owner. If the soul leaves the body without breaking its shell the owner becomes crazy.

The art of shamanism is bestowed by Snq. It is impossible to obtain it by means of fasting and praying, as is the case among the neighbouring tribes, but it is a free gift from the deity. A person who is to become a shaman will fall sick, and, during his illness, Snq will give him a song which must be kept a deep secret. After this he is able to cure diseases. If a person falsely pretends to have received the gift of shamanism, and tries to suck out diseases from a patient, he will fall sick himself.

When asked more closely about the curious difference between this method of obtaining the power and that of the neighbouring tribes my informant said: 'When an Awiky'e'noq wishes to become a shaman he may go to the mountain where the deity of their shamans resides (probably Mā'tem) who will initiate him. No Bilqula can obtain the art in such a way.'

Sickness is caused by a disease entering the body or by witchcraft (see p. 417). The shaman is able to extract the disease by sucking. A peculiar method of witchcraft, somewhat similar to the 'ek'a' of the Kwakiutl (see Sixth Report of the Committee, p. 612), was described to me as follows: The person who wants to bewitch his enemy endeavours to obtain some of his old clothing, portions soaked by perspiration being considered especially effective. After it is obtained a wolf is killed, and the clothing is put into its mouth, which is then tied up. Then the wolf is placed in a box. This procedure is called *suak*. Sometimes the clothing or some hair is inclosed in the bone of a wolf or of a dead person. No shaman can counteract these charms.

If a person has been murdered, and a string is tied firmly around the neck of the corpse, the murderer's neck will become diseased and he will be unable to breathe and will die. If sand is strewn in the corpse's eyes and the lids closed over it the murderer will die. If a person has been killed with a knife or arrow, or another weapon, to which some of his blood adheres, the latter is brought into contact with a wolf's head, deg's hair, or anything else that is bad, and then thrown into the fire or put into a frog's or snake's mouth; then the murderer will die.

I add here a few current beliefs:—

Sneezing indicates that people are talking about one.

Slight ringing of the ears indicates rain, loud ringing good weather.

Twitching of the muscles of the left side of the body is unlucky; of the right side lucky. Twitching of the skin under the eyes indicates that one will cry.

If a dog dreams and howls in its sleep its owner will die.

The breaking of a box without an apparent cause is unlucky.

WARS.

When a war party was organised the warriors did not paint their faces, but they put on headbands of white cedar-bark and strewed their

hair with white eagle-down. Warriors when on a war party must not drink more than four mouthfuls of water, else they would be killed. A watchman was appointed in each canoe, who sat in the bow. On landing near the village of their enemies they divided themselves into a number of parties, one house of the village being assigned to each. Then, early in the morning, when all were asleep, they rushed up to the village uttering their war cry 'wai!' They took a stand at the fire which burns in the centre of the house, and if any one of the enemies succeeded in taking up his arms and came out of his bedroom they killed him. Then they entered the bedrooms, killed the men, and took the women and children along as slaves. The heads of the dead were cut off, the houses burnt, and they returned home singing war-songs. The heads which they had taken along were then scalped, and the scalps tied to each end of a pole. When they approached their village one man stood up in the bow of each canoe and swang the pole to which the scalps were attached, and they all sang songs, in which their deeds were recounted. The scalps were valued the higher the longer and fuller the hair. They were used in the *Sisau'ku*.

The following tales of war expeditions offer some points of interest. About thirty or forty years ago there was a famine at *Bella Coola*. The people went overland to *Knight Inlet*, which belongs to the *Tenaqtaq*, a tribe of the *Kwakiutl*, to fish there. The *Tenaqtaq* made fun of them, took from them the fish they caught, tore the blankets from the backs of the women, and seduced many of them. Finally the *Bilqula* returned home. There they held a council and resolved to make war upon the *Tenaqtaq*. The *Tinneh* joined them in this expedition. They crossed the mountains in four days. When they approached *Knight Inlet* they sent two spies in advance, who were to count the number of houses in the village of the *Tenaqtaq*. Early in the morning they attacked the houses and killed a great many men. The *Tenaqtaq* could not escape, as they were hemmed in by the river. The *Bilqula* slew them with knives, lances, and stone axes. They took away the clothes of the women, leaving them naked, and subjected them to shameful insults in revenge for the disgrace put upon their wives and daughters. Then they burnt the village.

About thirty-five years ago the *Talio'mh* were attacked by the *Kwakiutl*. Originally they intended to attack *Nuqa'lkH*, but the raven, according to the narrator, changed their mind, as he always protects the village of *Nuqa'lkH*. They came in many canoes, while most of the *Talio'mh* were at the lake, which is situated above that town, fishing. Four men were in charge of the village, and a number of old men and women had also remained at home. The father of *Nusk'elu'sta*, who told me of these events, happened to be out picking berries, accompanied by his wife. He saw the canoes passing by and kept himself hidden. The village of *Talio* was at that time surrounded by a strong stockade, which consisted of a double row of palisades crowned with thorns. At each corner there was a strong box fastened on the stockade like a tower. Here watchmen were stationed, who were able to shoot at the enemy while being themselves protected. At that time the *Talio'mh* had only four guns. The *Kwakiutl* sent out two spies, who reported that the village was well fortified. The *Talio'mh* had seen the canoes coming and were on their guard. The *Kwakiutl* thought that they would not be able to enter the village until after the stockade had been destroyed.

They resolved to make an attempt to burn it and to break open the door. On the following day they came up to the village, but the guard on the towers used their guns to such good effect that the enemy had to retreat with severe losses. They made still another attempt, but with no better success. They had lost many men, while only two old men of the Talio'mh, Tumhā'akyas and A'lk'ius by name, and one woman had been hurt. The latter had been killed. When the Kwakiutl turned back a messenger was at once sent up to the lake to call the young men, who then went to Nuqa'lkh to ask for help. The Kwakiutl passed close to Nusk'elu'sta's father's canoe, but they were so terrified by the losses they had sustained that they passed by without so much as noticing it. Two of their number were so ashamed of their defeat that they would rather remain in the enemy's country than return with their friends, and they stayed ashore. Meanwhile the Talio'mh and the Bilqula were pursuing the fugitives. They had reached the outlet of Bentinck Arm without overtaking them. Then their chiefs resolved to return, as they believed that their enemies had a long start upon them. Later on they learnt that the Kwakiutl were at that moment only a few miles from them, about to continue their homeward journey, after having encamped at the outlet of the channel. Afterwards the Talio'mh found the two men who had remained ashore. They called them and promised to send them back to their friends, saying that the war had ended, and that they had no grudge against them. The men were, however, too much afraid, and finally starved to death.

Later on the Talio'mh and Bilqula organised an expedition against the Kwakiutl to take revenge for the unprovoked attack. A chief named Koani'la, whose father was a Talio'mh, while his mother was a Kwakiutl, was their leader. They intended to attack the Lē'kwiltok' and the Kwē'k'sōt'ēnoq. When they approached the village of the latter they sent a canoe ahead to search for the village, and to report the number of houses. For two days they were unable to find the village, which lies in a labyrinth of islands; but finally they found it, and saw that it consisted of sixteen houses. On the next morning they attacked it. The tribe was wholly taken by surprise and almost all of them were killed. Koani'la's mother lived at this place, and when she heard the Bilqula coming she asked at once for her son, and was taken care of by him. Only five men and four women escaped. The Bilqula allowed these to run away, as they had killed as many as they desired. Anukhī'tsem, a chief of the Senqtlē'mh, was the only man of the Bilqula who was wounded. He died on the way home. They returned, but in the country of the Nā'koartok' they were overtaken by four Kwakiutl canoes which pursued them. The Bilqula were victorious, but Koani'la induced them to desist. During the fight two of the women, whom they had taken as slaves, and one boy jumped overboard, and were rescued by the Kwakiutl.

MEDICINE.

Boils are treated by cauterisation with dry bark or with gunpowder. Sometimes a series of parallel cuts is made over swellings or boils. Fractured bones are set, and fastened between splints of cedar-bark.

Enemata of shark oil or olachen oil are given by means of a kelp tube, with a mouthpiece made of the wing-bone of an eagle. Snake poison is collected and used as a poison. Women wear tight anklets 'to prevent

the calves of their legs from slipping down.' During their monthly periods women place soft cedar-bark in the vagina. The bark is afterwards burnt in the woods. The smoke of this fire is believed to be poisonous.

It is evident that the culture of the Bilqula is very greatly influenced by that of the Kwakiutl. The secret societies and the potlatch ceremonies are almost a copy of those of the Hëiltsuk'. This influence has been so deep that names of even deities and of the mythical ancestors of certain gentes are purely Kwakiutl words, or have at least Kwakiutl endings. Thus the name Aiumkī'likya (see p. 413) is purely Kwakiutl, meaning 'good all over the world.' K'ōmk'ōmkī'likya is also a Kwakiutl word, meaning 'the rich one of the world.' The chief's name, Mā'lakyilatl (see p. 409) belongs to the same class of Kwakiutl names. On the other hand, the religious ideas of the Bilqula are very curiously developed, and apparently but slightly influenced by their neighbours. The whole Masmasalā'niq tradition is peculiar to them, but has been partly adopted by the Awiky'-ē'noq, with whom the Bilqula have intermarried.

PHYSICAL CHARACTERISTICS OF THE TRIBES OF THE NORTH PACIFIC COAST.

The following tables embrace a considerable amount of material which I collected on a journey in Oregon and Washington, undertaken for the U.S. Bureau of Ethnology, together with material which I collected in British Columbia. Thanks to the liberality of Major J. W. Powell, Director of the Bureau of Ethnology, I am enabled to present here the results of all the measurements which I made on the North Pacific coast.

The tribes of this region proved to be so heterogeneous that it was necessary to subdivide the material into eleven groups, each embracing a number of closely allied tribes. I have distinguished the following groups:—

1. Tribes of British Columbia, north of Dean Inlet.
2. Kwakiutl and Nootka.
3. Bilqula.
4. Lower Fraser River.
5. Harrison Lake and Lillooet.
6. Tribes of Washington, including the whole coast of that State west of the Cascade Range.
7. Columbians, including the tribes in the immediate neighbourhood of Columbia River and in the Lower Willamette Valley.
8. Northern Oregon, including the Yakonan and Salish tribes between Umpqua and Columbia Rivers.
9. Oregonian Tinneh and Coosan.
10. Crosses between Oregonian Tinneh and Northern Californians.
11. Northern Californians.

Only a short series of measurements of each individual was made, such as could be taken by the removal of only a small portion of the clothing. Following is a list of the measurements.

- | | |
|--|---|
| <ol style="list-style-type: none"> 1. Stature. 2. Finger-reach. 3. Height of ear. 4. Height of 7th vertebra. 5. Height of acromion. 6. Height of point of second finger. 7. Width between acromia. 8. Height, sitting. 9. Length of head. | <ol style="list-style-type: none"> 10. Width of head. 11. Width between zygomatic arches. 12. Distance from naso-frontal suture to chin. 13. Distance from naso-frontal suture to mouth. 14. Height of nose. 15. Width of base of nose. 16. Maximum width of nose. |
|--|---|

In measuring the 'stature,' the subject was asked to stand erect, but care was taken to avoid excessive stretching, as in these cases the stature during the process of measuring would undergo material changes. The 'finger-reach' is the greatest distance between the tips of the second fingers, the arms being extended horizontally. In this case the subject was encouraged to make the strongest possible effort. The measurements of stature, height of acromion, height of point of second finger, were taken in rapid succession, in order to avoid changes of position as much as possible. In measuring the point of the second finger the arms and hands were stretched out downward, so that hand and arm formed as nearly as possible a straight line. A glance at the tables will show that the results of the measurements of 'height of ear' (being the difference between the stature and the height of ear above the ground) as obtained by this method are very unsatisfactory. In most cases it was difficult to obtain a sufficiently level surface for a satisfactory comparison of the two measurements. Only among the Bilqula and the last three groups this difficulty did not present itself. But even in these cases I do not consider the results very accurate, mainly on account of the unavoidable movements of the subject. I should prefer, at another time, to measure the distance directly by Topinard's method. The difference between the heights of the acromion and of the point of the second finger gives the length of arm with greater accuracy, because I was able to take these two measurements without moving the scale. The length and width of the head are maximum measurements; the former is always taken from the glabella; the vertical measurements of the face were taken from the naso-frontal suture.

The indices require little explanation. The cephalic index is the proportion between length and width of the head, the latter being expressed in per cents. of the former. The index of the height of ear is the proportion between the length of head and the difference in height of the ear and vertex. The facial index is the proportion of the naso-mental line to the width of face, the index of the upper part of the face the proportion of the naso-oral line to the width of face. I have given two nasal indices, the proportions of the basal width and maximum width of the nose, the former being measured at the insertion of the alæ, to the height of nose. The last three columns contain finger-reach, height sitting, and length of arm, expressed in per cents. of the stature.

Before discussing the measurements I give the tables. The descriptions are withheld for the present, as it is desirable to gain some new data.

1. Various Northern Tribes.

Number	Males						
	1	2	3	4	5	6	7
Name	Samuel Getgalgao	Johnny Dixie	Johnny	William Seba'sa	Peter Vann Kesuwá'tk	Ke'lataq	Anguá'gamé
Tribes	Haida, Gold Harbour	Haida, Skidegate	Tsimshian, Fort Simpson	Tsimshian, Metlakahla	Tsimshian Metlakahla	Gyt'amá't	Gyt'amá't
Age	25	50	32	28	25	21	20
Stature	mm. 1,689	mm. 1,603	mm. 1,637	mm. 1,649	mm. 1,589	mm. 1,628	mm. 1,619
Finger-reach	1,705	1,692	1,727	—	1,676	1,747	1,713
Height of seventh vertebra	—	1,362	—	1,400	1,353	1,390	1,355?
Height of acromion	1,382	1,311 ^r 1,286 ^z	1,313	1,329	1,321	1,330	1,333
Height of point of second finger	612	570 ^z	571	614	597	598	600
Width between acromia	—	—	—	—	—	381	368
Height, sitting	—	873	876	—	—	908	895
Length of arm	770	716	742	715	724	732	733
Length of head	192	203	201	192	199	196	200
Width of head	149	159	154	160	159	155	166
Height of ear	149	—	127	127	126	133	127
Width of face	154	142	151	146	151	151	158
Distance from chin to naso-frontal suture	130	118	128	126	122	125	124
Distance from mouth to naso-frontal suture	76	86	90	81	74	81	75
Height of nose	58	—	57	62	54	54	56
Width of base of nose	—	—	—	—	—	31	31
Maximum width of nose	38	41	38	33	38	42	38
Cephalic index	77.6	78.3	76.6	83.3	79.9	79.1	83.0
Index of height of ear	77.6	—	63.2	66.1	63.3	67.9	63.5
Facial index	84.4	83.1	84.1	86.3	80.8	82.8	78.3
Index of upper part of face	49.4	60.6	59.6	55.5	49.0	53.6	47.6
Nasal index	65.5	—	66.7	53.2	70.4	77.8	67.9
Index of base of nose	—	—	—	—	—	57.4	55.4
Finger-reach in per cent.	101.0	105.5	105.5	—	105.5	107.3	105.8
Height, sitting " "	—	54.5	53.5	—	—	55.8	55.3
Length of arm " "	45.6	44.7	43.5	43.4	45.6	45.0	45.3

2. Kwakiutl and Nootka.

I. Males								II. Females	
1	2	3	4	5	6	7	8	9	10
Makamos	Koá'nutlema	Sé'wit	Nalakyutsa	Shiwish	Nutchi	Aetlchimik	Wispu	Anuult	Ts'ahwasamó'koa
F. Tsawateenoq M. Salmon R.	F. Awiky'énoq M. Kue'tela	Nakoartok	Fort Rupert	Clayoquaht	Clayoquaht	Clayoquaht	Nittinaht	Clayoquaht	Clayoquaht
24	34	40	50	40	48	55	25	52	55
mm. 1,647 1,756 —	mm. 1,695 1,833 1,450	mm. 1,633 1,780 1,380	mm. 1,575 1,664 1,299?	mm. 1,612 1,651 1,365	mm. 1,574 1,791 —	mm. 1,565 1,742 1,626	mm. 1,711 1,829 1,475	mm. 1,441 1,555 1,225	mm. 1,471 1,571 1,238
1,330	1,381	1,314	1,292	1,313	1,276	1,254	1,403	1,191	1,191
574	629	578	571	589	496	524	618	521	536
387	397	371	—	370	386	386	—	330	340
889	876	898	873	876	838	838	914	799	804
756	752	736	721	724	780	730	785	670	655
201 ¹	195 ¹	200 ¹	206 ¹	193	196	193	189	177	187
161 ¹	158 ¹	164 ¹	175 ¹	149	150	155	162	143	151
139 ¹	144 ¹	136 ¹	130 ¹	136	120	140	135	138	126
146	152	157	138	150	154	150	152	139	152
116	127	140	121	127	121	141	127	113	119
73	84	90	81	79	78	87	78	75	81
53	57	63	54	50	55	63	60	51	53·5
33	30	30	—	37	39	34	—	31	33
39	35	39	35	41	40	37	41	32	37
80·1 ¹	81·0 ¹	82·0 ¹	85·0 ¹	77·2	76·5	80·3	85·7	80·8	80·7
69·2 ¹	73·8 ¹	73·0 ¹	63·1 ¹	70·5	61·2	72·5	71·4	78·0	67·4
79·5	83·5	89·2	87·7	84·6	78·6	94·0	83·6	81·3	78·3
50·0	55·3	57·3	58·7	52·6	50·6	58·0	47·3	54·0	53·3
73·6	61·4	61·9	64·8	82·0	72·7	58·7	68·3	62·7	69·1
62·3	52·8	47·6	—	74·0	70·9	54·0	—	60·8	61·7
106·6	108·1	109·0	105·6	102·4	113·8	111·3	106·9	107·9	106·8
54·0	51·7	55·0	55·4	54·3	53·2	53·5	53·4	55·4	54·7
45·9	44·4	45·1	45·8	44·9	49·6	46·6	45·9	46·4	44·5

¹ Head deformed.

4.—Lower Fraser River. Males.

Number	1	2	3	4	5	6	7	8
Name	Auguste	Jimmy Amiry	Baptiste	Willie Coutas	George	Baptiste Amiry, brother of 2	Tommy	Pierre
Tribes	F. Skaulits M. Sumass	Squotash	F. Sumass M. Nlakyapamug	F. Hope M. Kaltash Lake	F. Skaulits M. Sumass	Squotash	F. Ewahoos M. Nlakyapamug	Chilliwick
Age	9	9-10	10	10	10	12	12	12
Stature	mm. 1,219	mm. 1,260	mm. 1,378	mm. 1,324	mm. 1,332	mm. 1,381	mm. 1,368	mm. 1,365
Finger-reach	1,238	1,279	1,435	1,364	1,378	1,462	1,419	1,428
Height of 7th vertebra	1,020	1,062	1,168	1,117	1,125	1,167	1,156	1,143
Height of acromion	974	1018	1108	1,062	1,079	1,093	1,105	1,077
Height of point of second finger	432	451	493	469	486	475	504	469
Width between acromia	273	289	322	289	316	314	318	310
Height, sitting	684	705	733	717	724	749	743	747
Length of arm	542	559	615	593	593	620	601	608
Length of head	170	172 ¹	183	177·5	170	178	165 ¹	175
Width of head	145	154 ¹	155	151	152	155	154 ¹	152
Height of ear	119	112	132	125	126	129	130	137
Width of face	125	128	142	127	133	132	135	136
Distance from chin to naso-frontal suture	102	106	105	106	105	110	104	107
Distance from mouth to naso-frontal suture	64	64	64	65	68	69	67	72
Height of nose	41	41	43	46	44	44	43	45
Maximum width of nose	28	29	28	22	25	28·5	28	29
Width of base of nose	35	34	34	29	33	35	33	33
Cephalic index	85·3	89·5 ¹	84·7	85·1	89·4	87·1	93·3 ¹	86·9
Index of height of ear	70·0	65·1	72·1	70·4	74·1	72·5	78·8	78·3
Facial index	81·6	82·8	73·9	83·4	78·9	83·3	77·0	78·7
Index of upper part of face	51·2	50·0	45·1	51·2	51·1	52·3	49·6	52·9
Nasal index	85·3	82·9	79·1	63·0	75·0	79·5	76·7	73·3
Index of base of nose	68·3	70·7	65·1	47·3	56·8	64·7	65·1	64·4
Finger-reach, per cents.	101·5	101·5	104·1	103·0	103·4	105·8	103·7	104·6
Height, sitting, "	56·1	56·0	53·2	54·1	54·4	54·2	54·3	54·7
Length of arm, "	44·5	44·4	44·6	44·8	44·5	44·9	43·9	44·5

¹ Doubtful whether head deformed.

4.—Lower Fraser River. Males (continued).

9	10	11	12	13	14	15	16	17	18	19	20
Andrew Shea	Harry Jimmy	Felix	Alec	George	Felix	Billy	Captain Paul	George Tseelis	Joe	Sam	Captain Jim
Scooyam	Chilliwack	Hope	Scooyam	Sumass	Nekamen	Koantel	Nekamen	Tseelis	Tseelis	Tseelis	Tseelis
12	12	14-15	15	15	31	35	48	50	50-55	65	70-80
mm. 1,403 1,438 1,191 {1114r 1124z} 511z	mm. 1,397 1,419 1,184 1,125	mm. 1,549 1,614 — 1,272	mm. 1,576 1,682 1,359 1,279	mm. 1,600 1,634 1,359 1,289	mm. 1,657 1,720 — 1,343	mm. (1,663) 1,807 — — (581)	mm. — — — —	mm. 1,649 1,750 — 1,349	mm. 1,606 1,701 — 1,321	mm. 1,651 1,867 — 1,359	mm. — — — —
286 744 613	277 749 593	348 825 686	371 849 711	349 851 693	406 898 726	— — —	— — —	378 900 792	370 870 741	381 — 819	— — —
176·5 153 131 129 103	171 152 131 129 105	180 157·5 130 144 121	185 158 141 143 116	183 155 138 137 114	191 158 130 151 122	200 ¹ 181 ¹ — 167·5 119	188 ² 166 ² — 157 122	183·5 ¹ 183 ¹ 138 162 137	187·5 ¹ 170 ¹ 133 161 132	190 ¹ 171 ¹ 138 161 130	187 ¹ 166 ¹ — 160 124
70 45 31 37	68 42 33 37	77 46 28 34	73 49 35 41	72 51 31 36	76 55 33 39	74 52 32 41	85 56 35 40	89 62 37 45	86 58 31 38	83 56 33 38	81 60 32 39
86·7 74·2 79·8 54·3	88·9 76·6 81·4 52·7	87·5 72·2 84·0 53·5	85·4 76·2 81·1 51·0	84·7 75·4 83·2 52·6	82·7 68·1 80·8 50·3	90·5 ¹ — 71·0 44·2	88·3 ² — 77·7 54·1	100·0 ¹ 75·2 84·6 54·9	90·6 ¹ 70·9 82·0 53·4	89·5 ¹ 72·6 80·8 51·6	88·8 ¹ — 77·1 50·6
82·2 68·9	88·3 78·6	73·9 60·9	83·8 71·4	70·7 60·8	70·9 60·0	78·8 61·5	71·4 62·5	72·4 59·7	65·5 53·4	67·9 58·9	65·0 53·3
102·5 53·0 43·7	101·6 53·6 42·5	104·2 53·3 44·3	106·7 53·9 45·1	102·1 53·2 43·3	103·7 54·2 43·8	108·7 — —	— — —	106·1 54·6 48·1	105·9 54·2 46·1	113·1 — 49·0	— — —

¹ Head deformed.² Doubtful whether head deformed.

7. *Columbians.*

I. Males					
Number	1	2	3	4	5
Name	Charles Dan	Howard Cultee, son of No. 10	Eddy Riggs	Joseph Cultee, brother of No. 2, son of No. 10	?
Tribe	Yakima	F. Chinook M. Chihalis	F. Umpqua M. Klickitat	F. Chinook M. Chihalis	F. Yakima M. Snohomish
Age	12	15	17	21	24
Stature	mm. 1,447	mm. 1,634	mm. 1,666	mm. 1,747	mm. 1,625
Finger-reach	1,466	1,713	1,708	1,833	1,775
Height of seventh vertebra	1,222	—	—	1,501	1,403
Height of acromion	1,168	1,295	1,336	1,400	1,308
Height of point of second finger	517	552	622	613	578
Width between acromia	310	375	—	426	370
Height, sitting	775	867	889	952	897
Length of arm	651	743	714	787	730
Length of head	178	179	184	191 ¹	186
Width of head	147	150	149	164 ¹	153
Height of ear	133	129	146	154 ¹	124
Width of face	131	140	135	153	145
Distance from chin to naso-frontal suture	116	116	118	129	120
Distance from mouth to naso-frontal suture	76	72	69	84	76
Height of nose	50	52	48	59	55
Width of base of nose	24	32	33	29	33
Maximum width of nose	31	38	—	37	40
Cephalic index	82.6	83.8	81.0	85.9 ¹	82.3
Index of height of ear	74.7	72.1	79.3	80.6 ¹	66.7
Facial index	88.6	82.9	87.4	84.3	82.8
Index of upper part of face	58.0	51.4	51.1	54.9	52.4
Nasal index	62.0	73.1	—	62.7	72.7
Index of base of nose	48.0	61.5	63.5	49.1	60.0
Finger-reach in per cent.	101.3	104.8	102.5	104.9	109.2
Height, sitting, „	53.6	53.0	53.5	54.5	55.1
Length of arm, „	45.0	45.5	42.8	45.1	45.0

¹ Head deformed.

7. *Columbians* (continued).

I. Males							II. Females		
6	7	8	9	10	11	12	13	14	15
Oscar Wilbur	George Wilbur	Henry Winslow	Tom Gilbert	Charles Cultee, father of Nos. 2 and 4	John Pratt	Dick Hall	Lena Wilbur	Louise Wilbur	Catherine
Klickitat	Klickitat	Clackamas	F. $\frac{3}{4}$ Molalla, $\frac{1}{4}$ Clackamas. M. $\frac{3}{4}$ Molalla, $\frac{1}{4}$ Clackamas	F. Chinook M. Katlamat	Kalapooya	Klickitat	F. Klickitat, No. 6 M. Alsea	F. Klickitat, No. 6 M. Alsea	F. Chinook M. Clatsop
34-35	37	40	46	50	50	56-60	8-9	13	55
mm.	mm.	mm.	mm.	mm.	mm.	mm.	mm.	mm.	mm.
1,777	1,615	1,758	1,668	1,682	1,722	1,651	1,224	1,459	1,520
1,851	1,727	1,865	1,750	1,731	1,803	1,719	1,244	1,514	1,560
1,549	1,371	—	1,438	1,447	1,501	1,417	1,006	1,247	—
1,454	1,329	1,441	1,373	1,362	1,447	1,365	971	1,175	1,238
676	600	670	654	584	676	613	465	552	581
387	343	—	381	397	—	—	277	348	356
952	894	927	895	921	941	869	672	797	817
778	729	771	719	778	771	752	506	623	657
193	184	201	190 ¹	186 ¹	181 ¹	182 ¹	171	175	173 ¹
156	157	158	176 ¹	185 ¹	153 ¹	156 ¹	151	158	161 ¹
120	129	153	135 ¹	139 ¹	116 ¹	129 ¹	132	130	129 ¹
156	147	145	164	160	144	147	130	141	149
129	124	114	128	129	124	126	104	112	111
83	75	75	85	85	82	76	63	71	77
54	52	47	61	62	59	55	42	48	50
29	33	29	32	37	27	34	26	33	34
—	—	36	38	39	36	37	—	—	39
80·8	85·3	78·6	92·6 ¹	99·5 ¹	84·5 ¹	85·7 ¹	88·3	90·3	93·1 ¹
62·2	70·1	76·1	71·1 ¹	74·7 ¹	—	70·9 ¹	77·2	74·3	74·6 ¹
82·7	84·4	78·6	78·0	80·1	86·1	85·7	80·0	79·4	74·5
53·2	51·0	51·7	51·8	53·1	56·9	51·7	48·5	50·4	51·7
—	—	76·6	62·3	62·9	61·0	67·3	—	—	78·0
53·7	63·5	61·7	52·4	59·7	45·7	61·8	61·9	68·7	68·0
105·0	106·9	106·1	104·9	102·9	104·7	104·1	101·6	103·7	102·6
53·6	55·3	52·7	53·7	54·7	54·6	52·7	54·9	54·6	53·8
43·8	45·2	43·9	43·2	46·3	44·8	45·6	41·4	42·7	43·2

¹ Head deformed.

8. *Aalsea and Tillamook.*

I. Males					
Number	1	2	3	4	5
Name	Evans Johns	Andie Baxter	David Dick	Frank Stanton	Louis Fuller
Tribe	Aalsea	Tillamook	Salmon River	Aalsea	F. Tillamook M. Siletz
Age	8	8-9	12	20	22
Stature	mm. 1,238	mm. 1,270	mm. 1,384	mm. 1,676	mm. 1,698
Finger-reach	1,247	1,311	1,364	1,708	1,752
Height of seventh vertebra	1,038	1,048	1,152	1,422	1,427
Height of acromion	981	991	1,101	1,374	1,378
Height of point of second finger	443	419	511	649	640
Width between acromia	260	283	310	360	402
Height, sitting	687	690	754	941	924
Length of arm	538	572	590	725	738
Length of head	169.5	185	181	182 ¹	178
Width of head	153.5	145	154	164 ¹	149
Height of ear	121	127	146	140 ¹	135
Width of face	128	131	—	155	138
Distance from chin to naso-frontal suture	102	97	116	126	112
Distance from mouth to naso-frontal suture	66	61	—	80	73
Height of nose	44	40	53	55	52
Width of base of nose	27	28	28	28	30
Cephalic index	90.5	78.4	85.1	90.1 ¹	83.7
Index of height of ear	71.4	68.6	80.7	76.9 ¹	75.8
Facial index	79.6	74.0	—	81.3	81.2
Index of upper part of face	51.6	46.6	—	51.6	52.9
Index of base of nose	61.4	70.0	52.8	50.9	57.7
Finger-reach in per cent.	100.7	103.2	98.6	101.9	103.2
Height, sitting, "	55.5	54.3	54.5	56.1	54.4
Length of arm, "	43.4	45.1	42.7	43.3	43.5

¹ Head deformed.

8. *Alsea and Tillamook* (continued).

I. Males					II. Females				
6	7	8	9	10	11	12	13	14	15
Marcellus, brother of No. 5	Fred Jackson	Thomas Jackson	U. S. Grant	William Smith	Ollie Jim	Julia Ben	Louise George	Wife of Oscar Wilbour (No. 6, table 7)	Wife of Haias John, grandmother of No. 2
F. Tillamook M. Siletz	Alsea	Alsea	Alsea	Alsea	Alsea	Alsea	Tillamook	Alsea	Alsea
23	25	30	30	55	11	16	18	30	55-60
mm. 1,596 1,685 1,364 1,289 584 393 887 705	mm. 1,662 1,780 1,425 1,330 583 390 911 757	mm. 1,684 1,791 1,452 1,373 603 370 931 770	mm. 1,631 1,706 1,384 1,311 611 373 907 700	mm. 1,609 1,713 1,397 1,310 594 379 887 716	mm. 1,416 1,428 — 1,139 533 318 768 606	mm. 1,508 1,524 1,301 1,225 552 330 — 673	mm. 1,530 1,576 1,308 1,228 551 352 841 677	mm. 1,562 1,636 1,321 1,266 569 367 824 697	mm. 1,460 1,499 1,233 1,199 581 325 811 618
184 156 130 144 122 76 54 31	180 ¹ 165 ¹ 151 ¹ 152 124 77 57 36	180 ¹ 159 ¹ 141 ¹ 152 120 72 53 32	176 ¹ 170 ¹ 140 ¹ 152 120 75 54 34	187 ¹ 167 ¹ 140 ¹ 154 116 75 52 33	178 149 159 133 102 — 43 35	165 145 127 128 107 — 49 28	186 ¹ 166 ¹ 149 ¹ 145 119 80 58 28	185 ¹ 162 ¹ 134 ¹ 145 120 81 56 30	179 ¹ 159 ¹ 143 ¹ 14 11 — 58 31
84.8 70.7 84.7 52.8 57.4	91.7 ¹ 83.9 ¹ 81.6 50.7 63.2	88.3 ¹ 78.3 ¹ 78.9 47.4 60.4	96.6 ¹ 79.5 ¹ 78.9 49.3 63.0	89.3 ¹ 74.9 ¹ 75.3 48.7 63.5	83.7 89.3 76.7 — 81.4	87.9 ² 77.0 83.6 — 57.1	89.2 ¹ 80.1 ¹ 82.1 55.2 48.3	87.6 ¹ 72.4 ¹ 82.6 55.9 53.6	88.8 ¹ 79.9 ¹ 76.6 — 53.4
105.6 55.6 44.2	107.1 54.8 44.9	106.4 55.3 45.7	104.6 55.6 42.9	106.5 55.1 41.5	100.8 53.5 42.8	101.1 — 44.7	103.0 55.0 44.2	104.7 52.8 44.6	102.7 55.5 42.4

¹ Head deformed.
1891.² Doubtful whether head deformed.

10. *Crosses between Oregonian Tinneh and Northern Californians.*

Number	I. Males					
	1	2	3	4	5	6
Name	Joseph Adams	Walter A. Ben	Isaak Washington	David John	Launy	John Adams
Tribe	F. Shasta M. Sixes	F. Galice Creek M. Klamath	F. Klamath M. Applegate	F. Klamath M. Rogue River	F. Shasta M. Rogue River	F. Applegate M. Shasta
Age	17	22	22	24	26	45
Stature	mm. 1,593	mm. 1,681	mm. 1,570	mm. 1,636	mm. 1,636	mm. 1,647
Finger-reach	1,717	1,747	1,615	1,703	1,676	1,753
Height of seventh vertebra	1,355	1,441	1,322	1,390	1,371?	1,438
Height of acromion	1,297	1,352	1,265	1,352	1,330	1,362
Height of point of second finger	549	624	571	619	600	592
Width between acromia	360	386	375	362	—	376
Height, sitting	841	892	886	881	908	876
Length of head	173	187	181	177	193 ¹	184
Width of head	155	149	155	154	149	148
Height of ear	149	145	135	133	116	133
Width of face	144	135	143	136	142	148
Distance from chin to naso-frontal suture	121	125	119	122	122	120
Distance from mouth to naso-frontal suture	—	76	80	78	71	—
Height of nose	53	52	55	54	50	53
Width of base of nose	32·5	27	28	24	32	31
Cephalic index	89·6	79·7	85·6	87·0	77·2	80·4
Index of height of ear	86·1	77·5	74·6	75·1	—	72·3
Facial index	84·0	92·6	83·2	89·7	85·9	81·1
Index of upper part of face	—	56·3	55·9	57·4	50·0	—
Index of base of nose	61·3	52·0	50·8	44·4	64·0	58·3
Finger-reach, in per cent.	107·8	103·9	102·9	104·1	102·4	106·4
Height, sitting, „	52·8	53·1	56·4	53·9	55·5	53·2
Length of arm, „	47·0	43·3	44·2	44·8	44·6	46·7
Minimum width of forehead	—	—	—	108	—	—
Maximum width of nose	—	—	—	41	—	—

¹ 197 from glabella.

11. *Southern Oregon and Northern California.*

Number	I. Males							II. Fe- male
	1	2	3	4	5	6	7	8
Name	Edward Metcalf, son of No. 4	Clark Smith	Klamath Billy	Robert Metcalf	Thomas Smith	Klamath Bob	Klamath Charlie	Annie Shellhead
Tribe	Shasta	Klamath	Klamath	Shasta	F. Shasta, M. Klamath	Klamath	Klamath	Klamath
Age	16	18	35	40	48	50	60	45-50
Stature	mm. 1,606	mm. 1,615	mm. 1,622	mm. 1,666	mm. 1,612	mm. 1,551	mm. 1,570	mm. 1,554
Finger-reach	1,665	1,756	1,681	1,719	1,714	1,651	1,630	1,525
Height of seventh ver- tebra	1,365	1,374	1,381	1,437	1,365	1,313	1,349	—
Height of acromion . . .	1,282	1,303	1,301	1,359	1,317	1,227	1,238	1,241
Height of point of second finger	565	559	581	619	576	557	557	611
Width between ac- romia	—	400	373	—	352	367	340	325
Height, sitting	870	847	881	889	854	795	813	889
Length of head	189	194	183	190	190	187	189	187
Width of head	150	154	149	152	152	155	154	146
Height of ear	130	133	133	127	141	146	158	142
Width of face	139	144	147	148	145	142	148	148
Distance from chin to naso-frontal suture	120	128	123	121	121	123	128	116
Distance from mouth to naso-frontal suture	76	79	76	71	72	79	85	74
Height of nose	52	51	55	53	47	55	62	52
Width of base of nose . .	29	31	31	34	30	31	36	31
Cephalic index	79·4	79·4	81·4	80·0	80·0	82·9	81·5	78·1
Index of height of ear . .	68·8	68·6	72·7	66·8	74·2	78·1	83·6	75·9
Facial index	86·3	88·9	83·7	81·8	83·5	86·6	86·5	81·1
Index of upper part of face	54·7	54·9	51·7	48·0	49·7	55·6	57·4	51·7
Index of base of nose . .	55·8	60·8	56·3	64·1	63·9	56·3	58·1	59·8
Finger-reach in per cent.	103·7	108·7	103·6	103·2	106·3	106·4	103·8	98·1
Height, sitting, "	54·2	52·4	53·7	53·4	53·0	51·3	51·8	57·2
Length of arm, "	44·7	46·1	44·4	44·4	46·0	43·2	43·4	40·5
Minimum width of fore- head	102	—	—	100	—	—	—	—
Maximum width of nose	35	—	—	36	—	—	—	—

In order to discuss the material contained in the preceding tables, I have arranged it in series. The series for 'Stature,' 'Cephalic Index,' 'Facial Index,' 'Index of Upper Part of Face,' 'Finger-reach,' 'Height, sitting,' and 'Length of Arm,' are given here. In selecting the cases to be included in each series, it was necessary to exercise some criticism. The ages of all individuals are estimated more or less incorrectly. In order to fix the lower limit, I assumed nineteen years for males and seventeen years for females as the limit. For the facial index I assumed the limits as twenty and eighteen. Only in such cases where the measurements of a male of about eighteen years exceeded the corresponding most frequent measurements of adults; I included the case in the series, as the probability is, that such an individual had reached approximately its maximum growth. By this method the total results cannot be depressed. It is more difficult to decide on an upper limit. It appears clearly from the tables that the changes incident to old age begin very early among these Indians. The stature decreases, and the facial index diminishes on account of the wearing down of the teeth. But there are great individual differences regarding the time of the beginning of these changes. A decrease of stature will always tend to increase the relative length of arm, because the absolute length of the latter does not decrease proportionately. In the same way the proportional part of the 'height, sitting' decreases as the trunk loses more rapidly, through the increasing curvature of the spine, than the legs do. I have, therefore, excluded all such individuals over forty-eight years (estimated), in whom these indices differ from the most frequently occurring indices in such a sense that they might be explained as caused by loss in size.

A comparison of children's cephalic indices and of those of adults does not seem to bring out any typical differences between the two; for this reason, which is entirely in accord with Welcker's investigations of the growth of the skull ('*Untersuchungen über Wachstum und Bau des menschlichen Schädels*,' Leipzig, 1862), I have not separated children and adults. Neither do I find an appreciable difference between the indices of males and females, and consider it therefore justifiable to lump all the observations on this point. If, in Table 9, the measurements of Oregonian Tinneh, north of Rogue River, are tabulated separately [for what reason this separation is made, will appear later], the following result is obtained, which shows how nearly the maxima of frequency of occurrence of values of the cephalic index coincide among boys, girls, adult males and adult females:—

Cephalic Index	75	76	77	78	79	80	81	82	83	84	85	86	87	88	89	90	Average
Boys	—	—	—	—	—	—	—	—	—	—	1	1	—	—	2	—	87.7
Girls	—	—	—	—	—	1	—	—	—	1	—	—	—	—	—	—	83.9
Adult males	1	—	—	—	—	—	2	1	2	1	4	—	1	—	—	1	83.8
Adult females	—	—	—	—	—	—	2	—	2	1	—	2	—	—	—	—	83.8

The following tables give the number of occurrences of certain values of stature and various indices among the different tribes. I have refrained from reducing the figures in such a way that they would indicate how many individuals among a thousand would have a certain stature or a certain index. Although apparently by such a procedure the figures become more easily comparable, there is no justification for such a reduction, as the frequency of occurrence of certain values is not proportional to the number of observations. With an increasing number

II. Females

	19	20	21	22	23	24	25	26	27	28	29
	Temqoagya's	E'sk-el, Mú'iat	AtlmEná'm	Naná'lak'umai	Ai'amaic		K'amsthoalá'- aqstsa	Tlak'oai'tl	Ileaqaí'h	Anuqau'waks	Sineqé'm
	Nusk'E'lst	Nuqa'lkh	Nuqa'lkh	Sátsk	Sátsk		Nuqa'lkh	F. Guasila M. Bilqula	Nuqa'lkh	Nuqa'lkh	Senqtl
	36	35-40	44	45	50-55	20	22	24	25	28-30	32
	mm.	mm.	mm.	mm.	mm.	n.	mm.	mm.	mm.	mm.	mm.
	1,685	1,587	1,679	1,670	1,606	12	1,581	1,588	1,525	1,614	1,549
	1,781	1,756	1,807	1,753	1,743	12	1,708	1,666	1,612	1,713	1,607
	—	—	1,422	—	1,378		—	1,349	—	1,393	—
	1,374	1,279	1,371	1,353	1,314	17	1,270	1,308	{ 1,244 1,260r	1,317	{ 1,260r 1,238r
	619	543	591	604	616		530	597	559r	578	562r
	384	381	389	384	325	9	359	321	365	367	346
	898	889	892	879	864	8	876	855	826	883	834
	755	736	780	751	698		740	711	685	739	676
	193	183	201	195	180	5 ¹	178 ¹	182 ¹	174 ¹	177·5 ¹	169 ¹
	165	151	157	157	157·5	5 ¹	157 ¹	151 ¹	163 ¹	153 ¹	157 ¹
	134	138	138	137	133	5 ¹	138 ¹	131 ¹	130 ¹	133 ¹	127 ¹
	157	149	146·5	157	150	7	149	144	156	138·5	146
	129	128	128	139	121	8	123	125	119	124	121
De	85	77	79	92	81	6	74	80	78	77	82
He	62	53·5	59	64	58	1	50	53	57	55	58
W	32	33	35	35	31	1	29	28	30	29	26
Ma	40	40	42	38	36	6	33	36	39	33	32
Ce	36·0	82·5	78·5	85·5	87·5	1 ¹	88·2 ¹	83·0 ¹	93·7 ¹	86·2 ¹	92·9 ¹
Inc	29·4	75·4	68·7	70·3	73·9	8 ¹	77·5 ¹	72·0 ¹	74·7 ¹	74·9 ¹	75·1 ¹
Fac	2·2	85·9	87·4	88·5	80·7	3	82·6	86·8	76·3	89·5	82·9
Ind	4·1	51·7	54·0	58·6	54·0	7	49·0	55·6	50·0	55·6	56·2
Nas	7·5	74·8	71·2	59·4	62·1	6	66·0	67·9	68·4	60·0	55·2
Ind	3·2	65·4	59·3	54·7	53·4	8	58·0	52·8	52·8	52·7	44·8
Fin	7·7	110·6	107·6	105·0	108·5	15	108·1	104·9	105·6	106·2	103·7
Heig	4·3	56·0	53·1	52·6	53·0	4	55·4	53·8	54·1	54·7	53·8
Len	4·6	46·4	46·5	45·0	43·5		46·8	44·8	44·9	45·8	43·6

	18	20	21
Nam	Dominy	Lucie, father, No. 12	Mary, mother, No. 29
Tribe	Sq̄tein	Ft. Douglass	Ft. Douglass
Age .	75 10	11	
Statur	mm.mm. 1,419082	mm 1,381	
Finger	1,498156	1,358	
Height	— 892	1,171	
Height	1,15857	1,127	
Height	511365	547	
Width	32145	311	
Height	77691	787	
Length	64892	582	
Length	17963	180	
Width	160551	152	
Height	12927	118	
Width	141523	130	
Distance sut	1041	112	
Distance sut	678	72	
Height	490	51	
Width of	363	27	
Maximu	430	34	
Cephalic	87.2	84.4	
Index of	72.1	65.7	
Facial in	73.5	80.6	
Index of	47.4	51.8	
Nasal in	87.7	66.7	
Index of	73.5	52.9	
Finger-r	105.5	98.4	
Height, s	54.7	57.0	
Length of	45.7	42.2	



of

Num

Nam

T

A

S
F
H
H
H
W
H
L

L
W
H
W
D

D

H
W
M

C
I
F
I
N
I

F
H
L



C. *Cost of Washington*

[To face p. 436]

Age	I Miles											II Miles														
	9	11	12	14	15	16	17	18	19	20	25	30	35	40	45	50	55	60	65	70	75	80	85	90	95	100
Height of nose	1.222	1.314	1.393	1.499	1.533	1.551	1.605	1.622	1.635	1.672	1.708	1.711	1.741	1.762	1.783	1.807	1.827	1.847	1.867	1.887	1.907	1.927	1.947	1.967	1.987	2.007
Height of ear	1.12	1.20	1.28	1.36	1.44	1.52	1.60	1.68	1.76	1.84	1.92	2.00	2.08	2.16	2.24	2.32	2.40	2.48	2.56	2.64	2.72	2.80	2.88	2.96	3.04	3.12
Height of ear to nose	0.12	0.16	0.20	0.24	0.28	0.32	0.36	0.40	0.44	0.48	0.52	0.56	0.60	0.64	0.68	0.72	0.76	0.80	0.84	0.88	0.92	0.96	1.00	1.04	1.08	1.12
Height of ear to eye	0.12	0.16	0.20	0.24	0.28	0.32	0.36	0.40	0.44	0.48	0.52	0.56	0.60	0.64	0.68	0.72	0.76	0.80	0.84	0.88	0.92	0.96	1.00	1.04	1.08	1.12
Height of eye to nose	0.12	0.16	0.20	0.24	0.28	0.32	0.36	0.40	0.44	0.48	0.52	0.56	0.60	0.64	0.68	0.72	0.76	0.80	0.84	0.88	0.92	0.96	1.00	1.04	1.08	1.12
Height of eye to ear	0.12	0.16	0.20	0.24	0.28	0.32	0.36	0.40	0.44	0.48	0.52	0.56	0.60	0.64	0.68	0.72	0.76	0.80	0.84	0.88	0.92	0.96	1.00	1.04	1.08	1.12
Height of nose to eye	0.12	0.16	0.20	0.24	0.28	0.32	0.36	0.40	0.44	0.48	0.52	0.56	0.60	0.64	0.68	0.72	0.76	0.80	0.84	0.88	0.92	0.96	1.00	1.04	1.08	1.12
Height of nose to ear	0.12	0.16	0.20	0.24	0.28	0.32	0.36	0.40	0.44	0.48	0.52	0.56	0.60	0.64	0.68	0.72	0.76	0.80	0.84	0.88	0.92	0.96	1.00	1.04	1.08	1.12
Width of nose	0.86	0.94	1.02	1.10	1.18	1.26	1.34	1.42	1.50	1.58	1.66	1.74	1.82	1.90	1.98	2.06	2.14	2.22	2.30	2.38	2.46	2.54	2.62	2.70	2.78	2.86
Width of base of nose	0.33	0.32	0.31	0.30	0.29	0.28	0.27	0.26	0.25	0.24	0.23	0.22	0.21	0.20	0.19	0.18	0.17	0.16	0.15	0.14	0.13	0.12	0.11	0.10	0.09	0.08
Width of tip of nose	0.15	0.14	0.13	0.12	0.11	0.10	0.09	0.08	0.07	0.06	0.05	0.04	0.03	0.02	0.01	0.00	0.00	0.00	0.00	0.00	0.00	0.00	0.00	0.00	0.00	0.00
Width of base of eye	0.11	0.12	0.13	0.14	0.15	0.16	0.17	0.18	0.19	0.20	0.21	0.22	0.23	0.24	0.25	0.26	0.27	0.28	0.29	0.30	0.31	0.32	0.33	0.34	0.35	0.36
Width of tip of eye	0.02	0.02	0.02	0.02	0.02	0.02	0.02	0.02	0.02	0.02	0.02	0.02	0.02	0.02	0.02	0.02	0.02	0.02	0.02	0.02	0.02	0.02	0.02	0.02	0.02	0.02
Width of base of ear	0.09	0.09	0.09	0.09	0.09	0.09	0.09	0.09	0.09	0.09	0.09	0.09	0.09	0.09	0.09	0.09	0.09	0.09	0.09	0.09	0.09	0.09	0.09	0.09	0.09	0.09
Width of tip of ear	0.01	0.01	0.01	0.01	0.01	0.01	0.01	0.01	0.01	0.01	0.01	0.01	0.01	0.01	0.01	0.01	0.01	0.01	0.01	0.01	0.01	0.01	0.01	0.01	0.01	0.01
Width of base of ear to nose	0.01	0.01	0.01	0.01	0.01	0.01	0.01	0.01	0.01	0.01	0.01	0.01	0.01	0.01	0.01	0.01	0.01	0.01	0.01	0.01	0.01	0.01	0.01	0.01	0.01	0.01
Width of base of ear to eye	0.01	0.01	0.01	0.01	0.01	0.01	0.01	0.01	0.01	0.01	0.01	0.01	0.01	0.01	0.01	0.01	0.01	0.01	0.01	0.01	0.01	0.01	0.01	0.01	0.01	0.01
Width of base of ear to nose to eye	0.01	0.01	0.01	0.01	0.01	0.01	0.01	0.01	0.01	0.01	0.01	0.01	0.01	0.01	0.01	0.01	0.01	0.01	0.01	0.01	0.01	0.01	0.01	0.01	0.01	0.01

M. CHECKO

8
7
6
5
4
3
2
1
0
9
8
7
6
5
4
3
2
1
0
9
8
7
6
5
4
3
2
1
0

	41	42	
	Dora Ross	Jessie Baptiste	
	Naltené'tine	F. Galice Creek M. Tututine	F. Rogue River
	7-8	8-9	9
mm.	mm.	mm.	
1,178	1,228	1,111	
1,209	1,216	1,111	
979	999	999	
924	962	999	
403	435	411	
289	267	277	
646	705	646	
521	527	511	
180	173	166	
145	157	144	
124	155	100	
122	127	122	
105	101	99	
67	67	—	
48	47	44	
28	26	33	
80.6	90.8	88.8	
68.9	89.6	62.2	
85.2	77.6	76.6	
54.9	52.8	—	
58.3	55.3	73.3	
102.6	99.0	101.1	
54.8	57.4	54.4	
44.2	43.0	44.4	
—	—	—	
—	—	—	



Oregonian Trans.

Age	Sex	Locality	Length		Wing		Tail		Culmen		Tarsus		Middle toe		Claw	
			mm	in	mm	in	mm	in	mm	in	mm	in	mm	in	mm	in
5	♂	Elm River M. C. ...	150	5.9	100	3.9	70	2.8	15	0.6	25	1.0	15	0.6	10	0.4
6	♂	Elm River M. C. ...	155	6.1	105	4.1	75	3.0	16	0.6	26	1.0	16	0.6	11	0.4
7	♂	Elm River M. C. ...	160	6.3	110	4.3	80	3.2	17	0.7	27	1.1	17	0.7	12	0.5
8	♂	Elm River M. C. ...	165	6.5	115	4.5	85	3.4	18	0.7	28	1.1	18	0.7	13	0.5
9	♂	Elm River M. C. ...	170	6.7	120	4.7	90	3.6	19	0.8	29	1.2	19	0.8	14	0.6
10	♂	Elm River M. C. ...	175	6.9	125	4.9	95	3.8	20	0.8	30	1.2	20	0.8	15	0.6
11	♂	Elm River M. C. ...	180	7.1	130	5.1	100	4.0	21	0.9	31	1.3	21	0.9	16	0.7
12	♂	Elm River M. C. ...	185	7.3	135	5.3	105	4.2	22	0.9	32	1.3	22	0.9	17	0.7
13	♂	Elm River M. C. ...	190	7.5	140	5.5	110	4.4	23	1.0	33	1.4	23	1.0	18	0.8
14	♂	Elm River M. C. ...	195	7.7	145	5.7	115	4.6	24	1.0	34	1.4	24	1.0	19	0.8
15	♂	Elm River M. C. ...	200	7.9	150	5.9	120	4.8	25	1.1	35	1.5	25	1.1	20	0.9
16	♂	Elm River M. C. ...	205	8.1	155	6.1	125	5.0	26	1.1	36	1.5	26	1.1	21	0.9
17	♂	Elm River M. C. ...	210	8.3	160	6.3	130	5.2	27	1.2	37	1.6	27	1.2	22	1.0
18	♂	Elm River M. C. ...	215	8.5	165	6.5	135	5.4	28	1.2	38	1.6	28	1.2	23	1.0
19	♂	Elm River M. C. ...	220	8.7	170	6.7	140	5.6	29	1.3	39	1.7	29	1.3	24	1.1
20	♂	Elm River M. C. ...	225	8.9	175	6.9	145	5.8	30	1.3	40	1.7	30	1.3	25	1.1
21	♂	Elm River M. C. ...	230	9.1	180	7.1	150	6.0	31	1.4	41	1.8	31	1.4	26	1.2
22	♂	Elm River M. C. ...	235	9.3	185	7.3	155	6.2	32	1.4	42	1.8	32	1.4	27	1.2
23	♂	Elm River M. C. ...	240	9.5	190	7.5	160	6.4	33	1.5	43	1.9	33	1.5	28	1.3
24	♂	Elm River M. C. ...	245	9.7	195	7.7	165	6.6	34	1.5	44	1.9	34	1.5	29	1.3
25	♂	Elm River M. C. ...	250	9.9	200	7.9	170	6.8	35	1.6	45	2.0	35	1.6	30	1.4
26	♂	Elm River M. C. ...	255	10.1	205	8.1	175	7.0	36	1.6	46	2.0	36	1.6	31	1.4
27	♂	Elm River M. C. ...	260	10.3	210	8.3	180	7.2	37	1.7	47	2.1	37	1.7	32	1.5
28	♂	Elm River M. C. ...	265	10.5	215	8.5	185	7.4	38	1.7	48	2.1	38	1.7	33	1.5
29	♂	Elm River M. C. ...	270	10.7	220	8.7	190	7.6	39	1.8	49	2.2	39	1.8	34	1.6
30	♂	Elm River M. C. ...	275	10.9	225	8.9	195	7.8	40	1.8	50	2.2	40	1.8	35	1.6
31	♂	Elm River M. C. ...	280	11.1	230	9.1	200	8.0	41	1.9	51	2.3	41	1.9	36	1.7
32	♂	Elm River M. C. ...	285	11.3	235	9.3	205	8.2	42	1.9	52	2.3	42	1.9	37	1.7
33	♂	Elm River M. C. ...	290	11.5	240	9.5	210	8.4	43	2.0	53	2.4	43	2.0	38	1.8
34	♂	Elm River M. C. ...	295	11.7	245	9.7	215	8.6	44	2.0	54	2.4	44	2.0	39	1.8
35	♂	Elm River M. C. ...	300	11.9	250	9.9	220	8.8	45	2.1	55	2.5	45	2.1	40	1.9
36	♂	Elm River M. C. ...	305	12.1	255	10.1	225	9.0	46	2.1	56	2.5	46	2.1	41	1.9
37	♂	Elm River M. C. ...	310	12.3	260	10.3	230	9.2	47	2.2	57	2.6	47	2.2	42	2.0
38	♂	Elm River M. C. ...	315	12.5	265	10.5	235	9.4	48	2.2	58	2.6	48	2.2	43	2.0
39	♂	Elm River M. C. ...	320	12.7	270	10.7	240	9.6	49	2.3	59	2.7	49	2.3	44	2.1
40	♂	Elm River M. C. ...	325	12.9	275	10.9	245	9.8	50	2.3	60	2.7	50	2.3	45	2.1
41	♂	Elm River M. C. ...	330	13.1	280	11.1	250	10.0	51	2.4	61	2.8	51	2.4	46	2.2
42	♂	Elm River M. C. ...	335	13.3	285	11.3	255	10.2	52	2.4	62	2.8	52	2.4	47	2.2
43	♂	Elm River M. C. ...	340	13.5	290	11.5	260	10.4	53	2.5	63	2.9	53	2.5	48	2.3
44	♂	Elm River M. C. ...	345	13.7	295	11.7	265	10.6	54	2.5	64	2.9	54	2.5	49	2.3
45	♂	Elm River M. C. ...	350	13.9	300	11.9	270	10.8	55	2.6	65	3.0	55	2.6	50	2.4
46	♂	Elm River M. C. ...	355	14.1	305	12.1	275	11.0	56	2.6	66	3.0	56	2.6	51	2.4
47	♂	Elm River M. C. ...	360	14.3	310	12.3	280	11.2	57	2.7	67	3.1	57	2.7	52	2.5
48	♂	Elm River M. C. ...	365	14.5	315	12.5	285	11.4	58	2.7	68	3.1	58	2.7	53	2.5
49	♂	Elm River M. C. ...	370	14.7	320	12.7	290	11.6	59	2.8	69	3.2	59	2.8	54	2.6
50	♂	Elm River M. C. ...	375	14.9	325	12.9	295	11.8	60	2.8	70	3.2	60	2.8	55	2.6
51	♂	Elm River M. C. ...	380	15.1	330	13.1	300	12.0	61	2.9	71	3.3	61	2.9	56	2.7
52	♂	Elm River M. C. ...	385	15.3	335	13.3	305	12.2	62	2.9	72	3.3	62	2.9	57	2.7
53	♂	Elm River M. C. ...	390	15.5	340	13.5	310	12.4	63	3.0	73	3.4	63	3.0	58	2.8
54	♂	Elm River M. C. ...	395	15.7	345	13.7	315	12.6	64	3.0	74	3.4	64	3.0	59	2.8
55	♂	Elm River M. C. ...	400	15.9	350	13.9	320	12.8	65	3.1	75	3.5	65	3.1	60	2.9
56	♂	Elm River M. C. ...	405	16.1	355	14.1	325	13.0	66	3.1	76	3.5	66	3.1	61	2.9
57	♂	Elm River M. C. ...	410	16.3	360	14.3	330	13.2	67	3.2	77	3.6	67	3.2	62	3.0
58	♂	Elm River M. C. ...	415	16.5	365	14.5	335	13.4	68	3.2	78	3.6	68	3.2	63	3.0
59	♂	Elm River M. C. ...	420	16.7	370	14.7	340	13.6	69	3.3	79	3.7	69	3.3	64	3.1
60	♂	Elm River M. C. ...	425	16.9	375	14.9	345	13.8	70	3.3	80	3.7	70	3.3	65	3.1

325 centigrade
223 centigrade

116 from Oregon.

116 from Oregon.

Index of upper part of face of Males.

Tribes	44	45	46	47	48	49	50	51	52	53	54	55	56	57	58	59	60	61	Number of Cases
Northern tribes and Vancouver Island	—	—	—	2	—	2	2	—	1	1	—	2	—	1	2	1	1	—	15
Bilqula	—	—	—	—	1	1	1	5	8	3	5	3	1	—	1	—	—	—	29
Fraser River	1	—	—	—	—	—	2	1	—	1	2	—	—	—	—	—	—	—	7
Harrison Lake	1	1	—	2	1	—	—	1	2	1	—	—	—	—	—	—	—	—	9
Washington	—	—	—	—	—	1	—	1	1	—	2	—	—	—	—	1	—	—	6
Columbians	—	—	—	—	—	—	—	4	1	2	1	—	1	—	—	—	—	—	9
Northern Oregon	—	—	—	1	1	1	1	1	2	—	—	—	—	—	—	—	—	—	7
Oregonian Tinneh	—	—	—	—	—	1	4	1	2	1	4	2	1	2	1	—	—	1	20
Crosses between Oregonian Tinneh and Californians	—	—	—	—	—	—	1	—	—	—	—	1	1	1	—	—	—	—	4
Northern Californians	—	—	—	—	1	1	—	1	—	—	2	1	—	1	—	—	—	—	7

Index of upper part of face of Females.

Bilqula	—	—	—	—	—	1	1	1	—	—	—	2	1	—	—	—	—	—	6
Harrison Lake	—	—	3	—	—	1	1	1	—	2	—	—	—	1	—	—	—	—	9
Washington	—	—	—	1	1	—	1	2	1	—	—	—	—	—	—	—	—	—	6
Northern Oregon	—	—	—	—	—	—	—	—	—	—	—	2	—	—	—	—	—	—	2
Oregonian Tinneh	—	—	—	—	—	1	2	1	—	1	1	—	—	1	—	—	—	—	7

Length of arm of Males.

Tribes	Per cent.									Number of Cases
	41	42	43	44	45	46	47	48	49	
Northern tribes and Vancouver Island	—	—	2	3	8	1	—	—	1	15
Bilqula	—	1	1	5	10	6	1	1	—	25
Fraser River	—	—	1	—	—	—	—	1	—	3
Harrison Lake	—	—	2	3	2	2	—	—	—	9
Washington	—	1	2	2	1	—	—	—	—	6
Columbians	—	—	3	1	4	1	—	—	—	9
Northern Oregon	—	1	2	3	1	—	—	—	—	7
Oregonian Tinneh	—	3	1	8	3	1	—	1	—	17
Crosses between Oregonian Tinneh and Californians	—	—	1	3	—	1	1	—	—	6
Northern Californians	—	—	2	3	—	2	—	—	—	7

Length of arm of Females.

Tribes	Per cent.									Number of Cases
	41	42	43	44	45	46	47	48	49	
Bilqula	—	—	1	2	1	1	—	—	—	5
Harrison Lake	—	—	—	4	3	—	—	—	—	7
Washington	1	2	—	—	2	—	1	—	—	6
Northern Oregon	—	1	—	3	—	—	—	—	—	4
Oregonian Tinneh	—	1	1	6	1	—	—	—	—	9

We will direct our attention to the maximum of frequency in each of these series. It will then appear that in several of the groups two maxima occur, or are, at least, indicated. The principal maximum in each series is indicated by bold type.

Tribes	Stature in cm.			
Northern tribes and Vancouver Island	—	159-165	—	—
Bilqula	—	158-163	166-172	—
Fraser River	—	—	—	—
Harrison Lake	about 146	156-164	—	—
Washington	—	—	—	—
Columbians	—	162-166	—	173-177
Northern Oregonians	—	158-162	166-170	—
Oregonian Tinneh	—	160-170	—	—
Crosses between Tinneh and Northern Californians	—	about 163	—	—
Northern Californians	—	about 161	—	—

Tribes	Cephalic Index			Facial Index		
Northern tribes and Vancouver Island	77-81	83	—	—	78-81	82-85
Bilqula	80-82.5	85-88	—	—	78-81	83-86
Fraser River	—	84-87	—	—	—	—
Harrison Lake	—	82-84	87-92	about 75	—	81-84
Washington	80-82	83-87	—	—	—	—
Columbians	—	—	—	—	—	—
Northern Oregonians	—	83-85	—	—	—	—
Oregonian Tinneh	80-82	84-87	—	—	—	82-87
Crosses between Tinneh and Northern Californians	about 79	about 87	—	—	—	—
Northern Californians	79-81	—	—	—	—	83-86

This table gives a clue to the understanding of the types of the

various tribes. In looking over the figures given for the Bilqula, it appears that in the three cases considered here, two maxima of frequency occur, while cases between the two maxima are quite rare. Furthermore, it will be seen that the secondary maximum of this series coincides very nearly with the maximum of the first group, embracing the northern tribes and those of Vancouver Island. The cephalic indices do not coincide quite so well as the other measurements, but still sufficiently nearly. The primary maximum of the Bilqula agrees very closely with that of the Oregonian Tinneh. It appears that the stature of the latter varies more than that of the Bilqula, but I shall show later on the cause of this curious fact. The resemblance of the two maxima of frequency to the types of the Coast Indians and of the Tinneh is very far-reaching. As this comparison is entirely based on the occurrence of the two maxima among the Bilqula, it is desirable to show their actual existence more evidently. For this purpose I have divided the whole series of the Bilqula into two parts according to the order of the observations.

Bilqula.

Stature			Cephalic Index			Facial Index		
Cm.	Nos. 4-17	Nos. 18-32	Cm.	Nos. 1-16	Nos. 17-32	Cm.	Nos. 4-17	Nos. 18-32
154-157	—	1	78, 79	2	1	76, 77	—	1
158-161	5	3	80, 81	4	3	78, 79	3	3
162-165	2	1	82, 83	2	2	80, 81	3	1
166-169	3	6	84, 85	2	3	82, 83	—	3
170-173	4	3	86, 87	5	4	84, 85	5	3
174-177	—	1	88, 89	—	3	86, 87	1	2
			90, 91	1	—	88, 89	1	2
						90, 91	1	—

It appears from this table that the distribution of cases in the two halves of the series remains unchanged.

The explanation of these phenomena must be sought for in the mixture of the two types of people: the coast people of shorter stature, and with longer heads, and the Tinneh with shorter heads and of taller stature. We know that a mixture of these two people has taken place among the Bilqula. We even know, based on linguistic considerations, that the Bilqula must have lived at one time with the Salish tribes farther south-east. Therefore the explanation given here appears quite plausible.

While coming to these conclusions, I read a preliminary notice of the anthropological investigations carried on in Baden ('Globus,' vol. lix. p. 51), in which the same point is brought out most clearly. O. Ammon, who reports on these investigations, states that in the case of a mixture of types no middle forms originate, but that the parent forms are preserved separately. The same fact has been brought out by Dr. von Luschan in his investigations in Lycia. ('Reisen in Lykien,' &c., Vienna, 1889.) He found that among the Greeks of that country the Shemitic and Armenian types are preserved without having undergone any mixture. If we study among the Bilqula the individual distribution of observations, it appears that the types of the component forms which appear so clearly in a statistical treatment of the material, appear in all possible combinations among the single individuals, so that each indivi-

dual, as we might express it, is a mechanical mixture of the features of the parent types. He may have the face of a Tinneh, and the stature or head of a Coast Indian, and *vice versa*. This important fact also tallies exactly with Ammon's conclusions on the blonde and brunette population of Baden, and confirms the views which Kollmann expressed in 1883. ('Archiv für Anthropologie,' xiii. 79, 179; xiv. 1.) The fact that these conclusions have been arrived at independently on entirely independent material seems to give them great strength.

When we turn to a consideration of the Oregonian Tinneh, we shall find the same phenomena, although apparently somewhat obscured. Instead of two distinct maxima, we find here a great number of cases distributed equally over a long interval. The next northern group differs but little from the Tinneh, but their southern neighbours show quite a marked contrast, particularly regarding their cephalic index. If we assume the Oregonian Tinneh to be a mixture of the two, and keep the fact in mind that no middle forms originate, the form of the curve explains itself easily. In looking at the crosses between the two groups, their distribution according to the maxima of the two component groups is brought out most strikingly, notwithstanding the small number of cases.

In order to ascertain in how far these assumptions are justified, we will subdivide the material in a different way. If the Oregonian Tinneh contain a Californian element, we may assume that it is more prevalent in the south than in the north. For this reason we will arrange the material in the following groups: South of Rogue River, North of Rogue River, and crosses between the two. We will compare preliminarily the measurements from Northern Oregon with those of the group north of Rogue River.

Cephalic Index.

Tribes	75	76	77	78	79	80	81	82	83	84	85	86	87	88	89	90
North of Rogue River	1	—	—	—	—	1	4	1	4	3	5	4	1	—	2	1
Northern Oregon	—	—	—	1	—	—	—	—	2	1	1	—	1	—	—	1

Stature.

Tribes	152, 153	154, 155	156, 157	158, 159	160, 161	162, 163	164, 165	166, 167	168, 169
North of Rogue River	—	—	2	—	2	2	—	3	2
Northern Oregon	—	—	—	1	1	1	—	2	2

It appears that the two groups are quite homogeneous, so that we may be allowed to combine them. Thus we obtain the following table:—

Cephalic Index.

Tribes	75	76	77	78	79	80	81	82	83	84	85	86	87	88	89	90	91
South of Rogue River	—	—	1	3	4	7	4	3	—	2	3	—	1	—	1	1	—
Crosses	—	1	—	1	—	1	1	1	1	1	1	—	1	1	1	2	1
North of Rogue River	1	—	—	1	—	1	4	1	6	4	6	4	2	—	2	2	—

Stature.

Tribes	152, 153	154, 155	156, 157	158, 159	160, 161	162, 163	164, 165	166, 167	168, 169	170, 171
South of Rogue River	—	1	2	—	3	3	4	2	—	—
Crosses	1	—	—	1	—	—	—	—	—	1
North of Rogue River	—	—	2	1	3	3	—	3	4	—

It appears from these tables, particularly from that of the cephalic indices, that the individuals south of Rogue River are similar to the Northern Californians. But we also recognise distinctly in the series the secondary maximum belonging to the Oregonian Tinneh. In the same way we see that the tribes north of Rogue River are much more homogeneous, but recognise a secondary maximum corresponding to the Northern Californians. The table brings out exactly what might be expected: a greater admixture of Californian blood in the south than in the north. It is also important to note that the crosses in all these cases appear more variable than the individual races. This is what must take place if the crosses contain both the component types, and are not arranged around a middle type. The measurements, in the two groupings discussed above, give the following ranges of variation:—

Tribes	Range of Cephalic Index	Number of Cases	Range of Stature	Number of Cases
Oregonian Tinneh	17	57	10	19
Crosses	13	6	7	6
Northern Californians	5	8	7	6
North of Rogue River	16	34	7	18
Crosses	16	13	10	3
South of Rogue River	14	30	7	15

If the crosses and the component groups were equally variable, we ought to expect much narrower limits of variation among the former, as they embrace only a few individuals; while actually their ranges of variation equal or exceed those of the purer tribes.

I believe all these points, taken in connection with the results of Dr. von Luschan and O. Ammon, prove beyond a doubt the fact that in a mixture of tribes the component types remain unaltered.

The tables of finger-reach, height (sitting), length of arm, do not bring out these relations, because their ranges are almost the same among all the tribes, and therefore intermixture cannot be detected in the compound tribe.

We will try to explain the observations based on these considerations. Among the Bilqula, in Washington, and throughout Oregon, we find a type present of a stature, ranging from 166 to 172 cm., with a cephalic index of from 84 to 87, and a facial index of from 83 to 86. Among the Bilqula, and in Oregon, this is the prevailing type, while in Washington

it is of secondary importance. In all these regions Tinneh are the main mass of the population. They were present in Washington, and form a considerable element among the Bilqula. Therefore it must be assumed that this type represents the Tinneh of the Pacific Coast. We do not know much on the physical characteristics of the Tinneh east of the mountains. But according to Petitot they are tall ('Dictionnaire de la langue Déné-Dindjé,' p. xxi). Quatrefages and Hamy ('Crania Ethnica,' p. 470) mention seven skulls of Tinneh, and find them to be brachycephalic. Both these facts tally with what we found on the Pacific Coast. I had occasion to question a number of former officers of the Hudson Bay Company regarding the general appearance of the Tinneh of the interior of British Columbia, and of the Mackenzie Basin. According to their descriptions, they resemble the tribes of the North-West Coast much more closely than the Algonquin. The complete absence of dolichocephali—at least according to the present state of our knowledge—distinguishes the Tinneh most clearly from the eastern groups of Americans, the Algonquin and Iroquois, as well as the eastern and central Eskimo, so that I am inclined to class them as one of the Pacific peoples. This view is supported by linguistic and ethnological evidence, which, however, it is not the place to discuss here (see 'Journal of American Folk-Lore, vol. iv. p. 13, ff.). It is worth mentioning that the Tlingit of Alaska, who have intercourse with the Tinneh, appear also to be taller and more brachycephalic.

The tribes of the northern parts of the coast of British Columbia appear to be of shorter stature, ranging from 159 to 162 cm., and have much more elongated heads. They are mesocephalic, the index ranging from 77 to 81. We find the same type present, although to a lesser degree, in Washington and on Fraser River, as well as among the Bilqula. It appears to be absent in Oregon, but, remarkably enough, reappears as we approach California. Still farther south true dolichocephali appear. I cannot discover any difference of type between the northern tribes and those of Vancouver Island. This conclusion, drawn from measurements of living subjects, is confirmed by measurements of skulls from this region.

I published in the 'Verh. der Berliner Ges. f. Ethn.,' 1890, p. 30, measurements of a series of ten undeformed crania from Vancouver Island. All of them were obtained from a burial ground near Victoria, and belong, therefore, probably to the Lkuñgen tribe. I reproduce the cephalic and facial indices here for comparison. Besides these, No. III. of the Songish crania, described on p. 813 of the Fifth Report of the Committee, may be made use of. To these may be added a skull described by Flower ('Catalogue of the Specimens illustrating the Osteology,' &c., in the Museum of the Royal College of Surgeons, p. 148), which belongs to the West Coast of Vancouver Island, and another from the head of Alberni Channel, from the Museum of the Geological Survey of Canada. Furthermore, I add a series of measurements of slightly deformed crania from various parts of Vancouver Island from my own collection; the Tsimshian skulls, described on p. 812 of the Fifth Report; three Tsimshian skulls described by Barnard Davis, and another, described by the same author as a 'round head,' from Vancouver Island ('Thesaurus Craniorum,' p. 229). Finally, I add a Haida cranium, which I measured in the Provincial Museum of Victoria. The numbers given here are those of the catalogues of the various collections.

—	Lkufigen crania											
	1 ♂	2 ♂	3 ♂	4 ♀?	5 ♀	6 ♀	7 ♀?	8 ♂	9 ♂	10 ♀	11 Inf.	12 Inf.
Cephalic Index . . .	76.4	77.7	80.1	77.0	81.1	77.4	78.8	74.6	74.9	78.5	81.8	76.4
Facial Index . . .	79.9	—	86.6	83.5	85.7	—	92.6	—	—	99.2	—	—

—	III. 5th Rep.	Nootka		Cowitchin	Comox			Salmon River	Nimkish	
		Flower	Geol. Sur.	94	109	111	113	122	123	135
Cephalic Index . . .	85.8	77.4	81.2	78.0	79.6	81.6	78.9	77.4	78.2	79.5
Facial Index . . .	—	—	—	—	—	—	—	—	—	—

—	Kwakiutl		Tsimshian 5th Rep., p. 812				Barnard Davis				Haida ♀
	140	142	1 ♂	II. ♂	III.	IV. ♂	1,022	1,023	1,024	1,211	—
Cephalic Index . . .	81.7	75.8	76.7	78.2	76.7	83.0	79	76	78	76	82.4
Facial Index . . .	—	—	92.1	—	—	—	—	—	—	—	—

Or arranged in a series :

Indices		74	75	76	77	78	79	80	81	82	83	84	85
Skulls		2	1	6	5	7	3	1	5	1	1	—	1
Living		2	2	1	2	3	—	—	2	—	1	—	—

For the purpose of comparison I have added the indices of the living subtracting two from each [according to Broca] in order to make them comparable to the skulls. The close correspondence between the two groups becomes at once apparent.

It is of interest to investigate the further distribution of this form of head. Turning to the interior of British Columbia we have a series of skulls from Lytton, which were described in the Fifth Report. To these may be added one from the same place which is in my own collection, and has an index of 77.4. All these skulls have suffered somewhat by post-mortem deformation.

72	73	74	75	76	77	78	79	80	81	82
. 1	—	—	1	—	1	1	—	2	—	2

This series agrees very closely with that of the coast tribes. Measurements of the long bones from the same place show that the tribe must have been a very short one, probably resembling also in this respect the coast people.

Besides these, we have the measurements of two Shushwap crania in Davis's collection (p. 226), which have indices of 76 and 83. A single Shushwap, whom I measured at New Westminster, had an index of 82.9, corresponding to about 81 on the skull. It seems, therefore, that these people resemble the coast tribes, but further investigations are necessary to prove this theory.

Among the other groups, the tribe of Harrison Lake is particularly

remarkable. The prevailing type is exceedingly brachycephalic and chamæprosopic, and their small stature is also quite unique. Their difference from all the other tribes appears so clearly from our tables that further remarks seem unnecessary. I have not found any analogy among the neighbouring tribes, except at the mouth of Fraser River, where the same type might be expected to occur on account of the intermarriage of these groups. The question regarding the relationship of this tribe must remain at present an open one.

Among the other tribes the Columbians appear remarkable on account of their tallness. It seems that their heads are a little longer than those of the neighbouring tribes, but the data do not bring out the difference with sufficient clearness. There appears to be no reason to suppose that more favourable conditions prevailed in this region, and should have produced the development of greater stature.

We will finally consider the proportions of the bodies of the various groups. It appears that the finger-reach of the southern groups, especially of those of southern and central Oregon, is much smaller than that of the northern tribes. I am inclined to attribute this fact to a difference of occupation, the first-named two groups living on reservations, while the others are fishermen. Together with this lengthening of the finger-reach seems to go an increase in the length of the arm. These variations may be seen in females as well as in males. The women pass also much of their time in the canoe, which explains the corresponding variation in their sex. The table also shows that the trunk of these Indians is much longer than that of Europeans and also longer than that of the Iroquois, which, according to Gould, is 53.4 per cent. It seems that the trunk of the southern group is a little longer than that of the northern ones.

I will finally sum up the results of this investigation. We find an almost homogeneous population on the coast of British Columbia, with the exception of the region of Dean Inlet. It is characterised by a stature ranging between 159 and 162 cm.; a cephalic index ranging between 77 and 81, a facial index ranging between 78 and 81. At Bentinck Arm and in Washington this type is mixed with another, which also prevails in Oregon, so far as it is inhabited by Tinneh. This type is characterised by a stature ranging between 166 and 172 cm.; a cephalic index ranging between 84 and 87, and a facial index of from 83 to 86. In Northern Oregon this type is found quite pure. Farther to the south the type is mixed with that of the northern Californians, which becomes the more prevalent the farther south we go. In Washington the same type seems to exist, but subordinate to it the northern type is found. It is the primary element among the Bilqula. We consider this type to be peculiar to the Tinneh. The type of northern California is characterised by a stature ranging from 160 to 164 cm.; a cephalic index of from 79 to 81, and a facial index of from 83 to 86. On the whole this type resembles the first so much that I am inclined to identify them. A third and a quite unique type is found at Harrison Lake. The individuals are short, with very wide faces and heads. There is no similar tribe known to exist in this region, and their affinities appear doubtful. On Columbia River we find a fourth type, remarkable for its tallness, with a cephalic index of from 80 to 84. I believe that these may be identified with the tall tribes of the interior, but further evidence is required on this point.

Errata in the Sixth Report of the Committee.

- Page 604, line 43, *instead of* K'oi'kyaqtēnoq *read* K'oi'kyaqtēnoq.
 " 606, " 15, " Ts'E'ntsēNHK'aiō *read* Ts'E'ntsēNHK'aiō.
 " 616, " 8 of footnote, *instead of* Ts'ētsū'ēka. *Generally read* Ts'ētsū'ēka, generally.
 " 617, " 33, *instead of* sū'latlila *read* sū'latlila.
 " 618, " 5, " hū'mats'a following *read* hū'mats'a, following.
 " 618, " 50, " k'ū'k'ntsē *read* k'ū'k'ntsē.
 " 623, " 33, " Hā'ili'kyilatī *read* Hā'ilikyilatī.
 " 623, " 49, " Ts'ētsū'ēka *read* Ts'ētsū'ēka.
 " 625, " 13, *omit* Newette.
 " 625, " 21, *instead of* ts'ē'tsēqk'enqēlis *read* ts'ē'tsēqk'enqēlis.
 " 625, song 1, line 3, *instead of* Hāmats'a's *read* Hāmats'a's.
 " 628, " VII, last line, *instead of* Si'siutlkyas *read* Si'siutlkyas.
 " 631, " VIII, first line, *instead of* Ts'ē'k'oa *read* Ts'ē'k'oa.
 " 635, line 14, from *much more usually* to end of paragraph is a footnote following the next paragraph, to be signed G. M. Dawson.
 " 638, lines 16 to 18, by G. M. Dawson.
 " 640, lines 9 and 12, *instead of* wandering *read* meandering.
 " 640, line 34, *instead of* lower *read* fore.
 " 658, " 8 of table, *instead of* mātltsmō'ts'utl *read* mātltsmō'ts'utl.
 " 659, in table, possessive pronoun, last line, fifth column, *instead of* qents *read* qenuq.
 " 660, in table at head of page, 2nd line, 4th column, *instead of* ō'mduqsē *read* ō'mpuqsē.
 " 661, in table, read under thy father, near person addressed, *instead of* au'mpuqs *read* au'mpuqs.
 " 662, line 31, *instead of* uā'qpsī *read* uā'qpsī.
 " 662, " 40, " ak'ā'stla *read* nak'ā'stla.
 " 663, " 4 following table, *instead of* tlelāmas'utlennu'qūtl *read* tlelāmasutlennu'qūtl.
 " 663, footnote 5, second line, *instead of* is *read* are.
 " 666, line 26, *instead of* t'ks *read* t'ks.
 " 668, " 35, " —ks *read* —k's.
 " 669, " 1, " dialect *read* dialect h.
 " 672, " 12, " wakh'k *read* wakh'k.
 " 673, " 32, " hiscitlak'latak *read* hiscitlak'tlatak.
 " 674, " 5, " k'agsapū'minic *read* k'agsapū'minic.
 " 674, " 3, last table, *instead of* hiscianitic *read* hiscianitic.
 " 674, " 58, *instead of* māptqsath *read* māptaqsath.
 " 675, " 31, " bush *read* beach.
 " 678, " 53, " t'ō't'ōa *read* t'ō't'ōa.
 " 680, " 6, below table, *instead of* mūtīl *read* mūtīl.
 " 682, " 6, *instead of* (n)ē-(E)c *read* (n)ē-(E)tc.
 " 682, " 11, " k'āik'ēiētlēn *read* k'ā'ik'ēiētlēn.
 " 683, " 48, " kotō't *read* kolō't.
 " 684, " 6, " tiksū'ha *read* tiksū'la.
 " 684, " 23, " antsū'wa *read* ntsū'wa.
 " 691, " 7, " sqū'goū *read* sqū'qaa.
 " 691, " 29, " sē'ntsā *read* sē'sentsā.
 " 695, column mother, dialect 15, *instead of* skēqēdā'a *read* skēqēdzā'a.
 " 697, " face, " 3, " ts'al " ts'al.
 " 697, " head, " 16, " —k'ēn " k'ēn.
 " 697, " nose, " 13, " nE'k'sēn " nE'k'sēn.
 " 698, " body, " 15, " mEā'tc " mEzā'tc.
 " 699, " finger, " 12, " snE'qtsES " snE'qtsES.
 " 700, " blood, " 2, " gā'i " gā'i.
 " 701, " bow, " 3, " haukta'k' " haukta'k'.
 " 701, " star, " 3, " p'ia'ls " piā'ls.
 " 703, " sea, " 3, " mán " mán'.
 " 704, " valley, " 7, " nut'E'l " nut'E'l (gorge).
 " 704, " leaf, " 2, " tleya'ñgual " tliya'ñgual.

Page	705, column salt,	dialect	14, instead of	ts'alt	read	ts'alt.		
"	705,	deer,	"	2,	"	g'at	"	g'at.
"	706,	white,	"	1,	"	tlēdi'qatē'	"	tlēdi qatē'.
"	707,	bird,	"	15,	"	spEō'ō	"	spEzō'zō.
"	707,	fish,	"	17,	"	k'āk.qu'lq	"	k'āk'qu'lq.
"	707,	light blue,	"	1,	"	ts'ōyi'qatē	"	ts'ōyi'qatē.
"	707,	great,	"	15,	"	qEō'm	"	qEzō'm.
"	708,	strong,	"	2,	"	diākuya'	"	dakuya'.
"	708,	he,	"	5,	"	hē	"	hēt.
"	709,	dead,	"	15,	"	ō'uk'	"	zō'uk'.
"	710,	near,	"	9,	"	dje'ē'djimit	"	djiē'djimit.
"	711,	six,	"	8,	"	t'aqaniā'ē	"	t'aqaniā'ē.
"	714,	to kill,	"	15,	"	ōk's	"	zōk's.
"	715,	tolied down,	"	18,	"	'a'k'qka	"	g'a'k'qka.

Fifth Report of the Committee, consisting of Sir JOHN LUBBOCK, Dr. JOHN EVANS, Professor W. BOYD DAWKINS, Dr. R. MUNRO, Mr. W. PENGELLY, Dr. HENRY HICKS, Professor MELDOLA, Dr. MUIRHEAD, and Mr. JAMES W. DAVIS, appointed for the purpose of ascertaining and recording the localities in the British Islands in which evidences of the existence of Prehistoric Inhabitants of the country are found. (Drawn up by Mr. JAMES W. DAVIS.)

YOUR Committee, in presenting their fifth report, have pleasure in drawing attention to the list of lake dwellings found in the British Islands compiled by one of their number.

The Sites of Lake-Dwellings or Crannogs known up to this Date in Great Britain and Ireland.

The following alphabetically-arranged lists have been compiled mainly from Munro's 'Lake Dwellings of Europe,' to which work we refer our readers for an epitome of the scientific results obtained from practical investigation, as well as further references to the voluminous literature on the subject. As many of the sites and remains of these ancient habitations have been destroyed in the course of drainage and other agricultural operations, and are now known to have existed merely from tradition or incidental allusions to them in the early annals of the country, we distinguish by an asterisk (*) those that have been carefully observed or more or less practically investigated, and when the recorded observations are of special archaeological value we give the reference to the original source of their publication. To include more than this, as, for example, the merest abstract of researches, would so greatly add to the length of this report that its tabular character would be entirely destroyed.

I. ENGLAND.

- *Barton Mere, co. Suffolk. *Quart. Journ. Suf. Inst. of Arch. and Nat. Hist.*, 1869.
 Cold Ash Common, co. Berks. *Wiltshire Arch. Soc.*, 1869.
 Crowland (Fen district), co. Lincoln. *Fenland Past and Present*, by Miller and Skertchly.
 *Holderness (four or five localities), Yorkshire. *Lake Dwellings of Europe. Proc. York. Geol. and Polytech. Soc.*, vol. xi. 1891.

- *Llangorse Lake, co. Brecon. *Arch. Cambrensis*, 4th S., vol. i.
- *London, co. Middlesex. *Journal of Anthropol. Institute*, 1866, and *Journ. Arch. Association*, 1866.
- *Preston, Lancashire. *Proc. York. Geol. Polyt. Soc.*, vol. xi. 1889.
- *Wretham Mere, co. Norfolk. *Quart. Journ. Geol. Soc.*, vol. xii., and *Cam. Phil. Soc.*, March 31, 1862.

II. SCOTLAND.

- Achilty, L., co. Ross.
- Achray, L., co. Perth.
- *Airrieoulland, co. Wigtown. *Collections of Ayr and Galloway Arch. Association*, vol. v.
- Ard, L., co. Perth.
- *Arisaig, L., co. Inverness. *Proc. S. A. Scot.*, vol. viii.
- *Banchory (Loch of the Leys), co. Aberdeen. *Ibid.*, vols. i. and vi.
- Barean, L., co. Kirkcudbright. *Ancient Scot. L. Dwellings*, p. 37.
- *Barhapple, L., co. Wigtown. *Col. Ayr and Gal. Arch. Association*, vols. iii. and v.
- Barlockhart, L., co. Wigtown.
- Barnsallzie, L., co. Wigtown.
- Battleknowes, co. Berwick.
- Black Cairn (submarine), Beaully Firth, co. Ross.
- Boghall (Beith), co. Ayr.
- Borgue, co. Kirkcudbright.
- Brora, L., co. Sutherland.
- *Bruich, L. (near Beaully), co. Ross. *Proc. S. A. Scot.*, vol. xx.
- *Buston, co. Ayr. *Ancient Scot. L. Dwellings*, and *Col. Ayr and Gal. Arch. Association*.
- *Canmor (Kinord), L., co. Aberdeen. *Proc. S. A. Scot.*, vol. vi.
- *Carlingwark, L. *Ibid.*, vi., vii., and x.
- Castle Loch, co. Wigtown.
- Castletown, co. Roxburgh.
- Closeburn, co. Dumfries.
- Clunie, L., co. Perth.
- Collessie, co. Fife.
- Corncockle (Applegarth), co. Dumfries. *Proc. S. A. Scot.*, vol. vi.
- Cot, L., co. Linlithgow. *Ibid.*, vol. vi.
- Croy, co. Inverness.
- *Dhu Loch, co. Bute. *Ibid.*, vol. iii.
- Dolay, L., co. Sutherland.
- Doon, L., co. Ayr.
- *Dawalton, L. co. Wigtown. *Rep. British Association*, 1863; *Proc. S. A. Scot.*, vol. vi.; *Ancient Scot. L. Dwellings*; and *Ayr and Gal. Arch. Association*, vol. v.
- Earn, L., co. Perth.
- Eldrig, L., co. Wigtown.
- *Eriska, co. Argyll (submarine). *Proc. S. A. Scot.*, vol. xix.
- Fasnaclloch (Appin), co. Argyll.
- Federatt, co. Aberdeen.
- Fell, L., co. Wigtown.
- Fergus, L., co. Kirkcudbright.
- *Flemington, L., co. Nairn. *Proc. S. A. Scot.*, vol. v.
- *Forfar, Loch of, co. Forfar. *Arch. Scotica*, vol. ii.; *Proc. S. A. Scot.*, vols. vi. and x.
- Freuchie, L., co. Perth.
- *Friar's Carse, co. Dumfries. *Ancient Scot. L. Dwellings*.
- Fullah, L., co. Perth.
- Glass, L., co. Ross.
- Granech, L., co. Perth.
- Green Knowe, co. Lanark.
- Gynag, L., co. Inverness.
- Heron, L., co. Wigtown.
- Hogsetter, L., Shetland. *Proc. S. A. Scot.*, vol. xv.
- *Kielziebar, L., co. Argyll. *Ibid.*, vol. vii.
- *Kilbirnie, L., co. Ayr. *Ibid.*, vol. xi.
- Kilchonan, co. Argyll.
- Kinder, L., co. Kirkcudbright.
- Kinellan, L., co. Ross.

- Laggan, co. Perth.
- *Ledaig, co. Argyll. *Proc. S. A. Scot.*, vols. ix. and x.
- *Leven, L., co. Kinross. *Ibid.*, vol. xxii., and *Lake Dwellings of Europe*, p. 492.
- *Loch-of-the-Clans, co. Nairn. *Proc. S. A. Scot.*, vol. v.
- *Loch-in-Dunty, co. Nairn. *Ibid.*
- *Loch-inch-Cryndil, co. Wigtown. *Ibid.*, vol. ix.
- Lochindorb, co. Moray.
- *Lochlee, co. Ayr. *Ayr and Gal. Arch. Association*, vol. ii.; *Proc. S. A. Scot.*, vol. xiii.; and *Ancient Scot. L. Dwellings*.
- Lochmaben, co. Dumfries. *Proc. S. A. Scot.*, vol. vi.
- *Loch-na-Mial, Island of Mull. *Ibid.*, vol. viii.
- Lochnell, co. Argyll. *Ibid.*, vol. ix.
- Lochore, co. Fife. *Ibid.*, vol. vi.
- Lochrutton, co. Kirkcudbright.
- *Lochspouts, co. Ayr. *Col. Ayr and Gal. Arch. Association*, vols. iii. and iv.; and *Ancient Scot. L. Dwellings*.
- Lockwood, co. Dumfries.
- Lochy, L., co. Inverness.
- Lomond, L., co. Stirling.
- Lotus, L., co. Kirkcudbright. *Proc. S. A. Scot.*, vol. xi.
- Machermore, L., co. Wigtown. *Ibid.*, vols. ix. and x.
- Merton, L., co. Wigtown. *Ibid.*
- Mochrum, L., co. Wigtown. *Ibid.*
- Monivaird, L., co. Perth.
- Morall, L., co. Perth.
- Morton, co. Dumfries.
- Moulin, L. (drained), co. Perth.
- Mountblairy, co. Moray.
- Moy, L. (Ellan-na-Glack), co. Inverness.
- Oban (Lochavoullin), co. Argyll. *Lake Dwellings of Europe*.
- Ore, L., co. Dumfries.
- Peel Bog, co. Aberdeen.
- Quien Loch, co. Bute. *Proc. S. A. Scot.*, vol. iii.
- Rannoch, L., co. Perth.
- *Ravenstone, L., co. Wigtown. *Col. Ayr and Gal. Arch. Association*, vol. v.
- Rescobie, L., co. Forfar.
- Rothiemurchus, Loch-an-Eilan, co. Moray.
- *Sangahar, Black Loch of, co. Dumfries. *Dumfries and Gal. N. H. Soc.*, 1865.
- Shin, L., co. Sutherland.
- Spinie, L., co. Moray.
- Stravithy, co. Fife.
- Sunonness, L., co. Wigtown.
- Tay, L., co. Perth.
- Tolsta, Lewis, co. Ross. *Proc. S. A. Scot.*, vol. x.
- Torlundie, drained loch at, co. Inverness. *Ibid.*, vol. vii.
- Tullah, L., co. Perth.
- Tummell, co. Perth.
- Ure, L., co. Dumfries.
- Vennachar, L., co. Perth.
- Weyoch, L., co. Wigtown.

III. IRELAND.

- Aconnick, L., co. Cavan.
- Acrussel, L., co. Fermanagh.
- Allen, L., co. Leitrim. *Arch. Journal*, vol. iii.
- Aghakilconnel, L., co. Leitrim.
- Aghnamullen ('Glebe Island'), co. Monaghan.
- Annagh, L., between King and Queen's County. *Journ. R. H. A. Association*, 3rd S., vol. i.
- Annagh, parish of Kilbarron, co. Tipperary.
- *Ardakillen, co. Roscommon. *Proc. R. I. Acad.*, vol. v.
- *Ardmore Bay, co. Waterford (submarine). *Ibid.*, 2nd S., vol. ii.; *Journ. R. H. A. Association*, 4th S., vol. v.
- Arrow, L., co. Sligo.

- Aughlish, co. Fermanagh. *Ibid.*, vol. ii.
- Ballaghmore, co. Fermanagh. *Ibid.*
- Ballinafad, co. Galway. *Ibid.*
- Ballinabinch, co. Galway. *Ibid.*
- *Ballinlough (4 crannogs), co. Galway. *Proc. R. J. Acad.*, vol. ix.
- *Ballydoolough, co. Fermanagh. *Journ. R. H. A. Association*, 4th S., vols. i. and ii.
- Ballygawley, L., co. Sligo. Wood-Martin's *Lake Dwellings of Ireland*.
- Ballyhoe, L. (2 crannogs), co. Monaghan. *Journ. Kilk. Arch. S.*, 2nd S., vol. vi.
- Ballykinler, co. Down. *Ulster Journal of Arch.*, vol. vii.
- Ballywoolen, co. Down. *Journ. Kilk. Arch. S.*, 2nd S., vols. iii. and iv.
- Bohermeen, co. Meath.
- Bola, L., co. Galway. *Journ. R. H. A. Association*, 4th S., vol. ii.
- Breagho, co. Fermanagh. *Ibid.*
- Camlough, co. Armagh.
- Campsie, near Londonderry. (Report not yet published. See *Journal of Royal Society of Antiquaries of Ireland.*, vol. i. p. 327.)
- *Cargahoge, co. Monaghan. *Ibid.*, 3rd S., vol. i., and 4th S., vol. v.
- Castleforbes, co. Longford.
- Castlefore, L. (2 crannogs), co. Leitrim.
- *Clogherny co. Tyrone. *Keller's Lake-Dwellings*, 2nd ed.
- Cloncorick Castle, L., co. Leitrim.
- *Cloneygonnell, L. (3 crannogs), co. Cavan. *Proc. R. I. Acad.*, vol. viii.
- Cloonbo, L. (2 crannogs), co. Leitrim.
- Cloonboniagh, L., co. Leitrim.
- Cloonfinnen, L., co. Leitrim.
- *Cloonfinlough (2 crannogs), co. Roscommon. *Ibid.*, vol. v., and *Lake Dwellings of Europe*.
- *Cloonfree (2 crannogs), co. Roscommon. *Proc. R. I. Acad.*, vol. v.
- Cloonturk, L. (2 crannogs), co. Leitrim. *Ibid.*
- Cloughwater Bog, co. Antrim.
- *Coal Bog (Kilnamaddo), co. Fermanagh. *Ibid.*, 2nd S., vol. ii., and *Journ. Arch. Association*, vol. xxxvi.
- Coolcranoge, co. Limerick.
- Corcreevy (Loch-Laoghaire), co. Tyrone.
- Corrib, L., co. Galway.
- *Cornagall, L., co. Cavan. *Journ. R. H. A. Association*, 4th S., vol. i.
- Cornaseer, co. Cavan. *Ibid.*, vol. vii.
- Crannagh MacKnavin, co. Leitrim.
- Crannagh, L., co. Antrim. *Proc. R. I. Acad.*, 2nd S., vol. ii.
- Crannog-na-n-Duini, co. Donegal.
- Crannog-boy, co. Donegal.
- Crannog Mac Samhradhain, co. Cavan.
- Greenhagh, L. (2 crannogs), co. Leitrim. *Journ. R. H. A. Association*, 4th S., vol. vii.
- Crumkill, co. Antrim. Notes by Rev. Mr. Buick.
- Cullina, near Maryborough, Queen's co.
- Currygrane, L. (2 crannogs), co. Longford. *Ibid.*
- Derreen, L., co. Roscommon.
- Derreskit, L., co. Cavan.
- *Dromiskin, co. Louth. *Ibid.*, 4th S., vol. ix.
- *Drumaleague, L. (2 crannogs), co. Leitrim. *Proc. R. I. Acad.*, vol. v.
- *Drumdarragh or Trillick, co. Fermanagh. *Ibid.*, vols. ii. and vii.
- *Drumgay (3 crannogs), co. Fermanagh. *Ibid.*, vols. i. and ii.
- *Drumkeery, L., co. Cavan. *Archæologia*, vol. xxxix.
- *Drumkelin, co. Donegal. *Ibid.*, vol. xxvi.
- Drumlane (2 crannogs), co. Cavan. *Journ. R. H. A. Association*, 4th S., vol. vii.
- *Drumskimly (3 crannogs), co. Fermanagh. *Ibid.*, vols. i. and ii.
- *Drumsloe, co. Fermanagh. *Ibid.*, vol. ii.
- Effernan, co. Clare. *Ibid.*, vol. v.
- *Eyes, L. (6 crannogs), co. Fermanagh. *Ibid.*, vols. i. and ii.
- *Faughan, L., co. Down. *Proc. R. I. Acad.*, vol. vii.
- Fort, L., co. Donegal.
- Funshinagh, L., co. Leitrim.

- Galbally, co. Tyrone.
 Glencar, L. (5 crannogs). Wood-Martin's *Lake-Dwellings of Ireland*.
 Gortalough, co. Fermanagh. *Journ. R. H. A. Association*, 4th S., vol. v.
 *Grantstown, co. Queen. *Ibid.*, N.S., vol. v.
 Guile, L., co. Antrim. *Ibid.*, 3rd S., vol. i.
 Gur, L., co. Limerick. *Wilde's Catalogue*.
 Hackett, L. (Cimbe), co. Galway. *Ibid.*, and *Keller's L. Dwellings*.
 Hilbert, L. (Goronna Island), co. Galway.
 Inishrush (Green L.), co. Derry. *Proc. R. I. Acad.*, vol. vii.
 Joristown (in river Deal), co. Westmeath. *Ibid.*, vol. v.
 Kilglass, L., co. Roscommon.
 Killynure, co. Fermanagh.
 Kilmore, L. (2 crannogs), co. Monaghan.
 Kilknock, L., co. Antrim.
 Knockany (Lough Cend), co. Limerick.
 *Lagore or Dunshaughlin, co. Meath. *Proc. R. I. Acad.*, vol. i., *Arch. Journal*, vol. vi.
 Lane, L., co. Roscommon.
 Lankhill, co. Fermanagh.
 Leesborough, L., co. Monaghan.
 Lenaghan, co. Fermanagh.
 *Lisanisk, co. Monaghan. *Arch. Journal*, vol. iii.
 *Lisnacroghera (Craigyarren), co. Antrim. *Journ. R. H. A. Association*, vols. vi. and ix. *Lake Dwellings of Europe*.
 Lochanacrannog, co. Sligo.
 Loughran's Island, co. Antrim. *Proc. R. I. Acad.*, vol. v., and *Ulster Journal of Arch.*, vol. vii.
 *Loughannaderriga, Achill Island, co. Mayo. Wood-Martin's *Lake-D. of Ireland*.
 Loughinsholin, co. Derry.
 Loughavarra, co. Antrim.
 *Loughavilly, co. Fermanagh. *Journ. R. H. A. Association*, 4th S., vols. ii. and v.
 Lochlea (3 crannogs), co. Roscommon.
 *Lough-na-Glack, co. Monaghan.
 Lough Cam, co. Galway.
 Loughmagarry, co. Antrim. *Proc. R. I. Acad.*, vol. vii.
 Loughtamend, co. Antrim. *Ibid.*
 Loughtown, co. Leitrim.
 *Loughrea (4 crannogs), co. Galway. *Ibid.*, vol. viii.
 *Lough Oughter (3 or more crannogs), co. Cavan. *Journ. R. H. A. Association*, 4th S., vol. vii.
 Lynch, L., co. Antrim.
 Mac Hugh, L. (2 crannogs), co. Leitrim. *Ibid.*
 Macnean, L. (3 crannogs).
 Mac Nevin, crannog, co. Galway.
 Manorhamilton, co. Leitrim.
 Marlacoo, co. Armagh.
 Mask, L., Hag's Castle.
 Melvin, L., co. Fermanagh.
 Moinenoe, co. Fermanagh.
 Monaincha, co. Tipperary.
 *Monalough, co. Meath. *Proc. R. I. Acad.*, 2nd S., vol. ii.
 Monalty, co. Monaghan. *Arch. Journal*, vol. iii.
 Monea, co. Fermanagh.
 Mongavlin, co. Donegal.
 Monnachin, L., co. Monaghan.
 *Mourne, L. (2 crannogs), co. Antrim. *Journ. R. H. A. Association*, 4th S., vol. vi.; *Proc. S. A. Scot.*, vol. xx., and *L.-D. of Europe*.
 *Moylag, near Cullybacky, co. Antrim. (Recently investigated by the Rev. Mr. Buick of Cullybacky, who is preparing a report of his discoveries for the *Journal of the Royal Society of Antiquarians of Ireland*.)
 Muickenagh, L., co. Roscommon.
 Mucknoe, L., co. Monaghan.
 *Muintir Eolais, co. Leitrim.

- *Nahinch, L., co. Tipperary. *Ibid.*, vol. ix.
 Naneevin, L., co. Galway.
 Ooney, L., co. Monaghan.
 Owel, L., co. Westmeath.
 Pad or Boat, L., co. Fermanagh.
- *Ravel, L., co. Antrim. *Ibid.*, vol. vii.; *Journ. R. H. A. Association*, 2nd S., vols. iii. and iv., 3rd S., vol. i., and 4th S., vol. ii.
- *Rohan's, L., co. Monaghan.
- *Ramor, L., co. Cavan. *Ibid.*, 4th S., vol. vii.
- *Rinn, L. (3 or 4 crannogs), co. Leitrim. *Ibid.*
 Ross, L., co. Armagh. *Ibid.*, vol. vi.
 Roughan, L., co. Tyrone. *Ibid.*, vol. vii.
 Rouskey, L., co. Monaghan.
 Scur, L. (2 crannogs), co. Leitrim.
 St. John's, L. (4 crannogs), co. Leitrim.
 Talogh, L. (several crannogs), co. Leitrim.
- *The Miracles, co. Fermanagh. *Journ. R. H. A. Association*, 4th S., vols. ii. and v.
 Toome Bar, co. Antrim. *Ibid.*, N.S. vol. v.
- *Tully, L. (3 crannogs), co. Cavan. *Ibid.*, 4th S., vol. vii.
 Tullyline, co. Cavan.
 Veagh, L., co. Donegal.
 Williamstown, L., co. Galway. *Ibid.*, 5th S., vol. i. p. 337.
 Yoan, L., co. Fermanagh. *Ibid.*, 4th S., vol. ii.

Several reports on prehistoric objects have been promised by scientific observers in various parts of the country, and your Committee urge that no more delay should be made in presenting them than is compatible with accuracy and thoroughness. It is requested that the Committee be reappointed as before without grant.

Fourth and Final Report of the Committee, consisting of the Hon. RALPH ABERCROMBY, Dr. A. BUCHAN, Mr. J. Y. BUCHANAN, Mr. J. WILLIS BUND, Professor CHRYSAL, Mr. D. CUNNINGHAM, Professor FITZGERALD, Dr. H. R. MILL (Secretary), Dr. JOHN MURRAY (Chairman), Mr. ISAAC ROBERTS, Dr. H. C. SORBY, and the Rev. C. J. STEWARD, appointed to arrange an investigation of the Seasonal Variations of Temperature in Lakes, Rivers, and Estuaries in various parts of the United Kingdom in co-operation with the local societies represented on the Association. (Drawn up by Dr. H. R. MILL.)

[PLATE XV.]

At the meeting of 1890 this Committee requested reappointment with a grant of 50*l.* in order to draw up a final report on the work inaugurated at its suggestion and carried on by observers, most of whom acted under the auspices of local scientific societies represented on the Association. It was proposed to include in the final report a quantity of material of great value bearing on the seasonal and diurnal variation of river- and sea-temperature accumulated by the Scottish Meteorological Society and still unpublished, and, in addition, to give a general discussion (supported by recent publications of observations in the 'Reports of the Fishery Board for Scotland' and other journals) of the whole question of the variation of temperature in exposed bodies of water as determined

by season, actual meteorological conditions, tidal influence, &c. The grant of 20*l.* which was given to the Committee on its reappointment was quite inadequate to pay the working expenses of the scheme and admit of employing a competent person to tabulate and compute means of the great mass of available material.

It was accordingly resolved to confine the scope of this report to an account of the observations made on the direct initiative of the Committee, and to the statement of such brief summaries as might be supplied in tabular form by previous observers. The main object held in view by members of this Committee from its first appointment, viz. to produce an authoritative and exhaustive memoir on the seasonal variations of temperature in the lakes, rivers, and estuaries of the British Islands had to be abandoned. At the close of its four years of existence the Committee can only claim to add some additional data to the store awaiting future discussion. This addition is of considerable scientific value, and casts light on several problems in the *régime* of lakes and rivers. The observations have, however, led directly to another and perhaps even more beneficial result. Great interest was taken by the Conference of Delegates from local societies in the establishment of observations in their own neighbourhood. The consciousness that they were engaged in collecting data for a special and definite purpose has stimulated many of the observers to a more earnest study of science, and done something to forward that spirit of fellowship amongst all scientific workers which for the last few years the Association has been so successfully advancing by means of the annual conferences. The results of this stimulus may, it is hoped, continue even when the observations which produced it have ceased.

The three previous reports of the Committee may be referred to for particulars as to the method of working, the instruments employed, and the period over which the observations extended; a comparatively small number were continued into the year 1891. The first report¹ was mainly preliminary. The observations it records were upon rivers in Scotland, and although several of the observers have continued their work, most contented themselves with the record of a few months only. The second report² notes a large accession of observers on the rivers of England and of Ireland, and as an appendix the directions to observers are reprinted, showing the conditions in which it was desirable that all the observations should be made. In 1889 the reappointment of the Committee was not accompanied by a grant of money, and the observations in that year consequently suffered to a certain extent. The third report³ gives an epitome of the material collected by the Committee, which forms the basis of the present discussion. The three previous reports, it will be noticed, deal exclusively with the organisation and extent of the observations, none of the data being recorded or discussed in them.

Some of the sets of observations have been published in detail. Of these the most important is that accumulated by Dr. Sorby during the years 1884–1888 on the estuaries of the south-east of England, which appeared in the 'Scottish Geographical Magazine' for 1889 (vol. v. p. 589). An abstract of the results is included in the present report. Observations on the River Thurso, by Mr. John Gunn and others, were

¹ *B.A. Reports*, 1888, p. 326.

² *Ibid.* 1889, p. 44.

³ *Ibid.* 1890, p. 92.

printed in the 'Journal' of the Scottish Meteorological Society for 1888. The observations of Mr. W. Watts on behalf of the Manchester Geological Society at the Piethorn and Denshaw Reservoirs have been printed in full in the 'Transactions' of that Society. Mr. Ashworth's observations on the Cown and Spring Mill Reservoirs have also been published in a summarised form with detailed curves in the 'Proceedings' of the Rochdale Literary and Scientific Society.

In addition to the observations specially made or discussed for the Committee, many papers are to be found in the 'Proceedings' of the Royal Society of Edinburgh, the publications of the Meteorological Societies, in the annual reports of the Fishery Board for Scotland from 1887 onward, and in the 'Scottish Geographical Magazine.' A full discussion by Dr. H. R. Mill of very detailed temperature observations made by the staff of the Scottish Marine Station on the Clyde Sea area is nearly completed, and will be presented to the Royal Society of Edinburgh.

The best method of publishing the results of the observations dealt with in this report has been carefully considered. There are peculiar difficulties in dealing with a mass of data compiled by observers, some of whom are skilled and others uninstructed in their work, especially when—as in this case—the observations are taken with regularity in few cases and often at different hours. The record of actual observations will be preserved by the secretary of the Committee, who will be glad at any time to place it at the disposal of any one interested in this branch of meteorology. Weekly means have been calculated for each of the stations where reasonably regular observations were made, and these are published in the form of curves in this report. The curve-form was chosen in preference to printing the figures, on account of the much more vivid impression conveyed by inspection as to the relative air- and water-temperatures and their seasonal variations. The unit of the curve is the weekly mean, as in many cases on one or more days of the week the observations were omitted, and a curve of actual daily readings would present a very broken appearance, besides throwing into undue prominence purely temporary variations. The monthly means are given in tabular form. The monthly means are usually calculated as the average of the four or five weekly periods comprised in the month; but in the case of very regular observations the monthly mean is given as the average of the daily readings. Comparison of the two methods shows practically identical results in the case of regular observations, and where the observations are irregular the method adopted for general use obviously gives more satisfactory results. On account of the much greater difficulty of measuring the temperature of air, less reliance must be placed on that part of the work than on the temperature of the water, which is easily found in a readily comparable manner.

For the drawing of most of these curves and the calculation of the means from them the Committee has to acknowledge the assistance of Mr. John Gunn, F.R.S.G.S.

In several instances, when the observations were carried on by skilled meteorologists in conjunction with the routine of a meteorological station, the observers accompanied their records with a short summary and discussion, in which the most striking relations of temperature were pointed out. These statements, either completely or in abstract, are embodied in this report.

A. Observations not recorded in full in this Report.

These observations were, as a rule, made by skilled observers for special purposes, and the abstracts were prepared specially for this report by the investigators, to whom the thanks of the Committee are very cordially given.

RIVER CHERWELL AT OXFORD.

Observations of the temperature of the Cherwell have been made regularly every morning since 1878 by Mr. Edward Chapman, M.A., F.L.S., of Magdalen College, Oxford. The ordinary meteorological observations having been made at the same time, make it possible to compare river-temperature, air-temperature, and rainfall. The river-temperature recorded below is the mean of daily observations at 9 A.M., the air-temperature is the mean of the maximum and minimum thermometer in the shade for the previous twenty-four hours, and the rainfall is the amount in inches which fell in the previous twenty-four hours.

The length of this series of observations gives it peculiar value in affording an indication of average conditions. The average air-temperature for the ten years was $48^{\circ}9$, the average water-temperature at 9 A.M. $50^{\circ}3$, or $1^{\circ}4$ warmer than the air; the mean annual rainfall for these years being 24.79 inches. The average monthly means are shown in the Curve below. The year of lowest air-temperature was 1887, with $47^{\circ}6$,

Curve of Temperature of Cherwell. Mean of 10 years.

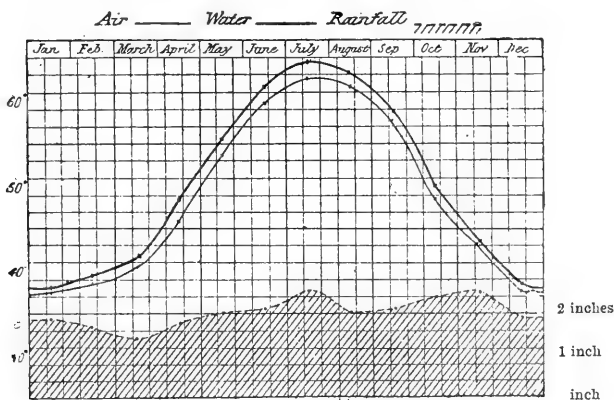

the average water-temperature for that year being $49^{\circ}8$ and the rainfall 18.78 inches, very exceptionally low. The lowest mean water-temperature was in 1888, $49^{\circ}0$, when the mean air-temperature was $47^{\circ}9$ and the rainfall 27.39. The highest air-temperature was $50^{\circ}9$, the mean of 1884, when the water-temperature was also highest, $51^{\circ}5$, and the rainfall was 19.48 inches. In 1890, the year of lowest rainfall, when only 17.02 inches fell, the temperatures of air and water were almost at their average ($49^{\circ}0$ and $50^{\circ}8$ respectively); while in 1886, which was the wettest year, with 32.12 inches of rain, the air-temperature was also normal ($49^{\circ}0$), but the

water-temperature was nearly a degree below the average ($49^{\circ}5$). The difference between the average temperature of the warmest and coldest year recorded was only $2^{\circ}5$ for the water.

The highest mean temperature of the water for any month was $68^{\circ}7$ in July 1887, the month of highest air-temperature also, with an abnormally low rainfall, but in a year the temperature of which was below the average. The lowest mean temperature of the water was $32^{\circ}4$ for January 1891 (air $32^{\circ}6$), but the lowest air-temperature was $29^{\circ}2$ for December 1890 when the water had a mean of $33^{\circ}3$.

The difference in average temperature of water for the same month in different years was greatest in the months of annual maxima and minima. The hottest June was $10^{\circ}6$ warmer than the coolest June; the warmest January was $9^{\circ}7$ warmer than the coldest January. At the time of annual average temperature the difference was least; thus the warmest April was only $5^{\circ}6$ and the warmest September only $4^{\circ}2$ above the temperature of the coldest month of the same name.

On the average, as shown in Curve XXX., the air-temperature came nearest the water-temperature in the winter months, notably in November and January, when they almost coincided (difference $0^{\circ}2$), and the two temperatures diverged most in the summer months, particularly April, May, and July, when the difference averaged $2^{\circ}3$. During the ten years of observation the average monthly air-temperature was higher than the average monthly water-temperature at 9 A.M. on 17 occasions. Of these 6 occurred in January, 2 in February, 4 in November, and 2 in December, or 14 in the winter months; 1 was in March, 1 in May, and 1 in October. In no April, June, July, August, or September, between 1882 and 1891, has there been an instance of air being warmer than water on the average of a whole month. Of course, in the remarkably fine observations now recorded the comparison is made between average air-temperature for the whole 24 hours, and average water-temperature at 9 A.M. only, while in the short series of observations specially made for the Committee the air- and water-temperature are both calculated for 9 A.M.

Mean Monthly Observations on the Temperature of the River Cherwell at Oxford. By Mr. EDWARD CHAPMAN, Magdalen College.

1882.

—	Mean Maximum in Shade	Mean Minimum in Shade	Mean Air Tempera- ture	Mean River Tempera- ture	Total Rainfall in inches
January	41·3	36·0	38·6	41·8	1·13
February	42·3	36·6	39·4	41·7	1·75
March	48·0	38·0	43·0	46·8	1·18
April	51·3	40·5	45·9	51·0	3·78
May	58·1	45·1	51·6	57·3	1·66
June	61·0	49·7	55·3	53·9	3·08
July	64·0	53·0	58·5	63·6	3·56
August	67·6	53·2	60·4	62·9	1·36
September	63·1	46·0	54·5	57·3	2·08
October	56·2	44·2	50·2	50·9	5·54
November	48·5	37·3	42·9	41·9	3·41
December	43·1	34·6	38·8	40·3	3·20
Year	—	—	48·3	50·8	31·73

MEAN MONTHLY OBSERVATIONS—*continued.*

1883.

—	Mean Maximum in Shade	Mean Minimum in Shade	Mean Air Tempera- ture	Mean River Tempera- ture	Total Rainfall in inches
January	45.7	37.0	41.3	41.0	2.29
February	48.2	37.3	42.7	42.4	3.60
March	43.7	29.7	36.7	39.9	0.99
April	53.3	38.5	45.9	49.9	1.07
May	62.0	44.7	53.3	56.3	1.94
June	69.9	50.9	60.4	62.5	4.35
July	69.7	52.5	61.1	62.6	3.53
August	71.3	53.2	62.2	63.2	0.70
September	65.0	50.5	57.7	58.7	4.50
October	56.6	44.1	50.3	51.2	1.90
November	48.8	36.1	42.4	43.0	3.11
December	44.7	36.4	40.5	41.1	0.54
Year	—	—	49.5	51.0	28.52

1884.

—	Mean Maximum in Shade	Mean Minimum in Shade	Mean Air Tempera- ture	Mean River Tempera- ture	Total Rainfall in inches
January	47.1	39.3	43.2	42.1	2.30
February	47.5	37.1	42.3	42.6	1.32
March	51.3	36.3	43.8	45.2	1.41
April	54.0	41.2	47.6	49.1	1.69
May	65.3	44.3	54.8	51.3	0.80
June	69.0	50.4	59.7	61.5	2.05
July	73.5	54.9	64.2	64.9	2.25
August	75.7	53.9	64.8	66.8	1.52
September	67.9	51.3	59.6	61.1	1.36
October	57.0	42.0	49.5	51.9	0.97
November	47.5	36.2	41.8	43.0	1.74
December	43.9	36.0	39.9	38.4	2.07
Year	—	—	50.9	51.5	19.48

1885.

—	Mean Maximum in Shade	Mean Minimum in Shade	Mean Air Tempera- ture	Mean River Tempera- ture	Total Rainfall in inches
January	40.3	32.1	36.2	34.0	2.17
February	48.5	38.2	43.3	41.2	2.67
March	48.2	33.6	41.9	42.7	1.10
April	55.9	38.3	47.1	49.1	1.72
May	59.2	41.8	50.5	54.3	2.03
June	70.4	50.7	60.5	63.1	1.67
July	74.9	54.3	64.6	66.5	0.18
August	68.3	50.9	59.6	60.8	1.56
September	63.9	47.3	55.6	57.0	4.36
October	52.6	39.9	46.2	47.2	3.89
November	46.7	38.0	42.3	41.4	3.51
December	42.5	33.1	37.8	37.5	1.02
Year	—	—	48.8	49.6	25.88

MEAN MONTHLY OBSERVATIONS—*continued.*

1886.

—	Mean Maximum in Shade	Mean Minimum in Shade	Mean Air Tempera- ture	Mean River Tempera- ture	Total Rainfall in inches
January	40.5	31.0	35.7	35.1	4.00
February	38.7	29.6	34.1	35.7	0.68
March	46.3	33.9	40.1	39.5	1.61
April	55.6	39.2	47.4	47.7	2.13
May	61.8	44.0	52.9	53.4	4.58
June	67.9	50.1	59.0	59.9	1.14
July	73.4	53.9	63.6	65.9	3.39
August	71.7	54.4	63.0	64.0	1.65
September	66.7	50.6	58.6	60.1	2.27
October	59.2	47.5	53.3	53.1	3.16
November	49.2	38.5	43.8	43.5	2.50
December	41.3	31.3	36.3	36.5	5.01
Year	—	—	49.0	49.5	32.12

1887.

—	Mean Maximum in Shade	Mean Minimum in Shade	Mean Air Tempera- ture	Mean River Tempera- ture	Total Rainfall in inches
January	38.7	29.9	34.3	35.2	2.16
February	42.1	33.3	37.7	39.8	0.67
March	44.2	31.9	38.0	40.5	1.58
April	53.5	35.9	44.7	47.8	1.11
May	58.8	43.5	51.1	53.7	1.51
June	71.2	51.4	61.3	64.5	1.56
July	78.0	54.9	66.4	68.7	0.71
August	72.4	51.4	61.9	64.5	2.20
September	62.7	47.4	55.0	56.9	2.10
October	50.3	38.2	44.2	46.8	1.96
November	44.3	34.9	39.6	40.8	1.85
December	42.3	32.1	37.2	37.7	1.37
Year	—	—	47.6	49.8	18.78

1888.

—	Mean Maximum in Shade	Mean Minimum in Shade	Mean Air Tempera- ture	Mean River Tempera- ture	Total Rainfall in inches
January	41.1	32.0	36.5	36.5	0.70
February	33.3	31.4	32.3	34.7	3.38
March	42.0	32.8	37.4	38.3	2.94
April	51.2	37.3	44.2	45.4	1.59
May	63.0	43.8	53.4	56.8	1.18
June	67.6	50.2	58.9	61.0	3.19
July	67.6	52.1	59.8	61.0	4.44
August	68.1	51.4	59.7	60.9	1.97
September	64.0	48.6	56.3	57.8	1.13
October	54.4	38.3	46.3	47.6	0.77
November	57.8	42.2	50.0	46.8	4.13
December	44.4	35.9	40.1	42.0	1.97
Year	—	—	47.9	49.0	27.39

MEAN MONTHLY OBSERVATIONS—*continued.*

1889.					
—	Mean Maximum in Shade	Mean Minimum in Shade	Mean Air Tempera- ture	Mean River Tempera- ture	Total Rainfall in inches
January	40·2	31·9	36·0	38·1	0·66
February	43·1	32·4	37·7	38·0	1·82
March	48·2	34·7	41·4	41·9	1·69
April	52·5	39·2	45·8	47·5	2·51
May	66·0	48·9	57·4	57·8	2·91
June	71·1	53·1	62·1	64·3	1·90
July	70·9	53·5	62·2	64·7	2·69
August	69·3	52·0	60·6	63·4	2·29
September	65·3	49·4	57·3	59·2	1·49
October	54·9	42·0	48·4	49·6	2·36
November	45·8	39·5	42·6	45·3	0·88
December	41·9	31·8	36·8	37·3	1·04
Year	—	—	49·0	50·6	22·24

1890.					
—	Mean Maximum in Shade	Mean Minimum in Shade	Mean Air Tempera- ture	Mean River Tempera- ture	Total Rainfall in inches
January	46·8	36·9	41·8	41·5	1·86
February	43·2	32·8	38·0	39·3	0·71
March	50·4	36·2	43·3	43·6	0·72
April	53·8	38·0	45·9	48·6	1·03
May	65·3	45·2	55·2	58·3	1·75
June	69·4	50·3	59·8	61·9	1·51
July	69·6	53·2	61·4	63·7	2·96
August	69·4	52·2	60·8	63·4	2·26
September	68·6	50·5	59·5	60·2	1·02
October	57·1	42·4	49·7	51·2	1·14
November	48·5	37·7	43·1	44·4	1·51
December	32·8	25·7	29·2	33·3	0·55
Year	—	—	49·0	50·8	17·02

1891.					
—	Mean Maximum in Shade	Mean Minimum in Shade	Mean Air Tempera- ture	Mean River Tempera- ture	Total Rainfall in inches
January	38·0	27·2	32·6	32·4	1·40
February	45·3	32·1	38·7	39·3	0·00
March	46·5	34·0	40·2	40·5	1·55
April	52·9	36·5	44·7	46·9	1·41
May	59·7	42·5	51·1	54·4	2·15
June	70·9	52·0	61·4	63·6	1·27
July	70·7	52·4	61·5	64·5	2·14
August	67·5	52·0	59·7	61·3	4·51
September	66·8	49·9	58·3	59·4	1·34
October	—	—	—	—	—
November	—	—	—	—	—
December	—	—	—	—	—
Year	—	—	—	—	—

Mean Temperature of Cherwell for Ten Years, 1882–1891.

(The portion from October to December is the mean of nine years, and the yearly averages are also the mean of the nine years 1882–1890.)

Month	Mean Air Temperature for Day	Mean River Temperature, 9 A.M.	Excess of River over Air Temperature	Average Rainfall in inches
January	37·6	37·8	0·2	1·87
February	38·6	39·5	0·9	1·66
March	40·6	41·9	1·3	1·48
April	45·9	48·3	2·4	1·80
May	53·1	55·4	2·3	2·05
June	59·6	61·6	2·0	2·17
July	62·3	64·6	2·3	2·58
August	61·3	63·1	1·8	2·00
September	57·2	58·8	1·6	2·16
October	48·7	49·9	1·2	2·41
November	43·2	43·4	0·2	2·51
December	37·4	38·2	0·8	1·86
Year	48·9	50·3	1·4	24·79

Extreme Values of Monthly Means of River-Temperature and Range between Warmest and Coldest Months of the same Name.

Month	Maximum	Minimum	Range	Date of Maximum	Date of Minimum	Air Warmer Occasions
January	42·1	32·4	9·7	1884	1891	6
February	42·6	34·7	7·9	1884	1888	2
March	46·8	38·3	8·5	1882	1888	1
April	51·0	45·4	5·6	1882	1888	0
May	58·3	51·3	7·0	1890	1884	1
June	64·5	53·9	10·6	1887	1882	0
July	68·7	61·0	7·7	1887	1888	0
August	66·8	60·9	5·8	1884	1888	0
September	61·1	56·9	4·2	1884	1887	0
October	53·1	46·8	6·3	1886	1887	1
November	46·8	40·8	6·0	1888	1887	4
December	42·0	33·3	8·7	1888	1890	2
Year	51·5	49·0	2·5	1884	1888	0

ESTUARY TEMPERATURES.

Abstract of Discussion of the Temperature of the Tidal Estuaries in the South-east of England. By Dr. H. C. SORBY, F.R.S.

Temperature of the air on deck and of the water at surface and bottom were made at high and at low tide from the yacht 'Glimpse.' The district specially studied extends from the Strait of Dover up 'the mouth of the Thames' to the West Swale and Chatham; thence to the estuaries of the Roche, Crouch, Blackwater, and Colne (where each season's observations began and ended); to Walton Creek, the Stour, the Deben, and the Alde on to Lowestoft. The open water most frequently examined was that of the Swin and Wicket, from which the

estuaries named above diverge more or less directly. The depth in the estuaries at low tide was usually from $1\frac{1}{2}$ to 4 fathoms, that of the open water about 6 fathoms. The observations extend over the period from May to September in each year, as long a time as it is practicable to live on a yacht in such an exposed situation.

The following table gives the monthly means observed in the estuaries:—

Date	High Tide	Low Tide	Air
1884			
May	57·9	58·5	56·8
June	61·7	62·4	65·5
July	65·5	66·9	68·5
August	67·7	67·5	65·9
September	63·2	62·7	63·1
1885			
May	52·3	53·1	53·0
June	62·8	64·2	62·3
July	66·8	66·8	63·7
August	62·5	62·5	63·1
September	59·1	59·2	60·6
1886			
May	54·6	57·0	60·2
June	59·0	59·3	57·4
September	64·9	63·5	61·8
1887			
May	49·7	52·0	54·9
July	69·4	69·7	67·1
September	58·7	57·5	56·9
1888			
May	55·1	54·3	52·9
June	59·6	59·2	61·7
July	59·4	60·8	60·9
August	61·1	62·2	64·4
September	59·9	60·4	60·0

Making allowance for the incomplete data, the mean temperatures in the estuaries and open water were as follows:—

Date	Air	Estuaries		Open Water Swin and Wallet	Difference between Estuaries and Open Water	
		High Tide	Low Tide		High Tide	Low Tide
May	55·4	54·2	55·5	51·8	+2·38	+3·68
June	60·1	60·8	61·5	60·2	+0·53	+1·24
July	65·1	65·7	66·4	64·2	+1·49	+2·26
August	64·3	64·0	64·2	63·4	+0·67	+0·89
September	60·5	61·0	60·6	61·3	-0·30	-0·74
Means	61·1	61·1	61·6	—	—	—

In July 1886 the North Sea was $2^{\circ}3$ cooler than the Waiet, and $5^{\circ}6$ cooler than the estuaries. The water of the shallow estuaries evidently heats up more rapidly in spring, attains a higher temperature in summer, and cools down more rapidly in autumn, than does the open sea. The observed maximum temperatures were as follows:—

—	Water	Air
1884	$72^{\circ}1$, August 12	$76^{\circ}6$, July 4
1885	$74^{\circ}1$, July 11	$78^{\circ}1$, June 4
1886	$72^{\circ}2$, July 6	$75^{\circ}5$, July 5
1887	$73^{\circ}5$, July 26	$81^{\circ}0$, August 8
1888	$65^{\circ}4$, August 10	$81^{\circ}0$, June 3
Mean	$71^{\circ}4$, July 25	$78^{\circ}5$, June 29

Hence the average maximum for the water was $7^{\circ}1$ less than that for the air, and occurred about twenty-six days later.

In extreme cases, when the tide has risen over a wide expanse of heated mud, the surface temperature has been seen as much as 2° above that of the bottom; when the sun is shining strongly a difference of 1° may be observed; but, as a rule, in the estuaries the rush of tide prevents any difference of more than half a degree. When the air is very cold the surface water has been observed half a degree or so colder than that at the bottom. During the period of observation, the surface temperature was always in excess of that of the bottom, the greater difference at high water being accounted for by the cold current setting in from the open sea:—

Period	Excess of Surface over Bottom Temperature		
	High Tide	Low Tide	Mean
May and June	$0^{\circ}35$	$0^{\circ}15$	$0^{\circ}25$
July and early August	$0^{\circ}17$	$0^{\circ}20$	$0^{\circ}18$
Late August and September	$0^{\circ}03$	$0^{\circ}07$	$0^{\circ}05$

Low water is usually warmer than high water in the summer season, but, as shown below, variations are experienced in particular years.

Excess (+) or Deficiency (−) of Low Water Temperature.

Year	May	June	July	August	September
1884	$+0^{\circ}6$	$+0^{\circ}7$	$+1^{\circ}4$	$-0^{\circ}2$	$-0^{\circ}5$
1885	$+0^{\circ}8$	$+1^{\circ}4$	$+0^{\circ}1$	$-0^{\circ}05$	$+0^{\circ}05$
1886	$+2^{\circ}4$	$+0^{\circ}3$	$-1^{\circ}4$
1887	$+2^{\circ}3$...	$+0^{\circ}3$...	$-1^{\circ}2$
1888	$-0^{\circ}8$	$-0^{\circ}4$	$+1^{\circ}4$	$+1^{\circ}2$	$+0^{\circ}4$
Mean	$+1^{\circ}0$	$+0^{\circ}5$	$+0^{\circ}8$	$+0^{\circ}3$	$-0^{\circ}5$

The effect of solar radiation in heating the water of estuaries during the day, and of radiation from the water reducing their temperature at night, has been arrived at by comparison of the same tidal phase occurring consecutively by day and night. The results are as follows:—

—	May	June	July	August	September
HIGH WATER					
Day	+1·6	+0·5	+2·2	+0·5	+0·6
Night	-1·2	-0·5	-0·6	-0·8	-0·7
LOW WATER					
Day	+0·9	+2·9	+2·5	+1·5	+0·7
Night	-1·0	-2·0	-2·4	-1·5	-0·6
MEAN					
Day	+1·2	+1·7	+2·3	+1·0	+0·6
Night	-1·1	-1·3	-1·5	-1·1	-0·6

Neglecting sign the total changes are :—

—	May	June	July	August	September
Mean, high tide	1·4	0·5	1·4	0·6	0·6
„ low tide	1·0	2·5	2·4	1·5	0·6
„ tide	1·2	1·5	1·9	1·1	0·6

A comparison of the general means for the whole five months shows the mean effects of day heat and night cold to be :—

	High Water	Low Water	Mean
Heat of day	1·07	1·71	1·39
Cold of night	0·76	1·50	1·12
Difference	+0·31	+0·21	+0·27

This shows, although only as a rough approximation, the average daily rate of storing heat in the summer months.

RIVER DERWENT (DERBYSHIRE).

Observations made at Belper by Mr. WM. HUNTER.

	1877	1878	1879	1880	1881	1882	1883	1884	1885	Mean
January	—	42·5	37·7	39·5	38·2	43·6	41·9	44·2	41·2	41·1
February	—	43·7	40·3	42·2	40·0	43·4	43·5	43·4	42·9	42·4
March	—	45·1	42·5	45·0	43·8	44·6	41·1	45·1	43·4	43·8
April	—	48·2	45·6	47·4	46·0	48·0	48·1	46·0	50·0	47·4
May	—	52·8	49·0	52·5	53·6	52·8	51·6	54·4	49·2	52·0
June	57·7	55·8	53·7	55·8	57·9	51·6	56·7	67·8	57·1	57·4
July	58·1	61·4	54·6	57·8	61·5	56·4	57·1	62·7	62·6	59·1
August	58·0	58·9	54·9	57·7	57·5	57·3	58·5	62·6	58·0	58·2
September	51·7	55·0	52·0	55·3	52·9	52·4	54·0	58·2	55·7	54·1
October	48·4	49·3	48·9	46·7	46·2	44·7	49·3	49·9	—	47·9
November	45·4	42·2	42·5	43·0	45·8	43·7	43·4	45·3	—	44·0
December	42·4	37·7	37·6	43·1	42·2	—	42·9	41·6	—	40·7
Means	—	49·4	46·6	48·8	48·8	49·2	49·0	51·7	—	49·0

SEA OBSERVATIONS AT ARBROATH.

*Observations at Mason's Cove, two miles north of Arbroath.**By Mr. W. M. GLEN.*

—	1888	1889	1890	1891	Mean
January	— ^o	41 ^o ·5	47 ^o ·5	42 ^o ·5	(44 ^o ·0)
February	—	41·5	45·0	43·5	(42·7)
March	42·0	43·5	43·5	44·5	43·3
April	44·0	45·5	47·5	44·5	45·4
May	49·5	49·0	50·0	48·0	49·1
June	54·0	55·0	54·5	53·5	54·2
July	55·0	59·5	57·5	57·0	57·3
August	57·5	60·5	58·5	58·0	58·6
September	57·5	57·5	58·5	58·0	57·9
October	51·5	54·5	55·5	—	(54·0)
November	47·5	51·0	52·5	—	(50·4)
December	47·5	47·0	46·5	—	(47·0)
Mean	(48·8)	50·7	51·4	(50·2)	(50·3)

SEA OBSERVATIONS AT DOVER.

Notes of Observations made at Admiralty Pier, Dover, by Captain J. GORDON MCDAKIN, under the auspices of the Dover Natural History Society.

The place of observation is about 1,000 feet from the shore. Depth of water about 32 feet at lowest tide.

In the previous year temperatures were taken (at irregular intervals, and therefore not in conformity with the requirements of the Committee) to ascertain the difference of temperature of the surface water of the tides running north and south, their relation to fogs, &c.

The temperature does not appear to be affected by the northerly or southerly set of the tide.

The average water-temperatures during the abnormally cold winter of 1890-91 were for December 33°·0, January 36°·5, February 40°·0, or 7°·3 below the average of the same three months of the previous winter, when the temperature might be considered normal. The low temperature appears to have been caused by the melting snow on the surface water. I am inclined to think, from numerous careful observations made by myself, that 40° is the lowest normal winter temperature.

The lowest temperatures were on December 16, air 27°, water 28°, and January 10, air 26°, water 28°. It was stated in the local press that at Margate 'the ice was drifted and packed at the foot of the cliffs to the height of six feet. The shore for a great distance was covered with crabs and starfish which had been frozen to death.'

The small river Dour, rising from two springs at Alkham and Ewell, and flowing into the sea at Dover, about four miles distant, remained unfrozen during this severe winter. The temperature on one occasion was 48° when the surrounding country was covered with snow and ice.

DISCUSSION OF SEA OBSERVATIONS CARRIED OUT FOR THE FISHERY BOARD ON THE COAST OF SCOTLAND. BY HUGH ROBERT MILL, D.Sc.

In the Ninth Annual Report of the Fishery Board for Scotland, part iii. p. 353, a detailed discussion of temperature and other physical obser-

variations on the water of the sea at certain fixed stations is given. The summarised results in tabular form are given below, in order to render them more available to other workers, and to afford ready comparison with other records carried on simultaneously in different places. The following tables are expressed in Centigrade degrees, most of the instruments used by the Board's observers being graduated on that system.

ArdriSHAIG and Brodick are situated on the Clyde Sea Area, and observations of surface-water only are taken twice daily at the end of the steamboat piers in water never less than 6 feet deep at low water.

The Bell Rock Lighthouse stands in the North Sea nearly opposite the estuary of the Tay and twelve miles south-east of Arbroath, being thus quite beyond land influence.

Monthly Mean Temperatures of the Sea.

Month	Year	ARDRISHAIG				BRODICK		BELL ROCK LIGHTHOUSE		OXCAR LIGHTHOUSE		
		9 A.M.		3 P.M.		10 A.M.	4 P.M.	9 A.M.	3 P.M.	9 A.M.		3 P.M.
		Air	Surface	Air	Surface	Surface	Surface	Surface	Surface	Air	Surface	Surface
January	1890	—	—	—	—	—	—	6.5	—	6.5	6.2	6.0
February	"	4.2	5.6	6.9	5.9	—	—	5.7	—	4.1	5.0	6.0
March	"	8.4	6.9	10.9	7.2	—	—	5.3	5.5	7.4	5.7	5.9
April	"	10.5	8.0	14.4	8.5	7.9	8.5	6.3	6.4	8.6	7.1	7.1
May	"	15.4	11.1	18.9	11.6	10.4	11.2	8.6	8.8	11.6	9.8	9.8
June	"	16.5	11.3	19.4	11.6	11.6	12.2	10.0	10.3	14.1	11.0	11.3
July	"	14.7	11.7	16.8	12.4	12.5	13.6	11.6	11.7	14.8	10.8	11.4
August	"	14.9	13.3	17.4	13.7	13.7	14.1	12.7	12.7	14.9	10.3	10.7
September	"	14.9	12.8	16.4	13.3	13.3	13.8	13.0	13.1	—	—	—
October	"	10.6	11.0	11.4	11.3	11.4	11.9	11.6	11.9	10.0	8.2	8.9
November	"	5.6	9.1	6.6	9.2	9.7	9.8	9.5	9.5	6.3	7.1	7.6
December	"	3.2	6.5	3.5	6.6	8.0	8.1	7.6	—	—	—	—
January	1891	3.0	5.1	4.6	5.5	6.5	6.7	5.3	5.2	3.1	3.9	4.3
February	"	5.7	6.8	7.1	6.8	6.5	7.1	5.2	5.4	—	—	—
March	"	3.6	5.9	5.2	6.1	5.8	6.0	4.8	4.9	4.6	4.3	5.0

Oxcar Lighthouse is situated in the Firth of Forth a little to the west of Aberdour, and is built on a rock surrounded by deep water. From its situation it is much under the influence of fresh water carried down by the Forth and its small tributary the Almond, when in flood. The tide here has considerable power, and the observations were sorted out in order to detect any tidal disturbance. As the two daily observations were taken six hours apart, they were almost exactly at opposite phases of the tide. Neglecting all cases except those in which the observations were within an hour and a half of high or of low water the results were classified as given in the table on next page.

The North Carr Rock Light-vessel is anchored off Fife Ness, just beyond the mouth of the Firth of Forth, in 24 fathoms of water. The situation is a very exposed one and little subject to land influence. The monthly means at this station and their tidal discussion are on pp. 468, 469. The surface-temperatures recorded are probably too low on account of the time which was allowed to elapse between raising the thermometer from the water and reading it, and of the exposure of the wet bulb to the air.

Oscar Lighthouse. Mean Tidal Effect on Temperature.

Month	Year	Temperature			Differ- ence S ₃ -S ₉	Temperature		S ₃ -S ₉
		High Water 9 A.M. S ₉	Low Water 3 P.M. S ₃	° C.		Low Water 9 A.M. S ₉	High Water 3 P.M. S ₃	
January . . .	1890	6.0	6.7	0.7	6.2	6.4	0.2	
February . . .	"	4.6	4.8	0.2	4.9	5.6	0.7	
March . . .	"	6.3	6.8	0.5	5.4	5.5	0.1	
April . . .	"	7.2	7.7	0.5	7.0	7.0	0.0	
May . . .	"	10.4	11.3	0.9	9.6	9.3	-0.3	
June . . .	"	11.1	11.7	0.6	11.2	10.8	-0.4	
July . . .	"	10.7	12.3	1.6	10.8	11.4	0.6	
August . . .	"	9.7	10.5	0.8	10.8	10.9	0.1	
September . . .	"	—	—	—	—	—	—	
October . . .	"	8.0	9.0	1.0	8.0	8.6	0.6	
November . . .	"	7.4	7.6	0.2	6.5	7.2	0.7	
December . . .	"	—	—	—	—	—	—	
January . . .	1891	3.4	3.9	0.5	3.8	5.2	1.4	
February . . .	"	5.4	5.4	0.0	4.9	5.1	0.2	
March . . .	"	4.7	5.4	0.7	4.0	4.6	0.6	
Mean . . .	—	7.3	7.9	0.6	7.2	7.5	0.3	

North Carr Light-vessel. Temperature of Water (Monthly Means).

Month	Year	Observations, 9 A.M.				Observations, 3 P.M.			
		Air	Surface	12 fms.	Bottom	Air	Surface	12 fms.	Bottom
December . . .	1889	5.9	6.9	7.3	7.6	6.4	6.9	7.6	7.6
January . . .	1890	6.6	6.6	6.4	6.4	6.9	6.6	6.4	6.7
February . . .	"	5.1	5.6	5.7	6.0	6.3	5.7	5.9	6.0
March . . .	"	5.3	5.6	5.3	5.2	6.5	5.6	5.4	5.3
April . . .	"	8.7	5.5	6.4	6.3	9.1	6.7	6.5	6.4
May . . .	"	8.4	8.8	8.3	7.5	10.5	9.0	8.4	7.7
June . . .	"	14.0	10.5	10.2	9.4	14.9	10.6	10.4	9.4
July . . .	"	14.9	11.8	11.2	10.4	15.4	12.5	12.0	11.3
August . . .	"	15.0	12.0	12.9	12.0	15.6	12.3	13.2	12.1
September . . .	"	14.4	12.8	13.0	12.4	16.0	13.2	13.6	12.8
October . . .	"	11.6	11.4	11.5	11.6	12.4	11.5	11.5	11.6
November . . .	"	7.1	9.2	8.9	9.4	7.7	9.2	9.0	9.5
December . . .	"	4.9	7.6	7.6	7.8	5.1	7.5	7.5	7.7
January . . .	1891	2.8	5.4	5.1	5.4	4.7	5.5	5.3	5.5
February . . .	"	5.7	5.3	5.3	5.6	7.5	5.5	5.6	5.6
March . . .	"	4.0	4.9	4.2	4.7	6.0	5.1	4.6	4.7

The following table shows that when high water occurs at 9 A.M. and low water at 3 P.M. in the warm months, the heating effect of the sun and of the ebb from the Forth makes the water 0.4 warmer on the surface and 0.3 warmer on the bottom in the afternoon than in the morning. But in the cold months the cold ebb-water from the Forth completely neutralises the feeble heating effect of the sun, and no rise of temperature occurs in the afternoon. On the other hand, when high water occurs in the afternoon in the warm months and low water in the morning, the colder water

from the North Sea prevents sun-heat from raising the surface temperature more than 0°·1 C. in the warm months, and allows no rise of temperature at all in the cold months. It is probable that the effect is produced by the warming power of the ebb-water at 9 A.M. making up for loss by radiation at night, and this would completely account for the range being greater at the bottom than on the surface, as the surface is naturally more affected by the fresher ebb-water.

North Carr Light-vessel. Mean Tidal Effect on Temperature.

Month	Year	SURFACE						BOTTOM					
		High Water	Low Water	S ₂ -S ₃	Low Water	High Water	S ₂ -S ₃	High Water	Low Water	B ₃ -B ₅	Low Water	High Water	B ₃ -B ₅
		9 A.M. S ₂	3 P.M. S ₃		9 A.M. S ₂	3 P.M. S ₃		9 A.M. B ₂	3 P.M. B ₃		9 A.M. B ₂	3 P.M. B ₃	
		° C.	° C.	° C.	° C.	° C.	° C.	° C.	° C.	° C.	° C.	° C.	° C.
December	1889	7·1	7·0	-0·1	6·6	6·7	0·1	7·9	7·9	0·0	6·0	6·5	0·5
January	1890	6·2	6·2	0·0	6·5	6·7	0·2	6·4	6·2	-0·2	6·9	6·9	0·0
February	"	5·4	5·4	0·0	5·6	5·6	0·0	5·6	5·8	0·2	6·1	6·1	0·0
March	"	5·7	5·7	0·0	5·4	5·4	0·0	5·3	5·4	0·1	5·2	5·2	0·0
April	"	6·5	6·8	0·3	6·2	6·5	0·3	6·4	6·3	-0·1	6·1	6·1	0·0
May	"	9·7	9·9	0·2	7·9	8·3	0·4	7·8	8·0	0·2	7·4	7·6	0·2
June	"	10·6	10·5	-0·1	10·6	10·0	-0·6	9·4	9·2	-0·2	9·0	9·1	0·1
July	"	11·7	12·4	0·7	11·5	12·1	0·6	10·5	11·4	0·9	10·7	11·1	0·4
August	"	11·7	12·8	1·1	12·0	12·3	0·3	11·7	12·3	0·6	11·8	11·9	0·1
September	"	13·0	13·3	0·3	12·6	12·9	0·3	12·6	13·0	0·4	12·4	13·0	0·6
October	"	11·3	11·5	0·2	11·1	11·1	0·0	11·6	11·7	0·1	11·4	11·3	-0·1
November	"	9·0	9·3	0·3	8·9	8·7	-0·2	9·5	9·7	0·2	8·7	9·0	0·3
December	"	7·4	7·3	-0·1	7·1	6·5	-0·6	8·0	7·7	-0·3	7·4	7·3	-0·1
January	1891	5·5	5·3	-0·2	5·2	5·3	0·1	5·3	5·5	0·2	5·1	5·6	0·5
February	"	5·4	5·4	0·0	5·3	5·4	0·1	5·4	5·6	0·2	5·6	5·6	0·0
March	"	5·1	5·2	0·1	4·7	4·8	0·1	5·2	5·2	0·0	4·7	4·8	0·1
Mean	—	8·2	8·4	0·2	7·9	8·0	0·1	8·0	8·2	0·2	7·8	7·9	0·1

Abertay Light-vessel. Temperature of Water (Monthly Means).

Month	Year	Observations, 9 A.M.						Observations, 3 P.M.						
		Air	Surface	1 fm.	3 fms.	5 fms.	Bottom	Air	Surface	1 fm.	3 fms.	5 fms.	Bottom	
		° C.	° C.	° C.	° C.	° C.	° C.	° C.	° C.	° C.	° C.	° C.	° C.	° C.
June	1889	14·9	11·4	11·0	10·9	10·5	10·4	15·7	11·5	11·3	10·9	10·8	10·7	
July	"	15·1	12·6	12·5	12·4	12·3	12·3	17·2	12·6	12·4	12·4	12·3	12·3	
August	"	14·8	13·7	13·6	13·5	13·4	13·4	17·4	13·8	13·6	13·6	13·5	13·5	
September	"	12·5	12·8	12·8	12·8	12·8	12·8	14·5	13·0	12·9	12·9	12·9	12·9	
October	"	8·8	10·3	10·3	10·3	10·4	10·4	10·8	10·7	10·6	10·6	10·6	10·7	
November	"	7·4	9·2	9·2	9·1	9·1	9·1	8·5	9·3	9·2	9·3	9·3	9·4	
December	"	4·5	6·5	6·6	6·7	6·9	7·0	5·7	6·9	6·8	7·0	7·1	7·1	
January	1890	5·6	5·9	5·9	6·0	6·2	6·3	6·8	6·0	6·1	6·2	6·3	6·4	
February	"	3·5	5·2	5·3	5·3	5·4	5·4	5·7	5·3	5·4	5·4	5·5	5·5	
March	"	5·7	5·4	5·3	5·3	5·3	5·3	7·7	5·7	5·5	5·5	5·5	5·5	
April	"	7·5	6·6	6·5	6·5	6·5	6·4	9·8	6·7	6·6	6·5	6·5	6·4	
May	"	11·3	9·1	9·0	8·9	8·8	8·8	12·3	9·0	8·8	8·7	8·6	8·6	
June	"	14·3	10·8	10·7	10·5	10·4	10·4	15·7	10·7	10·6	10·3	10·3	10·1	
July	"	15·5	12·1	12·0	11·8	11·7	11·6	16·6	12·0	11·9	11·8	11·7	11·7	
August	"	13·3	12·8	12·8	12·8	12·8	12·7	17·1	12·9	12·8	12·8	12·8	12·8	
September	"	13·9	13·1	13·1	13·0	12·9	12·9	17·2	13·1	13·1	13·0	13·0	13·0	
October	"	10·3	11·1	11·1	11·1	11·1	11·1	12·1	11·4	11·4	11·4	11·4	11·4	
November	"	6·1	8·1	8·3	8·5	8·6	8·6	7·6	8·8	9·0	9·1	9·2	9·2	
December	"	3·7	6·4	6·6	6·6	6·8	6·8	4·3	6·6	6·8	6·9	7·0	7·0	
January	1891	2·8	4·4	4·5	4·5	4·6	4·6	4·2	4·7	4·7	4·7	4·8	4·8	
February	"	4·9	4·8	5·0	5·0	5·0	5·1	8·2	5·3	5·1	5·1	5·2	5·2	
March	"	3·4	4·4	4·3	4·3	4·3	4·3	6·5	5·0	4·9	4·8	4·8	4·8	

The Abertay Light-vessel is anchored in about 8 fathoms of water, the depth varying from 6 to 10 fathoms according to the tide, at the mouth of the Firth of Tay. Its position differs from that of any of the other stations, most nearly resembling Oxcar, but subject to much more intense and variable conditions. The tides run very strongly, and the shifting of the sandbanks on both sides of the entrance to the Firth must produce corresponding changes in the direction of the tidal streams.

The tidal effects at Abertay are remarkably distinct and striking. They are brought out in the following table, which extends and confirms the conclusions drawn from the Oxcar and North Carr observations.

Abertay Light-vessel. Mean Tidal Effect on Temperature.

Month	Year	SURFACE						BOTTOM					
		High Water 9 A.M. S ₀	Low Water 3 P.M. S ₁	S ₂ -S ₀	Low Water 9 A.M. S ₂	High Water 3 P.M. S ₃	S ₃ -S ₂	High Water 9 A.M. B ₀	Low Water 3 P.M. B ₁	B ₂ -B ₀	Low Water 9 A.M. B ₂	High Water 3 P.M. B ₃	B ₃ -B ₂
		° C.	° C.	° C.	° C.	° C.	° C.	° C.	° C.	° C.	° C.	° C.	° C.
June . . .	1889	10.0	12.5	2.5	12.4	10.5	-1.9	9.3	11.4	2.1	11.7	10.0	-1.7
July . . .	"	12.0	13.1	1.1	13.1	12.6	-0.5	11.8	12.9	1.1	13.1	12.6	-0.5
August . . .	"	13.3	13.9	0.6	13.7	13.4	-0.3	13.4	13.6	0.2	13.5	13.3	-0.2
September . . .	"	13.0	13.3	0.3	12.7	12.7	0.0	13.1	13.1	0.0	12.7	12.7	0.0
October . . .	"	10.7	10.7	0.0	9.7	10.5	0.8	11.1	10.8	-0.3	9.7	10.6	0.9
November . . .	"	9.5	8.7	-0.8	9.3	9.6	0.3	9.7	9.3	-0.4	8.8	9.7	0.9
December . . .	"	7.0	6.2	-0.8	5.6	7.3	1.8	7.4	6.5	-0.9	6.2	7.5	1.3
January . . .	1890	5.6	5.1	-0.5	5.5	6.1	0.6	6.4	6.0	-0.4	5.8	6.4	0.6
February . . .	"	5.0	4.6	-0.4	5.1	6.0	0.9	5.2	5.0	-0.2	5.6	6.1	0.5
March . . .	"	5.6	6.4	0.8	4.9	5.1	0.2	5.6	5.8	0.2	5.1	5.3	0.2
April . . .	"	6.4	6.8	0.4	6.6	6.1	-0.5	6.4	6.6	0.2	6.8	6.2	-0.6
May . . .	"	8.6	10.0	1.4	9.1	8.1	-1.0	8.6	9.5	0.9	9.0	8.0	-1.0
June . . .	"	10.1	12.1	2.0	11.2	9.5	-1.7	9.8	10.5	0.7	11.0	9.5	-0.5
July . . .	"	11.2	12.9	1.7	12.7	11.4	-1.3	11.3	12.3	1.0	12.4	11.2	-1.2
August . . .	"	12.1	13.6	1.5	13.3	12.2	-1.1	12.5	13.2	0.7	13.2	12.2	-1.0
September . . .	"	12.6	13.3	0.7	13.3	12.7	-0.6	12.7	13.1	0.4	13.1	13.0	-0.1
October . . .	"	11.3	11.0	-0.3	10.1	10.8	0.7	11.5	11.4	-0.1	10.4	11.0	0.6
November . . .	"	8.9	8.2	-0.7	6.7	8.8	2.1	9.6	9.2	-0.4	7.5	9.1	1.6
December . . .	"	6.9	5.8	-1.1	5.2	6.7	1.5	7.5	6.7	-0.8	5.4	7.1	1.7
January . . .	1891	5.2	3.8	-1.4	3.4	3.8	0.4	5.3	4.6	-0.7	4.7	4.8	0.1
February . . .	"	5.1	4.9	-0.2	4.8	5.3	0.5	5.1	5.1	0.0	4.9	5.3	0.4
March . . .	"	4.9	4.7	-0.2	3.8	4.4	0.6	5.0	4.9	-0.1	3.9	4.5	0.6
Mean . . .	—	8.9	9.2	0.3	8.8	8.9	0.1	9.0	9.1	0.1	8.8	8.9	0.1
" . . .	—	(disregarding sign)	0.9	—	—	—	0.9	—	—	0.5	—	—	0.7

It appears from this table that the average change of temperature on the surface between morning and afternoon is about a degree C., and the daily range of temperature on the bottom something more than half a degree C. The changes are sometimes in one direction, sometimes in the other, and the mean of the whole series shows a slight warming in the afternoon.

The tidal relation of the water is remarkably simple, and affects the bottom almost equally with the surface. It may be summed up thus:—

In the warm months, when high tide occurs in the morning, and low tide in the afternoon, the water in the afternoon is nearly a degree C. warmer than in the morning—the average of the month of June shows even 2° 25 C. of increased warmth. But in the warm months, when low tide occurs in the morning, and high tide in the afternoon, the water is

about three-quarters of a degree C. colder in the afternoon than in the morning—the average of the month of June shows this afternoon cooling to be as much as $1^{\circ}8$ C. In the cold months the phenomena are reversed. When the tide is high in the morning and low in the afternoon, the water is about half a degree C. colder in the afternoon than in the morning—in December as much as $1^{\circ}0$ C. When the tide is low in the morning and high in the afternoon, the water is about three-quarters of a degree C. warmer in the afternoon—in December as much as $1^{\circ}6$ C.

It thus appears that the tidal effect on temperature is stronger than the solar. In summer, no matter how hot the day may be, the water at the Abertay lightship cools steadily until the hour of high tide; in winter, no matter how cold the night may have been, the water warms steadily until the hour of high tide. The explanation is simple and sufficient. The temperature of the water of the Tay is always higher in summer and lower in winter than that of the sea, and putting the case generally, the Abertay light-vessel floats in Tay water at low tide, in North Sea water at high tide.

These observations, which are not further alluded to in this report, serve to record a very large amount of thoroughly trustworthy observations. Especial attention is directed to Mr. Chapman's magnificent series of mean monthly temperatures, which illustrate very clearly the variations in the seasonal swing of temperature in water in one of the most extreme average climates of the British Islands, taking its low altitude into account. It serves not only to record the variations in temperatures of the Cherwell, but to suggest the range of deviations from normal seasonal temperatures to be expected in any case. Thus we are warned not to assume the mean of one or two years as being the real mean temperature of any exposed body of water.

B. Record of Occasional Observations.

Many observations taken regularly at intervals of a week acquire some value in tracing the seasonal variations if they have been carefully performed and carried out at exactly the same hour on each occasion.

RIVER WANDLE.

Observations by Mr. F. C. BAYARD, LL.M., F.R.Met.Soc., made under the auspices of the Croydon Microscopical and Natural History Club.

These observations were made once a week at a number of points near the sources of the river Wandle, which takes its rise as an outflow from the chalk, and throughout its course of ten miles to the Thames is never known to freeze.

The observations of temperature on the Wandle by Mr. Bayard once a week for 1889 are published by Mr. Thomas Cushing, F.R.Met.Soc. in Report of the Meteorological Sub-Committee of the Croydon Microscopical and Natural History Club for 1891. Mr. Cushing gives the following abstract of the extreme temperatures observed and the yearly range:—

Carshalton Branch of Wandle.

Station	Lowest	Highest	Lowest	Highest	Greatest Differences.
1.	37.7	58.3	December 29	August 4	20.6
2.	45.1	54.9	December 15	September 1	9.8
3.	49.9	51.6	December 30	August 4	1.7
4.	46.6	55.0	January 6	June 2	8.4
5.	49.8	50.7	January 6	July 28	0.9

Croydon Branch of Wandle.

6.	48.3	52.6	April 4	September 1	4.3
7.	46.9	53.4	January 6	June 2	6.5
8.	41.6	66.2	December 29	June 2	24.6
9.	36.7	63.0	January 6	June 2	26.3
10.	48.5	52.0	February 24	September 1	3.5

Weekly mean air-temperature was lowest (30.5) on January 6, and highest (64.1) on September 15, a difference of 33.6.

RIVER HULL.

Observations of Temperature made at Driffild on the River Hull by Mr. JOHN LOVELL, F.R.Met.Soc., January–September 1891.

The observations were made once a week at three stations until June 21, thereafter at one station.

Station 1.—King's Mill Stream, over quarter of a mile south of the observer's climatological station (lat. 54° 0' 30'' N., long. 0° 27' 15'' W.), and fed by springs from distances of from one quarter to one half a mile.

Station 2.—River Head. More than one mile south-east of King's Mill; a deep-water basin above a lock on the canal known as River Head. The river here flows S.S.E., and is partially sheltered on north, east, and west.

Station 3.—Whinhill. About two miles farther down the river at the second lock, E.S.E. from River Head, stream flowing due east. Greatly exposed to all winds.

Sea temperature in Bridlington Bay from boat:—

June 6, 53° 2; June 20, 56° 0 at 6 P.M.

Observations of Temperature at Driffield, Yorkshire, 1891.

Date	Screen temperature for the day			Stations:—			Previous week		For the day at 9 A.M.		
	9 A.M.	Max.	Min.	King's Mill	River Head	Whin Hill	Rain-fall	Bright Sunshine	Cloud	Wind	Force
January 18	18·8	27·6	15·0	43·9	44·7	40·2	Ins.	H. M.			0
" 25	37·2	44·2	34·2	45·0	45·9	42·8	·33	17 55	0	W.	3
February 1	37·0	46·5	35·7	46·3	47·4	45·3	·21	16 20	1	N.W.	3
" 8	41·2	44·0	39·5	47·5	47·9	47·3	·01	22 10	10	W.	1
" 15	39·3	53·7	33·8	46·9	48·0	47·3	·05	16 55	2	W.	0
" 22	29·8	37·7	29·3	46·2	46·6	44·9	·02	23 10	10	S.E.	2
March 1	48·8	55·7	37·0	48·0	48·8	48·4	·05	33 15	10	W.	4
" 8	32·3	37·3	31·1	46·3	46·7	46·3	·24	27 40	8	N.W.	1
" 15	35·0	42·4	32·0	46·0	46·9	46·0	·61	35 30	10	S.E.	3
" 22	39·5	45·0	28·2	46·1	48·0	46·8	·57	21 10	1	N.	1
" 29	39·4	43·6	34·2	45·3	47·5	45·0	·41	32 0	1	N.	4
April 5	39·4	41·6	39·2	45·5	46·3	—	·26	32 0	10	E.	5
" 12	43·1	47·1	37·0	47·2	50·0	50·3	·88	12 0	7	N.E.	2
" 19	43·4	47·0	38·1	47·4	50·3	51·0	·34	37 0	9	E.N.E.	3
" 26	45·9	52·2	25·5	48·0	50·8	52·0	·15	40 0	6	S.E.	0
May 3	46·2	53·5	36·7	48·0	49·6	51·6	·45	45 0	7	S.W.	3
" 10	50·4	56·2	44·9	49·0	49·0	50·0	·10	53 0	9	N.E.	5
" 17	41·2	44·7	28·2	47·8	48·0	48·0	·26	54 0	10	W.	2
" 24	48·1	49·4	41·8	49·0	49·6	—	·42	39 0	5	E.	3
" 31	50·0	56·9	39·8	49·7	53·0	57·0	·74	23 0	10	E.	2
June 7	47·7	53·4	45·5	49·0	51·0	55·6	·15	67 0	10	N.N.E.	2
" 14	57·1	61·0	47·3	50·9	—	—	·02	35 0	10	N.W.	3
" 21	53·2	62·4	49·0	51·0	55·7	62·0	·28	37 0	10	N.E.	2
" 28	61·9	—	—	52·0	—	—	·30	46 15	9	S.W.	2
July 5	62·0	—	—	51·0	—	—	·60	60 45	6	S.E.	1
" 12	57·6	—	—	—	—	—	·63	27 45	10	N.N.W.	1
" 19	60·3	—	—	52·2	—	—	·24	26 15	9	S.W.	1
" 26	64·0	—	—	52·3	—	—	·63	33 35	3	W.	2
August 2	62·1	—	—	53·0	—	—	1·63	32 55	7	S.W.	2
" 9	61·5	—	—	53·2	—	—	·37	26 50	10	S.W.	2
" 16	55·8	—	—	51·3	—	—	·90	32 25	10	N.W.	2
" 23	54·0	—	—	51·4	—	—	·73	9 45	10	N.W.	3
" 30	53·7	—	—	49·8	—	—	1·10	20 10	3	S.	0
September 6	57·0	—	—	51·4	—	—	·84	43 50	10	S.W.	3
" 13	64·5	—	—	51·7	—	—	·16	57 30	2	E.	1
" 20	58·0	—	—	51·0	—	—	·38	19 55	10	S.	2
" 27	55·6	—	—	49·9	—	—	·58	23 50	1	W.	5

C. Observations regularly made for the Committee.

The remainder of the observations have been specially taken from the commencement for the Committee, and are recorded in the manner already explained. The curves expressing weekly means are inserted in the text, except Curves XX. and XXIII., which are shown on Plate XVI. In a few instances the monthly means have been calculated from the daily readings by the observers, and discussed more or less completely.

ROCHDALE RESERVOIRS.

Full particulars of the situation of the reservoirs are given in Mr. Ashworth's report of the work done on them, and the corresponding curves of weekly means are given as No. I. and II.; the true monthly means, calculated from daily observations, are entered below:—

Discussion of Temperature Observations of Air and Water at Cown and Spring Mill Reservoirs. By Mr. J. REGINALD ASHWORTH.

In furtherance of the work of the Committee, and under the auspices of the Rochdale Literary and Scientific Society, observations are being

carried on at Cowm and Spring Mill Reservoirs, permission to do this having been obtained from Mr. W. Tomlinson, the manager of the Rochdale Corporation Waterworks.

The observations began on January 1, 1890, and a synopsis of the results obtained is given below. A record of the rainfall and the number of days on which rain fell has also been included. The hour for observing the instruments is nine o'clock in the morning, but at Cowm during the month of January 1890 the readings were taken at twelve o'clock, noon, and in consequence a considerable difference will be remarked in the mean temperature of the atmosphere at the two stations in that month.

Both reservoirs lie in valleys running nearly north and south (open to the south) about one and a half mile apart, and from three to four miles north of Rochdale. Cowm, the larger reservoir of the two, is 816 feet above sea level, and its drainage area is 900 to 1,000 acres. Spring Mill is 771 feet above sea level, and has a drainage area of 500 to 600 acres.

The accompanying table sufficiently explains itself. The figures at both stations differ but little, but in column iv. it will be noticed that the monthly range of *water* temperature has been generally greater at Cowm than at Spring Mill; the extreme oscillation during six months covers $25^{\circ}5$ at the former and $25^{\circ}2$ at the latter station. The wide difference in the fluctuations of air and water temperatures is brought out more strikingly in the chart.

CURVE I.—Cowm Reservoir, Rochdale. 9 A.M.

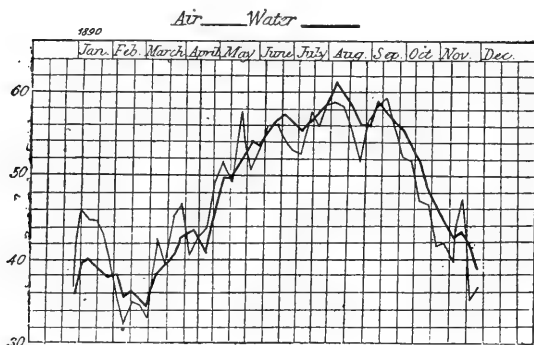

On three occasions in the months of June and July the temperature of the principal feeding stream to Spring Mill Reservoir was taken, and it was found to be $5^{\circ}7$, $5^{\circ}8$, and $5^{\circ}3$ respectively *colder* than the main body of the water as tested near the overflow. The first of these observations was taken at 9 o'clock in the evening, and the other two at the usual observing hour.

Mr. James Diggle, C.E., F.G.S., has also thermometric observations

in progress (commenced on March 1), on Clay Lane Reservoir of the Heywood Corporation Waterworks.

Cowm Reservoir.

1890	I.		II.		III.		IV.		V.		VI.	VII.
	Mean Temperature		Maximum Temperature		Minimum Temperature		Range of Temperature		Maximum Difference			
	Air	Water	Air	Water	Air	Water	Air	Water	Air above Water	Water above Air	Rain-fall	No. of days on which rain fell
January, 12 noon.	41·6	38·5	49·8	40·8	24·7	32·7	25·1	8·1	11·0	8·0	Ins.	24
February, 9 A.M.	34·9	36·3	44·0	39·0	28·7	33·7	15·3	5·3	5·0	6·4	0·765	7
March	40·1	38·4	50·8	43·5	25·7	32·7	25·1	10·8	11·0	7·0	5·245	22
April	44·1	43·3	55·8	47·5	37·8	42·0	18·0	5·5	9·0	5·0	1·815	10
May	50·7	51·3	61·7	55·8	45·8	46·3	15·9	9·5	7·9	7·0	3·765	13
June	54·8	56·0	63·7	58·2	50·3	52·5	13·4	5·7	6·3	9·9	3·960	18
July	55·3	57·1	63·7	59·4	51·8	55·5	11·9	3·9	6·0	4·4	4·665	18
August	55·5	58·5	63·7	61·7	48·3	54·8	15·4	6·9	2·5	6·9	6·705	19
September	56·7	56·2	62·7	59·7	52·3	54·8	10·4	4·9	5·0	3·5	1·920	12
October	46·8	50·8	55·5	55·9	30·9	44·8	24·6	11·1	1·5	14·9	5·510	17
November	40·3	42·6	50·8	45·8	27·7	38·5	23·1	7·3	8·0	12·3	9·020	22
December	—	—	—	—	—	—	—	—	—	—	0·820	8

Spring Mill Reservoir.

—	I.		II.		III.		IV.		V.		VI.	VII.
	Mean Temperature		Maximum Temperature		Minimum Temperature		Range of Temperature		Maximum Difference			
	Air	Water	Air	Water	Air	Water	Air	Water	Air above Water	Water above Air	Rainfall	No. of days on which Rain fell
1890												
January	38·3	38·5	48·8	40·8	22·2	34·7	26·6	6·1	10·0	13·0	Ins.	27
February	35·0	36·2	44·0	39·3	29·7	34·2	14·3	5·1	5·0	5·4	0·714	8
March	40·6	38·6	50·8	42·8	26·7	33·2	24·1	9·6	10·0	6·5	5·369	23
April	43·7	43·3	53·8	45·8	38·8	42·3	15·0	3·5	8·0	4·2	1·679	11
May	52·7	51·5	62·7	55·8	46·0	46·3	16·7	9·5	8·1	6·5	3·688	13
June	55·5	56·4	61·7	58·4	50·3	53·8	11·4	4·6	6·0	6·4	3·794	20
July	56·0	57·4	64·7	59·3	51·8	55·9	12·9	3·4	5·6	4·9	4·701	19
August	55·8	58·4	64·7	62·2	49·6	54·4	15·1	7·8	3·5	8·9	6·616	21
September	57·6	56·8	64·7	59·0	51·8	54·3	12·9	4·7	6·2	4·0	2·163	12
October	47·2	50·2	55·4	55·7	30·7	43·8	24·7	11·9	5·0	13·1	5·821	18
November	39·9	42·5	52·8	46·1	27·7	38·6	25·1	7·5	9·4	12·1	9·603	22
December	30·1	34·3	39·0	38·4	18·0	32·0	21·0	6·4	5·5	15·6	0·733	9
1891												
January	32·2	33·2	44·0	35·0	15·3	32·4	28·7	2·6	10·0	17·2	4·182	16
February	38·2	35·6	45·0	37·0	32·0	34·0	13·0	3·0	10·0	4·0	0·425	5
March ¹	38·6	38·2	—	—	—	—	—	—	—	—	2·995	19
April	41·4	39·7	50·2	42·5	33·0	36·2	17·2	6·3	7·7	3·2	2·242	13
May	47·1	47·5	61·3	51·5	35·0	43·2	26·3	8·3	10·2	11·0	4·499	21
June	58·2	56·8	65·6	61·0	48·0	50·0	17·6	11·0	8·0	6·0	1·793	13
July ²	58·2	59·9	64·0	62·2	52·0	58·0	12·0	4·2	3·0	8·0	4·211	18

¹ 14 days only.

² 26 days.

CURVE II.—Spring Mill Reservoir, Rochdale, 9 A. M.

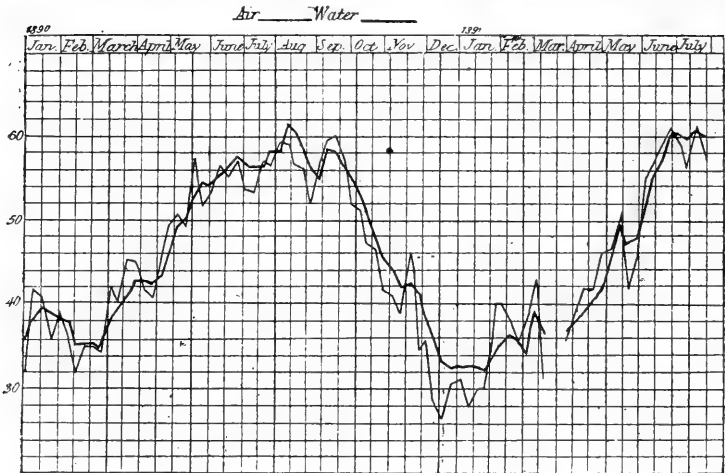

OLDHAM RESERVOIRS.

The weekly means of Piethorn and Denshaw reservoirs are given in Curves Nos. III. and IV. Both reservoirs are situated in a region the prevailing formation of which is Millstone grit. Piethorn reservoir has an area of 40 acres, a depth of 58 feet, and a capacity of 344 million gallons. Its surface is 823 feet above sea level. Denshaw reservoir is of smaller size, 23 acres, with a depth of 54 feet, and capacity of 146 million gallons, and it stands 1,000 feet above the sea. Piethorn may be compared in elevation with Cowm and Spring Mill reservoirs, referred to above, and it is interesting to compare the respective temperatures.

Discussion of Temperature Observations on Air and Water at Piethorn and Denshaw. By Mr. WILLIAM WATTS, F.G.S.

The temperature observations of the atmospheric air and water taken at Piethorn and Denshaw have been in accordance with the instructions of the Committee, and under the auspices of the Manchester Geological Society. The area and capacity of each reservoir remain unchanged, and the readings are taken daily at 9 A.M. A higher temperature both of atmospheric air and water is still maintained at Piethorn, although the two valleys are near together, similar in their geological substrata, and not much unlike in their physical conformation. Trees in both valleys are scarce and grow with difficulty, although in former times they appear to have flourished luxuriantly at a much higher elevation than we find them existing now. The absence of trees is to be explained rather by the keen north-east winds to which the valleys are exposed, and by the rapid denudation of the valley sides by rain which washes the soil from the roots, than by the pollution of the atmosphere by factory smoke. A glance at the tables shows that the water is warmer

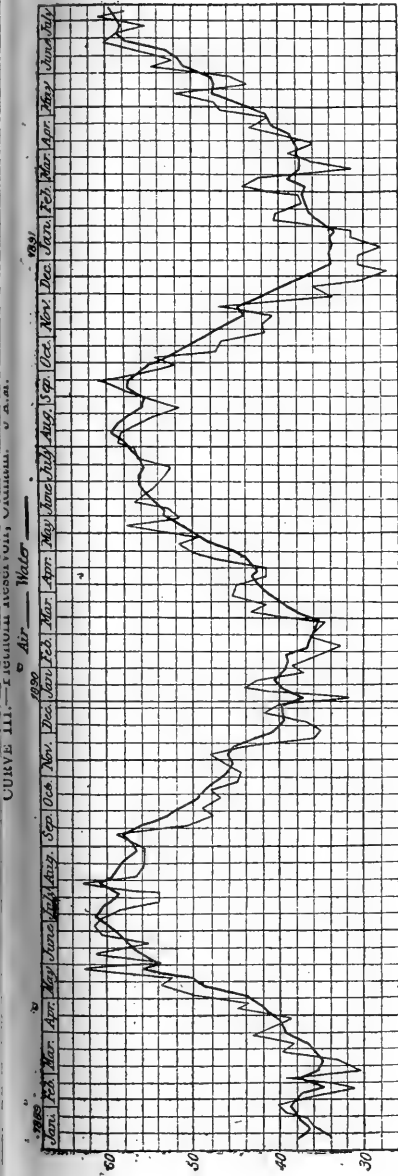

CURVE IV.—Denshaw Reservoir, Oldham. 9 A.M.

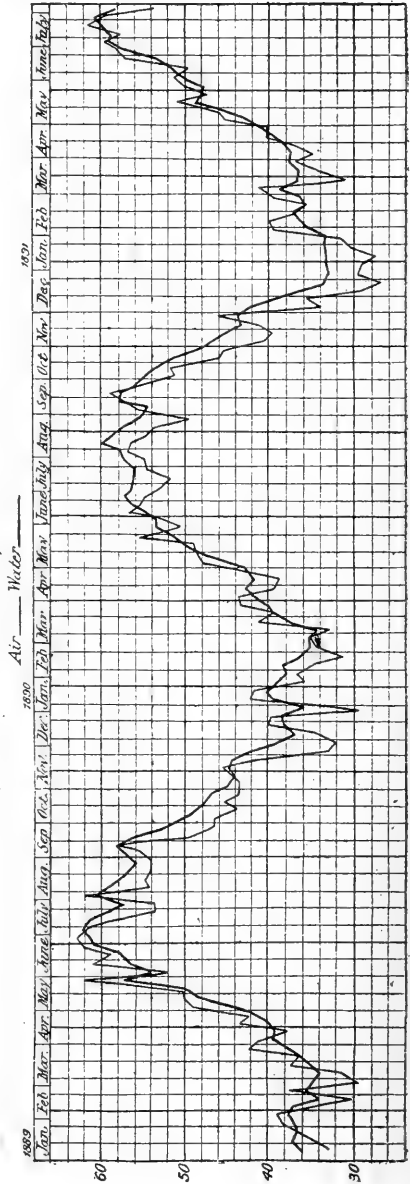

in winter and cooler in summer than the surrounding air, consequently it must not be objectionable to reside on the margin of large reservoirs except that an increase in the humidity of the air may be a drawback.

Average Daily Temperature.

Month	PIETHORN		DENSHAW	
	Air	Water	Air	Water
1889				
June	59·6	58·1	60·8	58·7
July	57·8	59·8	57·5	59·8
August	56·5	58·2	54·9	57·6
September	53·1	55·9	51·7	55·4
October	46·5	48·4	44·2	47·6
November	43·3	44·6	41·2	43·9
December	37·5	39·3	35·7	38·0
1890				
January	39·2	39·0	37·9	38·7
February	35·1	37·1	34·4	36·3
March	40·8	38·6	39·1	38·0
April	44·1	42·9	41·9	42·4
May	52·6	49·8	50·6	49·9
June	54·7	55·1	54·2	55·4
July	55·4	56·5	53·9	56·5
August	56·7	58·1	53·7	57·7
September	57·4	56·8	56·2	56·2
October	47·2	51·2	46·4	50·6
November	40·6	44·2	39·9	43·4
December	30·2	36·3	29·7	35·0
1891				
January	32·8	34·1	32·1	33·5
February	39·9	36·8	37·6	36·2
March	36·7	37·9	35·8	37·4
April	40·7	40·0	39·2	39·6
May	47·4	46·9	46·5	47·3
June	56·5	53·8	54·5	54·1
July	57·1	58·7	58·2	59·2

In order to make the observations as complete and interesting as possible, the monthly rainfall returns for each district are given in the following tables:—

Month	RAINFALL AT PIETHORN Gauge 894 ft. above sea level				RAINFALL AT DENSHAW Gauge 1,012 ft. above sea level			
	Rain-fall	Greatest fall in 24 hours	No. of days on which rain fell		Rain-fall	Greatest fall in 24 hours	No. of days on which rain fell	
1889								
June . . .	Inches 0·61	Date 2nd	Inches 0·26	5	Inches 0·70	Date 2nd	Inches 0·38	5
July . . .	3·92	21st	0·67	17	4·47	21st	0·83	16
August . . .	6·55	5th	0·82	23	7·73	5th	1·18	22
September . . .	2·59	26th	0·70	12	3·16	26th	0·82	13
October . . .	5·59	7th	0·92	24	5·88	7th	0·98	21
November . . .	1·83	24th	0·46	15	2·37	24th	0·54	15
December . . .	3·16	21st	0·84	18	2·66	21st	0·65	17
1890								
January . . .	5·65	26th	1·68	27	4·80	21st	1·12	27
February . . .	0·73	15th	0·45	9	0·88	15th	0·56	7
March . . .	3·87	23rd	0·46	21	3·72	10th	0·51	21
April . . .	1·35	6th	0·31	11	1·58	6th	0·39	9
May . . .	3·30	11th	0·80	13	3·45	11th	0·72	13
June . . .	3·97	30th	0·70	21	4·01	30th	1·02	21
July . . .	3·34	25th	0·38	21	3·25	16th	0·48	20
August . . .	6·05	1st	0·78	19	6·07	22nd	0·82	18
September . . .	1·88	30th	0·56	16	1·84	30th	0·42	13
October . . .	3·14	6th & 15th	0·40	18	3·41	6th	0·43	18
November . . .	5·70	22nd	1·21	23	5·49	22nd	0·87	22
December . . .	0·37	25th	0·10	8	0·41	4th & 23rd	0·12	6
1891								
January . . .	2·87	23rd	0·82	16	3·22	23rd	0·92	16
February . . .	0·30	3rd	0·11	6	0·37	3rd	0·12	7
March . . .	1·47	24th	0·29	13	1·72	6th & 24th	0·26	18
April . . .	1·91	29th	0·44	15	1·99	29th	0·46	13
May . . .	3·28	1st	0·43	19	3·68	1st	0·49	18
June . . .	1·69	4th	0·72	11	1·96	4th	0·90	8
July . . .	3·32	22nd	0·76	17	3·50	22nd	0·74	14

THE NITH AND DEE (DUMFRIES).

The Committee is indebted to the Rev. Wm. Andson, of Dumfries, for enthusiastic assistance in inaugurating observations at various points in the south-west of Scotland, and in summarising and discussing the results. The weekly means of the observations discussed below will be found as curves, No. V. for the Nith, No. VI. for the Dee, and No. VII. for Little Ross lighthouse. The monthly means in the accompanying discussion are calculated from the daily observations.

*Discussion of Temperature Observations on the Nith and its Estuary,
April 15, 1889, to April 15, 1890. By Rev. W. ANDSON.*

These observations were made under the auspices of the Dumfries and Galloway Natural History and Antiquarian Society. The observa-

tions at Dumfries were taken throughout the twelve months. Mr. Jas. Lewis took the observations of the estuary at Kingholm Quay, from June 25 to March 21, and observations were begun at later dates in the River Dee by Rev. W. I. Gordon, of Tongland, and in the Dee estuary by Mr. Macdonald, lighthouse-keeper, Little Ross. These are not reported upon in the present discussion. The Nith observations were taken at the Dumfries boathouse, where there was an average depth of more than 3 feet. In consequence of the damming of the water by the weir below the Old Bridge the river at this point never falls very low, the depth never being less than $2\frac{1}{2}$ feet. On two occasions of heavy flood the parapet wall was overflowed—once in the beginning of November, when the depth was estimated to have been fully 10 feet, towards midnight on the 1st; and again on January 25, after heavy rain and the melting of snow on the high grounds, with a south-west gale, when the depth of 9 feet was registered at the gauge on the Old Bridge. The hour of observation was at or near noon. The following table shows the mean temperature of the air and water for each month separately, along with the state of the river or the mean depth as registered at the gauge (which was erected in July), viz. :—

Corrected Means for	Air	Water	Difference	State of River
April	51 ^o ·3	45 ^o ·8	5 ^o ·5	Average
May	60 ^o ·5	56 ^o ·6	3 ^o ·9	Under average
June	65 ^o ·8	63 ^o ·0	2 ^o ·8	Low—and very low
July	63 ^o ·3	60 ^o ·3	3 ^o ·0	Very low till 10th, then above average
August	62 ^o ·3	57 ^o ·5	4 ^o ·8	Mean depth at gauge—
September	59 ^o ·7	53 ^o ·1	6 ^o ·6	5 ^o ·0 feet
October	49 ^o ·6	45 ^o ·0	4 ^o ·6	4 ^o ·6 "
November	45 ^o ·6	43 ^o ·1	2 ^o ·5	5 ^o ·1 "
December	40 ^o ·2	38 ^o ·2	2 ^o ·0	5 ^o ·2 "
January	44 ^o ·4	40 ^o ·5	3 ^o ·9	5 ^o ·5 "
February	42 ^o ·8	38 ^o ·1	4 ^o ·7	6 ^o ·0 "
March	48 ^o ·5	41 ^o ·1	7 ^o ·4	4 ^o ·8 "
Means for whole year	52 ^o ·8	48 ^o ·5	—	4 ^o ·9 "
Mean excess of air temperature for year	4 ^o ·3	—	—	—

From this table it will be seen that the highest monthly mean temperature of the air for the year was in June, when it was $65^{\circ}8$; the mean temperature of the water for the same month being 63° , also the highest mean for the year. The lowest was in December, when that of the air was $40^{\circ}2$, and the water $38^{\circ}2$; but the mean temperature of February for the water was a fraction lower than this, viz., $38^{\circ}1$, while that of the air was $42^{\circ}8$.

The highest single reading for the air was on July 31	76 ^o
The lowest single reading for the air was December 1	31
Extreme range for air	45
Highest single reading for water was on July 4	66 ^o ·6
Lowest single reading for water was on February 13	32
Extreme range for water	34 ^o ·6

The months in which the mean monthly temperature of the air and water most nearly approximated were: December, when the difference was only 2° (i.e., of air above water); November $2^{\circ}5$; June $2^{\circ}8$; and July 3° . Those in which the difference of temperature varied most were: March $7^{\circ}4$; September $6^{\circ}6$; and April $5^{\circ}5$. Mean difference for whole year $4^{\circ}3$. Thus it will be seen that the months in which the temperatures of the air and water most nearly approximated were those in which the day was at the shortest and the longest. In other words, there were two maxima and two minima of difference between the temperatures of the air and water, the former occurring in the months of March and September, the equinoctial months; and the latter in December and June, the months of the winter and summer solstice. The former fact is easily explained, but it is rather a curious circumstance that the same thing should hold good of the month in which the sun is longest above the horizon, and most nearly vertical. The explanation, I have no doubt, is that in the latter part of June and the first part of July, when there was a period of drought and warm weather, which lasted more than three weeks, the river fell to its lowest level, and the current was very sluggish. Hence the water became more heated than in ordinary circumstances, and its temperature more nearly approached that of the air.

CURVE V.—Nith, Dumfries. 12 noon.

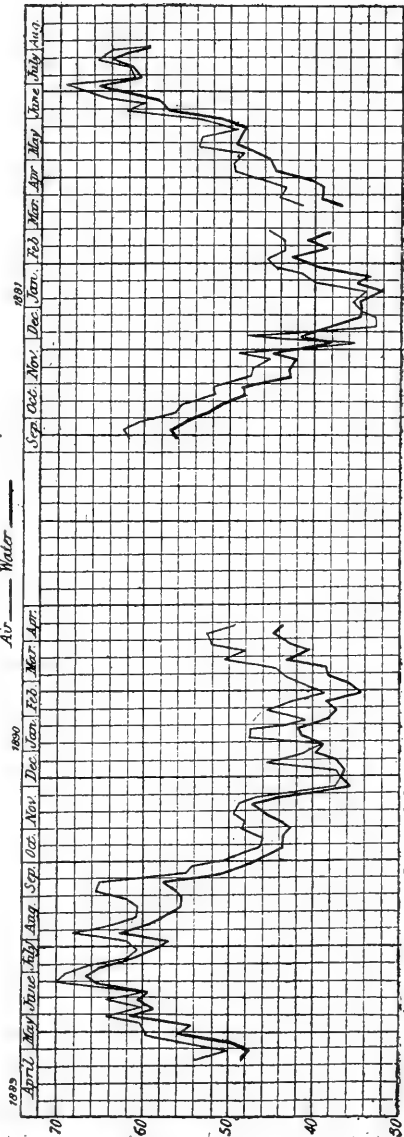

Though, as a rule, the temperature of the air was higher than that of the water, there were a good many exceptions to this rule, especially in the months of May, June, July, November, and December. Thus there were five days in May in which the water was warmer than the air, six in June, and four in July, with an aggregate excess in the temperature of the water of 37°. In November and December there were also fifteen days with an aggregate excess of 30°·4, the greatest number being in December, viz., ten days, while on other two days of that month the temperature of air and water was equal. The conditions under which this state of things was observed were, as a rule, in summer, when the air temperature was lowered by cloudy and wet, or dull and foggy weather, or by the prevalence of cold winds; and, in winter, when the conditions were similar, or when frost set in. The most extreme difference was observed on July 7, when the reading of the air temperature was 53°, and that of the water 65°—a difference of 12°. This was at the close of the period of drought before alluded to. The greatest excess in the temperature of the air above that of the water occurred in March, when on sixteen days it was higher by more than 7°, ranging from 7° to 14°·5; and the next in September, in which month there were thirteen days in which the difference exceeded 7°, ranging from 7° to 13°·2. On these occasions the weather was for the most part bright and sunny, or, if cloudy or rainy, very mild, with south or south-west winds.

The following table shows the mean monthly temperatures of the air and water of the estuary of the Nith at Kingholm Quay, where observations were taken with great regularity by Mr. James Lewis, for a period of about nine months, from June 25, 1889, to March 21, 1890. The hours of observation necessarily varied, because the proper temperature of the estuary could be obtained only when the tide was up. For the most part they were taken between the hours of 9 A.M. and 4 P.M., though sometimes a little earlier and sometimes a little later.

From	Means		Difference
	Air	Water	
June 25 to July 31	61·3	61·5	+0·2
August 1 to 31	59·0	56·9	-2·1
September 1 to 30	56·2	54·4	-1·8
October 1 to 31	45·5	45·8	+0·3
November 1 to 30	45·8	41·6	-4·2
December 1 to 14	38·3	36·8	-1·5
January 1 to 31	41·1	39·5	-1·6
February 1 to 28	40·0	37·4	-2·6
March 1 to 21	42·7	40·4	-2·3
Means	47·7	46·0	-1·7

From this table it will be seen that for the period from June 25 to July 31 the mean temperature of the estuary was a fraction of a degree higher than that of the air, and the same thing occurred again in October. In all the other months it was lower, but not to the same extent as in the case of the river temperature. Taking the whole period during which observations have been made, the mean temperature of the air was 47°·7, and of the water 46°, giving a mean difference of only 1°·7, instead of 4°·3, as in the case of the river. This result might have been

somewhat modified if the observations had been extended over the whole year instead of nine months, but not, I think, to any great extent, there being an obvious reason why the temperature of the estuary should be higher than that of the river as compared with that of the air, viz., the fact that when the tide rises it passes over the extensive tracts of sand which in the Solway Firth are left bare by the receding tide, and in sunny days become heated by the sun.

By the kindness of Mr. Beck and Mr. Lindsay, observations were made from August 8 to 19, and from September 13 to October 1, on Lochrutton loch, with the following results:—

—	Means		Difference
	Air	Water	
From August 8 to 19	58·3	61·1	+ 2·8
From September 13 to October 1	54·3	55·2	+ 0·9

From this we may probably infer that during at least the autumn and winter months, and possibly in summer also, the temperature of the loch is, as a rule, in excess of that of the air. But the observations are too limited in number to warrant any decided conclusion being founded upon them.

Observations of Temperature of Rivers Nith (Dumfriesshire) and Dee (Kirkcudbrightshire) for year 1890-91.

The observations of the temperature of the Nith at Dumfries were begun on September 8, 1890, and continued to August 31, 1891. They

CURVE VI.—Dee at Tongland, Kirkcudbrightshire. 12.30 P.M.

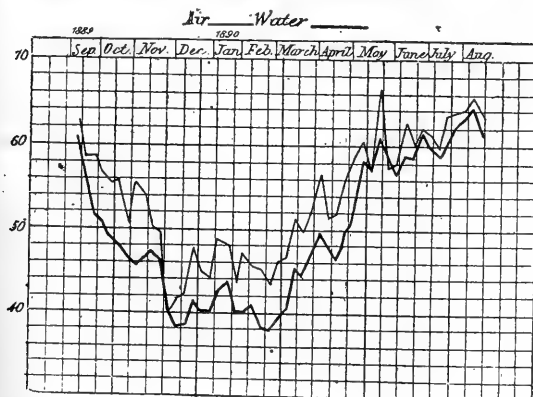

were taken daily, with some exceptions, at or near noon. Those for the Dee were taken at Tongland by Rev. William I. Gordon, for the most part also daily, about 12.30 P.M. The following table shows the monthly means both for air and water during that period at each station:—

	NITH			DEE	
	Air	Water	—	Air	Water
1890					
September . . .	61·0	55·6	{ Wind, W. and S.W. Rainfall, average.	63·1	59·4
October . . .	52·2	48·3	{ Mostly W., S.W., and N.W. Rainfall, under average.	55·4	49·5
November . . .	44·3	42·3	{ Wind, S.E., S.W., and N.W. Rainfall, 8·23 inches.	47·7	43·9
December . . .	36·0	36·5	{ Wind, N. and E. Very dry and cold.	39·6	36·9
1891					
January . . .	39·0	35·0	{ Wind, N.W. and S.W. Rainfall, under average.	41·2	34·7
February . . .	44·2	40·0	{ Mostly W., S.W., and N.W. Rainfall, 0·23 inch—fine.	46·0	41·1
March . . .	42·5	39·0	{ Mostly N., N.E., and N.W. Rainfall, under average.	44·3	40·2
April . . .	47·8	43·5	{ Mostly E. and N.E. Rainfall, under average.	48·4	44·7
May . . .	52·0	50·2	{ Mostly E., N.E., and N.W. Rainfall, nearly average.	56·2	53·1
June . . .	63·5	60·1	{ Mostly N.E. and S.W. Rainfall, under average.	67·2	64·3
July . . .	62·6	61·5	{ Mostly S.W., N.W., and W. Rainfall, half average.	65·1	64·2
August . . .	59·2	56·5	{ Mostly S.W. and N.E. Rainfall, double average.	61·0	60·0

Means for Year.

NITH			DEE		
Air	Water	Excess of Air above Water	Air	Water	Excess of Air above Water
50·3	47·4	2·9	52·9	49·3	3·6

In the autumn quarter (September, October, and November) the difference of temperature between the air and water was, for the Nith 3°·8; Dee 4°·5. Winter quarter (December, January, and February), Nith 2°·5; Dee 4°·7. Spring quarter (March, April, and May), Nith 3°·2; Dee 3°·6. Summer quarter (June, July, and August), Nith 2°·4; Dee 1°·6. Though as a rule the temperature of the air was higher than that of the water, there were many single days on which an opposite state of things occurred, and these were chiefly in the winter and summer quarters. In the month of December, for example, when dull and foggy weather prevailed, with cold northerly winds, or when severe frost was experienced, there were twelve days on which the temperature of the water was in excess of that of the air, the accumulated excess amounting to over 40°, and ranging from 0°·3 to 6°·6. In the month of July again there were ten days which showed a similar result, the accumulated

excess amounting to $13^{\circ}6$, and ranging from $0^{\circ}1$ to $3^{\circ}6$. The maxima of difference were, as regards the Nith, in September and April—September $5^{\circ}4$, April $4^{\circ}3$. But in the case of the Dee they occurred in October $5^{\circ}9$, and January $6^{\circ}5$. The minima occurred, for Nith, in December, $0^{\circ}5$ (water higher than air), and July $1^{\circ}1$ (water lower); for Dee, July $0^{\circ}9$ (air higher than water), August 1° .

The extreme range of temperature at Dumfries (hour of observation being about noon) was: air, highest on June 23, $75^{\circ}6$; lowest on December 13, $27^{\circ}7$; range, $47^{\circ}9$. Water, highest on June 22, 68° ; lowest on January 5, $33^{\circ}1$; range, $34^{\circ}9$.

CURVE VII.—Little Ross Lighthouse, Solway Firth. 10 A.M.

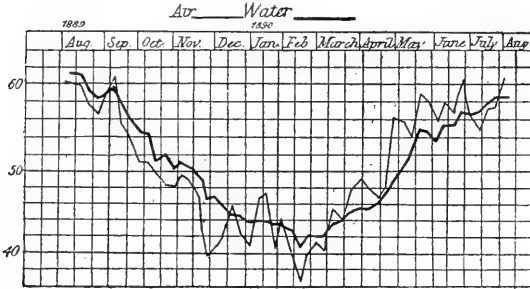

THE STOUR, CANTERBURY.

Colonel Horsley, R.E., has taken a great interest in the observations on the Stour at Canterbury. His reports on the work done are followed by the monthly means calculated from the weekly means which are shown in Curve No. VIII.

Notes on Temperature of Air and Water on the Stour at Canterbury during 1889, by Colonel W. H. HORSLEY, R.E., under the auspices of the East Kent Natural History Society, December 1888—May 1889.

With the view of giving effect to the intentions of the Committee, the Committee of the East Kent Natural History Society appointed a sub-committee to carry out the observations on river-temperature. They were fortunate in securing the willing services of an Associate of their Society, Mr. Henry Dean, of 35 St. Peter's Street, Canterbury, by whom the observations now reported on were made.

The observations commenced on December 13, 1888, and have been continued day by day to the present time (May 15), a period of five months.

The river in which the observations are taken is the western branch of the Stour, which flows through Canterbury and empties itself into the sea at Pegwell Bay, near Sandwich, about 15 miles distant. The depth of water is about 2 feet in the ordinary state of the river, increasing to 3 feet or more when the river is in flood. The direction of the stream is from south-west to north-east. The banks are low, and shaded with trees.

In accordance with the directions received from the Secretary of the Committee, the observations were taken at 9 A.M. regularly day by day, always at the same place, and within five minutes walk from Mr. H.

Dean's house. Remarks on 'State of River and Weather' are entered in the observing book at the same time. The following are some of the results noticed.

In December, as a general rule, the temperature of the water is higher than that of the air, but there are exceptions, *e.g.*, on December 19 the temperature of air and water was nearly the same, viz., 43° , the wind at the time was W.S.W., and the weather clear and fine. It was the same on December 24. The greatest difference in the temperature of air and water was on the 25th, when that of the air was 35° , and of the water $44^{\circ}3$. On January 1, 1889, the difference is more remarkable, viz., air $30^{\circ}6$, water 40° , and the same was the case on the day following, viz., air 29° , water $38^{\circ}5$, with the wind N.E. and weather fine.

A sudden rise of temperature occurred on January 8, when that of the air was $39^{\circ}8$, and of the water $38^{\circ}2$, somewhat colder than the air, the wind S. and the weather fine. The same was the case the day following, viz., air 45° , water $41^{\circ}5$.

As a rule the temperature of the water does not increase so rapidly as that of the air. On May 5, for instance, the air was 69° and the water $57^{\circ}2$, the same on May 9, viz., air 62° , water 57° .

In February, with snow on the ground, the temperature of the air varied from $25^{\circ}8$ to $34^{\circ}8$, and that of the water from $34^{\circ}6$ to $39^{\circ}5$, the wind at the time being E. to N.E.

Speaking generally, it is observed that with the wind S. or S.W., and rain falling, the temperature of air and water differs by only one or two degrees.

Notes on Temperatures of Air and Water at Canterbury, from May 1889 to December 1889. By Colonel W. H. HORSLEY, R.E.

The previous set of notes refers to observations taken up to May 15, 1889. In the same month the temperature of the air rose considerably, the highest being on the 29th, when it was $69^{\circ}8$, while that of water was only 60° , the wind being S.W. and weather fine. Towards the end of May the temperature of air and water once more approximated.

On June 2 there was a sudden and considerable rise in the air-temperature, but only a moderate rise in that of the water, the difference between them being 14° , with the wind as above; this again showing that the water-temperature rises slower than that of the air.

On June 10, with a N.N.E. gale blowing, the temperature of the air fell to 53° , while that of the water was $55^{\circ}2$. As a general rule throughout this month the water-temperature was below that of the air. The last-mentioned is in fact the only instance to the contrary.

On June 20 the thermometer in use was accidentally broken, and considerable delay ensued in procuring a new one of similar construction. An ordinary instrument was, in the interval, supplied to Mr. Dean, and with it the observations were taken and recorded until September 19. The readings of this instrument, and that supplied subsequently from Edinburgh, were found to agree very fairly, and the results of the observations taken during the interval show, as might have been expected, that the air-temperature is above that of water throughout the summer months, June, July, and August. There was only one exception, viz., on August 23, when the air was one degree colder than the water, with the wind in the N.W. and weather fine. A similar exception to the general rule occurred on September 16, the air being 53° and the water 55° , with

the wind also in the N.W. Again on September 17, with the wind S.E. and weather fine, the air was one degree colder than the water.

From September 20 to the end of December the new thermometer was in use, and it is observable that from that date to October 7 the temperature of air and water approximated very nearly, the water as a rule being the colder of the two. From October 9, however, there are several exceptions to this rule, notably on the 13th and 14th, when the water-temperature was 4° higher than that of the air, the latter having fallen suddenly some 6° in two days, and the water only 2° during the same interval. The same was the case on October 25, with the wind N.N.W. and the weather fine. In November and December the fluctuations in the relative temperatures of air and water were frequent, but, speaking generally, the water-temperature was higher than that of the air—the greatest difference between them being on December 29, on which date the air registered $26^{\circ}5$, and the water $40^{\circ}3$, a difference of $13^{\circ}8$. This is the coldest day recorded, with the wind S.W. and weather fine.

In conclusion it should be mentioned that the prevailing direction of the wind in Canterbury and neighbourhood for the greater part of the year is from the S.W., veering to W. and N.W. In the spring of the year it is from the E., veering to E.N.E. and N.E. At such period the temperature of the air is invariably colder than that of the water, the atmosphere very dry, and plenty of dust flying about. At other seasons of the year when the wind is from the S. and S.W. the reverse is the case, *i.e.*, the water is the colder of the two. The highest air-temperature recorded in these observations was on June 7, *viz.*, 74° , while the water-temperature on the same date was 62° .

Notes on the Temperature of Air and Water as taken at the River Stour, Canterbury, during 1890. By Colonel W. H. HORSLEY, R.E.

In the report for 1889 it was stated that in the months of November and December the fluctuations in the relative temperatures of air and water were frequent, but speaking generally, the water-temperature was higher than that of the air. The same remark applies to the observations taken in January 1890, though there are some remarkable exceptions, showing that the temperature of water is not influenced so quickly as that of the air. For instance, the temperature of the air, which had averaged 39° in the first five days of January, suddenly rose on the 6th to $51^{\circ}3$, while that of the water, which had been 44° on the 5th, only rose $1^{\circ}6$ on the 6th of the same month. The same was the case on January 12—air 51° , water 48° , with wind S.W. and W. And again, on the 16th and 19th, air $50^{\circ}3$, water $47^{\circ}5$, on the last-mentioned date. Another remarkable instance is reported on January 25, *viz.*, air-temperature 54° , and that of water $44^{\circ}5$, difference $9^{\circ}5$, that of air having risen suddenly from 37° on the 24th to 54° on the 25th, while that of the water had only risen $2^{\circ}5$ in the same interval. The weather throughout January was unusually mild, the wind for the most part S.W. with occasional rain.

In February the temperature of the water was, with one exception, higher than that of the air. The exception occurred on the 13th, the temperature of the air rising suddenly from 31° to 45° , while that of the water rose only 1° , *viz.*, from 39° to 40° .

In March there was a remarkably sudden fall in the temperature of the air, *viz.*, from 29° on the 3rd to 14° on the 4th. The frost on that

day was the severest that had been experienced in the memory of 'the oldest inhabitant,' and told hard on water-pipes and shrubs. On the same dates the temperature of the river Stour was 37° and 36° , a difference of 1° only, while that of the air was 15° . The severe frost, it will be observed, did not last long, for on the following morning, the 5th, the temperature of the air rose to $38^{\circ}\cdot3$, and that of water was 38° , or only 2° higher than it was on the 4th. Further instances of the rapid rise in the air-temperature as compared with that of the water are observable in the observations taken on March 6, 7, and 8, and again on the 9th a rapid fall in the air occurred, and little or none in the water-temperature. Wind N.W. and weather fine.

Observations were omitted in April, May, and June, as the observer was not furnished with a book to enter them in.

In the month of July the temperature of the air usually exceeded that of the water, as it might be expected it would. The highest air-temperature was 71° on the 17th, when the water was 62° , difference 9° . The lowest air-temperature was 55° on the 11th, and that of water on the same date 57° , difference 2° . Wind generally westerly, veering to N.W. and S.W., with occasional showers but generally fine.

The same rule, as respects the relative temperatures of air and water, applies to the observations taken in August and September, the water being invariably colder, though not more than 6° or 7° difference, and often less, especially towards the end of each month.

In October a change is observable, the water being frequently the warmer of the two, notably on the 22nd and 28th, when the difference was 9° and 10° in favour of the water, with a cold easterly wind on the former date, and N.W. on the latter.

A further instance of the sudden rise in the air-temperature, as compared with that of the water, is seen by comparing the observations taken on October 28 and 29. A warm S.W. wind caused the air-temperature to rise 10° , while that of the water remained the same on both days.

The same remarks are applicable to the month of November, the water-temperature being usually the higher of the two. The exceptions occurred on the 13th, 15th, and 23rd. On each of these dates there was a sudden rise of air-temperature, and no corresponding rise in that of water. The wind S.W. and weather dull and wet. The lowest air-temperature in this month was on the 30th, viz., $22^{\circ}\cdot5$, the water being 38° , difference $15^{\circ}\cdot5$.

December 1890 was an unusually cold month, the thermometer standing at or below freezing point for twenty out of thirty-one days. It opened with a temperature of $17^{\circ}\cdot5$ on the first, on which date the water was 37° , or $19^{\circ}\cdot5$ warmer than the air. This state of things did not last long, for on the 4th the temperature of the air was $4^{\circ}\cdot5$ higher than that of the water. As a rule, however, the water-temperature was higher than that of the air throughout the month. The Stour being a running stream, the surface was not frozen even with the air-temperature at 18° . On the contrary, the water-temperature on these days, viz., 13th and 14th, is recorded to have been 36° and 37° , that is, 18° and 19° warmer than the air. The wind for the most part of the month was from the cold quarter, viz., E. and N.E. A fall of snow occurred on the 19th with the wind at E.S.E., and again on the 27th. The weather throughout the month was dull and cold.

It only remains to state that the observations referred to in this paper

were taken at the same place and time, and by the same person, Mr. Henry Dean, as those of the previous year.

CURVE VIIIa.—Stour, Canterbury. 9 A.M.

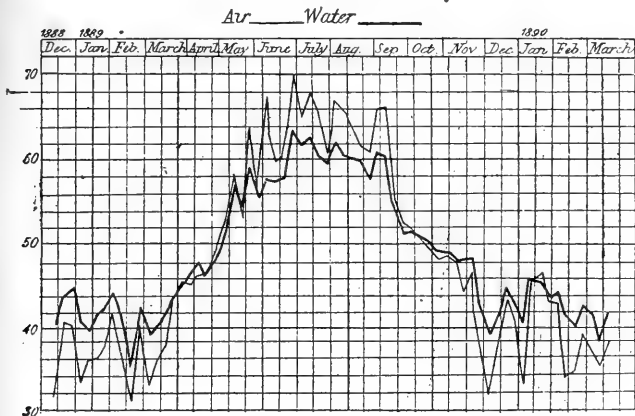

Monthly Mean Temperature of Stour at Canterbury.

Month	Year	Air	Water	Weather and General Direction of Wind
December	1888	37·8	42·8	Changeable; some fog.
January	1889	35·1	41·8	E. and W.; changeable.
February	"	35·5	39·7	W. wind; fine; some snow and rain.
March	"	40·8	42·8	Changing wind; fine; some rain.
April	"	47·0	47·5	Changeable.
May	"	56·8	55·3	S. and W. winds; some rain.
June	"	64·3	59·0	Changeable.
July	"	65·1	61·2	S. and W. winds; fine; some rain.
August	"	62·9	57·6	S.W. wind; some rain.
September	"	57·9	56·7	S.W. and N.W. winds; fine.
October	"	49·7	50·1	S.W. and N. winds.
November	"	44·1	46·8	S. and W. winds; dull.
December	"	38·9	42·0	S.W. wind; fine; some rain.
January	1890	42·5	44·1	S.W. wind; fine; some rain.
February	"	36·7	46·5	N. wind; snow.
March	"	37·3	40·1	N. and W. winds; dull.
—	—	—	—	—
—	—	—	—	—
July	1890	60·9	58·2	W. winds; fine; some rain.
August	"	61·3	57·9	Changeable.
September	"	60·3	56·6	"
October	"	50·8	50·9	W. winds; fine; some rain.
November	"	44·3	45·9	W. winds; some snow.
December	"	28·6	36·2	E. winds; dull fog; snow.
January	1891	32·9	38·5	Changing winds; snow.
February	"	38·2	41·9	W. and E. winds; fine; some fog.
March	"	41·6	42·9	W. and N. winds; some rain.
April	"	46·1	47·6	N. winds; fine.
May	"	59·7	53·7	Changeable.
June	"	61·2	56·2	"
July	"	62·7	58·4	W. winds.

CURVE VIIIb.—Stour, Canterbury. 9 A.M.

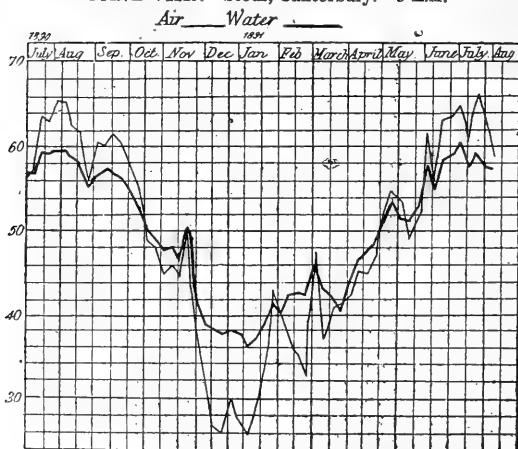

Month	Year	Air	Water	Weather
March	1889	44·3	40·8	Fine; some sun.
April	"	46·3	42·3	Fine.
May	"	51·3	50·7	Fine; some rain and mist.
June	"	59·5	60·3	Cloudy; rain
July	"	58·5	61·6	Cloudy; some rain.
August	"	55·6	55·5	Changeable; generally cloudy; some rain.
September	"	53·9	55·3	Overcast; rain.
October	"	48·3	46·6	Overcast; mist; rain.
November	"	44·5	43·5	Cloudy; some rain and snow.
December	"	39·1	37·5	Rain; snow; a few clear days.
January	1890	41·1	39·7	Some hail, rain, and snow; cloudy.
February	"	37·9	38·7	Overcast; cold.
March	"	45·5	42·2	Fine; cold.
April	"	48·6	46·0	Fine; some snow.
May	"	57·5	50·5	Some rain; cold.
June	"	60·9	56·3	Fine; cloudy; some rain.
July	"	61·0	58·4	Fine; some rain.
August	"	61·4	57·7	Fine; a little rain.
September	"	60·7	55·5	Fine.
October	"	52·6	49·7	Fine; a little rain.
November	"	42·3	41·7	Cold; fog; some rain and snow.
December	"	32·4	35·5	Cold; some fog and rain.
January	1891	34·3	34·0	Cold; snow; rain.
February	"	37·6	37·3	Fine; some fog.
March	"	41·0	38·7	Fine; some snow.
April	"	42·7	41·9	Mostly fine; some rain and snow.
May	"	51·1	49·2	Fine.
June	"	60·5	57·6	Fine.
July	"	62·6	60·3	Fine.

The weekly means from which the above table is calculated are given in Curve No. IX. Mr. Paul's observations are remarkably regular and

CURVE IX.—Nidd, Knaresborough. 9.30 A.M.

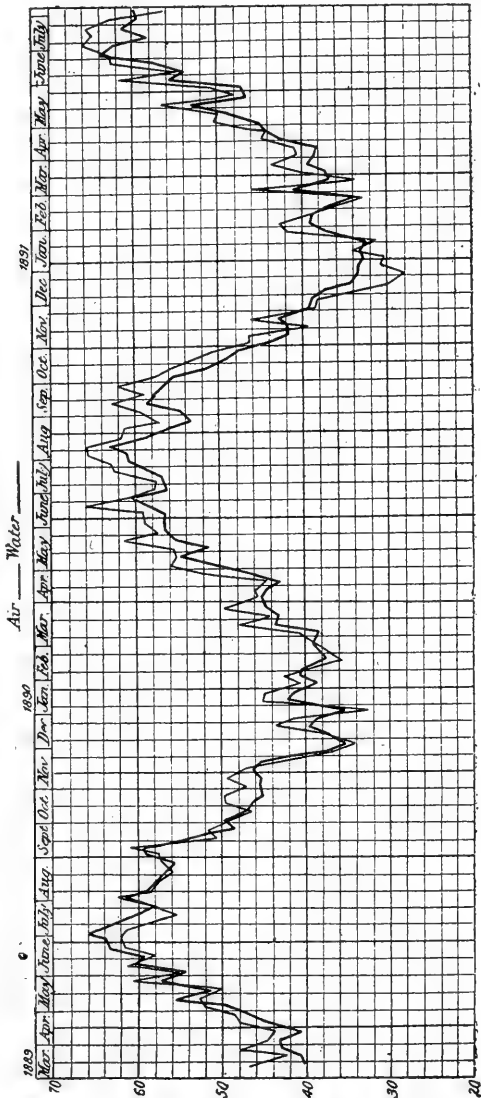

consistently careful. He has reinforced them with some interesting observations on the exceptionally severe winter of 1890-91, which

contain some apparently new observations on the protective character of a sheet of ice against the cooling of water by radiation. The rapid fall of temperature following a thaw is analogous to the effect observed on earth thermometers not far from the surface in like conditions.

Notes on the River Temperatures for the Winter 1890-91 in the Nidd.
By Mr. G. PAUL, *Knaresborough.*

Some very interesting effects were observed during the long period of intense cold. The river was frozen over, but the water under the ice remained at the constant temperature of $34^{\circ}0$ from December 20 to January 2 inclusive. It fell to 33° on thawing on January 3. On January 6 a second period of ice on the water commenced, and during it the temperature under the ice remained at $33^{\circ}0$. Not until the next thaw set in and a third frozen period commenced on February 27, did the temperature of the water under the ice fall to $32^{\circ}0$.

Compared with this the record of earth-temperature at the depth of 1 foot acquires a special interest. An ice-cap was formed on the ground on December 21 and remained until January 21. During this entire month the temperature at the depth of 1 foot scarcely varied. On December 20, before the severe cold set in, the temperature at that depth was $37^{\circ}4$, on the 21st it fell to $36^{\circ}5$, next day to $36^{\circ}4$, and until January 4 its range was only between $36^{\circ}4$ and $36^{\circ}3$. From January 2 to 17 the temperature at 1 foot was $36^{\circ}3$ or $36^{\circ}2$; on the 18th it fell to $36^{\circ}0$, and on that day the grass thermometer registered only $3^{\circ}8$, the minimum temperature of the winter. On January 20 the 1-foot earth thermometer registered $36^{\circ}4$, but on the 21st it fell to $35^{\circ}5$, coincident with a rise of air-temperature and a general thaw. Next day the temperature at 1 foot had risen to $36^{\circ}2$; and did not again fall below this value.

The rest of the observations are given in the form of tabulated monthly means and of curves expressing the weekly means. Had time and other circumstances permitted, many or all of these sets of observations would have been fully discussed, but the mere record suggests many interesting relations as to the period of maximum and minimum temperature, the manner in which water-temperature follows air-temperature, and the effect of situation in latitude and altitude on the rate and amount of monthly change.

BRISTOL CHANNEL AND TAFF.

The Cardiff Naturalists' Society arranged for three sets of observations from February 1889 to July 1891. One was taken by Mr. Pettigrew in the Cardiff Castle Gardens on the Dock Feeder, a large stream diverted from the Taff. This set of observations (Curve XII.) shows the water-temperature to be always higher than that of the air. This is the only case in which this relation, so clearly shown in the Cherwell observations, was distinctly seen in another river.

The Breaksea Lightship is anchored in the Bristol Channel about the centre, south of Barry Island. Observations were made on it daily at 9 A.M. by Mr. J. Walters and Mr. J. R. Johnson. The record (Curve X.) shows that while the temperature is rising, from February to July, the water is colder than the air; but when the temperature is falling, from

July or August to February, the water remains warmer than the air. This relation holds good for almost all observations made on the sea or

CURVE X.—Breaksea Lightship, Bristol Channel (off Barry). 9 A.M.

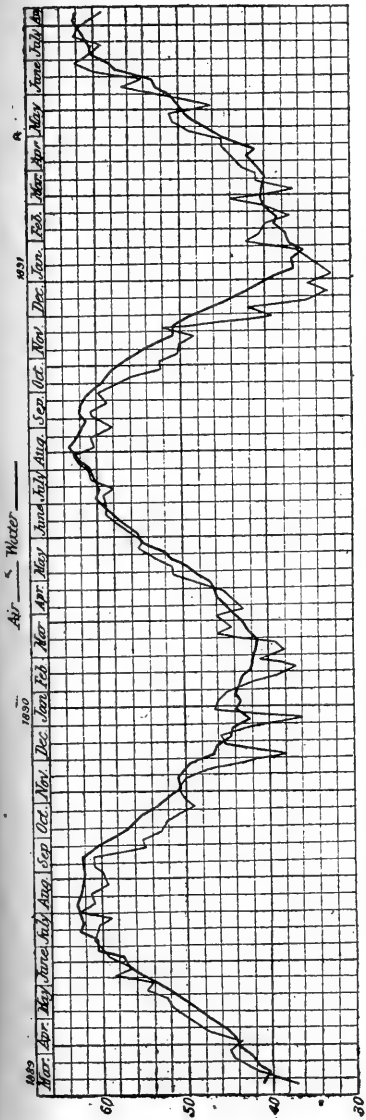

CURVE XI.—English and Welsh Grounds Lightship, Bristol Channel (off Newport). 9 A.M.

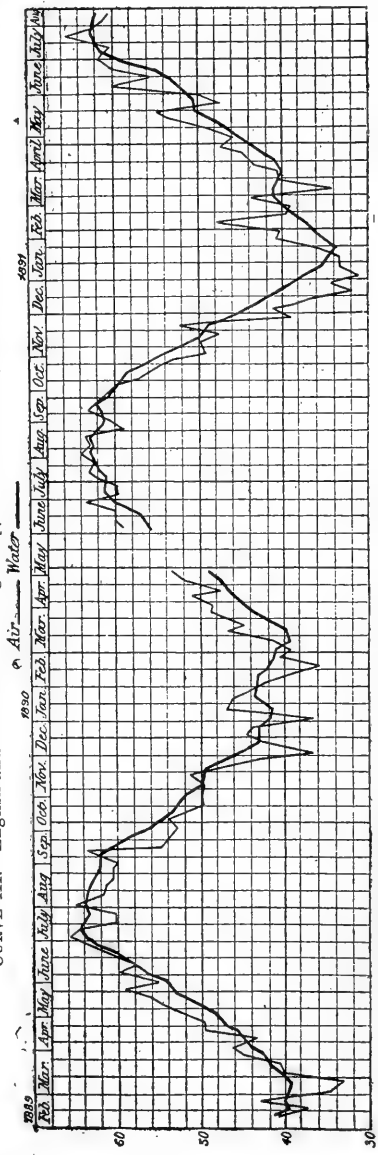

large bodies of water, and is very well brought out in the reservoirs of the Pennine district (Curves I. to IV.).

CURVE XII.—Taff, Cardiff Castle Gardens. 9 A.M.

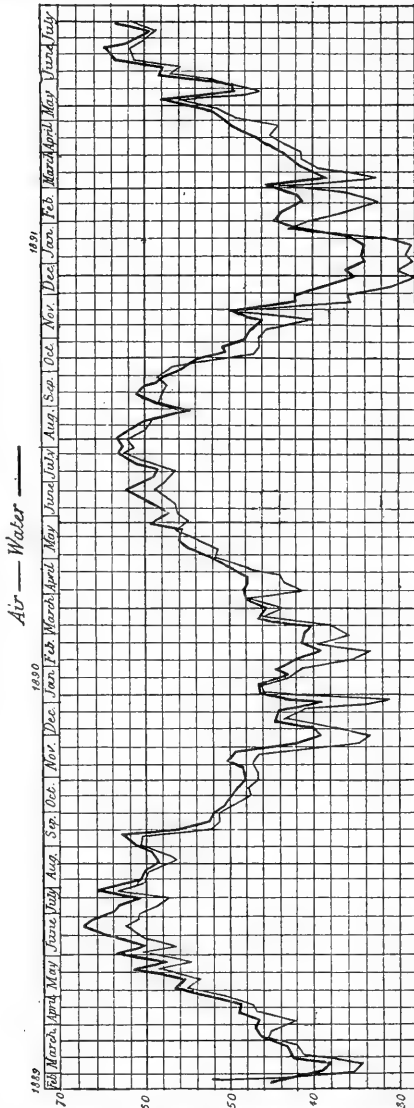

|| The English and Welsh Grounds Lightship is anchored nearly in mid-channel off Newport, the depth being $5\frac{1}{2}$ fathoms at low water, and 12

fathoms at high water. Observations were taken by Mr. J. Pain and Mr. J. Bartlett. They show (see Curve XI.) the same general features as those at Breaksea, but the seasonal interchange of position in the air and water curves is not quite so clearly marked. The tidal effects must be important, judging from the result of calculations on observations made at the Scottish lightships; but it was impossible to carry out the laborious reductions in time for this report. These three sets of observations were taken with great care and regularity.

Monthly Means of Temperature Observations.

Month	Year	Breaksea Lightship		English and Welsh Grounds Lightship		Taff, Cardiff Castle Gardens	
		Air	Water	Air	Water	Air	Water
February . . .	1889	—	—	39·9	39·9	—	—
March . . .	"	41·5	41·7	38·5	40·1	39·9	42·2
April . . .	"	46·4	45·1	46·9	45·0	45·5	48·0
May . . .	"	52·7	50·3	54·9	50·6	54·7	56·2
June . . .	"	58·0	57·0	59·3	57·8	59·0	52·4
July . . .	"	60·6	62·3	62·5	63·6	59·9	63·4
August . . .	"	60·8	62·7	61·6	62·8	59·6	60·7
September . . .	"	56·5	61·3	57·7	60·7	56·1	58·4
October . . .	"	51·3	55·5	51·7	54·0	49·0	50·4
November . . .	"	48·7	50·9	48·3	49·6	44·6	47·9
December . . .	"	45·5	45·6	41·4	43·4	39·4	42·3
January . . .	1890	44·1	43·7	43·2	42·3	41·8	43·8
February . . .	"	40·4	42·9	39·5	42·2	37·6	41·9
March . . .	"	43·2	42·5	45·2	40·9	42·6	44·7
April . . .	"	45·5	46·1	49·6	46·3	44·6	48·8
May . . .	"	53·4	51·5	—	—	53·9	55·8
June . . .	"	58·1	57·6	60·5	57·7	57·4	59·8
July . . .	"	60·0	60·4	61·2	61·3	59·2	60·5
August . . .	"	61·2	62·9	62·4	62·6	59·5	60·5
September . . .	"	60·1	61·8	61·9	61·6	58·2	59·6
October . . .	"	55·0	57·1	56·6	58·7	50·9	52·9
November . . .	"	48·1	52·0	47·9	49·2	43·8	47·1
December . . .	"	36·3	43·7	36·5	41·9	31·7	38·4
January . . .	1891	36·0	37·1	35·1	35·6	32·9	38·6
February . . .	"	39·5	38·8	41·9	38·7	36·7	43·2
March . . .	"	40·8	40·4	39·9	40·6	39·9	42·2
April . . .	"	44·2	42·5	45·4	42·9	43·9	47·1
May . . .	"	49·6	49·0	50·9	49·3	50·7	52·5
June . . .	"	58·4	55·5	59·2	55·0	59·3	61·4
July . . .	"	61·4	61·0	62·5	62·1	60·3	61·2

SEVERN.

Observations were made on the Severn at Stourport by Mr. Edward Collens from March 1889 to May 1890. The observations were made daily at 10 A.M. at a point on the east bank of the Severn, about 100 yards above the entrance of the Stour. A minimum depth of water is retained in the river by a weir about a mile below the point of observation. At Stourport the Severn is rather less than 50 feet above sea level, and it is 75 miles from Chepstow, where the river may be supposed to meet the sea. The observations (Curve XIII.) show that the temperature of the water was almost always below that of the air, taking weekly

means of both, although occasionally they approach very closely. This greater cold of the water was observable in nearly all the rivers on which observations were taken, and on some was more marked than in the case of the Severn. The river-temperature followed the air-temperature closely at all seasons.

Monthly Means of Temperature Observations on the Severn at Stourport.

Month	Year	Air	Water	Weather and General Direction of Wind
March	1889	48·9	47·0	W. wind; stormy.
April	"	47·1	45·9	N. winds; wet; dull.
May	"	56·7	55·5	S. winds; thunder-storms.
June	"	63·5	63·7	S. and E. winds; fine.
July	"	66·0	64·1	Changing winds; fine; cloudy.
August	"	61·7	61·4	W. winds; fine; mists.
September	"	59·8	58·7	N., S., and W. winds; fine; some rain.
October	"	50·4	48·6	Changing winds; overcast.
November	"	46·3	45·6	W., S., and E. winds; fine; some frost.
December	"	39·5	39·6	S. winds; dull; some frost and snow.
January	1890	42·4	41·0	S. winds; fine; some rain.
February	"	38·0	39·0	N. and E. winds; dull; stormy; snow.
March	"	47·1	43·0	N. and W. winds; changeable: slight frosts.
April	"	49·2	47·9	Changing winds; damp.
May	"	57·4	58·2	E. winds; fine; overcast.

CURVE XIII.—Severn, Stourport. 9 A.M.

CURVE XIV.—Lugg, Aymestry, 9 or 10 A.M.

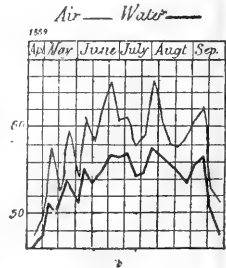
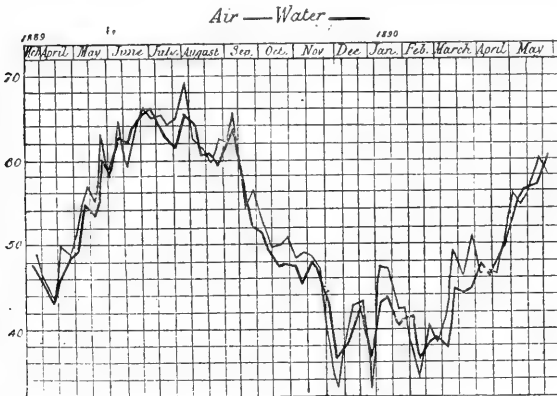

LUGG.

Observations on the Lugg were made by Mr. A. Ward from April to September 1889, at Aymestry, in the north of Herefordshire. The temperature of the water was always considerably below that of the air, but the period of observation was too short to bring out any important relations (see Curve XIV.).

Monthly Means of Temperature Observations on the Lugg at Aymestry.

Month	Year	Air	Water	Weather
April	1889	47·5	46·0	W. winds; some rain.
May	"	54·7	50·5	S. and N. winds; storms.
June	"	61·5	54·9	N.E. wind; haze.
July	"	60·4	55·6	W. winds; fine; some rain.
August	"	57·0	54·7	S. and W. winds; some rain.
September	"	55·2	52·0	N.W. winds; fine.

KENNET.

Observations on the Kennet at Marlborough were made by Mr. W. B. Maurice and Mr. H. G. Maurice, acting for the Marlborough College Natural History Society. The stream at the point of observation was about 6 or 7 feet deep and about 24 feet in breadth, about 10 miles from its source, and nearly 40 miles from its junction with the Thames. The depth of water varied considerably on account of a weir about quarter of mile down stream erected to supply a mill, and when the mill was not at work the level was allowed to fall very low.

The observations, shown in Curve XV., are remarkable in showing a very much less range of temperature in water than air. While the weekly means of air-temperature ranged from 30° to 70°, those of water-temperature were confined between 40° and 55°. The river was always cooler than the air in summer and warmer than the air in winter, being at the same temperature in April and October. The record is unfortunately somewhat irregular, but the main facts of annual change of temperature are sufficiently outlined by it.

Monthly Means of Temperature Observations on the Kennet at Marlborough.

Month	Year	Air	Water	Weather
December	1888	37·8	44·5	Changing winds; frost; fog.
January	1889	36·6	42·2	W. winds; snow; frost.
February	"	37·4	41·8	W. and E. winds; snow.
March	"	43·3	44·5	W. winds; rain.
April	"	46·1	47·4	W. and E. winds; rain; overcast.
May	"	58·4	51·3	Changing winds; some fog, rain and thunder.
June	"	63·3	54·3	Changing winds; bright.
July	"	63·0	54·2	W. and E. winds; rain.
August	"	61·5	52·8	W. winds; rain.
September	"	57·6	51·7	W. winds; some frost and rain.
October	"	48·1	48·3	W. and E. winds; rain.
November	"	45·4	47·0	" " frost.
December	"	38·7	43·5	E. winds; frost; fog.
January	1890	41·2	44·1	W. winds; rain.
February	"	35·4	42·3	E. winds; fog; rain; frost.
March	"	46·0	44·9	N. and W. winds.
April	"	47·6	47·3	E. winds; cloudy; rain.
May	"	—	—	—
June	"	—	—	—
July	"	63·6	55·5	E. and W. winds; cloudy.

CURVE XV.—Kennet, Marlborough. 9 A.M.

Air— Water —

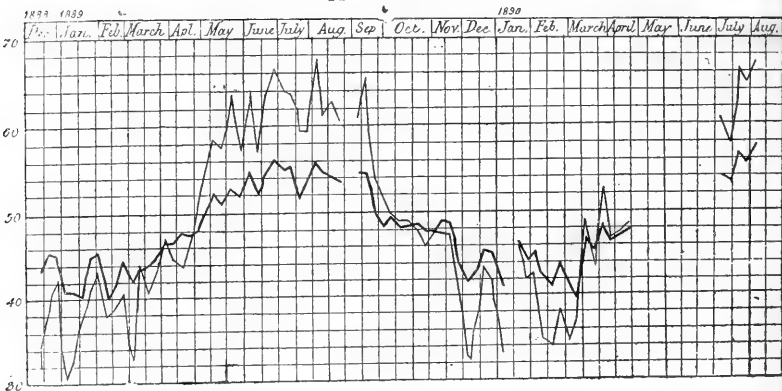

TRENT.

Observations were made from January 1889 to January 1890, and from September 1890 to July 1891, by Mr. Frank E. Lott, acting for the Burton-on-Trent Natural History Society. The temperature was observed on the right bank of the main stream, immediately below Burton Bridge, and the depth by a flood gauge on the other branch of the river was read at the same time, usually about 9.30 A.M.

CURVE XVIa.—Trent, Burton. 9.30 A.M.

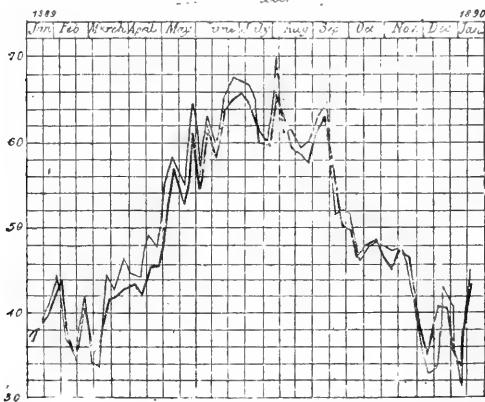

The Curves XVIa. and XVIb. show that water- and air-temperature kept very close together, and had almost an equal range, in complete contrast to the Kennet. On the whole, the air was warmer while the

temperature was rising for the season, and the water remained warmer when the temperature was falling for the season. This effect was not, however, nearly so pronounced as in the reservoirs and the sea or estuary observations.

CURVE XVIb.—Trent, Burton. 9.30 A.M.

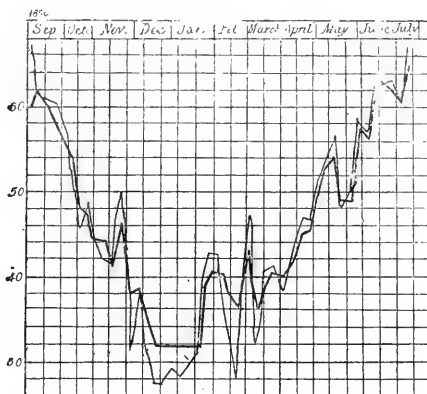

Monthly Means of Temperature Observations on the Trent at Burton-on-Trent.

Month	Year	Air	Water	Weather and General Direction of Wind
January	1889	40·4	40·0	Changeable winds; cloudy; flood gauge, ¹ 42 ft. 7 in.
February	„	37·1	36·8	W. winds; overcast; flood gauge. 42 ft. 9 in.
March	„	41·7	40·5	E. and N. winds; fine; dull; flood gauge. 43 ft. 6 in.
April	„	46·5	44·1	N. winds; dull; flood gauge, 43 ft. 6 in.
May	„	57·9	55·1	N. and E. winds; some fog and rain; fine; flood gauge, 43 ft. 1 in.
June	„	63·8	62·5	Changing winds; fine; some rain; flood gauge, 42 ft. 1 in.
July	„	64·6	63·3	N., S., and W. winds; fine; dull; some thunder; flood gauge, 41 ft. 11 in.
August	„	60·4	59·6	W. winds; fine; some fog; flood gauge, 42 ft. 1 in.
September	„	57·7	57·7	N. winds; cloudy; flood gauge, 42 ft. 2 in.
October	„	48·1	47·7	S. and N.E. winds; dull; fog; flood gauge, 42 ft. 6 in.
November	„	44·8	44·3	Changing winds; dull; fog; flood gauge, 42 ft. 3 in.
December	„	36·0	37·3	S.W. winds; fog; some snow; flood gauge, 43 ft. 2 in.
January	1890	45·5	43·9	S.W. winds; changeable; flood gauge, 42 ft.
—	—	—	—	—
September	„	62·6	59·7	S.W. and N.W. winds; dull; frequent fog; flood gauge, 41 ft. 8 in.

¹ Flood gauge average height 41 ft. 10 in.

MONTHLY MEANS OF TEMPERATURE OBSERVATIONS—*continued.*

Month	Year	Air	Water	Weather and General Direction of Wind
October	1890	50·8	51·4	S.W. mainly; dull; flood gauge, river too low to read.
November	"	41·6	42·9	S.W. in beginning, N.N.E. winds end of month; dull; flood gauge, 43 ft. 7 in.
December	"	31·1	34·5	E. and N.E. winds; fog; snow; river frozen latter half; flood gauge, 41 ft. 10 in.
January	1891	32·2	33·4	N. winds; fine; river frozen first half; S.W. winds later; flood gauge, 42 ft. 5 in.
February	"	35·3	38·8	N. and N.E. winds; dull; flood gauge, 42 ft. 4 in.
March	"	40·4	39·7	N. winds; fine; flood gauge, 41 ft. 11 in.
April	"	43·4	42·9	N.E. winds; fine; flood gauge, 42 ft. 3 in.
May	"	52·1	51·1	N.W. winds; fine; flood gauge, 42 ft. 4 in.
June	"	60·7	59·8	S.W. wind; dull; flood gauge, 42 ft.
July	"	63·8	62·6	N.W. wind; flood gauge, 42 ft. 1 in.

DOVE.

Observations were made from March to November 1889 by Mr. H. H. Brindley at a point on the right bank of the Dove $1\frac{1}{2}$ miles east of Uttoxeter and about 14 miles from the junction of the river with the Trent. At the place of observation the river runs through a flat meadow, and the banks are low, but an adjacent railway embankment shelters it from southerly and south-westerly winds. The stream is liable to sudden floods, but rapidly regains its normal size. Curve XVII. reproduces the weekly means, and, as far as its fragmentary nature allows one to judge, it appears to closely resemble that for the Trent.

CURVE XVII.—Dove, Uttoxeter. 9 or 10 A.M.

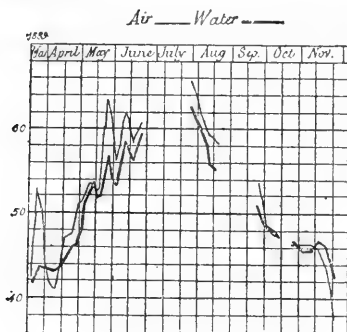
*Monthly Means of Temperature Observations on the Dove near Uttoxeter.*

Month	Year	Air	Water	Weather
March	1889	47·3	42·7	Changeable.
April	"	44·7	44·6	N. and E. winds; hail; rain; thunder.
May	"	55·6	53·0	E. winds; fair.
June	"	60·3	57·9	E. winds.
July	"	65·5	62·5	E. and S.W. winds; some rain.
August	"	59·8	57·3	W. winds; rain.
September	"	54·8	50·7	W. winds.
October	"	47·6	47·7	Changeable; rain.
November	"	43·8	45·3	Calm; misty; rain and snow.

WITHAM.

Mr. Henry Preston carried on a set of observations from April 1889

CURVE XVIII.—Witham, Saltersford Pumping Station, Grantham. 9 A.M.

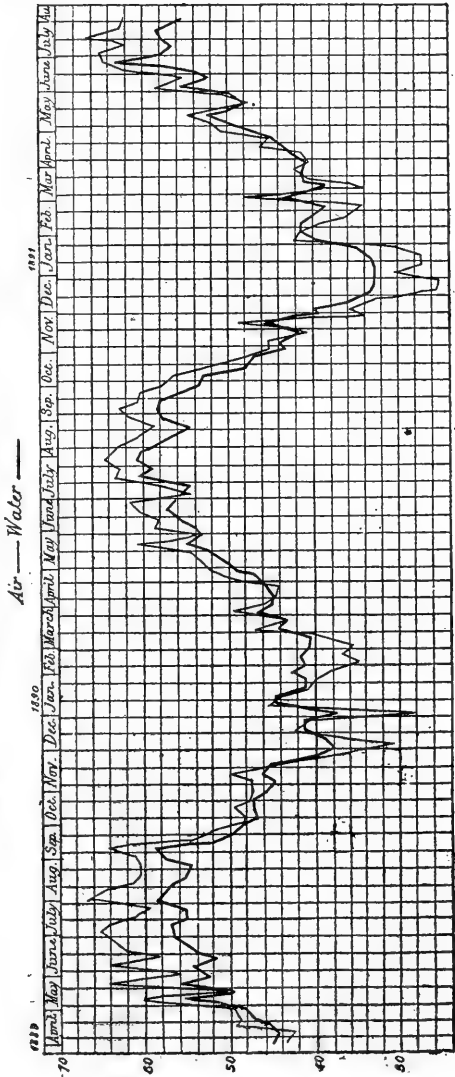

to July 1891 for the Grantham Scientific Society at the Saltersford Pumping Station of the Grantham Waterworks.

The result of this set of observations is shown in Curve XVIII, which is a particularly valuable one on account of its length and regularity. The range of water-temperature is markedly less than that of air-temperature, although not to such a striking degree as in the case of the Kennet. The interesting feature of this curve is, however, that at all temperatures above the annual mean for water and air the water remains cooler and there is only a scarcely appreciable approach of the two curves at the seasonal fall of temperature, compared with their position during the seasonal rise.

*Monthly Means of Temperature Observations on the Witham at
Saltersford, Grantham.*

Month	Year	Air	Water	Weather and General Direction of Wind
April	1889	45·8	45·5	Changeable.
May	"	56·0	52·0	S. winds; fog; rain.
June	"	61·9	54·0	N. winds; fine; cloudy.
July	"	63·0	56·4	N. and S. winds; overcast.
August	"	61·6	55·9	S. and W. winds; some rain.
September	"	58·0	54·3	Changing winds; fine.
October	"	48·2	47·0	S. winds; fog; dull.
November	"	44·5	44·0	S. and W. winds; some snow.
December	"	37·8	39·7	Changing winds; dull.
January	1890	39·7	41·5	S. winds; fine.
February	"	36·2	41·3	N. and E. winds; some snow and rain.
March	"	44·6	43·4	W. winds; dull.
April	"	47·4	46·3	Changing winds; fine.
May	"	55·4	52·9	W. winds; " " "
June	"	57·6	55·8	W. winds; dull.
July	"	60·6	58·0	W. winds; some rain.
August	"	61·4	55·9	W. winds.
September	"	61·4	57·7	S. and W. winds.
October	"	52·0	48·8	W. winds; some fog.
November	"	42·2	42·4	Changing winds.
December	"	29·7	35·0	" " "
January	1891	34·7	35·2	N. and S. winds.
February	"	37·7	40·1	S. winds; some fog.
March	"	41·4	41·2	N. and W. winds.
April	"	44·8	43·8	Changing winds.
May	"	51·3	50·0	" " "
June	"	60·2	55·3	N. and E. winds.
July	"	63·5	57·3	W. winds.

NORTHAMPTON RESERVOIR.

Mr. G. S. Eunson made observations for the Northampton Natural History Society from January 1889 to March 1890 on a small reservoir supplying water to Northampton. The reservoir stands 360 feet above sea level on a stream near Guilsborough, eight miles N.N.E. of Northampton, close to one of the sources of the river Nene. The observations made are shown in Curve XIX., the chief features of which resemble those of the Grantham curve, although they are not so pronounced.

Small Reservoir. Northampton. G. S. EUNSON, Observer.

Month	Year	Air	Water	Month	Year	Air	Water
January . . .	1889	37·4	38·7	September . . .	1889	55·5	54·9
February . . .	"	36·0	37·4	October . . .	"	48·2	47·1
March . . .	"	41·2	40·6	November . . .	"	44·1	44·9
April . . .	"	45·1	43·0	December . . .	"	37·4	39·6
May . . .	"	55·6	52·0	January . . .	1890	41·0	40·9
June . . .	"	61·4	56·0	February . . .	"	37·0	39·6
July . . .	"	61·6	58·8	March . . .	"	40·6	40·2
August . . .	"	60·3	56·8				

CURVE XIX.—Reservoir, Northampton. 9 A.M.

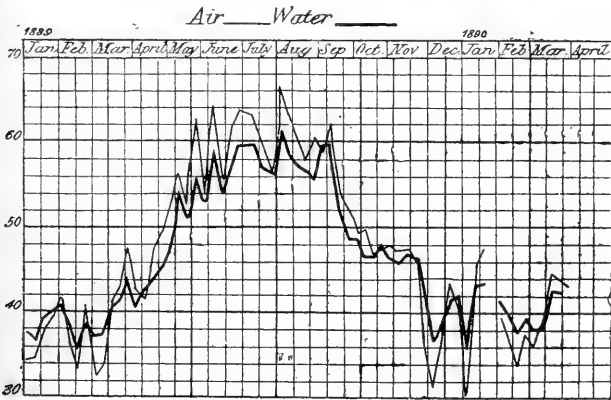

ARAY.

The record extends from August 1888 to July 1891 and is of unbroken regularity. Observations were made daily at noon from August to November 1888 and thereafter at 9 A.M., by Mr. G. Taylor at a point in the grounds of Inveraray Castle about one mile from the entrance of the Aray into Loch Fyne. At the place of observation the river is to a slight extent shaded by trees, but it is a typical Highland stream flowing rapidly from a bare moorland glen and subject to frequent and rapid floods. The Curve No. XX. (see Plate) shows that, as in other rapid rivers, the water is always of lower temperature than the air, and as the winters on the west coast are not severe and the water rarely falls to freezing point, this relation holds good for the weekly means all the year round. Sudden falls of temperature are common in summer after heavy rain on the surrounding hills, and sudden rises of temperature, although not to such a pronounced degree, frequently follow a heavy shower in winter.

Monthly Means of Temperature Observations on the Aray at Inveraray.

Month	Year	Air	Water	Weather
August	1888	61·8	56·5	—
September	”	57·9	53·4	—
October	”	52·1	46·6	—
November	”	47·8	44·3	—
December	”	42·7	41·2	—
January	1889	39·4	38·0	—
February	”	39·5	37·9	—
March	”	41·5	38·2	—
April	”	47·4	43·0	—
May	”	58·4	52·7	—
June	”	62·9	59·3	—
July	”	61·1	57·5	—
August	”	60·7	56·9	—
September	”	55·0	52·5	—
October	”	47·5	45·1	—
November	”	43·9	42·6	Snow; rain.
December	”	42·6	41·2	” ” thunder.
January	1890	40·2	38·7	” ” thunder.
February	”	37·6	36·9	Bright; some snow and rain.
March	”	42·9	39·7	Snow and rain.
April	”	47·0	43·1	Bright.
May	”	58·9	52·9	Bright; some rain.
June	”	62·6	60·2	Rain.
July	”	62·2	59·9	Showery to dry and bright.
August	”	59·5	55·7	Rain.
September	”	55·2	52·6	Changeable.
October	”	45·8	44·4	Some rain, hail, and thunder.
November	”	42·9	42·4	Snow; rain.
December	”	37·8	36·8	Much rain and some snow.
January	1891	37·3	35·7	Showery, with many dry days.
February	”	41·4	40·1	Dry on the whole; showers of rain and sleet.
March	”	40·1	37·4	Showery, with frequent sleet showers.
April	”	45·0	40·5	Dry and bright on the whole.
May	”	53·3	49·3	—
June	”	63·5	60·2	—
July	”	60·6	58·9	—

THURSO.

Curves XXI. and XXII. give the weekly means of observations made by Mr. David Gunn at Thurso, Caithness, near the mouth of the river, and by Mr. John Gunn and Mr. J. B. Johnstone on the same river at Dale about nine miles farther up stream. The detailed observations were made the subject of a communication by Mr. John Gunn to the Scottish Meteorological Society, and they are published in the *Journal* of that Society for 1888. At both stations the temperature of the water is under that of the air for the whole year, even at a time when the river was partially or completely frozen for several weeks. This apparent anomaly, seen also in other curves, is probably due to taking the forenoon or 10 A.M. observations of air-temperature as the basis of the curve, while the minimum night temperature is really the chief factor in determining the chilling and freezing of the water.

thereafter.

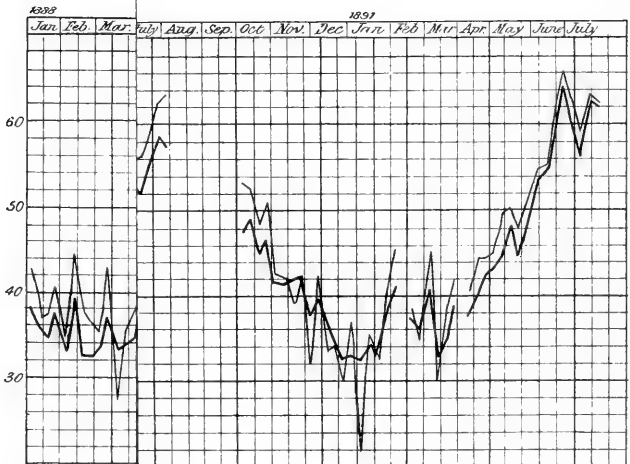
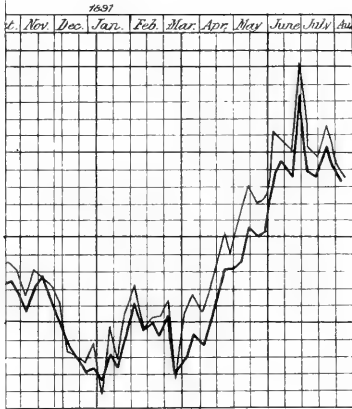

ons of Temperature in Lakes,
om.

Curve XX - Army, Inverary, Anglilshire 12 noon until November 30, 1848, 9 A.M. thereafter

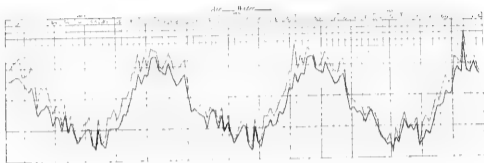

Curve XXIII - Army, Alderney, Pertlabure 9 A.M.

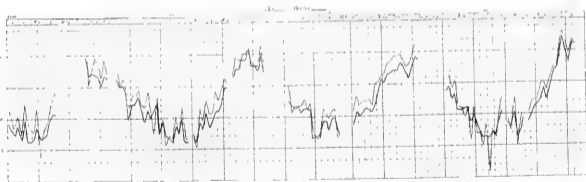

Illustrating the Report of the Committee appointed to investigate the Seasonal Variations of Temperature in Lakes, Rivers, and Estuaries in various parts of the United Kingdom.

CURVE XXI.—Thurso at Thurso. 10 to 10.30 A.M.

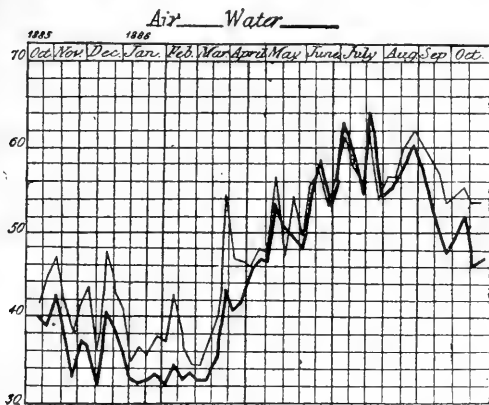

CURVE XXII.—Thurso at Dale. 10 A.M.

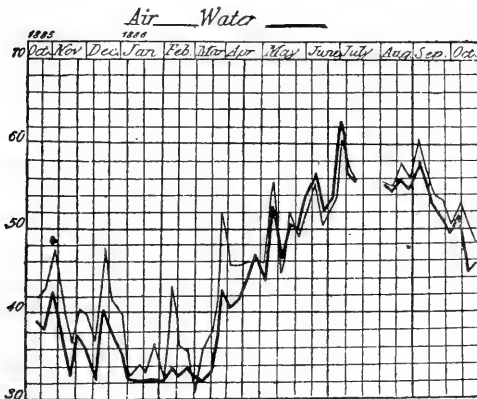

ALMOND.

From January 1888 to July 1891, with a few unavoidable interruptions, Mr. J. Paterson, Almondbank, Perthshire, observed the temperature of the Almond at a point about one and a half mile above the junction of that river with the Tay. The weekly means are given in Curve XXIII. (see Plate), from which it appears that, except in some winter minima, the temperature of the water is always lower than that of the air, although the two come closer together when the seasonal temperature is falling than when it is rising. A noticeable feature in this curve is its very irregular form, and the fact that the fall and rise of temperature from one week to another is often greater for the water than for the air.

This is probably to be accounted for by the chilling effect of rain or snow-fall on the mountain streams which feed the Almond and bring it down in frequent and heavy floods.

Monthly Means of Temperature Observations on the Almond at Almondbank, Perthshire.

Month	Year	Air	Water	Weather
January . . .	1888	39·4	36·7	N. wind; mostly calm; some frost.
February . . .	"	35·8	34·4	W. and E. winds; mostly calm.
March . . .	"	35·7	34·7	Stormy.
April . . .	"	45·5	37·3	N. winds.
May . . .	"	—	—	
June . . .	"	60·5	59·4	E. winds; mostly calm.
July . . .	"	55·3	53·9	S.W. winds; mostly calm.
August . . .	"	55·4	52·1	W. winds.
September . . .	"	52·1	50·2	W. winds.
October . . .	"	46·3	43·6	Calm; rain.
November . . .	"	42·4	40·9	E. and W. winds; some rain.
December . . .	"	37·4	38·5	Calm; rain.
January . . .	1889	35·5	35·8	Calm; frost.
February . . .	"	33·5	33·3	Calm; snow and rain.
March . . .	"	39·7	37·2	W. and E. winds; mostly calm.
April . . .	"	44·2	39·8	"
May . . .	"	51·3	49·2	Changing winds; rain; mostly calm.
June . . .	"	58·6	57·8	Calm.
July . . .	"	58·9	58·2	E. winds.
August . . .	"	57·6	55·1	Calm; rain; fog.
September . . .	"	—	—	
October . . .	"	44·4	43·2	W. winds; dull; fog.
November . . .	"	41·6	40·3	" mostly calm.
December . . .	"	37·4	36·4	S. and W. winds or calm.
January . . .	1890	39·1	37·7	W. winds or calm.
March . . .	"	43·6	39·5	—
April . . .	"	45·3	41·9	—
May . . .	"	53·4	50·9	—
June . . .	"	58·2	55·0	—
July . . .	"	58·7	55·1	—
August . . .	"	—	—	—
September . . .	"	—	—	—
October . . .	"	50·7	46·6	—
November . . .	"	39·2	40·3	—
December . . .	"	34·8	35·6	—
January . . .	1891	33·1	33·8	—
February . . .	"	39·0	37·7	—
March . . .	"	38·5	36·1	—
April . . .	"	43·0	39·3	—
May . . .	"	48·5	45·4	—
June . . .	"	59·2	57·7	—
July . . .	"	61·8	60·1	—

EARN.

Observations on the Earn were made by Mr. John Ellis from January to June 1888 at Bridge of Earn, about three miles above the junction of the river with the Tay. The record given by weekly means in Curve XXIV. is too short to admit of discussion.

Monthly Means of Temperature Observations on the Earn at Bridge of Earn.

Month	Year	Air	Water	Weather
January	1888	39·2	39·2	Changeable.
February	"	32·3	35·7	N.W. and E. winds.
March	"	36·0	37·1	N. winds; snow.
April	"	44·0	42·8	N. winds.
May	"	53·0	49·9	S.W. and E. winds.
June	"	48·5	48·5	E. winds.

CURVE XXIV.—Earn at Bridge of Earn.
8.45 A.M.

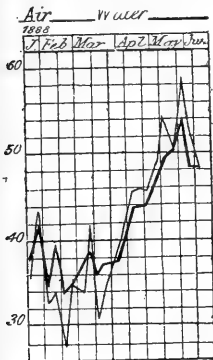

CURVE XXV.—Tay at Perth.
8 to 10 A.M.

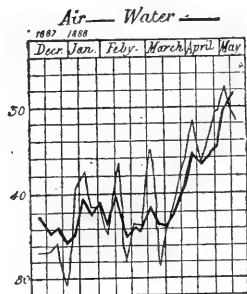

TAY AND BRAAN.

Observations on the Tay at Perth were made at different hours in the forenoon and afternoon by Mr. W. Wilson (see Curve XXV.), Mr. R. Dow, and Mr. Mechie for a few months in 1858. The morning observations are most interesting to compare with other rivers, and they alone are given. The record is too short to admit of any attempt at discussion. The same observers made a series of observations in 1887 and 1888, but not in the conditions required by the Committee.

Monthly Means of Temperature Observations on the Tay at Perth, 9 a.m.

Month	Year	Air	Water	Weather
December	1887	32·5	35·9	Some snow and frost.
January	1888	40·0	37·8	Some fog and rain.
February	"	36·7	37·5	W. and N.E. winds; some snow.
March	"	37·9	37·4	W. winds; some snow.
April	"	45·8	43·6	N. winds; some rain.
May	"	50·3	46·9	N. and W. winds.

At Inver, near Dunkeld, Messrs. C. and J. Macintosh made observations on the rivers Tay and Braan from March 17, 1889, to June 20, 1890, at 8.15 A.M. The Tay at the point of observation is narrow and deep, with a comparatively slow current when the river is low. In flood instances have been known of the water-level rising as much as 16 feet above the average. The banks are high and wooded to the margin of the stream.

The temperature is taken about 8 feet from the bank, where the depth of water varies from 4 feet to 12 feet or more.

The Braan is a rapid mountain stream; about half a mile above the point at which observations are taken, it emerges from a deep narrow rocky ravine well wooded and about one and a half mile long. Before its junction with the Tay a mill-lead is cut from it to the Tay, and the temperature is observed near the outlet of this artificial channel.

Both sets of observations are shown in the same diagram, Curve XXVI. The Braan is always a few degrees colder than the Tay and follows the variations of air-temperature much more closely than does the larger river. The Tay was almost always warmer than the air, and this was particularly the case in the summer of 1889, when for more than a month both rivers had a temperature over 60°, a temperature which the air did not reach on any occasion as a weekly mean. It must, however, be noticed that the early hour of observation would account for a low air-temperature. The river-temperature runs much closer to the air-temperature during the period of heating up than while cooling down.

Monthly Means of Temperature Observations on the Tay and Braan at Inver, near Dunkeld.

Month	Year	Air	Tay	Braan	Weather and General Direction of Winds.
March . . .	1889	41·2	39·8	39·0	N.W. wind; changeable; some thunder.
April . . .	"	42·0	41·3	39·2	N.W. wind; stormy; some snow.
May . . .	"	50·8	50·3	49·0	E. winds; fine; dull; showers.
June . . .	"	55·7	57·0	56·4	N.W. and E. winds.
July . . .	"	56·2	60·7	58·5	No remarks.
August . . .	"	53·5	55·5	55·3	"
September . . .	"	50·5	53·4	51·2	"
October . . .	"	43·2	46·1	43·8	"
November . . .	"	40·7	43·0	40·4	"
December . . .	"	37·9	39·5	36·6	"
January . . .	1890	36·6	39·5	37·6	"
February . . .	"	34·5	37·8	34·7	"
March . . .	"	42·6	39·3	38·3	"
April . . .	"	41·7	43·3	41·7	"
May . . .	"	49·2	50·5	49·9	"
June . . .	"	55·5	53·4	53·4	"

CURVE XXVI.—Tay and Braan, Dunkeld. 8.15 A.M.

Air— River Tay — River Braan----

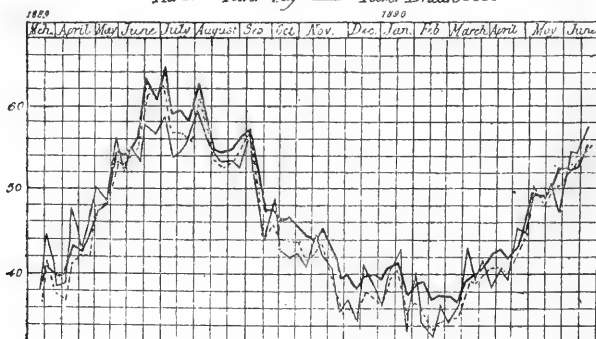

Observations were also made on the Tummel at Ballinluig, on the Dochart and other feeding streams of Loch Tay at Killin, on the Forss in the north-west of Caithness, in the sea at Scrabster and at Wick in Caithness, on the Wick river, on the Glass in Strathglass, the Eden near Cupar Fife, on the Nith estuary and on Lochrutton, Kirkcudbrightshire; but from irregular hours of observation, short period of observing, or other causes, they have not been reduced to the form of curves.

A number of observers in various parts of Ireland were supplied with instruments, but only two sent in reports of work done.

SEA AT MOVILLE.

One of the records was an admirable series of observations in the sea at Moville, on Lough Foyle, by Mr. J. Lowry, from January 1889 to May 1890.

CURVE XXVII.—Sea at Moville, Ireland. 9 A.M.

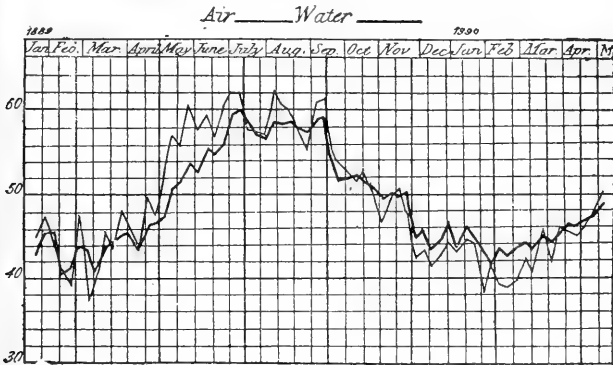

Monthly Means of Temperature Observations on Lough Foyle at Moville.

Month	Year	Air	Water	Weather
January	1889	45·8	44·6	S. and W. winds; some hail and rain.
February	"	41·2	42·3	Changeable; rain and snow.
March	"	44·2	43·3	W. winds.
April	"	46·9	46·0	N. and E. winds.
May	"	56·2	51·3	S. and E. winds.
June	"	59·7	55·3	" "
July	"	59·3	58·1	S. and W. winds; some rain.
August	"	58·1	58·0	" "
September	"	57·8	54·9	S, and E. winds.
October	"	50·4	51·0	Changing winds.
November	"	47·6	48·5	S. and W. winds.
December	"	43·2	44·9	" "
January	1890	42·4	44·2	" "
February	"	40·1	43·5	S. and E. winds.
March	"	43·7	44·9	S. and W. winds.
April	"	46·0	46·2	S. winds.
May	"	50·4	49·2	"

Curve XXVII. gives the weekly means and affords an interesting

comparison with the Bristol Channel observations. The water was colder than the air while the temperature was rising and at the seasonal maximum, but warmer than the air when the temperature was falling and at the seasonal minimum. The range of sea-temperature was decidedly less than that of air-temperature, and the curve for the water is more uniform than that for the air, showing little tendency to follow sudden and temporary changes.

BELVEDERE LAKE.

Mr. J. Bayliss made observations on the east side of Belvedere Lake from January 1889 to January 1890. Belvedere Lake is a small sheet of water three miles south-west of Mullingar, in West Meath. The temperature of the water (Curve XXVIII.) was almost always higher than that of the air, and had a nearly equal range but was less subject to small irregularities.

Monthly Means of Temperature Observations on Belvedere Lake, West Meath.

Month	Year	Air	Water	Weather
January . . .	1889	39·7	39·3	S. and W. winds; stormy.
February . . .	"	38·9	39·8	W. and N. winds; snow.
March . . .	"	42·2	42·1	Changing winds; stormy.
April . . .	"	45·8	46·4	N., S., and W. winds; some rain.
May . . .	"	53·9	55·4	S. winds; overcast.
June . . .	"	60·1	61·8	Changing winds; cloudy.
July . . .	"	59·9	60·9	W. winds; stormy; rain.
August . . .	"	58·3	59·8	S. and W. winds; overcast.
September . . .	"	58·0	57·6	Changing winds; some rain.
October . . .	"	47·9	49·5	S.W. and N. winds; rain.
November . . .	"	46·1	47·9	S. winds; fog; rain; stormy.
December . . .	"	41·5	41·4	S. winds; stormy.
January . . .	1890	45·0	42·1	S. winds.

CURVE XXVIII.—Belvedere Lake, West Meath, Ireland.
10 A.M.

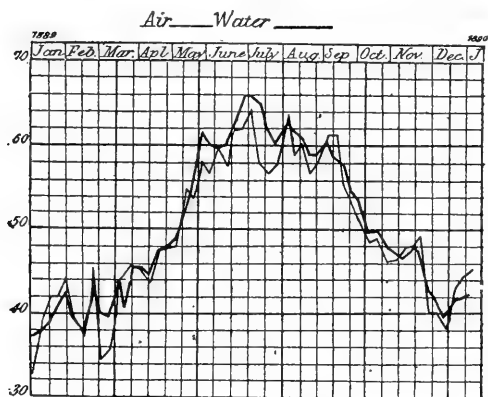

CURVES.

Weekly means of water- and air-temperature at twenty-eight stations. The curves are drawn on the same scale, the entries corresponding to the average temperature (usually at 9 A.M.) for the week ending each Saturday. The temperature readings are corrected for instrumental errors, but in several instances the readings are subject

to uncertainty sometimes on account of the observer only reading to whole degrees or to half or quarter degrees,

On the Capture of Comets by Planets, especially their Capture by Jupiter. By Professor H. A. NEWTON.

[A communication ordered by the General Committee to be printed *in extenso* among the Reports.]

1. SOME years ago I obtained and published¹ a formula expressing in simple terms the total result of the action of a planet in increasing or diminishing the velocity of a comet or small body that passes near the planet. This formula is practically a modification of the integral of energy, the smaller terms in the perturbing function being omitted. A very brief and partial treatment of it was presented to this Association in 1879 at its Sheffield meeting.² Within the last two or three years several astronomers have made special study of the manner of Jupiter's action in changing the orbits of comets that pass very near him. M. Tisserand has given us an expression connecting the major axis, inclination, and parameter of the orbit described before coming near to Jupiter with the corresponding elements of the orbit after leaving the neighbourhood of the planet.³ M. Schulhof has applied the formula of M. Tisserand as a criterion for determining the possible identity of various comets whose orbits pass near to Jupiter's orbit.⁴ Messrs. Seeliger, Callandreau, and others have continued these investigations. The interest thus shown in the problem has led me to resume the study of the subject and to work out the results of the formula obtained by me in 1878 more fully than they have been hitherto developed.

2. One of the remarkable distinctions between the comets of long (or infinite) periods and those of short periods is that the orbits of the latter have almost without exception direct motions and small inclinations to the plane of the ecliptic, while the orbits of the former have all possible inclinations between 0° and 180°. At first sight this seems to imply that the two groups of comets are radically distinct in origin or nature one from the other. The most natural line of investigation therefore is the effect of perturbations in bringing or not bringing the comets to move with the planet after the perturbation.

3. The algebraic processes by which was obtained the formula for the change of energy which a small body experiences from passing near a planet were given in the article cited, and they need not be here reproduced. The following was the resulting equation, viz. :—

$$\Delta = - \frac{4mfa^2v_0 \cos \phi \sin \alpha}{pv_0} \quad . \quad . \quad . \quad (1)$$

and it was obtained from the general differential equations of motion by making assumptions not greatly differing from those used in obtaining Laplace's well-known theorem, that a sphere of suitable magnitude may be described about the planet as a centre, and that for a tolerable first approximation the comet may be regarded as moving when without

¹ *American Journal of Science*, III., vol. xvi., 1878, p. 175.

² *Report*, 1879, p. 274.

³ 'Sur la théorie de la capture des comètes périodiques,' *Bull. Astron.*, tome vi., juin et juillet, 1889.

⁴ 'Notes sur quelques comètes à courte période,' *Astron. Nachrichten*, No. 2964.

this sphere in a conic section of which the sun is the focus, and as moving when within the sphere in a conic section (an hyperbola) of which the planet is the focus. In other words, only perturbations of the first order of magnitude are taken account of. A comet is treated throughout this paper as a small indivisible body whose mass may be neglected.

4. *Notation.*—The symbols used in (1) and also other symbols which I shall have occasion to use may be thus defined:—

- Let \mathcal{C}_1 be the orbit of the comet about the sun before the comet comes under the appreciable action of the planet ;
 \mathcal{C} the orbit of the comet about the sun after perturbation by the planet ;
 C the hyperbolic orbit of the comet relative to Jupiter when near the planet ;
 \mathfrak{F} the elliptic orbit of Jupiter about the sun ;
 A the point on \mathcal{C}_1 which is nearest to \mathfrak{F} ;
 E the point on \mathfrak{F} which is nearest to \mathcal{C}_1 ;
 d the length of the straight line EA , being the perpendicular distance between the orbits at their nearest approach ;
 ω the angle between the tangent of \mathcal{C}_1 at A and the tangent to \mathfrak{F} at E ;
 h the distance which the planet has yet to pass over to reach E when the comet is at A (h may be negative) ;
 m the mass of the planet ; sun's mass = unity ;
 a the unit of distance, in general the mean distance of the earth from the sun ;
 f the sun's attractive force at the unit of distance ;
 v_1 the planet's velocity in its orbit at E ;
 v_c the comet's velocity in its orbit C when the comet enters the sphere of Jupiter's perceptible influence ;
the comet's velocity at A relative to the sun ;
 $s = v_c/v_1$;
 $@_1$ the semi-axis major of \mathcal{C}_1 (negative if \mathcal{C}_1 is an hyperbola) ;
 $@$ the semi-axis major of \mathcal{C} (negative if \mathcal{C} is an hyperbola) ;
 p the perpendicular from the planet upon asymptote to C ;
 α the acute angle between the transverse axis of C and the asymptote to C ;
 ϕ the angle between the tangent to \mathfrak{F} at O (drawn in the direction of the planet's motion) and the line from the planet to the vertices and centre of C ;
 A the semi-transverse axis of C ;
 B the semi-conjugate axis of C (hence equal to p) ;
 r the distance of the planet from the sun ;
 r_1 the distance of the comet from the sun ;
 r_c the distance of the comet from the planet ;
 ρ_1 and ρ distances of the comet from the sun at selected epochs before and after perturbation ;
 v_1 and u the velocities of the comet at the selected epochs ;
 Δ the increase to which $v^2 - \frac{2fa^2}{r_1} - \frac{2mfa^2}{r_c}$ receives by the planet's action during the whole period in which the comet is passing near to Jupiter.

5. If we assume two epochs, one before and one after the perturbation, at which the comet is equally distant from the planet, the term $2mf\alpha^2/r_0$ is the same at both instants, and it disappears from the value of Δ . Therefore

$$\Delta = u^2 - \frac{2fa^2}{\rho} - u_1^2 + \frac{2fa^2}{\rho_1}.$$

But by the well-known formulas from the law of gravitation,

$$u_1^2 = 2fa^2 \left(\frac{1}{\rho_1} - \frac{1}{2@_1} \right),$$

and

$$u^2 = 2fa^2 \left(\frac{1}{\rho} - \frac{1}{2@} \right);$$

hence

$$\Delta = fa^2 \left(\frac{1}{@} - \frac{1}{@_1} \right),$$

that is, from (1)

$$\frac{1}{@} - \frac{1}{@_1} = - \frac{4m \cos \phi \sin \alpha}{ps}.$$

This equation is valid whatever be $@_1$ the major axis of the orbit \mathfrak{C}_1 , and may be used to determine the major axis of either orbit from the elements of the other. My present purpose is, however, to study the action of Jupiter in changing orbits that are originally parabolas, and hence in general $@_1$ will be taken infinite. In that case

$$@ = \frac{ps}{4m \cos \phi \sin \alpha} \quad . \quad . \quad . \quad . \quad (2)$$

It will be found that the second member of (2) depends on ω , d , and h , and these are known quantities when the elements of \mathfrak{C}_1 and \mathfrak{F} are given. The use of the equation is, moreover, greatly simplified and enhanced by the fact that the plane of the planet's orbit is involved only in so far as that it must contain the tangent to \mathfrak{F} at E.

6. In the second member of (2) all the factors are positive except $\cos \phi$; hence if $\phi < \frac{1}{2}\pi$, $@$ is positive and the orbit \mathfrak{C} is an ellipse; but if $\phi > \frac{1}{2}\pi$, $@$ is negative and \mathfrak{C} is an hyperbola. This result may be thus expressed: *If the comet passes in front of Jupiter the kinetic energy of the comet is diminished; if it passes behind the planet the kinetic energy of the comet is increased.* The reason for this may also be given in general language. If the comet passes in front of the planet the comet's attraction increases the velocity, and hence increases the kinetic energy of the planet, and *vice versa*. But the total energy of the two bodies is constant, so that when that of the planet is increased that of the comet is diminished, and *vice versa*.

7. It is desirable now to transform the value of $@$ given in equation (2) so as to be able to determine the major axis of the new orbit of the comet directly from the circumstances of its initial approach to the planet before perturbation; in other words, to find $@$ in terms of ω , d , and h . For this we must find in terms of ω , d , and h values for s , p , a , and ϕ .

8. *To find s.*—In fig. 1 let A and E represent the two points A and E as defined above (Art. 4), and the line AE represent d . Let AY be the tangent to \mathcal{C} , at A, and EO the tangent to \mathfrak{S} at E. It is an admissible supposition that the planet is describing the *straight* line OE, and that the comet in its unperturbed orbit is describing the *straight* line YA. At some certain moment the line joining the planet and the unperturbed comet must evidently be perpendicular to OE. Let OY be the line joining the bodies at that moment, so that the planet is at O when the comet is at Y, and EOY is a right angle. Instead, however, of supposing the planet to move from O towards E we may apply an equal, opposite

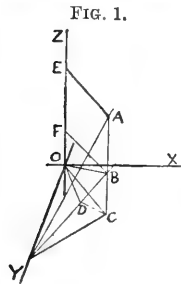

motion to the comet, and consider the planet to remain at rest at O. Draw AC parallel to EO and make AB equal to the distance described by the planet during the time that the comet is moving from Y to A. Join YB. Then since YA and BA represent in direction and magnitude the motions of the two bodies in a given interval, the third side YB of the triangle represents in magnitude and direction the motion of the comet relative to the planet. The angle YAB is the angle ω , and the three sides of the triangle YA, YB, and BA are proportional to $v, v_o,$ and v_i . Let the angle YBC be θ ; then from the triangle YAB we have

$$v_o^2 = v_i^2 - 2v_i v \cos \omega + v^2,$$

and

$$v : v_i : v_o :: \sin \theta : \sin (\theta - \omega) : \sin \omega \quad . \quad . \quad . \quad (3)$$

Since v and v_i can be computed from the given elements of the orbits of the planet and comet, we may readily compute from ω the value of s , or v_o/v_i . But if the planet is at its mean distance from the sun, and the comet's orbit is parabolic, $v^2 = 2v_i^2$, and we have

$$s^2 = 3 - 2\sqrt{2} \cos \omega \quad . \quad . \quad . \quad . \quad (4)$$

Also from the triangle

$$2v_i^2 = v_o^2 + 2v_o v_i \cos \theta + v_i^2,$$

or

$$2s \cos \theta = 1 - s^2 \quad . \quad . \quad . \quad . \quad (5)$$

9. *To find p.*—The planet being regarded at rest at O and the *relative* unperturbed motion of the comet being along YB, this line may within admissible limits of error be treated as one asymptote of the relative orbit C. The perpendicular from O upon YB will then be by definition (Art. 4) the line p . Draw OX from O perpendicular to OY and OE, and let these three lines be coordinate axes. Let the line AB meet the plane XOY in C. Join OC, let fall OD perpendicular to YB, and join CD. Since EA is perpendicular to AY, and also to EO, and so to its parallel line AC, therefore it is perpendicular to the plane YAC. Hence OC parallel to EA is perpendicular to the plane, and so perpendicular to CD. Again CDY is a right angle; for $OD^2 + DY^2 = OY^2 = OC^2 + CY^2$, and $OD^2 = OC^2 + DC^2$. Hence $DC^2 + DY^2 = CY^2$, and consequently CDY is a right angle.

The quantity h is the line BC; for h is the distance which the planet, when the comet is at A, has yet to pass over before reaching E. But the

comet was at Y when the planet was at O, and the planet describes BA while the comet describes YA, leaving BC as the distance yet to be described, or h . But the angle CBD is θ , so that we have

$$p^2 = OD^2 = OC^2 + CD^2 = d^2 + h^2 \sin^2 \theta \quad (6)$$

10. *To find α .*—The angle α is the acute angle between the asymptote and the transverse axis of the hyperbola, and hence from the nature of the hyperbola $\tan \alpha = B/A$. By known formulas we have, if the planet is at its mean distance,

$$v_i^2 = 2fa^2 \left(\frac{1}{r} - \frac{1}{2r} \right),$$

$$v_o^2 = 2mfa^2 \left(\frac{1}{\infty} + \frac{1}{2A} \right).$$

Therefore

$$\left. \begin{aligned} \frac{v_o^2}{v_i^2} &= \frac{mr}{A}, \text{ or } A = \frac{mr}{s^2}. \end{aligned} \right\}$$

Hence from (6)

$$\tan \alpha = \frac{B}{A} = \frac{p}{A} = \frac{s^2(d^2 + h^2 \sin^2 \theta)^{\frac{1}{2}}}{mr} \quad (7)$$

11. *To find ϕ .*—The orbit of the comet relative to Jupiter lies in the plane YOY. Let i be the inclination of the plane YOY to YOX, measured positive from x positive to z positive; let l be the longitude of the direction YC, measured in the plane YOX from OY, that is, the angle made by YC with OY produced; let λ be the longitude of the direction YB measured in the plane YOY from OY, that is, the angle made by YB with OY produced. Imagine now a sphere described about Y as a centre that shall cut the three planes XOY, BOY, and BCY in three sides of a right-angled spherical triangle. The hypotenuse of this triangle is λ , the base l , the perpendicular $\frac{1}{2}\pi - \theta$, and the angle opposite to the perpendicular is i ; hence we have

$$\cos \lambda = \cos l \sin \theta \quad (8)$$

$$\cos \theta = \sin i \sin \lambda \quad (9)$$

$$\cot i = \sin l \tan \theta \quad (10)$$

Also from the triangles OCY and BCY

$$\tan l = \tan OYC = -\frac{OC}{YC} = -\frac{d}{h \tan \theta} \quad (11)$$

The angle ϕ is by definition the angle between the direction OE and a line in the plane YOY that makes with YB an angle α . Hence we have readily

$$\cos \phi = \sin i \sin (\lambda \pm \alpha) \quad (12)$$

These equations enable us to compute ϕ in terms of d , h , and ω ; for in succession θ may be computed by (3), l by (11), λ by (8), i by (10), and ϕ by (12).

12. These values of s , p , α , and ϕ give by equation (2) the value of $@$. The suppositions that the planet is at its mean distance, and that $@$ is a parabola, are involved in that equation, but they are not necessary to the

determination of @ when no such hypotheses are made, and changes in the equation that are not serious would make it applicable without these limitations. The quantities in the several equations may be regarded as having values:—

$$\begin{aligned} d & \text{ positive,} \\ h & \text{ positive or negative,} \\ a & \text{ positive and less than } \frac{1}{2}\pi, \\ \omega, \theta, \phi, \text{ and } i & \text{ positive and less than } \pi, \\ l \text{ and } \lambda & \text{ positive and less than } 2\pi. \end{aligned}$$

13. We may, however, also find directly the value of @ in terms of $d, h,$ and the known functions of ω .

From (12):

$$\cos \phi \sin \alpha = \sin i \sin \lambda \cos \alpha \sin \alpha \pm \sin i \cos \lambda \sin^2 \alpha.$$

From (7):

$$\cos \alpha \sin \alpha = \frac{AB}{A^2 + B^2}, \text{ and } \sin^2 \alpha = \frac{B^2}{A^2 + B^2}.$$

From (10) and (8):

$$\sin i \cos \lambda = \pm \frac{\cos l \sin \theta}{(1 + \sin^2 l \tan^2 \theta)^{\frac{1}{2}}} = \pm \frac{\cot l \sin \theta}{(\sec^2 \theta + \cot^2 l)^{\frac{1}{2}}},$$

hence from (6) and (11):

$$\sin i \cos \lambda = \pm \frac{h \sin^2 \theta}{(d^2 + h^2 \sin^2 \theta)^{\frac{1}{2}}} = \pm \frac{h \sin^2 \theta}{B}.$$

From these and (9):

$$\cos \phi \sin \alpha (A^2 + B^2) = AB \cos \theta \pm hB \sin^2 \theta,$$

and hence from (2):

$$@ = \frac{s}{4m} \cdot \frac{A^2 + B^2}{A \cos \theta \pm h \sin^2 \theta} = \frac{s}{4m} \cdot \frac{A + d^2 + h^2 \sin^2 \theta}{A \cos \theta \pm h \sin^2 \theta}. \quad (13)$$

Since m is the known mass of the planet, and $\theta, s,$ and A are known functions of ω , equation (13) gives directly the value of @, the semi-axis major of the new orbit \mathfrak{C} , in terms of $d, h,$ and ω .

14. For a particular case of approach, equation (13) is convenient for computation. We may, however, now treat $d, h,$ and ω as independent variables whose varying values may express all the different possible cases of approach of the comet to the planet, so far as change of periodic time of the comet is concerned. The dependence of @ upon the three variables cannot be very easily represented graphically in a single plane diagram. But by giving to ω successive values in multiples of 10° , viz., $\omega = 10^\circ, 20^\circ, 30^\circ,$ &c., to 170° , I have prepared a series of diagrams to exhibit in each case in succession the relation of @ to the other two variables. The values of $\theta, s,$ and A for the several values of ω were needed in making the diagrams, and they are given in Table I. Equations (4), (5), and (7) are used in making the table. The disturbing planet is assumed to be Jupiter, so that m was taken equal to $1/1050$ and $r = 5.2$.

TABLE I.

ω	θ	s	A	ω	θ	s	A	
0	0	0	0.414	0.2886	100	131 48	1.868	.00142
10	32	1	0.463	.02309	110	138 9	1.992	.00125
20	55	47	0.585	.01448	120	144 21	2.101	.00112
30	72	22	0.742	.00900	130	150 26	2.195	.00103
40	84	46	0.913	.00594	140	156 26	2.273	.00096
50	94	47	1.087	.00419	150	162 22	2.354	.00091
60	103	27	1.259	.00312	160	168 16	2.379	.00088
70	111	14	1.426	.00244	170	174 8	2.405	.00086
80	118	27	1.584	.00197	180	180 0	2.414	.00085
90	125	16	1.732	.00165				

15. Using these values of θ , s , and A we may now represent graphically the dependence of $@$ upon the other two variables d and h for each specified value of ω . Let d and h be Cartesian coordinates, then for each point of the coordinate plane there is a value of $@$. The ambiguous sign will be fully satisfied by giving positive and negative values to h . For an assumed value of $@$ we shall have a curve whose equation is (13), and each point of this curve represents values of d and h for which the total action of the planet upon the comet will be to reduce the energy of the comet a constant amount. This locus will be called an *isergonal* curve.

16. *Faisceau of isergonal ellipses.*—The equation (13) of the isergonal curve may be written

$$4m@ (A \cos \theta + h \sin^2 \theta) = s (A^2 + d^2 + h^2 \sin^2 \theta),$$

and this is the equation of an ellipse. As $@$ changes its value we may treat it as a parameter, and we have a faisceau of similar isergonal ellipses, each ellipse symmetrical with the axis of h . The radical axis of the faisceau $A \cos \theta + h \sin^2 \theta = 0$, and the imaginary ellipse $A^2 + d^2 + h^2 \sin^2 \theta = 0$, are theoretically two members of the faisceau. For points on the radical axis $@ = \infty$, and therefore for this locus there is no change in the energy of the comet.

17. *Centre and area of the isergonal ellipse.*—The centre of the isergonal ellipse is upon the axis of h ; making $d = 0$ and solving for h , we have

$$h = \frac{2m@}{s} \pm \frac{2m@}{s \sin \theta} \left(1 - \left(\cos \theta - \frac{As}{2m@} \right)^2 \right)^{\frac{1}{2}}. \quad (14)$$

The first term of the second member of (14) is the ordinate of the centre, and the second term is the semi-axis major of the ellipse. The ratio of the axes being $1 : \sin \theta$, and As^2 being $= mr$, the area of the ellipse will be equal to

$$\frac{4\pi m^2 @^2}{s^2 \sin \theta} \left(1 - \left(\cos \theta - \frac{r}{2as} \right)^2 \right).$$

18. *Maximum action of the planet.*—For two particular values of $@$ the isergonal ellipses become points. These values of $@$ result if the maximum effect of the planet in increasing and in decreasing the energy of the comet takes place, and they are obtained by making

the two values of h equal to each other in (14), that is, by making $\cos \theta - \frac{A_s}{2m@} = \pm 1$. Since at the same time $h = 2m@/s$, we obtain

$$h = \frac{A}{\cos \theta \pm 1}, \text{ and } @ = \frac{A_s}{2m(\cos \theta \pm 1)} \quad (15)$$

Let h' and h'' , and $@'$ and $@''$, be the positive and negative values of h and $@$ in (15), and we may construct the following table of their values. As in Table I, Jupiter is assumed to be the perturbing planet.

TABLE II.

ω	h'	h''	$@'$	$@''$	ω	h'	h''	$@'$	$@''$
0	·01443	α	3·14	— α	100	·00426	—·00085	4·17	—0·83
10	·01250	—·15174	3·04	—36·90	110	·00489	—·00072	5·12	—0·75
20	·00927	—·03307	2·85	—10·15	120	·00598	—·00062	6·60	—0·68
30	·00690	—·01290	2·69	—5·03	130	·00789	—·00055	9·09	—0·63
40	·00544	—·00654	2·61	—3·13	140	·01149	—·00050	13·71	—0·60
50	·00457	—·00387	2·61	—2·21	150	·01934	—·00047	23·70	—0·57
60	·00407	—·00253	2·69	—1·68	160	·04192	—·00044	52·36	—0·55
70	·00382	—·00179	2·86	—1·34	170	·16336	—·00043	206·30	—0·54
80	·00377	—·00134	3·14	—1·11	180	α	—·00043	α	—0·54
90	·00390	—·00105	3·55	—0·95	—	—	—	—	—

19. *Explanation of Table II.*—The meaning of the numbers in this table may be explained by an example. If a comet moving in a parabola passes near to Jupiter, and the directions of the two original motions at nearest points of the orbits make an angle of 10° , then the greatest action of Jupiter (during the whole period of transit) in diminishing the velocity of the comet in its orbit about the sun will take place if the two orbits actually intersect ($d=0$), and if the comet in its unperturbed orbit arrives first at the point of intersection at the instant when Jupiter is distant therefrom ·01250 (the earth's mean distance from the sun being unity), the resulting semi-axis major of the comet's orbit about the sun will be 3·04.

On the other hand, the greatest effect in increasing the velocity of the comet will take place when the two orbits actually intersect, and the comet in its unperturbed orbit reaches the point of intersection later than the planet and when the planet is distant therefrom 0·15174. The semi-transverse axis of the resulting hyperbolic orbit about the sun will be 36·90.

20. *Resulting orbits of maximum perturbation.*—The position of the relative orbit about Jupiter in these cases of maximum perturbation for given values of ω is easily determined. From the equations (7), (6), and (15)

$$\tan \alpha = B/A = h \sin \theta / A = \sin \theta / (\cos \theta \pm 1).$$

The positive sign gives $2\alpha = \theta$, and the negative sign gives $2\alpha = \pi + \theta$. But the angle 2α in the first case is the angle of the asymptotes enclosing the branch of the hyperbola described about Jupiter by the comet. Since the two original orbits intersect, the plane of the relative orbit contains the planet's path, so that the comet passes directly in front of the planet, and being turned backward leaves Jupiter exactly in the

direction of Jupiter's quit.¹ The place of encounter with Jupiter will be near an apse of the comet's resulting orbit about the sun. The comet leaves the planet with the relative velocity v_0 , so that if $s < 1$ the motion about the sun in the new orbit will be direct; if $s > 1$ the motion in the new orbit will be retrograde. That is, by (4) when $\omega < \frac{1}{4}\pi$ the resulting motion is direct; when $\omega > \frac{1}{4}\pi$ the resulting motion is retrograde.

In the second case the angle $2a$, being greater than 180° , stands for the angle between the asymptotes exterior to the orbit. Hence the comet passing behind the planet will be turned forward and will leave the planet in the direction of Jupiter's goal, and have a velocity that will send it permanently out of the solar system.

21. The results of Art. 20 assume that ω is given. To find for what value of ω the period of the resulting orbit is the shortest possible we may put $As^2 = mr$ and $1 - s^2 = 2s \cos \theta$ in (15), so that

$$@ = \frac{r}{1 - s^2 \pm 2s}.$$

To find the minimum for @ place $\frac{d@}{ds} = 0$ in this equation. This gives $s = \pm 1$, in which result, since s is inherently positive, only the positive sign is used. But when $s = 1$, $@ = \frac{1}{2}r$, $h = mr$, and $\omega = \frac{1}{4}\pi$. Hence the greatest effect of perturbation of a planet moving in a circular orbit in shortening the periodic time of a comet originally moving in a parabola is obtained if the comet's original orbit actually intersects the planet's orbit at an angle of 45° , and if the comet is due first at the point of intersection at the instant when the planet's distance therefrom is equal to the planet's distance from the sun multiplied by the ratio of the mass of the planet to the mass of the sun.

The relative velocity of the comet on leaving the planet's sphere of action would be equal to, and directly opposite, the planet's velocity ($s = 1$), and the comet would be left entirely at rest to fall to the sun. This case could not happen for planets like the earth where mr is less than the semi-diameter of the planet. In the case of the earth mr is less than 300 miles, and actual collision would result. But for Jupiter mr is greater than the distance of the second satellite from the planet. The nearest approach of the comet to the planet would be $mr(\sqrt{2} - 1)$, which is more than four times the radius of Jupiter. Hence this case of maximum diminution of major axis could occur near Jupiter.

22. *Isergonal ellipse for $\omega = 10^\circ$.*—If we make $\omega = 10^\circ$ the vanishing points of the isergonal ellipses will be (Table II.) at $d = 0$, $h = .01250$ and $d = 0$, $h = -.15174$. In fig. 2 let OE and OH be the axes of d and h respectively. The vanishing points will be on the axis OH at distances h' and h'' above and below O. Upon this diagram are shown the halves of four isergonal ellipses. The scales used for d and h are not equal to each other, since the use of the same scale for both coordinates would make the figures of inconvenient shape. In this and in all the figures 2-18, the unit in d is to the unit in h as 1 to $\sin \omega$. But to indicate more clearly this scale, and at the same time to give a kind of shading to a part of the area, there are drawn above the radical axis ae lines parallel to OE, and parallel to OH, at intervals of .01; that is, the sides

¹ The goal and the quit of a moving body are those two points on the celestial sphere towards which and from which the body is moving.

of each of the small rectangles in the quadrant HOE are $\cdot 01$, or about 925,000 miles. Only the positive values of d are represented in the figures. The positive vanishing point being 1.250 of these divisions above

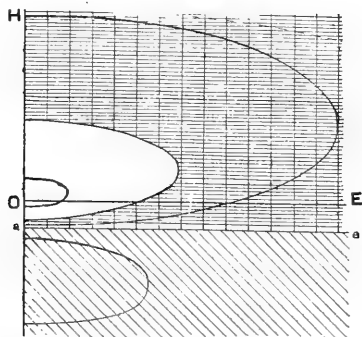
FIG. 2.— $\omega = 10^\circ$.FIG. 3.— $\omega = 170^\circ$.

O, and the negative vanishing point 15,174 below O, we lay off $Oa = \frac{1}{2}(h' + h'') = -6.962$ divisions, and draw ae for the radical axis. The smallest positive value of $@$ is (Table II.) 3.04. As $@$ increases from

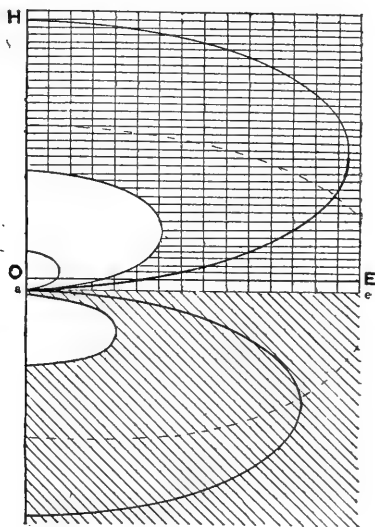
FIG. 4.— $\omega = 20^\circ$.FIG. 5.— $\omega = 160^\circ$.

3.04 the ellipse increases in size, and the innermost curve represents what it becomes when $@ = 5$. The second curve (separating the blank and shaded areas) corresponds to $@ = 20$. Any parabolic comet passing

Jupiter with an original angle of $\omega = 10^\circ$, and having d and h such as to be represented by a point within the blank area of fig. 2, will leave the vicinity of the planet in an elliptic orbit whose semi-axis major is less than 20, and whose period therefore is less than ninety years.

The larger curve that lies above ae in the shaded area is the isergonal ellipse for $@ = 50$. As $@$ increases the lower part of the curve tends to approach the radical axis ae , with which it coincides when $@ = \infty$. For points in the area below ae (distinguished by the oblique-line shading), the planet increases the velocity of the comets, and the comet would be thrown permanently out of the solar system. The smallest semi-transverse axis, the one corresponding to the vanishing ellipse, is (Table II.) 36.90, and the isergonal curve for $@ = -50$ is drawn in the figure.

23. *Isergonal ellipses for $\omega = 170^\circ$.*—In fig. 3 are drawn the three ellipses corresponding to the values of $@$, -5 , -20 , and -50 . The ellipses above ae do not appear, inasmuch as the smallest possible elliptic orbit has a semi-axis major of 206.3 (Table II.) and a period of about 3,000 years. The radical axis ae is .08146 (or over eight divisions) above OE.

24. Figs. 4 and 5 are like diagrams for $\omega = 20^\circ$ and $\omega = 160^\circ$. With altered numbers the explanation of Arts. 22 and 23 apply with slight change to these figures. The line ae in figs. 4 and 5 is nearer to

FIG. 6.— $\omega = 30^\circ$.

FIG. 7.— $\omega = 150^\circ$.

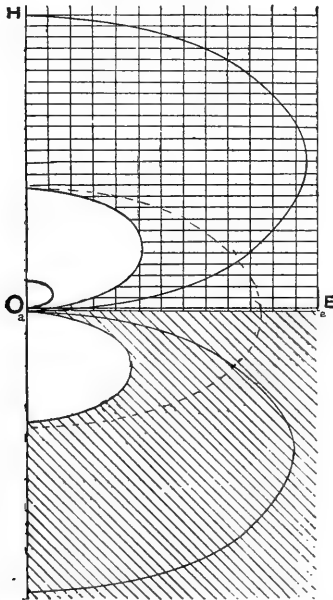

OE than is the same line in figs. 2 and 3. In fig. 4 the line for $@ = -20$ appears below ae , while above ae are the three curves for $+5$, $+20$, and $+50$ respectively. In fig. 5 the ellipse for $@ = 50$ is wanting, since the

minimum ellipse has a semi-axis major 52.36 (Table II.), while below ae the three curves are present.

In figs. 6 and 7 are contrasted in like manner the isergonal curves for the angles $\omega = 30^\circ$ and $\omega =$ the supplement of 30° . In fig. 6 the curve $@ = -5$ is wanting, and in fig. 7 the two curves $@ = 5$ and $@ = 20$ are both wanting.

In like manner are to be explained figs. 8–18. The numbers needed for drawing the figures are furnished by equation (13). The curves that in each figure separate the shaded area from the non-shaded

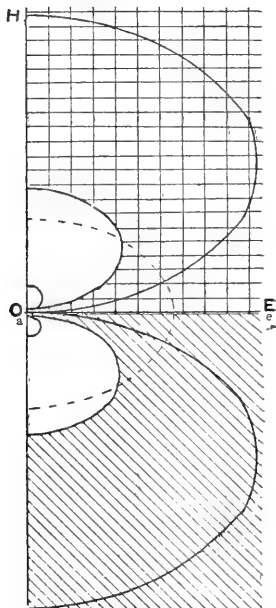
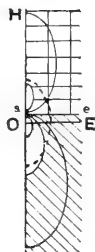
FIG. 8.— $\omega = 40^\circ$.FIG. 9.— $\omega = 140^\circ$.

area are the ellipses for $@ = 20$ and $@ = -20$. The shading is introduced in order to compare more readily the corresponding curves in the figures.

25. The dotted curve in the several figures represents those values of d and h for which the total change of direction in the relative orbit is 10° ; that is, $a = 85^\circ$. It is that curve whose equation is $A \tan 85^\circ = B$, or $d^2 + h^2 \sin^2 \theta = A^2 \tan^2 85^\circ$. It is therefore an ellipse whose centre is the origin of coordinates, and it is similar in each figure to the isergonal ellipses.

26. *Hypotheses about the parabolic cometary orbits.*—It will be convenient to make two assumptions about the distribution of the parabolic comets and the distribution of the goals of their motions. There seems to be no very well-marked relation between the ecliptic, or to speak more strictly

the invariable plane of the solar system, and the known parabolic cometary orbits. The following two assumptions do not seem likely therefore to introduce any very serious error into our reasonings.

If about the sun as a centre a sphere \mathcal{S} be described with an arbitrary radius r , it will be *assumed* that near the surface of \mathcal{S} , space is filled equably with comets. We may express this by supposing that in each cubic unit of space near \mathcal{S} , there are at each and every instant n comets. As the orbits are all assumed to be parabolic, the n comets have a common velocity v .

It will be furthermore *assumed* that the directions of the comets in

FIG. 10.— $\omega = 50^\circ$.

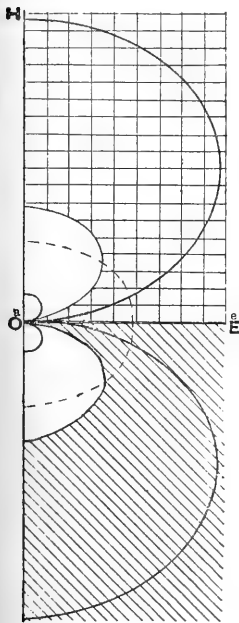

FIG. 11.
 $\omega = 130^\circ$.

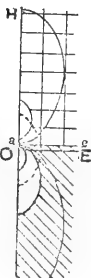

FIG. 12.— $\omega = 60^\circ$.

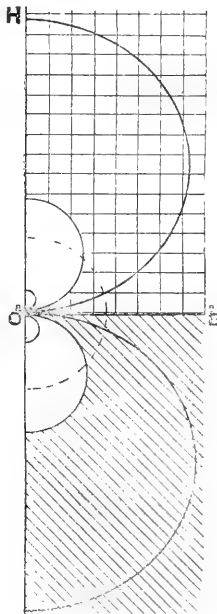
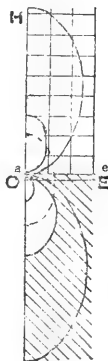

FIG. 13.
 $\omega = 120^\circ$.



each cubic unit of space near \mathcal{S} are at random—that is, that the quits and goals of the comet's motions relative to the sun are distributed equably over the surface of the celestial sphere.

27. *Number of comets entering \mathcal{S} .*—If about a normal to \mathcal{S} as an axis there be described two cones cutting the celestial sphere in two small circles distant from the point where the normal meets the celestial sphere ψ and $\psi + d\psi$, then of the n comets there will be $\frac{1}{2}n \sin \psi d\psi$ comets whose quits are between the two circles. Each of these comets will move perpendicularly to the spherical surface \mathcal{S} with the velocity $v \cos \psi$. Hence in a unit of time $\frac{1}{2}nv \cos \psi \sin \psi d\psi$ comets will cross a unit of the surface \mathcal{S} going towards the sun. The total entering the sphere in the unit of

time will be this number multiplied by the number of units in the surface of \mathbb{S} , or

$$4\pi r^2 \int_0^{\frac{\pi}{2}} \frac{1}{2} nv \cos \psi \sin \psi d\psi = \pi nvr^2.$$

28. *Distribution of parabolic comets as to perihelion distance.*—This supposition of equable distribution of the goals of comets as they cross the spherical surface \mathbb{S} involves also a law of distribution of comets as to perihelion distance. The number of comets that enter the sphere in a given time whose motions make with the normal angles between ψ and $\psi + d\psi$ is proportional to $\sin \psi \cos \psi d\psi$. If N be the number of comets that enter \mathbb{S} in a given period of time with an angle with the normal less than ψ , we may write $dN = k \sin \psi \cos \psi d\psi$, where k is some constant.

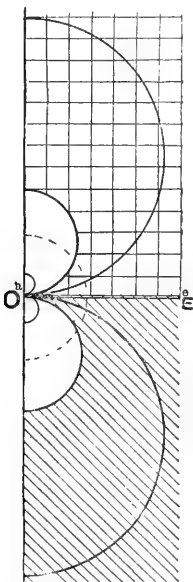
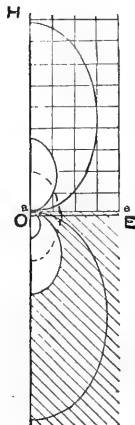
FIG. 14.— $\omega = 70^\circ$.FIG. 15.— $\omega = 110^\circ$.

But if q is the perihelion distance of a comet which at the distance r from the sun moves at an angle with the radius equal to ψ , then $q = r \sin^2 \psi$, and $dq = 2r \sin \psi \cos \psi d\psi$. But comets that enter \mathbb{S} with angles to the normal between ψ and $\psi + d\psi$ have perihelion distances between q and $q + dq$. Hence N may also represent the number of comets that in the given period of time pass their perihelia, and whose perihelion distances are less than q . Therefore $\frac{dN}{dq}$ is a constant, and we conclude that if comets be grouped according to their perihelion distances the number of comets whose perihelion distances are less than q is proportional to q .

29. It follows as a corollary to Art. 28 that if the two assumptions of Art. 26 be made for the spherical surface \mathcal{S} , the like distributions are true for every smaller concentric spherical surface. It would be but a reasonable extension of the assumptions to make them apply to larger spheres if finite.

30. If there are assumed to be n comets equably distributed in each unit of the space near and through which a planet is moving, and if these comets are all assumed to be moving in parabolas about the sun with the

FIG. 16.— $\omega = 80^\circ$.

FIG. 17.— $\omega = 90^\circ$.

FIG. 18.— $\omega = 100^\circ$.

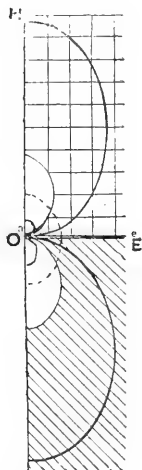
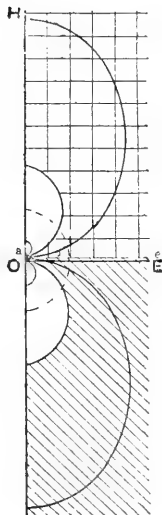
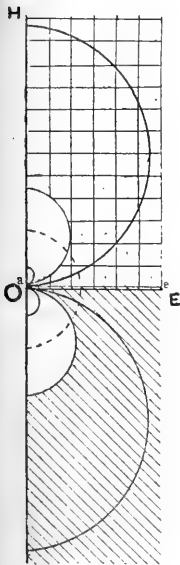

velocity v , having also their directions of motion equably distributed, then the number that are moving from quits lying within an element dS of the surface of the celestial sphere will be $\frac{ndS}{4\pi}$. Let v_0 be the common

velocity of these comets relative to the planet. Then suppose that a spherical surface S' is described with a radius r' about the planet as centre; r' being small relative to the sun's distance, yet not so-small as to forbid the omission of the planet's perturbing action so long as the comet is without the surface S' . In each unit of time out of these comets directed from the element dS of the celestial sphere there would pass nearer than r' to the planet $n \frac{dS}{4\pi} \cdot \pi r'^2 v_0 = \frac{1}{4} n v_0 r'^2 dS$ comets if unperturbed.

Evidently an equal number cross the surface S' entering the sphere in each unit of time.

If now ω be the angle which the comet's unperturbed motion is making with the planet's motion, and if v_1 or its equal $v/\sqrt{2}$, be the planet's velocity in its orbit about the sun, then $v_0^2 = \frac{1}{2} v^2 [3 - 2\sqrt{2} \cos \omega]$.

The element dS may be taken to be the elemental zone between the two small circles whose common pole is the planet's quit, and whose distances from the planet's quit are ω and $\omega + d\omega$. Then $dS = 2\pi \sin \omega d\omega$. The number of comets entering S' in a unit of time with quits within that elemental zone will be

$$\frac{1}{4}nv_0r'^2 \times 2\pi \sin \omega d\omega = \frac{\pi nvr'^2}{2\sqrt{2}}(3 - 2\sqrt{2} \cos \omega)^{\frac{1}{2}} \sin \omega d\omega.$$

The integral of this,

$$\frac{\pi nvr'^2}{2\sqrt{2}} \int_0^\pi (3 - 2\sqrt{2} \cos \omega)^{\frac{1}{2}} \sin \omega d\omega = \frac{7}{8}\pi nvr'^2,$$

expresses the total number of comets that, under the hypotheses that have been made, would in a unit of time enter the sphere S' .

31. If we compare the two expressions obtained in Arts. 27 and 30 we find that the number of comets which, in a given period of time, come nearer to the sun than r is to the number that (unperturbed) come nearer to the planet than r' as $6r^2$ is to $7r'^2$. The factor $\frac{7}{6}$ expresses the increase of numbers caused by the planet's motion in its circular orbit. The value of r' , as has been said, must not be too small, nor yet must it be very large.

32. In order to determine the number N of comets which in a unit of time will have their periodic times reduced below a given period we may make use of the isergonal curves represented in figs. 2-18. Although the diagrams were not constructed to exhibit the motions of the bodies, yet they may be utilised for that purpose. Let OH be the tangent to the planet's orbit, O the place of the planet considered at rest, and let the plane HOE contain the shortest line d between the two orbits. This d will be the abscissa of the point at which the comet's unperturbed orbit will cut the plane. The ordinate of the same point, produced if necessary, will be the projection of the comet's path upon the plane HOE , and the comet's path makes with the plane the angle θ . The velocity of the comet perpendicular to the plane will be $v_0 \sin \theta$. By reason of the hypothesis that the comets are equably distributed, the points of intersection with the plane HOE will be equably distributed over the plane. Hence the number of comets whose quits are in the element dS of the celestial sphere and that will pass the planet in a unit of time in such a way as to have their periodic times reduced below a given period will be equal to the area inclosed in the corresponding isergonal curve multiplied by the velocity perpendicular to the plane, $v_0 \sin \theta$, and by the factor $\frac{ndS}{4\pi}$. If $@$ is the semi-major axis of the orbit for the limiting periodic time, the area of the corresponding isergonal curve will be (Art. 17)

$$\frac{\pi}{\sin \theta} \left(\frac{4m^2@^2}{s^2} - \left(\frac{2m@ \cos \theta}{s} - \frac{mr}{s^2} \right)^2 \right).$$

For dS we may, as before, take $2\pi \sin \omega d\omega$, and we shall then have

$$N = \frac{\pi n}{2} \int v_0 \sin \omega \left[\frac{4m^2@^2}{s^2} - \left(\frac{2m@ \cos \theta}{s} - \frac{mr}{s^2} \right)^2 \right] d\omega.$$

The integration must extend through the positive values of the quantity in square brackets beginning at $\omega = 0$. [In case $\omega = 0$ gives a

negative value for the quantity in square brackets we must integrate between the two values of ω corresponding to the zero value of the bracketed quantity.] We may make S the independent variable by the equations

$$sds = \sqrt{2} \sin \omega d\omega, v_0 \sqrt{2} = sv, \text{ and } 2s \cos \theta = 1 - s^2.$$

These give :

$$N = \frac{1}{4} \pi n m^2 v \int \left[4@^2 - \left(\frac{@ - r - @s^2}{s} \right)^2 \right] ds.$$

33. If now we require the number of comets which in each unit of time shall pass the planet in such way as that they shall have after the passage respectively less than one-half, once, three-halves, and twice, the planet's period of revolution, we may place $@ = rT^{\frac{2}{3}}$, and make T equal successively to $\frac{1}{2}$, 1, $\frac{3}{2}$, and 2, and compute in each case the value of N as given in the last article. The results are found to be $\pi n m^2 r^2 v$ multiplied severally by the coefficients 0.139, 0.925, 1.876, and 2.943.

34. By comparing the results of Arts. 27 and 33, and making the assumptions of Art. 26, we have the proposition, that *the number of comets which in a given period of time pass their perihelia nearer to the sun than a given planet is to the number of comets whose periodic times are reduced by the perturbing action of the planet so as to be less severally than one-half, once, three-halves, and twice, the periodic time of the planet, as unity is to the square of the mass of the planet multiplied severally by 0.139, 0.925, 1.876, and 2.943.*

35. If Jupiter is the planet, $m = \frac{1}{1050}$, and we may express these ratios as

$$1\ 000\ 000\ 000 : 126 : 839 : 1701 : 2670.$$

That is, assuming the hypotheses of Art. 26, and regarding the planet as without dimension so as to intercept any comets, *if in a given period of time a thousand million comets come in parabolic orbits nearer to the sun than Jupiter, 126 of them will have their orbits changed into ellipses with periodic times less than one-half that of Jupiter; 839 of them will have their orbits changed into ellipses with periodic times less than that of Jupiter; 1,701 of them will have their orbits changed into ellipses with periodic times less than once and a half times that of Jupiter; and 2,670 of them will have their orbits changed into ellipses with periodic times less than twice that of Jupiter.*

36. Another and perhaps a more important inquiry is this, what effect have the perturbations of the planet in bringing or not bringing the comets to move in the same direction that the planet is moving after the comets have by perturbation had their periodic times largely reduced? For simplicity and as a special example I shall consider the action of Jupiter only, and also only his action upon those comets whose periodic times are reduced to be less than Jupiter's period, the original orbits of the comets being parabolic. In other words, how many of the 839 comets which are reduced (Art. 35) to have periodic times less than Jupiter's period will after perturbation have goals distant less than 15° , 30° , 45° , &c., severally from Jupiter's goal?

37. Let BA , fig. 19, be drawn to represent v_1 and CA to represent $v_1 \sqrt{2}$. With A as a centre and AB and AC as radii describe the semicircumferences BLO and CHG . Let the angle BAH be made equal to ω and BH be drawn; then HA will represent the comet's velocity about

the sun, BA the planet's velocity about the sun, and therefore HB the comet's velocity v_0 in its orbit about the planet before perturbation. About B as centre describe the semi-circumference KHT. Since the relative

FIG. 19.

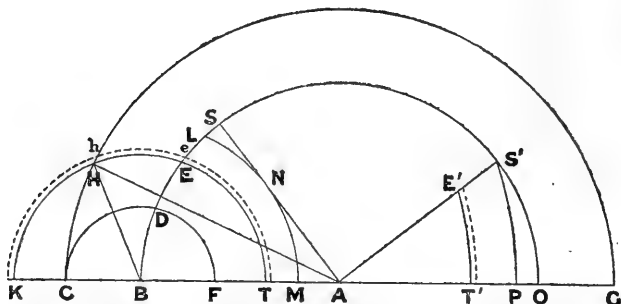

velocity after as well as before perturbation is equal to HB, therefore the velocity of the comet about the sun after perturbation will evidently be represented by a line drawn from some point in the semi-circumference KHT to A. If the velocity is increased the new velocity will be represented by a line to A from some point in the arc KH, if diminished by a line to A from some point in the arc HT. If the new velocity is less than the planet's velocity, and so the new cometic period less than the planet's period, the new velocity will be represented by a line to A from some point in the arc ET. If in a diagram constructed for $\omega = \text{BAH}$ the isergonal curve be drawn for $@ = r$, those comets for which d and h represent points within that isergonal curve will after perturbation have velocities represented by lines drawn from points in ET to A, while comets for which d and h represent points outside that isergonal curve will after perturbation have directions of motion represented by lines drawn to A from points in EHK. The number of comets having motions represented by lines to A from points in ET will be proportional to the area of the isergonal curve $@ = r$. Let the angle BAS represent a limiting value ω'' of distance of quits of comets from Jupiter's quit after perturbation. The comets which are thus limited and at the same time have $@ < r$ will be moving in lines directed to A from points in the area bounded by the straight lines SA and AF, and the arcs FD and DS. Let ω receive an increment $d\omega = \text{Hh}$ and let a new semi-circumference be drawn with B h as radius. To the elemental arc H h will correspond the elemental area along the semi-circumference KET. If ET lies wholly in SAFD the number of comets that pass the planet in a unit of time having initial angles of direction with Jupiter's motion between ω and $\omega + d\omega$ will be equal to the area of the isergonal curve for $@ = r$ multiplied by the elemental number $\frac{1}{2}n \sin \omega d\omega$, and by the relative velocity $v_0 \sin \theta$ of the comet perpendicular to the isergonal area. If the area of the isergonal curve be represented by $\phi s^2 \sin \theta$, then this product will be

$$\frac{\phi}{s^2 \sin \theta} \cdot v_0 \sin \theta \cdot \frac{n \sin \omega d\omega}{2} = \frac{nv}{4} \phi ds,$$

since $\sqrt{2}v_0 = sv$, and $\sqrt{2} \sin \omega d\omega = ds$.

38. This expresses the elemental number of comets corresponding to the elemental area Te . The integral of this expression, that is, $\frac{1}{4}nv\phi ds$, so taken as to cover the area AFDS will give the number of comets which in a unit of time will pass the planet in such a way as to have $@ < r$ and $\omega' < \text{BAS}$. When the elemental area does not extend from the arc DS to the line BA, the area of another appropriate isergonal curve is to be used in determining ϕ .

By Art. 17 we have

$$\phi = \pi n^2 \left[4@^2 - \left(\frac{@ - r - @s^2}{s} \right)^2 \right].$$

For the elemental areas of the surface AFDS which end on the arc DS we make $@ = r$, and let ϕ_0 be the resulting value of ϕ ; then $\phi_0 = \pi n^2 r^2 (4 - s^2)$.

For elemental areas that end on the radius AS the values of $@$ on that line are functions of s . To compute them let v' be the comet's velocity in its orbit about the sun, and hence equal to the distance of the point on AS from A; then, by the triangle of velocities

$$v_i^2 + v'^2 - 2v'v_i \cos \omega'' = v_0^2 = s^2 v_i^2.$$

Again by the laws of gravitation,

$$v'^2 = \left(2 - \frac{r}{@} \right) v_i^2.$$

Hence

$$s^2 = 3 - \frac{r}{@} - 2 \sqrt{2 - \frac{r}{@} \cos \omega''},$$

or

$$\frac{@}{r} = \frac{3 - s^2 - 2 \cos^2 \omega'' \pm 2 \cos \omega'' (s^2 - \sin^2 \omega'')^{\frac{1}{2}}}{9 - 8 \cos^2 \omega'' - 6s^2 + s^4}.$$

Let ϕ' and ϕ'' be the two values of ϕ obtained by substituting in ϕ these values of $@$, ϕ'' representing the value for the point nearer to A.

39. If $\omega'' = 90^\circ$, and therefore $\cos \omega'' = 0$, we have along the limiting line the two values of $@$ equal; hence

$$\frac{@}{r} = \frac{1}{3 - s^2} \text{ and } \phi' = \frac{s^2 - 1}{s^2(3 - s^2)^2},$$

so that the number of comets having quits less than 90° from Jupiter's quit and $@ < r$ is

$$\begin{aligned} \frac{nv}{4} \int_{\sqrt{2-1}}^{\sqrt{2}} \phi_0 ds - \frac{nv}{4} \int_1^{\sqrt{2}} \phi' ds &= \frac{\pi n v m^2 r^2}{4} \left[\int_{\sqrt{2-1}}^{\sqrt{2}} (4 - s^2) ds - 4 \int_1^{\sqrt{2}} \frac{(s^2 - 1) ds}{s^2(3 - s^2)} \right] \\ &= \frac{\pi n v m^2 r^2}{12} (7 + \sqrt{2}) = .7012 \pi n v m^2 r^2. \end{aligned}$$

Since the whole number of such comets is (Art. 33) equal to $.925 \pi n v m^2 r^2$, the number of comets the distance of whose quits from Jupiter's quit is between 90° and 180° is $.224 \pi n v m^2 r^2$. The number of the comets for which $@ < r$ that have inclinations to the ecliptic less than 90° is to the number that have inclinations greater than 90° as 701 is to 224. *Of the*

839 comets spoken of in Art. 36, 203 will after perturbation have retrograde motions, and 636 will have direct motions.

40. If ω'' is less than 90° the expression to be integrated in order to cover the area SAFD will be

$$\int_{\sqrt{2}-1}^{\sin \omega''} \phi_0 ds + \int_{\sin \omega''}^{2 \sin \frac{1}{2} \omega''} (\phi_0 - \phi') ds + \int_{\sin \omega''}^1 \phi'' ds.$$

If ω'' is greater than 90° the corresponding expression becomes

$$\int_{\sqrt{2}-1}^{2 \sin \frac{1}{2} \omega''} \phi_0 ds - \int_1^{2 \sin \frac{1}{2} \omega''} \phi'' ds$$

As the value of @ introduces into ϕ' and ϕ'' only one radical in s , and that a radical of the second degree, these integrations are possible. Finite summation is however more convenient. Computing the values for each interval of 15° we construct the following table. The first column indicates the interval in values of ω'' ; the second column gives that coefficient of $\frac{1}{4} \pi n v m^2 r^2$ that must be used to obtain the number of comets which in a unit of time will pass perihelion nearer than Jupiter's distance to the sun, shall also have their periodic times reduced to be less than Jupiter's period, and shall also leave Jupiter's vicinity so that the distance between the quits of the two bodies is between the two values in column 1; the third column indicates the distribution of the 839 comets of Art. 36 through the twelve zones.

TABLE III.

Limiting values of ω''	Coefficient of $\frac{1}{4} \pi n v m^2 r^2$	No. out of 839 comets
From 0° to 15°	26	6
From 15 to 30	401	91
From 30 to 45	751	170
From 45 to 60	670	152
From 60 to 75	548	124
From 75 to 90	443	101
From 90 to 105	296	67
From 105 to 120	235	53
From 120 to 135	162	37
From 135 to 150	99	23
From 150 to 165	50	11
From 165 to 180	16	4

We see also from the last column of this table that of the 839 comets under consideration 267 have quits less than 45° from Jupiter's quit, while only thirty-eight of them have quits within 45° of Jupiter's goal.

41. Table III. gives the distribution of the comet quits relative to Jupiter's quit. It may also be used to determine how many of the comets whose orbits are thus changed shall have an inclination to the plane of Jupiter's orbit less than a given angle.

Let the angle be 30° . Let Q be Jupiter's quit on the celestial sphere, Q' the comet's quit, and S the sun's position as seen from Jupiter. Then in the triangle QQ'S put ω'' for QQ', the distance of the quits. The side QS = 90° , and QSQ' will be the inclination of the orbits. Represent this angle by i and the angle Q'QS by η . Then $\sin \eta = \cot \omega'' \cot i$.

Let two small circles be drawn about Q at distances ω'' and $\omega'' + d\omega''$;

then if $d\omega''$ be made 15° the numbers in the second or third columns of Table III. indicate how many quits are in the several zones of 15° on the celestial sphere. These may be distributed at smaller intervals than 15° by known processes. All the quits that lie in the lune between two semi-circles drawn through S, so as to make angles of 30° with QS, will evidently have orbits inclined less than 30° to Jupiter's orbit. From $\omega'' = 0$ to $\omega'' = 30^\circ$ all the quits are included in the lune. From $\omega'' = 30^\circ$ to $\omega'' = 90^\circ$ we compute η from the equation $\sin \eta = \cot \omega'' \cot 30^\circ$; then the portion of the quits in any elemental zone that fall in the lune is to the whole number of quits in that elemental zone as this value of η is to 90° . These may be summed by finite summation, and the result is that among the 839 comets 257 would move in orbits inclined less than 30° to the orbit of Jupiter.

42. If a like summation be made for the equal lune that contains Jupiter's goal we find 51 to be the number out of the 839 comets which move in orbits inclined more than 150° to Jupiter's orbit. That is, *some-what more than five times as many of these comets move in direct orbits inclined less than 30° to Jupiter's orbit as move in retrograde orbits inclined less than 30° to Jupiter's orbit.*

43. The comet has been thus far considered as approaching Jupiter while moving in a parabolic orbit about the sun. If the comet, however, is moving in any other orbit, and it passes near to the planet, the result of the planet's perturbing action will in general be quite similar to the result when the orbit is parabolic, the other circumstances of the approach being assumed to be alike in the two cases.

44. These are perturbations during one transit past the planet. But the comet, unless the orbit is further changed by another planet, must return at each revolution to the place where it encountered Jupiter. At some time Jupiter will be nigh that place nearly at the same time as the comet, and the comet will suffer a new, and perhaps a large perturbation. Its period will again be changed, being shortened or lengthened according as the comet passes before or behind the planet. This process will be repeated again and again, since after any number of encounters the new orbit of the comet will still pass near to the orbit of the planet.

This repeated action makes it possible to have an orbit shortened in period by several passages near to Jupiter instead of its being done at one passage. A much larger proportion of comets than 839 out of 1,000,000,000 might therefore have their periodic times reduced below the period of Jupiter.

45. If the comet's orbit is largely inclined to the ecliptic, and hence its motion makes a large angle with that of Jupiter, the diagrams figs. 10-18 show that there is nearly an even chance that the velocity will be increased or diminished. A considerable fractional part of the whole number of such comets will at each passage be thrown out of the solar system altogether, or thrown into such long orbits that they will return only at very great intervals of time. This class of comets cannot be therefore regarded as permanent members of the family of short period comets, except such of them as happen to come so near to other planets as to have their orbits changed in such wise that they do not have thereafter the near approach to Jupiter's orbit. But when an orbit is greatly inclined to the plane of the solar system the comet passes through the plane in general at a considerable angle, and the chance of coming close to another planet is relatively small.

46. On the other hand all the comets which after perturbation are moving in orbits somewhat but not greatly inclined to the ecliptic are liable to meet, in fact are sooner or later almost certain to meet, other planets in such a way as to suffer perturbations that will prevent future close encounters with Jupiter. After such changes those comets must be regarded as tolerably permanent members of the solar system.

47. Comets that have motions not greatly inclined to Jupiter's motion are, as figs. 2 and 4 show, more likely in subsequent passages near to Jupiter to have their periodic times shortened than lengthened. On the contrary those passing in nearly opposite direction to Jupiter's motion will, as figs. 3, 5, and 7 show, be much more likely to have their periods lengthened than shortened.

All these causes combine and work together to the one end that those comets which are changed by the perturbing action of Jupiter, or other planets, from parabolic orbits of every possible inclination to the ecliptic into short period ellipses, and become permanent members of the solar system, will as a rule (but with exceptions) move in orbits of moderate inclination to the ecliptic, and with direct motions.

We know as a fact that most short period comets do move in orbits having small inclinations and direct motions, while long period and parabolic comets move at all possible inclinations to the ecliptic. If the short period comets have been changed by Jupiter and other planets from parabolic orbits, the preceding investigation shows why their orbits have now small inclinations to the ecliptic, and the comets themselves have direct motions.

The Recent Progress of Agriculture in India. By C. L. TUPPER.

[A Communication ordered by the Council to be printed *in extenso* among the Reports.]

SINCE 1884-5 the Revenue and Agricultural Department of the Government of India has published very comprehensive returns of the agricultural statistics of British India, showing from year to year the area irrigated by Government canals, the acreage under cereals and pulses, fibres, and other crops, the total area cropped, and many other particulars. I have abstracted some leading figures from these returns, and append my abstracts to this paper.

It will be observed that in the period of six years, from 1884-5 to 1889-90, comprised in these returns the total cultivated area has risen from 126 million acres to 136 million acres. I give the increase in round numbers, and I propose throughout the text of this paper to use round numbers only, showing the most precise figures I can get, either in footnotes or in the appended abstracts from the returns. The figures of 1884-5 necessarily do not include Upper Burmah, nor do they include Ajmere, or the *pargana*, or tract known as Manpur in Central India. Accordingly, to arrive at the total increase of cultivation in the six years, we must deduct for these localities some three million acres. We thus arrive at an increase of seven million acres, or a little more than one million acres a year. The population of India now amounts to 286 millions, of which 220½ millions live in British territory and 65½ millions in the protected native states. In the decade 1881 to 1891 the increase

has been 29 millions. But if we take only British territory, and exclude Upper Burmah as a fresh acquisition, it appears that the population has risen by nearly 19 millions,¹ or by $14\frac{1}{2}$ millions if we exclude Bengal, which it is necessary to do because the Bengal figures are omitted from the returns, the land revenue system which obtains in Bengal affording no facilities for their compilation. The proportionate increase in the area under review during the six years comprised in the returns would be about 8,700,000; so that for each extra mouth to be fed we have nearly '81 acre of additional cultivation. This is not much, seeing that, according to the figures given by the Famine Commission in 1880, the ratios of the cropped area in the principal provinces ranged from '88 of an acre per head in the North-West Provinces to 1·9 acres in the Central Provinces.

The second statement I have prepared (Statement B) shows the extension of the irrigated area during the same six years. The increase due to the inclusion of Upper Burmah is 400,000 acres, so that the extension of the irrigated area in India generally, less Bengal, may be taken at $4\frac{1}{2}$ million acres, from 23 million in 1885-6 to $27\frac{1}{2}$ million in 1889-90.² The figures include all sources of water supply—Government and private canals, tanks, wells, and hill streams. It is not possible to state with precision the portion of this area which is irrigated by Government canals because the Bombay returns of land irrigated in that way include also the acreage watered from canals which are the property of private persons. But I may estimate the area irrigated by Government canals at nine million acres. The Famine Commissioners assumed that an acre of irrigated land can produce enough food to support 2·5 people. It is safe to suppose that at least $2\frac{1}{2}$ million out of the $4\frac{1}{2}$ million acres newly brought under irrigation were untilled before, thus allowing 2 million acres as old cultivation now improved by being irrigated. On these data, with the additional assumption that one unirrigated acre will yield enough food for one person in the year, we may calculate that $4\frac{1}{2}$ million acres of fresh irrigation will produce enough food for $9\frac{1}{4}$ million people. I have shown that the increase of the cultivated area, irrigated and unirrigated, amounts to seven million acres; so that, on the supposition—too favourable a one—that the whole addition to the tilled breadth is given to food crops, we have an additional food supply for $11\frac{3}{4}$ millions to set against an actual increase of 8,700,000 in the population. Without pretending that this result possesses any greater degree of accuracy than is warranted by the nature of the returns and suppositions on which it is founded, I think it a safe general conclusion that the agricultural development which is implied in the extension of cultivation and the extension of irrigation keep pace, and do not do much more than keep pace with the simultaneous increase in the numbers of the people.

This is not a startling conclusion; and it is one, I think, to be weighed with sobriety of judgment, with a mind neither specially elated nor unduly depressed. There are physical limits, of course, to the extension of cultivation, and to the application of that most obvious and in many places, but not in all, most useful of Indian agricultural improve-

¹ Year 1881	Population 198,655,160
Year 1891	Population 217,487,370
Difference	+ 18,832,210

² I exclude the figures for 1884-5 because in that year statistics for Bombay and Sindh are not available.

ments—the supply of artificial irrigation to dry areas by means of wells or canals. There are considerable parts of India, such as the Patna and Burdwan Divisions of Bengal, the Benares Division, and the Lower and Middle Doáb in the North-West Provinces, with parts of Rohilkhand and Oudh, and two or three of the most populous districts in the Punjab, where the population is already so dense that it presses closely on the means of subsistence. Elsewhere it is important to distinguish between the wastes already included in village areas, used as common grazing grounds for cattle, and great unoccupied blocks of arable land available for new settlers. Village grazing lands are to be found practically everywhere. In British India there are only a few well-defined tracts fit for settlers, though of some of these the areas are enormous. In the southern plains of the Punjab, between the great rivers, there are some eight or nine million acres of fairly fertile soil, ready for cultivation, if only water can be given to them. In the Central Provinces the Famine Commissioners mentioned two tracts, one in the western end of the Nerbudda Valley and the other in the eastern, or Chatisgarh Division, to which the attention of immigrants might be directed. In Assam and Burmah there is a vast extent of culturable land. I cannot do better here than quote the report of the Famine Commission, from which these facts are derived:—‘There is,’ it says, ‘outside the congested tracts, in most villages, scope for a slow and gradual extension of cultivation by the breaking up of uncultivated land, and for the more careful cultivation of what is now under tillage, and outside the village areas there is an immense extent of land which is more or less fit for cultivation. But much of it is poor land, and where it is not poor either the climate is feverish or else the conditions are so different from those that prevail in the densely populated places from which emigration might be desired or expected to come that settlers would be alarmed and discouraged. Probably the only tracts to which these objections do not apply are the desert waste plains between the Punjab rivers and along the Indus, in which, if irrigation is ever introduced, cultivation can be carried on under much the same conditions as those which prevail in the greater part of Upper India.’

Any such attempt as this to convey in the space of less than half an hour some prominent facts connected with any recent development of agriculture in India must almost necessarily start from the admirable report in which the remarks I have just quoted were made. That report gathered into a focus all the light then available as to Indian agriculture, and it has been diffusing it ever since. I draw special attention to the conclusions of the Famine Commissioners as regards the waste lands between the great Punjab rivers because I am anxious to point out that the Government of India is fully alive to what is probably the greatest agricultural improvement that it is at present within its power to effect, and that the Local Government concerned and its officers are energetically co-operating in the endeavour to bring about that improvement in a satisfactory way. In every one of the vast interspaces between the Punjab rivers, including the space between the Swat and Cabul Rivers and the Indus, we now have either important irrigation canals or projects for such canals sanctioned or unsanctioned. It must not be supposed that this is any direct result of the recommendations of the Famine Commission. Two of the permanent canals, the Bari Doáb and the Western Jumna, are of old date; and the Swat River Canal was planned and the

Sirhind Canal was under construction years before that famine in southern India which led to the appointment of the Commission. Still the recommendations of the Commission coincided with conclusions locally well known and already in process of practical acceptance. I append a statement (Statement C) of the perennial canals in the Punjab constructed and under construction. I have to add that for the space between the Indus and the combined Jhelum and Chenab there were projects not yet sanctioned, so far as I know, when I left India; while, further north, between these two rivers, the Jhelum Canal, already sanctioned, had been begun: this work, for reasons on which I need not enter here, had been temporarily discontinued. All the other Doábs, or spaces between the rivers, are accounted for in the appended statement.

In addition to these perennial canals there are, both in the Punjab and in Sindh, very numerous inundation canals. These are cuts of simple construction filled by the flood waters of the Sutlej, Chenab, and Indus, as the rivers rise in the late summer and autumn. Some of these, notably the Muzaffargarh canals, have been greatly improved of late years, and new ones, such as the Sohág and Pára and Sidhnai, have been constructed. Here we have been able to induce cultivators from crowded districts to settle on virgin soil, and the success of the measures taken has been very great. The system of tenure and allotments which has given this result was devised by the late Colonel Wace and put into execution by Lieut.-Colonel Hutchinson. I believe it to possess great importance as a precedent, not only with reference to the spread of irrigation to other waste lands in the Punjab, but also with reference to other parts of India where the cultivating settlement of immigrants may be contemplated as a possibility. The area irrigated by inundation canals in Sindh is, I believe, about 1,800,000 acres. In the Punjab it was some 930,000 acres at the date of the report of the Famine Commission, and is by the latest returns 1,242,000 acres.

Of the $27\frac{1}{2}$ million acres shown as irrigated nearly 10 million acres are irrigated by wells. It is in the alluvial soil of upper India that a water-bearing stratum is found from 10 to 40 feet below the surface, and the irrigation of crops by means of wells is commonly seen along the courses of the rivers of the Indus and Ganges systems. In the uplands of the spaces between the Punjab rivers the depth of the water-table from the surface is so great that well-sinking becomes an unprofitable venture. In the Central Provinces, Berar, the Bombay Deccan and parts of Madras the subsoil is often rocky and the use of wells is much restricted. I have prepared a return (Statement D) showing the area irrigated by wells in Madras, the North-Western Provinces and Oudh, and the Punjab, with the totals including other provinces, for the five years ending with 1889-90. This shows a steady and general improvement, the area having risen in every province almost year by year, and having increased on the whole from some 8,750,000 acres in 1885-6 to nearly 10 million acres in 1889-90. An increase of $1\frac{1}{4}$ million acres of cultivation from wells is valuable, not only because this additional area is thus secured from famine, and enabled to produce better and more valuable crops, but because these improvements are made by private persons at their own cost, and are thus evidence of enterprise and security of tenure.

Before I leave the returns showing the extension of cultivation there are two further remarks I wish to make; which I owe partly to Mr. O'Connor's 'Review of the Trade of India for 1888-9' and partly to a

speech I not long ago heard made by Mr. H. J. S. Cotton, one of the Secretaries to the Bengal Government, at a meeting of the East India Association. It is obvious that the mere extension of the cultivated area is not necessarily a good thing in itself. If poorer soils, with a precarious rainfall and no other means of irrigation, are broken up and barely supply the wants of an increasing population, this merely means a spread of the insecure area already liable to famine. Now in the case of the Punjab canals, which I mentioned just now, water is being brought to virgin soils; and we hope that, as far as possible, the land allotments will be taken up by incoming settlers from congested districts. All this is, I think, unmixed gain.

The other remark is that the changes which have taken place in Indian trade must necessarily produce corresponding changes in Indian agriculture. The historic exports of India, such as spices, silk, lac, and dye stuffs, now take a secondary place; opium and indigo still hold their ground, but the rapid advance in the export trade is of recent origin and is based upon the European demand for Indian raw products. The great export of cotton followed the American War of Secession (1861-5). The export of jute practically began after the Crimean War. 'The seed trade,' Mr. O'Connor says, 'and the trade in wheat and rice took their present large proportions only after the opening of the Suez Canal. The great tea trade and the trade in coffee are the creations of the last quarter of a century. So with the exports of hides and skins, wool and timber.' It is a question for experts whether, in taking raw products and returning cotton piece goods of English manufacture, we do not slowly add to the impoverishment of the soil. The remedy for the evil, if evil there be, is doubtless to be found in greater diversity of occupations. There is a beginning in this; of the 114 cotton mills and 26 jute and hemp mills now at work in India not one existed in 1848 and nearly all have been started within the last twenty years.

Some of the most valuable recommendations of the Famine Commission had reference to the relations of proprietors and tenants. The Commission urged that, where this was not already sufficiently provided by law, guarantees should be accorded to the landed classes that they should without hindrance enjoy the fruits of improvements made at their own expense. In the case of those persons who pay the land revenue direct to Government, all of them, though called by different names and holding tenures of different kinds in different parts of the country, have always under British rule, at least during the present century, had the benefit of security of tenure. In many parts of the country, particularly in portions of Northern and Western India, where the old Hindu institutions successfully reasserted themselves against Muhammadan supremacy, or where that supremacy was never effectual, or where wise Muhammadan emperors or governors laid down fairly lasting lines of revenue administration conceived in the Hindu spirit, the revenue-payers are very commonly, though by no means invariably, themselves the actual cultivators, and a class of tenants interposed between them and the soil, though it occurs, is not general. Even in these provinces there is a tenant question; the stratification of Indian society, indeed, bears witness almost everywhere to the superposition of race upon race, or tribe upon tribe, due doubtless to untold ages of internal warfare and successive invasions of new tribes or races from without. In other parts of the country we found the old state of things terribly confused and almost entirely obliterated

by the misrule of the mushroom Muhammadan governments that sprang up outside the spheres of influence of the Sikhs and Mahrattas in the wide ruins left by the downfall of the Delhi Empire. The cruel and grasping expedient of farming the revenues adopted by our unscrupulous predecessors, and continued for a space by ourselves when we had not the knowledge or experience to enable us to dispense with it, left us in large provinces a tangled web of tenures which we are only now getting straight. Since 1880, when the Famine Commissioners submitted their report, the whole law of landlord and tenant has been thoroughly reconsidered, both in the light of their recommendations and in accordance with local needs and proposals, in Bengal, in the North-West Provinces, in Oudh, in the Punjab, and in the Central Provinces; that is, the best efforts of the Government and of the most competent officials and other persons whom it could consult have been given to the amelioration of land tenure in the whole of Northern India, so far as it is British, from the Himalaya to far below the Nerbudda and Tapti, and from Peshawur almost to Manipur. In the same period the land revenue law, that is, the law for the assessment and collection of the land revenue, vitally affecting the economic conditions of the country, has been carefully revised in the Central Provinces and the Punjab. How extensive and how onerous these tasks have been few know besides those who have had to deal with them. To my mind they are, in their successful completion, agricultural improvements of the first consequence; and no economist can impute to the State misguided intervention here. No hand but that of the law could hold the balance between the conflicting interests of those who draw their livelihood from the soil, and who have learnt from our inevitable accentuation of individual right, derived from Western theories of legal equality, to enforce, by legal processes, in novel and powerful courts of justice, their antagonistic claims. Nor could any authority but that of the State itself determine from time to time the most suitable methods of assessing and collecting that public demand, wholly unlike any impost in this country, which may, according to our point of view, be described as a land-tax or a State rental.

There was another set of proposals made by the Famine Commissioners which has produced and is producing very important effects in India. As they advised, the Revenue and Agricultural Department of the Supreme Government, which had been temporarily in abeyance, was quickly revived. In all the great provinces officers have been appointed under the designation of directors of land records and agriculture, or of commissioners of settlements and agriculture, whose duty it is, under the Local Governments and Administrations, to supervise the detailed execution of that policy of agricultural inquiry upon which it was a main object of the Famine Commissioners to insist. It is a recommendation of that policy that it is founded on native institutions of great antiquity and wide extent; and it is only so far new that it utilises them for beneficent purposes that were unknown to our predecessors, and too little realised by ourselves, until the examination of the evidence connected with a series of famines produced the abiding conviction that the effort to prevent or circumscribe, or at least to mitigate, those disastrous evils is amongst the first duties of the State in India. Wherever a just and careful assessment of the land-revenue demand has been made in temporarily settled districts, the basis of it has been sound agricultural inquiry. Practically the Famine Commissioners may be said to have

pointed out that the sort of knowledge of the agricultural conditions of an Indian district necessarily gathered by an assessing officer in the process of fixing the land-revenue demand for a term of years ought, for the proper administration of the charge, to be continuously available during that term of years to every officer in charge of a district. The foundation of this knowledge is the returns and records which are annually prepared by the village accountants—officials, usually hereditary officials, who have existed in India for ages before our time. Attention has therefore been directed to the improvement of this indigenous agency and to its more effective supervision in each district by a staff of native officials acting under the orders of the district officer and his principal assistants. The object in view has been to provide for each village a record, always kept up to date, of all essential particulars bearing on its agricultural efficiency, so that from harvest to harvest the responsible functionaries may be supplied with sufficient and trustworthy information as to the extent and character of the crops grown, as to the prosperous or depressed condition of the peasantry, and as to any risk there may be of famine or scarcity. In this way, if famine comes, it will take no one by surprise, and those concerned will be able to battle with it to the best advantage, because they will possess detailed knowledge of the actual circumstances of particular tracts. If scarcity comes, not amounting to famine, the district officer by timely suspensions or remissions of the land-revenue demand, or by the institution of timely relief works, if required, may be able to avert that terrible weakening of the health of the people, due to hard times, which when the sickly autumn months come round culminates in appalling mortality. If there is neither famine nor scarcity the continuous maintenance of correct records of the state of agriculture will enable the next reassessment of the land revenue to be made with speed, and in proportion as the whole system is efficient, the people will be spared, at intervals of twenty or thirty years, the harassment of inquiries by a small army of strange officials, and that cruel drag upon agricultural improvement which consists of prolonged uncertainty as to the rate of land-tax or State rent that they will have to pay.

If the first great work which in part resulted from, or at least was largely influenced by, the labours of the Famine Commission was the revision of the law of landlord and tenant in Upper India, the second great work has been this thorough and extensive organisation of agricultural inquiry which I have been endeavouring to describe. There is a third great work which deserves mention, though it is not really comparable in extent and complexity with the other two. In each province a famine code has been prepared which will serve as a manual of famine relief for the guidance of all concerned on the next occurrence of famine. I have already explained that due regard is being paid to the extension of canal irrigation. As to railway extension, as probably the most powerful of all prophylactics against famine, I leave that subject for the next paper, which is to deal with recent improvements in communications. I will only remark, lest I appear to have overlooked so very important an item in agricultural conditions, that in India generally, including native states, there were 8,492 miles of railway open in 1879-80, and that there were open in 1889-90 (by the last return), 16,097 miles. The railway mileage has thus been nearly doubled in eleven years.

I suppose I ought also to say a very few words on what are known as

agricultural improvements in this country of peace and plenty, where, in these days, famine never comes, and where farming is a business conducted on business principles, not the sole means of subsistence for the vast mass of the population. You will anticipate the general drift of my remarks when I say that I agree with those who hold that we have far more to learn from the Indian peasant about Indian agriculture than, even with the resources of science at command, we are at all likely, for some time to come, to be able to teach him. Reforms have been attempted—the introduction of new crops, improvements in the methods of cultivating the ordinary crops of the country, the adaptation of English or other machinery to Indian conditions, and the breeding of cattle. Anything I might tell you under these heads would be a mere repetition of what is said in Part II. of the ‘Report of the Famine Commission,’ pp. 137–9. Of the important staples successfully introduced—viz., tea, coffee, the Mauritius sugar cane, New Orleans cotton, cinchona, and potatoes—it may, however, be interesting to mention, in connection with British trade, the areas now cultivated with coffee and tea. The coffee area has slightly contracted. It was some 121,000 acres in 1884–5, and some 118,000 in 1889–90. In the same period the area under tea has risen from nearly 130,000 acres to more than 250,000. In my own province, the Punjab, the breed of horses has certainly been improved within my recollection. For the rest, I will only say that the Indian agriculturist is well aware of the value of manure, but with reference to the vast distances that have to be traversed, and to some other considerations, either could not afford to buy or would be unwilling to use imported manures, while he wants a great part of his farmyard manure for fuel. There are many practical difficulties in the way of the employment of English ploughs and of deep ploughing; and expensive machines worked by steam, which could not be mended by village blacksmiths, are out of the question for peasant holders of small plots scattered in villages over the face of a vast, very primitive country. The most that can be said, I think, is that the Indian peasant may possibly plough deep, use more manure, and abstain from drenching the soil with all the water he can let on to it, when he is convinced that an alteration of practice in these respects will be profitable to himself in his lifetime. We have hitherto entirely failed to demonstrate to his satisfaction the pecuniary advantage of a change. Our efforts, too, in technical education in agriculture have not, so far, either reached or formed the practical farmer. They have merely resulted in a new brood of hungry aspirants for employment as officials.

I hope that in the space I have at my disposal I have been able to make it sufficiently clear that in speaking of such a primitive country as India we cannot use such an expression as the development of agriculture in quite the same sense in which we apply it to the highly cultivated and civilised countries of Europe at the present day. Famine, it has been well said, is one of the diseases of the infancy of nations; and at present our best efforts are needed rather to prevent or mitigate that sudden and terrible deterioration of agriculture which is implied in famine than to convert the empiricism of a thousand generations to Western beliefs in scientific farming. I do not deny that to improve agricultural methods is a part of the means of famine prevention; but I would add that another disease of the infancy of nations is chronic war. To England, to this land of ours where there is indeed much poverty,

famine, as I have said, never comes, pestilence but rarely, and we have almost forgotten that the fire and sword of the invader or freebooter were for centuries part of the ordinary lot of human kind. Those touching and familiar supplications for deliverance from plague, pestilence and famine, from battle and murder, and that peace may be given in our time, have happily lost here that sort of significance which attaches to an attempt to ward off evils known in all their bitterness by personal and recent experience. In India we are far nearer to the actual conditions of society which existed when that litany was framed upon which ours was largely modelled. In India we have given the land peace; and that is, indeed, one of the greatest of all agricultural improvements, as anyone knows well enough who has seen on or beyond the Indian north-west frontier armed men ploughing their fields, armed shepherds and graziers pasturing their flocks, and the village towers of refuge dotted about the village lands, lest perchance there should come some band of raiders too strong to be dealt with in the open plain. We have given the land peace and must maintain it. That alone is no light task. We must also decide justly those conflicting claims of various sections of the people which have arisen in part from the imposition of civilised rule upon primitive societies and in part from centuries of incessant violence and war; and we must be prepared to face pestilence and famine, and when they come, to do our best to mitigate their ravages. I do not say that in securing all this we should neglect agricultural chemistry and experimental farms. I only say that in promoting these means of agricultural improvement we must not forget their relative importance in view of some of the first duties which Indian Governments have to discharge.

In India three important committees have lately assembled to consider agricultural affairs. A Bombay committee, which reported on July 8, 1890, recommended an increase in the number of experimental farms, the establishment of cattle farms, and an increased expenditure on seed for distribution and improved machinery and implements. The Madras Government on the 4th of the same month, reviewing the report of the Madras Committee, condemned in some lively sarcasms the operations of the past, noting that the amount of real good secured had been infinitesimal, and that the greater part of the money which had been spent on agricultural improvement and education in the Madras Presidency had been thrown away. A project was approved for the establishment of combined agricultural schools and farms at or near the headquarters of five representative districts, the College of Agriculture was to be maintained with some improvements in its course, and the branch of the Agricultural Department which dealt with cattle disease was to be abolished. The third committee was held in October 1890 under the presidency of Sir Edward Buck. It was mainly the outcome of the mission of Dr. Voelcker, the agricultural chemist to the Royal Agricultural Society of England, who was deputed to India by the Secretary of State to investigate the conditions under which action may usefully be taken in connection with agricultural experiments in that country. The Committee proposed the appointment of an agricultural chemist in India for a term of seven years; the maintenance in each province of a system of farms for inquiry and experiment; the better extension of primary education amongst the agricultural classes; and the combination of instruction in agriculture with the existing course of instruction. In

several of these matters past experience alone would hardly justify any sanguine expectation of great results. But let us trust that the sober and serious spirit of resolve to try again with more system and with a frank recognition of past mistakes—a spirit which, I think, may be said to characterise all these proceedings—may lead in course of time to improvements which will, at all events, beat the past record. I will venture to add a suggestion for the consideration of the authorities. More than a decade has now elapsed since the submission of the Report of the Famine Commission. It contained a vast number of detailed proposals. I have not troubled you to-day with more than a very few of the leading heads, but I may mention that the second part of the report, dealing with measures of protection against famine and its prevention, suggests a great number of administrative changes, many of which have since come under separate consideration. I may instance the general organisation of the superior official staff—since the subject of the labours of the Public Service Commission; the relations of landlord and tenant; the assessment and collection of the land revenue; the indebtedness of the landed classes; the policy of Government in regard to railways and canals, emigration, and forest conservancy; and the encouragement of diversity in occupations. Would it not be a good employment for the next Agricultural Committee assembled in India to refer one by one to all the proposals in the second part of the report of the Famine Commission that were approved by the Secretary of State, and to report, for the information of Government and the public, what proposals have been carried out and in what manner, what still remain for consideration, and whether any of these should be taken up and put into execution now? As a study of Indian agricultural conditions and of the principal problems bearing upon agriculture in India, I do not think it likely that the report of the Famine Commissioners will, in this generation, be excelled; and I am sure all who have looked into that most valuable record will agree with me that very full justice should be done to the great knowledge of Indian life, character, physical surroundings, and possibilities which it displays throughout. Sir Edward Buck, in his address to the Committee of October last, was careful to point out that the gradual establishment of a sound system of scientific investigation and of education in connection with agriculture was the next point to be taken up in the approved programme of the Famine Commission. Without disputing that view or undervaluing in any way the possibilities of important additions to knowledge and of improvement which may result from the employment of a first-class expert, I merely wish to draw attention to the wider measure of a general examination at this date of the scheme of the Famine Commission considered as a whole. The remarks made in this paper have necessarily been slight, and have dealt much more with the conditions of Indian agriculture than with the connection between Indian agriculture and British trade. I hope that part of the subject will be more fully discussed by other speakers. If such an examination of the views of the Famine Commission as I have here suggested be undertaken in India within the next two or three years, the time spent on this paper will not, I trust, prove to have been altogether thrown away.

I will, in conclusion, refer to one proposal made by the Famine Commissioners which, I think, might be revived with advantage. At present members of the Indian Civil Service are forbidden to hold land in the provinces where they are employed. No doubt it is undesirable that

Indian Civil Servants should farm for profit. They must not be distracted from their official duties or have interests that might clash with those duties, or be even open to suspicion of irregularities in dealings with tenants or labourers or traders in produce. But these objections would hardly apply to district officers permitted to hold small areas of 50 or 100 acres on lease for purposes of recreation and experiment. If this permission were given to the comparatively few who would care to have it, a good deal of practical experience of much value might be accumulated.

STATEMENT A.—*Cultivated Area.*

Year	Madras	Bombay and Sindh	N.W.P.	Oudh	Punjab	Total (excluding Bengal)
1884-5	21,331,674	25,966,024	22,244,943	8,764,086	22,553,701	125,955,122
1885-6	22,463,253	25,424,532	25,102,975	8,819,063	20,512,118	128,282,535
1886-7	23,004,643	26,355,920	25,466,869	8,801,909	18,387,661	128,316,277
1887-8	23,326,272	26,352,865	25,244,378	8,828,303	20,586,028	131,231,180
1888-9	23,157,408	26,928,859	24,829,969	8,857,670	20,720,695	134,653,056
1889-90	23,797,036	28,088,955	25,123,483	8,873,699	19,407,513	136,168,899

STATEMENT B.—*Area Irrigated.*

Year	Madras	Bombay and Sindh	N.W.P.	Oudh	Punjab	Total (excluding Bengal)
1884-5	5,546,191	Statistics not available	6,820,931	2,957,765	6,672,966	22,470,244
1885-6	5,815,378	2,440,620	5,820,559	1,928,068	6,635,951	23,098,822
1886-7	5,999,922	2,305,974	5,568,943	2,269,446	6,555,592	23,250,530
1887-8	6,234,432	2,417,836	6,208,299	2,448,267	6,990,682	24,936,091
1888-9	6,231,358	2,835,375	6,232,092	2,496,996	7,379,293	26,343,519
1889-90	6,398,285	3,363,024	6,693,541	2,507,510	7,487,483	27,722,441

STATEMENT C.—*Punjab Canals.*

—	I.	II.	III.	IV.	V.	VI.
	Swat River Canal	Western Jumna Canal	Sirsa Branch Western Jumna Canal	Bari Doab Canal	Sirhind Canal	Chenab Canal
<i>Area Irrigable—</i>						
By complete project	Acres 120,000	Acres 550,000	Acres 175,200 ¹	Acres 525,000	Acres 800,000 ²	Acres 400,000
At present	120,000	550,000	Under construction	525,000	778,000 ³	148,000
<i>Mileage of works as now sanctioned—</i>						
1. Main and branch canals	Miles 22	Miles 280	Miles 138	Miles 362	Miles 542	Miles 125
2. Distributaries	129	916	528	1,049	4,413	273

The miles shown in this statement are canal miles of 5,000 feet.

¹ British, 126,290; Native States, 48,910. Total, 175,200.

² British, 522,000; Native States, 278,000. Total, 800,000.

³ British, 500,000; Native States, 278,000. Total, 778,000.

STATEMENT D.—*Area Irrigated by Wells.*

Year	Madras	N.W.P.	Oudh	Punjab	Total (including other Provinces)
1885-6 . . .	803,479	2,925,159	1,063,780	3,831,051	8,742,798
1886-7 . . .	816,648	2,805,020	956,015	3,749,818	8,489,566
1887-8 . . .	1,055,912	3,104,326	1,235,878	3,839,447	9,398,590
1888-9 . . .	1,100,083	3,221,444	1,247,290	3,882,921	9,618,466
1889-90 . . .	1,169,141	3,462,484	1,217,849	3,959,427	9,967,701

The returns for 1884-5 are too imperfect to be worth abstracting.

STATEMENT E.—*Coffee and Tea Culture.*

Year	Coffee	Tea	Year	Coffee	Tea
1884-5 . . .	121,468	129,314	1887-8 . . .	117,894	234,176
1885-6 . . .	119,142	219,111	1888-9 . . .	118,262	241,077
1886-7 . . .	117,504	227,258	1889-90 . . .	118,219	251,672

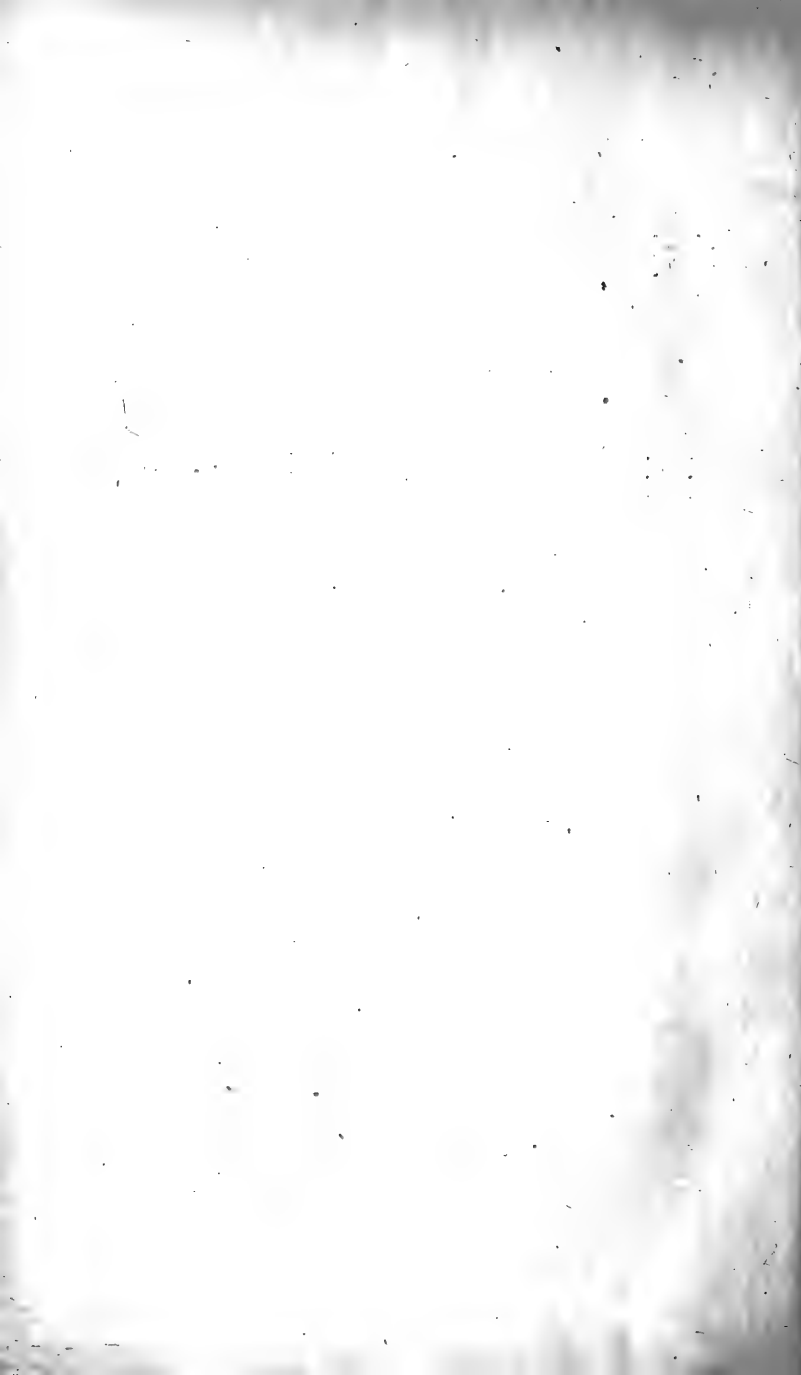

TRANSACTIONS OF THE SECTIONS.

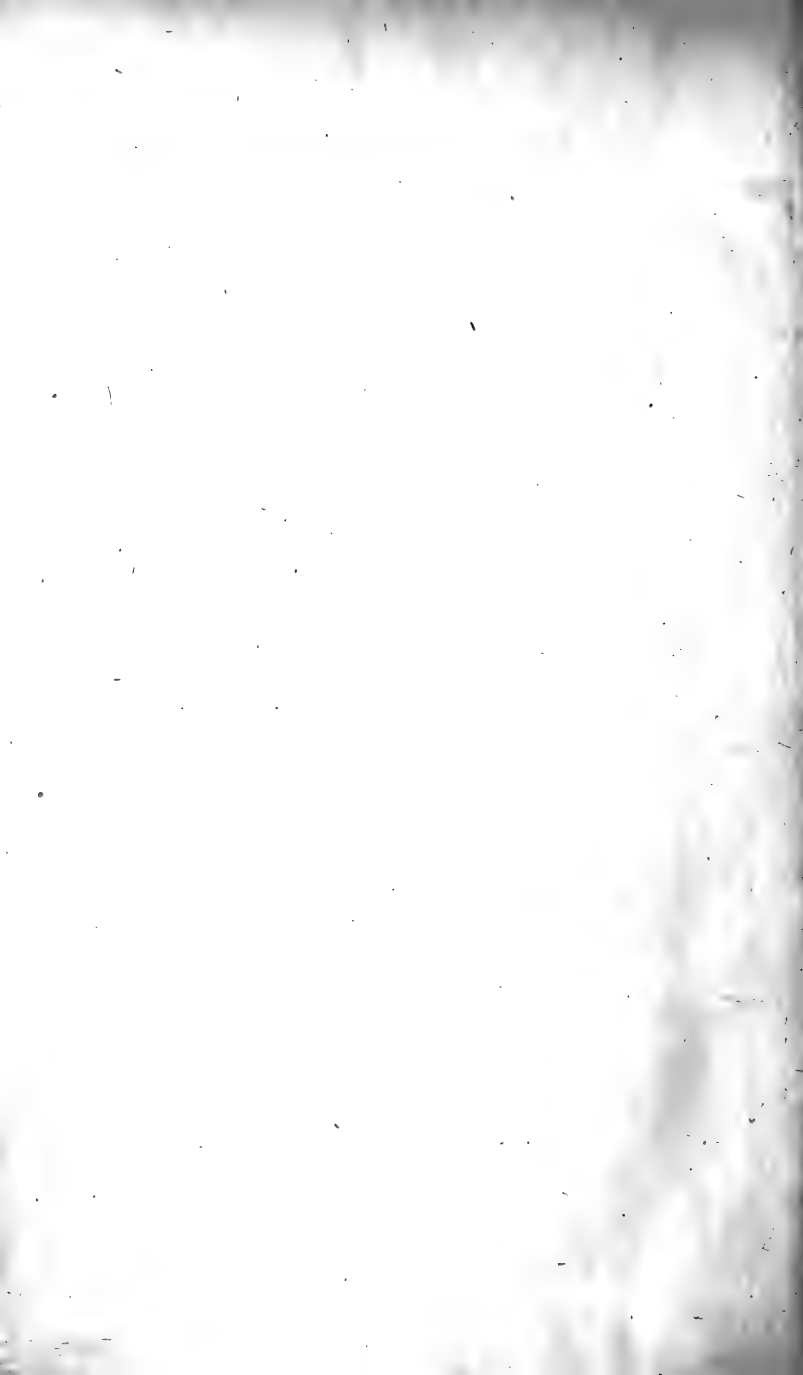

TRANSACTIONS OF THE SECTIONS.

SECTION A.—MATHEMATICAL AND PHYSICAL SCIENCE.

PRESIDENT OF THE SECTION—Professor OLIVER J. LODGE, D.Sc., LL.D., F.R.S.

THURSDAY, AUGUST 20.

The PRESIDENT delivered the following Address:—

DURING the past year three or four events call for special mention in an annual deliverance of this kind by a physicist.

One is the Faraday centenary, which was kept in a happy and simple manner by a cosmopolitan gathering in the place so long associated with his work, and by discourses calling attention to the modern development of discoveries made by him.

Another is the decease of the veteran Wilhelm Weber, one of the originators of that absolute system of measurement which, though still hardly grasped in its simplicity and completeness by the majority of men engaged in practice, nor even, I fear, wholly understood by some of those engaged in University teaching, has yet done so much, and is destined to do still more, for the unification of physical science, and for a thorough comprehension of its range and its limitations.

A third event of importance during the year is the discovery in America of a binary system of stars, revolving round each other with grotesque haste, and with a proximity to each other such as to render their ordinary optical separation quite impossible. Ideas concerning the future of such systems, if, as seems probable, their revolution period is shorter than their axial period, will readily suggest themselves, in accordance with the principles elaborated by Prof. George Darwin. The subject more properly belongs to our President, but I may parenthetically exclaim at the singular absurdity of the notion which was once propounded by a philosopher, that motion of stars in our line of sight must for ever remain unknown to us; whereas the mere time of revolution of a satellite, compared with its distance from its central body, is theoretically sufficient to give us information on this head. As a matter of pedagogy it is convenient to observe that the principle called Doppler's, which is generally known to apply to the periodic disturbances called Light and Sound, applies equally to all periodic occurrences; and that the explanation of anomalies of Jupiter's first satellite by Roemer may be regarded as an instance of Doppler's principle.¹ Any discrepancy between the observed and the calculated times of revolution of stars round each other can possibly be explained by a relative motion between us and the pair of bodies along the line of sight.

If our text-books clearly recognised this, we should not so often find examination candidates asserting that the apparent time of revolution of a satellite of Jupiter depends on the distance of the earth from that planet, instead of on the speed.

¹ Dr. Huggins has just pointed out to me a perfectly clear statement to the above effect in Professor Tait's little book on Light.

I should indeed be sorry to be judged by the performance of my own students, but I fear that many of the less obvious mistakes made by reasonably trained examination candidates are more directly traceable to their teachers than some of us as teachers would like to admit.

The change in the refrangibility of light by reason of the motion of its source, though familiar enough now, was at first regarded as too small to be observed, and one or two attempts directed to detecting the effect of this principle on the spectra of the stars, or sometimes on sunlight reflected by a 45° mirror into the line of the earth's motion (which is not a possible method), wholly failed. I take pleasure in remembering that this effect was clearly observed for the first time by the gentleman we this year honour as our President; and that it is by this very means that the latest sensational discovery in astronomy of the rapidly revolving twin star β -Aurigæ, by Prof. Pickering and the staff connected with the Draper Memorial, was made.

The funds for the investigation that led to this result were provided by Mrs. Draper, as a memorial to her late husband; and if β -Aurigæ does not constitute a satisfactory memorial, I am at a loss to conceive the kind of tombstone which the relations of a man of science would prefer.

The fourth event to which it behoves me to refer is the practical discovery of a physical method for colour photography. When I say practical I do not mean commercial, nor do I know that it will ever become applicable to the ordinary business of the photographer. Whether it does or not, it is a sound achievement by physical means of a result which the chemical means hitherto tried failed, some think necessarily failed, to produce. I say practical, because already it had been suggested as possible theoretically; and a step toward it, indeed very near it, had been actually made. The first suggestion of the method, so far as I know, was made by Lord Rayleigh in the course of a mathematical paper on the reflection of light, and with reference to some results of Becquerel obtained on a totally different plan. He said in a note that if by normal reflection waves of light were converted into stationary waves, they could shake out silver in strata half a wave-length apart, and that such strata would give selective reflection and show iridescence.

The colour of certain crystals of chlorate of potash, described in a precise manner by Sir George Stokes,¹ and also the colours of opal and ancient glass, had been elaborately and completely explained by Lord Rayleigh on this theory of a periodic structure (the laminated structure in the case of chlorate of potash being caused by twinning²); and he subsequently illustrated it with sound and a series of muslin discs one behind the other on a set of lazy-tongs. Each membrane reflected an inappreciable amount, but successive equidistant membranes reinforced each other's action, and the entire set reflected distinctly one definite note, of wave-length twice the distance between adjacent muslins. So also with any series of equidistant strata each very slightly reflecting. They should give selective reflection, and the spectrum of their reflected beam should show a single line or narrow band, corresponding to a wave-length twice the distance of the strata apart.³

¹ *Proc. Roy. Soc.* Feb. 1885.

² *Phil. Mag.* Sept. 1888, pp. 256 and 241.

³ The footnote of Lord Rayleigh on page 158, *Phil. Mag.* 1887, vol. xxiv., is brief and forcible enough to quote in full:—'A detailed experimental examination of the various cases in which a laminated structure leads to a powerful but highly selected reflection would be of value. The most frequent examples are met with in the organic world. It has occurred to me that Becquerel's reproduction of the spectrum in natural colours upon silver plates may perhaps be explicable in this manner. The various parts of the film of subchloride of silver with which the metal is coated may be conceived to be subjected during exposure to stationary luminous waves of nearly definite wave-length, the effect of which might be to impress upon the substance a periodic structure occurring at intervals equal to half the wave-length of light; just as a sensitive flame exposed to stationary sonorous waves is influenced at the loops, but not at the nodes (*Phil. Mag.* March 1879, p. 153). In this way the operation of any kind of light would be to produce just such a modification of the film as would cause it to reflect copiously that particular kind of light. I abstain at present from developing this suggestion, in the hope of soon finding an opportunity of making myself experimentally acquainted with the subject.'

Independently of all this, Herr Otto Wiener, imitating Hertz's experiments with ordinary light, in 1889 reflected a beam directly back on itself, and, by interposing a very thin collodion film at extraordinarily oblique incidence, succeeded in the difficult experiment of so magnifying by the cosine of inclination the half wave-length, as to get the silver deposited in strata of visible width, and thus to photograph the interference nodes themselves at the places where they were cut by the plane of the film.¹

Then M. Lippmann, using a thicker film, not put obliquely but normal to the light, obtained the strata within the thickness of the film itself—hundreds of layers; and so, employing incidence light of definite wave-length, was able to produce a stratified deposit, which reflected back at appropriate incidence the same wave-length as produced it; thus reproducing, of course, the definite colour.

It is probable that the silver is first shaken out at the ventral segments, but that the strata so formed are thick and blurry. I conjecture that by over-exposure this deposit is nearly all mopped up again, traces being left only at the nodes, where the action is very feeble and takes a long time to occur; but that these residual strata, being fairly sharp and definite, would be likely to give much better effects. And so I suppose that these are what are actually effective in obtaining M. Lippmann's very interesting, though not yet practically useful, result.

I now leave the retrospect of what has been done, although many other topics might usefully detain us, and I proceed to glance forward at the progress ahead and at the means we have for effectively grappling with our due share of it.

There is a subject which has long been in my mind, and which I determined to bring forward whenever I had a cathedral opportunity of doing so; and now, if ever, is a suitable occasion. It is to call attention to the fact that the further progress of physical science in the somewhat haphazard and amateur fashion in which it has been hitherto pursued in this country is becoming increasingly difficult, and that the quantitative portion especially should be undertaken in a permanent and publicly-supported physical laboratory on a large scale. If such an establishment were likely to weaken the sinews of private enterprise and individual research it should be strenuously opposed; but, in my opinion, it would have the opposite effect, by relieving the private worker of much which he can only undertake with great difficulty, sacrifice, and expense. To illustrate more precisely what I mean, it is sufficient to recall the case of astronomy. The amateur astronomer has much work lying ready to his hand, and he grapples with it manfully. To him is left the striking out of new lines and the guerilla warfare of science. Skirmishing and brilliant cavalry evolutions are his natural field; he should not be called upon to take part in the general infantry advance. It is wasting his energies, and he could not in the long run do it well. What, for instance, would have been the state of astronomy—the nautical almanac department of astronomy—without the consecutive and systematic work of the National Observatory at Greenwich? It may be that some enthusiastic amateurs would have devoted their lives to this routine kind of work, and here at one time and there at another a series of accurate observations would have been kept for several years. Pursued in that way, however, not only would the effort be spasmodic and temporary, but the energy and enthusiasm of those amateurs would have been diverted from the pioneering more suited to them, and would have been cramped in the groove of routine, eminently adapted to a permanent official staff but not wholesome for an individual.

Long-continued consecutive observations may be made by a leader of science, as functions may be tabulated by an eminent mathematician; but if the work can be done almost equally well (some would say better) by a professional observer or computer, how great an economy results.

Now all this applies equally to physics. The ohm has been determined with 4-figure, perhaps with 5-figure, accuracy; but think of the list of eminent men to whose severe personal labour we owe this result, and ask if the spoil is worth the cost. Perhaps in this case it is, as a specimen of a well-conducted determination. We must have a few specimens, and our leaders must show us the way to do things. But let us not continue to use them for such purposes much longer. The

¹ Wiedemann's *Annalen*, vol. xl. 1890.

quest of the fifth or sixth decimal is a very legitimate, and may become a very absorbing, quest, but there are plenty of the rank and file who can undertake it if properly generalised and led: not as isolated individuals, but as workers in a National Laboratory under a competent head and a governing committee. By this means work far greater in quantity, and in the long run more exact in quality, can be turned out, by patient and conscientious labour without much genius, by the gradual improvement of instrumental means, by the skill acquired by practice, and by the steady drudgery of routine. Paris has long had one form of such an institution, in the Conservatoire des Arts et Métiers, and has been able to impose the metric system on the civilised world in consequence. It can also point to the classical determinations of Regnault as the fruits of just such a system. Berlin is now starting a similar or a more ambitious scheme for a permanent National Physical Institute. Is it not time that England, who in physical science, I venture to think, may in some sort claim a leading place, should be thinking of starting the same movement?

The Meteorological and Magnetic Observatory at Kew (in the inauguration of which this Association took so large a part) is a step; and much useful quantitative work is done there. The new Electric Standardizing Laboratory of the Board of Trade is another and, in some respects perhaps, a still closer approximation to the kind of thing I advocate. But what I want to see is a much larger establishment, erected on the most suitable site, limited by no specialty of aim nor by the demands of the commercial world, furnished with all appropriate appliances, to be amended and added to as time goes on and experience grows, and invested with all the dignity and permanence of a national institution: a Physical Observatory, in fact, precisely comparable to the Greenwich Observatory, and aiming at the very highest quantitative work in all departments of physical science. That the arts would be benefited may be assumed without proof. It is largely the necessity of engineers that has inspired the amount of accuracy in electrical matters already attained. The work and appliances of the mechanical engineer eclipse the present achievements of the physicist in point of accuracy, and it is by the aid of the mechanic and optician that precision even in astronomy has reached so high a stage. There is no reason why physical determinations should be conducted in an amateur fashion, with comparatively imperfect instruments, as at present they mostly are. Discoveries lie along the path of extreme accuracy, and they will turn up in the most unexpected way. The aberration of light would not have been discovered had not Bradley been able to measure to less than 1 part in 10,000; and what a brilliant and momentous discovery it was! He was aiming at the detection of stellar parallax, but the finite velocity of light was a greater discovery than any parallax. This is the type of result which sometimes lurks in the fifth decimal, and which confers upon it an importance beside which the demands of men who wish to serve the taste and the pocket of the British public sink into insignificance.

In a National Observatory accuracy should be the one great end: the utmost accuracy in every determination that is decided on and made. Only one thing should be more thought of than the fifth significant figure, and that is the sixth. The consequences flowing from the results may safely be left; such as are not obvious at once will distil themselves out in time. And the great army of outside physicists, assured of the good work being done at headquarters, will (to speak again in astronomical parable) cease from peddling with taking transits or altitudes, and will be free to discover comets, to invent the spectroscope, to watch solar phenomena, to chemically analyse the stars, to devise celestial photography, and to elaborate still more celestial theories; all of which novelties may in their maturity be handed over to the National Observatory, to be henceforth incorporated with, and made part of, its routine life; leaving the advance guard and skirmishers free to explore fresh territory, secure in the knowledge that what they have acquired will be properly surveyed, mapped, and utilised, without further attention from them. As to the practical applications, they may in any case be left to take care of themselves. The instinct of humanity in this direction, and the so-called solid gains associated with practical achievements, will always secure a sufficient number of acute and energetic workers to turn the new territory

into arable land and pasture adapted to the demands of the average man. The labour of the agriculturist in rendering soil fertile is, of course, beyond praise; but it is not the work of the pioneer. As Mr. Huxley eloquently put it, when contrasting the application of science with the advance of science itself, speaking of the things of commercial value which the physical philosopher sometimes discovers:—'Great is the rejoicing of those who are benefited thereby, and, for the moment, science is the Diana of all the craftsmen. But even while the cries of jubilation resound, and this flotsam and jetsam of the tide of investigation is being turned into the wages of workmen and the wealth of capitalists, the crest of the wave of scientific investigation is far away on its course over the illimitable ocean of the unknown.'

I have spoken of the work of the National Laboratory as devoted to accuracy. It is hardly necessary to say that the laboratory will be also the natural custodian of our standards, in a state fit for use and for comparison with copies sent to be certified. Else perhaps some day our standard ohm may be buried in a brick wall at Westminster, and no one living may be able to recall precisely where it is.

But, in addition to these main functions, there is another, equally important with them, to which I must briefly refer. There are many experiments which cannot possibly be conducted by an individual, because forty or fifty years is not long enough for them. Such are secular experiments on the properties of materials—the elasticity of metals, for instance; the effect of time on molecular arrangement; the influence of long exposure to light, or to heat, or to mechanical vibration, or to other physical agents.

Does the permeability of soft iron decay with age, by reason of the gradual cessation of its Ampèrian currents? Do gases cool themselves when adiabatically preserved, by reason of imperfect elasticity or too many degrees of freedom of their molecules? Unlikely, but not impossible. Do thermo-electric properties alter with time? And a multitude of other experiments which appear specially applicable to substances in the solid state—a state which is more complicated, and has been less investigated, than either the liquid or the gaseous: a state in which time and past history play an important part.

Upon whichever of these long researches we may decide to enter, a National Laboratory, with permanent traditions and a continuous life, is undoubtedly the only appropriate place. At such a place as Glasgow the exceptional magnitude of a present occupant may indeed inspire sufficient piety in a successor to secure the continuance of what has been there begun; but in most college laboratories, under conditions of migration, interregnum, and a new régime, continuity of investigation is hopeless.

I have at any rate said enough to indicate the kind of work for which the establishment of a well-furnished laboratory with fully equipped staff is desirable, and I do not think that we, as a nation, shall be taking our proper share of the highest scientific work of the world until such an institution is started on its career.

There is only one evil which, so far as I can see, is to be feared from it: if ever it were allowed to impose on outside workers as a central authority, from which infallible dicta were issued, it would be an evil so great that no amount of good work carried on by it could be pleaded as sufficient mitigation.

If ever by evil chance such an attitude were attempted, it must rest with the workers of the future to see that they permit no such shackles; for if they are not competent to be independent, and to contemn the voice of authority speaking as mere authority, if their only safeguard lies in the absence of necessity for struggle and effort, they cannot long hope to escape from the futility which surely awaits them in other directions.

I am thus led to take a wider range, and, leaving temporary and special considerations, to speak of a topic which is as yet beyond the pale of scientific orthodoxy, and which I might, perhaps more wisely, leave lying by the roadside. I will, however, take the risk of introducing a rather ill-favoured and disreputable looking stranger to your consideration, in the belief—I might say, in the assured conviction—that he is not all scamp, and that his present condition is as much due to our long-continued neglect as to any inherent incapacity for improvement in the subject.

I wish, however, strenuously to guard against its being supposed that this Association, in its corporate capacity, lends its countenance to, or looks with any favour on, the outcast. What I have to say—and after all it will not be much—must rest on my own responsibility. I should be very sorry for any adventitious weight to attach to my observations on forbidden topics from the accident of their being delivered from this chair. At the same time not only do I claim the right to express myself concerning matters on which I have worked, but I conceive it to be a duty, from which, if I shrank, I should shrink from no higher motive than simple cowardice, though I know them to be topics on which it is quite impossible, as well as undesirable, for everyone to think alike.

It is but a platitude to say that our clear and conscious aim should always be truth, and that no lower or meaner standard should ever be allowed to obtrude itself before us. Our ancestors fought hard and suffered much for the privilege of free and open inquiry, for the right of conducting investigation untrammelled by prejudice and foregone conclusions, and they were ready to examine into any phenomenon which presented itself. This attitude of mind is perhaps necessarily less prominent now, when so much knowledge has been gained, and when the labours of many individuals may be rightly directed entirely to its systematisation and to the study of its inner ramifications; but it would be a great pity if a too absorbed attention to what has already been acquired, and to the fringe of territory lying immediately adjacent thereto, were to end in our losing the power of raising our eyes and receiving evidence of a totally fresh kind, of perceiving the existence of regions into which the same processes of inquiry as had proved so fruitful might be extended, with results at present incalculable and perhaps wholly unexpected. I myself think that the ordinary processes of observation and experiment are establishing the existence of such a region; that in fact they have already established the truth of some phenomena not at present contemplated by science, and to which the orthodox man shuts his ears.

For instance, there is the question whether it has or has not been established by direct experiment that a method of communication exists between mind and mind irrespective of the ordinary channels of consciousness and the known organs of sense, and if so, what is the process? It can hardly be through some unknown sense organ, but it may be by some direct physical influence on the ether, or it may be in some still more subtle manner. Of the process I as yet know nothing. Further investigation is wanted. No one can expect others to accept his word for an entirely new fact, except as establishing a *prima facie* case for investigation.

But I am only now taking this as an instance of what I mean; whether it be a truth or a fiction, I doubt if one of the recognised scientific societies would receive a paper on the subject. What I wish is to signalise a danger—which I believe to be actual and serious—that investigation in this and cognate subjects may be checked and hampered by active hostility to these researches on the part of the majority of scientific men, and a determined opposition to the reception or discussion of evidence.

That individuals should decline to consider such matters is natural enough; they may be otherwise occupied and interested. Everybody is by no means bound to investigate everything; though, indeed, it is customary in most fields of knowledge for those who have kept aloof from a particular inquiry to defer in moderation to those who have conducted it, without feeling themselves called upon to express an opinion. But it is not of the action of individuals that I wish to speak, it is of the attitude to be adopted by scientific bodies in their corporate capacity; and for a corporate body of men of science, inheritors of the hard-won tradition of free and fearless inquiry into the facts of nature untrammelled by prejudice, for any such body to decline to receive evidence laboriously attained and discreetly and inoffensively presented by observers of accepted competency in other branches, would be, if ever actually done and persisted in, a terrible throwing away of their prerogative, and an imitation of the errors of a school of thought against which the struggle was at one time severe.

In the early days of the Copernican theory, Galileo for some years refrained from teaching it, though fully believing its truth, because he considered that he had

better get more fully settled in his recent University chair before evoking the storm of academic controversy which the abandonment of the Ptolemaic system would arouse. The same thing literally is going on to-day. I know of men who hesitate to avow interest in these new investigations (I do not mean credence—the time is too early for avowing credence in any but the most rudimentary and definitely ascertained facts—but hesitate to avow interest) until they have settled down more securely and made a name for themselves in other lines. Caution and slow progress are extremely necessary; fear of avowing interest or of examining into unorthodox facts is, I venture to say, not in accordance with the highest traditions of the scientific attitude.

We are, I suppose, to some extent afraid of each other, but we are still more afraid of ourselves. We have great respect for the opinions of our elders and superiors; we find the matter distasteful to them, so we are silent. We have, moreover, a righteous mistrust of our own powers and knowledge; we perceive that it is a wide region extending into several already cultivated branches of science, that a many-sided and highly-trained mind is necessary adequately to cope with all its ramifications, that in the absence of strict inquiry imposture has been rampant in some portions of it for centuries, and that unless we are preternaturally careful we may get led into quagmires if we venture on it at all.

Now let me be more definite, and try to state what this field is, the exploration of which is regarded as so dangerous. I might call it the borderland of physics and psychology. I might call it the connection between life and energy; or the connection between mind and matter. It is an intermediate region, bounded on the north by psychology, on the south by physics, on the east by physiology, and on the west by pathology and medicine. An occasional psychologist has groped down into it and become a metaphysician. An occasional physicist has wandered up into it and lost his base, to the horror of his quondam brethren. Biologists mostly look at it askance, or deny its existence. A few medical practitioners, after long maintenance of a similar attitude, have begun to annex a portion of its western frontier. The whole region seems to be inhabited mainly by savages, many of them, so far as we can judge from a distance, given to gross superstition. It may, for all I know, have been hastily traversed and rudely surveyed by a few clear-eyed travellers; but their legends concerning it are not very credible, certainly are not believed.

Why not leave it to the metaphysicians? I say it has been left to them long enough. They have explored it usually with insufficient equipment. The physical knowledge of the great philosophers has been necessarily scanty; and though the ideas which we owe to their genius may ultimately be of the greatest service to us as physicists, still their methods are not our methods. They may be said to have floated a balloon over the region with a looking-glass attached, in which they have caught queer and fragmentary glimpses. They may have seen more than we give them credit for, but they appear to have guessed far more than they saw.

Our method is different. We prefer to creep slowly from our base of physical knowledge, to engineer carefully as we go, establishing forts, making roads, and thoroughly exploring the country; making a progress very slow, but very lasting. The psychologists from their side may meet us. I hope they will; but one or other of us ought to begin.

A vulnerable spot on our side seems to be the connection between life and energy. The conservation of energy has been so long established as to have become a commonplace. The relation of life to energy is not understood. Life is not energy, and the death of an animal affects the amount of energy no whit; yet a live animal exerts control over energy which a dead one cannot. Life is a guiding or directing principle, disturbing to the physical world but not yet given a place in the scheme of physics. The transfer of energy is accounted for by the performance of work; the guidance of energy needs no work, but demands force only. What is force? and how can living beings exert it in the way they do? As automata, operated on by preceding conditions—that is, by the past—say the materialists. Are we so sure that they are not controlled by the future too? In other words, that the

totality of things, by which everyone must admit that actions are guided, may not include the future as well as the past, and that to attempt to deduce those actions from the past only will prove impossible.¹ In some way matter can be moved, guided, disturbed, by the agency of living beings; in some way there is a control, a directing-agency active, and events are caused at its choice and will that would not otherwise happen.

A luminous and helpful idea is that *time* is but a relative mode of regarding things; we progress through phenomena at a certain definite pace, and this subjective advance we interpret in an objective manner, as if events necessarily happened in this order and at this precise rate. But that may be only our mode of regarding them. The events may be in some sense existent always, both past and future, and it may be we who are arriving at them, not they which are happening. The analogy of a traveller in a railway train is useful. If he could never leave the train nor alter its pace, he would probably consider the landscapes as necessarily successive, and be unable to conceive their co-existence.

The analogy of a solid cut into sections is closer. We recognise the universe in sections, and each section we call the present. It is like the string of slices cut by a microtome; it is our way of studying the whole. But we may err in supposing that the body only exists in the slices which pass before our microscope in regular order and succession.

We perceive, therefore, a possible fourth-dimensional aspect about time, the inexorableness of whose flow may be a natural part of our present limitations. And if once we grasp the idea that past and future may be actually existing, we can recognise that they may have a controlling influence on all present action, and the two together may constitute 'the higher plane,' or the totality of things, after which, as it seems to me, we are impelled to seek, in connection with the directing of force or determinism, and the action of living beings consciously directed to a definite and preconceived end.

Inanimate matter is controlled by the *vis a tergo*; it is operated on solely by the past.² Given certain conditions, and the effect in due time follows. Attempts have been made to apply the same principle to living and conscious beings, but without much success. These seem to work for an object, even if it be the mere seeking for food; they are controlled by the idea of something not yet palpable. Given certain conditions, and their action cannot certainly be predicted; they have a sense of option and free will. Either their actions are really arbitrary and indeterminate—which is highly improbable—or they are controlled by the future as well as by the past. Imagine beings thus controlled: automata you may still call them, but they will be living automata, and will exhibit all the characteristics of live creatures. Moreover, if they have a merely experiential *knowledge*, necessarily limited by memory and bounded by the past, they will be unable to predict each other's actions with any certainty, because the whole of the data are not before them. May not a clearer apprehension of the meaning of life and will and determinism be gradually reached in some such direction as this?

By what means is force exerted, and what, definitely, is force or stress? I can hardly put the question here and now so as to be intelligible, except to those who have approached and thought over the same difficulties; but I venture to say that there is here something not provided for in the orthodox scheme of physics; that modern physics is not complete, and that a line of possible advance lies in this direction.

I might go further. Given that force can be exerted by an act of will, do we understand the mechanism by which this is done? And if there is a gap in our knowledge between the conscious idea of a motion and the liberation of muscular energy needed to accomplish it, how do we know that a body may not be moved

¹ The expression 'controlled by the future' I first heard in a conversation with G. F. Fitzgerald, who seemed to consider it applicable to all events, without exception.

² This is, of course, not assertion, but suggestion. It may be erroneous to draw any such distinction between animate and inanimate.

without ordinary material contact by an act of will? I have no evidence that such a thing is possible. I have tried once or twice to observe its asserted occurrence, and failed to get anything that satisfied me. Others may have been more fortunate. In any case, I hold that we require more knowledge before we can deny the possibility. If the conservation of energy were upset by the process, we should have grounds for denying it; but nothing that we know is upset by the discovery of a novel mode of communicating energy, perhaps some more immediate action through the ether. It is no use theorising; it is unwise to decline to examine phenomena because we feel too sure of their impossibility. We ought to know the universe very thoroughly and completely before we take up that attitude.

Again, it is familiar that a thought may be excited in the brain of another person, transferred thither from our brain, by pulling a suitable trigger; by liberating energy in the form of sound, for instance, or by the mechanical act of writing, or in other ways. A pre-arranged code called language, and a material medium of communication, are the recognised methods. May there not also be an immaterial (perhaps an ethereal) medium of communication? Is it possible that an idea can be transferred from one person to another by a process such as we have not yet grown accustomed to, and know practically nothing about? In this case I have evidence. I assert that I have seen it done; and am perfectly convinced of the fact. Many others are satisfied of the truth of it too. Why must we speak of it with bated breath, as of a thing of which we are ashamed? What right have we to be ashamed of a truth?

And after all, when we have grown accustomed to it, it will not seem altogether strange. It is, perhaps, a natural consequence of the community of life or family relationship running through all living beings. The transmission of life may be likened in some ways to the transmission of magnetism, and all magnets are sympathetically connected, so that if suitably suspended a vibration from one disturbs others, even though they be distant ninety-two million miles.

It is sometimes objected that, granting thought-transference or telepathy to be a fact, it belongs more especially to lower forms of life, and that as the cerebral hemispheres develop we become independent of it; that what we notice is the relic of a decaying faculty, not the germ of a new and fruitful sense; and that progress is not to be made by studying or attending to it. It may be that it is an immature mode of communication, adapted to lower stages of consciousness than ours, but how much can we not learn by studying immature stages? As well might the objection be urged against a study of embryology. It may, on the other hand, as W. F. Barrett has suggested, be an indication of a higher mode of communication, which shall survive our temporary connection with ordinary matter.

I have spoken of the apparently direct action of mind on mind, and of a possible action of mind on matter. But the whole region is unexplored territory, and it is conceivable that matter may react on mind in a way we can at present only dimly imagine. In fact, the barrier between the two may gradually melt away, as so many other barriers have done, and we may end in a wider perception of the unity of nature, such as philosophers have already dreamt of.

I care not what the end may be. I do care that the inquiry shall be conducted by us, and that we shall be free from the disgrace of jogging along accustomed roads, leaving to isolated labourers the work, the ridicule, and the gratification, of unfolding a new region to unwilling eyes.

It may be held that such investigations are not physical and do not concern us. We cannot tell without trying; and as the results are physical, or at least have a physical side, it seems reasonable to assume that the process by which they are produced is a proper subject for physical inquiry. I believe that there is something in this region which does concern us as physicists. It may concern other sciences too. It must indeed concern biology; but with that I have nothing to do. Biologists have their region, we have ours, and there is no need for us to hang back from an investigation because they do. Our own science, of Physics or Natural Philosophy in its widest sense, is the King of the Sciences, and it is for us to lead, not to follow.

And I say, have faith in the Intelligibility of the universe. Intelligibility has

been the great creed in the strength of which all intellectual advance has been attempted, and all scientific progress made.

At first things always look mysterious. A comet, lightning, the aurora, the rainbow—all strange anomalous mysterious apparitions. But scrutinised in the dry light of science, their relationship with other better-known things becomes apparent. They cease to be anomalous; and though a certain mystery necessarily remains, it is no more a property peculiar to them, it is shared by the commonest objects of daily life.

The operations of a chemist, again, if conducted in a haphazard manner, would be an indescribable medley of effervescences, precipitations, changes in colour and in substance; but, guided by a thread of theory running through them, the processes fall into a series, they all become fairly intelligible, and any explosion or catastrophe that may occur is capable of explanation too.

Now I say that the doctrine of ultimate intelligibility should be pressed into other departments also. At present we hang back from whole regions of inquiry and say they are not for us. A few we are beginning to grapple with. The nature of disease is yielding to scrutiny with fruitful result: the mental aberrations and abnormalities of hypnotism, duplex personality, and allied phenomena, are now at last being taken under the wing of science after long ridicule and contempt. The phenomena of crime, the scientific meaning and justification of altruism, and other matters relating to life and conduct, are beginning, or perhaps are barely yet beginning, to show a vulnerable front over which the forces of science may pour.

Facts so strange that they have often been called miraculous are now no longer regarded as entirely incredible. All occurrences seem reasonable when contemplated from the right point of view, and some are believed in which in their essence are still quite marvellous. Apply warmth for a given period to a sparrow's egg, and what result could be more incredible or magical if now discovered for the first time. The possibilities of the universe are as infinite as is its physical extent. Why should we grope with our eyes always downward, and deny the possibility of everything out of our accustomed beat?

If there is a puzzle about free-will, let it be attacked; puzzles mean a state of half-knowledge; by the time we can grasp something more approximating to the totality of things the paradoxicality of paradoxes drops away and becomes unrecognisable. I seem to myself to catch glimpses of clues to many of these old questions, and I urge that we should trust consciousness, which has led us thus far; should shrink from no problem when the time seems ripe for an attack upon it, and should not hesitate to press investigation, and seek to ascertain the laws of even the most recondite problems of life and mind.

What we know is as nothing to that which remains to be known. This is sometimes said as a truism; sometimes it is half doubted. To me it seems the most literal truth, and that if we narrow our view to already half-conquered territory only, we shall be false to the men who won our freedom, and treasonable to the highest claims of science.

If I were asked (as I am not) to suggest any practical proposal for immediate action in the direction indicated, I should not urge anything at all revolutionary. I do not think that the time is ripe for the Royal Society, for instance, to move in the matter; the early stages of such an investigation, in which the human element is so obtrusive and perturbing, may very properly be left to a society devoted to that special end; and, thanks to the single-hearted, persistent, and admirably judicious labours of a few workers, whose names I need not mention because they are so well known, such a society exists. I do, however, think that whenever in the view of the leaders of that society the time may have come to put the scientific world in official possession of their more securely ascertained facts—for instance, by presenting a report to this or some other section—they ought not to ask in vain for some recognition of the work accomplished by them. It seems to me desirable that the work in which they have been so long engaged should be established on a more permanent basis, such a basis as scientific recognition would be likely to bestow, so that the existence of the society may not be imperilled by the mortality of individuals. I will not press the suggestion further; it may bear fruit

in due season or it may not. I must return to the work of this section, from which I have apparently wandered rather far afield, further than is customary—perhaps further than is desirable.

But I hold that occasionally a wide outlook is wholesome, and that without such occasional survey, the rigid attention to detail and minute scrutiny of every little fact, which are so entirely admirable and are so rightly here fostered, are apt to become unhealthily dull and monotonous. Our life-work is concerned with the rigid framework of facts, the skeleton or outline map of the universe; and, though it is well for us occasionally to remember that the texture and colour and beauty which we habitually ignore are not therefore in the slightest degree non-existent, yet it is safest speedily to return to our base and continue the slow and laborious march with which we are familiar and which experience has justified. It is because I imagine that such systematic advance is now beginning to be possible in a fresh and unexpected direction that I have attempted to direct your attention to a subject which, if my prognostications are correct, may turn out to be one of special and peculiar interest to humanity.

The following Reports and Papers were read:—

1. *Interim Report of the Committee on Phenomena connected with Recalescence.*—See Reports, p. 147.

2. *On the Action of a Planet upon small Bodies passing near the Planet, with Special Reference to the Action of Jupiter upon such Bodies.* By Professor H. A. NEWTON.—See Reports, p. 511.

3. *On the Absorption of Heat in the Solar Atmosphere.*
By W. E. WILSON, M.R.I.A., F.R.A.S.

The author endeavours to determine with accuracy the ratio of the heat received from the limb and the centre of the solar disc, and thus, by taking yearly observations through a sun-spot cycle, to find out if the solar atmosphere varies in depth.

The apparatus consists of a heliostat which throws a small pencil of sunlight into a dark room. It is received on a 4-inch concave silver-on-glass mirror of about 10 feet focus. A small convex mirror is placed inside the focus of the concave mirror, and thus forms an image of the sun of 80 centimètres in diameter. This image is allowed to fall on a radio-micrometer of Prof. C. E. Boys. The tube of the instrument is stopped down to nearly 1 mm. in diameter, so that only about $\frac{1}{5000000}$ part of the solar image is at any moment giving its heat to the instrument.

A slice of limelight is allowed to fall on the mirror of the radio-micrometer, and is reflected from it on to a horizontal slit in the side of a box which contains a photographic plate. This plate during an observation is allowed to fall with a uniform rate by a piece of clockwork. Any motion of the mirror of the radio-micrometer thus records itself on the plate in a curved line.

The clock of the heliostat is stopped and the image of the sun is allowed to transit across the mouth of the radio-micrometer, and the curve giving the values of the heat received from the solar disc is recorded on the photographic plate.

A seconds pendulum swings across the track of the limelight, so that the photographed curve is notched into seconds of time, and a means thus given of localising the position of the instrument on the solar disc.

4. *The Ultra-Violet Spectrum of the Solar Prominences.* By Professor GEORGE E. HALE, Director of the Kenwood Physical Observatory, Chicago.

The prominence spectrum has been photographed with a large solar spectro-scope attached to the 12·2 inch equatorial refractor. Several new lines have been

thus discovered, and those for which the wave-length has been deduced are given in the first column of the table. The wave-lengths of the H and K calcium lines are to be regarded as provisional only, as Professor Rowland has not yet published the final values. The other columns contain measures of the lines in the hydrogen series, all reduced to Rowland's scale.

Prominences Hale	Hydrogen Ames	Calcium Rowland	Hydrogen Cornu	First Type Stars Huggins
3968.56	—	3968.61 (H)	—	—
3933.86	—	3933.80 (K)	—	—
3888.73	—	—	—	—
3970.11 (?)	3970.25	—	3969.6	3969.6
3889.14	3889.15	—	3888.5	3888.2
3835.54	3835.6	—	3835.1	3834.6
3798.1	3798.0	—	3797.5	3795.6
3770.8	3770.7	—	3770.0	3768.1
—	3750.15	—	3749.9	3746.1
—	3734.15	—	3734.2	3730.6
—	3721.8	—	3721.1	3717.9
—	3711.9	—	3711.1	3707.9
—	—	—	—	3699.4

It will be seen that the first two lines are in all probability due to calcium; they are narrow and sharp, and fall at the centres of the dark bands in the solar spectrum. The next line is as yet unaccounted for, but it does not appear to be a component of the hydrogen line at $\lambda 3889.14$. The line at $\lambda 3970.11$ is marked doubtful, because it falls very nearly at the position of a ghost of H; everything points, however, to an independent origin, though the agreement with Ames' hydrogen line at $\lambda 3970.25$ is far from satisfactory. The remaining four lines are evidently members of the hydrogen series.

Prominence forms have also been photographed through H and K, the dark shades allowing the use of a very wide slit. The research is to be continued with improved apparatus.

5. *Report on Researches Relative to the Second Law of Thermodynamics.*
By Dr. J. LARMOR and G. H. BRYAN.—See Reports, p. 85.

6. *Note on a Simple Mechanical Representation of Carnot's Reversible Cycle.*¹
By G. H. BRYAN.

FRIDAY, AUGUST 21.

The following Reports and Papers were read:—

1. *Interim Report of the Committee on Researches in Electro-optics.*
See Reports, p. 147.

2. *Note on the Electromagnetic Theory of the Rotation of the Plane of Polarised Light.* By Professor A. GRAY, M.A., F.R.S.E.

Sir William Thomson has explained the turning of the plane of polarised light in a magnetic field by supposing the ether to have imbedded in it a large number

¹ This note is reproduced in Par. 33 of the Report on the Second Law of Thermodynamics by the author.

of small gyrostats, having the undisturbed positions of their axes in the common direction of the magnetic force and the propagation of the beam, and all vibrating in the same sense. When in consequence of the vibrating motion each gyrostat has its axis of rotation displaced from this direction, it reacts on the surrounding medium with transverse force at right angles to the plane through the axis of rotation and the direction of motion.

By compounding this stress with the elastic forces of displacement of the ether, differential equations of motion are obtained which are of precisely the form necessary to account for the difference in rate of propagation of the two circularly polarised rays constituting the plane polarised ray.

It is obviously suggested by the gyrostatic investigation that it ought to be possible to explain the magneto-optic rotation on the electromagnetic theory of light as a consequence of the existence of the small magnets which are supposed imbedded in the medium with their axes in the direction of propagation of the ray, and therefore producing the magnetisation which the medium has in that direction.

In consequence of the motions of the ether, the direction of the chains of magnetised molecules which are supposed to exist along the direction of magnetisation (here taken as axis of z) in the undisturbed state of the medium is continually undergoing change at every point, and thus the direction of the axial magnetic force along each chain also undergoes alteration. It is obvious that if the displacements be everywhere small, the actual magnitude of this force will sustain only a very small percentage of alteration, but that each small change of direction will produce a component magnetic force in each of the two directions at right angles to the axis. The calling into existence of these components will produce corresponding electromotive forces tending to increase the displacements.

The electromotive force in the direction of y is given by

$$Q = -\frac{dG}{dt} - \frac{\partial \Psi}{\partial y}$$

where dG/dt stands for the total time rate of change of G , the component of vector potential in the direction of y . Also since H , the component along z , does not perceptibly vary along x , if the direction of propagation be as taken here along z , $-\partial G/\partial z$ denotes magnetic induction through unit of area in the plane of yz . Hence any part of the total time-rate of variation of $-\partial G/\partial z$ will denote the space-rate of variation in the direction of z of an electromotive force parallel to y , provided the time and space differentiations of the part are commutative.

Now if the displacement of the ether particles from the undisturbed positions be taken as parallel and proportional to the electric displacement, and C be the component of magnetisation of the substance in the direction of z due to the existence of the molecular magnets, then considering the electric displacement f in the direction of x , we see that the component magnetic force in the direction of x is $eC\partial f/\partial z$, and thus the magnetic induction through unit of area in the plane of yz is $\mu eC\partial f/\partial z$, where e is a coefficient of proportionality. The time-rate of variation of this is

$$\mu eC \frac{\partial}{\partial t} \frac{\partial f}{\partial z}$$

But we have by the equations of electric currents

$$\frac{\partial f}{\partial t} = \frac{1}{4\pi} \left(\frac{\partial g}{\partial y} - \frac{\partial \beta}{\partial z} \right) = -\frac{1}{4\pi} \frac{\partial \beta}{\partial z}$$

since there is no conduction current.

Further, by the relation of magnetic force to vector potential, $\beta = (\partial F/\partial z)/\mu$, and therefore the last equation becomes

$$\frac{\partial f}{\partial t} = -\frac{1}{4\pi\mu} \frac{\partial^2 F}{\partial z^2}$$

Now, since the differentiation of f with respect to t is partial only, we may use the substitution

$$\frac{\partial}{\partial z} \frac{\partial f}{\partial t} = \frac{\partial}{\partial t} \frac{\partial f}{\partial z}$$

Hence differentiating $\partial f / \partial t$ with respect to z we find

$$\mu e C \frac{\partial}{\partial z} \frac{\partial f}{\partial t} = -\frac{eC}{4\pi} \frac{\partial^3 F}{\partial z^3}$$

which gives an electromotive force in the direction of y of amount

$$-\frac{eC}{4\pi} \frac{\partial^2 F}{\partial z^2}$$

Hence we have finally

$$Q = -\frac{\partial G}{\partial t} - \frac{eC}{4\pi} \frac{\partial^2 F}{\partial z^2} - \frac{\partial \psi}{\partial y}$$

the two first terms on the right making up $-dG/dt$.

We have therefore

$$\frac{\partial Q}{\partial t} = -\frac{\partial^2 G}{\partial t^2} - \frac{eC}{4\pi} \frac{\partial^3 F}{\partial t \partial z^2}$$

But the displacement current in the direction of y is dq/dt , and thus is $K/4\pi \cdot \partial Q / \partial t$. Also, by the equations of currents $dj/dt = -1/4\pi\mu \cdot \partial^2 G / \partial z^2$. Therefore we have the equation

$$\frac{K}{4\pi} \frac{\partial Q}{\partial t} = \frac{dj}{dt} = -\frac{1}{4\pi\mu} \frac{\partial^2 G}{\partial z^2}$$

which would in the equation already found for $\partial Q / \partial t$ yield

$$\frac{\partial^2 G}{\partial t^2} = \frac{1}{K\mu} \frac{\partial^2 G}{\partial z^2} - \frac{eC}{4\pi} \frac{\partial^3 F}{\partial t \partial z^2}$$

Similarly for the other component in the case of circularly polarised light we find the equation

$$\frac{\partial^2 F}{\partial t^2} = \frac{1}{K\mu} \frac{\partial^2 F}{\partial z^2} + \frac{eC}{4\pi} \frac{\partial^3 G}{\partial t \partial z^2}$$

These two equations are identical in form with those given by the gyrostatic theory, and of course lead to the same results; that is to say, the plane of polarisation of an electromagnetic beam will show a turning effect when the beam is transmitted along the lines of force in a magnetised medium.¹

3. *On an Experiment on the Velocity of Light in the neighbourhood of Rapidly-moving Matter.* By PROFESSOR OLIVER J. LODGE, F.R.S.

An apparatus was described which had been constructed to apply Michelson's interference method to a beam of light sent round and round by mirrors between a pair of circular saws clamped together and rotating rapidly. The results were, at present, negative.

4. *The Action of Electrical Radiators, with a Mechanical Analogy.* By J. LARMOR.

In an electrical vibrator of rapid period the currents in the metallic parts are confined to the surface; the periodic times are therefore independent of the metals

¹ It ought to be stated that I understand from a reference in M. Poincaré's 'Théories de Maxwell' that a similar theory has been proposed by M. Potier in a note to his French translation of 'Maxwell's Electricity.' I have not seen M. Potier's investigations, which may have completely anticipated the present note.

of which the vibrators are made, being determined only by their forms, and there is no considerable loss due to degradation into heat in these conductors. The question occurs, what are the surface conditions that must be imposed under these circumstances at the boundaries of the dielectric, in order that the vibrations may be discussed with reference only to the dielectric in which they exist and are propagated?

It appears that the vibrations are analogous to those of an elastic solid, when elastic displacement is made the analogue of the electric displacement in the dielectric. It is demonstrable¹ that if the velocity of propagation is the inverse square root of the specific inductive capacity, this auxiliary solid must be considered as incompressible, and the scheme of electro-dynamics must be that of Maxwell. The surface condition will then be absolute stiffness in the surface layer for all tangential displacement, and freedom for normal displacement.

The mathematical examination of a typical case shows that this way of presenting the phenomena is practically exact for all wave-lengths greater than a centimetre for copper or other good conducting metal. For very minute waves the circumstances are not independent of the material of the conductor, but are similar to those which actually exist in the case of the metallic reflexion of light-waves.

By aid of this representation a qualitative view of the possible modes of vibration is rendered feasible in cases where the mathematical analysis would be difficult or impossible.²

5. *On the Measurement of Stationary Hertzian Oscillations along Wires, and the Damping of Electric Waves.* By Professor D. E. JONES, B.Sc.

An account was given of preliminary experiments made in Bonn (at the suggestion of Professor Hertz) on electric waves in wires. The first object was to find a simple method of measuring the disturbance at different points of a wire (or pair of wires) along which are sent waves which interfere after reflection at the ends. It was found that satisfactory measurements could be made by inserting a very small thermo-junction in the circuit at different points, and noting the deflection of a low-resistance galvanometer connected up to it. The method is delicate enough to detect and measure exceedingly small currents, such as those produced by telephones.

The method was applied to measure disturbances along a pair of parallel wires about 8 cm. apart and each about 130 metres in length. One end of each wire was connected to a (secondary) metallic plate 40 cm. in diameter. In the first set of experiments the other (far) ends of the wires were left free. The vibrator was of the usual type, provided with plates of the same size as those on the near ends of the wires and facing them. The wave-length of the disturbance along the wires was about 4.3 metres. On plotting curves with distances from the (far) ends of the wires as abscissæ and galvanometer deflections as ordinates the following results were obtained:—

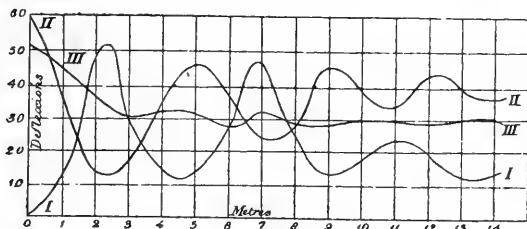

I. The disturbance was zero at the end (0) rising to a maximum (51) at 2.2 m. There was no further absolute minimum, *i.e.* the disturbance did not fall to zero

¹ *Proc. Roy. Soc.* May 1891.

² *Proc. Camb. Phil. Soc.* May 1891.

at any point. At about 4.6 m. there was a minimum deflection of 11, at 6.7 m. a maximum of 46, at 9 m. a minimum of 13, at 11 m. a maximum of 23, and so on. Thus the waves tail off rapidly. There are two complete strongly-marked waves and indications of a third, after which the disturbance tends to become steady along the wire.

II. When the far ends of the wires were joined together similar results were obtained, excepting that the positions of maxima and minima were interchanged, the disturbance, *e.g.*, being a maximum at the ends. The results indicate that only a small number of waves are sent out by the primary vibrator, and that these are rapidly damped. In both the above sets of experiments the primary and secondary plates were 30 cm. apart.

III. (Ends joined). On bringing the secondary and primary plates nearer together the damping became more and more rapid, as if the secondary more quickly absorbed the energy radiated out by the primary. When the plates were 5 cm. apart only one wave could be detected.

The curves (I, II, III) given above were measured on different days and under different circumstances. They cease where the errors of observation become comparable with the variations to be measured. The author's method has the advantage of requiring only the simplest apparatus. The only other published method which has been used for such measurements is Dr. Rubens' bolometric method, but Mr. Bjerknæs has obtained similar results to those of the author with an electrometer instead of a thermo-junction.

In order to find whether the junction produced any disturbance, loops of wire of varying lengths were inserted at 17 m. from the far end; but loops up to 1 m. long did not appear seriously to affect the positions of the maxima and minima.

6. *On the Propagation of Electromagnetic Waves in Wires.*

By WALTER THORP.

The following is an account of some experiments made in the physical laboratory at Trinity College, Dublin, with apparatus kindly placed at the author's disposal by Professor Fitzgerald.

The experiments are incomplete, inasmuch as Mr. Trouton's value (0.68 metre) of the wave-length in air is assumed for the resonating circle which the author used. The author's determinations of this wave-length agree with Mr. Trouton's, but they were few in number, and made at the very commencement of the work.

These experiments were undertaken with the hope of throwing some light upon the results previously obtained by Professor Hertz.¹ He found the ratio of the velocity of propagation of electromagnetic waves in air to the velocity in copper wires to be as 75 : 47, or 1.6. His wave-length in air was 7.5 metres.

Using much shorter waves (0.68m.) and wires of different diameters, the author obtained a ratio varying from 1.77 for very fine wires to very near unity for thick wires.

The apparatus has been fully described by Mr. Trouton.² The wire used was soldered at one end to a piece of iron plate (9 × 4cm. and 0.3cm. thick), which was attached by means of silken cord to the vertical wooden support of the oscillators. The plate being fixed opposite one of the cylindrical oscillators. The wire was supported horizontally along the axis of the parabolic cylinder used to concentrate the radiations.

In the first few experiments the further end of the wire was bent into a very small hook, to which a piece of string was attached to keep the wire taut; but this minute hook was found to cause considerable disturbance at the end which was never a node, and the distance from the end to the first node along the wire was always less than the other internodes. The hook was therefore removed, and the end of the wire kept straight.

The resonating circle was 7.5cm. diameter, and was held with its plane parallel to the wire, and with the spark gap at its greatest distance from the wire.

¹ Wiedemann's *Annalen*, vol. 34, p. 551.

² *Nature*, vol. 39, p. 391; vol. 40, p. 398.

The method of experiment was to adjust the gilt knobs of the oscillators about 5mm. apart, and, starting from the most distant end of the wire, pick out nodes by careful adjustment of the length of the spark gap in the resonating circle. Two internodal distances were usually measured, but sometimes three or four.

The lengths of the internodal distances were found to agree well for the same wire and receiver. The mean of thirteen measurements with a wire 4.9 metres long and 1.57mm. diameter gave a wave-length of 0.605 metre. Five experiments with a wire 4 metres long and 2.9mm. diameter showed the wave-length 0.65 metre. A brass gas-pipe was next tried. This was 3.6 metres long and 11mm. diameter and gave a wave-length of 0.62 metre, as a mean of fourteen experiments.

A thin wire, 5 metres long and 0.36mm. diameter, gave a wave-length of 0.476 metre (mean of ten experiments).

A very fine wire, 4 metres long and 0.078mm. diameter, gave as a mean of twelve experiments a wave-length of 0.384 metre.

The author thinks that these experiments show that Professor Hertz's results were due to the comparative thinness of the wire he used as judged by the length of his waves.

7. On Reflection near the Polarising Angle from the Clean Surfaces of Liquids. By LORD RAYLEIGH, Sec.R.S.

If the image of the sun, reflected at the polarising angle from the surface of ordinary water, be examined through a good nicol, no complete extinction can be observed. At most a dark nebulous patch is seen upon the face of the sun. If, however, the surface of the water be free from contamination, a well-defined band crosses the solar disc, coloured above and below, and to all appearance black, or nearly so, at its centre. The width of this band may be estimated at about one-fifth of the solar diameter. A trace of olive-oil, decidedly short of what is required to stop the camphor movements, practically obliterates the band. The colour seen from clean water, which is due to the variation of the polarising angle with wave-length, may be compensated by holding a 20° water prism between the eye and the nicol. The band is thus achromatised, but colour is of course introduced at the upper and lower limbs of the sun.

The deterioration of the band by contamination is not measured by the decrement of surface tension. A strong solution of oleate of soda or a saturated solution of camphor may give a much better band than distilled water with a somewhat greasy face. Moreover, different parts of the same surface (over which the tension is constant) are often observed to produce very different effects.

Precise measures of the ellipticity abundantly confirm these preliminary results. Sunlight passing through a round hole fitted with cross-wires falls upon a collimating lens, thence after reflection from an adjustable mirror traverses the polarising nicol, and after reflection from the horizontal liquid surface passes a quarter-wave mica and an analysing nicol. The latter is set alternately to a deviation of $\pm 30^\circ$ from the plane of incidence, and the azimuth of the polariser required to bring the dark spot upon the cross-wires in each case is recorded. If 2α be the difference of readings, $\tan 30^\circ \tan \alpha$, denoted by κ , represents the ellipticity, measuring as it does the ratio of reflection of amplitudes of the two principal components. Jamin found for water $\kappa = -0.0577$, and for alcohol $\kappa = +0.0208$.

In my apparatus, which worked remarkably well, a change of setting of the polariser of about two minutes was directly apparent when the analyser stood at $\pm 30^\circ$, and very early experiments showed that the ellipticity of clean water could barely be measured. While in the ordinary water 2α might lie between $\frac{1}{2}^\circ$ and $1\frac{1}{2}^\circ$, the value for clean water seemed not to exceed $2'$. Usually no error could be perceived by mere inspection when the analyser was put over from $+30^\circ$ to -30° ; and the mean of long series of alternations gave a difference sometimes in one direction and sometimes in the opposite. These discrepancies could only be attributed to real changes in the purity of the surfaces, and evidence gradually accumulated that the value for a clean surface was not zero, as had been expected,

but about $2'$, and that in the direction opposite to what is found for an ordinary surface. This $2'$ can hardly be other than real, for it has been recovered several times after complete resetting of all the apparatus.

In any case the ellipticity here presenting itself is exceedingly small. We have

$$\kappa = +\tan 30^\circ \tan 1' = +\cdot00017.$$

The intensity of the light reflected from water at the polarising angle, measured by κ^2 , is not more than about $\frac{1}{10000}$ of that found by Jamin. Alcohol is not nearly so dependent as water upon the methods for freeing its surface from contamination; but, on the other hand, I was unable to apply these methods so completely. The value obtained was

$$\kappa = +\cdot00085.$$

A strong brine, cleansed like the water, gave

$$\kappa = -\cdot00042.$$

About the same value applies to a saturated solution of camphor, while for oleate of soda the value was $-\cdot002$. For petroleum again $\kappa = +\cdot0010$.

It is impossible to feel confidence that these small values really express properties of the liquids whose names are attached to them. What is certain is that, in a large number of cases, the ellipticity is very much less than has hitherto been supposed, and it is not improbable that even the residual ellipticity may be due to contamination, or, if not to contamination properly so-called, to insufficient abruptness in the transition from the one medium to the other.

SATURDAY, AUGUST 22.

The following Reports and Papers were read:—

DEPARTMENT I.—PHYSICS.

1. *Sixth Report of the Committee on Electrolysis.*—See Reports, p. 122.

2. *Interim Report on the Present State of our Knowledge in Electrolysis and Electro-Chemistry.*

Mr. W. N. Shaw was not able to present a Report this year.

3. *Electrolytic Problems.* By ROBERT L. MOND.

The author establishes the complete analogy between electric conduction through electrolytes and what may be called metallic conduction.

He assumes with Wiedemann that the better conducting molecules in the electrolyte form chains, while the worse conducting molecules form dielectric tubes surrounding them. According to Clerk Maxwell's theory, electric energy is transmitted through the dielectric along conductors. The author assumes that this transmission is accompanied by molecular dissociation in the dielectric tubes surrounding each electrolytic chain. With these assumptions he explains the chief electrical and chemical effects produced during electrolysis.

The author gives an account of experiments he has made to test the validity of the above views.

4. *On Clausius' Theory of Electrolytic Conduction, and on some Secret Evidence for the Dissociation Theory of Electrolysis.*¹ By J. BROWN.

¹ See the Report of the Committee on Electrolysis, p. 122.

5. *Report of the Committee on the Phenomena accompanying the Discharge of Electricity from Points.*—See Reports, p. 139.

6. *On the Electrification of Needle Points in Air.*¹

By A. P. CHATTOCK.

The author measures the strength of the electrostatic field at the surface of a needle point by the mechanical force exerted by the field upon the needle parallel to its axis; and justifies experimentally the formula

$$f = \frac{\sqrt{8P}}{r},$$

where f is the field strength at a point of radius of curvature r , and P the mechanical pull upon it.

Values of f at the instant of discharge in air are given for air pressures, varying from 10 cm. to 76 cm. of mercury; the measurements having been made on needle points, for which the values of r lie between 7×10^{-4} cm. and 6×10^{-2} cm. It is shown that for radii less than about 10^{-2} cm. the product $f \times r^{0.8}$ is fairly constant; its value at 76 cm. mercury pressure being 16.5.

In the light of these results the possible ways are discussed in which resistance to discharge may arise at a point. The conclusion is arrived at that the resistance at a clean point is due to the formation of Grotthuss chains of the air molecules surrounding the point; and it is shown that, on this view, the charges carried by the gas atoms are probably of the same order of magnitude as those carried by the same atoms in electrolytes.

The variations of f with air pressure are then referred to, and are shown to be in accordance with the Grotthuss chain hypothesis so far as they go.

7. *On the Measurement of Liquid Resistances.*² By J. SWINBURNE.

To avoid errors due to variations of resistance or polarisation at the electrodes, the fall of potential over a portion of the electrolyte is measured. Siphon tubes are arranged to connect the feeling points with vessels containing non-polarisable electrodes in a suitable electrolyte. Various ways of arranging the apparatus are described.

8. *The Surface-Tension of Ether and Alcohol at Different Temperatures.*

By Professor WILLIAM RAMSAY, Ph.D., F.R.S.

Measurements of the ascent of these liquids in a calibrated capillary tube were made at temperatures varying from that of the atmosphere to within a short distance of the critical point. These measurements, combined with determinations of the angle of contact of the meniscus of the liquid with the walls of a containing narrow-bore tube, and also with a knowledge of the densities of the liquid and the vapour, give data for calculating the surface-tension. The results go to prove that surface-tension is not a linear function of temperature. It is apparently related to the heat of the vaporisation of the liquid in a somewhat simple manner.

The angle of contact of the liquid with the tube walls varies in a remarkable manner with the temperature. While, at temperatures for ether up to 160° , the angle of contact is a small and a gradually decreasing quantity, at that temperature it is zero: with rise of temperature above 160° , the angle of contact increases slowly at first, rapidly as the temperature approaches the critical, until at the critical point it is a right angle. It is remarkable that above 160° no bubble will stick in the tube, but ascends to the top; whereas below that temperature a bubble will remain in

¹ Printed *in extenso* in the *Phil. Mag.* September 1891.

² Published in full in *Electrical Review*, August 28, 1891.

one position, until it is compressed to such an extent that its form becomes lenticular, the edges of the lens being just in contact with the sides of the tube when it commences to ascend. There appears, therefore, to be a special temperature for each liquid, at which the angle of contact of its meniscus with the walls of the containing vessel is zero.

DEPARTMENT II.—MATHEMATICS.

1. *Interim Report of the Committee on Mathematical Functions.*
See Reports, p. 129.

-
2. *Interim Report of the Committee on the Pellian Equation Tables.*
See Reports, p. 160.

-
3. *On Periodic Motion of a Finite Conservative System.*¹
By Sir WILLIAM THOMSON, *Pres.R.S.*

-
4. *On a Geometrical Illustration of a Dynamical Theorem.*
By Sir ROBERT BALL, *F.R.S.*

It was observed in this paper that a dynamical system when moving in any way could be constrained to adhere to the same motion, so that every element should continue to twist about the same screw as it was twisting about at the moment. The forces to be applied for this purpose could be simply expressed, and a geometrical construction was given in the particular case of a rigid body, which was possessed of three degrees of freedom. It was shown that the screws about which a body so restricted could twist might be represented by points in a plane made on two ellipses, one representing the screws about which the body could twist with zero kinetic energy, the other representing the screws of zero pitch. It was then shown that two homographic systems of points could be constructed such that if any point P be joined to its correspondent Q, then the line of the ray with regard to the pitch ellipse represents the screw on which a wrench could be placed which should just steady the motion. The pole of the same ray with regard to the kinetic ellipse gives the acceleration of the body if permitted to pursue its movement without interference. A complete account of the investigation will shortly appear in the publications of the Royal Irish Academy.

-
5. *On the Transformation of a Differential Resolvent.*
By the Rev. ROBERT HARLEY, *M.A., F.R.S.*

If there be two algebraic equations such that they can be changed, the one into the other, by assuming, without loss of generality, certain relations among their variables; and if the differential resolvent of one of these equations is known, how can we pass directly to the differential resolvent of the other, without having recourse to a separate and independent calculation? That is the question I propose to consider in the present paper. Nearly thirty years ago, when seeking to determine the form of the differential resolvents of two trinomial algebraic equations connected in the manner above described, I endeavoured to effect a passage from one differential resolvent to another by a simple transformation, but was stopped by what seemed to me at the time to be an anomalous result. Fortunately the result was placed upon record for future discussion; it will be found in Art. 13 of a paper read before the Literary and Philosophical Society of Manchester (November 4, 1862),

¹ Printed in *extenso* in *Phil. Mag.* October 1891.

and printed in the second volume of the third series of the Society's Memoirs, pp. 232-245. A few weeks ago on re-studying this result, I succeeded in clearing up the supposed anomaly, and in converting one of the differential resolvents into the other. I will here indicate briefly the method employed, as it appears to admit of general application.

The differential resolvents of the equations

$$y^n - ny + (n-1)x = 0 \quad . \quad . \quad . \quad (a)$$

$$y^n - ny^{n-1} + (n-1)x = 0 \quad . \quad . \quad . \quad (b)$$

are

$$n^{n-1}[D]^{n-1} - (n-1)^n \left[\frac{n}{n-1} D - \frac{2n-1}{n-1} \right]^{n-1} x^{n-1} y = 0 \quad . \quad (a')$$

$$n^{n-1}[(n-1)D]^{n-1} y - (n-1)(nD - n - 1)[nD - 2]^{n-2} xy = [n-1]^{n-1} x \quad . \quad (b')$$

respectively, where $D = x \frac{d}{dx}$, and the usual factorial notation

$$[\theta]^a = (\theta)(\theta-1)(\theta-2) \dots (\theta-a+1)$$

is followed. The question is, how to pass from (a') to (b'); or, in other words, given the differential resolvent of (a) to find that of (b). The following method is effective.

If in equation (a) we write

$$-n', \left(\frac{n'^{n'-1}}{x'} \right)^{\frac{1}{n'+1}}, \left(\frac{1}{n'^2 x'} \right)^{\frac{1}{n'+1}} y'$$

for n, x, y respectively, it becomes

$$y'^{n'+1} - (n'+1)y'^{n'} + n'x' = 0 \quad . \quad . \quad . \quad (y)$$

which is of the same form as (b). Here

$$x \frac{d}{dx} = -(n'+1)x' \frac{d}{dx'}, \text{ or } D = -(n'+1)D'$$

These substitutions being made in the resolvent (a') we are led to

$$(n'+1)^{n'+1} [-(n'+1)D' + 1]^{-(n'+1)} y - n'^2 [-(n'D' + 1)]^{-(n'+1)} x' y' = 0 \quad . \quad (y')$$

the result given in the paper above cited.

Now, observing that, in general,

$$[-\theta]^{-a} = \frac{(-1)^a}{[\theta-1]^a}$$

we have

$$[-(n'+1)D' + 1]^{-(n'+1)} = \frac{(-1)^{n'+1}}{[(n'+1)D' - 2]^{n'+1}}$$

and

$$[-(n'D' + 1)]^{-(n'+1)} = \frac{(-1)^{n'+1}}{[n'D']^{n'+1}}$$

so that (y') may be written in the form

$$(n'+1)^{n'+1} [n'D']^{n'+1} y' - n'^2 [(n'+1)D' - 2]^{n'+1} x' y' = 0 \quad . \quad (y'_1)$$

which contains the common factor $(D-1)$, and therefore admits of a first integration. Operating with $(D-1)^{-1}$, and determining the constant by summing for the $(n+1)$ roots of $y'(\Sigma y' = n'+1)$, we obtain the differential resolvent of (y), namely,

$$(n'+1)^{n'} [n'D']^{n'} y' - n'(\overline{n'+1}D' - \overline{n'+2}) [(n'+1)D' - 2]^{n'-1} x' y' = [n']^{n'} x' \quad . \quad (y'_2)$$

Dropping accents and writing $n-1$ for n , we are conducted finally to the equation (b'), the differential resolvent of (b).

6. *On the Transformations used in connection with the duality of Differential Equations.* By E. B. ELLIOTT, F.R.S.

The Monge-Chasles-De Morgan reciprocal transformation of partial differential expressions

$$\begin{aligned} x' = p, y' = q, z' = px + qy - z, \\ x = p', y = q', z = p'x' + q'y' - z', \end{aligned}$$

is readily carried beyond the second order of derivatives by noticing that what is required is to express the derivatives of p, q with regard to p', q' in terms of those of p', q' with regard to p, q . Now a theory of the reversion of partial derivatives of two variables with regard to two others by interchange of the dependent and independent pairs has been developed.

The analogous but simpler reciprocal transformation of ordinary differential expressions

$$x' = p, y' = px - y$$

or

$$x = p', y = p'x' - y'$$

amounts only to the interchange of dependent and independent variables in derivatives of p with regard to p' ; and a quite complete theory of such a reversion is at our disposal. One consequence is that any reciprocant gives us on replacing $\frac{dp}{dp'}, \frac{d^2p}{dp'^2}, \dots$ by $\frac{d^2y}{dx^2}, \frac{d^3y}{dx^3}, \dots$ a self-reciprocal expression, *i.e.* the criterion of a family of curves whose polar reciprocals with regard to the parabola $x^2 = 2y$ constitute the same family.

7. *Note on a Method of Research for Invariants.*

By E. B. ELLIOTT, F.R.S.

This note was of the nature of an inquiry as to whether adequate use had been made of methods of direct determination of invariants of a binary form in terms of its co-efficients when deprived of its second term. The invariants of

$$ax^n + \frac{n(n-1)}{1.2} cx^{n-2} + \frac{n(n-1)(n-2)}{1.2.3} dx^{n-3} + \dots$$

are as shown by Cayley those functions of a, c, d, \dots whose degree i and weight w satisfy $in = 2w$, and which are annihilated by the differential operator

$$\begin{aligned} (n-2)d\delta_e + (n-3)e\delta_d + \dots \\ + (n-1)\frac{c}{a} \left\{ 3c\delta + 4d\delta_e + \dots \right\} \end{aligned}$$

8. *On Liquid Jets under Gravity.* By Rev. H. J. SHARPE, M.A.

The motion, which is in two dimensions, is supposed to be symmetrical with regard to $x'Ox$, which is the axis of the vessel and jet. BEF is the semi-outline of the vessel, FJ of the jet. AF is the semi-orifice which is *small* compared with the dimensions of the vessel and the depth of the liquid. Gravity acts parallel to $x'Ox$. OF is the surface of the liquid, which is maintained steady. AF is supposed to be so small that it may be considered either as the arc of a circle with centre O in the surface of the liquid, or as a small straight line perpendicular to Ox . For simplicity we shall take OA the radius of the circle (or the depth of the liquid) as unity. If g be the acceleration of gravity referred to this unit, it will be convenient to put a^2 for $2g$. We shall take O as the origin of Cartesian and polar coordinates x, y, r, θ and we shall put x' for $(x-1)$. Let χ and ψ be the stream functions on the *right* and *left* respectively of AF and let u, v be the velocities parallel to Ox, Oy . Further let $AF = \pi/p$ where p is a *large* number.

On the *right* of AF we take

$$\left. \begin{aligned} \frac{d\chi}{dy} = u = ar^3 \cos \frac{1}{2}\theta + \Sigma c'_n \epsilon^{-pnx'} \cos pny \\ - \frac{d\chi}{dx} = v = -ar^3 \sin \frac{1}{2}\theta + \Sigma c'_n \epsilon^{-pnx'} \sin pny \end{aligned} \right\} \dots (1)$$

Where c'_n is an arbitrary constant and Σ indicates summation with regard to n for all integral values from 1 to infinity.

On the *left* of AF we take

$$\left. \begin{aligned} \frac{d\psi}{dy} = u = S(a_m \epsilon^{mx'} \cos my) + \Sigma c_n \epsilon^{pnx'} \cos pny + A \\ - \frac{d\psi}{dx} = v = -S(a_m \epsilon^{mx'} \sin my) - \Sigma c_n \epsilon^{pnx'} \sin pny \end{aligned} \right\} \dots (2)$$

Where a_m , c_n and A are arbitrary constants and S indicates summation with regard to m for a *finite* number of values of m , the largest of which is supposed to be small compared with p .

Since the velocities must be continuous on each side of AF, we must have along AF.

$$\left. \begin{aligned} S(a_m \cos my) = a - A + \Sigma(c'_n - c_n) \cos pny \\ - S(a_m \sin my) + \frac{1}{2}ay = \Sigma(c'_n + c_n) \sin pny \end{aligned} \right\} \dots (3)$$

These must hold from $y = 0$ to $y = \pi/p$. But if we expand the left-hand sides by Fourier's Theorem we get c_n and c'_n as functions of n . Since the left-hand side of the second equation of (3) must vanish when $y = \pi/p$, this furnishes one relation among the constants. We can then show that c_n and c'_n are small quantities at most of the order $1/p^2$.

It is easy to form from (2) the equation to the outer stream-line BEF. If the vessel be of finite breadth at infinity, A will be a small quantity of the order $1/p$.

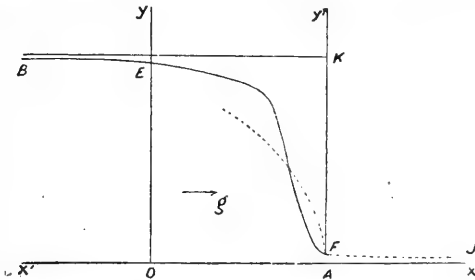

Looking now at (2), we see that if OE be the surface of the liquid, u and v must when $x' = -1$ be small quantities at most of the order $1/p$. A and the Σ term already satisfy that condition. In the S term m has several values. Suppose the particular m in (2) to be the smallest of these values, and suppose $m = \log p$, then when $x' = -1$ the S term also satisfies the surface condition, and the more accurately the larger p is, since $\log p/p$ diminishes as p increases.

If FJ is a *jet* we must have, since AF is small, at every point of the jet, nearly

$$u^2 + v^2 = 2gr.$$

But we see at once from (1) that this condition is nearly fulfilled, the error being of the order $1/p^2$.

As a particular case, if we give to m in (2) the two values 8 and 9, p will be about 2980 and the maximum error (which will be at F) will be about +.0000143.

If p be large enough, we can by taking a sufficient number of values of m , make the error of the order $1/p^3$ &c.

Roughly speaking, when the orifice is small compared with the depth of the liquid, the shape of the jet depends only on the orifice, being almost entirely independent of the shape of the vessel.

9. The Geometry of Confocal Conics. By Professor T. C. LEWIS.

1. If PP' , QQ' be chords of contact of T in two confocal conics, then a conic can be described with Q, Q' as foci which shall touch the conic PP' at P and P' .

FIG. 1.

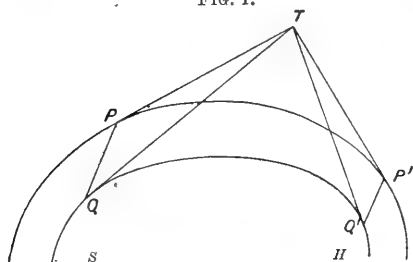

2.

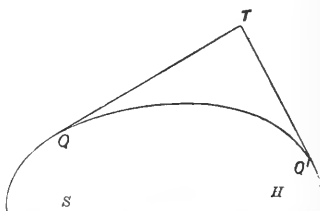

2. By taking T on the outer of the two ellipses, it follows that the ellipse with foci at Q, Q' which passes through T will have contact of the third order with the confocal through T ; and the hyperbola with foci at Q, Q' which passes through T will have contact of the third order with the hyperbola whose foci are S and H which passes through T .

3. In fig. 3 $PQ, PQ', P'Q, P'Q'$ are all tangents to one ellipse confocal with that through Q, Q' . Let this be q_1, q_2, q_3, q_4 (fig. 3). The four tangents to an ellipse intersect in three pairs of points. If each of one pair is on a confocal conic, so also is each of the others. Q, Q' lie on one confocal; T, T' lie on another confocal.

4. As in 1, a conic with P, P' as foci can be drawn touching the confocal TT' at T and T' $\therefore PT - TP' = P'T' - T'P'$.

\therefore a circle can be inscribed in the quadrilateral $TPT'P'$.

FIG. 3.

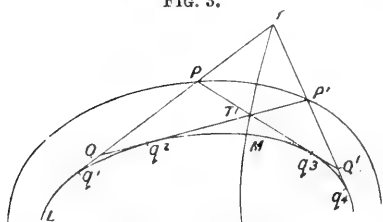
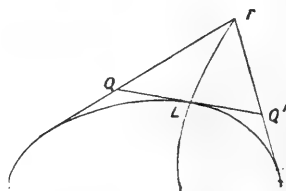

FIG. 4.



5. As a particular case, when P and Q coincide the two tangents from T meet the tangent at L in Q, Q' (fig. 4) which are on a confocal, and the circle inscribed in TQQ' touches the ellipse at L .

6. In fig. 3, $QP + PQ' = QP' + P'Q'$. Add to each $Qq_1 + \text{arc } q_1q_4 + q_4Q'$; and let PP' be consecutive points; Q being the intersection of consecutive tangents lies on the inner ellipse. Hence the string which must be placed round the inner ellipse to stretch to P is equal to the one which must be placed round it to stretch to P' .

Hence mode of describing confocal ellipses by placing strings round an ellipse and keeping them stretched by a pencil point.

And, similarly if an endless string be placed round an ellipse whose circumference is shorter than the string, and if the point M' be fixed, and a loop of the string be passed through a small ring at L and pulled tight, then if a pencil be put through the ring and moved steadily away from the ellipse, a confocal hyperbola will be described (fig. 5).

Various other cases arise.

7. As long as T is on a confocal ellipse $PT - PL$ is constant.

Also the tangents from T to the circle inscribed in TQQ' are of constant length.

If the tangent at L meet the confocal ellipse through T in T' and T'' , the confocal hyperbolas through T', T'' will pass through P, P' respectively and $T'T'' - \text{arc } PP'$ is constant.

Eight equal tangents can be drawn from the outer to the inner of two confocal ellipses.

8. If in fig. 5 the tangent be drawn at M, M' or L' to meet the tangent from T in Q and Q' , then the point of contact of this tangent will be the point at which either an inscribed or an escribed circle of the triangle TQQ' will touch the ellipse.

9. If a triangle be drawn with each side touching an ellipse, then an infinite number of triangles of equal perimeter can be drawn whose sides touch the ellipse; their three angular points lying one on each of three confocal ellipses.

10. If the three confocals which are the loci of the angular points coincide, the triangles are inscribed in one and circumscribed about another of two confocal ellipses.

In this case their perimeter is a maximum for all triangles inscribed in the outer ellipse, and a minimum for all triangles circumscribing the inner ellipse.

11. So for a polygon of any number of sides.

Also each tangent is divided into two sections at the point of contact. If the polygon has n sides there are $2n$ sections; starting with any one of them and

FIG. 5.

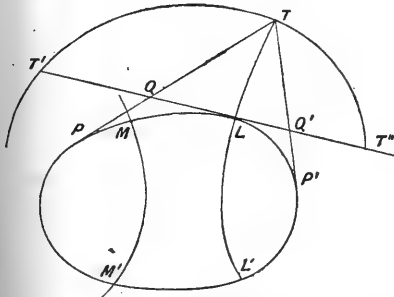
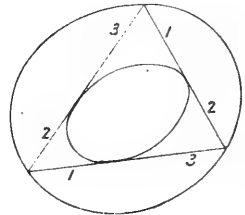

FIG. 6.



numbering the sections in order from 1 to n , the remaining sections are equal in magnitude to those already passed, occurring in the same order. The sections of the sides of the triangle in fig. 6 with the same number attached are equal to one another.

10. *Some Tangential Transformations, including Laguerre's Semi-Droites Réciproques.* By Professor R. W. GENESE, M.A.

The equation to a straight line cutting off a length a from the positive axis of x and making an angle $\cot^{-1}m$ with that axis, being $x - a = my$, a relation of the form

$$am^2 + 2hma + bu^2 + 2gm + 2fa + c = 0 \quad . \quad . \quad (1)$$

makes the line a tangent to the conic

$$Ay^2 + B + Cx^2 - 2Fcx - 2Gxy + 2Hy = 0 \quad \dots \quad (2)$$

If now a second line $x - a = m'y$ be obtained from the first by means of the relation

$$pm^2 + 2r'mm' + qm'^2 + 2q'm + 2p'm' + r = 0 \quad \dots \quad (3)$$

the envelope of this line will in general be of the fourth class. If, however, the minors of the discriminants of (1) and (3) be connected by the relations

$$\frac{A}{P} = \frac{C}{R} = \frac{G}{Q'} \quad \dots \quad (4)$$

then the envelope degenerates into two of the second class.

The conditions (4) were obtained thus:—Considering a, m', m as the coordinates of a point referred to three orthogonal planes, (1) and (3) represent *two cylinders*, and (4) gives the conditions that these should have two common plane sections. The conditions may be geometrically interpreted thus; *if two conic cylinders lie between two parallel planes (i.e. each cylinder touch both planes) their complete intersection consists of two conics.*

Laguerre's transformation, analytically considered, gives the relation

$$m^2 + 2kmm' + m'^2 = k^2 - 1 \quad \dots \quad (3')$$

here

$$P = 1 - k^2, R = 1 - k^2, Q' = 0.$$

Then by (4), $A = C$ and $G = 0$, and the transformation is seen to be of simple use only for the case of circles. M. Laguerre's results, however, of which an account is given in his '*Géométrie de Direction*,' are of exceptional elegance.

11. *Note on the Normal to a Conic.* By R. H. PINKERTON.

12. *On the Importance of the Conception of Direction in Natural Philosophy.* By E. T. DIXON.

This importance has already been recognised in the higher branches of science in the guise of Vector theories, and the chief reason it has not been made use of in elementary geometry is the want of a proper definition. Such proper definition might be deduced from the conception of direction as a relation between two positions which is independent of the distance between them and of the absolute position of either of them in space. The concept thus defined is independent of the conception of a straight line, and so may be used to define it, and is therefore distinct from the concept defined, by saying that two straight lines which have a common point have the same or different directions according as they coincide or not. That some notion of direction is necessary to elementary geometry is shown by the fact that without it right- and left-handed figures which are equal in every respect cannot be distinguished; and that the concept as defined is commonly entertained, is proved by the fact that it follows from Newton's Laws of Motion that absolutely fixed directions may be conceived in space, although absolutely fixed positions cannot.¹

¹ Vide *The Foundations of Geometry* (Deighton, Bell & Co.)

MONDAY, AUGUST 24.

The following Reports and Papers were read:—

1. *Report of the Committee on Researches on the Ultra-Violet Rays of the Solar Spectrum.*—See Reports, p. 147.
-
2. *Comparison of Eye and Hand Registration of Lines in the Violet and Ultra-Violet of the Solar Spectrum, against Photographic Records of the same, with the same Instrument, after a lapse of several years.*
By C. PIAZZI SMYTH, LL.D., F.R.S.E.

A comparison of the plates seems to lead to such practically useful conclusions as the following:—

1. Two photographic representations are far more trustworthy than three or probably a much greater number of hand-drawn views of solar-spectrum lines, even when the eye imagines it sees them very clearly.

2. The photographic principle records with ease, and the utmost vigour of black, white and grey of various shades, a world of objects in certain spectral regions where the eye can see nothing whatever.

3. What photography depicts in such cases is what the human eye ought to see, and would see were it divinely perfect simply as an eye.

4. The ordinary spots, pin-holes and dust-marks, which too often abound in photography, never assume such shapes as might lead to their being mistaken by any experienced observer for a single one of Nature's solar-spectrum lines of light or shade.

5. The frequent errors, and then ail-pervading effects, fallen into by some photographers in the way of over or under exposure, and over or under development, may prevent the *absolute* intensity of any one line, on one plate alone, being usefully quoted as a scientific datum. But the *relative* intensities, and innumerable distinctions in hue and shape, of thick or thin, dark or light, closely arrayed or widely scattered, flutings gradating towards the violet or towards the red end, and regularly or irregularly spaced lines on the *same* plate, are full of most important and instructive particulars. While they mostly hold good also, from plate to plate of the same parts of spectral space, on all the proofs that may be taken both day after day, and through a very wide range of all the possibilities of perversion and misuse which may be humanly committed upon this most exquisite *aid*, viz. photography, to the noblest of the senses of man, vision.

6. In principle, all this has long been known to advanced workers in every civilised nation. But as it is not everywhere yet utilised to the extent it might well be, it is hoped that this further and rather multitudinous example, on an extreme scale too, of spectral separation, and capable of showing such a Titanic instance of a dark thunder-cloud-looking column as 'Great K,' by pure photography only eight months ago, in a solar-spectrum telescopic field which was at the time absolute emptiness to the eye, may be useful in calling increased attention to similar and more extensive employments of photography in the future.

-
3. *Note on Observing the Rotation of the Sun with the Spectroscope.*
By G. JOHNSTONE STONEY, M.A., D.Sc., F.R.S.

In this note the author described an arrangement for conspicuously exhibiting to the eye the rotation of the sun by the spectroscop. The sun's light, after reflection from the mirror of a heliostat, is received by a telescope lens which forms an image of the sun on the slit of the spectroscop. The lens is attached to a vertical board, and two screws are partly screwed side by side into the board and at some distance above the lens. The projecting heads of the screws rest on a

fixed support so that the board can oscillate a little sideways. This carries the image of the sun backwards and forwards over the slit, so that the light admitted by the slit is alternately taken from a part of the solar disk near the following limb which is advancing towards the earth, and from a part near the preceding limb which is receding. Accordingly the solar lines in the spectrum are alternately shifted a little—perhaps about one-twentieth or one-thirtieth of a tenth-metre—to the right and left, while the earth-lines maintain their position unaltered. The eye readily detects this motion even when so small.

There is a solar line a little less refrangible than the eighth pair of double lines in the great B oxygen group, which, with the arrangement described above, is seen to approach and recede from the double line in sympathy with the motion of the pendulum. Another line well placed for the observation is the earth-line, which is a very little more refrangible than D_2 ; and another convenient group is where there is a strong iron line on the more refrangible side of D_2 , about as far from D_2 on one side as D_1 is on the other. There is an earth-line in nearly the same position. The two appear as a single line when the light is taken from the preceding limb of the sun, and as a double line when it is taken from the following limb; and with the pendulum arrangement these appearances alternate.

Of these three the observation on the B line can be well made in the second spectrum of a Rowland's grating $1\frac{3}{4}$ inch long. The observations near D are best made in the fifth spectrum.

There are of course multitudes of other lines, on which the observation can be made.

A. *On the Cause of Double Lines in Spectra.*

By G. JOHNSTONE STONEY, M.A., D.Sc., F.R.S.

The lines of the spectrum of a gas are due to some events which occur within the molecules, and which are able to affect the æther. These events may be Hertzian discharges between molecules that are differently electrified, or they may be the moving about of those irremovable electric charges, the supposition of which offers the simplest explanation of Faraday's law of electrolysis. The amount of the charge which is associated with each of the bonds, and of which two or more seem to be present in every chemical atom, is always the same quantity of electricity. In a communication made to the British Association in 1874 the author invited attention to this fixed quantity of electricity as one of three fundamental units presented to us by nature (see 'Phil. Mag.' for May 1881), and estimated its value, which is about the twentietheth (*i.e.* $1/10^{20}$) of the electro-magnetic unit of quantity in the ohm series.

Several considerations (of which perhaps the most decisive is the phenomenon of the reversal of lines) suggest that the source of the spectral lines is to be sought not in the Hertzian discharges, but in the carrying about of the fixed electric charges, which for convenience may be called the electrons. The present investigation however is not dependent on this or any other particular hypothesis, since it is with the laws of the events within the molecules that it is concerned, and the course of the investigation shows that these laws are the laws of the motion of separate elements of volume, which may be conveniently thought of as the motion of those parts of the molecule to which the electrons are to be regarded as indissolubly bound. An electron, if waved about in some particular way by the motions within the molecule, would occasion such electro-magnetic waves as are revealed to us by the spectroscope.

Now the irrotational motion of an element of volume consists in its traversing some orbit, accompanied perhaps by a simultaneous distortion of its form. We are only concerned with the orbital motion. This motion may be resolved by Fourier's Theorem into the superposition of partials, each of which is a simple pendulous motion in an ellipse, and each of these partials produces its own line in the spectrum. Seven constants are required for the full determination of each partial if the orbit of the electron is a curve of double curvature, or five if it is a plain curve. Now the observation of a line supplies only two equations between

these. The wave-length of the line, when corrected for the refraction of the air, gives the periodic time of the motion of the electron in the corresponding partial, and the brightness of the line gives a quantity proportional to $a^2 + b^2$, a and b being the axes of the ellipse.

But there is one case, and fortunately a case which at all events frequently occurs, and that perhaps is universal, in which we receive a very interesting addition to our knowledge; explaining on the one hand the double lines that are so frequent in spectra, and on the other telling us the actual forms of the elliptic partials of the motion going on in the molecules. This important case occurs whenever some of the forces which determine the motion of the electron are feeble compared with the others, and are such as to produce that familiar form of perturbation which consists in an apsidal motion of the elliptic partials. When this perturbation prevails, the lines are rendered double by it, and an examination of the positions and intensities of the two constituents of a double line enables us to determine (*a*) the form of the elliptic partial to which they are due, (*b*) the time which the electron takes to travel round it, and (*c*) both the direction and speed of the apsidal perturbation. Thus the principal double line of sodium is found to have its source in a long elliptic partial, the ratio of the axes of which lies somewhere between 11:1 and 13:1. Round this partial the electron travels about 1,984 times during one revolution of its slow apsidal perturbation, and there is time for about 36 of these slow apsidal revolutions to take place during each flight of the molecule. Moreover in this case the apsidal motion takes place in the same direction as the motion of the electron round the ellipse. An equal amount of information can be obtained in the case of every other double line that can be adequately observed.

The author thought he had reason to suspect from observation that almost *all* spectral lines are double, and that they appear single only when our spectroscopes have insufficient revolving power, or when each of the constituents has so widened out as to obliterate the interval between them, or in the rare cases when the partial from which they arise being circular one of the two constituents of the double line is of cypher intensity.¹ If this shall turn out to be the case, there must be some common cause for the apsidal perturbation, and the author ventured to suggest as the most probable cause the feeble reaction which the æther exerts on the electron, consequent on the energy which the molecule imparts to the æther when producing the electromagnetic waves. A fuller account of the investigation is being printed by the Royal Dublin Society in its Scientific Transactions.

5. *Seventh Report of the Committee on Solar Radiation.*
See Reports, p. 160.

6. *Report of the Committee on Meteorological Photography.*
See Reports, p. 130.

7. *Report of the Committee on the Meteorological Observations on Ben Nevis.*
See Reports, p. 140.

8. *Report of the Committee on the Reduction of Magnetic Observations.*
See Reports, p. 149.

¹ It is shown in the investigation that *each* of the two *constituents* of a double line arises from a circular motion. Accordingly they would not suffer further duplication if an additional apsidal perturbation were introduced.

9. *Report of the Committee on the Seasonal Variations in the Temperature of Lakes, Rivers, and Estuaries.* See Reports, p. 454.

10. *On the probable Nature of the Bright Streaks on the Moon.*
By Dr. RALPH COPELAND, F.R.A.S., F.R.S.E.

In this paper the author described the chief features of the bright lunar streaks, especially their invisibility when the shadows of the mountains are most conspicuous, and their great prominence when the lunar shadows are imperceptible. It was explained that the bright streaks demanded for their visibility not so much a high angle of illumination, as a front illumination. In other words, they become visible when the light falls more or less closely in the line of sight.

If this condition is fulfilled the streaks come prominently into view quite regardless of the inclination of the surfaces on which they occur. The surfaces indeed may make almost any angle, either with the line of sight or with the sun's rays, provided they are at all turned towards the common direction of the spectator and the sun.

An important deduction from this fundamental fact is that each elementary portion of the streak surface is of a form that is symmetrical to the spectator from whatever point it is seen. The sphere alone appears to fulfil this condition; hence it may be assumed that the surface of the streak material must be made up of a large number of more or less complete spherical surfaces. These minute surfaces may be either concave or convex. We may therefore regard the streaks as being produced by a material pitted with minute cavities of spherical figure, or strewn over with minute solid spheres. In the latter case it is probable that the material is more or less transparent, or at least translucent.

To test this hypothesis, a plaster model of the moon 22 inches in diameter was made, on which the bright streaks are represented by lines of minute spherules of transparent glass attached to the surface. These possess in a marked degree the desired property of remaining inconspicuous under cross light, while they flash out brilliantly when lit up from the front. Although the spherules are but 1-50th to 1-30th inch in diameter, they are still too large in proportion to the model, and therefore cast perceptible shadows when they would otherwise be invisible. This might have been largely avoided by the tedious process of partially imbedding them in the model. The corresponding diameter on the moon's surface would be from 2 to 3½ miles.

When suitably illuminated the phases of the model were found, on photometric examination, to follow a law not very unlike that of the lunar phases as derived by Zöllner from his own observations, and those of Sir John Herschel, the light of the 'full moon' being nearly five times that at quadrature. Without streaks the model closely agreed with Lambert's formula for a non-reflecting sphere, for which the full disc is 3.1416 times as bright as the half disc illuminated from the side. The paper was illustrated by a diagram showing the relative brightness of the phases as well as by the model and photographs of the same. The model, suitably illuminated, was also exhibited at the evening conversazioni of the Association.

TUESDAY, AUGUST 25.

The following Report and Papers were read:—

1. *Report of the Committee on Electrical Standards.*—See Reports, p. 152.
2. *The Causes of Variation of Clark Standard Cells.*¹ By J. SWINBURN.

The various parts of the cell are examined separately. Any zinc will do, if amalgamated before use. The greatest variations are due to impurities, such as

¹ Published in full in *Electrical Review*, August 28, 1891.

traces of iron, which are found in even the best purchased sulphate of zinc. The sulphate of zinc solution may also contain basic sulphates, and it is not homogeneous after any variations of temperature. This gives rise to variations of the electromotive force of the cell, and also to large variations of temperature-coefficient. The mercurous sulphate bought as pure nearly always contains a great deal of mercuric sulphate. The effects of these and other causes of variation are discussed, and an amalgam cell, preferably with a non-saturated solution, recommended.

3. *A Joint Discussion with Section G. on Units and their Nomenclature was opened by Professor OLIVER J. LODGE, F.R.S., followed by W. H. PREECE, F.R.S.*

The following Papers were read in connection with the discussion, viz. :—

Some Revolutionary Suggestions on the Nomenclature of Electrical and Mechanical Units. By Professor W. STROUD.

Present Practical System of Units.—1. The present practical system of units is very objectionable on three grounds—

- (a) There is no *primâ facie* reason why the practical unit of current should be equal to 1-10th c.g.s. unit.
- (β) The relation between the other practical electric units and the corresponding c.g.s. units is much more complex than need be.
- (γ) The units of work and power are far too small for practical requirements.

2. If we were starting to devise a practical system to-day, such a system could best be formed by taking 10^9 cm. as the unit of length, 10^{-9} gm. as the unit of mass, and the second as unit of time.

3. That in the interests of the 'practical' men of the future and in the interests of the electrical students of both the present and the future, it is highly desirable to initiate a revolution with the object of dethroning the present practical system of units.

Nomenclature.—1. That the term Dyne to indicate 10^7 of our present (1891) dynes is objectionable, as custom has restricted the use of Greek derivatives entirely to c.g.s. units.

That 10^7 dynes, if required, might be called a Hebdomodyne, suitably contracted, of course, or preferably a joc (joule over centimetre).

2. That the classical languages are of little or no service for the provision of names for modern, more or less complex, physical conceptions, and therefore this method of coining words it is desirable to abandon.

3. That for c.g.s. units some system of *automatic nomenclature* in which every name shall be self-explanatory would prove a boon to the teachers and a blessing to the student, and that such a system is quite capable of being devised.

4. That the prefixes *meizo* to indicate 10^9 , and *mei* to indicate 10^{-9} may be found useful.

On a Table to Facilitate the Conversion of Electrostatic and Electromagnetic Measures into one another. By G. JOHNSONE STONEY, M.A., D.Sc., F.R.S.

The fundamental equations of electricity are :—

$$F = a^2 \frac{QQ'}{\gamma^2}, \text{ for the repulsion between two quantities of electricity.}$$

$$F = b^2 \frac{PP'}{\gamma^2}, \text{ for the repulsion between two quantities of magnetism, and}$$

$F = c^2 \frac{PQ}{T}, \frac{e}{\gamma^2}$, for the repulsion between a linear current and a magnet; a , b , and c depending on the specific inductive capacities of the medium for electricity and magnetism.

The dimensions of the various units in electricity and magnetism, if written out in full, would contain these coefficients, which are so related that ab/c^2 is a velocity. Our knowledge of the significance of this standard velocity is chiefly owing to Clerk Maxwell, and the author suggested that it shall be called the Maxwell. It appears from the electromagnetic theory of light that it is also the velocity of light.

The above relation may be written in either of the forms,

$$a = v, \frac{c^2}{b}, \text{ or } b = v, \frac{c^2}{a}.$$

Accordingly, if we choose to confine our attention to the cases in which c^2/a has its unit of value,

$$b = v \text{ [multiplied by a coefficient of dimensions, } c^2/a, \text{ and of unit value]};$$

and if, on the other hand, we confine our attention to the cases in which c^2/b has its unit of value,

$$a = v \text{ [multiplied by a coefficient of dimensions, } c^2/b, \text{ and of unit value]}.$$

The first of these assumptions is that the specific inductive capacity for electricity of the medium (usually air) is taken as our unit of specific inductive capacity for electricity, and the second assumption is that the specific inductive capacity for magnetism of the medium is taken as the unit of specific inductive capacity for magnetism.

Electrical units consistent with the first assumption are called electrostatic units, those consistent with the second assumption are the electromagnetic units. In the dimensional equations of the electrostatic system c^2/a disappears and is replaced by unity, in those of the second system it is c^2/b which disappears. This makes the difference between the imperfect dimensional equations of the two systems, which is therefore only apparent; and the ratios between the units of each physical quantity, whether estimated electrostatically or electromagnetically, are essentially numerical.

Units consistent with both assumptions can only be obtained if we use the Maxwell velocity as our unit of velocity, in which case a , b , and c can all have unit values; and the central column of the following table is based on this assumption, and is introduced to afford a common ground up to which it is sufficient separately to trace from the right and left the numerical relations of the units of the systems in common use (by the help of the two systems of imperfect dimensional equations), in order to arrive at the numerical relations the whole way across. The Maxwell must be our unit of velocity in the central column; but we are at liberty to choose two other units arbitrarily, and they are so selected as to make the unit of time and the unit of \sqrt{LM} the same in the central column as in the two adjoining ohm columns. This reduces the numerical relations to their simplest form. The table can easily be extended to include the units of every other electrical quantity.

The name *potency* is suggested for what is too often miscalled a force, or the intensity of the field. At every station in space there is potency over the magnetism that is there present, over the electricity, over the mass, and over the volume occupied (producing buoyancy), if the surrounding medium is excluded from it. There are, therefore, four potencies at each point of space, each being one factor of a force, the other factor being a quantity of magnetism, of electricity, of mass, or of volume, as the case may be. The author also expressed his hope that the phrases electromotive force and pressure may be discontinued, for what is in fact one factor of an energy, the other factor being a quantity of electricity. Voltage, which has in some degree come into use, was recommended instead.

QUANTITY	Dynamical Dimensions	Electro-Static Dimensions	ELECTRO-STATIC		MAXWELL, Unit of	ELECTRO-MAGNETIC		Electro-Magnetic Dimensions
			C.G.S., Unit of	Ohm, Unit of		Ohm, Unit of	C.G.S., Unit of	
			p' gramme cubic centimetre	p q m b		pP qQ M B	P' Q'	
Of Magnetism	—	α	$10^8 <$	aA	$30 <$	Ampère	A'	β
Of Electricity	T^2	$\beta\beta$	$10^8 <$	$\frac{pV}{qV}$	$30 <$	Volt	V'	β
Of Mass	β^2	β	$10^{11} <$	$\frac{pV}{qV}$	$30 <$	Volt	V'	β
Of Volume	T^2	—	$10^{27} <$	V	$30^2 >$	—	—	—
Electric Current	—	$\beta\beta$	$10^8 <$	α	$30 <$	Ampère	A'	β
On Magnetism	—	$\beta\beta$	$10^8 <$	α	$30 <$	Ampère	A'	β
On Electricity	T^2	$\beta\beta$	$10^8 <$	$\frac{pV}{qV}$	$30 <$	Volt	V'	β
On Mass	β^2	β	$10^{11} <$	$\frac{pV}{qV}$	$30 <$	Volt	V'	β
On Volume	T^2	—	$10^{27} <$	V	$30^2 >$	—	—	—
On Magnetism	—	γ	$10 >$	h	$30 <$	Gauss	G'	γ
On Electricity	—	γ	$10^{10} >$	h	$30 >$	H	H'	γ
On Mass	$\frac{v}{T}$	—	$10^9 <$	h	$30 <$	—	—	—
On Volume	$\frac{\beta^2}{T^2}$	—	$10^{20} >$	h	$30^2 >$	—	—	—
Magnetic Force of which per unit area = [Potency]	—	$\frac{v^2 \alpha}{v \alpha}$	$10^{17} >$	$\frac{nN}{nN}$	$30 >$	N	N'	$\frac{v^2 \alpha}{v^2 \alpha}$
Resistance	—	$\frac{v^2 \alpha}{v \alpha}$	$10^9 >$	$\frac{nN}{nN}$	$30 >$	Ohm	R'	v
Coefficient of Self-induction	—	$\frac{v^2 \alpha}{v \alpha}$	$10^9 >$	$\frac{nN}{nN}$	$30 >$	S	S'	L
Capacity	—	$\frac{v^2 \alpha}{v \alpha}$	$10^9 <$	$\frac{nN}{nN}$	$30 <$	Farad	C'	$\frac{L}{v^2}$
Specific inductive capacity	—	$\frac{v^2 \alpha}{v \alpha}$	$10^9 <$	$\frac{nN}{nN}$	$30 <$	K	K'	O

E [Voltage, or Electromotive force], identical with Potential on Electricity.

In the columns of dimensions $\alpha = \sqrt{LM}$, $\beta = \frac{\sqrt{LM}}{T}$, $\gamma = \frac{\sqrt{LM}}{T^2}$. The units of L, M, and T for the Maxwell column are so selected that the unit of v becomes in it the velocity of light and that the units of α , β , and γ remain the same as in the Ohm columns. * Asterisks are introduced to direct attention to the more important of the horizontal lines

Absolute Units of Measurement. By W. MOON.

The disadvantages of the C.G.S. system of units are that the units are so small that one can form no conception of their value, and that owing to this smallness it is necessary to introduce a separate set of practical units for ordinary purposes of measurement. These disadvantages may be overcome by taking as fundamental units L and M larger or T smaller.

Of all the systems of metrical units that can be formed by varying L and T by multiples or sub-multiples of ten, that system is the best that is founded upon the 'Decimetre, Kilogramme, and Decisecond.' If the name 'Instant' were given to the Decisecond, the system could be spoken of as the D.K.I. system.

In the D.K.I. system 'g' = .981, or nearly unity, so that the weight of a kilogramme could be taken as the unit of force for rough calculations. This would be a great improvement, since the simplest way to conceive a force is as the weight of unit mass.

A prepared table shows that all the D.K.I. units are sufficiently large to be used for practical purposes, and that all the multiples and sub-multiples of them that would be required could be expressed by the usual Greek prefixes to their names.

To express the large numbers required for insulation, resistances, and the small capacities of condensers, the Greek prefixes 'omega' and 'omicron' might be used for powers of 10 and 10^{-1} respectively.

WEDNESDAY, AUGUST 26.

The following Papers and Report were read:—

1. *On the Measurement of Lenses.*

By Professor SILVANUS P. THOMPSON, F.L.S.

The author described his focometer and some results obtained upon microscopic objectives and camera lenses. Wide-angled lenses were found in all cases to have the positions of principal planes inverted.

2. *On a New Polariser.* By Professor SILVANUS P. THOMPSON, F.R.S.3. *Some Experiments on a new Method for the Determination of 'v.'*

By A. G. WEBSTER.

The method is similar to that proposed by Maxwell with the title, 'Measurement of a resistance in Electrostatic Measure.' A condenser is connected in parallel with the two sets of quadrants of an electrometer, and both are connected in series with a battery and a high inductionless resistance. Contact being made and broken after a short time t by means of a Helmholtz pendulum-interrupter, the potential of the charge of the condenser and electrometer, measured by the first swing of the latter, is

$$p = p_0 \left(1 - e^{-\frac{t}{w(c+\gamma)}} \right)$$

p_0 being the E.M.F. of the battery used, w the large resistance, c and γ the respective capacities of the condenser and electrometer. A second set of experiments, c being disconnected, gave the value of γ , which included the capacity of the leading wires and of an auxiliary condenser inserted for the purpose of making $c + \gamma$ and γ more nearly equal.

By turning the micrometer screw of the pendulum-interruptor, and thus changing the distance between the contacts, t can be varied and a large number of points on the logarithmic curve found. By a process of calibration with the pendulum, it was found that the electrometer-throws were strictly proportional to the potentials p_0 . This calibration was made by taking a w so small that the exponential term vanished and measuring p for various p_0 's.

The resistances used were made by ruling pencil lines upon finely-ground glass, upon the ends of which a thin film of platinum had been firmly deposited by burning in and soldering the connecting wires to this, giving a firm and reliable connection to the resistance.

The condenser was a large plate-condenser, 50 cm. in diameter, whose capacity was found by Kirchhoff's formula. Three capacities, 350·204, 770·513, and 998·459 cm. were used, with resistances of from one-half to five megohms.

The time-constant of the pendulum was found by the method of Pouillet for short intervals, by means of a ballistic galvanometer. One division of the micrometer was found to correspond to

$$1\cdot1346 \times 10^{-6} \text{ sec.}$$

In the experiments, readings were taken at intervals between 100 and 2,000 micrometer-divisions.

A large number of observations was taken, in which all the measured quantities c , w , and t were varied.

The value of v arrived at was

$$2\cdot987 \times 10^{10} \text{ cm. sec}^{-1}$$

-
4. *On the Magnetic Field in the neighbourhood of the South London Electrical Railway.* By Professor W. E. AYRTON, F.R.S., and Professor RÜCKER, F.R.S.

Observations were made by means of a mirror galvanometer the period of which was 10 sec., and which was used as a magnetometer. The instrument was placed in two rooms about 70 and 180 feet respectively from the centre of the road, under which the railway runs at a depth of about 70 feet. It is believed that the earth was acting as the return portion of the circuit. In accord with this the instrument was found to be in continual vibration. The amplitude of the swing at the station nearer to the railway was often 50 mm., and the law of decrease with distance appeared to be inversely as the first power. It is, therefore, evident that experiments of the most ordinary accuracy could not be made within a very great distance of such a railway.

-
5. *On the Periodic Time of Tuning-Forks maintained in Vibration Electrically.* By Professor J. VIRIAMU JONES and T. HARRISON.

-
6. *Magnetic Experiments made in Connection with the Determination of the Rate of Propagation of Magnetisation in Iron.* By F. T. TROUTON.

-
7. *On the Connection between the Crystal Form and the Chemical Composition of Bodies. The Symmetry of Crystals accounted for by the Application of Boscovich's Theory of Atoms to the Atoms of the Chemist.* By WILLIAM BARLOW, F.G.S.

After mentioning that he read papers on the same subject at the meetings of the British Association at Aberdeen in 1885 and Leeds in 1890, the author states that he is now prepared to deal with the matter in a more general way, and to submit proof that the mutual interaction of different kinds of atoms present in

simple proportions is competent to produce the various kinds of symmetry exhibited by crystals if the fundamental doctrine of Boscovich is admitted—that the ultimate atoms are points endowed each with inertia, and with mutual attractions or repulsions dependent on mutual distances—repulsion manifesting itself at the smallest distances and becoming infinite at infinitely small distances.

After referring to the principal views which have been put forward as to the nature of the molecules or units of crystals he goes on to argue that stable equilibrium of a group of atoms endowed with Boscovich's properties is evidently found in that disposition of the atoms which gives the repulsions greatest play; that it is, in fact, the arrangement in which the packing is closest, or, in the language of modern conceptions, the arrangement in which the potential energy of the system is a minimum.

He then proceeds to answer the question, What grouping of a concourse of atoms will give closest packing? first pointing out that the answer depends on whether the atoms are of different kinds, and, if they are, on the numerical proportion of each kind present, and also on the relative magnitude of the spaces they occupy, or, in other words, on their relative capacities for repelling or being repelled.

For simplicity sake, he takes first the imaginary case of atoms confined to the same plane, and points out that if there are two kinds of atoms present in equal numbers, one of which exercises a feebler repulsion than the other, their repulsions may be so proportioned that closest packing will be attained when one kind of atom lies at the angles of a system of equal squares fitted close together, the other at the centres of the same squares.

He then applies similar reasoning to cases of atoms not in the same plane, and, after remarking that atoms which are all of one kind will pack closest when their centres have the relative situation of the centres of a close-packed assemblage of equal globes—a familiar example of which is found in the stacking of cannon-shot—he states that the more general case of the closest packing of two or more kinds of atoms is approximately depicted by the closest packing of globes, if the globes are of different sizes, to represent the effects of the difference in the repulsions exercised by the different atoms.

After saying that the nature of the grouping in which stable equilibrium is found will depend on the ratio between the lengths of the radii of the globes employed, the author traces the nature of the grouping for several particular values of this ratio.

He points out that not only holohedral groupings corresponding to the simpler forms of the crystallographic systems can be obtained in this way, but that the more complicated partial symmetry of hemihedral and tetartohedral forms are also to be obtained.

As examples of the latter he gives a grouping in closest-packing that has the precise symmetry of zinc-blende ZnS , which, according to Groth, crystallises in the *tetraëdrische hemiëdrie* of the cubic system, and another grouping that has the precise symmetry of cuprite Cu_2O , which, according to Groth, crystallises in the *pygädrische hemiëdrie* of the cubic system. The numerical proportion of the spheres of different radius employed is, in each case, that of the atoms present in the molecule of the compound represented.

Polar-pyroelectric phenomena and circular polarisation are, the author points out, associated with peculiarities of the internal symmetry of the groupings, which correspond in outward symmetry with the bodies displaying these phenomena.

The grouping is portrayed by beads of different colours suspended in space in the symmetrical manner requisite in each case.

The author concludes his paper by referring to some geometrical properties of the symmetrical systems of the crystallographer which he has discovered by an extension of the methods adopted by Bravais and by Sohncke, and which have greatly facilitated his work in finding symmetrical groupings to fit the forms and composition of a variety of different substances.

8. *Report of the Committee on the Volcanic and Seismological Phenomena of Japan.*—See Reports, p. 123.

9. *On Phenomena which might be Observable if the Hypothesis that Earthquakes are connected with Electrical Phenomena be entertained.* By Professor JOHN MILNE, F.R.S.

It seems reasonable to assume that superheated high pressure steam escaping at a volcanic focus A through fissures to a region B—A and B being more or less insulated by partially non-conducting material—might also result in the development of large quantities of electricity, followed ultimately by violent discharges.

If a conductor C electrically connected with the surface, say the ocean, is separated from B by partially non-conducting matter I, then B I C may be regarded as a condenser, and the charges at B and C are intensified. Discharges might also take place between B and C, and the charges at A, B and C would act inductively at the points *a, b, c*, of the surface respectively nearest to them.

The phenomena related to the above hypothesis are as follows:—

1. *Earthquakes and Earth-currents.*—From a comparison of observations at 700 stations in Japan, there seems to be no connection between earthquakes and abnormal disturbances on land lines. It would, however, seem that any subterranean discharge—as, for instance, between A and B—must produce simultaneous change of potential at *a* and *b*, and that therefore no change of current should be expected. Thus the hypothesis is not opposed to the facts.

2. *Connection between Earthquakes and Volcanoes.*—Most earthquakes do not originate at volcanoes, but below the sea or on the coast-line where flat ground suddenly slopes down below a deep ocean. From the hypothesis we should expect that the greatest electric stress, and therefore the greatest disruptive stress, would be between B and C.

3. *Potential at Hot Springs.*—Measurements made at seven springs in the same valley extending from Yumoto, 100 to 200 feet above sea-level, to Ashinoyu 3,000 feet above sea-level. Between a hot spring and the earth, 10 to 100 yards distant, the difference at the foot of the valley is about 0.5 of a volt, but at high elevations, where the water is most sulphurous, the difference rose to 0.6 volt.

The difference of potential between *b* and a neighbouring point ought to increase when *b* is a volcanic vent. The existence of sulphurous water, however, is not to be overlooked.

4. *Variations in Potential between Water-Bearing Strata and the Superincumbent Surface.*—For more than 100 days a continuous photographic record was taken of the difference of the potentials of the water in a well 30 feet deep, and of a point on the surface of the earth 25 yards off. At the time of three small earthquakes deflections equivalent to 2 or 3 volts were observed, but they may have been due to mechanical disturbance.

10. *Experimental Study of a Curious Movement of Ovoids and Ellipsoids.* By Professor LECONTE.

11. *On Vowel Sounds.* By Dr. R. J. LELOYD.—See p. 796.

12. *A Latent Characteristic of Aluminium.* By Dr. A. SPRINGER.

According to the author's investigations aluminium is remarkably adapted for use in the construction of sound-boards by possessing an elasticity capable of sympathetic vibration uniformly through a wide range of tone-pitch, and by the absence of higher partial tones during vibration.

SECTION B.—CHEMICAL SCIENCE.

PRESIDENT OF THE SECTION—Professor W. C. ROBERTS-AUSTEN, C.B., F.R.S.

THURSDAY, AUGUST 20.

The President delivered the following Address:—

THE selection of Cardiff as a place of meeting of the British Association led to the presidency of Section B being entrusted to a metallurgist. It will be well, therefore, to deal in this address mainly with considerations connected with the subject to which my life has been devoted, and I hope that it may be possible for me to show that this practical art has both promoted the advancement of science and has received splendid gifts in return.

It is an art for which in this country we have traditional love; nevertheless the modes of teaching it, and its influence on science, are but imperfectly understood and appreciated. Practical metallurgists are far too apt to think that improvements in their processes are mainly the result of their own experience and observation, unaided by pure science. On the other hand, those who teach metallurgy often forget that for the present they have not only to give instruction in the method of conducting technical operations, but have truly to educate, by teaching the chemistry of high temperatures, at which ordinary reactions are modified or even reversed, while they have further to deal with many phenomena of much importance, which cannot, as yet, be traced to the action of elements in fixed atomic proportions, or in which the direct influence of the atom is only beginning to be recognised.

The development of a particular art, like that of an organism, proceeds from its internal activity; it is work which promotes its growth and not the external influence of the environment. In the early stage of the development of an industry the craftsmen gather a store of facts which afford a basis for the labours of the investigator, who penetrates the circle of the 'mystery' and renders knowledge scientific. Browning, inspired by the labours of a chemist, finely tells us in his 'Paracelsus':—

To know
Rather consists in opening out a way
Whence the imprisoned splendour may escape,
Than in effecting entry for a light
Supposed to be without.

If it be asked who did most in gaining the industrial treasure and in revealing the light of chemical knowledge, the answer is certainly the metallurgists, whose labours in this respect differ materially from others which have ministered to the welfare of mankind. First it may be urged that in no other art have the relations between theory and practice been so close and enduring. Bacon, who never undervalued research, tells us that in the division of the labour of investigation in the New Atlantis there are some 'that raise the former discoveries by

experiment into greater observations, axioms, and aphorisms: these we call the *interpreters of nature.*' There are also others 'that bend themselves, looking into the experiments of their fellows and casting about how to draw out of them things of use and practice for man's life and knowledge . . . these we call the *dowry men or benefactors.*' In reviewing the history of metallurgy, especially in our islands, it would seem that the two classes of workers, the interpreters of nature and the practical men, have for centuries sat in joint committee, and, by bringing theoretical speculation into close connection with hard industrial facts, have 'carried us nearer the essence of truth.'

The main theme of this address will therefore be the relation between theory and practice in metallurgy with special reference to the indebtedness of the practical man to the scientific investigator.

We will then consider—

- (1) Certain facts connected with 'Oxidation' and 'Reduction,' upon which depend operations of special importance to the metallurgist.
- (2) The influence in metallurgical practice of reactions which are either limited or reversible.
- (3) The means by which progress in the metallurgic art may be effected, and the special need for studying the molecular constitution of metals and alloys.

(1) The present year is a memorable one for chemists, being the centenary of the birth of Faraday and the bi-centenary of the death of Robert Boyle. The work of the former has recently been lovingly and fittingly dealt with in the Royal Institution, where he laboured so long. I would, in turn, briefly recall the services of Boyle, not, however, on account of the coincidence of date, but because with him a new era in chemistry began. He knew too much about the marvellous action of 'traces' of elements on masses of metal to feel justified in pronouncing absolutely against the possibilities of transmutation, but he did splendid service by sweeping away the firm belief that metals consist of sulphur, salt, and mercury, and by giving us the definition of an element. He recognised the preponderating influence of metallurgy in the early history of science, and quaintly tells us that 'those addicted to chemistry have scarce any views but to the preparation of medicines or to the improvement of metals,' a statement which was perfectly correct, for chemistry was built up on a therapeutic as well as a metallurgic basis. The fact is, however, that neither the preparation of materials to be employed in healing, nor the study of their action, had anything like the influence on the growth of theoretical chemistry which was exerted by a few simple metallurgical processes. Again, strange as it may seem, theoretical chemistry was more directly advanced by observations made in connection with methods of purifying the precious metals, and by the recognition of the quantitative significance of the results, than by the acquisition of facts incidentally gathered in the search for a transmuting agent. The belief that chemistry 'grew out of alchemy' nevertheless prevails, and has found expression in this Section of the British Association. As a fact, however, the great metallurgists treated the search for a transmuting agent with contempt, and taught the necessity of investigation for its own sake. George Agricola, the most distinguished of the sixteenth-century metallurgists, in his work '*De Ortu et Causis Subterraneorum*' (lib. v.), written about the year 1539, disdainfully rejects both the view of the alchemists that metals consist of sulphur and mercury, and their pretended ability to change silver into gold by the addition of foreign matter.

Biringuccio (1540) says, 'I am one of those who ignore the art of the alchemists entirely. They mock nature when they say that with their medicines they correct its defects, and render imperfect metals perfect.' 'The art,' he adds, 'was not worthy of the consideration of the wise ancients who strove to obtain possible things.' In his time, reaction between elements meant their destruction and re-constitution, nevertheless his sentence 'transmutation is impossible, because in order to transmute a body you must begin by destroying it altogether,' suggests that he realised the great principle of the conservation of mass upon which the science

of chemistry is based. We have also the testimony of the German metallurgist, Becher, who improved our tin-smelting in Cornwall. He is said to have caused a medal to be struck in 1675, which bore the legend: 'Hanc unciam argenti finissimi ex plumbo arte alchymica transmutavi,' though he should have been aware that he had only extracted the precious metal from the lead, and had not transmuted the base one. This is a lapse which must be forgiven him, for his *terra pinguis* was the basis of the theory of Phlogiston, which exerted so profound an influence for a century after his death, and he wrote, 'I wist that I have got hold of my pitcher by the right handle, for the pseudo-chemists seek gold, but I have the true philosophy, science, which is more precious.'

At this critical period what was Boyle doing when the theory of Phlogiston dawned in the mind of the metallurgist Becher? In 1672 Boyle wrote his paper on 'Fire and flame weighed in the balance,' and came to the conclusion that the 'ponderous parts of flame' could pass through glass to get at melted lead contained in a closed vessel. It has been considered strange that he did not interpret the experiment correctly, but he, like the phlogistic chemists, tried to show that the *subtilis ignis*, the material of fire or phlogiston, would penetrate all things, and could be gained or lost by them. Moreover, his later experiments showed him that glass was powerless to screen iron from the 'effluvium of a loadstone.' His experiment with lead heated in a closed glass vessel was a fundamental one, to which his mind would naturally revert if he could come back now and review the present state of our knowledge in the light of the investigations which have been made in the two centuries that have passed since his own work ceased. If he turned to the end of the first century after his death he would see that the failure to appreciate the work of predecessors was as prevalent in the eighteenth century as in the sixteenth. The spirit of intolerance which led Paracelsus to publicly burn, in his inaugural lecture at Basle, the works of Galen, Hippocrates, and Avicenna, survived in the eighteenth century when Madame Lavoisier burnt the works of Stahl, but it was reserved for the nineteenth century to reverently gather the ashes, recognising that when the writers of the School of Becher spoke of Phlogiston they meant what we understand by potential energy.

If Boyle, finding that the Fellows of the Royal Society had not carried out their intention to build a 'Repository and Laboratory,' sought the School of Mines and came to the Royal College of Science he would surely thank my colleague, Professor Thorpe, for his vigorous defence last year, as President of this Section, of the originality of the work of Priestley and Cavendish, to which Boyle's own researches had directly led. We on our part, remembering Berzelius's view that 'oxygen is the centre point round which chemistry revolves,' would hope to interest him most by selecting the experiments which arose out of the old metallurgical operation of separating the precious metals from lead by 'cupellation.' When, in conducting this operation, lead is heated in the presence of air it becomes converted into a very fluid dross. Boyle had, in 1661, taken this operation as the very first illustration in his 'Sceptical Chemist' in proof of his argument as to the elemental nature of metals. He would remember the quantitative work of Geber in the eighth century, who stated that the lead so heated in air acquired a 'new weight,' and he would appreciate the constant reference to the operation of cupellation from the close of the sixth century B.C., when the prophet Jeremiah wrote, to the work of Jean Rey in 1629, whose conclusions he would wish he had examined more closely. Lord Brouncker, as first President of the Royal Society, had called attention to the increase in weight of the lead in the 'coppels' in the Assay Office in the Mint in the Tower, and Mayo had shown that the increase in weight comes from a distinct '*spiritus*' in the air. Boyle would incidentally see that Newton had accepted office in the Mint, where he doubtless continued his experiments on calcination begun some time before, and, as if to mark his interest in the operation of assaying, figures are represented on a bas-relief on his tomb in Westminster Abbey as conducting cupellation in a muffle. The old work merges wonderfully into the new. Chevreul, in the nineteenth century, confirms Otto Tachen's view in the seventeenth, as to the saponifying action of litharge. Deville employs molten litharge to absorb oxygen dissociated from its compounds, and Graham, by extract-

ing occluded gases from iron and other metals, proves the accuracy of the old belief that elastic fluids can freely permeate even solid metals.

We may imagine with what vivid interest Boyle would turn, not merely to the results of Priestley's work, but to his methods. Priestley had decomposed litharge with the electric spark, and had satisfied himself in 1774 by heating red lead that the gas he obtained in his earlier experiments was really the one now called oxygen.

Boyle would see that in the period 1774-7 Lavoisier, being attracted by the 'sceptical chemist's' own experiment on the heating of lead in closed vessels, overthrew the Phlogistic theory and placed chemistry on a firm basis by showing that the increase in weight of lead and tin, when heated in air, represents exactly the weight of the gaseous body added, and, finally, Dalton having developed the atomic theory and applied it to chemistry, Berzelius made lead memorable by selecting it for the first determination of an atomic weight.

Without diverting his attention from the phenomena of oxidation, Boyle would find questions the interest of which is only equalled by their present obscurity. He would contemplate the most interesting phase of the history of chemical science, described by van't Hoff as that of its evolution from the descriptive to the rational period, in the early days of which the impossibility of separating physics and chemistry became evident, and Boyle would find that chemistry is now regarded from the point of view of the mechanics of the atoms.

Deville's experiments on dissociation have rendered it possible to extend to the groups of atoms in chemical systems the laws which govern the fusion and vaporisation of masses of matter, and this has produced a revolution comparable in its importance to that which followed the discovery of the law of definite proportions, for dissociation has shown us that true causes of chemical change are variations of pressure and of temperature. For instance, oxygen may be prepared on an industrial scale from air by the intervention of oxide of barium heated to a constant temperature of 700° , provided air be admitted to the heated oxide of barium, under a pressure of $1\frac{1}{2}$ atmospheres, while the oxygen, thus absorbed, is evolved if the containing vessel be rendered partially vacuous. It will be evident, therefore, that at a certain critical temperature and pressure the slightest variation of either will destroy the equilibrium of the system and induce chemical change.

The aim of Boyle's chemical writings was to show that no barrier exists between physics and chemistry, and to 'serve the commonwealth of learning by begetting a good understanding betwixt the chemists and the mechanical philosophers,' who had, as he said, 'been too great strangers to each other's discoveries.' In view of the dominant lines of research which occupy chemists at the present time, such, for instance, as the investigations of 'Osmotic pressure' and of the application of Boyle's own law to salts in solution, he would feel that his hope had been realised, and that, though he lived a century too soon to take part in Berthollet's discussion with Proust, he nevertheless shares Berthollet's triumph in the long-delayed but now rapid development of chemistry as a branch of applied mechanics.

We need, however, no longer look at these questions from the point of view of Boyle, for our own interest in the application of chemical mechanics to metallurgy is sufficiently vivid, as instances to be given subsequently will show.

Hitherto I have mainly dwelt on questions relating to oxidation, but not less interesting is the history of the steps by which an accurate knowledge was acquired of the other great process practised by the metallurgist, the one to which Paracelsus was the first to apply the name of 'Reduction.' Its explanation followed naturally from the elucidation of the phenomena of combustion by Lavoisier, who in continuation of Macquer's experiments of 1771 proved, in conjunction with other workers, that carbonic anhydride is produced when the diamond is burnt in air or oxygen. Carbon has been known for ages as the most important of the reducing agents, but when, in 1772, Lavoisier heated oxide of lead and carbon together, he did not at first recognise that carbonic anhydride had been produced, simply because the volume of the gas set free was the same as if oxygen merely had been liberated. He soon, however, saw that neither the carbon alone, nor the oxide of lead alone, gave rise to the evolution of carbonic anhydride, which resulted from the *mutual action* of carbon and a constituent of the litharge. 'This

last observation leads us insensibly,' he adds, 'to very important reflections on the use of carbon in the reduction of metals.' It most certainly did, and by 1815 an accurate, if incomplete, view of reduction had passed into the encyclopædias. It was seen that the removal of oxygen from burnt metals, by carbon, 'give the metals,' as Fourcroy and Vauquelin put it, 'a new existence.' Some ten years later Le Play attempted to show that reduction is always effected by the intervention of carbonic oxide, which elicited the classical rejoinder from Gay-Lussac, who pointed out that 'carbon alone, and at very moderate temperatures, will reduce certain metallic oxides without the intervention of carbonic oxide or of any other elastic fluid.' I mention these facts because metallurgists are slow to recognise their indebtedness to investigators, and too often ignore the extreme pains with which an accurate knowledge has been acquired of the principles upon which their processes have been based.

The importance of a coherent explanation of reduction in smelting pig-iron is enormous. The largest blast-furnaces in 1815 hardly exceeded those in use in the previous century, and were at most only 40 feet high with a capacity of 5,000 cubic feet. At the present day their gigantic successors are sometimes 90 feet high with a capacity of 25,000 cubic feet. This development of the blast-furnace is due to the researches of a number of investigators, among whom von Tunner, Lowthian Bell, and Grüner deserve special mention. We are, however, forcibly reminded of the present incompleteness of our knowledge of the mechanism of reduction, when we remember that the experiments of H. B. Baker have led us to believe that pure carbon cannot be burnt in perfectly dry and pure oxygen, and therefore that the reducing agent, carbonic oxide, would not be produced at all unless moisture be present.

Ludwig Mond, Langer, and Quincke teach us not only that nickel can separate carbon from carbonic oxide, but the wholly unexpected fact that dry carbonic oxide can at a temperature of 100° take up nickel, which it again deposits if heated to 150° . Mond and Quincke and, independently, Berthelot, have since proved the existence of the corresponding compound of iron and carbonic oxide, and it may safely be concluded that in the blast-furnace smelting iron this peculiar action of carbonic oxide plays an important part, and it doubtless aids the carburisation of iron by cementation. It is truly remarkable that the past year should have brought us so great an increase in our knowledge of what takes place in the reduction of an oxide of iron, and in the carburisation of the liberated metal. My own experiments have, I trust, made it clear that iron can, at an elevated temperature, be carburised by the diamond *in vacuo*; that is, in the absence of anything more than 'a trace' of an elastic fluid or of any third element. Osmond has further shown within the last few months that the action between iron and carbon is a mutual one, for though carbon in the pure diamond form carburises iron, the metal in its turn, at a temperature of $1,050^{\circ}$, attacks the diamond, invests it with a black layer, and truly unites with it.

The question of the direct carburisation of iron (Darby's process) by filtering the molten metal through carbon, promises to be of much importance, for at present, as is well known, two millions of tons of steel which are made in the Bessemer converter in this country alone, are re-carburised after 'the blow' by the addition of spiegeleisen.

Carbonic oxide, moreover, would appear to be more chemically active than had been supposed; for during the present year Berthelot has shown that the perfectly pure gas heated to 500° or 550° produces carbonic anhydride with deposition of carbon at red heat, not by ordinary dissociation, but by decomposition preceded by polymerisation. He further shows that carbonic oxide will decompose ammoniacal nitrate of silver, and thus brings it into close connection with the aldehydes.

(2) In turning to the modern aspects of metallurgical practice, we shall see that the whole range of the metallurgist's field of study is changing. It is no longer possible for him to devise a series of operations on the evidence afforded by a set of equations which indicate the completion of an operation; he has, as I have already suggested, to consider the complicated problems which have been introduced into

chemistry from the sciences of physics and mechanics. He has, in fact, no longer to deal merely with atoms and molecules, but with the influence of mass. As Ostwald points out, we are reminded that many chemical processes are reciprocating so that the original bodies may be obtained from the product of the reaction. The result of such opposed processes is a state of CHEMICAL EQUILIBRIUM, in which both the original and the newly-formed substances are present in definite quantities that remain the same so long as the conditions, more especially temperature and pressure, do not undergo further change. Again, in very many metallurgical processes, reactions are rendered incomplete by the limitations imposed by the presence of bodies which cannot be speedily eliminated from the system, and the result may be to greatly retard the completion of an operation. The time has come when the principles of dynamic chemistry must be applied to the study of metallurgical problems if they are to be correctly understood, and it is, moreover, necessary to remember the part played by the surface separating the different aggregates in contact with one another. When, for instance, a reaction has to take place accompanied by the evolution of gas, there must be space into which the gas can pass. The rate, therefore, at which change takes place will obviously depend on the state of division of the mass.

One of the most remarkable points in the whole range of chemistry is the action engendered between two elements capable of reacting by the presence of a third body. It may be, and this is the most wonderful fact of all, that merely a trace of a third body is necessary to induce reaction, or to profoundly modify the structure of a metal. H. Le Chatelier and Mouret have pointed out that in certain cases it is inaccurate to say that the third body causes the reaction to take place, because, after it has destroyed the inter-molecular resistances which prevented the reaction taking place, the third body ceases to intervene. This is apparently the case when platinum sponge effects the union of oxygen and hydrogen, or conversely, when very hot platinum splits up water vapour into its constituent gases. Future investigation will, it is to be hoped, show whether the platinum does not exert some direct action in both cases. We can no longer neglect the study of such questions from the point of view of their practical application. The manufacture of red-lead presents a case in point. In 'drossing' molten lead, the oxidation of the lead is greatly promoted by the presence of a trace of antimony, and conversely, in the separation of silver from molten lead, by the aid of zinc, H. Roessler and Endelmann have recently shown that aluminium has a remarkable effect in protecting the zinc from loss by oxidation, and, further, the presence of one-thousandth part of aluminium in the zinc is sufficient to exert this protecting action on that metal. I am satisfied that if our metallurgists are to advance their industrial practice, they must, if I may use such an expression, persistently think in calories, and not merely employ the ordinary atomic 'tools of thought.' They will then be able to state what reactions can, under given conditions, take place; to indicate those which will be completed; and to avoid those that are impracticable.

In France, the country of so many great metallurgists, men like Le Chatelier and Ditte are doing admirable service by bringing the results of the labours and teaching of St. Claire Deville within the range of practical men. And if I do not refer more specifically to their work it is for want of space and not of appreciation, but a few simple cases of reversible actions will perhaps make the subject clear. In the blast-furnace the main reducing agent, carbonic oxide, is produced from the solid fuel by the reaction $\text{CO}_2 + \text{C} = 2 \text{CO}$, a reaction which is theoretically impossible because it is endothermic, and would be attended by absorption of heat. But heat external to the system intervenes, and acts either by depolymerising the carbon into a simpler form which can combine with oxygen of the CO_2 with evolution of heat, or by dissociating carbonic anhydride sets oxygen free which combines with the carbon. Reduction of oxide of iron in the blast-furnace is mainly effected by carbonic oxide according to the well-known reaction

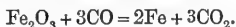

But the gas issuing from a blast-furnace contains carbonic oxide, an important source of heat. The view that this loss of carbonic oxide was due to the fact that

the contact of the ore and the reducing gas was not sufficiently prolonged, led to a great increase in the height of blast-furnaces, but without, as Gruner showed, diminishing the proportion of carbonic oxide escaping from the throat. The reduction of an iron ore by carbonic oxide only takes place within certain well-defined limits, and a knowledge of the laws of chemical equilibrium would have saved thousands and thousands of pounds which have been wasted in building unduly high furnaces. I would add that large sums have also been sacrificed in the vain attempt to smelt oxide of zinc in the blast-furnace, for which operation patents have frequently been sought, in ignorance or defiance of the readiness with which the inverse action occurs, so that the reducing action of carbon on oxide of zinc may be balanced by the re-oxidation of the reduced zinc by carbonic anhydride, which is the product of the reduction. A further instance may be borrowed from an electro-chemical process which has been adopted for obtaining alloys of aluminium. As is well known, all attempts to effect the direct reduction of alumina by carbon have failed, because the reaction

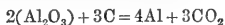

requires 783.2 calories, while only 291 calories would result from the conversion of carbon into carbonic anhydride, therefore the reaction cannot be effected; but in Cowle's process aluminium is nevertheless liberated when alumina is mixed with charcoal and strongly heated by the passage of an electric current. This result is due, not to a simple reduction of alumina, but to its dissociation at the high temperature produced by the passage of a current of 1,600 ampères between carbon poles, the liberated aluminium being at once removed from the system by metallic copper which is simultaneously present and may not be without action itself.

An instance of the importance of these considerations is presented in the manufacture of steel by the basic process. Much care is devoted to obtaining conditions which will ensure not only the elimination, but the order of the disappearance of the impurities from the molten pig iron. In the basic process as conducted in the closed converter, the phosphorus does not disappear until the carbon has left the fluid bath, whilst, when the open-hearth furnace is used, the elimination of the phosphorus may be effected before that of the carbon, and it is asserted that if the carbon goes before the phosphorus is got rid of, a further addition of carbon is necessary. A curious and subtle case of chemical equilibrium is here presented. In the open-hearth furnace and Bessemer converter respectively, the temperatures and pressures are different, and the conditions as to the presentation of oxygen to the fluid bath are not the same. The result is that the relative rates of oxidation of the phosphorus and carbon are different in the two cases, although in either case, with a given method of working, there must be a ratio between the phosphorus and carbon in which they disappear simultaneously. The industrial bearing of the question is very remarkable. In the basic Bessemer process the tendency of the phosphorus to linger in the bath renders an 'after-blow' necessary, it may be only of a few seconds' duration, but much iron is nevertheless burnt and wasted, and Mr. Gilchrist tells me that if this after-blow could be avoided, a saving of some six per cent. of the yield of steel would be effected annually, the value of which, at the present rate of output and price of steel, is no less than a quarter of a million sterling.

The larger loss of sulphur by the steel in the converter than that which occurs in the open-hearth furnace, and the increase in the percentage of manganese, which leaves the slag and returns to the bath of metal in the converter at the end of the 'blow,' will probably be traced to the disturbance of equilibrium which attends very slight variations in the conditions, especially as regards temperature and pressure, under which the operations are conducted.

In the blast-furnace the reducing action must be greatly dependent on the rate at which alkaline cyanides are formed, and Hempel has recently shown, by the aid of well-devised experiments, that the quantity of cyanides which may be obtained at a high temperature from carbon, nitrogen, and alkaline oxides, increases as the pressure becomes greater.

Metallurgical chemistry is, in fact, a special branch of chemical science which

does not come within the ordinary sphere of the academic teaching of chemistry. It is often urged that metallurgical practice depends upon the application of chemical principles which are well taught in every large centre of instruction in this country, but a long series of chemical reactions exist which are of vital importance to the metallurgist, though they are not set forth in any British manual of chemistry, nor are dealt with in courses of purely chemical lectures. I feel bound to insist upon this point, because, as Examiner in Metallurgy for the Science and Art Department, I find that purely analytical and laboratory methods are so often given in the belief that they are applicable to processes conducted on a large scale and at high temperatures.

We are told that technical instruction should be kept apart from scientific education, which consists in preparing the student to apply the results of past experience in dealing with entirely new sets of conditions, but it can be shown that there is a whole side of metallurgical teaching which is truly educational, and leads students to acquire the habit of scientific thought as surely as the investigation of any other branch of knowledge.

It is, in fact, hardly possible in a course of theoretical chemistry to devote much attention to specific cases of industrial practice in which reactions are incomplete, because they are limited by the presence of bodies that cannot be directly eliminated from the chemical system. Take, for instance, the long series of reactions studied by Plattner, who published the results of his investigations in his celebrated treatise, 'Die Metallurgische Röstprozesse,' Freiberg, 1856, whose work I have chosen as a starting-point on account of our presence in South Wales near the great copper smelting district of Swansea. A complex sulphide, of which copper is the main metallic constituent, contains some fifty ounces of silver to the ton. The problem may be supposed for the present to be limited to the extraction of the precious metal from the mass in which it is hidden, and the student deriving his knowledge from an excellent modern chemical treatise would find the case thus stated:—

'Ziervogel's process depends upon the fact that when argentiferous copper pyrites is roasted, the copper and iron sulphides are converted into insoluble oxides, whilst the silver is converted into a soluble sulphate which is dissolved out by lixiviating the roasted ore with hot water, the silver being readily precipitated from this solution in the metallic state.'

It is certain that if an observant, chemically-trained student visited a silver extraction works, and possessed sufficient analytical skill to enable him to secure evidence as to the changes that occur, he would find a set of facts which his training had not enabled him to predict, and he would establish the existence of a set of reactions to the nature of which his chemical reading had hardly given him a clue. The process to be considered is a simple one, but it is typical, and applies to a large proportion of the 7,000,000 ounces of silver annually obtained in the world from cupriferous compounds. He would be confronted with a ton or more of finely divided material spread in a thin layer over the bed of a reverberatory furnace. Suppose the material is what is known as a complex regulus as imported into Swansea or produced at Freiberg, to which are added rich native sulphides. The mixture then consists of sulphides mainly of iron and copper, with some sulphide of lead, and contains fifty or sixty ounces of silver to the ton, and a few grains of gold. It may also contain small quantities of arsenic and antimony as arsenides, antimonides, and sulpho-salts, usually with copper as a base.

The temperature of the furnace in which the operation is to be performed is gradually raised, the atmosphere being an oxidising one. The first effect of the elevation of the temperature is to distil off sulphur, reducing the sulphides to a lower stage of sulphurisation. This sulphur burns in the furnace atmosphere to sulphurous anhydride (SO_2), and coming in contact with the material undergoing oxidation is converted into sulphuric anhydride (SO_3). It should be noted that the material of the brickwork does not intervene in the reactions, except by its presence as a hot porous mass, but its influence is, nevertheless, considerable. The roasting of these sulphides presents a good case for the study of chemical equilibria.

brium. As soon as the sulphurous anhydride reaches a certain tension the oxidation of the sulphide is arrested, even though an excess of oxygen be present, and the oxidation is not resumed until the action of the draught changes the conditions of the atmosphere of the furnace, when the lower sulphides remaining are slowly oxydised, the copper sulphide being converted into copper sulphate mainly by the intervention of the sulphuric anhydride formed as indicated. Probably by far the greater part of the iron sulphide only becomes sulphate for a very brief period, being decomposed into the oxides of iron, mainly ferric oxide, the sulphur passing off. Any silver sulphide that is present would have been converted into metallic silver at the outset were it not for the simultaneous presence of other sulphides, notably those of copper and of iron, which enables the silver sulphide to become converted into sulphate. The lead sulphide is also converted into sulphate at this low temperature. The heat is now raised still further with a view to split up the sulphate of copper, the decomposition of which leaves oxide of copper. If, as in this case, the bases are weak, the sulphuric anhydride escapes mainly as such; but when the sulphates of stronger bases are decomposed the sulphuric anhydride is to a great extent decomposed into a mixture of sulphurous anhydride and oxygen. The sulphuric anhydride, resulting from the decomposition of this copper sulphate, converts the silver into sulphate, and maintains it as such, just as, in turn, at a lower temperature, the copper itself had been maintained in the form of sulphate by the sulphuric anhydride eliminated from the iron sulphide. When only a little of the copper sulphate remains undecomposed, the silver sulphate begins to split up, and the furnace charge must therefore be immediately withdrawn, or the whole of the silver sulphate would be converted into metallic silver, partly by the direct action of heat alone, and partly by reactions such as those shown in the following equations:—

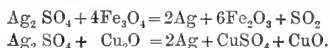

If the charge were not withdrawn, the silver would thus be effectually removed from the solvent action of water, and the smelter's efforts would have failed entirely. The charge still contains lead sulphate, which cannot be completely decomposed at any temperature attainable in the roasting furnace, except in the presence of silica, and it is well to leave it where it is if the residue has subsequently to be smelted with a view to the extraction of the gold. The elimination of arsenic and antimony gives rise to problems of much interest, and again confronts the smelter with a case of chemical equilibrium. For the sake of brevity it will be well for the present to limit the consideration to the removal of antimony, which may be supposed to be present as sulphide. Some sulphide of antimony is distilled off, but this is not its only mode of escape. An attempt to remove antimony by rapid oxidation would be attended with the danger of converting it into insoluble antimoniates of the metals present in the charge. In the early stages of the roasting it is therefore necessary to employ a very low temperature, and the presence of steam is found to be useful as a source of hydrogen, which removes sulphur as hydrogen sulphide, the gas being freely evolved. The reaction

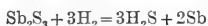

between hydrogen and sulphide of antimony is, however, endothermic, and could not, therefore, take place without the aid which is afforded by external heat. The facts appear to be as follows: sulphide of antimony, when heated, dissociates, and the tension of the sulphur vapour would produce a state of equilibrium if the sulphur thus liberated were not seized by the hydrogen and removed from the system. The equilibrium is thus destroyed and fresh sulphide is dissociated. The general result being that the equilibrium of the system is continually restored and destroyed until the sulphide is decomposed. The antimony combines with oxygen and escapes as volatile oxide, as does also the arsenic, a portion of which is volatilised as sulphide.

The main object of the process which has been considered is the formation of

soluble sulphate of silver. If arsenic and antimony have not been eliminated, their presence at the end of the operation will be specially inconvenient, as they give rise to the formation of arseniate and antimoniate of silver, insoluble in water, which may necessitate the treatment of the residues by an entirely different process from that which has hitherto been considered.

It will have been evident that effecting this series of changes demands the exercise of the utmost skill, care, and patience. The operations beginning at a dull red heat, or a temperature of some 500° , are completed at 700° , within a range, that is, of 200° . Judicious stirring has been necessary to prevent the formation of crusts of sulphates, which would impede the reactions, and, as has been shown, an undue elevation of temperature within a very limited range would, at any stage, have been fatal to the success of the operation. It is difficult to appreciate too highly the delicacy of sight and touch which enables an operator to judge by the aid of rough tests, but mainly from the tint of the streak revealed when the mass is rabbled, whether any particular stage has or has not been reached, and it will be obvious that the requisite skill is acquired solely by observation and experiment. The technical instructor may impart information as to the routine to be followed, and the appearances to be observed, but scientific knowledge of a high order can alone enable the operator to contend with the disturbing influences introduced by the presence of unexpected elements or by untoward variations in temperature. In the training of a metallurgist it is impossible to separate education from instruction, and the above description of a very ordinary operation will show the intimate relations between science and practice which are characteristic of metallurgical operations. Practice is dependent on science for its advancement, but scientific workers too often hesitate to attack metallurgical problems, and to devote the resources of modern investigation to their solution, because they are not aware of the great interest of the physical and chemical problems which are connected with many very simple metallurgical processes, especially with those that are conducted at high temperatures.

Proceeding yet one step further, suppose that the copper smelter takes possession of the residual mass, consisting mainly of oxide of copper, he would smelt it with fresh sulphide ores and obtain, as a slag from the earthy matters of the ore, a ferrous silicate containing some small proportion of copper. The displacement of the copper from this silicate may be effected by fusing it with sulphide of iron, a fusible sulphide of iron and copper being formed which readily separates from the slag. By this reaction some twenty thousand tons of copper are added to the world's annual production. Proceeding a step further, suppose the smelter to have reduced his copper to the metallic state. If arsenic had been originally present in the ore, and had not been eliminated entirely in the roasting, extraordinary difficulties would be met with in the later stages of the process, in extracting small quantities of arsenic which resist the smelter's efforts. Copper, moreover, containing above one per cent. of arsenic cannot be 'overpoled,' as the presence of arsenic hinders the action of gases on the copper. The amount of arsenic which the copper smelter has to remove may vary from mere traces up to one per cent., and if the copper is destined for the use of the electrical engineer, he will insist on its being as pure as possible, for the presence of a trace of arsenic would materially increase the electrical resistance of the copper, and would be fatal to its use in submarine telegraphy. If, on the other hand, the copper is intended for the maker of locomotive fire-boxes, he will encourage the retention of small quantities of arsenic, as it is found to actually increase the endurance of the copper, and the smelter will in such a case have no inducement to employ the basic furnace lining which Mr. Gilchrist has offered him, nor will he care to use the special methods for the removal of arsenic with which he is familiar. It may all seem simple enough, but the modern process of copper smelting has been laboriously built up, and has a long and interesting pedigree which may be traced to at least the eighth century, when Geber described the regulus 'coarse metal' as being 'black mixed with livid,' and our familiar 'blue metal' as being 'of a most clean and pleasant violet colour,' and indicated the reason for the difference.

(3) The foregoing instances have been given to indicate the general nature of metallurgical chemistry. It will be well now to show how the great advances in metallurgical practice have been made in the past, with a view to ascertain what principles should guide us in the future.

It is a grave mistake to suppose that in industry, any more than in art, national advance takes place always under the guidance of a master possessed of some new gift of invention, yet we have been reminded that we are apt to be reverent to these alone, as if the nation had been unprogressive, and suddenly awakened by the genius of one man. The way for any great technical advance is prepared by the patient acquisition of facts by investigators of pure science. Whether the investigators are few or many, and consequently whether progress is slow or rapid, will depend in no small measure on the spirit of the nation as a whole. A genius whose practical order of mind enables him to make some great invention suddenly arises, apparently by chance, but his coming will, in most cases, be found to have 'followed hard upon' the discovery by some scientific worker of an important fact, or even the accurate determination of a set of physical constants. No elaborate monograph need have reached the practical man—a newspaper paragraph, or a lecture at a Mechanics' Institute may have been sufficient to give him the necessary impulse; but the possessors of minds which are essentially practical often forget how valuable to them have been the fragments of knowledge they have so insensibly acquired that they are almost unconscious of having received any external aid.

The investigating and the industrial faculty are sometimes, though rarely, united in one individual. Rapid advance is often made by those who are untrammelled by a burden of precedent, but it should be remembered that though the few successes, which have been attained in the course of ignorant practice, may come into prominence, none of the countless failures are seen.

I would briefly direct attention to certain processes which have been adopted since the year 1849, when Dr. Percy presided over this Section at Birmingham, a great metallurgical centre. In that year the President of the Association made a reference to metallurgy, a very brief one, for Dr. Robinson only said 'the manufacture of iron has been augmented six-fold by the use of the puddling-furnace and the hot-blast, both gifts of theory'; and so, it may be added, are most of the important processes which have since been devised. Take the greatest metallurgical advance of all, the Bessemer process, which has probably done more than any other to promote the material advance of all countries. It was first communicated to the world at the Cheltenham Meeting of the British Association, 1856. Its nature is well known, and I need only say that it depends on the fact that when air is blown through a bath of impure molten iron, sufficient heat is evolved by the rapid combustion of silicon, manganese, and carbon to maintain the bath fluid after these elements have been eliminated, there being no external source of heat, as there is in the puddling furnace or the refinery hearth. We have recently been told that at an early and perilous stage of the Bessemer process confidence in the experiments was restored by the observation that the temperature of the 'blown' metal contained in a crucible was higher than that of the furnace in which it was placed. The historian of the future will not fail to record that the way for the Bessemer process had been prepared by the theoretical work of Andrews, 1848, and of Favre and Silbermann, 1852, whose work on the calorific power of various elements showed that silicon and phosphorus might be utilised as fuel, because great heat is engendered by their combustion.

The basic process for removing phosphorus, a process of great national importance, the development of which we owe to Thomas and Gilchrist, is entirely the outcome of purely theoretical teaching, in connection with which the names of Gruner and Percy deserve special mention. In the other great group of processes for the production of steel, those in which Siemens' regenerative furnace is employed, we have the direct influence of a highly trained theorist, who concluded his address as President of this Association in 1882 by reminding us that 'in the great workshop of nature there is no line of demarcation to be drawn between the most exalted speculation and commonplace practice.' The recent introduction of

the method of heating by radiation is, of course, the result of purely theoretical considerations.

The progress in the methods of extracting the precious metals has been very great, both on the chemical and engineering sides, but it is curious that in the metallurgy of gold and silver many ancient processes survive which were arrived at empirically,—a noteworthy exception being presented by the chlorine process for refining gold, by the aid of which many millions sterling of gold have been purified. The late Mr. H. B. Miller based this process for separating silver from gold on the knowledge of the fact that chloride of gold cannot exist at a bright red heat. The tension of dissociation of chloride of gold is high, but the precious metal is not carried forward by the gaseous stream, at least not while chloride of silver is being formed.

The influence of scientific investigation is, however, more evident in that portion of the metallurgic art which deals with the adaptation of metals for use, rather than with their actual extraction from the ores.

Only sixteen years ago Sir Nathaniel Barnaby, then Director of Naval Construction, wrote, 'our distrust of steel is so great that the material may be said to be altogether unused by private ship-builders . . . and marine engineers appear to be equally afraid of it.' He adds, 'the question we have to put to the steel makers is, what are our prospects of obtaining a material which we can use without such delicate manipulation and so much fear and trembling?' All this is changed, for, as Mr. Elgar informs me, in the year ending on June 30 last, no less than 401 ships, of three quarters of a million gross tonnage, were being built of steel in the United Kingdom.

Why is it, then, that steel has become the material on which we rely for our ships and for our national defence, and of which such a splendid structure as the Forth Bridge is constructed? It is because side by side with great improvement in the quality of certain varieties of steel, which is the result of using the open-hearth process, elaborate researches have shown what is the most suitable mechanical and thermal treatment for the metal; but the adaptation of steel for industrial use is only typical, as the interest in this branch of metallurgy generally appears for the moment to be centred in the question whether metals can, like many metalloids, pass under the application of heat or mechanical stress from a normal state to an allotropic one, or whether metals may even exist in numerous isomeric states.

It is impossible to deal historically with the subject now further than by stating that the belief in more than one 'modification' is old and widespread, and was expressed by Paracelsus, who thought that copper 'contains in itself its female,' which could be isolated so as to give 'two metals' . . . 'different in their fusion and malleability' as steel and iron differ. Within the last few years Schützenberger has shown that two modifications of copper can exist, the normal one having a density of 8.95, while that of the allotropic modification is only 8.0, and is moreover rapidly attacked by dilute nitric acid which is without action on ordinary copper. It may be added that Lord Rayleigh's plea for the investigation of the simpler chemical reactions has been partly met, in the case of copper, by the experiments conducted by V. H. Veley on the conditions of chemical change between nitric acid and certain metals.

Bergmann, 1781, actually calls iron polymorphous, and says that it plays the part of many metals. 'Adeo ut jure dici queat polymorphum ferrum plurimum simul metallorum vices sustinere.' Osmond has recently demonstrated the fact that at least two modifications of iron must exist.

Professor Spring, of Liège, has given evidence that in cooling lead-tin alloys polymerisation may take place after the alloys have become solid, and it seems to be admitted that the same cause underlies both polymerisation and allotropy. The phenomenon of allotropy is dependent upon the number of the atoms in each molecule, but we are at present far from being able to say what degree of importance is to be attached to the relative distance between the atoms of a metal or to the 'position of one and the same atom' in a metallic molecule, whether the metal be alloyed or free; and it must be admitted that in this respect organic

chemistry is far in advance of metallurgic chemistry. I cannot, as yet, state what is the atomic grouping in the brilliantly-coloured gold-aluminium alloy, AuAl_2 , which I have had the good fortune to discover, but, in it, the gold is probably present in the same state as that in which it occurs in the purple of cassius.

Much valuable information on the important question of allotropy in metals has already been gathered by Pionchon, Ditte, Moissan, Le Chatelier, and Osmond, but reference can only be made to the work of the two latter. Le Chatelier concludes that in metals which do not undergo molecular transformation the electrical resistance increases proportionally to the temperature. The same law holds good for other metals at temperatures above that at which their last change takes place, for example in the case of nickel above 340° , and in that of iron above 850° .

It is probable that minute quantities of foreign matter which profoundly modify the structure of masses of metal also induce allotropic changes. In the case of the remarkable action of impurities upon pure gold I have suggested that the modifications which are produced may have direct connection with the periodic law of Mendeléeff, and that the causes of the specific variations in the properties of iron and steel may thus be explained. The question is of great industrial importance, especially in the case of iron; and Osmond, whose excellent work I have already brought before the members of this Association in a lecture delivered at Newcastle in 1889, has specially studied the influence upon iron exerted by certain elements. He shows that elements whose atomic volumes are smaller than that of iron delay, during the cooling of a mass of iron from a red heat, the change of the β , or hard variety of iron, to the α , or soft variety. On the other hand, elements whose atomic volumes are greater than that of iron tend to hasten the change of β to α iron. It is, however, unnecessary to dwell upon this subject, as it was dealt with last year in the Address of the President of the Association.

It may be added that the recent use of nickel-steel for armour plate and the advocacy of the use of copper-steel for certain purposes, is the industrial justification of my own views as to the influence of the atomic volume of an added element on the mechanical properties of iron, and it is remarkable that the two bodies, silicon and aluminium, the properties of which when in a free state are so totally different, should, nevertheless, when they are alloyed with iron, affect it in the same way. Silicon and aluminium have almost the same atomic volumes.

The consequences of allotropic changes which result in alteration of structure are very great. The case of the tin regimental buttons which fell into a shapeless heap when exposed to the rigorous winter at St. Petersburg is well known. The recent remarkable discovery by Hopkinson of the changes in the density of nickel-steel (containing 22 per cent. of nickel) which are produced by cooling to -30° , affords another instance. This variety of steel, after being frozen, is readily magnetizable, although it was not so before; its density, moreover, is permanently reduced by no less than 2 per cent. by the exposure to cold; and it is startling to contemplate the effect which would be produced by a visit to the arctic regions of a ship of war built in a temperate climate of ordinary steel and clad with some three thousand tons of such nickel-steel armour; the shearing which would result from the expansion of the armour by exposure to cold would destroy the ship. Experimental compound armour-plates have been made faced with 25 per cent. nickel-steel, but it remains to be seen whether a similar though lessened effect would be produced on the steel containing 5 to 7 per cent. of nickel, specially studied by J. Riley, the use of which is warmly advocated for defensive purposes. Further information as to the molecular condition of nickel-steel has within the last few weeks been given by Mercadier, who has shown that alloying iron with 25 per cent. of nickel renders the metal isotropic.

The molecular behaviour of alloys is indeed most interesting. W. Spring has shown, in a long series of investigations, that alloys may be formed at the ordinary temperature, provided that minute particles of the constituent metals are submitted to great pressure. W. Hallock has recently given strong evidence in favour of the view that an alloy can be produced from its constituent metals with but slight pressure if the temperature to which the mass is submitted be above the melting-point of the alloy, even though it be far below the melting-point of the most easily

fusible constituent. A further instance is thus afforded of the fact that a variation of either temperature or pressure will effect the union of solids. It may be added that B. C. Damien is attempting to determine what variation in the melting-point of alloys is produced by fusing them under a pressure of two hundred atmospheres. Italian physicists are also working on the compressibility of metals, and F. Boggio-Lera has recently established the existence of an interesting relation between the coefficient of cubic compressibility, the specific gravity, and the atomic weight of metals.

Few questions are more important than the measurement of very high temperatures. Within the last few years H. le Chatelier has given us a thermo-couple of platinum with platinum containing 10 per cent. of rhodium, by the aid of which the problem of the measurement of high temperatures has been greatly simplified. A trustworthy pyrometer is now at hand for daily use in works, and the liberality of the Institution of Mechanical Engineers has enabled me to conduct an investigation which has resulted in the adoption of a simple appliance for obtaining, in the form of curves, photographic records of the cooling of masses of metal. A report on the subject has already been submitted to a Committee, of which the Director-General of Ordnance Factories is the Chairman; and Dr. Anderson, to whom I am indebted for valuable assistance and advice, intends to add this new method for obtaining autographic curves of pyrometric measurements to the numerous self-recording appliances used in the Government factories which he controls. It has proved to be easy to ascertain, by the aid of this pyrometer, what thermal changes take place during the cooling of molten masses of alloys, and it is possible to compare the rate of cooling of a white-hot steel ingot at definite positions situated respectively near its surface and at its centre, and thus to solve a problem which has hitherto been considered to be beyond the range of ordinary experimental methods. Some of the curves already obtained are of much interest, and will be submitted to the Section. It is probable that the form of the curve which represents the solidification and cooling of a mass of molten metal affords an exceedingly delicate indication as to its purity.

Prof. H. E. Armstrong holds that the molecules of a metal can unite to form complexes with powers of coherence which vary with the presence of impurity. Crookes, by a recent beautiful investigation, has taught us how electrical evaporation of solid metals may be set up in vacuo, and has shown that even an alloy may be decomposed by such means. We may hope that such work will enable us to understand the principles on which the strength of materials depends.

Before leaving the consideration of questions connected with the molecular constitution of metals, I would specially refer to the excellent work of Heycock and Neville, who have extended to certain metals with low melting-points Raoult's investigations on the effect of impurity on the lowering of the freezing-point of solids. With the aid of one of my own students, H. C. Jenkins, I have further extended the experiments by studying the effect of impurity on the freezing-point of gold. Ramsay, by adopting Raoult's vapour-pressure method, has been led to the conclusion that when in solution in mercury the atom of a metal is, as a rule, identical with its molecule. The important research on the liquation of alloys has been extended by E. Matthey to the platinum-gold and palladium-gold series, in which the manipulation presented many difficulties; and E. J. Ball has studied the cases presented by the antimony-copper-lead series. Dr. Alder Wright has continued his own important investigation upon ternary alloys, and A. P. Laurie has worked on the electro-motive force of the copper-zinc and copper-tin and gold-tin series, a field of research which promises fruitful results.

In no direction is advance more marked than in the mechanical testing of metals, in which branch of investigation this country, guided by Kirkaldy, undoubtedly took the leading part, and in connection with which Kennedy and Unwin have established world-wide reputations. I would also specially mention the work which has been carried on at the Government testing works at Berlin under Dr. Wedding, and the elaborate investigations conducted at the Watertown Arsenal, Massachusetts, not to mention the numerous continental testing laboratories directed

by such men as Bauschinger, Jenny, and Tetmajer. Perhaps the most important recent work is that described by Prof. Martens, of Berlin, on the influence of heat on the strength of iron.

I might have dwelt at length on all these matters without doing half the service to metallurgy that I hope to render by earnestly pleading for the more extended teaching of the subject throughout the country, and for better laboratories, arranged on the model of engineering laboratories, in which the teaching is conducted with the aid of complete, though small, 'plant.' The Science and Art Department has done great and lasting service by directing that metallurgy shall be taught practically, but much remains to be done. With regard to laboratories in works, which are too often mere sheds, placed, say, behind the boiler-house, when may we hope to rival the German chemical firm which has recently spent 19,000*l.* upon its laboratories, in which research will be vigorously conducted? There is hardly any branch of inorganic chemistry which the metallurgist can afford to neglect, while many branches both of physics and mechanics are of utmost importance to him.

The wide range of study upon which a metallurgical student is rightly expected to enter is leading, it is to be feared, to diminution in the time devoted to analytical chemistry, and this most serious question should be pressed upon the attention of all who are responsible for the training of our future chemists. There can be no question that sufficient importance is not attached to the estimation of 'traces,' an analysis being considered to be satisfactory if the constituents found add up to 99·9, although a knowledge as to what elements represent the missing 0·1 may be more useful in affording an explanation of the defects in a material than all the rest of the analysis. This matter is of growing interest to practical men, and may explain their marked preference for chemists who have been trained in works, to those who have been educated in a college laboratory.

The necessity for affording public instruction in mining and metallurgy, with a view to the full development of the mineral wealth of a nation, is well known. The issues at stake are so vast, that in this country it was considered desirable to provide a centre of instruction in which the teaching of mining and metallurgy should not be left to private enterprise or even entrusted to a corporation, but should be under the direct control of the Government. With this end in view, the Royal School of Mines was founded in 1851, and has supplied a body of well-trained men who have done excellent service for the country and her colonies. The Government has recently taken a step in advance, and has further recognised the national importance of the teaching of mining and metallurgy by directing that the School of Mines shall be incorporated with the Royal College of Science, which is, I believe, destined to lead the scientific education of the nation.

It is to be feared that as regards metalliferous mining, other than that relating to iron, our country has seen its best days, but the extraordinary mineral wealth of our colonies has recently been admirably described by my colleague, Professor Le Neve Foster, in the inaugural lecture he delivered early in the present year on his appointment to the chair so long held by Sir Warrington Smyth. We shall, however, be able to rightly estimate the value of our birthright when the Imperial Institute is opened next year, and the nation will have reason to be grateful to Sir Frederick Abel for the care he is devoting to the development of this great institution, which will become the visible exponent of the splendours of our Indian and colonial resources, as well as a centre of information.

The rapid growth of technical literature renders it unnecessary for a president of a Section to devote his address to recording the progress of the subject he represents. As regards the most important part of our national metallurgy, this has, moreover, been admirably done by successive Presidents of the Iron and Steel Institute, but it may have been expected that references would have been made to the main processes which have been adopted since Percy occupied this chair in 1849. I have not done so, because an enumeration of the processes would have been wholly inadequate, and a description of them impossible in the time at my disposal. Nevertheless, it may be well to remind the Section of a few of the more prominent

additions the art has received in the last half century, and to offer a few statements to show the magnitude on which operations are conducted. As regards iron, in the last twenty-five years the price of steel has been reduced from 55*l.* per ton to 5*l.* per ton, but, after giving the world the inestimable boon of cheap steel by the labours of Bessemer and of Siemens, we were somewhat slow to accept the teaching of experiment as to the best method of treating the new material; on the other hand, Hadfield has brought manganese steel and aluminium steel within the reach of the manufacturer, and J. Riley has done much to develop the use of nickel steel.

In the case of copper, we have mainly contributed to extraordinary development of wet processes for its extraction from poor sulphides, and have met the great demands for pure metal by the wide adoption of electrolytic processes.

As regards the precious metals, this country is well to the front, for Great Britain and her colonies produce about 38 per cent. of the gold supply of the world; and it may be well to add, as an indication of the scale on which operations are conducted, that in London alone one ton of gold and five tons of silver bullion can easily be refined in a day. No pains have been spared in perfecting the method of assay by which the value of gold and silver is ascertained, and during my twenty years' connection with the Royal Mint I have been responsible for the accuracy of the standard fineness of no less than five hundred and fifty-five tons of gold coin, of an aggregate value of seventy millions five hundred thousand pounds sterling. In the case of the platinum industry we owe its extraordinary development to the skill and enterprise of successive members of the firm of Johnson, Matthey, & Co., who in later years have based their operations upon the results of the investigations of Deville and Debray. Some indication of the value of the material dealt with may be gathered from the statement that two and a half hundredweight of platinum may easily be melted in a single charge, and that the firm, in one operation, extracted a mass of palladium valued at 30,000*l.* from gold-platinum ore actually worth more than a million sterling.

I wish it were possible to record the services of those who have advanced metallurgy in connection with this Association, but the limitations of time render it difficult to do more than refer to some honoured names of past presidents of this Section. Michael Faraday, president of this Section in 1837 and 1846, prepared the first specimen of nickel-steel, an alloy which seems to have so promising a future, but we may hardly claim him as a metallurgist; nor should I be justified in referring, in connection with metallurgical research, to my own master, Graham, president of this Section in 1839, and again in 1844, were it not that his experiments on the occlusion of gases by metals have proved to be of such extraordinary practical importance in connection with the metallurgy of iron. Sir Lyon Playfair presided over this Section in 1855, and again in 1859. His work in connection with Bunsen on the composition of blast-furnace gases was published in the Report of this Association in 1847, and formed the earliest of a group of researches, amongst which those of Sir Lowthian Bell proved to be of so much importance. The latter was President of this Section in 1889. Sir F. Abel, President of this Section in 1877, rendered enduring service to the Government by his elaborate metallurgical investigations, in connection with materials used for guns and projectiles, as well as for defensive purposes. I will conclude this section of the address by a tribute to the memory of Percy. He may be said to have created the English literature of metallurgy, to have enriched it with the records of his own observations, and to have revived the love of our countrymen for metallurgical investigation. His valuable collection of specimens, made while Professor at the Royal School of Mines, is now appropriately lodged at South Kensington, and will form a lasting memorial of his labours as a teacher. He exerted very noteworthy influence in guiding the public to a just appreciation of the labours of scientific men, and he lived to see an entire change in the tone of the public press in this respect. In the year of Percy's presidency over this Section the 'Times' gave only one-tenth of a column to a summary of the results of the last day but one of the Meeting, although the usual discourse delivered on the previous evening had been devoted to a question of great importance—'The application of Iron to Railway purposes.' Space was, however, found for the interesting state-

ment that the 'number of Quakeresses who attended the meetings of the Sections was not a little remarkable.' Compare the slender record of the 'Times' of 1849 with its careful chronicle of the proceedings at any recent meeting of the Association.

In drawing this address to a close, I would point to the great importance of extending the use of the less known metals. Attention is at present concentrated on the production of aluminium, and reference has already been made to the Cowles process, in which, as in that of Héroult, the reduction of alumina is effected by carbon, at the very high temperature of the electric arc; while, on the other hand, in the Kleiner and similar processes, the electric current acts less as a source of heat than by decomposing a fluid bath, the aluminium being isolated by electrolytic action; and doubtless, in the immediate future, there will be a rapid increase in the number of metallurgical processes that depend on reactions which are set up by submitting chemical systems to electric stress. Incidental reference should be made to the growing importance of sodium, not only in cheapening the production of aluminium, but as a powerful weapon of research. In 1849, when Percy was president of this Section, magnesium was a curiosity; now its production constitutes a considerable industry. We may confidently expect to see barium and calcium produced on a large scale as soon as their utility has been demonstrated by research. Minerals containing molybdenum are not rare; and the metal could probably be produced as cheaply as tin if a use were to be found for it. The quantities of vanadium and thallium which are available are also far from inconsiderable; but we, as yet, know little of the action of any of these metals when alloyed with others which are in daily use. The field for investigation is vast indeed, for it must be remembered that valuable qualities may be conferred on a mass of metal by a very small quantity of another element. The useful qualities imparted to platinum by iridium are well known. A small quantity of tellurium obliterates the crystalline structure of bismuth; but we have lost an ancient art, which enabled brittle antimony to be cast into useful vessels. Two-tenths per cent. of zirconium increases the strength of gold enormously, while the same amount of bismuth reduces the tenacity to a very low point. Chromium, cobalt, tungsten, titanium, cadmium, zirconium, and lithium are already well known in the arts, and the valuable properties which metallic chromium and tungsten confer upon steel are beginning to be generally recognised, as the last Exhibition at Paris abundantly showed; but as isolated metals we know but little of them. Is the development of the rarer metals to be left to other countries? Means for the prosecution of research are forthcoming, and a rich reward awaits the labours of chemists who could bring themselves to divert their attention, for even a brief period, from the investigation of organic compounds, in order to raise alloys from the obscurity in which they are at present left.

It must not be forgotten that metallurgical enterprise rests on (1) scientific knowledge, (2) capital, and (3) labour, and that if the results of industrial operations are to prove remunerative, much must depend on the relation of these three elements, though it is difficult to determine accurately their relative importance. A modern ironworks may have an army of ten thousand workmen, and commercial success or failure will depend in no small measure on the method adopted in organising the labour. The relations between capital and labour are of so much interest at the present time that I do not hesitate to offer a few words on the subject.

Many examples might be borrowed from metallurgical enterprises in this and other countries to show that their nature is often precarious, and that failure is easily induced by what appear to be comparatively slight causes. Capitalists might consequently tend to select Government securities for investment in preference to metallurgical works, and the labouring population would then severely suffer. It is only reasonable, therefore, that if capitalists are exposed to great risks, they should, in the event of success, receive the greater part of the profits. There is a widespread feeling that the interests of capital and labour must be antagonistic, and as it is impossible to ignore the fact that the conflict between them is giving rise to grave

apprehension, it becomes the duty of all who possess influence to strive not merely for peace, but to range themselves on the side of justice and humanity. The great labour question cannot be solved except by assuming as a principle that private ownership must be held inviolable, but it must be admitted that there was a time when capital had become arbitrary and some kind of united action on the part of workmen was needed in self-defence. If, however, we turn to the action of the leaders of trades unions in the recent lamentable strikes, we are presented with a picture which many of us can only view as that of tyranny of the most close and oppressive kind, in which individual freedom cannot even be recognised. There are hundreds of owners of works who long to devote themselves to the true welfare of those they employ, but who can do little against the influence of the professional agitator, and are merely saddened by contact with prejudice and ignorance. I believe the view to be correct that some system by which the workman participates in the profits of enterprise will afford the most hope of putting an end to labour disputes, and we are told that profit-sharing tends to destroy the workman's sense of social exclusion from the capitalistic board, and contents him by elevating him from the precarious position of a hired labourer. No pains should therefore be spared in perfecting a system of profit-sharing.

Pensions for long service are great aids to patience and fidelity, and very much may be hoped from the fact that strenuous efforts are being made by men really competent to lead. The report of the Labour Commission which is now sitting will be looked for with keen interest. Watchful care over the health, interests, and instruction of the employed is exercised by many owners of works; and in this respect the Dowlais Works, which are being transplanted into your midst at Cardiff, have long presented a noteworthy example. Workmen must not forget that the choice of their own leaders is in their own hands, and on this the future mainly depends. 'We may lay it down as a perpetual law that workmen's associations should be so organised and governed as to furnish the best and most suitable means for attaining what is aimed at, that is to say, for helping each individual member to better his condition to the utmost in body, mind, and property.' The words will be found in the Encyclical letter which Pope Leo XIII. has recently issued on the 'Condition of Labour.' To me it is specially interesting that the Bishop of Rome in his forcible appeal again and again cites the opinion of St. Thomas Aquinas, who was a learned chemist as well as a theologian.

Those of us who realise that 'the higher mysteries of being, if penetrable at all by human intellect, require other weapons than those of calculation and experiment,' should be fully sensible of our individual responsibility. Seeing that the study of the relations between capital and labour involve the consideration of the complex problems of existence, the solution of which is at present hidden from us, we shall feel with Andrew Lang that 'where, as matter of science, we know nothing, we can only utter the message of our temperament.' My own leads me to hope that the patriotism of the workmen will prevent them from driving our national industries from these shores, and I would ask those to whom the direction of the metallurgical works of this country is confided, to remember that we have to deal both with metals and with men, and have reason to be grateful to all who extend the boundaries, not only of our knowledge, but also of our sympathy.

The following Reports were read:—

1. *Report of the Committee on International Standards for the Analysis of Iron and Steel.*—See Reports, p. 273.

2. *Report of the Action of Light upon Dyed Colours.*—See Reports, p. 263.

3. *Report on the Influence of the silent discharge of Electricity on Oxygen and other Gases.*—See Reports, p. 264.

4. *Report on the Bibliography of Solution.*—See Reports, p. 273.
-
5. *Report on the Properties of Solutions.*—See Reports, p. 273.
-
6. *Report on the Bibliography of Spectroscopy.*—See Reports, p. 264.
-

FRIDAY, AUGUST 21.

The following Report and Papers were read:—

1. *Report of the Committee on the Formation of Haloids.*
See Reports, p. 274.
-

2. *The Spontaneous Ignition of Coal.* By PROFESSOR VIVIAN B. LEWES.

Ever since Berzelius first suggested that the heat evolved by the oxidation of the pyrites in coal might have an important bearing on spontaneous ignition, it has been adopted as the popular explanation of that phenomenon, and although the researches of Richter and others have gone far to disprove it, this theory is the generally accepted one. It can be shown, however, that the coals most liable to spontaneous ignition often contain as little as 0·8 per cent. of pyrites, and rarely more than 2 per cent., and if this amount were concentrated in one spot, instead of being spread over a very large mass, and if it were entirely oxidised with the greatest rapidity, instead of taking months and often years to complete the action, the total rise of temperature would be totally inadequate to account for ignition of the coal, which requires a temperature of 370° C. to 477° C., according to its characteristics. The liability to spontaneous ignition also does not increase with percentage of pyrites, whilst heaps of pure pyrites free from carbonaceous matter never show any tendency to serious heating.

The true explanation of the ignition of coal is partly physical and partly chemical. Freshly won coal has the power of absorbing from 1·5 to 3 times its volume of oxygen from the air, and this being rendered chemically highly active, partly by compression and partly by elimination of nitrogen, attacks some of the bituminous hydrocarbons in the coal, converting them into carbon dioxide and water vapour. Many causes tend to affect the rapidity of this action, which is the real source of the heat, and directly the temperature begins to rise, unless the heat evolved can freely diffuse itself, the chemical action is so energetic that ignition quickly follows. Up to 38° C. the absorption of oxygen, and consequent chemical action, goes on so slowly that there is little or no chance of undue heating; but directly this temperature is exceeded, with some classes of coal ignition is only a question of time and mass. The action of mass, condition, and temperature can be beautifully traced in the statistics of spontaneous ignition in coal cargoes, whilst the bunker fires, which are now becoming perilously frequent on the fast liners, are due entirely to rise in temperature from the bunker bulkheads being too close to the hot air up-cast shafts from the boilers and furnaces.

3. *On Nickel Carbon Oxide and its Application in Arts and Manufactures.*
By LUDWIG MOND, F.R.S.

The existence of a volatile compound of nickel and carbonic oxide was first discovered in the author's London laboratory in October, 1889, in the course of an

investigation on which he was engaged with his assistants, Dr. Carl Langer and Dr. Friedrich Quincke, into the remarkable property of metallic nickel to induce, at the comparatively low temperature of 350°C ., the complete dissociation of carbonic oxide into carbon and carbonic acid, which, according to Victor Meyer and Carl Langer, by the application of heat alone remains incomplete at a temperature of $1,690^{\circ}\text{C}$.

A very small quantity of nickel can effect the dissociation of a large quantity of carbonic oxide, and becomes converted into a very voluminous black mass containing varying quantities of carbon up to 85 per cent. This mass takes fire on exposure to air, so that it had to be cooled with exclusion of air for the purpose of analysis, which was done in a slow current of carbonic oxide gas. This gas was subsequently led into a Bunsen burner, so as to keep it out of the atmosphere of the room. In this way it was observed that when the cooling had proceeded to a certain point (about 150°C .) the Bunsen flame became luminous and remained so, and even became intenser, down to ordinary atmospheric temperature. When the gas before entering the burner was heated in a glass tube, a metallic mirror was obtained, while the luminosity of the flame disappeared.

At first this phenomenon was referred to the presence in the nickel of an unknown element, perhaps to Krüss and Schmidt's Gnomium, which at this time still haunted chemical literature. The metal of the mirror, however, gave all and every one of the reactions of nickel with remarkable brilliancy, and an approximate determination of the atomic weight came out so nearly to the very carefully determined figure of Russel for nickel (58.58 as compared with 58.74) that there could be no doubt about its identity with our well-known old friend, whose character as a simple body, called in question by Krüss and Schmidt, was thus rehabilitated.

In repeating the experiment with carbonic oxide, quite free from hydrogen and moisture, and only contaminated with nitrogen, the same result was obtained. After removing the carbonic oxide by cuprous chloride and heating the residual gas to 180° in aniline vapour, at which temperature nickel, quite free from carbon, is separated, the volume of the gas expanded considerably, and the gas contained only nitrogen and carbonic oxide. It was thus evident that a volatile compound of nickel and carbonic oxide had been obtained, which, on heating, dissociated into its constituents. The increase of volume proved that one volume of gas yielded four volumes of carbonic oxide, and the determination of the amount of nickel deposited and the carbonic oxide formed led to a proportion of four equivalents of carbonic oxide to one of nickel. To further study the properties of this compound it was necessary to produce larger quantities, which took a long time to accomplish. By preparing the nickel in a very fine state of division, at the lowest possible temperature, by reducing the oxide, or, better still, the oxalate, in a current of hydrogen at about 400°C ., and by carefully purifying and regulating the current of carbonic oxide, the compound was formed quite readily, and the gas passed through a refrigerator, cooled by ice and salt, was condensed to a liquid.

This liquid is colourless, mobile, highly refracting, possesses a characteristic odour, and is very volatile. It is soluble in a large number of organic liquids, such as alcohol, ether, chloroform, benzole, petroleum, tar oils, &c. It boils at 43°C . and 751 mm. pressure without decomposition, and evaporates rapidly at ordinary temperatures in a current of other gases. The specific gravity is 1.3185 at 17°C .; at -25° it solidifies, forming needle-shaped crystals; the pure vapour explodes when suddenly heated to above 60° , and even when the tube containing it is scratched roughly with a file. A mixture of the vapour with air explodes violently on the application of a flame. Both the liquid and the vapour are poisonous, the latter approximating carbonic oxide in this respect. According to an investigation kindly undertaken by Professor McKendrick, the liquid dissolved in chloroform produces, when injected subcutaneously in extremely small doses in rabbits, an extraordinary reduction of temperature, amounting in some cases to 12°C .

Careful determinations of the quantity of nickel contained in the liquid, made by introducing a weighed quantity into chlorine water and precipitation of the nickel from the resulting solution, led to figures agreeing very closely with the

formula $\text{Ni}(\text{CO})_4$, viz., 34.33 and 34.26 per cent. of nickel, the formula requiring 34.28. The vapour density determined by Victor Meyer's method at 50° was found equal to 6.01; the formula $\text{Ni}(\text{CO})_4$ requires 5.89.

The compound is chemically very inactive; generally speaking, it only reacts with substances having a considerable affinity for nickel, such as the halogens, sulphur, oxygen, and oxidising substances, which combine with the nickel and liberate carbonic oxide. Chlorine and bromine when used in excess also enter into combination with the carbonic oxide. Sulphur in the dry state forms a sulphide of nickel corresponding to the formula Ni_2S_3 , and dissolved in bi-sulphide of carbon it forms a sulphide containing more sulphur, but of varying composition. Selenium acts similarly but very slowly. Tellurium shows hardly any action. Metals (even potassium) are not acted upon.

Alkalies and acids (even strong hydrochloric acid) produce no change except they are oxidising agents, such as nitric acid and aqua regia. With metallic salts no reaction is obtained unless they have oxidising properties as hypochlorites, which form a higher oxide of nickel, or which are capable of giving off sulphur, such as hyposulphites and bisulphites.

The author has tried in vain to substitute other bivalent groups for the carbonic oxide in this compound, or to introduce the carbonic oxide by means of this compound into organic substances. Experiments in this direction have covered a very wide range and have included, amongst others, the following: hydroxylamine hydrochloride, phenylhydrazin hydrochloride hydroxylamine, dichloroacetic acid, tetrabromophenolbromide, ethylchloride, and aceto-acetic-ether, but in no single instance was the desired result obtained.

On exposure to moist or dry air a flocculent substance, which varies in colour from a light green to a dark brown, is very slowly formed. This substance dissolves completely in dilute acids with evolution of carbonic acid; numerous analyses have not led to a definite proportion between Ni and CO_2 in this compound. On heating it to dull red heat it turns black. Professor Berthelot, in a paper recently communicated to the French Academy of Sciences, assumes that this black colour is produced by the separation of carbon, and bases upon this an argument that the compound is of a complex composition, and that the nickel carbon oxide, on exposure to air, behaves like a real compound radical analogous to organo-metallic radicals. As, however, the black substance so obtained dissolves in dilute acids without leaving any residue, and as an exactly similar black substance is obtained by heating precipitated nickel carbonate, this argument does not seem to be conclusive, since Professor Berthelot has not substantiated so important a conclusion by a complete analysis of the black substance.

Professor Berthelot describes in the same paper a very beautiful blue compound obtained by treating nickel carbon oxide with nitric oxide. Unfortunately he does not publish an analysis of this beautiful substance either, so that until he has done so we are unable to judge of its bearing on the constitution of nickel carbon oxide.

With a view to elucidate this constitution the author has, in conjunction with Professor R. Nasini, of Rome, studied the physical properties of the liquid, more especially its refraction and dispersion. The details of this investigation have been communicated to the Accademia dei Lincei at Rome, and have also been published in the 'Journal für physikalische Chemie.'

The author has determined the freezing-point of a dilute solution in benzole containing 4.8991 per cent., and has found the coefficient of diminution .2776, corresponding to a molecular weight of 176.5; while nickel carbon oxide requires 170.6. The mean cubical coefficient of expansion between 0° and 36° C. is equal to .001853, which is one of the highest coefficients of expansion yet found for any liquid, and is only slightly exceeded by ethylic ether, ethyl chloride, and silicium tetrachloride. The indices of refraction and the dispersion for the lines α , β , and γ of hydrogen, and for the lines of lithium, sodium, and thallium have been determined at three different temperatures, and are found to be very high. The dispersion is about the same as carbon disulphide. The refraction varies very much with the temperature, the amount of variation being very nearly equal to that of carbon disulphide. The index of refraction for the D line at 10° C. is 1.45843.

According to Gladstone's formula this leads to the specific refraction of $\cdot 3437$ and the molecular refraction of $58\cdot 63$. Under the supposition that the group CO had the same value in this compound which results from the sum of the atomic refraction of carbon and that of the divalent oxygen molecule in organic compounds, which is the more probable, as the group CO shows very nearly the same molecular refraction in compounds of the most different constitution, such as oxalic acid, ketones, and carbonyldichloride, the atomic refraction of nickel would come out equal to $25\cdot 02$. This figure is very much higher, nearly two and a half times as high as it is in nickel salts, in which it has been found by Gladstone to be about 10; and about four times as high as the atomic refraction of metallic nickel as determined by Kundt and Dubois and Rubens, viz., about 6.

This difference of the atomic refraction of nickel in this compound and in its ordinary combinations is by far greater than that found in any other element. According to the generally accepted view, such differences are due to the element possessing a large number of valencies, and are proportional to the number of valencies of each compound. Nickel is generally bivalent. Its very high atomic refraction in nickel carbon oxide would thus lead to the conclusion that in this compound the nickel exercises a considerably higher valency than two, and that it has probably reached its maximum of saturation foreseen by Mendeléeff, who placed this metal in the eighth group of his Periodic System, to be equal to eight; so that the constitution of our compound would be a simple combination of one octovalent equivalent of nickel with four bivalent equivalents of carbonic oxide, or that of nickel tetracarbonyl.

All that we definitely know of the chemical properties of the compound is in accord with this view of its constitution.

A determination of the magnetic rotary power of the compound kindly made by Dr. W. H. Perkin has shown this to be quite as exceptional as its refraction, and, with the exception of phosphorus, greater than any substance he has yet examined.

Professor Quincke, of Heidelberg, has had the kindness to investigate the magnetic properties of the liquid. He found the constant of diamagnetism, at 16° C., $k = -3\cdot 131 \times 10^{-10}$ for magnetic fields of 6,000 to 14,000 C.G.S. units. This is nearly the same as the constant for ethylic ether = $-3\cdot 218 \times 10^{-10}$.

The liquid is an exceptionally bad conductor of electricity. Up to 40 volts no current was observed to pass, the electrodes of 1 sq. cm. area being 1 cm. apart.

The highly interesting properties of nickel carbon oxide naturally led the author to try whether he could not obtain similar compounds of other metals. It seemed a foregone conclusion that cobalt, in every respect so much like nickel, must give an analogous compound. It seemed probable that other metals of the eighth group and those standing near to nickel in other groups would also combine with carbonic oxide. A large number of elements were tried, including osmium, palladium, ruthenium, rhodium, iridium, and manganese by acting upon them in the finely divided state with carbonic oxide gas over a wide range of temperature. The author tried it by double decomposition with numerous compounds, including zinc ethyl and mercury methyl, but, with one sole and single exception, without success.

This sole exception is iron. This metal, too, had for a long time given negative results; but by preparing it at the lowest possible temperature by reduction of the oxalate in a current of hydrogen, and by acting upon this at about 80° C. with a very slow current of very pure carbonic oxide, the author succeeded at last, in conjunction with Dr. F. Quincke, in obtaining evidence that a volatile compound of this element with carbonic oxide exists. The gas obtained imparted a yellow tinge to a Bunsen flame and yielded slight metallic mirrors composed of pure iron. The quantity of the iron compound in the gas was, however, extremely small. By passing the gas through heavy tar oils, in which the compound is soluble, but from which it cannot be separated by fractionation, as on heating it decomposes the solution into iron and carbonic oxide before it volatilises, and by determining the iron and carbonic oxide so obtained, it was ascertained, as far as the very small quantities of the substance available would

allow, that it contained iron and carbonic oxide in the proportion of 1 equivalent of iron to 4.126 of carbonic oxide, or very nearly 1 to 4.

Since these results were communicated to the Chemical Society (June 18, 1891) the author has continued the study of this body, in collaboration with Dr. Carl Langer, and has obtained it as an amber-coloured liquid, which, on standing, deposits tabular crystals of a darker colour, and solidifies entirely below -21° C. to a mass of needle-shaped crystals. It boils at 102° C., but leaves a small quantity of green-coloured oil behind.

Several analyses and vapour density determinations have been made, but it is not yet certain whether a pure substance is in hand or a mixture of several iron carbonyls. The author hopes to be able very shortly to publish a full account of this interesting substance, which differs considerably in its chemical behaviour from nickel carbon oxide.

The fact that under ordinary circumstances nickel alone is acted on when a mixture of this metal with any other metallic or mineral substances is treated by carbonic oxide gas led the author to institute experiments to ascertain whether it would not be possible by means of carbonic oxide to extract nickel direct from its ores, and such metallurgical products as nickel speiss and nickel matte. As the nickel is volatilised at the ordinary temperature in the form of a vapour disseminated through other gases from which it can be deposited without first condensing the nickel compound by simply heating these gases to the moderate temperature of 200° C., as it is thus obtained in the form of bright coherent masses of great purity, as the carbonic oxide used is completely liberated and can be employed over and over again, and as small quantities of the poisonous nickel compound which may escape decomposition would thus never leave the closed apparatus in which the process would be carried out, it seemed probable that such a process might be capable of industrial application, and might prove more economical than the very complicated operations metallurgists have now to resort to to produce tolerably pure nickel.

Experiments carried out under the author's instructions by Dr. Langer with a great variety of nickel ores from all parts of the world, containing from 4 to 40 per cent. of nickel, as well as a number of samples of nickel speiss and nickel matte, have proved that as long as the nickel is combined with arsenic or sulphur the process is entirely successful on a laboratory scale. In the majority of cases the nickel has been extracted almost completely in three to four days.

Such ores or matte or speiss have in the first instance to be calcined, so as to convert the nickel completely into oxide. The mass is then reduced in a current of hydrogenous gases, in practice water-gas, at a temperature of 450° C. It is cooled down to ordinary temperature and treated with carbonic oxide in a suitable apparatus. For this purpose any good apparatus for treating solids by gases, of which a great number are in common use, will answer. Methodical apparatus moving the reduced ore in a direction opposite to the current of carbonic oxide, at the same time exposing fresh surfaces, facilitates the operation. After a certain time the action of the carbonic oxide upon the nickel becomes sluggish. The mass is then heated to about 350° C. in a current of carbonic oxide, which regenerates the activity of the nickel. This may be done in the same apparatus, but it is preferable to use a separate apparatus connected with the first, and from which it is returned to the first by mechanical means, so that each apparatus can be kept at the same temperature. The carbonic oxide gas can be employed dilute, as it is obtained from gas-producers; but since it is continuously recovered, a purer gas such as can be cheaply prepared by passing carbonic acid through incandescent coke is more advantageous, as it extracts the nickel more quickly and requires smaller apparatus. The gas charged with the nickel compound leaving the apparatus is passed through tubes or chambers heated to about 200° C., in which the nickel is deposited. The gas leaving these tubes is returned to the first apparatus and circulates continuously. From time to time the nickel is removed from the tubes in which it has been deposited. To facilitate this operation thin nickel sheets bent to fit the tubes are inserted, on which the nickel deposits, and which are easily taken out. The metal so obtained is almost chemically pure;

only very rarely in the case of certain ores it is slightly contaminated with iron. Its density is equal to that of ordinary sheet nickel. Its mechanical properties still await investigation.

As the nickel is deposited in perfectly coherent films upon heated surfaces exposed to the gas containing the nickel carbon oxide, the author finds it possible to produce direct from such gas articles of solid nickel or goods plated with nickel resembling in every way those obtained by galvanic deposition of metals, and reproducing with the same exactitude and fineness any design upon such articles.

This result can also be obtained by immersing heated articles in a solution of nickel carbon oxide in such solvents as benzole, petroleum, tar oils, &c., or by applying such solution to the heated articles with a brush or otherwise.

These processes open up a wide perspective of useful application, considering the many valuable properties of nickel, especially its power of resisting atmospheric and other chemical influences.

4. *On the Electrical Evaporation of Metals and Alloys.*¹

By W. CROOKES, F.R.S.

5. *On the Cause of Imperfections in the Surface of Rolled Copper Alloys.*

By T. TURNER, A.R.S.M.

In those rolled copper alloys which are of a yellow colour it is common to find surface stains of a copper colour. These stains render the rolled metal unfit for many purposes. The cause of these stains has been much discussed, but no definite evidence as to their origin has been forthcoming. Among the supposed causes have been overheating during annealing, sulphur in the fuel used, the presence of soot or ashes, irregularity in the alloy, and the use of an iron stirring-rod. The author has conducted a number of experiments, and concludes that none of these causes is responsible for the production of the stains observed, but that the stains are merely on the surface, and are produced by dirt in some form or other. The use of wash-water containing chlorides, after pickling, is in the author's opinion the chief cause of the imperfections (see 'Trans. Birmingham Phil. Soc.,' May 1891).

SATURDAY, AUGUST 22.

The Section did not meet.

MONDAY, AUGUST 24.

The following Papers were read :—

1. *Certain Pyrometric Measurements and Methods of Recording them.*

By Professor W. C. ROBERTS-AUSTEN, C.B., F.R.S.

2. *On the Existence of a Compound in Alloys of Gold and Tin.*

By A. P. LAURIE, M.A.

The alloys are prepared by melting the metals in a clay pipe and drawing into the stem. They are then used in place of zinc in a voltaic cell, consisting of

¹ See *Proceedings of the Royal Society*, 1891.

stannic chloride, gold chloride, and gold. The E.M.F. is found to rise abruptly on passing from alloys containing 36 per cent. to those containing 38 per cent. of tin, thus indicating the existence of a compound of the formula AuSn . This agrees with the maximum point in Matthiessen's conductivity curve for these alloys. Some preliminary experiments with gold aluminium alloys show that there is a rise in E.M.F. on passing over Professor Roberts-Austen's new purple alloy. This method not only indicates the existence of a compound, but also enables us to calculate approximately the heat of formation of the compound from the rise in E.M.F. in passing from the alloys below to those above the compound.

3. *On the Relation between the Composition of a Double Salt and the Composition and Temperature of the Solution in which it is formed.* By A. VERNON HARCOURT, F.R.S., and F. W. HUMPHERY, of Christ Church, Oxford.

The particular double salt of which the authors have prepared and analysed some seventy specimens is ferrous and ammonium chloride. Probably many other double salts, if similarly examined, would show similar variations. When ferrous chloride and ammonium chloride are dissolved together in warm water, and the saturated liquid is allowed to cool, white crystals are deposited, whose composition varies with the proportion of the two salts in solution and with the temperature at which the crystals are formed. Since the proportion of the two chlorides in the liquid and in the crystals which form in the liquid is very different, the composition of the liquid changes continually during crystallisation, and no two portions of the double salt are formed under exactly the same conditions. In the authors' later experiments the variation from the beginning to the end of a crystallisation was reduced to about 2 per cent. by taking a crop of crystals weighing only eight or ten grams from a liquid containing some hundreds of grams of each chloride. By the use of a water-bath, in which the flask holding the solution was plunged, warmed by a gas-burner which was governed by a thermostat in the liquid, the temperature was kept at that point at which crystallisation began within $0^{\circ}\cdot 02$ C.

The general relations observed are as follows:—The proportion of ammonium chloride in the salt increases with that in the solution nearly in direct ratio for a given temperature, the ratio varying from about thrice the proportion of ammonium chloride in the salt that there is in the solution, at the highest temperature, up to nearly six times the proportion at the lowest. The same solution yields crystals containing more ferrous chloride at a higher temperature and less at a lower. Solutions containing two or more molecules of ammonium chloride to one molecule of ferrous chloride yield well-formed crystals, white and transparent, having sides of one millimetre or more in length. When the salt contains twenty or thirty molecules of ammonium chloride to one molecule of ferrous chloride the crystals are as large as when the proportion of ammonium chloride is smaller. With less than two molecules of ammonium chloride the crystals are apt to be very small and to resemble those of ammonium chloride in form though not in composition.

In most cases the composition of the crystals can be represented by a formula $\text{FeCl}_2, n\text{H}^+\text{NCl}$ where n is integral. Salts have been analysed with closely concordant results in which n has the following values:—7, 11, 12, 13, 15, 16, 17, 18, 19, 20, 23. But in some cases, where equal or greater care has been taken that the conditions may not change during crystallisation, the values of n are not integral. Also the double salt is hydrated; the determination of the amount of water presents greater difficulties than the rest of the analysis, a temperature of about 200° C. being necessary to expel the whole; the results thus obtained, which generally agree with the estimation of water by difference, frequently correspond to 2.5 molecules of water for each molecule of ferrous chloride. Perhaps, therefore, the formulæ of the double salts should be multiplied by two, or some larger even number.

The whole of the results obtained can be grouped together in a Table, in which each salt is represented by the value of n and is assigned a position showing (1) the composition, (2) the temperature, of the solution in which it was formed.

4. *Some Experiments on the Molecular Refraction of Dissolved Electrolytes.*
By Dr. J. H. GLADSTONE, F.R.S., and W. HIBBERT.

This was a preliminary notice of some experiments undertaken in the hope of throwing some further light on the nature of electrolytes in solution, and especially on the views advocated by Van t'Hoff, Ostwald, and Arrhenius.

It was discovered many years ago that hydrochloric acid had an increased molecular refraction when it was dissolved in water, and it has been more recently observed that this increase has further augmented as the solution is made weaker. It was now found that on raising the temperature 55° there is a distinct reduction of the molecular refraction. This is scarcely what would be expected from an increase of ionic dissociation. It would appear that chloride of lithium follows the same law as hydrochloric acid in regard to the effect of dilution, but on raising the temperature it was found that the molecular refraction was slightly increased in strong solutions, but decidedly decreased in weak ones. Chloride of sodium shows much the same molecular refraction at different strengths and in different temperatures. Sulphate of magnesium was examined as a salt of a different type, but it closely resembled the sodium chloride. As the results obtained from these four electrolytes were so diverse no general conclusions were drawn.

5. *The Action of Heat on Alkaline Hypochlorites.* By Professor H. M. MCLEOD, F.R.S.

6. *A Simple Apparatus for Storing Dry Gases.* By W. SYMONS, F.C.S.

Requiring some dry carbonic acid gas and ammonia, with only very limited appliances at hand, the author was at a loss how to store them. A mercurial trough was out of the question. Ordinary petroleum as sold in the oil shops suggested itself. For this purpose a large wide-mouth bottle had inserted into its cork a short delivery tube with a tap, and a metal funnel, with a long metal tube reaching nearly to the bottom of the bottle, also with a tap below the funnel. This is to supply the petroleum. To increase the pressure the tube should be long enough above the bottle. A glass tube, open both ends, is inserted in the cork, as large as it can be, say $\frac{3}{4}$ -inch internal diameter, or more. This reaches to about half an inch from the bottom of the bottle. With the cork well secured by cement or varnish not acted on by petroleum, the bottle can be filled with petroleum through the funnel, both taps being open. When full they are closed. A glass siphon, with one end turned up and the other end a little enlarged to facilitate filling it with petroleum, is then inserted in the large tube, the finger being kept on the enlarged end so as to retain the petroleum while inserting it. If the whole be air-tight no petroleum will escape, and this will test the gasholder. Another tube, with the bottom turned, also fits into the large tube, and the bent end must be kept outside it, in the bottom of the bottle, so as to deliver the gas into the bottle. To the upper end of this tube is attached, by india-rubber tubing, the gas-generating apparatus, but with a small Woulfe's bottle intervening as a safety bottle to catch any petroleum which may be drawn over by any irregularity in generating the gas. Of course, the gas must also be passed through a drying apparatus. When sufficient gas has been collected, both tubes are withdrawn, and the gas stored for use. When required, petroleum must be put in the funnel, and the supply regulated by the tap. If the gas is to be stored for some time the siphon should remain in the gasholder, and the outer end of it be put into a bottle partially filled with petroleum to provide for the expansion or contraction of the gas by variations of temperature or atmospheric pressure.

TUESDAY, AUGUST 25.

The following Reports and Papers were read :—

1. *Report on Isomeric Naphthalene Derivatives.* See Reports, p. 265.

 2. *Report on Wave-Length Tables of the Spectra of the Elements.*
See Reports, p. 161.

 3. *Report on the Absorption Spectra of Pure Compounds.*
See Reports, p. 275.

 4. *On the Specific Heat of Basalt.* By W. C. ROBERTS-AUSTEN, C.B.,
F.R.S., and A. W. RÜCKER, F.R.S.
- Having been asked by the Rev. O. Fisher to determine for him the latent heat of basalt, we made some experiments on a specimen which was furnished to us by Professor Judd. Fragments of the rock were melted in a platinum crucible, the junction of a thermal couple consisting of platinum with platinum containing 10 per cent. of rhodium was immersed in the pasty mass, which was then allowed to cool. The scale of the galvanometer had previously been standardised by an observation on the solidifying point of pure gold, and this was repeated from time to time whilst the experiments were in progress. When the spot of light had reached the desired point, the wires were nipped off close to the basalt, and the crucible and its contents were plunged into 1,000 grammes of water contained in a silver calorimeter. The water was stirred by a screw or fan of silver, which was rotated by an electro-motor. The temperature was read by means of a mercurial thermometer which had been carefully corrected.
- The two main sources of error in the experiments are probably an uncertainty as to the mean temperature of the basaltic mass, owing to its being a bad conductor of heat, and the fact that in the processes of heating and cooling, it undergoes more or less important changes of constitution.
- The first error was reduced to small proportions by using small quantities of basalt, the most employed rarely much exceeding 20 grammes.
- The second error is in part unavoidable; the rapidly cooled basalt was always glazed like olivine. We also found that frequent heatings and coolings, and the nature of the flame, whether oxidising or reducing, employed to heat the mass, appeared to affect the results very seriously.
- In some experiments the crucible was heated in a small gas furnace, in others in a coke furnace. All the former were consistent with each other, and those of the latter group in which fresh specimens of basalt were used, were in agreement with them. The results obtained with specimens which had been heated two or more times in the coke furnace were, however, very irregular, and as we have not definitely proved what was the cause of these discrepancies, we publish our results with a certain amount of reserve. In the following table T is the temperature (Cent.) of the basalt at the moment of immersion, C is the mean specific heat between about 20° C. and T :—

T.	C.	T.	C.
467	0·199	924	0·282
747	·217	977	·284
759	·223	983	·283
792	·220	1,090	·285
846	·257	1,192	·290
860	·277		

These results are plotted in the figure.

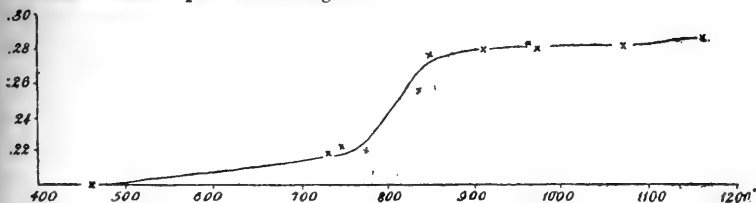

If $C_{1,2}$ be the mean specific heat between two temperatures t_1 and t_2 , we have the relation—

$$C_{1,3}(t_3 - t_1) = C_{1,2}(t_2 - t_1) + C_{2,3}(t_3 - t_2).$$

If then we take the mean specific heat from 20° C.

to 470°	to be	0.199
" 750°	" "	0.216
" 880°	" "	0.278
and " 1,190°	" "	0.290,

we get the following results:—

The mean specific heat between—

20° and 470°	is	0.199
470° " 750°	"	.243
750° " 880°	"	.626
880° " 1,190°	"	.323.

As Mr. Fisher was anxious to use our results in some calculations, we supplied him with approximate numbers before all our observations were completed. They do not, however, differ much from the above.

The general result seems to be that the specific heat of basalt follows the ordinary rule that the specific heat of a substance is greater in the liquid than in the solid state. There is a large absorption of heat in the neighbourhood of 800°, which raises the mean specific heat between 750° and 880° to the large value of 0.626.

*5. *An Apparatus for Testing Safety Lamps.*

By Professor F. CLOWES, F.C.S.

6. *On Didymium from different Sources.*

By Professor C. M. THOMPSON, F.C.S.

According to Kiesewetter and Krüss (Berichte, xxi., 2,313), a solution of the earths from Yttrotitanite from Arendal shows only three bands due to didymium. On examining a moderately concentrated solution after separation from the bulk of the other metals by precipitation with potassium sulphate, all the bands shown by an ordinary didymium solution of similar strength were seen.

Specimens of didymium from Gadolinite, from Orthite, and from Monazite were also examined. No differences as compared with didymium from cerite could be observed sufficiently marked to justify the inference that the bands varied in strength in an independent manner.

7. *On the Nature of Solution.* By Professor W. RAMSAY, F.R.S.8. *The Interpretation of Certain Chemical Reactions.*

By C. H. BOTHAMLEY, F.C.S.

9. *Action of Nitrosyl Chloride on Unsaturated Carbon Compounds.*

By J. J. SUDBOROUGH, B.Sc., A.I.C., F.C.S.

The author, after mentioning the work done by Tilden with regard to the action of nitrosyl chloride on phenol and on the terpenes,¹ and also that of Tönnies on the action of the same reagent on amylene and anethol,² gave a brief account of experiments, conducted by himself, on the action of nitrosyl chloride on the following substances: ethylene, propylene, amylene, cinnamene; crotonic, oleic, erucic, and cinnamic acids. Of these ethylene is chlorinated and forms the dichloride $C_2H_4Cl_2$; propylene is practically unacted upon; amylene forms a nitroso-chloride, $C_5H_{10}NOCl$, melting at 152° ; and cinnamene, a similar compound, C_8H_8NOCl , melting at 97° . Crotonic acid is unacted upon even when heated to 90° , while oleic and erucic acids readily form definite nitroso-chlorides, the former melting at 86° and the latter at 92° . Cinnamic acid is unacted upon when cooled, but forms the dichloride $C_9H_8O_2Cl_2$ when heated to 100° .

The nitroso-chlorides are best prepared by dissolving the substance in chloroform, cooling to -10° , and then passing the nitrosyl chloride in until there is a strong smell of it. The chloroform is then evaporated off, and the nitroso-chloride recrystallised from alcohol or chloroform.

These nitroso-chlorides are not merely molecular compounds, but definite and stable bodies undecomposed by alcohol or water.

Up to the present the author can find no laws regulating the action of nitrosyl chloride on various carbon compounds, but he hopes to continue the work at some future date with that object in view.

10. *On the Formation of Peaty Colouring Matters in Sewage by the Action of Micro-organisms.* By W. E. ADENEY, F.I.C., Assoc.R.C.Sc.I., Curator, Royal University of Ireland. (Preliminary Notice.)

The author gave a preliminary description of some experiments showing that when sewage is treated with a plentiful supply of nitre, and kept out of contact with fresh air, the soluble organic fermentable matters in it are completely destroyed by the influence of micro-organisms, without undergoing any intermediate stage of putrefaction, and that a liquid is finally obtained deeply coloured with a brown colouring matter, having similar properties to the colouring matters in natural peaty waters. The author also showed that the liquid, after the micro-organisms have died down, probably contains no organic matter save the colouring matter referred to.

11. *On a new Method of Disposal of Sewage, with some references to Schemes now in use.* By C. G. MOOR, B.A.

This paper is divided into three headings.

The first gives the titles and objects of a few of the best known schemes, with some very short remarks as to how far their aims are accomplished.

The second part deals with the method of utilisation of sludge, which the author has experimented on. He mentioned the important fact that the yield of ammonia amply pays the cost of this part of the process.

¹ *Journ. Chem. Soc.* 27, 851 and 31, 554.

² *Berichte*, 12, 169.

The third part contains suggestions as to the lines on which one must work to obtain knowledge as to the best means of precipitation, with a view to subsequent utilisation.

12. *The Reaction of Glycerides with Alcoholic Potash.*

By A. H. ALLEN, F.C.S.

13. *Note on the Electrolysis of Alloys.* By HENRY C. JENKINS,

Assoc.M.Inst.C.E., F.C.S.

The importance of the question as to whether alloys are capable of being electrolysed has for a long time been recognised, and has already been under the notice of a Committee of this Association. Several experimenters have endeavoured to separate the constituents of some alloys by this means, but hitherto no success in this direction has been recorded.

Doubtless one reason of this negative result may be found in the difficulty of submitting a metallic bath to a sufficiently large difference of potential, owing to its very low resistance; but from the same cause there is another reason why electrolysis should not take place, at least in the case of the majority of alloys, a reason to which prominence does not hitherto seem to have been given.

The variable polarisation, and the resistance of electrolytic baths generally, have led to the adoption of the view that in an electrolytic bath the electricity is conveyed by some method of convection or of successive molecular discharge, streams or chains of molecules carrying electrical charges from one electrode to the other. The bath itself is formed of some body whose resistance when pure is extremely high, so that it is usually necessary to add another body to it, an impurity, which probably acts by increasing the number of free molecules present. It is easy to imagine that in such an insulating medium molecules can be charged with electricity, which charge they can retain until they reach some body having a different potential to their own. But free molecules could not retain any charge if entirely within a conducting envelope, and in contact with it; and although the possibility of the possession of a gaseous envelope by the molecules forming a liquid has been recognised, still the conductivity of pure molten metals is scarcely in favour of any view that there is insulation between their molecules. If there were any considerable insulation it is difficult to account for the effects upon electrolytes of very small electro-motive forces, and it will be thus seen from these considerations that the want of success in the attempts to electrolyse alloys still leaves quite open the question of their constitution, whilst it is in full accordance with the conditions of Electrical Potential expressed by Laplace's equation.

From the fact that alloys in many cases form true compounds, which may be obtained in a crystalline form if proper conditions are chosen, and because the conditions as to temperature of an electrolytic bath may be those most favourable for the precipitation of such a compound out of solution, it follows that all future electrolytic experiments with alloys should be made at temperatures sufficiently high to fuse any possible compounds, otherwise very deceptive results would be obtained, owing to the difficulty of correctly sampling the bath.

SECTION C.—GEOLOGY.

PRESIDENT OF THE SECTION—Professor T. RUPERT JONES, F.R.S., F.G.S.

THURSDAY, AUGUST 20.

The PRESIDENT delivered the following Address:—

CONTENTS.

1. Introduction. 2. Coal-field of South Wales, as studied by Logan, De la Beche, and others. 3. Origin of Coal. 4. Area of the Coal-growth. 5. Coal-field of South Wales: its extent, thickness, and constituent strata. 6. Output of Coal in South Wales. 7. Varieties of Coal. 8. Constituents of Coal-measures and of Coal. 9. Fossils of the Coal-measures of South Wales. 10. Extent of the Coal-measures under the South of England. 11. Conclusion.

1. *Introduction.*—The *black stones that burn* probably came to be known by pre-historic people through accident, here and there, long before any notion of their worth to the community at large was entertained. Wood at first, and then charcoal, supplied fuel far into historic times, on every hand, except perhaps in China. In the first century of the Christian era the Romans, occupying England, met with coal, and probably learnt its use from the natives. It seems, however, to have been disregarded during the Saxon conquest and domination of this island; but by the beginning of the twelfth century the use of coal was well in hand again, as shown by old charters relating to places in Scotland and the county of Durham.

The history of the use of coal is treated of in the following books:—‘The Coal-fields of Great Britain: their History, Structure, and Resources, with notices of the Coal-fields of other parts of the World.’ By Edward Hull, M.A., &c., with maps and illustrations. 8vo. London. First edition, 1861; second, 1861; third, 1873; fourth, 1881. ‘Coal: its History and Uses.’ By Professors Green, Miall, Thorpe, Rücker, and Marshall. Edited by Professor Thorpe. 8vo. London, 1878. Also in the unpretentious pamphlet, ‘The History of Coal.’ By the Rev. Thomas Wiltshire, M.A., &c. 8vo. London, 1878. Of course the most comprehensive work on the British Coal-measures is the ‘Report of the Commissioners appointed to Inquire into the several matters relating to Coal in the United Kingdom,’ 3 vols., with maps and sections. Fol. London, 1871. Other valuable works are: W. W. Smyth’s ‘Coal and Coal-mining,’ 8vo. 1867, and later editions; and Richard Meade’s ‘Coal and Iron Industries of the United Kingdom,’ &c. 8vo. London, 1882. ‘Coal: its Geological and Geographical Position,’ by Professor John Morris, 8vo., London, 1862, although only a pamphlet, is valuable for its information.

The subject of Coal and the Coal-measures is abundantly treated of in the scientific literature of this century in nearly all parts of the world, and it would be useless to endeavour to do justice to its bibliography. Besides having had the advantage of the labours of the many eminent foreign geologists who have advanced

our knowledge of the subject in one or other of its various aspects, both by original research¹ and by condensing published results in treatises and manuals for students,² we have had some of the most enthusiastic students of the natural history of the Carboniferous strata and fossils in our own country and within our own times. Their names must frequently occur in speaking of coal and its belongings.

The text-books and manuals of geology by De la Beche, Phillips, Trimmer, Lyell, Ansted, Jukes, Geikie, Prestwich, Green, Etheridge, and others, are safe guides; the Memoirs of the Geological Surveys of England and Wales, Scotland, Ireland, and India are mines of scientific wealth as regards the same matter; our palæobotanists Lindley, Hutton, Artis, Witham, Morris, Hooker, Binney, Bunbury, Dawes, Williamson, Carruthers, Balfour, Kidston, &c., have given us good results; and others, not specialists, have written good matter for our consideration. Abroad, among our American friends, we have, or have had, several of the State geologists (Emmons, Lesquereux, Rogers, Lesley, Newberry, Dana), who have studied the Coal-measures with care, besides Steinhauer, Brown, and others; but no one has so earnestly and successfully given his serious attention to this branch of geology and palæontology as Sir J. W. Dawson, of Montreal, not long since President of the British Association when we met at Birmingham in 1886. His numerous memoirs and his elaborate work on 'Acadian Geology' supply abundant facts and sound theories in elucidation of the history of the Coal Period. Sir W. E. Logan, who indeed by his studies in South Wales was the first to give geologists a clue to the interpretation of much that was very obscure about coal, worked with Sir J. W. Dawson in the Nova-Scotian coal-field; and so also did Sir Charles Lyell, who there and elsewhere devoted much energy and acumen to the elucidation of the origin and formation of coal.

The indexes of successive volumes of the 'Geological Record' show how abundant have been papers and books on Coal, Coal-mines, Coal-fields, Carboniferous fossils, and correlative studies, within the last few years, abroad and at home. The subject is so extensive that we must confine ourselves to the coal of South Wales.

2. *The Coal-field of South Wales, as studied by Logan, De la Beche, and others.*—Had it been that the stone axe found in Monmouthshire by Edward Lloyd³ were really associated with the outcrop of the coal there, and if truly belonging to the Stone-age and used in hewing the coal, as Professor Hull's mention of it seems to imply,⁴ it would, indeed, have been one among the few known evidences of prehistoric coal-mining, and would tend to show that South Wales was among the places first made to yield this useful mineral.

At the present day South Wales and Monmouthshire yield coal in greater quantity and of more value (by over a million pounds sterling a year) than the coal-fields of Northumberland and Durham, or of Yorkshire and Derbyshire; and considerably more (by nearly 5,000,000*l.*) than that of the Clyde Basin and associated coal-fields of Scotland. Indeed, the annual value of the coal produced in South Wales with Monmouthshire may be said to be about eleven millions out of the whole forty-five millions sterling estimated as the value of the coal at the pit's mouth throughout the United Kingdom.

The great coal-field of South Wales has the especial credit of having supplied some of the earliest and most important facts and phenomena illustrative of the geological succession of the materials of the Coal-measures, and of the natural history of the coal itself. To the persevering energy and accurate observation of Sir William E. Logan and Sir Henry T. De la Beche South Wales gave up the secrets of coal-growth, strengthening some earlier suppositions, correcting others,

¹ Especially Sternberg, Brongniart, Goepfert, P'etzholdt, Geinitz, Unger, Schimper, Weiss, Renault, and Grand'Eury.

² Omalius d'Halloy, Leonhard and Hoernes, Vogt, C. D'Orbigny and Gente, Beudant, Credner, Lapparent, Contjean, and others.

³ 'In a steep rock called Craig y park, and others in the parish of Istrayd Dyvodog, we observed divers veins of coal, exposed to sight as naked as the rock; and found a flint axe, somewhat like those used by the Americans' (*Phil. Trans.*, vol. xxviii., 1714, p. 501; in a letter dated September 22, 1697).

⁴ *The Coalfields, &c.*, 4th edit., p. 12.

and establishing a firm basis for the theory that the coal has, for by far the most part, been formed of plants growing where the coal now lies, although some local varieties have arisen from the occasional driftage of floating timber and herbage, and of long-continued maceration of vegetable matter in lakes and pools elsewhere.

Mr. (afterwards Sir) W. E. Logan, having for several years worked on the geology of South Wales, in 1837 gave his maps and information to the enthusiastic promoter of the Geological Survey of the British Islands, Mr. (afterwards Sir) H. T. De la Beche, for public use in the construction of the Survey Map and in developing the structure of the country. The first volume of the 'Memoirs of the Geological Survey,' 1846, contains, at p. 145, Sir H. T. De la Beche's acknowledgment of Sir (then Mr.) W. E. Logan's gift of the valuable results of his investigations in the Coal-measures and discovery of the nature and meaning of the frequent underclays, an account of which Mr. Logan had already published in the 'Annual Report of the Royal Institution of South Wales' for 1839; in the 'Proceedings of the Geological Society of London,' vol. iii., February 1840, p. 276, and March 1842, p. 707, &c.: and 'Transactions of the Geological Society,' second series, vol. vi., 1842, p. 491, &c.

The hypotheses of the formation of coal offered by earlier writers are carefully reviewed in De la Beche's elaborate memoir; and the growth of opinion as to coal having been made by plants growing in place is traced from De Luc (1793), Lindley and Hutton (1833 and 1835), Adolphe Brongniart (1838), to W. E. Logan, by whom, indeed, it was fully established before 1837. Opinions as to the nature of the *Stigmaria ficoïdes*, so abundant in the 'underclays,' are also referred to; and that it is really the root of *Sigillaria* is accepted on the good authority of Brongniart and Binney (p. 150). Dr. Buckland's summary (in his Anniversary Addresses to the Geological Society, 1840 and 1841)¹ of what had been advanced by British geologists in the elucidation of the Coal-measures and their natural history comprised mainly the observations made by Ansted, Harkshaw, Barber, Beaumont, J. E. Bowman, and particularly W. E. Logan. He stated in his Address of 1840 that 'some of the vegetables which formed our beds of coal grew on the identical banks of sand and silt and mud which, being now indurated to stone and shale, form the strata that accompany the coal; whilst other portions of these plants have been drifted to various distances from the swamps, savannahs, and forests that gave them birth, particularly those that are dispersed through the sandstones, or mixed with fishes in the shale beds.'

Dr. Buckland's summary in 1841 is given by De la Beche² 'as expressing his opinion that the *Stigmaria ficoïdes* [which was at that time still regarded by many as an individual floating plant], growing in ponds or lagoons in the localities where we now discover its remains, by mixture with mud or silts disseminated among them, formed the underbeds, upon which also grew the plants which now form the coal-beds, these latter, by subsidence, being covered by sand or mud, forming sandstone or shale, between the coal strata, successive coal-beds being formed as the necessary conditions arose.' Sir (then Mr.) C. Lyell's important additions to the subject, then lately given in his 'Travels in North America,' 2 vols., 1845, quoted and applied by De la Beche, were subsequently enlarged in his 'Second Visit,' &c., 2 vols., 1849, and in his 'Elements of Geology,' edition of 1851, and subsequently.

De la Beche's Memoir, after having presented some explanations of geological phenomena, and treated of the general range and occurrence of the Silurian and Devonian rocks in the southern moiety of Wales and the South-western Counties of England, proceeds to describe the Carboniferous strata, and at p. 143 takes up the Coal-measures; and his work remains a classic authority on the subject. De la Beche's account of these strata has not been much modified, except by the descriptions of many additional fossils, and details about the special characters of those then known.

Other information, however, on the past and present conditions of the South-Welsh Coal-field is found in Mr. (now Sir) A. C. Ramsay's paper 'On the Denudation of South Wales and the adjacent English Counties,' in the same volume of

¹ *Proceed. Geol. Soc.*, vol. iii., pp. 229 and 487.

² *Mem. Geol. Surv.*, vol. i., 1846, p. 152.

the 'Memoirs of the Geological Survey'; and very much has been added by local observers, as shown by numerous papers on this coal-field and its constituents in the Reports, Proceedings, and Transactions of the Scientific Societies of South Wales.

3. *Origin of Coal.*—Coal is now generally accepted as being a compressed and chemically altered mass of ancient vegetables. The tissue of some of the trees and other plants may be detected in the substance more or less distinctly by fracture, by burning, and in thin sections. In some cases trees occur rooted in the attitude of growth, their stems rising upwards and their roots remaining in or below the coal. The accumulation of coal as seams of varying thicknesses, in very numerous parallel beds, can be explained by the gradual and long-continued subsidence of long and wide tracts of old marginal sea-beds, estuaries, and lagoons, with adjoining lands,¹ all more or less invested with vegetation. At the same time limited, isolated, and lenticular patches and nests of pure coal, usually in sandstone, have been probably due to floating masses of vegetation, matted plants and trees, becoming waterlogged and sinking in estuaries and shallow seas.

Some highly bituminous coal, like cannel and torbanite, may have been due to limited accumulations of macerated plants rotting in water; or to the bursting of those natural reservoirs, like peat-bogs, and a local arrangement of the resulting flow of Carbonaceous mud.

Mr. W. Galloway, in his memoir 'On the Mode of Occurrence of Coal,'² carefully places before his readers the two sets of opinions about the origin and formation of coal. First, as to the place of growth and of carbonisation being on the same ground, following De la Beche's statements and conclusions; and, secondly, as to the accumulation of vegetable matter, some dead and broken, some already decomposed, derived from the forests and herbage of marshy lands, and deposited in great lakes (as expressed by C. Grand'Eury in the 'Annales des Mines,' 1882), with the *Stigmariæ* living and dying as water-plants (as they were at first regarded, and thought to have been formed of a central body and long-spreading arms and leaves); while tall trees grew here and there on the water-side, until, falling down, they lay prostrate in the black mud; or, breaking off, left their rotting stumps still standing upright.

Mr. Galloway accepts the latter opinion to some extent, because he finds the roots in underclays to have no direct communication with the coals above them,—on account of the presence of persistent shaly layers, or 'partings,' traversing coal-beds, and very intimately passing into the coaly matter itself,—on account of a seam being cannel-coal, blackband-ironstone, and shale in different parts of its extent, with a coal lying on it without an intervening underclay; and if this shows that a coal can have been formed without an underclay, he argues that any underclay need not have been necessarily the soil of a coal-seam. He acknowledges the subject to be one of difficulty; and it seems to me that some at least, if not all, of the difficulties have been already removed by De la Beche, Lesley, Lyell, Dawson, and other observers.

4. *Area of the Coal-growth.*—For knowledge of what ruled the local occurrence of coal, we owe a great debt to Mr. R. A. C. Godwin-Austen, who had studied the geology of the South-western Counties with De la Beche. To him we are indebted for the approximate demarcation of the bounds and margins of the Carboniferous Formations, particularly for the probable land-limits and outward extension of the Coal-measures. In his valuable memoir 'On the possible Extension of the Coal-measures,'³ he explained the reasons for his indicating on the map then communicated to the Geological Society the physical configuration of North-western Europe at the close of the Palæozoic Period, and the outline of the surfaces which supported the coal-vegetation. He concluded to

¹ *The Coalfields of Great Britain*, 4th edit., p. 81, &c.

² *Report and Transactions of the Cardiff Naturalists' Society*, vol. xvii. (for 1885), 1886, pp. 20–34.

³ *Quart. Journ. Geol. Soc.*, vol. xii., 1856, pp. 38–73; also *Report Coal Commission*, 1871, pp. 424 and 511, with plates; and *Rep. Brit. Assoc.* for 1879, p. 227, plate XIV.

define the place and range of this old coal-growth of what is now Western Europe as—

‘An internal sea, around and occasionally over large parts of which the peculiar vegetation of the time was developed and entombed as the area rose and sank. A region with a central depressed area, such as Australia is supposed to present, and going down, by means of a long series of oscillations, would ultimately present just such an assemblage of deposits as our own Carboniferous group’ (p. 73).

A further reference to this kind of level or hollow region is as follows:—

‘The large level tracts which lie west of the Blue Mountains in Australia, into which the Lachlan, the Darling, the Murrumbidgee, and the Darling discharge.’ (Godwin-Austen’s Lecture, Royal Institution of Great Britain, April 16, 1858.)

Such an area had also been indicated in Sir H. De la Beche’s note to p. 296 of his memoir above mentioned, where he refers to ‘the great area extending from the country drained by the Volga, eastward through eighty degrees of longitude into China, and from which the waters find no course outwards to the main ocean or to the seas connected with it.’ With a gradual depression—with the detritus swept in by the rivers—and with a suitable flora and climate, there might here be both extensive accumulations of vegetable matter grown in place, as well as limited deposits of drifted plants, under different conditions. De la Beche, moreover, referred (p. 146) to the long flat coast of the eastern seaboard of South America, with its great rivers and abundant flora, as being analogous to some parts, at least, of the areas on which the coal-seams were formed.

The area of coal-growth in this North-west European region is represented on Mr. R. A. C. Godwin-Austen’s map¹ as a littoral belt (varying in width as now exposed at the surface), reaching, in an approximately semicircular or bay-like shape, from the Elbe near Magdeburg, and north of the Hartz, westward to the valley of the Ruhr, including a southern extension to Marburg; and, taken up again, it passes from the Ruhr to Aix-la-Chapelle, and to Namur and Charleroi; then by the Franco-Belgian coal-field to Calais, and beneath the valley of the Thames to Bristol, Forest of Dean, and South Wales, south of the Old Red area, towards Ireland. On the eastern side of Hereford, and along the east border of the old rocks of Wales, the range of the coal-growth is shown by the coals appearing here and there along the Severn and the Dee; and doubtless it widened out considerably eastward across what is now England. Continuing northward it occupied Northumbria, and stretched westward locally between the old Cumbrian land and the South Highlands; passing around the east end of the latter, it was strong across what is now Central Scotland, with indications in North Ireland. Thus the coal-growth invested the southern and western edges of Godwin-Austen’s ‘internal sea’ above mentioned, and extended westward by two outlets: one at its south-west corner, by South Wales; and the other on the north-west, by Central Scotland, each into the Irish area, and thus roughly surrounding the several older Palæozoic lands of Wales, Ireland, Cumbria, and South Scotland.

In Professor Ramsay’s account of the denuded remnants of the Welsh coal-fields² the stretch of coal-growth along the border of the old Cambrian land is clearly indicated in his statement, that—

‘One denuded edge of these accumulations now forms part of the counties of Pembroke, Caermarthen, Glamorgan, and Monmouth, and is elsewhere exhibited in the Forest of Dean, the narrow strips of Coal-measures north of May Hill in Gloucestershire, the Clee Hills (outliers of the Forest of Wyre and Coalbrookdale), the coal-fields south and west of Shrewsbury, and that of Oswestry, Wrexham, and Mold. All these are but fragments of one great original coal-field, once mantling round North Wales and the older rocks west of the Severn and north of Bristol Channel.’

Both north and south, however, of the old Cumbrian area are a few seemingly isolated patches of coal; but the Whitehaven field is really the western portion of the North-of-England coal-growth; the coal of Anglesea belongs to the westward extension of the Lancashire field; and that of Ingleton is a remnant of the northern part of the latter towards the margin of the old Cumbrian land.

¹ Pl. I., *Q.J.G.S.*, vol. xii., 1856.

² *Mem. Geol. Surv.*, vol. i., 1846, p. 314.

5. *Coal-field of South Wales: its extent, thickness, and constituent strata.*—The valuable coal-field of South Wales (estimated by some to occupy 640,000 acres, and stated by others to be 906 square miles in extent) forms an irregular oval basin or trough lying E. and W. (about fifty-six miles long, from Pontypool to Caermarthen Bay), with a narrow extension westward beyond Caermarthen Bay, through Pembrokeshire, to St. Bride's Bay (about seventeen miles long). The greatest width is about sixteen miles. In 1881 there were 662 collieries at work (see Hull, 1881). The strata of the whole area have been much undulated and broken; on the south they dip at an angle of 45° , and at about 12° on the north. Great faults, approximately north and south, alter the levels from forty to a hundred fathoms; they are generally filled with clay; but one, near Swansea, many fathoms wide, is filled with fragments of the broken strata. (Trimmer.)

A strong *anticline* once passed along the middle of the trough (E. and W.), with its complemental *synclines*, one on each side. These have been somewhat shifted (the eastern moiety towards the S.W., and the other to the N.E.) by a great oblique *fault* coincident with the valley of the Neath. Except at Swansea and Caermarthen Bays, the outcrops of the lowest part of the series of strata, of irregular width, are continuous around the coal-field. About seven unequal patches of the upper measures have been preserved from denudation in the *synclines*. Two of these areas are in the eastern moiety; both long, but the southern syncline retains only a narrow and interrupted series of patches.¹ The Ebbw, the Sirhowy, the Rhymney, and the upper part of the Afon cross the former; the Taff and the Rhondda, with their branches, cross both synclines; and the Ely and Ogwr cross the lower syncline. The respective valleys give local opportunities for opening certain beds, and afford facilities for roads and railways from the hills to the sea-coast. In the western moiety there are five circumscribed areas of the upper measures in the two synclines; the united Amman and Llwchwr River runs between four of them, and the Tawe between two and across one (just north of Swansea). The favourable position for mining some of the measures is due to the local angle of dip in the synclinal strata; and, indeed, without the anticlinal arrangement some of the coals could never have been reached even by deep mines.²

Mr. Etheridge (in his new edition of Phillips's 'Manual of Geology,' 1885, p. 238) mentions that in the southern part of the western moiety the Coal-measures have a thickness of 11,000 feet; and that on the northern side of the anticlinal axis there they are 7,000 feet thick, and that near Britton Ferry, in the middle, they diminish to 4,800 feet on that side.

Taking the whole basin or trough, it may be roundly said that in the north-east side the coals are mainly *coking* or *partly bituminous*; to the west and north-west they are *anthracitic*; and in the south *bituminous* or *gaseous*; and more especially that 'in the Aberdare area the coals are very free-burning, but at the same time smokeless; hence their importance for steam purposes, especially the Aberdare four-foot steam-coal.'³

The physical features and structural condition of the South-Welsh coal-field, also the occurrence of fossils, were succinctly treated of by G. P. Bevan in the 'Geologist,' vol. iii., 1860, pp. 90–99.

The order and thickness of the strata belonging to the coal-field of South Wales as given in Geikie's 'Textbook of Geology,' 2nd edit., 1885, p. 742, are (for Glamorganshire):—

	Feet.
Upper series: sandstones, shales, &c., with 26 coal-seams, more than	3,400
Pennant grit: hard, thick-bedded sandstones, and 15 coal-seams	3,246
Lower series: shales, ironstones, and 34 coal-seams	450 to 850
Millstone-grit.	

¹ See Hull's *The Coalfields*, &c., 4th edit., pp. 88, &c., and map.

² *Ibid.*, Chap. I.

³ Etheridge, 1885, p. 238.

The Coal-measures are thus estimated at 7,496 feet, or nearly $1\frac{1}{2}$ mile in thickness, besides the Millstone-grit and the Carboniferous or Mountain Limestone occupying a still lower position.

Differences of observation or of opinion from time to time have caused different estimates. In 1855 Professor J. Phillips, who took a very strong interest in the geology of the coal-fields, published the following measurements (in his 'Manual of Geology,' 1855, p. 201) as representing only a general view, and he indicated that nearly 12,000 feet thickness may occur near Llanely:—

	Feet.
Llanely series, with several beds of coal	1,000
Penllergare series of shales, sandstones, and beds of coal—110 beds; 26 beds of coal	3,000
Central series (Townhill sandstones of Swansea = Pennant-grit of the Bristol coalfield)—62 beds; 16 beds of coal	3,246
Lower shales, coals, and ironstones (Merthyr)—266 beds; 34 beds of coal	812
	<hr style="width: 50px; margin-left: auto; margin-right: 0;"/>
	8,058
Farewell Rock and Gower Shales, above the Carboniferous Limestone.	

Professor Hull¹ gives about 1,200 to the Coal-measures, with twenty-five seams of coal of two feet thickness and upwards; making a total of eighty-four feet of workable coal. In 1881 Professor Hull calculated that there remained about 32,166 millions of tons of available coal, which might possibly last for more than 1,000 years at the present rate of consumption.

Mr. E. Rogers, in the 'Memoirs of the Geol. Survey: Iron-ores,' Part III., 1861, p. 169, divides the Coal-measures of South Wales into an Upper and a Lower series, with the hard siliceous sandstone (locally a conglomerate), known as 'Cockshute' and 'White Rocks' between them. The upper measures, he says, are mostly micaceous sandstones, locally known as 'Pennant Rocks.' The lower series is sometimes termed the 'iron-bearing measures,' as it contains the bulk of the ironstone as well as coal, which is bituminous on the east and gradually less and less bituminous westward, until after passing the great dyke or fault in the Vale of Neath it becomes anthracite. The upper series contains few iron-ores, and the coal is bituminous, even when anthracite exists below it, as in the Swansea district and elsewhere.

In his communication to the British Association in 1837,² Sir W. E. Logan stated that 'the non-bituminous coal, or stone-coal, is found on the north side and at the west end; the bituminous coal on the south side and east end; and that there is an intermediate region occupied by an intermediate quality.' These conditions of the coal-seams indicated to Logan 'the possibility of a rule in the change of quality—namely, that it occurs in parallel planes, cutting the seams of coal without regard to their strike or inclination, and dipping to the south or east of south.'

These coals begin to become anthracitic at Rhymney; and the change becomes gradually more and more marked as we pass by Dowlais, Cyfartha, Hirwain, Onlwyn, and Neath Valley, to the Swansea Valley,³ according to analyses given by Mr. David Mushet in the Appendix to his 'Papers on Iron and Steel,' 8vo., London, 1840. At page 68 of this book Mr. Mushet notes that 'in South Wales as the coals approach the anthracite district they are found to contain 90 per cent. (of carbon), with no more flame than is necessary to convert the coal into coke.'

Mr. Etheridge (1885) accepts (p. 238) Professor Phillips's foregoing table; but he also arranges the coal-bearing portions as divisible into—1. Upper Pennant

¹ *The Coalfields, &c.*, 1881, p. 108.

² *Report*, 1838, Trans. Sect., p. 85.

³ Bevan, *Geologist*, vol. ii., 1859, pp. 78, 79.

series; 2. Lower Pennant series; 3. White-ash series; and gives the following plan in addition:—

1. Upper or Penllergare series, more than 3,400 feet.
2. Pennant-grit (Swansea), 3,246 feet.
3. Lower Coal-measures, 450 to 850 feet.

At p. 219 he reviews the whole of the series as—

	Feet.
Coal-measures	11,000
Millstone-grit ('Farewell Rock')	300
Yoredale Rocks? ('Gower Shale')	1,600?
Scar Limestone	1,900
Lower Limestone Shales	400
	15,200

making the Coal-measures more than $1\frac{1}{2}$ mile thick, and the whole series more than $2\frac{1}{2}$ miles.

Looking at these Coal-measures alone, and considering that slow depression accompanied their formation, the mind is strained in estimating the time required for the gradual subsidence to 10,000 feet, with shallow water always in place, and jungle growing steadily after jungle, inundation following inundation at intervals,—and is somewhat confused in reasoning on the possible causes and the exact processes by which not only the sinking of this region of the earth's crust was brought about, but how, in turn, the 10,000 feet of new accumulations and deposits were raised into the great undulations, which Professor Ramsay has described and depicted in his Memoir before mentioned, and how and when they were slowly worn down day by day into the present beautifully varied surface of South Wales and adjacent country.

I may here remark that the analogous coal-field of Nova Scotia, investigated by Sir W. E. Logan, Sir J. W. Dawson, and others, has a thickness of 14,570 feet, including seventy-six seams of coal and ninety distinct Stigmarian underclays.

Mr. W. Galloway communicated, in 1885, to the Cardiff Naturalists' Society¹ some valuable observations on both the vertical and the horizontal occurrence of different coals in South Wales; and showed by a map (pl. iii.) where the 'steam-coal' mainly exists in the large *eastern* third; the 'intermediate coal' in the narrow *middle* third; and 'anthracite' in the *western* third of the Glamorgan-Monmouthshire area. He refers to the gradual transition from bituminous to anthracitic coal along a hypothetical *plane* passing through the coal-field, with its major axis lying E.N.E.—W.S.W., and its minor axis dipping at a very low angle towards S.S.E. He accepts Professor Geikie's tabular scheme of the strata at p. 24. Mr. W. Galloway has favoured me with the following remarks on the *vertical* place of the several kinds of coal in the series:—'The *long-flaming* bituminous seams are about 700 yards higher in the ground than the semi-bituminous seams; the semi-bituminous, or good *steam-coal* seams are 200 or 300 yards above the *dry steam-coal* seams; the last are perhaps 300 yards above the *bastard anthracites*; and these *inferior anthracites* may be 400 yards or more above the perfect *anthracites*. You have thus somewhere about, say, 1,500 or 1,600 yards from the *long-flaming* coals to the *anthracites*. It may be a good deal more in some parts of the coal-field; but, as the deepest shaft is only about 800 yards, we cannot get a direct measurement.'

Of these three sorts of coal—the *long-flaming dry* coals above have some seams suitable for gas-making; the middle are *caking coal*, good for making coke; the others produce *dry steam-coal* and *anthracites*.

6. *Output of Coal in South Wales*.—The following is the official account of the quantity of coal raised in South Wales last year as compared with that got ten years ago:—

¹ *Trans.*, vol. xvii., 1886, pp. 20-34.

Table showing the Output of Coal in the South Wales District in the years 1880 and 1890.

County	1880	1890	Increase or Decrease in the ten years
	Tons	Tons	Tons
Breconshire	100,616	259,260	+ 158,644
Caermarthenshire	625,933	762,032	+ 136,099
Glamorganshire	15,320,096	21,426,415	+ 6,106,319
Monmouthshire	5,039,549	6,895,410	+ 1,855,861
Pembrokeshire	79,386	71,908	- 7,478
Totals: South Wales	21,165,580	29,415,025	+ 8,249,445

Total Output for the United Kingdom.

—	1880	1890	Total Increase in the ten years
	Tons	Tons	Tons
England, Wales, Scotland, and Ireland	146,969,409	181,614,288	34,644,879

Dr. E. Hull refers to the increased production in the South-Welsh coal-field, together with remarks on other fields and the future supply and working of coal, in the 'Transactions of the Edinburgh Geological Society,' vol. vi., part 2, 1890, where also Mr. H. M. Cadell follows with valuable notes on the probable future of the coal-trade.

7. *Varieties of Coal.*—The coal of the British coal-fields exhibits every variety of composition between *anthracite*, which is nearly pure carbon, and the so-called *bituminous coals*, such as ordinary coal and cannel coal (hydrocarbons), rich in hydrogen. Anthracitic beds are rarely seen except in districts where the strata have been much disturbed, or peculiarly affected by other circumstances. Heat, whether direct or induced by pressure, vertical or lateral, has probably been the important agent in depriving coal of its hydrogen with some of its carbon, and thus changing it into anthracite. Neither in this latter nor in the compact cannel coal are the laminar structure and symmetrical jointing so distinct as in the ordinary coals. The last lose their volatile hydrocarbons also by exposure to the air, at outcrops and in open faults; hence they are not nearly so good for burning as those got at a greater depth. As it is well to have definite notions as to the appearance and structure of the different kinds of coal, some notes on the several sorts will now be offered.¹

Anthracite is glossy or semi-lustrous, sometimes iridescent; it ignites with difficulty, and burns without smoke, and with little flame, on account of no volatile hydrocarbons being formed during combustion. This purely carbonaceous material differs from ordinary coal by its brilliant, semi-metallic lustre, its greater density, hardness, and brittleness, and by its massive and conchoidal fracture with sharp edges. Some of it can be cut or turned on the lathe into fancy articles.

Called *anthracite* (from *ἀνθραξ*, coal) by Karsten and the older mineralogists, it is also known as mineral carbon, blind-coal, stone-coal, culm, glance-coal, and non-bituminous coal. It is mentioned by mineralogists and geologists as having been found at many places in the Alps, Pyrenees, France, Germany, the United States, and the British Isles, under various geological conditions; but in regular and extensive beds it occurs chiefly in Pennsylvania, and largely also in South Wales. It is reported to have been found in China and elsewhere.

¹ Much information as to the constitution of coal and its varieties is given in Roland and Richardson's *Chemical Technology*.

In the Franco-Belgian coal-field the coals become more and more anthracitic as they pass down to greater depths; both kinds, therefore, were of the same age in formation; in South Wales also, as already stated, the anthracite and the other coals are all of one age. The squeezing, faulting, and inversions in the former field are accompanied by an alteration of the highly bituminous coals into *dry coals* and *anthracite*.

An interesting historical sketch of the use of anthracite, and some systematic remarks on its distribution in South Wales, were given by J. P. Bevan, F.G.S., in the 'Geologist,' vol. ii., 1859, pp. 75-80.

The anthracite of Pennsylvania is traceable from the inner folds of the mountain chain, where the strata have become more and more crystalline, and contain graphite as well as this non-bituminous coal, westward into Ohio, where the same beds consist of ordinary coal. In the eastern part of the Alleghanies the coal has only 6 to 14 per cent. of volatile matter, further west 16 to 22 per cent., 30 to 35 per cent., and in Ohio 40 to 50 per cent. (Prestwich.) This coal-field before compression was probably 900 miles long by more than 200 broad in some places. (Lyell.)

The depression of strata by accumulated sediment above them may raise their temperature by the rise of the isotherms (surfaces of equal subterranean temperature), and they may reach a relatively high temperature. 'Mere descent to a great depth, however, will not necessarily result in any marked lithological change, as has been shown in the cases of the Nova-Scotian and South-Welsh coal-fields, where sandstones, shales, clays, and coal-seams can be proved to have been once depressed 14,000 to 17,000 feet below the sea-level, under an overlying mass of rock, and yet to have sustained no more serious alteration than the partial conversion of the coal into anthracite. They must have been kept for a long period exposed to a temperature of at least 212° Fahr. Such a temperature would have been sufficient to set some degree of internal change in progress had any appreciable quantity of water been present, whence the absence of alteration may perhaps be explicable on the supposition that those rocks were comparatively dry.'

Coal in contact with granite is changed into anthracite or graphite; when in contact with volcanic and trappean rocks it may become coke (columnar or otherwise) or mere soot.

Steam coal is very compact, burns with little smoke, and contains so little bituminous matter that it is not liable to spontaneous combustion, whether pyrites be present or not. It is an intermediate kind of coal, having more hydrocarbon than any anthracite has.

Ordinary coal, common coal, household coal, pit coal, black coal, coal proper, bituminous stone coal: of this there are several sorts:—

1. *Caking coal, coking coal, bituminous coal* (not really bituminous, but containing the constituents of bitumen—7 to 9 per cent. of hydrogen, with carbon and oxygen, or 4 to 6 per cent. of hydrogen and 6 to 8 per cent. of oxygen). When heated, it undergoes a kind of fusion and 'cakes' together, one piece adhering to another by the soft bituminous matter into which it is mainly changed. Such coals are used for *coking*, coke being more or less impure carbon left after the hydrocarbons have been driven off.

2. *Cherry coal, or soft coal*, is thinly laminated, soft, velvety, *short-fractured, friable*.

3. *Splint coal* (breaking off in long 'boards,' and into fragments with angular ends called 'splints'—Mushet), *bone coal, hard coal, free-burning coal, dry coal* (passing into *shaly, slaty, and stony coal*). This is less bituminous than some of the foregoing; burns free and open (that is, without swelling and caking), with a long smoky flame; with less than 6 to 8 per cent. oxygen and 4 to 6 per cent. hydrogen; it is also called *dry coal*. The *hard coal* comes out in long blocks; the *cherry coal* in short pieces.

Reedy coal has alternate layers of *splint coal* and *bright coal*. (Mushet.)

Cannel coal, or parrot coal, is compact, and varies from lustrous to a dull earthy aspect; breaks irregularly, but with a conchoidal (shell-like) fracture; can be

¹ Geikie, *Textbook*, &c., 2nd edit., 1885, p. 273.

polished and cut into ornaments in a lathe. Yields mineral oil by distillation. Much used in gas-making; not fit for coking.

Torbanite, Torbanehill mineral, Boghead cannel-coal, or Boghead coal, is a kind of dark brown cannel-coal, good for making gas and oil (paraffin, &c.), and gives a light, spongy coke. It consists of minute light brown granules of hydrocarbon, with some earthy matter and portions of the tissues of coal-plants.

As a scheme for the general classification of the coals the following table may be useful:—

Highly Bituminous . . .	} Gas coals . . .	} { Torbanite, cannel-coal, parrot-coal . . . Tasmanite, Better-bed coal, &c.	} Vegetable matter much altered. Spore-coals.
Common Bituminous . . .			
Semi-bituminous . . .	} Free-burning steam coals . . .	} { 1. Charcoal deposited abundantly at first. 2. Hydrocarbon partially lost by change.	
Anthracitic . . .			
Anthracite . . .	Smokeless coal . . .	} { All the hydrocarbon lost by heat under pressure.	
Coke	} { 1. Natural . . . 2. Artificial . . .		

8. *Constituents of the Coal-measures and of Coal.*—Sandstone, shale, coal, and clay, in successive repetitions, constitute (as we all know) the main materials of the 'Coal-measures' ('measures' being an old mining term for strata). Each of these substances well deserves the close investigation they have received from numerous observers. We need not take the sandstone in hand now; it will be enough to say that the quartz-grains have been derived from the quartz of the same granite rocks which gave the little mica-flakes to mix with much of the sandstone, and the kaolin to form the basis of the shales and clays in the same great Carboniferous formation.

Shales and Ironstone.—The *shales* are varied; some are almost purely argillaceous; others contain carbonaceous matter in different proportions, even becoming quite black and bituminous. The lighter coloured shales often have plant-remains, especially ferns, scattered through them, and even whole stems and branches of *Lepidodendron* and *Sigillaria*, squeezed flat, and reaching long distances. The darker shales also have plant-remains, but less perfect, and very often shells and other fossils, including relics of fish and numbers of small bivalved crustaceans; with regard to the last, the fishes, when alive, fed on the Cypridæ and such like, and in turn these little Ostracoda ate the dead fishes when they could.

Here and there are more or less continuous layers of *ironstone*, or more frequently groups of nodules parallel with the planes of bedding, and containing either parts of plants, more rarely small limuloids or other crustaceans, or even spiders, scorpions, insects, or relics of fishes and amphibia. In some cases the shales are of marine origin, judging from the character of the shells imbedded in them; but usually the evidence from the fossils is of a negative character. The shells that were formerly thought to be mussel-shells, like freshwater Unios, are now known to belong to a different family; and, not being quite the same as any known sea-shell, they may have been estuarine.

The nodular and the flat masses of clay-ironstones in the shales have been due to the formation of carbonic acid in the water and mud by the decomposition of vegetable matter and the removal of some oxygen from the peroxide of iron present there, and by the carbonic acid thereupon forming carbonate of iron. This then segregated around some organic object in the mud, and, mingled with clay, gave rise to nodules or larger masses of argillaceous ironstone.¹ In consolidating,

¹ De la Beche, *Memoirs Geol. Survey*, vol. i., pp. 185, 186.

the nodules frequently split internally, and the fissures of retreat, filled with calcite, blende, pyrites, or other mineral, constitute *septa*, or divisions, in the *septarium* or septarian nodule. The so-called 'beetle-stones' are septarian nodules broken across, showing a central and diverging lines.

The iron-ores of South Wales are fully treated of in the 'Memoirs Geol. Surv.,' Iron-Ores, Part III., 1861, by E. Rogers, and their fossils by J. W. Salter. From official sources we learn that the details of Production of Ironstone, chiefly Argillaceous Carbonate from mines under the Coal-mines Regulation Act, for the year 1889 were—

County	Quantity	Total quantity	Average price per ton	Total value of ironstone at the mine	Amount of metal obtainable
	Tons	Tons	s. d.	£	Tons
Breconshire	{ Eastern part of	512	{ 11 6	29	12,548
	{ Western part of		{ 9 0		
Caermarthenshire	—	118	9 0	53	
Glamorgan-shire	{ Eastern part of	23,764	{ 9 0	10,694	
	{ Western part of		{ 23,764		
Monmouthshire	—	17,435	11 6	10,025	
	24,276	41,829	—	21,009	—

In Mr. J. P. Lesley's 'Manual of Coal,' &c., 8vo., Philadelphia, 1856, at pp. 22, &c., the variations in shales, and their passage even into coal, as the proportion of carbonaceous (vegetable) matter increases by local conditions, are carefully detailed.

Coal, Mother-coal, Coal-balls, &c.—The coal itself, to which the shales ('batts,' 'binds,' &c., as they are variously termed) usually serve as a roof, or in which they form 'partings,' or thin intermediate layers, comes next to be considered. Some remarks on the different kinds of coal have already been made. Common black coal is easily seen to be composed of thin alternate laminæ of dull and bright material, and usually the blocks or pieces have flat sides nearly at right angles with those delicate layers of deposition. These faces are due to shrinkage-joints; one is termed the 'face' (as it is presented on the long edge of the seam exposed in working), or the 'bord,' and the other or cross joint is the 'end'; the former is also called the 'cleat,' and this term is sometimes applied to both sets of joint-divisions. The block of coal usually breaks also along the flat laminæ, exposing a somewhat dull, charcoaly surface, more or less interfered with by the next-lying bright lamina. The dull parts are real charcoal, or decomposed wood, and soil the fingers when touched; whilst the bright, or hydrocarbon, portion keeps clean when dry. On the fire the coal breaks more easily along the laminæ, because the bright portion softens and swells up with its bituminous change, and the 'mineral charcoal,' or 'mother-coal,' keeps the portions distinct for a time; so also the jointings open then, or give way easily to the poker.

The *mineral charcoal* may readily be seen to be flat fragments of woody tissue in a carbonised state; it is more or less impregnated with bituminous and mineral matter from the associated beds, and retains the mineral matter of the original wood. It is due to 'the chemical changes experienced by woody matter in decay in the presence of air,' when 'wood parts with its hydrogen and oxygen and a portion of its carbon, in the forms of water and carbonic acid. . . . Under water, or imbedded in aqueous deposits, the principal loss consists of carbon and oxygen; and the resulting coaly product contains proportionally more hydrogen than the original wood. This is the condition of the compact bituminous coal.'¹

The 'mother-coal' necessarily indicates a periodical change (may be that of the rainy season) in the formation of a coal-seam, for it lay exposed, as decaying wood, whilst that which was accumulated just before must have been sufficiently covered

¹ Dawson, *Quart. Journ. Geol. Soc.*, vol. xv., 1859, pp. 627, &c.

up by water (a few inches may have been enough) to undergo the advanced chemical change causing a proportional increase of hydrogen. The dead sticks and stems projecting out of and above the water-covered peaty mass below would naturally supply the decaying touchwood and charcoal now lying as described above.

Doubtless a progressive change in the elaboration of hydrocarbon soon took place to some extent, even as it does in peat; but probably it was not completed in the compact coal until many layers of both vegetable and earthy matters had been accumulated (the former in place, and the latter from inundations), and caused some amount of pressure and consequent heat.

As, under favourable circumstances, the bright coal can be seen to have been made up of spores, leaves, branches, and stems of special trees and other plants, the place of growth must have been a swampy forest or jungle, of enormous extent, probably in a warm (perhaps sub-tropical¹) climate, to account for the hundreds of square miles of continuous coal-seams.

Much has been learnt from the broken and rotting ruins of a forest, standing on an area of the coal-growth, having been here and there sealed up and preserved in that original state, before hydrocarbonisation had proceeded far; whilst the rest of the fallen timber and accumulated relics passed into the state of bright coal, and became almost indistinguishable as to its structure except under the microscope after special manipulation. The 'coal-balls' of Oldham, in Lancashire, and the 'bullions' at South Ofram, in Yorkshire, are calcareo-carbonaceous nodules, having been formed by the infiltration of water carrying carbonate of lime from the shells in an overlying shale down into the bed of woody fragments and other bits of dead plants. The carbonate of lime there segregated from the mass to certain centres, and preserved, in round nodules, the vegetable structures, before they were quite decomposed, more or less distinct as they had fallen on the forest floor. Hooker, Binney, Williamson, and others have elucidated much of the botany of the coal from this source.

In the Lower Carboniferous series at Péttycur Bay, Burntisland, in the Firth of Forth, are some well-preserved relics of the materials which would otherwise have been used to form a coal-seam (referred to by Williamson and Binney). In this case volcanic material has been ejected into or through a peaty mass, and, having removed by force some of the soft wet material, has been mixed up with it and settled down as a hard stratum, with well-preserved fragments of wood and other tissues, into which carbonate of lime was subsequently infiltrated. (Carruthers.)

A third instance was discovered by Mr. Wunsch, in 1865, in the Lower Carboniferous series on the north-eastern shore of the Isle of Arran, where numerous plant-remains are well preserved in and under volcanic ashes. The strata are alternate sandy shales, thin coal-seams, and peperino-like tuff. Numerous truncated trees remain upright, rooted in the shale. *Sigillaria*, *Lepidodendron*, *Lepidophloios*, and *Halonis*, besides *Sphenopteris* and other ferns, are present.²

Cannel, &c.—Under the name of 'cannel' are known some important varieties of coal, useful for distillation and gas-making; and certainly they differed in their method of deposition both from ordinary coal and in some particulars among themselves. They all appear to have been formed of vegetable matter that, having been soaked and macerated to a black pulp, like the most rotten and semi-fluid peat, in lakes, lagoons, or other limited water-areas, became homogeneous masses of hydrocarbon, with much still discernible vegetable tissue, and occasionally with bones, teeth, and scales of fishes, and the low kind of reptiles called *Amphibia*. Earthy matter was sometimes mixed with the cannel; and occasionally so much accumulated that the black mud graduated into carbonaceous shale. Light substances would also have been blown into the water by wind. According to the relative abundance of yellow-reddish hydrocarbons and macrospores, or of amorphous black substance (carbon) and microspores, is the difference between black and brown cannel. (Carpenter.)

Elsewhere the condition and place of the cannel are such as to suggest that,

¹ A great predominance of ferns and lycopods indicates moisture, equability of temperature, and freedom from frost, rather than intense heat. (Lyell.)

² *Geol. Mag.*, 1865, and *Trans. Geol. Soc.*, Glasgow, 1882.

like a burst peat-bog of the present day (Buckland), the fluid carbonaceous pulp escaped from its birthplace, and found local hollows at lower levels that could receive and keep it. It is also suggested that such black, decomposed, fluid refuse of a swampy jungle, bordering a lagoon, might drain into the water, and settle as carbonaceous mud, or as coal itself, among the water-plants there. (Grand'Eury.) If poured in suddenly, it probably overwhelmed and poisoned many fishes. 'The canal coals, being wholly subaqueous, have not formed and do not possess mineral charcoal.' (Dawson.)

Torbanite consists almost entirely of minute sub-globular accretions of hydrocarbon (amber-coloured by transmitted light), derived either from chemical change of plant-remains, or, more probably, directly from lycopodiaceous spores.

Spore-coal.—Very much of the substance of some coal-beds consists of lycopodiaceous spores that have been traced to the great lycopods, *Lepidodendron* and *Sigillaria*, allied to the club-mosses and *Selaginella*, and were probably shed periodically in enormous quantities. (Prestwich and Morris, Hooker, Binney, Williamson, Carruthers, Balfour, Huxley, E. T. Newton, Orton, Dawson, Rheinsch, Wethered, Bennie, Kidston, and others.) Mr. E. Wethered has suggested that the chief material in common coal was derived from the spores of a water-plant nearly allied to *Isoëtes*, and that woody material has supplied but little of the hydrocarbon. He objects to the theory of 'submerged forests' because of the difficulty that Professor Dana has described, resulting in the calculation that for a four-foot seam of coal there would be required a thickness of 32 feet of accumulated forest vegetation and 48 feet for four feet of anthracite.¹ The macrospores of *Isoëtes lacustris* have been found in the mud dredged in Loch Coulter, Stirlingshire, by Mr. Thos. Scott.²

'Dawson is disposed to think that the tuberin of cork, of epidermis in general, and of spore-cases in particular, is a substance so rich in carbon that it is very near to coal, and so indestructible and impermeable to water that it has contributed more largely than anything else to the mineral.'³ Prestwich refers to these, and especially to gums and resins, as main constituents of the coal; and argues that the climate was warm and moist, with a larger percentage of carbonic acid than exists at the present day, and a more rapid plant-growth.⁴

Messrs. Bennie and Kidston⁵ have not only carefully given the botanical history of *Lepidodendron* and *Sigillaria*, and of their fructification, but have described the spores met with in their examination of the Scotch Carboniferous strata, and have given their conclusions as to the nature and condition of the beds from which the spores were collected. The splint and parrot coals yielded most; the cherry or soft coals are too far bituminised to show them clearly, though present. Some fireclays yield them in the upper two or three inches. Some thin shales (plant-beds and fakes) yield spores, and some have plant-remains as well. 'Carbonised wood was common in all the poor or shale-like coals. . . . Some of the thin coals were almost entirely composed of such carbonised vegetable matter.' Fragments of scorpions and eurypterids occur plentifully in some of the 'old soils' (fireclays). The former, being land-animals, and probably adapted to a hot (or, at least, warm) climate, are among the most interesting of the coal-fossils.

Drift-coal.—Formerly, more so than now, it was thought by some that the coal had been formed by the accumulation of drifted timber and floating masses of vegetation in rivers and estuaries. There are several difficulties in the way of this hypothesis. There would have been more ash in the coal, because the water would shift and deposit sand and clay, together with rafts and grass islands; and the ash of pure coal agrees in relative quantity and composition with the earthy matter naturally contained in plants. (Green and others.) How far a calculation could be made as to a given quantity of ash in coal, and the amount of mineral

¹ *Journ. Roy. Microsc. Soc.*, ser. 2, vol. v., 1885, pp. 406-420.

² *Report of the Fishery Board*, 1890.

³ Balfour, *Palæontological Botany*, 1872, p. 67.

⁴ *Geology*, vol. ii., 1888, pp. 117-120.

⁵ *Proceed. Royal Phys. Soc.*, Edinburgh, vol. ix. 1886, pp. 82-117.

matter belonging to plants, as a basis for proving the original quantity of woody matter concerned in a given quantity of coal, would be difficult to determine, for some of the original mineral constituents have been probably removed by percolating water.

Professor Lesley¹ has calculated that the Mississippi could not supply by driftage from the forests of its valley in 100,000 years wood enough for one of the Schuylkill anthracite beds; mineral sediments would also interfere with the results. Under favourable conditions, he adds, tropical forests (Central Africa) and coast-swamps (Florida, Guiana, India) would supply good and sufficient material. So also the swamps of the 'Sunk Country' of Arkansas and Louisiana, as well as the 'Great Dismal Swamp' in Virginia, for one set of conditions (Lyell); and the mangrove jungles in the West Indies and elsewhere for another.

Fireclay, underclay, undercliff, underbed, seat-earth, seat-stone, bottom-stone, spavin, clunch, fake, pouncin. This is usually a dense clay,² but sometimes sandy, and even altogether a hard sandstone ('ganister'). It varies in colour from black to white; and is from six inches to ten feet or more in thickness. A characteristic feature is its being penetrated in all directions by the stigmarian roots and rootlets of the trees (*Sigillaria* and *Lepidodendron*) that grew on it when it was the soil of the coal-forest, having been slowly deposited by the quiet, shallow, muddy waters that succeeded the deposition of shale or sandstone by waters with stronger currents, these last terminating one of the periodical disturbances to which the many stages of gradual subsidence gave rise. Every coal-bed (or coal-seam, according to the application of those words to either a simple or compound layer of coal) lies on a more or less distinguishable 'underclay'; but this is often omitted to be recorded in coal-mining sections and documents.³ Sometimes an underclay forms the roof of a coal; but it is the seat-earth of a coal lying on it.

Denudation.—Among the many examples of denudation in the Coal-measures, coal-beds have been washed away from their underclays; but these latter are so greatly toughened by their contained network of roots that they have more effectually resisted denudation. Both coals and underclays, however, were not unfrequently destroyed, or, at least, deeply and widely channelled by contemporaneous floods and rivers; for not only are the 'horses,' 'lows,' and 'washes' such watercourses, but the occurrence of pebbles of coal and small detrital particles scattered through some of the sandstones are due to similar denudation.⁴

Sir J. W. Dawson, in 'Acadian Geology,' 1868, p. 139, states:—'The occasional inequalities of the floors of the coal-beds, the sand and gravel ridges which traverse them, the channels cut through the coal, the occurrence of patches of sand, and the insertion of wedges of such material, splitting the beds, . . . are constantly represented in modern swamps and marshes, more especially near their margins, or where they are exposed to the effects of ocean storms or river inundations.' The great thickness of coal and carbonaceous shale in the Albion Coal-measures at Pictou, Nova Scotia, were formed in a depression separated by a shingle bar (conglomerate) from the more exposed flats outside.⁵

9. *Fossils of the Coal-measures of South Wales.*—An examination, or even an enumeration, of the fossils would be much more than we have time for now, whether we took in hand the *plants* or the *animals*.

I. Of the characters of the former⁶ we have indicated some particulars, such as

¹ *Manual of Coal, &c.*, 1856.

² In examining microscopically the ultimate particles of some shales and underclays, Mr. W. M. Hutchings has discovered that these are composed of a 'micaceous deposit,' in which there is some fragmental mica, but that the mass appears to consist mainly of minute, rutiliferous, mica-like flakes, regarded by him as of secondary origin, made from the original components of the stratum. (*Geol. Mag.*, 1890 and 1891.) Mr. Hutchings kindly informs me that, of the numerous fireclays which he has examined, several are being used for brick-making. (Letter, May 20, 1891.)

³ De la Beche, *Mem. Geol. Surv.*, vol. i., pp. 173 and 177.

⁴ Logan, De la Beche, Buddle, and others. ⁵ Dawson, *Q.J.G.S.*, vol. x., p. 46.

⁶ A useful compendium of our knowledge of coal-plants in 1863, by Professor John Morris, was published in the *Proceed. Geol. Assoc.* of that date.

facts about the spores and roots of the gigantic trees of which the humble *Selaginella*, *Isoetes*, *Sphagnum*, and *Equisetum* are the living representatives. Descriptions of their roots, trunks, leaves, woody and other structures have been given to the world by both Foreign and British palæobotanists in numerous goodly memoirs and volumes, illustrated with excellent plates; and the many ferns, tree-ferns, and cycadaceous plants (the last known by their fruits chiefly) have been well described and figured. Kidston's 'Catalogue of the Carboniferous Plants in the British Museum' gives full references to many of the above, and the others are well known. With increased knowledge, the supposed dome-like, long-armed, stigmarian plants, with subaqueous leaves or processes, either floating on or in the water, or growing on the mud, have become the depressed stools, dichotomous roots, and innumerable long, narrow, leaf-shaped rootlets of *Sigillaria* and *Lepidodendron*. (Binney and others.) C. Grand'Eury, however, still distinguishes some perfectly aquatic and peculiar plants, which floated in the water with their roots trailing on the bottom; and of *Stigmaria* he holds the opinion that it indicates a formation in deep water, contrary (as he says) to what is generally stated.¹ The supposed palms have disappeared in the explanation that the supposed fruits are only the marks of compressed gas bubbles fixed during their escape from the fœtid black, decomposing mud.²

Great advances have been made by Prof. Dr. W. C. Williamson in the knowledge of the lycopodiaceous trees of the coal, which he shows to have partaken of the exogenous structure of modern trees.

Various more or less artistic representations of ideal coal-forests are to be met with, both in special books treating of the subject and in treatises on geology in general. Eloquent descriptions of such a forest by Ansted and Hugh Miller are quoted by Balfour.³

Of the flora of the Uplands, which were bordered by the peaty coal-swamps, very little is known; only that the fern fronds and some other plants in the roof shales, and the occasional either prostrate or snag-like trunks of conifers in the sandstones were probably brought to lower levels by streams or river-floods. (Dawson, Lyell, and others.)

II. The fossil animals of the coal are necessarily of very great interest, but we can now refer to only a few.

1. Of the invertebrates a fair number occur in South Wales, but none of the myriopods, spiders, scorpions, eurypterids, land shells, and other rare forms known elsewhere have yet been met with.

In the 'Memoirs of the Geological Survey of Great Britain,' &c., Iron-Ores, &c., Part III., the late Mr. J. W. Salter very carefully classified and tabulated the fossils found in the 'ironstone bands' of South Wales, describing and figuring the most characteristic species. He hoped to have taken up the fossils of the coal bands in like manner, but unfortunately the time never came. His observations, at p. 220, on the importance of managers of collieries and others making very careful collections of fossils, with notes on their exact beds, should even now command attention. He notes as follows:—

Black Band; Anthracomya, Fish remains	Brackish
Soap Vein; Worm-burrows, Anthracomya, Ferns	Brackish
Black Pins; Anthracosia, Dadoxylon, Knorria, and Halonia .	Brackish
Ell Balls, above Elled Coal; Asterophyllites, Lepidodendron, and Ulodendron, Ferns	Brackish
Under Big-vein Coal; Anthracosia	Brackish
Over Three-quarter Coal; Anthracomya	Brackish
Will Shone, or Pin Will Shone, over the Bydylog Coal; Athyris	Marine
Darran Pins; Anthracosia, Anthracomya, Myalina	Brackish
Over Engine Coal; Spirifer and Productus, Fern	Marine

¹ *Mém. présentés, &c., Acad. Sciences, &c., France*, vol. xxiv., No. 1, 1877; and *Annales des Mines*, sér. 8, Mémoires, vol. i., 1882, p. 161.

² Carruthers, *Geol. Mag.*, 1870, p. 215.

³ *Palæont. Botany*, pp. 70, 71.

Black Band, over Old Coal; Anthracosia, Fish	Brackish
Spotted Vein; Spirorbis; track of Limulus (?) 6 feet below the vein	Brackish
Red Vein; Anthracosia, Modiola, Edmondia (?)	Marine?
Blue or Big Vein; Myalina, Anthracosia, Spirorbis	Marine?
Bottom Veins; Fish (8 genera)	Brackish
Rosser Veins (under the Farewell Rock and above the Millstone Grit); Brachiopoda (7 genera), Conchifera (8 genera), Gasteropoda, Heteropoda, and Cephalopoda (9 genera), Encrinite Stems, Fish remains	Marine

*Anthracosia*¹ was originally regarded as *Unio* by Sowerby, then referred to *Cardinia* by Agassiz, and to *Pachyodon* by Stutchbury; but it was ultimately defined by W. King as related to *Unio*, but, being distinct from that genus, it was named by him *Anthracosia*. Mr. Salter noticed that it has a wrinkled epidermis, and considered that it was related to the *Myadæ*, and of brackish, if not marine, habitat. This is the shell composing the so-called 'mussel bands' and 'Unio bands' of the Coal-measures.

Anthracomya, 'Iron-ores,' &c., page 229. Mr. Salter indicates that the shells which he describes under this name have oscillated in catalogues between *Avicula*, *Modiola*, and *Unio*, and that it has a wrinkled epidermis, like the foregoing.

*Anthracoptera*² is a triangular shell, with wrinkled epidermis, and belonging to the same group as the above.

All the forms of this characteristic group of Coal-measure shells are called *Naiadites* by Dawson,³ and regarded by him as allied to D'Orbigny's *Byssonodonta*. Gumbel and Geinitz have described them as belonging to *Unio* and *Anodon*; and Ludwig refers *Anthracoptera* to *Dreissena*. At all events there is a great probability of their not being truly marine. They may have lived in the brackish water of lagoons and creeks in the black, muddy swamps, having some communication with the sea, and often or occasionally inundated with salt water. (Dawson, Salter, &c.)

Spirorbis carbonarius is frequent in the Coal-measures of South Wales and elsewhere. This little annelid, though belonging to a marine genus, is often found attached to plant fragments in the coal-shales. These plants may have hung down into the water and been infested by the annelid; or it may have attached itself to floating plants which were ultimately drifted back to the littoral mud-swamp. This *Spirorbis* is an important constituent in the Ardwick limestone of Manchester and Shropshire, but is associated with Ostracoda (*Carbonia*), which are probably of brackish-water habitat.

The Brachiopoda are necessarily marine. The fish are not good witnesses, for they might have migrated to and fro, as some now inhabit both fresh and salt waters; and some might have been essentially estuarine.

Thus there are few decidedly marine beds in this series, and these, of course, correspond with the occasional domination of the sea during its inroads and during extreme depressions of the district.

In addition to the occurrences of fossils in Salter's list above quoted we may notice that in the 'Geol. Mag.,' 1870, pp. 214-220, is an account of some fossils discovered by the late Mr. W. Adams, of Cardiff, in 1869, in a 'Black Band' in the Rhymney Valley, about 800 feet higher in the Coal-measures of South Wales than any hitherto found. The band is calculated to have been rightly 81 feet above the Mynyddysllwyn coal, from which it is divided by a fault; it is in five layers, and about 8 feet thick, with its associated shales. One of these in its midst and the lowest shale carry the fossils. With some plant remains there is *Anthracomya*, with *Estheria* (?) *Adamsii*, *E. tenella*, and *Leaia Leidyi*, all probably of brackish habitats; also *Carbonia Evelinæ* and *C. Agnes*, Ostracodes typical of a genus which is found in the black shales, presumably of either fresh- or brackish-water origin. Mr. Adams also found a shale full of *Anthracomya* at Aberbeeg, Ebbw Vale, overlying the Troed-rhiw-Clawdd coal, and 226 yards below the Mynyddysllwyn coal (p. 215).

¹ *Iron-Ores South Wales*, pp. 226, 227.

² Salter, *Q.J.G.S.*, vol. xix., 1863, p. 80.

³ *Acadian Geol.*, 1868, pp. 201-203.

2. Of the Vertebrata the fishes enumerated in Mr. Salter's list are important. The following are the genera named:—Megalichthys, Rhizodus, Pleuracanthus, Byssacanthus (?), Palæoniscus, Amblypterus, Helodus, and Pœcilodus.

Although reptilian remains are rare in South Wales, yet they are not altogether wanting. In 1865¹ Professor (now Sir Richard) Owen described some remains of a small amphibian (between newt and lizard), found by the late J. E. Lee in the lower part of the Middle (or upper part of the Lower) Coal-measures at Llantrissant, Glamorganshire. The animal was rather larger than the allied *Dendrorepeton Acadianum*, and Professor Owen named it *Anthrakerpeton crassosteuum*, 'the thick-boned coal-reptile.' This paper and its illustrations were reproduced in the 'Trans. Cardiff Nat. Soc.'

10. *Extent of the Coal-measures under the South of England.*—Sir H. De la Beche in 1846² noted that a great sheet of palæozoic rocks, including the Coal-measures, extending from Belgium to Central England, had been rolled about, undulated, crumpled, and then partially worn away before the New Red Sandstone and other Mesozoic strata were laid down upon them; and that these, in their turn, had been denuded so as to expose here and there portions of the underlying Coal-measures, though near by a ridge of profitless Mountain-limestone or other older rock might come to the surface.

In 1856 Mr. Godwin-Austen, following up his reasoning about the areas of coal-growth (see above, page 617), explained that the movements of disturbance which they have undergone had tended to preserve the great Franco-Belgian coal-band, and had rendered it available; and he proceeded to state that the course of that band of Coal-measures may be traceable westward, and probably coincided with, and may some day be reached along the line of, the Valley of the Thames.

Professor Prestwich in 1871 extended this inquiry;³ and, having carefully compared the coal-beds of Somerset and Belgium, described the characters and relations of the strata in detail, and showed that the coal might be met with at a workable distance from the surface along a narrow but interrupted curved area from Westphalia, through Belgium and France, to England; then along the north-eastern part of Kent (Isle of Thanet, &c.), and through Herts, Bucks, Oxfordshire, Gloucestershire, to the Bristol coal-field, and on to South Wales. The coincident axis of disturbance is south of the river Thames, in his opinion throwing off the coal-beds on its northern flank.

Mr. W. Galloway has given in the 'Cardiff Nat. Soc. Report,' vol. xvii. 1856, p. 23, a sketch of the views here alluded to. A full account of the history and literature of the question of the underground range of the older rocks in the South-east of England, especially as to the possible occurrence of the Coal-measures, is published in the 'Memoirs of the Geological Survey: The Geology of London and of Part of the Thames Valley,' vol. i., 1889, pp. 13-28, by Mr. Whitaker, F.R.S., who, having given close attention to this subject, has suggested the following localities as likely sites in the search for coal in the South-east of England: St. Margaret's, Chartham, Chatham, and Shoreham, all in Kent; Bushey (Herts), Loughton (Essex), and Coombs, near Stowmarket (Suffolk).⁴

An interesting fact relating to this matter is that in February 1890 the engineer of a boring at the foot of Shakespear's Cliff, Dover, announced that at 1,204 feet below the surface there a thin seam of coal was met with, and at several yards lower down coal eight feet thick was pierced, associated with clays, grits, and blackish shales. (Newspapers.) Dr. Blanford, in his 'Anniversary Address to the Geological Society' on February 21, 1890, stated that Professor Boyd Dawkins, in a letter received the day before, had informed him that a coal-seam had really 'been reached at a depth of 1,180 feet, and that this seam is proved to be of Carboniferous age by the plant-fossils in the associated clays. . . . The discovery is solely

¹ *Geol. Mag.*, vol. ii., pp. 6, 8, plates I. and II.

² *Mem. Geol. Surv.*, vol. i., pp. 213-214.

³ *Report Royal Commission Coal-Supply*, 1871; *Anniv. Address Geol. Soc.*, 1872; *Popular Science Review*, July, 1872; and *Proceed. Instit. Civil Engineers*, vol. xxxvii., 1874, p. 110, &c., plates VIII. and IX.

⁴ *Geol. Mag.*, November, 1890; *Rep. Brit. Assoc.* 1890, p. 819.

the result of scientific induction, and arrived at by following the line of research first indicated, I believe, by the late Mr. Godwin-Austen and subsequently by Professor Prestwich.⁷ The boring was undertaken with the advice of Professor W. Boyd Dawkins;¹ and we learn, from his latest Report,² that the Coal-measures were reached at 1,113 feet below high-water mark, and were penetrated to 1,500 feet; also that in the 387 feet of Coal-measures six seams were met with, giving an aggregate of 10 feet of coal. The distance of the Coal-measures below high-water mark is a near approximation to Professor Prestwich's computation of the probable depth at which coal might be found in that part of Kent, namely, 1,000 to 1,100 feet.³ The account of the coal-plants or other fossils from these beds has not yet been published.

11. *Conclusion.*—The formation and subsequent arrangement of coal and the Coal-measures have been so ordered that the blessings of civilisation have been largely enjoyed wherever the fossil fuel at man's feet has been industriously worked by his hands, and carefully applied to the improvement of his social being. These labours of careful perseverance, and arts of skilful manipulation, have given special characters to those whose energies have been directed to coal-mining and various manufacturing enterprises; and all conditions of society have been influenced thereby.

So also the geologist, chemist, and botanist, seeking out the composition of the various coals, their local position and extent, their special natural history, the mode of passage from dead plants to first-rate fuel—in fact, aiming at a complete mastery over all the mazy events and complicated results of the coal-formation—not only find a useful exercise of their cultivated intelligence and accumulated knowledge, benefiting all by the practical results, but they widen the mental culture of others, and show how the study of nature is an indispensable element in good education, and necessarily productive of lasting benefit to society at large.

Light, heat, motion, fragrance, and colour are all now obtainable from coal. What more could the sun himself do for us? It is as if the sunshine that cherished the luxuriant jungles of the past had been preserved in the coaly mass of the buried trees. Indeed, the light and heat of former days, expended in thus converting carbonic acid and water into coal, are here stored up for man. By converting coal into carbonic acid and water he can again evolve that heat and light, and use them in a thousand ways beneficial to his race—nave, essential to his very existence as a civilised being. (J. W. Salter and others.)

Nevertheless, a great deal has yet to be learnt about the natural history of the Coal-measures, the order and extent of the special kinds of their animals and plants, the time occupied in formation, and the geographical and hydrographical conditions. At all events, we know that all their strata have been arranged *in order*, have been buried under circumstances favourable to production of the various coaly fuels, and then turned up in *orderly disorder*, ready to the hand of man, and well adapted for his use in this passage-stage of his civilisation and development, helping him, when intelligent, active, careful, and persevering, to higher ends. For we cannot doubt that all things here are arranged for his better being, his progress towards more and more useful arts, wider ranges of science, and fitter aptitudes of life, of which as yet we have but little conception. We are still the early settlers in a beautiful world, whose capabilities, imperfectly known as yet, wait until higher developments of man can understand them fully, and apply the results to the general good.

¹ See also *Contemporary Review*, April 1890; and his *Lecture to the Royal Institution*, June 6, 1890.

² *Report of Proceed. General Meeting of the South Eastern Railway Company*, July 23, 1891, p. 10; and *Financial News*, July 24, 1891.

³ *Proceed. Instit. Civil Engineers*, vol. xxxvii., 1874, pp. 16 and 26 of the separate paper.

The following Papers and Reports were read :—

1. *Discovery of the Olenellus-zone in the North-west Highlands.*

By Sir ARCHIBALD GEIKIE, F.R.S., Director-General of the Geological Survey.

Ever since the Geological Survey began the detailed investigation of the structure of the North-west Highlands of Scotland the attention of its officers has been continuously given to the detection of any fossil evidence that would more clearly fix the geological horizons of the various sedimentary formations which overlie the Lewisian gneiss. A large collection of organic remains has been made from the Durness Limestone, but it has not yet yielded materials for a satisfactory stratigraphical correlation. The study of this collection, however, has confirmed and extended Salter's original sagacious inference that the fauna of the Durness limestone shows a marked North American facies, though, according to our present terminology, we place this fauna in the Cambrian rather than in the Silurian system. Below the Durness Limestone lies the dolomitic and calcareous shaly group known as the 'Fucoid beds,' which, though crowded with worm-castings, has hitherto proved singularly devoid of other recognisable organic remains. In following this group southwards through the Dundonnell Forest, in the west of Ross-shire, my colleague, Mr. John Horne, found that, a few feet below where its upper limit is marked by the persistent band of 'Serpulite grit,' it includes a zone of blue or almost black shales. During a recent visit to him on his ground, when he pointed out to me this remarkable zone, I was struck with the singularly unaltered character of these shales, and agreed with him that, if fossils were to be looked for anywhere among these ancient rocks, they should be found here, and that the fossil-collector, Mr. Arthur Macconochie, should be directed to search the locality with great care. The following week this exhaustive search was undertaken, and Mr. Macconochie was soon rewarded by the discovery of a number of fragmentary fossils, among which Mr. B. N. Peach, who was also stationed in the district, recognised what appeared to him to be undoubtedly portions of *Olenellus*. The importance of this discovery being obvious, the search was prosecuted vigorously, until the fossiliferous band could not be followed further without quarrying operations, which in that remote and sparsely inhabited region could not be at that time undertaken. The specimens were at once forwarded to me, and were placed in the hands of Messrs. Sharman and Newton, Palæontologists of the Geological Survey, who confirmed the reference to *Olenellus*. More recently Mr. Peach and Mr. Horne, in a renewed examination of the ground, have found, in another thin seam of black shale interleaved in the 'Serpulite grit,' additional pieces of *Olenellus*, including a fine head-shield with eyes complete. There may be more than one species of this trilobite in these Ross-shire shales. The specific determinations and descriptions will shortly be given by Mr. Peach.

The detection of *Olenellus* among the rocks of the North-west Highlands, and its association with the abundant *Salterella* of the 'Serpulite grit,' afford valuable materials for comparison with the oldest Palæozoic rocks of other regions, particularly of North America. The 'Fucoid beds' and 'Serpulite grit' which intervene between the quartzite below and the Durness Limestone above are now demonstrated to belong to the lowest part of the Cambrian system. The quartzites are shown to form the arenaceous base of that system, while the Durness Limestones may be Middle or Upper Cambrian. On the other hand, the Torridon Sandstone, which Murchison placed in the Cambrian series, can now be proved to be of still higher antiquity. The marked unconformability which intervenes between it and the overlying quartzite points to a long interval having elapsed between the deposition of the two discordant formations. The Torridon Sandstone must therefore be pre-Cambrian. Among the 8,000 or 10,000 feet of strata in this group of sandstones and conglomerates, there occur, especially towards the base and the top, bands of grey and dark shales, so little altered that they may be confidently expected somewhere to yield recognisable fossils. Already my colleagues have detected traces of annelids and some more obscure remains of other organisms in these strata. These, the oldest relics of life yet known in this country, have excited a vivid desire in the Geological Survey to discover further and more

determinable fossils associated with them in the same primeval resting-place. We shall spare no pains to bring to light all that can be recovered in the North-west Highlands of a pre-Cambrian fauna.

2. *On some recent Work of the Geological Survey in the Archæan Gneiss of the North-west Highlands.* By Sir ARCHIBALD GEIKIE, F.R.S., Director-General of the Survey.

For some years past the officers of the Geological Survey have spent much time and labour upon the investigation of the old or fundamental gneiss of the North-west Highlands. They have succeeded in showing that it consists mainly of materials which were originally of the nature of eruptive igneous rocks, but which by a long succession of processes have acquired the complicated structures which they now present. No evidence of anything but such eruptive rocks had been met with until the mapping was carried into the west of Ross-shire. In that area it had long been known that the gneiss includes some mica-schists and limestones which were believed to be integral parts of its mass. With the accumulated experience of their work further north my colleagues were naturally predisposed to accept this view, and to look on even the limestones as the result of some crushing-down and re-formation of basic igneous rocks containing lime silicates; but as they proceeded in their work they encountered various difficulties in the acceptance of such a theoretical explanation. In particular they found that with the mica-schist were associated quartz-schists and graphitic schists, and that the limestone occurred in thick and persistent bands, with included minerals like those found in the Eastern Highlands in districts of contact metamorphism. The microscopic examination of some of these rocks showed them to present close affinities to certain members of the crystalline series of the Eastern and Central Highlands, which can be recognised as consisting mainly of altered sedimentary strata (Dalradian series); yet the officers of the Survey could not separate these doubtful rocks from the surrounding gneiss. The several materials seemed to pass insensibly into each other in numerous sections, which were examined with great care. Within the present month, however, one of the members of the staff, Mr. C. T. Clough, who has been specially engaged in this investigation, has obtained what may prove to be conclusive evidence on the subject. He has ascertained that the main bands of graphitic schist occur evenly bedded in an acid mica-schist, in which also these graphitic layers are distributed at intervals of an inch or less. These rocks are sharply marked off from the true gneiss, though where they actually join they appear to be, as it were, crushed along a line of intense movement. Mr. Clough and his colleagues are at present disposed to believe that these schists are really an older series of sediments, into which the original igneous rocks now forming the gneiss were erupted. If they succeed in demonstrating the correctness of this inference they will have established a fact of the greatest interest in regard to the geological history of our oldest rocks. Already they have shown the thick masses of Torridon sandstone to be an accumulation of sedimentary materials of pre-Cambrian age. They will push back the geological record to a still more remote past if they can establish the existence of a yet more ancient group of sedimentary strata, among which layers of graphite and beds of limestone remain to suggest the existence of plant and animal life.

3. *Report of the Committee on the Registration of Type Specimens.*
See Reports, p. 299.

4. *Remarks on the Lower Tertiary Fish Fauna of Sardinia.*
By A. SMITH WOODWARD, F.G.S.

The author referred to a series of fragmentary fish-remains from the Miocene of the neighbourhood of Cagliari, Sardinia, collected and submitted for exami-

nation by Professor D. Lovisato. A memoir on the subject by Professor F. Bassani had lately appeared ('Atti R. Accad. Sci. Napoli,' Series 2, vol. iv., Mem. No. 3, 1891), and the present communication contained only brief supplementary observations. In addition to the Selachian genera and species recognised by Bassani, the author identified teeth of *Scymnus*, *Oxyrhina Desori*, *Galeus*, *Aprionodon*, and probably *Physodon*, besides dermal scutes of *Trygon*. The collection comprises no evidence of ganoid fishes, and most of the remains of teleosteans are too imperfect even for generic determination. Traces of Scomberoids and Labroids occur, and there is evidence of a new species of the Berycoid *Holocentrum*. Teeth of *Chrysophrys*, *Sargus*, and other common Mediterranean genera are abundant; and a few detached yellow teeth represent an indeterminate species of *Balistes*.

5. *Evidence of the Occurrence of Pterosaurian and Plesiosaurian Reptiles in the Cretaceous Strata of Brazil.*¹ By A. SMITH WOODWARD, F.G.S.

The author exhibited and described two examples of the articular end of the quadrate bone of a Pterodactyl, and one imperfect propodial bone of a Plesiosaur, discovered by Mr. Joseph Mawson, F.G.S., in the Cretaceous Formation near Bahia, Brazil. Though not generically determinable, the fossils are of much interest as being the first evidence of the reptilian orders in question from the Mesozoic deposits of South America.

6. *The Cause of Monoclinical Flexure.* By A. J. JUKES-BROWNE, F.G.S.

Folds of the ordinary arch and trough type are generally ascribed to the influence of lateral pressure; but it is not easy to see how a monoclinical flexure which appears in section as a flexure connecting two horizontal bars of strata can have been produced by direct lateral pressure exerted at the ends of the bars.

The author suggests that monoclinical flexuring is a structure impressed upon a horizontal series of uncompressed strata by the displacement of a subjacent mass of faulted and flexured rocks, the lateral compression of the deep-seated mass resulting in the vertical uplift of certain portions of the 'cover.' If a series of stratified rocks rests in a horizontal position on a mass of ancient rock, which has been compressed, indurated, flexured, and faulted before the deposition of the upper series, it is supposed that the lower series of rocks would give way under lateral pressure along the pre-existing faults, and that the blocks which lie between upward diverging faults would be forced to move upwards, carrying with them those tracts of the 'cover' which rest on them. It is evident that these tracts would be divided from those resting on blocks defined by downward diverging faults by faults or monoclinical flexures, the production of a fracture or a flexure depending partly on the thickness and pliability of the strata forming the cover and partly on the amount of local uplift. It is conceivable that the displacement might take place partly by faulting and partly by flexuring, and that what was a fault near the plane of unconformity might pass upward into a flexure.

The writer desires criticism on the above suggestion, especially from those who will have a chance of seeing the grand monoclinical flexures of the Colorado region during the excursion of the approaching International Geological Congress.

7. *Note on an Undescribed Area of Lower Greensand, or Vectian, in Dorsetshire.* By A. J. JUKES-BROWNE, F.G.S.

[Communicated by permission of the Director-General of the Geological Survey.]

A recent examination of the ground below the escarpment of the Chalk in North Dorset has revealed the existence of a tract of Vectian or Lower Greensand which had not previously been suspected. Reference to the Geological Survey

¹ Published *in extenso* in *Ann. Mag. Nat. Hist.* [6] vol. viii. pp. 314-317.

map, Sheet 15, will show that the Gault was supposed to thin out and disappear near Shaftesbury, so as to allow the Upper Greensand to rest directly on the Kimmeridge Clay. This proves to be a mistake; the Gault is continuous into and beyond the valley of the Stour. Moreover two miles south of Shaftesbury a tract of sand emerges from beneath the Gault, and forms a terrace which for a little distance has a separate escarpment of its own.

Near Bedchester this tract of sand is nearly half a mile wide, and thence it can be traced to Child Okeford, on the eastern side of the Stour valley, its length being between four and five miles.

Exposures near Bedchester show that it consists chiefly of quartz sand containing a variable amount of glauconite, some beds being yellow and consisting chiefly of quartz, others being grey or dark green and containing a large amount of glauconite. There is also a bed of greenish-black glauconitic clay, $2\frac{1}{2}$ feet thick, consisting of dark purple clay and minute grains of dark green glauconite intimately mixed together. Most of the sand is of fine grain, but there are some thin layers of coarse sand.

So far as is yet known, and with the exception of a small exposure near Lulworth Cove, this is the most westerly tract of Lower Greensand in England.

8. *On the Continuity of the Kellaways Beds over extended areas near Bedford, and on the Extension of the Fuller's Earth Works at Woburn.* By A. C. G. CAMERON.

[Communicated by permission of the Director-General of the Geological Survey.]

In this paper further evidence is submitted from different parts of the country, of the continuity over extended areas of the Kellaways Rock above the Lower Oxford Clay. Several fine excavations, the result of railway enterprise, have afforded sections of these beds in places where their presence was only inferred before. More than the usual thickness is indicated by records recently obtained from deep sinkings and borings in the Midland districts, especially the Bletchley boring of 1886-7.

The extraordinary concretionary stones, noticed in Wiltshire by Smith as characterising this formation, and quarried away years ago at Kellaways for road-stone, jut out in the Valley of the Churn, near Cirencester, and stand about in clusters in the Valley of the Ouse at Bedford like gigantic fungi. The plane of separation of the Upper Oxford and the Kellaways in Bedfordshire is formed by a shelly calcareous band in contact with a shelly cap to the concretionary stones. Where this plane is a broken one there is no development of concreted rock, and the lowest sediment of Upper Oxford clay is loamy, passing down into Kellaways sand. Above the calcareous band there is sometimes an indurated seam of sandy marl, breaking into conical forms; the product, apparently, of stalactitic infiltration. Pits are opened at the outcrop of the Kellaways (a persistent stratum in the Ouse Valley) and are carried down through the Lower Oxford (selenite clay), Cornbrash and Cornbrash clay to Great Oolite limestone, which is quarried for lime-burning; the 'lam earth,' the loamy portion of the Kellaways, being mixed in the mill with the Lower Oxford, which is dug for brickmaking. Excellent sections, showing the above series, are to be seen.

Observations on the extension of the Fuller's Earth Works at Woburn Sands, with some description of the beds, are given, and the mining industry now springing up is commented on.

FRIDAY, AUGUST 21.

The following Papers were read:—

1. *On the Discovery of the South-Eastern Coal-field.*
By Professor W. BOYD DAWKINS, F.R.S.

The author pointed out that although the physical identity of the South-Western coal-fields with those of Northern France and Belgium was recognised by Buckland and Conybeare as far back as 1826, it was reserved for Godwin-Austen to point out the possibility (in 1855) and the probability (in 1858) of the extension of the coal measures under the secondary rocks of South-Eastern. These views were ratified by Prestwich, before the Coal Commission in 1866. After referring to the sub-wealden boring, abandoned when carried to a depth of 1,904 feet, the author stated that in 1886 he recommended to Sir E. Watkin that a boring should be made on the site of the Channel Tunnel works, almost in sight of Calais, where the coal measures had been reached at 1,104 feet, and near the spot where about four hundredweight of bituminous material, possibly derived from the coal measures below, had been found in the chalk. Professor Prestwich had pointed out in 1873 the possibility of tunnelling across the Channel in the older rocks, and Mr. Whitaker had also pointed out in 1886 the desirability of making trial for coal at Dover.

A shaft was sunk on the west side of Shakespeare's Cliff to a depth of 44 feet, and from the bottom of this a bore-hole was carried to a depth of 1,500 feet, through the following strata: Cretaceous, 500 feet; Jurassic, 613 feet; Coal measures, 387 feet. The first seam of coal was struck at 1,140 feet, and five other seams were met with at intervals down to 1,500 feet, giving, according to Mr. Brady, 10 feet of workable coal in all. These coal measures dipped gently at an angle of 2 degrees to the south, and are clearly within the limits at which mining can be carried on at a profit, for the British coal-fields are worked to depths of 3,000 feet, those of Belgium to 4,000 feet, and year by year the improved means of ventilation carry the limit downwards.

The coal is bright and blazing, with cleat slightly lozenge-shaped, and, although with marks of crushing in two seams, is much less injured in this respect than the coals of the Boulonnais. Comparison with the Westphalian coal-field, which has 294 feet of workable coal, that of Liège with 212 feet, that of Mons with 250 feet, and that of Somerset with 98 feet, suggests that the discovery of other and thicker seams is merely a question of sinking deeper.

In conclusion, the author pointed out the importance of a new coal industry in the south-east of England, carrying in its train many other industries, and not improbably reviving under more favourable conditions the ancient wealden iron-field, while he also indicated the important bearing of these discoveries on the question of the durability of our coal supply.

The Geology of Petroleum and Natural Gas.

By W. TOPELEY, F.R.S., Assoc.Inst.C.E.

The object of this paper is to give a summary of some of the more important facts as to the geological conditions under which petroleum and natural gas are found in various parts of the world, noting the geological ages of the rocks in which they occur, and the influence of geological structure in determining this occurrence.

Few cases are known in which petroleum occurs in rocks older than the Silurian, and none where the amount is of any importance.

Petroleum occurs, but not in large quantity, in a trachyte-breccia at Taranaki, New Zealand. In N.W. Hungary it is found in a trachytic tuff of Miocene age, and in some other areas small indications of petroleum are found in volcanic

rocks. These, however, are exceptional cases; for in the great majority of cases petroleum is far removed from any known indications of true volcanic action.

The great stores of petroleum and gas in Pennsylvania and New York are in sandstone beds of the Devonian and Lower Carboniferous rocks. Of late years great quantities of gas and oil have been obtained, chiefly in Ohio and Indiana, from the Trenton Limestone (Ordovician).

The oil- and gas-fields of Pennsylvania and New York have a very simple geological structure. The rocks lie comparatively undisturbed, being only gently folded into a series of anticlinals and synclinals parallel with, and along the N.W. side of, the main axes of the Alleghanies. These folds have themselves a gentle inclination towards the S.W. In the Alleghanies, and to the S.E. of the range, where the rocks are greatly disturbed, neither oil nor gas is found. Some of the larger gas wells are on or near the summits of anticlinals, but many are not so placed. In the Trenton Limestone fields of Ohio and Indiana the productive areas are mainly over anticlinals, gas occurring at the crown of the arch, oil on the slopes.

The essential conditions for a largely productive field of gas or oil are—a porous reservoir (generally sandstone or limestone) in which the hydrocarbons can be stored, and an impervious cover of shale retaining them in the reservoir. It is also believed that they only occur where, in or under the porous reservoir, there have been accumulations of fossil remains, the original decomposition of which yielded the hydrocarbons. In the case of the sandstones the original source was probably the fossiliferous shales which underlie them; in the case of the Trenton Limestone the source was probably the fossiliferous limestone itself. The limestone is only productive under certain circumstances; in its normal condition it is a compact rock, and then it contains neither gas nor oil. But over large areas the limestone has been dolomitized, and so transformed into a cavernous and porous rock in which gas and oil are stored. The enormous quantities of gas and oil given out from beds of limestone and sandstone can be fully accounted for when their porous nature, thickness, and extent are taken into consideration. Some of these rocks can contain from $\frac{1}{10}$ th to $\frac{1}{8}$ th of their bulk of oil.

The high pressure under which gas and oil flow from deep borings can in most cases be fully explained by artesian pressure.

In Kansas gas occurs mainly in the Lower Coal Measures. In Kentucky and Tennessee oil is found in the Ohio shales (Up. Devonian), in Colorado in shales of Cretaceous age. In California it is found in Tertiary strata, mostly much disturbed.

In Canada the chief source, in Ontario, is in Devonian rocks, along a well-marked anticlinal; but gas and oil also occur in the Trenton Limestone. In the North-West Territories there seem to be great stores of oil in Devonian rocks. Gas and oil now found in Cretaceous strata of the prairies and Athabasca may have been derived from underlying Devonian rocks; but in the Rocky Mountains, at Crow's Nest Pass, oil is probably native to the Cretaceous beds.

In Mexico, the West Indies, and parts of South America, Tertiary strata seem to be the chief source of oil. The age of the petroleum-bearing unfossiliferous sands, &c., of the Argentine Republic (province of Jujuy) is not certainly known; they have been referred by different writers to various ages from Silurian to Tertiary; they are probably sub-Cretaceous. In Europe and Asia the petroleum-bearing beds are of Secondary or Tertiary age, the Palæozoic rocks yielding only an insignificant supply.

In North-west Germany we find petroleum in the Keuper Beds, and more or less in other strata up to and including the Gault. As we pass to the south and south-east from this district we find, as a general rule, that oil occurs in newer strata. The various productive horizons of different districts are as follows:—

North-west Germany	Keuper to Gault.
Rhone Valley }	Jurassic.
Savoy }	
Pyrenees }	Neocomian and Cretaceous.
Spain }	
Elsass	Oligocene.

Bavaria	Lower Tertiary (Flysch).
Italy	Eocene.
Galicia	}	Neocomian to Miocene.
North-east Hungary		
Poland	}	Miocene.
Roumania		
Caucasus		

The important districts of Baku occur on plains over anticlinals of Miocene beds. The petroleum-bearing sands are interstratified with impervious clays, separating the strata into distinct productive horizons.

In Algeria oil occurs in Lower Tertiary beds. The Egyptian petroleum comes from Miocene strata.

Petroleum seems to be unknown in peninsular India; but it occurs in many places along the flanks of the Himalayan range, and also in Lower Burma, generally in Lower Tertiary strata. In Upper Burma and Japan the oil-bearing rocks are probably Newer Tertiary. In all these areas the beds are greatly disturbed, and the same is the case with the great Carpathian field; but it frequently happens that the most productive regions are along anticlinal lines.

In New Zealand oil occurs in Cretaceous and Tertiary strata.

Petroleum and gas almost universally occur associated with brine. This may come wholly or partly from the decomposition of the animal matter which has produced the hydrocarbons, together with the remains of the sea-water originally present in the rocks. But the frequent occurrence of rock-salt in the neighbourhood of petroleum-bearing districts is worthy of note.

Summary.—The main points to be considered in respect to the geological conditions under which petroleum and gas occur in quantity seem to be as follows:—

1. They occur in rocks of all geological ages, from Silurian upwards. The most productive areas are Palæozoic in North America, Miocene in the Caucasus.
2. There is no relation to true volcanic action.
3. The most productive areas for oil in great quantity are where the strata are comparatively undisturbed. Oil, but in less abundance, frequently occurs when the strata are highly disturbed and contorted, but gas is rarely so found.
4. The main requisites for a productive oil- or gas-field are a porous reservoir (sandstone or limestone) and an impervious cover.
5. Both in comparatively undisturbed and in highly disturbed areas, an anticlinal structure often favours the accumulation of oil and gas in the domes of the arches.
6. Brine is an almost universal accompaniment of oil and gas.

3. *The Origin of Petroleum.*¹ By O. C. D. ROSS.

In the course of introductory remarks the author contends that, owing to the mystery surrounding the origin of petroleum, and to the paucity of indications where to seek for it, practical men in this country distrust the permanence of the supply, and hesitate to adopt it for many useful purposes; while the object of this paper is to suggest a way of resolving the mystery which is calculated to dissipate that distrust. The theories suggested by Reichenbach, Berthelot, Mendelejeff, Virlet, Verneuil, Peckham, and others, which are briefly described, make no attempt to account for the remarkable variety in its chemical composition, in its specific gravity, its boiling points, &c., and are all founded on some hypothetical process which differs from any with which we are acquainted; but modern geologists are agreed that (as a rule) the records of the earth's history should be read in accordance with those laws of Nature which continue in force at the present day. *E.g.*, the decomposition of fish would not now produce paraffin oil; hence we can hardly believe it possible thousands, or millions, of years ago, so long as it can be shown that any of the ordinary processes of Nature is calculated to produce it. The chief characteristics of petroleum strata are enumerated as: I. The

¹ See the *Chemical News* for October 16, 1891.

existence of adjoining beds of limestone, gypsum, &c.; II. Volcanic action in close proximity; III. The presence of salt water in the wells; IV. The great extent of the production of oil, indicating subterranean receptacles of vast dimensions.

I. The close and invariable proximity of limestone to the wells has been noticed by all writers, but they have been most impressed by its being 'fossiliferous,' or shell limestone, and have drawn the erroneous inference that the animal matter once contained in those shells originated petroleum, but no fish oil ever contained *paraffin*. On the other hand, the fossil shells are carbonate of lime, and, as such, capable of producing petroleum under circumstances such as many limestone beds have been subjected to. All limestone rocks were formed under water, and are mainly composed of calcareous shells, corals, encrinites, and foraminifera, the latter similar to the foraminifera of 'Atlantic ooze' and of English chalk beds. Everywhere, under the microscope, its organic origin is conspicuous. Limestone is the most widely diffused of all rocks and contains 12 per cent. of carbon. Petroleum consists largely of carbon, and there is a far larger accumulation of carbon in the limestone rocks of the United Kingdom than in all the Coal-measures the world contains. A range of limestone rock 100 miles in length by 10 miles in width and 1,000 yards in depth would contain 743,000 million tons of carbon, or sufficient to provide carbon for 875,000 million tons of petroleum. Deposits of bituminous shale have also limestone close at hand; e.g., coral-rag underlies the Kimmeridge clay, which is more or less saturated throughout with petroleum, and it also underlies the famous Black-shale in Kentucky, which is extraordinarily rich in oil.

II. The evidence of volcanic action in close proximity to petroleum strata is next dealt with, and extracts in proof thereof are given from several writers. In illustration of volcanic action on carbonate of lime, a sulphur mine in Spain, within a short distance of an extinct volcano (with which the author is well acquainted), is mentioned. That petroleum is not far off is indicated by a perpetual gas flame in a neighbouring chapel and other symptoms; and, these circumstances having attracted his attention, he observed that Dr. Christoph Bischof records in his writings that he had produced sulphur in his own laboratory by passing hot volcanic gases through chalk, which fact further led the author to remark that, in addition to sulphur, *ethylene*, and all its homologues (C_nH_{2n}), which are the oils predominating at Baku, would be produced by treating—

2, 3, 4, 5.....equiv. of limestone (carbonate of lime) with
 2, 3, 4, 5.....equiv. of sulphurous acid (SO^2), and
 4 6 8 10.....equiv. of sulphuretted hydrogen (H^2S);

and that *marsh gas* and its homologues, which are the oils predominating in Pennsylvania, would be produced by treating—

1, 2, 3, 4, 5.....equiv. of carbonate of lime, with
 1, 2, 3, 4, 5.....equiv. of sulphurous acid, and
 3, 5, 7, 9, 11.....equiv. of sulphuretted hydrogen.

Thus, we find that

Carbonate of lime	$2Ca^2CO^3$	}	yield	{	$2(Ca^2SO^4.H^2O)$	(gypsum)
Sulphurous acid	$2SO^2$				4S	(sulphur)
and sulphuretted hydrogen	$4H^2S$				C^2H^4 , which is	<i>ethylene</i> ,

and

Carbonate of lime	Ca^2CO^3	}	yield	{	$Ca^2SO^4.H^2O$	(gypsum)
Sulphurous acid	SO^2				3S	(sulphur)
and sulphuretted hydrogen	$3H^2S$				CH^4 , which is	<i>marsh gas</i> .

These and all their homologues would be produced in nature by the action of volcanic gases on limestone.

But much the most abundant of the volcanic gases appears (at any rate at the surface) as steam, and petroleum appears to have been more usually produced without sulphurous acid and with part of the sulphuretted hydrogen H^2S replaced by H^2O (steam), or H^2O^2 (peroxide of hydrogen), which is the product that results

from the combination of sulphuretted hydrogen and sulphurous acid ($\text{H}^2\text{S} + \text{SO}^2 = \text{H}^2\text{O}^2 + 2\text{S}$). Thus

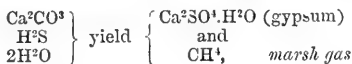

and

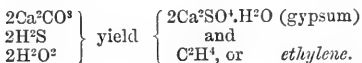

Four tables are given at the end of the paper, showing the formulæ for the homologues of ethylene and marsh gas resulting from the increase in regular gradation of the same constituents.

It is explained that these effects must have occurred, not at periods of acute volcanic eruptions, but in conditions which may be and have been observed at the present time wherever there are active solfataras, or fumaroles, at work. Descriptions of the action of solfataras by the late Sir Richard Burton and a British Consul in Iceland are quoted, also a paragraph from Lyell's 'Principles of Geology,' in which he says that the mud-volcanoes at Girgenti, in the Tertiary limestone formation, 'are known to have been casting out water, mixed with mud and *bitumen*, with the same activity for the last fifteen centuries.' Probably at all these solfataras, if the gases traverse limestone, fresh deposits of oil-bearing strata are accumulating; and how much may there not have been produced during fifteen centuries!

Gypsum may also be an indication of oil-bearing strata, for the substitution in limestone of sulphuric for carbonic acid can only be accounted for by the action of these sulphurous gases. The abundance of gypsum in the United Kingdom indicates that large volumes of petroleum are probably stored in places where it has never yet been sought for. Gypsum is found extensively in the petroleum districts of the United States, and it underlies the rock-salt beds of Middlesboro' (N.E. Yorkshire), where, on being pierced, it has given passage to oil-gas, which issues abundantly mixed with brine, and under great pressure from a great depth.

III. and IV.—Besides the space occupied by 'natural gas,' 17,000 million gallons of petroleum have been raised in America since 1860, and that quantity must have occupied 100,000,000 cubic yards; a space equal to a subterranean cavern 100 yards wide by twenty feet high and eighty-two miles in length, and it is suggested that beds of 'porous sandstone' could hardly find room for so much; while vast receptacles may exist, carved by water out of former beds of rock-salt adjoining the limestone.

This would account for the brine; and the increase to the molecular volume of the gases consequent thereon would in part account for the pressure. It is further suggested that when no such open spaces were available, the hydrocarbon vapours were absorbed into and condensed in contiguous clays and shales, and perhaps also in beds of coal, only partially consolidated at the time. There is an extensive *bituminous limestone* formation in Persia, containing 20 per cent. of bitumen; and the theory elaborated in the paper would account for bitumen and oil having been found in Canada and Tennessee imbedded in limestone, which fact Mr. Peckham (in his article on Petroleum in the 'Encyclopædia Brit.,' 9th edition) thought was a corroboration of his belief that some petroleums are a 'product of the decomposition of animal remains.'

Above all, this theory accounts for the many varieties in the chemical composition of paraffin oils, in accordance with ordinary operations of Nature during successive geological periods.

4. *A Comparison between the Rocks of South Pembrokeshire and those of North Devon.* By HENRY HICKS, M.D., F.R.S., Sec. Geol. Soc.

The clear succession from the Silurian rocks to the Carboniferous to be observed in many sections in South Pembrokeshire offers, in the author's opinion, the key to the true interpretation of the succession in the rocks of North Devon, for there

cannot be a doubt that the post-Carboniferous earth-movements which so powerfully affected and folded the beds in North Devon extended into and produced almost identical results in South Pembrokeshire. In the latter area, however, the succession remains clearer, and can be traced more continuously.

The base of the Silurian (Upper Silurian of Survey) is exposed at many points, and the lower beds, usually conglomerates, repose transgressively on the Ordovician, and even on some pre-Cambrian rocks. Near Johnston and Stoney Slade the conglomerate contains numerous pebbles of the Johnston and Great Hill granite as well as of other igneous masses which were formerly supposed to be intrusive in these beds. From the Silurian conglomerate to the Carboniferous beds there does not appear to be any evidence of a very marked break in the series; moreover, all these beds were folded together and suffered equally by the movements which affected the area. The axes of the folds strike from about W.N.W. to E.S.E. The movements, therefore, at this time were in a nearly opposite direction to those which affected the Ordovician and Cambrian rocks at the close of the Ordovician period. Within the broken anticlinal folds portions of the old land surfaces have been exposed in several places by denudation.

The succession exposed in this area and the effects produced by the earth-movements so nearly resemble those already described by the author as occurring in North Devon, that he is convinced that the beds must have been deposited contemporaneously in one continuous subsiding area, and that the differences recognisable are chiefly in the basal beds, which were deposited on an uneven land surface. He believes that the Morte slates of North Devon are a portion of an old land surface on which the so-called Devonian rocks were deposited, and he also believes that the Devonian rocks are only the representatives in Devonshire of the Lower Carboniferous, Old Red Sandstone (and possibly of some of the Silurian rocks), of Pembrokeshire. A critical examination of the fossil evidence tends strongly to confirm this view.

5. *Vulcanicity in Lower Devonian Rocks. The Prawle Problem.* By W. A. E. USSHER, F.G.S.

[Communicated by permission of the Director-General of the Geological Survey.]

In the area extending south from the Middle Devonian volcanic series of Ashprington to the Prawle there appears to be no proof of the occurrence of strata older than Lower Devonian. There is no adequate reason for assuming that Lower Devonian rocks as old as the Gedinnian occur on the surface, and there is no certainty that the lowest beds are older than the Lower Coblenzian.

The occurrence of local volcanic action in Lower Devonian time is proved by a series of diabases and tuffs near Dartmouth, in the Kingswear Promontory, near Stoke Fleming, and in the line of country west from Torcross.

In association with the northern chloritic band (running from the mouth of the valley on the north of Hall Sands on the east to Hope on the west) we find volcanic materials identical in character with varieties of volcanic rocks associated with the Devonian slates in the line of country west from Torcross; and here and there in the line of country west from Torcross the volcanic rocks assume a more or less pronounced chloritic aspect. The junction of the slates on the north with the northern chloritic band is a strictly normal one, the chloritic rocks being almost invariably separated from the slates by brown volcanic materials which are everywhere succeeded by the same type of Devonian slate, and in the Southpool Creek and many other sections are found to pass insensibly into the chloritic type. In the Southpool Creek section a hard bluish diabase (? aphanite) occurs in the chloritic band. In the southern chloritic districts of the Prawle the volcanic rocks may still be here and there detected by texture or colour. Volcanic rocks occur in the mica schists of the Start coast, and can be detected even when only a few inches in thickness. At Spirit-of-the-Ocean Cove chloritic rock with much calc-spar occurs in association with tuffs and a grey rock with incipient foliation, presenting a slightly gneissoid appearance, and apparently a much sheared diabase. The association of the chloritic rocks with the mica schists is of as intimate a

nature as that of the volcanic materials with the unaltered slates to the north. From these facts it seems evident that the chloritic series is nothing more than a Devonian volcanic group, of which the Torcross, Stoke Fleming, Dartmouth, and Kingswear coast tufts and diabases were either sporadic offshoots or evidences of more or less contemporaneous local vulcanicity.

The more evident crinkling of the mica schists in contact with the chloritic group seems to be due to their comparative softness and greater fissility during the crumpling and contraction to which both were subjected.

The comparative suddenness of the transition from unaltered to more or less highly altered rocks may be explained by the lessening of strain (in receding from the harder masses of ancient rocks, against which the beds were jammed), being coincident with the thinning out of the volcanic materials northward, and furthermore favoured by the soft character of the grey slates with limonitic interfilings which everywhere bound the northern chloritic band on the north. It is not the author's present purpose to enter more particularly into the stratigraphy of this interesting region, which is not yet thoroughly worked out. It only remains to acknowledge the prior claim of Mr. Somervail to the suggestion of the identity of the Devonian diabases with the chloritic rocks.¹

6. *On the Occurrence of Detrital Tourmaline in a Quartz-schist west of Start Point, South Devon.* By A. R. HUNT, M.A., F.G.S.

While examining the Devonian cliffs near Street Gate, at the north-east end of Slapton Sands, South Devon, in company with Mr. W. A. E. Ussher, F.G.S., the author selected a hard micaceous sandstone of fine grain, occurring as a band between softer rocks, for comparison with a micaceous quartzite or quartz-schist, previously noticed by Mr. Ussher at a point on the coast south of Start Farm and west of Start Lighthouse. The quartz-schist occurs as an impersistent band among the mica-schists west of Start Point.

Mr. A. Harker, F.G.S., on examining the sandstone, at once pointed out the presence of tourmaline and white mica, of detrital origin; and considered that the rock had the appearance of having been derived from a tourmaline-bearing granite.

On a careful examination of two slides of the quartz-schist,² the author detected a single grain of tourmaline. Six additional slides were forthwith prepared, and detrital tourmaline was found in them all. One of these slides contains a pellucid grain of quartz with fluid inclusions and active bubbles; another contains a grain crowded with hair-like inclusions and with one fluid inclusion whose bubble is easily moved by the heat of a wax match. Both these grains could be easily matched in the quartzes of different granites.

The derivation of the quartz-schist from granites of more than one character, but one of which must have been schorlaceous, seems clearly indicated.

The above facts have two distinct bearings, viz., as to the age of the metamorphic schists of South Devon, and as to the derivation of the tourmaline.

The two rocks under consideration, viz., the quartz-schist and the Devonian sandstone, are related to each other in four particulars, inasmuch as they contain four constituents common to both, viz., detrital tourmaline, detrital mica, quartz of fine grain, and iron.

It seems difficult to avoid the conclusion that such similar rocks must be of like age and derivation; and that as the sandstone is undoubtedly Devonian, the quartz-schist, one of the metamorphic schists of South Devon, must be of Devonian age also, and not Archæan, as has been supposed by some geologists.

The derivation of the tourmaline is a more difficult question. Whatever may be the age of the mass of the Dartmoor granites, those of a schorlaceous character seem to be post-Carboniferous. Moreover, no tourmaline has been noticed in the

¹ The views above expressed are those to which the author himself has been led, but they have not yet been fully considered and adopted by the Geological Survey.

² The hand specimen selected for slicing was kindly placed at the author's disposal by Mr. A. Somervail, of Torquay.

granites trawled in the English Channel. There is thus no recognised source of pre-Devonian tourmaline in the neighbourhood of South Devon, yet the source of derivation of the rocks under discussion could not seemingly be remote, or the tourmaline, quartz, and mica could scarcely have kept together. The tourmaline granites of Cornwall would meet the case, if any of these are of pre-Devonian age; but on this point the author has no information.

Besides the tourmaline observed in the rocks at Street Gate and Start Point, the author has noticed the same mineral, occurring in the same way, in a sandstone from near Tinsey Head in Start Bay, and in a sandstone from near Charleton, on the Kingsbridge estuary, both of Devonian age.

SATURDAY, AUGUST 22.

The following Reports and Papers were read:—

1. *Report of the Committee on the Circulation of Underground Waters.*
See Reports, p. 300.

2. *Note on the Discovery of Estheria Minuta (var. Brodieana) in the New Red Sandstone.* By C. E. DE RANCE, F.G.S., of H.M. Geological Survey.

This minute crustacean was first discovered by the Rev. P. B. Brodie, F.G.S., in the Rhætic, at Wainlode Cliff, Gloucestershire, and was named after him by Professor Rupert Jones. It was afterwards found in a band of fine sandstone occurring in the Keuper marls, at several localities in the Midland counties. Still later it was discovered in the Letten Kohl of the Baden Trias, which is the lowest horizon of the German Keuper.

In September of last year I discovered a small assemblage of these shells in the lowest member of the Cheshire Keuper, viz. the Lower Keuper building stones; they occurred in a pebble of marl, of a deep purple colour, enclosed in a pale yellow sandstone, at Broadhurst's quarry, Alderley Edge. The majority of the specimens are now in the British and Jermyn Street Museums, and they have been described by our President, Professor Rupert Jones, in the 'Geological Magazine.' I have failed to find any more, after the most careful search.

It is worthy of note that the oldest-known mammal, *Microlestes Moorei*, Owen, occurs in the German Letten Kohl; but in England, where it was discovered by Mr. Charles Moore in 1858, it is not known below the Rhætic. The small mammal, and the minute crustacean, occurring both above and below the Keuper marls, may it not be hoped that the mammal may also be found in England, and support the views of the late Professor Forbes, that the beds now called Rhætic are really part of the Trias: a view also held by the late Sir Philip Egerton, on the evidence of the fish remains.

3. *Report of the Committee on Geological Photographs.*
See Reports, p. 321.

4. *Notes upon Colobodus, a Genus of Mesozoic Fossil Fishes.*
By MONTAGU BROWNE, F.Z.S., F.G.S.

Colobodus appears to have been first constituted a genus in the year 1837 by Louis Agassiz (see 'Poissons Fossiles,' Tome II., ii^e partie, p. 237), who gave this name to some *Lepidotus*-like teeth (*Colobodus hogardi*) from the Muschelkalk,

which he described thus:—‘Par leur taille elles tiennent le milieu entre les *Microdon* et les *Sphærodon*. De formes arrondies et cylindracées vers la base, les dents ont leur couronne renflée en forme de massue, et sur le milieu de la couronne s’élève encore un petit mammelon tronqué, ce qui a valu à ce genre son nom de *Colobodus*.’

Since that time teeth of a similar generic character have been described or figured by various authors, e.g. Count Münster (assuming *Asterodon* to be identical), Plieninger, Giebel, Gervais, Meyer, Chop, E. E. Schmid, Alberti, Eck, Winkler, Gürich, W. Dames, and A. S. Woodward. The typical teeth, however—i.e. those upon which the ‘nipple,’ or apical tubercle, is present—must be sought amongst the various species of *Colobodus* and *Lepidotus* (of Plieninger, 1847); whilst intermediate forms, or those from which the ‘nipple’ has been partly or entirely removed by wearing or by *post-mortem* abrasion, must be sought amongst those described under the various species of *Lepidotus*, *Sphærodon*, *Gyrodon*, ‘*Tetragonolepis*’ (of Winkler, and of Agassiz in part), *Tholodus* and *Theلودus*, *Eupleurodon*, *Sargodon* (not cutting teeth), and even amongst teeth variously attributed to *Saurichthys* and to ‘Saurians,’ whilst the chisel-shaped, or pre-maxillary, teeth are probably those attributed to *Sargodon tomicus*.

Fragments of the head and trunk and scales of *Colobodus* have been described or figured by H. B. Geinitz, Meyer and Plieninger, Giebel, Meyer, Quenstedt, Eck, Kner, H. Kunisch, W. Dames, J. von Rohon, and A. S. Woodward, and must be sought amongst the various species ascribed to *Gyrolepis* and *Amblypterus*, *Lepidotus*, *Heterolepidotus*, *Eugnathus*, *Pleurolepis*, *Dactylolepis*, and also amongst various Ganoid scales (‘Ganoidschuppen’ and ‘Fischschuppen’).

Up to the present neither the teeth nor the scales of *Colobodus* have been recognised as such in Britain by any authors, or, above the Muschelkalk and Lettenkohle, abroad: its occurrence and recognition, therefore, in the Rhaetic of Britain is interesting, and the author exhibited typical and transitional teeth which he found and recognised in the Rhaetic ‘bone-beds’ of Watchet and Aust Cliff; worn and abraded teeth (‘*Sargodon tomicus*’ and ‘*Sphærodon*’) from thence and from Leicestershire; and what are probably the larger cutting teeth from Aust and Leicestershire; also fine characteristic scales and (? head-) bones showing vermiculated sculpture from Aust. All may, for the present, be referred to *Colobodus maximus* (Quenstedt).

Finally, should *Colobodus* prove to be identical with *Lepidotus*, a further fusion of *Heterolepidotus* and *Eugnathus* will give *Colobodus* a more extended upward range than has hitherto been supposed.

5. *Report of the Committee on Earth Tremors.*—See Reports, p. 333.

6. *Report of the Committee on the Volcanic Phenomena of Vesuvius.*
See Reports, p. 312.

MONDAY, AUGUST 24.

The following Papers and Reports were read:—

1. *The Cause of an Ice Age.* By Sir ROBERT BALL, F.R.S.

The ordinary statement of the astronomical theory of the Ice Age seems to be founded on a passage in Sir John Herschel’s outlines of Astronomy. It is from this that Dr. Croll’s theory has been developed. It is the object of this communication to point out that by what seems to have been a mathematical mistake on the part of Herschel, a wholly erroneous statement of the matter was presented.

The error was not perceived by Croll. He, perhaps not unnaturally, accepted Herschel's authority on such a matter, and consequently a thorough revision of Croll's calculations and his doctrines based thereon becomes necessary.

In a work now in the press, bearing the title of this paper, I have endeavoured to develop the correct view of the subject, and to rewrite the astronomical theory of the Ice Age. I may, however, here remark that the error into which Dr. Croll unfortunately fell was very prejudicial to the conclusion he strove to prove. Had he been acquainted with the accurate version of the mathematical facts, he would have been able to show a much stronger case for the astronomical doctrine of the Ice Age than that he actually presented.

The essential point of the present communication lies in the announcement that—

If 100 represent the total number of heat units received on a hemisphere of the earth in a year, then 63 will be the share received during summer, and 37 during winter.

A special importance attaches to these figures from the circumstance that they are absolutely independent of the eccentricity of the earth's orbit, or of the position of the equinoxes. They depend solely upon the obliquity of the ecliptic, and this is a magnitude which, so far as our present purpose is concerned, may be regarded as constant during geological time.

The distribution of the heat just stated is the point which I now desire to emphasise. Herschel stated the numbers to be 50 and 50. If his attention had been sufficiently given to the matter, he would have seen that the numbers were 63 and 37. The correction is an important one.

It is to be remembered that the units in which we are reckoning express the total heat received from the sun. As the sun heat alone preserves the earth from sinking to the temperature of space, it follows that the sun heat really maintains a temperature some hundreds of degrees greater than we would otherwise have. A fluctuation in sun heat, which appeared small in comparison with the total amount, might involve a vast change in climate.

Owing to the perturbations of the planets, it will occasionally happen that the eccentricity of the earth's orbit will become larger than it is at present. It seems that the maximum eccentricity is sufficient to produce an inequality between the duration of summer and winter amounting to 33 days. We have, therefore, the following possible conditions in either northern or southern hemisphere:—

Summer	199 days.	or	Summer	166 days.
Winter	166 days.		Winter	199 days.

In each case it must be borne in mind that 63 heat-units arrive in summer and 37 in winter. If the summer be the long one and the winter be short, then the allotment of heat between the two seasons is fairly adjusted. The 63 units are distributed over the 199 days, and the 37 units over 166 days, and a milder climate than our present one results. This is the genial inter-glacial state for that hemisphere. If, however, a torrent of heat represented by 63 units is received during a brief summer of 166 days, while the balance of 37 units is made to stretch itself over 199 days, then a brief and intensely hot summer is followed by a very long and cold winter. As this condition lasts for many centuries it seems sufficient to produce a glacial epoch.

I have only to add that on this view there must have been not only one but several Glacial epochs throughout geological time, but they doubtless occurred at very irregular intervals, and with wide differences in severity. It is, however, noteworthy that the theory requires that when the northern hemisphere is glaciated the southern hemisphere shall be in a genial state, and *vice versa*. It is also to be observed that so long as the high eccentricity of the earth's orbit is maintained the procession of the equinoxes will cause the glaciation to shift from one hemisphere to another in a period of 10,500 (ten thousand five hundred) years. I do not mean that this will always be the interval, but it does seem probable that there may be clusters of two, three, or more ice ages, the individual members of which are so divided. Each cluster is separated from the next by a vast period

of hundreds of thousands of years. There is no means, so far as I at present know, of indicating the law of recurrence of ice ages with any further accuracy of detail.

I would also like to say that while I have here striven to enunciate with precision the astronomical aspect of the problem, I am profoundly conscious of the many geological agents which may contribute to modify the effects of which I am treating.

2. *Report of the Committee on Erratic Blocks.*—See Reports, p. 276.

3. *Notes on the Glacial Geology of Norway.* By H. W. CRESSKEY, LL.D., F.G.S.

Attention was called to a passage in the standard work on 'Norway and its Glaciers' by Forbes, p. 24, in which it is stated that they are questionable traces of glaciers on the Dovre-fjeld, and that nothing decisive of their action, either by wearing and polishing the rocks where they come into view or in the deposition of glaciers, could be seen. 'Nor are the mounds of stone (it is added), which are abundant enough, sufficiently characteristic to deserve the appellation of moraines. They are indeed sometimes disposed in flat-topped ridges; but this is due, if I mistake not, to the eroding action of torrents, which have gradually undermined them, leaving abrupt talus, which at first resemble moraines, but in their present form it is difficult or impossible to identify them.'

Since the time of Forbes the deposits of the Glacial epoch have been studied in greater detail, and it is now possible to assign to their proper places and causes many deposits which it has previously been regarded as impossible to identify. The description given of the Dovre-fjeld needs many corrections and additions. The plateau is hidden to a considerable extent by a rough layer of stony material, but wherever the basement rock is exposed glaciation may be found. The mounds that are alluded to by Forbes are related to the action of ice among the mountains which bound the Dovre-fjeld. The glaciers in the valleys of those mountains descended over the Dovre-fjeld, and accumulated their moraines upon it, and the mounds are the relics of lateral glaciers. As the snows melted, torrents of water were poured down from the surrounding mountains over the Dovre-fjeld, larger lakes than those now existing were formed within any hollows and within the boundaries of morainic dams.

As the climate ameliorated the snows lessened, and the torrents of water were less excessive; but streams and rivers abounded, connecting the diminished lakes. Owing to these processes, the moraines were swept away to a large extent, only small mounds being left, and their material was distributed over the surface of the plateau. Angular blocks were rounded, and glaciated surfaces buried beneath the *débris*.

In the deposits of the Dovre-fjeld there is thus every proof—(1) of a period of extreme glaciation; (2) of the existence of glaciers descending from lateral valleys in the surrounding mountains; (3) of the gradual disappearance of these glaciers and the washing of their moraines over the general surface of the fjeld.

Not a few erratic ice-worn blocks also occur, although in many cases they have been water-worn during the course of the history described.

4. *Recent Discoveries concerning the Relation of the Glacial Period in North America to the Antiquity of Man.* By Professor G. FREDERICK WRIGHT, F.G.S.A., LL.D., Oberlin, Ohio, U.S.A.

Palæolithic implements of the type of those found in the high-level gravel of the Valley of the Somme, and of various streams of Southern England, have now been found in similar gravel deposits in no less than seven different places in the United States—namely at Trenton, New Jersey, by Dr. C. C. Abbott; at

Claymont, Delaware, by Dr. H. T. Cresson; at Newcomerstown, Ohio, by Mr. W. C. Mills; at Loveland and Madisonville, Ohio, by Dr. M. C. Metz; at Medora, Indiana, by Dr. Cresson; and at Little Falls, Minnesota, by Miss Babbitt. The determination of the age of these implements requires a general study of the Glacial phenomena of the continent.

Through the combined labours of many observers, the southern boundary of the glaciated region has been carefully traced across the continent, and found to run in an irregular course from the vicinity of New York City, south-westward through Cincinnati in Ohio, to Carbondale, about latitude 38° , in southern Illinois. Thence it bears north-westward, following approximately the course of the Missouri River, and entering Canada a hundred miles or more east of the Rocky Mountains. The centre of radiation for this portion of the ice-field was in the vicinity of the south-east of Hudson Bay, and this portion has been named the Laurentide glacier. From that centre the ice movement was west and north, as well as east and south.

Whether the Laurentide glacier became confluent on the west with the Cordilleran glacier, which occupied the vast region in British Columbia west of the Rocky Mountains, is still in dispute. But it is certain that the ice from that centre, as well as in the mountains of southern Alaska, moved outward in all directions. The glaciation of the Rocky Mountains, and of the Cascade Range south of the Canadian boundary, was comparatively slight.

The distribution of ice during the Glacial period in North America bears strongly against all theories which attribute the phenomena to cosmical causes. There was not a Polar ice-cap, but an accumulation about centres mainly south of the Arctic Circle. While there is accumulating evidence pointing to an extensive elevation of the glaciated areas during the latter part of the Tertiary period, and of a subsidence at the same time of the Isthmus of Panama. The valleys occupied by the great lakes were probably mainly formed by erosion during that period of elevation, the old lines of drainage having been closed up by the *débris* of the Glacial period. This is clearly the case with Lake Erie, and, to a large extent, may be the case with the other lakes. There are positive signs of such old channels, now buried, leading to the Mississippi from Lake Michigan, and to the Hudson from Lake Ontario.

The Palaeolithic implements discovered in North America are from the terraces of streams flowing outward from the glaciated region—namely, the Delaware, on the Atlantic coast, the Tuscarawas, the Little Miami, and the White, in the Valley of the Ohio, and the Upper Mississippi. Similar terraces are universal along the streams flowing out of the glaciated region, and are composed mainly of material which was first transported from the distant north by Glacial ice. They are doubtless the deposits occurring during the floods which characterised the closing portion of the Glacial period. Associated with these implements are the bones of the mammoth and some other animals, now either wholly extinct, or extinct in that region. In New Jersey the bones of several Arctic species have been found.

The approximate date of these closing scenes of the Glacial period seems pretty clearly to be indicated by the recession of the Falls of Niagara and of St. Anthony, where the conditions are uniform, and the length of the gorges, as well as the rate of recession, known. In both cases the length is a little over seven miles, and the rate has been ascertained to be between 3 feet and 5 feet per year. The streams cannot have been at their work of erosion in those channels much more than 10,000 years. A similar result is obtained independently from calculations respecting the enlargement of post-Glacial valleys, the erosion of the banks of Lake Michigan, and the post-Glacial silting-up of many small lakes. But how much earlier than this man's advent on the continent may have occurred it is not so easy to determine.

The extent of post-Glacial subsidence is much disputed, and has important bearings on the question of the continuity of Glacial man with the races now occupying the continent. The post-Glacial subsidence, of which there seems to be sufficient evidence, amounts only to about 500 feet in the lower axis of the

Mississippi Valley, to 230 feet on the coast of Maine, and to 500 feet at Montreal and in the valley of the Ottawa River.

The question of a succession of Glacial epochs has narrowed itself down in America to the question whether or not there have been two epochs, or one epoch, with minor halts in the recession of the ice. So far as my own observation goes, and it has been extensive, the complete separation between the epochs does not seem to be proved. The forest beds are all pretty well towards the southern part of the area, and are many of them probably pre-Glacial, while others are of such a nature that they might have accumulated in a comparatively brief episode of oscillation of the ice front. The terminal moraine of what is called the Second Glacial epoch, which stretches with a good degree of continuity from the Atlantic to the Mississippi, may well enough be regarded as a moraine of retrocession, of which there are numerous other instances, on a smaller scale, both north and south of this.

5. *On the Evidences of Glacial Action in Pembrokeshire, and the Direction of Ice-flow.* By HENRY HICKS, M.D., F.R.S., Sec. Geol. Soc.

The occurrence of ice-scratched rocks and of northern erratics in north-west Pembrokeshire has already been mentioned by the author, but in this paper he brings forward much additional evidence to show that, during the glacial period, a great thickness of land-ice must have passed over Pembrokeshire.

The glacial striae which are so well preserved under the drift along the north-west coast, especially at Whitesand Bay, show that the ice travelled over that area mainly from a north-western direction. The presence of erratics from North Wales and from Ireland would tend to the conclusion that glaciers from these areas coalesced in St. George's Channel, and that the ice which overspread Pembrokeshire was derived from both of these sources, as well, probably, as from a flow extending down the channel from more northern areas. Although there are in the district many northern erratics, notably a large boulder of granite and another of picrite, which the author found on Porthlisky farm, two miles south-west of St. David's, yet by far the majority are of local origin and can be traced back to the parent rocks. The great igneous masses which now form such conspicuous hills along the north coast yielded most of the boulders, many of very large size, which are so freely spread over the undulating land reaching to the coast of St. Bride's Bay. There are clear evidences to show that this bay was itself overspread by a great thickness of drift from these hills. The intervening pre-glacial valleys were also filled by this drift, and the plains and rising grounds up to heights of between 300 and 400 feet still retain evidences of its former presence, and many perched blocks. Excellent sections of unstratified drift, containing large ice-scratched boulders, are exposed in Whitesand Bay, and a thickness of several feet of an irregularly stratified sand was, some time since, exposed under the boulder clay on the east side of the bay. Chalk flints have been found at heights of over 300 feet, probably having been brought from Ireland. The picrite boulder already referred to has been shown by Professor Bonney to resemble masses of that rock exposed in Carnarvonshire and Anglesea, and the granite boulder, which before it was broken must have been over 7 feet in length and 3 to 4 feet in thickness, is identical with a porphyritic granite exposed in Anglesea, but not found anywhere in Pembrokeshire. The evidences, therefore, which go to prove that Pembrokeshire was buried under an ice-sheet that must have spread southwards into the Bristol Channel, are, the presence of many northern erratics, both as perched blocks and in drifts at heights above 300 feet, ice-scratched, smoothed and polished rock surfaces, and, in places, much crushing and bending of some of the strata; also great dispersions of boulders from igneous rocks on the north coast in a south-west direction, and some well-marked examples of 'crag and tail.'

6. *Note on Boulders at Darley, near Matlock, Derbyshire.*

By HERBERT BOLTON, *Assistant Keeper, Manchester Museum.*

During the excavation for a small lake close to the Midland Railway Station at Darley, near Matlock, a cluster of fifteen boulders was exposed, the size of several being sufficient to justify an examination. The size of the largest boulder was 10 feet \times 6 feet \times 6 feet.

The boulders lay in a bed of boulder clay which had a thickness of nine feet.

The upper part of the clay was of a strong yellow colour and very stiff. Below, the colour varied from yellow to brown and red, and pockets of sand were common.

Only two boulders were well rounded, the rest being sub-angular on their upper half, and fairly angular on the lower.

All the boulders consist of gritstone identical in character with the Chatsworth grit of the adjoining hills.

No striations occur on the boulders, but this may be due to the original surface having crumbled away.

A series of parallel and shallow grooves occurs on the side of the largest boulders, and a deep hollow has been scooped out of its southern face.

The major axis of the undisturbed boulders was approximately north and south, the general direction for the cluster being 8° west of north.

The blocks were arranged in the order of their weight in a north to south direction.

The clay was found to rest upon a deposit of the nature of river gravel.

The writer is of opinion that the clay is redistributed boulder clay brought down from the adjoining heights, and that the boulders were brought down at the same time from the line of outcrop of the grit.

He is led to this conclusion by the local character of the boulders, the almost total absence of foreigners, and the character of the clay.

The red and brown colour of the latter at its base seems to show that oxidation of the contained iron has proceeded for a longer time than in the case of the uppermost clay.

This would be expected if the clay was redistributed, for the basement mass of clay must have been the superficial clay of the heights.

The enclosed sand would also indicate the complete disintegration of boulders of gritstone, &c., whilst the clay was in its primary position.

The amount of disintegration which has taken place since redistribution is marked by the crumbling surface of the large boulders.

The general direction of the boulders may be explained by noting that the river flows from north to south.

7. *Notes of a Section of Drift at Levenshulme, Manchester.*

By PERCY F. KENDALL, *F.G.S.*

In the construction of a new railway between Chorlton-cum-Hardy and Fairfield a good opportunity was afforded of studying the effects of land-ice. The part of the cuttings particularly observed was that extending from Fallowfield almost to the L. and N.-W. Railway at Levenshulme, in a line almost accurately from west to east.

Throughout the whole distance the solid geology was displayed with a covering of boulder clay. The rocks consisted in descending sequence (and from west to east) of triassic pebble beds (fault), Permian marl, Permian sandstone, and upper coal measures containing several beds of Ardwick limestone (see 'Brockbank and De Rance, Mem. Manch. Lit. and Phil. Soc.,' 4th Series, Vol. iv.). The triassic rocks when soft were much mangled and crushed at their contact with the drift; but in places, nearly horizontal intrusions of boulder clay were interposed between the bedding. These intrusions always entered from the west.

At one point the triassic beds rose to within about 2 feet of the top of the cutting, the ground being nearly level.

At the fault blocks of triassic rocks were dragged over on to the Permian marls. The marls were greatly mangled, and some erratics of large size (andesites, &c.) were involved in their mass. At the base of the marls a coarse bed of hard breccia occurred and its surface was striated from N. 65° W. It was observed that this surface was about 16 feet lower than the triassic sandstone, and therefore the striæ could not have been produced by floating ice, for ice which could clear the ridge to the westward could not ground at a lower level.

The bands of Ardwick limestone had been much ice-worn, and from each outcrop a long train of boulders stretched away to eastward.

A large boulder of coal measure sandstone (not local) lay embedded in the base of the boulder-clay, and having lodged against its eastern end a large mass of Ardwick limestone derived from an outcrop to the westward. The upper surface of the sandstone boulder was scratched from N. 50° W. This stone had probably been dragged by land-ice across the limestone, and had torn off a mass which in a transit of 50 yards brought it to a stand, tearing it out of the ice which moved on and glaciated the upper surface of the boulder. Fragments of each formation were carried to eastward of the parent mass, but never to westwards. Several large erratics were observed and, with one exception, all had their long axes in approximately the same direction, viz.—a few degrees north of west. The exceptional direction was about N. 20° W.

The author is of opinion that the agreement between the direction of—(1) the boulder-transportal; (2) the intrusions of boulder-clay; (3) the orientation of large boulders; and (4) of ice-scratches upon rock-surface and the upper surfaces of boulders, constitutes proof of the action of land, and not floating, ice.

8. *The Lava Beds of California and Idaho, and their Relation to the Antiquity of Man.* By Professor G. FREDERICK WRIGHT, LL.D., F.G.S.A., Oberlin, Ohio, U.S.A.

A brief account was given of the extent of the basaltic beds on the Pacific Coast, and evidence was presented in proof that they were in the main of post-tertiary age.

New evidence, collected by Professor Wright and by Mr. Geo. F. Becker, was presented confirmatory of the genuineness of the Calaveras skull and other human remains reported upon by Professor Whitney as from under the lava flow of Table Mountain, near Sonora, California. Evidence was also presented of the discovery of a small clay image under the western edge of the lava plains of Idaho, at Nampa. These lava outbursts are correlated with the Glacial period in the eastern part of the continent.

9. *Report of the Committee on Excavations at Oldbury Hill.*
See Reports, p. 353.

10. *Preliminary Notes on the Excavations at Oldbury Hill.*
By JOSEPH PRESTWICH, D.C.L., F.R.S.

No rock-shelters like those in Central France have yet been discovered in this country. In France they occur in a cretaceous district, where the strata weather unequally, so that projecting ledges of rock are left over recesses worn out by natural agencies, and adapted by palæolithic man for his rude dwelling-places. Large numbers of flint and other implements, mixed with the *débris* of animals on which he fed, afford proofs of his habitation. Sites presenting somewhat similar adaptabilities occur on Oldbury Hill, near Ightham, in Kent. This hill rises above the level of the surrounding Lower Greensand to the height of 600 feet, and is capped by some of the hard siliceous grits of the Folkestone beds, which

form a flat top to it, 137 acres in extent. Its isolation and commanding position caused it to be chosen for the site of an encampment, first by the Britons and subsequently by the Romans. For the same reasons, it had attracted at an earlier date palæolithic man to the district, and he left a considerable number of his flint implements scattered around and on the slopes of the hill. This led Mr. Harrison and myself to suppose that the capping of rock, which was underlaid by loose friable sands, and overhung in places, might have afforded facilities for rock shelters; and for the purpose of inquiry Mr. Harrison undertook to direct the necessary search, aided by a grant from the British Association. The summit of the hill and much of the slopes are, however, so thickly wooded that it was with difficulty that a proper site could be fixed upon. The one that seemed to us and others most likely was on the north-east side of the hill, where a large mass of rock formed a low cliff with a small cavity beneath it. Excavations were accordingly commenced here, but the fallen blocks and the large roots of the adjacent trees so interfered with the work that, after digging to the depth of 2 to 3 feet without making any discovery, the spot had to be abandoned. It next occurred to Mr. Harrison that the talus, which extended for some distance on the slope in front of this ledge of rocks, might have carried with it some of the inhabited ground, or might have covered some of the original sites. He therefore proceeded to dig lower down the hill where the ground was undisturbed and free from large trees.

Here he was successful in finding, at a depth of about 3 feet, a considerable number of flint implements and a large quantity of chips and flakes, which look as though the implements had been made on the spot.

There is little to distinguish these implements from the ordinary valley-implements that are so common in the Ightham district, except that, on the whole, they are more carefully finished and of fewer forms. The prevailing forms at Oldbury are the small pointed lance-shaped implements worked on both sides, and the thin, neatly-worked, long, triangular, spear-shaped, of which there are some highly finished specimens. These are forms which occur at Le Moustier, as do likewise some of the ruder Oldbury forms. As also at Le Moustier, there is an absence so far of bone implements, so common in the other Dordogne shelters. Again, at Oldbury the more ordinary valley-types are wanting; and so also are rolled and worn specimens so frequent in other localities. The explorations, however, have been at present on too limited a scale to allow of any general conclusions being drawn. But as there are still other spots at Oldbury which are likely to have been used for rock-shelters, it is to be hoped that the work may be continued, and further information obtained. Mr. Harrison's Report, which gives the result of the work up to the present time, is both satisfactory and encouraging.

11. *Report of the Committee on Elbolton Cave, near Skipton.*
See Reports, p. 351.

TUESDAY, AUGUST 25.

The following Papers and Report were read:—

1. *On the Occurrence of Pachythecca and a Species of Nematophycus in the Silurian Beds at Tymawr Quarry, Runney.* By J. STORRIE.

For a long number of years I have been interested in the fossils known by these names, and for that purpose have collected and sectioned wherever practical all specimens likely to show structure, and the collection now submitted are the results.

In the Silurian beds exposed near Cardiff, which are over 900 feet in thickness, I have found *Pachythecca* in nearly every individual bed, from the very top of the

Ludlow to the bottom of the Wenlock series, and although *Nematophycus* has not occurred in so many beds or has escaped my notice, it has exactly the same range, as I have found it in the top of the Ludlow and at the base of the Wenlock and in a considerable number of intermediate beds; still it is only in two beds in Tymawr Quarry that I have found the two species in question preserved in a state which allowed of transparent sections being made. The lowest bed is a muddy sandstone, full of *Rhynchonella Stricklandi*, and the other being a thin parting on the top of the *Ctenodonta* sandstone of Sollas, and about 10 feet above the Rumney grit. The specimens from the last bed being much superior to the lower one, I will only deal with it.

This bed is only from 1 to 2 inches in thickness, and contains large numbers of *Discina rugata*, of *Lingula* two species and a large *Orbicula* with casts of branching Zoophytes of a species not known to me; it is wholly of a marine character, and at a point west-south-west becomes of a concretionary character, every little nodule of which when broken open shows a fragment, or a whole, *Lingula*, *Discina*, *Comularia*, or other shell; the whole bed is highly impregnated with iron, which rapidly oxidises when broken and exposed to the atmosphere, and the difficulty is to understand how perhaps the most mineralised bed of the section should contain the best preserved specimens of these organisms.

When preserved in mudstone the *Pachytheca* and *Nematophycus* do not display any minute structure, the form and general appearance being the only points to be recognised.

When preserved in limestone the carbonaceous character is most readily noticed, but the microscopic details are not very perfect; its resemblance to fragments of drift-wood is very striking to the naked eye or when a hand lens is used.

When preserved in concretionary nodules the outer wall is usually perfect, but the cellular structure of the interior is reduced to a pocket of carbonate of lime or oxide of iron.

There are undoubtedly two totally distinct organisms known at present as *Pachytheca spherica*; one of which is a perfectly spherical body, variable in size like the *Pachytheca* and like it consisting of a more compact outer layer and a less dense centre, but, however thin this is cut, it never contains any internal structure, showing only a chitinous-like appearance, with sometimes a fungous-like growth on the exterior; this, I think, is no doubt the egg of a crustacean, more especially as *Pterogotus* has been found in this quarry and in a section of the same beds. Yesterday, a member picked up a specimen which may likely turn out to be a fragment of *Slimonia*.

Pachytheca may be described as a thick-walled globular rind of tubular tissue, with small intertubular spaces enclosing a small cavity of much looser and more branched tissue, coral-like in appearance, which is in continuous structural connection with the radiating thick-walled, slightly branched and rather densely packed tubes of the exterior, the intertubular spaces in the exterior portion, as seen in transverse section, being small in comparison with the intertubular spaces found in *Nematophycus*. I have examined large numbers of *Pachytheca* to see whether any hilum or point of attachment was present, and have never seen any indication either on the external wall or in the internal structure of any such as might be reasonably expected to show some differentiation, were there any ground for believing that it was either a fruit of a conifer, or the conceptacle or even one of the floats of a seaweed like *sargassum* or *fucus*.

Nematophycus occurs principally in small fragments, waterworn and irregular in shape and never over an inch in length, and in only one specimen have I found any appearance of branching; in this case it was a small stem from the *Discina* bed about $\frac{1}{4}$ -inch in diameter, rather oval in section and with one branch of barely $\frac{1}{8}$ -inch diameter and a $\frac{1}{4}$ -inch long, which was again forked at the extremity, the branchlets being about $\frac{1}{16}$ -inch in length and nearly the same in thickness. The tissue of the outer part of the stem was slightly differentiated from the interior, but essentially the structure was the same, and the apparent difference may have been more dependent on the different degree of oxidisation of the iron in the weathering of the fossil than any bark-like difference of structure.

This good piece had no external symmetrical markings visible to the naked eye, but there are two small depressions similar to the scar of a dicotyledon at the articulation of a branch and slight indications of a coleorrhiza, as shown in the section exhibited, and this shows the tissue departing from its normally perpendicular position, and becoming more horizontal as it nears the depression, and bending round and running straight towards the scar; this would indicate that a branch had died off and that the stem increased in size after the death of the branch.

One peculiar thing about the woody tubes is that they are frequently penetrated by the mycelium of a fungoid growth, and in some cases the resting spore of from twenty to thirty cells is fully formed and appears exactly like a minute blackberry in the interior of the woody tubes.

The structure of *Nematophycus* may be described as a mass of endless tubes as far as can be seen in our local specimens, and each individual tube when examined with the $\frac{1}{16}$ power seems to be composed of a very delicate wickerwork of interlaced fibrillæ with polygonal interspaces and bearing no resemblance to the structure of any coniferous wood, sections of several hundreds of which I have cut and examined from the local beds, at Pwllpant, Caerphilly, &c.

The structure of the stem of *Nematophycus* is generically, if not specifically, identical with that described by Mr. Carruthers from the Canadian Devonian series as *Nematophycus Loganii*, except that the main tubes are only of about half the size, and the secondary series of tubes, so well seen in the American specimens, is very much less prominent in our local specimens, and the coniferous glandular markings of Dawson are seen to be the resting spores of the fungus before mentioned.

The *Nematophycus* found at Rumney differs also from the Canadian specimens, in that they show no trace of the concentric rings or the true or apparent medullary rays referred to by Dawson.

One curious circumstance is that both *Nematophycus* and *Pachythecca* are preserved without any appearance of flattening in beds in which the pressure has crushed flat and distorted greatly such firm and solid shells as *Discina rugata*, *Rhynchonella Stricklandi*, and *Conularia*, which would show that if they were of an algæ-like nature they must have had a power during their life of secreting mineral matter like certain algæ in Devonport Harbour.

2. Report of the Committee on the Iias of Northamptonshire.

See Reports, p. 334.

3. The Mastodon and Mammoth in Ontario, Canada.

By Prof. J. HOYES PANTON, M.A., F.G.S.

The writer in this paper gives a complete description of the remains of a mastodon discovered (1890) in a marl-bed near Highgate, in the Province of Ontario, Canada, and also the remains of a mammoth found under similar conditions near Shelburne in the same Province (1889).

Both specimens were discovered by John Jelly, Esq., of Shelburne. The following measurements are given for comparison:—

	Jumbo	Newburg Mastodon ¹	Highgate Mastodon
Longest rib	44 inches .	54 $\frac{3}{4}$	55 $\frac{1}{2}$
Humerus	36 " .	39 .	40
Radius	— " .	29 .	34
Femur	42 " .	39 .	47 $\frac{1}{2}$
Tibia	— " .	28 .	29
Tusk	— " .	10 $\frac{1}{2}$.	92 not complete.
Third spinous process .	15 " .	23 $\frac{1}{2}$	23 $\frac{3}{4}$

¹ The Newburg mastodon is one of the finest ever discovered in America. The bones are in a most excellent state of preservation, and sufficient have been obtained to enable the skeleton to be set up.

The bones obtained of the mammoth are not so numerous, the chief being thirty-one ribs, one 50 inches in length and 11 in circumference; several vertebræ, some 14½ inches across; a massive tusk 12¾ feet with a portion broken off; and a tooth weighing 16¾ lbs. The writer also refers to remains of Proboscoidea found at other points in Ontario, viz., St. Catharine's, Dunnville, Goat Island, Niagara Falls, and Kimbal, near the western side of the province.

4. *Note on the occurrence of Ammonites jurensis in the Ironstone of the Northampton Sands, in the neighbourhood of Northampton.* By E. T. NEWTON, F.G.S., F.Z.S.

This paper records the discovery, by Mr. Thomas Jesson, of *Ammonites jurensis* in the ironstone of the Northampton Sands at Brixworth, near Northampton. A considerable number of fossils were collected, most of which were referable to *Am. jurensis* and *Am. opalinus*; but with these were also found *Am. insignis*, *Am. Murchisonæ*, *Nautilus*, *Belemnites*, *Trigonia compta*, *Trigonia V. scripta*, and *Tancredia*.

5. *On certain Ammonite-zones of Dorset and Somerset.*
By S. S. BUCKMAN, F.G.S., Hon. Memb. Yorks. Phil. Soc.

The lower part of the *Murchisonæ*-zone is often intimately connected with the upper part of the *Opalinum*-zone; but, a little higher, there is a horizon characterised by numerous specimens of *Ludwigia Murchisonæ*. The fauna of this horizon corresponds to the *Murchisonæ*-zone of Opper, and to the Brauner Jura β of Quenstedt. Above the *Murchisonæ*-zone a considerable break in the sequence of strata is frequently met with. In the neighbourhood of Bradford Abbas, however, is found, superior to the *Murchisonæ*-zone, a horizon marked by a very peculiar fauna, in which *Lioceras concavum* and species of the genus *Sonninia* predominate. Taken in a general sense the fauna of this zone (*Concavum*-zone) does not agree with that of Quenstedt's Brauner Jura β or γ , or with that of the *Sowerbyi*-zone, as illustrated by Waagen, Douvillé, &c. Further, the *Sonninæ* of the *Concavum*-zone are, biologically, of an earlier type than those of the *Sowerbyi*-zone.

Continental authors find a marked stratigraphical and palæontological break between the *Murchisonæ*- and *Sowerbyi*-zones; and they wish to draw, at this point, a dividing line between Lias and Oolite, or between Toarcian and Bajocian. It is suggested that the absence of the *Concavum*-zone is the cause of this break; and, in former papers to the Geological Society, the author, in supporting the Continental plan, regarded the *Concavum*-zone as Toarcian.

In the Bradford Abbas district there is a break above the *Concavum*-zone. So far as is known at present, Dundry is the only locality showing a complete sequence; but some years ago a quarry—Coombe, near Sherborne—was open, and it yielded a large series of Ammonites indicating a fauna agreeing with the *Sowerbyi*-zone, as illustrated by Continental authors. This quarry has been closed for years; and nothing is known as to how the strata are situated with regard to the *Concavum*-zone below, or with superior horizons. It is richer than Dundry, and is, practically speaking, unique among Inferior-Oolite exposures. It is the only locality in England which yields this particular fauna. So far as is known, the true *Sowerbyi*-zone is absent from all quarries in Dorset and Somerset, with the exception of Coombe and Dundry; and, therefore, the majority of exposures in the district fully support the Continental geologists in their contention as regards a dividing line.

Waagen places a zone of *Am. Sauzei* above the *Sowerbyi*-zone; and a horizon with this species and with a particular fauna is shown in 'the marl with green grains' at Frogden quarry, near Sherborne.

Above this is the zone of *Am. Humphriesianus*, in which *Stephanoceras* and *Sphæroceras* predominate. This is the equivalent of the *Coronaten-schichten* of Quenstedt's Brauner Jura δ . The upper part of the Brauner Jura δ is the *Bifurcaten-schichten*; and this corresponds with the *Cadomensis*-beds of Frogden—a

horizon which, containing a fauna distinct from the *Humphriesianus*-zone, may therefore be known as the *Cadomensis*-zone.

The strata above this horizon have usually been called 'Parkinsoni-zone.' There are several objections to this name; and the strata are capable of more subdivision.

The bed at Halfway House, which yields the large *Parkinsonia*, is superior to the *Cadomensis*-zone. It may be called the *Truelli*-zone. At the top of the limestone of the Broad-Windsor district *Stephan. zigzag*, and species of *Morphoceras* are found: and this is a still higher horizon (*Zigzag*-zone). Just below the Fullers' Earth of this same district, in the Fullers' Earth itself of Eype, but in the upper white limestones (about 25 feet thick) of the Bradford-Abbas district, are found *Oppelia fusca* and other species indicating a still higher horizon. It is suggested that the white limestone of the Bradford-Abbas district is contemporaneous with the so-called 'Fullers' Earth clay' of Eype. This horizon may be called the zone of *Oppelia fusca*; and whether this zone belongs to the Inferior Oolite or to the Fullers' Earth depends on whether the observer be regarding the limestones of the Bradford-Abbas district or the clay of Eype cliff.

Several Continental geologists, however, commence the Bathonian with the *Cadomensis*-zone. To this idea the presence of *Parkinsonia* and other facts give considerable support.

6. Notes on the Polyzoa (Bryozoa) of the Zones of the Upper Chalk.

By GEORGE ROBERT VINE.

In the year 1867, in a paper on the Lincolnshire Wolds,¹ Professor Judd remarked that 'the time has not yet come for separating the great mass of the chalk-formation in this country into zones characterised by their peculiar assemblages of organic life. Indeed, such a task has not yet been accomplished in the case of the best-explored districts of the chalk, except in a very imperfect manner.' Since these sentences were written the task has been attempted, and to some extent accomplished, but much still remains to be done by specialists. The present paper, however, deals with the polyzoa only, and with those of the Upper Chalk particularly.

In 1870, Mr. C. Evans² gave a section of the Surrey Hills from Croydon, through the North Downs to Oxted, in which he shows the following succession for the Upper Chalk:—

250 feet.	{	Zone with <i>Micraster-cor-anguinum</i>	Purley beds.
		" " " " <i>testudinarium</i>	Riddlesdown beds.
		" " <i>Holaster planus</i>	Kenley beds.

In 1875, Dr. Charles Barrois, in his 'Geology of the Isle of Wight,' established four paleontological divisions of the Upper Chalk, based on the stratigraphical divisions of Bristow, Ibbetson, and Whitaker:—

Zone with <i>Belemnitella mucronata</i>	Feet.
" " <i>Micraster-cor-anguinum</i>	265
" " <i>cor-testudinarium</i>	525
" " <i>Holaster planus</i>	165
	65

In the neighbourhood of Margate we have, according to Whitaker and others, the following:—

Zone of <i>Micraster-cor-anguinum</i>	Margate.
" " <i>cor-testudinarium</i>	Ramsgate, &c.
" <i>Holaster planus</i>	St. Margaret.

In Buckinghamshire and Cambridgeshire only the base of the Upper Chalk is represented:—

Zone of <i>Micraster-cor-bovis</i>	Upper Chalk with flints.
--	--------------------------

¹ *Quart. Journ. Geol. Soc.* vol. xxiii. p. 235.

² *Proc. Geol. Assoc.* for 1870.

Whilst in Yorkshire the following zonal divisions are recognised by Professor Prestwich :—

500 feet.	{	Zone of <i>Belemnitella mucronata</i>	}	Chalk without flints.
		„ <i>Marsupites (testudinarius)</i> and sponges		Chalk with flints.
		„ <i>Micraster-cor-anguinum</i>		

‘The typical white chalk,’ says Professor Prestwich,¹ ‘extends from England through the North of France, South Belgium, East Holland, Westphalia, Hanover, Denmark, South Sweden, the coast of Pomerania, Poland, Silesia, Russia; then in one direction to the Crimea, and in the other, with intervals, to the south of the Ural Mountains. The pure earthy white chalk is not found outside these districts.’

By way of comparison it will be necessary to select, as a type section of the Upper Chalk in France, the petrological zones of M. A. d’Orbigny, which, according to Professor Hébert, may be tabulated as follows :—

Zone of <i>Belemnitella mucronata</i>	Meudon, Epernay.
„ „ <i>quadrata</i>	„ „ „
„ <i>Micraster-cor-anguinum</i>	Chalk Cliffs east of Dieppe.
„ „ <i>cor-testudinarium</i>	„ „ west of Dieppe.

The most typical zonal succession of the Upper Chalk known to me is found in the neighbourhood of Salisbury, and from this district I have examined a mass of well-preserved polyzoa, which had been collected by Dr. Blackmore and his friends; and it will be more convenient for me to work the other horizons by reference to this :

	Feet.
A. Zone of <i>Belemnitella mucronata</i>	about 100
B. „ „ <i>quadrata</i>	100
C. „ „ <i>Marsupites testudinarius</i> and <i>Holaster pilula</i>	150
D. „ „ <i>Micraster-cor-anguinum</i>	100
E. „ „ „ <i>testudinarium</i>	50

The *Belemnitella quadrata* zone is largely developed at Salisbury because it is worked for the manufacture of whiting, and I think we may take the collection of Dr. Blackmore, derived from this particular zone, as fairly representative of the forms of the horizon. The other zones have yielded a fair proportion of the forms submitted to me for examination, some of which are quite new to the British Upper Chalk, or new altogether. From the neighbourhoods of Gravesend and Chatham I have also a fine series of polyzoa, many examples of which are free from the matrix, while others—and these are some of the best of the forms—are attached to flints; details, however, of the species could not be given in this brief abstract of my contemplated work.

It was while collecting information for a full description of the polyzoa of the whole of the cretaceous rocks, that my attention was drawn to certain peculiarities of the fossils under consideration, and which seemed to me to separate the polyzoa of one bed from that of another; but though the species from one bed were not, on the whole, widely divergent in character, the *facies* of allied forms generally was well marked, or at least peculiar. These divergencies, therefore, I do think merit something more than a mere passing notice.

Of course, in giving specific or varietal details of our British cretaceous polyzoa it will be necessary to work along lines so ably planned and utilised by M. A. d’Orbigny in his palæontological studies, but any slavish adherence to his plan of characterising, or even of classifying species, would retard rather than advance our knowledge of the zonal distribution of the polyzoa. Let any one, however, who is at all acquainted with the polyzoa of the cretaceous formation, select and carefully study the species belonging to various genera characterised by the specific name *Meudonensis* d’Orb. or *Parisiensis* d’Orb., and he will soon find when correlating British forms bearing somewhat similar characters to the species

¹ *Geology*, vol. ii. 1883, for Cretaceous zones generally, pp. 299-306.

referred to, the value of the contemplated zonal divisions. I cannot say that I shall be completely successful in my labours, but I may be able to lay foundations on which some one, far more competent than myself, may build advantageously at least. If, however, I take two or three well-marked types of polyzoa I shall be able to explain my meaning better.

In 1864 Ignaz Beissel¹ described and illustrated a peculiar species of *Entalophora*, which, on account of the delicate markings on the surface of the zoarium, he named *E. lineata*, from the chalk marl of Friedrichsburg. The species was found in three different localities, and is marked 'rare.' When working out my Cambridge Greensand material² I found that one species in particular was rather abundant, and, not having at the time any knowledge of Beissel's description or species, I named the Greensand form *Entalophora striatopora*, Vine.³ In 1874 Dr. Reuss described and illustrated two species from the Quader Sandstone of Strehlen, which he called *Entalophora lineata* Beiss., and *Filisparsa ornata* Reuss, both of which are marked 'rare.' Two years before Reuss, in 1872, Stoleczka, in his 'Palæontologica Indica' (iv. 2, The Ciliopoda), also described *E. lineata* from the 'Arria loor gruppe bei Yermamoor in Ostandien.' In 1887, however, Dr. Marsson³ introduced a new genus, *Clinopora*, for the inclusion of Beissel's species, and also a new species in some respects similar to *E. striatopora* Vine, but not so coarsely marked on the surface. These are:

Clinopora costulata, Marsson (Op. cit. p. 24, pl. II. fig. 2)
 ,, *lineata*, Beissel (id. ,, ,, ,, 3)

After submitting examples of my own species to Dr. Pergens, of Belgium, he expressed the opinion that as the Cambridge Greensand form was the same as *Clinopora costulata*, by right of priority the Rügen form should be characterised as *Clinopora striatopora* Vine. For reasons which could be easily given I should prefer to retain my own name, as given in the last British Association Report,⁴ as *Entalophora lineata* Beissel, Var. *striatopora* Vine.

There is still another very characteristic polyzoon found in the Cambridge Greensand, and also in the chalk marl material from Charing, though not previously recorded by me. This is the *Eschara tenuis*, Hag.,⁵ or the *Epidictyon tenue*, Marsson.⁶ The species is rare everywhere. Marsson records it from Upper Turonian and Middle Senonian, Rügen, but it is present also in the English Chalk of Salisbury (but rare), in the *Belemnitella mucronata* zone. The same species is recorded by Reuss from the marl-beds of the Quader Sandstone of Saxony as *Lanceopora striolata* Reuss.⁷ In the Cambridge Greensand the examples are very strongly marked on the surface.

In the Rügen example, and also in the Salisbury example, the surface lines are distinct but faint, and, like *Entalophora lineata* and its varieties, the *facies* of the various examples indicate, to some extent, the horizon from which they have been derived.

The presence of "Cretaceous" polyzoa in the Miocene rocks of Australia may at first seem to upset the usefulness of any attempt to fix the zonal distribution of species. I possess a slide containing examples of all the *Vincularia* species described by Mr. A. W. Waters in his first paper on the Australian Bryozoa,⁸ (from Yarra-Yarra, Victoria), but I am not able to deal with these forms in this abstract; their presence in Australian rocks may be easily accounted for when we remember that both in Australia and New Zealand, according to Prestwich,⁹ there is a considerable development of Cretaceous or Cretaceous-Tertiary strata.

¹ *Die Bryozoen der Aachner Kreidebildung*, p. 80, Tab. IX. figs. 116-119, 1865.

² *Proc. Yorksh. Geol. Soc.* vol. ix. p. 6, pl. I. fig. 5, and *Ibid.* vol. xi. pp. 250-275.

³ *Die Bryoz. der Weissen Schreieckreide der Insel Rügen*, p. 24, &c. 1887.

⁴ *Brit. Assoc. Reports*, 1890-91, p. 389.

⁵ *L.c. Nachtrag*, p. 645.

⁶ *Op. cit.* p. 17, Tab. I. fig. 4.

⁷ Reuss in Geinitz, *Elbthalgebirge*, ii. 1874, p. 130, Tab. XXIV. figs. 17, 18.

⁸ *Quart. Journ. Geol. Soc.* vol. xxxvii. p. 309-347, Pl. XIV.

⁹ *Geology*, vol. ii. p. 308.

In his latest paper, however, Mr. Waters,¹ after reviewing Mr. Ulrich's work on the Palæozoic Bryozoa² of America, remarks (p. 53): 'I would urge the importance of a thorough comparison of Palæozoic with Cretaceous genera, for the number of known Cretaceous genera is very large, and with these and the present fauna comparison can be made, thus giving the best stepping-stone between the rich carboniferous fauna and the recent.' Such a comparison would be of great value to the palæontologist, but the comparison must be made with actual examples of the fauna from the several formations, and not with figures or mere descriptions of the same. During the last twenty years some thousands of examples from all formations have passed through my hands, and possibly some light could be thrown upon the question indicated by Mr. Waters, but ample space and special illustrations are necessary to do the work well.

¹ *Ann. Mag. Nat. Hist. s. t.* vol. viii. p. 53, July 1891.

² *Geology and Palæontology*, vol. viii. Geol. Survey, Illinois, 1890.

SECTION D.—BIOLOGY.

PRESIDENT OF THE SECTION—FRANCIS DARWIN, M.A., M.B., F.R.S.

THURSDAY, AUGUST 20.

The PRESIDENT delivered the following Address:—

On Growth-curvatures in Plants.

A SEEDLING plant, such as a young sunflower when growing in a state of nature, grows straight up towards the open sky, while its main root grows straight down towards the centre of the earth. When it is artificially displaced, for instance, by laying the flower-pot on its side, both root and stem execute certain curvatures by which they reach the vertical once more. Curvatures such as these, whether executed in relation to light, gravitation, or other influences, may be grouped together as growth-curvatures, and it is with the history of our knowledge on this subject that I shall be occupied to-day. I shall principally deal with geotropic curvatures, or those executed in relation to gravitation, but the phenomena in question form a natural group, and it will be necessary to refer to heliotropism and, indeed, to other growth-curvatures. The history of the subject divides into two branches, which it will be convenient to study separately.

When a displaced apogeotropic organ curves so as to become once more vertical, two distinct questions arise, which may be briefly expressed thus:—

1. How does the plant recognise the vertical line; how does it know where the centre of the earth is?
2. In what way are the curvatures which bring it into the vertical line executed?

The first is a question of irritability, the second of the mechanism of movement. Sachs has well pointed out that these two very different questions have been confused together.¹ They should be kept as distinct as the kindred questions how, by what nervous apparatus, does an animal perceive changes in the external world; and how, by what muscular machinery, does it move in relation to such changes?

The history of our modern knowledge of geotropism may conveniently begin with Hofmeister's researches, because in an account of his work some of the points which re-occur in recent controversy are touched, and also because in studying his work the necessity of dividing the subject into the two above-named headings, Irritability and Mechanism will be more clearly perceived.

In 1859² Hofmeister published his researches on the effect of disturbance, such as shaking or striking a turgescent shoot. This appears at first sight sufficiently remote from the study of geotropism, but the facts published in this work were the basis of the theory of geotropism formed by Hofmeister and accepted with some modification by Sachs. When an upright, vigorously-growing, turgescent shoot is struck at its base the upper end is made to curve violently towards the

¹ *Arbeiten*, ii. p. 282 (1879).

² Hofmeister, *Berichte d. k. Sächs. Ges. d. Wiss.*, 1859.

side from which the blow came. When the shoot comes to rest it is found to be no longer straight, but to have acquired a permanent bend towards the side on which it was struck. In explaining this phenomenon Hofmeister described those conditions of growth which give rise to what is known as the tension of tissues: these facts are still an important part of botanical study, though they hold quite a different position from that assigned to them by Hofmeister. The classification into active or erectile tissue and passively extended tissue was then first made. The pith, which is compressed, and strives to become longer, is the active or erectile part, the cortical and vascular constituents being passively extended by the active tissue. Hofmeister showed that when the shoot is violently bent the elasticity of the passive tissues on the convex side is injured by overstretching. The system must assume a new position of equilibrium; the passive tissues are now no longer equally resisting on the two sides, and the shoot must necessarily assume a curvature towards that side on which passive tissues are most resisting.

In a second paper, in 1860, Hofmeister¹ applied these principles to the explanation of geotropism. It is true that in his second paper he does not refer to the former one, but I think that it can hardly be doubted that the knowledge which supplied the material for his paper of 1859 suggested the theory set forth in 1860. He had shown that in the system of tensions existing in a turgescent shoot lay the power of producing artificial curvatures, and he applied the same principle to the natural curvatures. When an apogeotropic organ is placed in a horizontal position Hofmeister² supposed that the resisting tissues on the lower side became less resisting, so that they yielded more readily than those on the upper side to the longitudinal pressure of the turgescent pith. The system in such a case comes to rest in a new position, the shoot curving upwards; the passive tissues on the upper and lower sides once more resist the expansion of the pith in equal degrees. In this way Hofmeister hit on an explanation which, as far as mechanism is concerned, is in rough outline practically the same as certain modern theories, which will be discussed in the sequel.

His views resembled more modern theories in this, too: he clearly recognised that they were, *mutatis mutandis*, applicable to acellular³ organs. The manner in which Hofmeister compared the mechanics of multicellular and acellular parts was curious; nowadays we compare the turgescent pith of a growing shoot with the hydrostatic pressure inside the acellular organ. Just as the pressure inside a single cell stretches the cell-walls, so in a growing shoot the turgescent pith stretches the cortex. As pith is to cortex, so is cell-pressure to cell-membrane. But Hofmeister would not have accepted any such comparison. In the case of acellular organs he localised both the erectile and passive tissues in the membrane. The cuticle was said to be passively extended by the active growth of the inner layers of the cell-wall.

It is remarkable that the obvious source of power which the pressure of the cell-sap against the cell-walls supplies should have been so much neglected. This may perhaps be accounted for as a revulsion against the excessive prominence given to osmosis in the works of Dutrochet.

The great fault of Hofmeister's views was the purely mechanical manner in which he believed changes in extensibility in the passive tissues to be brought about. When an apogeotropic shoot is placed horizontal there would be a tendency, according to Hofmeister, for the resisting passive tissues along the lower side of the shoot to become waterlogged owing to the fluid in the shoot gravitating towards that side. They would thus be rendered more extensible, and the shoot would bend up, since its lower parts would yield to the erectile tissues in the centre. Such a conception excludes the idea of gravitation acting as a stimulus, and tends to keep geotropism out of the category in which it now takes its place

¹ Hofmeister, *Berichte d. k. Sächs. Ges. d. Wiss.* 1860.

² Knight had previously suggested an explanation (*Philosophical Transactions*, 1806), which is so far similar, that the sinking downwards by gravitation of the juices of the plant is supposed to be the primary cause of apogeotropism. Knight's explanation of positive geotropism is practically the same as Hofmeister's.

³ Sachs' term *acellular* is, in the present connection, equivalent to *unicellular*.

along with such obvious cases of response to stimulation as the movements of *Mimosa*. In this respect it was a retrogression from the views of some earlier writers. Dutrochet's clear statement (1824) as to growth-curvatures being an affair of stimulus and response will be quoted lower down. Treviranus in his 'Physiologie' (1838) speaks of geotropism as a *Trieb*, or impulse, and adds that though there is no question of desire or sensation as in the impulses of animals, yet geotropism must be thought of as something higher than a merely mechanical or chemical action.

In taking such a view Hofmeister naturally neglected the biological side of the study of geotropism. Now we think of gravitation as a stimulus, which the plant translates according to its needs. The plant, so to speak, knows where the centre of the earth is, and either grows away from it, or towards it, according as either direction suits its mode of existence.

We have seen how Hofmeister's view enabled him to apply a common explanation to acellular and multicellular organisms. But it led him into an error which more than counterbalances the credit due to such a generalisation, namely, into separating what are now universally considered parts of a single phenomenon—viz., negative and positive geotropism. He gave totally different explanations of the bending down of a root and the bending up of a stem. It is well known that he supposed a root to be plastic, and to bend over by its own weight, like a tallow candle on a hot day or a piece of heated sealing-wax.

The development of a unified view of heliotropism, geotropism, and other similar curvatures is a part of my subject, and for that reason the curious want of unity in Hofmeister's views is interesting.

In 1865 Sachs published his 'Experimental-Physiologie.' He here accepts Hofmeister's views with certain modifications.

Irritability.

When by a touch on a trigger the explosion of a pistol is caused we do not say that the pistol is irritable, but when in an organism a similar release of stored-up energy occurs we apply the term *irritability* to the phenomenon, and we call the influence which produced the change a stimulus. At this time (1865) there was, as far as I can discover, no idea that growth-curvatures were produced by external influences acting as stimuli. Gravitation and light were supposed to act directly, and not as releasing forces. This is all the more remarkable, because Dutrochet¹ had expressed with great clearness the conception which we now hold. He wrote:—'La cause inconnue de l'attraction n'est que la cause occasionelle du mouvement descendant des racines et de l'ascension des tiges; elle n'en est point la cause immédiate; elle agit dans cette circonstance comme agent nervimoteur. Nous verrons plus bas de nouvelles preuves de la généralité de ce fait important en physiologie, savoir que les mouvements visibles des végétaux sont tous des mouvements *spontanés*, exécutés à l'occasion de l'influence d'un agent extérieur et non des mouvements imprimés par cet agent.' Nothing could be more to the purpose than this, and it is one of the most curious points in the history of the subject that the botanical mind should have taken more than fifty years to assimilate Dutrochet's view.

In 1868 Albert Bernhard Frank published his valuable 'Beiträge zur Pflanzenphysiologie,' which was of importance in more than one way. In this work the term 'geotropism' was first suggested in imitation of the existing expression 'heliotropism.' This uniformity of nomenclature had an advantage beyond mere convenience, for it served to emphasise the view that the curvatures were allied in character. His criticisms of Hofmeister and Sachs were directed against the following views:—(i.) That roots and other positively geotropic organs bend owing to plasticity. By repeating and varying certain older experiments, Frank helped materially to establish the now universally accepted view that positive

¹ *Recherches anat. sur la Structure intime*, &c. 1824, p. 107. Dutrochet, however, was not consistent in this matter, and later on gave explanations as mechanical as Hofmeister's.

geotropism is an active, not a passive, curvature, and that it depends, like apogeotropism, on unequal distribution of longitudinal growth. Here, again, he introduced unity, bringing what had been considered different phenomena under a common heading. By studying the distribution of growth and of tension in a variety of curvatures he helped still more to unite them under a common point of view.

(ii.) He showed that Hofmeister's classification of organs into those (1) which have and (2) which have not tension, was valueless in connection with growth-curvatures; that is to say that apogeotropism is not necessarily connected with the form of longitudinal tension found in growing shoots, and that the distinct kind of tension existing in roots has no connection with their positive geotropism. His work thus served to bring the subject into a more purely physiological condition, not only by his downright opposition to a mechanical theory backed by the great name of Hofmeister, but also by giving importance to physiological individuality.

In 1870 Frank published a more important work, 'Die natürliche wagerechte Richtung der Pflanzentheilen.' This paper not only tended to unite geotropism and heliotropism by proving the phenomena described to be common to both categories, but it more especially widened the field of view by showing that horizontal growth must be considered as kindred to vertical growth, and thus introduced a new conception of the reaction of plants to light and gravitation which has been most fruitful.

Frank showed that certain parts of plants, for instance the runners of the strawberries, even when kept in the dark, grow horizontally, and when displaced from the horizontal returned to it. Here, said Frank, is a new type of geotropism, neither positive nor negative, but *transverse*. Ten years later Elfving,¹ working in Sachs' laboratory, got similar results with rhizomes of *Scirpus*, &c. These experiments are more conclusive than Frank's in one way, because the strawberry runners when darkened were in abnormal conditions, whereas the rhizomes used by Elfving were normally freed from light-effects. When a rhizome which has been placed so as to point obliquely upwards moves down towards the horizontal position it is, according to the old nomenclature, positively geotropic, and, *vice versa*, when it reaches the horizontal from below it is negatively geotropic. But it cannot be both positively and negatively geotropic. We are bound to assume that it is so organised that it can only assume a position of rest, and continue to grow in a straight line when it is horizontal, just as an ordinary geotropic organ cannot devote itself to rectilinear growth unless it is vertical. In this way Frank's conception of transverse geotropism paved the way for the theory that there are a variety of different organisations (or, as we may now say, irritabilities) in growing plants; and that, whether a plant grows vertically upwards or downwards or horizontally, depends on the individual and highly sensitive constitution of the plant in question. It is, of course, true that those who seek for mechanical explanations of growth curvatures might be able to find such a one for transverse geotropism. But when Frank's conception has once been seized such views are less and less acceptable; and, judging from my own experience, I cannot doubt that Frank's work deserved to have a powerful effect in preparing the minds of physiologists for a just view of irritability.

The belief in transverse geotropism received interesting support from Vöchting's² work on the movement of certain flowers which retain a horizontal position under the influence of gravitation.

Frank's views, it may be added, were accepted by my father and myself in our 'Power of Movement,' in which the term diageotropism was proposed, and has been generally accepted, for transverse geotropism. Nevertheless, though Frank was undoubtedly right, his views were strongly opposed at the time. He held similar views on the effect of light, believing that the power possessed by leaves of placing themselves at right angles to the direction of incident light must be considered as a new type of heliotropic movement, transverse or diaheliotropism. Frank's views were criticised and opposed by De Vries,³ who, by means of experi-

¹ Elfving, Sachs' *Arbeiten*, 1880. ² *Die Bewegung der Blüten und Früchte*, 1882.

³ De Vries, Sachs' *Arbeiten*, 1872.

ments carried out in the Würzburg laboratory, tried to show that Frank's results can be explained without having resort to new types of geo- or heliotropism. De Vries believed, for instance, that a leaf may be apheliotropic and apogeotropic, and that its horizontal position under vertical illumination is due to a balance struck between the opposing tendencies, one of which calls forth an upward, the other a downward curvature.

The same point of view occurs again in Sachs' paper on 'Orthotrope and Plagiotrope Plant-members.'¹ Sachs holds to the opinion that Frank's theory is untenable, that it is upset by De Vries, and that the oblique or horizontal position is to be explained as the result of a balance between opposing tendencies.

In a paper published the following year (1880)² I attempted to decide between the opposing views. My experiments proved that at least certain leaves can place themselves at right angles to the direction of incident light when there is no possibility of a balance being struck. The outcome of my experiments was to convince me that Frank's views are correct, namely, that the quality of growth called transverse heliotropism does exist.

This view was accepted by my father in the 'Power of Movement.' The conclusions of Vöchting, in the 'Bot. Zeitung,' 1888, and Krabbe in Pringsheim's 'Jahrbücher,' 1889, vol. xx. are on the same side of the question.

The general result of these confirmations of Frank's conception has been to bring to the front a belief in the individuality of the plant in deciding what shall be the effect of external conditions. Such a view does not necessarily imply irritability in a strict sense, for Frank himself explained the facts, as we shall see, in a different way. But it could not fail to open our eyes to the fact that in growth-curvatures as in other relations to environment external changes are effective as guides or sign-posts, not as direct causes.

Frank saw clearly that plants may gain such various aptitudes for reacting to light and gravitation as best suit their modes of life.

In stating this view he refers to the influence of the 'Origin of Species,' which had shown how any qualities useful to living things might be developed by natural selection. Frank described the qualities thus gained under the term *polarity*. He supposed that the cell-membranes of a transversely heliotropic leaf (for instance) were so endowed that a ray of light striking it obliquely from base to apex produced an increase of growth on the side away from the light: while a ray oblique from apex to base caused a reverse movement. The polarity-assumption of Frank is a purely gratuitous one, and, if strictly interpreted, hardly tends to bring growth curvatures into harmony with what we know of the relation of life to environment.

It will no doubt appear to be a forcing of evidence if, after such a statement as the last, I still claim for Frank that he led the way to our modern view of irritability. I can of course only judge of the effect of his writings on myself, and I feel sure that they prepared me to accept the modern views. It must also be insisted that Frank, in spite of his assumption of polarity, seems to have looked at the phenomena in a manner not very different to ours of the present day. Thus he compares the action of gravitation on plants to the influence of the perception of food on a chicken. He speaks too of custom,³ or use, building up the specialised 'instinct' for certain curvatures. These are expressions consistent with our present views, and I think that Vines⁴ is perfectly just in speaking of Frank's belief in different kinds of irritability, although in so judging he may perhaps have followed equity rather than law.

One of the chief bars to the development of our present views on irritability was the fact that simple growth in length is influenced, and markedly influenced, by differences in illumination. Plants grow more quickly, *ceteris paribus*, in darkness than in light. With this fact to go on, it was perfectly natural that simple mechanical explanations of heliotropism should be made. De Candolle, as is well known, explained such curvatures by the more rapid growth of the shaded side. Thus it came about that heliotropism was discussed, for instance, in Sachs'

¹ Sachs' *Arbeiten*, 1879.

² *Journal Linn. Soc.* 1880.

³ *Loc. cit.* p. 91.

⁴ Vines' *Physiology*.

'Text-Book,' edit. 4, 1874, under the same heading as the influence of light on rectilinear growth.

Shortly afterwards, in 1876, a pupil of Sachs, Müller-Thurgau, published¹ a research carried out in the Würzburg Laboratory, which is of some importance. In the introductory remarks he wrote:—'It has been hitherto supposed that heliotropic curvatures depend on a difference in intensity of illumination on the two sides. Sachs came to a different opinion in his work on geotropism: he found himself compelled to believe that in heliotropic just as in geotropic curvatures it is not a question of different intensities on opposite sides, but rather that heliotropic effect depends on the direction of the light.'²

Müller's research gave weight to this union of geo- and heliotropic effects by showing a number of resemblances in the manner and form of the two curvatures. Again, when it was found³ that apheliotropic organs are influenced by light and darkness in precisely the same manner as positively heliotropic ones, it became clear that the mechanical explanation of De Candolle was untenable for negatively heliotropic organs. It might still no doubt be upheld for positively heliotropic organs, but as a matter of fact it was not so upheld. There was a tendency to unify our view of growth-curvatures, and the union of the two forms of heliotropism gave strength to the movement. Nor was this all; when it became clear that light did not produce heliotropic curvatures by direct mechanical effect it was natural to remember that gravitation has none either; we cannot point to any reason (except the crudest ones) why the lower side of a horizontal stem, or the upper side of a horizontal root, should grow the faster for the direct effects of gravitation. That being so, light and gravitation could be classed together as external agencies acting, not directly, but in some unknown indirect manner. I do not imply that such a result followed immediately, but that the line of research above alluded to helped in some degree to lead the way to a belief in growth-curvatures as phenomena of irritability.

When my father was writing our book, 'The Power of Movement in Plants' (1880), in which he adopted to the fullest extent a belief that growth curvatures are phenomena of irritability, the only modern statement of such a view which he could find was in a passage by Sachs,⁴ where he writes that 'The living material of plants is internally differentiated in such a way that different parts are supplied with specific energies resembling those of the sensory-nerves (Sinnesnerven) of animals. Anisotropy in plants fulfils the same purpose as do sense-perceptions in animals.'

The idea of irritability as applied to growth curvatures is expressed with sufficient clearness in the 'Power of Movement.' Thus for the case of geotropism we wrote (p. 521): 'Different parts or organs on the same plant, and the same part in different species, are thus excited to act in a widely different manner. We can see no reason why the attraction of gravity should directly modify the state of turgescence and subsequent growth of one part on the upper side and of another part on the lower side. We are therefore led to infer that both geotropic, apogeotropic, and diageotropic movements, the purpose of which we can generally understand, have been acquired for the advantage of the plant by the modification of the ever present movement of circumnutation. This, however, implies that gravitation produces some effect on the young tissues sufficient to serve as a guide to the plant.' A similar view is given for heliotropism. It should be noted that the essence of the view, namely, that light and gravitation act as guides or landmarks by which the plant can direct itself, can be held without a belief in circumnutation.

In Pfeffer's admirable 'Pflanzenphysiologie,' 1881, the conception of stimulus

¹ *Flora*, 1876.

² In his *Vorlesungen*, p. 854, Sachs states that he wrote Müller-Thurgau's introduction.

³ Schmitz, *Linnaea*, 1843; Müller-Thurgau (*Flora*, 1876); F. Darwin, Sachs' *Arbeiten*, 1880. The two latter researches were carried out under the direction of Sachs in his laboratory.

⁴ Sachs (*Arbeiten*, ii. 1879, p. 282).

and reaction is fully given, and is applied, among other cases, to that of heliotropism and geotropism. Pfeffer states clearly, and without reserve or obscurity, the view that light and gravitation act as stimuli or releasing forces, in manners decided by the organisation of the plant. Pfeffer seems to me to be the first writer who has treated the subject fully and consistently.

In Sachs' 'Vorlesungen,' 1882, a view similar to that briefly sketched in his paper of 1879 is upheld. Geotropism and heliotropism are described as Reizerscheinungen, *i.e.* phenomena of stimulation. The phenomena in question are described under the heading Anisotropy, a word which expresses, according to Sachs,¹ 'the fact that different organs of a plant under the influence of the same external forces assume the most varied directions of growth.' In another passage² he states that the anisotropy of the different organs 'is nothing else than the expression of their different irritability to the influence of gravity [and] light, &c.'

Vines,³ who has recently (1886) summarised the evidence on growth curvatures, and whose researches on kindred subjects entitle his opinion to respect, accepts fully the view that gravitation, light, &c., act as stimuli.

It is not necessary to trace the subject further, the views under discussion being now well recognised canons of vegetable physiology.

I cannot, however, omit to mention Pfeffer's⁴ brilliant researches on the chemotaxis (irritability to certain reagents) of low organisms, such as antherozoids and bacteria. To take a single instance, Pfeffer showed that the antherozoids in responding to the effect of malic acid follow precisely the same law that in animals correlates the strength of stimulus and amount of effect. This result, although it has no direct connection with growth-curvatures, is nevertheless of the highest importance in connection with the general question of vegetable irritability.

Nor can I omit to mention the ingenious reasoning by which Noll⁵ localised the seat of irritability in a vegetable cell. He points out how in acellular plants, such as *Caulerpa* or *Derbesia*, the flowing protoplasm may travel from positively geotropic root to apogeotropic stem, and he argues from this that the motile endoplasm cannot be the seat of specific irritability. The flowing plasma which is always changing its position with regard to external forces must be as fully incapacitated from responding to them as though the plant were turning on a klinostat. It follows from this that it must be the stationary ectoplasm which perceives external change. From a different point of view this is what we should expect—we should naturally suppose that the part which regulates the growth of the membrane, and therefore the curvature of the cell, should be the irritable constituent of the cell contents.

In attempting to trace the history of the establishment of growth-curvatures as phenomena of irritability, I have been forced to confine myself to a slight sketch. I have found it impossible to give a full account of the course of research on the subject. I have given an account of some of the halting-places in the journey of thought, but not of the manner in which belief has travelled from stage to stage. Far greater knowledge than mine would be required to compile such an itinerary.

Mechanism.

The first step in advance of Hofmeister's views was the establishment that the curvatures under consideration are due to unequal growth, that is to say, to an excess of longitudinal growth on the convex than the concave side. It is not, however, easy to say how far Hofmeister had this idea, for it, in fact, depends on how we define 'growth.' Hofmeister knew, of course, that the convex side of a curved shoot was longer than it had been before the curvature occurred; this is a mathematical necessity. But he also made out the important point that the concave side increases in length during the curvature. These permanent elongations he must have known to be growth, but his attention was directed to what is, after all, the more important point, namely, *why* it was that unequal elongation took place.

Sachs, in his 'Experimental-Physiologie,' held that growth curvatures are due

¹ P. 855.

² P. 859.

³ *Physiology of Plants.*

⁴ *Tübingen. Untersuchungen*, vol. i.

⁵ Sachs' *Arbeiten*, vol. ii. p. 466.

to unequal growth. In his Text-Book (1874), English translation, 1882, p. 853, the author, referring to Hofmeister's work, says: 'I pointed out that the growth of the under surface of an organ capable of curving upwards was accelerated, and that of the upper surface retarded; I did not at the time express an opinion as to whether these modifications of growth were due to an altered distribution of plastic material or to a change in the extensibility of the passive layers of tissue.' Frank's already quoted paper made valuable contributions to the subject. He showed that the epidermic cells on the convex side of the root are longer than those on the concave side,—that is, they have grown more; he explained apogeotropic curvatures in precisely the same way. He showed, moreover, that the sharp curve close to the tip of a geotropic root, and the long gradual curve of an apogeotropic shoot, are necessary consequences from the manner in which growth is distributed in these parts. He demonstrated that rectilinear growth and geotropic curvature require the same external conditions; that, for instance, a temperature low enough to check growth also puts a stop to geotropism.

The distribution of longitudinal growth which produces geotropism was afterwards studied by Sachs,¹ who thoroughly established the fact that the convex side grows faster, while the concave side grows slower, than if the organ had remained vertical and uncurved.

These facts are of interest in themselves, but they do not, any more than Frank's results, touch the root of the matter. Until we know something of the mechanics of rectilinear growth, we cannot expect to understand curves produced by growth. The next advance in our knowledge did in fact accompany advancing knowledge of rectilinear growth. It began to be established, through Sachs' work, that turgescence is a necessary condition of growth. A turgescient cell is one which is, as it were, over-filled with cell sap; its cell-walls are stretched by the hydrostatic pressure existing within. In osmosis, which gives the force by which the cells are stretched, a force was at hand by which growth could be conceived to be caused. The first clear definition of turgor, and a statement of its importance for growth, occurs in Sachs' classical paper on growth.²

As soon as the importance of turgor in relation to growth was clearly put forward, it was natural that its equal importance with regard to growth curvatures should come to the fore, and that increased growth on the convex side (leading to curvature) should be put down to increased internal cell-pressure in those tissues. In the fourth edition of Sachs' 'Lehrbuch,' 1874, Eng. tr. 1882, p. 834, such a view is tentatively given, but the author saw very clearly that much more evidence was needed before anything like a conclusion as to the mechanism of movement could be arrived at. The difficulty which faced him was not a new one—in a slightly different form it had occurred to Hofmeister—the question, namely, whether the curvatures of acellular and multicellular organs depend on the same or on different causes. If one explanation is applicable to both, then we must give up as a primary cause any changes in the osmotic force of the cells. For no change in the pressure inside a cell will produce a curvature in that cell, whereas, in a multicellular organ, if in the cells in one longitudinal half an increase of osmotic substances takes place, so that the cell walls are subject to greater stretching force, curvature will take place.

On the other hand, if the cause of bending of acellular and multicellular organs is the same, we must believe that the curvature takes its origin in changes in the cell-walls. In an acellular organ, if the cell membranes yield symmetrically to internal pressure, growth will be in a straight line; if it yields asymmetrically it will curve. Thus, if the membrane along one side of a cell becomes more or less resisting than the rest of the membrane, a curvature will result.

If we are to apply strictly the same principle to acellular and multicellular organs, we must suppose that the whole organ curves, because each individual cell behaves like one of the above described free cells, the curvature of the whole resulting from the sum of the curves of the separate cells. This was Frank's view, and it also occurs in Sachs' Text-Book, 1874, Eng. trans., 1882, p. 842.

Are we bound to believe that the mechanism of acellular and multicellular

¹ *Arbeiten*, i. p. 193, June 1871.

² *Ibid.* p. 104, Aug. 1871.

curvatures is so strictly identical as Frank supposed? In the first place, it is not clear why there should be identity of mechanism in the movements of organs or plants of completely different types of structure. The upholders of the identity chiefly confine themselves to asseveration that a common explanation must apply to both cases. I believe that light may be thrown on the matter by considering turgescence, not in relation to growth, but in regard to stability of structure.

An acellular organ, such as the stalk of the sporangium of *Mucor*, owes its strength and stiffness to the tension between the cell contents and the elastic cell-wall, but it does not follow from this that in multicellular organs strength and stiffness are due to the sum of the strengths of its individual cells. Indeed, we know that it is not so; the strength of a multicellular organ depends on the tension between pith and cortex. It is, in fact, a model of the single cell; the pith represents the cell-sap, the cortex the cell-wall. Here, then, it is clear that the function performed by the cell-wall in one case is carried out by cortical tissues in the other. If this is the case for one function there is no reason why it should not hold good in another, viz., the machinery of movement.

If we hold this view that the cortex in one case is analogous with a simple membrane in the other, we shall not translate the unity of acellular and multicellular organs so strictly as did Frank. Indeed, we may fairly consider it harmonious with our knowledge in other departments to find similar functions performed by morphologically different parts. The cortex of a geotropic shoot would thus be analogous with the membrane of a geotropic cell in regard to movement, just as we know that these parts are analogous in regard to stability.

In spite of the difficulties sketched above, one writer of the first rank, namely, H. de Vries, has upheld the view that growth curvatures in multicellular organs¹ are due to increased cell-pressure on the convex side; the rise in hydrostatic pressure being put down to increase of osmotic substances in the cell-sap of the tissues in question. Such a theory flowed naturally from De Vries' interesting plasmolytic work.² He had shown that those sections of a turgescent shoot which were in most rapid growth show the greatest amount of shortening when turgescence is removed by plasmolysis. This was supposed to show that growth is proportional to the stretching or elongation of the cell-walls by turgor. Growth, according to this view, consists of two processes: (1) of a temporary elongation due to turgescence, and (2) of a fixing process by which the elongation is rendered permanent. De Vries assumed that where the elongation occurred, its amount must be proportional to the osmotic activity of the cell contents; thus neglecting the other factor in the problem, namely, the variability in the resistance of the membranes. He applied the plasmolytic method to growth curvatures, and made the same deductions. He found that a curved organ shows a flatter curve³ after being plasmolysed. This, according to his previous argument, shows that the cell-sap on the convex is more powerfully osmotic than that on the concave side. This again leads to increased cell-stretching, and finally to increased growth.

The most serious objection to De Vries' views is that the convex half of a curving organ does not contain a greater amount of osmotically active substance.⁴ It must, however, be noted in the heliotropic and geotropic curvature of pulvini, there is an osmotic difference between the two halves⁵—so that, if the argument from uniformity is used against De Vries (in the matter of acellular and multicellular organs), it may fairly be used in his favour as regards the comparison of curvatures produced with and without pulvini.

It is not easy to determine the extent to which De Vries' views on the mechanics of growth curvature were accepted. The point, however, need not detain us, for the current of conviction soon began to run in an opposite direction.⁶

¹ *Bot. Zeitung*, 1879, p. 835.

² *Ibid.* 1877, p. 1.

³ Frank made similar experiments but failed to find any diminution of curvature.

⁴ Kraus, *Abhand. Nat. Gesell. zu Halle*, xv., 1882. See also a different proof by Wortmann, *Deutsch. Bot. Gesell.* 1887, p. 459.

⁵ Hilburg in Pfeffer's *Tübingen. Untersuch.*, vol. i., 1881, p. 31.

⁶ An opportunity will occur later on for referring to some details of De Vries' work not yet noticed.

Sachs¹ had already pointed out that attention should be directed to changes in extensibility of cell-walls as an important factor in the problem.

Wiesner, in his 'Heliotropische Erscheinungen,'² held that the curvature of multicellular organs is due both to an increase of osmotic force on the convex side, and to increased ductility³ of the membranes of the same part. He repeated De Vries' plasmolytic experiments, and made out the curious fact that in many cases the curvature is increased instead of being diminished. He attributed the result to the concave tissues being more perfectly elastic than ductile convex tissues, so that when turgescence is removed the more elastic tissues shorten most, and, by diminishing the length of the concave side, increase the curvature.

Strasburger, in his 'Zellhäute,' 1882, suggested that growth curvatures are due to increased ductility of the convex membranes, and gave a number of instances to prove that a change to a ductile condition does occur in other physiological processes, such as the stretching of the cellulose ring in *Edogonium* to a uniform thin membrane, the branching of *Cladophora*, and the escape of sexual products in certain algae.

We now pass on to the work of two observers, Wortmann and Noll, who have devoted special attention to mechanism of curvatures. Wortmann⁴ started on the assumption, already several times mentioned, that the growth-curvature of acellular and multicellular organs must have a common cause. He began by testing Kohl's statement⁵ that when the sporangiferous hypha of a *Phycomyces* curves apogeotropically or heliotropically, &c., there is a collection of protoplasm on the concave wall. Wortmann principally investigated the curvature discovered in *Phycomyces* by Errera,⁶ which can be produced by contact. When the hypha is touched with a glass filament or with a platinum wire, or by allowing a speck of indian ink to dry on it, it curves over towards the touched side. The hypha is so highly sensitive to contact that it curves in from three to six minutes; it is clearly a growth-curvature, for it only occurs in the part of the hypha which is growing. In curvatures thus produced, as well as in apogeotropic and heliotropic curvatures the accumulation of protoplasm on the concave side is, according to Wortmann, clearly visible, and, what is more important, the membrane becomes thicker on the concave side, sometimes twice as thick as on the opposite side of the cell. In consequence of the unequal thickening of the membranes, the cell is supposed to yield asymmetrically cell-pressure, and the necessary consequence is that the cell grows into a curved form.

In applying the same method of investigation to multicellular parts, Wortmann followed Ciesielski,⁷ who noticed that in geotropically curved roots the cells of the concave (lower) side of the organ are much more densely filled with protoplasm than are the convex cells. Sachs⁸ describes a similar state of things in the halms of grasses, and Kohl, again, in tendrils and the stems of climbing plants.

Wortmann first of all made sure that no redistribution of protoplasm could be observed in the *individual* cells of curving multicellular organs. If each cell behaved independently like a free cell, we might expect to find a collection of protoplasm on the concave wall of all the constituent cells of a curving shoot. But this is not the case. Nor at first could any microscopic differences be made out between the concave and convex tissues of a curving shoot. But when the stimulus was made to act for a long time, differences were apparent. A young *Phaseolus* plant was placed so that the epicotyl was horizontal and was forced to grow in the horizontal direction by a thread attached to the end of the stem, passing over a pulley and fastened to a weight. Here the geotropic stimulus could continue to act

¹ *Lehrbuch*, ed. 4, Eng. tr. p. 835.

² *Wiener Sitzungs.* vol. lxxxi. 1880, p. 7; also in the *Denkschriften*, 1882.

³ Weinzierl, *Sitzungs.* *Wien*, 1877, showed that strips of epidermis taken off the convex side of heliotropically curved flower-stalks of tulip and hyacinth were about twice as extensible when stretched by a small weight, 7.5 grammes, as approximately corresponding strips for the concave side.

⁴ *Bot. Zeit.* 1887, p. 785.

⁵ *Bot. Hefte*, Marburg, Heft v. [I have not seen Kohl's paper.]

⁶ *Bot. Zeitung*, 1884.

⁷ Cohn's *Beiträge*, 1872, p. 1.

⁸ *Vorlesungen*, p. 842.

for 24-36 hours, and under such conditions a marked change in the tissues was visible. The cells of the cortex on the upper side became densely filled with protoplasm, while the lower cortical cells were relatively poor in protoplasmic contents. The same changes in the membranes occur as those noticed in Phycomyces, that is to say, the walls of the cortex on the upper side are very much thicker than those on the lower side.¹

Since the walls of the cortical cells have become more resisting on the upper than on the lower side, then (assuming the osmotic expanding force to be the same in both cases) the growth will be quicker on the lower side, and the shoot will curve upwards. Wortmann states that his observations account for the fact that the convex side grows quicker, not merely than the concave, but than a normal unbent shoot. But he does not seem to have compared the thickness of the convex cell-walls with the normal, although he states that they are poorer in protoplasm than is usual, and from this it may, according to his views, be perhaps assumed that the membranes are abnormally thin.

Wortmann points out that his views account for two well-known features in growth curvatures, viz., the *latent period* and the *after-effect*. If a curvature can only occur when a difference in structure of cell-walls has arisen, it is certainly natural that some time should occur before the curvature is apparent. I do not lay much stress on this part of the subject, as I feel sure the whole question of latent period needs further investigation. With regard to after-effect it is true that Wortmann's views account for the continuance of curvature after the stimulus has ceased to act.

Wortmann attaches great importance to another point in his theory, which, could it be established, would be of the greatest interest, and would unite under a common point of view, not only acellular and multicellular organs, but also naked protoplasm, e.g. the plasmodia of myxomycetes. The view in question was tentatively suggested by Sachs,² and mentioned by Pfeffer³ in a similar spirit. The apogeotropic curvature of a phycomyces-hypha is supposed to be due to the unequal thickening of the membrane on the upper and lower sides, and this to be due to the migration of protoplasm from the lower to the upper side of the cell. In the same way in a multicellular organ the protoplasm is supposed to migrate from the lower cortex and pith to the upper cortex and pith, such migration being rendered possible by the now generally admitted intercellular protoplasmic communication. Thus the apogeotropism of a cell or a multicellular part would be due to the apogeotropism or tendency to migrate vertically upwards of the protoplasm. There are great difficulties in the way of accepting this attractive theory.

Noll⁴ states that when a curved phycomyces-hypha, in which protoplasm has accumulated in the upper (concave) side, is reversed so that the mass of protoplasm is below, it does not migrate upward again, as might be expected. Moreover he points out that in *Nitella* and in *Bryopsis* the circulating protoplasm continues in movement, and does not accumulate in any part of the cell. Lastly, there seems, as Noll points out, a difficulty in believing in the migration of protoplasm through the very minute pores by which the plasmic strands pass from cell to cell. There seems much probability in Noll's view that the plasmic strands only serve for the passage of impulses, or molecular changes, and that they consist of ectoplasm alone, not of the endoplasm which Wortmann describes as the migratory constituent of the cell.

Wortmann's theory has been criticised by Elfving.⁵ The essence of Elfving's paper is that appearances similar to those described by Wortmann can be produced by curvatures not due to stimulation. Thus, when *Phycomyces* is made to grow against a glass plate it is mechanically forced to bend. Yet here, where there is no question of stimulation, the plasma collects along the concave side of the cell.

¹ Both protoplasmic change and thickening of cell-walls occur to some extent in the pith.

² *Lehrbuch*, 1874; English tr. 1882, p. 841.

³ *Pflanzenphysiologie*, ii. p. 331.

⁴ Sachs' *Arbeiten*, 1888, p. 530.

⁵ *Finska Vet. Soc. Förhand.* (Helsingfors), Bd. 30, 1888.

Elfving concludes that the visible changes are the result and not the cause of the curvature. Elfving also produced curvature in *Phaseolus* by bending the apex of the plant towards its base and tying in that position. Under these conditions the convex side of the shoot showed the changes described by Wortmann in geotropic plants. Here again Elfving gives reason to believe that the thickening of the cell-walls is a result, not of curvature, but of strain mechanically produced. When a plant is prevented from executing an apogeotropic movement it is clear that a longitudinal strain is put on the upper (concave) side. But the longitudinal strain in Elfving's plants is on the convex side. Therefore, if, as Elfving believes, the visible changes are due to strain, they should, as they do, occur on the convex side in his experiments, on the concave in Wortmann's.

Wortmann replied in the 'Bot. Zeitung,' 1888, p. 469, and attempted to explain how Elfving's results might be explained and yet his own theory hold good. The reply is by no means so strong as the criticism, and it must be allowed that Elfving has seriously shaken Wortmann's argument.

Somewhat similar criticisms have been made by Noll.¹ In the acellular plants, *Derbesia* and *Bryopsis*, Noll studied growth-curvatures, and was quite unable to detect any thickening of the concave cell-walls, except when the curvatures were very sudden, and in these cases the result could equally well be produced by mechanical bending.

Noll further points out what is undoubtedly a fault in Wortmann's theory, namely, that he explains the retardation on the concave rather than acceleration on the convex side. This criticism is only partially just, for though Wortmann's description only shows a *relative* thinness of the walls on the convex side, yet it is clear he believed there to be an absolute diminution of resisting power on that side.

Noll's experiments with grass-halms show clearly that acceleration of growth on the convex side is the primary change, rather than retardation along the concave half. When the halms are fixed in horizontal glass tubes, so that they are stimulated but unable to bend, the lower half of the pulvinus forms an irregular out-growth, increasing radially since it is not able to increase longitudinally.

A similar argument may be drawn from Elfving's experiments. He found that the pulvini of grass-halms placed on the klinostat increase in length. This experiment shows incidentally that the klinostat does not remove but merely distribute equally the geotropic stimulus: also that geotropic stimulus leads to increased, not to diminished growth. The same thing is proved by the simple fact that a grass halm shows no growth in its pulvinus while it is vertical, so that when curvature begins (on its being placed horizontal) it must be due to acceleration on the convex, since there is no growth on the concave side in which retardation could occur. Noll's view is that the primary change is an increase in extensibility of the tissues on the convex side. This view he proceeded to test experimentally. A growing shoot was fixed in a vertical position, and a certain bending force was applied to make it curve out of the vertical, first to the right and then to the left. If the cortical tissues are, at the beginning of the experiment, equally resisting all round, it is clear that the excursions from the vertical to the right and left will be equal. As a matter of fact the excursions to the right and left were nearly the same, and the difference was applied as a correction to the subsequent result. The shoot was then placed horizontally until geotropic or other curvature was just beginning, when the above bending experiment was repeated. It was then found that when it was bent so that the lower side was made convex, the excursion was greater than it had been. In the few experiments given by Noll the excursion in the opposite direction (stretching of the concave side) was less than it had been, and he states that all the other experiments showed a similar result. The increased extensibility of the convex side is clearly the most striking part of the phenomenon, but I fail to see why Noll takes so little notice of the diminution in the extensibility of the concave side, which is only mentioned towards the end of his paper.² Yet such a diminution is a necessary factor in the mechanism of curvature. It should be noted that results like Noll's might be obtained under other conditions

¹ Sachs' *Arbeiten*, 1888, p. 496.

² *Loc. cit.* p. 529.

of growth-curvatures. Thus if De Vries' view were the true one and the curvature were due to difference in osmotic force on the convex and concave sides, the shoot would react differently in the two directions; for instance, the concave side would be the more easily compressed. Noll and Wortmann's explanations differ in this: the former lays the greater stress on the increased extensibility of the convex side, the latter on the diminution of that of the concave side. Again, Wortmann explains the difference in extensibility as due to differences in thickness of the cell-walls. Noll gives no mechanical explanation, but assumes that the ectoplasm has the power of producing changes in the quality of the cell-wall in some unknown way.

In the early stages of curvature, a phenomenon takes place to which Noll attaches great importance as supporting his view. When a curved organ is plasmolysed, it suffers a diminution of curvature, as De Vries showed, but Noll¹ has proved that in the early stages of curvature a contrary movement occurs, that is to say, the curvature is increased. This seems to show that the yielding of the convex side is owing to a ductility, which prevents its holding its own against the more perfect elasticity of the concave side. But this is only the beginning of the phenomenon; as the plasmolysing agent continues to act, a reverse movement takes place, the well-known flattening of the curvature described by De Vries. It is to me incomprehensible how in a given condition of cell-walls these results can occur in different stages of plasmolysis. I can understand one occurring when the curvature is recent, and the other, the flattening of the curve, occurring when the ductile convex parts have reacquired elasticity. The fact undoubtedly is as Noll describes it: his explanation seems to me inadequate.

We have now seen that the most acceptable theory of the machinery of these curvatures is in its main features akin to Hofmeister's, the power of elongation supplying the motive force, while the varying extensibility of the membranes determines the nature and direction of the bend.

The question now arises: Is it possible by these means to account for all the facts that must be explained. Taking the theory for which there is most to be said on experimental grounds—viz., Noll's—it will be noted that it is essentially connected with the doctrine of growth by apposition. The question, therefore, whether the apposition-theory is sufficient to account for the phenomena of ordinary growth, may be applied *mutatis mutandis* to growth curvature. This doctrine in its original purity absolutely requires turgescence to account for the elongation of growth. The older layers, separated from the ectoplasm by the younger layers of cell-wall, can *only* be elongated by traction. Growth by intussusception does not absolutely require this force; the theory that the micellæ are separated by traction, and thus allow intercalation of fresh micellæ, is a view for which Sachs is chiefly responsible.

Since surface-growth by apposition is absolutely dependent on the traction exercised by cell-pressure, it is a fair question—how far growth is influenced by forcible elongation. Baranetzky² states that when a plant is subject to traction, as by even a small weight attached to the free end, the rate of growth is lowered. Ambrohn,³ as Zimmermann points out in the same connection, found no increased elongation of collenchyma when stretched for some days by means of a weight. A greater difficulty is that growth may be absolutely and at once stopped by placing the growing organ in an atmosphere free from oxygen.⁴ Such treatment apparently does not diminish turgescence, yet growth stops. If the cell-walls are increasing in length by mechanical stretching, and if the turgor is not interfered with, increase in length ought to continue. The same thing applies to curvatures. Wortmann has shown⁵ that in an atmosphere of pure hydrogen a geotropic curvature which has begun in ordinary air cannot continue; in other words, after-effect ceases. This seems to me inexplicable on Noll's or Wortmann's theories; the convex side has become more extensible than the concave, turgescence, as far as we know, continues, yet no after-effect is observed. The same result may

¹ The similar results obtained by Wiesner are noticed above.

² *Mém. Acad. St. Pétr.* v. vol. xxvii. p. 20.

³ Pringsheim's *Jahrb.* xii.

⁴ Wieler, *Pfeffer's Untersuch.* Bd. i. p. 189.

⁵ *Bot. Zeit.*, 1884, p. 705.

be gathered from Askenasy's¹ interesting experiments on the growth of roots. He showed that lowering the temperature has an almost instantaneous inhibitive effect on growth. Thus maize roots (at a temperature of 26.6°) growing at the rate of 33 divisions of the micrometer per hour, were placed in water at 5°, and absolutely no growth occurred during the following ten minutes, in which the thermometer rose to 6.5. This result is to some extent more valuable because we know from Askenasy's² other results that the turgor, as estimated by plasmolytic shortening, is about the same whether the root is in full growth or not growing at all. This, however, is not conclusive, for if the growing cell-walls were ductile they might shorten but little although under great pressure, whereas the non-growing cells might shorten a good deal, owing to their more perfect elasticity;³ therefore, Askenasy's plasmolytic results are not in this particular connection of great importance, except as showing that the non-growing roots were certainly to some extent turgescient.

There are other facts which make it extremely difficult to understand how surface-growth can depend on cell-pressure. Nägeli⁴ pointed out that the growth of cylindrical cells which elongate enormously without bulging outwards laterally, is not explicable by simple internal pressure. An internodal cell of *Nitella* increases to 2,000 times its original length, while it only becomes ten times as wide as it was at first. The filaments of *Spirogyra* become very long, and keep their original width. Nägeli found that in *Spirogyra* the shortening produced by plasmolysis was practically the same in the longitudinal and in the transverse direction. He therefore concluded that the growth of *Spirogyra* cannot be accounted for by the cell-wall being differently extensible along different axes. But it must once more be pointed out that this type of plasmolytic experiment has not the force which Nägeli ascribes to it. If the cell-wall stretched like putty in one direction and like india-rubber in the other, there might be no plasmolytic shortening in the line of greatest growth. Nevertheless, in spite of this flaw in Nägeli's argument, great elongation in a single direction remains a problem for those who believe in surface-growth by apposition.

The point of special interest is that differences in extensibility in different directions cannot be supposed to exist in a homogeneous membrane. If any purely physical characters can explain the facts, they must be architectural characters. That is to say, we must be able to appeal to remarkable structural differences along different axes if we are to explain the facts. Such structural differences do, of course, exist, but whether they are sufficient to account for the phenomena is a different question. Strasburger⁵ supposes that the elasticity of a cell-wall depends on the last-formed layers, and as in these the microsomes are seen arranging themselves in lines or patterns, we have a heterogeneity of structure which may or may not be sufficient.

We have now seen that it is difficult to believe, although it is not inconceivable, that the extending force of cell-turgor, combined with differences in extensibility of the membranes (depending on structural characters), may account for the phenomena of rectilinear growth. But, even if we allow that this is so, how are we to apply the same explanation to growth-curvatures? How are we to account for the rapid changes in extensibility necessary to produce geotropic or heliotropic curvatures? The influences which Strasburger and Noll suppose to act on the cell-walls and render them ductile cannot account for extensibility in one direction only. Nor does Wortmann's theory, that difference in extensibility depends on difference in thickness, meet the case completely. What we need is an increase

¹ *Deutsch. Bot. Ges.*, 1890, p. 61. This paper contains an excellent discussion on the mechanics of growth, to which I am much indebted.

² *Loc. cit.* p. 71.

³ Wiesner (*Sitz. Wien. Akad.*, 1884, vol. lxxxix.-xc., Abth. i. p. 223) showed that under certain conditions decapitated roots grow much more quickly than normal ones, yet the amount of plasmolytic shortening is less. Decapitated: growth, 79 per cent.; plasmolytic shortening, 8 per cent.; normal: growth, 39 per cent.; shortening, 13 per cent.

⁴ *Stärkekörner*, p. 279.
1891.

⁵ *Zellhäute*, p. 194.

in longitudinal, not in general extensibility. I presume that these writers might say that the excess in longitudinal extensibility is always present whether general extensibility is greater or less. In the meanwhile we must pass on to more recent researches connected with surface-growth by apposition.

In Strasburger's later work, 'Histologische Beiträge,' 1889, his views on growth have undergone considerable modification. The study of certain epidermic cells, of the folds in membranes, and the repetition of Krabbe's work on certain bast fibres, have convinced him that apposition does not account for all forms of growth. Krabbe¹ showed that in full-grown sclerenchyma (*e.g.* in Oleander) local widenings occur without any such amount of thinning in the membrane as would occur if the bulging were due to stretching. The only possible explanation seems to be that there is a migration of new material into the cell-wall. Such intussusception might be, as Nägeli supposed, a flow of fluid out of which new micellæ crystallise; but it is now established that cellulose arises as a modification of protoplasm, so that it would harmonise with our knowledge of the origin of cellulose if we assume that intussusception was preceded by a wandering of protoplasm into the cell-wall. Such a state of things would render possible the regulation of longitudinal growth in the case of *Nitella* and *Spirogyra*, already alluded to, as well as in growth curvatures. This view might also harmonise with Wiesner's² theory that the cell-wall contains protoplasm as long as it continues to grow.

For the sake of brevity I content myself with the above examples: I think it will be allowed that there is a focussing of speculation from many sides in favour of 'active' surface-growth—or, what is perhaps a better way of putting it, in favour of a belief that the extension of cell membranes depends on physiological rather than physical properties, that it is in some way under the immediate control of the protoplasm. We may take our choice between Wiesner's wall-protoplasm (dermatoplasm), protoplasmic intussusception as conceived by Strasburger, or the action of the ectoplasm in the manner suggested by Vines,³ who supposes that the crucial point is a change in the motility of the protoplasm, not of the cell membrane. The latter theory would undoubtedly meet the difficulties—if we could believe that so yielding a substance as protoplasm could resist the force of turgor.

The great difficulty is, it seems to me, that since *e.g.* in *Caulerpa*, surface-growth is clearly due to stretching, as Noll has demonstrated, and since in osmotic cell-pressure a stretching force does exist, it cannot be doubted that turgor, and ordinary physical extensibility are conditions of the problem. This remains true in spite of Klebs'⁴ curious observations on the growth of plasmolysed algæ, or in spite of the fact that pollen tubes may grow without turgor, in spite of the same being perhaps true of young cells filled with protoplasm.⁵ In the face of all these facts, osmotic pressure in the cell must remain a *vera causa* tending to surface-growth.

If we accept some form of 'active' surface-growth, we must deal with turgor in another way, although to do so may require a violent exercise of the imagination. Are we to believe, for instance, that the function of turgescence is the attaining of mechanical strength? If we hold that cell-walls increase in area independently of turgor, we shall be forced to invent a hypothesis such as the following—which I am far from intending to uphold. It is possible to imagine that the function of the force of turgor is merely to spread out the growing membrane to its full extent, and, as it were, to make the most of it. Turgor would in this respect play the part occupied by the frame used in embroidery, making it easier to carry on the work satisfactorily, but not being absolutely necessary. When

¹ Pringsheim's *Jahrb.* xviii.

² *Sitz. Wien. Akad.* 1886, vol. xciii. p. 17.

³ Sachs' *Arbeiten*, 1878, and *Physiology*, 1886. See also Gardiner, on protoplasmic contractility, in the *Annals of Botany*, i. p. 366. Pfeffer has, I think, shown that Vines' and Gardiner's theories assume the existence of too great strength in the ectoplasm. See Pfeffer in *Abhandl. der k. Sächs. Gesellsch.* xvi. 1890, p. 329.

⁴ *Tübingen. Untersuchungen*, ii. p. 489.

⁵ See Noll, *Würzburg. Arbeiten*, iii. p. 530.

mechanical strength is gained by turgor (as in *Mucor*), instead of by brute strength of material, as in a tree-trunk, a great economy in cellulose is effected. If turgor played our hypothetical part of smoothing out the membrane and insuring that it shall occupy as large a space as possible, it would effect the same kind of economy.

It is not necessary to inquire how far this hypothesis accords with our knowledge of cell mechanics. It is only put forth as an example of the difficulties in which we land if we seek for a new function for turgor. We are, indeed, surrounded by difficulties; for, though the theories which are classed together as protoplasmic have much in their favour, they, too, lead us into an *impasse*.

Circumnutation.

I shall conclude by saying a few words about the theory of growth-curvatures put forward in the 'Power of Movement in Plants.' I can here do no more than discuss the relation of circumnutation to curvature, which is the thesis of the book in question, without attempting to enter the arena with regard to the many objections which have been raised to other parts of our work.

A distinguished botanist, Professor Wiesner, of Vienna, published in 1881 a book, 'Das Bewegungsvermögen der Pflanzen,' entirely devoted to a criticism of the 'Power of Movement.' It is founded on a long series of experiments, and is written throughout in a spirit of fairness and candour which gives it value, apart from its scientific excellence, as a model of scientific criticism. The words written on the title-page of the copy presented to my father are characteristic of the tone of the book:—'In getreuer Opposition, aber in unwandelbarer Verehrung.' A letter printed among my father's correspondence shows how warmly he appreciated his opponent's attack both as to matter and manner. Wiesner's opposition is far-reaching, and includes the chief theoretical conclusion of the book, namely, that movements such as heliotropism and geotropism are modifications of circumnutation. Neither will he allow that this revolving nutation is the widely-spread phenomenon we held it to be. According to Wiesner, many parts of plants which do not circumnutate are capable of curving geotropically, &c.; he is, therefore, perfectly justified, from his own point of view, in refusing to believe that such curvatures are derivations from circumnutation. He points out that our method of observing circumnutation is inaccurate, inasmuch as the movement is recorded in oblique projection. This we were aware of,¹ and I cannot but think that Wiesner has unintentionally exaggerated its inaccuracy; and that, if used with reasonable discretion, it cannot lead to anything like such faulty records as in the supposititious cases given by our critic. However this may be, Wiesner's results are perhaps more trustworthy than ours, and should receive the most careful consideration.

Wiesner's conclusions, taken from his own summaries, are as follows:—

The movement described as circumnutation is not a wide-spread phenomenon in plants. Stems, leaves, and acellular fungi are to be found which grow in a perfectly straight line. Some roots grow for considerable periods of time without deviating from the vertical. When circumnutation does occur, it cannot be considered to have the significance given to it in the 'Power of Movement.' The movements observed by Wiesner are explained by him in three different ways:—

i. As the expression of a certain irregularity in growth depending on the want of absolute symmetry in structure, and on the fact that the component cells of the organ have not absolutely similar powers of growth.

ii. As the expression of opposing growth-tendencies. Thus certain organs have inherent tendencies to curve in definite planes—for instance, the bending of the hypocotyl in the plane of the cotyledons. Wiesner believes that such tendencies, when combined with others—heliotropic, geotropic, &c.—lead to alternate bendings in opposite directions, according as one or other of the components is temporarily the stronger.

iii. Wiesner allows that circumnutation does exist in some cases. This last

¹ *Power of Movement*, p. 8.

class he considers a small one; he states, indeed, that 'nearly all, especially the clearly perceptible circumnutations,' are combined movements belonging to the second of the above categories.

Although I have perhaps no right to such an opinion without repeating Wiesner's work, yet I must confess that I cannot give up the belief that circumnutation is a widely-spread phenomenon, even though it may not be so general as we supposed.

If, then, circumnutation is of any importance we are forced to ask what is its relation to growth-curvatures. It was considered by my father to be 'the basis or groundwork for the acquirement, according to the requirements of the plant, of the most diversified movements.'¹ He also wrote:² 'A considerable difficulty in the way of evolution is in part removed, for it might be asked how did all these diversified movements . . . first arise? As the case stands, we know that there is always movement in progress, and its amplitude, direction, or both, have only to be modified for the good of the plant in relation to internal or external stimuli.'

Those who have no belief in the importance of circumnutation, and who hold that movements may have arisen without any such basis, may doubtless be justified in their position. I quite agree that movement *might* be developed without circumnutation having anything to do with the matter. But in seeking the origin of growth-curvatures it is surely rational to look for a widely-spread movement existing in varying degrees. This, as I believe, we have in circumnutation; and here comes in what seems to me to be characteristic of the evolution of a quality such as movement. In the evolution of structure, each individual represents merely a single one of the units on which selection acts. But an individual which executes a number of movements (which may be purposeless) supplies in itself the material out of which various adapted movements may arise. I do not wish to imply that tentative movements are of the same order of importance as variations, but they are undoubtedly of importance as indication of variability.

The problem may be taken back a stage further; we may ask why circumnutation should exist. In the 'Power of Movement' (p. 546) we wrote: 'Why every part of a plant whilst it is growing, and in some cases after growth has ceased, should have its cells rendered more turgescient and its cell-walls more extensile first on one side then on another . . . is not known. It would appear as if the changes in the cells required periods of rest.' Such periods of comparative rest are fairly harmonious with any theory of growth; it is quite conceivable by intussusceptionists and appositionists alike that the two stages of elongation and fixation should go on alternately,³ but this would not necessarily lead to circumnutation. It might simply result in a confused struggle of cells, in some of which extension, in others elongation, was in the ascendant; but such a plan would be an awkward arrangement, since each cell would hinder or be hindered by its neighbour. Perfection of growth could only be attained when groups of contiguous cells agreed to work together in gangs, that is, to pass through similar stages of growth synchronously. Then, if the different gangs were in harmony, each cell would have fair play, elongation would proceed equally all round, and the result would be circumnutation.⁴ Whether or no any such origin of circumnutation as is here sketched may be conceived, there can be no doubt that it had its origin in the laws of growth apart from its possible utilisation as a basis for growth-curvature.

It is, however, possible to look at it from a somewhat different point of view, namely, in connection with what Vöchting has called *rectipetality*.⁵ He made out the fact that when an organ has been allowed to curve geotropically, heliotropically, &c., and is then removed from further stimulation by being placed on

¹ *Power of Movement*, p. 3.

² *Loc. cit.*, p. 4.

³ Strasburger, *Histolog. Beiträge*, p. 195, speaks of the pause that must occur after the formation of a cellulose lamella. Hofmeister, *Württemberg. Jahreshefte*, 1874, describes the growth in length of *Spirogyra* as made up of short intervals of rapid growth alternating with long pauses of slow growth.

⁴ I purposely omit the circumnutation of pulvini.

⁵ *Die Bewegung der Blüten und Früchte*, 1882.

the klinostat, it becomes straight again. This fact suggested to Vöchting his conception of rectipetality, a regulating power leading to growth in a straight line. It may be objected that such a power is nothing more than the heredity, which moulds the embryo into the likeness of its parent, and by a similar power insists that the shoot or root shall take on the straight form necessary to its specific character. But the two cases are not identical. The essence of rectipetality is the power of recovering from disturbance caused by external circumstances. When an organ has been growing more quickly on one side than another, the regulating power reverses this state of things and brings the curving organ back towards the starting-point. We have no means of knowing how this regulating power acts in undisturbed growth. It is possible to imagine a type of irritability which would insure growth being absolutely straight, but it is far more easy to conceive growth as normally made up of slight departures from a straight line, constantly corrected. In drawing a line with a pencil, or in walking towards a given point, we execute an approximately straight line by a series of corrections. If we may judge in such a matter by our own experience, it is far more conceivable that the plant should perceive the fact that it is not growing absolutely straight and correct itself, than that it should have a mysterious power of growing as if its free end were guided by an external force along a straight-edge. The essence of the matter is this: we know from experiments that a power exists of correcting excessive unilateral growth artificially produced; is it not probable that normal growth is similarly kept in an approximately straight line by a series of aberrations and corrections? If this is so, circumnutation and rectipetality would be different aspects of the same thing.

This would have one interesting corollary: if we fix our attention on the regulating power instead of on the visible departures from the straight line, it is clear that we can imagine an irritability to internal growth-changes existing in varying intensities. With great irritability very small departures from the straight line would be corrected. With a lower irritability the aberration would be greater before they are corrected. In one case the visible movement of circumnutation would be very small, in the other case large, but the two processes would be the same. The small irregular lateral curvatures which Wiesner allows to exist would therefore be practically of the same value as regular circumnutation, which he considers comparatively rare.

The relation between rectipetality and circumnutation may be exemplified by an illustration which I have sometimes made use of in lecturing on this point. A skilful bicycle-rider runs very straight, the deviations from the desired course are comparatively small; whereas a beginner 'wobbles' or deviates much. But the deviations are of the same nature; both are symptoms of the regulating power of the rider.

We may carry the analogy one step further: just as growth-curvature is the continuance or exaggeration of a nutation in a definite direction, so when the rider curves in his course he does so by wilful exaggeration of a 'wobble.'

It may be said that circumnutation is here reduced to the rank of an accidental deviation from a right line. But this does not seem necessarily the case. A bicycle cannot be ridden at all unless it can 'wobble,' as every rider knows who has allowed his wheel to run into a frozen rut. In the same way it is possible that some degree of circumnutation is correlated with growth in the manner suggested above, owing to the need of regular pauses in growth. Rectipetality would thus be a power by which irregularities, inherent in growth, are reduced to order and made subservient to rectilinear growth. Circumnutation would be the outward and visible sign of the process.

I feel that some apology is due from me to my hearers for the introduction of so much speculative matter. It may, however, have one good result, for it shows how difficult is the problem of growth-curvature, and how much room there still is for work in this field of research.

The following Reports and Papers were read:—

1. *Fourth Report of the Committee appointed for the purpose of reporting on the present state of our knowledge of the Zoology and Botany of the West India Islands, and taking steps to investigate ascertained deficiencies in the Fauna and Flora.*—See Reports, p. 354.

2. *Report of the Committee appointed to report on the present state of our knowledge of the Zoology of the Sandwich Islands, and to take steps to investigate ascertained deficiencies in the Fauna.*—See Reports, p. 357.

3. *Fifth Report of the Committee appointed for the purpose of taking steps for the establishment of a Botanical Laboratory at Peradeniya, Ceylon.*—See Reports, p. 358.

4. *Report of a Committee appointed to make a digest of the observations on the Migration of Birds at Lighthouses and Light-vessels which have been carried on by the Migration Committee of the British Association.*—See Reports, p. 363.

5. *Fourth Report of the Committee for the purpose of collecting information as to the Disappearance of Native Plants from their Local Habitats.*—See Reports, p. 359.

6. *Report of the Committee appointed for the purpose of arranging for the occupation of a Table at the Laboratory of the Marine Biological Association at Plymouth.*—See Reports, p. 364.

7. *Report of the Committee appointed for Improving and Experimenting with a Deep-sea Tow-net.*—See Reports, p. 382.

8. *Non-sexual Formation of Spores in the Desmidiaceæ.*

By A. W. BENNETT.

In at least two gatherings of Desmids from the neighbourhood of Hindhead in Surrey, I have come across a phenomenon which I am not aware has been recorded before in this family of Algæ, viz. the formation of parthenospores without conjugation. The species was in all cases *Closterium lanceolatum*, Ktz., and I have at present seen four examples of it. In two of them one spore, in the other two two spores, were formed within the frond. They appeared spherical or ellipsoidal according to the view in which they were seen, and with perfectly smooth surface. The fronds were distinctly alive, and the longitudinal chlorophyll-bands had undergone but little change from their ordinary form, except where interrupted by the intervention of the spore. A similar phenomenon has been recorded in the allied Zygnemaceæ.

9. *On a simple Apparatus for the Cultivation of small organisms in Hanging Drops, and in various Gases, under the Microscope.* By Professor MARSHALL WARD, F.R.S.

The author has found it necessary to devise a culture-chamber capable of supplying relatively large quantities of gases to the ordinary hanging-drop cultiva-

tions of yeasts, bacteria, &c. ; it must also be firm, strong, and readily taken to pieces and sterilised by heat.

He has accomplished this by taking a piece of thick-walled glass tubing, about $\frac{3}{8}$ inch in diameter and 3 inches long ; the two ends are softened and slightly drawn to narrow tubes, not too thin. The piece of glass now looks like a narrow tube with a thick-walled bulb in the middle. One face of this central bulb is then ground flat, until a hole about $\frac{1}{2}$ inch in diameter is cut through ; a similar hole is then ground in the *opposite* face of the bulb. The apparatus is now ready to be put together.

It is sterilised at 150° C., and cemented by paraffin (or by gelatine in acetic acid), by one of the ground faces, to a broad glass slide properly sterilised. Sterilised cotton-wool is stuffed into the two narrow tubulures, and the hanging-drop culture, properly prepared on a sterile coverslip is cemented (by means of sterilised oil, vaseline, or paraffin, &c.) over the upper hole of the chamber.

The apparatus is now ready for use if the culture is required in air only ; a slow diffusion of air and retardation of evaporation may be insured by simply wetting the cotton-wool in the tubulures with pure water.

If it is necessary to pass gases into the culture, one of the stuffed tubulures is connected by means of caoutchouc tubing (sterilised in corrosive sublimate, absolute alcohol, and boiling) with the appropriate gas apparatus. The pressure can be regulated by the stuffing in this, the proximal tubulure, and by clip or screw-taps. The stuffed exit tubulure is also protected by caoutchouc tubing and a clip.

If a very strong cover-slip and careful cementing are employed, the author finds that a very good partial vacuum can be obtained, and even retained for some hours. This is very useful in cases where it is necessary to remove the oxygen or carbon-dioxide from the imprisoned atmosphere. This may be accomplished more or less readily by attaching bulbs containing an alkaline solution of pyrogallic acid, or a solution of potassium hydrate. Obviously the apparatus can also be used for testing the effect of poisonous gases, or for observing the action of light of different intensities, or of various low temperatures, and so forth. Obviously, also, it may be used for testing the action of different coloured lights, and of darkness, &c., with certain simple modifications, *e.g.* employing different coloured glass tubing, or opalescent or blackened glass for making the culture-chamber, and adding various screens, covers, &c., as required.

10. *On some Simple Models illustrating the Vascular System of Vertebrates.*
By Professor W. N. PARKER.

11. *On the Progress of the Investigation of the Natural History of the Friendly Islands.* By J. J. LISTER.

At the meeting of the British Association at Bath in September 1888, a Committee was appointed for the purpose of taking steps for the investigation of the Natural History of the Friendly Islands and other groups in the Pacific visited by H.M.S. *Egeria*.

I was then starting to join the *Egeria*, and a grant of 100*l.* was voted to assist me in carrying out the object of the Committee. At the next meeting the Committee reported that I had joined the *Egeria* on her arrival at Tonga and was carrying on my researches.

I beg leave to offer the following brief account of the further steps that I took in pursuance of my object.

H.M.S. *Egeria* arrived at Tongatabu on May 23, 1889, and after a short visit to the neighbouring island of Eua, I left Tonga for a cruise among the islands lying to the northward, between Tongatabu and the Equator.

In the course of this cruise the *Egeria* called twice at Samoa, and also visited Viti Levu, the principal island in Fiji, and made surveys of Fakaofu in the Union Group, and Canton (or Mary) Island in the Phoenix Group, besides touching at several of the neighbouring islands.

On returning to Tonga I had the opportunity of visiting Falcon Island, which was thrown up by volcanic eruption in 1885, and some of the other less accessible islands of the group.

After the departure of the *Egeria* in November, I paid two visits to the Vavau Islands in the northern part of the Tonga group, and owing to the courtesy of Mr. S. Parker of Eua I stayed two weeks with him on that island.

I finally left Tonga on April 24, 1890, and returned to England at the end of the following September. My collections have been disposed of as follows:—

The geological specimens have been placed in the Woodwardian Museum at Cambridge. Specimens of the skins and eggs of the rarer birds and my collections in other groups of animals, in the British Museum of Natural History. The collections of dried plants, in the Herbarium of the Royal Gardens at Kew. A small collection of the skulls of the natives of Fakaofu and Tonga in the Museum of the Royal College of Surgeons.

The examination of the material is still in progress, but the following papers have appeared:—

‘Woodwardian Museum Notes, Sections IV. and V.’ by Alfred Harker, M.A., F.G.S., ‘Geological Magazine,’ April 1891.

‘Rocks from the Tonga Islands,’¹ by the same author, ‘Geological Magazine,’ June 1891;

together with the following by myself:—

‘A Visit to the newly-emerged Falcon Island, Tonga Group,’ ‘Proceedings of the Royal Geographical Society,’ March 1890.

‘Notes on the Natives of Fakaofu,’ read before the Anthropological Society, March 1891.

‘Notes on the Birds of the Phoenix Islands,’ read before the Zoological Society, April 21, 1891.

‘Notes on the Geology of the Tonga Islands,’ read before the Geological Society, June 24, 1891.

FRIDAY, AUGUST 21.

The following Report and Papers were read:—

1. *Report of the Committee nominated for the purpose of arranging for the Occupation of a Table at the Zoological Station at Naples.* See Reports, p. 365.

2. *On some Species of Diatoms with Pseudopodia.*

By J. G. GRENFELL, F.G.S., F.R.M.S.

The diatoms are two small species of *Melosira* and *Cyclotella Kützingiana*, which occur mainly as isolated frustules and are non-motile. They have been found in London, Hertfordshire, and Wiltshire. The pseudopodia are delicate, often invisible till the material is dried on a cover glass. Comparatively thick ones are occasionally found. Gentian violet and methylene blue are good stains for them. The pseudopodia are apparently non-retractile, generally straight, sometimes branched, but those of the earliest gathering in April were often repeatedly branched. Their number is fairly constant. Most of them are placed fairly symmetrically round the edge of the valves. The length varies from two-and-a-half to nine times the diameter of the frustule. The diatoms are sometimes connected by broad bands which seem to be anastomosed pseudopodia. Very similar bands

¹ This paper includes the description of the specimens collected by Captain C. F. Oldham, R.N., in his survey of 1890.

are found amongst the Heliozoa. The protoplasmic nature of the pseudopodia is inferred from the following facts:—

They are destroyed by nitric acid and by a low red heat; they give no cellulose reaction with Schultze's solution or with iodine and sulphuric acid; they stain readily with Kleinenberg's hæmatoxylin; they also stain with borax carmine, picro-nigrosin and alcoholic saffranin. Pseudopodia similar in shape are found amongst the Heliozoa generally, but pseudopodia agreeing with these in the minutest details are found on some specimens of *Archerina Boltoni*, a Heliozoa which occurred in vast numbers with the diatoms in London. Other as yet undetermined Heliozoa occurring in the same water have very similar pseudopodia.

3. On Nuclear Structure in the Bacteria. By HAROLD WAGER.

Owing to the small size of the cells in the bacteria, the presence of a nucleus, or of anything akin to nuclear structure in them, has not yet been satisfactorily demonstrated. Dr. P. Ernst, has, however, described certain bodies which to him appeared to be of the nature of nuclei, inasmuch as they possessed a reaction towards reagents different from that observed in spores.

It is interesting to note that in the closely allied group of the *Cyanophyceæ*, Scott and Zacharias have been able to detect structures resembling a nucleus.

According to Bütschli, the central portion of the protoplasmic contents of the bacterium cell is to be regarded as of the nature of a nucleus, in that it takes up very readily certain aniline dyes. It should be noted, however, that such stains as hæmatoxylin, carmine, saffranin have but little staining power for the contents of the bacterium cell, compared with such stains as gentian violet, fuchsin, &c., which stain them deeply, but which also stain the protoplasm of the cells of higher plants almost as deeply as the contents of the bacterium cell. This seems to show that the bacteria contain very little of the chromatic substance which is found in the nuclei of the higher plants. The author of this paper has for some time been working at the bacteria in the hope of elucidating this point, and has obtained a bacillus in which a distinct nuclear structure can be observed.

The bacillus referred to forms a thin scum on the surface of water containing *Spirogyra* in a state of decay. The cells, which consist of short rods, occur either singly or in pairs. They are about 2.5 to 3 μ in length, and from 1.3 to 1.5 μ in diameter, and when seen in a fresh state one or more brightly refractive granules can be observed in each cell. In cover-glass preparations stained with fuchsin, all stages in the division of the bacillus could be observed. The preparations should be made during the earlier stages of the development of the scum on the surface of the water, while the bacillus is in a healthy state of division.

In the centre of each cell a substance deeply stained by the fuchsin is found. This in young cells consists of two rods placed side by side, with a less deeply stained substance between them, the whole being surrounded by a very thin membrane which is only visible at the two ends. This is the structure which we may call a nucleus. It is surrounded by a space containing a substance which is only slightly stainable, and this again is surrounded by a deeply-stained membrane, outside which is the slightly stained gelatinous envelope. Previous to its division the cell elongates; the nucleus also elongates and contracts slightly about the middle of its length. A dumb-bell shaped structure is thus obtained. The two rods divide completely, so as to form two groups, containing two rods each, which remain connected together for some time by the less deeply-stained portion of the nucleus. The constriction becomes more and more pronounced, until finally the two halves of the nucleus are completely separated. The outer capsule or cell-wall has meanwhile been contracting towards the middle, the contraction keeping pace with the division of the central mass. This contraction goes on until at a certain stage a delicate transverse partition appears, dividing it into two; each half contains one of the halves of the original nucleus. Ultimately the two halves become completely separated, and two new cells are formed.

In the majority of cases the cells are completely separated before the division

of the nucleus again begins, but in many instances the nuclear rods were seen to be dividing in cells which were still connected with each other.

After a time the division of the cells takes place less rapidly, and finally ceases altogether. The division of the nucleus becomes very irregular, and at the time when cell division has ceased the nucleus has become broken up into granules which are distributed irregularly in the contents of the cell.

This breaking up of the nucleus appears to be preliminary to the formation of spores, although the formation of spores has not been satisfactorily observed.

5. *A Discussion was held on the Systematic Position of certain Organisms that are regarded by some Naturalists as Animals, and by others as Plants.*

SATURDAY, AUGUST 22.

The following Papers were read:—

1. *On Anatomical Nomenclature.* By Professor W. KRAUSE, Göttingen.

The subject of the paper, 'Anatomical Nomenclature,' may seem to be only of interest to the anatomist in the dissecting-room. This is, however, an error, for the names of several parts of the body occur in every branch of Biological Science, Zoology, Embryology, &c., and especially in the practice of Medicine and Surgery. There have been and there are many complaints that a great many parts of the body have not one but several different anatomical names, for instance—conarium, pineal body, epiphysis. This state of things has every year become worse and worse; in Germany, especially, it has become almost insupportable.

The reason is obvious. Germany was and is not united in the administration of the internal affairs of the single states, and every state, and even every little university, has had and has to-day its own anatomical nomenclature. If one compares the anatomical papers and the handbooks of different nations, one meets with the same difficulties. In Germany, however, there are still greater difficulties to face. Here in the same university sometimes different anatomical nomenclatures exist. Much time and labour are lost by student and teacher owing to these differences.

This labour is completely lost, because it is and it must be of little importance whether this or that name be given to a particular muscle or a particular artery. Sometimes confusion and misunderstandings arise, but the worst is that the mere reader is unwilling or does not care to translate the anatomical terms of an author, foreigner or otherwise, into his own anatomical terminology. So reading becomes superficial; the reader understands the words but not the real meaning of the author. This state of things cannot last, and so a Committee has been elected for preparing, not a new one, but at least a homogeneous nomenclature. This Committee consists of seventeen anatomists, of whom twelve are Germans and four or five from other countries. Sir William Turner from Edinburgh and Professor Cunningham from Dublin represent Great Britain. This Committee has begun to work in earnest, and has already done much. The author referred to a little paper, only three pages, which contains nothing but the names of the muscles of the human body, but much work had to be done before it was completed. Now Germans can, at least, answer the question, if a foreigner should ask, 'What is the German name for a certain muscle?' A year ago no German anatomist could have given any answer but 'I do not know, some call it the trapezius, others the cucullaris.' In conclusion, the author said, 'In two or three years we shall have finished the whole, and then we shall ask the anatomists of other countries to give their candid opinion on the results of our labours.'

Some general principles have already been laid down by the Committee.

Firstly: The name should be as short as possible.

Secondly: Personal nomenclature should not if possible be used. There are some anatomical names which are known in every country, as 'Hunter's canal,' but a great many are known only in one country. There are little nodules on the margin of the semilunar valves of the pulmonary artery: some call them 'nodes of Arantius,' others the 'nodes of Morgagni'; but Arantius certainly never saw them. There is a prominence on the external ear of man, in Germany known as 'Darwin's prominence,' but in England it is often called 'Woolner's tip,' and so on.

Thirdly: No part of the body should have more than one name; more synonyms only cause confusion. This name shall always be a Latin one; every nation can afterwards easily translate it after its own fashion. Latin is the only real international language, and by adopting it we hope to have a sound foundation.

NOTE.—Anyone who may wish to have a copy of the paper referred to above is requested to apply to the author.

2. *On Fertilisation and Conjugation Processes as allied Modes of Protoplasmic Rejuvenescence.* By Professor MARCUS HARTOG, M.A., D.Sc., F.L.S.

3. *A Preliminary Classification of Sexual and allied Modes of Protoplasmic Rejuvenescence, &c.*¹ By Professor MARCUS HARTOG, M.A., D.Sc., F.L.S.

I. The following modes of rejuvenescence occur in cellular and in certain apocytial organisms:—

A. PLASTOGAMY: the fusion of cytoplasts into a plasmodium, the nuclei remaining free (*Myxomycetes*).

B. KARYOGAMY: the union of cells (gametes), cytoplasm to cytoplasm and nucleus to nucleus, to form a 1-nucleate cell, the zygote. The following variations occur:—

1. ISOGAMY. The union of gametes undistinguishable in size, form, and behaviour; this may vary as follows:—

(a) MULTIPLE: between several gametes (up to 6).

(b) BINARY: between a pair of gametes;
or, from another point of view—

(c) INDIFFERENT: between any gametes of the species.

(d) EXOGAMOUS: between gametes of distinct broods only
(*Ulothrix*).

(e) ENDOGAMOUS: between gametes of the same brood only
(*Hydrodictyon*).

2. ANISOGAMY: the union of two gametes differing chiefly in size; the smaller (*micro-*) gamete is *male*, the larger (*mega-*) gamete, *female*.

3. HYPERANISOGAMY: the female gamete, at first active, comes to rest before fusion with the male (*Lower Melanophyceæ*).

4. OOGAMY: The female is never actively motile; the male is termed a *spermatozoon*, the female an *oosphere*.

From another point of view karyogamy is—

5. ZOOIDIOGAMOUS: one gamete at least is actively motile (flagellate, ciliate, or amoeboid).

6. SIPHONOGAMOUS: karyogamy is effected by a tubular outgrowth from one or both of the gametes (*Phanerogams*).

¹ Examples are only given in cases where it is necessary, from the introduction of new terms, or where the examples are not generally familiar.

II. In apocytial fungi multinucleated masses of protoplasm (*gametoids*) may conjugate to form a *zygotoid*, by a siphonogamous process. The union may be *isogamous* (most *Mucorini*), or *anisogamous* (*M. heterogamus*, Vuill, some *Chytridiæ*).

III. Gametes may be classified as follows:—

A. According to their formation—

1. **EUSCHIST**: formed by repeated complete divisions from a parent cell, the gametogonium.
 - (a) **EUTHYSCHIST**: each nuclear division is accompanied by cell division.
 - (b) **BRADYSCHIST**: the nuclear divisions are completed before any cell division takes place (spermatozoa of *Lumbricus*).
 - (c) **ISOSCHIST**: the brood-cells of a gametogonium are all equal and functional.
 - (d) **ANISOSCHIST**: the brood cells are unequal, some of them being reduced to aborted or degraded gametes (spermatozoa with 'nucleated blastophore,' 'ovum' with polar bodies of most Metazoa).
2. **HEMISCHIST**: the divisions are limited to the nucleus, none occurring in the cytoplasm (ovum with polar nuclei of many Arthropods).
3. **APOSCHIST**: the cell divisions do not occur, but a cell directly assumes the behaviour of a gamete (*Volvox*).
4. **SYMPHYTIC**: the gameto-nucleus is formed by the fusion of several nuclei (oogametes of *Peronospora*, isogametes of *Dasycladus*).

B. According to their behaviour, as—

1. **FACULTATIVE**: retaining the power of development if karyogamy fails to occur.
2. **OBLIGATORY**: with no power of independent development.

IV. **PARAGENESIS** will include the following modes of rejuvenescence, usually grouped under the terms 'parthenogenesis,' 'apogamy' (*pro parte*), &c.:—

A. **TRUE PARTHENOGENESIS**: the direct development of a facultative gamete without karyogamy. This may occur in the case of—

- (1) Isogametes; (2) Anisogametes, male (microgametes of *Ectocarpeæ*), and female; (3) Oogametes (*Liparis*, drone egg).

B. **SIMULATED PARTHENOGENESIS**:—

1. **CELLULAR**: a cell assumes directly the behaviour of a zygote (azygospores of *Conjugatæ*).
2. **APOCYTIAL**: a multinucleate mass of protoplasm assumes directly the behaviour of a zygote (azygospores of *Mucorini*).

C. **METAGAMETAL REJUVENESCENCE**:—

1. **UNICELLULAR**: a single cell in the neighbourhood of the gamete assumes the form and behaviour of the zygote (formation of 'adventitious embryos' in embryo-sac of *Funkia*, *Citrus*, and *Calebogyne*).
2. **MULTICELLULAR**: a mass of cells in the position where gametes should be produced, assumes the character of the young organism formed by the zygote ('Apogamy' in prothallus of *Pteris cretica*, &c.).

D. **PARAGAMY** or **ENDOKARYOGAMY**: vegetative or gametal nuclei lying in a continuous mass of cytoplasm fuse to form a zygote nucleus.

1. Progamie paragamy: the fusing nuclei are the normal gameto-nuclei of the progamous cell (ovum which has formed one polar body in *Pterotrachæa*, *Astropecten*).
2. Apocytial paragamy: the vegetative nuclei of an apocytium fuse to form a zygote nucleus ('oospores' of *Saprolegniæ*).

4. *On Recent Investigations of the Marine Biological Association (Fishery and Physical)*. By W. L. CALDERWOOD, Director.

1. *Fishery Investigations*.—In the absence of general returns as to the increase or decrease of any particular fishery in a given locality, we at Plymouth are from time to time discussing the local fisheries. Papers have now been published on the mackerel, herring, long-line, *i.e.* cod, conger, skate, &c., pilchard, and lobster fisheries, the object being to show, as time goes on, any changes that may take place in the relative abundance of the various fishes.

Three investigations, started within the present year, which it is hoped will prove of great value to the fishing population of this country, are:—

a. The attempt to produce an artificial bait for use in long-line fishing. This investigation is being carried on by a chemist from Professor Meldola's laboratory. Considerable advance has been already made towards a satisfactory solution of this difficult problem.

b. An inquiry into the occurrence of anchovies off the south-west coast of England. At present no net small enough in the mesh to capture anchovies is employed, but these fishes appear so often when the ordinary pilchard nets become entangled, as to suggest that they must be present in considerable quantities. Anchovy nets have therefore been constructed and will be used during the pilchard season this autumn.

c. An investigation into the condition of the North Sea Fisheries, at present declared to be rapidly declining:—

1. To draw up a history of the North Sea trawling grounds, comparing the present condition with the condition, say, twenty to thirty years ago, when comparatively few boats were at work.
2. To continue, verify, and extend observations as to the average sizes at which prime fish (soles, turbot, brill) become sexually mature.
3. To collect statistics as to the sizes of all fish captured in the vicinity of the Dogger Banks and the region lying to the eastward, so that the number of immature fish annually captured may eventually be estimated.
4. To make experiments with beam-trawl nets of various meshes, with a view to determine the relation, if any, between size of mesh and size of fish taken.

2. *Physical Investigations*.—A regular survey of the English Channel has been commenced not only in the deep water but in the various estuaries.

A Meteorological Station of the second order has been recently established where observations at 9 A.M. and 9 P.M. will be taken daily with wet and dry bulb thermometers, barometer, rain-gauge, anemometer, and sunshine recorder.

5. *On the Growth of Food-fishes and their Distribution at different ages*. By J. T. CUNNINGHAM, M.A.

As the result of observations extended over the past two years, I have reached some conclusions as to the rate of growth of certain food-fishes, the age at which they begin to breed, and their distribution at different ages.

(1) *Rate of growth and age of sexual maturity*.—Numerous specimens of the Flounder (*Pl. flesus*), were reared from the larval state in the Aquarium of the Plymouth Laboratory. Measured in April, when a year old, they varied from 4 to 19 cm. (about 1½ to 7½ inches). Specimens obtained in the Cattewater, and

known to be not less than a year old, are from 12 to 19 cm. in length. None of these captive flounders nor any taken in the Cattewater were sexually mature, but, according to Dr. Fulton, of the Scottish Fishery Board, sexually mature flounders have been observed which were only 7 inches long. I conclude therefore that (a) the rate of growth varies greatly for different individuals, but its maximum for the first year is 19 cm. or $7\frac{1}{2}$ inches, (b) sexual maturity is not reached till the end of the second year, although the minimum size of sexually mature individuals may be slightly exceeded by some specimens in one year's growth.

I have obtained similar results for the Plaice (*Pl. platessa*) and the Dab (*Pl. limanda*).

(2) *Distribution*.—The young of the above-mentioned species in their first year, and of certain round fish, especially *Gadus luscus* and *G. minutus*, occur in shallow water, within the 10-fathom line. But there has hitherto been considerable difficulty in obtaining young specimens of other more valuable species in order to study their rate of growth. These species, namely, the Sole, Turbot, Brill, Lemon Sole, Megrim (*Arnoglossus megastoma*), do not pass the first year of their lives in shallow water. I have obtained young Soles in the larval state in tidal pools at Mevagissey, and young Turbot and Brill 2 to 3 cm. in length are commonly found from June to August in Plymouth Sound and Sutton Pool, swimming at the surface in a semi-metamorphosed stage. Soles a little over 16 cm. in length are frequently taken in Plymouth Sound in summer; these are just over one year old and are not sexually mature. Turbot 23 to 34 cm. long I have taken in 5 to 7 fathoms; these also are over one year old and not sexually mature. But the young stages between 3 months and 12 months old have not been taken in shallow water, and apparently live at depths greater than 10 fathoms. It seems that our commoner and more valuable food-fishes do not attain to sexual maturity till the end of their second year, that their size at this age is subject to great individual variation, and that the young in the first year of growth have a characteristic distribution. Investigation of the deeper water from this point of view is now being carried on at Plymouth.

6. *The Reproduction of the Pilchard.* By J. T. CUNNINGHAM, M.A.

In a paper published in the 'Journal' of the Marine Biological Association in 1889, I described the egg of the Pilchard, obtained from the sea by the tow-net, and identified by comparison with the mature egg taken from ripe female Pilchards. The distinguishing features are four in number: (1) size 1.65 to 1.72 mm. in diameter, (2) the very large perivitelline space, (3) the vesicular composition of the yolk, (4) the large single oil-globule in the yolk.

Professor Pouchet, who has studied the Sardine at the Marine Laboratory of Concarneau, persists in denying that this egg obtained by me is that of the Pilchard, believing that the egg of the Sardine or Pilchard is not pelagic.¹ My identification confirmed that suggested by Raffaele from observations at Naples. Marion at Marseilles² has entirely confirmed my results and also traced the growth of the Sardine at that place, showing that it reaches a length of 9 to 13 cm. in one year. This year at Plymouth, in June, I obtained ripe female Pilchards, but no males. However, I placed the ripe unfertilised ova in clean sea-water, and found that after twenty-four hours the ova were alive and floating, the perivitelline space was formed, and the eggs presented all the characteristic peculiarities I had previously attributed to the ova of the Pilchard. I also at the same time obtained the same eggs in process of development from the sea, by means of the tow-net. In July I obtained the alevins of the Pilchard at the surface near the Eddystone, a number of specimens varying from .8 to 2.5 cm. in length. I hope to trace their further growth and compare it with that of the Mediterranean Sardine. The ripe Pilchards at Plymouth are 23 to 25 cm. long, ripe adult Sardines in the Mediterranean are only 15 to 18 cm.

¹ See 'Rapport sur le Lab. de Concarneau for 1889,' in *Journal d'Anat. et de Physiol.*, 1890.

² *Annales du Musée d'Histoire Nat. de Marseille, 'Zoologie Appliquée,'* 1891.

7. *Observations on the Larvæ of Palinurus vulgaris.*

By J. T. CUNNINGHAM, M.A.

On July 9 and 16 of the present year I obtained a large number of the *Phyllosoma* larvæ of *Palinurus vulgaris*. Previously, in the summer of 1889, the eggs of this species were hatched in the tanks of the Plymouth Laboratory of the Marine Biological Association, and I preserved a number of the newly hatched larvæ. The latter are 3.1 mm. in length from the front of the *cephalon* to the end of the abdomen. The largest of these taken in the sea are 7 mm. in length. I find that the first maxilliped is not absent altogether at any of the stages I have obtained; it is represented in the newly hatched larvæ as a small but distinct conical process, and does not increase or decrease in any way up to the oldest stage I have obtained. In the *Phyllosoma* of 7 mm. the antennæ are more developed, the fourth and fifth ambulatory appendages, present at hatching as minute processes, have developed considerably, the fourth being already biramous. Richter's statement therefore ('*Zeitsch. f. wiss. Zoologie*,' 1873) that the first maxilliped is entirely absent in *Palinurus phyllosoma* in the earliest stages is not true in the case of *P. vulgaris*. I find also that stages of *Phyllosoma* figured and described by Claus (*ibid.*, 1863) from 3.5 mm. to 21 mm. in length, are certainly larvæ of *P. vulgaris*, although this identification seems never to have been definitely made before.

8. *Distribution of Crystallogobius Nilssonii, Gill.*

By J. T. CUNNINGHAM, M.A.

I obtained this species in large numbers on July 9 of the present year when trawling with a small beam-trawl about two miles north of the Eddystone, in about twenty-seven fathoms of water. Day mentions only one specimen found in British waters, namely, one taken by Thos. Edward in a rock-pool at Banff. This specimen was a male. The species is distinguished by having only two rays in the anterior dorsal fin in the male, this fin and the pelvic fins being rudimentary in the female. The fish is quite transparent when alive, and scaleless; the mature male is about 4 cm. in length, the female smaller. There is a good paper on the species by R. Collett, of Christiania, in '*Proc. Zool. Soc.*' for 1878. It is there stated that the fish is fairly common in the Christiania Fjord, thirty specimens having been taken there. A few specimens have been taken near Bergen, at Christiansund, and also in Bohuslan, in Sweden. I took in a single haul about 100 specimens, more than all those that had been taken in Norway and Sweden since 1843, when the species was first discovered. All my specimens were adult or nearly so, which agrees with Collett's conclusion that the fish is an annual, dying after breeding. Mr. E. W. L. Holt also took many specimens of the same species in Ballinskelligs Bay, thirty fathoms, on August 21, 1890. The shrimp trawl used by me was lined inside with mosquito netting, on purpose to retain small animals. Probably the species is fairly abundant between twenty and thirty fathoms, on smooth sandy ground, all along the British and Irish coasts.

MONDAY, AUGUST 21.

The following Papers were read:—

1. *Facts regarding Prothalli and the Propagation of Ferns.*

By E. J. LOWE, F.R.S., F.L.S.

Occasionally in a batch of seedling ferns there will occur several plants of some strangely marked variety identical in their characters and growing so closely together that it is difficult to separate them. I have long suspected these were produced on the same prothallus; indeed this seemed evident in four instances of

remarkable seedling *Athyrium*s, yet the development was too far advanced for absolute certainty. To examine this carefully, a number of *Scolopendrium*s were planted in the prothallus state, and on the young fronds appearing, two were noticed identical in character and unusual in form, which when examined were found to have their origin in one well-developed prothallus. With a penknife it was possible to divide the prothallus so as to secure the two plants, which were planted in a pan and have not since been disturbed.

Prothalli were then planted from a pan of mixed muricate and undulate *Scolopendrium*s, and these were divided before the formation of fronds into two equal parts, in some examples the two plants resulting were alike, in others they differed but showed their muricate and undulate origin.

The next experiment was dividing the prothallus into four equal parts. This was done in January 1888. Every division grew and spread in a more bush-like manner than is the case with undivided prothalli, but up to July 1890 there was no sign of any frond. It appeared evident that the male and female organs of generation were on separate divisions. To test this, in May 1890 another prothallus was planted in close proximity to one of these, in fact made to actually intermingle, and in August fronds appeared. The other divisions except four were similarly treated, and all have now produced fronds. The spores had been sown in August 1887, and divided on January 12, 1888, so that the prothallus exhibited has been in this condition four years. The usual time from prothallus to frond being only a few months.

In an interesting example of the lady fern (alluded to in the next paper), a prothallus produced three plants exactly alike and having two kinds of fronds. It was from a mixture of eight varieties, and these show the parentage of six, and now and then seven. They have the lax pinnæ of *uncum*, the cruciate pinnæ of *Victoria*, the projected pinnæ of *projectum*, the lunulate pinnules of *Frizellia*, the cruciate pinnules of *erucipinula*, the truncate terminals of *truncatum*, and occasionally the crested of *multifidum*. This fern has reproduced six and occasionally seven characters. According to the doctrine of probability it is 720 to 1 against the production of six varieties on the same plant, and 5,040 against seven.

Turning to other means of reproduction, experiments are required in order to ascertain why the bulbils that form on some fronds do not always produce plants like the parent, and why it is possible to transfer the bulb-bearing character to other varieties. *Scolopendrium densum* often produces much more coarse and less divided ferns than itself. [*Densum* and one of its coarse bulbils were exhibited.]

The beautiful plumose shield fern known as *plumosodivisolobum* has produced two plants from its bulbils that are strikingly distinct from the parent and each other; one is densely imbricate and procumbent like the parent, whilst the other is as finely divided as *Todea superba*, and is erect in habit.

Again, aposporous plants, that is those raised from the prothalli direct without the intermediate spore, also vary. [An aposporous plant of *Clarissima* of the Lady fern was described.] Even plants raised from bits of the stipes of plumose *Scolopendrium*s produced a marginal belt.

There are so many truths yet to learn with regard to ferns that it is desirable that some younger man should take up these inquiries.

2. On Ferns and their Multiple Parents. By E. J. LOWE, F.R.S., F.L.S.

Colonel Jones and myself read a joint paper on abnormal Ferns at the Bath meeting of the British Association, which is printed in full with illustrations in the third volume of the 'Annals of Botany.' The present paper is a report on further experiments, and of the surprising discoveries that have resulted.

Since 1887 other hybrids have been obtained, and although these hybrids are more or less sterile, a few plants (grandchildren of the original parents) have been raised, and they differ so much from the parent that nearly all resemblance has disappeared. What will be the characters of the great-grandchildren is now in course of proof. It is very different in the case of the offspring of crossed varieties:

they are copiously fertile, and when sown alone reproduce their varietal form. Not only have certain forms been imparted to other Ferns, but even variegation, notably so in the Shield Fern and the Hart's-tongue. In the latter spores from a normal but variegated form were sown thickly with a plumose (or crispum form) and a branching form, and their offspring have become variegated. By sowing a muriate and a plumose Hart's-tongue together, muriate plumose varieties have also resulted.

For illustrating multiple parentage the Hart's-tongue has been selected, as the simple, strop-shaped fronds are best able to show the various departures from the normal form.

In repeating the experiment of mixed spores the varieties in each case have been limited to three or four, so that the resultant changes could be more narrowly investigated. Distinct mixtures were sown in 1887, 1888, 1889, and 1890, and the results in all the experiments established the fact that the antheridia of more than one variety have assisted in the impregnation. The varieties had conspicuously distinct characters, and in the example of 1888 the spores were gathered from a dwarf spiral form, a muricate or warty form, an undulate and a ramose one; more exactly speaking, the varieties were *spirale*, *undulatum*, *muricatum*, and *keratoides*. The parents were exhibited as well as three of their children, the latter having the names of *quadriparens*, *Darwiniana*, and *echinatum*. These unmistakably show on each plant the characters of the whole four parents. In the hundreds of these seedlings, as might be expected, the majority show only the characters of two parents, in a less though considerable number the characters of three, whilst a small number exhibit those of the four parents. The plants in the 1889 experiments are from a muricate, a branched, and a cup-bearing form, known as *periferens*, the object being to obtain cups on a branching muricate Fern, as this was a desideratum. There was no previous example of more than one cup on a frond. In the seedlings a divided frond can be observed with cups on each division, a tasselled form with a rosette in place of an actual cup, and in another example a marginal row of small cups; and all are muricate. It is worth remarking that the seedlings from mixed spores never seem to produce any plants that exactly resemble any one variety; they are all combinations; in other words, antherozoids from a number of different antheridia are required for fertilisation. In sowing varieties of the Lady Fern I have raised the combination of five and six. This is alluded to in my paper 'On Prothalli.' These plants that give evidence of multiple parentage were obtained in the identical manner formulated before they had any existence. Spores require to be sown thickly to enable the prothalli to intermingle, otherwise they are only fertilised from the same prothallus. If we take the reasoning of Sir John Herschel on the doctrine of probability, and apply it to these experiments, the chances against the reasoning adopted being incorrect are as great as that of the haphazard distribution of the stars. These experiments regarding the changes in animal and vegetable life were commenced forty years ago. Bearing to some extent on this subject, experimenting on the Mimulus, a yellow variety was crossed with a spotted one, and the seedlings were spotted; later on, and further up the same stem, two blooms were this time crossed with a yellow one, but the seedlings were still spotted. The effect of the first cross had become a part of the life-history of the plant; in a second experiment the same plant was simultaneously crossed with pollen from two other varieties, and several of the seedlings are combinations of the three. It requires dexterity in crossing the Mimulus, as the pistil is as sensitive as the sensitive Mimosa. Natural changes are slow, but culturally we can accelerate that process that continues age after age. The germ once changed, the new element is retained, which becomes combined with others until the normal appearance is lost. The illustration of the Hart's-tongue shows this alteration, helped on as it were by artificial means that have accelerated the process, and these changes will continue whilst the world lasts. Affectionate respect causes tablets to be erected in memory of the departed, but age obliterates this record. It is, however, far different with the philosopher who has discovered great truths; he has erected a monument to himself 'more lasting than brass.' Time wears away the hardest

rock, but it will require the crumbling of this world to obliterate the truths that have been taught by Charles Darwin.

3. *The Ciliated Organs of the Leeches.* By Professor GILSON.

It is well known that the segmental organ of the *Chetopods* terminates in the cœlum in the form of a funnel-shaped and ciliated structure.

In the leeches, on the contrary, though it is generally taught that there exists a similar feature, our knowledge of it is imperfect.

Several authors confess that they have not been able to detect in these worms any relation between the segmental organ and certain ciliated bodies that have been regarded by others as terminal funnels or nephridiostome.

I have undertaken with one of my pupils, Dr. Bolsius, several researches in order to resolve if possible that interesting question. I shall content myself with an extremely short account of the results we arrived at up to the present as regards the genus *Nephelis*.

The ciliated organs of the *Nephelis* are not funnel- but cup-shaped bodies, with a non-perforated bottom. The sides of the cup are composed of large bilobed cells. The bottom, on the contrary, consists only of smaller and non-ciliated cells.

This cup lies enclosed in the cavity of a large vesicle, from the sides of which it vibrates freely, being only suspended by a small number of large connective cells. The vesicle is only a dilatation of one of these non-contractile blood-vessels that represent, according to the view of Dr. Bourne, the greatly modified cœlum of the leeches. It lies at a certain distance from the segmental organ, and is ordinarily separated from the same by muscles or connective cells.

The result of these observations is that the ciliated organs of the *Nephelis* deserve by no means the name of funnels, and that there is no anatomical connection between them and the segmental gland.

We can assert also that this gland does not open into the cœlum, at least not in certain genera of leeches, and especially the *Nephelis*, as it does in the well-known case of the *Chetopods*.

The absence of connection between the ciliated bodies and the segmental gland seems to be a result of the profound modification the cœlum undergoes in these remarkable forms of annelids.

The terminal or cœlomic part of the segmental organ is separated from the rest of the gland, and as this separation is not followed by immediate degeneration of the nephridiostome, it seems evident that the latter—that is to say, the cup-shaped organ—acquires at the same time a new significance and another physiological function.

As regards this new function we may propose two hypotheses which do not exclude each other:—

1. The cilia cause the blood to run through the non-contractile capillaries; at least they help its motion through the cœlomic system.

2. The organ is a place of proliferation of the blood-cells.—In fact the cup-shaped organ is ordinarily crowded with blood-corpuscles, the nuclei of which are often remarkable for their chromatophile power. We detected also amongst them several phases of karyocinesis.

These results, I think, are noteworthy for anyone who is interested with the position of the formation and evolution of the segmental organs and with the kidney-theory. They will soon be published in full in the Louvain Review 'La Cellule.'

4. *Some Points in the Early Development of Mus musculus and Mus decumanus: the Relation of the Yolk Sac to the Decidua and the Placenta.* By ARTHUR ROBINSON, M.D.

1. At the seventh day the ovum consists of a large yolk sac and a small mass of primitive epiblast which rests upon one pole of the ovum. The ovum is con-

tained within a crypt in the distal wall of the uterine cavity, and the uterine epithelium is disappearing from the walls of the crypt.

2. A few hours later the primitive epiblast divides into formative epiblast and trophoblast.

3. During the latter part of the seventh day the trophoblast rapidly increases, becomes closely attached to the decidua, and pushes the formative epiblast towards the yolk sac, which becomes invaginated. The non-invaginated portions of the yolk sac lie in direct contact with the decidua, in which numerous slit-shaped blood spaces have appeared.

4. In the early part of the eighth day the walls of the ovular crypt, which sprang from the distal side of the uterine cavity, fuse with the proximal wall of that canal, and thus the crypt is converted into a closed space, and the continuity of the uterine canal is interrupted. The greater part of this space is occupied by the ovum, but at the mesometrial and anti-mesometrial ends portions of the cavity remain, and are transformed into maternal blood sinuses. The blood in the mesometrial sinus bathes the proximal end of the trophoblast, and that in the anti-mesometrial sinus bathes the distal end of the yolk sac. Further, by the disappearance of the inner wall of the slit-shaped spaces at the sides of the yolk sac the maternal blood is brought into direct relation with a large part of the circumference of the yolk sac, and spaces which have in the meantime appeared in the trophoblast also become filled with the same fluid.

5. During the ninth day the coelom is formed, and the allantois, which is a solid mass of mesoblast containing no diverticulum from the alimentary canal, grows into the coelom, but it does not become attached to the trophoblast until the eleventh day.

6. Between the ninth and the seventeenth days the decidua reflexa gradually separates from the distal wall of the uterus, and the continuity of the uterine canal is re-established. The decidua reflexa is reduced to a thin membrane, and the circulation within it ceases. When these changes are accomplished the distal part of the vitelline cavity is obliterated by the apposition of its walls, but the proximal portion remains; and by means of diverticula, which project from it into the placenta, the intimate relation of the yolk sac to the maternal blood is maintained after the circulation in the decidua reflexa has terminated.

7. The close relation of the yolk sac to the maternal blood suggests the idea that the sac itself is an important agent in the early nutrition of the embryo, and the peculiar relationship of the hypoblast to the placenta indicates the possibility that the hypoblast cells play some special part in embryonic nutrition.

5. *Observations upon the Development of the Spinal Cord in Mus musculus and Mus decumanus: the Formation of the Septa and the Fissures.* By ARTHUR ROBINSON, M.D.

1. At the eleventh day the spinal cord is a hollow rod of nucleated protoplasm.

2. Within a few hours the neuroblasts are differentiated.

3. On the twelfth day the formation of the grey matter commences, and the rudiments of the white columns appear.

4. The antero-lateral white columns consist of nerve fibrils derived from the neuroblasts of the cord embedded in a spongioblastic reticulum.

5. The posterior white columns are formed by the processes of the neuroblasts of the spinal ganglia.

6. *The spongioblasts of the dorsal and ventral walls of the central canal are drawn out into two septa, an anterior and a posterior, which extend respectively to the ventral and dorsal surfaces of the cord.*

7. The extension of the anterior septum is due to the formation of the anterior commissures and the shrinking of the central canal.

8. The extension of the posterior septum is due principally to the formation of the posterior columns, but also to the formation of the posterior commissure and the shrinking of the central canal.

9. The anterior septum does not form a complete partition between the two sides of the cord. It is traversed by the transverse fibres of the commissures.

10. The posterior septum is traversed by the transverse fibres of the posterior commissure, but it forms a complete partition between the posterior white columns.

11. *There is no posterior fissure, and the posterior septum is not a septum of pia-mater, but of spongioblastic fibrils; it is, therefore, essentially a portion of the cord substance, not of its sheath.*

12. The anterior fissure is formed in the usual manner, and contains a fold of pia-mater.

6. *On the Innervation of the Epipodial Processes of some Nudibranchiate Mollusca.* By Professor W. A. HERDMAN, D.Sc., and J. A. CLUBB.

In 1889 one of us (W. A. Herdman) read a paper at the Newcastle-on-Tyne meeting of the British Association on the structure and functions of the cerata in Nudibranchs, in which these dorso-lateral processes were regarded as being probably epipodial outgrowths. In other papers published since we have compared the conditions of these structures in various genera of Nudibranchs, and have tried to show that they are all modifications of simple lateral epipodial ridges.

The question has, however, been raised lately by Pelseneer and others as to whether the so-called epipodia of mollusca are all homologous structures, and one of the subjects of controversy now is the origin of the nerve supply in various forms, it being supposed that where the processes are innervated from the pleural ganglia they are pallial in their nature, and where supplied from the pedal ganglia they are to be regarded as outgrowths from the foot.

Consequently, it seemed to us of importance to determine afresh the origin of the nerves supplying the cerata in several different types of Nudibranchiata, especially as the results of former investigations, depending entirely, we believe, upon minute dissection, are puzzling, and to some extent contradictory. We have traced the nerves from the ganglia, by means of serial sections, in representatives of the genera *Polycera*, *Ancula*, *Tritonia*, *Dendronotus*, and *Eolis*, with the following results:—

In *Polycera quadrilineata* the cerebral and pleural ganglia are completely fused to form a cerebro-pleural mass. The 'epipodial' nerves are found arising from the ventral and posterior part of this mass (*i.e.* distinctly from the pleural ganglia), and they run along the sides of the back to supply the ceratal ridges.

In *Ancula cristata* the pleural ganglia are fairly distinct from the cerebral. In a specimen cut into about 500 sections, we find in the 100th section or so from the anterior end six distinct ganglia (the cerebral, pleural, and pedal pairs) surrounding the oesophagus. A few sections further back the cerebrals disappear, and then the epipodial nerves are found arising from the dorsal edge of the pleural ganglia. The nerves soon turn posteriorly, and then give off their first branches dorsally. These branches enter the mesoderm of the body wall, and can then be traced back through over a hundred sections to the first pair of cerata, which they enter. The main nerve passes back to the remaining cerata.

In *Tritonia* and *Dendronotus* also the epipodial nerves arise from the pleural ganglia; but in *Eolis* (or *Facelina*) *coronata* we find that the main nerves to the cerata arise distinctly from the pedal ganglia. We have also traced in the same series of sections the ordinary pedal nerves to the foot proper, so there can be no question as to the nature of the ganglia from which the nerves arise. The epipodial nerves spring from about the middle of the pedal ganglion, rather on the dorsal surface, and, after a short course, pass through the muscular layer of the body wall and are distributed to the clumps of cerata.

But in addition to these main epipodial nerves in *Eolis*, we find also a nerve arising from the compound ganglionic mass, immediately ventral to the eye (probably therefore from the pleural element), which goes to the front cerata. This pleural nerve has its origin distinctly anterior to the origin of the main epipodial nerves from the pedal ganglia.

We arrive, then, at the curious result that the innervation of the ceratal processes is not the same in all these Nudibranchs. In *Polycera*, *Ancula*, *Tritonia*, and *Dendronotus* the epipodial nerves arise from pleural ganglia, or from the ventral and posterior parts of cerebro-pleural masses; while in *Eolis* the chief epipodial nerves are from the pedal ganglia, but there are also smaller nerves from the pleurals. In the ordinary Rhipidoglossate gastropod, such as *Trochus*, the epipodial ridges and processes are supplied, according to Pelseener, by nerves arising from the dorsal part of the elongated pedal ganglia. So, judging from the nerve supply alone, it might be said that the cerata of *Eolis* are pedal in their nature, and homologous with the epipodial processes of *Trochus*, while those of *Ancula* and the rest are totally distinct structures of pallial¹ origin. But these dorso-lateral processes in the various Nudibranchs are so much alike in their relations, and are connected by such series of gradations, that it is difficult to believe that they are not all homologous, and the presence of the accessory epipodial nerve in *Eolis* arising from the pleural ganglion suggests the possibility of another explanation, viz., that these outgrowths, starting at first as pedal structures innervated by nerves from the pedal ganglia, may have acquired, possibly as the result of having moved further up the sides of the body, a supplementary nerve supply from the adjacent integumentary nerves arising from the pleural ganglia, and this supplementary supply, while remaining subsidiary in *Eolis*, may in the other types have gradually come to supplant the original epipodial nerves, which are now no longer found in such forms as *Polycera* and *Ancula*. This is at present only a suggestion, which, however, we hope to be able either to disprove or support by the examination of the nerves of a number of additional Nudibranchs.

7. *Exhibition of a New Apparatus for Opening and Closing a Tow-Net by Electricity.* By W. E. HOYLE and L. F. MASSEY.

8. *Exhibition of, and Remarks upon, some Young Specimens of Echinidna aculeata.* By Professor W. N. PARKER, Ph.D.

The specimens are from the collection of the late Professor W. K. Parker, who received them from Dr. E. P. Ramsay, Curator of the Australian Museum, Sydney. They are much curved towards the neutral side, the snout pointing backwards, and the tail, in the older of the two stages, forwards. The younger stage measures along the dorsal curve, from the end of the snout to the tip of the tail, 12 cm., the greatest diameter of the body being 3 cm.; the corresponding measurements of the older stage are respectively 21.5 cm. and 6 cm. In the latter the body is covered with short scattered bristles. In both stages the snout is very similar in form to that of *Ornithorhynchus*, and is covered by a thick horny layer, but in other respects the specialisation characteristic of *Echinidna* is already apparent. The gape is narrow, and extends only a short distance down the snout, and the manus, even in the younger stage, is already much larger and stronger than the pes. The tail is short and conical. There is no caruncle, or 'egg-breaker,' in the snout, such as is seen in *Ornithorhynchus*.

A few points in the structure of the fore part of the head in the older stage were described. The mouth has the narrow and tubular form seen in the adult, and the long tongue has a horny tip. The glands in relation with the mouth and nose are very numerous. There is no trace of any teeth-rudiments, and in many other respects the structure of the head shows extreme specialisation. Jacobson's organ is large and highly developed; a well marked 'turbinal' is present in it.

¹ *I.e.* dorsal to the foot, whether there is a distinct pallium present or not.

9. *Experiments on Respiration in Tadpoles of the Common Frog (Rana temporaria)*. By Professor W. N. PARKER, Ph.D.

After referring to the great power of adaptation to external conditions seen amongst amphibious larvæ, the author described some experiments on frog tadpoles, which, although not yet complete, show as follows:—

1. Soon after the lungs become functional—i.e. in tadpoles measuring more than 20 mm. in length—the gills are no longer sufficient for purposes of respiration, and the animals die in a very short time if prevented from coming to the surface to breathe.

2. If tadpoles are prevented from using their lungs from an earlier stage onwards the gills remain perfectly functional, and development proceeds as usual. At metamorphosis the fore limbs are slow in becoming free, owing to the retention of the operculum, that on the same side as the spiracle appearing first. Eventually a slit-like spiracle is present on either side. In respiration the mouth is opened and closed as in the tadpole. Specimens of branchiate frogs were exhibited in which the tail had shrunk to less than half its original length.

10. *On the Arrangement of the Living Fishes, as based upon the Study of their Reproductive System*. By Professor G. B. HOWES, F.L.S., F.Z.S.

On comparing the urino-genital organs of those Osteichthyes having a non-abbreviated kidney with the same organs of the higher vertebrata and the Elasmobranchs, the female genital duct and the kidney are seen to be inversely proportionate in length. No feature more fully characterises the development of the Müllerian duct than the accompanying abbreviation of the kidney and the disappearance of its head segment. The persistence of the last-named among the Osteichthyes, and its possible retention of the renal function in rare cases, taken in conjunction with the mode of development of the ovary duct in these fishes, point to the conclusion that the latter is in no way homologous with the Müllerian duct as ordinarily understood. Balfour's belief that the genital ducts are homologous in both sexes of the Teleostei is supported by the facts of anatomy; and comparison of the reproductive system of the Ganoids with that of the Teleosteans shows the two to be modifications of the same common type; and the absolute structural community of the parts in the males and females of the Sturiones, while further confirming Balfour's doctrine, is opposed to Jungersen's implication that the subtle differences in the mode of development of the ducts in the opposite sexes of the Teleostei are indicative of their non-homology.

The facts above alluded to justify us in regarding the genital ducts of the Osteichthyes not only as homologous in the two sexes and primarily independent of the genital glands, but as distinct structures *sui generis* probably unrepresented in all other vertebrates.

The Plagiostomi and Holocephali, in which vasa efferentia are present and the kidney becomes an accessory to reproduction in the male, may be grouped together into a *Nephrochidic Series*, as distinguished from an *Euthorchidic Series* embracing the Osteichthyes (Ganoids and Teleosteans). Comparison of the pori-genitales in relation to the coalesced ureters of the Marsipobranchii with the corresponding parts of the females of those Teleostei destitute of genital ducts, especially in consideration of the facts concerning the development of the parts recorded by Scott, Liszt, and others, supports Rathke's conclusion that the ancestors of the first-named fishes must have possessed genital ducts. The Osteichthyes, although specialised in respect to many features of their organisation, have, together with the Marsipobranchs, retained the least modified type of urino-genital system known for living vertebrates. W. N. Parker's recent and important discovery, that while in *Protopterus* a Müllerian duct is present vasa efferentia are absent, the testicular products being discharged through a duct more nearly comparable to that of the bony fishes than to the genital ducts of any other vertebrates, suggests that the development of vasa efferentia and the assumption of a genital

function by the Wolffian duct, may have been effected subsequently to the formation of the Müllerian oviduct. And further comparison of the Dipnoi with the Elasmobranchii suggests that the former may have struck off from the Holocephalic branch of the latter before the differentiation of the ancestors of its existing members.

The following diagram expresses the relationship of the reproductive system of fishes, as estimated upon the foregoing considerations:—

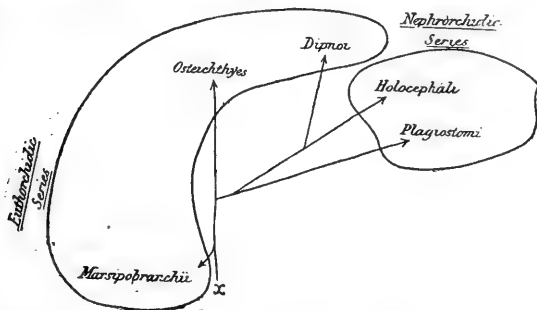

11. *On the Recent Visitation of Plutella Crucifera.* By W. FREEM.

TUESDAY, AUGUST 25.

The following Papers were read:—

1. *On the Artificial Production of Rhythm in Plants.*
By FRANCIS DARWIN and DOROTHEA F. M. PERTZ.

The apparatus employed is a new form of klinostat designed by the Cambridge Scientific Company. The plant to be experimented on is fixed to a spindle, which, by means of a clockwork escapement, makes a sudden semi-revolution every half hour. Thus the plant is subjected to a series of alternate and opposite influences from light or gravitation as the case may be. To take the case of gravitation, the plant will tend to curve upwards during the first half hour, and during the second interval (when the horizontal spindle has made half a turn) it will tend to curve geotropically in the opposite direction.

Under these conditions it is found that a rhythmic state is induced which closely resembles the periodicity in rate of growth which is set up in plants by the alternation of day and night.

A remarkable result is obtained by stopping the clockwork—that is to say, by substituting a continuous for a changing stimulus. The plant continues to curve with an acquired rhythm just as if the clockwork were still in action; it has, in fact, learned and remembered the half-hourly period. This is precisely similar to certain natural rhythms—for instance, to the 'sleep' of flowers, which for a short time continue to open and shut although kept constantly in the dark.

2. *On Floating Leaves.* By Professor MIALL, F.L.S.

3. *Notes on Internal Phloëm in the Dicotyledons.* By D. H. SCOTT, M.A., Ph.D., F.L.S., Assistant Professor in Biology (Botany), Royal College of Science, London.

The questions discussed in this paper are:—

(1) The relation of internal (or intraxylary) phloëm to the vascular bundles and to the pith. Do bicollateral bundles exist? Views of De Bary, Hérail, Van Tieghem, Weiss, and Lamounette. Cases in which internal phloëm is accompanied by centripetal medullary wood. Significance of this. Phylogenetic importance of Lamounette's view of the medullary nature of internal phloëm. Bearing of the question on general Dicotyledonous anatomy.

(2) Systematic importance of internal phloëm. Numerous orders in which this character is constant.

(3) Structure of the root in plants which have internal phloëm in the stem. Changes in the position of the phloëm in the transitional region. Plants which have internal phloëm in the root.

(4) Physiological significance of internal phloëm with reference to recent views as to the function of the phloëm in general.

4. *On the Occurrence of Diastase in Pollen.*

By Professor J. R. GREEN, M.A., B.Sc.

Though recent researches have led to the discovery of the various points of interest connected with the morphology of the pollen grain and the pollen tube, but little attention has been given to the details of its physiology. It is known that the contents of the ripe grain, besides its protoplasm, include proteid and carbohydrate bodies, the latter being in part starch, in part some form of sugar. That these are reserve materials, intended to be used during the growth of the pollen tube, seems to admit of no question. Indeed Van Tieghem has shown that like other storehouses of reserve materials, the pollen grain of some plants contains certainly one ferment or enzyme leading to the utilisation of these stores, the ferment invertase which is capable of inverting cane sugar.

Starch being of such frequent occurrence in pollen, attention was directed in the experiments now briefly to be summarised to the possibility of there being also present some form of diastase. The pollen taken for investigation was that of the lily and that of the sunflower. A starch paste of about 1 per cent. strength was the medium on which to test the action. In the first experiments the contents of one ripe anther of a lily were mixed with 5 c.c. of this paste and exposed in a test tube for some hours to the temperature of about 20° C. A precisely similar tube was boiled and set aside with the other to serve as a control. The diastatic action slowly became evident, the unboiled starch paste passed through the several stages of soluble starch and dextrin to sugar, the boiled one remaining unchanged. Sunflower pollen gave a similar result.

Diastatic action being so established, it remained to see whether diastase itself was present or whether the change was brought about by the pollen grain apart from such a body. Diastase being readily soluble in water or in glycerine, an attempt was made to prepare it from the pollen cells. A quantity of the pollen of the sunflower was collected and ground up between two glass surfaces with some dilute glycerine. When the pollen was completely broken up, as shown by microscopical examination, it was left in contact with the glycerine for twelve hours and then filtered free from *débris*.

A similar experiment to the first was then arranged, the glycerine extract being used instead of the pollen grains. In this case again, in the unboiled tube the starch gradually disappeared by the usual stages, and there was simultaneously a gradual and increasing appearance of sugar.

The germination of the pollen grain thus, so far as its reserve of starch is concerned, proceeds upon the same lines as the germination of the complex bodies which we know as seeds.

Further experiments are in progress which will deal with the fate of the nitrogenous and fatty reserves, and further with the subsequent growth of the pollen tube and the way in which this latter structure is enabled to avail itself of the nutritive materials among which it finds itself during its passage down the tissue of the style.

5. *The Presence of a Diastatic Ferment in Green Leaves.*

By S. H. VINES, M.A., F.R.S.

The author was led to investigate this point in consequence of the statement recently made by Wortmann¹ that green leaves either do not contain any diastatic ferment, or contain it in so minute a quantity that its physiological importance is practically *nil*. Wortmann accounts for the well-known fact that starch is transformed into sugar in green leaves by attributing the chemical change to the direct action of the living protoplasm.

The author's observations lead him to the quite contrary conclusion, viz., that diastatic ferment is present (probably at all times) in green leaves; and that its physiological activity is so well marked that it appears superfluous to invoke, as Wortmann does, the direct action of the protoplasm in the conversion of starch into sugar in the living leaf.

The author's method of experimentation consisted in mixing equal volumes of leaf-extract and starch-solution; and then, after the mixture had been allowed to stand for some hours, volumetrically determining the amount of sugar present by means of standard Fehling's solution.

The leaf-extract was prepared by triturating leaves with distilled water (100 c.c. of water to 100 grammes of leaves), and then at once pressing the mass through a strainer. A turbid, more or less acid extract is thus obtained. In the earlier experiments a filtered clear extract was prepared; but filtration was abandoned, for it was found that a clear extract was much less active than a turbid extract. Probably Wortmann's negative results are to be mainly ascribed to the use of filtered extract.

The starch-solution was prepared by boiling starch with distilled water, in the proportion of .5 gramme of the former to 100 c.c. of the latter. The vessel was closed with a plug of cotton-wool whilst the liquid was boiling, to prevent the access of bacteria, and was allowed to cool for some hours; a certain amount of sediment was deposited at the bottom of the vessel, but only the nearly clear supernatant liquid was used for experiment. The starch used appeared, on microscopical examination, to consist of a mixture of wheat-starch with some potato-starch.

The mixture of leaf-extract and starch-solution was usually allowed to stand all night (about fourteen to sixteen hours). A sample of the leaf-extract, diluted to the corresponding strength, was in all cases analysed for sugar, and in most cases a larger or smaller amount of sugar was found to be present in it. In some cases a control experiment was made in which the leaf-extract had been *boiled* before being mixed with the starch-solution; in these cases the amount of sugar ultimately determined did not exceed that found to be originally present in the leaf-extract, thus showing that the boiled extract had not affected the starch. In others, again, thymol or boracic acid (.5 per cent.) was added to the mixture in order to prevent any possibility of the interference of bacteria; in these, the amount of sugar ultimately determined was about the same as that in the simple mixture of leaf-extract and starch-solution alone, showing that the results obtained were not in any degree due to the action of bacteria. The whole experiment was generally completed within twenty-four hours, and the flasks containing the mixture were not artificially heated but were kept on the laboratory table during the night whilst the action was proceeding.

In his experiments Wortmann made use of the colour-reactions, given with iodine by solutions of starch and dextrin, for the purpose of determining the amount of action, if any, of the leaf-extract on the starch-solution. The author, however, discarded this method altogether; for, according to Wortmann's own

¹ *Bot. Zeitung*, 1890.

showing, it is not one which can give satisfactory results; he preferred the more laborious but more definite method of determining the sugar present by means of standard Fehling's solution. This method involved careful preparation of the liquids to be tested, so that they should be quite clear and colourless. At the close of the period of digestion, the liquid was neutralised with lime-water, and then boiled and filtered through 5 grammes of recently ignited animal charcoal until all the colour was removed; the charcoal was well washed, the washings being added to the filtrate, which was then made up to standard volume, when it was ready for the determination of sugar. The liquids belonging to each experiment were all simultaneously treated in precisely the same manner. The determination of sugar was effected by allowing the liquid to drop from a graduated burette into a fixed quantity of boiling standard Fehling's solution, continuing the boiling for three minutes. The purity and the uniform strength of the Fehling's solution were carefully attended to. The amount of the reducing substance was, in all cases, calculated as dextrose.

In order to determine whether or not the substance in the liquids which reduced Fehling's solution really was sugar, a quantity of leaf-extract was made, filtered, and dialysed: the resulting clear solution evaporated to dryness. A residue was thus obtained which smelt strongly of sugar, and which dissolved readily in water; the strong watery solution of the substance gave a well-marked reaction with sodium acetate and phenyl-hydrazine hydrochloride, a reddish-yellow precipitate being formed on warming, consisting of tufts of large acicular crystals. The solution did not, however, have any rotatory effect on polarised light when examined in the polarimeter. There can be no doubt that the substance is a sugar, and presumably it should be maltose; but it does not resemble maltose in being strongly dextro-rotatory. In order to determine whether or not it is capable of undergoing alcoholic fermentation, some yeast (10 c.c.) was added to some of the pure sugar-solution (100 c.c.) and the mixture was kept for twenty-six hours in an incubator at about 36° C. It appeared to be fermenting, and when distilled, a liquid came over of sp. gr. .997, which would correspond to about 2 per cent. of alcohol: this liquid also gave the iodoform reaction. The sugar in question appears, therefore, to be fermentable.

A further peculiarity, which may be of some importance, is that the crystals of the phenyl-compound produced in the phenyl-hydrazine hydrochloride test are soluble in absolute alcohol, giving an orange-coloured solution, but they are almost insoluble in ether; whereas the crystals formed (phenylglucosazone) when dextrose is similarly treated are readily soluble in both alcohol and ether, giving a yellow solution.

The sample of the sugar above described was obtained from a mixture of 800 c.c. of leaf-extract (prepared from 750 grammes fresh lawn-mowings consisting chiefly of grass, with some clover and *Achillea*) with 900 c.c. starch-solution. The sugar obtained included that which was originally present in the leaf-extract, as well as what was formed from the added starch.

The following will serve as an example of the experiments, and of the results obtained:—Six flasks were prepared, and were allowed to stand overnight for 14½ hours: the leaf-extract was prepared from fresh lawn-mowings.

	c.c.	c.c.		Dextrose per cent.
No. 1.—	50 leaf-extract	+ 50 starch-solution	gave .0793
„ 2.—	50 „	(boiled) + 50 „	„ .0450
„ 3.—	50 „	+ 50 „	+ thymol	„ .0740
„ 4.—	50 „	+ 50 „	+ boracic acid ½ grm.	„ .0690
„ 5.—	50 „	+ 50 distilled water	„ .0440
„ 6.—	50 starch-solution	+ 50 „ „	„ none

The sugar was estimated as fractions of grammes of dextrose in 100 c.c. of liquid. Similar results were obtained with leaf-extracts of the Marrow (*Cucurbita ovifera*), the Sunflower (*Helianthus annuus*), and the Dwarf Runner (*Phaseolus vulgaris*); also with those of the Lime (*Tilia europæa*) and of the Dwarf Runner when a 1 per cent. solution of dextrin was used.

In the two following cases results were obtained which appear to be at variance with the preceding; in both of them the percentage of sugar present in the mixture of leaf-extract and distilled water was greater than that in the mixture of leaf-extract and starch-solution.

Rheum hybridum (extract strongly acid, digestive period 24 hours):—

	c.c.	c.c.		Dextrose per cent.
No. 1.—50 leaf-extract		+ 50 starch-solution	. .	gave .1587
„ 2.—50 „		+ 50 distilled water	. .	„ .2702
„ 3.—50 starch-solution		+ 50 „ „	. .	„ mere traces

Daucus carota (extract slightly acid, digestive period 4 hours; the whole experiment was completed in a single day):—

	c.c.	c.c.		Dextrose per cent.
No. 1.—50 leaf-extract		+ 50 starch-solution	. .	gave .1052
„ 2.—50 „		+ 50 distilled water	. .	„ .1250
„ 3.—50 starch-solution		+ 50 „ „	. .	„ traces
„ 4.—50 leaf-extract (<i>boiled</i>)		+ 50 starch-solution	. .	„ .0847
„ 5.—50 „		+ 50 distilled water	. .	„ .0800

It is probable that in these cases the starch-solution added to the leaf-extract (No. 1 in both) was not in the least degree attacked. The peculiarity to be accounted for is the large amount of sugar present in the diluted leaf-extract (No. 2 in both). It is clear, in the case of the carrot, that the amount of sugar originally present in the leaf-extract (see Nos. 4 and 5) was about .08 per cent.; the excess of sugar in No. 2 (about .045 per cent.) appears to be due to the action of the diastatic ferment upon starch contained normally in the leaf-extract. The presence of added starch-solution (Carrot, No. 1) appears to have actually impeded the action of the ferment upon the leaf-starch already present.

The experiments were carried on from the end of June to the middle of August, 1891.

The author is aware that various points connected with this research require more complete investigation; he is, however, unable to continue the work at present, but hopes to return to it next year. The foregoing facts will, he believes, suffice to prove that Wortmann's conclusion as to the absence of diastatic ferment from green leaves, or its unimportance, is based upon insufficient evidence. It may be objected that the amount of ferment-action indicated in the foregoing experimental results is very small, but much weight cannot be attached to this objection. What the results really indicate is that the amount of diastatic ferment which can, at any one time, be extracted from a leaf is small; but doubtless the secretion of the ferment goes on continuously, so that the total ferment-action in, say, the course of a warm night would be very considerable—quite sufficiently so to account for the conversion of starch into sugar which actually occurs, without the direct intervention of the living protoplasm.

As a conclusive piece of evidence in support of his view, Wortmann cites an experiment which shows that if a leaf be kept in an atmosphere of CO₂, the starch which it contains is not converted into sugar; and he infers that this is due to an arrest of the action of the protoplasm upon the starch in consequence of the absence of free oxygen. It appears to the author that this inference is not the true one to be drawn from the fact as stated: a more satisfactory explanation would seem to be that, in the absence of free oxygen, the secretion of diastatic ferment by the protoplasm is arrested, and that it is on this account that the conversion of starch into sugar does not proceed.

The author desires to acknowledge the valuable help which he has received in this work from Mr. Manley, Assistant in the Chemical Laboratory of Magdalen College, Oxford.

6. *On the Nuclei of the Hymenomycetes.* By HAROLD WAGER.

In this paper an account is given of some observations upon the structure and changes which take place in the nuclei of the basidia of *Agaricus* (*Stropharia*) *stercorarius*. Rosenvinge states that the young basidia of the various species of Hymenomycetes which he has examined never contain more than one nucleus.

In *A. stercorarius* and other species of *Agarici* which I have examined, I have found in the very young basidia two nuclei; these probably pass into the basidia from the hyphæ. At this early stage each basidium contains a small quantity of protoplasm and one or more vacuoles.

The two nuclei fuse together to form a single large nucleus which is placed near the centre of the basidium. The basidium then becomes filled with a dense protoplasm containing no vacuoles.

The structure of the nucleus is similar to that of the higher plants; it consists of a nuclear membrane enclosing a dense nucleolus and a thread-like network. The nucleolus stains very deeply, the threads slightly.

As the basidium increases in size so also does the nucleus. The latter places itself near the apex of the basidium. The nuclei vary in size, generally speaking they are from 3.5 to 4 μ in diameter, but some of them have a diameter of 4.5 to 5 μ . The nucleoli are about 1.9 to 2 μ in diameter.

The nucleus now divides, first of all into two and then into four. The division, which is an indirect one, takes place before the appearance of the sterigmata. Previous to the division, the nucleus elongates slightly towards the apex; its outline becomes somewhat irregular; the thread-like network accumulates at the apex, and the nucleolus takes up its position at the opposite end of the nucleus. The nucleolus gradually disappears, and at the same time a group of deeply stained short threads or granules appears in place of the thread-like network at the upper end of the nucleus.

At this stage the nuclear membrane seems to have disappeared, but a somewhat irregular and somewhat clear space surrounds both the nucleolus and the deeply stained chromatic elements. These latter separate into two groups which pass to either side of the basidium. In this way two new nuclei are formed which are small at first, but gradually increase in size, and have a structure similar to that of the parent nucleus. The two new nucleoli appear to be formed from the chromatic elements. The two nuclei then elongate and divide in the same manner as the primary nucleus. The four nuclei thus formed have a structure similar to the parent nucleus, but are much smaller.

Previous to the development of the sterigmata, they pass to the lower end of the basidium, where they come into such close contact with each other as to appear as if fused together; it is not quite certain whether fusion does or does not take place; in any case they undergo certain changes resulting in the accumulation of a more or less irregular mass of chromatin on their walls. This chromatin presents the appearance of a very loose network surrounding the four nucleoli.

While these changes are taking place, the four sterigmata appear at the apex of the basidium. At the apex of each sterigma a spore is produced; protoplasm from the basidium passes into the spores.

The nuclei at the base of the basidium now separate and pass to the apex; each nucleus takes up a position at the base of one of the sterigmata, and this position they retain for some time. The protoplasm of the basidium becomes more and more vacuolated as it decreases in amount. Finally, nearly the whole of it passes into the spores.

The outline of each nucleus gradually disappears; the nucleolus becomes smaller—small enough to pass without difficulty into the spore, but whether such a passage takes place or not I have not been able to determine. The spores certainly do not contain a nucleus until a very late stage, *e.g.* after the formation of the thick spore membrane.

When the spores are ripe they are seen to contain two nuclei, probably derived from the single nucleus which passes into them in some way or other from the basidium.

7. *New Form of Appendicularian 'Haus.'* By GEO. SWAINSON, F.L.S.

'Haus' was the name given by the Russian naturalist, Von Mertens, to the large transparent envelope or sac so rapidly formed by the Appendicularia, *Oikopleura cophocerca*, as a secretion from the ectoderm which he met with in the arctic seas in 1829. He asserted that this envelope was an organ of respiration, consisting of a regular network of vessels, in which the circulation of blood-corpuscles was evident. This was greatly doubted by Professor Huxley as being, if true, 'unique and startling,' and constant search was made for other specimens but without success until 1858, when Professor Allman captured another and very different form of 'Haus' in the Clyde.¹ Since then Von Mertens' species has been seen and described by Fol.²

Fishing off St. Anne's Pier (Lancashire) with a small bottle attached to my surface net in June, 1890, I captured a new form of this 'Haus' (see drawing annexed), but unfortunately lost it before I had time to properly examine it.

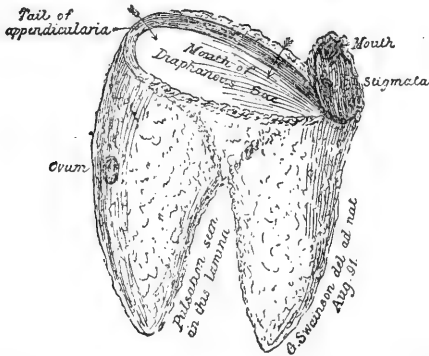

There was no doubt about the tunicate body of the Appendicularia with its 'stigmata,' &c.; but the gelatinous envelope or sac appeared to have two whips or fan-like organs. Professor Herdman on seeing my drawing at once suggested these were probably the optical expression of the tail of the Appendicularia turned upon itself.

This diaphanous sac was shaped very like a bishop's mitre and into it the salt water was constantly being driven by the lashing whips, and I saw an oval body ejected from it, which I now believe to have been a fertilised ovum.

Fortunately on the third of this present August I was successful in capturing a second specimen, brought along by a strong tidal current from the North-west Atlantic. On examining it in a watch-glass I found Dr. Herdman was quite right, for the tail of the Appendicularia formed the upper side of the mouth of the sac, while the other side of the opening was made of the thickened and folded edge of the gelatinous membrane which was connected with and secreted by the posterior part of the Appendicularia.

The constant lashing of the tail was responded to by a co-ordinate muscular action in this thickened membrane, and the whole gelatinous mass was carried about through the surrounding water by these continuous vibrations. Although constructed for a similar purpose, the size and form of the 'Haus' in my specimens differed very much from both Allman's and Von Mertens', being about half the size and possessing neither the 'double fans' of Allman's nor the 'horns' of Von Mertens', and the bifurcation of the sac being most distinct and noticeable.

¹ *Quarterly Journal of Microscopical Science*, 1859.

² 'Etudes sur les Appendiculaires du Detroit de Messine' in *Mém. Soc. Phys. Hist. Genève*, vol. xxi.

Like Professor Allman I must deny the possession of blood-vessels, or that the 'Haus' has any respiratory function, although I must admit there were some grounds for Von Mertens' idea in the very perceptible systole and diastole seen in the thickened laminae of the horns of the mitre, in apparent response to the vibration of the tail. By this means the water contained in the envelope was constantly renewed, and the ova therein protected duly oxygenised.

I feel quite certain that this is the main function of this 'Haus,' and that Dr. Allman was correct in calling it a *nidamental covering for the ova*, for in the envelopes of both my specimens were ova to be seen, while in those of Dr. Allman there were young Appendiculariæ.

This sac is probably a primitive test, resembling the transparent test of *Clavelina*, and this supports the idea of Professor Herdman that the Appendiculariæ were an early offshoot from the ancestral chordate form. In the Appendicularia there is no separate peribranchial cavity within which the ova can be fertilised and developed.

This envelope is only loosely attached to the animal's body, for in the struggle of the creature to get away from the strong light thrown upon it by the microscope it made a most vigorous contraction, and thereby jerked itself free from the membrane, leaving it behind in a limp, collapsed condition, without apparent vitality of any kind.

8. *On the Customary Methods of Describing the Gills of Fishes.*

By Professor G. B. HOWES, F.L.S., F.Z.S.

The gills of Marsipobranchs and Plagiostomes are not unfrequently enumerated in relation to the opposite walls of the visceral sacs which give origin to them, while those of the higher fishes are enumerated in relation to the opposite faces of the septa which bear them. The confusion arising out of this is well known to teachers, and is in itself sufficient to justify the introduction of a revised nomenclature for the parts concerned. The facts of development show (i.) (on the assumption that the mandibular or mouth cavity is serially homologous with a pair of post oval visceral clefts) that each gill lies in front of its corresponding skeletal arch; (ii.) that the saccular type of gill met with in the Marsipobranchs and Plagiostomes is that from which the pectinate one of the higher gnathostomatous fishes has been derived, and (iii.) that a mandibular gill has no existence in living fishes. Gills of the Marsipobranch-Plagiostome type may be conveniently described for general anatomical purposes as *Cystobranchiæ*, and those of the higher Teleosteid type as *Pectinobranchiæ*; while the parts of the individual gills should be in both and in all cases enumerated in relation to the visceral pouches from which they arise. Thus, the spiracular gill of Elasmobranchs (often termed the mandibular pseudobranch) should be described as the hyoid hemibranch, and the opercular gill of the higher fishes (often termed the hyoid pseudobranch) as the first branchial hemibranch.

The well-known series of buccal filaments met with in certain Chelonia appear to have the fundamental relationships of gill folios, and in view of the discovery by Dohrn, Platt, and others that the buccal sac would appear, from its mode of development in the Teleostei, to be the morphological equivalent of a pair of gill pouches, the possibility that these filaments may (at any rate for the most part) represent mandibular gills of a reversional character must not be overlooked.

9. *Exhibition of a very small Parrot from the Solomon Islands.*

By Canon TRISTRAM, F.R.S.

SECTION E.—GEOGRAPHY.

PRESIDENT OF THE SECTION—E. G. RAVENSTEIN, F.R.G.S., F.S.S.

THURSDAY, AUGUST 20.

The PRESIDENT delivered the following Address:—

The Field of Geography.

It behoves every man from time to time to survey the field of his labours, and to render an account unto himself of the work he has accomplished, and of the tasks which still await him, in order that he may perceive whether the means employed hitherto are commensurate with the magnitude of his undertaking, and likely to lead up to the desired results.

Such a survey of the 'Field of Geography' I propose to make the subject of my address to-day. You are aware that this field is a large one, that its boundaries are defined no more precisely than are the boundaries of other fields of human research, and that the fellow-labourers who join us in its cultivation are not always agreed as to the tasks that are peculiarly their own, or as to the methods in accordance with which their work should be carried on. By some of our neighbours we have not infrequently been accused of encroachments, and of overstepping our legitimate boundaries in order to invade adjoining fields already in the occupation of others, who are not only willing to cultivate them, but even claim to be better qualified than we are. There is undoubtedly some truth in this reproach, for, although there have been, and perhaps still are, geographers who would limit their task to a mere description of the earth's surface, there are others, to judge them by their performances, to whom earth and universe, geography and cosmography, are synonymous terms.

If, as a lexicographer, I were merely called upon to define the literal meaning of the word 'geography,' I should content myself by saying that it meant a 'description of the earth.' This, however, is merely the translation of a name given to our department of knowledge in an age when all natural science was descriptive, and scientific inquirers were still content to collect facts, without attempting to reduce them to a system. The ancient name, however, has been retained, notwithstanding that our conception of the duties of the geographer has undergone a notable change. The German word 'Erdkunde,' although too comprehensive, would perhaps be preferable, but could be rendered only by the word 'geology,' a term already appropriated to quite a distinct department of science, which has much in common with geography, and may even be described as its offspring, but is most certainly not identical with it.

Very varied have been the views as to what geography should embrace. Whilst Ptolemy would confine the duties of the geographer to the production of a correct map of the earth's surface, others fell into the opposite extreme, and were unable to resist the temptation of embellishing their 'systems of geography' with historical excursions, and with information of the most varied kind, only remotely, if at all, connected with their subject. But whilst the geographer should guard, on the one hand, against being drawn away from his legitimate task, he should not,

on the other, allow himself to be intimidated by those who, on the pretence of creating a geographical 'science,' would frighten him away from fields of research which his training enables him to cultivate to greater advantage than can be done by representatives of other departments of knowledge.

But whatever changes may have taken place respecting the aims of the geographer, it is very generally acknowledged that the portraiture of the earth's surface in the shape of a map lies within his proper and immediate domain. And there can be no doubt that a map possesses unique facilities for recording the fundamental facts of geographical knowledge, and that with a clearness and perspicuity not attainable by any other method. You will not, therefore, think it strange if I deal at considerable length with the development of cartography, more especially as my own labours have in a large measure been devoted to that department of geographical work. An inspection of the interesting collection of maps of all ages which I am able to place before you will serve to illustrate what I am about to say on this subject.

You may take it for granted that maps have existed from the very earliest times. We can hardly conceive of Joshua dividing the Promised Land among the twelve tribes, and minutely describing their respective boundaries, without the assistance of a map. The surveyors and land-measurers of the civilised states of antiquity undoubtedly produced cadastral and engineering plans, which answered every practical requirement, notwithstanding that their instruments were of the simplest. This is proved by a plan of Rome, the only document of the kind which has survived, at least in fragments, to the present time. It is engraved on slabs of marble on a scale of 1:300, and was originally fixed against a wall of the Roman Town Hall, so that it might be conveniently consulted by the citizens.

Of the existence of earlier maps of the world or even of provinces, we possess only a fragmentary knowledge. Anaximander of Miletus (610-546 B.C.) is credited among the Greeks with having produced the first map. His countryman Hecataeus the Elder, who had seen many lands, and of whom Herodotus borrowed the terse saying that Egypt was the gift of the Nile, about 500 years before Christ, exhibited to his fellow-citizens a brazen tablet upon which was engraved 'a map of the entire circuit of the world, with all its seas and rivers,' and pointed out to them the vast extent of the Empire of Darius, with whom they were about to engage in hostilities. But his warning proved in vain, and their disregard of the teachings of geography had, as usual, to be dearly paid for.

That maps grew popular at an early age is proved by Aristophanes, who, in his comedy of 'The Clouds,' 423 B.C., has a map of the world brought upon the stage by a disciple of the Sophists, who points out upon it the position of Athens and of other places familiar to the audience.

A real advance in cartography was made when Dicæarchus of Messana (390-290 B.C.) introduced the parallel of Rhodes, as a separator between the northern and the southern habitable worlds. This 'diaphragm' was intersected at right angles by parallel lines representing meridians. This system of graduating a map was accepted by Eratosthenes (276-196 B.C.), and appears to have kept its hold upon the more scientific cartographers up to the time of Marinus of Tyre, the immediate predecessor of Ptolemy. Whether the map of the Roman Empire, which Agrippa, the son-in-law of Augustus, caused to be placed under a portico, and which was based upon itinerary surveys begun forty-four years before Christ, was furnished with parallels and meridian we do not know. It probably resembled in appearance some of our mediæval maps, like that of Richard of Haldingham, still preserved in the cathedral of Hereford. Widely different from it were the road-maps or 'Itineraria picta' of the Romans, of which 'Peutinger's Table' is a well-known example of a late date.

Such, then, were the maps which existed when Ptolemy of Alexandria appeared upon the field, and introduced reforms into the methods of representing the earth's surface which fully entitled him to the foremost place among ancient cartographers, and which inspired his successors when the study of science revived in the fifteenth century.

Ptolemy, like all great reformers, stood upon the shoulders of the men who had

preceded him, for before a map like his could be produced much preliminary work had been accomplished. Parmenides of Elea (460 B.C.) had demonstrated that our earth was a globe, and Eratosthenes (276-196 B.C.) had approximately determined its size. Hipparchus (190-120), the greatest astronomer of antiquity, the discoverer of the precession of the equinoxes, and the author of a catalogue of stars, had transferred to our earth the auxiliary lines drawn by him across the heavens. He had taught cartographers to lay down places according to their latitude and longitude, and how to project a sphere upon a plane. It is to him we are indebted for the stereographic and orthographic projections of the sphere. Ptolemy himself invented the tangential conical projection.

The gnomon or sun-dial, an instrument known to the Chinese 600 years before Christ, had long been used for the determination of latitudes, and the results were relatively correct, although uniformly subject to an error of 16 minutes, which was due to the observers taking the altitude of the upper limb of the sun, when measuring the shadow cast by their dial, instead of that of the sun's centre.

It was known, likewise, that differences of longitude could be determined by the simultaneous observation of eclipses of the sun or moon, or of occultations of stars, and Hipparchus actually calculated Ephemerides for six years in advance to facilitate computations. Ptolemy himself suggested the use of lunar distances. But so imperfect were the astrolabes and other instruments used by the ancient astronomers, and especially their time-keepers, that precise results were quite out of the question.

Ptolemy, in fact, contented himself with accepting eight latitudes determined by actual observation, of which four were in Egypt, whilst of the three longitudes known to him he only utilised one in the construction of his map. Unfortunately, the one selected proved the least accurate, being erroneous to the extent of 32 per cent., whilst the error of the two which he rejected did not exceed 13 per cent.¹ This want of judgment, pardonable, no doubt, under the circumstances, vitiated Ptolemy's delineation of the Mediterranean to a most deplorable extent, far more so than did his assumption that a degree only measured five hundred stades, when in reality it measures six hundred. For whilst the breadth of his Mediterranean, being dependent upon the relatively correct latitudes of Alexandria, Rhodes, Rome, and Massilia, fairly approximates the truth, its length is exaggerated to the extent of nearly 50 per cent., measuring 62° instead of 41° 40'. This capital error of Ptolemy is due therefore to the unfortunate acceptance of an incorrect longitude, quite as much as to an exaggeration of itinerary distances. It is probable that Ptolemy would have presented us with a fairer likeness of our great inland sea had he rejected observed latitudes and longitudes altogether and trusted exclusively to his itineraries and to such bearings as the mariners of the period could have supplied him with.

No copy of Ptolemy's original set of maps has reached us, for the maps drawn by Agathodæmon in the fifth century are, under the most favourable circumstances, merely reductions of Ptolemy's originals, or they are compiled from Ptolemy's 'Geography,' which, apart from a few explanatory chapters, consists almost wholly of lists of places, with their latitudes and longitudes.

An examination of Ptolemy's maps shows very clearly that they were almost wholly compiled from itineraries, the greater number of which their author borrowed from his predecessor Marinus. It shows, too, that Ptolemy's critical acumen as a compiler cannot be rated very high, and that he failed to utilise much information of a geographical nature which was available in his day. His great merit consisted in having taught cartographers to construct their maps according to a scientific

¹ The three longitudes are the following:—

	Re-sult of ancient observations	Adopted by Ptolemy	Actual difference of longitude
Arbela . . .	45° E. of Carthage . . .	45°	34°
Babylon . . .	12° 30' E. of Alexandria . . .	18° 30'	14° 18'
Rome . . .	20° E. of Alexandria . . .	23° 50'	17° 24'

method. This lesson, however, they were slow to learn, and centuries elapsed before they once more advanced along the only correct path which Ptolemy had been the first to tread.

During the 'Dark Ages' which followed the dismemberment of the Roman Empire there was no lack of maps, but they were utterly worthless from a scientific point of view. The achievements of the ancients were ignored, and the principal aim of the map-makers of the period appears to have been to reconcile their handiwork with the orthodox interpretation of the Holy Scriptures. Hence those numerous 'wheel maps,' upon which Jerusalem is made to represent the hub, whilst the western half of the disk is assigned to Europe and Africa, and the eastern to Asia.

As it is not my intention to introduce you to the archaeological curiosities of an uncritical age, but to give you some idea of the progress of cartography, I at once pass on to the Arabs.

The Arabs were great as travellers, greater still as astronomers, but contemptible as cartographers. Their astronomers, fully possessed of the knowledge of Ptolemy, discovered the error of the gnomon, they improved the instruments which they had inherited from the ancients, and carefully fixed the latitudes of quite a number of places. Zarkala, the Director of the Observatory of Toledo, even attempted to determine the difference of longitude between that place and Bagdad; and if his result differed to the extent of three degrees from the truth, it nevertheless proved a great advance upon Ptolemy, whose map exhibits an error amounting to eighteen degrees. Had there existed a scientific cartographer among the Arabs, he would have been able, with the aid of these observations and of the estimates of distances made by careful observers like Abul Hasan, to effect most material corrections in the map of the known world. If Edrisi's map (1154) is better than that of others of his Arab contemporaries, this is simply due to his residence at Palermo, where he was able to avail himself of the knowledge of the Italians.

Quite a new epoch in the history of Cartography begins with the introduction of the magnetic needle into Europe. Hitherto the seaman had governed his course by the observation of the heavens; thenceforth an instrument was placed in his hands which made him independent of the state of the sky. The property of the magnet or 'loadstone' to point to the north first became known in the eleventh century, and in the time of Alexander Neckam (1185) it was already poised upon a pivot. It was, however, only after Flavio Gioja of Amalfi (1302) had attached to it a compass-card, exhibiting the direction of the winds, that it became of such immediate importance to the mariner. It is only natural that the Italians, who were the foremost seamen of that age, should have been the first to avail themselves of this new help to navigation. At quite an early date, as early probably as the twelfth century, they made use of it for their maritime surveys, and in course of time they produced a series of charts upon which the coasts frequented by them, from the recesses of the Black Sea to the mouth of the Rhine, are delineated for the first time with surprising fidelity to nature. The appearance of these so-called compass-charts, with gaily coloured roses of the winds and a bewildering number of rhumb-lines, is quite unmistakable. A little consideration will show you that if the variation of the compass had been taken into account in the construction of these charts, they would actually have developed into a picture of the world on Mercator's projection. But to deny them all scientific value, because they do not fulfil this condition, is going too far. As correct delineations of the contours of the land they were a great advance upon Ptolemy's maps, and it redounds little to the credit of the 'learned' geographers of a later time that they rejected the information so laboriously collected and skilfully combined by the chart makers, and returned to the deformities of Ptolemy. The adjustment of these charts to positions ascertained by astronomical observations could have been easily effected. An inspection of my diagrams will prove this to you. The delineation of Italy, on the so-called Catalan map, is surprisingly correct; whilst Gastaldo, whose map of Italy is nearly

two hundred years later, had not yet been able to emancipate himself from the overpowering authority of Ptolemy. And in this he did not sin alone, for Italian and other cartographers of a much later time still clung pertinaciously to the same error.

There were others, however, who recognised the value of these charts, and embodied them in maps of the entire world. Among such were Marino Sanute (1320) and Fra Mauro (1453), both of whom made their maps the repository of much information gathered from the Arabs or from their own countrymen who had seen foreign parts. Fra Mauro, more especially, has transmitted to us a picture of Abyssinia marvellously correct in its details, though grossly exaggerated in its dimensions.

Another step in the right direction was taken when the cartographers and pilots of Portugal and Spain returned to the crude projection of Dicæarch, Eratosthenes, and Marinus, which enabled them to lay down places according to latitude and longitude upon their 'plane charts.'

Germany, debarred from taking a share in the great maritime discoveries of the age, indirectly contributed to their success by improvements in mathematical

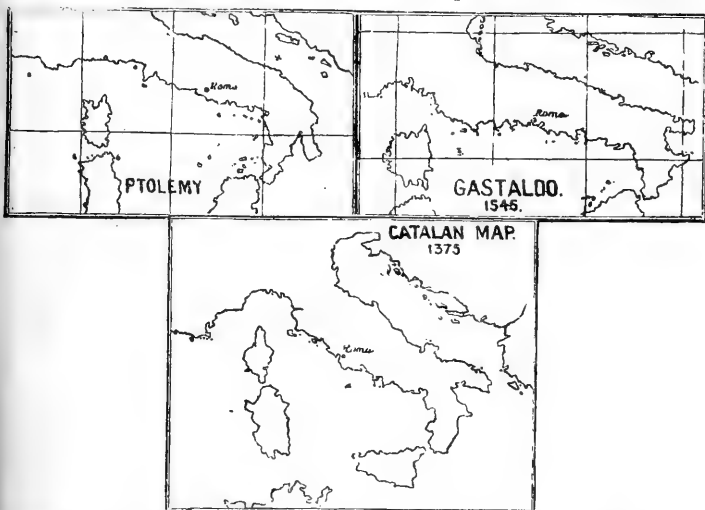

geography and the introduction of superior instruments. The navigators of the early middle ages still made use of an astrolabe when they desired to determine a latitude, but this instrument, which in the hands of an expert observer furnished excellent results on land, was of little use to a pilot stationed on the unsteady deck of a vessel. Regiomontanus consequently conferred an immense service upon the mariners of his time when, in 1471, he adapted to their use an instrument already known to the ordinary surveyors. It was this cross staff which Martin Behaim introduced into the Portuguese navy, and which quickly made its way among the navigators of all countries. Most observations at sea were made with this simple instrument, variously modified in the course of ages, until it was superseded by Hadley's sextant. In the hands of the more skilful navigators of the seventeenth century, such as Baffin, James, and Tasman, the results obtained with the cross-staff were correct within two or three minutes.

Far greater difficulties were experienced in the observations of longitudes. Lunar eclipses were most generally made use of, but neither the Ephemerides of

Regiomontanus, for the years 1474 to 1506, which Columbus carried with him on his voyages, nor those of Peter Apianus, for 1521-70, were sufficiently accurate to admit of satisfactory results, even though the actual observation left nothing to be desired. Errors of 30 degrees in longitude were by no means rare, and it was only when Kepler had published his 'Rudolphine Tables' (1626), which according to Lalande formed the basis of all astronomical calculations during a century, that more exact results were obtained. The suggestion to determine longitude by means of lunar distances or occultations of stars bore no fruit at that time, as the knowledge of the complicated motion of the moon was still very imperfect. Still less was known about the movements of the satellites of Jupiter which Galileo had first espied in 1610 when looking at that planet through his telescope. They became available only after tables of their revolutions and eclipses had been published by Cassini in 1668.

Another suggestion for the determination of longitude was made by Gemma Frisius in 1530, namely, that a clock or timekeeper should be employed for the purpose. One of Huygens's pendulum clocks was actually carried by Holmes to the Gulf of Guinea, but the results obtained were far from encouraging.

The difficulties which still attended the determination of longitude in the sixteenth century are conspicuously illustrated by the abortive attempts of a Congress of Spanish and Portuguese navigators who met at Badajoz and Yelves in 1524 for the purpose of laying down the boundary line, which Pope Alexander VI. had drawn at a distance of 370 Spanish leagues to the west of Cape Verde Islands, to separate the dominions of Spain from those of Portugal. Not being able to agree either as to the length of a degree, nor even as to that of a league, they separated without settling the question placed before them.

So uncertain were the results of observations for longitude made during the sixteenth and seventeenth centuries, that it was thought advisable to trust to the results of dead-reckoning rather than to those of celestial observations. But the method of dead-reckoning is available only when we have a knowledge of the size of the earth, and this knowledge was still very imperfect, notwithstanding the renewed measurement of an arc of the meridian by Snellius, the Dutch mathematician (1615). This measurement, however, is remarkable on account of its having for the first time applied the exact method of triangulation to a survey.

The problem of measuring the ship's way had been attempted by the Romans, who dragged paddle-wheels behind their ships, the revolutions of which enabled them to estimate the distance which the ship had travelled. But time, the strength of the wind, and the pilot's knowledge of the qualities of his ship, still constituted the principal elements for calculations of this kind, for the 'catena a poppa' which Magellan attached to the stern of his ship was merely intended to indicate the ship's leeway and not the distance which it had travelled. The log, which for the first time enabled the mariner to carry out his dead-reckoning with confidence, is first described in Bourne's 'Regiment for the Sea,' which was published in 1577.

The eminent position which Italian cartographers occupied during the fourteenth and fifteenth centuries had to be surrendered by them, in the beginning of the sixteenth, to their pupils, the Portuguese and Spaniards, upon whom extensive voyages and discoveries had conferred exceptional advantages. These, in turn, had to yield to the Germans, and later on to the Dutch, who were specifically qualified to become the reformers of cartography by their study of mathematics and of the ancient geographers, as also by the high degree of perfection which the arts of engraving on wood and copper had attained among them. German mathematicians first ventured to introduce the long-neglected geographical projections of Hipparchus and Ptolemy, and devised others of their own. Werner of Nürnberg (1514) invented an equivalent heart-shaped projection, whilst both Apianus and Staben (1520 and 1522) suggested equivalent projections. Still greater were the services of Gerhard Cremer, or Mercator (1512-94), the Ptolemy of the sixteenth century, who not only introduced the secant conical projection, but also invented that still known by his name, which was calculated to render such great service to

the navigator, but was nevertheless not universally accepted until the middle of the fifteenth century, when the mediæval compass and plane charts finally disappeared.

The German cartographers of that age are to be commended, not because they copied Ptolemy's maps—for in this they had been preceded by others—but because they adopted his scientific methods in producing maps of their own. Their reforms began at home, as all reforms should. They were amply supported in their efforts by the many astronomers of note of whom Germany then boasted, and by quite a staff of local 'geographers,' of whom nearly every district of the empire boasted the possession of one. Among these local maps, that of Bavaria, by Philipp Bienewitz, or Apianus (1566), holds a distinguished place, for it is the first map on a large scale (1 : 144,000) based upon a regular survey. Its errors in latitude do not exceed 1', and those in longitude 3', which is marvellously correct considering the age of its production. Like most maps of the period, it is engraved on wood, for though the art of engraving on copper was invented in Germany before 1446, and the first map was engraved there in 1450, copper engraving only became general at a much later date.

Perhaps the earliest general map of Germany, and certainly one of the most interesting, was that which the famous Cardinal Nicolas of Cues or Cusa completed in 1464, the only existing copy of which is to be found in the British Museum, where it was 'discovered' by Baron Nordenskjöld. Mercator's map of Germany, published more than a century after that of the learned Cardinal (in 1585), was naturally far more complete in all respects, and was certainly far superior to the maps of any other country existing at that time. This fact is brought home to us by an inspection of a collection of maps to be found in the well-known *Theatrum Orbis* of Ortelius (first published in 1570), where we may see that the maps supplied by Humphrey Lloyd and other British cartographers are still without degree lines.

But when we follow Mercator, or, in fact, any other cartographer of the period, into regions the successful delineation of which depended upon an intelligent interpretation of itineraries and of other information collected by travellers, they are found to fail utterly. Nowhere is this utter absence of the critical faculty more glaringly exhibited than in the maps of Africa of that period.

Among the Dutch cartographers of that age one of the foremost places must be accorded to Waghenaer of Enkhuizen, whose 'Mirror of the Sea,' a collection of charts published in 1583, enjoyed a considerable reputation among British seamen. Other famous Dutch publishers of charts were Ortelius, Janssen, Blaeuw, and Vischer, who accumulated large stocks of copper plates, which constituted valuable heirlooms, and, not unlike the plates of certain modern map-publishers, supplied edition after edition without undergoing any change, except perhaps that of the date.

The age of great discoveries was past. All blanks upon our maps had not yet been filled up, but the contours of the great continents stood out distinctly, and in the main correctly. Discoveries on a large scale had become impossible, except in the Polar regions and in the interior of some of the continents; but greater preciseness had to be given to the work already done, and many details remained to be filled in. In this 'Age of Measurements,' as Peschel significantly calls it, better instruments, and methods of observation superior to those which had sufficed hitherto, were needed, and were readily forthcoming.

Picard, by making use of the telescope in measuring angles (1667), obtained results of a degree of accuracy formerly quite unattainable, even with instruments of huge proportions. For the theodolite, that most generally useful surveying instrument, we are indebted to Jonathan Sission (1737 or earlier). More important still, at all events to the mariner, was the invention of the sextant, generally ascribed to Hadley (1731), but in reality due to the genius of Newton. Equally important was the production of a trustworthy chronometer by John Harrison (1761), which first made possible the determination of meridian distances, and is invaluable whenever a correct knowledge of the time is required. One other instru-

ment, quite recently added to the apparatus of the surveyor, is the photographic camera, converted for his especial benefit into a photogrammeter. This instrument can perhaps never be utilised for ascertaining the relative positions of celestial bodies, but has already done excellent service in ordinary surveying, especially when it is required to portray the sides of inaccessible mountains.

But the full fruits of these inventions could be enjoyed only after Bradley had discovered the aberration of light (1728) and the nutation of the earth's axis (1747); Dominique Cassini had furnished trustworthy tables of the refraction of light; and the complicated movement of the moon had been computed by Euler (1746), Tobias Mayer (1753), Bradley (1770), and, more recently by Hansen.

Positively novel methods for determining the latitude and longitude of a place can scarcely be said to have been proposed during this period, but many of the older methods only became really available after the improvements in the instruments indicated above had taken place, and the computations had been freed from the errors which vitiated them formerly.

Real progress, however, has been made in the determination of altitudes. Formerly they could be ascertained only by trigonometrical measurement, or by a laborious process of levelling, but since physicists have shown how the decrease of atmospheric pressure with the altitude, and the boiling-point of water depending upon this decrease, afforded a ready means of determining heights, the barometer, aneroid, and boiling-point thermometer have become the indispensable companions of the explorer, and our knowledge of the relief of the land has advanced rapidly.

Equally rapid have been the improvements in our instruments for measuring the depth of the ocean, since a knowledge of the configuration of its bed was demanded by the practical requirements of the telegraph engineers.

And in proportion as the labours of the surveyors and explorers gained in preciseness, so did the cartographer of the age succeed in presenting the results achieved in a manner far more satisfactory than had been done by his predecessors. His task was comparatively easy so long as he only dealt with horizontal dimensions, though even in the representation of these a certain amount of skill and judgment is required to make each feature tell in proportion to its relative importance. The delineation of the inequalities of the earth's surface, however, presented far greater difficulties. The mole-hills or serrated ridges, which had not yet quite disappeared from our maps in the beginning of this century, failed altogether in doing justice to our actual knowledge. The first timid attempt to represent hills as seen from a bird's-eye view, and of shading them according to the steepness of their slopes, appear on a map of the Breisgau, published by Homann in 1718. We find this system fully developed on La Condamine's map of Quito, published in 1751, and it was subsequently popularised by Arrowsmith. In this crude system of hill shading, however, everything was left to the judgment of the draughtsman, and only after Lehmann (1783) had superimposed it upon a ground-work of contours, and had regulated the strength of the hatching in accordance with the degree of declivity to be represented did it become capable of conveying a correct idea of the configuration of the ground.

The first to fully recognise the great importance of contours was Philip Buache, who had prepared a contoured map of the Channel in 1737, and suggested that the same system might profitably be extended to a delineation of the relief of the land; and this idea, subsequently taken up by Ducarla of Vabres, was for the first time carried into practice by Dupain-Triel, who published a contoured map of France in 1791. Up to the present time more than eighty methods of showing the hills have been advocated, but it may safely be asserted that none of these methods can be mathematically correct unless it is based upon horizontal contours.

The credit of having done most towards the promotion of cartography in the course of the eighteenth century belongs to France. It was France which first equipped expeditions to determine the size of the earth; France which produced

the first topographical map based upon scientific survey—a work begun by César François Cassini in 1744, and completed by his son five years after his father's death; it was France again which gave birth to D'Anville, the first critical cartographer whom the world had ever seen.

Delisle (1675–1726), a pupil of Cassini's, had already been able to rectify the maps of the period by utilising the many astronomical observations which French travellers had brought home from all parts of the world. This work of reform was carried further by D'Anville (1697–1782), who swept away the fanciful lakes from off the face of Africa, thus forcibly bringing home to us the poverty of our knowledge; who boldly refused to believe in the existence of an Antarctic continent covering half the southern hemisphere, and always brought sound judgment to bear upon the materials which the ever-increasing number of travellers placed at his disposal. And whilst France led the way, England did not lag far behind.

In that country the discoveries of Cook and of other famous navigators, and the spread of British power in India, gave the first impulse to a more diligent cultivation of the art of representing the surface of the earth on maps. There, to a greater extent than on the Continent, the necessities of the navigator called into existence a vast number of charts, amongst which are many hundreds of sheets published by Dalrymple and Joseph Desbarres (1776). Faden, one of the most prolific publishers of maps, won distinction especially for his county maps, several of which, like that of Surrey by Linley and Gardner, are based upon trigonometrical surveys carried on by private individuals. England was the first to follow the lead of France in undertaking a regular topographical survey (1785). Nor did she lack critical cartographers. James Rennell (b. 1742) sagaciously arranged the vast mass of important information collected by British travellers in India and Africa; but it is chiefly the name of Aaron Arrowsmith (died 1823) with which the glory of the older school of English cartographers is most intimately connected. Arrowsmith became the founder of a family of geographers, whose representative in the third generation, up to the date of his death in 1873, worthily upheld the ancient reputation of the family. Another name which deserves to be gratefully remembered is that of John Walker, to whom the charts published by our Admiralty are indebted for that perspicuous, firm, and yet artistic execution which, whilst it enhances their scientific value, also facilitates their use by the mariner.

Since the beginning of the present century Germany has once more become the head-quarters of scientific cartography; and this is due as much to the inspiring teachings of a Ritter and a Humboldt as to the general culture and scientific training, combined with technical skill, commanded by the men who more especially devoted themselves to this branch of geography, which elsewhere was too frequently allowed to fall into the hands of mere mechanics. Men like Berghaus, Henry Kiepert, and Petermann, the best-known pupil of the first of these, must always occupy a foremost place in the history of our department of knowledge. Berghaus, who may be truly described as the founder of the modern school of cartography, and who worked under the immediate inspiration of a Ritter and a Humboldt, presented us with the first comprehensive collection of physical maps (1837). Single maps of this kind had, no doubt, been published before—Kircher (1665) had produced a map of the ocean currents, Edmund Halley (1686) had embodied the results of his own researches in maps of the winds and of the variation of the compass (1686), whilst Ritter himself had compiled a set of physical maps (1806)—but no work of the magnitude of Berghaus's famous Physical Atlas had seen the light before. Nor could it have been published even then had it not been for the unstinted support of a firm like that of Justus Perthes, already the publisher of Stieler's Atlas (1817–23), and subsequently of many other works which have carried its fame into every quarter of the globe.

And now, at the close of this nineteenth century, we may fairly boast that the combined science and skill of surveyors and cartographers, aided as they are by the great advance of the graphic arts, are fully equal to the production of a map which shall be a faithful image of the earth's surface. Let us imagine for one moment that an ideal map of this kind were before us, a map exhibiting not merely the features of the land and the depth of the sea, but also the extent of forests and

of pasture-lands, the distribution of human habitations, and all those features the representation of which has become familiar to us through physical and statistical atlases. Let us then analyse the vast mass of facts thus placed before us, and we shall find that they form quite naturally two well-defined divisions—namely, those of physical and political geography, whilst the third department of our science, mathematical geography, deals with the measurement and survey of our earth, the ultimate outcome of which is the production of a perfect map.

I shall abstain from giving a laboured definition of what I consider geography should embrace, for definitions of this kind help practical workers but little, and will never deter anyone who feels disposed and capable from straying into fields which an abuse of logic has clearly demonstrated to lie outside his proper domain. But I wish to enforce the fact that topography and chorography, the description of particular places or of entire countries, should always be looked upon as integral portions of geographical research. It is they which furnish many of the blocks needed to rear our geographical edifice, and which constitute the best training school for the education of practical geographers, as distinguished from mere theorists.

That our maps, however elaborate, should be supplemented by descriptions will not even be gainsaid by those who are most reluctant to grant us our independent existence among the sciences which deal with the earth and its inhabitants. This concession, however, can never content us. We cannot allow ourselves to be reduced to the position of mere collectors of facts. We claim the right to discuss ourselves the facts we have collected, to analyse them, to generalise from them, and to trace the correlations between cause and effect. It is thus that geography becomes comparative; and whilst comparative physical geography, or morphology, seeks to explain the origin of the existing surface features of our earth, comparative political geography, or anthro-geography, as it is called by Dr. Ratzel, one of the most gifted representatives of geographical science in Germany, deals with man in relation to the geographical conditions which influence him. It is this department of geography which was so fruitfully cultivated by Karl Ritter.

Man is indeed in a large measure 'the creature of his environment,' for who can doubt for a moment that geographical conditions have largely influenced the destinies of nations, have directed the builders of our towns, determined the paths of migrations and the march of armies, and have impressed their stamp even upon the character of those who have been subjected to them for a sufficiently extended period.

The sterile soil of Norway, bordering upon a sea rich in fish, converted the Norwegians first into fishermen, and then into the bold mariners who ravaged the shores of Western Europe and of the Mediterranean and first dared to cross the broad waves of the Atlantic. Can it be doubted that the uniformly broad plains of Eastern Europe contributed largely to the growth of an empire like that of Russia, stretching from the Arctic to the Black Sea; or that the more varied configuration of Western and Southern Europe promoted the development of distinct nationalities, each having a history of its own, and presenting individual traits which characteristically mark it off from its neighbours?

The intelligent political geographer cannot contemplate the great river systems of the continents without becoming aware that their influence has been very diverse, and is not solely dependent upon size or volume. The rivers of Siberia, ice-bound during the greater part of the year, run to waste into an inhospitable ocean, which even our modern resource of steam has failed to render really accessible. They contrast very unfavourably, notwithstanding their huge size, with the far smaller rivers of Northern Europe, which open freely into the sea and afford navigable highways into the very heart of the continent. And these European rivers, fed as they are by rains falling in all seasons, and by the ice stored up in the recesses of the Alps, again differ very widely in their character from the rivers of tropical regions, dependent upon an intermittent supply of rain. Again, who can look upon such mighty rivers as the Amazon and Mississippi without becoming conscious of the fact that they have given geographical unity to regions of vast

extent, which, had their drainage been different, would have presented all the variety which we meet with in Europe—a variety which has proved so favourable to the progress of human culture and civilisation?

It is an old remark that climatic conditions exercise a most powerful influence upon man, and that the development of countries, where Nature yields the necessities of life without requiring a serious effort on the part of the inhabitants, has been very different from those whose climatic conditions compel the putting forth of a certain amount of well-directed energy to make life bearable, or even possible.

These instances of the dependence of human development upon natural resources and geographical features might be multiplied, and their study must at all times be profitable and instructive. It must not, however, be assumed for one moment that this dependence of man upon Nature is absolute. The natural resources of a country require for their full development a people of energy and capacity; and instances in which they have been allowed to lie dormant, or have been wasted, are numerous. What were America and Australia, as long as they remained only the homes of the wandering savages who originally inhabited them; and what has become of certain countries of the East, at one time among the most flourishing regions of the earth, but presenting now a most deplorable picture of exhaustion and decay? The geographer must not shut his eye to the fact that the existing state of affairs is not merely the outcome of given geographical conditions and natural resources, but has in a large measure been brought about by man's conquests over the forces of Nature. We do not exaggerate, for instance, when we assert that the introduction of steam as a motive force has largely changed the geographical relations of countries. By facilitating intercourse between distant regions, and encouraging travel, it has tended to uniformity among nations, and rendered available for the common good resources which otherwise must have lain fallow. A tunnel, such as that under the Saint Gotthard, may not have 'abolished' the Alps, but it certainly has brought the populations who occupy their opposite slopes nearer to each other, and has given a new direction to commerce.

Perhaps one of the most instructive illustrations of the complex human agencies which tend to modify the relative importance of geographical conditions is presented to us by the Mediterranean. The time when this inland sea was the centre of civilisation and of the world's commerce, whilst the shores of Western Europe were only occasionally visited by venturesome navigators or conquering Roman hosts, does not lie so very far behind us. England, at that period, turned her face towards Continental Europe, of which it was a mere dependency. The prosperity of the Mediterranean countries survived far into the middle ages, and Italy at one time enjoyed the enviable position of being the great distributor of the products of the East, which found their way across the Alps into Germany, and through the gates of Gibraltar to the exterior ocean. But a change was brought about, partly through the closing of the old Oriental trade routes, consequent upon the conquests of the Turks, partly through the discovery of a new world and of a maritime highway to India. When Columbus, himself an Italian, returned from the West Indies in 1493, and Vasco da Gama brought the first cargo of spices from India in 1499, the star of Italy began to fade. And whilst the spices of the Indies and the gold of Guinea poured wealth into the lap of Portugal, and Spain grew opulent on the silver mines of Mexico and Peru, Venice was vainly beseeching the Sultan to re-open the old trade route through the Red Sea. The dominion of the sea had passed from Italy to Spain and Portugal, and passed later on to the Dutch and English. But mark how the great geographical discoveries of that age affected the relative geographical position of England! England no longer lay on the skirts of the habitable world, it had become its very centre. And this natural advantage was enhanced by the colonial policies of Spain and Portugal, who exhausted their strength in a task far beyond their powers, took possession of tropical countries only, and abandoned to England the less attractive but in reality far more valuable regions of North America. England was thus enabled to become the founder of real colonies, the mother of nations; and her language, customs, and political institutions found a home in a new world.

And now, when the old highway through the Red Sea has been reopened,

when the wealth flowing through the Canal of Suez is beginning to revivify the commerce of Italy, England may comfort herself with the thought that in her own colonies and in the states which have sprung up across the Atlantic she may find ample compensation for any possible loss that may accrue to her through geographical advantages being once more allowed to have full play.

I am afraid I have unduly tried your patience. I believe you will agree with me that no single individual can be expected to master all those departments which are embraced within the wide field of geography. Even the master-mind of a Humboldt fell short of this, and facts have accumulated since his time at an appalling rate. All that can be expected of our modern geographer is that he should command a comprehensive general view of his field, and that he should devote his energies and capacities to the thorough cultivation of one or more departments that lie within it.

The following Papers were read:—

1. *The Art of Observing.* By JOHN COLES, F.R.A.S., Map Curator and Instructor in Practical Astronomy and Surveying to the Royal Geographical Society.

In this paper the art of observing with portable instruments, for latitude and longitude, is described, as well as the use of such simple surveying instruments as the plane table and prismatic compass. The different methods suitable to explorers of fixing positions by astronomical observations are explained, and the manner in which they may be taken so as to eliminate errors is pointed out. The latter part of the paper deals with surveying, fixing heights by barometer, route surveying in a jungle or forest, and concludes with a description of the Solar Compass attachment, as applied to theodolites for finding the true meridian, and some remarks on Mercator's projection in cases where it is required to lay down bearings, &c., or plot a route. The author also calls attention to the fact that such instruments as the plane table and prismatic compass might be used with advantage in schools, and that such practical teaching in the field could not fail to give pupils a more intimate knowledge of the principle on which maps are constructed and surveys carried out than they could gain in any other way.

-
2. *Recent Geographical Progress in Great Britain.*
By J. SCOTT KELTIE.

Mr. Keltie referred to the efforts made by the Royal Geographical Society during the last twenty-six years to improve the position of geography in British schools. For about twenty years the Society offered prizes annually to be competed for by the pupils of the great public schools; but very few schools availed themselves of the examination, and so few candidates came forward that the scheme was dropped. The Society also instituted a course of lectures by eminent men of science on various aspects of geography, in order to improve the prevailing conception of the subject, but this also had little result.

In 1884 the Society appointed Mr. Keltie to conduct an inquiry into the position of geography in educational institutions in Great Britain and in the Continent of Europe. He visited the leading schools in the British Islands, conferred with the University authorities of Oxford and Cambridge, and inquired into the position of the subject in the examinations for the public service. He visited France, Germany, Austria, Switzerland, Italy, Belgium, Holland, and made inquiries concerning other European countries, as well as the United States of America. Mr. Keltie also collected the materials for an exhibition of appliances used in geographical education. He presented to the Society a report on the results of his inquiry. The exhibition was held in London, Birmingham, Bradford, and Edinburgh, and in connection therewith a series of lectures on various aspects of geo-

graphy were given by a number of specialists. On the basis of the report and its recommendations, the Council of the Royal Geographical Society took action in order to improve the position of geography in the British Islands. The result during the past six years has, on the whole, been satisfactory.

Lecturers (ranking with professors) of geography have been appointed at the Universities of Oxford and Cambridge, where before the subject was not recognised. The Oxford lecturer, Mr. H. J. Mackinder, has been most successful, and at that university the subject is taking an important place, both on its own account and in its relations to the historical and scientific studies of the university. It is hoped that in Cambridge equally satisfactory progress will be made.

The great public schools are influenced by the universities; but as yet the general subject is not recognised in these schools as it ought to be, though physical geography is generally taught. Even in these schools, however, there are signs of improvement. Among the mass of middle-class schools, the subject is spreading, and a higher conception begins to prevail.

In the elementary schools, which are now under Government jurisdiction, the programme prescribed is highly satisfactory, though unfortunately the subject is not compulsory. In the training colleges or normal schools the position of geography is, on the whole, satisfactory; the Royal Geographical Society awards prizes each year on the results of the examinations in geography in the normal schools.

In the lectures which are given all over the country to thousands of students by members of the Universities of Oxford and Cambridge, geography holds an important place. What is known as commercial geography is also attracting great attention.

As a result of the action of the Society the general conception of geography has greatly improved in England; the leaders of the movement of reform, following Ritter and Peschel and their disciples, regard geography mainly as dealing with the earth's surface as the topographical environment of humanity.

3. *Trees and Prairies.* By MILLER CHRISTY.

4. *The Homology of Continents.* By DR. HUGH R. MILL, F.R.S.E.

5. *On the Comparative Value of African Lands.* By ARTHUR SILVA WHITE, F.R.S.E., Secretary to the Royal Scottish Geographical Society.

This paper explained the principles on which a novel map of Africa has been designed by the author to illustrate (1) areas of highest resistance against the European domination, (2) areas of highest relative value to the European Powers, and (3) the intermediate or transitional regions. A free reading of the map shows the lines of least resistance against the European domination in Africa.

FRIDAY, AUGUST 21.

The following Papers were read:—

1. *On Acclimatisation.*¹ By ROBERT W. FELKIN, M.D.

The subject of acclimatisation increases in importance every year, and during the past few years many papers have been read in reference to it. It is therefore very difficult to find anything new to say about it. There are two schools of

¹ Printed in full in the *Scottish Geographical Magazine*, p. 647, December 1891.

thought, the one regarding acclimatisation as impossible, the other more sanguine and pronouncing it possible. Probably the truth will be found to be a mean between the two. In considering the subject, it is necessary to specify first, the various nations who are to be acclimatised, and secondly, the places where they are to be located. As regards the first point, the national characteristics, habits, customs, and environment must be taken into account, and with respect to the second, the nature of the country, its climatology, its inhabitants, their mortality and endemic diseases must be brought under survey. The next point is to classify the various European nations, and it becomes evident that they can only become readily acclimatised in the temperate zone, where climatic and other conditions are approximately akin to their present habitat.

In reference to Europeans becoming acclimatised in the Tropics, what are those factors which prevent it or which must be overcome before it is possible? They are as follows:—Heat, cold, damp, various endemic diseases, especially malaria, and those constitutional conditions induced by climate which either destroy the immigrants or diminish their fertility after one or two generations. Progress has been made during recent years in enabling persons to reside longer and to enjoy greater health in the Tropics. What probability is there that science will accomplish still more in rendering acclimatisation possible for Europeans in tropical countries?

2. *Changes in Coast Lines.* By Dr. J. S. PHENÉ.

Dr. Phené pointed out that the changes in the configuration of the coast lines of the earth exceeded even the large estimate of those who attributed so much to erosion by rivers, glaciers, and general aqueous causes. The contiguous currents in the Gulf of Florida, which originated the Gulf Stream, attested by the results of their operation decades of millions of years; and the configuration of what were now the British Islands appeared mainly due to that influence.

3. *Morocco as a Field for Geographers.* By J. E. BUDGETT MEAKIN.

Only a small portion of the country is at all fairly known, and on the whole it may be considered, not only for geographers, but for all men of science, as virgin soil. Only one traveller has explored the famous Atlas to any extent, and given to the world satisfactory maps and other topographical data. This is the Baron de Foucauld, who travelled some years ago in the disguise of a Jewish Rabbi. The failure of all others who have attempted this task has been due to their unsuitability, chiefly arising from their ignorance of the people and the language. Rohlf's penetrated as far as De Foucauld, on the whole, but had no means of preserving a scientific record. The only authority with regard to the flora and geology of any portion of the highlands is the work of Hooker and Ball. There is no reliable map of Morocco, the only real attempt having been made by Capt. Baudouin, for the French War Office, in 1848. This is compiled partly from actual observation and the records of travellers, but for the most part depends on the vague information of natives.

The configuration of the Atlas is considerably different from that shown on most maps. Instead of one long chain stretching in a south-westerly direction, it is in reality composed of three more or less parallel lines, which are best defined as the Medium, the Great, and the Lesser Atlas; the first named being the northernmost, and the last bordering on the Sahara. Of these only the centre of the Great Atlas has been to any extent explored.

4. *On the Aborigines of Western Australia.* By Miss E. M. CLERKE.

The monastic settlement of New Nursia, seventy miles from Perth, in Western Australia, is the most striking refutation of the generally received belief in the irredeemable degradation of the Australian aborigines. Founded in 1846, by two

Spanish Benedictines, Fathers Serra and Salvado, who gradually won the confidence of the natives by sharing their pursuits, it now forms a flourishing industrial colony, consisting of a monastery, church, and schools; surrounded by a vast cultivated domain, workshops for different trades, and a native village of about fifty cottages inhabited by as many Christian families. One of the girls trained here is in receipt of a Government salary as head of the post and telegraph office; in which, when absent on sick leave, she was efficiently replaced on short notice by one of her companions. The boys, too, learn with great facility, and many of them prove steady tradesmen or trustworthy servants and foremen.

In the wild state these aborigines are cannibals who devour the flesh of their own kinsfolk and exhume for food bodies after three days' burial. They believe in an omnipotent creator and an evil principle, but do not propitiate either by worship; regard the moon as maleficent, the sun as a benefactor, and the stars as a numerous family sprung from the marriage of several couples amongst them. The soul is believed to survive after death in a disembodied state, and to transmigrate into the body of others, remaining in that of the last of the party who approach to invite it. They are grouped in families of ten or twelve under the absolute rule of the head, but no longer, as formerly, form tribes by the agglomeration of these families. The men are prohibited from marriage before the age of thirty, have often but one wife, sometimes two, and a larger number only when they adopt those of relatives or friends left otherwise unprotected. Defective infants and superfluous girls are killed, but the others are reared with great tenderness, which is also exhibited to aged parents.

5. *The Application of Indian Geographical Survey Methods to Africa.*¹
By Lieut.-Colonel T. H. HOODICH, R.E.

The origin of the paper is requests from private sources for information as to the best methods of commencing surveys in Africa. These surveys may be assumed to be of a geographical rather than a revenue class, and to have in view objects similar to those obtained by the geographical surveys carried out by Indian survey officers. An outline of the methods proposed may be summarised as—

1. The adoption of a rapid system of triangulation along the most important lines for first survey.
2. The extension of a graphic system of mapping from these lines by means chiefly of native labour.

The most important lines for first survey are the international boundary lines. Until lately England has been peculiarly free from the necessity of demarcating or maintaining national boundaries. Even India offers but a comparatively short line for defence. The new partition of Africa largely increases her responsibilities in this respect, though there may be no immediate cause for action.

There is, however, a great necessity for a topographical acquaintance with the boundaries adopted. Only a small portion of them apparently follow permanent natural features, the rest being defined by rivers, &c.

Danger of river boundaries and uncertainty of some other forms of boundary.

It would appear, then, advantageous to commence triangulation along the boundary lines. This is, however, so far a national or international question, and consequently in these preliminary stages of survey State assistance might very well be expected, and Imperial resources drawn upon for carrying it out.

1. What are these resources?
2. What is the nature of surveys already existing in Africa?
3. What is the nature of the survey we ought to build up?

Replying to 2 and 3 we find that if a continuous and comprehensive scheme is to be adopted, with unity of design for all the scattered districts of the African colonial system, nothing has very much been done as yet which would assist us in carrying out our scheme. This scheme should be largely borrowed from experiences in Asia. A consideration of it shows (in reply to 1) to what extent Imperial

¹ Printed in full in the *Proceedings of the Royal Geographical Society*, p. 596, October 1891.

survey resources might be utilised during the processes of laying out the preliminary lines of triangulation. From this triangulation the extension of topography would thereafter probably depend on private enterprise.

Then follows a short consideration of the general topographical processes as carried out by natives of India, of the value of such native labour, and of the possibility of raising survey establishments in Africa similar to those which have done such excellent work in Asia.

6. *Bar-Subtense Survey.*¹ By Colonel HENRY TANNER, *Indian Survey.*

The paper dealt with a system of survey carried out by Colonel Tanner during the past four years in the Punjab Himalayas, with suggestions as to its adaptability for isolated surveys of unexplored countries.

SATURDAY, AUGUST 22.

The following Paper was read:—

1. *Suggestions for the Revision and Improvement of the Large Scale Maps of the Ordnance Survey.* By HENRY T. CROOK, *C.E.*

Reforms having been promised in the Ordnance Survey productions, it is desirable to consider whether the large scale plans and maps answer the requirements of those who chiefly use them, namely, engineers, geologists, and other scientific men, and those engaged in the administration of imperial and local affairs. The purposes which the Cadastral Survey has to subserve are constantly increasing with the advance of scientific knowledge. It is admitted that the production of this class of maps is a proper function of Government. The efficiency of the organisation and the accuracy of the work done by the survey department is not disputed, but there is room for much improvement in the style of maps published, and in the amount of information conveyed. No adequate provision has been made for the revision of the survey, and in consequence a very large portion of the maps is obsolete. The author makes suggestions for clearing off the arrears of revision work, and for maintaining the survey maps reasonably up to date. He proposes that the country should be divided into districts under superintendents, each district office being charged with the revision of the maps of its district within a limited period. He suggests that the services of these district offices might be at the disposal of anyone requiring plans or maps with manuscript corrections up to date on payment of suitable fees. He thinks by these means the cost of maintaining the survey would be materially reduced. Then follow some suggestions for improving the six-inch county maps, and he concludes by urging that the scale of prices should be revised, and that better indexes should be provided for the different maps.

2. *Mr. Ravenstein explained a Series of Maps illustrating his Presidential Address to the Section.*

3. *A Local Collection of Maps was described by the Librarian of the Public Library.*

¹ Printed in the *Proceedings of the Royal Geographical Society*, p. 675, November 1891.

MONDAY, AUGUST 24.

The following Papers were read:—

1. *Antarctic Exploration.* By E. DELMAR MORGAN.¹

The author pointed out that no serious attempt has been made to explore the South Polar region since the expedition under Sir James Ross fifty years ago. He urged that it was the duty of the British Government to take the work in hand, and to send an expedition equipped to spend a year in the highest attainable latitude.

2. *Photography applied to Exploration.*² By JAMES THOMSON.

3. *Journeys to the Lake Ngami Region.* By HARRY D. BUCKLE.

4. *A Visit to Kilimanjaro and Lake Chala.* By Mrs. FRENCH SHELDON.

Mrs. Sheldon succeeded in descending to the small crater, Lake Chala, at the S.E. foot of Kilimanjaro. The results of her observations will be found in the 'Proceedings, R.G.S.' for July 1891.

5. *The Geography of South-West Africa.*³ By Dr. HENRY SCHLICHTER.

South-West Africa is in many respects only imperfectly known to geographers. Our information about Great Namaqualand, the western Kalahari, the large Kaoko district, and the belt between the Atlantic Ocean and the highlands of the interior is by no means satisfactory. Since Germany has acquired territories in South-West Africa many scientific and other travellers have traversed the German sphere of influence, and hereby contributed to our knowledge of the country. But geographical science has not yet gained much by these recent German explorations, for, with the exception of a few books and scientific publications, all the information has reached the public and been preserved only in various German papers and periodicals, mixed with many more or less unimportant colonial matters. The author has therefore tried to collect the geographically important facts from these sources.

Moreover, the old explorations of South-West Africa needed revision. Mr. Theal, who has searched the archives of the Cape colony, has recently discovered that the Orange River was known before Gordon reached it in 1777, and that in 1761-62 a well-equipped expedition penetrated into the interior of Namaqualand, much farther north than Paterson, Gordon, and other travellers did. In 1791-92 a second exploring party reached a point still further north. But these interesting journeys were soon afterwards forgotten. The author has found that the British Museum contains the full diary (printed in Amsterdam, 1778) of the first of these expeditions, and as Mr. Theal has given only short reports, without going into geographical details, the author has examined this diary and compared it with the literature of the present and the last century. He finds that this old expedition is of considerable importance for our knowledge of South-West Africa.

The object of the author in this paper, therefore, is to collect and criticise the new and old reports unknown to geographers and to give a correct account of the present state of the geography of South-West Africa.

¹ See *Proceedings of the Royal Geographical Society*, p. 632, October 1891.

² Printed in the *Proceedings of the Royal Geographical Society*, p. 669, November 1891.

³ Published in full in the *Scottish Geographical Magazine* for September and October 1891.

TUESDAY, AUGUST 25.

The following Papers were read:—

1. *The Siam Border.*¹ By LORD LAMINGTON.2. *Colorado.* By DR. BELL.3. *The Physical and Industrial Geography of Florida.*
By ARTHUR MONTEFIORE, F.G.S., F.R.G.S.

General.—Florida is a peninsula with certain unique characteristics. Though an integral part of North America, a large portion of it belongs, climatically and botanically, to the West Indies. The southern half of the peninsula is subtropical, the extreme south tropical. Florida lies between 24° 25' and 31° 0' N. Lat.; 80° 2' and 87° 37' W. Long. Its area is 58,680 square miles—about that of England and Wales. Of this, 4,440 square miles are water. The extreme length is 465 miles, of which 400 miles belong to peninsular Florida and 65 miles to continental Florida. The average breadth of the peninsula is 100 miles. The coast line is variously estimated—about 1,200 miles is approximate. Florida, though the largest of the States E. of the Mississippi, is one-third the size of California. It is forty-five times the size of Rhode Island. The west, south, and east coasts are much influenced by the Gulf Stream, which escapes into the Atlantic through the Florida Strait; as it turns northward along the S.E. coast, it is a volume of water 2,000 feet deep, 30 miles wide, flowing with a velocity of five miles an hour, and possessing a temperature of 84° Fahr. The most remarkable inlet is the Indian River, on the E. coast. It is about 130 miles in length from N. to S., is salt and tidal, has an average width of a mile, and is seldom further than a mile from the ocean. The southern extremity of the peninsula is a network of lagoons and reefs united and formed by mangroves, and presenting to the Gulf Stream the long barrier of coral reefs known as the Florida Keys.

Surface.—With the exception of Louisiana, Florida has the lowest average altitude of any State in the Union. The low watershed of the peninsula follows the anticlinal whose axis runs N. and S. through the central and northern regions, and it spreads out here and there into a low group of rolling hills. The loftiest point is Table Mountain, by Lake Apopka, and is barely 500 feet. The altitude of the great swampy tract called the Everglades (10,000 square miles), which lies in the extreme south, is, at its northern point, 16 feet, and at its southern point 5.5 feet above sea-level. The majority of the lakes are situated in the higher rolling country at altitudes from 150 to 300 feet; but there are many that are low—e.g. Okeechobee (1,000 square miles), 20.44 feet. The main aspect of the surface is rolling country with light sandy soil, and heavy and continuous forests of long-leaved yellow pine (*Pinus australis*), pitch pine (*Pinus cubensis*). Low hummocks frequently occur with clayey soil, topped with fibrous humus, and having dense growth of cypress (*Taxodium distichum*), red bay (*Persea carolinensis*), live oak (*Quercus virens*), palmetto, magnolias, mahogany, swamp ash (*Fraxinus viridis*), Ficus aurea, &c. Numerous rivers and streams, and about 1,500 lakes and 'springs,' diversify the surface. Swamps and 'prairies'—low grassy land with standing water—are frequent.

Hydrography.—Florida is dominated by water. It has numerous rivers, and streams, and lakes. Nineteen of its rivers are at present navigated by steamers to a total distance of 1,000 miles. The waterway navigable by boats is nearly ten times this length. The only important rivers that empty into the Atlantic are the St. Mary's and St. John's Rivers. The former forms the natural boundary

¹ *Proceedings of the Royal Geographical Society*, p. 701, December 1891.

between Georgia and Florida. The latter rises within ten miles of the Ocean into which, after a N.W. course of 300 miles, it flows. Into the Gulf of Mexico flow the Caloosahatchee, draining Lake Okeechobee; the Peace River, which rises in the highlands west of Lake Kissimmee, and flows S.W.; the Withlacoochee, rising in the same highlands, and flowing N.W.; the Suwannee rising in the Okefenokee swamp of Georgia; and the Apalachicola.

Of lakes and 'springs' there are about 1,500. Some are mere expansions of a river's course, but the majority occur in the high rolling district which runs N. and S. through the peninsula. Okeechobee (1,000 square miles) is the largest. The water is quite clear. The springs are sulphurous, and occur everywhere. Silver Spring, 200 yards in diameter and 30 yards deep, is the largest.

Climate.—The water surface of Florida is 4,440 square miles. The isotherms run from W. to E. in an E.N.E.—N.E. direction. The isotherm of 75° mean annual runs from Tampa Bay to Cape Canaveral, and represents that of the important section of central or semi-tropical Florida. The average mean of Jacksonville, the industrial capital, and the northern limit of the orange belt, for twenty years has been for January 55° and for August 82°. At Key West, sub-tropical Florida, the mean for January is 71.04°, and for August 84.33°. The annual mean humidity is 68.8. Rainfall during the five winter months at Jacksonville = 16.62; at Key West 9.10. The annual rainfall at Jacksonville is 54 inches. The prevailing winds are from the S.E., blowing from the tropics over the heated Gulf Stream and N.E., also over the stream. This makes the E. coast milder than the W. The W. coast also occasionally suffers from a cold 'snap,' which has descended the Mississippi Valley.

Geology and Soil.—As far as has yet been ascertained, the oldest strata are, if not coeval, at least similar or equivalent to the Tertiaries of the Thames Valley, or those of the Paris Basin. But all the divisions of the Tertiaries are represented. The Eocene is present in great depth; the Miocene and Pliocene are less thick; Pleistocene beds are very thick. Fossil remains have been found, not only of the mastodon, but of hippopotamus, rhinoceros, tiger, hyena, lion, elephant, and llama. An anticlinal, with an axis parallel to the peninsula, runs through central and northern Florida. True coral rock is found continuously in the south and in many districts further north. Under this are dense beds of limestone, consisting of shells of marine organisms. *Cf.* reef-limestones of Cuba. The soil is divided into—(1) hummocks; (2) 'pine' or sand lands. Hummock land is low-lying clayey soil, in which much potash and phosphorus (from decaying vegetation) are found. The sand lands contain 50 per cent. soluble matter—are a mixture of sand and clay—of very various mineral character, but uniformly light to work.

Vegetation.—Florida may be divided into three zones according to vegetation. (1) The northern or continental portion. (2) The central or semi-tropical portion, whose southern limit extends from the Caloosahatchee on W. coast (26° 35' N.L.) to the Indian River inlet (27° 30' N.L.). Iso-floral lines may be drawn from W. to E. across the peninsula in a direction varying from N.E. to N.N.E. The three divisions might be called southern, semi-tropical, and sub-tropical. Of the 200 species of forest trees about 38 per cent. are tropical, and similar to those of West Indies. Many of these trees grow luxuriantly on the Keys and extreme south, but dwindle and become mere bushes at the northern limit of the belt—26° 35' N.L. to 27° 30' N.L. from W. to E. The following fruits are cultivated with great success:—(1) in north: pear, peach, grape, and orange (risky); (2) in central or semi-tropical belt: orange, lemon, lime, pine-apple, persimmon; (3) in sub-tropical belt: lime, pine-apple, banana, cocconut. A large number of tropical fruits are being tried. Sugar and rice are grown extensively in lowlands north of Okeechobee.

Industries.—Fruit growing, vegetable raising, and lumbering are main industries. Recently extensive phosphate beds have been discovered in river valleys, and great outputs been registered. Kaolin of superior quality has been discovered S. of Lake Harris and elsewhere. Cotton and tobacco are largely grown in N. Oyster and sponge fisheries employ thousands of hands. The ranches of Lee County are famous for their large herds, and infamous for quality of same.

Inhabitants.—The aboriginals were Miccosukies. These have disappeared, the 1891.

remnant mingling with the Seminoles, who were originally Creeks, but in seceding from that tribe under leadership of Secoffee (1750 A.D.) were styled Seminoles—runaways, vagabonds. Not more than 300 Seminoles now in Florida—chiefly in Everglades. Negroes, old Southerners, northern immigrants, and foreigners (chiefly English) make up, in this order of proportion, the population, which in 1880 was 269,000, and is now estimated at nearly 500,000.

4. *The Volta River.* By G. DOBSON.

5. *The Bakhtiari Country and the Karun River.*¹ By Mrs. BISHOP.

6. *Physical Aspects of the Himalayas, and Notes on the Inhabitants.*²
By Colonel HENRY TANNER.

7. *On the proposed Formation of a Topographical Society in Cardiff.*
By E. G. RAVENSTEIN, F.R.G.S.

¹ See *Proceedings of the Royal Geographical Society*, p. 633, October 1891.

² Published in full in the *Scottish Geographical Magazine*, p. 581, November 1891.

SECTION F.—ECONOMIC SCIENCE AND STATISTICS.

PRESIDENT OF THE SECTION—Professor W. CUNNINGHAM, D.D., D.Sc., F.S.S.

THURSDAY, AUGUST 20.

The PRESIDENT delivered the following Address:—

Nationalism and Cosmopolitanism in Economics.

THE year which has elapsed since this Association met at Leeds has afforded ample evidence of the vitality of economic studies in England at the present time. It is no small proof of a widely diffused desire to pursue such investigations seriously that a second edition of such a substantial volume as our late President's 'Principles of Economics' should have been called for within a few months of the issue of the first. While, too, economics alone among sciences has been hitherto unrepresented by any journal or review published in England, the year which has passed has seen first one and then another quarterly periodical started with the avowed object of catering for the wants of economic students. The larger of these magazines has come into being as the organ of an Association which is designed to do other work for our science besides that which it has already undertaken.

Both of these new ventures deserve a hearty welcome from this Section, though in different ways, for they have emanated from different sources. The 'Review' bears on the forefront that it hails from Oxford; while the 'Journal' and its destinies have been often talked over at Cambridge, and it seems to me, at least, to be full of the Cambridge spirit. The old contrast between these two Universities comes out strongly and distinctly. The intense interest which Oxford has always shown in the study of man and of conduct has put her in practical touch with many sides of actual life, and has caused her to be the mother of not a few great movements. But in Cambridge we are so engrossed in the study of things that we have no time to spare for trying to know ourselves. If we ever do give our thoughts to man, we like to think of him as if he were a kind of thing; so that we may apply the same methods which we are wont to use in the study of physical phenomena. If we turn our attention to history, we try to classify the various forms of constitution that have existed on the globe, and then we call the result Political Science. We may devote ourselves to Ancient or Modern Literature, but they seem to interest us not as vehicles of thought or as forms of art, but as the bases of Philological or Phonological Science. If we investigate human industry, we like to treat the individual as if he were a mere mechanism, and busy ourselves in measuring the force of the motives that may be brought to bear upon him. It is when we deal with physical things that we can be precise; this we are determined to be at all hazards; and of course we may always attain to precision in our statements on human affairs so long as we are content to be superficial, and are not at pains to penetrate to the very heart of the matter. But indeed there are dangers on either hand, whether we give ourselves as best we may to the study of Man, and deal with Economics in its more human aspects; or whether we are chiefly interested in the study of things, and try to

make the fullest use we can of the methods and conceptions of physical science for investigating certain aspects of human affairs. In the new periodicals, there is an excellent corrective against either evil, since the Oxford 'Review' is largely written by Cambridge men, and the 'Journal,' which exemplifies the Cambridge spirit, is edited by an Oxford Professor.

It might almost seem that with all this new activity there is not so much occasion as there used to be for these annual reunions in Section F. But indeed it is not so. There is much needful work, which will hardly be done at all unless it is done here. There are certainly two ways in which this Section offers great opportunities for promoting economic science, and opportunities which are not available elsewhere in England. Some points may be rendered clearer by debate, and this Section affords an open field for such discussions. It is frequently useful to throw out some hypothesis as a tentative explanation of some group of facts; and the conversations which take place here may help to confirm or to correct a suggestion thus hazarded. A similar result might be obtained by rejoinders in the magazines, but there is, at least, a saving of time when opponents can meet face to face and thresh out their differences by means of talk.

It may easily occur, too, that interesting problems are raised and stated rather than solved by the papers read before this Section; and the power we have of selecting special committees, to work throughout the year at some particular point in order to report to this Section at a subsequent meeting, is an instrument for advancing knowledge which we cannot but value highly.

These advantages might, I conceive, be found in connection with any of the sciences which are represented in the different sections of this Association. But there are reasons in the very nature of our science which render it specially advantageous for economists to take part in such a gathering as this. Our science, as treated by Mill, and I name him because, whatever our differences may be, I feel sure we should all regard ourselves as his disciples, rests on certain assumptions, and takes for granted results which it does not profess to have investigated independently. Many of its premises are derived from some branch of physical science. As Mill has taught us, Political Economy assumes the facts of the physical world.¹ But that is a large order; and the economist may often be doubtful what he is at liberty to assume as a physical fact. A meeting of the British Association, where many specialists are brought together, may surely be turned to good account in connection with this difficulty. In previous years we have learnt from one of the Sections what we may assume about the future production of gold; while we have heard from another what we may take for granted about the physical possibilities of procuring additional subsistence. We hope to learn from other specialists this year on the one hand about the prospects of our coal supply and on the other in regard to the physical effects of prolonged hours of work. It is no small advantage to have the annual opportunity of finding more definitely what physical facts we may assume as the bases for economic argument.

Once more—and here we come to the feature which distinguishes our science from the work of so many of the other Sections—Political Economy, as Mill has taught us, also assumes the facts of human nature; but human nature and human institutions vary from age to age, and among different races and in different regions. It has sometimes been a complaint against economic science that it assumes a certain type of human being as though it were universal, and that it also takes for granted the excellent but insular institutions under which we live; on this point I shall have more to say presently. But holding, as I do, that some such assumption may often be a convenient instrument for scientific investigation, I would yet urge that there can be few better correctives to possible exaggeration and one-sidedness (from the undue extension of our hypotheses) than that of meeting men who are habituated to different temperaments and different institutions from our own, *e.g.* to the habits and institutions of our fellow-subjects in India. This Association has proved to be a convenient centre, which attracts economists from other lands. It is with genuine pleasure that I welcome, in your name, the visitors from other

¹ J. S. Mill, *Principles of Political Economy*, p. 13.

countries who have honoured us by joining our gathering to-day. By our intercourse with them we may surely help to correct insular prejudices, which are hastily formed and are not unlikely to affect our assumptions about human nature.

It has been from time to time the task of Presidents of this Section to deal, in an opening Address, with some fresh economic problem that had forced itself upon public attention in the immediately preceding year. I must crave your indulgence if I make no such attempt to-day. For the last thirteen years I have given such time as I could spare from clerical duty and the routine of teaching to the study of English industry and commerce in the past, and I have made no pretence of keeping myself fully informed about the burning questions of the present day. To me the burning controversies of two or three centuries ago are much more fascinating, because we generally know¹ how they ended, and we can hope to decide with some approximation to truth who was in the right and who was in the wrong, or how far both were in the wrong. But after all English history is continuous, and the economic life of to-day is the outcome of the economic life of the past. I do not think it will be wholly idle if I try to set before you, however broadly and superficially, some thoughts about economic affairs to-day, as they appear to one who has spent many hours in trying to habituate himself to the various phases of economic life and opinion in England during stages of her development which have passed away for ever.

I.

During the century which succeeded the Crusades there seems to have been a very rapid development of English industry and commerce; and if we tried for a little to place ourselves in thought in that period, we should find ourselves in a world that was strangely like and yet strangely unlike our own. The dialect would be unfamiliar, if not unintelligible; though we might recognise the well-known churches at Westminster, and Salisbury, and Durham, the aspect of the landscape with the open fields would be monotonous, the houses would appear mean and poor, and most of the towns would seem to be big and sleepy villages. While these were the external characteristics, the habits of thought would strike us as equally strange, since each village, and each town, was so curiously isolated from its neighbours. The ideal of good management in every village, controlled as it practically was by a manorial bailiff, was that it should be self-sufficing and supply its own wants from its own resources, that it should only buy from the outside world what it could not produce for itself and could not do without, and should only sell to the outside world what it had to spare as a surplus. In the towns which were becoming centres of trade there was more enterprise, but it was carefully controlled and organised so as to minister to the good of the particular town. No business man had a wider view; his town was the economic unit, and afforded the means by which he was able to enjoy unimpeded intercourse with the inhabitants of other towns. The prosperity of the town was the economic ideal, and the rivalry of two towns in the same county, like Lincoln and Boston,² was as keen as the jealousy between French and English fishermen to-day. There appears to have been some collective buying of foreign wares for the common advantage of the townsmen,³ but all industry and commerce were organised and regulated under municipal authority with the view of making them subservient to the advantage of the town where they were carried on. The manner in which the townsmen contributed to royal taxation rendered them not unnaturally jealous of anyone who tried to evade his fair share of public burdens by taking advantage of the facilities which their town offered for carrying on his trade without helping to discharge the public obligations. The fact remains that in the thirteenth century commerce was intensely municipal, that the legal forms which were in vogue for recovering debts took this

¹ Some few, like the Newfoundland fisheries dispute, never come to an end. It was decided in 1697, and settled in 1713 and 1763; it was finally laid to rest in 1783, but it seems as lively as ever.

² P. Thompson, *History of Boston*, 54.

³ *Quarterly Journal of Economics*, V., 343.

municipal type, while writers on political and economic matters¹ seemed to assume that the city was the sort of group to be regulated and taken into account.

In Tudor times this local and municipal economy was rapidly superseded by a larger system. There had been a decided growth of national feeling and a great deal of national regulation for commerce during the fourteenth and fifteenth centuries, and as this larger economic life developed the old municipal institutions were to some extent superseded. In some cases the old institutions had come to be cramping and positively noxious, so that industry sought other centres and commerce betook itself to new channels. The precise story of the growth of this national economic life in England and the corresponding decadence of the old municipal institutions for industry and commerce is not easy to trace. It may suffice to say that in the time of Elizabeth the change was practically complete; and the subsequent development of economic life can be most easily followed when we look at it from a national rather than a municipal standpoint. From that time onwards there was, comparatively speaking, free intercourse between the different parts of the country; each district, instead of being an isolated unit organised for itself, as it had been in the time of the first Edward, was treated as contributing its quota to the material welfare of the nation; the prosperity of England as a whole, and the consequent strength of England as a political power, were the ideals which economists kept consciously in view, and which gave the framework for all their projects and all their writing on economic topics.

Here, then, from the time of Elizabeth onwards, we have to deal with a larger economic organism—the Nation, not merely the town—but we still find people pursuing the old economic policy, though they applied it on a much more extended scale than before. Their leading economic idea was to render the nation self-sufficing; to develop its resources, to procure from other countries what England needed and could not produce for herself, and to sell them the surplus of our native commodities. If we were able to open a new market for English exports, we congratulated ourselves that we had got a vent for our surplus. If we introduced a new industry, like the silk trade, we rejoiced that we could now hope to supply ourselves with this article instead of purchasing it from the foreigner. If we planted a colony in some distant region, the trouble and expense was gladly undertaken in the hope that the products of the new land would render us independent of some supplies from foreign sources, and thus subserve the economic self-sufficiency of the English nation: the encouragement given to tobacco-growing in Virginia, so as to enable us to dispense with supplies which reached us from Spain, is a case in point. Just as there had been a keen rivalry in the thirteenth century between neighbouring towns, so in the seventeenth and eighteenth centuries there was the keenest rivalry between different nations; a rivalry which was fundamentally political, but which affected every side of economic life, since it was recognised that wealth supplied the sinews of power. The whole economic skill of the day was devoted to the task of building up the wealth of the nation as an independent economic organism, that it might be able to hold its own in political disputes with other countries.

II.

The national scheme of economic policy is not so unfamiliar to us as the municipal scheme which it superseded; it is still pursued in many countries, and it seems to me to dominate the present economic policy of the United States. That great nation aims at being self-sufficing, and at dispensing so far as possible with the products and manufactures of other lands. This nationalist policy has found an advocate in List, who has stated the case with wide practical knowledge and careful discrimination of the circumstances of different peoples. But for England and Englishmen that policy is dead. The Anti-Corn Law agitation killed it so far as we are concerned. We no longer contemplate isolation from the rest of the globe; we only grumble because other people interpose barriers which check free commercial intercourse between all parts of the known world. The free-traders have demonstrated that the world as a whole will be better provided with

¹ For example compare S. Thomas Aquinas, *De Regimine Principum*.

material goods if each nation specialises in those kinds of production for which it is particularly adapted, and caters for the rest of the world in these departments. We have given up all idea that the nation should be self-sufficing; we depend, even for the most necessary articles of subsistence, on communication with other countries; we produce with direct reference to the requirements of foreign markets, and do not merely export a surplus which we cannot advantageously use ourselves. So far as our economic scheme is concerned, we regard England as part of a greater whole—not as an independent national organism, but as one portion of a cosmopolitan economic organism; we desire to have the freest communication with all parts of the world, for on this our very life, our national prosperity in all its branches, depends.

It seems to me, then, that just as there was a struggle in England between the municipal scheme of economic life and the national one in the fourteenth and fifteenth centuries, so there is in the present day a contest all the world over between the nationalist economic policy on the one hand, and the international and cosmopolitan scheme which we Englishmen have adopted for economic purposes on the other. I have argued elsewhere¹ that our commercial success has been greatly due to the early date at which a national economic life was developed in this country; and I cannot regard it as a matter for regret that we have been the first among the nations to throw ourselves heartily into the cosmopolitan economic scheme.

It is a commonplace to say that we live in a period of transition; of course every period is in a sense a time of transition, for the world never does stand absolutely still, but the change that is going on in the economic life of the world to-day is something more than common; the framework on which English policy was fashioned for three hundred years has been laid aside, and all our schemes for industry and commerce are being devised on a new model and worked out on a larger scale. This new model and larger growth are affecting all parts of the globe, and even those countries which would fain pursue the old nationalist economic scheme cannot escape the new influence; international and cosmopolitan economic forces are gradually breaking down national exclusiveness in all parts of the known world.

(a) A very few words will illustrate what I mean. There is in this country a very large formation of capital every year. Mr. Wilson² traced it for the earlier years of this century, and Mr. Giffen has calculated it for more recent periods. The capital thus formed seeks investment, and it is ready to flow into any channel where there seems a reasonable chance of profit. It is not confined by national barriers, but is transferred to any country, however distant or however uncivilised, so long as arrangements are made that give a prospect of regular or of handsome profits. The resources of distant colonies, of South American Republics, and of Egypt, have been developed by capital borrowed in England. There are, therefore, moneyed men in this country who have a stake, and are directly interested, in the prosperity of many lands they have never seen. Space is ignored, patriotism is left out of sight, and capital is invested wherever there is an apparent promise of profit.

(b) Capital tends too to minimise the differences between nations, since wherever it goes it tends to modify the forms of industrial life. Capital introduces new methods of production, for it brings machinery and thus induces the labourer to spend his whole time in working for wages. There are still many lands where the old system which was general in this country at the close of last century holds good; and where the artisan supports himself partly by labour on his land and partly by his trade. But industrial capital, and expensive machinery, and factory towns are not compatible with such conditions of life. As they are introduced the old domestic system and the family life maintained by bye-occupations are gradually broken up; the artisan becomes wholly dependent on the wages he earns and has no other source of income; thus social life tends to shape itself in a new form. As capital becomes a dominant force in industry, the artisan is induced

¹ *Growth of English Industry and Commerce*, 244, 413.

² *Capital, Currency, and Banking*. Preface.

wholly to relinquish agricultural pursuits, and society is separated into the two great classes of capitalists who employ and labourers who earn wages. There thus comes to be a class sympathy between wage-earners in many lands, such as has never existed before in the history of the world; their difficulties are similar, their voting power is great, and their aspirations are alike; with many of them the interest of their own class in other lands calls forth more real sympathy than the love of a country which is theirs in common with the classes who employ them. The similarity of the conditions of employment in Western Europe was recognised by the Emperor of Germany when he invited the representatives of various powers to join in conference on the Labour problems. In the world of Labour, as in the investment of capital, national differences and peculiarities are ceasing to be of much importance.

(c) The most striking illustration of the decadence of nationalist economic sentiment is to be found in contrasting the attitude which is now taken by the mother country towards the colonies with that which was constantly assumed during the eighteenth century. The right of the Crown to tax the colonies was frequently questioned or resisted, but the right to regulate the development of the colony in the interest of the mother country may be said to have passed unchallenged till the very eve of the War of Independence. In the present day, however, we are inclined to blame a government which does not administer its colonial affairs solely in the interest of the colony itself and its inhabitants, without attempting to render it economically subservient to the mother country any farther than purely colonial considerations seem to demand. Our colonies give us prestige and importance in all parts of the globe, they form a ring of settlements that are English in language and habits and customs, but they are not directly subservient to our national economic interests, for they may encourage the commerce of foreign countries and they may come to be our rivals in neutral markets.

(d) Nor is this all; the international movements of labour are far more frequent and rapid than they used to be. Till 1825, English artisans were positively forbidden to emigrate, either to our own colonies or to foreign parts; it was doubtful if engineers were at liberty to go abroad temporarily to set up machinery they had made. But the legal prohibition has been withdrawn, and the new facilities for travel have entirely altered the habits of the labouring classes. There is, of course, some little hesitation from differences of law and of language in foreign parts; but the Lancashire man who gets a good offer to go out as a foreman and organise a spinning mill in Bombay is not likely to overestimate the importance of these things. He has got a good opening and he will take his chance about his power of making his orders understood.

(e) One consideration which helps to reconcile an Englishman to such a life abroad is the frequency of intercommunication, together with the excellence of the postal service all over the world. The very fact that there is such international organisation is in itself a noticeable sign of the tendency of which I am speaking. Postal communication between different parts of the world is far cheaper and easier than it was between different parts of this country sixty years ago. National barriers offer no practical resistance to the passage of news or the driving of bargains; mail steamers and telegraphs have combined to produce many changes in the habits of business men in the present day.

(f) One more illustration will suffice. For many articles there is now a world-wide market, and it is possible to speculate with the view of engrossing the whole available stock in the world, at any rate so as to be able to rule the market. Corners in cotton may be looked for from time to time. Great trusts like the Standard Oil Company monopolise an article of common consumption, and a Copper Syndicate has run its course. The questions whether such speculations are likely to be profitable or not, and whether they are public dangers, do not concern us now; I merely wish to point out that in actual commerce in the present day we find what may be termed cosmopolitan speculation, which disregards all national differences and takes account of the world as a whole.

These symptoms that economic life in the present day is breaking down national barriers and forming international connections of every kind are very interesting.

I know that they are not the only features of our time; there is a revival of national sentiment in many quarters, and national aspirations, if they are more than the idlest sentimentality, involve a desire to create economic life that is national too; in many lands there are increasing attempts to protect native industry. The Nationalists of 1784 were enthusiasts for stimulating native industry in Ireland, and for prohibiting the importation of British goods: and the prospects of protection do not seem to daunt the advocates of Home Rule to-day. Nationalism cannot but be a living power in an age which has seen the union of Italy and the formation of the German Empire. I do not ignore these facts though I lay stress on another side, and say that, so far as industrial life is concerned, it is, on the whole, becoming more and more cosmopolitan and international, and less and less fettered by national barriers all over the world. We in England have for good or for evil committed ourselves to the cosmopolitan scheme, and have definitely and deliberately discarded the nationalist system.

III.

1. This striking change in economic life and commercial practice must, one would suppose, be reflected sooner or later in economic doctrine. Of course it cannot be felt all at once; economists, like other men of science, can only observe what has actually occurred and reflect upon it. The science grows as new forms of industrial and commercial life appear, and demand that they shall be taken into account. But we can at least see the manner in which modification must come into the science as conceived by Mill; in accordance with these new phenomena we shall have to entertain *additional* hypotheses about human nature and human institutions. The whole science is, as everyone now seems to agree, hypothetical.¹ The method which Ricardo pursued and Mill formulated has been generally adopted by English economists, and they are ready to admit that all their results rest on certain assumptions in regard to the physical world and human nature. But while the facts of physical nature may on the whole be regarded as constant for the period of human life on the globe, the historian knows that it is not so with the facts of human nature; human institutions, and the characters which are formed by them are modified from age to age; *if we wish to study the economic condition of any actual people at any time, we must work with conceptions that are appropriate to their habits of life.* To Mill it seemed sufficient to assume a single type of human nature—one in which self-interest predominated; and one kind of society—where free competition was usual; all other economic phenomena he dismissed as unsusceptible of scientific treatment. But we do not alter the logical form or change the scientific character of our study if, instead of framing a single hypothesis in regard to human nature and society, and restricting our attention to such phenomena as can be conveniently studied in connection with it, we are prepared to investigate all economic phenomena by making such assumptions in regard to men as are appropriate to the various ages with which we may have to deal. Professor Edgeworth has rightly pointed out that economists often blunder in treating something as constant that is really variable,² and I should like to add that the most common illustration of this error may be found in arguments which seem to assume that human nature is a constant,³ and that the variations, even in long periods, may be neglected. Such is the discussion of the applicability of Ricardo's law, with all it involves,⁴ to rents, several centuries ago; but perhaps this is meant as a sort of scientific witticism; it is not always easy to tell when a Professor of the dismal science is making a joke.

Pardon me if I dwell on this point with some iteration; in all economic study hypothesis is necessary; it is only by stating some hypothesis that we can artificially isolate a group of facts, and thus give a clear explanation of a portion of the com-

¹ Keynes, *Scope*, 209, 293.

² Marshall, *Present Position*, 15.

² *Mathematical Psychics*, p. 127, note.

⁴ See my article, 'What did our Forefathers mean by Rent?' *Lippincott's Magazine*, Feb. 1890.

plicated phenomena which go to make up human society; only by carefully stating our hypotheses can we avoid the dogmatism with which economists are so often charged; since by putting forward the condition we assume, we are also stating the limits within which our conclusions hold good. In reasoning from assumed premisses we may obtain conclusions that have demonstrative certainty and state laws which have universal validity¹ in any sphere we can think about, even if there is no place or time where the conditions on which they depend are realised, so that these laws have nothing corresponding to them in any actual existence. Our results may have no material truth, even though they have universal validity. The pursuit of such speculations may be most valuable as a mental discipline, if for no other reason because they may assist us to see how many matters must be taken into consideration if we wish to make our investigations of actual phenomena exhaustive. But if we are careful that our hypotheses about human nature shall not be arbitrary, but shall have as much *appropriateness* as possible to actual men and women in some actual place at some actual time, we get conclusions that are not only universally valid in form, but that also serve to be a convenient instrument for investigating facts. We may assume that people are grouped in nations, and that each individual acts out of pure self-interest; or we may assume that people are grouped in families, and always act from a sense of duty in adhering to known customs; in either case we can state laws that have universal validity on the assumed conditions; but for purposes of empirical investigation, one hypothesis is more convenient for studying the actual facts in Western Europe, and the other is more convenient for studying the actual facts on the Russian Steppes; they are not equally appropriate to both groups of economic phenomena.

As Dr. Whewell pointed out in excellent terms,² the progress of empirical science demands the employment of appropriate conceptions; but an illustration may enforce this necessity in regard to economic investigation. Some little time ago I was anxious to get a few statistics about the growth of British shipping during last century, and I turned to the beautiful 'Statistical Atlas' which was published by William Playfair, who first applied the graphic method to statistics. But I found that his careful diagrams were useless for my purpose, and I think I may add for any possible purpose. He has arranged all his facts with the view of showing in the clearest manner how the balance of trade stood between Great Britain and each of the other countries with which we had commercial dealings, and he thus demonstrated whether any branch was a losing or a gaining trade. At the time when he wrote the unwisdom of this way of looking at things had been clearly exposed, but he had failed to move with the times, and the work on which he spent so much labour was simply thrown away. He only serves as a warning to other economists, lest by adhering rigidly to habits of thought which have ceased to be appropriate to the changing conditions of industry and commerce their investigations and reflections should be out of touch with actual life, and should all too soon find their place in the limbo of misapplied erudition.

(a) To my mind the cosmopolitan and international character of industry and commerce has not yet been sufficiently taken into account by economists. They inherit the conception of mankind as grouped for economic purposes in nations, and they adhere to it very closely. Adam Smith did much to break the old spell and to show that it was not worth while to try and build up an independent national economic life, but he was still under the thralldom of the old phrases. He still spoke of the *Wealth of Nations*, and treated the nation as the economic unit. List³ does indeed speak of Adam Smith as concerned with a world-wide economy, but this is hardly correct; he describes, not a cosmopolitan system, but economic principles that would serve for any nation—they are nationalist still. Cobden and the Free Traders took the same standpoint; they thought of the nation as an economic whole; they hoped that unimpeded intercourse would bring about more friendly feeling between nations; they anticipated a great brotherhood in which each nation should be a member; but Cobden was intensely nationalist and in-

¹ Marshall, *Present Position*, 15.

² *Philosophy of Inductive Sciences*, II., 184

³ *National System of Political Economy*, 120.

tensely patriotic.¹ The intercourse has come about, but it has not drawn nations more closely together as nations: it has drawn the elements which composed separate nations into new relationships so as to form cosmopolitan ties and interests, and to break down national barriers and weaken national sentiments. Neither the political economy of Adam Smith nor the political economy of Richard Cobden took much account of the cosmopolitan character of economic life; it has sprung up since their time, but I think that we ought to take account of it, and to make sure that the fundamental conceptions of our science are appropriate to the industrial and commercial phenomena of the present day. We need to think more of the world as a whole; for the practical economic interests of the present are no longer so exclusively national as they used to be. The nation will doubtless continue to have great importance for many economic purposes, just as under the nationalist régime municipalities have been useful organisations, which have at present an increasing importance. But the reality of the change is most obvious when we remember the diminished importance of national prosperity with reference to the sources of taxation. In days when national prosperity was the recognised basis of national power, Parliament desired to increase the 'funds' from which it could draw for the expenses of the realm. For this purpose the limits of the nation have ceased to be of exclusive importance. Capital flows into all lands, and the income returns to London, and the Income Tax Commissioners collect their quota with remorseless impartiality. English capital invested in the United States pays income tax in just the same way as capital invested here; the maintenance of the national revenue is, to some extent, dissociated from the development of our own national resources or the material prosperity of our own realm; this is a curious phenomenon of modern life which was first clearly brought out, as I believe, by Sir Charles Wood in his Budget speech² of 1847. The decreasing importance of national prosperity for political purposes presents an analogy with the decline of municipal economy. In old days the townsmen had been bound together by their obligations to contribute to the royal exchequer; it was this that united the municipalities into a single body for economic purposes; their decline coincided with the development of a national system of taxation, which in turn called forth a system of fostering the national sources of wealth. There was a great advance in economic doctrine in the fourteenth century when it was losing its old form and men began to deal with national and not merely with civic interests, and it seems to me that we might do well to let national wealth take a subordinate place in our economic discussions, and to frame our inquiries with direct reference to the bearing of economic changes on the world as a whole.

(b) At all events the assumption in regard to individual human nature, which is explicitly or implicitly made in current economic treatises, requires to be reconsidered. The isolated individual, who acts out of self-interest, still holds a prominent place in economics, implicitly at least; for we still hear about the measurement of motives which act on the individual will as if they were the sole object of scientific economic study, not merely a single though an important factor. Motives which affect the collective will of an association act in a different plane and cannot be easily co-ordinated with the others; the individual self-interest of the workman and the collective interest of the trade-union to which he belongs often conflict, and most economists have found it convenient to leave these associated and corporate movements in the background and to justify themselves for concentrating attention on individualist motives by the assertion that 'now, as ever, the main body of movement depends on the deep, silent, strong stream of the tendencies of normal distribution and exchange.' It is, of course, the simplest assumption to make, and for short periods in recent times it may be sufficiently satisfactory; but there is a danger of falling into grave error if we rely on this assumption for simplicity's sake and take individual earnings to gauge the labourer's standard of comfort in different centuries of English history.³ It is not difficult to generalise from the past so as to make it appear that this mode of treatment, by isolating the individual, is less inappropriate now than it has been in some earlier ages;

¹ *Political Writings*, p. 144.

² *Hansard*, xc., 318, 320.

³ *Rogers, Agriculture and Prices*, V., 618.

that may be granted at once; individualism, like nationalism, will doubtless be an important economic category for many purposes, but who shall say that it is even as widely appropriate in England now as it was sixty years ago, when the tide of legislation was dominated by *laissez faire* and the Combination Laws were repealed? Is it so dominant in these days of capitalist trusts and labour leagues as to be the most appropriate conception with which to study all economic phenomena in our own country in the present day?

One disadvantage about this mode of treatment is that we really know so little about the isolated individual and his manner of dealing with other isolated individuals; the mere statement brings out the difficulty. Our assumptions regarding such human nature could only be a satisfactory basis for argument if they tallied with observations made in a large number of instances, so as to form the basis for a valid induction like the great argument of Malthus in his Essay. As Mr. Keynes has admirably pointed out, the value of the deductive method as a means of studying actual economic phenomena depends on the inductive determination of premisses.¹ But in regard to the unfettered action of individuals there can be no such induction, for there are no cases to observe. If we wish to state abstract principles of individual human action, we are forced to fall back on another method; to take a type of human nature and analyse it; and it is on this line that economists proceed in framing their fundamental assumption about individual human nature. Bentham many years ago attempted to analyse the motives which may be brought to bear upon a man and reduced them all to quantities of pleasure and pain. Thirty years have elapsed since Mill demonstrated the insufficiency of this analysis and showed that we must take qualitative as well as quantitative differences into account;² and in economics it is specially necessary to attend to qualitative distinctions. It is far less important to measure the force of self-interest than to distinguish the cases where self-interest coincides with family welfare and national prosperity, and those where it does not. Here, if anywhere, it is essential that we should keep abreast of the times, and recognise the importance of qualitative as well as quantitative distinctions in discussing the motives which influence men in their material concerns. But some recent economists seem satisfied that a defective analysis is good enough for them; the crude method which Bentham suggested has been adopted by Jevons;³ the quantitative analysis of individual motives is spoken of as if it were the principal work of an economist; writers still discuss quanta of pleasure and pain, of utility and disutility; and the individual, as Bentham analysed him, is still a fundamental conception in current economic treatises. 'Put a penny in the slot and the model will work.' Society is too frequently regarded as an aggregate of similar individuals, whose actions can all be represented with sufficient accuracy by the Benthamite analysis of motives. Such a conception of society is surely out of date to-day.

Very fruitful results have certainly been obtained by those economists who have not busied themselves about measuring supposititious motives, and who do not assume that man is an isolated self-interested individual. Frederic Le Play regards the family as the most convenient unit for economic observations, both in the advanced and the primitive societies; he has distinguished the different types of family, and their social importance, with rare acuteness; and he has set forth with admirable judgment their respective characters as elements in society. Though too little known in England, his work does not stand alone; for Mr. Charles Booth's monumental investigation into the condition of the dwellers in East London is based on a number of investigations in regard to the circumstances of families. In the family there is a natural social and economic unit which was of much actual importance before English municipalities arose, and before English national life asserted itself in economic affairs. The family is a natural unit which is destined to survive even if our national industry and commerce are more and more merged in cosmopolitan and international progress.

2. When I thus criticise the fundamental conceptions and assumptions of current economic science, as very imperfectly appropriate to the actual conditions

¹ *Scope*, 214.

² *Utilitarianism*, 17.

³ *Theory*, 30.

of industry and commerce to-day, I fear I may be charged with misrepresenting the work of recent economists. To this charge I am ready to plead guilty at once; I think it very likely I have misrepresented them, and I am extremely sorry for it, for I have not done it carelessly or deliberately—I have sedulously endeavoured to avoid it. The fault lies not with me, but with writers who, when they leave their studies and translate their formulæ into the language of common life, forget that they have to do with stupid people; they claim a liberty to alter their definitions from time to time as the exigencies of their argument shall require, and they do not take sufficient pains to state clearly and fully what their assumptions are. Despite my best endeavours I may not always succeed in following them and reconciling their apparent inconsistencies. Ricardo, as Professor Marshall excellently says,¹ made 'the great error of taking for granted that his readers would supply those conditions that were present to his own mind.' 'He changes from one hypothesis to another without giving notice.' And this brings me to the second point on which an historian may be inclined to insist: *that since human nature and institutions change so much, it is most important that our hypotheses regarding them should be stated fully and clearly.* Unless we do so we are not able to keep quite clearly before us the limits within which our arguments are applicable to actual life; but when our hypotheses are clearly stated, we can see directly how far our reasoning is irrelevant to some past condition of society, or how far it would become inapplicable if human nature were to change for the better. Just because economic reasoning is hypothetical and the results are universal in form, hasty readers are apt to forget the comparatively narrow area and short time of actual life to which any single hypothesis is really appropriate, and the limits within which economic generalisations are approximately true; there is a constant tendency to the undue extension of principles that have universal validity, as if they had therefore a wide range of applicability. By clearly stating our hypotheses, we may secure all the advantages which accrue from modern economic science and push the refinements of theory much farther, while we shall keep well before us the hypothetical character and limited applicability of our conclusions, so that we need fear no apparent conflict either with the facts furnished by history or with the ideals which moralists may be endeavouring to realise.

Ricardo, Senior, and some of those who have followed them, have not been careful to state exactly what they assumed. This neglect was often very excusable in Ricardo, especially when he assumed things that were prominent and well-known features in the economic conditions of his day. He did not feel called upon to state some assumption, because it was so clear to common sense that it did not seem worth while to put it on paper. But if there is any lesson that history teaches us, it is that nothing is so well known that we can assume it will always be well known and does not need to be explained. William the Conqueror framed an elaborate scheme for the taxation of England, and recorded the results in 'Domesday Book.' He said that every place was to pay according to *hides*. This place was rated at so many *hides* and that other at so many more or less. But what was a *hide*? He did not think it necessary to state that, because it was obviously a thing that everybody knew; in the course of time it came to be a thing that everybody had forgotten, and the precise meaning of which is being gradually recovered. But William the Conqueror could hardly be expected to foresee all that, or to know that, in the interests of historical research, he ought to have given a plain definition of the everyday language which he used.

In much the same way Ricardo could not be expected to foresee that within half a century after he wrote there would be an extraordinary agricultural revolution; he lived before the days of thorough draining, when high farming was still in an experimental stage; in his time English agriculture was still mainly extensive. If prices promised well the farmer would plough more ground and bring a larger area under crop; if prices ruled low the worst land would go out of cultivation. There were many fields which were actually on the margin of

¹ *Principles*, 213, 530.

cultivation, and were left waste after the fall of prices in 1816. Ricardo and Ricardo's readers would have the clearest picture before them of the agricultural conditions he assumed when his 'Principles' were published in 1817. It is said that his theory of rent does not apply, without modification, to new countries which have been developed since he wrote, or to old conditions of society of which he was unaware, or to the highly intensive farming that has been developed since he died. Very likely it does not; it would be very odd if it did; surely a man may get the credit of giving an admirable explanation of the facts before him even if the terms he used do not directly apply to facts which were about to come into being subsequently. As his reasoning is hypothetical it has universal validity in form, but Ricardo was far too good a logician to suppose that it therefore had general applicability to all places and times. If he had only stated the conditions he assumed—conditions which were obvious to him and might be easily discerned by us if we chose—the value of his explanation, and the limits within which it is true, would have been clear.

Somewhat similar and similarly excusable carelessness was shown by those economists among whom the doctrine of a wages fund grew up.¹ They did not define it as fixed, but they thought and argued about it as though it was fixed owing to the actual circumstances of their times which they implicitly assumed. So far as real wages are concerned and the available 'fund' of the necessities of life, this was restricted by the operation of the Corn Laws: it could not be easily increased as a matter of fact. So far as money payments for labour were concerned, the additional outlay which the capitalist was prepared to make for wages was also closely restricted in the great trades of the country. In the textile trades machinery was being introduced but slowly; the contest between hand-combing and machine-combing had still to be fought, and the power loom was beginning to be a practical success, not only in cotton weaving, but in the ancient and staple trades of the country. The expense of machine weaving could be definitely calculated, and if the expense of production by paying hand labour came up to it then the power loom would be introduced, and the weavers thrown out of employment, in so far as they were not needed to mind the machines. The expense of the machine production of a given quantity of cloth was a 'wages fund.' This wages fund was practically fixed, and was divided between the large numbers who applied for employment, and among whom the work was 'spread out.' We may be thankful that these conditions have passed away, but we need not denounce those who formulated a theory of wages, which was on the whole applicable to the times in which they lived, because these times have changed, and it is no longer so applicable to ours. The great English economists of the early part of this century gave excellent explanations of the industrial phenomena with which they were familiar; their error—and a very excusable error—lay in not stating the conditions they assumed, and thus indicating the limits within which their doctrine could be considered to hold good.

I fear I have occupied a long time in saying very little; yet it is not unnecessary to insist that we shall have the best chance of advancing economic science if we try to make sure, at least for ourselves, that we know what we are talking about. It is well to be clear how far we are dealing with reasonings that have a merely formal validity and universality, and how far with the phenomena of the world we live in. If we are to preserve and develop economics on all its sides, both as a formal science which deals with the relations between economic units of all kinds, and as an instrument for investigating actual facts and understanding them better, then we must be careful to see that our hypotheses are appropriate to the actual conditions of life and most anxious in our endeavour to state fully the conditions we assume.

¹ Bonar, *Malthus*, 270.

The following Papers were read:—

1. *Labour and Capital.—Their Differences and how to Reconcile them.*
By C. H. PERKINS.

The appointment of a Royal Commission for the purpose of inquiry into the causes of the constantly occurring disputes between Labour and Capital, is an additional proof of the extreme gravity of the question.

The results of that inquiry it would be unwise to predict. That much valuable information will be obtained there is no doubt, but it will afterwards rest with practical men to use that information to advantage and in furtherance of the objects in view. Thus, even while the Commission is sitting, there is ample scope and a most useful field for thought and inquiry.

The causes that have produced the present state of things are readily to be understood. Employers, as a rule, and very naturally, have sought to secure labour at the lowest possible cost; and so long as they held absolutely the upper hand, disputes could not long continue, and there would be no impediment to the progress of the country in wealth, industry, and commerce, however much the philanthropist, and indeed the political economist, might have reason to deplore the subservience of the working classes and their deprivation of much of the true enjoyments and happiness of life.

But now an enormous alteration has taken place, through the spread of education, a cheap press, ready and cheap means for emigration, and the power of combination by means of trade and other unions.

Thus the forces of labour and capital are equalised, and strikes and disputes have become protracted and dangerous, and the necessity of some mode of identifying the respective interests of labour and capital, and of promptly settling disputes when they do arise, is rendered absolutely necessary.

While much has been said and written as to the identity of the interests of labour and capital, it is apparent that capital has in some respects a preferential claim. Such claim includes interest for its use and its eventual return to the investor.

The power to labour is, on the other hand, the workman's capital, and for its use he is entitled to wages at current rates, and, as that power is an exhaustive one, its possessor should be recouped, so far as possible, for its expenditure.

But as regards capital, the money invested can only, as a rule, be refunded if success attends the undertaking in which it is embarked, while the workman, after receiving wages at current rates, can, if he likes, remove to other scenes of labour, and thus incurs no risk of loss beyond the expenditure of a certain amount of his physical strength.

Before, therefore, *profits* can be regarded as having been attained, interest at a rate depending upon the nature of the undertaking must be paid, and also a certain annual sum, or a percentage on the profits, for redemption of capital.

These preferential claims being provided for, it is proposed that all further profits or income be divided between capital and labour in the proportion that the amount invested and employed as working capital bears to the collective amount paid annually in wages.

Thus, presuming a colliery, for example, has cost and employs capital to the extent of 20,000*l.* and that the interest is 5 per cent., and the charge for redemption $2\frac{1}{2}$ per cent., 1,500*l.* per annum out of the profits would thus be paid to the investors. Presuming that the annual profits were 5,200*l.*, there would be a residue of 3,700*l.* for division between capital and labour. If the latter, as represented by the wages paid, amounted to 20,000*l.*, half of this residue of 3,700*l.*, that is, 1,850*l.*, would accrue to labour and half to capital. Thus, presuming a man's annual earnings amounted to 66*l.* he would receive a bonus of 5*l.* 18*s.* 8*d.* per annum.

Capital would really lose nothing by this apparent surrender, for it would first receive interest at fair rates and redemption, and secondly the immunity from strikes and stoppages; and the additional care and economy that would be shown

by the workmen would probably more than make up for the amount paid to them.

In all these co-operative undertakings the workmen would be invited to select three or more of their body to act as 'Workmen's Directors,' and consult with the employers upon all matters connected with the *work and wages* of the undertaking. In this way careful supervision would be exerted, and bad and careless workmen speedily got rid of.

To establish this system it is necessary that it receive official recognition. The men will not believe in it if it merely appears as a gift on the part of the employers.

Thus it is necessary that registration offices should be established by Government in convenient localities, where these co-operative undertakings would be registered, the main particulars as to capital, interest, &c., being stated, and each half-year the amount paid in wages and the profits made. Attached to each registration office there would be commissioners, men of known standing in their respective districts, and these would form a Board of Appeal to which any labour disputes that might arise could be referred.

The importance and advantage of such a Board cannot be overestimated. Disputes that now ripen into long and protracted strikes would be settled at once and great loss prevented.

It is appropriate that this scheme should be considered in the great theatre of labour where the British Association this year meets for the prosecution of the great and beneficent objects that it so powerfully advances.

2. *On the Coal Question.* By T. FORSTER BROWN, M.Inst.C.E.

After referring to various writers on the subject, the writer proceeded to discuss the probable duration of our total coal resources.

This depends upon whether the ratio of increase in production will continue to ascend or diminish.

It will probably be a decreasing ratio for the following reasons:—

1. The population of the country is increasing in a diminishing ratio.
2. The earlier developed coalfields already show a retarded rate of output.
3. The working of thinner seams will further reduce the output capacity.

This would make it appear that the *total* exhaustion of coal, if the Report of the Royal Commission of 1871 is to be relied upon, is in no way imminent; but, as the coal is worked in thinner seams and greater depth, the cost of producing it, after a certain period, will begin probably to steadily increase.

The writer exemplified the retarded rate of output of the earlier coalfields.

The maximum output may probably be reached in twenty-five years, and continue for another twenty-five years. After this period a new element in the commercial position of the nation, viz., the greatly enhanced cost of fuel, will commence to be felt.

This increased cost will be partially obviated for a time by reduction in the rate of wages, and of prices for materials, as well as in royalties and other charges, but it will be impossible to maintain the cost of production at the present limits. As the expansion of our industries is absolutely dependent on a low range in the cost of fuel, the effect of an increased cost will begin to manifest itself, and will operate first of all on our carrying trade.

We are now able to export large quantities of coal, which acts as ballast, receiving in return all, or nearly all, the raw material required for our manufactures, as well as a large proportion of our food supplies, at low freights. With coal at an increased price, we shall have to pay a higher price for our raw material, and this, with the increased cost for steam, must raise the cost of producing our manufactured goods, and limit our power of competing with other countries, leading to a continuance of bad trade, with shorter intervals of prosperity, to the transfer of much of our capital and investments abroad, the loss of that which remains, and to the lowering of wages and the emigration of the best of the working classes.

Present importance of our industries illustrated by *statistics*.

The mere loss of capital, though serious, will not be of prime importance to future generations, but outlay, for the redemption of which no provision has been made during the period of continuous prosperity, and on which interest must be paid, will be a crushing burden.

This will especially apply to—

1. The National Debt.
2. Our railways and docks.
3. Our municipal debts.
4. Our water and lighting works.

The interest upon this capital, with continued bad trade, must inevitably ultimately lead to national bankruptcy, and probably fundamental social changes, unless the capital is paid off.

It is obviously the duty of this, and the next, generation to devise means, if possible, of repaying the great expenditure incurred in the development of our resources; before these exceptional resources are exhausted the expenditure would never have been necessary in a purely agricultural country or in a country in which the coal resources were inferior in quality or costly to work.

Remedy.

The writer suggests that the remedy is the acquirement by the State of the railways, docks, municipal and other loans, and of all lighting and water works, and the liquidation of the National Debt.

By this means the cost of carriage of coal, of passengers, and goods, could ultimately be reduced to the mere cost of maintenance and working, the total amount of the purchase by the State being gradually extinguished by the operation of a sinking-fund.

The total charge for the National Debt is at the present moment 25,000,000*l.*; the profits on railways, docks, and canals are about 39,817,000*l.* per annum, and should it be possible to purchase for the nation all the above, and to extinguish the capital by the operation of a sinking fund, the total gain to the nation would ultimately be 60,000,000*l.* per annum. This sum would cover a very large increased cost in the price of coal, and go a great way towards enabling the nation to maintain its commercial position, so long as our coal resources endure.

The paper further discussed the probable mode in which the nation could acquire the railways without involving a large annual outlay, and winds up with some general observations upon the whole question, and points out that the time has arrived when the subject requires serious legislative investigation.

FRIDAY, AUGUST 21.

The following Papers were read:—

1. '*Miners' Thrift and Employers' Liability: a Remarkable Experience.*'
By GEORGE L. CAMPBELL, *Secretary of the Central Association for Dealing with Distress caused by Mining Accidents.*

The thrift dealt with in Mr. Campbell's paper was that embodied in the system of miners' permanent societies, which was commenced about thirty years ago in the north of England, and has steadily grown until it now represents the chief voluntary endeavour to meet the distress arising from the dangerous vocation of mining. The liability of employers was chiefly that set up by the Employers' Liability Act of 1880; and the principal question submitted to the section was as to the desirableness on grounds of public policy of legislation suggested for the purpose of hindering miners and their employers entering into arrangements

whereby, in view of the existing law, they jointly provide against all the casualties incidental to their trade. The words, 'contracting out of the Act,' were advisedly set aside as not representing fairly the arrangements now prevailing, and it was contended that the existing contracts are in view of the Act, and are the result of legislation rather than an attempt to evade its provisions. The history of colliery clubs having been lightly touched upon, the paper set out the progress of the movement for establishing permanent funds, one of whose chief objects is to remove the anomaly as to fatal accidents, whereby when men were killed in large numbers subscriptions provided for their dependents, but when men died singly there was no attempt to elicit public help. When representatives of the societies met in conference for the first time in 1878, the total membership was 90,000, and a central association was formed, at whose conference this year (1891) were represented societies with an aggregate membership of 268,971; with a revenue of 242,658*l.*; with accumulated funds amounting to 367,293*l.*; with 2,395 widows and 3,842 children in receipt of allowances, and having in the year 1890 dealt with 39,411 cases of disability through accident. The increase of membership from 1889 to 1890 was over 30,000. Mr. Campbell proceeded to show what had been done in view of the Employers' Liability Act in the coalfields having permanent societies, and it appeared that at December, 1890, there were 110,973 of the members of the permanent societies under arrangement with their employers, the general principle being that the masters contributed 25 per cent. on the contributions of the men. The 'remarkable experience' referred to in the title of the paper had special reference to Monmouthshire and South Wales, where the society was formed after the Act of 1880 was passed. It was now second in point of numbers of the permanent societies, and had 52,760 members. Add to these 12,978 members of the North Wales society, the 44,824 of Lancashire and Cheshire, and a small contingent of North Staffordshire, and then let the question be squarely put—was it possible that, in view of the powerful agitation maintained in and out of Parliament since 1880, these 110,973 men could have been forced into an arrangement or by force could be kept under an arrangement with their employers? No more than they could coerce a nation could they coerce 110,000 men who stood almost shoulder to shoulder from Cumberland to Cornwall, and who had shrewdly made the Act of 1880 the means of making provision for all accidents—not only those for which the employer is legally responsible and those caused by the workman's inadvertence, but for that great proportion of disasters for which neither masters nor men could be held accountable. Elaborate statistics were appended to the paper, from which Mr. Campbell said it would not be difficult to ascertain how much had been lost to the sufferers from accident in the mining community by reason of there not being general combination between masters and men for their mutual insurance and benefit. The tables of figures answered the question whether monetary considerations hindered safe management; and especially was this the case as to North Wales, where, with a most compact organisation of employers and employed in view of the Act, there had since its passing been a steady reduction in the number of accidents. It was contended that the miners' permanent societies ought not to be disturbed, and that, while the Legislature should be encouraged to make the Act of 1880 permanent and to prohibit contracts based alone on consideration of employment, contracts should be permitted and encouraged which made provision for all accidents as sufficient as the Act gave in cases where the employers were liable. The risk was an insurable one, and the Legislature were not likely to hinder a man insuring against an insurable risk; nor was it reasonable to say that while it might be covered by a proprietary company it ought not to be available business for a concern in which the parties interested were proprietors with the profits returned to them. Since the select committee of 1886 received evidence the number of contracts in view of the Act had increased by no less than 38,000 in mining alone. Every year strengthened the position of those who contend that in this matter freedom of contract should be maintained, coupled with reasonable security against the workmen being placed at a disadvantage; and the object of the paper would be served if it assisted in maturing public opinion in the direction

of hindering the Legislature striking a severe blow at a system of thrift which had admirably served its purpose, and which, by reason of its excellent work among a class who suffer greatly for the public good, had strong claim for consideration at the hands of the nation at large.

2. *State Provision against Sickness and Old Age, and the German Invalidity and Superannuation Law.* By LOUIS TYLOR.

The writer proposed to present the German law in an English dress and draw a slight sketch of what would be the experience of English workpeople were we to adopt the principle of State insurance in our own way of doing things by combining officialism with voluntarism in much the same way as we have already dealt with education and military service. Among the proposed modifications of the German system are the adoption in England of a uniform standard of relief, in place of the fourfold classification according to wages which prevails in Germany, and the substitution of sixty-five years for seventy years as the limit of superannuation. Other readjustments are enumerated under several heads. The total cost of the scheme is estimated at 1s. 3d. per week, which the writer apportions between employers and employed. Further information has increased the estimate to 1s. 5d. per week.

3. *On Some Economic Aspects of Life Assurance.* By JOHN M. McCANDLISH, F.R.S.E., formerly President of the Faculty of Actuaries in Scotland.

After referring to the growing interest of the public in this subject and to the fact that to Life Assurance are due the existence and the security of tens of thousands of families, the author defined Life Assurance as being, like Fire or Marine or Accident Insurance, a means of mitigating the pecuniary loss arising from an accident by distributing it among the many who are liable to the like accident, the accident in this case being that of premature death. The paper proceeded to show among other things that legitimate life insurance was the antithesis of gambling, and that the real gambler is he who refuses or delays to insure his life when he has no other means of providing for his family; while Insurance Institutions or Governments or Municipal Bodies gamble if they conduct insurance or annuity schemes on unsound principles. It was useful also to recognise that the advantages of life assurance must be paid for, and that while every man gets what he has paid for, namely, protection against loss to his family in case of his premature death, in another sense the advantage to the families of those who die soon must be paid for by those who live long. And in the case of annuities the advantages to those who live long must be paid for by those who die soon.

The paper dealt with the question to which Canon Blackley, and more lately Mr. Chamberlain, have invited attention—of how 'the masses' can be induced or compelled or assisted to provide for their own old age, so as to escape the degradation of pauperism and relieve the country of the cost of it. It was shown that by an extension and a popularising of the existing arrangements by which Government sells deferred annuities it might be made easy for almost every member of the so-called 'working-classes' to secure by means of payments well within his power, and extending over a limited number of years, a sufficient income for himself in old age. It was recommended that the necessary facilities should be given and a staff of men employed to promote the scheme, leaving it for future consideration whether any form of compulsion, as has been proposed, or any further inducements should be used to ensure its universal adoption. It was pointed out at the same time that any large contribution out of public funds towards this object, unless it could be shown to be for the benefit of taxpayers universally, would be simply an arbitrary transfer of money from the pockets of those who would derive no advantage from the scheme to the pockets of other people.

4. *The Survival of Domestic Industries.* By PROFESSOR GONNER.

The complaints at the time of the depression of home industries and their suspension by the factory system lay stress on four main points. 1. Machinery and steam power. 2. Currency changes and taxation. 3. Foreign competition. 4. Irregularities. These grievances exemplified from the Reports of Royal Commissions and Select Committees of the House of Commons. On analysis the chief causes of the change in mode of employment may be deduced from these. They are:—

(a) The effect of machinery.

(b) The economy of labour in the factory.

(c) The need of some centralised system of manufacture to counteract irregularity and uncertainty of demand. This owing to what may be termed the decentralisation of demand.

Importance of these two latter as showing that the tendency to change existed before, though it was much accelerated by the introduction of great mechanical appliances and the use of steam-power. Continuing the investigation it is necessary to observe separately the effect of the two systems (home industries and factories) on (a) the work produced, (b) the condition of the workers.

I. Industries in which the work is largely affected or which allow of factory organisation. Some other industries, viz., those requiring regular work and not demanding any unusual degree of skill, may be included with these. Where machinery can be used, the work produced by its aid is cheaper and often better. The condition of the workers in these trades does not seem to have deteriorated on their employment in factories. Reasons for this. The instance of the hosiery trade and the nail- and chain-workers in the midland counties.

II. Industries in which the three main causes of change are less operative. These may be divided into three classes—

(a) Industries requiring individual artistic skill or in which the commodities produced require adaptation, e.g. carving, hand-lace making, brass-working, &c., of first kind; and of second, bespoke clothes trade, &c.

(b) Supplementary trades where a large portion of the labour is given by those who, by reason of domestic duties, &c., cannot or are most unwilling to work in factories, e.g. straw-plaiting, lace-making, &c.

(c) Local industries, where the demand is local and the industry local, e.g. crab-pot making, &c.

In some instances of the two former of these classes a tendency to factory organisation exists owing to the action of the third cause (see above c) and of a fourth cause (d), viz. the desire to restrict competition by combination.

Conclusion.—The need of further investigation. Its importance.

5. *Free Travel.* By S. M. BURROUGHS.

That it would be desirable to have railways throughout the country as free for use by the public as lifts or elevators in hotels are free for the use of the guests, there is no doubt. The only difficulty which arises in making them so is the construction and management of railways, which is a very costly enterprise.

The arguments in favour of free travel are numerous, and apparently unanswerable. It would relieve congestion in towns, it would greatly assist the commerce and industry of the country, would create a greater demand for labour, and so advance wages and the social well-being of the people, and at the same time tend to a great improvement in general healthfulness and morality.

If the cost of travel is not collected from passengers, it must be obtained by taxation. In the vicinity of Melbourne the children are carried to and from the free schools without charge, which, of course, makes it necessary that the amounts otherwise collected from them are collected by taxation in other ways. One aim in taxation should be to avoid taxing any class of individuals for the benefit of another class; in other words, making some rich and others poor by law.

There is a free ferry at Woolwich which carries any who wishes to travel between that place and North Woolwich without any charge whatever. It has been observed that until the ferry was started the land at North Woolwich was comparatively valueless; that the ferry created a rental value on the north side of the river which did not previously exist; and that when the ferry was made as free as a free bridge, the land values at North Woolwich increased still further in rental value, even more than enough to pay for the cost of maintaining the free ferry. It therefore appears that the occupiers of land in North Woolwich pay a higher ground-rent on account of the ferry being free, or in other words, that they pay in rent what they save in fares; and while they are saved some trouble in buying tickets, &c., the financial benefit of the free ferry goes into the pockets of the ground-landlords in North Woolwich. This instance points the way to secure free travel without burdensome taxation by simply taking the increased land values imparted by making travel free to pay the cost of the same. This would not be unjust or oppressive to anyone. It would not tax anyone's industry, but simply appropriate for public uses one of the effects of the public enterprise.

Until the several upper floors of a new building are connected with the ground floors by stairways, the upper floors are comparatively valueless; but when the stairways are put in the upper floors begin to have a value. If these floors are made still more accessible by free lifts or elevators, the value is still further increased. No company fitting up a large building for rental would think of letting another company put in lifts and charge a toll on their tenants. They would know that such a course would depreciate the rents of the upper floors. On the other hand, they make the use of the lifts free to the tenants, and more than recoup themselves for the cost by the increased rental value imparted to the upper floors. The situation with reference to free travel on railways and tramways is the same, only that passengers would not be carried up and down, but to and fro laterally instead of vertically.

Some years since, in Sydney, it became necessary for the municipality of Sydney to purchase certain lands for public purposes. When the holder was approached for a price, he charged a great deal more than the then present value, 'because,' said he, 'in a few years the value of the land will be considerably increased by the construction of railways and wharves in the vicinity of the land.' The Government decided that this prospective value could not justly belong to the landowner, and that it would be the result, not of his industry, but of the public progress. They therefore took the land, paying the then present value for it. If this principle could be applied to the free travel question, there would be no difficulty in securing it without direct loss to anyone. If certain landowners should fail to receive a prospective value, being the result of public and other improvements in their vicinity or the result of making their lands more accessible by means of free travel, they cannot claim that they have suffered loss, but can only say that the public have decided not to make them a present of such unearned increment, but rather to appropriate it to pay the expenses of making the land more accessible. It would not be difficult to imagine the great benefits that would result from applying this fair principle of taxation, because it would result in the payment of all costs of roads, sewers, lights, police, parks, by a tax upon the lands enhanced in value by these public expenditures. The question would simply be whether the unearned increment should be given to landholders, or whether it should be taken by the public, who create it, to pay the expense of creating it.

If this method of free travel should be adopted, the enormous expense of constructing and maintaining railways would be greatly lessened, (1) for the reason that the Government, in constructing railways, would only have to pay for the value of the improvements upon land which they appropriate for the purpose, the unearned increment being previously taken in taxation. (2) There would be another economy in the amount of taxes which are levied upon the plant and rolling-stock of railways, which would be exempt from taxation. (3) A good economy would be effected in the management of railways, as all the expenses of printing, selling, and collecting tickets would be avoided. If the carriage of goods were also made free, the expense would easily be met by a taxation of the increased

land values imparted by these means. The saving of time on the part of the public which is now spent in purchasing tickets and in booking merchandise would also be very great.

The author does not claim originality for this idea, as free travel has already been adopted in the few isolated instances which he has quoted. Mr. Cooper, of Norwich, has given some very interesting figures showing the great economy which would ensue to the public from the adoption of free travel.

SATURDAY, AUGUST 22.

The following Papers were read:—

1. *The Alleged Differences in the Wages paid to Men and to Women for Similar Work.* By SIDNEY WEBB, LL.B.

The inferiority of women's earnings as compared with men's is notorious, but it is not so clear that this inferiority is unconnected with a real inferiority of work, either in quantity, quality, or nett advantageousness to the employer.

(a) *Manual labour.*—Statistics indicate that the average earnings of women in manufacturing industries are from one-third to two-thirds those of men. But it is difficult to find many cases in which men and women are engaged upon precisely similar work in the same place and at the same epoch. Thus, in the tailoring trade it is practically impossible to discover any such instance. A similar difficulty has been experienced in discovering crucial instances in the boot and shoe trade, paper making, cigar making, and all the Birmingham industries.

The clearest case is that of the Lancashire cotton weavers, where men and women perform the same work, in the same shed, under practically the same legal restrictions. Here the women, who are as strongly organised in Trade Unions as the men, have for at least two generations received the same piecework rates as the men, and skilled hands earn as much per week. Statistics are given showing that this equality prevails in the weaving of other fabrics, both in France and in England, but not in other branches of the textile industries.

On the other hand, women compositors (who are not trade unionists) habitually receive in Edinburgh and Paris, as well as in London, not only lower time wages than men, but also distinctly lower piecework rates for work of exactly equal quality. Facts given as to other occupations of women, where no organisation of workers exist, show a general inferiority of women's wages.

Where custom prevails, as in agricultural hirings by time, women, like boys, get less than men. But in competitive agricultural hirings by the piece, as in turnip-hoeing or harvesting, women and boys receive equal piecework rates with the men.

(b) *Routine mental work.*—Here the statistics quoted with regard to typewriters, clerks in the Post Office and a large insurance company, telegraphists, and teachers, both in elementary and in secondary schools, show that women habitually receive less than men for work of equivalent grade. Statistics of sickness in the Post Office show that women are away from their work more days than men.

The salaries of women teachers in the United States are less than those of men, but the difference is greatest where women have least independence, and it disappears altogether in Wyoming, where women have the suffrage, and the School Law enacts that no distinction of wages according to sex shall be made.

(c) and (d) *Artistic and intellectual work.*—Few facts of economic significance can be gleaned in these fields, but the cases of women singers and novelists, and those of the Paris correspondent of the 'Daily News' and the postmistress of Gibraltar, show that women of special skill obtain their full 'rent of ability.'

The only general conclusion that can be drawn appears to be that the inferiority of earnings is nearly always connected with inferiority of work. As a rule the competition between men and women is a competition for *kinds* of work;

and women earn less not only because they produce less, but also because what they produce is usually valued in the market at a lower rate. This seems due mainly to (a) custom, (b) public opinion, (c) women's lower standard of life, and (d) failure to combine for their own protection. The remedies seem to lie in the direction of education, both of public opinion and of women.

2. *The Taxation of Inventors.* By LEWIS EDMUNDS, D.Sc.

There are few classes of the community, in a manufacturing and industrial country like Great Britain, to whom the nation at large is more indebted for its prosperity than the inventors. It would therefore appear to be to the interest of the Government to offer every facility and encouragement to inventors, and with this object to afford them full opportunity for the acquisition and retention of property in their discoveries. But the contrary is the fact. There is no species of property which is so heavily pressed upon or so burdened with taxes as the very limited one which the law allows an inventor to acquire.

Although distinctions may be drawn, the monopoly granted by a patent is in many respects of the same character as the copyright acquired by an author, and the word copyright might be almost equally well applied to the rights acquired by an author and by an inventor. But while the properties of an author and an inventor are very similar in their nature, the position of an author is immensely superior. He or his representatives hold the copyright for life and seven years after, or for forty-two years from the date of publication, whichever may be the longer term; and no fees of any kind are payable to the Government, except when for the purpose of securing rights in foreign countries, or of taking legal proceedings for an infringement, it is necessary to register the copyright at Stationers' Hall, in which case a small fee is demanded. There is no *special taxation* of authors of any kind, unless, indeed, we count as such the five copies which have to be presented to the British Museum and the University libraries, and this is a small matter. But an inventor is not so fortunate. By the nature of the case, he can only secure himself after complying with numerous formalities and making a full disclosure of what his invention is. This, of course, cannot be complained of. But even then the inventor obtains the monopoly of his invention for fourteen years only, and this is now subject, after the first four years of the term, to the payment of heavy annual fees, ranging from 10*l.* to 20*l.* and amounting to 150*l.* in all. It is contended that these renewal fees are an unjustifiable tax upon inventors, and also that the preliminary fees payable at the Patent Office in connection with the application for the grant of the patent and the lodging of the specifications being 4*l.*, and quite sufficient to cover the whole of the Office expenses, no further demand ought to be made by the Treasury.

If it were proposed to put a tax of 10*l.* or more a year on every literary work, or else to abolish the copyright of the author, the suggestion would be scouted; yet inventors, with every claim to equality of treatment, are mulcted of these heavy fees or else lose their patent right.

Under the recent Patents Act of 1883, the total expense of a patent running for the full term of fourteen years was reduced from 175*l.* to 154*l.*, but the whole abatement took place in the initial expenses, which were reduced from 25*l.* to 4*l.* What are now called 'renewal fees' to the amount of 150*l.* are payable as before, either in amounts of 50*l.* and 100*l.* before the end of the fourth and eighth years, or in annual payments in the fourth and succeeding years varying from 10*l.* to 20*l.* As a matter of fact, the patentees, with few exceptions, elect to make the annual payments in preference to the lump sums of 50*l.* and 100*l.*

In the United States of America inventors are not discouraged as they are here. There, a patent may be obtained, which lasts for seventeen years, for a payment of about 7*l.* 10*s.* in the first instance, and no further fees of any kind are payable. A British patent which runs for fourteen years, therefore, costs more than twenty times as much as a United States patent which endures for seventeen years. Consequently, although there is a search as to novelty which weeds out a large proportion, there are twice as many patents issued in the States as there are in

England, with corresponding advantages to the industries of that country. The patenting of not only home but also foreign inventions is thereby encouraged, and an inventor having obtained a patent is induced to push his invention, and to make further improvements in it. The success of an invention means the improvement or creation of some new industry, and hence the country shares with the patentee in the profits of the invention.

Looking to the report of the Comptroller-General of Patents in this country for the year 1889, it appears that the total income from fees on patents was 151,794*l.* 4*s.* 4*d.*, of which sum 93,205*l.* was paid by way of renewal fees. The surplus profit of the Office was a little more than this sum, namely, 93,534*l.* 8*s.* 9*d.*, and this went to the Treasury, and was used for the general purposes of government. It follows that if the annual taxes were abolished the Patent Office could still pay its way. This surplus profit is, therefore, a direct tax upon the inventors.

The taxation of inventors through the medium of 'renewal fees' is a remnant of the old demands and perquisites incident to the passing of letters patent under the Great Seal. It is entirely inequitable in principle, it works great injustice and hardship in practice, and, by damaging the value of property in inventions, acts as a drag upon the inventive genius of the nation, and thereby injuriously affects all the industries of the country.

MONDAY, AUGUST 24.

The following Papers and Report were read :—

1. *On Recent Progress in Indian Agriculture.* By C. L. TUPPER, *Chief Secretary to the Punjaub Government.*—See Reports, p. 532.
2. *Railway Communications of India.* By W. C. FURNIVALL, *M.Inst.C.E.*

The paper gave at the outset a short history of railways in India since their commencement about forty years ago, and stated the reasons for the introduction of the metre gauge in 1871. Up to the beginning of this year (1891) 16,277 miles were open to public traffic, at a cost of 2,128 millions of rupees; two-thirds of the length have been built on the standard gauge of 5 ft. 6 in., and the remainder on the narrower gauge of one metre. The cost of these lines, according to the records, has been—standard gauge about 170,000 rupees, and narrow gauge 75,000 rupees per mile. But in this calculation no allowance has been made in the capital account for the fluctuating value of the rupee. The gold loan from England has been debited to India at the Exchange rates of the dates of transactions, and as the sterling value of the rupee has ranged between 2*s.* 2*d.* and something under 1*s.* 6*d.* during the last forty years, the obligations of the Government of India for gold interest, calculated in rupees, are heavy. On the capital outlay, estimated in rupees, the railways paid over 4 $\frac{3}{4}$ per cent. last year. It is advanced as worthy of remark that the narrow gauge gave almost a similar return to that of the broad gauge on an expenditure per mile of less than one-half, but the broad gauge has been adopted for all frontier railways which are at present unremunerative. The author contended that—1. Indian railways have been well laid out, and are well built, but the introduction of a break of gauge must be viewed as a misfortune. 2. Passenger fares and goods rates are sufficiently low to attract traffic and promote trade with England, especially that of a supply of wheat. 3. The demands of Indian railways on England for iron and steel equalled about one-tenth of the whole English exports of last year.

A comparison is made between the rate of development of railways in the United States and India per unit of population. The census for this year gave 286 millions in India, and the expenditure was, therefore, rupees 7.44 per head, or 11 shillings. In like manner the length of the line finished was computed at 3 $\frac{1}{2}$

inches per head. In the United States in 1888 the length of railways open to public traffic was 156,082 miles, and the outlay on construction was calculated at 9,369 millions of dollars. Estimating the population at 60 millions, these figures give $13\frac{3}{4}$ feet at a cost of 32l. 4s. per head, which equal 47 times the length, and $58\frac{1}{2}$ times the expenditure per head in India. At this point it is observed the comparison may be permitted to cease, because it would be absurd to imagine conditions in India which could cause the profitable development of railways at the rate maintained during recent years in the United States.

The question arises, however, Have the English done enough in India? The latest records show that the population has increased by 29 millions within the last decade, and it might reasonably be anticipated that increase in the future will be progressive. Accounts show that a reasonable return for railway investments has been obtained, and that the older lines are securing handsome dividends. Experience indicates that the development of Indian railways opens an important field of demand in the iron and steel industries of England, and furnishes a supply of wheat, the price of which competes with America and Russia, so that the cost of bread to the English consumer may be regulated. Experience also shows that railways in India have done much to awaken the people to new lights, and to a sense of new responsibilities which tend to the obliteration of old superstitions and the generation of loyalty towards the central governing power, and of interest in the maintenance of the Empire.

It is true that the Indian currency has depreciated in its comparative value to sterling money of late years, but it is pointed out that similar risks occurred elsewhere, as, for instance, in the Argentine Republic, where the paper dollar depends for its value in relation to gold on the honesty of a nation whose interests seem to be separated widely from the interests of England. Up to the present time practically all railways constructed in India have been obtained by English capital guaranteed to pay a certain percentage by the Secretary of State, and consequently progress has been slow. India is poor, and the trading classes do not accept railway investments; but now that the circumstances of India are known in England, and now that the records show that reasonable returns can be obtained if the railway routes are selected with intelligence, even on the depreciated value of the rupee, because its relative value has only changed in regard to gold, not as regards grain and labour in India, the author suggests the question whether the private enterprise of England cannot lift this burden from off the shoulders of the Government, and be induced to supply capital without the trammels of a Government contract.

3. *Report on the Teaching of Science in Elementary Schools.*
See Reports, p. 383.

4. *On the Upbringing of Destitute and Pauper Children.*
By the Rev. J. O. BEVAN, M.A.

The author touched upon the importance of the subject, having reference to the number concerned and the disadvantages under which they laboured from birth.

He deprecated the massing together in workhouses and district schools.

- (a.) For physical reasons.
- (b.) For moral reasons.
- (c.) For economic reasons.

He then laid stress on—

- (a.) The evils of the system, especially as affecting girls.
- (b.) Recommendation that larger powers be granted to Boards of Guardians as against profligate and drunken parents.

(c.) The provisions of the following Acts:—

The Poor Law Act, 1889.

The Prevention of Cruelty to, and Protection of, Children Act, 1889.

The Industrial Schools Acts Amendment Act, 1881.

The writer next touched upon District Schools, and especially Cottage Homes.

I. Advantages. II. Disadvantages.

The following remedies were suggested:—

I. Classification according to character, previous history, and associations.

II. Small homes for incorrigibles and those removed from immoral surroundings.

III. Boarding-out in every practicable case.

(a.) Finds homes, &c., ready to its hand.

(b.) Brings the child back into family life; interests foster-parents and influential friends in present and future welfare; enables the child to make suitable friendships.

(c.) It is inexpensive.

(d.) It tends to merge the child into the general mass of the population.

(e.) It provides for a supply of domestic servants and workers in every branch of industry.

(f.) It enables Boards of Guardians to avail themselves of help from Voluntary Committees composed of persons in a good social position.

(g.) It has been adequately tested for many years in the three kingdoms with satisfactory results.

IV. Emigration.

TUESDAY, AUGUST 25.

The following Papers were read:—

1. *On the Data Available for Determining the best Limit (physically) for Hours of Labour.* By J. T. ARLIDGE, M.D.

The author began by remarking that the great variability in capacity of the human machine forbade the collection of facts, capable of measurement and of statement in a statistical shape, for exact data. Consequently, those sought must be derived from physiological facts and from consideration of the demands upon human vigour made by the several occupations followed.

He treated his subject, therefore, under two heads, according as data are derived from the consideration (A) of the individual worker, and (B) of the work to be performed. The title of the paper confined his remarks to bodily or physical labour, leaving undiscussed the equally distinct labour of the intellect, which happens to be largely ignored in the popular idea of work and working-people.

Individual qualification for work varies in direct relation to (a) innate physical endowments; (β), to the extent of freedom from disease, hereditary or acquired, and from bodily deformity; (γ) to original and acquired aptitude for labour; and (δ), in some measure, to mental gifts. Idiosyncrasy and racial characteristics are other minor factors determining ability for certain kinds of employment. These diversities in individual capacity for work show the futility of general rules to govern all men's labour.

In the second division of the subject the leading conditions of labour as affecting the construction of data were examined. First of these is the amount of actual bodily effort called for. Though this in great excess is detrimental to health and

life, its effects are less pronounced than sedentary work, statistics clearly proving that the comparative mortality figure of the latter, as illustrated by numerous trades, is considerably greater than that of active and strong muscular exertion.

Moreover, apart from physical toil, there are a multitude of collateral and accidental conditions of employment of great influence upon capability for labour, and which call for examination when data for limiting the extent and duration are searched for. Among such are the situation of work, whether in the open country or in a town; whether above or beneath the surface of the ground; and, in connection with these circumstances, the existence of darkness, of foul air, or noxious fumes, of the presence of dust, whether poisonous or not, of elevated temperature, or of highly increased atmospheric pressure. With reference to mining, in which many unfavourable conditions enter, it seemed desirable that the hours of labour be shortened. Nevertheless, were the evidence of the production of a high death-rate to be accepted as the criterion for curtailing working hours, mining would not challenge the first place, but be surpassed by several other occupations, and especially by the manufacture of cutlery and of pottery. In demonstrating the influence of incidental conditions of work upon the sources of data, illustrations were, for the most part, drawn from the character of mining operations.

To guard against misunderstanding, the writer called attention to the fact that the remarks made applied to adults; and that, in the case of children, distinct data for limiting labour existed in imperfect development and advancing growth in body and mind—data, indeed, rightly used in framing the restrictions of the Factory Acts.

Lastly, whilst admitting the existence of trades presenting conditions of labour seriously prejudicial to health and life, and calling, in consequence, for some limitation of the hours and extent of labour, he deprecated general interference by legislative enactments with the freedom of men in the pursuit of their selected trades, as being prejudicial to enterprise and to the manufacturing interests of the country, and also as destructive of individual responsibility, and of the feeling of independence, by replacing the natural law of self-preservation by State nursing.

2. *The Cure of Consumption in its Economic Aspect.*

By G. W. HAMBLETON.

3. *The Increase of Food and Population.* By W. E. A. AXON.

4. *Le Play's method of Systematic Observation.* By F. AUBURTIN.

5. *Recent Changes in the Distribution of Population in England and Wales.*

By EDWIN CANNAN.

The rough-and-ready method of describing the great change which has taken place in the distribution of the population of England and Wales during the present century is to say that the North has enormously increased in comparison with the South. It is more accurate to say that the tendency of the increasing population has been to mass itself more and more in six comparatively small areas, viz., London, Lancashire, the West Riding of Yorkshire, Staffordshire with Birmingham, the county of Durham with Newcastle, Tynemouth, and Middlesbrough, and, lastly, Glamorgan.

Of these six localities Glamorgan only is shown by the Preliminary Report of the Census of 1891 to be gaining on the rest of the country as fast as ever. The rate of gain on the part of the Durham district, Lancashire, the West Riding, and the Staffordshire district shows so great a decline that it seems likely to disappear entirely before long. The gain of London has also somewhat diminished, but is still very great if all the suburban country be included.

The diminution of loss which counterbalances this diminution of gain is spread over the rest of England. It is greatest in the south-western counties.

Trustworthy statistics as to the comparative growth of urban and rural population, or of large and small towns, seem scarcely obtainable; but there seems no reason to suppose there is any great change in the prevailing tendencies with regard to either of these matters.

The diminishing gain of the manufacturing districts may result from some check being received by the tendency of this country to become weaver and blacksmith for the whole world, or from the proportionate decline which, in the progress of civilisation, inevitably overtakes the industries which supply the necessaries of life as compared with those which supply its conveniences and amusements.

SECTION G.—MECHANICAL SCIENCE.

PRESIDENT OF THE SECTION—T. FORSTER BROWN, Esq., M.Inst. C.E.

THURSDAY, AUGUST 20.

The PRESIDENT delivered the following Address:—

I FEEL extremely diffident in assuming the Presidential Chair of Section G at the present meeting of the British Association.

The addresses of my eminent predecessors have, year by year, in the best language, and in the most condensed form, gauged the progress of, and indicated the direction in which, further improvements in mechanical science may be looked for. In so large a field as that of mechanical engineering my somewhat limited knowledge will not admit of my following very closely in their footsteps; but possibly, by tracing the modern practice of this branch as applied to mining operations in Great Britain, I may be able to submit some points of interest to mechanical engineers.

Great progress has been made in mechanical science since the British Association met in the Principality of Wales eleven years ago; and some of the results of that progress are exemplified in our locomotives, marine engineering, and in such works as the Severn Tunnel, the Forth and Tay Bridges, and the Manchester Ship Canal, which is now in progress of construction.

In mining, the progress has been slow, and it is a remarkable fact that, with the exception of pumping, the machinery in use in connection with mining operations in Great Britain has not, in regard to economy, advanced so rapidly as has been the case in our manufactures and marine.

This is probably due, in metalliferous mining, to the uncertain nature of the mineral deposits not affording any adequate security to adventurers that the increased cost of adopting improved appliances will be reimbursed; whilst in coal mining, the cheapness of fuel, the large proportion which manual labour bears to the total cost of producing coal, and the necessity for producing large outputs with the simplest appliances, explain, in some measure, the reluctance with which high-pressure-steam compound engines, and other modes embracing the most modern and approved types of economising power, have been adopted.

Metalliferous mining, with the exception of the working of iron ore, is not in a prosperous condition owing to causes to which it is unnecessary to refer; but in special localities, where the deposits of minerals are rich and profitable, progress has been made within a recent period by the adoption of more economical and efficient machinery.

For example, at the Tincroft Tin Mine, in Cornwall, a compound winding plant has been erected by Messrs. Harvey, of Hayle, of which the following are particulars: The high-pressure cylinder is 17 inches in diameter and steam-jacketed, and the low-pressure cylinder is 30 inches in diameter, each having a stroke of 6 feet. A condenser is worked by levers off the crosshead of the low-pressure cylinder. The drum is 8 feet 6 inches in diameter, and of the plain cylindrical type. The engine is fitted with steam reversing gear, and an auxiliary steam valve for

admitting high-pressure steam to either end of low-pressure cylinder when required. The working pressure of steam is 90 lbs. per square inch. This engine has proved so satisfactory that the management of the mine have been induced to erect a new horizontal condensing compound air-compressing engine in place of their existing plant. This engine will have high- and low-pressure cylinders of 15½ and 27 inches diameter respectively, by 48-inch stroke, and the air cylinder is 22 inches in diameter, with an equal stroke, and is fitted with Trestrail's patent inlet and outlet valves, and is arranged for a working pressure of 100 lbs. per square inch.

At the Greenside Lead Mines, near Ullswater, a waterfall of upwards of 100 horse-power is now being utilised by means of a turbine to drive dynamos, the energy from which is transmitted for the purposes of winding, pumping, and lighting; and, again, at the Morgan Gold Mines, near Dolgelly, there is a modern example of the successful utilisation of water-power for compressed air, and for driving forty head of stamps. The water-power for driving the mill is obtained from the river Mawddach, and is brought on to a 22-inch turbine, with a 68-foot head; this fall, with 650 cubic feet of water, easily drives the mill, stone breakers, &c., and with 800 cubic feet of water applied, if required, the water-power can be raised to 100 horse-power.

And, as an example of the very large amount of mechanical power applied in exceptional circumstances to metalliferous mining operations, the Whicham Hæmatite Iron Mines, in South Cumberland, may be named, where the quantity of water raised from a depth of 552 feet occasionally exceeds 4,800 gallons per minute, the machinery employed consisting of—

Firstly, a Cornish beam-condensing pumping engine, having a 90-inch diameter cylinder by 11-foot stroke, with a 10-foot stroke in the pumps. The beam weighs 50 tons. There are attached to this engine three pump-rams, each 28 inches in diameter, fixed at certain points in the shaft, the bottom ram being fixed 552 feet below the surface, from which level the whole of the water is pumped. The quantity of water delivered per minute is 2,210 gallons. There is also another Cornish beam-condensing pumping engine, with a cylinder of 110 inches in diameter by 11-foot stroke, with a 9-foot stroke in the pumps. This beam weighs 55½ tons. Attached to this engine are three 30-inch diameter pump-rams forcing from the same level as that before mentioned a quantity of 2,295 gallons of water per minute. In November and December during heavy floods as much as 4,680 gallons have been pumped from this mine per minute by these two engines.

The average consumption of coal by these engines is equal to about 4 lbs. per indicated horse-power.

There is another engine erected at this mine which is kept in reserve in the event of anything happening to either of the two other engines which I have described, viz., a tandem horizontal compound condensing pumping engine, having a 40-inch high pressure, and a 70-inch low pressure cylinder by 9-foot stroke. This engine is fitted with Davey's differential valve gearing. There is attached to this engine two 24-inch diameter pump-rams fixed at a point 372 feet below the surface. These pumps are capable of dealing with 280 gallons of water with each stroke of the engine, and the maximum speed is seven strokes per minute, which represents, therefore, 1,960 gallons of water per minute. Provision is made with this engine to extend the pumps to a lower level when necessary.

The weight of the pumps and pipes connected with these engines is about 250 tons.

In the raising of coal from our mines and placing it on board ship in our docks, there is a vast amount of machinery employed, much of which is now of an obsolete type. Where, however, new winnings have been made, or where in old mines it has been found necessary to replace the old machinery by new, the question of efficiency and, at the same time, economy in machinery has of late years received serious attention.

The consideration of the question of economy in the employment of steam in coal-mining operations has resulted in boilers of the most modern construction being erected, working to pressures varying from 80 to 150 lbs. per square inch, as compared with pressures varying from 40 to 50 lbs. per square inch in the old

boilers, whilst the various engines are now being constructed on the most modern and improved principle.

Compressed air has for many years been used extensively in our coal mines as a motive power. Electricity also has made rapid strides in the same direction; and I have no doubt that, in conjunction with a better type of machinery for the compression and use of air, will eventually become the principal agent in underground mechanical operations.

Many large electrical installations have already been in use for a considerable period. Notably amongst the number I may mention that at Messrs. Locke & Co.'s St. John's Colliery, Normanton, where both hauling on the endless-rope system and pumping are very largely adopted, and it has been proved that a useful effect equal to 65 per cent. can be obtained. This high rate of efficiency is undoubtedly very satisfactory. I am, however, of opinion that there is still great room for improvement in electrical plant before it will be adopted in preference to other machinery now in general use, especially in gaseous mines, and these improvements must embrace a certain means of rendering sparking absolutely harmless under all conditions, for it involves not only the question of the increased efficiency of one class of machinery over another, but also the protection of human life.

There must also be devised a ready means of reversing the power, so that the system of haulage known as the main-and-tail-rope system can be applied with equal safety and readiness in any part, as compared with absolute safety in the use of compressed air.

An electrical hauling plant to be worked on this system (which I am sure will be watched with very great interest) is now erected at one of the Plymouth collieries in this district, by an eminent firm of electricians, as a trial and demonstration of what can be done in this direction. This will comprise, when fully complete, a generating plant at the top of the pit, and two electrically-driven hauling-engines underground, connected by a suitable cable carried down the shaft and along the roadway for some 1,200 yards.

The generating plant and one hauling-engine are now erected, and the other hauling-engine will shortly be ready.

The generating plant consists of a 40 horse-power compound engine working at 110 revolutions per minute; this engine drives by belt a specially constructed dynamo, which is of a horizontal pattern, built on a wrought-iron girder bed plate. It is compound wound, and capable of giving off 160 ampères with 500 volts pressure, running at 500 revolutions per minute.

The cable, which is 3,200 yards in length, is made of 37 strands of No. 14 high conductivity copper-wire, highly insulated with vulcanised bitumen, double-taped, and surrounded with two layers of jute yarn compounded between each, and is protected by a double sheath of No. 8 steel-wire. It is of sufficient size to carry the necessary current, and in case of falls of roof it has been constructed so that it will stand a shearing strain of 10 tons per square inch.

The hauling-engine consists of two drums, each fitted with a clutch and foot-brake. The drum-shaft is driven from a counter-shaft by spur gearing, and this counter-shaft is driven from the motor by six ropes 1 inch in diameter.

The motor is a shunt-wound machine, built to run at 600 revolutions per minute, and works with 80 ampères at 450 volts, and is able to take 160 ampères without harm at starting. The whole engine is mounted on a wrought-iron bed-frame. The motor will be reversed by a specially-designed switch, the efficiency of which has yet to be proved. The useful effect of this plant, when working at full power, is expected to be from 60 to 65 per cent.

Possibly the leather-belted and ropes used for transmitting the power from the motor to the hauling-drums or pumps, might with advantage be replaced by something less liable to be damaged by the rough usage and other contingencies usually met with underground.

As I have previously mentioned, compressed air is another motive power very largely used in coal-mining, it being not only absolutely safe in explosive atmospheres, but tends to reduce any danger which might exist from sudden outbursts of gas by assisting the ventilation. This may be considered as rather an expensive

means of assisting ventilation ; but it is very seldom that the air is used direct from the mains for this purpose. A very interesting paper was read at the Newcastle-upon-Tyne Meeting of this Association, in 1889, by Professor Alex. B. W. Kennedy, on the experiments he had made in Paris upon the transmission of power by compressed air, in which he states that an indicated efficiency of 31 per cent. can be got from cold air, and 45 per cent. from air which has been heated after compression. It is very doubtful, however, if in any compressed-air installation used in coal-mining there is more than 30 per cent. of useful effect obtained ; in many instances it is much less, as it is impossible in almost every case to heat the air after it has passed into the mine ; and another source of loss is due to leakage, caused in a great measure by the occasional upheaval of the ground disturbing the pipes. It is thus obvious that compressed air is more costly than electricity ; but up to the present time it is the only absolutely safe power which is capable of being conveyed long distances underground in mines giving off fire-damp.

A very large compressing plant has quite recently been erected in this district, and another will very shortly be installed ; this latter will consist of two pairs of tandem compound steam-engines, each pair having two high-pressure cylinders 22 inches in diameter, and two low-pressure cylinders each 40 inches in diameter, by 5-foot stroke. The air cylinders are 34 inches in diameter, one being placed behind each low-pressure cylinder. Each high-pressure cylinder is provided with variable expansion valves, which can be adjusted whilst the engines are working. The independent condensing apparatus consists of a pair of engines having 10-inch diameter cylinders, and 20-inch diameter air-pumps, by 2-feet 6-inch stroke, and are so arranged that they can be worked together as a pair, or as single engines and condensers.

The pressure of steam at the boilers will be 150 lbs. per square inch, so that a high degree of expansion may be obtained, and as the inlet and outlet valves of the air-cylinders are of large area, and are perfectly free to act in sympathy with the pistons in the air-cylinders, it is only reasonable to expect the highest degree of efficiency which can be obtained from steam-power applied to compressing air. Each pair of air-compressing engines will be capable of developing at least 800 horse-power, or a total of 1,600 indicated horse-power in the installation.

No provision has been made in this plant for compounding the air-cylinders or the motors ; but it has been pointed out by Professor Elliott, of the Cardiff University, in a very interesting and able paper read before the South Wales Institute of Engineers, that great economy will result in compounding the air and motors. Professor Elliott estimates the extra efficiency, under certain conditions of high pressure, as upwards of 11 per cent. Further investigation in regard to defining the relative economy of using high- and low-pressed air for underground mining operations, and the relative cost of the plant adapted for the production and application of each, is required before it can be definitely decided that air of a pressure above four atmospheres, but with air-cylinders and motors compounded, will result in real economy. It appears on the first blush as if we might look in the direction indicated to secure a material increase in the effective power obtainable from compressed air.

In some of our coal fields very hard seams or veins of coal are met with, and various kinds of machinery have been devised to assist the coal hewer in severing the coal from the solid strata, and electrical appliances have in this class of machinery been more or less successful. It appears to me, however, that there is a want of simplicity about the majority of the machines which have come under my notice, which will operate against their general adoption.

In the conveyance of coal underground, from the face of the workings where it is loaded into the trams by the workmen, to the bottom of the shaft, several systems of haulage are adopted, either worked direct by steam-power, compressed air, or electrical motors, the principal of which are known as the endless-rope, main-and-tail-rope, and main-rope systems. The two former systems are used where the ground is either level or undulating, and where power has to be applied to haul the trams or tubs in both directions, and the latter system is generally used where there is a gradient in one direction, sufficient to allow the trams or tubs to run by

gravitation, and haul the rope after them. The cost of the conveyance of coal underground is a very considerable item in South Wales, probably amounting to 600,000*l.* to 700,000*l.* per annum, and consequently has caused great attention to be given to the subject. It has been found that the endless-rope system, where it can be conveniently applied, is the cheapest. This system, however, necessitates the laying and maintaining of either a double line of rails, or frequent passing points or loops, and as the nature of the strata does not always admit of the roads being made and maintained wide enough for this to be done, the main-and-tail system, which requires a single line of rails only, has in that event to be adopted. The distance to which some of these haulage systems extend is very great (in some cases exceeding three miles); and, having regard to the large quantities which have to be conveyed by mechanical haulage in single collieries, in many instances 1,000 to 1,500 tons of coal in ten hours, very good and powerful machinery is required, and it is not unusual to have engines of 600 indicated horse-power placed underground for this purpose. In other cases where the coal is brought from several districts to the bottom of the shafts, smaller engines are used. For endless-rope haulage, the speed at which the trams or tubs travel is from two to six miles per hour, as against from ten to twenty miles per hour by the main-and-tail system; thus there is much greater wear and tear in the latter than in the former. The type of engine usually adopted for this work varies considerably according to circumstances, and the ideas of the engineer by whom the work is planned. They are, however, invariably horizontal, and fitted with a second motion shaft, on which the hauling drums are arranged. There is still a large number of horses employed underground, at very great cost, principally to collect the trams from the colliers and convey them to the station, from which point the engine hauls them, and it is to this class of haulage that I would particularly direct the attention of mechanical engineers. What is required is an absolutely safe and simple means of light haulage, made as portable as possible, so that it can be readily moved from one position to another, as circumstances may require, and arranged so as to replace the horses.

Thus the coal is brought to the bottom of the shaft, and thence up the shaft by means of the winding engine. This class of engine has of late years been very materially improved; instead of the low-pressure vertical-beam condensing engine, which was so commonly in use many years ago, and some of which are still in existence, we have now the high-pressure compound condensing engine, working with a boiler pressure varying from 80 to 150 lbs. per square inch. Some of our winding engines are very powerful and run at very high velocities. This will be the more readily understood from the fact that, at some pits, the carriages on which the coal is raised in the shaft attain a speed equal to from forty to forty-five miles per hour, and the dead load lifted is as great as twenty tons each lift. A few of the leading sizes of a large pair of winding engines now in use at one of the collieries in this district may be mentioned. The engines are vertical, with inverted cylinders of 54 inches in diameter, and admit of a 7-foot stroke; the cylinders are steam-jacketed, and the valves double-beat, placed in pairs in nozzle-boxes, fixed to the port-branches at the top and bottom of each cylinder. The valves are worked by the ordinary rocking lifters, to which is added, for the steam valves, the simple triple expansion gear first introduced by Mr. Barclay, of Kilmarnock. The cylinders are supported by double A frames of cast iron, fixed to heavy cast-iron bedplates, to which also is attached the main shaft plummer-blocks. The winding-drum is of the conical type, graduating from 16 feet to 32 feet, and is made of steel plates and ribs and cast-iron centres. The total weight of the drum, drum-shaft, and the engine-cranks, and one rope, exceeds 100 tons. The engine is fitted with a powerful steam brake, and also a self-acting reversing gear, which reversing gear also applies the steam brake, in case of any neglect on the part of the engine-man. There is also being built, for a colliery in this coalfield, a pair of large compound condensing winding engines, by Messrs. Fowler, of Leeds, which will embrace all the latest improvements. They will consist of a pair of horizontal compound winding engines fitted with condensers; the high-pressure cylinder, being 32 inches in diameter by 5-foot stroke, will actuate one crank, whilst the low-pressure cylinder, 48 inches in diameter by 5-foot stroke, will actuate

the other crank; both cylinders are fitted with Cornish valves, and on the high-pressure cylinder there is fitted automatic variable expansion, worked by a governor, and the initial pressure of steam will be 150 lbs. per square inch. This engine will be fitted with a plain cylindrical drum, 18 feet in diameter, and a balance rope will be attached to the underside of the carriages, so that everything will be in perfect balance.

Between the high- and low-pressure cylinders is a receiver on which is fixed a valve arrangement, by which the steam can be expanded out of the receiver, or live steam can be admitted into it. This arrangement greatly facilitates the ease of starting the engines.

As it is intended to raise the load from the bottom to the top of the shaft in forty seconds, and as, during part of each lift, the speed will probably get up to 3,500 feet per minute, the engines at that time will probably indicate 1,500 horse-power.

Mechanical ventilation, by exhausting the air, has almost entirely superseded the furnace ventilation in general use many years ago, and which created a current by heat. There are many types of fans; the best known are the 'Schiele,' 'Guibal,' and 'Waddell.' Some very large fans are now in use, and at the present time the large quantity of 500,000 cubic feet of air per minute is capable of being passed through one of the mines in this district by a 'Schiele' fan, with a water-gauge of 4 inches. A very exhaustive series of trials is being made by a committee appointed by the North of England Institute of Engineers, which I have no doubt will bring to light many interesting features in the various types of fans in general use, and indicate accurately the relative economic values of each.

Some of our coal mines are very heavily watered, and this involves large and costly pumping machinery, which takes various forms, the most generally used of which is perhaps the old-fashioned but economical Cornish vertical condensing steam engine, which, with its heavy rods and pumps, occupies a considerable portion of the room in the shaft. In recent years, however, there has been a tendency to apply the direct-acting forcing engine, fixed at the bottom of the shaft, of which there are various forms; and still more recently, pumps, worked by electrical power, are being brought into use, and in underground workings far away from the shafts this power seems eminently suitable, as the work in pumping required can be so regulated as to be constant, thereby reducing the risk of danger from sparking.

Many excellent forms of direct-acting pumping engines have been designed, the most economical being the compound condensing direct-acting ram-pump, which takes up little space. Perhaps the worst feature in adopting direct-acting pumps is the fact that steam must be conveyed down the shaft, which means a certain loss by condensation; a loss which can, however, be very materially reduced by having the steam pipes properly protected from exposure by suitable coverings. The steam and water pipes for this type of pump take up much less pit room than those of the Cornish pump, and this is of very great moment where the area of the shafts is limited.

A type of pump which has been adopted in some of our northern mines, and which I should like to notice, is the hydraulic pump patented by Mr. Joseph Moore, C.E., of Glasgow.

The object of this invention is attained by means of hydraulic pressure, and one of the prominent advantages gained, is that it enables the steam engine, which generates the power, to be placed on the surface, and near to the boilers, thus obviating the loss due to the condensation of steam when conveyed great distances. To the steam engine on the surface is attached a double-acting power ram, of the ordinary type, and there are also similar power rams attached to the pump underground; these rams are connected to each other by small pipes, filled with water, which, when under pressure, convey the reciprocating motion of the engine on the surface to the pump underground.

Another type of pumping engine now largely used in mining is that manufactured by Messrs. Hathorn, Davey, & Co., of Leeds; a notable instance of this type of engine is at Bradley, in Staffordshire, where one engine raises 4,000,000 gallons a day, a height of 490 feet. The chief improvements introduced in these

engines of late years have been the trip gear, by means of which the steam communication between the high- and low-pressure cylinders is automatically stopped in case of accident, and the consequent cushioning of the steam in the high pressure cylinder brings the engine gradually to rest without shock; and also the pausing gear, by means of which a definite interval between the strokes is obtained. In heavy lifts, this is of great advantage, by giving time for the valves to settle down to their seats at the end of each stroke, which minimises wear and tear, and it also enables the engine, when running at one or two strokes a minute, to make a brisk stroke and then pause, thus obviating the disadvantage of water slipping back through the valves, which is always the case when an engine makes a very slow stroke.

Another type of engine, which is increasing in favour, is the hydraulic engine at the bottom of the shaft, actuated by a steam engine at the top, on a similar principle to that introduced many years ago by Lord Armstrong for working the machinery in docks. This system possesses the advantage of occupying the minimum of space either at the pit top or in the shaft, and the power can be applied at any point in the pit without the inconvenience which attends the actuation of pumps by spear rods at any other point than at the bottom of the shaft. A plant of this kind has been working at Marseilles for some years, raising 1,700 gallons per minute 311 feet high, with an accumulator pressure of forty-two atmospheres.

On leaving the carriage the trams of coal are weighed, and the coal is then tipped on to the screen, where it is cleaned and divided into the necessary number of saleable sizes (which is usually regulated by the quality of the coal), and then placed in the trucks for transportation. Considerable improvements have recently been made in our screening apparatus, which is probably due, partly to the increased proportion of dirt or dross found in some of the seams now worked, and partly to the necessity of having a more improved and effective apparatus, having regard to the increased cost of working the coal, and consequently to its increased value. The improvements in this direction have taken the form chiefly of travelling belts, moving at a slow speed in lieu of the ordinary falling screen.

At the docks also, the machinery for placing the coal on board ship has been greatly improved, so as to prevent breakage, one of the most recent improvements being the movable tip, which can be adjusted to suit the varying sizes of ships. Some of these tips are made on the principle of the jib crane, the coal being tipped from the truck into large iron boxes, which are lowered into the ship's hold, and the coal dropped out of the bottom of the box. Others are fitted with what might be termed an auxiliary crane, by which the coal is lowered in boxes into the ship's hold, the truck being, first of all, placed on a cradle, which is raised by hydraulic rams to the necessary height, when it is tipped to such an angle as to cause the coal to run out of the truck through a shoot, extending over the ship's hatchway, into what is termed the anti-breakage box. The box being filled is then lowered into the ship's hold, but its use is discontinued as soon as a sufficient quantity of coal has been loaded to form a cone sufficiently large to prevent further breakage. The anti-breakage box is then swung out of the way, and the coal allowed to slide from the shoot on to the cone, and into the hold where it is trimmed into position.

Summarising the position of mechanical science, as applied to our coal-mining industry in this country, it may be observed, that there is a general awakening to the necessity of adopting, in the newer and deeper mines, more economical appliances.

It is true that it would be impracticable, and probably unwise, to alter much of the existing machinery, but, by the adoption of the best-known types of electrical plant, and air compression in our new and deep mines, the consumption of coal per horse-power would be reduced, and the extra expense, due to natural causes, of producing minerals from greater depths would be substantially lessened. The consumption of coal at the collieries in Great Britain alone probably exceeds 10,000,000 tons per annum, and the consumption per horse-power is probably not less than 6 lbs. of coal, and it is not unreasonable to assume that, by the adoption of more efficient machinery than is at present in general use, at least one-half of the

coal consumed could be saved. There is, therefore, in the mines of Great Britain alone a wide and lucrative field for the inventive ingenuity of mechanical engineers in economising fuel, and especially in the successful application of new methods for dealing with underground haulage, in the inner workings of our collieries, more especially in South Wales, where the number of horses still employed is very large.

Leaving the subject of mining, I may observe that considerable progress has within recent years been made in the mechanical appliances intended to replace horses on our public tram lines. The steam engine now in use in some of our towns has its drawbacks as well as its good qualities, as also has the endless-rope haulage, and in the case of the latter system, anxiety must be felt when the ropes show signs of wear. The electrically-driven trams appear to work well. I have not, however, seen any published data bearing on the relative cost per mile of these several systems, and this information, when obtained, will be of interest.

At the present time, I understand, exhaustive trials are being made with an ammonia gas engine, which, it is anticipated, will prove both more economical and efficient than horses for tram roads. The gas is said to be produced from the pure ammonia, obtained by distillation from commercial ammonia, and is given off at a pressure varying from 100 to 150 lbs. per square inch. This ammonia is used in specially-constructed engines, and is then exhausted into a tank containing water, which brings it back into its original form of commercial ammonia, ready for re-distillation, and, it is stated, with a comparatively small loss.

Much attention in modern times has been given to the relative values of the numerous new explosives, which have been introduced for blasting in mines and for other purposes. Sir Frederick Abel is the greatest authority upon this subject. As applied to mining, various experiments have from time to time been made for the purpose of testing how far it would be safe to employ these explosives in the atmosphere of a coal mine without the risk of causing an explosion of fire-damp. A number of these are mainly composed of compounds of nitro-glycerine with aluminous earth. But, whilst the experiments have indicated that, with rare exceptions, they are practically flameless, it is undoubted that one which would be absolutely so, and which could be used with safety in fiery mines, has yet to be produced.

The adoption in our gaseous mines of a flameless explosive, a self-contained electric lamp of moderate weight which will burn without attention for twelve hours, and the general application of water to moisten the dust, are all more or less questions in which the mechanical engineer is interested, and, when adopted, will probably have the effect of putting an end to the disastrous explosions accompanied by loss of life which occur at intervals in our fiery collieries, and I trust that the deliberations of this Section may result in the practical adoption of steps to secure this desirable object.

In conclusion, as an inhabitant of Cardiff, I may be permitted to congratulate this port on this, the first visit of the British Association. Its rising importance is becoming generally recognised, and, since the last visit of the British Association to the Principality, material progress has been made. Lord Bute has constructed a large dock of 33 acres at Cardiff, and a still larger dock of nearly 70 acres has been constructed at Barry within the port of Cardiff. The tonnage of shipping cleared at the port has increased during the past eleven years 91 per cent. Various new industries have been established here, notably, the manufacture of hæmatite iron for steel making, on a large scale, by the Dowlais Iron Company; and the exportation of coal has increased from 5,862,349 tons in 1880 to 12,250,652 tons in 1890, or 109 per cent. At Swansea the manufacture of tin plates, which is one of the leading industries of the western part of this country, has increased from 25,343 tons to 229,791 tons in 1890; and the trade at the neighbouring port of Newport has also materially developed, all showing a rapid progressive development of the large resources of South Wales.

I trust that only a short interval will elapse before we are honoured with another visit of the British Association, and that it will be the good fortune of the President, who may have the honour of occupying this chair on that occasion, to chronicle similar progress.

The following Report and Papers were read:—

1. *Report of the Estuaries Committee.* See Reports, p. 386.

2. *The Ystradyfodwg and Pontypridd Main Sewerage.*
By G. CHATTERTON.

3. *The River Usk, and the Harbour of Newport.* By L. F. VERNON-HARCOURT,
M.A., M.Inst.C.E., Engineer to the Newport Harbour Commission.

The river Usk rises on the western border of Brecknockshire, and, traversing this county and Monmouthshire, it flows into the Bristol Channel, about 4 miles below Newport, after a course of 65 miles. Its basin is 634 square miles; and the Afon Llwyd joins it at Caerleon, and the Ebbw near its mouth. The commercial importance of the Usk commences below Newport Bridge, about 6 miles from its mouth; and wharves extend along the right bank for $2\frac{1}{4}$ miles below the bridge, and the vessels lying at the wharves rest, at low tide, on the soft mud covering specially levelled berths. The Newport and Alexandra Docks also afford floating accommodation for large vessels on the western side of the river, on which side the town of Newport is mainly situated. These docks have water areas of $11\frac{1}{2}$ and $28\frac{3}{4}$ acres respectively, and the depth of water over the sills of their entrances, at spring tides, is 30 and 35 feet. A large extension of the Alexandra Dock, and a new entrance lower down the river, are approaching completion. The quays are supplied with coal tips, sidings, and hydraulic appliances; and the docks and wharves are connected by railway with the mines and works in the neighbouring district. The eastern side of the river is almost wholly undeveloped; but roads are being made, and the East Usk Railway has been authorised, which will give facilities for trade, and should lead to the extension of the port along the left bank. The portion of the river constituting the harbour of Newport is very winding; and though it increases considerably in width between the bridge and its mouth, thus favouring the tidal influx, the enlargement is not uniform, which causes changes in the velocity of the current, and promotes deposit in the channel where the cross section is excessive. Moreover, the bends of the river make the flow and ebb, coming in opposite directions, form channels on opposite sides of the river between the bends, leading to the growth of a central sandbank between these side channels. Besides these central shoals of sand and silt, readily formed in a river densely charged with material in suspension, there are some hard natural shoals of clay and stones, and also shoals at the confluence of tributaries, formed of detritus and refuse from works, brought down by the current in flood-time, and deposited in the Usk. The great tidal rise of the Usk, amounting to 34 feet at the bridge and 40 feet at the mouth at the top of springs, and 14 and $16\frac{1}{2}$ feet respectively at neaps, has hitherto enabled Newport to maintain a large and increasing sea-going trade, in spite of the deficiencies mentioned above. Comparative cross sections of the river, taken in 1884 and 1890, have shown, however, that accretion is taking place in the river, and gradually reducing its depth, whilst the draft of vessels tends to increase. Accordingly the Commissioners have decided, on the advice of the author, to dredge a channel across these shoals, so as to form an adequately wide navigable channel, not less than from 24 to 26 feet deep at high water of the lowest neap tide, down to the Alexandra Dock entrance, and 26 feet deep (or 2 feet lower than the lowest dock sill) from this point to the mouth of the river. These works, involving the removal of over 300,000 cubic yards of material from the bed of the river, will meet the present requirements of the port; and further improvements can be gradually carried out in conjunction with the work of maintenance, as circumstances may render expedient. The formation of this improved channel will lower the low-water line, and regulate its fall, which at present is not uniform, and thus increase the tidal capacity of the river, and improve the scour of the current. In order to render the flow of the river more

uniform, to stop the erosion of the banks, to reduce the rate of accretion, and to aid the development of the left side of the river, regulation works have been proposed at certain places where the width of the river is excessive. By these works, the Harbour Commissioners will give to Newport and the surrounding mineral districts similar advantages to those which have been conferred, by more extensive works, upon other river ports less favoured by nature, will aid in promoting that growth of trade which Newport has enjoyed during the last thirty years, and will prevent the diversion of traffic which an irregular channel of occasionally inadequate depth would sooner or later produce.

4. *On Mechanical Ventilation and Heating of Buildings.* By W. KEY.

FRIDAY, AUGUST 21.

The following Papers were read:—

1. *On the Channel Tubular Railway.*
By Sir EDWARD REED, K.C.B., M.P., F.R.S.

After referring to former proposals for establishing railway communication between England and France, and stating that the Channel Tunnel scheme of Sir Edward Watkin provided for taking the traffic far below the bed of the Channel at its deepest part, thus lengthening the underground route, and adding to the working charges as compared with a tubular railway, the author said that it was desirable in the first place to make plain the nature of the Channel bed which it was designed to traverse. He stated that for several miles out from the English Coast the Channel, on the line selected by him, was only about 90 feet deep, and, although it gradually sloped down to double that depth further on, nowhere exceeded a depth of 186 feet, from which depth it gradually sloped up to the French shore. In no place is the gradient even one-half that of the Severn tunnel; in fact the change of level is small and so gradual as to be almost imperceptible upon any true-scale diagram of moderate dimensions. 'Here, then, we have,' the author said, 'an almost level stretch of ground of over twenty miles in length to be traversed by a railway, and, if it were dry, no mortal man would ever dream of tunnelling underneath it in order to construct a railway, nor would anyone be so insane as to propose to build a viaduct or series of bridges 500 feet high across it.' The railway would in that case, of course, be laid along the ground, as it is laid over any other stretch of level country. The presence of the sea simply renders it necessary to make the railway a closed instead of an open one, to secure it against being moved by the tidal waters, and to provide its proper ventilation. To provide a closed railway, metallic tubes are employed—one for each line of rails—and to make the structure durable, all the essential parts are carefully imbedded in good Portland cement. The two tubes are set at a distance apart, and connected by partial webs, so as to combine the two into a huge horizontal girder of unprecedented strength. This device is adopted in order to make each length of the tube structure (which is on the whole to be slightly buoyant) strong enough to withstand the force of the tide when one end of it is carried to the bottom, the other end being left emerging from the surface by virtue of the surplus buoyancy. To this emerged end is brought and connected afloat another floating structure which is to serve as a pier (when it is subsequently sunk to the bottom), and beyond this floating pier the next length of the tube is brought and connected by large cast-steel hinge-like joints. The pier is then sunk by suitable appliances, carrying down with it the second end of the first of the tubes just mentioned, and also the first end of the second length of tube. In this manner the tube is paid out length by length like the links of a huge cable, the junction of

the successive tubes and piers being effected from within the tubes already laid, which are in direct railway communication with the shore. The author pointed out that the necessity which drives us to the use of water-tight tubes for our purpose is incidentally attended by enormous advantages, enabling us to build our structures in the ordinary shipbuilding and engineering establishments of the country, and tow them to their places, thus avoiding the cost, difficulty, delay, and danger of doing our construction work at the bottom of the sea. The piers will stand upon and be pressed into the bottom where the consistency of the bottom admits of this, but the tubes themselves will not lie upon the sea-bed, but will stretch from pier to pier, striding over the minor inequalities of the bottom, and allowing the tidal water to pass both below and above it. The estimated cost of the work (which depends somewhat upon details to be determined by close survey) is from twelve to fifteen millions sterling for the whole distance between England and France, which the author regarded as small by comparison of the cost of such bridges as the Forth Bridge, which cost over three millions sterling for bridging 5,700 feet of water, the tubular railway being 120,000 feet long. The ventilation will be an easy matter, seeing that all the trains passing through either tube will move in one direction, and act somewhat as pistons for forcing out air, the effect being increased by throwing out wings from the train so as to make it fit the interior of the tube more approximately. The author intimated that electric engines will probably be used, but, if not, and if further ventilation be needed, any one or more of the piers can be fitted with ventilating machinery for forcing the deteriorated air out through suitable chambers and non-return valves into the sea. As regards the question of national security, the author pointed out that the opposition to the Channel Tunnel had arisen from the fact that it provided a subterranean road, inaccessible to, and therefore indestructible by, the Navy; whereas the tubular railway could be pierced, and have the sea admitted to it, either by gun-fire at the shore ends, or by dynamite or torpedoes at every point of its length. He concluded by stating that a great many members of Parliament, who always strongly oppose the Channel Tunnel, are quite in favour of his system, and among these are several of such great influence that he has little fear of his Bill being successfully opposed in either House of Parliament.

2. Petroleum Oil-engines. By Professor WILLIAM ROBINSON, M.E., Assoc. M.Inst.C.E.

The use of ordinary petroleum oil at once as fuel and working agent in the internal combustion engine has extended rapidly since the successful introduction of the oil engine by Messrs. Priestman Brothers in 1888.

Hitherto, for large engines above 40 horse-power, the heavy intermediate oils have been converted into gas by means of a *gas-producer*, and this oil-gas takes the place of coal-gas in the ordinary gas-engine cylinder. Now, instead of the gas-producer we find in *one class of oil-engine* a retort, spiral coil of tubing or other *vaporiser*, in which the oil is heated and converted into *vapour* by a lamp or oil-burner. A mixture of this vapour and air is drawn into the cylinder, and the charge is compressed before ignition—the cycle of operations in the engine cylinder being usually that of Beau de Rochas, as in the well-known Otto gas-engine. For instance, Messrs. Crossley Brothers are making an oil-engine in which a lamp performs the twofold function; first, to heat and evaporate the oil in a retort, and second, to heat the tube-igniter, which is timed by a valve similar to that in their gas-engines. This lamp has a separate supply of oil given to it by a pump and a current of air from an air-pump. The details of this and several other attempts at workable engines of this class are still in the transition stage.

Again, in the petroleum *spirit-engine* there are many *air-carburetted devices* to evaporate the highly volatile hydro-carbons which make up the lighter products of petroleum, such as benzoline and gasoline. The terrible danger and risk in the storage of these light oils prohibit their common use for this purpose.

In the Priestman *Spray-maker* and *Vaporiser* we have a neat and *practical com-*

bination of these two methods, by means of which a sprayed jet of oil is first broken up by compressed air playing on it in the inverted spray-nozzle, then it is further mixed with air, heated and completely vaporised by the hot products of combustion from exhaust led round this vaporiser or mixing chamber, before being allowed to escape. This might be called a *regenerator*. The oil vapour thus thoroughly mixed with air in the proper proportions is drawn through an automatic suction valve into the engine cylinder by the piston in its forward stroke. The action of this *spray-maker* (shown) will be seen by the following experiment:—First, turn off the air supply and a flame does not light the unbroken oil-jet; next, allow the air under pressure to break up and thoroughly spray the oil, the vapour formed is so intimately mixed with air that it can easily be ignited, and burns with a bright flame. (The drawings of this spray-maker showed the *governing arrangement* adopted in the Priestman engine.) The amount of hydro-carbon is diminished or increased, together with the amount of air, so as to form a high explosive charge or a low one, according to the amount of work to be done by the engine. The air through the wing-valve is rightly proportioned to mix with the oil which is allowed through the V-shaped slot cut in the conical plug regulated by the governor. By this means there is a regular explosion and impulse, every cycle giving admirable regularity of running. (Indicator-cards illustrating this mode of governing with full load and running light were shown.) The compressed charge is *fired* by an intermittent electric spark, made to play between ends of two platinum wires insulated by porcelain in the *igniting* plug (shown), and connected to an induction coil excited by a storage-cell of about two volts, which has been known to work for more than 1,100 hours.

The author explained the action in horizontal engines by means of diagrams, and gave a short description of a double cylinder vertical launch engines specially designed for running at a high speed with the centre of gravity kept low. Each cylinder of launch engine is 7 inches diameter by 7 inches stroke, arranged to give an explosion or working stroke every revolution of fly-wheel. The actual horse-power at 250 revolutions per minute is 5·7, and 9·1 indicated horse-power. These engines are working in a small launch 28 feet from stem to stern by 6 feet 2 inches beam, and are giving good results. Speed 7 miles, and engines work with regularity. These engines are now in use on barges in canals, and also for deep-sea trawling. The horizontal type is remarkably self-contained, and well adapted for isolated electric lighting installations and lighthouse work. It is used for pumping and hauling in collieries, and for rock-drilling in mines; in fact, its sphere of usefulness is rapidly extending, because it is found reliable and steady at work, with decided economy of fuel.

The main object desired in oil-engines is to *prevent clogging* in the cylinder, so that the engine may run without attention or frequent cleaning. This is secured by thoroughly mixing the air and vapour, so as always to form an explosive mixture which gives complete combustion and clean exhaust. It must be pointed out, however, that during the compression of the charge before ignition a considerable proportion of the vapour comes into contact with the walls of the cylinder, condenses on them, and *never* gets burned, however useful it may be for lubrication. This the author has proved by comparing the pressure along the compression curves of the indicator diagrams, with the pressure obtained by experiment from each charge consisting of the explosive mixture 0·15 cubic inch of oil and 191 cubic inches of air at the same temperature. Taking the temperature of the charge 170° F. on entering the cylinder, the indicator diagram shows the highest pressure before ignition only 38 lbs. per square inch. This pressure is kept low for fear of much condensation, as well as to give smooth running. In the gas-engine we know that compression of the charge before ignition is essential to high efficiency, and similar considerations lead one to expect the same to hold true for oil-engines. Indeed, by adding fresh air to the charge after leaving the vaporiser, and compressing more than usual, greater power or higher efficiency is obtained, but the temperature of the cylinder becomes too high for lubrication. In some published trials an engine may be run with a special cylinder liner to withstand the high temperatures due to high compression used, but these are not

the conditions for ordinary work. In fact for any particular oil experience must decide the degree of compression that gives best results as regards power and efficiency consistent with economy and durability of engine.

The author briefly noticed his investigation of the relation between the pressure and temperature of the vapours from different burning oils, intermediate oils, and some heavier lubricating oils, in order to throw some light on the action in the cylinder of the common oil-engine. At the same time he has tried to find out which oils are best adapted for this use. His experiments prove that, notwithstanding the complex and varied character of the different oils examined, *the law according to which the pressure of petroleum vapour varies with its temperature is represented by a perfectly regular curve for each oil.* He compared these results with the figures obtained from the different oils when used in the same engine during special tests for the purpose.

By far the simplest type of oil-engine is that in which the *oil is injected directly into compressed and heated air in a cartridge* which at once acts as vaporiser and combustion-chamber. Such an oil-engine is the invention of Mr. H. Akroyd Stuart, of Bletchley, and is now being made by Messrs. Hornsby & Sons, Grantham. A novel feature of this engine is that the ordinary gear for firing the charge by heated tube, flame, or electric spark is dispensed with altogether, and heavy intermediate oil is ignited and completely burned when injected into the compressed and heated air in the red-hot vaporiser or cartridge. This chamber is heated up at start with a special oil-lamp supplied with air-blast by a small fan, as shown in drawings. It was seen by the wall-diagrams that this engine is of the simplest design. The working parts are few and simple, and some details are being improved by Messrs. Hornsby & Sons. The oil-cistern is fitted in the base of the casting, exposed to ordinary atmospheric pressure, and the oil supply can easily be replenished at any time during a run by sliding open the top cover and pouring in the oil.

Every charge of oil is forced, by means of a positive action oil-pump, through a thin pipe and simple nozzle into the vaporiser at the proper moment for ignition, just after the hot air has been compressed and the piston is on the return stroke. The oil supply is regulated by a governor, whilst by using a large fly-wheel and high speed, about 210 revolutions per minute, this engine runs very steadily. The author tried a 6 horse-power engine during a run of about three hours, using oil of specific gravity .854, and flashing point 220°F., and the consumption was less than a pint per brake horse-power per hour. Even heavier oils might be tried, the hot water from the water-jacket going to warm up the heavy oil and keep it in a fluid state fit for use in winter.

The action in the engine-cylinder is here very different from that in the Priestman, inasmuch as there is an excess of air in the cylinder, and this is compressed before the oil is injected. Consequently, the combustion is rapid and will be complete even when heavy oils of great heating power are used. However, since the air is dry, and there is no condensation of oil, the cylinder requires independent lubrication, as in the case of the gas-engine.

A feeling of safety to the public naturally tends to the use of heavy oil, from which the lighter constituents have been distilled. The author has found the loss in weight of some heavy oils by prolonged heating at low temperatures, keeping the oils exposed to the air and allowing free *evaporation*. Known weights of oil were taken in shallow dishes, about three inches across top, and gently heated on a sand-bath by a very small steady flame for three hours, the temperature of the oil being kept constant. The proportions of volatile constituents present in the samples are indicated.

The terribly explosive character of the hydro-carbons driven off at the ordinary temperature renders the *safe storage of petroleum* imperative. Instead of the present tank system, Mr. B. H. Thwaite has devised the safety oil-tank. It is very much like a gas-tank, the cover-plate being kept in contact with the oil and counterbalanced by weights to give only a slight pressure of one or two inches of water on the surface of the oil. The frame moves into an annular water seal stand-pipe, to draw off any gas that collects. There is no necessity for the

introduction of air to allow the tank to be emptied, and as the oil is kept cool, and always under pressure, it is impossible for a dangerous explosive mixture to accumulate inside the tank.

Evaporation.

Name of Sample	Specific Gravity at 60°F. (15°-5C.)	Constant Temperature (Centigrade)	Time of Evaporation (Hours)	Percentage Loss	Total Percentage Loss in 3 Hours.
Broxburn Lighthouse Oil used in Priestman Engine.	·811	40 to 45	1·5	1·63	6·90
		60 to 65	1·5	5·27	
Intermediate Shale Oil	·846	40 to 45	1·5	1·12	3·57
		65 to 75	1·5	2·45	
Lubricating Oil used in Hornsby Akroyd Engine.	·854	40 to 45	1·5	1·00	2·96
		60 to 65	1·5	1·96	
		Steam Bath (95)	3	12·42	12·42

3. *On the Revolving Purifier for the Treatment of Water by Metallic Iron.*
By W. ANDERSON, D.C.L., F.R.S., M.Inst.C.E.

After pointing out the advantage of being able to purify in a satisfactory manner the water of rivers available for the supply of towns, the paper proceeds to relate some of the recent experiences of the system first introduced at Antwerp some 7 years ago. Practical working in several places has shown that satisfactory purification can be obtained after treatment with iron at a much greater rate of filtration and through a thinner layer of sand than in ordinary filtering arrangements—a speed of as much as 100 gallons per square foot per twenty-four hours being the usual rate of running at Dordrecht, for example. The complete installation is briefly described, and the marked effect in reducing organic contamination, in the arrest of free ammonia, and in the destruction of microbes is attributed to the formation of ferric oxide, which acts as a coagulant, depositing a very fine filtering medium on the surface of the sand in the filter beds. The comparative cost of the ordinary systems of sand filtration and the author's method are contrasted, and a considerable economy, both in capital, outlay, and in working expenses, is shown to exist.

The installation at Agra, on the river Jumna, is next described, and the highly satisfactory results obtained noted. The experimental apparatus on the Seine, near Paris, is mentioned, and figures are quoted to show the large degree of purity attained. The effect of the iron treatment on waters containing very finely-divided argillaceous matter, like the Nile, the Mississippi, and other rivers, is described, and abundant evidence is given that these waters, which will not subside clear in any reasonable time and cannot be filtered bright, yield immediately to the iron treatment. Several instances of successful application in the United States are given, and especially at Chicago, where a reduction of albuminoid ammonia from 3·08 to ·122 parts in a million has been obtained.

The paper goes on to describe some improvements connected with the introduction of air and small doses of carbonic acid, which are found to be beneficial in obstinate waters, such as those highly coloured by peaty matters; and it is also shown that the introduction of air is often beneficial, even with waters which purify readily, by expediting the action and so increasing the efficiency of the plant; and it is suggested that the energetic action which often takes place with very badly contaminated waters may be due to the carbonic acid generated by putrefaction.

The whole of the results dealt with have been obtained either from existing installations or from experimental plant working on a large scale.

4. *A Steady Platform for Guns, &c., at Sea.* By BEAUCHAMP TOWER.

I propose to describe two important improvements which I have introduced into my apparatus for securing a Steady Platform for Guns, &c., at Sea, on which I read a paper at the meeting of the British Association at Newcastle two years ago. It will be remembered that the apparatus consists of a water-driven gyroscope revolving in a horizontal plane on a spherical bearing, and directing the action of four cylinders by means of an axial jet, so as to keep the gymbal-hung platform coaxial with the gyroscope. The gyroscope itself was caused to revolve in a horizontal plane by having its centre of gravity about $\frac{7}{8}$ inch below its centre of suspension; this caused it to act as a long-period conical pendulum. If it started with its axis out of the vertical, it would go through a gradually-diminishing conical movement, which would be extinguished by the friction of the bearing. This acted very well in short waves; but November before last I took my yacht into a long sea in the Channel after a westerly gale, and found that the time during which the horizontal force of each long wave was acting was sufficient to disturb the gyroscope about a degree. This led me to make the following improvement. I lowered the centre of suspension of the gyroscope to the centre of gravity. I made four little pendulums, each 3 inches long, the weight of each bob being only $\frac{6}{16}$ lb. These four pendulums are suspended from the bodies of the four cylinders, and press slightly little wheels on the ends of bell-crank arms on the rim of the gyroscope. They are arranged so that, should the gyroscope be out of the horizontal plane, these pendulums press on it in such a way as to cause it to become horizontal. In the old arrangement the end of the axial jet approached the zenith by a spiral path; in this improved arrangement it approaches it in a straight line, and, having reached it, has no oscillatory tendency to go beyond it; so that the time taken by the gyroscope in assuming the horizontal is much shorter than before. The disturbing effect of the horizontal forces of wave-motion acting on the little pendulums is only about a twelfth of what it was when the whole gyroscope was a pendulum; so that the longest waves produce no sensible disturbance. The machine steadies up much quicker than before, and the slow wandering of the zero through a degree or two has entirely disappeared.

The other improvement is the addition of what I call the Correcting Cylinder. It is clear that in the arrangement I described two years ago a certain small, lagging-behind error must exist, owing to the necessary departure of the centre of the ports from the centre of the axial jet, in order that the necessary filling and emptying of the cylinders should be performed. I endeavoured at first to diminish this error as much as possible by enlarging the area of the jet and ports relatively to the area of the cylinders, but found a tendency to a hunting oscillation if this was carried too far. I then constructed the correcting cylinder, which has entirely removed this error.

In the thickness of the partition between each pair of ports I made two other ports, which were merely narrow slits connected by small pipes, one to one end, and the other to the other end of a double-acting cylinder, having a piston held in mid-stroke between two stiff, spiral springs, the piston-rod having the elevating screw of the gun on the top of it. Supposing the centre of the ports to have departed one degree from the centre of the axial jet, one of these narrow-slit ports will in consequence be more covered by the jet, while the other is less covered, and the consequent difference of pressure, acting on the piston and springs in the correcting cylinder, will cause the level of the gun to be altered one degree, so that its axis is still at right angles to the axis of the gyroscope.

Thus a correction is applied to the gun to compensate for any error in horizontality of the platform, whether caused by the lagging behind of the platform over the jet due to motion, or to a disturbing statical movement applied to the platform.

5. *Description of Lewis and Hunter's System of Coaling Ships.* By C. HUNTER.

6. *On some of the Peculiarities to be observed in Portland Cements, and on the most advanced methods for determining their Constructive Value.* By HENRY FAIJA, *M.Inst.C.E.*

After dealing with the manufacture of Portland Cement, and the materials from which it is manufactured, the author proceeds to describe in detail the proportions of lime, silica, and alumina which would constitute an ordinary Portland cement, and further explains that their degree of chemical affinity materially affects the quality of the cement produced. The peculiarities appertaining to quick- and slow-setting cements is exhaustively considered, and, after defining the ordinary behaviour of cements when gauged with water, he says that any cement deviating materially from these recognised laws, though it may be a perfectly good cement, should be used with caution until its quality is absolutely determined by further tests and experiments.

The necessity of making tests for tensile strength at two dates, in order that the growth or increase in strength of a cement may be ascertained, is explained, and the author makes use of Professor Unwin's formula for determining the ultimate strength of a cement in order to compare the respective value of quick- and slow-setting cements.

With respect to the setting properties of a cement, the author explains that there are two periods which may with advantage be noted when carrying out a test; the one being the 'initial set,' or, in other words, the time which elapses between the addition of water to the cement and its commencing to set, and the time when it is 'set hard'; the time of 'initial set' being considered the most important, as it represents the commencement of an actual chemical process, and that any disturbance of the cement after the setting or crystallisation has commenced would detract from its ultimate strength, whereas the time of 'set hard' is only a somewhat undefinable period, and really indicates no change in the chemical process, being only one step towards the ultimate hardness and strength which the cement will attain.

The test, however, which the author considers the most important is that by which its 'soundness,' or freedom from expansion or contraction, is determined, and he explains that no matter in what time the cement sets, to what fineness it is ground, or what tensile strength it develops within the limited period of an ordinary test, can possibly be of any value if the cement proves an unsound one, and that in the course of time it will 'blow' and destroy the work of which it is a component. The causes which make a cement an unsound one are also considered, and it is explained that a cement may 'blow' within a day or two of its being gauged, or it may not blow until several months afterwards.

The method of determining the soundness of a cement, which the author devised some ten years ago, is then explained; it consists in submitting a freshly-made pat to a moist atmosphere of about 100° F., and when set hard immersing it for some hours in water at a temperature of 115° F. This treatment greatly expedites the set and hardening of a cement, and in like manner develops any blowing tendency which may exist in it, and consequently in the short time of twenty-four hours the 'soundness' or 'unsoundness' of a cement may be absolutely determined.

The nature of aggregates used with cements in concretes and mortars is also touched upon, and it is explained that they may in themselves, through being unsuitable, cause a failure of the mass even when a perfectly good cement is used, and that, therefore, the user should be as careful in his choice of aggregates as in his choice of cements.

Several peculiarities appertaining to old and new cements are also described, and the author concludes with a reference to the Pontypridd Sewage Works, which the members attending the meeting afterwards had an opportunity of visiting under the guidance of Mr. Chatterton, the engineer of the works.

7. *On the Compound Principle in the Transmission of Power by Compressed Air.* By Professor A. C. ELLIOTT, D.Sc. (Edin.).

The heat dissipated in the compressors, passages, and supply-pipes of a compressed-air power, transmission system is a waste product. Under the condition that the compressed air must ultimately attain a temperature but little above that of the atmosphere, it is easy to show that the heat waste is a minimum when the compression is performed isothermally (even were a sink temperature lower than that of the atmosphere available).

But the practical problem of effecting isothermal compression has never been satisfactorily solved; and, in fact, attempts in this direction have hitherto been mainly based on mere adaptations of the old cylinder water-jacket and jet appliances. But even in cases where both jets and water jackets have been applied, the compression curve has been found to fall only to a very small extent below the adiabatic. Amount of heat conducted is directly proportional, other things being equal, to time and to difference of temperature. Now, the difference of temperature between the air and the cooling water is zero at the beginning of the stroke, and increases to a maximum at the point when the eduction valve opens. We are, therefore, able to conclude in harmony with practical experience, first, that to effect anything like complete isothermal compression the piston speed must be excessively small; and, secondly, that the rate of flow of heat from the air to the cooling water attains a maximum value just at completion of the compression. At ordinary speeds, then, it appears that even with the jet a large proportion of the total heat must be abstracted after the eduction valves have opened—that is to say, *after* compression has been effected.

The author stumbled some time ago on the principle of intermediate cooling. On this plan the compression is effected in two or more successive stages by a compressor with a corresponding number of properly proportioned cylinders connected by receivers, forming a mechanism analogous, as the case may be, with a compound, a triple, or a quadruple expansion steam-engine worked, as it were, in the reverse direction. The outstanding point of difference is that each receiver is provided with a jet or (preferably) surface cooling arrangement by which the temperature of the air as it leaves the receiver is brought nearly to equality with that of the atmosphere; and there is practically no difficulty in effecting this cooling, because the size and surfaces of the receivers are at our disposal.

As compared with the ordinary simple system, the result to be expected is either (*a*) with the same pressure a substantial gain in efficiency; or (*b*) with a higher pressure and the same efficiency a reduction in the size of the supply-pipes and the plant generally. Another point of very great importance is that if surface-cooling be adopted in the receivers, trouble from the formation of ice in the exhaust passages of the motors will almost certainly vanish.

The author, however, soon learned that, at all events, the idea of the compound (or two-stage) compressor had been suggested some considerable time previously by Professor Riedler in connection with the designs for the new plant to be put down as an extension of the present Popp installation in Paris. But there is no doubt whatever that he in turn has been anticipated by Mr. Morrison, the manager of the Marquess of Lothian's colliery at Newbattle, near Edinburgh. The author has just returned from a visit of inspection, and can vouch for the fact that Mr. Morrison's claims are well grounded.

It next occurred to the author that, just as the compression-line on the combined diagram could be made up of discontinuous parts of adiabatics hugging the ideal isothermal curve by the devices of a multiple-cylinder compressor and intermediate cooling, so the expansion-line of a motor could be made to hug the ideal isothermal curve by very similar means. In fact, the compound motor is simply the compound compressor, as it were, worked in the reverse direction; but, instead of intermediate cooling, as in the compressor, we have intermediate heating. We are thus enabled to recover from the atmosphere in the motor-cylinders part of the energy dissipated at the compressors.

The maximum economy is obtained in a compound, triple, or quadruple com-

pressor when the total horse-power is equally distributed among the cylinders. A similar statement applies to multiple-expansion motors.

For the purposes of an example designed to show the value of the compound principle, the author has assumed the Paris pressure—namely, six atmospheres absolute—and made allowances for all losses on the scale that Professor Kennedy found them to exist in the present machinery at Paris over a distance of four miles.¹ The efficiency of the system is taken to be the ratio of the indicated horse-power in the motor-cylinders to the indicated horse-power in the steam-cylinders of the compressor. The following are typical results:—

	Efficiency per Cent.
Simple compressor and simple motor	39·1
Compound compressor and simple motor	44·9
Compound compressor and compound motor	50·7
Triple compressor and triple motor	55·3

8. *Sinking Wells and Shafts.* By HENRY DAVEY, *M.Inst.C.E.*

In 1881 the President of this Section, Mr. Forster Brown, read a paper before the Institution of Civil Engineers on 'Deep Mining of Coal in South Wales.'

In that paper the author pointed out the great difficulty and expense attending the sinking of shafts through water-bearing strata, and suggested that a boring might be put down in advance of the sinking into which a pump might be placed to facilitate the operation of sinking. The water being pumped down in the boring below the bottom of the shaft the sinking would be done in dry ground, and would go on without intermission.

The suggestion appeared to be a valuable one.

In sinking shafts and wells through water-bearing strata, on time-honoured methods, there is not only the great cost, but, what is often more serious, the great length of time taken in doing the work. A single well for town water supply often takes two or three years or more to execute.

The subject is of considerable local importance, because of its bearing on the sinking of mining shafts, and it is on that account that the author ventured to bring it briefly before the Section.

The problem is simply that of keeping down the water in water-bearing strata in advance of the sinking operations, so that the excavation of the shaft or well shall be done in dry ground.

The ordinary method of shaft or well sinking is to sling a pump or pumps in the shaft and to lower the pumps from time to time as the sinking continues; obviously the excavation has to be performed in water, and if the quantity of water to be dealt with is very great, a large portion of the work has to be done by the men working in a depth of two or three feet of water.

To facilitate the work, and to reduce the water in which the men have to work, a sump is made under the suction pipe of the pump, and it is the keeping this sump excavated in advance of the other work which is most difficult and tedious. Then there is the delay occasioned by the lowering of the pumps, and providing the appliances necessary to the operation.

In the plan now proposed, the pump would be placed in a borehole made before the commencement of the sinking of the shaft. The only novelty in the pump is that of adapting it to the purpose.

It is necessary that débris shall not go down the borehole in quantity sufficient to choke it up. That is provided against by means of a heavy taper shield of cast steel surrounding the pump and resting on the edge of the borehole. This shield is perforated with holes inclined upwards towards the pump to allow water to get into the borehole, but to exclude débris. The shield is made very heavy, and by its own weight follows the excavation around the pump, and also protects it from injury through the blasting of the rock. The pump is made without a foot-valve, the rod of the bucket working through the seating of a valve which rests on the

¹ See *British Association Reports*, Newcastle, 1889.

top of the working barrel; by this arrangement the drawing of the bucket also draws the valve, and should the bottom of the borehole be filled up with sand, it can be removed by lowering a sand pump such as is used in making boreholes.

The boreholes should be made to a greater depth than that required for the pump to provide a space for sand and débris.

The application of this pump to the sinking of shafts would be varied to suit the local circumstances, and the geological formation of the strata to be passed through. Details of various applications which might present themselves are omitted.

It is quite evident that in some situations the shaft might be drained by means of boreholes outside, and this is a plan now being carried out in one or two cases in procuring water for Town Water Supply.

It is the usual and necessary practice to provide duplicate pumping engines, and where two engines are made to pump from the same well, the well must be very large that it may accommodate two sets of pumps.

Such wells are usually 12 to 14 feet in diameter. To sink such a well in the ordinary way is a very long and costly undertaking, especially if quicksand is met with. On the completion of the well it may be necessary to drive adits to increase the water supply.

A simple borehole is made very cheaply and very expeditiously—four 30-inch boreholes can be put down in a very small fraction of the time required to sink a 12-foot well in the ordinary way.

Instead of making a large well the author puts down four boreholes to accommodate the pumps for duplicate pumping engines—a pair of pumps to each engine. The boreholes being completed, the pumps are lowered into them, and coupled up to the permanent engines. Immediately that is done the water found in the boreholes can be pumped, and supplied to the town.

Should it be insufficient, then a small well would be sunk in the dry to the bottom of the borehole pumps. The boreholes at the level of the pumps would be connected to the centre well, and adits driven to collect more water. Should the boreholes yield sufficient water there would be no necessity to sink the well.

It would be absurd to advocate any particular system of well sinking as being universally applicable and expedient. This system of making wells and shafts certainly promises advantages under ordinary conditions; but the advisability of its adoption in any particular case must be a matter of judgment with the engineer planning the work.

It may be of interest to know that the practice of 'dowsing' for finding water is not altogether extinct in the West of England.

SATURDAY, AUGUST 22.

[The Section did not meet.]

MONDAY, AUGUST 24.

The following Papers were read:—

1. *The London-Paris Telephone.* By W. H. PREECE, F.R.S.

1. I have already on two occasions, at Newcastle and at Leeds, brought this subject before Section G, and have given the details of the length and construction of the proposed circuit. I have now to report not only that the line has been constructed and opened to the public, but that its success, telephonic and commercial, has exceeded the most sanguine anticipations. Speech has been maintained

with perfect clearness and accuracy. The line has proved to be much better than it ought to have been, and the purpose of this paper is to show the reason why.

The lengths of the different sections of the circuit are as follows:—

	Miles
London to St. Margaret's Bay	84·5
St. Margaret's Bay to Sangatte (cable)	23·0
Sangatte to Paris	199·0
Paris underground	4·8
Total	311·3

The resistances are as follows:—

	Ohms
Paris underground	70
French line	294
Cable	143
English line	183
Total (R)	693

The capacities are as follows:—

	Microfarads
Paris underground	0·43
French line	3·33
Cable	5·52
English line	1·32
Total (K)	10·62

$$693 \times 10 \cdot 62 = 7,359 = K R.$$

2. *Trials of Apparatus.*—The preliminary trials were made during the month of March between the chief telegraph offices of the two capitals, and the following microphone transmitters were compared:—

Ader	Pencil form.
Berliner	Granular „ (Hunnings).
D'Arsonval	Pencil „
De Jongh	„ „
Gower-Bell	„ „
Post Office switch instrument	Granules and lamp filaments.
Roulez	Lamp filaments.
Turnbull	Pencil form.
Western Electric	Granular

The receivers consisted of the latest form of double-pole Bell telephones with some Ader and D'Arsonval receivers for comparison. After repeated trials it was finally decided that the Ader, D'Arsonval, Gower-Bell (with double-pole receivers instead of tubes), Roulez and Western Electric were the best, and were approximately equal.

These instruments were therefore selected for the further experiments, which consisted of using local extensions in Paris and London. The wires were in the first instance extended at the Paris end to the Observatory through an exchange at the Avenue des Gobelines. The length of this local line is 7 kms. The wires are gutta-percha covered, placed underground, and not suitable for giving the best results.

The results were, however, fairly satisfactory. The wires were extended to the Treasury in London by means of the ordinary underground system. The distance is about two miles, and although the volume of sound and clearness of articulation were perceptibly reduced by these additions to the circuit, conversation was quite practicable.

Further trials were also made from the Avenue des Gobelines on underground wires of five kilometres long, and also with some renters in Paris with fairly satisfactory results. The selected telephones were equally efficient in all cases, which

proves that to maintain easy conversation when the trunk wires are extended to local points it is only necessary that the local lines shall be of a standard not lower than that of the trunk line. The experiments also confirm the conclusion that long distance speaking is solely a question of the circuit and its environments, and not one of apparatus. The instruments finally selected for actual work were Gower-Bell for London and Roulez for Paris.

3. The results are certainly most satisfactory. There is no circuit in or out of London on which speech is more perfect than it is between London and Paris. In fact, it is better than I anticipated, and better than calculation led me to expect. Speech has been possible not only to Paris but through Paris to Bruxelles, and even, with difficulty, through Paris to Marseilles, a distance of over 900 miles. The wires between Paris and Marseilles are massive copper wires specially erected for telephone business between those important places.

4. *Business Done.*—The charge for a conversation between London and Paris is 8s. for three minutes' complete use of the wire. The demand for the wire is very considerable. The average number of talks per day, exclusive of Sunday, is eighty-six. The maximum has been 108. We have had as many calls as nineteen per hour—the average is fifteen during the busy hours of the day. As an instance of what can be done, 150 words per minute have been dictated in Paris and transcribed in London by shorthand writing. Thus in three minutes 450 words were recorded, which at 8s. cost five words for a penny.

5. The difficulties met with in long distance speaking are several, and they may be divided into (a) those due to external disturbances and (b) those due to internal opposition.

6. The paper enters fully into the technical details by which these difficulties have been surmounted.

7. *Lightning.*—A metallic telephone circuit may have a static charge induced upon it by a thunder cloud. Such a charge is an electric strain which is released when the charged cloud flashes into the earth or into a neighbouring cloud. If there be electro-magnetic inertia present the charge will surge backward and forward through the circuit until it dies out. If there be no E.M.F. present it will cease suddenly, and neutrality will be attained at once. Telephone circuits indicate this operation by peculiar and characteristic sounds. An iron wire circuit produces a long swish or loud sigh, but a copper wire circuit like the Paris-London telephone emits a short, sharp report, like the crack of a pistol, which is sometimes startling, and has created fear, but there is no danger or liability to shock. Indeed, the start has more than once thrown the listener off his stool, and has led to the belief that he was knocked down by lightning.

8. The future of telephone working, especially in large cities, is one of underground wires, and the way to get over the difficulties of this kind of work is perfectly clear. We must have metallic circuits, twisted wires, low resistance, and low capacity. In Paris, a remarkable cable, made by Fortin-Herman, gives an exceedingly low capacity, viz. only $\cdot 069 \phi$ per mile. In the United States they are using a wire insulated with paper which gives $\cdot 08 \phi$ per mile. We are using in London Fowler-Waring cable giving a capacity of $1\cdot 8 \phi$ per mile, the capacity of gutta-covered wire being 3ϕ per mile.

2. On the Telephoning of Great Cities. By A. R. BENNETT, M.I.E.E.

The paper discusses how the extensive demand for Telephonic Exchange communication, which in the course of a few more years is certain to arise in all large cities—a demand of which no conception can be formed from the present condition of Telephone Exchanges in this country—can be met and satisfied. Given low rates and a fairly efficient service, the time will come, and that at no distant day, when every shopkeeper, and almost every householder, will look upon a Telephone Exchange connection as as much of a necessity as gas or water. Indications are not wanting even now of what may be expected when the inhabitants of large towns come to realise what an important business and social auxiliary a properly conducted Telephone Exchange is, for in Galashiels and some other

towns there is already a telephone for every 200 inhabitants, the principal supporters, after the manufacturers and merchants, being professional men, shopkeepers, and householders. If telephoned to the same extent as the town named, London, with its 5,600,000 inhabitants, would possess 28,000 subscribers, but owing to its greater wealth and extent it is not only possible, but almost certain, that eventually London will require a telephone for every 50 inhabitants, which with its present population would mean 112,000 subscribers. That number would only represent four times the proportion already existing in the small towns named. A successful telephonic scheme for London or any large town would require to comprise several essential conditions: firstly, privacy and efficient speaking must be secured; secondly, the connecting together of subscribers and their subsequent disconnection, and, if required, reconnection with others, must be rendered rapid and certain; thirdly, the rates must be within the reach of small shopkeepers and householders, and should not exceed 8*l.* per annum; fourthly, the system must be laid out so as to be capable of indefinite expansion without the necessity of periodical reconstruction; and lastly, the undertakers of the system must have equal rights with gas and water companies to lay in their conductors underground. All these requirements, excepting the fourth, have from time to time severally been met and conquered, but no existing Exchange system, so far, comprises them all, although technically and commercially it is perfectly practicable to combine them so as to attain as nearly to perfection as possible. The sanction of the Legislature to the laying of underground conductors constitutes the only doubtful quantity. The Post Office has demonstrated the feasibility of perfect privacy and effective speech in conjunction with a system of underground wires; and the Mutual Telephone Company, in their recently-constructed Exchange at Manchester, has shown that privacy, distinct speech, and rapid and certain switching are quite compatible with as low a rate of subscription as 5*l.* per annum. The only essential requirement that has not yet been demonstrated is the laying out of a system so as to permit of vast and easy expansion in every direction, and this, the paper shows, is a problem admitting of easy solution provided that the laying of wires is made independent of private caprice. The leading feature of a cheap, efficient, and easily extensible Exchange in a large town is the division, as far as feasible, of the area to be telephoned into sections not exceeding a square mile in extent, with some smaller ones in situations where, as in the City of London, very great commercial activity prevails. In the centre of each section will be situated a switch-room, to which the wires of the subscribers resident within that square mile will be led. As some subscribers will be resident quite near the switch-room and others at the maximum distance from it, it is assumed that with mile squares the average length of a subscriber's line will be about a quarter of a mile, and therefore cheap to construct. Each of these secondary switch-rooms will be connected, according to the geographical configuration of the town, to either one or two central switch-rooms by a sufficient number of junction wires. Such a multiplication of switch-rooms would be impracticable with the ordinary methods of switching, but a system exists which has been thoroughly proved in practice during the last nine years, and which is specially applicable where a very large number of subscribers has to be dealt with. By the aid of this system, which is known as the 'Mann,' or a modification of it devised by the author, with the switch-rooms distributed as described, the maximum time for establishing a connection between two subscribers situated at the extreme opposite limits of a telephone area as large as London would not exceed ten seconds. The Mann switching system only requires apparatus at the switch-rooms of extreme simplicity and compactness, and calls for only a minimum expenditure of labour on the part of the operators, while it interposes no obstacles in the shape of signalling electro-magnets at the intermediate switch-rooms to the freest possible passage of telephonic speech. The system is consequently better adapted than any other for communicating over long distances. Privacy and long-distance speaking would be secured by the universal adoption of metallic circuits. Such a system would afford the maximum possible telephonic efficiency, and would enable, supposing it were likewise fitted in other towns, London subscribers to talk from

their own offices direct to the offices of subscribers, not only in the most distant cities of Great Britain and Ireland, but in Paris and other Continental cities. It is asserted that such a system would lead to such a rapid increase in the number of subscribers that an annual subscription of 8*l.* would, even in the largest towns, be sufficient to yield a large profit on its cost, even if all the wires were placed underground.

3. *Recent Progress in the Use of Electric Motors.*

By Professor G. FORBES, F.R.S.

In the application of electric motors I have noticed three directions in which this country needs the testimony of independent and impartial people to assert the value of applications which in some other countries are generally adopted. These are:—(1) Electric railways. (2) Replacing shafting in shops by electric conductors and motors. (3) Transmitting power to a distance from waterfalls and rivers by electricity.

Electric Railways.—These are thoroughly established in America on the cheapest system, *i.e.* electricity supplied from a central station by overhead wires. The extensive adoption of electric tram lines in America, and the small number in England, is certainly due to the fact that they allow these overhead conductors, and we do not generally do so. The most trustworthy estimates seem to vary between 4-18 and 6-00 cents per car mile, including coal, attendance, land and buildings, machinery, line, oil, water, and waste. The question of repairs is serious and must be reduced. Most of the lines adopt spur gearing to reduce the speed from the electric motors to the car axles. They generally use two pinions and two spur wheels. This introduces great friction. It is very generally accepted that 8 horse-power is lost in gear friction, though this seems somewhat incredible, being about 30 per cent. These cars are large, and the motors are of 30 horse-power. This enormous power is absolutely demanded to enable them to start on a gradient with facility, and they do this. There is no crawling about these cars. You feel that there is plenty of power for the work. The noise in the cars used to be very considerable, and the injury to watches through magnetisation was at one time an objection. The noise from the gearing, especially when worn, has been deadened by enclosing the motor and gearing in cast-iron boxes. The magnetisation of watches is prevented by adopting a suitable type of motor. Another source of trouble in motors used to be the brushes, for sparking is liable to be very violent with the variable load of a tram motor, and the commutators wore away rapidly. Since carbon brushes have been introduced this difficulty has entirely disappeared.

The loss in double reducing gear and the wear and tear led to all the important companies turning to single reducing gear with rather heavier motors. It would at first appear impossible to go farther, and adopt armatures on the wheel axles without sacrificing the great advantage of gearing, which allows the motors to be independently supported without being subjected to the same shocks as the wheel axles. In spite of this, the Westinghouse Company have introduced a gearless motor, which has strength enough to stand the shocks. But other inventors had the idea of fixing the armature alone on the axle, and supporting the field magnet wholly on springs; to support it partially on springs is of little value. In this direction the most important and promising plan seems to be that adopted by Eickmeyer and Field. They support the whole motor in guides on springs, and connect the motor axle and the wheel axle by cranks and a coupling bar, the cranks on the right and left sides being at right angles to each other. This seems to reduce gearing friction to the minimum, while completely obviating shocks.

In America spur gearing is almost universal, but in Switzerland the Oerlikon Company are introducing worm gearing, which has been so much approved by Mr. Reckenzaun. Storage batteries have not generally been successful in America, but in some trials have worked very well.

Replacing Shafting by Electricity.—The benefit of replacing shafting by electric conductors and motors has been thoroughly appreciated in America. Everyone

knows of the hundreds of motors for small work which are supplied with electricity by central stations in Boston and New York, besides other places, and of the large number of electric lifts supplied by the Otis Company with electric motors designed by Eickmeyer. I will only place before English manufacturers two of the establishments where a statement of what has been done is enough to bring conviction to the mind of every shrewd and sensible employer of power. In the great works of William Sellers & Co. shafting has been abolished as far as possible. The second establishment is Baldwin's locomotive factory, whence from sixteen to twenty locomotives are sent off every week, and where space is so far valuable that there is no room for shunt lines, and where a 100-ton travelling crane picks up one out of the twenty, and puts it down where wanted. This fine travelling crane, and every other crane in this huge part of the works, are driven by electric motors.

Transmission of Power to a Distance from Waterfalls.—With regard to transmission of power to a distance from waterfalls, I have seen little to chronicle in America, and what there is seems rather antiquated; but in Switzerland important work has been done both by continuous and alternating currents. The high tension electrical work in connection with continuous currents that most impressed me was what has been done by Cuénod, Sautter, et Cie. Their six-pole machines with Gramme commutators up to 2,000 volts, designed by M. Thury, seem to work admirably and sparklessly, and I must here state my conviction, which I did not previously hold, that the insulation of such a machine can be made perfect, as there done, by supporting the dynamo or motor on a number of alternate slabs of vulcanised rubber and porcelain, and by connecting the shafts by Raffard couplings.

I will not take up time with describing different works of this kind, but I will now say something about the use of multiphase alternate, or rotary currents, about the prospective use of which so much has been published. I have seen the machines and transformers in course of construction at Oerlikon, and the insulators which have been used; the mechanical design is excellent. I can quite appreciate the difficulties of regulation of three currents referred to by M. Dobrowolski, but I think that there are further points upon which information is much wanted. I want to know, for hitherto I have utterly failed to see, the advantage of this three-phase synchronising alternator over the simple alternators which do such excellent work. I have been told that calculation shows that Mr. Brown's machine has 96 per cent. efficiency as a dynamo. Well, I reply that an ordinary alternator without iron, not having the hysteresis of Mr. Brown's machine, ought to have a higher efficiency. In the next place I am told by Mr. Brown that while you cannot switch one of these three-phase synchronising motors, with its load, on to an electric circuit, and expect it to get up to the synchronising speed, yet it will do so along with the electric generator of electricity, if the latter be also started from rest. In this it certainly has the advantage over the synchronising alternator with iron, but none whatever over those without iron, which will act in precisely the same way unless the motor happens to be stopped on dead centres, *i.e.* with the centres of coils (in a Mordey alternator, for example) half way between the poles of the field magnets. If this is the only gain over single-phase alternators with self-induction, and if there be no advantage gained over alternators without large self-induction, I fail to see the merit of the complication of three phases. I would not have drawn attention to the absence of advantage, but would have preferred to await the experiments before expressing an opinion, were it not for the great attention directed to the scheme by the Press, altogether out of proportion to the results which Mr. Brown and the Oerlikon managers hope to obtain. The great experiment about to be tried at Frankfort, which interests electricians all over the world, is not to prove that transformation is efficient, but to prove that 30,000 volts can be carried along 112 miles of overhead conductor.

M. Dobrowolski says that whatever load may be put on his motors, there is no serious difference in phase between the potential difference applied to the motor and the current, and there is no appreciable lag. If this be so, it would be a decided improvement; but I shall require strong proof before I accept the multiphase

motor as a great advance over the Tesla machine. The only advantage which it possesses over synchronising alternators without iron in the armatures and with large momentum, lies in its power to start with the load on. But I do not see that in large applications this advantage is to be compared with what it loses by its want of synchronism. M. Dobrowolski claims that these machines have the further advantage over the synchronisers that they will not stop when overloaded. After having tested Mr. Mordey's synchronising alternators, I have a strong conviction, almost amounting to a feeling of certainty, that it is impossible to put them out of step in ordinary conditions by merely increasing the load. The more you increase the load the more current goes through them to keep them in step. They would rather get red hot than get out of step. They behave just as a continuous current motor or Tesla motor, or a Dobrowolski motor, behaves under the same conditions; it gets hot, but it does not stop.

People seem to be greatly at a loss to explain why it is that some alternators work well as motors, while others do not. The explanation is simply that the former have a large momentum, and the latter have not. I announced this explanation of the difficulty at a meeting of electricians in Paris, last February, and found that M. Hospitalier had arrived at exactly the same conclusion, and quite independently. I feel confident in predicting that the Ferranti dynamo, if supplied with a heavy enough fly-wheel, will be found to work as well as the Mordey machine as a motor.

4. *On Electric Firedamp Indicators.* By N. WATTS.

5. *The Lighting of Railway Trains Electrically.* By I. A. TIMMIS.

The main conditions that are necessary are:—

(1) Every carriage must carry its own store of electricity (*i.e.* a battery).

This battery must be light, say less than 1 cwt.

No carriage must be detained at any time to change its battery.

(2) High voltage lamps must be used to give a brilliant light and economise the current used.

The system described in the paper can be, and is, used with—

(i.) A dynamo driven from an axle, or

(ii.) A dynamo and special engine on the locomotive;

(iii.) Central charging stations.

In the first and last cases it is necessary to have a large battery in the guard's van.

Whatever the main source of electricity may be, it supplies the current at a high voltage (say 50) to light a main system of lamps through the train.

But as any carriage may be detached at a station to be recoupled on to another train or break loose or be slipped from a train, it is absolutely necessary to have a storage or battery of accumulators in each carriage.

The cost and weight of batteries in each vehicle, with E.M.F. enough to light the main lamps (say 50 volts), makes them impossible. Further than this, it would be impracticable to charge them.

We therefore put another system of small lamps, 6 or 8 volts and 3 or 4 small cells, in each vehicle to light them.

These small batteries we charge from the main source of electricity on the train, and thus they are no trouble—small weight and small cost.

The working of these two systems, main and auxiliary, is under the control of the guard while the train is complete; but should any vehicle become detached from the main circuit the auxiliary lamps automatically light up.

If, also, anything happens to the main source of electricity, the auxiliary system can be put either under the control of the guard or be fitted to come into action automatically.

The placing of the main leads through each vehicle, and the couplers used, are fully described in the paper. We sometimes use four through leads and sometimes

only two. The circumstances of the case determine how many through leads are necessary, and also what the main source of electricity must be.

In every case, however (except in omnibus trains), we use the double system of main and auxiliary lamps with main and auxiliary supply of electricity.

TUESDAY, AUGUST 25.

The following Papers were read:—

1. *An Electrical Parcel Exchange System.* By A. R. BENNETT, M.I.E.E.

The congested state of the streets in many of the large towns, notably in the City of London, invites reflection as to whether it is not possible to devise means by which vehicular traffic may to a certain extent be diminished. To avoid absolute blocking of the thoroughfares, it is now necessary to forbid the collection or delivery of goods in certain localities during business hours, and trade certainly suffers under such restrictions, while warehouses have to be of larger capacity than would be needed were the free receipt and despatch of goods permissible. The author develops a scheme by which parcels and small packages may be freely interchanged between the various buildings of a town by means of miniature electric railways laid preferably, but not necessarily, underground, in pipes or culverts. Such pipes may be laid along the principal thoroughfares, communicating to the right and left by means of spurs or sidings with the premises of the subscribers to the system. In imitation of a telephone exchange, the pipes converge at one or more central stations, where operators having sole control of the traffic are on duty, and where are situated the dynamos and other apparatus. The scheme may be worked out in various ways, but the author proposes, by preference, a rectangular tube carrying two tracks or lines of rails, one above the other, the lower being used for the down, and the upper for the up, traffic. On the rails run trucks fitted with electro-motors, deriving propelling current from a parallel conductor laid between the two tracks, so that on the down journey trucks gather current by a collector pressing on the under, and on the up journey by one pressing against the upper, surface of the conductor. By dividing one of the rails of each track into insulated sections, the operators, by watching miniature semaphore signals placed in the central station, and worked by electro-magnets, are enabled to tell on which section a truck is, and to follow its progress out and home with the greatest exactitude. The sidings into the premises served are connected to the main line by switches resembling those of an ordinary railway, which are normally, by means of springs, kept in their position for through traffic, but which by the agency of electricity the operator at the Central Station can put over so as to connect with the sidings. The tracks enter the premises one above the other, but if there is room available, they then diverge and effect a junction, so that trucks can be shifted from the down to the up line without lifting them off the rails. On entering a siding a truck automatically signals the operator that it is clear of the main line, and on running into the premises it is brought up by means of catches and springs, which are depressed in one direction only, and which also serve to announce its arrival by ringing electric bells, and prevent its being returned by error or design into the tube on the wrong track. The connections of the motor are so arranged that a truck, even if placed on the wrong line, would not move backwards so as to cause a collision. The up track is blocked at the sending end, so that, although a truck may be placed on the up siding ready for despatch, it cannot obtain propelling current until the operator has a clear road for it. He then electrically removes the block, and gives the truck current by which it is brought into the Central. The operators have thus complete control over the movements of trucks. When a truck, or train of trucks, is intended by one subscriber for another, it is despatched in the first instance to the Central,

where, on reading the address, the operator forwards it to the siding of the consignee. Subscribers may telephone or otherwise communicate with the Central about despatch and receipt of trucks, but it is not necessary to do so, since trucks can be delivered into subscribers' sidings, and even unloaded automatically, and then withdrawn again without any attention on the subscriber's part, while trucks placed for despatch by subscribers can be brought into the Central at stated intervals if the operators make it a rule to tap all sidings occasionally for unannounced traffic. Goods could therefore be delivered during the night, and empty trucks sent into the various sidings for next day's traffic. If desired, collisions could be prevented between trucks in motion in the same direction by automatic blocks. In the event of a truck through any accident stopping in the tube, the semaphore connected with the section it is on will remain continuously at danger, and the operator will know that such a stoppage has taken place, together with its position, and take steps to remove it. For instance, he could send an empty truck forward, the speed of which can be reduced to a minimum as it approaches the disabled truck by modifying the propelling current until it strikes against the disabled vehicle, when, full current being turned on, both trucks can be forwarded to the consignee or shunted at the next convenient siding. Should trucks by mistake be delivered to the wrong siding, the subscriber would transfer them to the up track, and return them to the Central. The paper claims that such a system would prove of immense service if existing between the chief and branch post-offices of a city, between railway goods stations, parcel-receiving offices, and large business establishments, &c. The delivery of letters, telegrams, and parcels could be effected by the Post Office to subscribers without the aid of postmen, while matter for despatch by post and telegrams, together with the money to defray the charges thereon, could be forwarded by subscribers to the Post Office. For Post Office work the system would simply be a great development of the existing pneumatic tubes. Hotels and restaurants could telephone for and obtain in a few minutes viands they may be short of, and enable their customers to choose wine not only from the cellar of the establishment, but from those of every wine merchant on the system. It is not contended that such a system would pay if constructed specially for parcel work, although the surprising developments of the last decade scarcely permit of limits being assigned to the possible developments of the next; but the author assumes that the construction of subways beneath all the chief thoroughfares of large towns for the purpose of containing electric light and power leads, telephone wires, pipes for gas, fresh water, sea water, hydraulic power, compressed air, and other adjuncts of our complex civilisation, will shortly become an absolute necessity. A beginning in that direction has been made under the auspices of limited companies in some American cities, and we must sooner or later follow suit. Then when that time arrives an electrical parcel exchange could be carried out effectively and economically as part of the scheme. Our footpaths and carriage-ways will eventually be laid upon the lids of huge boxes, through which well-lighted pathways, affording crossings and short cuts for passengers at congested spots, may even be carried.

2. *The Bénier Hot-Air Engine.* By M. BÉNIER.

The question of hot-air or caloric engines has much interested the scientific and engineering world for many years. It has generally been admitted that the discovery of a really good hot-air engine would be of the greatest importance from economical and other considerations—amongst other advantages, boilers, with attending expense and danger, being entirely dispensed with.

Appended to this notice are illustrated drawings of the hot-air motor invented by Messrs. Bénier Frères. A considerable number of these engines are already in use in France and elsewhere on the Continent for industrial, electric-lighting, and other purposes. Several have been supplied to the French Government for use in lighthouses and fog-horn lightships. In the engine illustrated the air passes through the fire itself directly into the combustion-chamber. With this type of engine a much greater initial pressure can be obtained than in engines using a

separate combustion-chamber, or where the air is heated through an intervening metallic diaphragm. The drawing up of the grit and ashes is completely prevented in the present motor, this latter feature forming an important part of the invention.

As will be seen by the drawings, the engine is constructed on the beam principle, and the combustion-chamber is really a prolongation of the working cylinder.

The piston (or plunger) is of considerable length, the upper part only being made to fit the cylinder. The lower part of the piston is of slightly less diameter, consequently an annular space is formed between it and the cylinder. This space is connected with the main air-supply, which is controlled by a valve operated by

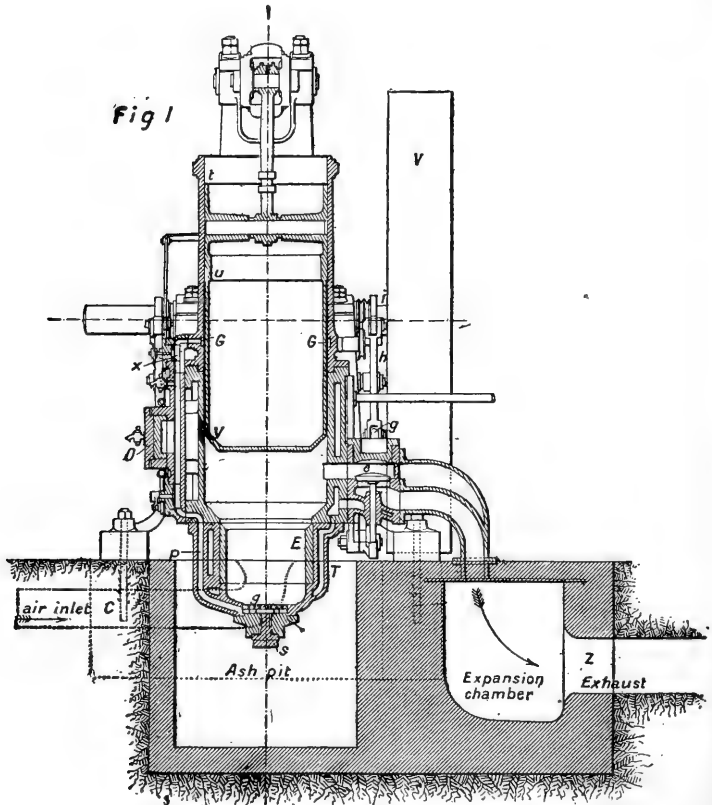

a connecting-rod and cam-lever worked from a cam on the crank-shaft of the engine. The air-pump is placed in the centre of the machine, immediately beneath the beam-standard, and is operated by a rod attached to the rocking-beam, and this is connected by a rod to the crank-shaft. Owing to the position of the beam, pump, and connecting-rods, the piston of the air-pump is at the outer end of its stroke when the working piston, on its return stroke, has reached a middle position. During the last half of the return stroke of the working piston the air-piston is pushed inwards, and compresses the charge of air previously drawn in until it has reached the middle of the stroke, at which moment the working piston is at the

end of its stroke. The air-valve, operated by the cam as already mentioned, has communicating passages with the air-pump, the furnace or combustion-chamber, and the annular air or packing space in the main cylinder. Consequently, the compressed air is forced partly through the fire and combustion-chamber, and partly into the annular air-space, the flow of air continuing during the time the air-piston performs the second half of the stroke. Meantime, the main piston receives its charge from the combustion-chamber, and cold compressed air passes into the annular space, and practically acts as a packing, effectually preventing grit and dust rising from the fire to the working faces of the cylinder. When the air-pump has finished its stroke, the air-valve is closed, and the air in the working cylinder is allowed to expand for the remainder of the stroke.

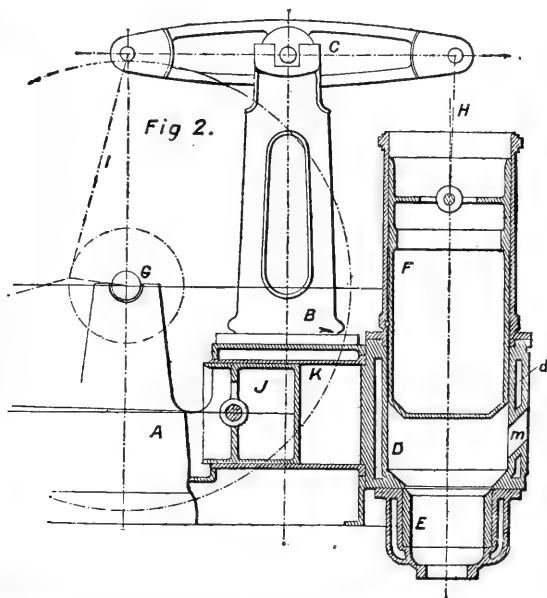

The cylinder is kept cool by means of a circulating-water jacket.

The bottom of the combustion-chamber is hinged, and the fuel is coke. As the combustion takes place under pressure, an air-valve, working automatically, is employed for feeding the fire.

The consumption of coke is about 3 lbs. (one kilogramme and a half) per brake horse power and per hour.

3. On the Internal and External Work of Evaporation.

By W. WORBY BEAUMONT, M.Inst.C.E.

Several of the most interesting problems in connection with the steam-engine turn upon the view that is taken of the mode of employment of the heat equivalent of the external work of evaporation.

When steam is generated under constant pressure external work is performed $=PV$, P being the pressure and V the volume generated. It may therefore, in accordance with the thermodynamic conceptions, be assumed that more heat is

used in the generation of steam under constant pressure than under constant volume, the extra quantity of heat being $U = \frac{PV}{J}$, J being Joule's equivalent, and U the heat units.

The author suggests the following explanation of the way in which the heat equivalent of the external work of evaporation is used. If heat flows out of steam when mechanical work is done by it during its formation, it must be supposed that steam is cooled by the outflow. If heat flows out and if cooling follows, the corresponding condensation or liquefaction takes place, and a further supply of heat is demanded to re-evaporate steam so liquefied; or, what is the same thing, the further supply of heat is used in continuously preventing the liquefaction from reaching more than the incipient stage. The action here sketched is readily conceived if for the purpose of explanation the evaporation and the external work be supposed to take place *per saltum*. Suppose a piston, immediately over the water in a simple evaporating vessel, to have been moved by the steam through a small distance A . Then heat corresponding to the work done in moving the piston through A will have flowed out of the steam, and this quantity of heat Q being gone, condensation $\frac{Q}{L}$ must have taken place in order that the temperature T and pressure P of the remaining steam may be unaffected (L being latent heat of evaporation). Now before the piston can be again moved through a further similar distance A^1 , that quantity Q must be restored by a further demand on the source of heat, and if Q^1 be the quantity of heat required to produce the volume of steam V , then the total quantity of heat Q^2 required to move the piston through distance A^1 will be $Q^2 = Q^1 + Q$, in order that volume V^1 may be produced and the condensed steam Q be re-evaporated.

Now if A be taken as less than any assignable distance or the process assumed continuous, then evaporation and incipient liquefaction may be supposed to be contemporaneous, and Q and Q^1 will be supplied contemporaneously.

In this way it appears to the author that an explanation can be found of the mode of conversion of heat into the external work of evaporation under constant pressure, or of conversion of heat into the work performed by a steam-engine during the admission part of the stroke, or, more correctly speaking, the work done by the steam on the piston during admission. If this be a true statement of the actual mode of employment of the heat converted into the mechanical work of a steam-engine during the admission part of the stroke, then it follows that liquefaction takes place during admission, which must be sufficient to represent the mechanical work done. This being so, the question arises, To what extent will this liquefaction result in water or suspended moisture in the cylinder of a steam-engine? The outflow of heat and corresponding liquefaction may be supposed to take place at the moving wall or piston, and in the hypothetical case supposed the liquefied steam may be assumed to be re-evaporated by the steam or water immediately below, which in its turn demands and receives more heat for its resuscitation from the source. In the case of the steam-engine cylinder, however, it is open to question whether the killed molecules in the cylinder or next the piston are resuscitated by the incoming steam, which follows up the movement of the piston. If they are not, then liquefaction will take place in the steam-engine cylinder during admission as a result of the performance of work, although the work is the external work of the evaporation which is performed in the boiler. The heat required for evaporation is that of Regnault's tables, but under the assumption here explained (when the liquefaction takes place in the cylinder and the resulting water does not return without loss of heat to the boiler), the heat required to raise the temperature of the quantity $\frac{U}{L}$ of feed water to the temperature of evaporation must be added, because in order that one pound of steam may be supplied to the cylinder as steam at cut off, the extra quantity $\frac{U}{L}$ of feed water must be supplied to the boiler. The quantity of water actually evaporated in the production of one pound

of steam in the steam-engine cylinder will thus be $1 \text{ lb.} + \frac{U}{L}$ when the evaporation takes place under constant pressure, although it is only 1 when evaporation takes place under constant volume. The heat required for evaporation under the author's assumption for the one pound of steam in the steam-engine will be $L + \frac{U}{L} - (T - t_0)$, T being temperature of evaporation and t_0 the temperature of the feed water. (In the elementary case $T = t_0$.) This, it must be noted, is the heat that will be required for each pound of steam accounted for by the indicator.

4. *On a new System of Screw Propulsion with non-reversible Engines.*¹

By W. WORBY BEAUMONT, *M.Inst.C.E.*

At the present time all screw propellers are driven by engines, which must be so designed that they may be fitted with all the paraphernalia necessary for reversing.

A considerable part of this reversing gear must be at work during the whole of the time the engines are running. Thus, although it may not be necessary to reverse the propeller or the direction of motion of a ship during a long run, the quickly moving parts of this gear must nevertheless be kept at work all the time. In order to avoid the practical objections to this, and the stresses which are brought to bear on the propeller and screw shaft by reversing the direction of their rotation, it is now proposed to effect the reversal of the direction of motion of the ship by means of the propeller, and the object of this paper is to bring before the Mechanical Science Section of the Association a description of the apparatus designed for this purpose by Mr. Robert McGlasson.

For several years the feathering screw propeller has been in use on a considerable number of vessels. By means of this, known as Bevis' propeller, the angle of the blades may be shifted by gear in the screw shaft tunnel, so that they may be placed fore and aft, and thus offer no impediment to the motion of the ship when it is desired to employ sails instead of engines.

By means of the same propeller the angle of the blades may be set so as to alter the pitch to that which may be found best for the ship, or to suit it for very low power when only slow steaming is wanted. As employed for these purposes this form of propeller has been long enough in use to show its practical sufficiency.

By an extension of the application of the principle of this propeller, it is now seen to be possible to achieve several ends which are considered to be of great importance. Some of these may be enumerated as follows:—

1. The propulsion of ships by means of screws, which rotate always in the same direction, and may be actuated by non-reversible engines and screw-shafts.

2. The simplification of marine engines, by dispensing with all the parts at present used for making the engines reversible.

3. The complete and quick reversal of the direction of propulsion of the ship, without any of that heavy stress which often amounts to strain and rupture of the screw-shaft, or couplings, or crank-shaft.

4. The facile adjustment of the pitch of the screw blades while the engines are running, so that the pitch may at all times be set to suit the form, trim, and condition of the ship, the requirements of navigation, or any sudden emergency requiring prompt action.

The extension of the application of the principle of the feathering screw consists in the employment of apparatus by means of which the pitch or angle of the blades is always under control, and may be changed from moment to moment with the same facility as is the rudder by means of steam or hydraulic steering gear.

Either form of the apparatus thus employed operates by moving in one or other direction a sliding collar on the tail shaft. This collar is connected to the rod of levers which gives angular motion to the screw blades.

¹ The discussion on this paper was given in *Engineering*, September 4, 1891, p. 269; and the paper with illustrations was published in *Industries* in September 1891; and in the *Marine Engineer*, October 1891.

Generally a hydraulic cylinder and piston will be employed for moving this collar, and the valve for admitting the water to either side of the piston will generally be operated in the engine-room, but may be operated from the bridge.

5. Action of Screw Propellers. By Major R. DE VILLAMIL, R.E.

Resultant action of a screw propeller is similar to a piston with an infinite stroke and velocity 'v.' The speed of screw is revolutions multiplied by effective pitch. Effective pitch = diameter $\sqrt{\text{pitch ratio}}$. Minimum circumferential velocity, which gives a thrust = $\sqrt{2gd}$. Most advantageous circumferential velocity = $\frac{\pi\sqrt{2gd}}{\sqrt{m}}$,

where m is pitch ratio. Centre portion of a screw is inert. Inert area = $\left(\frac{m}{\pi}\right)^2$.

Centre of screw acts as a drag or resistance—hence the 'Thrust deduction factor.' No screw will convert more than 70 per cent. of the power into longitudinal thrust. Thrust of screw depends on revolutions \times effective pitch. Methods of improving propellers:—

1. Adopting a form which feeds itself from the centre.

2. Forcing water to the centre by 'feeding blades' on leading side of propeller.

Desgoffe propeller satisfies the first requirement, and shows economy of 25 to 30 per cent. in fuel. Feeding blades will reduce or quite eliminate the 'Thrust deduction factor.'

The differences between theory now proposed and generally accepted theory were considered.

6. On the Comparative Values of Various Substances used as Non-conducting Coverings for Steam Boilers and Pipes. By W. HEPPORTH COLLINS, F.C.S., F.G.S., F.R.M.S.

The author has recently accurately determined the respective non-conducting values of several of the well-known substances and mixtures used as non-conducting material for covering steam boilers and pipes. These results are of much importance, more particularly as there does not appear to be any accessible record of an investigation in this country of a recent or reliable character.

TABLE I.

Substance 1 inch thick (in mass); heat applied, 310° F.	Pounds of water heated 10° F. per hour through 1 sq. ft.	Solid matter in 1 sq. ft. 1 inch thick, parts 1,000.	Air included, parts 1,000
1. Hair felt	11.4	189	957
2. Cotton felt	10.6	75	930
3. Jute felt	13.2	162	921
4. Linen felt	11.7	64	753
5. Loose cotton felt	9.3	17	990
6. Carded cotton	8.1	16	987
7. Rabbit-hair 'wool'	7.1	43	912
8. Poultry feathers	6.2	44	976
9. Cork powder	13.6	66	931
10. Sawdust powder	14.2	141	793
11. Asbestos powder	47.9	67	961
12. Fossil meal	52.1	78	910
13. Plaster of Paris	36.2	371	598
14. Calcined magnesia	14.7	24	979
15. Compressed calcined magnesia	53.4	291	711
16. Fine sand	66.3	533	473

Professor Ordway's (Massachusetts Inst. Technology) method—with modifications by the author of this paper—was applied to obtain the foregoing results. A mass of each non-conducting material, one inch thick, was used for each experiment. This mass was carefully prepared and placed on a perfectly true, flat, iron plate or tray, which was then carefully maintained at a constant temp. of 310° F. The heat transmitted through each non-conducting mass was calculated in pounds of water heated 10° F. per hour. Table II. gives the results of practically treating the several non-conducting mixtures on a 5-inch steam pipe, which was subject to much vibration.

TABLE II.

Prepared mixtures for covering steam pipes, &c.	Pounds of water heated 10° F. per hour, by 1 sq. ft.
1. Clay, dung, and vegetable fibre paste	39·6
2. Fossil meal and hair paste	10·4
3. Fossil meal and asbestos powder	26·3
4. Paper pulp, clay and vegetable fibre	40·6
5. Paper pulp, alone	14·7
6. Slag-wool, hair, and clay paste	10·0
7. Asbestos fibre, wrapped tightly	17·9
8. Coal ashes and clay paste wrapped with straw	29·9

7. *A joint Discussion with Section A. upon Units and their Nomenclature took place. See p. 577.*

SECTION H.—ANTHROPOLOGY.

PRESIDENT OF THE SECTION—Professor F. MAX MÜLLER, M.A., Foreign Member of the French Institute.

THURSDAY, AUGUST 20.

The PRESIDENT delivered the following Address:—

It was forty-four years ago that for the first and for the last time I was able to take an active part in the meetings of the British Association for the Advancement of Science. It was at Oxford, in 1847, when I read a paper on the 'Relation of Bengali to the Aryan and Aboriginal Languages of India,' which received the honour of being published in full in the 'Transactions' of the Association for that year. I have often regretted that absence from England and pressure of work have prevented me year after year from participating in the meetings of the Association. But, being a citizen of two countries—of Germany by birth, of England by adoption—my long vacations have generally drawn me away to the Continent, so that to my great regret I found myself precluded from sharing either in your labours or in your delightful social gatherings,

I wonder whether any of those who were present at that brilliant meeting at Oxford in 1847 are present here to-day. I almost doubt it. Our President then was Sir Robert Inglis, who will always be known in the annals of English history as having been preferred to Sir Robert Peel as Member of Parliament for the University of Oxford. Among other celebrities of the day I remember Sir Roderick Murchison, Sir David Brewster, Dean Buckland, Sir Charles Lyell, Professor Sedgwick, Professor Owen, and many more—a galaxy of stars, all set or setting. Young Mr. Ruskin acted as Secretary to the Geological Section. Our Section was then not even recognised as yet as a Section. We ranked as a sub-Section only of Section D, *Zoology* and *Botany*. We remained in that subordinate position till 1851, when we became Section E, under the name of *Geography* and *Ethnology*. From 1869, however, Ethnology seems almost to have disappeared again, being absorbed in Geography, and it was not till the year 1884 that we emerged once more as what we are to-day, Section H, or *Anthropology*.

In the year 1847 our sub-Section was presided over by Professor Wilson, the famous Sanskrit scholar. The most active debaters, so far as I remember, were Dr. Prichard, Dr. Latham, and Mr. Crawford, well known then under the name of the Objector-General. I was invited to join the meeting by Bunsen, then Prussian Minister in London, who also brought with him his friend, Dr. Karl Meyer, the Celtic scholar. Prince Albert was present at our debates, so was Prince Louis Lucien Bonaparte. Our Ethnological sub-Section was then most popular, and attracted very large audiences.

When looking once more through the debates carried on in our Section in 1847 I was very much surprised when I saw how very like the questions which occupy us to-day are to those which we discussed in 1847. I do not mean to say that there has been no advance in our science. Far from it. The advance of linguistic, ethnological, anthropological, and biological studies, all of which claim a hearing in our

Section, has been most rapid. Still that advance has been steady and sustained ; there has been no cataclysm, no deluge, no break in the advancement of our science, and nothing seems to me to prove its healthy growth more clearly than this uninterrupted continuity which unites the past with the present, and will, I hope, unite the present with the future.

No paper is in that respect more interesting to read than the address which Bunsen prepared for the meeting in 1847, and which you will find in the 'Transactions' of that year. Its title is 'On the Results of the recent Egyptian Researches in reference to Asiatic and African Ethnology, and the Classification of Languages.' But you will find in it a great deal more than what this title would lead you to expect.

There are passages in it which are truly prophetic, and which show that, if prophecy is possible anywhere, it is possible, nay, it ought to be possible, in the temple of science, and under the inspiring influence of knowledge and love of truth.

Allow me to dwell for a little while on this remarkable paper. It is true, we have travelled so fast that Bunsen seems almost to belong to ancient history. This very year is the hundredth anniversary of his birth, and this very day the centenary of his birth is being celebrated in several towns of Germany. In England also his memory should not be forgotten. No one, not being an Englishman by birth, could, I believe, have loved this country more warmly, and could have worked more heartily, than Bunsen did to bring about that friendship between England and Germany which must for ever remain the corner-stone of the peace of Europe, and, as the Emperor of Germany declared the other day in his speech at the Mansion House, the *sine qua non* of that advancement of science to which our Association is devoted. Bunsen's house in Carlton Terrace was a true international academy, open to all who had something to say, something worth listening to, a kind of sanctuary against vulgarity in high places, a neutral ground where the best representatives of all countries were welcome and felt at home. But this also belongs to ancient history. And yet, when we read Bunsen's paper, delivered in 1847, it does not read like ancient history. It deals with the problems which are still in the foreground, and if it could be delivered again to-day by that genial representative of German learning, it would rouse the same interest, provoke the same applause, and possibly the same opposition also, which it roused nearly half a century ago. Let me give you a few instances of what I mean.

We must remember that Darwin's 'Origin of Species' was published in 1859, his 'Descent of Man' in 1871. But here in the year 1847 one of the burning questions which Bunsen discusses is the question of the possible descent of man from some unknown animal. He traces the history of that question back to Frederick the Great, and quotes his memorable answer to D'Alembert. Frederick the Great, you know, was not disturbed by any qualms of orthodoxy. 'In my kingdom,' he used to say, 'everybody may save his soul according to his own fashion.' But when D'Alembert wished him to make what he called the *salto mortale* from monkey to man, Frederick the Great protested. He saw what many have seen since, that there is no possible transition from reasonlessness to reason, and that with all the likeness of their bodily organs there is a barrier which no animal can clear, or which, at all events, no animal has as yet cleared. And what does Bunsen himself consider the real barrier between man and beast? 'It is language,' he says, 'which is unattainable, or at least unattained, by any animal except man.' In answer to the argument that, given only a sufficient number of years, a transition by imperceptible degrees from animal cries to articulate language is at least conceivable, he says: 'Those who hold that opinion have never been able to show the possibility of the first step. They attempt to veil their inability by the easy but fruitless assumption of an infinite space of time, destined to explain the gradual development of animals into men; as if millions of years could supply the want of the agent necessary for the first movement, for the first step, in the line of progress! No numbers can effect a logical impossibility. How, indeed, could reason spring out of a state which is destitute of reason? How can speech, the expression of thought, develop itself, in a year, or in millions of years, out of inarticulate sounds, which express feelings of pleasure, pain, and appetite?'

He then appeals to Wilhelm von Humboldt, whom he truly calls the greatest and most acute anatomist of almost all human speech. Humboldt goes so far as to say, 'Rather than assign to all language a uniform and mechanical march that would lead them step by step from the grossest beginnings to their highest perfection, I should embrace the opinion of those who ascribe the origin of language to an immediate revelation of the Deity. They recognise at least that divine spark which shines through all idioms, even the most imperfect and the least cultivated.'

Bunsen then sums up by saying: 'To reproduce Monboddo's theory in our days, after Kant and his followers, is a sorry anachronism, and I therefore regret that so low a view should have been taken of the subject lately in an English work of much correct and comprehensive reflection and research respecting natural science.' This remark refers, of course, to the 'Vestiges of Creation,'¹ which was then producing the same commotion that Darwin's 'Origin of Species' produced in 1859.

Bunsen was by no means unaware that in the vocal expression of feelings, whether of joy or pain, and in the imitation of external sounds, animals are on a level with man. 'I believe with Kant,' he says, 'that the formation of ideas or notions, embodied in words, presupposes the action of the senses and impressions made by outward objects on the mind.' 'But,' he adds, 'what enables us to see the genus in the individual, the whole in the many, and to form a word by connecting a subject with a predicate, is the power of the mind, and of this the brute creation exhibits no trace.'

You know how for a time, and chiefly owing to Darwin's predominating influence, every conceivable effort was made to reduce the distance which language places between man and beast, and to treat language as a vanishing line in the mental evolution of animal and man. It required some courage at times to stand up against the authority of Darwin, but at present all serious thinkers agree, I believe, with Bunsen, that no animal has developed what we mean by rational language, as distinct from mere utterances of pleasure or pain, from imitation of sounds and from communication by means of various signs, a subject that has lately been treated with great fulness by my learned friend Professor Romanes in his 'Mental Evolution of Man.' Still, if all true science is based on facts, the fact remains that no animal has ever formed what we mean by a language. There must be a reason for that, and that reason is reason in its true sense, as the power of forming general concepts, of naming and judging. We are fully justified, therefore, in holding with Bunsen and Humboldt, as against Darwin and Professor Romanes, that there is a specific difference between the human animal and all other animals, and that that difference consists in language as the outward manifestation of what the Greeks meant by Logos.

Another question which occupies the attention of our leading anthropologists is the proper use to be made of the languages, customs, laws, and religious ideas of so-called savages. Some, as you know, look upon these modern savages as representing human nature in its most primitive state, while others treat them as representing the lowest degeneracy into which human nature may sink. Here, too, we have learnt to distinguish. We know that certain races have had a very slow development, and may, therefore, have preserved some traces of those simple institutions which are supposed to be characteristic of primitive life. But we also know that other races have degenerated and are degenerating even now. If we hold that the human race forms but one species, we cannot, of course, admit that the ancestors even of the most savage tribes, say of the Australians, came into the world one day later than the ancestors of the Greeks, or that they passed through fewer evolutions than their more favoured brethren. The whole of humanity would be of exactly the same age. But we know its history from a time only when it had probably passed already through many ups and downs. To suppose, therefore, that the modern savage is the nearest approach to primitive man would be against all the rules of reasoning. Because in some countries, and under stress of unfavourable influences, some human tribes have learnt to feed on human flesh, it does not

¹ See an article in the *Edinburgh Review*, July 1845.

follow that our first ancestors were cannibals. And here, too, Bunsen's words have become so strikingly true that I may be allowed to quote them: 'The savage is justly disclaimed as the prototype of natural, original man; for linguistic inquiry shows that the languages of savages are degraded and decaying fragments of nobler formations.'

I know well that in unreservedly adopting Bunsen's opinion on this point also I run counter to the teaching of such well-known writers as Sir John Lubbock, Reclus, and others. It might be supposed that Mr. Herbert Spencer also looked upon savages as representing the primitive state of mankind. - But if he ever did so, he certainly does so no longer, and there is nothing I admire so much in Mr. Herbert Spencer as this simple love of truth, which makes him confess openly whenever he has seen occasion to change his views. 'What terms and what conceptions are truly primitive,' he writes, 'would be easy if we had an account of truly primitive men. But there are sundry reasons for suspecting that existing men of the lowest type forming social groups of the simplest kind do not exemplify men as they originally were. Probably most of them, if not all, had ancestors in a higher state.'¹

Most important also is a hint which Bunsen gives that the students of language should follow the same method that has been followed with so much success in Geology; that they should begin by studying the modern strata of speech, and then apply the principles, discovered there, to the lower or less accessible strata. It is true that the same suggestion had been made by Leibniz, but many suggestions are made and are forgotten again, and the merit of rediscovering an old truth is often as great as the discovery of a new truth. This is what Bunsen said: 'In order to arrive at the law which we are endeavouring to find (the law of the development of language) let us first assume, as Geology does, that the same principles which we see working in the (recent) development were also at work at the very beginning, modified in degree and in form, but essentially the same in kind.' We know how fruitful this suggestion has proved, and how much light an accurate study of modern languages and of spoken dialects has thrown on some of the darkest problems of the science of language. But fifty years ago it was Sanskrit only, or Hebrew, or Chinese, that seemed to deserve the attention of the students of Comparative Philology. Still more important is Bunsen's next remark, that language begins with the sentence, and that in the beginning each word was a sentence in itself. This view also has found strong supporters at a later time, for instance, my friend Professor Sayce, though at the time we are speaking of it was hardly thought of. I must here once more quote Bunsen's own words: 'The supreme law of progress in all language shows itself to be the progress from the substantial isolated word, as an undeveloped expression of a whole sentence, towards such a construction of language as makes every single word subservient to the general idea of a sentence, and shapes, modifies, and dissolves it accordingly.'

And again: 'Every sound in language must originally have been significative of something. The unity of sound (the syllable, pure or consonantised) must therefore originally have corresponded to a unity of conscious plastic thought, and every thought must have had a real or substantial object of perception. . . . Every single word implies necessarily a complete proposition, consisting of subject, predicate, and copula.'

This is a most pregnant remark. It shows as clearly as daylight the enormous difference there is between the mere utterance of the sound *Pah* and *Mah*, as a cry of pleasure or distress, and the pronunciation of the same syllable as a sentence, when *Pah* and *Mah* are meant for 'This is *Pah*,' 'This is *Mah*'; or, after a still more characteristic advance of the human intellect, 'This is a *Pah*,' 'This is a *Mah*,' which is not very far from saying, 'This man belongs to the class or genus of fathers.'

Equally important is Bunsen's categorical statement that everything in language must have been originally significant, that everything formal must originally have been substantial. You know what a bone of contention this has been of late between what is called the old school and the new school of Comparative Philology.

¹ *Open Court*, No. 205, p. 2896.

The old school maintained that every word consisted of a root and of certain derivative suffixes, prefixes, and infixes. The modern school maintained that there existed neither roots by themselves nor suffixes, prefixes, and infixes by themselves, and that the theory of agglutination—of gluing suffixes to roots—was absurd. The old school looked upon these suffixes as originally independent and significant words; the modern school declined to accept this view except in a few irrefragable instances. I think the more accurate reasoners are coming back to the opinion held by the old school, that all formal elements of language were originally substantial, and therefore significative; that they are the remnants of predicative or demonstrative words. It is true we cannot always prove this as clearly as in the case of such words as *hard-ship*, *wis-dom*, *man-hood*, where *hood* can be traced back to *hād*, which in Anglo-Saxon exists as an independent word, meaning state or quality. Nor do we often find that a suffix like *mente*, in *claramente*, *clairement*, continues to exist by itself, as when we say in Spanish *clara*, *concesa y elegantemente*. It is perfectly true that the French, when they say that a hammer falls *lourdement*, or heavily, do not deliberately take the suffix *ment*—originally the Latin *mente*, 'with a mind'—and glue it to their adjective *lourd*. Here the new school has done good service in showing the working of that instinct of analogy which is a most important element in the historical development of human speech. One compound was formed in which *mente* retained its own meaning; for instance, *forti mente*, 'with a brave mind.' But when this had come to mean *bravely*, and no more, the working of analogy began; and if *fortement*, from *fort*, could mean 'bravely,' then why not *lourdement*, from *lourd*, 'heavily'? But in the end there is no escape from Bunsen's fundamental principle that everything in language was originally language—that is, was significative, was substantial, was material—before it became purely formal.

But it is not only with regard to these general problems that Bunsen has anticipated the verdict of our own time. Some of his answers to more special questions also show that he was right when many of his contemporaries, and even successors, were wrong. It has long been a question, for instance, whether the Armenian language belonged to the Iranian branch of the Aryan family, or whether it formed an independent branch, like Sanskrit, Persian, or Greek. Bunsen, in 1847, treated Armenian as a separate branch of Aryan speech; and that it is so was proved by Professor Hübschmann in 1883.

Again, there has been a long controversy whether the language of the Afghans belonged to the Indic or the Iranian branch. Dr. Trumpp tried to show that it belonged, by certain peculiarities, to the Indic or Sanskritic branch. Professor Darmesteter has proved but lately that it shares its most essential characteristics in common with Persian. Here, too, Bunsen guessed rightly—for I do not mean to say that it was more than a guess—when he stated that 'Pushtu, the language of the Afghans, belongs to the Persian branch.'

I hope you will forgive me for having detained you so long with a mere retrospect. I could not deny myself the satisfaction of paying this tribute of gratitude and respect to my departed friend, Baron Bunsen. To have known him belongs to the most cherished recollections of my life. But though I am myself an old man—much older than Bunsen was at our meeting in 1847—do not suppose that I came here as a mere *laudator temporis acti*. Certainly not. If one tries to recall what Anthropology was in 1847, and then considers what it is now, its progress seems most marvellous. I do not think so much of the new materials which have been collected from all parts of the world. These last fifty years have been an age of discovery in Africa, in Central Asia, in America, in Polynesia, and in Australia, such as can hardly be matched in any previous century.

But what seems to me even more important than the mere increase of material is the new spirit in which Anthropology has been studied during the last generation. I do not mean to depreciate the labours of so-called *dilettanti*. After all, *dilettanti* are lovers of knowledge, and in a study such as the study of Anthropology the labours of these volunteers, or *francs-tireurs*, have often proved most valuable. But the study of man in every part of the world has ceased to be a subject for curiosity only. It has been raised to the dignity, but also to the responsibility, of

a real science, and it is now guided by principles as strict and as rigorous as any other science—such as Zoology, Botany, Mineralogy, and all the rest. Many theories which were very popular fifty years ago are now completely exploded; nay, some of the very principles by which our science was then guided have been discarded. Let me give you one instance—perhaps the most important one—as determining the right direction of anthropological studies.

At our meeting in 1847 it was taken for granted that the study of Comparative Philology would be in future the only safe foundation for the study of Anthropology. Linguistic Ethnology was a very favourite term used by Bunsen, Prichard, Latham, and others. It was, in fact, the chief purpose of Bunsen's paper to show that the whole of mankind could be classified according to language. I protested against this view at the time, and in 1853 I published my formal protest in a letter to Bunsen, 'On the Turanian Languages.' In a chapter called 'Ethnology versus Phonology' I called, if not for a complete divorce, at least for a judicial separation between the study of Philology and the study of Ethnology. 'Ethnological race,' I said, 'and phonological race are not commensurate, except in antehistorical times, or, perhaps, at the very dawn of history. With the migration of tribes, their wars, their colonies, their conquests and alliances, which, if we may judge from their effects, must have been much more violent in the ethnic than ever in the political periods of history, it is impossible to imagine that race and language should continue to run parallel. The physiologist should pursue his own science, unconcerned about language. Let him see how far the skulls, or the hair, or the colour, or the skin of different tribes admit of classification; but to the sound of their words his ear should be as deaf as that of the ornithologist's to the notes of caged birds. If his Caucasian class includes nations or individuals speaking Aryan (Greek), Turanian (Turkish), and Semitic (Hebrew) languages, it is not his fault. His system must not be altered to suit another system. There is a better solution both for his difficulties and for those of the phonologist than mutual compromise. The phonologist should collect his evidence, arrange his classes, divide and combine as if no Blumenbach had ever looked at skulls, as if no Camper had ever measured facial angles, as if no Owen had ever examined the basis of a cranium. His evidence is the evidence of language, and nothing else; this he must follow, even though in the teeth of history, physical or political. . . . There ought to be no compromise between ethnological and phonological science. It is only by stating the glaring contradictions between the two that truth can be elicited.'

At first my protest met with no response; nay, curiously enough, I have often been supposed to be the strongest advocate of the theory which I so fiercely attacked. Perhaps I was not entirely without blame, for, having once delivered my soul, I allowed myself occasionally the freedom to speak of the Aryan or the Semitic race, meaning thereby no more than the people, whoever and whatever they were, who spoke Aryan or Semitic languages. I wish we could distinguish in English as in Hebrew between *nations* and *languages*. Thus in the Book of Daniel, iii. 4, 'the herald cried aloud, . . . O people, nations and languages.' Why then should we not distinguish between nations and languages? But to put an end to every possible misunderstanding, I declared at last that to speak of 'an Aryan skull would be as great a monstrosity as to speak of a dolichocephalic language.'

I do not mean to say that this old heresy, which went by the name of linguistic ethnology, is at present entirely extinct. But among all serious students, whether physiologists or philologists, it is by this time recognised that the divorce between Ethnology and Philology, granted if only for incompatibility of temper, has been productive of nothing but good.

Instead of attempting to classify mankind as a whole, students are now engaged in classing skulls, in classing hair, and teeth, and skin. Many solid results have been secured by these special researches; but, as yet, no two classifications, based on these characteristics, have been made to run parallel.

The most natural classification is, no doubt, that according to the colour of the skin. This gives us a black, a brown, a yellow, a red, and a white race, with several subdivisions. This classification has often been despised as unscientific; but it may still turn out far more valuable than is at present supposed.

The next classification is that by the colour of the eyes, as black, brown, hazel, grey, and blue. This subject also has attracted much attention of late, and, within certain limits, the results have proved very valuable.

The most favourite classification, however, has always been that according to the skulls. The skull, as the shell of the brain, has by many students been supposed to betray something of the spiritual essence of man; and who can doubt that the general features of the skull, if taken in large averages, do correspond to the general features of human character? We have only to look round to see men with heads like a cannon-ball and others with heads like a hawk. This distinction has formed the foundation for a more scientific classification into *brachycephalic*, *dolichocephalic*, and *mesocephalic* skulls. The proportion of 80 : 100 between the transverse and longitudinal diameters gives us the ordinary or mesocephalic type, the proportion of 75 : 100 the dolichocephalic, the proportion of 85 : 100 the brachycephalic type. The extremes are 70 : 100 and 90 : 100.

If we examine any large collection of skulls, we have not much difficulty in arranging them under these three classes; but if, after we have done this, we look at the nationality of each skull, we find the most hopeless confusion. Pruner Bey, as Peschel tells us in his 'Völkerrunde,' has observed brachycephalic and dolichocephalic skulls in children born of the same mother; and if we consider how many women have been carried away into captivity by Mongolians in their inroads into China, India, and Germany, we cannot feel surprised if we find some longheads among the roundheads of those Central Asiatic hordes.

Only we must not adopt the easy expedient of certain anthropologists who, when they find dolichocephalic and brachycephalic skulls in the same tomb, at once jump to the conclusion that they must have belonged to two different races. When, for instance, two dolichocephalic and three brachycephalic skulls were discovered in the same tomb at Alexanderpol, we were told at once that this proved nothing as to the simultaneous occurrence of different skulls in the same family; nay, that it proved the very contrary of what it might seem to prove. It was clear, we were assured, that the two dolichocephalic skulls belonged to Aryan chiefs and the three brachycephalic skulls to their non-Aryan slaves, who were killed and buried with their masters, according to a custom well known to Herodotus. This sounds very learned, but is it really quite straightforward?

Besides the general division of skulls into dolichocephalic, brachycephalic, and mesocephalic, other divisions have been undertaken, according to the height of the skull, and, again, according to the maxillary and the facial angles. This latter division gives us *orthognathic*, *prognathic*, and *mesognathic* skulls.

Lastly, according to the peculiar character of the hair, we may distinguish two great divisions, the people with woolly hair (*Ulotriches*) and people with smooth hair (*Lissotriches*). The former are subdivided into *Lophocomi*, people with tufts of hair, and *Eriocomi*, or people with fleecy hair. The latter are divided into *Euthycomi*, straight-haired, and *Euplocami*,¹ wavy-haired. It has been shown that these peculiarities of the hair depend on the peculiar form of the hair-tubes, which, in cross-sections, are found to be either round or elongated in different ways.

Now all these classifications, to which several more might be added, those according to the orbits of the eyes, the outlines of the nose, the width of the pelvis, are by themselves extremely useful. But few of them only, if any, run strictly parallel. It has been said that all dolichocephalic races are prognathic, and have woolly hair. I doubt whether this is true without exception; but, even if it were, it would not allow us to draw any genealogical conclusions from it, because there are certainly many dolichocephalic people who are not woolly-haired, as, for instance, the Eskimos.²

Now let us consider whether there can be any organic connection between the shape of the skull, the facial angle, the conformation of the hair, or the colour of the skin on one side, and what we call the great families of language on the other.

¹ Not *Euplo-comi*, wavy-haired, as Prizton gives it.

² Brinton, *Races of People*, p. 249.

That we speak at all may rightly be called a work of nature, *opera naturale*, as Dante said long ago; but that we speak thus or thus, *cosi o cosi*, that, as the same Dante said, depends on our pleasure—that is, our work. To imagine, therefore, that as a matter of necessity, or as a matter of fact, dolichocephalic skulls have anything to do with Aryan, mesocephalic with Semitic, or brachycephalic with Turanian speech, is nothing but the wildest random thought; it can convey no rational meaning whatever. We might as well say that all painters are dolichocephalic, and all musicians brachycephalic, or that all lophocomic tribes work in gold, and all lissocomic tribes in silver.

If anything must be ascribed to prehistoric times, surely the differentiation of the human skull, the human hair, and the human skin, would have to be ascribed to that distant period. No one, I believe, has ever maintained that a mesocephalic skull was split or differentiated into a dolichocephalic and a brachycephalic variety in the bright sunshine of history.

But let us, for the sake of argument, assume that in prehistoric times all dolichocephalic people spoke Aryan, all mesocephalic, Semitic, all brachycephalic, Turanian languages; how would that help us?

So long as we know anything of the ancient Aryan, Semitic, and Turanian languages, we find foreign words in each of them. This proves a very close and historical contact between them. For instance, in Babylonian texts of 3000 B.C. there is the word *sindhu* for cloth made of vegetable fibres, linen. That can only be the Sk. *sindhu*, the Indus, or *saindhava*, what comes from the Indus. It would be the same word as the Homeric *σινδών*, fine cloth.¹ In Egyptian we find so many Semitic words that it is difficult to say whether they were borrowed or derived from a common source. I confess I am not convinced, but Egyptologists of high authority assure us that the names of several Aryan peoples, such as the Sicilians and Sardinians, occur in the fourteenth century B.C., in the inscriptions of the time of Menephtah I. Again, as soon as we know anything of the Turanian languages—Finnish, for instance—we find them full of Aryan words. All this, it may be said, applies to a very recent period in the ancient history of humanity. Still, we have no access to earlier documents, and we may fairly say that this close contact which existed then existed, probably, at an earlier time also.

If, then, we have no reason to doubt that the ancestors of the people speaking Aryan, Semitic, and Turanian languages lived in close proximity, would there not have been marriages between them, so long as they lived in peace, and would they not have killed the men and carried off the women in time of war? What, then, would have been the effect of a marriage between a dolichocephalic mother and a brachycephalic father? The materials for studying this question of *métissage*, as the French call it, are too scanty as yet to enable us to speak with confidence. But whether the paternal or the maternal type prevailed, or whether their union gave rise to a new permanent variety, still it stands to reason that the children of a dolichocephalic captive woman might be found, after fifty or sixty years, speaking the language of the brachycephalic conquerors.

It has been the custom to speak of the early Aryan, Semitic, and Turanian races as large swarms—as millions pouring from one country into another. It has been calculated that these early nomads would have required immense tracts of meadow land to keep their flocks, and that it was the search of new pastures that drove them, by an irresistible force, over the whole inhabitable earth.

This may have been so, but it may also have not been so. Anyhow, we have a right to suppose that, before there were millions of human beings, there were at first a few only. We have been told of late that there never was a first man; but we may be allowed to suppose, at all events, that there were at one time a few first men and a few first women. If, then, the mixture of blood by marriage and the mixture of language in peace or war took place at that early time, when the world was peopled by some individuals, or by some hundreds, or by some thousands only, think only what the necessary result would have been. It has been calculated that it would require only 600 years to populate the whole earth with the

¹ *Physical Religion*, p. 87.

descendants of one couple, the first father being dolichocephalic and the first mother brachycephalic. They might, after a time, all choose to speak an Aryan language, but they could not choose their skulls, but would have to accept them from nature, whether dolichocephalic or brachycephalic.

Who, then, would dare at present to lift up a skull and say this skull must have spoken an Aryan language, or lift up a language and say this language must have been spoken by a dolichocephalic skull? Yet, though no serious student would any longer listen to such arguments, it takes a long time before theories that were maintained for a time by serious students, and were then surrendered by them, can be completely eradicated. I shall not touch to-day on the hackneyed question of the 'Home of the Aryas' except as a warning. There are two quite distinct questions concerning the home of the Aryas.

When students of Philology speak of Aryas, they mean by *Âryas* nothing but people speaking an Aryan language. They affirm nothing about skulls, skins, hair, and all the rest. Arya with them means speakers of an Aryan language. When, on the contrary, students of Physiology speak of dolichocephalic, orthognathic, eothycomic people, they speak of their physiological characteristics only, and affirm nothing whatever about language.

It is clear, therefore, that the home of the *Âryas*, in the proper sense of that word, can be determined by linguistic evidence only, while the home of a blue-eyed, blond-haired, long-skulled, fair-skinned people can be determined by physiological evidence only. Any kind of concession or compromise on either side is simply fatal, and has led to nothing but a promiscuous slaughter of innocents. Separate the two armies, and the whole physiological evidence collected by D'Omalius d'Halloy, Latham, and their followers will not fill more than an octavo page; while the linguistic evidence collected by Benfey and his followers will not amount to more than a few words. Everything else is mere rhetoric.

The physiologist is grateful, no doubt, for any additional skull whose historical antecedents can be firmly established; the philologist is grateful for any additional word that can help to indicate the historical or geographical whereabouts of the unknown speakers of Aryan speech. On these points it is possible to argue. They alone have a really scientific value in the eyes of a scholar, because, if there is any difference of opinion on them, it is possible to come to an agreement. As soon, however, as we go beyond these mere matters of fact, which have been collected by real students, everything becomes at once mere vanity and vexation of spirit. I know the appeals that have been made for concessions and some kind of compromise between Physiology and Philology; but honest students know that on scientific subjects no compromise is admissible. With regard to the home of the *Âryas*, no honest philologist will allow himself to be driven one step beyond the statement that the unknown people who spoke Aryan languages were, at one time, and before their final separation, settled somewhere in Asia. That may seem very small comfort, but for the present it is all that we have a right to say. Even this must be taken with the limitations which, as all true scholars know, apply to speculations concerning what may have happened, say, five thousand or ten thousand years ago. As to the colour of the skin, the hair, the eyes of those unknown speakers of Aryan speech, the scholar says nothing; and when he speaks of their blood he knows that such a word can be taken in a metaphorical sense only. If we once step from the narrow domain of science into the vast wilderness of mere assertion, then it does not matter what we say. We may say, with Penka, that all *Âryas* are dolichocephalic, blue-eyed, and blond, or we may say, with Piétrement, that all *Âryas* are brachycephalic, with brown eyes and black hair.¹ There is no difference between the two assertions. They are both perfectly unmeaning. They are *vox et præterea nihil*. May I be allowed to add that Latham's theory of the European origin of Sanskrit, which has lately been represented as marking the newest epoch in the study of Anthropology, was discussed by me in the 'Edinburgh Review' of 1851?

My experiences during the last forty years have only served to confirm the

¹ V. d. Gheyn, 1889, p. 26.

opinion which I expressed forty years ago, that there ought to be a complete separation between Philology and Physiology. And yet, if I were asked whether such a divorce should now be made absolute, I should say, No. There have been so many unexpected discoveries of new facts, and so many surprising combinations of old facts, that we must always be prepared to hear some new evidence, if only that evidence is brought forward according to the rules which govern the court of true science. It may be that in time the classification of skulls, hair, eyes, and skin may be brought into harmony with the classification of language. We may even go so far as to admit, as a postulate, that the two must have run parallel, at least in the beginning of all things. But with the evidence before us at present mere wrangling, mere iteration of exploded assertions, mere contradictions, will produce no effect on that true jury which in every country hardly ever consists of more than twelve trusty men, but with whom the final verdict rests. The very things that most catch the popular ear will by them be ruled out of court. But every single new word, common to all the Aryan languages, and telling of some climatic, geographical, historical, or physiological circumstance in the earliest life of the speakers of Aryan speech, will be truly welcome to philologists quite as much as a skull from an early geological stratum is to the physiologist, and both to the anthropologist, in the widest sense of that name.

But, if all this is so, if the alliance between Philology and Physiology has hitherto done nothing but mischief, what right, it may be asked, had I to accept the honour of presiding over this Section of Anthropology? If you will allow me to occupy your valuable time a little longer, I shall explain, as shortly as possible, why I thought that I, as a philologist, might do some small amount of good as President of the Anthropological Section.

In spite of all that I have said against the unholy alliance between Physiology and Philology, I have felt for years—and I believe I am now supported in my opinion by all competent anthropologists—that a knowledge of languages must be considered in future as a *sine qua non* for every anthropologist.

Anthropology, as you know, has increased so rapidly that it seems to say now, *Nihil humani a me alienum puto*. So long as Anthropology treated only of the anatomy of the human body, any surgeon might have become an excellent anthropologist. But now, when Anthropology includes the study of the earliest thoughts of man, his customs, his laws, his traditions, his legends, his religions, ay, even his early philosophies, a student of Anthropology without an accurate knowledge of languages, without the conscience of a scholar, is like a sailor without a compass.

No one disputes this with regard to nations who possess a literature. No one would listen to a man describing the peculiarities of the Greek, the Roman, the Jew, the Arab, the Chinese, without knowing their languages and being capable of reading the master-works of their literature. We know how often men who have devoted the whole of their life to the study, for instance, of Hebrew differ not only as to the meaning of certain words and passages, but as to the very character of the Jews. One authority states that the Jews, and not only the Jews, but all Semitic nations, were possessed of a monotheistic instinct. Another authority shows that all Semitic nations, not excluding the Jews, were polytheistic in their religion, and that the Jehovah of the Jews was not conceived at first as the Supreme Deity, but as a national god only, as the God of the Jews, who, according to the latest view, was originally a fetish or a totem, like all other gods.

You know how widely classical scholars differ on the character of Greeks and Romans, on the meaning of their customs, the purpose of their religious ceremonies—nay, the very essence of their gods. And yet there was a time, not very long ago, when anthropologists would rely on the descriptions of casual travellers, who, after spending a few weeks, or even a few years, among tribes whose language was utterly unknown to them, gave the most marvellous accounts of their customs, their laws, and even of their religion. It may be said that anybody can describe what he sees, even though unable to converse with the people. I say, Decidedly no; and I am supported in this opinion by the most competent judges. Dr. Codrington, who has just published his excellent book on the 'Melanesians: Their Anthropology and Folk-lore,' spent twenty-four years among the Melanesians,

learning their dialects, collecting their legends, and making a systematic study of their laws, customs, and superstitions. But what does he say in his preface? 'I have felt the truth,' he says, 'of what Mr. Fison, late missionary in Fiji, has written: "When a European has been living for two or three years among savages, he is sure to be fully convinced that he knows all about them; when he has been ten years or so amongst them, if he be an observant man, he knows that he knows very little about them, and so begins to learn."'

How few of the books in which we trust with regard to the characteristic peculiarities of savage races have been written by men who have lived among them for ten or twenty years, and who have learnt their languages till they could speak them as well as the natives themselves!

It is no excuse to say that any traveller who has eyes to see and ears to hear can form a correct estimate of the doings and sayings of savage tribes. It is not so, and anthropologists know from sad experience that it is not so. Suppose a traveller came to a camp where he saw thousands of men and women dancing round the image of a young bull. Suppose that the dancers were all stark naked, that after a time they began to fight, and that at the end of their orgies there were three thousand corpses lying about weltering in their blood. Would not a casual traveller have described such savages as worse than the negroes of Dahomey? Yet these savages were really the Jews, the chosen people of God. The image was the golden calf, the priest was Aaron, and the chief who ordered the massacre was Moses. We may read the 32nd chapter of Exodus in a very different sense. A traveller who could have conversed with Aaron and Moses might have understood the causes of the revolt and the necessity of the massacre. But without this power of interrogation and mutual explanation, no travellers, however graphic and amusing their stories may be, can be trusted; no statements of theirs can be used by the anthropologist for truly scientific purposes.

From the day when this fact was recognised by the highest authorities in Anthropology, and was sanctioned by some at least of our anthropological, ethnological, and folk-lore societies, a new epoch began, and Philology received its right place as the handmaid of Anthropology. The most important paragraph in our new charter was this, that in future no one is to be quoted or relied on as an authority on the customs, traditions, and more particularly on the religious ideas of uncivilised races who has not acquired an acquaintance with their language, sufficient to enable him to converse with them freely on these difficult subjects.

No one would object to this rule when we have to deal with civilised and literary nations. But the languages of Africa, America, Polynesia, and even Australia are now being studied as formerly Greek, Latin, Hebrew, and Sanskrit only were studied. You have only to compare the promiscuous descriptions of the Hottentots in the works of the best ethnologists with the researches of a real Hottentot scholar like Dr. Hahn to see the advance that has been made. When we read the books of Bishop Callaway on the Zulu, of William Gill and Edward Tregear on the Polynesians, of Horatio Hale on some of the North American races, we feel at once that we are in safe hands, in the hands of real scholars. Even then we must, of course, remember that their knowledge of the languages cannot compare with that of Bentley, or Hermann, or Burnouf, or Ewald. Yet we feel that we cannot go altogether wrong in trusting to their guidance.

I venture to go even a step further, and I believe the time will come when no anthropologist will venture to write on anything concerning the inner life of man without having himself acquired a knowledge of the language in which that inner life finds its truest expression.

This may seem to be exacting too much, but you have only to look, for instance, at the descriptions given of the customs, the laws, the legends, and the religious convictions of the people of India about a hundred years ago, and before Sanskrit began to be studied, and you will be amazed at the utter caricature that is often given there of the intellectual state of the Brahmans compared with what we know of it now from their own literature.

And if that is the case with a people like the Indians, who are a civilised race, possessed of an ancient literature, and well within the focus of history for the last

two thousand years, what can be expected in the case of really savage races? One can hardly trust one's eyes when one sees the evidence placed before us by men whose good faith cannot be questioned, and who nevertheless contradict each other flatly on the most ordinary subjects. We owe to one of our secretaries, Mr. Ling Roth, a most careful collection of all that has been said on the Tasmanians by eye-witnesses. Not the least valuable part of this collection is that it opens our eyes to the utter untrustworthiness of the evidence on which the anthropologist has so often had to rely. In an article on Mr. Roth's book in 'Nature,' I tried to show that there is not one essential feature in the religion of the Tasmanians on which different authorities have not made assertions diametrically opposed to each other. Some say that the Tasmanians have no idea of a Supreme Being, no rites or ceremonies; others call their religion Dualism, a worship of good and evil spirits. Some maintain that they had deified the powers of nature, others that they were Devil-worshippers. Some declare their religion to be pure monotheism, combined with belief in the immortality of the soul, the efficacy of prayers and charms. Nay, even the most recent article of faith, the descent of man from some kind of animal, has received a religious sanction among the Tasmanians. For Mr. Horton, who is not given to joking, tells us that they believed 'they were originally formed with tails, and without knee-joints, by a benevolent being, and that another descended from heaven and, compassionating the sufferers, cut off their tails, and with grease softened their knees.'

I would undertake to show that what applies to the descriptions given us of the now extinct race of the Tasmanians applies with equal force to the descriptions of almost all the savage races with whom anthropologists have to deal. In the case of large tribes, such as the inhabitants of Australia, the contradictory evidence may, no doubt, be accounted for by the fact that the observations were made in different localities. But the chief reason is always the same—ignorance of the language, and therefore want of sympathy and impossibility of mutual explanation and correction.

Let me in conclusion give you one of the most flagrant instances of how a whole race can be totally misrepresented by men ignorant of their language, and how these misrepresentations are at once removed if travellers acquire a knowledge of the language, and thus have not only eyes to see, but ears to hear, tongues to speak, and hearts to feel.

No race has been so cruelly maligned for centuries as the inhabitants of the Andaman Islands. An Arab writer of the ninth century states that their complexion was frightful, their hair frizzled, their countenance and eyes terrible, their feet very large and almost a cubit in length, and that they go quite naked. Marco Polo (about 1285) declared that the inhabitants are no better than wild beasts, and he goes on to say: 'I assure you, all the men of this island of Angamanain have heads like dogs, and teeth and eyes likewise; in fact, in the face they are just like big mastiff dogs.'

So long as no one could be found to study their language there was no appeal from these libels. But when, after the Sepoy mutiny in 1857, it was necessary to find a habitation for a large number of convicts, the Andaman Islands, which had already served as a penal settlement on a smaller scale, became a large penal colony under English officers. The havoc that was wrought by this sudden contact between the Andaman Islanders and these civilised Indian convicts was terrible, and the end will probably be the same as in Tasmania—the native population will die out. Fortunately one of the English officers (Mr. Edward Horace Man) did not shrink from the trouble of learning the language spoken by these islanders, and, being a careful observer and perfectly trustworthy, he has given us some accounts of the Andaman aborigines which are real masterpieces of anthropological research. If these islanders must be swept away from the face of the earth, they will now at all events leave a 'good name' behind them. Even their outward appearance seems to become different in the eyes of a sympathising observer from what it was to casual travellers. They are, no doubt, a very small race, their average height being 4 ft. 10 $\frac{3}{4}$ in. But this is almost the only charge brought against them which Mr. Man has not been able to rebut. Their

hair, he says, is fine, very closely curled, and frizzly. Their colour is dark, but not absolutely black. Their features possess little of the most marked and coarser peculiarities of the negro type. The projecting jaws, the prominent thick lips, the broad and flattened nose of the genuine negro are so softened down as scarcely to be recognised.

But let us hear now what Mr. Man has to tell us about the social, moral, and intellectual qualities of these so-called savages, who had been represented to us as cannibals; as ignorant of the existence of a deity; as knowing no marriage, except what by a bold euphemism has been called communal marriage; as unacquainted with fire; as no better than wild beasts, having heads, teeth, and eyes like dogs—being, in fact, like big mastiffs.

‘Before the introduction into the islands of what is called European civilisation, the inhabitants,’ Mr. Man writes, ‘lived in small villages, their dwellings built of branches and leaves of trees. They were ignorant of agriculture, and kept no poultry or domestic animals. Their pottery was hand-made, their clothing very scanty. They were expert swimmers and divers, and able to manufacture well-made dug-out canoes and outriggers. They were ignorant of metals, ignorant, we are told, of producing fire, though they kept a constant supply of burning and smouldering wood. They made use of shells for their tools, had stone hammers and anvils, bows and arrows, harpoons for killing turtle and fish. Such is the fertility of the island that they have abundance and variety of food all the year round. Their food was invariably cooked, they drank nothing but water, and they did not smoke. People may call this a savage life. I know many a starving labourer who would gladly exchange the benefits of European civilisation for the blessings of such savagery.’

These small islanders who have always been represented by a certain class of anthropologists as the lowest stratum of humanity need not fear comparison, so far as their social life is concerned, with races who are called civilised. So far from being addicted to what is called by the self-contradictory name of communal marriage, Mr. Man tells us that bigamy, polygamy, polyandry, and divorce are unknown to them, and that the marriage contract, so far from being regarded as a merely temporary contract, to be set aside on account of incompatibility of temper or other such causes, is never dissolved. Conjugal fidelity till death is not the exception but the rule, and matrimonial differences, which occur but rarely, are easily settled with or without the intervention of friends. One of the most striking features of their social relations is the marked equality and affection which exist between husband and wife, and the consideration and respect with which women are treated might, with advantage, be emulated by certain classes in our own land. As to cannibalism or infanticide, they are never practised by them.

It is easy to say that Mr. Man may be prejudiced in favour of these little savages whose language he has been at so much pains to learn. Fortunately, however, all his statements have lately been confirmed by another authority, Colonel Cadell—the Chief Commissioner of these islands. He is a Victoria Cross man, and not likely to be given to overmuch sentimentality. Well, this is what he says of these fierce mastiffs, with feet a cubit in length:—

They are merry little people, he says. One could not imagine how taking they were. Everyone who had to do with them fell in love with them (these fierce mastiffs). Contact with civilisation had not improved the morality of the natives, but in their natural state they were truthful and honest, generous and self-denying. He had watched them sitting over their fires cooking their evening meal, and it was quite pleasant to notice the absence of greed and the politeness with which they picked off the tit-bits and thrust them into each other's mouths. The forest and sea abundantly supplied their wants, and it was therefore not surprising that the attempts to induce them to take to cultivation had been quite unsuccessful, highly though they appreciated the rice and Indian corn which were occasionally supplied to them. All was grist that came to their mill in the shape of food. The forest supplied them with edible roots and fruits. Bats, rats, flying foxes, iguanas, sea-snakes, molluscs, wild pig, fish, turtle, and last, though not least, the larvæ of beetles, formed welcome additions to their larder. He remembered one morning

landing by chance at an encampment of theirs, under the shade of a gigantic forest tree. On one fire was the shell of a turtle, acting as its own pot, in which was simmering the green fat delicious to more educated palates; on another its flesh was being broiled, together with some splendid fish; on a third a wild pig was being roasted, its drippings falling on wild yams, and a jar of honey stood close by, all delicacies fit for an alderman's table.

These are things which we might suppose anybody who has eyes to see, and who is not wilfully blind, might have observed. But when we come to traditions, laws, and particularly to religion, no one ought to be listened to as an authority who cannot converse with the natives. For a long time the Mincopies have been represented as without any religion, without even an idea of the Godhead. This opinion received the support of Sir John Lubbock, and has been often repeated without ever having been re-examined. As soon, however, as these Mincopies began to be studied more carefully—more particularly as soon as some persons resident among them had acquired a knowledge of their language, and thereby a means of real communication—their religion came out as clear as daylight. According to Mr. E. H. Man, they have a name for God—*Pûluga*. And how can a race be said to be without a knowledge of God if they have a name for God? *Pûluga* has a very mythological character. He has a stone house in the sky; he has a wife, whom he created himself, and from whom he has a large family, all, except the eldest, being girls. The mother is supposed to be green (the earth?), the daughters black; they are the spirits, called *Môrowin*; his son is called *Pijchor*. He alone is permitted to live with his father and to convey his orders to the *Môrowin*. But *Pûluga* was a moral character also. His appearance is like fire, though nowadays he has become invisible. He was never born, and is immortal. The whole world was created by him, except only the powers of evil. He is omniscient, knowing even the thoughts of the heart. He is angered by the commission of certain sins—some very trivial, at least to our mind—but he is pitiful to all who are in distress. He is the judge from whom each soul receives its sentence after death.

According to other authorities, some Andamanese look on the sun as the fountain of all that is good, the moon as a minor power; and they believe in a number of inferior spirits, the spirits of the forest, the water, and the mountain, as agents of the two higher powers. They believe in an evil spirit also, who seems to have been originally the spirit of the storm. Him they try to pacify by songs, or to frighten away with their arrows.

I suppose I need say no more to show how indispensable a study of language is to every student of Anthropology. If Anthropology is to maintain its high position as a real science, its alliance with linguistic studies cannot be too close. Its weakest points have always been those where it trusted to the statements of authorities ignorant of language and of the science of language. Its greatest triumphs have been achieved by men such as Dr. Hahn, Bishops Callaway and Colenso, Dr. W. Gill, and last, not least, Mr. Man, who have combined the minute accuracy of the scholar with the comprehensive grasp of the anthropologist, and were thus enabled to use the key of language to unlock the perplexities of savage customs, savage laws and legends, and, particularly, of savage religions and mythologies. If this alliance between Anthropology and Philology becomes real, then, and then only, may we hope to see Bunsen's prophecy fulfilled, that Anthropology will become the highest branch of that science for which this British Association is instituted.

Allow me in conclusion once more to quote some prophetic words from the Address which Bunsen delivered before our Section in 1847:—

'If man is the apex of the creation, it seems right, on the one side, that a historical inquiry into his origin and development should never be allowed to sever itself from the general body of natural science, and in particular from Physiology. But, on the other side, if man is the apex of the creation, if he is the end to which all organic formations tend from the very beginning, if man is at once the mystery and the key of natural science, if that is the only view of natural science

worthy of our age, then Ethnological Philology (I should prefer to say Anthropology), once established on principles as clear as the physiological are, is the highest branch of that science for the advancement of which this Association is instituted. It is not an appendix to Physiology or to anything else; but its object is, on the contrary, capable of becoming the end and goal of the labours and transactions of a scientific association.

Much has been achieved by Anthropology to justify these hopes and fulfil the prophecies of my old friend Bunsen. Few men live to see the fulfilment of their own prophecies, but they leave disciples whose duty it is to keep their memory alive, and thus to preserve that vital continuity of human knowledge which alone enables us to see in the advancement of all science the historical evolution of eternal truth.

The following Papers and Report were read:—

1. *The Social and Religious Ideas of the Chinese, as illustrated in the Ideographic Characters of the Language.* By Professor R. K. DOUGLAS.

The paper begins with a short introduction, showing that the Chinese ideographic characters are picture-writings, and that as such they supply an interpretation of the meaning of words as these were understood by the inventors of the characters representing them.

Following on this is an account of the earliest or hieroglyphic form of the writing, with examples, and the development of this resulting in the ideographic characters. These are taken as being illustrative of the ideas of the people on political, social, scientific, and religious ideas. For example, the importance which was attached to the qualities of a sovereign is exemplified in the choice of the symbol employed to express a supreme ruler, the component parts of which together signify 'ruler of himself.' By means of the same graphic system a kingdom is shown as 'men and arms within a frontier.' Passing to the social habits of the people, their domestic life is illustrated by a number of ideograms descriptive of their household arrangements and relationships. In succession are traced in the written characters the ideas associated with men and women, their virtues and their failings; the notions associated with marriage; and the evidences of pastoral as well as of agricultural habits among the people. Turning to the popular religious faiths it is shown how prominent is the belief in the god of the soil, whose presence brings blessings, and whose averted countenance is followed by misfortune. The ideas associated with objects of nature are next treated of, and the paper concludes with references to the coinage of the country as described in the ideograms employed to represent its various forms.

2. *On recent Progress in the Analysis of Vowel-sounds.*
By R. J. LLOYD, D.Lit., M.A.

The object of this paper is to direct attention to three sets of researches which have recently been carried on by three different observers in various parts of Europe—viz., Professor Ludiman Hermann, of Königsberg, Dr. Hugo Pipping, of Helsingfors, and the writer of the memoir. Pipping's researches were carried out by means of Hensen's 'Sprachzeichner' or 'Phonautograph'¹ with certain modifications. Hermann's apparatus is identical in principle, but totally different in detail.² The vibrations of a phonographic plate are communicated to a mirror, and a ray of light is so directed upon the mirror as to record the vibrations of the latter upon the sensitive surface of a cylinder revolving at some distance. The writer's researches are based upon an examination and partial imitation of the shapes of the cavities which are created in the mouth and throat for the production of vowels, followed by calculation and observation of the resonances properly belonging to them.

¹ See *Zeitschrift für Biologie*, vol. xxiii. p. 291.

² Pfüger's *Archiv für die gesammte Physiologie*, vols. xlv. and xlvii.

Pipping and Hermann have both given their attention exclusively to the sung vowels. The writer of the memoir at first gave his attention exclusively to the whispered vowels, but has endeavoured, in his published articles on speech-sounds, since the appearance of the other writers' results, to bring his results into touch with theirs.¹

The questions about which all three writers are more or less concerned are briefly these: Has each vowel one characteristic tone, or more? What is this concomitant tone (or concomitant tones) for each vowel? Is this tone (or are these tones) of variable or constant pitch? Is it (or are they) harmonic, in a sung vowel, to the note which is sung? Does the resonance (or do the resonances) of a given vowel remain constant in the same individual through the whole compass of his voice? If the resonances are plural, have they any fixed relation to each other? These questions are answered differently by all the three writers, who nevertheless present some remarkable points of agreement in this hitherto chaotic branch of knowledge. The writer of the memoir is chiefly concerned with the answer to the last of the above-named questions, believing that all the leading vowels are distinguished by the possession of two resonances, not fixed in themselves, but bearing a fixed relation to each other.

3. *Family Life of the Haidas (Queen Charlotte Islands).*

By the Rev. CHARLES HARRISON.

The Haidas seem to be related from the lowest in rank to the supreme chief of the nation; but they are divided into certain families or crests, and members of the same crest are not allowed to intermarry.

The houses of the old Haidas are square and built with cedar hewn to the proper proportions with stone adzes or axes, having been erected before iron implements were known to the Haidas. Some of the houses are built over pits, which serve as a protection from dampness, from smoke, and from sudden attacks of enemies. In the centre of the pit is the camp fire, which is kept burning day and night during the winter months; and around it the Indians sleep and the children play. The Haidas feed twice in the day—early in the morning and after the day's work is over. They have a great variety of food, and grow turnips, potatoes, and other vegetables, sufficient to last them for the year.

Queen Charlotte Islands were formerly ruled by a single king, but now each village has its chief, whose rank and authority are transmitted, at his death, to a nephew or some other relative; but it is impossible according to Haida laws for a son to succeed his father or even to take his name.

Infants are left much to themselves, but are seldom either bound to a board, or tied up in such a way as to interfere with their movements.

As soon as a girl reaches puberty her lower lip is pierced, and the orifice is enlarged from time to time, according to her marriage and the number of children she bears, so that it is really a mark of caste.

Marriage is by purchase, but the choice is limited to members of a certain sept or crest; thus, the bear must marry an eagle, and the frog must marry a whale. The children always take the crest of their mother.

There is no difficulty about divorce when man and wife tire of one another.

The women are very fond of ornaments; the younger ones wear earrings similar to those worn by English ladies, while the ears of the older women are pierced in two or three places, and pieces of bone and wood were formerly inserted and worn continually. Nose-rings are still worn among the Haidas, but only the old Indians have their noses pierced, and the ring is seldom used except when in full dress for the dance or the feast.

The Haidas are tall and well-proportioned, and are exceedingly strong. Their intellectual power exceeds that of the ordinary coast Indians. The older men have no hair on their faces, but the younger men endeavour to cultivate whiskers and moustachios in imitation of the whites.

¹ See *Phonetische Studien*, vols. iii., iv., and v.

Funerals are conducted with much ceremony, the preparations being made by members of that crest from which the deceased was bound to choose his wife. After the funeral is over all the people are feasted by the deceased man's nephew, who then assumes his uncle's title and property.

4. *Report of the North-Western Tribes of Canada Committee.*

See Reports, p. 407.

5. *On the Work of Major J. W. Powell, Director of the U.S. Ethnological Bureau.* By Professor MAX MÜLLER, M.A.

Prof. Max Müller stated that he had just received proof sheets of a most important publication on the classification of the Indian languages spoken in America. It is a splendid piece of workmanship from Major Powell, the indefatigable director of the American Bureau of Ethnology. The publications of that bureau count among the most valuable contributions to anthropological science, and they reflect the highest credit, not only on Major Powell and his fellow-workers, but also on the American Government, which has sanctioned a very large outlay for the prosecution of these studies. There is no stint in the way in which these volumes are brought out, and most of the papers contained in them inspire the student with that confidence which can only be produced by honest, conscientious, and truly scholar-like work. Our American friends have perceived that it is a national duty to preserve as much as can still be preserved of the languages and thoughts of the indigenous races who were the earliest dwellers on American soil. They know that the study of what he himself had ventured to call intellectual geology is quite as important as that of terrestrial geology, and that the study of the lower strata contains the key to a right understanding of the higher strata in the growth of the human mind. Coming generations will call us to account for having allowed the old world to vanish without trying to preserve its records. People who ask what can be the use of preserving the language of the Mohawks forget what we should give if some scholar at the time of Cato or Cæsar had written down what many could then easily have done—a grammar of the Etruscan language.

Some years ago Prof. Max Müller succeeded in persuading a Secretary of State for the Colonies that it was the duty of the English Government to publish a series of colonial records containing trustworthy information on the languages, customs, laws, religions, and monuments of the races inhabiting the English colonies. Lord Granville saw that such an undertaking was a national duty, and that the necessary funds should be contributed by the various colonies. What a magnificent work this would have been! But while the American Government has pushed forward its work, Lord Granville's scheme expired in the pigeon-holes of the Colonial Office. America may well be proud of Major Powell, who would not allow the treasures collected by various scholars and Government officials to moulder and perish. He is a true enthusiast—not a man of mere impulse and good intentions, but a man of sustained effort in his work. He deserves the hearty thanks of our Association, which Professor Max Müller felt proud to be allowed to tender to him in the name of the Anthropological Section.

FRIDAY, AUGUST 21.

The following Papers were read :—

1. *On the Ancient Language of the Natives of Tenerife.*
By the MARQUESS OF BUTE, K.T., Mayor of Cardiff.

The author read a portion of a long paper, written by him, On the Ancient Language of the Natives of Tenerife,¹ a language which must have become extinct not earlier than 1650. The paper was based upon the materials collected in the second volume of the 'Estudios Históricos, Climatológicos y Patológicos de las Islas Canarias,' by Dr. Gregory Chil y Naranjo, of Las Palmas, in Grand Canary, published in 1889, with the addition of farther matter communicated by the Rev. Claudio Marrero and Don Manuel de Ossuna, from their own researches, or collected in the Canary Islands and elsewhere by Mr. De Gray Birch, of the British Museum.

The author mentioned the disputed point as to whether the Tenerifan language was or was not cognate to those of the other islands of the Archipelago, and also whether the inhabitants were of one or of several races. He confined himself exclusively to the Tenerifan language, and explained the difficulties besetting the study owing to the imperfect manner in which the existing remains have been transmitted to us in a variety of forms of phonetic spelling by different more or less illiterate Spanish writers.

Three separate opinions have been maintained as to the nature of the Tenerifan language, some holding it to be of an American family, some a Berber or African dialect, and some Teutonic.

The author discussed at length a set of about seventy words which have known meanings, comparing them with words of similar meaning in other languages, but mentioned that a vast number of other words are known which are either proper names of places or the names of plants or other things generally peculiar to the islands. He then analysed and discussed the nine complete sentences which are known to exist and proceeded to give a summary of the results at which he had arrived as to grammar. He considered it certain that there was a definite article in *t*, to which, however, there was often given a modified sound like that of *t* in the English termination *-tion*, and that among the nouns a regular feminine was formed by the termination *-ha*. He considered it as in the highest degree probable that a plural or dual of nouns was formed in *-en*, and that there existed a pre-formative of greatness or holiness in *hu-*, and a post-formative of greatness in *-to*. Of case endings nothing appeared clear, but the author considered it possible that a possessive was formed for nouns, and personal terminations for verbs, by the addition of pronominal suffixes, that of the first person being *-ec*, of the second *-t*, and of the third *-th*, and perhaps of the second person plural *-cra*. He also thought that the past tense may have been formed by prefixing *ta-* or *tan-*, and that there may have been a conjunction *ua*.

Entering upon the question of a Berber or African origin, the author made a comparison from Basset's 'Manuel de Langue Kabyle,' and, with regard to the American theory, from Breton's 'Grammaire Caraïbe' and from Massi's 'Manual del Idioma General del Perú.'

The author concluded by expressing the hope that more matter may be yet obtained, and greater results follow, from a deeper study of that which is known to exist. He disclaimed the intention of propounding any dogmatic theory of his own, but the general tendency of the paper was in favour of ascribing the Tenerifan language to the Aryan family.

¹ This paper has since been published *in extenso* by Messrs. J. Masters & Co., 78 New Bond Street, London.

2. *On the Limits of Savage Religion.*

By EDWARD B. TYLOR, D.C.L., F.R.S.

In defining the religious systems of the lower races, so as to place them correctly in the history of culture, careful examination is necessary to separate the genuine developments of native theology from the effects of intercourse with civilised foreigners. Especially through missionary influence since 1500, ideas of dualistic and monotheistic deities, and of moral government of the world, have been implanted on native polytheism in various parts of the globe. For instance, as has lately become clear by the inquiries of anthropologists, the world-famous Great Spirit of the North American Indians arose from the teachings of the Jesuit missionaries in Canada early in the seventeenth century. This and analogous names for a Supreme Deity unknown previously to native belief, have since spread over North America, amalgamating with native doctrines and ceremonial rites into highly interesting but perplexing combinations. The mistaken attribution to barbaric races of theological beliefs really belonging to the cultured world, as well as the development among these races of new religious formations under cultured influence, are due to several causes, which it is the object of this paper to examine. (1) Direct adoption from foreign teachers; (2) the exaggeration of genuine native deities of a lower order into a God or Devil; (3) the conversion of native words, denoting a whole class of minor spiritual beings, such as ghosts or demons, into individual names, alleged to be those of a Supreme Good Deity or a rival Evil Deity. Detailed criticism of the names and descriptions of such beings in accounts of the religions of native tribes of America and Australasia was adduced, giving in many cases direct proof of the beliefs in question being borrowed or developed under foreign influence, and thus strengthening the writer's view that they, and ideas related to them, form no original part of the religion of the lower races. The problems involved are, however, of great difficulty, the only hope of their full solution in many cases lying in the researches of anthropologists and philologists minutely acquainted with the culture and languages of the districts; while such researches will require to be carried out without delay, before important evidence, still available, has disappeared.

3. '*Couvade.*' By H. LING ROTH.

Couvade is the name of the curious custom which orders that when a child is born the father takes to his sleeping corner and behaves as though he had brought forth. The origin of the word is French, from *cower* to hatch. To Europeans the custom appears barbarous in its treatment of the wife, who has to get up and go about her usual duties and perhaps now attend to the husband. Savage women do not suffer in labour to the same extent as the more civilised women do; the reasons for this are explained on physiological grounds. In this inquiry the sufferings of the women may therefore be neglected. The geographical distribution of the custom: it is met with in Europe, Asia, and mostly in America. Its existence in Africa is doubtful. In the West Indies and South America at the present day travellers frequently come across it as a living custom. In Australia it is unknown. It is mostly found to exist amongst people who live in isolated districts and who appear to have been driven from more fruitful lands. It is not found amongst the lowest class of savages nor amongst the highly civilised. Comparisons between the state of the large continents do not explain the causes of its distribution, but an ethnological examination will probably explain it. The reasons for practising the custom given by the people themselves and the explanations given by anthropologists and travellers are all equally at variance. Bachofen's original theory that the custom indicates the turning point in society from the maternal to the paternal finds new support at the present day. The apparent correctness of this theory is most convincing. But if this theory be correct why is the custom not found in Australia, where the great society change is going on at the present day? Mr. im Thurn suggests that we should compare the custom with those apparently allied to it, and so get at its origin. The custom as practised by

savages briefly summarised in a table shows that the savage believes that there is some hidden link which binds the new-born child to its father. Many curious beliefs are met with among the uncivilised showing similar belief in occult links or bonds or lines of force. These forms of belief are usually described under the general heading of *witchcraft*. Similarly in the custom of *covade* the action of the father is to avoid bewitching his child, so that the custom, if not wholly an explanation of the change of mother right to father right, may be in effect an example of an aberrant form of reasoning.

4. On the 'Morong' and other Customs of the Natives of Assam.

By S. E. PEAL.

The author shows that the institution of the 'Morong,' or club-house for the unmarried of both sexes, is very widely distributed over the whole of the Indo-Pacific region; and he argues that it is in fact a relic of pre-marriage communism. But this custom being so often found associated with others of a distinctly non-Aryan character, such as juming, tattooing, blackening the teeth, building on piles, head-hunting, &c., has led the author to suspect former racial affinity, even among such widely distinct types as Papuan and Mongol, Dravidian and Savaiori.

1. The artificial blackening of the teeth is a fashion common amongst the Indo-Mongoloids and Bengalese; and there can be little doubt that the custom in some way preserves the teeth from decay.

2. The dislike of milk among the races bordering Assam is very general, possibly almost universal.

3. The extension of the ear-lobes, by large plugs of various sorts, is a well-known custom of all these races. The Miribelles have the largest ear-plugs of any tribes in or about Assam; they are made of silver, and not unlike napkin rings, 2 or 2½ inches in diameter by 1 inch in depth, the outside being closed by a large chased disc. The extended lobe passes round the ring in a wide shallow groove, like a band of vulcanised rubber.

4. Numeral affixes are found in Assam, as among the Malays.

5. Head hunting seems to be slowly dying out amongst the most eastern Nogas, and to the west of Dikhu River; but in most Noga tribes the young men cannot be tattooed until they have got or actively assisted in getting a head, hands, or feet of some Noga, not of their own or of a friendly tribe.

6. Tattooing in some tribes is on the face, in others on the body, and it is in some way a record of the numbers killed.

7. Platform burial is general amongst the Nogas of East Assam for men and adult women; it also prevails in Formosa, New Guinea, Borneo, Solomon Islands, New Britain, and amongst Lushais.

8. Communal houses of great length, 100 and 200 feet, are common in and around Assam; similar houses are found among the Dyaks of Borneo over 500 feet in length.

9. Barracks for the unmarried young men, and occasionally also for girls, are common in and around Assam, among non-Aryan races. The institution is here seen in various stages of decline or transition. In the case of 'head hunters' the young men's barracks are invariably *guardhouses* at the entrances to the village, and those on guard day and night keep tally of the men who leave or return. They are also guest and council houses; they contain skull trophies and the large war drums. In all cases there seem to be old and peculiar laws attaching to them, and in many instances they issue orders to the village. All these houses are *strictly tabu to married women*.

10. Pile dwellings are a leading feature among most of the hill races about Assam, and the custom extends all down the peninsula, and throughout the archipelago, to the Solomon Islands in the south and Formosa in the north. The pattern of these pile dwellings no doubt varies greatly, but there is a unity in the general plan which cannot be accidental.

11. The peculiar double-cylinder bellows, common in Burmah, Sumatra, Java, Madagascar, and the Philippines, is also used in and around Eastern Assam.

12. Bamboos pegged to a tall tree stem as a ladder are used in Assam and by the Dyaks of Borneo.
13. The 'jew's-harp' of New Britain, seen also in the Philippines, is very common in the hills of Assam.
14. The perineal bandage of New Guinea is also common amongst the Eastern Nogas.
15. Nose-plugs, as in New Guinea, are seen among the Noga women.
16. Flat wooden discs on the posts of houses, to keep out rats and mice, absolutely identical with those seen in New Britain, are also frequently met with in Assam.
17. The hide cuirasses seen in the island of Nias, west of Sumatra, and cut from a single skin, are an almost exact counterpart of those occasionally seen among Nogas, and are both spear and arrow proof.
18. Panjis or bamboo spikes, planted for defence in pathways, are as common in Assam as among the inhabitants of New Guinea, and form another link in the long chain of evidence which tends to prove that the Papuan and Mongoloid are descended from a common stock.
19. Hot stone cooking again is common in Assam as among the Papuans and other races.
20. The custom of obtaining fire by means of a long piece of cane passed under a dry log and pulled alternately by the right and left hand, so as to ignite some tinder placed in a hollow underneath, is absolutely identical amongst Nogas, Papuans, and the Dyaks of Borneo.
21. The huge canoe war drums appear to be the same as the 'Lali' or canoe drums of the Fiji Islands, and both are placed in semi-sacred houses, the Noga drums being in the 'Morongs.' The notable feature in these last being that they are veritable canoes, 20 to 30 feet long by 2½ or 3 feet beam, hollowed out of a tree stem, and in use by races who never enter, and in most cases have not seen a canoe for ages.
22. Cane bridges identical with those seen in New Guinea are found everywhere round Assam.
23. The system of Jum cultivation is pursued in and round Assam by most of the non-Aryan races in much the same way as amongst the wilder races of the Indo-Pacific region.
24. The way in which Nogas and other hillmen notch footholds to ascend a tall tree is absolutely identical with the custom of certain tribes in Australia, who use stone axes.

5. *Burial Customs of New Britain.* By the Rev. B. DANKS.

The grave is usually dug in the house the deceased inhabited while alive, or a light structure is erected over the grave to protect it from the rain. It is generally not more than eighteen inches or two feet deep, and it is the custom for the women of the family, and sometimes the men, to sleep upon it for a considerable time after the burial. A fire is also very often lighted upon or by the side of it, which is kept burning day and night for some time. Sometimes the grave is dug out in the open and fenced round with bamboos, the enclosure being kept in good order by the friends, who plant beautiful shrubs about it. They have also a method of calling to mind the circumstances and mode of death suffered by the departed by means of rude images cut out of the banana stem. Some have a piece of wood suspended from the neck; others have pieces of bamboo thrust into various parts of the body; another may have a rudely fashioned tomahawk driven deeply into it. The first shows that the individual represented has been clubbed, the second speared, the third tomahawked. The old men then instruct the young people in these matters, and this does much to promote blood-feuds.

Death is always the result of witchcraft, and details are given in the paper of the manner in which the person who has caused the death is discovered.

Sometimes a body is buried in a canoe set on poles, and the author gives a full description of a burial of this kind which took place on Duke of York Island, and was witnessed by the narrator.

Large quantities of food and property of various kinds are destroyed by the mourners, excessive grief being proved by excessive destruction; and all who come to a funeral are rewarded by a present of shell-money and food. Female mourners are always present, and are well paid for weeping.

In some parts of New Ireland the dead are buried in the sea.

SATURDAY, AUGUST 22.

This Section did not meet.

MONDAY, AUGUST 24.

The following Papers and Reports were read:—

1. *Barbaric Elements in Ancient Greece and Italy.*

By Prof. G. HARTWELL-JONES, M.A.

The civilisation of Greece and Italy, which saved Europe from stagnation on both sides, is valuable for the study of the growth of institutions; it was evolved slowly from an original barbarism. But, as the classics are now read, their scientific value is obscured.

Their history occupies a peculiar position: (a) geographically, they were influenced by two streams of culture converging, the Aryan and Eastern; (b) their growth was parallel; (c) both were similarly, but independently, affected by immediate neighbours.

(i.) Whatever may be the truth about the seat of the Aryans, first they came south by land; secondly they brought with them a high capacity for development, but were certainly not as advanced as Gobineau assumed.

(ii.) They were both affected by Asia Minor, Assyria, and Egypt, the North Semitic races being their intermediaries.

The materials for reconstructing prehistoric society must be sought in archæology, and nomology, as much as the science of language, this was seen by Hehn.

The purpose of this paper is to show by means of a few specimens the anthropological value of the classics, aided by the excavations of Schliemann, Helbig, Chierici, &c., and Sanskrit literature, in the (i.) *material and social*, (ii.) *mythological and religious* aspects of Greek and Italian life.

(I.) They passed through three stages:—(a) hunting, (b) pastoral, (c) agricultural; but the transition was gradual. The animals hunted were the stag, bison, and probably the horse; they used the fire-drill; fishing was a recent invention; religion was marked by ferocity. The change to agriculture humanised them; they fed on milk, meat, salt, spice, mead, and roamed in search of fresh fields. The ox left a deep impression upon language, custom, and myth; it was the unit of wealth and the medium of exchange; the horse was first used for the war chariot; the super-vention of horse-breeding later is reflected in language. The word for harvest was not known in the holoethnic period. Some tribes remained at the agricultural stage throughout; others, e.g. the Dorians, retained their old passion. The pile-dwellings of the *terra mare* reveal cattle-rearing giving way to husbandry and vine-culture; no doubt Epeiros would exhibit the same progress. The Pelasgoi were essentially agricultural; the transition in Italy is reflected in legend. The first plough was the branch of a tree. Tillage was practised before horticulture. Agriculture left a deep impression upon language and life.

The family was highly important in Greek and Italian life. Marriage clearly passed through the (a) capture, (b) purchase stage, and once polygamy prevailed; so, too, levirate, the vendetta, the suttee, but not polyandria, as Bachofen main-

tained. Their primitive savagery is proved by the destruction of the aged and infanticide.

(II.) The crudest form of their religion is

A. Animism, really a primitive philosophy. It may be divided into (a) spiritism, (b) fetishism. In both the spirit is cajoled or overcome by magic. Nowhere is the power of abstraction stronger than in Italy, to some extent owing to the influence of Etruria; the fear of these nebulous impersonal spirits and ill-omened plants was common; the fetish was widely distributed, e.g. the oracle of Pelasgian Dodona, a kind of instinctive meteorology. Further, animism was (a) vague, and (b) hypocritical.

B. Naturalism characterises Greek mythology especially. At this stage those objects were chosen which bore some resemblance to man and promoted his welfare. Magic gradually disappears, but the spirit is not omnipotent—he even betrays weakness. Environment exerts an important influence here, e.g. in Etruria and Greece. A kind of totemism frequently occurs, e.g. the Hera-idols of the megalithic tombs of Mycenæ. Ovid's 'Metamorphoses' was an attempt to account for the impersonation.

C. Anthropomorphism is a nobler and more intellectual form of worship, with which idolatry is closely connected; in Greece, which was influenced by Phœnician art, it reached its perfection; in Italy it remained an exotic in spite of Etruscan artists.

Thus their religion was (a) developmental, (b) acquisitive.

It would be seen upon examination that

(1) Their primitive culture was on the level of that of many savage races of the present time.

(2) The civilisation of Aryan Europe, as a whole, begins with contact with the East.

(3) The criteria must be sought in other prehistoric sciences, not philology alone.

(4) Their civilisation is of paramount interest to anthropologists.

2. *The Morocco Berbers.* By J. E. BUDGETT MEAKIN.¹

The people from whom Barbary takes its name occupy the mountain fastnesses of the whole of the northern coast of Africa. Notwithstanding the numerous invaders who have from time to time swept through the land, these hardy people still retain their racial characteristics, language, and customs in a comparative state of purity. They have, however, embraced Mohammedanism, in consequence of which their language has become largely adulterated with Arabic, and many new customs have been introduced. In Morocco the Berbers have to a great extent maintained their independence, and military expeditions are undertaken annually to control one section or another. Their weakness is their inter-tribal rivalry. The methods of self-rule employed in the independent districts vary considerably, including representative assemblies, hereditary autocrats, and a species of combination of these two. Among themselves there is always warfare, and every traveller must be protected by some member of the tribe he is visiting.

It is still a moot point whether the Berber language should be classed as Hamitic or Semitic. Though the construction, both of words and sentences, resembles the Semitic, its vocabulary is entirely distinct from that group. In most parts Arabic words have been introduced in great numbers. It has, however, no literature. Only one or two works are known to have been written in it, and those in Arabic characters. Its own characters are only to be found in inscriptions, which are very scarce, and hardly known in Morocco. The word Berber itself is of disputed origin, and, though used by some sections of the people, does not to them represent the whole.

The Berbers are essentially warlike, and are proud of their bravery and independence. Cowardice is to them a heinous crime. In most other points each tribe

¹ For some years acting editor of *The Times of Morocco*.

differs from its neighbour. No description entirely applies to more than one district, though much will be common to many. Some are religious, others indifferent; some are steeped in ignorance, while in others even the women learn to read. Dress and food differ everywhere remarkably, as also do minor social customs. A pall of gross superstition, nevertheless, casts its gloom over all alike. The physical features of the Berbers are, on the whole, good. They are strong and wiry, with much more energy than the Arab, or the mingled race of the plains. As a rule, they are well-knit, and many have fine, noble figures. Their countenances are often striking, and their looks keen and full of intelligence, though in cases debauchery wrecks the system at an early age, but not so often as in the towns. Their longevity is also greater, and their powers of endurance are wonderful.

Their hospitality, if not so profuse as that of the Arab, is sufficiently extensive, and regular systems for the entertainment of travellers are in force. Monogamy is more common than polygamy. Drunkenness prevails in some districts, but the use of strong drink at all is looked upon as a vice. Marriage customs are peculiar. In some places the women are practically sold by auction on the market once a year, and may be divorced by being brought back there on the anniversary. Intermarriage among the tribes is permissible, but not general. The Mohammedan laws as to the bar of relationship hold good throughout. Punishments are not, as a rule, severe, though great suffering is often inflicted upon the victims of powerful members of the community by imprisonment in dungeons, and by the *bastinado*. Criminals are subject to the *lex talionis*, which, as the source of the vendetta, leads to much bloodshed and loss of life.

The chief festivals are those of Islám, though several have survived from a previous creed, of which little is now really known. Some of these would point to a Christian origin, and many perceive traces of this faith among their superstitions. The festival of Midsummer (St. John's Day) is regularly observed, and it is a noteworthy fact that the European calendar, old style, is still employed among them.

The dress varies as much in the different localities as do the customs. In the interior it is almost entirely of wool, usually unsewn, made of one piece and knotted. A toga-like white blanket serves as overmantle. The most curious garment is a black goat-hair waterproof hooded cloak, with an assegai-shaped yellow patch behind. The manufactures, if rude in some parts, in others show a considerable degree of taste, as also does the ornamentation of many of their buildings. Their food is of the simplest, mostly consisting of cereals, meat being a comparative luxury. Smoking is common in many parts, and the elderly men are often much given to snuffing. Hemp is much used in the northern districts as a narcotic, with very bad results.

The houses of the people are as varied as their dress. It is believed that they were originally nomads, and to-day they occupy tent, hut, and house in one part or another. Substantial store towers dot the Atlas and serve as citadels in time of war. Almost every ruin is ascribed to European builders, but of history little is to be found. There have been several Berber historians of note, who have written in Arabic, some being translated, and several French scholars have paid considerable attention to this interesting people, of whom we even now know so comparatively little.

3. *On the Worship of Meteorites.* By Professor H. A. NEWTON.

The paper consists of a series of accounts of the worship of meteorites and of myths and traditions pointing to such worship in early times. More particularly are the indications of such worship that are found in Greek and Roman history and literature put together. No attempt to discuss the relations of this worship to the other worship of natural and artificial forms has been made.

4. *On Human Remains from the Duggleby 'Howe,' Yorkshire.*

By J. G. GARSON, M.D.

The description of the exploration of this barrow was communicated at the meeting of the British Association last year by the Rev. E. Maule Cole, M.A., and is published in the reports of the meeting, page 979.

The barrow is a round one, and consists of a thick outer layer of rough chalk, in which were found several secondary interments, consisting of burnt bones, the bones of horse and deer, some Roman and British pottery, and iron, bone, and flint implements. Below this was a layer of Kimmeridge clay a foot thick, covering over the whole of an inner mound in which the skeletons to be described were found. This inner mound was composed of two layers, an upper one of small chalk grit $4\frac{1}{2}$ feet thick, and an inner one of clay soil in which the skeletons were deposited. The implements found with them were flint flakes and worked flints, the remains of *Sus*, beaver, *Bos longifrons*, and fox. No metal of any kind occurred below the layer of Kimmeridge clay. In the centre of the mound was a large pit or grave 9 feet deep and a smaller and shallower one by its side. The large grave contained three skeletons and the skull of a fourth; over its mouth in the clay were other three skeletons. In the smaller grave was a skeleton, and between the two graves was another skeleton. Above the smaller grave were other two skeletons. The majority of the skeletons were found lying on the side; in all cases the limbs were drawn up and flexed. The directions in which the bodies had been placed varied. A food vase was found at the bottom of the large grave.

Several of the skeletons were considerably decayed, others were those of children, so that seven only were available for examination and the skull of an eighth person. Many of the long bones were not preserved, but most of them were measured at the time of excavation. These measurements were submitted by Mr. J. R. Mortimer (under whose direction the exploration of the barrow was conducted) to the author along with such of the long bones of three of the skeletons as had been preserved. From the measurements of the lower limb-bones of these three skeletons and those of the others measured by Mr. Mortimer, the author finds that the average stature of the skeletons is 1.667 m. estimated from the femur and tibia, and 1.665 m. from the femur alone. The shortest had an indicated stature of 1.555 m. estimated from the femur and tibia, and of 1.546 m. from the femur. The tallest was 1.939 m. estimated from the femur and tibia, and 1.890 m. from the femur alone. Excluding this very tall skeleton the average of the others is 1.619 m. from the femur and tibia, and 1.642 m. from the femur. The femur of the tall skeleton has been fortunately preserved, and was measured by the author.

The form of the skull viewed from above is that of an elongated oval. In most cases the walls appear very straight. The frontal region is narrow, and there is no bulging of the occipital region, the outline being, as a rule, very regular. The muscular ridges are feebly developed, the glabella and superciliary ridges are also feebly developed. The face is generally long and narrow, the orbital axes are depressed externally, the orbits themselves being in form either round, nearly square, or broadened rectangular. The interorbital width is narrow. The lower margins of the nasal openings are sharp. The maxillæ are orthognathous and the incisor teeth are vertical. The chin is generally pointed and sharp. The cephalic index of the eight adult skulls varies from 66.5 to 79.6. Five of the specimens are hyperdolichocephalic, one is dolichocephalic, and two are mesaticephalic. The cephalic index of the tall skeleton is 68.8. The other skulls found were those of children, and are consequently not included. These eight specimens include all the adult males found in and about the graves in the centre of the barrow.

In stature and the characters of the skull these specimens appear in all respects to be identical with the specimens found in long barrows of the dolichocephalic people admitted to be the earliest known inhabitants of Britain, whose skeletons are still available for examination. They are found in the interior of this round barrow, it will be noted, associated with flint implements only, and with no trace of the metal objects usually found in round barrows with brachycephalic skulls,

while these metal articles were found in the outer layer, which, from its contents, is evidently of later date and superadded to the original inner barrow.

5. *On Comparison of Ancient Welsh Customs, Devices, and Commerce, with those of Contemporary Nations.* By DR. PHENÉ, F.S.A.

It was pointed out that the present age, which is one enriched from commerce, science, and the arts, has, to a great extent, ceased to be influenced by heraldry, which is naturally connected with military advancement. But that, as a matter of history, the great influence it once had on the progress of civilisation in securing victory or averting defeat made it a subject well worthy review.

Though no written code of heraldic law is known to have existed in ancient times, yet the customs of different people in connection with their banners and ensigns indicate the important part they bore among conquering nations.

It is shown from the writings of Sidonius Apollinaris and others, that the Romans worshipped the image of the Emperor, which was attached to the staff of the standard eagle and other devices; and Constantine, taking advantage of this fact, and abhorring such profanity, placed the emblem of the new faith which he upheld in the place previously so occupied. It is impossible to imagine a more imperative call to conquest. The contempt with which the Romans at first treated the subject, by elevating a tuft of straw on a pike as an ensign, was no doubt changed on finding that the nations they combated elevated the objects they worshipped, and became obstinately brave around them. These being conquered and amalgamated with the Roman soldiers would be allowed either to carry their own banner or would see it at the head of their legion, thus preventing desertion and ensuring allegiance. The eagle was the standard of the legions, but each cohort carried a banner with a serpent woven on it called *dracôn* (the dragon),¹ which was carried by the *draconarius*. The Gauls and all the Gallic tribes are shown to have borne the dragon, distinguishing their tribes by the colour of their banner. Drayton gives the colour of the dragon of Wales to be red, and the dragon of England white. The Bayeux tapestry shows the banner of William the Norman to be the old Norse dragon, and he is also surrounded with dragon ensigns of the Keltic people, whose alliance he hoped for, or had already secured. When England and Scotland were at war, the great Scotch seals always exhibit the dragon as supporters in the various reigns; there are always more than one indicating the alliance with Wales, Ireland, and sometimes with Scandinavia.

The subject is of Oriental origin. Agamemnon had *three* dragons emblazoned in brilliant colours on his breast-plate. The Trojans also used the serpent for a device, it being sacred with them. When the two serpents from Tenedos had killed the Trojan priest, Laocoon, who had offended Apollo, they calmly retired to the shrine of Minerva, whose emblem was a serpent. She being the goddess of wisdom, it is not improbable that the term 'wise as serpents' arose from this. The Gallic dragon and the Roman eagle occupy equally the grand summit of the old papal mint at Avignon.

Dragon ceremonies still exist in several parts of Europe, and till recently were in use on the great main roads leading to Wales. On these roads are also vast draconic simulations. There is a cave of worship at Sarphe, near Llangollen in Denbighshire, beneath the head of a vast natural outcrop of white quartz, which assumes the undulations of a huge serpent. The name of the spot is '*The Place of the Serpent*;' the traditions attached to it are extraordinary. The late Welsh poet 'Ceiriog' adopted his name—his family name being Hughes—from what he called the inspiration given him at this place—the stream Ceiriog running at the foot of the hill on which the serpent reclines.

This information was privately given to Dr. Phené, who now—the poet being dead—considers it the property of the Welsh bards, it being, as it were, an inspiration from the Pythian Apollo of Parnassus.

¹ Also called *textilis anguis*.

In Stow's Annals an elaborate description is given of a procession of Queen Elizabeth on a throne chariot having a Lion on one side and a Dragon on the other, as supporters of the Arms of England.

Other customs of the early (Welsh) Britons were found to agree, like that of the Draconarius, with Roman, or rather with Italian customs, for they still exist in rural Italy. For example, the wooden constructions described by Cæsar as the residences of the Britons are still used in Latium. The one recorded to have been the house of Romulus (*Casa Romuli*) was preserved by the Romans on the Capitoline Hill till the time of Caractacus. Dionysius of Halicarnassus mentions it in his history of Rome only a few years before. The standard of Caractacus being the same as that of the cohorts, and his appeal being probably suggested by the 'humble cottage' of their own founder, which was like his own, described by him as being in Britain, would have had so startling an effect that there is no wonder his chains were struck off. This singular fact shows that the customs of Italy were not unlike those of the Welsh; though Caractacus and his relations were pardoned, they preferred to locate themselves in Italy and did not return home.

There was reason to think, from recent discoveries, that the great trade in metals and metallic works of art extended to the British Islands in times before the Phœnician traffic. The bronzes of Etruria, as pointed out by Mr. Dennis, have been found 'from Switzerland to Denmark, and from Ireland to Hungary.' This being so, and there being a chain of ports from Basta in Apulia, by those of the Bastetani, the tin workers in Spain, the name of Bassenthwaite in Cumberland and Bassaleg near Cardiff indicate a commercial connection between those places and Italy. It is not improbable that Basselg was in remote times the name of the port, as the word is equivalent to bright metal, and an old Italian word. If so, the roads reputed to have been made by Mael Mutius to and from Caerleon, and the local Venta are well accounted for.

6. *The First Sea-Wanderings of the English Race.* By W. M. ADAMS.

7. *Points of Contact between Old-world Myths and Customs and the Navajo Myth entitled 'The Mountain Chant.'* By A. W. BUCKLAND.

In presenting a slight sketch of a very curious myth of the Navajo Indians of New Mexico, which, under the name of 'The Mountain Chant,' is given at length in the 'Smithsonian Report of the Bureau of Ethnology,' vol. v., Miss Buckland draws attention to the numerous points in which the myth reproduces customs and beliefs of the Old World. Among these may be cited the singular prohibition against eating food in the under-world or abode of spirits, such as appears in the classical story of Persephone, but which is found slightly modified in the fairy folk-lore of Europe, in Aino and Japanese tales, and in New Zealand. In the American myth the prohibition is four times repeated in the abodes of gods in the form of animals. Then there is the ceremonial cutting of the hair of children in their fourth year, which is both an American and Japanese custom. The use of the *swastika* is also traced, both among the Navajos and the Japanese, and in both countries special reverence is paid to the cardinal points, which in America are symbolised by particular colours. The ceremonial use of flint implements in the Navajo rites is also noteworthy, and several other points in the myth denote a very early origin.

The great peculiarity in the healing rites, which are held in connection with the Navajo myth, are the use of sacrificial sticks, variously painted and adorned with beads and feathers, and buried in accordance with traditional usage, and the making and erasing, on the same day, of large sand pictures, regarded as of great sanctity and special healing power, the pigments from the forms of the gods depicted being applied to the similar afflicted parts of the patient's body.

Miss Buckland points out the great contrast between these bloodless Navajo

rites and the sanguinary ceremonies of the ancient Mexicans, and the dissimilarity in the forms of the Navajo and Mexican gods as denoting an entirely different origin for the two religions, incompatible with the belief, commonly entertained, of the wholly indigenous character of American culture, and believes that the Navajo rites point unmistakably to an Eastern origin.

8. *East Central African Customs.* By Rev. JAMES MACDONALD.

The author introduced the subject by a reference to the great dispersion in the plain of Shinar, and the tenacity with which man had clung to the slender stock of ideas in the land of his strangership.

The customs dealt with ranged over the whole domestic and social life of the people. He began by an account of trial by ordeal which is universal in the Lake region. The trial begins in open Court when evidence is led, but as it never occurs to anyone to tell the truth, the cause is usually decided by the accused drinking the poison bowl. If he vomits the poison he is innocent, even should he have been caught red-handed. There are times when the poison bowl is administered to large numbers by the magicians. This is to weed out thieves, wizards, and other undetected criminals.

At puberty boys are circumcised, and girls go through a process of initiation into womanhood. The former are now men, and discard all labour for the duties of war and hunting.

A man who wishes to form a new village community selects a site and strengthens his position by inducing others to join their fortunes to his; by the purchase of slaves; marrying slave wives, and raiding with the view of capturing slaves. When he has established his position, the village is recognised by the chief and comes under the general tribal laws and customs.

Under these laws a man holds as many slaves as he can capture or purchase. They are his absolute property, and the law permits a man to kill a slave, but should he do so unjustly, 'the flesh will melt off his bones and he will die.' Slaves have a *quasi* right to property, and often get rich under their masters. Should they be sold or die, the property reverts to the master.

Slaves and all property, as well as tribal and governing rights, descend not to a man's sons, but to his brother, the son of his own mother, or, failing that, to his sister's son. This is to make sure that the family blood is in his veins. Wives, like slaves, may be had by purchase, by presentation, or by raiding. An unborn infant may be—conditionally—betrothed; children of a few days old frequently are.

In all public undertakings the oracle must be consulted by means of divination. This may be by pouring out flour, which if it forms a perfect cone is favourable, or by shaking the contents of a gourd, teeth, pebbles, &c., and throwing them down as dice. Even after the omen is favourable, a rabbit or snake crossing the path on the first day stops the expedition.

Magicians have absolute power, and are in requisition in connection with every detail of life. They practise medicine, detect witches, protect crops, and generally are responsible for the conduct of all work during peace and war. The most formidable among them is the tribal prophetess. She sees the gods face to face, and dreams dreams which pertain to revelation. Her oracles are received without question, and when she orders a human sacrifice no one dare refuse her demands.

She travels about the country detecting wizards who cause sickness. This she does by assembling the whole community, and, after shouting and ranting among the crowd, touching each one's hand. The wizard's hand when touched is known to her, and he is summarily disposed of, but not before she has proved his guilt. This she does by finding the 'horns.' These are generally the horns of a small antelope, which are *par excellence* witches' horns. She finds the horns by ascending beside the stream, passing the patient's house, and at a certain spot, after much ceremony, digging them from the ground. She, meantime, has spent the previous night in the open air listening to spirit voices, while the villagers, on pain of being accused of witchcraft, must remain indoors. When she orders a human sacrifice

the victim is tied hand and foot to a forest tree and left for the night. If devoured by wild animals, the gods have accepted the offering; if not, he is thrown into lake or river or allowed to die of starvation. The slave was not worth the god's acceptance.

Like their Celtic sisters of the north of Scotland, African witches can by their arts 'steal the fret' of cows and goats. To this also the prophetess must see.

Murder, adultery, arson, and other serious crimes are capital. The murderer is handed over to the murdered man's relatives to be put to death in the manner most agreeable to their feelings and fancy. Arson is a crime in which the *lex talionis* is practised. House for house; field for field; the man's wives and family when he has nothing. Adultery and the law of marriage, in a land where chastity is hardly known, is a curious jumble. Divorce is granted for all sorts of small causes. Speaking disrespectfully of one's parents-in-law, neglecting to hoe the fields on the part of the wife, or the women's garment-mending on the part of the husband, is sufficient cause. At the same time adultery is punished in the most barbarous manner. A suspected wife is made to fish up a stone from a jar of boiling oil with her bare arm. As the injury is slight or severe she is innocent or guilty. If guilty, her head is placed in a huge kind of nut-cracker and squeezed to make her confess her lover's name. If she refuse, the torture may be continued till the walls of the skull collapse. A man may have determined to get rid of his wife because she neglected an afternoon's hoeing, but should he find her in an intrigue in the interval she is simply hacked to pieces. Some head men put all male offenders to death as they might interfere with their harems.

War in South Africa resolves itself into a cattle hunt; in Central Africa into a slave hunt, at times, it is to be feared, into a mutton hunt, for prisoners are now and then eaten by their captors.

Death is usually the work of wizards, and the magicians detect these, who are put to death. The dead are mourned for by beating of drums, wailing and weeping. Relatives shave their heads; in the case of a head man, the whole tribe do so. A votive pot is placed near the deceased's house where offerings are left. A slave may be killed to be buried with his master, so that the former 'may not go alone.' Mock funerals are common, at which the mourners attend to deceive demons, so that they may not get hold of the spirit of the departed. In this case the real funeral is conducted very quietly. Ancestor-worship is universal. The ancestors in the spirit-land are at peace. No Milton has set them by the ears. Lightning as an impersonal god is worshipped by some. Spirits may re-appear in material form, but never for good, always for evil.

Man and all animals came out of a hole in the earth which was 'closed by the great ancestor.' Monkeys were then human, but having quarrelled with their friends, went to live in the bush. To spite their relatives they began to pick up seeds sown. This tendency became hereditary, and so it is that monkeys cannot grow corn, as they pick up their own seed. Africans declare that monkeys play with firebrands when men leave fires in the forest, which may explain the wonderful sights witnessed by Emin Pasha.

The principal industrial arts are, working in metals and the pursuit of agriculture. In the former the Africans are making steady and sustained progress. Tradition points to an age of wooden spades and hoes; now iron is universal. This they smelt from its ore. In woodwork there does not appear to be the same progress made.

The minor customs and superstitions referred to incidentally by Mr. Macdonald were very numerous, and had reference to charms, sacred animals, how crows are always looking for seeds lost by an ancestor of theirs, and many others which are interesting not only to the ethnologist, but to all who wish to have an acquaintance with the habits of life among savage men. The chief must show unbounded hospitality, and the taxes must be light. How both these virtues are to be practised jurists do not define, but it has a curious resemblance to what was common among the Celtic clans two or three centuries ago.

9. *The Report of the Prehistoric Inhabitants Committee.*
See Reports, p. 549.

10. *The Report of the Elbolton Cave Committee.*—See Reports, p. 351.

TUESDAY, AUGUST 25.

The following Papers and Reports were read :—

1. *The Formation of a Record of the Prehistoric and Ancient Remains of Glamorganshire.* By EDWIN SEWARD.

Glamorganshire possesses a considerable number of those traces of the existence of man and his handywork which remain from the earliest historic and prehistoric periods. In caverns and fissures of the mountain limestone cliffs of Gower, in camps which crown their summits and those of the main ranges throughout the county, in tumuli and barrows elsewhere, and in Roman villas and dwellings discovered on the lower plains, are evidences of man through successive ages and varying stages of civilisation. One feature of much interest is the number and importance of ancient inscribed stones, many of which are still remarkable for beauty and intricacy of design in spite of the careless or mischievous treatment to which they have usually been exposed, even till very recently. In a district possessing heritages of such a kind, it is especially desirable that a systematic and comprehensive means of registering each of these objects of value should be set on foot and maintained, and that opportunities should be afforded for the further investigating, recording, and classifying all known examples, whilst also offering inducements and opportunities towards the discovery or efficient recognition of fresh ones.

Apart from a descriptive record, it is sought to indicate the nature and locality of these remains on maps, so as to produce a defined but progressive view of them as affecting, or as affected by, topographical conditions. Mr. Seward outlined the preliminary steps taken for organising the work of recording, and described a proposed method of utilising the smaller sheets of the Ordnance Survey for map purposes, showing also what has been done in the locality towards compiling a photographic survey of objects of interest, prehistorical and archæological.

2. *Instinctive Criminality : its true Character and National Treatment.*
By S. A. K. STRAHAN, M.D.

The instinctive criminal belongs to a decaying race, and is only met with in families whose other members show signs of degradation. In fact, instinctive criminality is but one of the many known signs of family decay. This is conclusively proven by the fact that the criminal's parents and relatives invariably show signs of decay, and that he himself has, in common with the idiot—which latter is the lowest form of human development consistent with a continuance of life—such grossly degenerate characters as a small, overlarge, and ill-shapen head, paralysis, squint, asymmetrical features, deformities; a shrunken, ill-developed body; abnormal conditions of the genital organs; liability to tubercular disease; premature decay of the tissues; large, heavy, misshapen jaws, outstanding ears, and a restless, animal-like, or brutal expression. The instinctive criminal lacks the moral sense as the idiot lacks the intellectual, and in both we find more or less deep degeneration affecting the whole economy, physical, moral, and intellectual.

Hereditary Character of Crime.—This has been known from very early times. It was advocated and demonstrated by Aristotle, yet it is only recently that this

view is approaching general acceptance. But what the writer wishes to impress is not that criminality is hereditary, that now being generally admitted, but the indisputable fact that it is interchangeable with other degenerate conditions, such as idiocy, epilepsy, suicide, insanity, prostitution, scrofula, drunkenness, &c., and that it is a mere chance whether the insanity or drunkenness, say, of the parent will appear as such in the child, or be transmuted in transmission to one or other of the above mentioned degenerate conditions.

Mode of Transmission.—Criminality here follows the same lines as other states of decay. In some cases it is transmitted through several generations unchanged, but this is rare. Occasionally a generation of criminals will appear in a decaying family as a generation of deaf-mutes or epileptics at times appears in the family of the scrofulous or insane diathesis. But in the majority of cases crime only appears in one, two, or three members of the family, the others showing the taint in various ways—*e.g.* one will be scrofulous or a deaf-mute, another insane, idiotic, or a prostitute, as the case may be.

Chief Sources of Instinctive Criminality.—All deteriorating influences are liable to result in crime as in other form of degeneration in the offspring. Alcoholism, however, is its most fruitful source. Rossi puts the percentage of drunkenness in parents of criminals at 43·6, Marro at 41, Wey at 38·7, and Tarnowsky, in the parents of prostitutes, at no less than 82·66. Here the environment must have an effect; but as education and example cannot account for the idiocy, epilepsy, deformity, &c., in the children of the drunkard, neither can it be held largely responsible for the crime and prostitution. Insanity, epilepsy, and suicide are often transmuted to crime in passing to the children. Of all persons convicted of murder in England and Wales in the decade 1879–88, 32 per cent. were found insane, and 32 per cent. more had their sentences commuted, many on the ground of mental disorder. A neurotic family history was found in criminals in Elmira Reform in 13·7 per cent. (parents alone); at Auburn, in 23·03; Rossi, 35.

Tubercular Disease is another cause. Great numbers of criminals are themselves tubercular—almost as many as of idiots—and it is common in their families. Tarnowsky found a phthisical parentage in 44 per cent. of prostitutes.

Senility and Immaturity of Parents are also fruitful sources of crime in the enfeebled descendants, as is proved by the statistics of Marro, Korosi, and others.

True Position of the Criminal.—He is not a free agent. He is as helpless against his instinct to crime as is the epileptic against his convulsion, or the suicide against the instinct which impels him to self-destruction. The great stumbling-blocks to the recognition of the criminal's true position are the doctrine of 'free-will,' and the belief that all come into the world with a certain regular quantum of moral sense. These are fundamental errors. When we accept the fact that moral feeling and volitional power are not unvarying gifts, but depend as much upon the proper development and healthy action of the higher nervous centres as does the exercising of any other intellectual function whatever, we shall see that the suicide without reasonable cause, his sister who becomes a prostitute, his brother who does murder at the command of a voice from heaven, and the other member of the family who is an incurable thief, are all equally the victims of a vicious organisation. This has been practically admitted by the recognition of the dipso- and klepto-maniac; but if justice is to be done, the system must be largely extended.

Present Treatment.—The present system has proved a disastrous failure. Short periods of punitive imprisonment can have no effect upon the instinctive criminal, either curative or deterrent. The records read in our courts daily prove this, and the present system must go after the whip and chain of the maniac.

Proposed Treatment.—Everything points in the direction of prolonged or indefinite confinement of the instinctive criminal and habitual drunkard in industrial penitentiaries. Upon detection as such, they would be permanently confined, as our imbeciles and incurable lunatics are at present, but with this difference. In these homes the inmates would be taught trades, &c., and would receive, with liberty to spend in any reasonable way, all they might earn over and above the cost of their maintenance. This would not only protect society against its anti-

social members, but it would protect these against themselves, while, by keeping the sexes apart, it would have an immediate and marked effect upon the production by propagation of the criminal classes. This system—at once Christian, humane, and economical—has been tried with success in America. Lifelong detention has not been found by any means necessary in all cases. Offenders captured young and taught morally and intellectually so far as may be possible, and also some trade, and made to feel that they really can earn an honest livelihood, will benefit most. Many such may be given a chance outside under surveillance, or may be turned free with safety to society; their anti-social instincts being sufficiently blunted as to be overcome even under the feeble will-power of their unfortunate owners.

3. *The Anthropometric Method of Identifying Criminals.*

By J. G. GARSON, M.D.

In daily life cases of difficulty not unfrequently occur in the identification of persons living or dead, or after accident, such as a railway collision, and in police-courts it is especially common, for evil-doers make a point, as far as possible, of concealing their identity. In 1879 M. Bertillon submitted to the Prefecture of Police of Paris a plan for the identification of criminals, founded upon the measurement of certain bony parts of the body not liable to alteration with age or accident. The plan had been adopted, and has been in use with signal success in Paris since 1882. Before the introduction of Bertillon's system, photographs and vague descriptions, much the same as those still used by the English police, were the only means for identifying persons previously convicted of crime. As time went on, the number of photographs of criminals increased so rapidly that in a few years they exceeded 100,000, and it was found that the system was almost if not altogether unworkable. By Bertillon's system these photographs and descriptions of criminals are divided primarily into three groups, according to whether their stature is tall, medium, or short. By the length of the head, these groups are still further subdivided into persons with long, medium, and short heads. A third measurement, the breadth of the head, divides the number in each group still more, according as the head is broad, medium, or narrow; and by other measurements groups are reduced to a number of smaller ones. The various descriptions and photographs are arranged in a series of drawers with subdivisions corresponding to the different measurements and their subdivisions. When a person is brought to the police-station, the first thing done is to ascertain if he is an old offender, and has been measured before, by taking his principal measurements and afterwards referring to the cabinet containing the descriptions and measurements of criminals. The measurements one by one guide the officer to the exact division of the cabinet where the description of the prisoner will be found. Should the prisoner's height when previously measured have been, say, just within the tall division, and now is at the upper end of the medium division, the officer, on not finding him in the medium division, would search for him in the tall group, just as he would look for a word in the dictionary about the spelling of which he was in doubt. The measurements relied upon in Bertillon's system are:—(1) Height of body; (2) length of head; (3) breadth of head; (4) length of middle finger (left); (5) length of little finger (left); (6) length of forearm; (7) length of foot (left); (8) length of span; (9) length of ear (right); (10) breadth of ear (right); (11) length and exact position of scars, moles, &c.; (12) colour of eyes and hair. The instruments used by M. Bertillon were exhibited, and the method of using them was shown. The whole operation of measuring a prisoner and taking his description occupies one officer and an assistant only seven minutes. The success with which the system has been attended may be judged of from the following facts: criminals who have tested the certainty with which they can now be recognised seldom give *aliases*; the number of identifications of previous offenders has greatly increased, and many known criminals have found it convenient to change the scene of their actions to places where the system is not in force. In the many thousands of cases tested there had not been one of mistaken identity.

The addition to the measurements of the prints of the impressions of the fingers, recently recommended by Mr. Francis Galton, would, in the author's opinion, be very valuable for personal identification. In conclusion the hope is expressed that Bertillon's system will soon be introduced into general use in this country.

4. *Recent Hittite Discoveries.* By Dr. PHÉNÉ, F.S.A.

A careful description of the monuments now known to be Hittite, but which term had not been used when Dr. Van Lennep wrote, was given, and Dr. Phéné was able to draw inferences from the examination of the monuments before they were known to be Hittite, and the new light which Professor Sayce, Sir Charles Wilson, and Professor Ramsay have thrown upon them. This was very interesting, as the older drawings by Texier and other travellers were found very much more to support the description by Herodotus than some of the new ones. And, while they all alike tended to confirm the fact that they belonged to a special people, who had a style of writing of their own, and which people and writings are now known under the term 'Hittite,' there was every reason to suppose the figures at Nymphi were those of the Egyptian king, Ramses II., known also as Ramses the Great, and also as Ramses—Sesostris, although 'Sesostris' was not found on his monuments, and was perhaps a family name. Dr. Phéné gave his own reading of the symbols at Nymphi as follows:—The symbols are a *crouching* bird on a level with the face of the victorious Sesostris, and close to it a sceptre; above it a sign frequently found in Hittite inscriptions, of a staff with smaller ones on each side, which symbol he considered was equivalent to the people—*i.e.* of high and low degree; and following this a broken sceptre. The bird usually found in Hittite inscriptions, as at Jerabis, is the eagle, and the position is one of majesty, which he considered implied kingly power, and hence the crouching and humbled bird was a king bereft of his power. The metaphor is purely Oriental, and in continual use in the Hebrew writings, 'a bird of the air shall tell the matter'—'mine enemies chased me like a bird'—'they shall tremble as a bird out of Egypt,' meaning clearly, escaped from the crushing power of Egypt. The broken reed or sceptre is also continually used as a sign of weakened power, so that reading from right to left the symbols read—The bird announces to the conqueror—'The sceptre, great conqueror, is yours'; 'Great and small (*i.e.* the nobles and people) follow; the sceptre of the vanquished is broken.' Several other of Dr. Phéné's readings, as of the inscription on Mount Sipylus, were given, as very strongly to support the views of Mr. Dennis as to this sculpture being the goddess Cybele, and not Niobe, and Dr. Phéné produced an ancient mace procured by him in Sivas, the head of which was the same symbol, as appears in the inscription near the figure. Dr. Phéné referred to the valuable comparison of Hittite and Cypriote letters made by Professor Sayce at the suggestion of Canon Taylor, and pointed out that the least powerful one—that of o = u—was not only capable of amendment, but of being put beyond question, as besides the evidence used by Professor Sayce, the actual V of the Cypriotes appears in the Hittite inscription on Mount Sipylus. The author further expressed his opinion that the figures at Iasili, Kaia, &c., were older than the Assyrian sculptures, and that in them were the ideas carried out in Assyrian art. The figures standing upon the animal forms in the Hittite carvings being finally combined with the animals in the Assyrian work. Dr. Phéné's attention was, however, more engaged with a remarkable Cyclopean temple on the Star mountain near Tokat than with the rock sculptures, which, when he visited them (and nearly all of which are illustrated in Dr. Van Lennep's book), were generally considered as a low class of Assyrian or Persian art.

One of the most important points of this journey had been the investigation of Cyclopean buildings, and this grandly elevated temple, which is semicircular in form, corresponds exactly with others he has found, one of which is in the centre of the Island of Minorca. The one in Anatolia, which he considers was the great temple of the district, is in the locality of the most remarkable Hittite sculptures. It is on the most westerly and the largest of a number of mounds running from east to west in a serpentine course. In conclusion, Dr. Phéné described two

sculptured groups, which appear to give a complete representation of the story of the Flood, and the district being so near Mount Ararat, it is less surprising that it should be so, as Armenia abounds with the tradition.

5. *Account of the Similkameen Indians of British Columbia.*

By Mrs. S. S. ALLISON.

The tribe at present inhabiting the upper valley of the Similkameen are immediately descended from a small band of the warlike Chilcotins, who established themselves in the upper valley of the river about a hundred and fifty years ago, and intermarried with the Spokans. They have much deteriorated, both physically and mentally, within the last twenty years, and are rapidly becoming extinct. The average stature of the men is about five feet six inches; their frames are lithe and muscular, and their movements quick and graceful. Their complexion is very light, and they have small hands and feet. The colour of their hair varies from jet-black to red-brown, and in some cases it is almost curly. They are born horsemen and capital shots. The sharp horns of the mountain goat were formerly fixed on shafts of hard wood and used as spears both in hunting and warfare; stone knives and hatchets were also used.

The summer dwellings of the Similkameen Indians were made of mats of cedar bark, manufactured by the Hope Indians, which were thrown over a circular frame of poles. The winter houses were simply pits dug in the ground and roofed with poles and earth. All sickness was supposed to be the work of an evil spirit, who fastened on a victim and hung on, drawing away his life, until charmed away by the doctor, who worked himself into a state of frenzy, singing and dancing while he was trying to lure the evil spirit from his patient. Many of the medicine-men exercise strong mesmeric power over their patients, and they use several herbs as medicines; their panacea for all ills, however, is the vapour-bath.

When an Indian died he was laid out in state on a couch of skins; everything put on the body was new; his bow and arrows were laid at his side, along with his knife. His friends then assembled round him to feast, and when the feast was over his friends advanced, and taking his hand bade him farewell. Immediately after a funeral takes place the encampment is moved, lest the spirit of the deceased should revisit it.

A widow or widower is forbidden to eat meat and certain vegetables for a month, and must wear quantities of spruce bush inside their shirts, next their skin.

Cannibalism was never known among the Similkameens.

In the mountain is a certain stone which is much venerated by the Indians, and it is said that striking it will produce rain.

Polygamy was allowed, and if the husband and wife tired of each other, the price of the woman, or its equivalent, was returned by her father or guardian, and the parties were then free to contract another matrimonial alliance; but adultery, though it was generally compromised, was sometimes punished by cutting off the woman's nose or slitting her ears.

Occasionally sick persons were buried before they were quite dead, and a good deal of infanticide was practised.

The author has not found these Indians to be thieves, and gives them a general good character in other respects.

6. *Nicobar Pottery.* By E. H. MAN.

In a brief but fairly exhaustive paper on the pottery made and used by the Nicobar Islanders, Mr. Man stated that the little island of Chowra has held for generations a monopoly of the manufacture, and the entire work of preparing the clay, as well as moulding and firing the finished utensil, devolves on the females of the community.

No traditions are apparently extant regarding the origin of the art, but a superstitious belief is entertained that an earthquake or sudden death would result from any rash endeavour to introduce the industry into any other island of the Archipelago, and a case is cited which to the Nicobarese mind is sufficiently confirmatory of the danger of attempting to act in contravention of the customs of their ancestors.

The inhabitants of the island appear to guard somewhat jealously this their art, and natives from the other islands, who accompanied Mr. Man when he was so fortunate as to find the manufacturers at their trade, had never before been permitted to witness the process now described in its various stages.

The value of 'trade-marks' is recognised, and before a vessel is fired the device of its maker is affixed; to their credit, be it noted, care is taken that the 'rights' of other makers are not infringed by the adoption of any symbol which might lead to confusion.

The amount of pottery manufactured during the year cannot of course be ascertained with any degree of accuracy, but it would seem to be considerable. Experience having taught them that pots are more serviceable if allowed to harden gradually, it is their practice to store all newly-made utensils on a lattice-platform (*lenpā*) in the roof of their huts, where in the course of a year the combined action of heat and smoke renders them hard and durable.

Indian pots and jars are readily purchased from the traders who visit the islands from time to time, and these, though preferred to the home-made article on account of their greater durability, are deemed unsuitable for certain of their culinary operations. There is also a latent fear lest the local manufacturers—should say nothing of the Higher Powers—should actively resent any exclusive use of imported utensils.

No vessels are made specially by the Nicobarese for funeral purposes, but in accordance with the almost universal custom of uncivilised races cooking pots are among the personal and household requisites which are laid on a grave after an interment.

Mr. Man illustrated his paper with two photographs, showing a group of Nicobarese potters engaged upon their craft; he further expressly denied that they had the knowledge of any implement answering the purpose of a 'potter's-wheel.'

7. *Report of the Anthropometric Laboratory Committee.*
See Reports, p. 405.

8. *Report of the 'Anthropological Notes and Queries' Committee.*
See Reports, p. 404.

9. *Report of the Indian Committee.*

[The Committee were unable to present a Report this year.]

INDEX.

[An asterisk (*) signifies that no abstract of the communication is given.]

- O**BJECTS and rules of the Association, xxiv.
- Places and times of meeting, with names of officers, from commencement, xxxiv.
- List of former Presidents and Secretaries of Sections, xliii.
- List of evening lectures, lx.
- Lectures to the Operative Classes, lxiii.
- Officers of Sections present at Cardiff, lxiv.
- Treasurer's account, lxvi.
- Table showing the attendance and receipts at the annual meetings, lxviii.
- Officers and Council for 1891-92, lxx.
- Report of the Council to the General Committee at Cardiff, lxxi.
- Committees appointed by the General Committee at Cardiff: 1. receiving grants of money, lxxvi; 2. not receiving grants of money, lxxx; other resolutions adopted, lxxxiv; resolutions referred to the Council for consideration, and action if desirable, *ib.*
- Synopsis of grants of money appropriated to scientific purposes, lxxxv.
- Places of meeting in 1892 and 1893, lxxxvi.
- General statement of sums which have been paid on account of grants for scientific purposes, lxxxvii.
- General meetings, c.
- Address by the President, Dr. William Huggins, F.R.S., F.R.A.S., Hon. F.R.S.E., &c., 3.
- Abel (Sir F.) on the best method of establishing an international standard for the analysis of iron and steel, 273.
- Abracromby (Hon. R.) on meteorological observations on Ben Nevis, 140; on arranging an investigation of the seasonal variations of temperature in lakes, rivers, and estuaries, 454.
- Abney (Capt.) on electrolysis in its physical and chemical bearings, 122; on the best methods of recording the direct intensity of solar radiation, 160; on the preparation of a new series of wave-length tables of the spectra of the elements and compounds, 161; on the action of light upon dyed colours, 263; on the absorption spectra of pure compounds, 275.
- Aborigines of Western Australia, Miss E. M. Clerke on the, 716.
- Absolute units of measurement, by W. Moon, 580.
- Absorption of heat in the solar atmosphere, W. E. Wilson on the, 557.
- Absorption spectra of pure compounds, provisional report on the, 275.
- Acclimatisation, Dr. R. W. Felkin on, 715.
- Action of light upon dyed colours, interim report on, 263.
- Action of screw propellers, by Major R. de Villamil, 780.
- Adams (Prof. W. G.) on the best means of comparing and reducing magnetic observations, 149; on standards for use in electrical measurements, 152.
- *Adams (W. M.), the first sea-wanderings of the English race, 808.
- Adeney (W. E.) on the formation of peaty colouring matters in sewage by the action of micro-organisms, 612.
- Africa, the application of Indian geographical survey methods to, by Lt.-Col. T. H. Holdich, 717.
- , south-west, the geography of, by Dr. H. Schlichter, 719.
- African, east central, customs, by Rev. J. Macdonald, 809.
- African lands, the comparative value of, A. S. White on, 715.

- Agriculture in India, the recent progress of, by C. L. Tupper, 532.
- Alcohol and ether, the surface tension of, at different temperatures, by Prof. W. Ramsay, 565.
- *Alkaline hypochlorites, the action of heat on, by Prof. H. M'Leod, 609.
- *Allen (A. H.), the reaction of glycerides with alcoholic potash, 613.
- Allison (Mrs. S. S.), account of the Similkameen Indians of British Columbia, 815.
- Alloys, the electrolysis of, note on, by H. C. Jenkins, 613.
- Alloys of gold and tin, the existence of a compound in, A. P. Laurie on, 607.
- Aluminium, a latent characteristic of, by Dr. A. Springer, 583.
- Ammonites jurensis* in the ironstone of the Northampton sands, in the neighbourhood of Northampton, E. T. Newton on the occurrence of, 655.
- Ammonite*-zones of Dorset and Somerset, S. S. Buckman on certain, 655.
- Anatomical nomenclature, Prof. W. Krause on, 682.
- Anderson (Dr. T.) on the collection, preservation, and systematic registration of photographs of geological interest in the United Kingdom, 321.
- Anderson (Dr. W.) on the investigation of the action of waves and currents on the beds and foreshores of estuaries by means of working models, 386; on the revolving purifier for the treatment of water by metallic iron, 762.
- Antarctic exploration, by E. D. Morgan, 719.
- *'Anthropological Notes and Queries,' report of the Committee for editing a new edition of, 404.
- Anthropological Section, Address by Prof. F. Max Müller to the, 782.
- Anthropometric laboratory, report of the Committee for carrying on the work of the, 405.
- Anthropometric method of identifying criminals, the, by Dr. J. G. Garson, 813.
- Antiquity of man, the relation of the glacial period in North America to the, recent discoveries concerning, by Prof. G. F. Wright, 647.
- , the relation of the lava beds of California and Idaho to the, by Prof. G. F. Wright, 651.
- Apparatus, a simple, for the cultivation of small organisms in hanging drops, and in various gases, under the microscope, Prof. M. Ward on, 678.
- Appendicularian 'haus,' new form of, by G. Swainson, 701.
- Archaean gneiss of the North-west Highlands, some recent work of the Geological Survey in the, Sir A. Geikie on, 634.
- Arlidge (Dr. J. T.) on the data available for determining the best limit (physically) for hours of labour, 746.
- Armstrong (Prof. H. E.) on electrolysis in its physical and chemical bearings, 122; on isomeric naphthalene derivatives, 265; on the direct formation of haloid compounds from pure materials, 274; on the absorption spectra of pure compounds, 275; on the teaching of science in elementary schools, 383.
- Art of observing, the, by J. Coles, 714.
- Assam, the natives of, the 'morong' and other customs of, S. E. Peal on, 801.
- *Auburtin (F.), Le Play's method of systematic observation, 747.
- *Axon (W. E. A.), the increase of food and population, 747.
- Ayrton (Prof. W. E.) on standards for use in electrical measurements, 152.
- and Prof. Rücker on the magnetic field in the neighbourhood of the South London electrical railway, 581.
- Bacteria, nuclear structure in the, H. Wager on, 681.
- Badger (E. W.) on the disappearance of native plants from their local habitats, 359.
- *Bakhtiari country, the, and the Karun river, by Mrs. Bishop, 722.
- Balfour (Prof. B.) on the steps taken for establishing a botanical laboratory at Peradeniya, Ceylon, 358.
- Ball (Sir R.) on a geometrical illustration of a dynamical theorem, 566; the cause of an ice age, 645.
- Ball (Dr. V.) on the collection, preservation, and systematic registration of photographs of geological interest in the United Kingdom, 321.
- Bamford (H.) on the investigation of the action of waves and currents on the beds and foreshores of estuaries by means of working models, 386.
- Barbaric elements in ancient Greece and Italy, by Prof. G. H. Jones, 803.
- Barlow (W.) on the connection between the crystal form and the chemical composition of bodies: the symmetry of crystals accounted for by the application of Boscovich's theory of atoms to the atoms of the chemist, 581.
- Barrett (Prof.) on the various phenomena connected with the recalcrescent points in iron and other metals, 147.
- Barrington (R. M.) on making a digest of the observations on the migration of birds, 363.
- Bar-subtense survey, by Col. H. Tanner, 718.

- Basalt, the specific heat of, Profs. W. C. Roberts-Austen and A. W. Rücker on, 610.
- Baerman (H.) on the volcanic phenomena of Vesuvius and its neighbourhood, 312.
- Beaumont (W. W.) on the internal and external work of evaporation, 777; on a new system of screw propulsion with non-reversible engines, 779.
- Beddoe (Dr.) on editing a new edition of 'Anthropological Notes and Queries,' 404.
- Bedford (J. E.) on the collection, preservation, and systematic registration of photographs of geological interest in the United Kingdom, 321.
- *Bell (Dr.), Colorado, 720.
- Ben Nevis, meteorological observations on, report of the Committee for co-operating with the Scottish Meteorological Society in making, 140.
- Bénier (M.), the Bénier hot-air engine, 775.
- Bennett (A. R.) on the telephoning of great cities, 769; an electrical parcel exchange system, 774.
- Bennett (A. W.), non-sexual formation of spores in the Desmidiaceæ, 678.
- Berbers, the Morocco, by J. E. B. Meakin, 804.
- Bevan (Rev. J. O.) on the upbringing of destitute and pauper children, 745.
- Bibliography of solution, fifth report on the, 273.
- Bibliography of spectroscopy, third report on the, 264.
- Bidwell (S.) on electrolysis in its physical and chemical bearings, 122.
- Biological Section, Address (on growth-curvatures in plants) by F. Darwin to the, 660.
- *Bishop (Mrs.), the Bakhtiari country and the Karun river, 722.
- Blandford (Dr.) on the present state of our knowledge of the zoology of the Sandwich Islands, and on the steps taken to investigate ascertained deficiencies in the fauna, 357.
- Bles (E. J.) on the occupation of the table at the zoological station at Naples, 372.
- Bloxam (G. W.) on the work of the anthropometric laboratory, 405; on the North-Western tribes of the Dominion of Canada, 407.
- Boas (Dr. F.) on the Indians of British Columbia, 408.
- Bolton (H.), note on boulders at Darley, near Matlock, Derbyshire, 650.
- Bonney (Prof. T. G.) on the work of the Corresponding Societies Committee, 41; on the erratic blocks of England, Wales, and Ireland, 276; on the collection, preservation, and systematic registration of photographs of geological interest in the United Kingdom, 321.
- Botanical laboratory at Peradeniya, Ceylon, fifth report on the steps taken for establishing a, 358.
- Botany and zoology of the West India Islands, fourth report on the present state of our knowledge of the, 354.
- Bothamley (C. H.) on the direct formation of haloid compounds from pure materials, 274; *the interpretation of certain chemical reactions, 612.
- Bottomley (J. T.) on electrolysis in its physical and chemical bearings, 122; on standards for use in electrical measurements, 152.
- Boulders at Darley, near Matlock, Derbyshire, notes on, by H. Bolton, 650.
- Bourne (S.) on the teaching of science in elementary schools, 383.
- Bower (Prof.) on the steps taken for establishing a botanical laboratory at Peradeniya, Ceylon, 358.
- Bramwell (Sir F. J.) on the advisability and possibility of establishing observations upon the prevalence of earth tremors, 333.
- Bright streaks on the moon, the probable nature of the, Dr. R. Copeland on, 576.
- British fossils, the registration of all the type specimens of, second report on, 299.
- Brown (Prof. A. Crum) on electrolysis in its physical and chemical bearings, 122; on meteorological observations on Ben Nevis, 140.
- Brown (J.) on electrolysis in its physical and chemical bearings, 122; on Clausius' theory of electrolytic conduction, and on some secret evidence for the dissociation theory of electrolysis, 564.
- Brown (M. W.) on the advisability and possibility of establishing observations upon the prevalence of earth tremors, 333.
- Brown (T. F.) on the coal question, 736; address to the Mechanical Section by, 749.
- Browne (M.), notes upon *Colobodius*, a genus of mesozoic fossil fishes, 644.
- Bryan (G. H.) on the present state of our knowledge of thermodynamics, specially with regard to the second law, 85; researches relating to the connection of the second law with dynamical principles, *ib.*; on a simple mechanical representation of Carnot's reversible cycle, 558.
- Buchan (Dr. A.) on meteorological observations on Ben Nevis, 140; on arranging an investigation of the seasonal variations of temperature in lakes, rivers, and estuaries, 454.

- Buchanan (J. Y.) on arranging an investigation of the seasonal variations of temperature in lakes, rivers, and estuaries, 454.
- Buckland (Miss A. W.), points of contact between old-world myths and customs and the Navajo myth entitled 'the Mountain Chant,' 808.
- *Buckle (H. D.), journeys to the Lake Ngami region, 719.
- Buckman (S. S.) on certain *Ammonite*-zones of Dorset and Somerset, 655.
- Bund (J. W.) on arranging an investigation of the seasonal variations of temperature in lakes, rivers, and estuaries, 454.
- Burial customs of New Britain, by Rev. B. Danks, 802.
- Burroughs (S. M.), free travel, 740.
- Bute (the Marquess of) on the ancient language of the natives of Tenerife, 799.
- Calderwood (W. L.) on recent investigations of the Marine Biological Association (fishery and physical), 685.
- Cameron (A. C. G.) on the continuity of the Kellaways beds over extended areas near Bedford, and on the extension of the Fuller's earth works at Woburn, 636.
- Campbell (G. L.), miners' thrift, and employers' liability: a remarkable experience, 737.
- Cannan (E.), recent changes in the distribution of population in England and Wales, 747.
- Capital and labour—their differences and how to reconcile them, by C. H. Perkins, 735.
- Capture of comets by planets, the, especially their capture by Jupiter, Prof. H. A. Newton on, 511.
- Carnot's reversible cycle, a simple mechanical representation of, G. H. Bryan on, 558.
- Carpmael (C. H.) on the best means of comparing and reducing magnetic observations, 149.
- Carruthers (Mr.) on the present state of our knowledge of the zoology and botany of the West India Islands, and on the steps taken to investigate ascertained deficiencies in the fauna and flora, 354; on the steps taken for establishing a botanical laboratory at Peradeniya, Ceylon, 358.
- Cayley (Prof.) on calculating tables of certain mathematical functions, 129; on carrying on the tables connected with the Pellian equation from the point where the work was left by Degen in 1817, 160.
- Changes in coast lines, by Dr. J. S. Phené, 716.
- Channel tubular railway, Sir E. Reed on the, 758.
- *Chatterton (G.), the Ystradyfodwg and Pontypridd main sêwera, e, 757.
- Chattock (A. P.) on the discharge of electricity from points, 139; on the electrification of needle points in air, 565.
- *Chemical reactions, the interpretation of certain, by C. H. Bothamley, 612.
- Chemical Section, Address by Prof. W. C. Roberts-Austen to the, 584.
- Chinese, the social and religious ideas of the, as illustrated in the ideographic characters of the language, by Prof. R. K. Douglas, 796.
- Christie (W. H. M.) on the best means of comparing and reducing magnetic observations, 149.
- *Christy (M.), trees and prairies, 715.
- Chrystal (Prof. G.) on the best means of comparing and reducing magnetic observations, 149; on standards for use in electrical measurements, 152; on arranging an investigation of the seasonal variations of temperature in lakes, rivers, and estuaries, 454.
- Clark standard cells, the causes of variation of, by J. Swinburne, 576.
- Clarke (W. E.) on making a digest of the observations on the migration of birds, 363.
- Clausius' theory of electrolytic conduction, J. Brown on, and on some secret evidence for the dissociation theory of electrolysis, 564.
- Clayden (A. W.) on the application of photography to the elucidation of meteorological phenomena, 130.
- Clerke (Miss E. M.) on the aborigines of Western Australia, 716.
- Clowes (Prof. F.), *an apparatus for testing safety lamps, 611.
- Clubb (J. A.) and Prof. W. A. Herdman on the innervation of the epipodial processes of some nudibranchiate mollusca, 692.
- Coal, the spontaneous ignition of, by Prof. V. B. Lewes, 602.
- Coal question, T. F. Brown on the, 736.
- *Coaling ships, description of Lewis and Hunter's system of, by C. Hunter, 763.
- Coast lines, changes in, by Dr. J. S. Phené, 716.
- Coles (J.), the art of observing, 714.
- Collins (W. H.) on the comparative values of various substances used as non-conducting coverings for steam boilers and pipes, 780.
- Colobodus*, a genus of mesozoic fossil fishes, notes upon, by M. Brown, 644.
- *Colorado, by Dr. Bell, 720.

- Comets, the capture of by planets, especially their capture by Jupiter, Prof. H. A. Newton on, 511.
- Comparative values of various substances used as non-conducting coverings for steam boilers and pipes, W. H. Collins on the, 780.
- Comparison, a, between the rocks of South Pembrokeshire and those of North Devon, by Dr. H. Hicks, 641.
- Comparison of eye and hand registration of lines in the violet and ultra-violet of the solar spectrum, against photographic records of the same, with the same instrument, after a lapse of several years, by Dr. C. P. Smyth, 573.
- Compound principle in the transmission of power by compressed air, Prof. A. C. Elliott on the, 765.
- Conception of direction, the importance of the, in natural philosophy, E. T. Dixon on, 572.
- Confocal conics, the geometry of, by Prof. T. C. Lewis, 570.
- *Consumption, the cure of, in its economic aspect, by G. W. Hambleton, 747.
- Copeland (Dr. R.) on the probable nature of the bright streaks on the moon, 576.
- Cordeaux (J.) on making a digest of the observations on the migration of birds, 363.
- Corresponding Societies Committee, report of the, 41.
- Cosmopolitanism and nationalism in economics, by Prof. W. Cunningham, 723.
- 'Couvade,' by H. L. Roth, 800.
- Cowper (E. A.) on the advisability and possibility of establishing observations upon the prevalence of earth tremors, 333.
- Creak (Commander) on the best means of comparing and reducing magnetic observations, 149.
- Crick (W. D.) on the very fossiliferous transition bed between the middle and upper lias in Northamptonshire, 334.
- Criminals, the anthropometric method of identifying, by Dr. J. G. Garson, 813.
- Crook (H. T.), suggestions for the revision and improvement of the large scale maps of the Ordnance Survey, 718.
- Crookes (W.) on electrolysis in its physical and chemical bearings, 122; *on the electrical evaporation of metals and alloys, 607.
- Crosskey (Dr. H. W.) on the erratic blocks of England, Wales, and Ireland, 276; on the circulation of underground waters, 300; on the teaching of science in elementary schools, 383; notes on the glacial geology of Norway, 647.
- Crystal form, the, and the chemical composition of bodies, the connection between, W. Barlow on, 581.
- Crystallogobius Nilssonii*, Gill, distribution of, by J. T. Cunningham, 687.
- Crystals, the symmetry of, accounted for by the application of Boscovich's theory of atoms to the atoms of the chemist, by W. Barlow, 581.
- Cunningham (D.) on arranging an investigation of the seasonal variations of temperature in lakes, rivers, and estuaries, 454.
- Cunningham (J. T.) on the growth of food-fishes and their distribution at different ages, 685; the reproduction of the pilchard, 686; observations of the larvæ of *Palinurus vulgaris*, 687; distribution of *Crystallogobius Nilssonii*, Gill, *ib.*
- Cunningham (Prof. W.), Address (nationalism and cosmopolitanism in economics) to the Economic Science and Statistical Section by, 723.
- Danks (Rev. B.), burial customs of New Britain, 802.
- Darwin (F.), Address (on growth-curvatures in plants) to the Biological Section by, 660.
- and D. F. M. Pertz on the artificial production of rhythm in plants, 695.
- Darwin (Prof. G. H.) on the best means of comparing and reducing magnetic observations, 149; on the advisability and possibility of establishing observations upon the prevalence of earth tremors, 333.
- Davey (H.), sinking wells and shafts, 766.
- Davis (J. W.) on the collection, preservation, and systematic registration of photographs of geological interest in the United Kingdom, 321; on the cave at Elbolton, 351; on the prehistoric inhabitants of the British Islands, 449.
- Davison (C.) on the advisability and possibility of establishing observations upon the prevalence of earth tremors, 333.
- Dawkins (Prof. W. Boyd) on the work of the Corresponding Societies Committee, 41; on the erratic blocks of England, Wales, and Ireland, 276; on the collection, preservation, and systematic registration of photographs of geological interest in the United Kingdom, 321; on the prehistoric inhabitants of the British Islands, 449; on the discovery of the south-eastern coal-field, 637.
- Dawson (Dr. G. M.) on the North-western tribes of the Dominion of Canada, 407.
- Deacon (G. F.) on the investigation of the action of waves and currents on the beds and foreshores of estuaries by means of working models, 386.

- Deep-sea tow-net, for opening and closing under water, report of the Committee for improving and experimenting with a, 382.
- De Rance (C. E.) on the erratic blocks of England, Wales, and Ireland, 276; on the circulation of underground waters, 300; note on the discovery of *Estheria Minuta* (var. *Brodieana*) in the new red sandstone, 644.
- Desmidiaceæ, non-sexual formation of spores in the, by A. W. Bennett, 678.
- Destitute and pauper children, the upbringing of, by Rev. J. O. Bevan, 745.
- Detrital tourmaline, the occurrence of, in a quartz-schist west of Start Point, South Devon, by A. R. Hunt, 643.
- Dewar (Prof.) on researches on the ultraviolet rays of the solar spectrum, 147; on the preparation of a new series of wave-length tables of the spectra of the elements and compounds, 161.
- Diastase in pollen, Prof. J. R. Green on the occurrence of, 696.
- Diastatic ferment in green leaves, the presence of, by Prof. S. H. Vines, 697.
- Diatoms with pseudopodia, some species of, J. G. Grenfell on, 680.
- Dicotyledons, internal phloëm in the, notes on, by Prof. D. H. Scott, 696.
- Didymium from different sources, Prof. C. M. Thompson on, 611.
- Differences, the alleged, in the wages paid to men and women for similar work, by S. Webb, 742.
- Differential equations, the duality of, the transformations used in connection with, E. B. Elliott on, 568.
- Differential resolvent, the transformation of a, Rev. R. Harley on, 566.
- Disappearance of native plants from their local habitats, fourth report on the, 359.
- Discharge of electricity from points, report on the, 139.
- Dixon (E. T.) on the importance of the conception of direction in natural philosophy, 572.
- Dixon (Prof. H. B.) on electrolysis in its physical and chemical bearings, 122.
- *Dobson (G.), the Volta river, 722.
- Domestic industries, the survival of, by Prof. Gonner, 740.
- Double lines in spectra, the cause of, Dr. G. J. Stoney on, 574.
- Double salt, the relation between the composition of a, and the composition and temperature of the solution in which it is formed, A. Vernon Harcourt and F. W. Humphery on, 608.
- Douglas (Prof. R. K.), the social and religious ideas of the Chinese, as illustrated in the ideographic characters of the language, 796.
- Douglass (Sir J. N.) on the investigation of the action of waves and currents on the beds and foreshores of estuaries by means of working models, 386.
- Drift, notes of a section of, at Levenshulme, Manchester, by P. F. Kendall, 650.
- Druce (G. C.) on the disappearance of native plants from their local habitats, 359.
- Dry gases, a simple apparatus for storing, by W. Symons, 609.
- Duggleby 'Howe,' Yorkshire, human remains from, Dr. J. G. Garson on, 806.
- Dunstan (Prof. W. R.) on the direct formation of haloid compounds from pure materials, 274.
- Dyed colours, the action of light upon, interim report on, 263.
- Dynamical theorem, a geometrical illustration of a, Sir R. Ball on, 566.
- Earth tremors, the prevalence of, report on the advisability and possibility of establishing in other parts of the country observations upon, similar to those now being made in Durham in connection with coal-mine explosions, 333.
- Earthquake and volcanic phenomena of Japan, eleventh report on the, 123.
- Earthquakes, phenomena which might be observable if the hypothesis that they are connected with electrical phenomena be entertained, Prof. J. Milne on, 583.
- East central African customs, by Rev. J. Macdonald, 809.
- Echidna aculeata*, some young specimens of, exhibition of, and remarks upon, by Prof. W. N. Parker, 693.
- Economic aspects of life assurance, J. M. McCandlish on some, 739.
- Economic Science and Statistics, Address (nationalism and cosmopolitanism in economics) by Prof. W. Cunningham to the Section of, 723.
- Edmunds (Dr. L.), the taxation of inventors, 743.
- Elbolton, near Skipton, the cave at, report of the Committee to complete the investigation of, in order to ascertain whether remains of palæolithic man occur in the lower cave earth, 351.
- *Electric firedamp indicators, N. Watts on, 773.
- Electric motors, recent progress in the use of, by Prof. G. Forbes, 771.
- *Electrical evaporation of metals and alloys, W. Crookes on the, 607.
- Electrical measurements, report of the Committee for constructing and issuing practical standards for use in, 152;

- report of the Committee appointed by the Board of Trade, 154.
- Electrical parcel exchange system, an, by A. R. Bennett, 774.
- Electrical radiators, with a mechanical analogy, the action of, by J. Larmor, 560.
- Electricity, the discharge of, from points, report on, 139.
- , the influence of the silent discharge of, on oxygen and other gases, provisional report on, 264.
- Electrification of needle points in air, A. P. Chattock on the, 565.
- Electrolysis in its physical and chemical bearings, sixth report on, 122.
- , some secret evidence for the dissociation theory of, J. Brown on, 564.
- Electrolysis of alloys, note on the, by H. C. Jenkins, 613.
- Electrolytes, dissolved, some experiments on the molecular refraction of, by Dr. J. H. Gladstone and W. Hibbert, 609.
- Electrolytic conduction, Clausius' theory of, J. Brown on, and on some secret evidence for the dissociation theory of electrolysis, 564.
- Electrolytic problems, by R. L. Mond, 564.
- Electromagnetic theory of the rotation of the plane of polarised light, Prof. A. Gray on the, 558.
- Electromagnetic waves in wires, the propagation of, W. Thorp on, 562.
- Electro-optics, second (interim) report on researches on, 147.
- Electrostatic and electromagnetic measures, the conversion of, into one another, Dr. G. J. Stoney on a table to facilitate, 577.
- Elliott (Prof. A. C.) on the compound principle in the transmission of power by compressed air, 765.
- Elliott (E. B.) on the transformations used in connection with the duality of differential equations, 568; note on a method of research for invariants, *ib.*
- Ellis (W.) on the best means of comparing and reducing magnetic observations, 149.
- Employers' liability, miners' thrift and: a remarkable experience, by G. L. Campbell, 737.
- Epipodial processes of some nudibranchiate mollusca, the innervation of the, Prof. W. A. Herdman and J. A. Clubb on, 692.
- Erratic blocks of England, Wales, and Ireland, nineteenth report on the, 276.
- Estheria Minuta* (var. *Brodieana*) in the new red sandstone, note on the discovery of, by C. E. De Rance, 644.
- Estuaries, model, Professor O. Reynolds on, 387.
- Ether and alcohol, the surface-tension of, at different temperatures, by Prof. W. Ramsay, 565.
- Etheridge (R.) on the earthquake and volcanic phenomena of Japan, 123; on the registration of all the type specimens of British fossils, 299.
- Evans (Dr. J.) on the work of the Corresponding Societies Committee, 41; on the advisability and possibility of establishing observations upon the prevalence of earth tremors, 333; on the cave at Elbolton, 351; on excavations at Oldbury Hill, near Ightham, 353; on the prehistoric inhabitants of the British Islands, 449.
- Evaporation, the internal and external work of, W. W. Beaumont on, 777.
- Everett (Prof.) on standards for use in electrical measurements, 152.
- Ewart (Prof. C.) on the occupation of a table at the zoological station at Naples, 365.
- Ewing (Prof.) on the advisability and possibility of establishing observations upon the prevalence of earth tremors, 333.
- Faija (H.) on some of the peculiarities to be observed in Portland cements, and on the most advanced methods for determining their constructive value, 764.
- Feilden (Col.) on the present state of our knowledge of the zoology and botany of the West India Islands, and on the steps taken to investigate ascertained deficiencies in the fauna and flora, 354.
- Felkin (Dr. R. W.) on acclimatisation, 715.
- Ferns, prothalli and the propagation of, facts regarding, by E. J. Lowe, 687.
- and their multiple parents, E. J. Lowe on, 688.
- *Fertilisation and conjugation processes as allied modes of protoplasmic rejuvenescence, Prof. M. Hartog on, 683.
- Festing (Gen.) on the absorption spectra of pure compounds, 275.
- Field of geography, the, by E. G. Ravenstein, 703.
- *Firedamp indicators, electric, N. Watts on, 773.
- Fishes, the living, the arrangement of, as based upon the study of their reproductive system, Prof. G. B. Howes on, 694.
- Fitzgerald (Prof. G. F.) on electrolysis in its physical and chemical bearings, 122; on the various phenomena connected with the recalcrescent points in iron and other metals, 147; on standards for

- use in electrical measurements, 152; on arranging an investigation of the seasonal variations in the temperature of lakes, rivers, and estuaries, 454.
- Fleming (Dr. J. A.) on electrolysis in its physical and chemical bearings, 122; on standards for use in electrical measurements, 152.
- *Floating leaves, Prof. Miall on, 695.
- Florida, the physical and industrial geography of, by A. Montefiore, 720.
- Flower (Prof.) on the present state of our knowledge of the zoology and botany of the West India Islands, and on the steps taken to investigate ascertained deficiencies in the fauna and flora, 354; on the present state of our knowledge of the zoology of the Sandwich Islands, and on the steps taken to investigate ascertained deficiencies in the fauna, 357; on the occupation of a table at the laboratory of the Marine Biological Association at Plymouth, 364; on editing a new edition of 'Anthropological Notes and Queries,' 404; on the work of the anthropometric laboratory, 405.
- *Food and population, the increase of, by W. E. A. Axon, 747.
- Food-fishes, the growth of, and their distribution at different ages, J. T. Cunningham on, 685.
- Forbes (Prof. G.), recent progress in the use of electric motors, 771.
- Forsyth (A. R.) on carrying on the tables connected with the Pellian equation from the point where the work was left by Degen in 1817, 160.
- Fossiliferous transition bed, the very, between the middle and upper lias in Northamptonshire, report of the Committee appointed to work, in order to obtain a more clear idea of its fauna, and to fix the position of certain species of fossil fish, and more fully investigate the horizon on which they occur, 334.
- Foster (Prof. G. C.) on electrolysis in its physical and chemical bearings, 122; on the discharge of electricity from points, 139; on standards for use in electrical measurements, 152.
- Foster (Prof. M.) on the steps taken for establishing a botanical laboratory at Peradeniya, Ceylon, 358; on the occupation of a table at the laboratory of the Marine Biological Association at Plymouth, 364; on the occupation of a table at the zoological station at Naples, 365.
- Fox-Strangeways (C.) on the circulation of underground waters, 300.
- Frankland (Prof.) on electrolysis in its physical and chemical bearings, 122.
- *Fream (W.) on the recent visitation of *Plutella Crucifera*, 695.
- Free travel, by S. M. Burroughs, 740.
- Friendly Islands, the natural history of the, the progress of the investigation of, J. J. Lister on, 679.
- Fuller's earth works at Woburn, the extension of the, A. C. G. Cameron on, 636.
- Furnivall (W. C.), railway communications of India, 744.
- Galton (Sir D.) on the work of the Corresponding Societies Committee, 41; on the circulation of underground waters, 300.
- Galton (F.) on the work of the Corresponding Societies Committee, 41; on editing a new edition of 'Anthropological Notes and Queries,' 404.
- Gardiner (W.) on the steps taken for establishing a botanical laboratory at Peradeniya, Ceylon, 358.
- Garnett (Prof. W.) on standards for use in electrical measurements, 152.
- Garson (Dr. J. G.) on the work of the Corresponding Societies Committee, 41; on the cave at Elbolton, 351; on editing a new edition of 'Anthropological Notes and Queries,' 404; on the work of the anthropometric laboratory, 405; on human remains from the Duggleby 'Howe,' Yorkshire, 806; the anthropometric method of identifying criminals, 813.
- Geikie (Sir A.), discovery of the *Olenellus*-zone in the North-west Highlands, 633; on some recent work of the Geological Survey in the archæan gneiss of the North-west Highlands, 634.
- Geikie (Prof. J.) on the collection, preservation, and systematic registration of photographs of geological interest in the United Kingdom, 321.
- Genese (Prof. R. W.), some tangential transformations, including Laguerre's semi-droites réciproques, 571.
- Geographical progress, recent, in Great Britain, by J. S. Keltie, 714.
- Geographical Section, Address (the field of geography) by E. G. Ravenstein to the, 703.
- *—, —, explanation of a series of maps illustrating, 718.
- Geological Section, Address by Prof. T. R. Jones to the, 614.
- Geology of petroleum and natural gas, the, by W. Topley, 637.
- Geometrical illustration of a dynamical theorem, Sir R. Ball on a, 566.
- Geometry of confocal conics, the, by Prof. T. C. Lewis, 570.
- George (T. G.) on the very fossiliferous

- transition bed between the middle and upper lias in Northamptonshire, 334.
- German invalidity and superannuation law, the, L. Tylor on, and on State provision against sickness and old age, 739.
- Gibbs (Prof. Wolcott) on the preparation of a new series of wave-length tables of the spectra of the elements and compounds, 161.
- Gills of fishes, the customary methods of describing the, Prof. G. B. Howes on, 702.
- Gilson (Prof.), the ciliated organs of the leeches, 690.
- Glacial action in Pembrokeshire, on the evidences of, and the direction of the ice-flow, by Dr. H. Hicks, 649.
- Glacial geology of Norway, notes on the, by Dr. H. W. Crosskey, 647.
- Glacial period in North America, the relation of, to the antiquity of man, recent discoveries concerning, by Prof. G. F. Wright, 647.
- Gladstone (G.) on the teaching of science in elementary schools, 383.
- Gladstone (Dr. J. H.) on electrolysis in its physical and chemical bearings, 122; on the teaching of science in elementary schools, 383.
- and W. Hibbert, some experiments on the molecular refraction of dissolved electrolytes, 609.
- Glaisher (J.) on the circulation of underground waters, 300; on the advisability and possibility of establishing observations upon the prevalence of earth tremors, 333.
- Glaisher (Dr. J. W. L.), on calculating tables of certain mathematical functions, 129.
- Glazebrook (R. T.) on electrolysis in its physical and chemical bearings, 122; on researches on electro-optics, 147; on standards for use in electrical measurements, 152.
- *Glycerides, the reaction of, with alcoholic potash, by A. H. Allen, 613.
- Godman (F. Du C.) on the present state of our knowledge of the zoology and botany of the West India Islands, and on the steps taken to investigate ascertained deficiencies in the fauna and flora, 354.
- Gonner (Prof.), the survival of domestic industries, 740.
- Gray (Prof. A.) on the electromagnetic theory of the rotation of the plane of polarised light, 558.
- Gray (Prof. T.) on the earthquake and volcanic phenomena of Japan, 123; on standards for use in electrical measurements, 152; on the advisability and possibility of establishing observations upon the prevalence of earth tremors, 333.
- Gray (W.) on the collection, preservation, and systematic registration of photographs of geological interest in the United Kingdom, 321.
- Green (Prof. J. R.) on the occurrence of diastase in pollen, 696.
- Greenhill (Prof. A. G.) on calculating tables of certain mathematical functions, 129.
- Grenfell (J. G.) on some species of diatoms with pseudopodia, 680.
- Growth-curvatures in plants, F. Darwin on, 660.
- Günther (Dr.) on the present state of our knowledge of the zoology and botany of the West India Islands, and on the steps taken to investigate ascertained deficiencies in the fauna and flora, 354.
- Haddon (Prof. A. C.) on improving and experimenting with a deep-sea tow-net for opening and closing under water, 382.
- Hadfield (R. A.) on the various phenomena connected with the recalescent points in iron and other metals, 147.
- Haidas (Queen Charlotte Islands), family life of the, by Rev. C. Harrison, 797.
- Hale (Prof. G. E.), the ultra-violet spectrum of the solar prominences; 557.
- Haliburton (R. G.) on the North-western tribes of the Dominion of Canada, 407.
- Haloid compounds, the direct formation of, from pure materials, provisional report on, 274.
- *Hambleton (G. W.), the cure of consumption in its economic aspect, 747.
- Harcourt (A. Vernon) and F. W. Humphery on the relation between the composition of a double salt and the composition and temperature of the solution in which it is formed, 608.
- Harcourt (L. F. Vernon), the river Usk and the harbour of Newport, 757.
- Harley (Rev. R.) on the transformation of a differential resolvent, 566.
- Harmer (S. F.) on the occupation of a table at the laboratory of the Marine Biological Association at Plymouth, 364.
- Harrison (B.) on excavations at Oldbury Hill, near Ightham, 353.
- Harrison (Rev. C.), family life of the Haidas (Queen Charlotte Islands), 797.
- *Harrison (T.) and Prof. J. V. Jones on the periodic time of tuning-forks maintained in vibration electrically, 581.
- Hartley (Prof.) on electrolysis in its physical and chemical bearings, 122;

- on the preparation of a new series of wave-length tables of the spectra of the elements and compounds, 161.
- Hartog (Prof. M.) on the steps taken for establishing a botanical laboratory at Peradeniya, Ceylon, 358; *on fertilisation and conjugation processes as allied modes of protoplasmic rejuvenescence, 683; a preliminary classification of sexual and allied modes of protoplasmic rejuvenescence, &c., *ib.*
- Harvie-Brown (J. A.) on making a digest of the observations on the migration of birds, 363.
- Heat, the absorption of, in the solar atmosphere, W. E. Wilson on, 557.
- *Heating and ventilation of buildings, mechanical, by W. Key, 758.
- Herdman (Prof. W. A.) on improving and experimenting with a deep-sea tow-net for opening and closing under water, 382.
- and J. A. Clubb on the innervation of the epipodial processes of some nudibranchiate mollusca, 692.
- Hertzian oscillations along wires, the measurement of stationary, and the damping of electric waves, Prof. D. E. Jones on, 561.
- Heywood (J.) on the teaching of science in elementary schools, 383.
- Hibbert (W.) and Dr. J. H. Gladstone, some experiments on the molecular refraction of dissolved electrolytes, 609.
- Hicks (Dr. H.) on the prehistoric inhabitants of the British Islands, 449; a comparison between the rocks of South Pembrokeshire and those of North Devon, 641; on the evidences of glacial action in Pembrokeshire, and the direction of ice-flow, 649.
- Hicks (Prof. W. M.) on calculating tables of certain mathematical functions, 129.
- Hickson (Dr.) on the present state of our knowledge of the zoology of the Sandwich Islands, and on the steps taken to investigate ascertained deficiencies in the fauna, 357.
- Hillhouse (Prof.) on the disappearance of native plants from their local habitats, 359.
- *Himalayas, physical aspects of the, and notes on the inhabitants, by Col. H. Tanner, 722.
- Hittite discoveries, recent, by Dr. Phené, 814.
- Holdich (Lt.-Col. T. H.), the application of Indian geographical survey methods to Africa, 717.
- *Homology of continents, the, by Dr. H. R. Mill, 715.
- Hopkinson (Dr. J.) on electrolysis in its physical and chemical bearings, 122; on the various phenomena connected with the recalcrescent points in iron and other metals, 147; on standards for use in electrical measurements, 152.
- Hopkinson (J.) on the work of the Corresponding Societies Committee, 41; on the application of photography to the elucidation of meteorological phenomena, 130.
- Hours of labour, the data available for determining the best limit (physically) for, Dr. J. T. Arlidge on, 746.
- Howes (Prof. G. B.) on the arrangement of the living fishes, as based upon the study of their reproductive system, 694; on the customary methods of describing the gills of fishes, 702.
- Hoyle (W. E.) on improving and experimenting with a deep-sea tow-net for opening and closing under water, 382.
- *— and L. F. Massey, exhibition of a new apparatus for opening and closing a tow-net by electricity, 693.
- Hughes (Prof. T. McK.) on the erratic blocks of England, Wales, and Ireland, 276.
- Hull (Dr. E.) on the circulation of underground waters, 300; on the advisability and possibility of establishing observations upon the prevalence of earth tremors, 333.
- Hull (W.) on the very fossiliferous transition bed between the middle and upper lias in Northamptonshire, 334.
- Human remains from the Duggleby 'Howe,' Yorkshire, Dr. J. G. Garson on, 806.
- Hummel (Prof.) on the action of light upon dyed colours, 263.
- Humphery (F. W.) and A. Vernon Harcourt on the relation between the composition of a double salt and the composition and temperature of the solution in which it is formed, 608.
- Hunt (A. R.) on the investigation of the action of waves and currents on the beds and foreshores of estuaries by means of working models, 386; on the occurrence of detrital tourmaline in a quartz-schist west of Start Point, South Devon, 643.
- *Hunter (C.), description of Lewis and Hunter's system of coaling ships, 763.
- Hymenomyces, the nuclei of the, H. Wager on, 700.
- Ice age, the cause of an, by Sir R. Ball, 645.
- Imperfections in the surface of rolled copper alloys, the cause of, T. Turner on, 607.
- *Increase of food and population, the, by W. E. A. Axon, 747.

- India, railway communications of, by W. C. Furnivall, 744.
- , the recent progress of agriculture in, by C. L. Tupper, 532.
- Indian geographical survey methods, the application of, to Africa, by Lt.-Col. T. H. Holdich, 717.
- Indians of British Columbia, Dr. F. Boas on the, 408.
- Innervation of the epipodial processes of some nudibranchiate mollusca, Prof. W. A. Herdman and J. A. Clubb on the, 692.
- Instinctive criminality: its true character and national treatment, by Dr. S. A. K. Strahan, 811.
- Internal ploëm in the dicotyledons, notes on, by Prof. D. H. Scott, 696.
- International standard for the analysis of iron and steel, third report on the best method of establishing an, 273.
- Invariants, note on a method of research for, by E. B. Elliott, 568.
- Inventors, the taxation of, by Dr. L. Edmunds, 743.
- Iron and steel, the best method of establishing an international standard for the analysis of, third report on, 273.
- Isomeric naphthalene derivatives, fifth report on, 265.
- Japan, the earthquake and volcanic phenomena of, eleventh report on, 123.
- Jeffs (O. W.) on the collection, preservation, and systematic registration of photographs of geological interest in the United Kingdom, 321.
- Jenkins (H. C.), note on the electrolysis of alloys, 613.
- Johnston-Lavis (Dr.) on the volcanic phenomena of Vesuvius and its neighbourhood, 312.
- Jones (Prof. D. E.), on the measurement of stationary Hertzian oscillations along wires, and the damping of electric waves, 561.
- Jones (Rev. E.), on the cave at Elbolton, 351.
- Jones (Prof. G. H.), barbaric elements in ancient Greece and Italy, 803.
- *Jones (Prof. J. V.) and T. Harrison on the periodic time of tuning-forks maintained in vibration electrically, 581.
- Jones (Prof. T. R.), Address to the Geological Section by, 614.
- Judd (Prof.) on the advisability and possibility of establishing observations upon the prevalence of earth tremors, 333.
- Jukes-Browne (A. J.), the cause of monoclinical flexure, 635; note on an undescribed area of lower greensand, or vectian, in Dorsetshire, *ib.*
- *Karun river, the Bakhtiari country and the, by Mrs. Bishop, 722.
- Kellaways beds, the continuity of the, over extended areas near Bedford, A. C. G. Cameron on, 636.
- Keltie (J. S.), recent geographical progress in Great Britain, 714.
- Kendall (P. F.), notes of a section of drift at Levenshulme, Manchester, 650.
- Kerr (Dr. J.) on researches on electro-optics, 147.
- *Key (W.) on mechanical ventilation and heating of buildings, 758.
- Kidston (R.) on the registration of all the type specimens of British fossils, 299; on the collection, preservation, and systematic registration of photographs of geological interest in the United Kingdom, 321.
- Kilimanjaro and Lake Chala, a visit to, by Mrs. F. Sheldon, 719.
- Knubley (Rev. E. P.) on making a digest of the observations on the migration of birds, 363.
- Krause (Prof. W.) on anatomical nomenclature, 682.
- Labour and capital—their differences and how to reconcile them, by C. H. Perkins, 735.
- Lake Chala, a visit to Kilimanjaro and, by Mrs. F. Sheldon, 719.
- *Lake Ngami region, journeys to the, by H. D. Buckle, 719.
- *Lamington (Lord), the Siam border, 720.
- Langley (Prof. J. W.) on the best method of establishing an international standard for the analysis of iron and steel, 273.
- Lankester (Prof. Ray) on the occupation of a table at the laboratory of the Marine Biological Association at Plymouth, 364; on the occupation of a table at the zoological station at Naples, 365.
- Larmor (J.) on the present state of our knowledge of thermodynamics, specially with regard to the second law, 85; on electrolysis in its physical and chemical bearings, 122; the action of electrical radiators, with a mechanical analogy, 560.
- Laurie (A. P.) on the existence of a compound in alloys of gold and tin, 607.
- Lava beds of California and Idaho, the, and their relation to the antiquity of man, by Prof. G. F. Wright, 651.
- Lebour (Prof. G. A.) on the circulation of underground waters, 300; on the advisability and possibility of establishing observations upon the prevalence of earth tremors 333

- *Leconte (Prof.), experimental study of a curious movement of ovoids and ellipsoids, 583.
- Leeches, the ciliated organs of the, by Prof. Gilson, 690.
- Leeds (Dr. A. B.) on the bibliography of solution, 273.
- Lenses, the measurement of, Prof. S. P. Thompson on, 580.
- *Le Play's method of systematic observation, by F. Auburtin, 747.
- Lewes (Prof. V. B.), the spontaneous ignition of coal, 602.
- Lewis (Prof. T. C.), the geometry of con-focal conics, 570.
- *Lewis and Hunter's system of coaling ships, description of, by C. Hunter, 763.
- Life assurance, some economic aspects of, J. M. McCandlish on, 739.
- Light, the action of, upon dyed colours, interim report on, 263.
- , the velocity of, in the neighbourhood of rapidly moving matter, Prof. O. J. Lodge on an experiment on, 560.
- Lighting of railway trains electrically, the, by I. A. Timmis, 773.
- Liquid jets under gravity, Rev. H. J. Sharpe on, 568.
- Liquid resistances, the measurement of, J. Swinburne on, 565.
- Lister (J. J.) on the progress of the investigation of the natural history of the Friendly Islands, 679.
- Living (Prof.) on researches on the ultra-violet rays of the solar spectrum, 147; on the preparation of a new series of wave-length tables of the spectra of the elements and compounds, 161.
- Lloyd (Dr. R. J.) on recent progress in the analysis of vowel-sounds, 796.
- Lockyer (J. N.) on the preparation of a new series of wave-length tables of the spectra of the elements and compounds, 161.
- Lodge (Prof. A.) on calculating tables of certain mathematical functions, 129; on carrying on the tables connected with the Pellian equation from the point where the work was left by Degen in 1817, 160.
- Lodge (Prof. O. J.) on electrolysis in its physical and chemical bearings, 122; on the discharge of electricity from points, 139; on standards for use in electrical measurements, 152; Address to the Mathematical and Physical Section by, 547; on an experiment on the velocity of light in the neighbourhood of rapidly moving matter, 560; *on units and their nomenclature, 577.
- London-Paris telephone, the, by W. H. Preece, 767.
- Lowe (E. J.), facts regarding prothalli and the propagation of ferns, 687; on ferns and their multiple parents, 688.
- Lower greensand, or vectian, note on an undescribed area of, in Dorsetshire, by A. J. Jukes-Browne, 635.
- Lower tertiary fish fauna of Sardinia, remarks on the, by A. S. Woodward, 634.
- Lubbock (Sir J.) on the teaching of science in elementary schools, 383; on the prehistoric inhabitants of the British Islands, 449.
- McCandlish (J. M.) on some economic aspects of life assurance, 739.
- Macdonald (Rev. J.), East central African customs, 809.
- McLaren (Lord) on meteorological observations on Ben Nevis, 140.
- McLeod (Prof. H.) on electrolysis in its physical and chemical bearings, 122; on the best methods of recording the direct intensity of solar radiation, 160; on the influence of the silent discharge of electricity on oxygen and other gases, 264; on the bibliography of spectroscopy, *ib.*; on the bibliography of solution, 273; *the action of heat on alkaline hypochlorites, 609.
- Madan (H. G.) on the bibliography of spectroscopy, 264.
- *Magnetic experiments made in connection with the determination of the rate of propagation of magnetisation in iron, by F. T. Trouton, 581.
- Magnetic field in the neighbourhood of the South London electrical railway, Profs. W. E. Ayrton and Rücker on the, 581.
- Magnetic observations, report of the Committee for considering the best means of comparing and reducing, 149.
- *Magnetisation in iron, the rate of propagation of, magnetic experiments made in connection with the determination of, by F. T. Trouton, 581.
- Magnus (Sir P.) on the teaching of science in elementary schools, 383.
- Mammoth, the, in Ontario, Canada, by Prof. J. H. Panton, 654.
- Man (E. H.), Nicobar pottery, 815.
- *Maps, a local collection of, description of, 718.
- *— illustrating Mr. Ravenstein's Address to Section E, explanation of, 718.
- Marine Biological Association, at Plymouth, report of the Committee for arranging for the occupation of a table at the laboratory of the, 364.
- , recent investigations (fishery and physical) of the, W. L. Calderwood on, 635.

- Marr (J. E.) on the registration of all the type specimens of British fossils, 299.
- Marshall (Prof. A. M.) on the occupation of a table at the zoological station at Naples, 365.
- Marten (E. B.) on the circulation of underground waters, 300.
- Maskelyne (Prof. N. S.) on the teaching of science in elementary schools, 383.
- *Massey (L. F.) and W. E. Hoyle, exhibition of a new apparatus for opening and closing a tow-net by electricity, 693.
- Mastodon, the, in Ontario, Canada, by Prof. J. H. Panton, 654.
- Mathematical and Physical Section, Address by Prof. O. J. Lodge to the, 547.
- Mathematical functions, second report of the Committee for calculating tables of certain, and, if necessary, for taking steps to carry out the calculations and publishing the results in an accessible form, 129.
- Meakin (J. E. B.), Morocco as a field for geographers, 716; the Morocco Berbers, 804.
- Measurement of lenses, Prof. S. P. Thompson on the, 580.
- Measurement of liquid resistances, J. Swinburne on the, 565.
- Mechanical Section, Address by T. F. Brown to the, 749.
- *Mechanical ventilation and heating of buildings, W. Key on, 758.
- Meldola (Prof. R.) on the work of the Corresponding Societies Committee, 41; on the application of photography to the elucidation of meteorological phenomena, 130; on the advisability and possibility of establishing observations upon the prevalence of earth tremors, 333; on the prehistoric inhabitants of the British Islands, 449.
- Melly (W. R.) on the occupation of the table at the zoological station at Naples, 366.
- Meteorites, the worship of, Prof. H. A. Newton on, 805.
- Meteorological observations on Ben Nevis, report of the Committee for co-operating with the Scottish Meteorological Society in making, 140.
- Meteorological phenomena, the application of photography to the elucidation of, report on, 130.
- *Miall (Prof.) on floating leaves, 695.
- Migration of birds, report of the Committee for making a digest of the observations on the, 363.
- Mill (Dr. H. R.) on arranging an investigation of the seasonal variations of temperature in lakes, rivers, and estuaries, 454; *the homology of continents, 715.
- Milne (Prof. J.) on the earthquake and volcanic phenomena of Japan, 123; on phenomena which might be observable if the hypothesis that earthquakes are connected with electrical phenomena be entertained, 583.
- Milne-Home (Mr.) on meteorological observations on Ben Nevis, 140.
- Miners' thrift and employers' liability: a remarkable experience, by G. L. Campbell, 737.
- Molecular refraction of dissolved electrolytes, some experiments on the, by Dr. J. H. Gladstone and W. Hibbert, 609.
- Mond (L.) on nickel carbon oxide and its application in arts and manufactures, 602.
- Mond (R. L.), electrolytic problems, 564.
- Monoclinical flexure, the cause of, by A. J. Jukes-Browne, 635.
- Montefiore (A.), the physical and industrial geography of Florida, 720.
- Moon (W.), absolute units of measurement, 580.
- Moor (C. G.) on a new method of disposal of sewage, with some references to schemes now in use, 612.
- Morgan (E. D.), antarctic exploration, 719.
- Morocco as a field for geographers, by J. E. B. Meakin, 716.
- Morocco Berbers, the, by J. E. B. Meakin, 804.
- 'Morong,' the, and other customs of the natives of Assam, S. E. Peal on, 801.
- Morris (D.) on the present state of our knowledge of the zoology and botany of the West India Islands, and on the steps taken to investigate ascertained deficiencies in the fauna and flora, 354.
- Morton (G. H.) on the circulation of underground waters, 300.
- 'Mountain Chant,' the, the Navajo myth entitled, points of contact between old-world myths and customs and, by Miss A. W. Buckland, 808.
- Muirhead (Dr.) on the prehistoric inhabitants of the British Islands, 449.
- Muirhead (Dr. A.) on standards for use in electrical measurements, 152.
- Müller (Prof. F. Max), Address to the Anthropological Section, by, 782; on the work of Major J. W. Powell, director of the U.S. Ethnological Bureau, 798.
- Munro (Dr. R.) on the prehistoric inhabitants of the British Islands, 449.
- Murray (Dr. J.) on meteorological observations on Ben Nevis, 140; on arranging an investigation of the seasonal variations of temperature in lakes, rivers, and estuaries, 454.

- Mus musculus* and *Mus decumanus*, some points in the early development of: the relation of the yolk sac to the decidua and the placenta, by Dr. A. Robinson, 690.
- , observations upon the development of the spinal cord in: the formation of the septa and the fissures, by Dr. A. Robinson, 691.
- Nationalism and cosmopolitanism in economics, by Prof. W. Cunningham, 723.
- Natural history of the Friendly Islands, the progress of the investigation of the, J. J. Lister on, 679.
- Navajo myth, the, entitled 'the Mountain Chant,' points of contact between old-world myths and customs and, by Miss A. W. Buckland, 808.
- Nematophycus*, a species of, in the silurian beds at Tymawr quarry, Rumney, J. Storrie on the occurrence of, 652.
- New Britain, burial customs of, by Rev. B. Danks, 802.
- Newall (H. F.) on the various phenomena connected with the recalcrescent points in iron and other metals, 147.
- Newport, the harbour of, and the river Usk, by L. F. Vernon Harcourt, 757.
- Newton (Prof.) on the present state of our knowledge of the zoology and botany of the West India Islands, and on the steps taken to investigate ascertained deficiencies in the fauna and flora, 354; on the present state of our knowledge of the zoology of the Sandwich Islands, and on the steps taken to investigate ascertained deficiencies in the fauna, 357; on making a digest of the observations on the migration of birds, 363.
- Newton (E. T.), note on the occurrence of *Ammonites jurensis* in the ironstone of the Northampton sands, in the neighbourhood of Northampton, 655.
- Newton (Prof. H. A.) on the capture of comets by planets, especially their capture by Jupiter, 511; on the worship of meteorites, 805.
- Nickel carbon oxide and its application in arts and manufactures, L. Mond on, 602.
- Nicobar pottery, by E. H. Man, 815.
- Nicol (Dr.) on the bibliography of solution, 273; on the properties of solutions, *ib.*
- Nitrosyl chloride, action of, on unsaturated carbon compounds, by J. J. Sudborough, 612.
- Non-conducting coverings for steam boilers and pipes, on the comparative value of various substances used as, by W. H. Collins, 780.
- Non-sexual formation of spores in the Desmidiaceæ, by A. W. Bennett, 678.
- *Normal to a conic, note on the, by R. H. Pinkerton, 572.
- North-western tribes of the Dominion of Canada, seventh report on the physical characters, languages, and industrial and social condition of the, 407; third report on the Indians of British Columbia, by Dr. F. Boas, 408.
- Norway, notes on the glacial geology of, by Dr. H. W. Crosskey, 647.
- Nuclear structure in the bacteria, H. Wager on, 681.
- Nudibranchiate mollusca, the innervation of the epipodial processes of some, Prof. W. A. Herdman and J. A. Clubb on, 692.
- Observing, the art of, by J. Coles, 714.
- Oldbury Hill, near Ightham, report of the Committee for carrying on excavations at, in order to ascertain the existence or otherwise of rock-shelters at this spot, 353; preliminary notes on the excavations at, by Dr. J. Prestwich, 651.
- Old-world myths and customs and the Navajo myth entitled 'the Mountain Chant,' points of contact between, by Miss A. W. Buckland, 808.
- Olenellus*-zone, discovery of the, in the North-west Highlands, by Sir A. Geikie, 633.
- Ordnance Survey, the large scale maps of the, suggestions for the revision and improvement of, by H. T. Crook, 718.
- *Ovoids and ellipsoids, experimental study of a curious movement of, by Prof. Leconte, 583.
- Pachythea* in the silurian beds at Tymawr quarry, Rumney, J. Storrie on the occurrence of, 652.
- Palinurus vulgaris*, the larvæ of, observations on, by J. T. Cunningham, 687.
- Panton (Prof. J. H.), the mastodon and mammoth in Ontario, Canada, 654.
- Parker (J.) on the circulation of underground waters, 300.
- Parker (Prof. W. N.) *on some simple models illustrating the vascular system of vertebrates, 679; exhibition of, and remarks upon, some young specimens of *Echidna aculeata*, 693; experiments on respiration in tadpoles of the common frog (*Rana temporaria*), 694.
- *Parrot, a very small, from the Solomon Islands, exhibition of, by Canon Tristram, 702.

- Pauper and destitute children, the up-bringing of, Rev. J. O. Bevan on, 745.
- Peal (S. E.) on the 'morong' and other customs of the natives of Assam, 801.
- Peaty colouring matters in sewage, the formation of, by the action of micro-organisms, W. E. Adeney on, 612.
- Pellian equation, interim report of the Committee for carrying on the tables connected with the, from the point where the work was left by Degen in 1817, 160.
- Pengelly (W.) on the erratic blocks of England, Wales, and Ireland, 276; on the circulation of underground waters, 300; on the cave at Elbolton, 351; on the prehistoric inhabitants of the British Islands, 449.
- Peradeniya, Ceylon, fifth report on the steps taken for establishing a botanical laboratory at, 358.
- *Periodic motion of a finite conservative system, Sir W. Thomson on, 566.
- *Periodic time of tuning-forks maintained in vibration electrically, Prof. J. V. Jones and T. Harrison on the, 581.
- Perkin (Dr.) on the action of light upon dyed colours, 263.
- Perkins (C. H.), labour and capital—their differences and how to reconcile them, 735.
- Perry (Prof. J.) on the earthquake and volcanic phenomena of Japan, 123; on standards for use in electrical measurements, 152.
- Pertz (D. F. M.) and F. Darwin on the artificial production of rhythm in plants, 695.
- Petroleum, the origin of, by O. C. D. Ross, 639.
- Petroleum and natural gas, the geology of, by W. Topley, 637.
- Petroleum oil-engines, Prof. W. Robinson on, 759.
- Phené (Dr. J. S.), changes in coast lines, 716; on comparison of ancient Welsh customs, devices, and commerce with those of contemporary nations, 807; recent Hittite discoveries, 814.
- Phenomena which might be observable if the hypothesis that earthquakes are connected with electrical phenomena be entertained, Prof. J. Milne on, 583.
- Photographs of geological interest in the United Kingdom, second report on the collection, preservation, and systematic registration of, 321.
- Photography, the application of, to the elucidation of meteorological phenomena, report on, 130.
- *Photography applied to exploration, by J. Thomson, 719.
- Physical and Mathematical Section, Address by Prof. O. J. Lodge to the, 547.
- Pickering (Prof.) on the bibliography of solution, 273.
- Pilchard, the reproduction of the, by J. T. Cunningham, 686.
- *Pinkerton (R. H.), note on the normal to a conic, 572.
- Pitt-Rivers (Gen.) on the work of the Corresponding Societies Committee, 41; on editing a new edition of 'Anthropological Notes and Queries,' 404.
- Plant (J.) on the erratic blocks of England, Wales, and Ireland, 276; on the circulation of underground waters, 300.
- Plesiosaurian and pterosaurian reptiles in the cretaceous strata of Brazil, evidence of the occurrence of, by A. S. Woodward, 635.
- *Plutella Crucifera, the recent visitation of, W. Fream on, 695.
- Polarised light, the electromagnetic theory of the rotation of the plane of, Prof. A. Gray on, 558.
- *Polariser, a new, Prof. S. P. Thompson on, 580.
- Polyzoa (Bryozoa)* of the zones of the upper chalk, notes on the, by G. R. Vine, 656.
- *Pontypridd and Ystradyfodwg main sewerage, the, by G. Chatterton, 757.
- *Population, the increase of food and, by W. E. A. Axon, 747.
- Population in England and Wales, recent changes in the distribution of, by E. Cannan, 747.
- Portland cements, on some of the peculiarities to be observed in, and on the most advanced methods for determining their constructive value, by H. Fajja, 764.
- Powell, Major J. W., director of the U.S. Ethnological Bureau, the work of, Prof. Max Müller on, 798.
- Poynting (Prof.) on electrolysis in its physical and chemical bearings, 122.
- *Prairies and trees, by M. Christy, 715.
- Prawle problem, the, by W. A. E. Ussher, 642.
- Preece (W. H.) on standards for use in electrical measurements, 152; *on units and their nomenclature, 577; the London-Paris telephone, 767.
- Prehistoric and ancient remains of Glamorganshire, the formation of a record of the, by E. Seward, 811.
- Prehistoric inhabitants of the British Islands, the localities in which evidences are found of the existence of, fifth report of the Committee for ascertaining and recording, 449.
- Prestwich (Prof. J.) on the erratic blocks of England, Wales, and Ireland, 276; on the circulation of underground waters

- 300; on the advisability and possibility of establishing observations upon the prevalence of earth tremors, 333; on excavations at Oldbury Hill, near Ightham, 353; preliminary notes on the excavations at Oldbury Hill, 651.
- Price (Prof. B.) on calculating tables of certain mathematical functions, 129.
- Prothalli and the propagation of ferns, facts regarding, by E. J. Lowe, 687.
- *Protoplasmic rejuvenescence, fertilisation and conjugation processes as allied modes of, Prof. M. Hartog on, 682.
- , a preliminary classification of sexual and allied modes of, by Prof. M. Hartog, 683.
- Pterosaurian and plesiosaurian reptiles in the cretaceous strata of Brazil, evidence of the occurrence of, by A. S. Woodward, 635.
- *Pyrometric measurements, certain, and methods of recording them, by Prof. W. C. Roberts-Austen, 607.
- Railway communications of India, by W. C. Furnivall, 744.
- Ramsay (Prof. W.) on electrolysis in its physical and chemical bearings, 122; on the influence of the silent discharge of electricity on oxygen and other gases, 264; on the bibliography of solution, 273; on the properties of solutions, *ib.*; the surface-tension of ether and alcohol at different temperatures, 565; *on the nature of solution, 612.
- Ravenstein (E. G.), Address to the Geographical Section (the field of geography) by, 703; *explanation of a series of maps illustrating his Address, 718; *on the proposed formation of a topographical society in Cardiff, 722.
- Rawson (Sir R.) on the work of the Corresponding Societies Committee, 41.
- Rayleigh (Prof. Lord) on electrolysis in its physical and chemical bearings, 122; on calculating tables of certain mathematical functions, 129; on standards for use in electrical measurements, 152; on reflection near the polarising angle from the clean surfaces of liquids, 563.
- Recalescent points in iron and other metals, the various phenomena connected with the, third (interim) report on, 147.
- Reed (Sir E.) on the Channel tubular railway, 758.
- Reflection near the polarising angle from the clean surfaces of liquids, Lord Rayleigh on, 563.
- Reid (A. S.) on the collection, preservation, and systematic registration of photographs of geological interest in the United Kingdom, 321.
- Reinold (Prof.) on electrolysis in its physical and chemical bearings, 122; on the bibliography of spectroscopy, 264.
- Respiration in tadpoles of the common frog (*Rana temporaria*), experiments on, by Prof. W. N. Parker, 694.
- Revolving purifier for the treatment of water by metallic iron, Dr. W. Anderson on the, 762.
- Reynolds (Prof. O.) on the investigation of the action of waves and currents on the beds and foreshores of estuaries by means of working models, 386; on model estuaries, 387.
- Rhythm in plants, the artificial production of, F. Darwin and D. F. M. Pertz on, 695.
- Riley (Prof.) on the present state of our knowledge of the zoology of the Sandwich Islands, and on the steps taken to investigate ascertained deficiencies in the fauna, 357.
- Riley (E.) on the best method of establishing an international standard for the analysis of iron and steel, 273.
- Roberts (I.) on the circulation of underground waters, 300; on the advisability and possibility of establishing observations upon the prevalence of earth tremors, 333; on arranging an investigation of the seasonal variations of temperature in lakes, rivers, and estuaries, 454.
- Roberts-Austen (Prof. W. C.) on electrolysis in its physical and chemical bearings, 122; on the various phenomena connected with the recalescent points in iron and other metals, 147; on the bibliography of spectroscopy, 264; on the best method of establishing an international standard for the analysis of iron and steel, 273; Address to the Chemical Section by, 584; *certain pyrometric measurements and methods of recording them, 607.
- and Prof. A. W. Rücker on the specific heat of basalt, 610.
- Robinson (Dr. A.), some points in the early development of *Mus musculus* and *Mus decumanus*: the relation of the yolk sac to the decidua and the placenta, 690; observations upon the development of the spinal cord in *Mus musculus* and *Mus decumanus*: the formation of the septa and the fissures, 691.
- Robinson (Prof. W.), petroleum oil-engines, 759.
- Rocks of South Pembrokeshire, the, and

- those of North Devon, a comparison between, by Dr. H. Hicks, 641.
- Rolled copper alloys, the cause of imperfections in the surface of, T. Turner on, 607.
- Roscoe (Sir H. E.) on the best methods of recording the direct intensity of solar radiation, 160; on the preparation of a new series of wave-length tables of the spectra of the elements and compounds, 161; on the teaching of science in elementary schools, 383.
- Ross (O. C. D.), the origin of petroleum, 639.
- Rotation of the sun, on observing the, with the spectroscope, by Dr. G. J. Stoney, 573.
- Roth (H. L.), 'couvade,' 800.
- Rücker (Prof. A. W.) on electrolysis in its physical and chemical bearings, 122; on researches on electro-optics, 147; on the best means of comparing and reducing magnetic observations, 149.
- and Prof. W. E. Ayrton on the magnetic field in the neighbourhood of the South London electrical railway, 581.
- and Prof. W. C. Roberts-Austen on the specific heat of basalt, 610.
- Rudler (F. W.) on the volcanic phenomena of Vesuvius and its neighbourhood, 312.
- Russell (Prof.) on the action of light upon dyed colours, 263.
- *Safety lamps, an apparatus for testing, by Prof. F. Clowes, 611.
- Salvin (O) on the present state of our knowledge of the zoology of the Sandwich Islands, and on the steps taken to investigate ascertained deficiencies in the fauna, 357.
- Sandwich Islands, draft report on the present state of our knowledge of the zoology of the, and on the steps taken to investigate ascertained deficiencies in the fauna, 357.
- Savage religion, the limits of, Dr. E. B. Tylor on, 800.
- Schlichter (Dr. H.), the geography of South-west Africa, 719.
- Schuster (Prof. A.) on electrolysis in its physical and chemical bearings, 122; on researches on the ultra-violet rays of the solar spectrum, 147; on the best means of comparing and reducing magnetic observations, 149; on standards for use in electrical measurements, 152; on the best methods of recording the direct intensity of solar radiation, 160; on the preparation of a new series of wave-length tables of the spectra of the elements and compounds, 161.
- Science, the teaching of, in elementary schools, report on, 383.
- Slater (Dr. P. L.) on the present state of our knowledge of the fauna and flora of the West India Islands, and on the steps taken to investigate ascertained deficiencies in the fauna and flora, 354; on the present state of our knowledge of the zoology of the Sandwich Islands, and on the steps taken to investigate ascertained deficiencies in the fauna, 357; on the occupation of a table at the zoological station at Naples, 365.
- Scott (Prof. D. H.), notes on internal phloem in the dicotyledons, 696.
- Screw propellers, action of, by Major R. de Villamil, 780.
- Screw propulsion, a new system of, with non-reversible engines, W. W. Beaumont on, 779.
- Seasonal variations of temperature in lakes, rivers, and estuaries in various parts of the United Kingdom, fourth and final report of the Committee for arranging an investigation of the, in co-operation with the local societies represented on the Association, 454.
- *Sea-wanderings, the first, of the English race, by W. M. Adams, 808.
- Sedgwick (A.) on the occupation of a table at the zoological station at Naples, 365.
- Seeley (Prof. H. G.) on excavations at Oldbury Hill, near Ightham, 353.
- Sewage, a new method of disposal of, with some references to schemes now in use, C. G. Moor on, 612.
- , the formation of peaty colouring matters in, by the action of micro-organisms, W. E. Adeney on, 612.
- Seward (E.) the formation of a record of the prehistoric and ancient remains of Glamorganshire, 811.
- Sexual and allied modes of protoplasmic rejuvenescence, &c., a preliminary classification of, by Prof. M. Hartog, 683.
- Sharp (Dr. D.) on the present state of our knowledge of the zoology and botany of the West India Islands, and on the steps taken to investigate ascertained deficiencies in the fauna and flora, 354; on the present state of our knowledge of the zoology of the Sandwich Islands, and on the steps taken to investigate ascertained deficiencies in the fauna, 357.
- Sharpe (Rev. H. J.) on liquid jets under gravity, 568.
- Shaw (W. N.) on electrolysis in its physical and chemical bearings, 122; on

- standards for use in electrical measurements, 152.
- Sheldon (Mrs. F.), a visit to Kilimanjaro and Lake Chala, 719.
- Shelford (W.) on the investigation of the action of waves and currents on the beds and foreshores of estuaries by means of working models, 386.
- Shenstone (W. A.) on the influence of the silent discharge of electricity on oxygen and other gases, 264; on the direct formation of haloid compounds from pure materials, 274.
- Sherborn (C. D.) on the registration of all the type specimens of British fossils, 299.
- *Siam border, the, by Lord Lamington, 720.
- Similkameen Indians of British Columbia, account of the, by Mrs. S. S. Allison, 815.
- Sinking wells and shafts, by H. Davey, 766.
- Sladen (P.) on the occupation of a table at the zoological station at Naples, 365.
- Smith (Dr. Wilberforce), on the work of the anthropometric laboratory, 405.
- Smyth (Dr. C. P.) on researches on the ultra-violet rays of the solar spectrum, 147; comparison of eye and hand registration of lines in the violet and ultra-violet of the solar spectrum, against photographic records of the same, with the same instrument, after a lapse of several years, 573.
- Snelus (G. J.) on the best method of establishing an international standard for the analysis of iron and steel, 273.
- Solar radiation, seventh report on the best methods of recording the direct intensity of, 160.
- Solar spectrum, the ultra-violet rays of the, report on researches on the, 147.
- Solution, the bibliography of, fifth report on, 273.
- * —, the nature of, Prof. W. Ramsay on, 612.
- Solutions, the properties of, fifth report on, 273.
- Sorby (Dr. H. C.) on arranging an investigation of the seasonal variations of temperature in lakes, rivers, and estuaries, 454.
- South-eastern coal-field, the discovery of the, Prof. W. Boyd Dawkins on, 637.
- Spectra, on the cause of double lines in, by Dr. G. J. Stoney, 574.
- Spectra of the elements and compounds, report on the preparation of a new series of wave-length tables of the, 161.
- Spectroscopy, the bibliography of, third report on, 264.
- Spiller (J.) on the best method of establishing an international standard for the analysis of iron and steel, 273.
- Spontaneous ignition of coal, the, by Prof. V. B. Lewes, 602.
- Springer (Dr. A.), a latent characteristic of aluminium, 583.
- State provision against sickness and old age, and the German invalidity and superannuation law, by L. Tylor, 739.
- Statistics, Economic Science and, Address by Prof. W. Cunningham to the Section of, 723.
- Steady platform for guns, &c., at sea, a, by B. Tower, 763.
- Steel and iron, the best method of establishing an international standard for the analysis of, third report on, 273.
- Steward (Rev. J. C.) on arranging an investigation of the seasonal variations of temperature in lakes, rivers, and estuaries, 454.
- Stokes (Sir G. G.) on the best methods of recording the direct intensity of solar radiation, 160.
- Stoney (Dr. G. J.) on the best methods of recording the direct intensity of solar radiation, 160; note on observing the rotation of the sun with the spectroscope, 573; on the cause of double lines in spectra, 574; on a table to facilitate the conversion of electrostatic and electromagnetic measures into one another, 577.
- Stooke (T. S.) on the circulation of underground waters, 300.
- Storrie (J.) on the occurrence of *pachytheca* and a species of *nematophycus* in the silurian beds at Tymawr quarry, Rumney, 652.
- Strahan (Dr. S. A. K.), instinctive criminality: its true character and national treatment, 811.
- Stroud (Prof.) on the action of light upon dyed colours, 263.
- Stroud (Prof. W.), some revolutionary suggestions on the nomenclature of electrical and mechanical units, 577.
- Sudborough (J. J.), action of nitrosyl chloride on unsaturated carbon compounds, 612.
- Surface-tension, the, of ether and alcohol at different temperatures, by Prof. W. Ramsay, 565.
- Survival of domestic industries, the, by Prof. Gonner, 740.
- Swainson (G.), new form of appendicularian 'haus,' 701.
- Swinburne (J.) on the measurement of liquid resistances, 565; the causes of variation of Clark standard cells, 576.
- Sylvester (Prof.) on carrying on the tables connected with the Pellian equation from the point where the work was left by Degen in 1817, 160.

- Symons (G. J.) on the work of the Corresponding Societies Committee, 41; on the application of photography to the elucidation of meteorological phenomena, 130; on the best methods of recording the direct intensity of solar radiation, 160; on the circulation of underground waters, 300; on the advisability and possibility of establishing observations upon the prevalence of earth tremors, 333.
- Symons (W.), a simple apparatus for storing dry gases, 609.
- *Systematic observation, Le Play's method of, by F. Auburtin, 747.
- *Systematic position of certain organisms that are regarded by some naturalists as animals, and by others as plants, discussion on the, 682.
- Tables of certain mathematical functions, second report of the Committee to calculate, and, if necessary, to take steps to carry out the calculations and publish the results in an accessible form, 129.
- Tadpoles of the common frog (*Rana temporaria*), experiments on respiration in, by Prof. W. N. Parker, 694.
- Tangential transformations, some, including Laguerre's semi-droites réciproques, by Prof. R. W. Genese, 571.
- Tanner (Col. H.), bar-subtense survey, 718; *physical aspects of the Himalayas, and notes on the inhabitants, 722.
- Taxation of inventors, the, by Dr. L. Edmunds, 743.
- Taylor (H.) on standards for use in electrical measurements, 152.
- Teall (J. J. H.) on the volcanic phenomena of Vesuvius and its neighbourhood, 312.
- Telephone, the London-Paris, by W. H. Preece, 767.
- Telephoning of great cities, the, A. R. Bennett on, 769.
- Temple (Sir R.) on the teaching of science in elementary schools, 383.
- Tenerife, the ancient language of the natives of, the Marquess of Bute on, 799.
- Thermodynamics, report on the present state of our knowledge of, specially with regard to the second law, 85; researches relating to the connection of the second law with dynamical principles, by G. H. Bryan, *ib.*
- Thiselton-Dyer (Mr.) on the present state of our knowledge of the zoology and botany of the West India Islands, and on the steps taken to investigate ascertained deficiencies in the fauna and flora, 354; on the steps taken for establishing a botanical laboratory at Peradeniya, Ceylon, 358.
- Thompson (B.) on the very fossiliferous transition bed between the middle and upper lias in Northamptonshire, 334.
- Thompson (Prof. C. M.) on didymium from different sources, 611.
- Thompson (Prof. S. P.) on electrolysis in its physical and chemical bearings, 122; on the teaching of science in elementary schools, 383; on the measurement of lenses, 580; *on a new polariser, *ib.*
- *Thomson (J.), photography applied to exploration, 719.
- Thomson (Prof. J. J.) on electrolysis its physical and chemical bearings, 122; on standards for use in electrical measurements, 152.
- Thomson (J. M.) on electrolysis in its physical and chemical bearings, 122.
- Thomson (Prof. Sir W.) on electrolysis in its physical and chemical bearings, 122; on the earthquake and volcanic phenomena of Japan, 123; on calculating tables of certain mathematical functions, 129; on researches on electro-optics, 147; on the best means of comparing and reducing magnetic observations, 149; on standards for use in electrical measurements, 152; *on periodic motion of a finite conservative system, 566.
- Thorp (W.) on the propagation of electromagnetic waves in wires, 562.
- Thorpe (Prof.) on the action of light upon dyed colours, 263.
- Tiddeman (R. H.) on the erratic blocks of England, Wales, and Ireland, 276; on the collection, preservation, and systematic registration of photographs of geological interest in the United Kingdom, 321; on the cave at Elbolton, 351.
- Tilden (Prof.) on electrolysis in its physical and chemical bearings, 122; on isomeric naphthalene derivatives, 265; on the bibliography of solution, 273; on the properties of solutions, *ib.*; on the best method of establishing an international standard for the analysis of iron and steel, *ib.*
- Timimis (I. A.) the lighting of railway trains electrically, 773.
- Tomlinson (H.) on standards for use in electrical measurements, 152.
- Topley (W.) on the work of the Corresponding Societies Committee, 41; on the circulation of underground waters, 300; on the investigation of the action of waves and currents on the beds and foreshores of estuaries

- by means of working models, 386; the geology of petroleum and natural gas, 637.
- *Topographical society in Cardiff, the proposed formation of a, E. G. Ravenstein on, 722.
- Tower (B.), a steady platform for guns, &c., at sea, 763.
- *Tow-net, a, exhibition of a new apparatus for opening and closing by electricity, by W. E. Hoyle and L. F. Massey, 693.
- , a deep-sea, for opening and closing underwater, report of the Committee for improving and experimenting with, 382.
- Transformation of a differential resolvent, Rev. R. Harley on the, 566.
- Transformations used in connection with the duality of differential equations, E. B. Elliott on the, 568.
- Transmission of power by compressed air, the compound principle in the, Prof. A. C. Elliott on, 765.
- *Trees and prairies, by M. Christy, 715.
- Trimen (Dr.) on the steps taken for establishing a botanical laboratory at Peradeniya, Ceylon, 358.
- *Tristram (Canon), exhibition of a very small parrot from the Solomon Islands, 702.
- Trouton (F. T.) on the various phenomena connected with the recalescent points in iron and other metals, 147; *magnetic experiments made in connection with the determination of the rate of propagation of magnetisation in iron, 581.
- *Tuning-forks maintained in vibration electrically, the periodic time of, Prof. J. V. Jones and T. Harrison on, 581.
- Tupper (C. L.), the recent progress of agriculture in India, 532.
- Turner (T.), on the best method of establishing an international standard for the analysis of iron and steel, 273; on the cause of imperfections in the surface of rolled copper alloys, 607.
- Tylden-Wright (Mr.) on the circulation of underground waters, 300.
- Taylor (Dr. E. B.) on editing a new edition of 'Anthropological Notes and Queries,' 404; on the North-western tribes of the Dominion of Canada, 407; on the limits of savage religion, 800.
- Taylor (L.), State provision against sickness and old age, and the German invalidity and superannuation law, 739.
- Type specimens of British fossils, the registration of all the, second report on, 299.
- Ultra-violet rays of the solar spectrum, report on researches on the, 147.
- Ultra-violet spectrum of the solar prominences, the, by Prof. G. E. Hale, 557.
- Underground waters in the permeable formations of England and Wales, the circulation of, and the quantity and character of the water supplied to various towns and districts from these formations, seventeenth report on, 300.
- Units, electrical and mechanical, some revolutionary suggestions on the nomenclature of, by Prof. W. Stroud, 577.
- *Units and their nomenclature, discussion on, 577.
- Units of measurement, absolute, by W. Moon, 580.
- Unwin (Prof. W. C.) on the investigation of the action of waves and currents on the beds and foreshores of estuaries by means of working models, 386.
- Uprising of destitute and pauper children, Rev. J. O. Bevan on the, 745.
- Usk, the river, and the harbour of Newport, by L. F. Vernon Harcourt, 757.
- Ussher (W. A. E.), vulcanicity in lower Devonian rocks: the Prawle problem, 642.
- 'v,' some experiments on a new method for the determination of, by A. G. Webster, 580.
- *Vascular system of vertebrates, some simple models illustrating the, Prof. W. N. Parker on, 679.
- Vectian, or lower greensand, note on an undescribed area of, in Dorsetshire, by A. J. Jukes-Browne, 635.
- Velocity of light in the neighbourhood of rapidly-moving matter, Prof. O. J. Lodge on an experiment on the, 560.
- *Ventilation and heating of buildings, mechanical, by W. Key, 758.
- *Vertebrates, some simple models illustrating the vascular system of, Prof. W. N. Parker on, 679.
- Vesuvius and its neighbourhood, the volcanic phenomena of, report on, 312.
- Villamil (Major R. de), action of screw-propellers, 780.
- Vine (G. R.) notes on the *Polyzoa* (*Bryozoa*) of the zones of the upper chalk, 656.
- Vines (Prof. H. S.) on the occupation of a table at the laboratory of the Marine Biological Association at Plymouth, 364; the presence of a diastatic ferment in green leaves, 697.
- Violet and ultra-violet of the solar spectrum, comparison of eye and hand registration of lines in the, against photographic records of the same, with the same instrument, after a lapse of several years, by Dr. C. P. Smyth, 573.

- Volcanic and earthquake phenomena of Japan, eleventh report on the, 123.
- Volcanic phenomena of Vesuvius and its neighbourhood, report on the, 312.
- *Volta river, the, by G. Dobson, 722.
- Vowel-sounds, recent progress in the analysis of, Dr. R. J. Lloyd on, 796.
- Vulcanicity in Lower Devonian rocks: the Prawle problem, by W. A. E. Ussher, 642.
- Wager (H.) on nuclear structure in the bacteria, 681; on the nuclei of the hymenomycetes, 700.
- Walford (E. A.) on the very fossiliferous transition bed between the middle and upper lias in Northamptonshire, 334.
- Ward (Prof. M.) on the steps taken for establishing a botanical laboratory at Peradeniya, Ceylon, 358; on a simple apparatus for the cultivation of small organisms in hanging drops, and in various gases, under the microscope, 678.
- Watts (Dr. M.) on the preparation of a new series of wave-length tables of the spectra of the elements and compounds, 161.
- *Watts (N.) on electric firedamp indicators, 773.
- Watts (W. W.) on the collection, preservation, and systematic registration of photographs of geological interest in the United Kingdom, 321.
- Wave-length tables of the spectra of the elements and compounds, report on the preparation of a new series of, 161.
- Waves and currents, the action of, on the beds and foreshores of estuaries, third report on the investigation of, by means of working models, 386.
- Webb (S.), the alleged differences in the wages paid to men and women for similar work, 742.
- Webster (A. G.), some experiments on a new method for the determination of 'v,' 580.
- Welsh customs, devices, and commerce, ancient, on comparison of, with those of contemporary nations, by Dr. Phené, 807.
- West India Islands, fourth report on the present state of our knowledge of the zoology and botany of the, and on the steps taken to investigate ascertained deficiencies in the fauna and flora, 354.
- Wethered (E.) on the circulation of underground waters, 300.
- Wheeler (W. H.) on the investigation of the action of waves and currents on the beds and foreshores of estuaries by means of working models, 386.
- Whidborne (Rev. G. F.) on the registration of all the type specimens of British fossils, 299.
- Whipple (G. M.) on the best means of comparing and reducing magnetic observations, 149; on the best methods of recording the direct intensity of solar radiation, 160.
- Whitaker (W.) on the work of the Corresponding Societies Committee, 41; on the circulation of underground waters, 300.
- White (A. S.) on the comparative value of African lands, 715.
- Williams (E. L.) on the investigation of the action of waves and currents on the beds and foreshores of estuaries by means of working models, 386.
- Williamson (Prof. A. W.) on the work of the Corresponding Societies Committee, 41.
- Wilkinson (J. J.) on the cave at Elbolton, 351.
- Wills (A. W.) on the disappearance of native plants from their local habitats, 359.
- Wilson (Sir D.) on the North-western tribes of the Dominion of Canada, 407.
- Wilson (E.) on the very fossiliferous transition bed between the middle and upper lias in Northamptonshire, 334.
- Wilson (W. E.) on the absorption of heat in the solar atmosphere, 557.
- Woodward (A. S.) on the registration of all the type specimens of British fossils, 299; remarks on the lower tertiary fish fauna of Sardinia, 634; evidence of the occurrence of pterosaurian and plesiosaurian reptiles in the cretaceous strata of Brazil, 635.
- Woodward (Dr. H.) on the earthquake and volcanic phenomena of Japan, 123; on the registration of all the type specimens of British fossils, 299; on the very fossiliferous transition bed between the middle and upper lias in Northamptonshire, 334.
- Woodward (H. B.) on the collection, preservation, and systematic registration of photographs of geological interest in the United Kingdom, 321; on the very fossiliferous transition bed between the middle and upper lias in Northamptonshire, 334.
- Worship of meteorites, the, Prof. H. A. Newton on, 805.
- Wright (Prof. G. F.), recent discoveries concerning the relation of the glacial period in North America to the antiquity of man, 647; the lava beds of California and Idaho, and their relation to the antiquity of man, 651.

- Young (Prof.) on the bibliography of solution, 273.
- *Ystradyfodwg and Pontypridd main sewerage, the, by G. Chatterton, 757.
- Zoological station at Naples, report of the Committee for arranging for the occupation of a table at the, 365 ; reports to the Committee, by Mr. W. R. Melly, 366 ; by Mr. E. J. Bles, 372.
- Zoology and botany of the West India Islands, fourth report on the present state of our knowledge of the, 354.
- Zoology of the Sandwich Islands, draft report on the present state of our knowledge of the, 357
-

BRITISH ASSOCIATION FOR THE ADVANCEMENT OF SCIENCE.

Life Members (since 1845), and all Annual Members who have not intermitted their Subscription, receive gratis all Reports published after the date of their Membership. Any other volume they require may be obtained on application at the Office of the Association, Burlington House, Piccadilly, London, W., at the following prices, viz.—Reports for 1831 to 1874 (*of which more than 15 copies remain*), at 2s. 6d. per volume; after that date, at two-thirds of the Publication Price. A few sets, from 1831 to 1874 inclusive, may also be obtained at £10 per set.

Associates for the Meeting in 1891 may obtain the Volume for the Year at two-thirds of the Publication Price.

REPORT OF THE FIFTY-EIGHTH MEETING, at Bath, September 1888, *Published at* £1 4s.

CONTENTS:—Third Report of the Committee for promoting Tidal Observations in Canada;—Report of the Committee for considering the desirability of introducing a Uniform Nomenclature for the Fundamental Units of Mechanics, and of co-operating with other bodies engaged in similar work;—Fourth Report on the best means of Comparing and Reducing Magnetic Observations;—Fourth Report on Standards of Light;—Report of the Committee for co-operating with the Scottish Meteorological Society in making Meteorological Observations on Ben Nevis;—Second Report on the Bibliography of Solution;—Report of the Committee for constructing and issuing Practical Standards for use in Electrical Measurements;—Second Report on the Influence of Silicon on the properties of Steel;—Third Report of the Committee for inviting designs for a good Differential Gravity Meter in superposition of the pendulum;—Report on the present methods of teaching Chemistry;—Report on the action of Light on the Hydracids of Halogens in presence of Oxygen;—Second Report on the Nature of Solution;—Report of the Committee for making arrangements for assisting the Marine Biological Association Laboratory at Plymouth;—Third Report on Isomeric Naphthalene Derivatives;—Third Report on the Pre-historic Race in the Greek Islands;—Report on the effects of different occupations and employments on the Physical Development of the Human Body;—Sixteenth Report

on the Erratic Blocks of England, Wales, and Ireland;—Report of the Committee for preparing a further Report upon the Provincial Museums of the United Kingdom;—Second Report on the 'Manure' Gravels of Wexford;—Report of the Committee for continuing the Researches on Food-Fishes at the St. Andrews Marine Laboratory;—Fourteenth Report on the Circulation of Underground Waters in the Permeable Formations of England and Wales, and the Quantity and Character of the Water supplied to various Towns and Districts from these Formations;—Report on the Migration of Birds;—Report on the Flora of the Carboniferous Rocks of Lancashire and West Yorkshire;—Report on the Occupation of a Table at the Zoological Station at Naples;—Report on the teaching of Science in Elementary Schools;—Sixth Report on the Fossil Phyllopora of the Palaeozoic Rocks;—Second Report on the best method of ascertaining and measuring Variations in the Value of the Monetary Standard;—Report as to the Statistical Data available for determining the amount of the Precious Metals in use as Money in the principal Countries, the chief forms in which the Money is employed, and the amount annually used in the Arts;—Fourth Report on the North-Western Tribes of the Dominion of Canada;—Report of the Corresponding Societies Committee;—Second Report on the Prehistoric Inhabitants of the British Islands;—Third Report of the Committee for drawing attention to the desirability of prosecuting further research in the Antarctic Regions;—Report of the Committee for aiding in the maintenance of the establishment of a Marine Biological Station at Granton, Scotland;—Report on the Volcanic Phenomena of Vesuvius and its neighbourhood;—Report of the Committee to arrange an investigation of the Seasonal Variations of Temperature in Lakes, Rivers, and Estuaries in various parts of the United Kingdom, in co-operation with the local societies represented on the Association;—Report on an ancient Sea-beach near Bridlington Quay;—Report on the Development of the Oviduct and connected structures in certain fresh-water Teleostei;—Third Report on Electrolysis in its Physical and Chemical Bearings;—Report on the Flora of the Bahamas;—Second Report on the Physiology of the Lymphatic System;—Report on our present knowledge of the Older Rocks of Anglesey;—Report on our present knowledge of the Flora of China;—Second Report of the Committee for taking steps for the establishment of a Botanical Station at Peradeniya, Ceylon;—Eighth Report on the Earthquake and Volcanic Phenomena of Japan;—Report on the present state of our knowledge of the Zoology and Botany of the West India Islands, and the steps taken to investigate ascertained deficiencies in the Fauna and Flora;—Second Report on our Experimental Knowledge of the Properties of Matter with respect to Volume, Pressure, Temperature, and Specific Heat;—Report on the advisability and possibility of establishing in other parts of the country observations upon the prevalence of Earth Tremors similar to those now being made in Durham;—The Relations between Sliding Scales and Economic Theory;—Index-numbers as illustrating the Progressive Exports of British Produce and Manufactures;—The Friction of Metal Coils;—Sur l'application de l'analyse spectrale à la mécanique moléculaire et sur les spectres de l'oxygène;—A List of Works referring to British Mineral and Thermal Waters;—Report on the Rate of Erosion of the Sea-coasts of England and Wales, and the Influence of the Artificial Abstraction of Shingle or other material in that Action.

Together with the Transactions of the Sections, Sir F. J. Bramwell's Address, and Resolutions of the General Committee of the Association.

REPORT OF THE FIFTY-NINTH MEETING, at Newcastle-upon-Tyne, September 1889, *Published at £1 4s.*

CONTENTS:—Fifth Report of the Committee for promoting Tidal Observations in Canada;—Report on the Molecular Phenomena connected with the Magnetisation of Iron;—Report on the Collection and Identification of Meteoric Dust;—Eighteenth Report on Underground Temperature;—Fifth Report on the best methods of recording the direct Intensity of Solar Radiation;—Report of the Committee for constructing and issuing Practical Standards for use in Electrical Measurements;—Second Report of the Committee to arrange an investigation of the Seasonal Variations of Temperature in Lakes, Rivers, and Estuaries in various parts of the United Kingdom, in co-operation with the local Societies represented on the Association;—Report on the proposals of M. Tondini de Quarenghi relative to the Unification of Time, and the adoption of a Universal Prime Meridian;—Fifth Report on

the best means of Comparing and Reducing Magnetic Observations;—Report on the best method of establishing International Standards for the Analysis of Iron and Steel;—Third Report on the Investigation of the Properties of Solutions;—Third Report on the Bibliography of Solution;—Report (Provisional) on the Influence of the Silent Discharge of Electricity on Oxygen and other Gases;—Report of the Committee appointed to confer with the Committee of the American Association for the Advancement of Science with a view of forming a Uniform System of recording the results of Water Analysis;—Report on the Action of Light on the Hydracids of the Halogens in presence of Oxygen;—Seventh Report on the Fossil Phyllopoda of the Palaeozoic Rocks;—Report on the Flora of the Carboniferous Rocks of Lancashire and West Yorkshire;—Report on an Ancient Sea-beach near Bridlington Quay;—Fifteenth Report on the Circulation of Underground Waters in the Permeable Formations of England and Wales, and the Quantity and Character of the Water supplied to various Towns and Districts from these Formations;—Report on the Higher Eocene Beds of the Isle of Wight;—Third Report on the 'Manure' Gravels of Wexford;—Second Report on the present state of our Knowledge of the Zoology and Botany of the West India Islands, and the steps taken to investigate ascertained deficiencies in the Fauna and Flora;—Second Report on the development of the Oviduct and connected structures in certain freshwater Teleostei;—Report on the Occupation of a Table at the Zoological Station at Naples;—Report of the Committee for improving and experimenting with a Deep-sea Tow-net, for opening and closing under water;—Third Report on our present Knowledge of the Flora of China;—Report on the steps taken for the investigation of the Natural History of the Friendly Islands, or other groups in the Pacific, visited by H.M.S. 'Egeria';—Report of the Committee for making a digest of the Observations on the Migration of Birds;—Report of the Committee for taking steps for the establishment of a Botanical Station at Peradeniya, Ceylon;—Seventeenth Report on the Erratic Blocks of England, Wales, and Ireland;—Third Report on the Physiology of the Lymphatic System;—Report on the Teaching of Science in Elementary Schools;—Third Report on the best methods of ascertaining and measuring Variations in the Value of the Monetary Standard;—Report as to the Statistical Data available for determining the amount of the Precious Metals in use as Money in the principal Countries, the chief forms in which the Money is employed, and the amount annually used in the Arts;—Report on the Geography and Geology of the Atlas Ranges in the Empire of Morocco;—Fourth Report on Isomeric Naphthalene Derivatives;—Report on the Habits and Customs and Physical Characteristics of the Nomad Tribes of Asia Minor, and on the excavation of Sites of ancient occupation;—Report on the effects of different Occupations and Employments on the Physical Development of the Human Body;—Report of the Committee for editing a new Edition of 'Anthropological Notes and Queries';—Report of the Corresponding Societies Committee;—Fourth Report on Electrolysis in its Physical and Chemical Bearings;—Report on the Absorption Spectra of Pure Compounds;—Second Report on the present methods of teaching Chemistry;—Third Report on the Influence of Silicon on the properties of Steel;—Report on the Volcanic Phenomena of Vesuvius and its neighbourhood;—Ninth Report on the Earthquake and Volcanic Phenomena of Japan;—Report of the Committee for co-operating with the Scottish Meteorological Society in making Meteorological Observations on Ben Nevis;—Third Report on the Prehistoric Inhabitants of the British Islands;—Report on the Development of Graphic Methods in Mechanical Science;—Report on the investigation of the Action of Waves and Currents on the Beds and Foreshores of Estuaries by means of Working Models;—Report of the Committee for continuing the Bibliography of Spectroscopy;—Report of the Committee for calculating the Anthropological Measurements taken at Bath;—Second Report on the Disappearance of Native Plants from their Local Habitats;—The Incidence and Effects of Import and Export Duties;—Experiments upon the Transmission of Power by Compressed Air in Paris (Popp's System);—The Comtist Criticism of Economic Science;—On the Advisability of assigning Marks for Bodily Efficiency in the Examination of Candidates for the Public Services;—On the Principle and Methods of assigning Marks for Bodily Efficiency;—Experiments at Eton College on the Degree of Concordance between different Examiners in assigning Marks for Physical Qualifications;—Fifth Report on the North-Western Tribes of the Dominion of Canada.

Together with the Transactions of the Sections, Professor W. H. Flower's Address, and Resolutions of the General Committee of the Association.

REPORT OF THE SIXTIETH MEETING, at Leeds, August 1890,
Published at £1 4s.

CONTENTS:—Report of the Corresponding Societies Committee;—Third Report of the Committee to arrange an Investigation of the Seasonal Variations of Temperature in Lakes, Rivers, and Estuaries in various parts of the United Kingdom, in co-operation with the Local Societies represented on the Association;—Report of the Committee for constructing and issuing Practical Standards for use in Electrical Measurements;—Fifth Report on Electrolysis in its Physical and Chemical Bearings;—Sixth Report on the best methods of recording the direct Intensity of Solar Radiation;—Report of the Committee for co-operating with Dr. Kerr in his Researches on Electro-optics;—Report on Molecular Phenomena associated with the Magnetisation of Iron;—Tenth Report on the Earthquake and Volcanic Phenomena of Japan;—Sixth Report on the best means of comparing and reducing Magnetic Observations;—Report of the Committee for co-operating with the Scottish Meteorological Society in making Meteorological Observations on Ben Nevis;—Sixth Report of the Committee for promoting Tidal Observations in Canada;—Report on the present state of our Knowledge in Electrolysis and Electro-chemistry;—Report on the Preparation of a new series of Wave-length Tables of the Spectra of the Elements and Compounds;—Report on the Bibliography of Spectroscopy;—Fourth Report on the Influence of Silicon on the Properties of Iron and Steel;—Second Report on the best method of establishing an International Standard for the Analysis of Iron and Steel;—Report on the Action of Light on the Hydracids of the Halogens in presence of Oxygen;—Third Report on the present Methods of Teaching Chemistry;—Fourth Report on the Properties of Solutions;—Fourth Report on the Bibliography of Solution;—Discussion on the Theory of Solution;—Provisional Report on the Influence of the Silent Discharge of Electricity on Oxygen and other Gases;—Report on the Absorption Spectra of Pure Compounds;—Report on the best methods for the Registration of all Type Specimens of Fossils in the British Isles;—Eighteenth Report on the Erratic Blocks of England, Wales, and Ireland;—Sixteenth Report on the Circulation of Underground Waters in the Permeable Formations of England and Wales, and the Quantity and Character of the Water supplied to various Towns and Districts from these Formations;—Final Report on an Ancient Sea-beach near Bridlington Quay;—Report on the Cretaceous Polyzoa;—Report on the Volcanic Phenomena of Vesuvius and its neighbourhood;—Fourth and final Report on the ‘Manure’ Gravels of Wexford;—Eighth Report on the Fossil Phyllopora of the Palaeozoic Rocks;—Report on the collection, preservation, and systematic registration of Photographs of Geological Interest in the United Kingdom;—Report on the occupation of a Table at the Laboratory of the Marine Biological Association at Plymouth;—Third Report on the present state of our Knowledge of the Zoology and Botany of the West India Islands, and on the steps taken to investigate ascertained deficiencies in the Fauna and Flora;—Report on the occupation of a Table at the Zoological Station at Naples;—Report of the Committee for making a Digest of the Observations on the Migration of Birds;—Third Report on the Disappearance of Native Plants from their Local Habitats;—Fourth Report of the Committee for taking steps for the establishment of a Botanical Station at Peradeniya, Ceylon;—Report of the Committee for improving and experimenting with a Deep-sea Tow-net for opening and closing under water;—The probable Effects on Wages of a general Reduction in the Hours of Labour;—Fourth Report on the best methods of ascertaining and measuring Variations in the Value of the Monetary Standard;—Report on the teaching of Science in Elementary Schools;—Fourth Report as to the Statistical Data available for determining the amount of the Precious Metals in use as Money in the principal Countries, the chief Forms in which the Money is employed, and the Amount annually used in the Arts;—On some new Telemeters or Range-finders;—Second Report on the Investigation of the Action of Waves and Currents on the Beds and Foreshores of Estuaries by means of Working Models;—Report on the Geography and the Habits, Customs, and Physical Characters of the Nomad Tribes of Asia Minor and Northern Persia, and on the excavation of Sites of Ancient Occupation;—Report on the Habits, Customs, Physical Characters, and Religions of the Natives of India;—Report of the Committee for editing a new Edition of ‘Anthropological Notes and Queries’;

—Fourth Report on the Prehistoric Inhabitants of the British Islands;—Report on the Calculation of the Anthropological Measurements taken at Newcastle;—Sixth Report on the North-Western Tribes of the Dominion of Canada.

Together with the Transactions of the Sections, Sir F. A. Abel's Address, and Resolutions of the General Committee of the Association.

12 OCT. 92



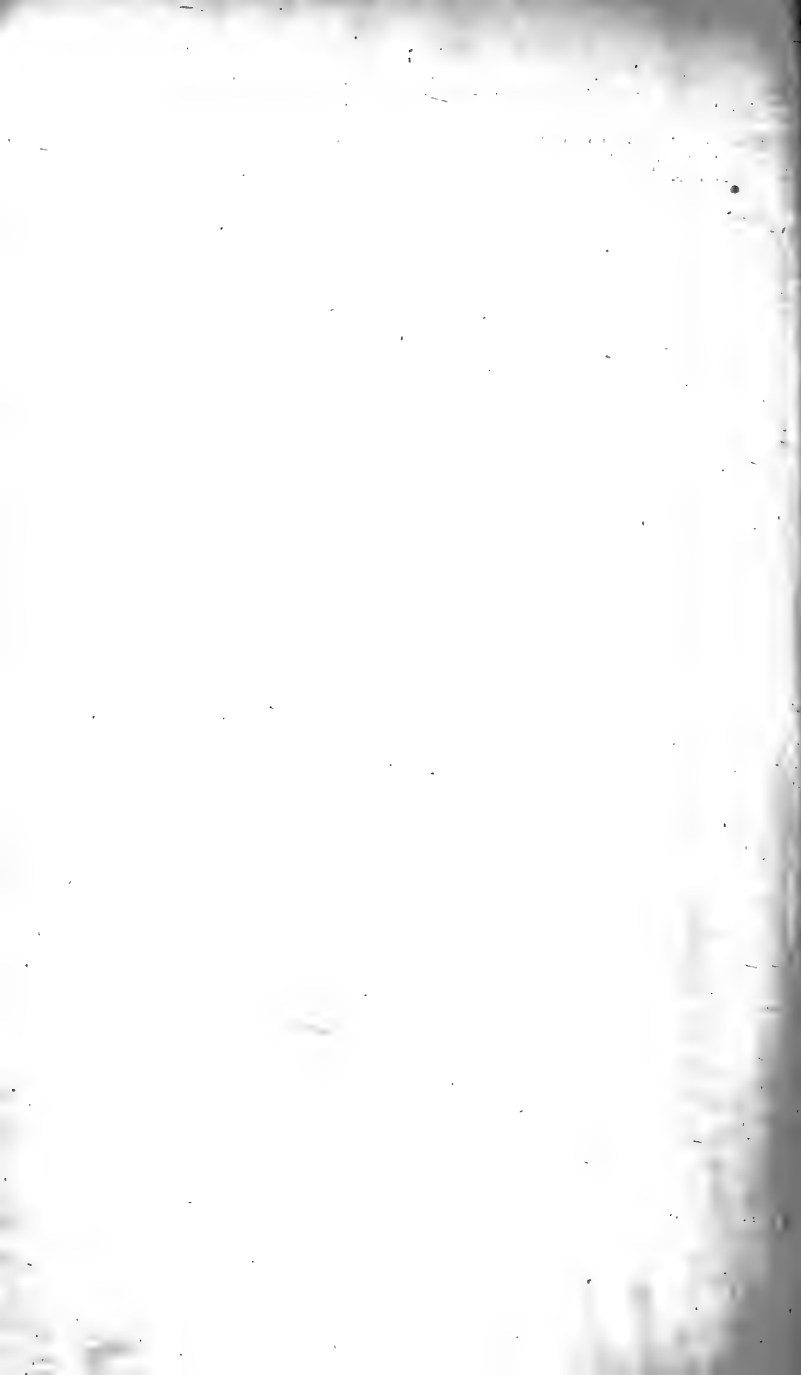

BRITISH ASSOCIATION
FOR
THE ADVANCEMENT OF SCIENCE.

LIST
OF
OFFICERS, COUNCIL, AND MEMBERS,

CORRECTED TO DECEMBER 31, 1891.

Office of the Association:
BURLINGTON HOUSE, LONDON, W.

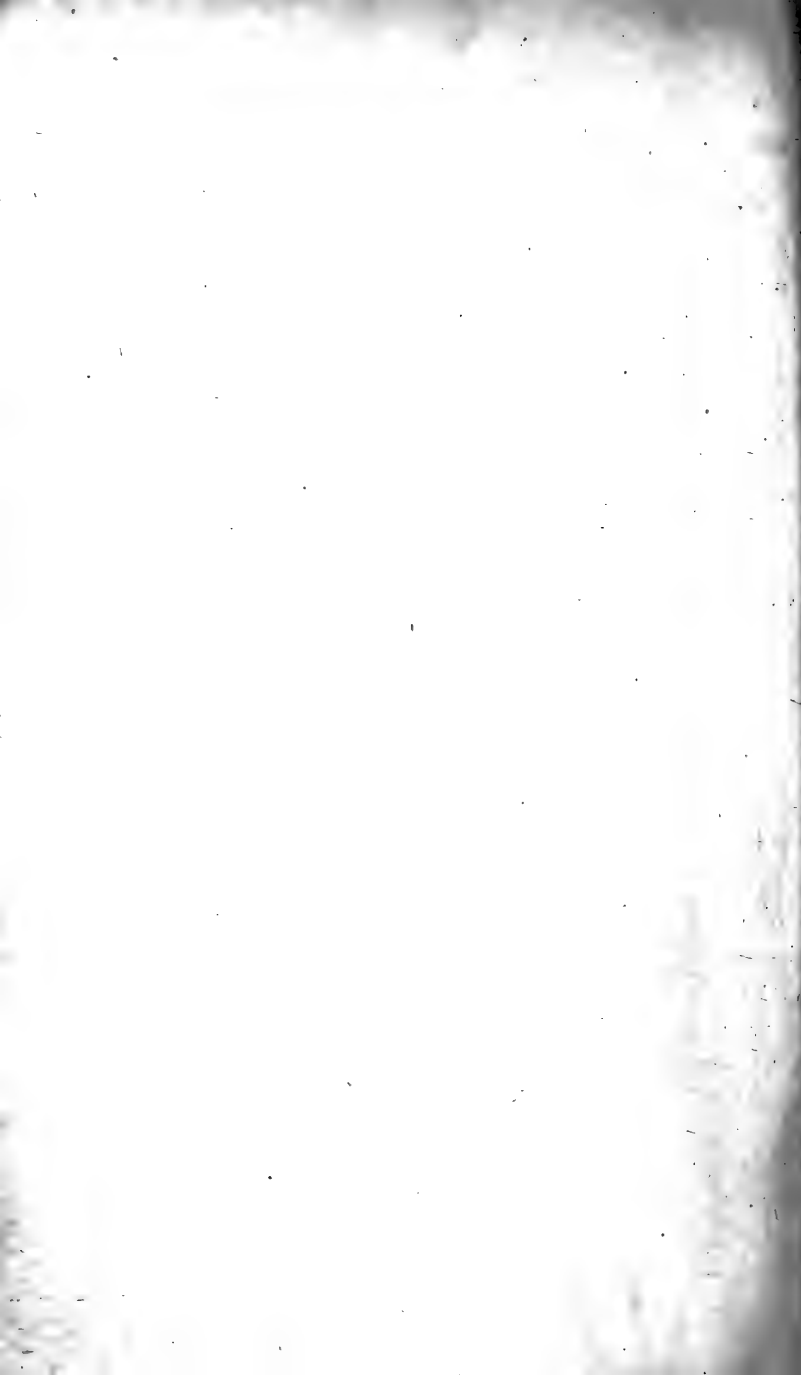

OFFICERS AND COUNCIL, 1891-92.

PRESIDENT.

WILLIAM HUGGINS, Esq., D.C.L., LL.D., F.R.S., Hon.F.R.S.E., F.R.A.S.

VICE-PRESIDENTS.

The Right Hon. LORD WINDSOR, Lord Lieutenant of Glamorganshire.

The Most Hon. the MARQUIS OF BUTE, K.T.

The Right Hon. LORD RAYLEIGH, M.A., D.C.L., LL.D., Sec.R.S., F.R.A.S., F.R.G.S.

The Right Hon. LORD TREDEGAR.

The Right Hon. LORD ABERDARE, G.C.B., F.R.S., F.R.G.S.

Sir J. T. D. LLEWELYN, Bart., F.Z.S.

Sir ARCHIBALD GEIKIE, LL.D., D.Sc., For.Sec. R.S., F.R.S.E., Pres.G.S., Director-General of the Geological Survey of the United Kingdom.

Sir ROBERT BALL, F.R.S., Royal Astronomer of Ireland.

PRESIDENT ELECT.

Sir ARCHIBALD GEIKIE, LL.D., D.Sc., For. Sec. R.S., F.R.S.E., Pres. G.S., Director-General of the Geological Survey of the United Kingdom.

VICE-PRESIDENTS ELECT.

The Right Hon. the LORD PROVOST OF EDINBURGH.

The Most Hon. the MARQUESS OF LOTHIAN, K.T.

The Right Hon. the EARL OF ROSEBURY, F.R.S.

The Right Hon. LORD KINGSBURGH, C.B., LL.D., F.R.S., F.R.S.E.

Principal Sir WILLIAM MUIR, K.C.S.I.

Professor Sir DOUGLAS MACLAGAN, M.D., Pres.R.S.E.

Professor Sir WILLIAM TURNER, F.R.S., F.R.S.E.

Professor P. G. TAIT, M.A., F.R.S.E.

Professor A. CRUM BROWN, M.D., F.R.S., F.R.S.E., Pres.C.S.

GENERAL SECRETARIES.

Capt. Sir DOUGLAS GALTON, K.C.B., D.C.L., LL.D., F.R.S., F.G.S., 12 Chester Street, London, S.W.
A. G. VERNON HARCOURT, Esq., M.A., D.C.L., LL.D., F.R.S., F.C.S., Cowley Grange, Oxford.

ASSISTANT GENERAL SECRETARY.

G. GRIFFITH, Esq., M.A., F.C.S., Harrow.

GENERAL TREASURER.

Professor ARTHUR RÜCKER, M.A., F.R.S., Burlington House, London.

LOCAL SECRETARIES FOR THE MEETING AT EDINBURGH.

Professor G. F. ARMSTRONG, M.A., C.E., F.R.S.E., F.G.S.

F. GRANT OGILVIE, Esq., M.A., B.Sc., F.R.S.E.
JOHN HARRISON, Esq.

LOCAL TREASURER FOR THE MEETING AT EDINBURGH.

ADAM GILLIES SMITH, Esq., C.A.

ORDINARY MEMBERS OF THE COUNCIL

ANDERSON, Dr. W., F.R.S.

AYRTON, Professor W. E., F.R.S.

BAKER, Sir B., K.C.M.G., F.R.S.

BATES, H. W., Esq., F.R.S.

DARWIN, Professor G. H., F.R.S.

DOUGLASS, Sir J. N., F.R.S.

EDGEWORTH, Professor F. Y., M.A.

EVANS, Dr. J., F.R.S.

FITZGERALD, Professor G. F., F.R.S.

GLAZEBROOK, R. T., Esq., F.R.S.

JUDD, Professor J. W., F.R.S.

LIVEING, Professor G. D., F.R.S.

LODGE, Professor OLIVER J., F.R.S.

PREECE, W. H., Esq., F.R.S.

RAMSAY, Professor W., F.S.S.

REINOLD, Professor A. W., F.R.S.

ROBERTS-AUSTEN, Professor W. C., C.B., F.R.S.

SCHÄFER, Professor E. A., F.R.S.

SCHUSTER, Professor A., F.R.S.

SIDGWICK, Professor H., M.A.

SYMONS, G. J., Esq., F.R.S.

THORPE, Professor T. E., F.R.S.

WARD, Professor H. MARSHALL, F.R.S.

WHITAKER, W., Esq., F.R.S.

WOODWARD, Dr. H., F.R.S.

EX-OFFICIO MEMBERS OF THE COUNCIL.

The Trustees, the President and President Elect, the Presidents of former years, the Vice-Presidents and Vice-Presidents Elect, the General and Assistant General Secretaries for the present and former years, the Secretary, the General Treasurers for the present and former years, and the Local Treasurer and Secretaries for the ensuing Meeting.

TRUSTEES (PERMANENT).

The Right Hon. Sir JOHN LUBBOCK, Bart., M.P., D.C.L., LL.D., F.R.S., F.L.S.

The Right Hon. LORD RAYLEIGH, M.A., D.C.L., LL.D., Sec.R.S., F.R.A.S.

The Right Hon. Sir LYON PLAYFAIR, K.C.B., M.P., Ph.D., LL.D., F.R.S.

PRESIDENTS OF FORMER YEARS.

The Duke of Argyll, K.G., K.T.

Sir Richard Owen, K.C.B., F.R.S.

Lord Armstrong, C.B., LL.D.

Sir William R. Grove, F.R.S.

Sir Joseph D. Hooker, K.C.S.I.

Sir G. G. Stokes, Bart., F.R.S.

Prof. Huxley, LL.D., F.R.S.

Prof. Sir Wm. Thomson, Pres.R.S.

Prof. Williamson, Ph.D., F.R.S.

Prof. Tyndall, D.C.L., F.R.S.

Prof. Allman, M.D., F.R.S.

Sir John Lubbock, Bart., F.R.S.

Prof. Cayley, LL.D., F.R.S.

Lord Rayleigh, D.C.L., Sec.R.S.

Sir Lyon Playfair, K.C.B.

Sir Wm. Dawson, C.M.G., F.R.S.

Sir H. E. Roscoe, D.C.L., F.R.S.

Sir F. J. Bramwell, Bart., F.R.S.

Prof. W. H. Flower, C.B., F.R.S.

Sir Frederick Abel, K.C.B., F.R.S.

GENERAL OFFICERS OF FORMER YEARS.

F. Galton, Esq., F.R.S.

Dr. T. A. Hirst, F.R.S.

Prof. Michael Foster, Sec.R.S.

G. Griffith, Esq., M.A., F.C.S.

P. L. Slater, Esq., Ph.D., F.R.S.

Prof. Bonney, D.Sc., F.R.S.

Prof. Williamson, Ph.D., F.R.S.

AUDITORS.

Dr. Gladstone, F.R.S.

Prof. H. M'Leod, F.R.S.

J. B. Martin, Esq., M.A., F.S.S.



LIST OF MEMBERS

OF THE

BRITISH ASSOCIATION FOR THE ADVANCEMENT OF SCIENCE.

1891

* indicates Life Members entitled to the Annual Report.

§ indicates Annual Subscribers entitled to the Annual Report.

† indicates Subscribers not entitled to the Annual Report.

Names without any mark before them are Life Members not entitled to the Annual Report.

Names of Members of the GENERAL COMMITTEE are printed in SMALL CAPITALS.

Names of Members whose addresses are incomplete or not known are in *italics*.

Notice of changes of residence should be sent to the Assistant General Secretary.

Year of
Election.

1887. *Abbe, Professor Cleveland. Weather Bureau, Department of Agriculture, Washington, U.S.A.
1881. *Abbott, R. T. G. Whitley House, Malton.
1887. †Abbott, T. C. Eastleigh, Queen's-road, Bowdon, Cheshire.
1863. *ABEL, Sir FREDERICK AUGUSTUS, K.C.B., D.C.L., D.Sc., F.R.S., V.P.C.S., President of the Government Committee on Explosives. The Imperial Institute, Imperial Institute-read, London, S.W.
1856. †*Abercrombie, John, M.D. 39 Welbeck-street, London, W.*
1886. †ABERCROMBY, The Hon. RALPH, F.R.Met.Soc. 21 Chapel-street, Belgrave-square, London, S.W.
1891. §ABERDARE, The Right Hon. Lord, G.C.B., F.R.S., F.R.G.S. Duffryn, Mountain Ash, South Wales.
1885. *ABERDEEN, The Right Hon. the Earl of, LL.D. 37 Grosvenor-square, London, W.
1885. †Aberdeen, The Countess of. 37 Grosvenor-square, London, W.
1885. †Abernethy, David W. Ferryhill Cottage, Aberdeen.
1863. *ABERNETHY, JAMES, M.Inst.C.E., F.R.S.E. 4 Delahay-street, Westminster, S.W.
1885. †Abernethy, James W. 2 Rubislaw-place, Aberdeen.

Year of
Election.

1873. *ABNEY, Captain W. DE W., R.E., C.B., D.C.L., F.R.S., F.R.A.S.,
F.C.S. Willeslie House, Wetherby-road, South Kensington,
London, S.W.
1886. †Abraham, Harry. 147 High-street, Southampton.
1877. †Ace, Rev. Daniel, D.D., F.R.A.S. Laughton, near Gainsborough,
Lincolnshire.
1884. †Acheson, George. Collegiate Institute, Toronto, Canada.
1873. †Ackroyd, Samuel. Greaves-street, Little Horton, Bradford, York-
shire.
1882. *Acland, Alfred Dyke. 38 Pont-street, Chelsea, London, S.W.
1869. †Acland, Charles T. D., M.P. Sprydoncote, Exeter.
1877. *Acland, Captain Francis E. Dyke, R.A. 22 Cheyne-gardens, Chelsea,
London, S.W.
1873. *Acland, Rev. H. D., M.A. Luccombe Rectory, Taunton.
1873. *ACLAND, Sir HENRY W. D., Bart., K.C.B., M.A., M.D., LL.D.,
F.R.S., F.R.G.S., Radcliffe Librarian and Regius Professor of
Medicine in the University of Oxford. Broad-street, Oxford.
1877. *Acland, Theodorè Dyke, M.A. 74 Brook-street, London, W.
1860. †ACLAND, Sir THOMAS DYKE, Bart., M.A., D.C.L. Sprydoncote,
Exeter; and Athenæum Club, London, S.W.
1887. †ADAMI, J. G., B.A. New Museums, Cambridge.
1884. †Adams, Frank Donovan. Geological Survey, Ottawa, Canada.
1876. †Adams, James. 9 Royal-crescent West, Glasgow.
*ADAMS, JOHN COUCH, M.A., LL.D., D.Sc., F.R.S., F.R.A.S., Director
of the Observatory and Lowndean Professor of Astronomy and
Geometry in the University of Cambridge. The Observatory,
Cambridge.
1871. §Adams, John R. 2 Nutley-terrace, Hampstead, London, N.W.
1879. *ADAMS, Rev. THOMAS, M.A., D.C.L., Principal of Bishop's College,
Lennoxville, Canada.
1877. †ADAMS, WILLIAM. 3 Sussex-terrace, Plymouth.
1869. *ADAMS, WILLIAM GRYLLE, M.A., D.Sc., F.R.S., F.G.S., F.C.P.S., Pro-
fessor of Natural Philosophy and Astronomy in King's College,
London. 43 Notting Hill-square, London, W.
1879. †Adamson, Robert, M.A., LL.D., Professor of Logic and Political
Economy in Owens College, Manchester. 1 Derby-road,
Fallowfield, Manchester.
1890. †Addyman, James Wilson, B.A. Belmont, Starbeck, Harrogate.
1890. §ADENEY, W. E., F.C.S. Royal University of Ireland, Earlsford-
terrace, Dublin.
1865. *Adkins, Henry. Northfield, near Birmingham.
1883. †Adshead, Samuel. School of Science, Macclesfield.
1884. †Agnew, Cornelius R. 266 Maddison-avenue, New York, U.S.A.
1887. †Agnew, William. Summer Hill, Pendleton, Manchester.
1884. †Ailkins, Dr. W. T. Jarvis-street, Toronto, Canada.
1864. *Ainsworth, David. The Flosk, Cleator, Carnforth.
1871. *Ainsworth, John Stirling. Harecroft, Cumberland.
1871. †Ainsworth, William M. The Flosk, Cleator, Carnforth.
1891. *Aisbitt, M. W. Mountstuart-square, Cardiff.
1871. §Aitken, John, F.R.S., F.R.S.E. Darroch, Falkirk, N.B.
Akroyd, Edward. Bankfield, Halifax.
1884. *Alabaster, H. 22 Paternoster-row, London, E.C.
1886. *Albright, G. S. The Elms, Edgbaston, Birmingham.
1862. †ALCOCK, Sir RUTHERFORD, K.C.B., D.C.L., F.R.G.S. The Athe-
næum Club, Pall Mall, London, S.W.
1861. *Alcock, Thomas, M.D. Oakfield, Sale, Manchester.
*Aldam, William. Frickley Hall, near Doncaster.

Year of
Election.

1887. †Alexander, B. *Fernlea, Fallowfield, Manchester.*
 1891. §Alexander, D. T. *Dynas Powis, Cardiff.*
 1883. †Alexander, George. *Kildare-street Club, Dublin.*
 1888. *Alexander, Patrick Y. *39 St. James's-square, Bath.*
 1873. †Alexander, Reginald, M.D. *13 Hallfield-road, Bradford, Yorkshire.*
 1858. †ALEXANDER, WILLIAM, M.D. *Halifax.*
 1891. *Alford, Charles J., F.G.S., *Boscombe, Hants.*
 1883. †Alger, Miss Ethel. *The Manor House, Stoke Damerel, South Devon.*
 1883. †Alger, W. H. *The Manor House, Stoke Damerel, South Devon.*
 1883. †Alger, Mrs. W. H. *The Manor House, Stoke Damerel, South Devon.*
 1867. †Alison, George L. C. *Dundee.*
 1885. †Allan, David. *West Cults, near Aberdeen.*
 1871. †Allan, G., M.Inst.C.E. *10 Austin Friars, London, E.C.*
 1871. †ALLEN, ALFRED H., F.C.S. *67 Surrey-street, Sheffield.*
 1887. *Allen, Arthur Ackland. *Overbrook, Kersal, Manchester.*
 1879. *Allen, Rev. A. J. C. *Cava House, Barton-road, Cambridge.*
 1887. *Allen, Charles Peter. *Overbrook, Kersal, Manchester.*
 1888. †Allen, F. J. *Mason College, Birmingham.*
 1884. †Allen, Rev. George. *Shaw Vicarage, Oldham.*
 1891. §Allen, Henry A., F.G.S. *Geological Museum, Jermyn-street, London, S.W.*
 1887. §Allen, John. *Kilgrimol School, St. Anne's-on-the-Sea, viâ Preston.*
 1878. †Allen, John Romilly. *5 Albert-terrace, Regent's Park, London, N.W.*
 1861. †Allen, Richard. *Didsbury, near Manchester.*
 1887. *Allen, Russell. *2 Parkwood, Victoria Park, Manchester.*
 1891. §Allen, W. H. *24 Glenroy-street, Roath, Cardiff.*
 1889. †Allhusen, Alfred. *Low Fell, Gateshead.*
 1863. †Allhusen, C. *Elswick Hall, Newcastle-on-Tyne.*
 1889. §Allhusen, Frank. *Low Fell, Gateshead.*
 *ALLMAN, GEORGE J., M.D., LL.D., F.R.S.L. & E., M.R.J.A., F.L.S.,
Emeritus Professor of Natural History in the University of Edinburgh. Ardmore, Parkstone, Dorset.
 1887. *Allnutt, J. W. F., M.A. *12 Chapel-row, Portsea, Hants.*
 1886. †Allport, Samuel. *50 Whittall-street, Birmingham.*
 1887. †Alward, G. L. *11 Hamilton-street, Grimsby, Yorkshire.*
 1873. †Ambler, John. *North Park-road, Bradford, Yorkshire.*
 1891. §Ambrose, D. R. *4 Richmond-terrace, Cardiff.*
 1883. §Amery, John Sparke. *Druid House, Ashburton, Devon.*
 1883. §Amery, Peter Fabyan Sparke. *Druid House, Ashburton, Devon.*
 1884. †Ami, Henry. *Geological Survey, Ottawa, Canada.*
 1876. †Anderson, Alexander. *1 St. James's-place, Hillhead, Glasgow.*
 1885. †Anderson, Charles Clinton. *4 Knaresborough-place, Cromwell-road, London, S.W.*
 1850. †Anderson, Charles William. *Belvedere, Harrogate.*
 1883. †Anderson, Miss Constance. *17 Stonegate, York.*
 1885. *Anderson, Hugh Kerr. *Frognaal Park, Hampstead, London, N.W.*
 1874. †Anderson, John, J.P., F.G.S. *Hollywood, Belfast.*
 1888. *Anderson, R. Bruce. *35A Great George-street, London, S.W.*
 1887. †Anderson, Professor R. J., M.D. *Queen's College, Galway.*
 1889. †Anderson, Robert Simpson. *Elswick Collieries, Newcastle-upon-Tyne.*
 1880. *ANDERSON, TEMPEST, M.D., B.Sc. *17 Stonegate, York.*
 1886. *ANDERSON, WILLIAM, D.C.L., F.R.S., M.Inst.C.E. *Lesney House Erith, Kent.*
 1880. †Andrew, Mrs. *126 Jamaica-street, Stepney, London, E.*

- Year of Election.
1883. †Andrew, Thomas, F.G.S. 18 Southernhay, Exeter.
1891. §Andrews, Thomas. 163 Newport-road, Cardiff.
1880. *Andrews, Thornton, M.Inst.C.E. Cefn Eithen, Swansea.
1886. §Andrews, William. Gosford Lodge, Coventry.
1883. †Anelay, Miss M. Mabel. Girton College, Cambridge.
1877. §ANGELL, JOHN, F.C.S. 5 Beacons-field, Derby-road, Fallowfield, Manchester.
1886. †Annan, John, J.P. Whitmore Reans, Wolverhampton.
1886. †Ansell, Joseph. 38 Waterloo-street, Birmingham.
1878. †Anson, Frederick H. 15 Dean's-yard, Westminster, S.W.
Anthony, John, M.D. 6 Greenfield-crescent, Edgbaston, Birmingham.
1890. §Antrobus, J. Coutts. Eaton Hall, Congleton.
1886. †Arblaster, Edmund, M.A. *The Grammar School, Carlisle.*
1870. †Archer, Francis. 14 Cook-street, Liverpool.
1874. †Archer, William, F.R.S., M.R.I.A. 11 South Frederick-street, Dublin.
1884. *Archibald, E. Douglas. *Grosvenor House, Tunbridge Wells.*
1851. †ARGYLL, His Grace the Duke of, K.G., K.T., D.C.L., F.R.S. L. & E., F.G.S. Argyll Lodge, Kensington, London, W.; and Inverary, Argyllshire.
1884. §Arlidge, John Thomas, M.D., B.A. The High Grove, Stoke-upon-Trent.
1883. §Armistead, Richard. 28 Chambres-road, Southport.
1883. *Armistead, William. 15 Rupert-street, Compton-road, Wolverhampton.
1887. †Armitage, Benjamin. Chomlea, Pendleton, Manchester.
1861. †Armitage, William. 95 Portland-street, Manchester.
1867. *Armitstead, George. Errol Park, Errol, N.B.
1857. *ARMSTRONG, The Right Hon. Lord, C.B., LL.D., D.C.L., F.R.S. Jesmond Dene, Newcastle-upon-Tyne.
1879. *Armstrong, Sir Alexander, K.C.B., M.D., LL.D., F.R.S., F.R.G.S. The Albany, London, W.
1886. †ARMSTRONG, GEORGE FREDERICK, M.A., F.R.S.E., F.G.S., Regius Professor of Engineering in the University of Edinburgh. The University, Edinburgh.
1873. †ARMSTRONG, HENRY E., Ph.D., F.R.S., Sec.C.S., Professor of Chemistry in the City and Guilds of London Institute, Central Institution, Exhibition-road, London, S.W. 55 Granville Park, Lewisham, S.E.
1876. †Armstrong, James. Bay Ridge, Long Island, New York, U.S.A.
1889. †Armstrong, John A. 32 Eldon-street, Newcastle-upon-Tyne.
1884. †Armstrong, Robert B. Junior Carlton Club, Pall Mall, London, S.W.
Armstrong, Thomas. Higher Broughton, Manchester.
1889. †Armstrong, Thomas John. 14 Hawthorn-terrace, Newcastle-upon-Tyne.
1870. †Arnott, Thomas Reid. Bramshill, Harlesden Green, London, N.W.
1853. *Arthur, Rev. William, M.A. Clapham Common, London, S.W.
1886. †Ascough, Jesse. Patent Borax Company, Newmarket-street, Birmingham.
1870. *Ash, Dr. T. Linnington. Holsworthy, North Devon.
1874. †Ashe, Isaac, M.B. Dundrum, Co. Dublin.
1889. §Ashley, Howard M. Airedale, Ferrybridge, Yorkshire.
1873. †Ashton, John. *Gorse Bank House, Windsor-road, Oldham.*
ASHTON, THOMAS, J.P. Ford Bank, Didsbury, Manchester.

Year of
Election.

1887. †Ashton, Thomas Gair, M.A. 36 Charlotte-street, Manchester.
 1866. †Ashwell, Henry. Woodthorpe, Nottingham.
 *Ashworth, Edmund. Egerton Hall, Bolton-le-Moors.
 1887. †Ashworth, Mrs. Harriet. Thorne Bank, Heaton Moor, near Stockport.
 Ashworth, Henry. Turton, near Bolton.
 1888. *Ashworth, J. J. 39 Spring-gardens, Manchester.
 1890. †Ashworth, J. Reginald. 20 King-street, Rochdale.
 1887. †Ashworth, John Wallwork. Thorne Bank, Heaton Moor, near Stockport.
 1887. †Aspland, Arthur P. Werneth Lodge, Gee Cross, near Manchester.
 1875. *Aspland, W. Gaskell. 93 Fellows-road, London, N.W.
 1861. †Asquith, J. R. Infirmary-street, Leeds.
 1861. †Aston, Theodore. 11 New-square, Lincoln's Inn, London, W.C.
 1887. †Atkinson, Rev. C. Chetwynd, M.A. Fairfield House, Ashton-on-Mersey.
 1865. *ATKINSON, EDMUND, Ph.D., F.C.S. Portesbery Hill, Camberley, Surrey.
 1884. †Atkinson, Edward. Brookline, Massachusetts, Boston, U.S.A.
 1863. *Atkinson, G. Clayton. 21 Windsor-terrace, Newcastle-on-Tyne.
 1861. †Atkinson, Rev. J. A. Longsight Rectory, near Manchester.
 1881. †Atkinson, J. T. The Quay, Selby, Yorkshire.
 1881. †ATKINSON, ROBERT WILLIAM, F.C.S. 44 Loudoun-square, Cardiff.
 1863. *ATFIELD, Professor J., M.A., Ph.D., F.R.S., F.C.S. 17 Bloomsbury-square, London, W.C.
 1884. †Auchincloss, W. S. 209 Church-street, Philadelphia, U.S.A.
 1886. †Aulton, A. D., M.D. Walsall.
 1860. *Austin-Gourlay, Rev. William E. C., M.A. The Gables, Winchester.
 1865. *Avery, Thomas. Church-road, Edgbaston, Birmingham.
 1881. †AXON, W. E. A. Fern Bank, Higher Broughton, Manchester.
 1888. †Ayre, Rev. J. W., M.A. 30 Green-street, Grosvenor-square, London, W.
 1877. *AYRTON, W. E., F.R.S., Professor of Applied Physics in the City and Guilds of London Institute, Central Institution, Exhibition-road, London, S.W.
 *BABINGTON, CHARLES CARDALE, M.A., F.R.S., F.L.S., F.G.S., Professor of Botany in the University of Cambridge. 5 Brookside, Cambridge.
 1884. †Baby, The Hon. G. Montreal, Canada.
 Backhouse, Edmund. Darlington.
 1863. †Backhouse, T. W. West Hendon House, Sunderland.
 1883. *Backhouse, W. A. St. John's Wolsingham, near Darlington.
 1887. *Bacon, Thomas Walter. 4 Lyndhurst-road, Hampstead, London, N.W.
 1887. †Baddeley, John. 1 Charlotte-street, Manchester.
 1881. †Baden-Powell, Sir George S., K.C.M.G., M.A., M.P., F.R.A.S., F.S.S. 8 St. George's-place, Hyde Park, London, S.W.
 1877. †Badock, W. F. Badminton House, Clifton Park, Bristol.
 1883. †Bagruel, P. H. St. Stephen's Club, Westminster, S.W.
 1883. †Baildon, Dr. 65 Manchester-road, Southport.
 1883. *Bailey, Charles, F.L.S. Ashfield, College-road, Whalley Range, Manchester.
 1870. †Bailey, Dr. Francis J. 51 Grove-street, Liverpool.
 1887. *Bailey, G. H., D.Sc., Ph.D. Owens College, Manchester.
 1878. †Bailey, John. The Laurels, Wittington, near Hereford.

Year of
Election.

1865. †Bailey, Samuel, F.G.S. Ashley House, Calthorpe-road, Edgbaston, Birmingham.
1855. †Bailey, William. Horseley Fields Chemical Works, Wolverhampton.
1887. †Bailey, W. H. Summerfield, Eccles Old-road, Manchester.
1866. †Baillon, Andrew. British Consulate, Brest.
1878. †Baily, Walter. 176 Haverstock-hill, London, N.W.
1885. †BAIN, ALEXANDER, M.A., LL.D., Rector of the University of Aberdeen. Ferryhill Lodge, Aberdeen.
1873. †Bain, Sir James, M.P. 3 Park-terrace, Glasgow.
1885. †Bain, William N. Collingwood, Pollokshields, Glasgow.
1882. *BAKER, Sir BENJAMIN, K.C.M.G., LL.D., F.R.S., M.Inst.C.E. 2 Queen Square-place, Westminster, S.W.
1866. †Baker, Francis B. Sherwood-street, Nottingham.
1886. †Baker, Harry. 262 Plymouth-grove, Manchester.
1891. §Baker, J. W. 195 Castle-road, Roath, Cardiff.
1861. *Baker, John. The Gables, Buxton.
1881. †Baker, Robert, M.D. The Retreat, York.
1863. †Baker, William. 6 Taptonville, Sheffield.
1875. †BAKER, W. PROCTOR. Brislington, Bristol.
1881. †Baldwin, Rev. G. W. de Courcy, M.A. Lord Mayor's Walk, York.
1884. †Balete, Professor E. Polytechnic School, Montreal, Canada.
1871. †Balfour, G. W. Whittinghame, Prestonkirk, Scotland.
1875. †BALFOUR, ISAAC BAYLEY, D.Sc., M.D., F.R.S.L. & E., F.I.S., Professor of Botany in the University of Edinburgh. Inverleith House, Edinburgh.
1883. †Balfour, Mrs. I. Bayley. Inverleith House, Edinburgh.
1878. *Ball, Charles Bent, M.D. 24 Merrion-square, Dublin.
1866. *BALL, Sir ROBERT STAWELL, LL.D., F.R.S., F.R.A.S., Andrews Professor of Astronomy in the University of Dublin, and Royal Astronomer of Ireland. The Observatory, Dunsink, Co. Dublin.
1878. †BALL, VALENTINE, C.B., M.A., LL.D., F.R.S., F.G.S., Director of the Museum of Science and Art, Dublin.
1883. *Ball, W. W. Rouse, M.A. Trinity College, Cambridge.
1886. §Ballantyne, J. W., M.B. 24 Melville-street, Edinburgh.
1869. †Bamber, Henry K., F.C.S. 5 Westminster-chambers, Victoria-street, Westminster, S.W.
1890. §Bamford, Harry, B.Sc. The Owens College, Manchester.
1882. †Bance, Major Edward. Limewood, The Avenue, Southampton.
1870. †BANISTER, Rev. WILLIAM, B.A. St. James's Mount, Liverpool.
1884. †Bannatyne, Hon. A. G. Winnipeg, Canada.
1884. †Barbeau, E. J. Montreal, Canada.
1866. †Barber, John. Long-row, Nottingham.
1884. †Barber, Rev. S. F. West Raynham Rectory, Swaffham, Norfolk.
1890. *Barber-Starkey, W. J. S. Aldenham Park, Bridgnorth, Salop.
1861. *Barbour, George. Bolesworth Castle, Tattenhall, Chester.
1855. †Barclay, Andrew. Kilmarnock, Scotland.
1871. †Barclay, George. 17 Coates-crescent, Edinburgh.
1852. *Barclay, J. Gurney. 54 Lombard-street, London, E.C.
1860. *Barclay, Robert. High Leigh, Hoddesden, Herts.
1876. *Barclay, Robert. 21 Park-terrace, Glasgow.
1887. *Barclay, Robert. Springfield, Kersal, Manchester.
1886. †Barclay, Thomas. 17 Bull-street, Birmingham.
1868. *Barclay, W. L. 54 Lombard-street, London, E.C.
1881. †Barfoot, William, J.P. Whelford-place, Leicester.
1882. †Barford, J. D. Above Bar, Southampton.

Year of
Election.

1863. *Barford, James Gale. Wellington College, Wokingham, Berkshire.
1886. †Barham, F. F. Bank of England, Birmingham.
1890. §Barker, Alfred, M.A., B.Sc. Aske's Hatcham School, New Cross, London, S.E.
1860. *Barker, Rev. Arthur Alcock, B.D. East Bridgford Rectory, Nottingham.
1879. †Barker, Elliott. 2 High-street, Sheffield.
1882. *Barker, Miss J. M. Hexham House, Hexham.
1879. *Barker, Rev. Philip C., M.A., LL.B. Boroughbridge Vicarage, Bridgewater.
1865. †Barker, Stephen. 30 Frederick-street, Edgbaston, Birmingham.
1870. †BARKLY, Sir HENRY, G.C.M.G., K.C.B., F.R.S., F.R.G.S. 1 Bina-gardens, South Kensington, London, S.W.
1889. †Barkus, Dr. B. 3 Jesmond-terrace, Newcastle-upon-Tyne.
1886. †Barling, Gilbert. 85 Edmund-street, Edgbaston, Birmingham.
1873. †Barlow, Crawford, B.A. 2 Old Palace-yard, Westminster, S.W.
1889. §Barlow, H. W. L. Holly Bank, Croftsbank-road, Urmston, near Manchester.
1883. †Barlow, J. J. 37 Park-street, Southport.
1878. †Barlow, John, M.D., Professor of Physiology in Anderson's College, Glasgow.
1883. †Barlow, John R. Greenthorne, near Bolton.
Barlow, Lieut.-Col. Maurice (14th Regt. of Foot). 5 Great George-street, Dublin.
1885. †Barlow, William, F.G.S. Hillfield, Muswell Hill, London, N.
1873. †BARLOW, WILLIAM HENRY, F.R.S., M.Inst.C.E. 2 Old Palace-yard, Westminster, S.W.
1861. *Barnard, Major R. Cary, F.L.S. Bartlow, Leckhampton, Cheltenham.
1881. †Barnard, William, LL.B. Harlow, Essex.
1889. †Barnes, J. W. Bank, Durham.
1868. §Barnes, Richard H. Heatherlands, Parkstone, Dorset.
1884. †Barnett, J. D. Port Hope, Ontario, Canada.
1886. †Barnsley, Charles H. 32 Duchess-road, Edgbaston, Birmingham.
1881. †Barr, Archibald, D.Sc., M.Inst.C.E. The University, Glasgow.
1890. †Barr, Frederick H. 4 South-parade, Leeds.
1859. †Barr, Lieut.-General. Apsleytoun, East Grinstead, Sussex.
1891. §Barrell, Frank R., M.A., Professor of Mathematics in University College, Bristol.
1883. †Barrett, John Chalk. Errismore, Birkdale, Southport.
1883. †Barrett, Mrs. J. C. Errismore, Birkdale, Southport.
1860. †Barrett, T. B. 20 Victoria-terrace, Welshpool, Montgomery.
1872. *BARRETT, W. F., F.R.S.E., M.R.I.A., Professor of Physics in the Royal College of Science, Dublin.
1883. †Barrett, William Scott. Winton Lodge, Crosby, near Liverpool.
1887. †Barrington, Miss Amy. Fassaroe, Bray, Co. Wicklow.
1874. *BARRINGTON, R. M., M.A., LL.B., F.L.S. Fassaroe, Bray, Co. Wicklow.
1874. *Barrington-Ward, Mark J., M.A., F.L.S., F.R.G.S., H.M. Inspector of Schools. Thorneloe Lodge, Worcester.
1885. *Barron, Frederick Cadogan, M.Inst.C.E. Nervion, Beckenham-grove, Shortlands, Kent.
1881. §BARRON, G. B., M.D. Summerseat, Southport.
1866. †Barron, William. Elvaston Nurseries, Borrowash, Derby.
1886. †Barrow, George William. Baldraud, Lancaster.
1886. †Barrow, Richard Bradbury. Lawn House, 13 Ampton-road, Edgbaston, Birmingham.

Year of
Election.

1886. †Barrows, Joseph. The Poplars, Yardley, near Birmingham.
 1886. †Barrows, Joseph, jun. Ferndale, Harborne-road, Edgbaston, Birmingham.
 1858. †BARRY, Right Rev. ALFRED, D.D., D.C.L. Knapdale, Upper Tooting, Surrey.
 1862. *BARRY, CHARLES. 15 Pembridge-square, London, W.
 1883. †Barry, Charles E. 15 Pembridge-square, London, W.
 1875. †Barry, John Wolfe, M.Inst.C.E. 23 Delahay-street, Westminster, S.W.
 1881. †Barry, J. W. Duncombe-place, York.
 1884. *Barstow, Miss Frances. Garrow Hill, near York.
 1890. *Barstow, J. J. Jackson. The Lodge, Weston-super-Mare.
 1890. *Barstow, Mrs. The Lodge, Weston-super-Mare.
 1858. *Bartholomew, Charles. Castle Hill House, Ealing, Middlesex, W.
 1858. *Bartholomew, William Hamond. Ridgeway House, Cumberland-road, Headingley, Leeds.
 1884. †Bartlett, James Herbert. 148 Mansfield-street, Montreal, Canada.
 1873. †Bartley, George C. T., M.P. St. Margaret's House, Victoria-street, London, S.W.
 1884. †Barton, H. M. Foster-place, Dublin.
 1852. †Barton, James. Farndreg, Dundalk.
 1887. †Bartrum, John S. 13 Gay-street, Bath.
 *Bashforth, Rev. Francis, B.D. Minting Vicarage, near Horncastle.
 1882. *BASING, The Right Hon. Lord, F.R.S. 74 St. George's-square, London, S.W.
 1876. †Bassano, Alexander. 12 Montagu-place, London, W.
 1876. †Bassano, Clement. Jesus College, Cambridge.
 1888. *Basset, A. B., M.A., F.R.S. Chapel Place Mansions, 322 Oxford-street, London, W.
 1891. §Bassett, A. B. Cheverell, Llandaff.
 1866. *BASSETT, HENRY. 26 Belitha-villas, Barnsbury, London, N.
 1889. §Bastable, Professor C. F., M.A., F.S.S. 74 Kenilworth-square, Rathgar, Co. Dublin.
 1869. †Bastard, S. S. Summerland-place, Exeter.
 1871. †BASTIAN, H. CHARLTON, M.A., M.D., F.R.S., F.L.S., Professor of the Principles and Practice of Medicine in University College, London. 8A Manchester-square, London, W.
 1889. †Batalha-Reis, J. Portuguese Consulate, Newcastle-upon-Tyne.
 1883. †Bateman, A. E. Board of Trade, London, S.W.
 1873. *Bateman, Daniel. Wissahickon, Philadelphia, U.S.A.
 1868. †Bateman, Frederick, M.D. Upper St. Giles's-street, Norwich.
 BATEMAN, JAMES, M.A., F.R.S., F.R.G.S., F.L.S. Home House, Worthing.
 1889. †Bates, C. J. Heddon, Wylam, Northumberland.
 1864. †BATES, HENRY WALTER, F.R.S., F.L.S., Assist.-Sec. R.G.S. 1-Savile-row, London, W.
 1884. †Bateson, William, B.A. St. John's College, Cambridge.
 1851. †BATH AND WELLS, The Right Rev. Lord ARTHUR HERVEY, Lord Bishop of, D.D. The Palace, Wells, Somerset.
 1881. *Bather, Francis Arthur, M.A., F.G.S. 207 Harrow-road, London, W.
 1836. †Batten, Edmund Chisholm. Thorn Falcon, near Taunton, Somerset.
 1863. §BAUERMAN, H., F.G.S. 9 Hazlebourne-gardens, Cavendish-road, Balham, London, S.W.
 1867. †Baxter, Edward. Hazel Hall, Dundee.
 Bayly, John. Seven Trees, Plymouth.
 1875. *Bayly, Robert. Torr-grove, near Plymouth.
 1876. *BAYNES, ROBERT E., M.A. Christ Church, Oxford.
 1887. *Baynes, Mrs. R. E. 3 Church-walk, Oxford.

Year of
Election.

1887. †Baynton, Alfred. 28 Gilda Brook Park, Eccles, Manchester.
1883. *Bazley, Gardner. Hatherop Castle, Fairford, Gloucestershire.
Bazley, Sir Thomas Sebastian, Bart., M.A. Hatherop Castle,
Fairford, Gloucestershire.
1886. †Beale, C. Calle Progress No. 83, Rosario de Santa Fé, Argentine
Republic.
1886. †Beale, Charles G. Maple Bank, Edgbaston, Birmingham.
1860. *BEALE, LIONEL S., M.B., F.R.S., Professor of the Principles and
Practice of Medicine in King's College, London. 61 Grosvenor-
street, London, W.
1882. §Beamish, Lieut.-Colonel A. W., R.E. 28 Grosvenor-road, London, S.W.
1884. †Beamish, G. H. M. Prison, Liverpool.
1872. †Beanes, Edward, F.C.S. Moatlands, Paddock Wood, Brenchley,
Kent.
1883. †Beard, Mrs. 13 South-hill-road, Toxteth Park, Liverpool.
1889. §Beare, Professor T. Hudson, F.R.S.E. University College, London,
W.C.
1887. †Beaton, John, M.A. 219 Upper Brook-street, Chorlton-on-Medlock,
Manchester.
1842. *Beatson, William. Ash Mount, Rotherham.
1888. †Beatson, W. B., M.D. 11 Cavendish-place, Bath.
1889. †Beattie, John. 5 Summerhill-grove, Newcastle-upon-Tyne.
1855. *Beaufort, W. Morris, F.R.A.S., F.R.G.S., F.R.M.S., F.S.S. 18 Picca-
dilly, London, W.
1886. †Beaugrand, M. H. Montreal.
1861. *Beaumont, Rev. Thomas George. Oakley Lodge, Leamington.
1887. *Beaumont, W. J. Emmanuel College, Cambridge.
1885. §BEAUMONT, W. W., M.Inst.C.E., F.G.S. Melford, Palace-road,
Tulse Hill, London, S.W.
1871. *Beazley, Lieut.-Colonel George G. 74 Redcliffe-square, London, S.W.
1887. *BECKETT, JOHN HAMPDEN. Corbar Hill House, Buxton, Derbyshire.
1885. §BEDDARD, FRANK E., M.A., F.Z.S., Prosecutor to the Zoological
Society of London. Society's Gardens, Regent's Park, London,
N.W.
1866. †Beddard, James. Derby-road, Nottingham.
1870. §BEDDOE, JOHN, M.D., F.R.S. The Manor House, Clifton, Bristol.
1858. §Bedford, James. Woodhouse Cliff, near Leeds.
1890. §Bedford, James E., F.G.S. Clifton-villas, Cardigan-road, Leeds.
1891. §Bedlington, Richard. Gadlys House, Aberdare.
1878. †BEDSON, P. PHILLIPS, D.Sc., F.C.S., Professor of Chemistry in the
College of Physical Science, Newcastle-upon-Tyne.
1884. †Beers, W. G., M.D. 34 Beaver Hall-terrace, Montreal, Canada.
1873. †Behrens, Jacob. Springfield House, North-parade, Bradford, York-
shire.
1874. †Belcher, Richard Boswell. Blockley, Worcestershire.
1891. *Belinfante, L. L., B.Sc., Assistant-Secretary G.S. Geological
Society, Burlington House, London, W.
1873. †Bell, Asabel P. 32 St. Anne's-street, Manchester.
1871. †Bell, Charles B. 6 Spring-bank, Hull.
1884. †Bell, Charles Napier. Winnipeg, Canada.
Bell, Frederick John. Woodlands, near Maldon, Essex.
1860. †Bell, Rev. George Charles, M.A. Marlborough College, Wilts.
1880. §Bell, Henry Oswin. 13 Northumberland-terrace, Tynemouth.
1862. *BELL, Sir ISAAC LOWTHIAN, Bart., F.R.S., F.C.S., M.Inst.C.E.
Rounton Grange, Northallerton.
1875. †Bell, James, C.B., D.Sc., Ph.D., F.R.S., F.C.S. The Laboratory,
Somerset House, London, W.C.

Year of
Election.

1891. §Bell, James, Bangor Villa, Clive-road, Cardiff.
 1871. *BELL, J. CARTER, F.C.S. Bankfield, The Cliff, Higher Broughton, Manchester.
 1883. *Bell, John Henry. Dalton Lees, Huddersfield.
 1864. †Bell, R. Queen's College, Kingston, Canada.
 1876. †Bell, R. Bruce, M.Inst.C.E. 203 St. Vincent-street, Glasgow.
 1863. *Bell, Thomas. Oakwood, Epping.
 1867. †Bell, Thomas. Belmont, Dundee.
 1888. *Bell, Walter George, M.A. Trinity Hall, Cambridge.
 1842. Bellhouse, Edward Taylor. Eagle Foundry, Manchester.
 1882. †Bellingham, William. 15 Killieser-avenue, Telford Park, Streat-
ham Hill, London, S.W.
 1884. †Bemrose, Joseph. 15 Plateau-street, Montreal, Canada.
 1886. §Benger, Frederick Baden, F.I.C., F.C.S. The Grange, Knutsford.
 1885. †BENHAM, WILLIAM BLAXLAND, D.Sc. University College, Lon-
don, W.C.
 1891. §Bennett, Alfred Rosling. 22 St. Alban's-road, Harlesden, London,
N.W.
 1870. †BENNETT, ALFRED W., M.A., B.Sc., F.L.S. 6 Park Village East,
Regent's Park, London, N.W.
 1836. §Bennett, Henry. Bedminster, Bristol.
 1887. †Bennett, James M. St. Mungo Chemical Company, Ruckhill, Glasgow.
 1881. §Bennett, John R. 16 West Park, Clifton, Bristol.
 1883. *Bennett, Laurence Henry. Bedminster, Bristol.
 1881. †Bennett, Rev. S. H., M.A. St. Mary's Vicarage, Bishopshill Junior,
York.
 1870. *Bennett, William. Oak Hill Park, Old Swan, near Liverpool.
 1887. †Bennion, James A., M.A. 1 St. James'-square, Manchester.
 1889. †Benson, John G. 12 Grey-street, Newcastle-upon Tyne.
 1848. †Benson, Starling. Gloucester-place, Swansea.
 1863. †Benson, William. Fourstones Court, Newcastle-upon-Tyne.
 1885. *Bent, J. Theodore. 13 Great Cumberland-place, London, W.
 1884. †Bentham, William. 724 Sherbrooke-street, Montreal, Canada.
 1863. †BENTLEY, ROBERT, F.L.S. 38 Penywern-road, Earl's Court, London,
S.W.
 1886. †Benton, William Elijah. Littleworth House, Hednesford, Stafford-
shire.
 1876. †Bergius, Walter C. 9 Loudon-terrace, Hillhead, Glasgow.
 1863. †Berkley, C. Marley Hill, Gateshead, Durham.
 1886. †Bernard, W. Leigh. Calgary, Canada.
 1887. †Berry, William. Parklands, Bowdon, Cheshire.
 1870. †Berwick, George, M.D. 36 Fawcett-street, Sunderland.
 1862. †Besant, William Henry, M.A., D.Sc., F.R.S. St. John's College,
Cambridge.
 1865. *BESSEMER, Sir HENRY, F.R.S. Denmark Hill, London, S.E.
 1882. *Bessemer, Henry, jun. Town Hill Park, West End, Southampton.
 1890. †Best, William Woodham. 31 Lyddon-terrace, Leeds.
 1883. †Betley, Ralph, F.G.S. Mining School, Wigan.
 1883. †Bettany, Mrs. 33 Oakhurst-grove, East Dulwich-road, London, S.E.
 1880. *Bevan, Rev. James Oliver, M.A., F.G.S. The Vicarage, Vow-
church, Hereford.
 1834. *Beverley, Michael, M.D. 54 Prince of Wales-road, Norwich.
 1885. †Beveridge, R. Beath Villa, Ferryhill, Aberdeen.
 1874. *Bevington, James B. Merle Wood, Sevenoaks.
 1890. §Bevington, Miss Mary E. The Elms, Bickley Park, Kent.
 1863. †Bewick, Thomas John, F.G.S. Suffolk House, Laurence Pountney
Hill, London, E.C.

Year of
Election.

1844. *Bickerdike, Rev. John, M.A. Shireshead Vicarage, Garstang.
 1886. †Bickersteth, The Very Rev. E., D.D., Dean of Lichfield. The Deanery, Lichfield.
 1870. †Bickerton, A.W., F.C.S. Christchurch, Canterbury, New Zealand.
 1888. *Bidder, George Parker. Trinity College, Cambridge.
 1885. *BIDWELL, SHELFORD, M.A., LL.B., F.R.S. Riverstone Lodge, Southfields, Wandsworth, Surrey, S.W.
 1882. §Biggs, C. H. W., F.C.S. Glebe Lodge, Champion Hill, London, S.E.
 1891. §Billups, J. E. 29 The Parade, Cardiff.
 1886. †Bindloss, G. F. Carnforth, Brondesbury Park, London, N.W.
 1887. *Bindloss, James B. Elm Bank, Eccles, Manchester.
 1884. *Bingham, John E. Electric Works, Sheffield.
 1881. §Binnie, Alexander R., M.Inst.C.E., F.G.S. London County Council, Spring-gardens, London, S.W.
 1873. †Binns, J. Arthur. Manningham, Bradford, Yorkshire.
 1880. †Bird, Henry, F.C.S. South Down, near Devonport.
 1866. *Birkin, Richard. Aspley Hall, near Nottingham.
 1888. *Birley, Miss Caroline. Seedley-terrace, Pendleton, Manchester.
 1887. *Birley, H. K. 13 Hyde-road, Ardwick, Manchester.
 1871. *BISCHOF, GUSTAV. 4 Hart-street, Bloomsbury, London, W.C.
 1883. †Bishop, John le Marchant. 100 Mosley-street, Manchester.
 1885. †Bissett, J. P. Wyndem, Banchory, N.B.
 1886. *Bixby, Captain W. H. War Department, Washington, U.S.A.
 1884. †Black, Francis, F.R.G.S. 6 North Bridge, Edinburgh.
 1889. †Black, W. 1 Lovaine-place, Newcastle-upon-Tyne.
 1889. §Black, William. 12 Romulus-terrace, Gateshead.
 1881. †Black, Surgeon-Major William Galt, F.R.C.S.E. Caledonian United Service Club, Edinburgh.
 1869. †Blackall, Thomas. 13 Southernhay, Exeter.
 1834. Blackburn, Bewicke. Calverley Park, Tunbridge Wells.
 1876. †Blackburn, Hugh, M.A. Roshven, Fort William, N.B.
 1884. †Blackburn, Robert. New Edinburgh, Ontario, Canada.
 Blackburne, Rev. John, jun., M.A. Rectory, Horton, near Chippenham.
 1877. †Blackie, J. Alexander. 17 Stanhope-street, Glasgow.
 1859. †Blackie, John S., M.A., Emeritus Professor of Greek in the University of Edinburgh. 9 Douglas-crescent, Edinburgh.
 1876. †Blackie, Robert. 7 Great Western-terrace, Glasgow.
 1855. *BLACKIE, W. G., Ph.D., F.R.G.S. 17 Stanhope-street, Glasgow.
 1884. †Blacklock, Frederick W. 25 St. Famille-street, Montreal, Canada.
 1883. †Blacklock, Mrs. Sea View, Lord-street, Southport.
 1888. †Blaine, R. S., J.P. Summerhill Park, Bath.
 1883. †Blair, Mrs. Oakshaw, Paisley.
 1863. †Blake, C. Carter, D.Sc. 4 Charlton-street, Fitzroy-square, London, W.
 1886. †Blake, Dr. James. San Francisco, California.
 1849. *BLAKE, HENRY WOLLASTON, M.A., F.R.S., F.R.G.S. 8 Devonshire-place, Portland-place, London, W.
 1883. *BLAKE, Rev. J. F., M.A., F.G.S. 40 Loudoun-road, London, N.W.
 1846. *Blake, William. Bridge House, South Petherton, Somerset.
 1891. §Blakesley, Thomas H., M.A., M.Inst.C.E. Royal Naval College, Greenwich, London, S.E.
 1878. †Blakeney, Rev. Canon, M.A., D.D. The Vicarage, Sheffield.
 1886. †Blakie, John. The Bridge House, Newcastle, Staffordshire.
 1861. §Blakiston, Matthew, F.R.G.S. Free Hills, Bursledon, Hants.
 1887. †Blamires, George. Cleckheaton.
 1881. §Blamires, Thomas H. Close Hill, Lockwood, near Huddersfield.

Year of
Election.

1884. *Blandy, William Charles, M.A. 1 Friar-street, Reading.
 1869. †BLANFORD, W. T., LL.D., F.R.S., F.G.S., F.R.G.S. 72 Bedford-gardens, Campden Hill, London, W.
 1887. *Bles, A. J. S. Moor End, Kersal, Manchester.
 1887. *Bles, Edward J. Moor End, Kersal, Manchester.
 1887. †Bles, Marcus S. The Beeches, Broughton Park, Manchester.
 1884. *Blish, William G. Niles, Michigan, U.S.A.
 1869. *BLOMEFIELD, Rev. LEONARD, M.A., F.L.S., F.G.S. 19 Belmont, Bath.
 1880. §Bloxam, G. W., M.A. 3 Hanover-square, London, W.
 1888. §Bloxsom, Martin, B.A., Assoc.M.Inst.C.E. 73 Clarendon-road, Crumpsall, Manchester.
 1883. †Blumberg, Dr. 65 Houghton-street, Southport.
 1870. †Blundell, Thomas Weld. Ince Blundell Hall, Great Crosby, Lancashire.
 1859. †Blunt, Sir Charles, Bart. Heathfield Park, Sussex.
 1859. †Blunt, Captain Richard. Bretlands, Chertsey, Surrey.
 1885. †BLYTH, JAMES, M.A., F.R.S.E., Professor of Natural Philosophy in Anderson's College, Glasgow.
 Blyth, B. Hall. 135 George-street, Edinburgh.
 1883. †Blyth, Miss Phœbe. 3 South Mansion House-road, Edinburgh.
 1867. †Blyth-Martin, W. Y. Blyth House, Newport, Fife.
 1887. †Blythe, William S. 65 Mosley-street, Manchester.
 1870. †Boardman, Edward. Queen-street, Norwich.
 1887. *Boddington, Henry. Pownall Hall, Wilmslow, Manchester.
 1889. †Bodmer, G. R., Assoc.M.Inst.C.E. 10 Westwick-gardens, West Kensington Park, London, W.
 1884. †Body, Rev. C. W. E., M.A. Trinity College, Toronto, Canada.
 1887. *Boissevain, Gideon Maria. 4 Jesselschade-straat, Amsterdam.
 1881. †Bojanowski, Dr. Victor de. 27 Finsbury-circus, London, E.C.
 1876. †Bolton, J. C. Carbrook, Stirling.
 Bond, Henry John Hayes, M.D. Cambridge.
 1883. §Bonney, Frederic, F.R.G.S. Colton House, Rugeley, Staffordshire.
 1883. §Bonney, Miss S. 23 Denning-road, Hampstead, London, N.W.
 1871. *BONNEY, Rev. THOMAS GEORGE, D.Sc., LL.D., F.R.S., F.S.A., F.G.S., Professor of Geology in University College, London.
 23 Denning-road, Hampstead, London, N.W.
 1866. †Booker, W. H. Cromwell-terrace, Nottingham.
 1888. §Boon, William. Coventry.
 1890. *Booth, Charles, F.S.S. 2 Talbot-court, Gracechurch-street, London, E.C.
 1883. §Booth, James. Hazelhurst, Turton.
 1883. †Booth, Richard. 4 Stone-buildings, Lincoln's Inn, London, W.C.
 1876. †Booth, Rev. William H. St. Germain's-place, Blackheath, London, S.E.
 1883. †Boothroyd, Benjamin. Rawlinson-road, Southport.
 1876. *Borland, William. 260 West George-street, Glasgow.
 1882. §Borns, Henry, Ph.D., F.C.S. Friedheim, Springfield-road, Wimbledon, Surrey.
 1876. *Bosanquet, R. H. M., M.A., F.R.S., F.R.A.S., F.C.S., New University Club, St. James's-street, London, S.W.
 *Bossey, Francis, M.D. Mayfield, Oxford-road, Redhill, Surrey.
 1881. §BOTHAMLEY, CHARLES H., F.C.S. Taunton, Somerset.
 1867. †Botly, William, F.S.A. Salisbury House, Hamlet-road, Upper Norwood, London, S.E.
 1887. †Bott, Dr. Owens College, Manchester.

Year of
Election.

1872. †Bottle, Alexander. Dover.
 1868. †Bottle, J. T. 28 Nelson-road, Great Yarmouth.
 1887. †Bottomley, James, D.Sc., B.A. 220 Lower Broughton-road, Manchester.
 1871. *BOTTOMLEY, JAMES THOMSON, M.A., F.R.S., F.R.S.E., F.C.S. 13 University-gardens, Glasgow.
 1884. *Bottomley, Mrs. 13 University-gardens, Glasgow.
 1876. †Bottomley, William, jun. 6 Rokeley-terrace, Hillhead, Glasgow.
 1890. §Boulnois, Henry Percy, M.Inst.C.E. Municipal Offices, Liverpool.
 1883. †Bourdass, Isaiah. Dunoon House, Clapham Common, London, S.W.
 1883. †BOURNE, A. G., D.Sc., F.L.S., Professor of Zoology in the Presidency College, Madras.
 1889. †Bourne, R. H. Fox. 41 Priory-road, Bedford Park, London, W.
 1866. §BOURNE, STEPHEN, F.S.S. Abberley, Wallington, Surrey.
 1890. †Bousfield, C. E. 55 Clarendon-road, Leeds.
 1884. †BOVEY, HENRY T., M.A., Professor of Civil Engineering and Applied Mechanics in McGill University, Montreal. Ontario-avenue, Montreal, Canada.
 1888. †Bowden, Rev. G. New Kingswood School, Lansdown, Bath.
 1870. †Bower, Anthony. Bowersdale, Seaforth, Liverpool.
 1881. *BOWER, F. O., F.R.S., F.L.S., Professor of Botany in the University of Glasgow.
 1867. †Bower, Dr. John. Perth.
 1856. *Bowlby, Miss F. E. 23 Lansdowne-parade, Cheltenham.
 1886. †Bowlby, Rev. Canon. 101 Newhall-street, Birmingham.
 1884. †Bowley, Edwin. Burnt Ash Hill, Lee, Kent.
 1880. †Bowly, Christopher. Cirencester.
 1887. †Bowly, Mrs. Christopher. Cirencester.
 1865. §Bowman, F. H., D.Sc., F.R.S.E. Halifax, Yorkshire.
 BOWMAN, Sir WILLIAM, Bart., M.D., LL.D., F.R.S., F.R.C.S. 5 Clifford-street, London, W.
 1887. §Box, Alfred M. Scissett, near Huddersfield.
 1884. *Boyd, M. A., M.D. 30 Merrion-square, Dublin.
 1887. †Boyd, Robert. Manor House, Didsbury, Manchester.
 1871. †Boyd, Thomas J. 41 Moray-place, Edinburgh.
 1865. †BOYLE, The Very Rev. G. D., M.A., Dean of Salisbury. The Deanery, Salisbury.
 1884. *Boyle, R. Vicars, C.S.I. Care of Messrs. Grindlay & Co., 55 Parliament-street, London, S.W.
 1872. *BRABROOK, E. W., F.S.A., V.P.A.I. 28 Abingdon-street, Westminster, S.W.
 1869. *Braby, Frederick, F.G.S., F.C.S. Bushey Lodge, Teddington, Middlesex.
 1884. *Brace, W. H., M.D. 7 Queen's Gate-terrace, London, S.W.
 1857. *Brady, Cheyne, M.R.I.A. Trinity Vicarage, West Bromwich.
 1863. †BRADY, GEORGE S., M.D., LL.D., F.R.S., F.L.S., Professor of Natural History in the Durham College of Science, Newcastle-on-Tyne. 2 Mowbray-villas, Sunderland.
 1880. *Brady, Rev. Nicholas, M.A. Rainham Hall, Rainham, Romford, Essex.
 1864. §BRAHAM, PHILIP, F.C.S. Bath.
 1870. †Braidwood, Dr. 35 Park-road South, Birkenhead.
 1888. §Braikenridge, W. J., J.P. 16 Royal-crescent, Bath.
 1879. †Bramley, Herbert. 6 Paradise-square, Sheffield.
 1865. §BRAMWELL, Sir FREDERICK J., Bart., D.C.L., F.R.S., M.Inst.C.E. 5 Great George-street, London, S.W.
 1872. †Bramwell, William J. 17 Prince Albert-street, Brighton.

- Year of Election.
1867. †Brand, William. Milnefield, Dundee.
1861. *Brandreth, Rev. Henry. 1 Cintra-terrace, Hill's-road, Cambridge.
1885. *Bratby, William, J.P. Oakfield Hall, Altrincham, Cheshire.
1890. *Bray, George. Belmont, Headingley, Leeds.
1868. †Bremridge, Elias. 17 Bloomsbury-square, London, W.C.
1877. †Brent, Francis. 19 Clarendon-place, Plymouth.
1882. *Bretherton, C. E. 1 Garden-court, Temple, London, E.C.
1881. *Brett, Alfred Thomas, M.D. Watford House, Watford.
1866. †Brettell, Thomas (Mine Agent). Dudley.
1875. †Briant, T. Hampton Wick, Kingston-on-Thames.
1886. †Bridge, T. W., M.A., Professor of Zoology in the Mason Science College, Birmingham.
1884. †Bridges, C. J. Winnipeg, Canada.
1870. *Bridson, Joseph R. Sawrey, Windermere.
1887. †Brierley, John, J.P. The Clough, Whitfield, Manchester.
1870. †Brierley, Joseph. New Market-street, Blackburn.
1886. †Brierley, Leonard. Somerset-road, Edgbaston, Birmingham.
1879. †Brierley, Morgan. Denshaw House, Saddleworth.
1870. *BRIGG, JOHN. Broomfield, Keighley, Yorkshire.
1889. †Brigg, T. H. *The Grange, Weston, near Otley, Yorkshire.*
1890. †Brigg, W. A. Kildwick Hall, near Keighley, Yorkshire.
1866. *Briggs, Arthur. Rawden Hall, Leeds.
1870. †Bright, H. A., M.A., F.R.G.S. Ashfield, Knotty Ash.
1868. †Brine, Captain Lindesay, F.R.G.S. United Service Club, Pall Mall, London, S.W.
1884. †Brisette, M. H. 424 St. Paul-street, Montreal, Canada.
1879. †Brittain, Frederick. Taptonville-crescent, Sheffield.
1879. *BRITTAI, W. H., J.P. Storth Oaks, Ranmoor, Sheffield.
1878. †Britten, James, F.L.S. Department of Botany, British Museum, London, S.W.
1884. *Brittle, John R., M.Inst.C.E., F.R.S.E. Farad Villa, Vanbrugh Hill, Blackheath, London, S.E.
1859. *BRODIE, BERNARD EDWARD, F.R.C.S., F.L.S. 20 Grosvenor-street, Grosvenor-square, London, W.
1883. *Brodie, David, M.D. 12 Patten-road, Wandsworth Common, S.W.
1865. †BRODIE, Rev. PETER BELLINGER, M.A., F.G.S. Rowington Vicarage, near Warwick.
1884. †Brodie, William, M.D. 64 Lafayette-avenue, Detroit, Michigan, U.S.A.
1883. *Brodie-Hall, Miss W. L. The Gore, Eastbourne.
1878. *Brook, George, F.L.S. The University, Edinburgh.
1881. §Brook, Robert G. Rowen-street, St. Helens, Lancashire.
1855. †Brooke, Edward. Marsden House, Stockport, Cheshire.
1864. *Brooke, Ven. Archdeacon J. Ingham. The Vicarage, Halifax.
1855. †Brooke, Peter William. Marsden House, Stockport, Cheshire.
1888. †Brooke, Rev. Canon R. E., M.A. 14 Marlborough-buildings, Bath.
1887. §Brooks, James Howard. Green Bank, Monton, Eccles, Manchester.
1863. †Brooks, John Crosse. 14 Lovaine-place, Newcastle-on-Tyne.
1887. †Brooks, S. H. Slade House, Levenshulme, Manchester.
1846. *Brooks, Sir Thomas, Bart. Cranshaw Hall, Rawtenstall, Manchester.
1887. *Bros, W. Law. Sidcup, Kent.
1883. †Brotherton, E. A. Fern Cliffe, Ilkley, Yorkshire.
1886. §Brough, Professor Joseph, LL.M., Professor of Logic and Philosophy in University College, Aberystwith.

- Year of
Election.
1885. *Browett, Alfred. 14 Dean-street, Birmingham.
1863. *BROWN, ALEXANDER CRUM, M.D., F.R.S. L. & E., Pres.C.S., Professor of Chemistry in the University of Edinburgh. 8 Belgrave-crescent, Edinburgh.
1867. †Brown, Charles Gage, M.D., C.M.G. 88 Sloane-street, London, S.W.
1855. †Brown, Colin. 192 Hope-street, Glasgow.
1871. †Brown, David. 93 Abbey-hill, Edinburgh.
1863. *Brown, Rev. Dixon. Unthank Hall, Haltwhistle, Carlisle.
1883. §Brown, Mrs. Ellen F. Campbell. 27 Abercromby-square, Liverpool.
1881. †Brown, Frederick D. 26 St. Giles's-street, Oxford.
1887. †Brown, George. Cadishead, near Manchester.
1883. †Brown, George Dransfield. Henley Villa, Ealing, Middlesex, W.
1884. †Brown, Gerald Culmer. Lachute, Quebec, Canada.
1883. †Brown, Mrs. H. Bienz. 26 Ferryhill-place, Aberdeen.
1884. †Brown, Harry. University College, London, W.C.
1883. †Brown, Mrs. Helen. 52 Grange Loan, Edinburgh.
1870. §BROWN, HORACE T., F.R.S., F.C.S. 47 High-street, Burton-on-Trent. Brown, Hugh. Broadstone, Ayrshire.
1883. †Brown, Miss Isabella Spring. 52 Grange Loan, Edinburgh.
1870. *BROWN, Professor J. CAMPBELL, D.Sc., F.C.S. University College, Liverpool.
1876. §Brown, John. Belair, Windsor-avenue, Belfast.
1881. *Brown, John, M.D. 68 Bank-parade, Burnley, Lancashire.
1882. *Brown, John. 7 Second-avenue, Sherwood Rise, Nottingham.
1859. †Brown, Rev. John Crombie, LL.D., F.L.S. Haddington, N.B.
1882. *Brown, Mrs. Mary. 68 Bank-parade, Burnley, Lancashire.
1886. §Brown R., R.N. Laurel Bank, Barnhill, Perth.
1863. †Brown, Ralph. Lambton's Bank, Newcastle-upon-Tyne.
1871. †BROWN, ROBERT, M.A., Ph.D., F.L.S., F.R.G.S. Fersley, Rydal-road, Streatham, London, S.W.
1868. †Brown, Samuel, M.Inst.C.E., Government Engineer. Nicosia, Cyprus.
1891. §BROWN T. FORSTER, M.Inst.C.E. Guildhall Chambers, Cardiff.
1865. †Brown, William. 41A New-street, Birmingham.
1885. †Brown, W. A. The Court House, Aberdeen.
1884. †Brown, William George. Ivy, Albemarle Co., Virginia, U.S.A.
1863. †Browne, Sir Benjamin Chapman, M.Inst.C.E. Westacres, Newcastle-upon-Tyne.
1879. †Browne, Sir J. Crichton, M.D., LL.D., F.R.S. L. & E. 7 Cumberland-terrace, Regent's Park, London, N.W.
1891. §Browne, Montagu, F.G.S. Town Museum, Leicester.
1862. *Browne, Robert Clayton, M.A. Sandbrook, Tullow, Co. Carlow, Ireland.
1872. †Browne, R. Mackley, F.G.S. Redcot, Bradbourne, Sevenoaks, Kent.
1865. *Browne, William, M.D. Heath Wood, Leighton Buzzard.
1887. †Brownell, T. W. 6 St. James's-square, Manchester.
1865. †Browning, John, F.R.A.S. 63 Strand, London, W.C.
1883. †Browning, Oscar, M.A. King's College, Cambridge.
1855. †Brownlee, James, jun. 30 Burnbank-gardens, Glasgow.
1889. §Bruce, J. Collingwood, LL.D., D.C.L., F.S.A. Framlington-place, Newcastle-upon-Tyne.
1863. *Brunel, H. M., M.Inst.C.E. 21 Delahay-street, Westminster, S.W.
1863. †Brunel, J. 21 Delahay-street, Westminster, S.W.
1875. *BRUNLEES, Sir JAMES, F.R.S.E., F.G.S., M.Inst.C.E. 5 Victoria-street, Westminster, S.W.
1875. †Brunlees, John. 5 Victoria-street, Westminster, S.W.

- Year of Election.
1868. †BRUNTON, T. LAUDER, M.D., D.Sc., F.R.S. 10 Stratford-place, Oxford-street, London, W.
1891. §Bruton, Edward Henry. 181 Richmond-road, Cardiff.
1878. §Brutton, Joseph. Yeovil.
1886. *BRYAN, G. H. Thornlea, Trumpington-road, Cambridge.
1884. †Bryce, Rev. Professor George. The College, Manitoba, Canada.
1859. †Bryson, William Gillespie. Cullen, Aberdeen.
1890. §Bubb, Henry. Pendyffryn, near Conway, North Wales.
1871. §BUCHAN, ALEXANDER, M.A., LL.D., F.R.S.E., Sec. Scottish Meteorological Society. 72 Northumberland-street, Edinburgh.
1867. †Buchan, Thomas. Strawberry Bank, Dundee.
1885. *Buchan, William Paton. Fairyknowe, Cambuslang, N.B.
Buchanan, Archibald. Catrine, Ayrshire.
Buchanan, D. C. 12 Barnard-road, Birkenhead, Cheshire.
1881. *Buchanan, John H., M.D. Sowerby, Thirsk.
1871. †BUCHANAN, JOHN YOUNG, M.A., F.R.S. L. & E. 10 Moray-place, Edinburgh.
1884. †Buchanan, W. Frederick. Winnipeg, Canada.
1883. †Buckland, Miss A. W. 54 Doughty-street, London, W.C.
1886. *Buckle, Edmund W. 23 Bedford-row, London, W.C.
1864. †BUCKLE, Rev. GEORGE, M.A. Wells, Somerset.
1865. *Buckley, Henry. The Upper Doon, Linthurst, near Bromsgrove, Birmingham.
1886. §Buckley, Samuel. Merlewood, Beaver-park, Didsbury.
1884. *Buckmaster, Charles Alexander, M.A., F.C.S. 16 Heathfield-road, Mill Hill Park, London, W.
1880. †Buckney, Thomas, F.R.A.S. 53 Gower-street, London, W.C.
1869. †Bucknill, J. C., M.D., F.R.S. East Cliff House, Bournemouth.
1851. *BUCKTON, GEORGE BOWDLER, F.R.S., F.L.S., F.C.S. Weycombe, Haslemere, Surrey.
1887. †Budenberg, C. F., B.Sc. Buckau Villa, Demesne-road, Whalley Range, Manchester.
1875. †Budgett, Samuel. Kirton, Albemarle-road, Beckenham, Kent.
1883. †Buick, Rev. George R., M.A. Cullybackey, Co. Antrim, Ireland.
1871. †Bulloch, Matthew. 4 Bothwell-street, Glasgow.
1881. †Bulmer, T. P. Mount-villas, York.
1883. †Bulpit, Rev. F. W. Crossens Rectory, Southport.
1865. †Bunce, John Thackray. 'Journal' Office, New-street, Birmingham.
1886. §Burbury, S. H., M.A., F.R.S. 1 New-square, Lincoln's Inn, London, W.C.
1842. *Burd, John. Glen Lodge, Knocknerea, Sligo.
1875. †Burder, John, M.D. 7 South-parade, Bristol.
1869. †Burdett-Coutts, Baroness. 1 Stratton-street, Piccadilly, London, W.
1881. †Burdett-Coutts, W. L. A. B., M.P. 1 Stratton-street, Piccadilly, London, W.
1891. §Burge, Very Rev. T. A. Ampleforth Cottage, near York.
1884. *Burland, Jeffrey H. 287 University-street, Montreal, Canada.
1888. †Burne, H. Holland. 28 Marlborough-buildings, Bath.
1883. *Burne, Colonel Sir Owen Tudor, K.C.S.I., C.I.E., F.R.G.S. 132 Sutherland-gardens, Maida Vale, London, W.
1876. †Burnet, John. 14 Victoria-crescent, Dowanhill, Glasgow.
1885. *Burnett, W. Kendall, M.A. The Grove, Kennay, Aberdeenshire.
1877. †Burns, David. Alston, Carlisle.
1884. §Burns, Professor James Austin. Southern Medical College, Atlanta, Georgia, U.S.A.
1883. †Burr, Percy J. 20 Little Britain, London, E.C.
1887. †Burroughs, Eggleston, M.D. Snow Hill-buildings, London, E.C.

Year of
Election.

1881. §Burroughs, S. M. Snow Hill-buildings, London, E.C.
 1883. *Burrows, Abraham. Greenhall, Atherton, near Manchester.
 1860. †Burrows, Montague, M.A., Professor of Modern History, Oxford.
 1891. §Burt, J. J. 103 Roath-road, Cardiff.
 1888. †Burt, John Mowlem. 3 St. John's-gardens, Kensington, London, W.
 1888. †Burt, Mrs. 3 St. John's-gardens, Kensington, London, W.
 1866. *BURTON, FREDERICK M., F.G.S. Highfield, Gainsborough.
 1889. †Burton, Rev. R. Lingens. Zetland Club, Saltburn-by-the-Sea.
 1887. *Bury, Henry. Trinity College, Cambridge.
 1878. †BUTCHER, J. G., M.A. 22 Collingham-place, London, S.W.
 1884. *Butcher, William Deane, M.R.C.S.Eng. Clydesdale, Windsor.
 1884. †Butler, Matthew I. Napanee, Ontario, Canada.
 1888. †Buttanshaw, Rev. John. 22 St. James's-square, Bath.
 1884. *Butterworth, W. Greenhill, Church-lane, Harpurhey, Manchester.
 1872. †Buxton, Charles Louis. Cromer, Norfolk.
 1883. †Buxton, Miss F. M. Newnham College, Cambridge.
 1887. *Buxton, J. H. 'Guardian' Office, Manchester.
 1868. †Buxton, S. Gurney. Catton Hall, Norwich.
 1881. †Buxton, Sydney. 15 Eaton-place, London, S.W.
 1883. †Buxton, Rev. Thomas, M.A. 19 Westcliffe-road, Birkdale, Southport.
 1872. †Buxton, Sir Thomas Fowell, Bart., F.R.G.S. Warlies, Waltham Abbey, Essex.
 1854. †BYERLEY, ISAAC, F.L.S. 22 Dingle-lane, Toxteth-park, Liverpool.
 1885. †Byres, David. 63 North Bradford, Aberdeen.
 1852. †Byrne, Very Rev. James. Ergenagh Rectory, Omagh.
 1883. §Byrom, John R. Mere Bank, Fairfield, near Manchester.
 1875. †Byrom, W. Ascroft, F.G.S. 31 King-street, Wigan.
1889. †Cackett, James Thoburn. 60 Larkspur-terrace, Newcastle-upon-Tyne.
1863. †Cail, Richard. Beaconsfield, Gateshead.
 1863. †Caird, Edward. Finnart, Dumbartonshire.
 1876. †Caird, Edward B. 8 Scotland-street, Glasgow.
 1861. *Caird, James Key. 8 Magdalene-road, Dundee.
 1875. †Caldicott, Rev. J. W., D.D. The Rectory, Shipston-on-Stour.
 1886. *Caldwell, William Hay. Birnam, Chaucer-road, Cambridge.
 1868. †Caley, A. J. Norwich.
 1857. †Callan, Rev. N. J., Professor of Natural Philosophy in Maynooth College.
 1887. †CALLAWAY CHARLES, M.A., D.Sc., F.G.S. Sandon, Wellington, Shropshire.
 1854. †Calver, Captain E. K., R.N., F.R.S. 23 Park-place East, Sunderland, Durham.
1884. †Cameron, Æneas. Yarmouth, Nova Scotia, Canada.
 1876. †Cameron, Charles, M.D., LL.D., M.P. 1 Huntly-gardens, Glasgow.
 1857. †CAMERON, Sir CHARLES A., M.D. 15 Pembroke-road, Dublin.
 1884. †Cameron, James C., M.D. 41 Belmont-park, Montreal, Canada.
 1870. †Cameron, John, M.D. 17 Rodney-street, Liverpool.
 1884. †Campbell, Archibald H. Toronto, Canada.
 1874. *CAMPBELL, Sir GEORGE, K.C.S.I., M.P., D.C.L., F.R.G.S., F.S.S. Southwell House, Southwell-gardens, South Kensington, London, S.W.; and Edenwood, Cupar, Fife.
 1883. †Campbell, H. J. 81 Kirkstall-road, Taifourd Park, Streatham Hill, S.W.
 Campbell, Sir Hugh P. H., Bart. 10 Hill-street, Berkeley-square, London, W.; and Marchmont House, near Dunse, Berwickshire.

Year of
Election.

1876. †Campbell, James A., LL.D., M.P. Stracathro House, Brechin.
 Campbell, John Archibald, M.D., F.R.S.E. Albyn-place, Edinburgh.
1862. *CAMPION, Rev. WILLIAM M., D.D. Queen's College, Cambridge.
1882. †Candy, F. H. 71 High-street, Southampton.
1890. §Cannan, Edwin, M.A., F.S.S. 24 St. Giles's, Oxford.
1888. †Cappel, Sir Albert J. L., K.C.I.E. 14 Harrington-gardens, London, W.
1880. †Capper, Robert. Norfolk House, Norfolk-street, Strand, London, W.C.
1883. †Capper, Mrs. R. Norfolk House, Norfolk-street, Strand, London, W.C.
1887. †Capstick, John Walton. University College, Dundee.
1873. *CARBUTT, EDWARD HAMER, M.Inst.C.E. 19 Hyde Park-gardens, London, W.
1883. †Carey-Hobson, Mrs. 54 Doughty-street, London, W.C.
1877. †Carkeet, John. 3 St. Andrew's-place, Plymouth.
1867. †Carmichael, David (Engineer). Dundee.
1867. †Carmichael, George. 11 Dudhope-terrace, Dundee.
1876. †Carmichael, Neil, M.D. 22 South Cumberland-street, Glasgow.
1884. †Carnegie, John. Peterborough, Ontario, Canada.
1887. †Carpenter, A., M.D. Duppas House, Croydon.
1884. †Carpenter, Louis G. Agricultural College, Fort Collins, Colorado, U.S.A.
1854. †Carpenter, Rev. R. Lant, B.A. Bridport.
1888. *Carpmael, Alfred. 1 Cophall-buildings, London, E.C.
1884. *Carpmael, Charles. Toronto, Canada.
1889. †Carr, Cuthbert Ellison. Hedgeley, Alnwick.
1889. †Carr-Ellison, John Ralph. Hedgeley, Alnwick.
1867. †CARRUTHERS, WILLIAM, F.R.S., F.L.S., F.G.S. British Museum, London, S.W.
1886. †CARSLAKE, J. BARIAM. 30 Westfield-road, Birmingham.
1883. †Carson, John. 51 Royal Avenue, Belfast.
1861. *Carson, Rev. Joseph, D.D., M.R.I.A. 18 Fitzwilliam-place, Dublin.
1868. †Carteighe, Michael, F.C.S. 172 New Bond-street, London, W.
1866. †Carter, H. H. The Park, Nottingham.
1855. †Carter, Richard, F.G.S. Cockerham Hall, Barnsley, Yorkshire.
1870. †Carter, Dr. William. 78 Rodney-street, Liverpool.
1883. †Carter, W. C. Manchester and Salford Bank, Southport.
1883. †Carter, Mrs. Manchester and Salford Bank, Southport.
1878. *Cartwright, E. Henry. 1 Courtfield-gardens, London, S.W.
1870. §Cartwright, Joshua, M.Inst.C.E., Borough Surveyor. Bury, Lancashire.
1884. *Carver, Rev. Canon Alfred J., D.D., F.R.G.S. Lynnhurst, Streatham Common, London, S.W.
1884. †Carver, Mrs. Lynnhurst, Streatham Common, London, S.W.
1883. †Carver, James. Garfield House, Elm-avenue, Nottingham.
1887. †Casartelli, Rev. L. C., M.A., Ph.D. St. Bede's College, Manchester.
1866. †Casella, L. P., F.R.A.S. The Lawns, Highgate, London, N.
1871. †Cash, Joseph. Bird-grove, Coventry.
1873. *Cash, William, F.G.S. 38 Elmfield-terrace, Saville Park, Halifax.
1888. †Cater, R. B. Avondale, Henrietta Park, Bath.
1874. †Caton, Richard, M.D., Lecturer on Physiology at the Liverpool Medical School. Lea Hall, Gateacre, Liverpool.
1859. †Catto, Robert. 44 King-street, Aberdeen.
1886. *Cave-Moyles, Mrs. Isabella. Repton Lodge, Harborne, Birmingham.
1887. §Cawley, George. 'Industries,' 358 Strand, London, W.C.
1886. †Cay, Albert. Ashleigh, Westbourne-road, Birmingham.

Year of
Election.

1860. §CAYLEY, ARTHUR, M.A., D.C.L., LL.D., D.Sc., F.R.S., V.P.R.A.S., Sadlerian Professor of Pure Mathematics in the University of Cambridge. Garden House, Cambridge.
Cayley, Digby. Brompton, near Scarborough.
Cayley, Edward Stillingfleet. Wydale, Malton, Yorkshire.
1871. *Cecil, Lord Sackville. Hayes Common, Beckenham, Kent.
1860. †CHADWICK, DAVID. The Poplars, Herne Hill, London, S.E.
1883. †Chadwick, James Percy. 51 Alexandra-road, Southport.
1859. †Chadwick, Robert. Highbank, Manchester.
1883. †Chalk, William. 24 Gloucester-road, Birkdale, Southport.
1859. †Chalmers, John Inglis. Aldbar, Aberdeen.
1883. †Chamberlain, George, J.P. Helensholme, Birkdale Park, Southport.
1884. †Chamberlain, Montague. St. John, New Brunswick, Canada.
1883. †CHAMBERS, CHARLES, F.R.S. Colába Observatory, Bombay.
1883. †Chambers, Mrs. Colába Observatory, Bombay.
1883. †Chambers, Charles, jun., Assoc.M.Inst.C.E. Colába Observatory, Bombay.
1842. Chambers, George. High Green, Sheffield.
- *Champney, Henry Nelson. 4 New-street, York.
1868. †Chambers, W. O. Lowestoft, Suffolk.
1881. *Champney, John E. Woodlands, Halifax.
1865. †Chance, A. M. Edgbaston, Birmingham.
1865. *Chance, James T. 51 Prince's-gate, London, S.W.
1886. *Chance, John Horner. 40 Augustus-road, Edgbaston, Birmingham.
1865. †Chance, Robert Lucas. Chad Hill, Edgbaston, Birmingham.
1888. †Chandler, S. Whitty, B.A. Sherborne, Dorset.
1861. *Chapman, Edward, M.A., F.L.S., F.C.S. Hill End, Mottram, Manchester.
1889. †Chapman, L. H. 147 Park-road, Newcastle-upon-Tyne.
1884. †Chapman, Professor. University College, Toronto, Canada.
1877. §Chapman, T. Algernon, M.D. Firbank, Hereford.
1874. †Charles, John James, M.A., M.D. 11 Fisherwick-place, Belfast.
1836. CHARLESWORTH, EDWARD, F.G.S. 277 Strand, London, W.C.
1874. †Charley, William. Seymour Hill, Dunmurry, Ireland.
1866. †Charnock, Richard Stephen, Ph.D., F.S.A., F.R.G.S. Junior Garrick Club, Adelphi-terrace, London, W.C.
1886. †Chate, Robert W. Southfield, Edgbaston, Birmingham.
1883. †Chater, Rev. John. Part-street, Southport.
1884. *Chatterton, George, M.A., M.Inst.C.E. 46 Queen Anne's-gate, London, S.W.
1886. §Chattock, A. P. 15 Lancaster-road, Belsize Park, London, N.W.
1867. *Chatwood, Samuel, F.R.G.S. High Lawn, Broad Oak Park, Worsley, Manchester.
1884. †CHAUVEAU, The Hon. Dr. Montreal, Canada.
1883. †Chawner, W., M.A. Emmanuel College, Cambridge.
1864. †CHEADLE, W. B., M.A., M.D., F.R.G.S. 2 Hyde Park-place, Cumberland-gate, London, S.W.
1887. †Cheetham, F. W. Limefield House, Hyde.
1887. †Cheetham, John. Limefield House, Hyde.
1874. *Chermside, Lieut.-Colonel H. C., R.E., C.B. Care of Messrs. Cox & Co., Craig's-court, Charing Cross, London, S.W.
1884. †Cherriman, Professor J. B. Ottawa, Canada.
1879. *Chesterman, W. Clarkehouse-road, Sheffield.
- CHICHESTER, The Right Rev. RICHARD DURNFORD, D.D., Lord Bishop of. Chichester.
1865. *Child, Gilbert W., M.A., M.D., F.L.S. Cowley House, Oxford.

- Year of Election.
1883. §Chinery, Edward F. Monmouth House, Lymington.
1884. †Chipman, W. W. L. 6 Place d'Armes, Ontario, Canada.
1889. †Chirney, J. W. Morpeth.
1842. *Chiswell, Thomas. 17 Lincoln-grove, Plymouth-grove, Manchester.
1863. †Cholmeley, Rev. C. H. The Rectory, Beaconsfield R.S.O., Bucks.
1882. †Chorley, George. Midhurst, Sussex.
1887. †Chorlton, J. Clayton. New Holme, Withington, Manchester.
1861. †Christie, Professor R. C., M.A. 7 St. James's-square, Manchester.
1884. *Christie, William. 29 Queen's Park, Toronto, Canada.
1875. *Christopher, George, F.C.S. 6 Barrow-road, Streatham Common, London, S.W.
1876. *CHRystal, GEORGE, M.A., LL.D., F.R.S.E., Professor of Mathematics in the University of Edinburgh. 5 Belgrave-crescent, Edinburgh.
1870. §CHURCH, A. H., M.A., F.R.S., F.C.S., Professor of Chemistry to the Royal Academy of Arts, London. Shelsley, Ennerdale-road, Kew, Surrey.
1860. †Church, William Selby, M.A. St. Bartholomew's Hospital, London, E.C.
1881. †CHURCHILL, Lord ALFRED SPENCER. 16 Rutland-gate, London, S.W.
1857. †Churchill, F., M.D. Ardtrea Rectory, Stewartstown, Co. Tyrone.
1857. †Clarendon, Frederick Villiers. 1 Belvidere-place, Mountjoy-square, Dublin.
1876. †Clark, David R., M.A. 31 Waterloo-street, Glasgow.
1890. †Clark, E. K. 81 Caledonian-road, Leeds.
1877. *Clark, F. J. Street, Somerset.
- Clark, George T. 44 Berkeley-square, London, W.
1876. †Clark, George W. 31 Waterloo-street, Glasgow.
1876. †Clark, Dr. John. 138 Bath-street, Glasgow.
1881. †Clark, J. Edmund, B.A., B.Sc., F.G.S. 20 Bootham, York.
1861. †Clark, Latimer, F.R.S., M.Inst.C.E. 11 Victoria-street, London, S.W.
1855. †Clark, Rev. William, M.A. Barrhead, near Glasgow.
1883. †Clarke, Rev. Canon, D.D. 59 Hoghton-street, Southport.
1887. §Clarke, C. Goddard. Ingleside, Elm-grove, Peckham, S.E.
1865. †Clarke, Rev. Charles. Charlotte-road, Edgbaston, Birmingham.
1875. †Clarke, Charles S. 4 Worcester-terrace, Clifton, Bristol.
1886. †Clarke, David. Langley-road, Small Heath, Birmingham.
1886. §Clarke, Rev. H. J. Great Barr Vicarage, Birmingham.
1872. *CLARKE, HYDE. 32 St. George's-square, Pimlico, London, S.W.
1875. †CLARKE, JOHN HENRY. 4 Worcester-terrace, Clifton, Bristol.
1861. *Clarke, John Hope. 62 Nelson-street, Chorlton-on-Medlock, Manchester.
1877. †Clarke, Professor John W. University of Chicago, Illinois, U.S.A.
1851. †CLARKE, JOSHUA. Fairycroft, Saffron Walden.
- Clarke, Thomas, M.A. Knedlington Manor, Howden, Yorkshire.
1883. †Clarke, W. P., J.P. 15 Hesketh-street, Southport.
1884. †Claxton, T. James. 461 St. Urbain-street, Montreal, Canada.
1861. †Clay, Charles, M.D. 101 Piccadilly, Manchester.
- *Clay, Joseph Travis, F.G.S. Rastrick, near Brighouse, Yorkshire.
1889. §CLAYDEN, A. W. Warleigh, Palace-road, Tulse Hill Park, London, S.W.
1866. †Clayden, P. W. 13 Tavistock-square, London, W.C.
1890. *Clayton, William Wikely. Gipton Lodge, Leeds.
1850. †CLEGHORN, HUGH, M.D., F.L.S. Stravithie, St. Andrews, Scotland.

- Year of Election.
1859. †Cleghorn, John. Wick.
1875. †Clegam, T. W. B. Saul Lodge, near Stonehouse, Gloucestershire.
1861. §CLELAND, JOHN, M.D., D.Sc., F.R.S., Professor of Anatomy in the University of Glasgow. 2 College, Glasgow.
1886. †Clifford, Arthur. Beechcroft, Edgbaston, Birmingham.
1888. †CLIFTON, The Right Rev. the Bishop of, D.D. Bishop's House, Clifton, Bristol.
1861. *CLIFTON, R. BELLAMY, M.A., F.R.S., F.R.A.S., Professor of Experimental Philosophy in the University of Oxford. Portland Lodge, Park Town, Oxford.
- Clonbrock, Lord Robert. Clonbrock, Galway.
1878. §Close, Rev. Maxwell H., F.G.S. 40 Lower Baggot-street, Dublin.
1873. †Clough, John. Bracken Bank, Keighley, Yorkshire.
1883. *CLOWES, FRANK, D.Sc., F.C.S., Professor of Chemistry in University College, Nottingham. University College, Nottingham.
1863. *Clutterbuck, Thomas. Warkworth, Acklington.
1881. *Clutton, William James. The Mount, York.
1885. †Clyne James. Rubislaw Den South, Aberdeen.
1868. †Coaks, J. B. Thorpe, Norwich.
1891. *Coates, Henry. Pitcullen House, Perth.
- Cobb, Edward. Falkland House, St. Ann's, Lewes.
1884. §Cobb, John. Summerhill, Apperley Bridge, Leeds.
1889. §Cochrane, Cecil A. Oakfield House, Gosforth, Newcastle-upon-Tyne.
1864. *Cochrane, James Henry. *Eln Lodge, Prestbury, Cheltenham.*
1889. †Cochrane, William. Oakfield House, Gosforth, Newcastle-upon-Tyne.
1883. †Cockshott, J. J. 24 Queen's-road, Southport.
1861. *Coe, Rev. Charles C., F.R.G.S. Fairfield, Heaton, Bolton.
1881. *COFFIN, WALTER HARRIS, F.C.S. 94 Cornwall-gardens, South Kensington, London, S.W.
1865. †Coghill, H. Newcastle-under-Lyme.
1884. *Cohen, B. L. 30 Hyde Park-gardens, London, W.
1887. †Cohen, Julius B. Hawkesmoor, Wilbraham-road, Fallowfield, Manchester.
1887. †Cohen, Sigismund. 111 Portland-street, Manchester.
1853. †Colchester, William, F.G.S. Burwell, Cambridge.
1868. †Colchester, W. P. Bassingbourn, Royston.
1879. †Cole, Skelton. 387 Glossop-road, Sheffield.
1878. †Coles, John, Curator of the Map Collection R.G.S. 1 Savile-row, London, W.
1854. *Colfox, William, B.A. Westmead, Bridport, Dorsetshire.
1857. †Colles, William, M.D. 21 Stephen's-green, Dublin.
1887. †Collie, Norman. University College, Gower-street, London, W.C.
1887. †Collier, Thomas. Ashfield, Alderley Edge, Manchester.
1869. †Collier, W. F. Woodtown, Horrabridge, South Devon.
1854. †Collingwood, Cuthbert, M.A., M.B., F.L.S. 69 Great Russell-street, London, W.C.
1861. *Collingwood, J. Frederick, F.G.S. 96 Great Portland-street, London, W.
1865. *Collins, James Tertius. Churchfield, Edgbaston, Birmingham.
1876. †Collins, J. H., F.G.S. 4 Clark-terrace, Dulwich Rise, London, S.E.
1876. †Collins, Sir William. 3 Park-terrace East, Glasgow.
1884. §Collins, William J., M.D., B.Sc. Albert-terrace, Regent's Park, London, N.W.
1868. *COLMAN, J. J., M.P. Carrow House, Norwich; and 108 Cannon-street, London, E.C.
1882. †Colmer, Joseph G., C.M.G. Office of the High Commissioner for Canada, 9 Victoria-chambers, London, S.W.

- Year of Election.
1884. †Colomb, Sir J. C. R., M.P., F.R.G.S. Dromquinna, Kenmare, Kerry, Ireland; and Junior United Service Club, London, S.W.
1888. †Commans, R. D. Macaulay-buildings, Bath.
1884. †Common, A. A., F.R.S., F.R.A.S. 63 Eaton-rise, Ealing, Middlesex, W.
1891. §Common, J. F. F. 4 Bute-crescent, Cardiff.
1884. †Conklin, Dr. William A. Central Park, New York, U.S.A.
1852. †Connal, Sir Michael. 16 Lynedoch-terrace, Glasgow.
1890. †Connor, J. W. Park-row, Leeds.
1871. *Connor, Charles C. Notting Hill House, Belfast.
1881. †CONROY, Sir JOHN, Bart., F.R.S. Balliol College, Oxford.
1876. †Cook, James. 162 North-street, Glasgow.
1882. †COOKE, Major-General A. C., R.E., C.B., F.R.G.S. Palace-chambers, Ryder-street, London, S.W.
1876. *COOKE, CONRAD W. 2 Victoria-mansions, Victoria-street, London, S.W.
1881. †Cooke, F. Bishopshill, York.
1868. †Cooke, Rev. George H. Wanstead Vicarage, near Norwich.
1868. †COOKE, M. C., M.A. 2 Grosvenor-villas, Upper Holloway, London, N.
1884. †Cooke, R. P. Brockville, Ontario, Canada.
1878. †Cooke, Samuel, M.A., F.G.S. Poona, Bombay.
1881. †Cooke, Thomas. Bishopshill, York.
1859. *Cooke, His Honour Judge, M.A., F.S.A. 42 Wimpole-street, London, W.; and Rainthorpe Hall, Long Stratton.
1883. †Cooke-Taylor, R. Whateley. Frenchwood House, Preston.
1883. †Cooke-Taylor, Mrs. Frenchwood House, Preston.
1865. †Cooksey, Joseph. West Bromwich, Birmingham.
1888. †Cooley, George Parkin. Cavendish Hill, Sherwood, Nottingham.
1883. †Coomer, John. Willaston, near Nantwich.
1884. †Coon, John S. 604 Main-street, Cambridge Pt., Massachusetts, U.S.A.
1883. †Cooper, George B. 67 Great Russell-street, London, W.C.
1850. †COOPER, Sir HENRY, M.D. 7 Charlotte-street, Hull.
1838. Cooper, James. 58 Pembroke-villas, Bayswater, London, W.
1884. †Cooper, Mrs. M. A. West Tower, Marple, Cheshire.
1846. †Cooper, William White, F.R.C.S. 19 Berkeley-square, London, W.
1889. †Coote, Arthur. The Minories, Jesmond, Newcastle-upon-Tyne.
1884. †Cope, E. D. Philadelphia, U.S.A.
1878. †Cope, Rev. S. W. Bramley, Leeds.
1871. †Copeland, Ralph, Ph.D., F.R.A.S., Astronomer Royal for Scotland and Professor of Astronomy in the University of Edinburgh.
1885. †Copland, W., M.A. Tortorston, Peterhead, N.B.
1881. †Copperthwaite, H. Holgate Villa, Holgate-lane, York.
1863. †Coppin, John. North Shields.
1842. Corbett, Edward. Grange-avenue, Levenshulme, Manchester.
1891. §Corbett, E. W. M. Y. Fron, Pwllypant, Cardiff.
1887. *Corcoran, Bryan. 31 Mark-lane, London, E.C.
1881. §Cordeaux, John. Eaton Hall, Retford, Nottinghamshire.
1883. *Core, Thomas H. Fallowfield, Manchester.
1870. *CORFIELD, W. H., M.A., M.D., F.C.S., F.G.S., Professor of Hygiene and Public Health in University College. 19 Savile-row, London, W.
1889. †Cornish, Vaughan. Ivy Cottage, Newcastle, Staffordshire.
1884. *Cornwallis, F. S. W. Linton Park, Maidstone.
1885. †Corry, John. Rosenheim, Parkhill-road, Croydon.
1888. †Corser, Rev. Richard K. 12 Beaufort-buildings East, Bath.
1891. §Cory, John, J.P. Vaindre Hall, Porthkerry, Cardiff.

Year of
Election.

1891. §Cory, Alderman Richard, J.P. Oscar House, Newport-road, Cardiff.
 1883. †Costelloe, B. F. C., M.A., B.Sc. 33 Chancery-lane, London, W.C.
 1891. *Cotsworth, Haldane Gwilt. Sand Park, Shaldon, Devonshire.
 Cottam, George. 2 Winsley-street, London, W.
 1857. †Cottam, Samuel. King-street, Manchester.
 1874. *COTTERILL, J. H., M.A., F.R.S., Professor of Applied Mechanics.
 Royal Naval College, Greenwich, S.E.
 1864. †COTTON, General FREDERICK C., R.E., C.S.I. 13 Longridge-road,
 Earl's Court-road, London, S.W.
 1869. †COTTON, WILLIAM. Pennsylvania, Exeter.
 1879. †Cottrill, Gilbert I. Shepton Mallett, Somerset.
 1876. †Couper, James. City Glass Works, Glasgow.
 1876. †Couper, James, jun. City Glass Works, Glasgow.
 1874. †Courtauld, John M. Bocking Bridge, Braintree, Essex.
 1889. †Courtney, F. S. 77 Redcliffe-square, South Kensington, London,
 S.W.
 1890. †Cousins, John James. Allerton Park, Chapel Allerton, Leeds.
 Cowan, John. Valleyfield, Pennycuik, Edinburgh.
 1863. †Cowan, John A. Blaydon Burn, Durham.
 1863. †Cowan, Joseph, jun. Blaydon, Durham.
 1876. †Cowan, J. B., M.D. 4 Eglinton-crescent, Edinburgh.
 1872. *Cowan, Thomas William, F.L.S., F.G.S. 31 Belsize Park-gardens,
 London, N.W.
 1886. †Cowen, Mrs. G. R. 9 The Ropewalk, Nottingham.
 Cowie, The Very Rev. Benjamin Morgan, M.A., D.D., Dean of
 Exeter. The Deanery, Exeter.
 1871. †Cowper, C. E. 6 Great George-street, Westminster, S.W.
 1860. †Cowper, Edward Alfred, M.Inst.C.E. 6 Great George-street,
 Westminster, S.W.
 1867. *Cox, Edward. Lyndhurst, Dundee.
 1867. *Cox, George Addison. Beechwood, Dundee.
 1882. †Cox, Thomas A., District Engineer of the S., P., and D. Railway.
 Lahore, Punjab. Care of Messrs. Grindley & Co., Parliament-
 street, London, S.W.
 1867. *Cox, Thomas Hunter. Duncarse, Dundee.
 1888. †Cox, Thomas W. B. The Chestnuts, Lansdown, Bath.
 1867. †Cox, William. Foggley, Lochee, by Dundee.
 1883. §Crabtree, William, M.Inst.C.E. Manchester-road, Southport.
 1890. †Cradock, George. Wakefield.
 1884. §CRAIGIE, Major P. G., F.S.S. 6 Lyndhurst-road, Hampstead,
 London, N.W.
 1876. †Cramb, John. Larch Villa, Helensburgh, N.B.
 1858. †Crane, Edward, Ph.D. The Old Hall, Wellington, Shropshire.
 1884. †Crathern, James. Sherbrooke-street, Montreal, Canada.
 1887. §Craven, John. Smedley Lodge, Cheetham, Manchester.
 1887. *Craven, Thomas, J.P. Woodhey Park, Ashton-upon-Mersey,
 Cheshire.
 1871. *Crawford, William Caldwell, M.A. 1 Lockharton-gardens, Slate-
 ford, Edinburgh.
 1871. *CRAWFORD AND BALGARRES, The Right Hon. the Earl of, K.T.,
 LL.D., F.R.S., F.R.A.S. The Observatory, Dun Echt, Aber-
 deen.
 1890. §Crawshaw, Charles B. Bank-terrace, Dewsbury.
 1883. *Crawshaw, Edward, F.R.G.S. 25 Tollington-park, London, N.
 1870. *Crawshay, Mrs. Robert. Cathedine, Bwlch, Breconshire.
 1885. §Creak, Staff Commander E. W., R.N., F.R.S. 36 Kidbrooke Park-
 road, Blackheath, London, S.E.

- Year of Election.
1879. †Creswick, Nathaniel. Chantry Grange, near Sheffield.
1876. *Crewdson, Rev. George. St. George's Vicarage, Kendal.
1887. *Crewdson, Theodore. Norcliffe Hall, Handforth, Manchester.
1880. *Crisp, Frank, B.A., LL.B., F.L.S. 5 Lansdowne-road, Notting Hill, London, W.
1890. *Croft, W. B., M.A. Winchester College, Hampshire.
1878. †Croke, John O'Byrne, M.A. University College, Stephen's Green, Dublin.
1857. †Crolly, Rev. George. Maynooth College, Ireland.
1885. †Crombie, Charles W. 41 Carden-place, Aberdeen.
1885. †Crombie, John. 129 Union-street, Aberdeen.
1885. †Crombie, John, jun. Daveston, Aberdeen.
1885. †CROMBIE, J. W., M.A. Balgownie Lodge, Aberdeen.
1885. †Crombie, Theodore. 18 Albyn-place, Aberdeen.
1887. †Crompton, A. 1 St. James's-square, Manchester.
1886. †Crompton, Dickinson W. 40 Harborne-road, Edgbaston, Birmingham.
1887. §Crook, Henry T. 9 Albert-square, Manchester.
1870. †Crookes, Joseph. Marlborough House, Brook Green, Hammersmith, London, W.
1865. §CROOKES, WILLIAM, F.R.S., F.C.S. 7 Kensington Park-gardens, London, W.
1879. †Crookes, Mrs. 7 Kensington Park-gardens, London, W.
1870. †Crosfield, C. J. Holmfield, Aigburth, Liverpool.
1870. *Crosfield, William. Annesley, Aigburth, Liverpool.
1890. §Cross, E. Richard, LL.B. Harwood House, New Parks-crescent Scarborough.
1887. §Cross, John. Beacliffe, Alderley Edge, Cheshire.
1861. †Cross, Rev. John Edward, M.A. Halecote, Grange-over-Sands.
1883. †Cross, Rev. Prebendary, LL.B. Part-street, Southport.
1868. †Crosse, Thomas William. St. Giles's-street, Norwich.
1886. †Crosskey, Cecil. 117 Gough-road, Birmingham.
1867. §CROSSKEY, Rev. H. W., LL.D., F.G.S. 117 Gough-road, Birmingham.
1853. †Crosskill, William. Beverley, Yorkshire.
1870. *Crossley, Edward, M.P., F.R.A.S. Bemerside, Halifax.
1871. †Crossley, Herbert. Ferney Green, Bowness, Ambleside.
1887. *Crossley, William J. Glenfield, Bowdon, Cheshire.
1883. †Crowder, Robert. Stanwix, Carlisle.
1882. §Crowley, Frederick. Ashdell, Alton, Hampshire.
1890. *Crowley, Ralph Henry. Bramley Oaks, Croydon.
1883. †Crowther, Elon. Cambridge-road, Huddersfield.
1863. †Cruddas, George. Elswick Engine Works, Newcastle-upon-Tyne.
1885. †Cruickshank, Alexander, LL.D. 20 Rose-street, Aberdeen.
1888. §Crummack, William J. London and Brazilian Bank, Rio de Janeiro, Brazil.
1873. †Crust, Walter. Hall-street, Spalding.
1883. *Cryer, Major J. H. The Grove, Manchester-road, Southport.
- Culley, Robert. Bank of Ireland, Dublin.
1883. *Culverwell, Edward P. 40 Trinity College, Dublin.
1878. †Culverwell, Joseph Pope. St. Lawrence Lodge, Sutton, Dublin.
1883. †Culverwell, T. J. H. Litfield House, Clifton, Bristol.
1859. †Cumming, Sir A. P. Gordon, Bart. Altyre.
1874. †Cumming, Professor. 33 Wellington-place, Belfast.
1861. *Cunliffe, Edward Thomas. The Parsonage, Handforth, Manchester.
1861. *Cunliffe, Peter Gibson. Dunedin, Handforth, Manchester.

Year of
Election.

1882. *CUNNINGHAM, Lieut.-Colonel ALLAN, R.E., A.I.C.E. 19 Palace Gardens-terrace, Kensington, London, W.
1887. †Cunningham, David, M.Inst.C.E., F.R.S.E., F.S.S. Harbour-chambers, Dundee; and Viewbank, Newport, Fife, Scotland.
1877. *CUNNINGHAM, D. J., M.D., F.R.S., Professor of Anatomy in Trinity College, Dublin.
1891. §Cunningham, J. H. 4 Magdala-crescent, Edinburgh.
1852. †Cunningham, John. Macedon, near Belfast.
1885. †CUNNINGHAM, J. T., B.A., F.R.S.E. Scottish Marine Station, Granton, Edinburgh.
1869. †CUNNINGHAM, ROBERT O., M.D., F.L.S., Professor of Natural History in Queen's College, Belfast.
1883. *CUNNINGHAM, Rev. WILLIAM, D.D., D.Sc. Trinity College, Cambridge.
1850. †Cunningham, Rev. William Bruce. Prestonpans, Scotland.
1885. †Cunrpey, William S. 268 Renfrew-street, Glasgow.
1884. †Currier, John McNab. Newport, Vermont, U.S.A.
1867. *Cursetjee, Manockjee, F.R.G.S., Judge of Bombay. Villa-Byculla, Bombay.
1878. †Curtis, William. Caramore, Sutton, Co. Dublin.
1884. †Cushing, Frank Hamilton. Washington, U.S.A.
1883. †Cushing, Mrs. M. Croydon, Surrey.
1881. §Cushing, Thomas, F.R.A.S. India Store Depôt, Belvedere-road, Lambeth, London, S.W.
1889. †Dagger, John H., F.I.C., F.C.S. Endon, Staffordshire.
1854. †Daglish, Robert, M.Inst.C.E. Orrell Cottage, near Wigan.
1883. †Dähne, F. W., Consul of the German Empire. 18 Somerset-place, Swansea.
1889. *Dale, Miss Elizabeth. Westbourne, Buxton, Derbyshire.
1887. †Dale, Henry F., F.R.M.S., F.Z.S. Royal London Yacht Club, 2 Savile-row, London, W.
1863. †Dale, J. B. South Shields.
1865. †Dale, Rev. R. W. 12 Calthorpe-street, Birmingham.
1867. †Dalgleish, W. Dundee.
1870. †DALLINGER, Rev. W. II., LL.D., F.R.S., F.L.S. Ingleside, Newstead-road, Lee, London, S.E.
1862. †DANBY, T. W., M.A., F.G.S. 1 Westbourne-terrace-road, London, W.
1876. †Dansken, John. 4 Eldon-terrace, Partickhill, Glasgow.
1849. *Danson, Joseph, F.C.S. Montreal, Canada.
1861. *DARBISHIRE, ROBERT DUKINFELD, B.A., F.G.S. 26 George-street, Manchester.
1883. †Darbishire, S. D., M.D. 26 George-street, Manchester.
1876. †Darling, G. Erskine. 247 West George-street, Glasgow.
1884. †Darling, Thomas. 99 Drummond-street, Montreal, Canada.
1882. †DARWIN, FRANCIS, M.A., M.B., F.R.S., F.L.S. Wychfield, Huntingdon-road, Cambridge.
1881. *DARWIN, GEORGE HOWARD, M.A., LL.D., F.R.S., F.R.A.S., Plumian Professor of Astronomy and Experimental Philosophy in the University of Cambridge. Newnham Grange, Cambridge.
1878. *Darwin, Horace. The Orchard, Huntingdon-road, Cambridge.
1882. †Darwin, W. E., F.G.S. Bassett, Southampton.
1888. †Daubeny, William M. Stratton House, Park-lane, Bath.
1872. †Davenport, John T. 64 Marine Parade, Brighton.

Year of
Election.

1880. *DAVEY, HENRY, M.Inst.C.E. 3 Prince's-street, Westminster, S.W.
1884. †David, A. J., B.A., LL.B. 4 Harcourt-buildings, Temple, London, E.C.
1870. †Davidson, Alexander, M.D. 2 Gambier-terrace, Liverpool.
1885. †Davidson, Charles B. Roundhay, Fonthill-road, Aberdeen.
1891. §Davies, Andrew, M.D. Cefn Parc, Newport, Monmouthshire.
1890. †Davies, Arthur. East Brow Cottage, near Whitby.
1875. †Davies, David. 2 Queen's-square, Bristol.
1870. †Davies, Edward, F.C.S. Royal Institution, Liverpool.
1887. *Davies, H. Rees. Treborth, Bangor, North Wales.
1842. Davies-Colley, Dr. Thomas. Newton, near Chester.
1887. †Davies-Colley, T. C. Hopedene, Kersal, Manchester.
1873. *Davis, Alfred. 28 St. Ermin's Mansions, London, S.W.
1870. *Davis, A. S. Vittoria House, Cheltenham.
1864. †DAVIS, CHARLES E., F.S.A. 55 Pulteney-street, Bath.
1887. §Davis, David. 55 Berkley-street, Liverpool.
1842. Davis, Rev. David, B.A. Almswood, Evesham.
1881. †Davis, George E. *The Willows, Fallowfield, Manchester.*
1882. §Davis, Henry C. Berry Pomeroy, Springfield-road, Brighton.
1873. *DAVIS, JAMES W., F.G.S., F.S.A. Chevinedge, near Halifax.
1883. †Davis, Joseph, J.P. *Park-road, Southport.*
1883. †Davis, Robert Frederick, M.A. Earlsfield, Wandsworth Common, London, S.W.
1885. *Davis, Rudolf. Almswood, Evesham.
1891. §Davis, W. 48 Richmond-road, Cardiff.
1886. †Davis, W. H. Hazeldean, Pershore-road, Birmingham.
1886. †Davison, Charles, M.A. 38 Charlotte-road, Birmingham.
1864. *Davison, Richard. Beverley-road, Great Driffield, Yorkshire.
1857. †DAVY, EDMUND W., M.D. Kimmage Lodge, Roundtown, near Dublin.
1869. †Daw, John. Mount Radford, Exeter.
1869. †Daw, R. R. M. Bedford-circus, Exeter.
1860. *Dawes, John T., F.G.S. Cefn Mawr Hall, Mold, North Wales.
1864. †DAWKINS, W. BOYD, M.A., F.R.S., F.G.S., F.S.A., Professor of Geology and Palæontology in the Victoria University, Owens College, Manchester. Woodhurst, Fallowfield, Manchester.
1836. †Dawson, Bernard. The Laurels, Malvern Link.
1891. §Dawson, Edward. 2 Windsor-place, Cardiff.
1885. *Dawson, Major H. P., R.A. Priddy's Hard, Gosport.
1884. †Dawson, Samuel. 258 University-street, Montreal, Canada.
1855. §DAWSON, Sir WILLIAM, C.M.G., M.A., LL.D., F.R.S., F.G.S., Principal of McGill University. McGill University, Montreal, Canada.
1859. *Dawson, Captain William G. The Links, Plumstead Common, Kent.
1871. †Day, St. John Vincent, M.Inst.C.E., F.R.S.E. 166 Buchanan-street, Glasgow.
1870. *DEACON, G. F., M.Inst.C.E. Municipal Offices, Liverpool.
1861. †DEACON, Henry. Appleton House, near Warrington.
1887. †Deakin, H. T. Egremont House, Belmont, near Bolton.
1861. †Dean, Henry. Colne, Lancashire.
1884. *Debenham, Frank, F.S.S. 26 Upper Hamilton-terrace, London, N.W.
1866. †DEBUS, HENRICH, Ph.D., F.R.S., F.C.S., Lecturer on Chemistry at Guy's Hospital, London, S.E. 1 Obere Sophienstrasse, Cassel, Hessen.

Year of
Election.

1884. §Deek, Arthur, F.C.S. 9 King's-parade, Cambridge.
 1887. §Dehn, R. Olga Villa, Victoria Park, Manchester.
 1878. †Delany, Rev. William. St. Stanislaus College, Tullamore.
 1879. †De la Sala, Colonel. Sevilla House, Navarino-road, London,
 N.W.
 1884. *De Laune, C. De L. F. Sharsted Court, Sittingbourne.
 1887. †De Meschin, Miss Hannah Constance. Sandycove Castle, Kingstown,
 Ireland.
 1870. †De Meschin, Thomas, B.A., LL.D. Sandycove Castle, Kingstown,
 Ireland.
 1889. †Dendy, Frederick Walter. 3 Mardale-parade, Gateshead.
 1873. †Denham, Thomas, J.P. Huddersfield.
 1884. †Denman, Thomas W. Lamb's-buildings, Temple, London, E.C.
 1889. §DENNY, ALFRED, F.L.S., Professor of Biology in the Firth College,
 Sheffield.
 Dent, William Yerbury. Royal Arsenal, Woolwich.
 1870. *Denton, J. Bailey. Orchard Court, Stevenage.
 1874. §DE RANCE, CHARLES E., F.G.S. 28 Jermyrn-street, London,
 S.W.
 1856. *DERBY, The Right Hon. the Earl of, K.G., M.A., LL.D., F.R.S.,
 F.R.G.S., Chancellor of the University of London. St. James's-
 square, London, S.W.; and Knowsley, near Liverpool.
 1874. *Derham, Walter, M.A., LL.M., F.G.S. 76 Lancaster-gate, Lon-
 don, W.
 1878. †De Rinzy, James Harward. Khelat Survey, Sukkur, India.
 1868. †Dessé, Eiheldred, M.B., F.R.C.S. 43 Kensington Gardens-square,
 Bayswater, London, W.
 1868. †DEWAR, JAMES, M.A., F.R.S.L. & E., F.C.S., Fullerian Professor of
 Chemistry in the Royal Institution, London, and Jacksonian
 Professor of Natural and Experimental Philosophy in the Uni-
 versity of Cambridge. 1 Scroope-terrace, Cambridge.
 1881. †Dewar, Mrs. 1 Scroope-terrace, Cambridge.
 1883. †Dewar, James, M.D., F.R.C.S.E. Drylaw House, Davidson's Mains,
 Midlothian, N.B.
 1884. *Dewar, William, M.A. Rugby School, Rugby.
 1872. †Dewick, Rev. E. S., M.A., F.G.S. 26 Oxford-square, Lon-
 don, W.
 1887. †DE WINTON, Colonel Sir F., K.C.M.G., C.B. D.C.L., F.R.G.S.
 United Service Club, Pall Mall, London, S.W.
 1884. †De Wolf, O. C., M.D. Chicago, U.S.A.
 1873. *DEW-SMITH, A. G., M.A. Trinity College, Cambridge.
 1889. †Dickinson, A. H. Portland House, Newcastle-upon-Tyne.
 1863. †Dickinson, G. T. Claremont-place, Newcastle-upon-Tyne.
 1887. †Dickinson, Joseph, F.G.S. South Bank, Pendleton.
 1884. †Dickson, Charles R., M.D. Wolfe Island, Ontario, Canada.
 1881. †Dickson, Edmund. West Cliff, Preston.
 1887. †Dickson, H. N. 38 York-place, Edinburgh.
 1885. †Dickson, Patrick. Laurencekirk, Aberdeen.
 1883. †Dickson, T. A. West Cliff, Preston.
 1862. *DILKE, The Right Hon. Sir CHARLES WENTWORTH, Bart., F.R.G.S.
 76 Sloane-street, London, S.W.
 1877. †Dillon, James, M.Inst.C.E. 36 Dawson-street, Dublin.
 1848. †DILLWYN, LEWIS LLEWELYN, M.P., F.L.S., F.G.S. Parkwerne,
 near Swansea.
 1869. †Dingle, Edward. 19 King-street, Tavistock.
 1889. †Dinning, William. 41 Eldon-street, Newcastle-upon-Tyne.
 1876. †Ditchfield, Arthur. 12 Taviton-street, Gordon-square, London, W.C.

- Year of
Election.
1868. †Dittmar, William, LL.D., F.R.S. L. & E., F.C.S., Professor of Chemistry in the Glasgow and West of Scotland Technical College. 11 Hillhead-street, Glasgow.
1884. †Dix, John William H. Bristol.
1874. *Dixon, A. E. Dunowen, Cliftonville, Belfast.
1883. †Dixon, Miss E. 2 Cliff-terrace, Kendal.
1888. §Dixon, E. T. Messrs. Lloyds, Barnetts, & Bosanquets' Bank, 54 St. James's-street, London, S.W.
1886. †Dixon, George. 42 Augustus-road, Edgbaston, Birmingham.
1879. *DIXON, HAROLD B., M.A., F.R.S., F.C.S., Professor of Chemistry in the Owens College, Manchester. Birch Hall, Rusholme, Manchester.
1885. †Dixon, John Henry. Inveran, Poolewe, Ross-shire, N.B.
1887. †Dixon, Thomas. Buttershaw, near Bradford, Yorkshire.
1885. †Doak, Rev. A. 15 Queen's-road, Aberdeen.
1890. §Dobbie, James J., D.Sc. University College, Bangor, North Wales.
1885. §Dobbin, Leonard. The University, Edinburgh.
1860. *Dobbs, Archibald Edward, M.A. 34 Westbourne Park, London, W.
1891. §Dobson, G. Alkali and Ammonia Works, Cardiff.
1878. *DOBSON, G. E., M.A., M.B., F.R.S., F.L.S. Adrigole, Spring Grove, Isleworth.
1864. *Dobson, William. Oakwood, Bathwick Hill, Bath.
1875. *Docwra, George, jun. 32 Union-street, Coventry.
1870. *Dodd, John. Nunthorpe-avenue, York.
1876. †Dodds, J. M. St. Peter's College, Cambridge.
1889. §Dodson, George, B.A. Downing College, Cambridge.
- Dolphin, John. Delves House, Berry Edge, near Gateshead.
1885. †Donaldson, James, M.A., LL.D., F.R.S.E., Senior Principal of the University of St. Andrews, N.B.
1882. †Donaldson, John. Tower House, Chiswick, Middlesex.
1869. †Donisthorpe, G. T. St. David's Hill, Exeter.
1877. *Donkin, Bryan, jun. May's Hill, Shortlands, Kent.
1889. †Donkin, R. S., M.P. Campville, North Shields.
1861. †Donnelly, Colonel, R.E., C.B. South Kensington Museum, London, S.W.
1887. †Donner, Edward, B.A. 4 Anson-road, Victoria Park, Manchester.
1887. †Dorning, Elias, M.Inst.C.E., F.G.S. 41 John Dalton-street, Manchester.
1881. †Dorrington, John Edward. Lypiatt Park, Stroud.
1889. †Dorsey, E. B. International Club, Trafalgar-square, London, S.W.
1867. †Dougall, Andrew Maitland, R.N. Scotsraig, Tayport, Fifeshire.
1871. †Dougall, John, M.D. 2 Cecil-place, Paisley-road, Glasgow.
1863. *Doughty, Charles Montagu. Care of H. M. Doughty, Esq., 5 Stonecourt, Lincoln's Inn, London, W.C.
1876. *Douglas, Rev. G. C. M., D.D. 18 Royal-crescent West, Glasgow.
1877. *DOUGLASS, Sir JAMES N., F.R.S., M.Inst.C.E. Trinity House, London, E.C.
1884. †Douglass, William Alexander. Freehold Loan and Savings Company, Church-street, Toronto, Canada.
1890. †Dovaston, John. West Felton, Oswestry.
1883. †Dove, Arthur. Crown Cottage, York.
1884. †Dove, Miss Frances. St. Leonard's, St. Andrews, N.B.
1834. †Dove, P. Edward, F.R.A.S., Sec.R.Hist.Soc. 23 Old-buildings, Lincoln's Inn, London, W.C.
1834. †Dowe, John Melnotte. 69 Seventh-avenue, New York, U.S.A.
1876. †Dowie, Mrs. Muir. Golland, by Kinross, N.B.

Year of
Election.

1884. *Dowling, D. J. Bromley, Kent.
 1878. †*Dowling Thomas. Claireville House, Terenure, Dublin.*
 1857. †DOWNING, S., LL.D. 4 The Hill, Monkstown, Co. Dublin.
 1865. *Dowson, E. Theodore, F.R.M.S. Geldeston, near Beccles, Suffolk.
 1881. *Dowson, Joseph Emerson, M.Inst.C.E. 3 Great Queen-street, London, S.W.
 1887. §Doxey, R. A. Slade House, Levenshulme, Manchester.
 1883. †Draper, William. De Grey House, St. Leonard's, York.
 1868. †DRESSER, HENRY E., F.Z.S. 110 Cannon-street, London, E.C.
 1890. §Drew, John. 12 Harringay Park, Crouch End, Middlesex, N.
 1887. †Dreyfus, Dr. Daisy Mount, Victoria Park, Manchester.
 1889. †Drummond, Dr. 6 Saville-place, Newcastle-upon-Tyne.
 1870. †Drysdale, J. J., M.D. 36A Rodney-street, Liverpool.
 1889. †Du Chaillu, Paul B. Care of John Murray, Esq., 50A Albemarle-street, London, W.
 1856. *DUCIE, The Right. Hon. HENRY JOHN REYNOLDS MORETON, Earl of, F.R.S., F.G.S. 16 Portman-square, London, W.; and Tortworth Court, Wotton-under-Edge.
 1870. †Duckworth, Henry, F.L.S., F.G.S. Christchurch Vicarage, Chester.
 1867. *DUFF, The Right Hon. Sir MOUNTSTUART ELPHINSTONE GRANT, G.C.S.I., F.R.S., Pres.R.G.S. York House, Twickenham.
 1852. †Dufferin and Ava, The Most Hon. the Marquis of, K.P., G.C.B., G.C.M.G., G.C.S.I., D.C.L., LL.D., F.R.S., F.R.G.S. Clандeboye, near Belfast, Ireland.
 1877. †Duffey, George F., M.D. 30 Fitzwilliam-place, Dublin.
 1875. †Duffin, W. E. L'Estrange. Waterford.
 1890. †Dufton, S. F. Trinity College, Cambridge.
 1884. †Dugdale, James H. 9 Hyde Park-gardens, London, W.
 1883. §Duke, Frederic. Conservative Club, Hastings.
 1866. *Duncan, James. 9 Mincing-lane, London, E.C.
 Duncan, J. F., M.D. 8 Upper Merrion-street, Dublin.
 1891. *Duncan, John, J.P. 42 Park-place, Cardiff.
 1880. †Duncan, William S. 143 Queen's-road, Bayswater, London, W.
 1881. †Duncombe, The Hon. Cecil. Nawton Grange, York.
 1881. †Dunhill, Charles H. Gray's-court, York.
 1865. †Dunn, David. Annet House, Skelmorlie, by Greenock, N.B.
 1882. §Dunn, J. T., M.Sc., F.C.S. High School for Boys, Gateshead-on-Tyne.
 1883. †Dunn, Mrs. Denton Grange, Gateshead-on-Tyne.
 1876. †Dunnachie, James. 2 West Regent-street, Glasgow.
 1878. †Dunne, D. B., M.A., Ph.D., Professor of Logic in the Catholic University of Ireland. 4 Clanwilliam-place, Dublin.
 1884. §Dunnington, F. P. University Station, Charlottesville, Virginia, U.S.A.
 1859. †Duns, Rev. John, D.D., F.R.S.E. New College, Edinburgh.
 1890. †Dunsford, Follett. Rougemont Villa, Headingley, Leeds.
 1885. *DUNSTAN, WYNDHAM R., M.A., F.C.S., Professor of Chemistry to the Pharmaceutical Society of Great Britain. 17 Bloomsbury-square, London, W.C.
 1866. †Duprey, Perry. Woodberry Down, Stoke Newington, London, N.
 1869. †D'Urban, W. S. M., F.L.S. Moorlands, Exmouth, Devon.
 1860. †DURHAM, ARTHUR EDWARD, F.R.C.S., F.L.S., Demonstrator of Anatomy, Guy's Hospital. 82 Brook-street, Grosvenor-square, London, W.
 1887. †Durham, William. Seaforth House, Portobello, Scotland.
 1887. †Dyason, John Sanford, F.R.G.S., F.R.Met.Soc. Boscobel-gardens, London, N.W.

Year of
Election.

1884. †Dyck, Professor Walter. The University, Munich.
 1885. *Dyer, Henry, M.A. 8 Highburgh-terrace, Downhill, Glasgow.
 1869. *Dymond, Edward E. Oaklands, Aspley Guise, Woburn.
1868. †Eade, Peter, M.D. Upper St. Giles's-street, Norwich.
 1861. †Eadson, Richard. 13 Hyde-road, Manchester.
 1883. †Eagar, Rev. Thomas. The Rectory, Ashton-under-Lyne.
 1877. †Earle, Ven. Archdeacon, M.A. West Alvington, Devon.
 1888. †Earson, H. W. P. 11 Alexandra-road, Clifton, Bristol.
 1874. †Eason, Charles. 30 Kenilworth-square, Rathgar, Dublin.
 1871. *EASTON, EDWARD, M.Inst.C.E., F.G.S. 11 Delahay-street, Westminster, S.W.
 1863. †Easton, James. Nest House, near Gateshead, Durham.
 1876. †Easton, John. Durie House, Abercromby-street, Helensburgh, N.B.
 1883. †Eastwood, Miss. Littleover Grange, Derby.
 1887. §Eccles, Mrs. S. White Coppice, Chorley, Lancashire.
 1884. †Eckersley, W. T. Standish Hall, Wigan, Lancashire.
 1861. †Ecroyd, William Farrer. Spring Cottage, near Burnley.
 1870. *Eddison, John Edwin, M.D., M.R.C.S. 6 Park-square, Leeds.
 *Eddy, James Ray, F.G.S. The Grange, Carleton, Skipton.
 1887. †Ede, Francis J. Silchar, Cachar, India.
 Eden, Thomas. Talbot-road, Oxtou.
 1884. *Edgell, R. Arnold, M.A., F.C.S. 66 Warwick-road, South Kensington, London, S.W.
 1887. §EDGEWORTH, F. Y., M.A., D.C.L., F.S.S., Professor of Political Economy in the University of Oxford. Athenæum Club, Pall Mall, London, S.W.
 1870. *Edmonds, F. B. 6 Furnival's Inn, London, E.C.
 1883. †Edmonds, William. Wiscombe Park, Honiton, Devon.
 1888. *Edmunds, Henry. Antron, 71 Upper Tulse-hill, London, S.W.
 1884. *Edmunds, James, M.D. 29 Dover-street, Piccadilly, London, W.
 1883. §Edmunds, Lewis, D.Sc., LL.B. 60 Park-street, Park-lane, London, W.
 1867. *Edward, Allan. Farington Hall, Dundee.
 1867. †Edward, Charles. Chambers, 8 Bank-street, Dundee.
 1855. *EDWARDS, Professor J. BAKER, Ph.D., D.C.L. Montreal, Canada.
 1884. †Edwards, W. F. Niles, Michigan, U.S.A.
 1887. *Egerton of Tatton, The Right Hon. Lord. Tatton Park, Knutsford.
 1876. †Elder, Mrs. 6 Claremont-terrace, Glasgow.
 1890. §Elford, Percy. Christ Church, Oxford.
 1885. *Elgar, Francis, LL.D., M.Inst.C.E., F.R.S.E., Director of H.M. Dockyards. The Admiralty, London, S.W.
 1868. †Elger, Thomas Gwyn Empy, F.R.A.S. Manor Cottage, Kempston, Bedford.
 1863. †Ellenberger, J. L. Workshop.
 1885. †Ellingham, Frank. Thorpe St. Andrew, Norwich.
 1883. †Ellington, Edward Bayzand, M.Inst.C.E. Palace-chambers, Bridge-street, Westminster, S.W.
 1891. §Elliott, A. C., D.Sc. Professor of Engineering in University College, Cardiff.
 1864. †Elliott, E. B. Washington, U.S.A.
 1883. *ELLIOTT, EDWIN BAILEY, M.A., F.R.S. Queen's College, Oxford.
 Elliott, John Fogg. Elvet Hill, Durham.
 1879. †Elliott, Joseph W. Post Office, Bury, Lancashire.
 1886. §Elliott, Thomas Henry, F.S.S. Local Government Board, Whitehall, London, S.W.

- Year of Election.
1877. †Ellis, Arthur Devonshire. Thurnscoe Hall, Rotherham, Yorkshire.
1875. *Ellis, H. D. 6 Westbourne-terrace, Hyde Park, London, W.
1883. †Ellis, John. 17 Church-street, Southport.
1880. *ELLIS, JOHN HENRY. Woodland House, Plymouth.
1864. *Ellis, Joseph. Hampton Lodge, Brighton.
1864. †Ellis, J. Walter. High House, Thornwaite, Ripley, Yorkshire.
1891. §Ellis, Miss, M.A. 13 Horbury-crescent, Notting-hill, London, W.
1884. †Ellis, W. Hodgson. Toronto, Canada.
1869. †ELLIS, WILLIAM HORTON. Hartwell House, Exeter.
Ellman, Rev. E. B. Berwick Rectory, near Lewes, Sussex.
1887. †Elmy, Ben. Eaton Hall, Congleton, Manchester.
1862. †Elphinstone, H. W., M.A., F.L.S. 2 Stone-buildings, Lincoln's Inn, London, W.C.
1883. †Elwes, George Robert. Bossington, Bournemouth.
1887. §Elworthy, Frederick T. Foxdown, Wellington, Somerset.
1870. *ELY, The Right Rev. Lord ALWYNE COMPTON, D.D., Lord Bishop of. The Palace, Ely, Cambridgeshire.
1863. †Embleton, Dennis, M.D. 19 Claremont-place, Newcastle-upon-Tyne.
1891. §Emerton, Wolseley. Banwell Castle, Somerset.
1891. §Emerton, Mrs. Wolseley. Banwell Castle, Somerset.
1884. †Emery, Albert H. Stamford, Connecticut, U.S.A.
1863. †Emery, The Ven. Archdeacon, B.D. Ely, Cambridgeshire.
1858. †Empson, Christopher. Bramhope Hall, Leeds.
1890. †Emsley, Alderman W. Richmond House, Richmond-road, Headingley, Leeds.
1866. †Enfield, Richard. Low Pavement, Nottingham.
1884. †England, Luther M. Knowlton, Quebec, Canada.
1853. †English, Edgar Wilkins. Yorkshire Banking Company, Lowgate Hull.
1869. †English, J. T. Wayfield House, Stratford-on-Avon.
1883. †Entwistle, James P. Beachfield, 2 Westclyffe-road, Southport.
1869. *Enys, John Davis. Care of F. G. Enys, Esq., Enys, Penryn, Cornwall.
1844. †Erichsen, John Eric, LL.D., F.R.S., F.R.C.S., President of, and Emeritus Professor of Surgery in, University College, London. 6 Cavendish-place, London, W.
1864. *Eskrigge, R. A., F.G.S. 18 Hackins-hey, Liverpool.
1885. †Esselmont, Peter, M.P. 34 Albyn-place, Aberdeen.
1862. *ESSON, WILLIAM, M.A., F.R.S., F.C.S., F.R.A.S. Merton College, and 13 Bradmore-road, Oxford.
1878. †Estcourt, Charles, F.C.S. 8 St. James's-square, John Dalton-street, Manchester.
1887. *Estcourt, Charles. Vyrnieu House, Talbot-road, Old Trafford, Manchester.
1887. *Estcourt, P. A. Vyrnieu House, Talbot-road, Old Trafford, Manchester.
1869. †ETHERIDGE, ROBERT, F.R.S. L & E., F.G.S., Assistant Keeper (Geological and Palæontological Department) Natural History Museum (British Museum). 14 Carlyle-square, London, S.W.
1888. †Etheridge, Mrs. 14 Carlyle-square, London, S.W.
1883. §Eunson, Henry J. Morvi, Kathiawar, Bombay Presidency.
1891. §Evan-Thomas, C., J.P. The Gnoll, Neath, Glamorganshire.
1881. Evans, Alfred, M.A., M.B. Pontypridd.
1889. *Evans, A. H. 9 Harvey-road, Cambridge.
1887. *Evans, Mrs. Alfred W. A. Hillside, New Mills, near Stockport, Derbyshire.

Year of
Election.

1870. *EVANS, Arthur John, F.S.A. 33 Holywell, Oxford.
 1865. *EVANS, Rev. CHARLES, M.A. The Rectory, Solihull, Birmingham.
 1891. §EVANS, Franklen. Llwynarthen Castleton, Cardiff.
 1889. §EVANS, Henry Jones. Greenhill, Whitchurch, Cardiff.
 1884. †EVANS, Horace L. Moreton House, Tyndall's Park, Bristol.
 1883. *EVANS, James C. Albany-buildings, Lord-street, Southport.
 1883. *EVANS, Mrs. James C. Albany-buildings, Lord-street, Southport.
 1861. *EVANS, JOHN, D.C.L., LL.D., D.Sc., Treas.R.S., F.S.A., F.L.S.,
 F.G.S. Nash Mills, Hemel Hempstead.
 1881. †EVANS, Lewis. Llanfyrnach R.S.O., Pembrokeshire.
 1885. *EVANS, Percy Bagnall. The Spring, Kenilworth.
 1875. †EVANS, Sparke. 3 Apsley-road, Clifton, Bristol.
 1865. *EVANS, William. The Spring, Kenilworth.
 1891. §EVANS, William Llewellyn. Guildhall-chambers, Cardiff.
 1886. †EVE, A. S. Marlborough College, Wilts.
 1871. †EVE, H. Weston, M.A. University College, London, W.C.
 1868. *EVERETT, J. D., M.A., D.C.L., F.R.S. L. & E., Professor of
 Natural Philosophy in Queen's College, Belfast. 5 Princess-
 gardens, Belfast.
 1863. *EVERITT, George Allen, F.R.G.S. Knowle Hall, Warwickshire.
 1886. †EVERITT, William E. Finstall Park, Bromsgrove.
 1883. †EVES, Miss Florence. Uxbridge.
 1881. †EWART, J. COSSAR, M.D., Professor of Natural History in the
 University of Edinburgh.
 1874. †EWART, Sir W. Quartus, Bart. Glenmachan, Belfast.
 1859. *EWING, Sir Archibald Orr, Bart., M.P. Ballikinrain Castle, Killearn,
 Stirlingshire.
 1876: *EWING, JAMES ALFRED, M.A., B.Sc., F.R.S. L. & E., Professor of
 Mechanism and Applied Mathematics in the University of
 Cambridge.
 1883. †EWING, James L. 52 North Bridge, Edinburgh.
 1871. *EXLEY, John T., M.A. 1 Cotham-road, Bristol.
 1884. *EYERMAN, John. Oakhurst, Easton, Pennsylvania, U.S.A.
 1882. †EYRE, G. E. Briscoe. Warrens, near Lyndhurst, Hants.
 Eyton, Charles. Hendred House, Abingdon.
 1890. †FABER, EDMUND BECKETT. Straylea, Harrogate.
 1891. *FAIJA, Henry, M.Inst.C.E. 2 Great Queen-street, London, S.W.
 1884. †FAIRBAIN, Dr. A. M. Airedale College, Bradford, Yorkshire.
 1865. *FAIRLEY, THOMAS, F.R.S.E., F.C.S. 8 Newton-grove, Leeds.
 1886. †FAIRLEY, William. Beau Desert, Rugeley, Staffordshire.
 1864. †FALKNER, F. H. Lyncombe, Bath.
 1886. †FALLON, T. P., Consul General. Australia.
 1883. †FALLON, Rev. W. S. 1 St. Alban's-terrace, Cheltenham.
 1877. §FARADAY, F. J., F.L.S., F.S.S. College-chambers, 17 Brazenose-
 street, Manchester.
 1891. §FARDS, G. Penarth.
 1887. †FARMER, Sir James. Hope House, Eccles Old-road, Manchester.
 1886. §FARNCOMBE, Joseph, J.P. Lewes.
 1879. *FARNWORTH, Ernest. Clarence Villa, Penn Fields, Wolverhampton.
 1882. †FARNWORTH, Walter. 86 Preston New-road, Blackburn.
 1883. †FARNWORTH, William. 86 Preston New-road, Blackburn.
 1885. †FARQUHAR, Admiral. Carlogie, Aberdeen.
 1859. †FARQUHARSON, Robert F. O. Haughton, Aberdeen.
 1885. †FARQUHARSON, Mrs. R. F. O. Haughton, Aberdeen.
 1866. *FARRAR, Ven. FREDERIC WILLIAM, M.A., D.D., F.R.S., Arch-
 deacon of Westminster. 17 Dean's-yard Westminster, S.W.

Year of
Election.

1883. †Farrell, John Arthur. Moynalty, Kells, North Ireland.
 1857. †Farrelly, Rev. Thomas. Royal College, Maynooth.
 1869. *Faulding, Joseph. Boxley House, Tenterden, Kent.
 1883. †Faulding, Mrs. Boxley House, Tenterden, Kent.
 1887. §Faulkner, John. 13 Great Ducie-street, Strangeways, Manchester.
 1890. *Fawcett, F. B. Torfels, Weston-super-Mare.
 1886. §Felkin, Robert W., M.D., F.R.G.S. 20 Alva-street, Edinburgh.
 Fell, John B. Spark's Bridge, Ulverstone, Lancashire.
 1864. *FELLOWS, FRANK P., K.S.J.J., F.S.A., F.S.S. 8 The Green, Hampstead, London, N.W.
 1852. †Fenton, S. Greame. Keswick, near Belfast.
 1883. †Fenwick, E. H. 29 Harley-street, London, W.
 1890. §Fenwick, T. Chapel Allerton, Leeds.
 1876. †Ferguson, Alexander A. 11 Grosvenor-terrace, Glasgow.
 1883. †Ferguson, Mrs. A. A. 11 Grosvenor-terrace, Glasgow.
 1871. *FERGUSON, JOHN, M.A., LL.D., F.R.S.E., F.S.A., F.C.S., Professor of Chemistry in the University of Glasgow.
 1867. †Ferguson, Robert M., Ph.D., F.R.S.E. 8 Queen-street, Edinburgh.
 1867. *Fergusson, H. B. 13 Airlie-place, Dundee.
 1883. †Fernald, H. P. Alma House, Cheltenham.
 1883. *Ferne, John. Box No. 2, Hutchinson, Kansas, U.S.A.
 1862. †FERRERS, Rev. NORMAN MACLEOD, D.D., F.R.S. Caius College Lodge, Cambridge.
 1873. †Ferrier, David, M.A., M.D., LL.D., F.R.S., Professor of Neuro-pathology in King's College. 34 Cavendish-square, London, W.
 1882. §Fewings, James, B.A., B.Sc. The Grammar School, Southampton.
 1887. †Fiddes, Thomas, M.D. Penwood, Urmston, near Manchester.
 1875. †Fiddes, Walter. Clapton Villa, Tyndall's Park, Clifton, Bristol.
 1868. †Field, Edward. Norwich.
 1886. †Field, H. C. 4 Carpenter-road, Edgbaston, Birmingham.
 1869. *FIELD, ROGERS, B.A., M.Inst.C.E. 4 Westminster-chambers, Westminster, S.W.
 1887. †Fielden, John C. 145 Upper Brook-street, Manchester.
 1882. †Filliter, Freeland. St. Martin's House, Wareham, Dorset.
 1883. *Finch, Gerard B., M.A. 1 St. Peter's-terrace, Cambridge.
 Finch, John. Bridge Work, Chepstow.
 1878. *Findlater, William. 22 Fitzwilliam-square, Dublin.
 1885. †Findlay, George, M.A. 50 Victoria-street, Aberdeen.
 1884. †Finlay, Samuel. Montreal, Canada.
 1887. †Finnemore, Rev. J., F.G.S. Aston-road, Birmingham.
 1881. †Firth, Colonel Sir Charles. Heckmondwike.
 Firth, Thomas. Northwich.
 1858. †Fishbourne, Admiral E. G., R.N. 26 Hogarth-road, Earl's Court-road, London, S.W.
 1891. §Fisher. Major H. O. The Highlands, Llandough, near Cardiff.
 1884. *Fisher, L. C. Galveston, Texas, U.S.A.
 1869. †FISHER, Rev. OSMOND, M.A., F.G.S. Harlton Rectory, near Cambridge.
 1873. †Fisher, William. Maes Fron, near Welshpool, Montgomeryshire.
 1879. †Fisher, William. Norton Grange, near Sheffield.
 1875. *Fisher, W. W., M.A., F.C.S. 5 St. Margaret's-road, Oxford.
 1858. †Fishwick, Henry. Carr-hill, Rochdale.
 1887. *Fison, Alfred H., D.Sc. University College, London, W.C.
 1885. †Fison, E. Herbert. Stoke House, Ipswich.
 1871. *FISON, FREDERICK W., M.A., F.C.S. Greenholme, Burley-in-Wharfedale, near Leeds.

Year of
Election.

1871. †FITCH, J. G., M.A., LL.D. 5 Lancaster-terrace, Regent's Park, London, N.W.
1883. †Fitch, Rev. J. J. Ivyholme, Southport.
1868. †Fitch, Robert, F.G.S., F.S.A. Norwich.
1878. †Fitzgerald, C. E., M.D. 27 Upper Merrion-street, Dublin.
1878. §FITZGERALD, GEORGE FRANCIS, M.A., F.R.S., Professor of Natural and Experimental Philosophy, Trinity College, Dublin.
1885. *Fitzgerald, Professor Maurice, B.A. 37 Botanic-avenue, Belfast.
1857. †Fitzpatrick, Thomas, M.D. 31 Lower Baggot-street, Dublin.
1888. *Fitzpatrick, Rev. Thomas C. Christ's College, Cambridge.
1865. †Fleetwood, D. J. 45 George-street, St. Paul's, Birmingham.
1881. †Fleming, Rev. Canon James, B.D. *The Residence, York.*
1876. †Fleming, James Brown. Beaconsfield, Kelvinside, near Glasgow.
1876. †Fleming, Sandford. Ottawa, Canada.
1867. §FLETCHER, ALFRED E., F.C.S. The Hill House, Chalfont St. Peter, Bucks.
1870. †Fletcher, B. Edgington. Norwich.
1890. §Fletcher, B. Morley. 12 Trevor-square, London, S.W.
1886. †Fletcher, Frank M.
1869. †FLETCHER, LAVINGTON E., M.Inst.C.E. Alderley Edge, Cheshire.
1888. *FLETCHER, LAZARUS, M.A., F.R.S., F.G.S., F.C.S., Keeper of Minerals, British Museum (Natural History), Cromwell-road, London, S.W.
1862. §FLOWER, WILLIAM HENRY, C.B., LL.D., D.C.L., D.Sc., F.R.S., F.L.S., F.G.S., F.R.C.S., Director of the Natural History Departments, British Museum, South Kensington, London. 26 Stanhope-gardens, London, S.W.
1889. §Flower, Mrs. 26 Stanhope-gardens, London, S.W.
1877. *Floyer, Ernest A., F.R.G.S., F.L.S. Helwan, Egypt.
1890. §Flux, A. W., M.A. St. John's College, Cambridge.
1887. †Foale, William. 3 Meadfoot-terrace, Mannamead, Plymouth.
1883. †Foale, Mrs. William. 3 Meadfoot-terrace, Mannamead, Plymouth.
1891. §Földvay, William. Museum Ring, 10, Buda Pesth.
1881. †Foljambe, Cecil G. S., M.P. 2 Carlton House-terrace, Pall Mall, London, S.W.
1879. †Foote, Charles Newth, M.D. 3 Albion-place, Sunderland.
1880. †Foote, R. Bruce. Care of Messrs. H. S. King & Co., 65 Cornhill, London, E.C.
1873. *FORBES, GEORGE, M.A., F.R.S. L. & E., M.Inst.C.E. 34 Great George-street, London, S.W.
1883. †Forbes, Henry O., F.Z.S., Director of the Canterbury Museum, Christchurch, New Zealand.
1885. †Forbes, The Right Hon. Lord. Castle Forbes, Aberdeenshire.
1890. †FORD, J. RAWLINSON. Quarry Dene, Weetwood-lane, Leeds.
1875. *FORDHAM, H. GEORGE, F.G.S. Odsey, near Royston, Cambridgeshire.
1883. §Formby, R. Formby, near Liverpool.
1887. †FORREST, Sir JOHN, K.C.M.G., F.R.G.S. Perth, Western Australia.
1867. †Forster, Anthony. Finlay House, St. Leonards-on-Sea.
1883. †Forsyth, A. R., M.A., F.R.S. Trinity College, Cambridge.
1884. †Fort, George H. Lakefield, Ontario, Canada.
1877. †FORTESCUE, The Right Hon. the Earl. Castle Hill, North Devon.
1882. §Forward, Henry. 4 Marine-avenue, Southend.
1870. †Forwood, Sir William B. Hopeton House, Seaforth, Liverpool.
1875. †Foster, A. Le Neve. 51 Cadogan-square, London, S.W.
1865. †Foster, Balthazar, M.D., Professor of Medicine in Queen's College, Birmingham. 16 Temple-row, Birmingham.

Year of
Election.

1865. *FOSTER, CLEMENT LE NEVE, B.A., D.Sc., F.G.S., Professor of Mining in the Royal College of Science, London. Llandudno.
1883. †Foster, Mrs. C. Le Neve. Llandudno.
1857. *FOSTER, GEORGE CAREY, B.A., F.R.S., F.C.S., Professor of Physics in University College, London. 18 Daleham-gardens, Hampstead, London, N.W.
1877. §Foster, Joseph B. 6 James-street, Plymouth.
1859. *FOSTER, MICHAEL, M.A., M.D., LL.D., Sec. R.S., F.L.S., F.C.S., Professor of Physiology in the University of Cambridge. Shelford, Cambridge.
1863. †Foster, Robert. 30 Rye-hill, Newcastle-upon-Tyne.
1866. †Fowler, George, M.Inst.C.E., F.G.S. Basford Hall, near Nottingham.
1868. †Fowler, G. G. Gunton Hall, Lowestoft, Suffolk.
1888. §Fowler, Gilbert J. Dalton Hall, Manchester.
1892. §Fowler, Miss Jessie A. 4 & 5 Imperial-buildings, Ludgate-circus, London, E.C.
1876. *Fowler, John. 4 Kelvin Bank-terrace, Sandyford, Glasgow.
1882. †FOWLER, Sir JOHN, Bart., K.C.M.G., M.Inst.C.E., F.G.S. 2 Queen Square-place, Westminster, S.W.
1884. †Fox, Miss A. M. Penjerrick, Falmouth.
1883. *Fox, Charles. The Cedars, Warlingham, Surrey.
1883. §Fox, Sir Charles Douglas, M.Inst.C.E. 28 Victoria-street, Westminster, S.W.
1883. †Fox, Howard, F.G.S. Falmouth.
1847. *Fox, Joseph Hoyland. The Cleve, Wellington, Somerset.
1860. †Fox, Joseph John. Lordship-terrace, Stoke Newington, London, N.
1876. †Fox, St. G. Lane. 9 Sussex-place, London, S.W.
1888. †Fox, Thomas. Court, Wellington, Somerset.
1886. †Foxwell, Arthur, M.A., M.B. 17 Temple-row, Birmingham.
1881. *FOXWELL, HERBERT S., M.A., F.S.S., Professor of Political Economy in University College, London. St. John's College, Cambridge.
1889. †Frain, Joseph, M.D. Grosvenor-place, Jesmond, Newcastle-upon-Tyne.
1866. *Francis, G. B. Inglesby, North-road, Hertford.
1884. †Francis, James B. Lowell, Massachusetts, U.S.A.
FRANCIS, WILLIAM, Ph.D., F.L.S., F.G.S., F.R.A.S. Red Lion-court, Fleet-street, London, E.C.; and Manor House, Richmond, Surrey.
1846. †FRANKLAND, EDWARD, M.D., D.C.L., LL.D., Ph.D., F.R.S., F.C.S. The Yews, Reigate Hill, Surrey.
1887. *Frankland, Percy F., Ph.D., B.Sc., F.R.S., Professor of Chemistry in University College, Dundee.
1889. †Franklin, Rev. Canon. Clayton-street West, Newcastle-upon-Tyne.
1882. †Fraser, Alexander, M.B. Royal College of Surgeons, Dublin.
1885. †FRASER, ANGUS, M.A., M.D., F.C.S. 232 Union-street, Aberdeen.
1859. †Fraser, George B. 3 Airlie-place, Dundee.
Fraser, James William. 8A Kensington Palace-gardens, London, W.
1865. *FRASER, JOHN, M.A., M.D. Chapel Ash, Wolverhampton.
1871. †FRASER, THOMAS R., M.D., F.R.S. L. & E., Professor of Materia Medica and Clinical Medicine in the University of Edinburgh. 13 Drumsheugh-gardens, Edinburgh.
1859. *Frazer, Daniel. 127 Buchanan-street, Glasgow.
1871. †Frazer, Evan L. R. Brunswick-terrace, Spring Bank, Hull.
1884. *Frazer, Persifor, M.A., D.Sc., Professor of Chemistry in the Franklin Institute of Pennsylvania. Room 1042, Drexel Buildings, Fifth and Chestnut-streets, Philadelphia, U.S.A.

Year of
Election.

1884. *FREAM, W., LL.D., B.Sc., F.L.S., F.G.S., F.S.S. The Vinery,
Downton, Salisbury.
1847. *Freeland, Humphrey William, F.G.S. West-street, Chichester.
1877. §Freeman, Francis Ford. 8 Leigham-terrace, Plymouth.
1865. †Freeman, James. 15 Francis-road, Edgbaston, Birmingham.
1841. Freeth, Major-General S. 30 Royal-crescent, Notting Hill, London, W.
1884. *Fremantle, The Hon. Sir C. W., K.C.B. Royal Mint, London, E.
1869. †Frere, Rev. William Edward. The Rectory, Bitton, near Bristol.
1886. †Freshfield, Douglas W., Sec.R.G.S. 1 Savile-row, London, W.
1886. †Freund, Miss Ida. *Eyre Cottage, Upper Sydenham, S.E.*
1887. †Fries, Harold H., Ph.D. 92 Reade-street, New York, U.S.A.
1857. *Frith, Richard Hastings, M.R.I.A., F.R.G.S.I. 48 Summer-hill,
Dublin.
1887. †Fröehlich, The Chevalier. Grosvenor-terrace, Withington, Man-
chester.
1882. §Frost, Edward P., J.P. West Wrattling Hall, Cambridgeshire.
1883. †Frost, Major H., J.P. West Wrattling Hall, Cambridgeshire.
1887. *Frost, Robert, B.Sc. St. James's-chambers, Duke-street, London, S.W.
1875. †Fry, F. J. 104 Pembroke-road, Clifton, Bristol.
1875. *Fry, Joseph Storrs. 2 Charlotte-street, Bristol.
1884. §Fryer, Joseph, J.P. Smelt House, Howden-le-Wear, Co. Durham.
1872. *Fuller, Rev. A. Pallant, Chichester.
1859. †FULLER, FREDERICK, M.A. 9 Palace-road, Surbiton.
1869. †FULLER, GEORGE, M.Inst.C.E. 71 Lexham-gardens, Kensington,
London, W.
1884. §Fuller, William. Oswestry.
1891. §Fulton, Andrew. 23 Park-place, Cardiff.
1881. †Gabb, Rev. James, M.A. Bulmer Rectory, Welburn, Yorkshire.
1887. †Gaddum, G. H. Adria House, Toy-lane, Withington, Manchester.
1836. *Gadesden, Augustus William, F.S.A. Ewell Castle, Surrey.
1857. †GAGES, ALPHONSE, M.R.I.A. Museum of Irish Industry, Dublin.
1863. *Gainsford, W. D. Skendleby Hall, Spilsby.
1876. †Gairdner, Charles. Broom, Newton Mearns, Renfrewshire.
1850. †Gairdner, Professor W. T., M.D. 225 St. Vincent-street, Glasgow.
1876. †Gale, James M. 23 Miller-street, Glasgow.
1863. †Gale, Samuel, F.C.S. 225 Oxford-street, London, W.
1885. *Galloway, Alexander. Dirgarve, Aberfeldy, N.B.
1888. †Gallenga, Mrs. Anna. The Falls, Chepstow.
1888. †Gallenga, Mrs. A. A. R. The Falls, Chepstow.
1861. †Galloway, Charles John. Knott Mill Iron Works, Manchester.
1861. †Galloway, John, jun. Knott Mill Iron Works, Manchester.
1889. †Galloway, Walter. Eighton Banks, Gateshead.
1875. †GALLOWAY, W. Cardiff.
1887. *Galloway, W. The Cottage, Seymour-grove, Old Trafford, Man-
chester.
1860. *GALTON, Sir DOUGLAS, K.C.B., D.C.L., LL.D., F.R.S., F.L.S.,
F.G.S., F.R.G.S. (GENERAL SECRETARY.) 12 Chester-street,
Grosvenor-place, London, S.W.
1860. *GALTON, FRANCIS, M.A., F.R.S., F.G.S., F.R.G.S. 42 Rutland-
gate, Knightsbridge, London, S.W.
1869. †GALTON, JOHN C., M.A., F.L.S. 40 Great Marlborough-street,
London, W.
1887. *Galton, Miss Laura Gwendolen Douglas. 12 Chester-street, Gros-
venor-place, London, S.W.
1870. §Gamble, Lieut.-Colonel D., C.B. St. Helens, Lancashire.
1889. §Gamble, David, jun. St. Helens, Lancashire.

Year of
Election.

1870. †Gamble, J. C. St. Helens, Lancashire.
 1888. †Gamble, J. Sykes, M.A., F.L.S. Surbiton.
 1877. †Gamble, William. St. Helens, Lancashire.
 1868. †GAMGEE, ARTHUR, M.D., F.R.S. Cambridge.
 1889. †Gamgee, John. 6 Lingfield-road, Wimbledon, Surrey.
 1883. †Gant, Major John Castle. St. Leonards.
 1887. †GARDINER WALTER, M.A., F.R.S., F.L.S. Clare College, Cambridge.
 1882. *Gardner, H. Dent, F.R.G.S. 25 Northbrook-road, Lee, Kent.
 1882. †GARDNER, JOHN STARKIE, F.G.S. 7 Damer-terrace, Chelsea, London, S.W.
 1884. †Garman, Samuel. Cambridge, Massachusetts, U.S.A.
 1865. †Garner, Mrs. Robert. Stoke-upon-Trent.
 1888. §Garnett, Frederick Brooksbank, C.B., F.S.S. 4 Argyll-road, Campden Hill, London, W.
 1887. *Garnett, Jeremiah. The Grange, near Bolton, Lancashire.
 1882. †Garnett, William, D.C.L., Principal of the College of Physical Science, Newcastle-on-Tyne.
 1873. †Garnham, John. Hazelwood, Crescent-road, St. John's, Brockley, Kent, S.E.
 1883. §Garson, J. G., M.D. 32 Duke-street, St. James's, London, S.W.
 1874. *Garstin, John Ribton, M.A., LL.B., M.R.I.A., F.S.A. Bragans-town, Castlebellingham, Ireland.
 1882. †Garton, William. Woolston, Southampton.
 1889. †Garwood, E. J. 14 St. Mary's-place, Newcastle-upon-Tyne.
 1870. †Gaskell, Holbrook. Woolton Wood, Liverpool.
 1870. *Gaskell, Holbrook, jun. Clayton Lodge, Aigburth, Liverpool.
 1862. *Gatty, Charles Henry, M.A., F.L.S., F.G.S. Felbridge Place, East Grinstead, Sussex.
 1890. †Gaunt, Sir Edwin. Carlton Lodge, Leeds.
 1875. †Gavey, J. 43 Stacey-road, Routh, Cardiff.
 1875. †Gaye, Henry S., M.D. Newton Abbot, Devon.
 1871. †Geddes, John. 9 Melville-crescent, Edinburgh.
 1883. †Geddes, John. 33 Portland-street, Southport.
 1885. §Geddes, Professor Patrick. 6 James-court, Edinburgh.
 1887. †Gee, W. W. Haldane. Owens College, Manchester.
 1867. †GEIKIE, Sir ARCHIBALD, LL.D., D.Sc., For. Sec. R.S., F.R.S.E., Pres. G.S., Director-General of the Geological Survey of the United Kingdom. (PRESIDENT ELECT.) Geological Survey Office, Jermyn-street, London, S.W.
 1871. †GEIKIE, JAMES, LL.D., D.C.L., F.R.S. L. & E., F.G.S., Murchison Professor of Geology and Mineralogy in the University of Edinburgh. 31 Merchiston-avenue, Edinburgh.
 1882. *GENESE, R. W., M.A., Professor of Mathematics in University College, Aberystwith.
 1875. *George, Rev. Hereford B., M.A., F.R.G.S. New College, Oxford.
 1885. †Gerard, Robert. Blair-Devenick, Cults, Aberdeen.
 1884. *Gerrans, Henry T., M.A. Worcester College, Oxford.
 1870. *Gervis, Walter S., M.D., F.G.S. Ashburton, Devonshire.
 1884. †Gibb, Charles. Abbotsford, Quebec, Canada.
 1865. †Gibbins, William. Battery Works, Digbeth, Birmingham.
 1889. †Gibson, Charles, M.D. 8 Eldon-square, Newcastle-upon-Tyne.
 1874. †Gibson, The Right Hon. Edward, Q.C. 23 Fitzwilliam-square, Dublin.
 1876. *Gibson, George Alexander, M.D., D.Sc., F.R.S.E., Secretary to the Royal College of Physicians of Edinburgh. 17 Alva-street, Edinburgh.
 1884. †Gibson, Rev. James J. 183 Spadina-avenue, Toronto, Canada.

Year of
Election.

1885. †Gibson, John, Ph.D. The University, Edinburgh.
 1889. *Gibson, T. G. 2 Eslington-road, Newcastle-upon-Tyne.
 1887. †GIFFEN, ROBERT, C.B., LL.D., V.P.S.S. 44 Pembroke-road, London, S.W.
 1888. *Gifford, H. J. Lyston Court, Tram Inn, Hereford.
 1884. †Gilbert, E. E. 245 St. Antoine-street, Montreal, Canada.
 1842. GILBERT, JOSEPH HENRY, Ph.D., LL.D., F.R.S., F.C.S., Professor of Rural Economy in the University of Oxford. Harpenden, near St. Albans.
 1883. †Gilbert, Mrs. Harpenden, near St. Albans.
 1857. †Gilbert, J. T., M.R.I.A. Villa Nova, Blackrock, Dublin.
 1884. *Gilbert, Philip H. 1375 Dorchester-street, Montreal, Canada.
 1883. †Gilbert, Thomas. Derby-road, Southport. Gilderdale, Rev. John, M.A. Walthamstow, Essex.
 1882. †Giles, Alfred, M.P., M.Inst.C.E. 26 Great George-street, London, S.W.
 1878. †Giles, Oliver. Crescent Villas, Bromsgrove. Giles, Rev. William. Netherleigh House, near Chester.
 1871. *GILL, DAVID, LL.D., F.R.S., F.R.A.S. Royal Observatory, Cape Town.
 1888. §Gill, John Frederick. Douglas, Isle of Man.
 1868. †Gill, Joseph. Palermo, Sicily. (Care of W. H. Gill, Esq., General Post Office, St. Martin's-le-Grand, E.C.)
 1887. †Gillett, Charles Edwin. Wood Green, Banbury, Oxford.
 1888. †Gilliland, E. T. 259 West Seventy-fourth-street, New York, U.S.A.
 1884. †Gillman, Henry. 130 Lafayette-avenue, Detroit, Michigan, U.S.A.
 1861. *Gilroy, George. Woodlands, Parbold, near Southport.
 1867. †Gilroy, Robert. Craigie, by Dundee.
 1867. †GINSBURG, Rev. C. D., D.C.L., LL.D. Holmlea, Virginia Water Station, Chertsey.
 1884. †Girdwood, Dr. G. P. 28 Beaver Hall-terrace, Montreal, Canada.
 1874. *Girdwood, James Kennedy. Old Park, Belfast.
 1884. †Gisborne, Frederick Newton. Ottawa, Canada.
 1886. *Gisborne, Hartley. Qu'Appelle Station, Assa, N.W.T., Canada.
 1883. *Gladstone, Miss. 17 Pembridge-square, London, W.
 1883. *Gladstone, Miss E. A. 17 Pembridge-square, London, W.
 1850. *Gladstone, George, F.C.S., F.R.G.S. 34 Denmark-villas, Hove, Brighton.
 1849. *GLADSTONE, JOHN HALL, Ph.D., F.R.S., F.C.S. 17 Pembridge-square, London, W.
 1890. *Gladstone, Miss Margaret E. 17 Pembridge-square, London, W.
 1861. *GLAISHER, JAMES, F.R.S., F.R.A.S. 1 Dartmouth-place, Blackheath, London, S.E.
 1871. *GLAISHER, J. W. L., M.A., D.Sc., F.R.S., F.R.A.S. Trinity College, Cambridge.
 1883. †Glasson, L. T. 2 Roper-street, Penrith.
 1881. *GLAZEBROOK, R. T., M.A., F.R.S. Trinity College, Cambridge.
 1887. †Glazier, Walter H., F.C.S. Courtlands, East Molesey, Surrey.
 1881. *Gleadow, Frederic. 84 Kensington Park-road, London, W.
 1870. §Glen, David Corse, F.G.S. 14 Annfield-place, Glasgow.
 1859. †Glennie, J. S. Stuart, M.A. The Shealing, Wimbledon Common, Surrey.
 1867. †Gloag, John A. L. 10 Inverleith-place, Edinburgh. Glover, George. Ranelagh-road, Pimlico, London, S.W.
 1874. †Glover, George T. 30 Donegall-place, Belfast. Glover, Thomas. 124 Manchester-road, Southport.
 1887. †Glover, Walter T. Moorhurst, Kersal, Manchester.

- Year of Election.
1870. †Glynn, Thomas R., M.D. 62 Rodney-street, Liverpool.
1889. †Goddard, F. R. 19 Victoria-square, Newcastle-upon-Tyne.
1872. †GODDARD, RICHARD. 16 Booth-street, Bradford, Yorkshire.
1886. †Godlee, Arthur. 3 Greenfield-crescent, Edgbaston, Birmingham.
1887. †Godlee, Francis. 51 Portland-street, Manchester.
1878. *Godlee, J. Lister. 3 New-square, Lincoln's Inn, London, W.C.
1880. †GODMAN, F. DU CANE, F.R.S., F.L.S., F.G.S. 10 Chandos-street, Cavendish-square, London, W.
1883. †Godson, Dr. Alfred. Cheadle, Cheshire.
1852. †Godwin, John. Wood House, Rostrevor, Belfast.
1879. †GODWIN-AUSTEN, Lieut.-Colonel H. H., F.R.S., F.G.S., F.R.G.S., F.Z.S. Shalford House, Guildford.
1876. †Goff, Bruce, M.D. Bothwell, Lanarkshire.
1886. †GOLDSMID, Major-General Sir F. J., C.B., K.C.S.I., F.R.G.S. Godfrey House, Hollingbourne.
1881. †Goldschmidt, Edward. Nottingham.
1873. †Goldthorp, Miss R. F. C. Cleckheaton, Bradford, Yorkshire.
1890. *Gonner, E. C. K., M.A., Professor of Political Economy in University College, Liverpool.
1884. †Good, Charles E. 102 St. François Xavier-street, Montreal, Canada.
1878. †Good, Rev. Thomas, B.D. 51 Wellington-road, Dublin.
1852. †Goodbody, Jonathan. Clare, King's County, Ireland.
1878. †Goodbody, Jonathan, jun. 50 Dame-street, Dublin.
1884. †Goodbody, Robert. Fairy Hill, Blackrock, Co. Dublin.
1886. †Goodman, F. B. 46 Wheeley's-road, Edgbaston, Birmingham.
1885. †GOODMAN, J. D., J.P. Peachfield, Edgbaston, Birmingham.
1865. †Goodman, J. D. Minories, Birmingham.
1884. *Goodridge, Richard E. W. Oak Bank, Manitoba, Canada.
1884. †Goodwin, Professor W. L. Queen's University, Kingston, Ontario, Canada.
1883. †Gouch, B., B.A. 2 Oxford-road, Birkdale, Southport.
1885. †Gordon, General the Hon. Sir Alexander Hamilton. 50 Queen's Gate-gardens, London, S.W.
1885. †Gordon, Rev. Cosmo, D.D., F.R.A.S., F.G.S. Chetwynd Rectory, Newport, Salop.
1885. †Gordon, Rev. George, LL.D. Birnie, by Elgin, N.B.
1871. *Gordon, Joseph Gordon, F.C.S. Queen Anne's Mansions, Westminster, S.W.
1884. *Gordon, Robert, M.Inst.C.E., F.R.G.S. Howley Lodge, 112 Harrow-road, London, W.
1857. †Gordon, Samuel, M.D. 11 Hume-street, Dublin.
1885. †Gordon, Rev. William. Braemar, N.B.
1887. †Gordon, William John. 3 Lavender-gardens, London, S.W.
1865. †Gore, George, LL.D., F.R.S. 50 Islington-row, Edgbaston, Birmingham.
1875. *Gotch, Francis, B.A., B.Sc., Professor of Physiology in University College, Liverpool. Holywell Cottage, Oxford.
1873. †Gott, Charles, M.Inst.C.E. Parkfield-road, Manningham, Bradford, Yorkshire.
1849. †Gough, The Hon. Frederick. Perry Hall, Birmingham.
1857. †Gough, The Right Hon. George S., Viscount, M.A., F.L.S., F.G.S. St. Helen's, Booterstown, Dublin.
1881. †Gough, Thomas, B.Sc., F.C.S. Elmfield College, York.
1888. †Gouraud, Colonel. Little Menlo, Norwood, Surrey.
1873. †Gourlay, J. McMillan. 21 St. Andrew's-place, Bradford, Yorkshire.
1867. †Gourley, Henry (Engineer). Dundee.

Year of
Election.

1876. †Gow, Robert. Cairndowan, Dowanhill, Glasgow.
 1883. §Gow, Mrs. Cairndowan, Dowanhill, Glasgow.
 1873. §Goyder, Dr. D. Marley House, 88 Great Horton-road, Bradford, Yorkshire.
 1886. †Grabham, Michael C., M.D. Madeira.
 1867. *GRAHAM, Sir CYRIL C., Bart., C.M.G., F.L.S., F.R.G.S. Travellers' Club, Pall Mall, London, S.W.
 1875. †GRAHAME, JAMES. 12 St. Vincent-street, Glasgow.
 1870. †GRANT, Colonel JAMES A., C.B., C.S.L., F.R.S., F.L.S., F.R.G.S. 19 Upper Grosvenor-street, London, W.
 1855. *GRANT, ROBERT, M.A., LL.D., F.R.S., F.R.A.S., Regius Professor of Astronomy in the University of Glasgow. The Observatory, Glasgow.
 1864. †Grantham, Richard F. Northumberland-chambers, Northumberland-avenue, London, W.C.
 1887. §Gratrix, Samuel. Alport Town, Manchester.
 1881. †Graves, E. 22 Trebovir-road, Earl's Court-road, London, S.W.
 1887. †Graves, John. Broomhurst, Eccles Old-road, Manchester.
 1881. †Gray, Alan, LL.B. Minster-yard, York.
 1890. §Gray, Professor Andrew, M.A., F.R.S.E. University College, Bangor.
 1864. *Gray, Rev. Charles. The Vicarage, Blyth, Rotherham.
 1865. †Gray, Charles. Swan Bank, Bilston.
 1876. †Gray, Dr. Newton-terrace, Glasgow.
 1881. †Gray, Edwin, LL.B. Minster-yard, York.
 1859. †Gray, Rev. J. H. Bolsover Castle, Derbyshire.
 1887. §Gray, Joseph W., F.G.S. Spring Hill, Wellington-road South, Stockport.
 1887. †Gray, M. H., F.G.S. Lessness Park, Abbey Wood, Kent.
 1886. *Gray, Robert Kaye. Lessness Park, Abbey Wood, Kent.
 1881. †Gray, Thomas, Professor of Engineering in the Rane Technical Institute, Terre Haute, Indiana, U.S.A.
 1873. †Gray, William, M.R.I.A. 8 Mount Charles, Belfast.
 *GRAY, Colonel WILLIAM. Farley Hall, near Reading.
 1883. †Gray, William Lewis. 36 Gutter-lane, London, E.C.
 1883. †Gray, Mrs. W. L. 36 Gutter-lane, London, E.C.
 1886. †Greaney, Rev. William. Bishop's House, Bath-street, Birmingham.
 1883. †Greathead, J. H., M.Inst.C.E. 15 Victoria-street, London, S.W.
 1866. §Greaves, Charles Augustus, M.B., LL.B. 84 Friar-gate, Derby.
 1887. †Greaves, H. R. The Orchards, Mill End, Stockport.
 1869. †Greaves, William. Station-street, Nottingham.
 1872. †Greaves, William. 3 South-square, Gray's Inn, London, W.C.
 1872. *Grece, Clair J., LL.D. Redhill, Surrey.
 1879. †Green, A. F. 15 Ashwood-villas, Headingley, Leeds.
 1889. †GREEN, A. H., M.A., F.R.S., F.G.S., Professor of Geology in the University of Oxford. 137 Woodstock-road, Oxford.
 1888. §GREEN, JOSEPH R., M.A., B.Sc., F.L.S., Professor of Botany to the Pharmaceutical Society of Great Britain. 17 Bloomsbury-square, London, W.C.
 1887. †Greene, Friese. 162 Sloane-street, London, S.W.
 1887. †Greenhalgh, Richard. 1 Temple-gardens, The Temple, London, E.C.
 1858. *Greenhalgh, Thomas. Thornydikes, Sharples, near Boltou-le-Moors.
 1882. †GREENHILL, A. G., M.A., F.R.S., Professor of Mathematics in the Royal Artillery College, Woolwich. 3 Staple Inn, London, W.C.
 1881. §Greenhough, Edward. Matlock Bath, Derbyshire.
 1884. †Greenish, Thomas, F.C.S. 20 New-street, Dorset-square, London, N.W.

- Year of Election.
1884. †Greenshields, E. B. Montreal, Canada.
 1884. †Greenshields, Samuel. Montreal, Canada.
 1887. †Greenwell, G. C., jun. Poynton, Cheshire.
 1863. †Greenwell, G. E. Poynton, Cheshire.
 1889. †Greenwell, T. G. Woodside, Sunderland.
 1890. †Greenwood, Arthur. Cavendish-road, Leeds.
 1877. †Greenwood, Holmes. 78 King-street, Accrington.
 1883. †GREENWOOD, J. G., LL.D. 34 Furness-road, Eastbourne.
 1849. †Greenwood, William. Stones, Todmorden.
 1887. §Greenwood, W. H., M.Inst.C.E. Adderley Park Rolling Mills, Birmingham.
 1887. *Greg, Arthur. Eagley, near Bolton, Lancashire.
 1861. *GREG, ROBERT PHILIPS, F.G.S., F.R.A.S. Coles Park, Buntingford, Herts.
 1860. †GREGOR, Rev. WALTER, M.A. Pitsligo, Rosehearty, Aberdeenshire.
 1868. †Gregory, Sir Charles Hutton. K.C.M.G., M.Inst.C.E. 2 Delahay-street, Westminster, S.W.
 1883. †Gregson, Edward, Ribble View, Preston.
 1883. †Gregson, G. E. Ribble View, Preston.
 1881. †Gregson, William. Baldersby, Thirsk.
 1875. †Grenfell, J. Granville, B.A., F.G.S. 55 West Cromwell-road, London, S.W.
 1859. †GRIERSON, THOMAS BOYLE, M.D. Thornhill, Dumfries-shire.
 1870. †Grieve, John, M.D. Care of W. L. Buchanan, Esq., 212 St. Vincent-street, Glasgow.
 1878. †Griffin, Robert, M.A., LL.D. Trinity College, Dublin.
 1859. *GRIFFITH, GEORGE, M.A., F.C.S. (ASSISTANT GENERAL SECRETARY.) Druries, Harrow.
 1870. †Griffith, Rev. Henry, F.G.S. Brooklands, Isleworth, Middlesex.
 1884. †Griffiths, E. H. 12 Park-side, Cambridge.
 1884. †Griffiths, Mrs. 12 Park-side, Cambridge.
 1891. §Griffiths, P. Rhys, B.Sc., M.B. 71 Newport-road, Cardiff.
 1847. †Griffiths, Thomas. Bradford-street, Birmingham.
 1879. †Griffiths, Thomas, F.C.S., F.S.S. Heidelberg House, King's-road, Clapham Park, London, S.W.
 1870. †Grimsdale, T. F., M.D. 29 Rodney-street, Liverpool.
 1888. *Grimshaw, James Walter. Australian Club, Sydney, New South Wales.
 1884. †Grinnell, Frederick. Providence, Rhode Island, U.S.A.
 1881. †Gripper, Edward. Nottingham.
 1864. †GROOM-NAPIER, CHARLES OTTLEY. 18 Elgin-road, St. Peter's Park, London, N.W.
 GROVE, The Hon. Sir WILLIAM ROBERT, Knt., M.A., D.C.L., LL.D., F.R.S. 115 Harley-street, London, W.
 1891. §Grover, Henry Llewellyn. Clydach Court, Pontypridd.
 1863. *GROVES, THOMAS B., F.C.S. 80 St. Mary-street, Weymouth.
 1869. †GRUBB, Sir HOWARD, F.R.S., F.R.A.S. 51 Kenilworth-square, Rathgar, Dublin.
 1886. †Grundy, John. 17 Private-road, Mapperley, Nottingham.
 1891. §Grylls, W. London and Provincial Bank, Cardiff.
 1867. †Guild, John. Bayfield, West Ferry, Dundee.
 1887. †GUILLEMARD, F. H. H. Eltham, Kent.
 Guinness, Henry. 17 College-green, Dublin.
 1842. Guinness, Richard Seymour. 17 College-green, Dublin.
 1885. †Gunn, John. Dale, Halkirk, Caithness.
 1891. §Gunn, John. Llandaff House, Llandaff.

Year of
Election.

1877. †Gunn, William, F.G.S. Office of the Geological Survey of Scotland, Sheriff's Court House, Edinburgh.
1866. †GÜNTHER, ALBERT C. L. G., M.A., M.D., Ph.D., F.R.S., Keeper of the Zoological Collections in the British Museum. British Museum, South Kensington, London, S.W.
1880. §Guppy, John J. Ivy-place, High-street, Swansea.
1876. †Guthrie, Francis. Cape Town, Cape of Good Hope.
1883. †Guthrie, Malcolm. 2 Parkfield-road, Liverpool.
1857. †Gwynne, Rev. John. Tullyagnish, Letterkenny, Strabane, Ireland.
1876. †GWYTHER, R. F., M.A. Owens College, Manchester.
1884. †Haanel, E., Ph.D. Cobourg, Ontario, Canada.
1887. †Hackett, Henry Eugene. Hyde-road, Gorton, Manchester.
1865. †Hackney, William. 9 Victoria-chambers, Victoria-street, London, S.W.
1884. †Hadden, Captain C. F., R.A. Woolwich.
1881. *HADDON, ALFRED CORT, B.A., F.Z.S., Professor of Zoology in the Royal College of Science, Dublin.
Haden, G. N. Trowbridge, Wiltshire.
1842. Hadfield, George. Victoria-park, Manchester.
1888. *Hadfield, R. A. Hecla Works, Sheffield.
1870. †Haigh, George. Waterloo, Liverpool.
1879. †HAKE, H. WILSON, Ph.D., F.C.S. Queenwood College, Hants.
1875. †Hale, Rev. Edward, M.A., F.G.S., F.R.G.S. Eton College, Windsor.
1887. †Hale, The Hon. E. J. 9 Mount-street, Manchester.
1872. †Hall, Dr. Alfred. 8 Mount Ephraim, Tunbridge Wells.
1879. *Hall, Ebenezer. Abbeydale Park, near Sheffield.
1883. *Hall, Miss Emily. Burlington House, Spring Grove, Isleworth, Middlesex.
1881. †Hall, Frederick Thomas, F.R.A.S. 15 Gray's Inn-square, London, W.C.
1854. *HALL, HUGH FERGIE, F.G.S. Tan-y-Bryn, Llandudno.
1887. †Hall, John. Springbank, Leftwich, Northwich.
1872. *Hall, Captain Marshall, F.G.S. Easterton Lodge, Parkstone R.S.O., Dorset.
1885. §Hall, Samuel. 19 Aberdeen Park, Highbury, London, N.
1884. †Hall, Thomas Proctor. School of Practical Science, Toronto, Canada.
1866. *HALL, TOWNSHEND M., F.G.S. Orchard House, Pilton, Barnstaple.
1891. *Hallett, George. Cranford, Victoria-road, Penarth, Glamorgan-shire.
1891. §Hallett, J. H. Maindy Lodge, Cardiff.
1873. *HALLETT, T. G. P., M.A. Claverton Lodge, Bath.
1888. §Halliburton, W. D., M.D., F.R.S. 9 Ridgmount-gardens, Gower-street, London, W.C.
Halsall, Edward. 4 Somerset-street, Kingsdown, Bristol.
1886. §Hambleton, G. W. 23 Bryanston-street, Portman-square, London, W.
1858. *Hambly, Charles Hambly Burbridge, F.G.S. Holmeside, Hazelwood, Derby.
1883. *Hamel, Egbert D. de. Middleton Hall, Tamworth.
1885. †Hamilton, David James. 1A Albyn-place, Aberdeen.
1869. †Hamilton, Rowland. Oriental Club, Hanover-square, London, W.
1888. *HAMMOND, ANTHONY, J.P. 10 Royal-crescent, Bath.
1851. †Hammond, C. C. Lower Brook-street, Ipswich.
1881. *Hammond, Robert. Hildrop, Highgate, London, N.

Year of
Election.

1878. †Hance, Edward M., LL.B. 15 Pelham-grove, Sefton Park, Liverpool.
1875. †Hancock, C. F., M.A. 125 Queen's-gate, London, S.W.
1861. †Hancock, Walter. 10 Upper Chadwell-street, Pentonville, London, E.C.
1876. †Hancock, Mrs. W. Neilson. 64 Upper Gardiner-street, Dublin.
1890. †Hankin, Ernest Hanbury. St. John's College, Cambridge.
1882. †Hankinson, R. C. Bassett, Southampton.
1884. §Hannaford, E. C. 1591 Catherine-street, Montreal, Canada.
1859. †Hannay, John. Montcoffer House, Aberdeen.
1886. §Hansford, Charles. 3 Alexandra-terrace, Dorchester.
1859. *HARCOURT, A. G. VERNON, M.A., D.C.L., LL.D., F.R.S., F.C.S. (GENERAL SECRETARY.) Cowley Grange, Oxford.
1890. *HARCOURT, L. F. VERNON, M.Inst.C.E. 6 Queen Anne's-gate, London, S.W.
1886. *Hardcastle, Basil W., F.S.S. Beechenden, Hampstead, London, N.W.
1884. *Hardcastle, Norman C., M.A., LL.D. Downing College, Cambridge.
1865. †Harding, Charles. Harborne Heath, Birmingham.
1869. †Harding, Joseph. Millbrook House, Exeter.
1877. †Harding, Stephen. Bower Ashton, Clifton, Bristol.
1869. †Harding, William D. Islington Lodge, King's Lynn, Norfolk.
1886. †Hardman, John B. St. John's, Hunter's-lane, Birmingham.
1880. †Hardy John. 118 Embden-road, Manchester.
1838. *HARE, CHARLES JOHN, M.D. Berkeley House, 15 Manchester-square, London, W.
1858. †Hargrave, James. Burley, near Leeds.
1883. †Hargreaves, Miss H. M. 69 Alexandra-road, Southport.
1883. †Hargreaves, Thomas. 69 Alexandra-road, Southport.
1890. †Hargrove, Rev. Charles. 10 De Grey-terrace, Leeds.
1881. †Hargrove, William Wallace. St. Mary's, Bootham, York.
1890. §Harker, Alfred. St. John's College, Cambridge.
1876. †Harker, Allen, F.L.S., Professor of Natural History in the Royal Agricultural College, Cirencester.
1887. †Harker, T. H. Brook House, Fallowfield, Manchester.
1878. *Harkness, H. W. California Academy of Sciences, San Francisco, California, U.S.A.
1871. †Harkness, William, F.C.S. Laboratory, Somerset House, London, W.C.
1875. *Harland, Rev. Albert Augustus, M.A., F.G.S., F.L.S., F.S.A. The Vicarage, Harefield, Middlesex.
1877. *Harland, Henry Seaton. 8 Arundel-terrace, Brighton, Sussex.
1883. *Harley, Miss Clara. 4 Wellington-square, Oxford.
1862. *HARLEY, GEORGE, M.D., F.R.S., F.C.S. 25 Harley-street, London, W.
1883. *Harley, Harold. 14 Chapel-street, Bedford-row, London, W.C.
1862. *HARLEY, Rev. ROBERT, M.A., F.R.S., F.R.A.S. 4 Wellington-square, Oxford.
1868. *HARMER, F. W., F.G.S. Oakland House, Cringleford, Norwich.
1881. *HARMER, SIDNEY F., M.A., B.Sc. King's College, Cambridge.
1882. †Harper, G. T. Bryn Hyfrydd, Portswood, Southampton.
1872. †Harpley, Rev. William, M.A. Clayhanger Rectory, Tiverton.
1884. †Harrington, B. J., B.A., Ph.D., Professor of Chemistry and Mineralogy in McGill University, Montreal. Wallbrac-place, Montreal, Canada.
1872. *Harris, Alfred. Lunefield, Kirkby Lonsdale, Westmoreland.
1888. †Harris, C. T. 4 Kilburn Priory, London, N.W.
1842. *Harris, G. W., M.Inst.C.E. Mount Gambier, South Australia.

- Year of Election.
1889. §HARRIS, H. GRAHAM, M.Inst.C.E. 5 Great George-street, Westminster, S.W.
1884. †Harris, Miss Katherine E. 73 Albert Hall-mansions, Kensington-gore, London, S.W.
1888. †Harrison, Charles. 20 Lennox-gardens, London. S.W.
1860. †Harrison, Rev. Francis, M.A. North Wraxall, Chippenham.
1864. †Harrison, George. Barnsley, Yorkshire.
1874. †Harrison, G. D. B. 3 Beaufort-road, Clifton, Bristol.
1858. *HARRISON, JAMES PARK, M.A. 22 Connaught-street, Hyde Park, London, W.
1889. §Harrison, J. C. Oxford House, Castle-road, Scarborough.
1870. †HARRISON, REGINALD, F.R.C.S. 6 Lower Berkeley-street, Portman-square, London, W.
1853. †Harrison, Robert. 36 George-street, Hull.
1883. †Harrison, Thomas. 34 Ash-street, Southport.
1886. §Harrison, William. The Horsehills, Wolverhampton.
1886. †Harrison, W. Jerome, F.G.S. 365 Lodge-road, Hockley, Birmingham.
1885. †HART, CHARLES J. 10 Calthorpe-road, Edgbaston, Birmingham.
1876. *Hart, Thomas. Brooklands, Blackburn.
1881. §Hart, Thomas, F.G.S. Yewbarrow, Grange-over-Sands, Carnforth.
1875. †Hart, W. E. Kilderry, near Londonderry.
Hartley, James. Sunderland.
1871. †HARTLEY, WALTER NOEL, F.R.S.L. & E., F.C.S., Professor of Chemistry in the Royal College of Science, Dublin.
1890. *Hartnell, Wilson. 8 Blenheim-terrace, Leeds.
1886. *HARTOG, Professor M. M., D.Sc. Queen's College, Cork.
1887. §Hartog, P. J., B.Sc. 6 Greville-road, London, N.W.
1885. †Harvey, Surgeon-Major Robert, M.D. *Calcutta*.
1885. §Harvie-Brown, J. A. Dunipace, Larbert, N.B.
1862. *Harwood, John, jun. Woodside Mills, Bolton-le-Moors.
1884. †Haslam, Rev. George, M.A. Trinity College, Toronto, Canada.
1882. †Haslam, George James, M.D. Owens College, Manchester.
1875. *HASTINGS, G. W., M.P. Barnard's Green House, Malvern.
1889. †Hatch, Dr. F. H., F.G.S. 28 Jermyn-street, London, S.W.
1857. †HAUGHTON, Rev. SAMUEL, M.A., M.D., D.C.L., LL.D., F.R.S., M.R.I.A., F.G.S., Senior Fellow of Trinity College, Dublin.
Trinity College, Dublin.
1887. *Hawkins, William. 11 Fountain-street, Manchester.
1872. *Hawkshaw, Henry Paul. 58 Jermyn-street, St. James's, London, S.W.
1864. *HAWKSHAW, JOHN CLARKE, M.A., M.Inst.C.E., F.G.S. 50 Harrington-gardens, South Kensington, S.W.; and 33 Great George-street, London, S.W.
1868. †HAWKSLEY, THOMAS, M.Inst.C.E., F.R.S., F.G.S. 30 Great George-street, London, S.W.
1884. *Haworth, Abraham. Hilston House, Altrincham.
1889. §Haworth, George C. Ordsal-lane, Salford.
1887. *Haworth, Jesse. Woodside, Bowdon, Cheshire.
1887. †Haworth, S. E. Warsley-road, Swinton, Manchester.
1886. †Haworth, Rev. T. J. Albert Cottage, Saltley, Birmingham.
1890. †Hawtin, J. N. Sturdie House, Roundhay-road, Leeds.
1877. †Hay, Arthur J. Lerwick, Shetland.
1861. *HAY, Admiral the Right Hon. Sir JOHN C. D., Bart., K.C.B., D.C.L., F.R.S. 108 St. George's-square, London, S.W.
1867. †Hay, William. 21 Magdalen-yard-road, Dundee.
1885. *Haycraft, Professor John Berry, M.B., B.Sc., F.R.S.E. Physiological Laboratory, The University, Edinburgh.

Year of
Election.

1891. §Hayde, Rev. J. St. Peter's, Cardiff.
 1873. *Hayes, Rev. William A., M.A. Dromore, Co. Down, Ireland.
 1869. †Hayward, J. High-street, Exeter.
 1858. *HAYWARD, ROBERT BALDWIN, M.A., F.R.S. Harrow.
 1888. †Hazard, Rowland R. Little Mulgrave House, Hurlingham.
 1879. *Hazlehurst, George S. *Rhyl, North Wales*.
 1851. §HEAD, JEREMIAH, M.Inst.C.E., F.C.S. Middlesbrough, Yorkshire.
 1883. †Headley, Frederick Halcombe. Manor House, Petersham, S.W.
 1883. †Headley, Mrs. Marian. Manor House, Petersham, S.W.
 1883. §Headley, Rev. Tanfield George. Manor House, Petersham, S.W.
 1871. §Healey, George. Brantfield, Bowness, Windermere.
 1883. *Heap, Ralph, jun. 1 Brick-court, Temple, London, E.C.
 1861. *Heape, Benjamin. Northwood, Prestwich, Manchester.
 1883. †Heape, Charles. Tovrak, Oxton, Cheshire.
 1883. †Heape, Joseph R. 96 Tweedale-street, Rochdale.
 1882. *Heape, Walter, M.A. St. Mary's, Trumpington, Cambridge.
 1877. †Hearder, Henry Pollington. Westwell-street, Plymouth.
 1877. †Hearder, William Keep, F.S.A. 195 Union-street, Plymouth.
 1883. †Heath, Dr. 46 Hoghton-street, Southport.
 1889. †Heath, Dr. Westgate-road, Newcastle-upon-Tyne.
 1866. †Heath, Rev. D. J. Esher, Surrey.
 1863. †Heath, G. Y., M.D. Westgate-street, Newcastle-on-Tyne.
 1884. †Heath, Thomas, B.A. Royal Observatory, Calton Hill, Edinburgh.
 1883. †Heaton, Charles. Marlborough House, Hesketh Park, Southport.
 1886. †Heaton, C. W. 44 Woodstock-road, Bedford Park, London, W.
 1886. †Heaton, Miss Ellen. Woodhouse-square, Leeds.
 1865. †Heaton, Harry. Harborne House, Harborne, near Birmingham.
 1889. *Heaviside, Arthur West. 7 Grafton-road, Whitley, Newcastle-upon-Tyne.
 1884. §Heaviside, Rev. George, B.A., F.R.G.S., F.R.Hist.S. 7 Grosvenor-street, Coventry.
 1833. †HEAVISIDE, Rev. Canon J. W. L., M.A. The Close, Norwich.
 1888. *Heawood, Edward, B.A., F.G.S. 41 Old Elvet, Durham.
 1888. *Heawood, Percy Y., Lecturer in Mathematics at Durham University. 41 Old Elvet, Durham.
 1855. †HECTOR, Sir JAMES, K.C.M.G., M.D., F.R.S., F.G.S., F.R.G.S., Director of the Geological Survey of New Zealand. Wellington, New Zealand.
 1867. †Hedde, M. Forster, M.D., F.R.S.E. St. Andrews, N.B.
 1869. †Hedgeland, Rev. W. J. 21 Mount Rudford, Exeter.
 1882. †Hedger, Philip. Cumberland-place, Southampton.
 1887. *HEDGES, KILLINGWORTH, M.Inst.C.E. 6 Storey's-gate, London, S.W.
 1863. †Hedley, Thomas. Cox Lodge, near Newcastle-upon-Tyne.
 1881. *HELE-SHAW, H. S., M.Inst.C.E., Professor of Engineering in University College, Liverpool.
 1887. §Hembry, Frederick William, F.R.M.S. Sussex Lodge, Sidcup, Kent.
 1867. †Henderson, Alexander. Dundee.
 1873. *Henderson, A. L. 277 Lewisham High-road, London, S.E.
 1883. †Henderson, Mrs. A. L. 277 Lewisham High-road, London, S.E.
 1880. *Henderson, Captain W. H., R.N. 21 Albert Hall Mansions. London, S.W.
 1891. *Henderson, G. G., D.Sc., M.A., F.C.S. The University, Glasgow.
 1885. †Henderson, William. Devanha House, Aberdeen.
 1856. †HENNESSY, HENRY G., F.R.S., M.R.I.A., Professor of Applied Mathematics and Mechanics in the Royal College of Science for Ireland. Brookvale, Donnybrook, Co. Dublin.

Year of
Election.

1873. *HENRICI, OLAUS M. F. E., Ph.D., F.R.S., Professor of Mechanics and Mathematics in the City and Guilds of London Institute. Central Institution, Exhibition-road, London, S.W.
Henry, Franklin. Portland-street, Manchester.
1873. Henry, J. Snowdon. East Dene, Bonchurch, Isle of Wight.
Henry, Mitchell. Stratheden House, Hyde Park, London, W.
*HENRY, WILLIAM CHARLES, M.D., F.R.S., F.G.S., F.R.G.S., F.C.S.
Haffield, near Ledbury, Herefordshire.
1884. †Henshaw, George H. 43 Victoria-street, Montreal, Canada.
1870. †Henty, William. 12 Medina-villas, Brighton.
1855. *Hepburn, J. Gotch, LL.B., F.C.S. Dartford, Kent.
1855. †Hepburn, Robert. 9 Portland-place, London, W.
1890. †Hepper, J. 43 Cardigan-road, Headingley, Leeds.
1890. †Hepworth, Joseph. 25 Wellington-street, Leeds.
1887. *HERDMAN, WILLIAM A., D.Sc., Professor of Natural History in University College, Liverpool.
1891. Hern, S. South Cliff, Marine Parade, Penarth.
1871. *HERSCHEL, ALEXANDER S., M.A., D.C.L., F.R.S., F.R.A.S., Honorary Professor of Physics and Experimental Philosophy in the University of Durham College of Science, Newcastle-on-Tyne. Observatory House, Slough, Bucks.
1874. §HERSCHEL, Colonel JOHN, R.E., F.R.S., F.R.A.S. Observatory House, Slough, Bucks.
1890. †Hewetson, H. Bendelack, M.R.C.S., F.L.S. 11 Hanover-square, Leeds.
1884. §Hewett, George Edwin. Cotswold House, St. John's Wood Park, London, N.W.
1883. †Hewson, Thomas. Care of J. C. C. Payne, Esq., Botanic-avenue, The Plains, Belfast.
1881. †Hey, Rev. William Croser, M.A. Clifton, York.
1882. †Heycock, Charles T., B.A. King's College, Cambridge.
1883. §Heyes, Rev. John Frederick, M.A., F.C.S., F.R.G.S. 9 King-street, Oxford.
1866. *Heymann, Albert. West Bridgford, Nottinghamshire.
1879. †Heywood, A. Percival. Duffield Bank, Derby.
1861. *Heywood, Arthur Henry. Elleray, Windermere.
1886. §HEYWOOD, HENRY, J.P., F.C.S. Cardiff.
*HEYWOOD, JAMES, F.R.S., F.G.S., F.S.A., F.R.G.S., F.S.S. 26 Kensington Palace-gardens, London, W.
1861. *HEYWOOD, OLIVER, J.P., D.L. Claremont, Manchester.
1887. †Heywood, Robert. Mayfield, Victoria Park, Manchester.
Heywood, Thomas Percival. Claremont, Manchester.
1888. §Hichens, James Harvey, M.A., F.G.S. The College, Cheltenham.
1881. §HICK, THOMAS, B.A., B.Sc. Brighton Grove, Rusholme, Manchester.
1875. †HICKS, HENRY, M.D., F.R.S., Sec.G.S. Hendon Grove, Hendon, Middlesex, N.W.
1877. §HICKS, Professor W. M., M.A., D.Sc., F.R.S., Principal of Firth College, Sheffield. Firth College, Sheffield.
1886. †Hicks, Mrs. W. M. Duvheved, Endcliffe-crescent, Sheffield.
1884. †Hickson, Joseph. 272 Mountain-street, Montreal, Canada.
1887. *HICKSON, SYDNEY J., M.A., D.Sc. Downing College, Cambridge.
1864. *HIERN, W. P., M.A. Castle House, Barnstaple.
1875. †Higgins, Charles Hayes, M.D., M.R.C.P., F.R.C.S., F.R.S.E. Alfred House, Birkenhead.
1871. †HIGGINS, CLEMENT, B.A., F.C.S. 103 Holland-road, Kensington, London, W.

Year of
Election.

1854. †HIGGINS, Rev. HENRY H., M.A. 29 Falkner-square, Liverpool.
 1891. §Higgs, Henry. 164 Brixton Hill, London, S.W.
 Hildyard, Rev. James, B.D., F.C.P.S. Ingoldsby, near Grantham,
 Lincolnshire.
 1885. *Hill, Alexander, M.A., M.D. Downing College, Cambridge.
 Hill, Arthur. Bruce Castle, Tottenham, Middlesex.
 1883. †Hill, Berkeley, M.B., Professor of Clinical Surgery in University
 College, London. 66 Wimpole-street, London, W.
 1872. §Hill, Charles, F.S.A. Rockhurst, West Hoathly, East Grinstead.
 1881. *HILL, Rev. EDWIN, M.A., F.G.S. The Rectory, Cockfield, R.S.O.,
 Suffolk.
 1887. †Hill, G. H. Albert-chambers, Albert-square, Manchester.
 1884. †Hill, Rev. James Edgar, M.A., B.D. 2488 St. Catherine-street,
 Montreal, Canada.
 1857. §Hill, John, M.Inst.C.E., M.R.I.A., F.R.G.S.I. County Surveyor's
 Office, Ennis, Ireland.
 1886. †Hill, M. J. M., D.Sc., Professor of Pure Mathematics in University
 College, London.
 1881. †Hill, Pearson. 50 Belsize Park, London, N.W.
 1872. *Hill, Rev. Canon, M.A., F.G.S. Sheering Rectory, Harlow.
 1885. *Hill, Sidney. Langford House, Langford, Bristol.
 1888. †Hill, William. Hitchin, Herts.
 1876. †Hill, William H. Barlanark, Shettleston, N.B.
 1885. *HILLHOUSE, WILLIAM, M.A., F.L.S., Professor of Botany in Mason
 Science College, Birmingham. 95 Harborne-road, Edgbaston,
 Birmingham.
 1886. §Hillier, Rev. E. J. Cardington Vicarage, Bedford.
 1863. †Hills, F. C. Chemical Works, Deptford, Kent, S.E.
 1887. †Hilton, Edwin. Oak Bank, Fallowfield, Manchester.
 1858. †HINCKS, Rev. THOMAS, B.A., F.R.S. Stokeleigh, Leigh Woods,
 Clifton, Bristol.
 1870. †HINDE, G. J., Ph.D., F.G.S. Avondale-road, Croydon, Surrey.
 1883. *Hindle, James Henry. 8 Cobham-street, Accrington.
 1888. *Hindmarsh, William Thomas, F.L.S. Alnbank, Alnwick.
 1886. †Hingley, Benjamin, M.P. Hatherton Lodge, Cradley, Worcester-
 shire.
 1881. †Hingston, J. T. Clifton, York.
 1884. †HINGSTON, WILLIAM HALES, M.D., D.C.L. 37 Union-avenue,
 Montreal, Canada.
 1884. †Hirschfelder, C. A. Toronto, Canada.
 1890. *Hirst, James Andus. Adel Tower, Leeds.
 1858. †Hirst, John, jun. Dobcross, near Manchester.
 1861. *HIRST, T. ARCHER, Ph.D., F.R.S., F.R.A.S. 7 Oxford and Cam-
 bridge Mansions, Marylebone-road, London, N.W.
 1884. †Hoadrey, John Chipman. Boston, Massachusetts, U.S.A.
 Hoare, J. Gurney. Hampstead, London, N.W.
 1881. §Hobbes, Robert George. Livingstone House, 374 Wandsworth-road,
 London, S.W.
 1879. §Hobkirk, Charles P., F.L.S. West Riding Union Bank, Dewsbury.
 1887. *Hobson, Bernard, B.Sc. Tapton Elms, Sheffield.
 1883. †Hobson, Rev. E. W. 55 Albert-road, Southport.
 1877. †Hockin, Edward. Poughill, Stratton, Cornwall.
 1883. †Hocking, Rev. Silas K. 21 Scarisbrick New-road, Southport.
 1877. †Hodge, Rev. John Mackey, M.A. 38 Tavistock-place, Plymouth.
 1876. †Hodges, Frederick W. Queen's College, Belfast.
 1852. †Hodges, John F., M.D., F.C.S., Professor of Agriculture in Queen's
 College, Belfast.

Year of
Election.

1863. *HODGKIN, THOMAS, B.A., D.C.L. Benwell Dene, Newcastle-upon-Tyne.
 1887. *Hodgkinson, Alexander. 18 St. John-street, Manchester.
 1880. §Hodgkinson, W. R. Eaton, Ph.D., F.R.S.E., Professor of Chemistry
 and Physics in the Royal Artillery College, Woolwich. 8
 Park-villas, Blackheath, London, S.E.
 1873. *Hodgson, George. Thornton-road, Bradford, Yorkshire.
 1884. †Hodgson, Jonathan. Montreal, Canada.
 1863. †Hodgson, Robert. Whitburn, Sunderland.
 1863. †Hodgson, R. W. 7 Sandhill, Newcastle-upon-Tyne.
 1889. †Hoey, D. G. 8 Gordon-street, Glasgow.
 1865. *HOFMANN, AUGUST WILHELM, M.D., LL.D., Ph.D., F.R.S., F.C.S.
 10 Dorotheen-strasse, Berlin.
 1854. *Holcroft, George. Tyddyngwladis, Ganllwyd, near Dolgelly, North
 Wales.
 1883. †Holden, Edward. Laurel Mount, Shipley, Yorkshire.
 1873. *Holden, Isaac, M.P. Oakworth House, near Keighley, Yorkshire.
 1883. †Holden, James. 12 Park-avenue, Southport.
 1883. †Holden, John J. 23 Duke-street, Southport.
 1884. †Holden, Mrs. Mary E. Dunham Ladies' College, Quebec, Canada.
 1857. *Holder, Henry William, M.A. Owens College, Manchester.
 1887. *Holdsworth, C. J. Hill Top, near Kendal, Westmoreland.
 1891. §Holgate, Benjamin, F.G.S. Regent House, Grosvenor-road, Head-
 ingley, Leeds.
 1879. †Holland, Calvert Bernard. Ebbw Vale, South Wales.
 *Holland, Philip H. 3 Heath-rise, Willow-road, Hampstead, Lon-
 don, N.W.
 1889. §Hollander, Bernard. Unionist Club, 68 Pall Mall, London, S.W.
 1886. †Holliday, J. R. 101 Harborne-road, Birmingham.
 1865. †Holliday, William. New-street, Birmingham.
 1883. †Hollingsworth, Dr. T. S. Elford Lodge, Spring Grove, Isleworth,
 Middlesex.
 1883. *Holmes, Mrs. Basil. 5 Freeland-road, Ealing, Middlesex, W.
 1866. *Holmes, Charles. 59 London-road, Derby.
 1873. †Holmes, J. R. Southbrook Lodge, Bradford, Yorkshire.
 1889. †Holmes, Ralph, B.A. Hulme Grammar School, Manchester.
 1882. *Holmes, Thomas Vincent, F.G.S. 28 Croom's-hill, Greenwich, S.E.
 1887. §Holt, Thomas. Atlas Iron Works, Molesworth-street, Rochdale.
 1891. *Hood, Archibald, M.Inst.C.E. 42 Newport-road, Cardiff.
 1875. *Hood, John. Chesterton, Cirencester.
 1847. †HOOKER, Sir JOSEPH DALTON, K.C.S.I., C.B., M.D., D.C.I., LL.D.,
 F.R.S., F.L.S., F.G.S., F.R.G.S. The Camp, Sunningdale.
 1865. *Hooper, John P. Coventry Park, Streatham, London, S.W.
 1877. *Hooper, Rev. Samuel F., M.A. The Vicarage, Blackheath Hill,
 Greenwich, S.E.
 1856. †Hooton, Jonathan. 116 Great Ducie-street, Manchester.
 1842. Hope, Thomas Arthur. 14 Airlie-gardens, Campden Hill, London, W.
 1884. *Hopkins, Edward M. 3 Upper Berkeley-street, Portman-square,
 London, W.
 1865. †Hopkins, J. S. Jesmond Grove, Edgbaston, Birmingham.
 1884. *HOPKINSON, CHARLES. 305 Moss-lane East, Manchester.
 1882. *Hopkinson, Edward, M.A., D.Sc. Oakleigh, Timperley, Cheshire.
 1870. *HOPKINSON, JOHN, M.A., D.Sc., F.R.S. Holmwood, Wimbledon,
 Surrey.
 1871. *HOPKINSON, JOHN, F.L.S., F.G.S., F.R.Met.Soc. 95 New Bond-
 street, London, W.; and The Grange, St. Albans.
 1858. †Hopkinson, Joseph, jun. Britannia Works, Huddersfield.
 1891. §Horder, T. Garrett. 29 Charles-street, Cardiff.

- Year of Election.
- Hornby, Hugh. Sandown, Liverpool.
1886. †Horne, Edward H. Innisfail, Beulah Hill, Norwood, S.E.
1885. †Horne, John, F.R.S.E., F.G.S. 41 Southside-road, Inverness.
1876. *Horne, Robert R. 150 Hope-street, Glasgow.
1875. *Horniman, F. J., F.R.G.S., F.L.S. Surrey Mount, Forest Hill, London, S.E.
1884. *Horsfall, Richard. Stoodley House, Halifax.
1887. †Horsfall, T. C. Swanscoe Park, near Macclesfield.
1884. *Hotblack, G. S. Prince of Wales-road, Norwich.
1868. †Hotson, W. C. Upper King-street, Norwich.
1859. †Hough, Joseph, M.A., F.R.A.S. Codsall Wood, Wolverhampton.
1886. †Houghton, F. T. S., M.A. 119 Gough-road, Edgbaston, Birmingham.
1887. †Houldsworth, Sir W. H., Bart., M.P. Norbury Booths, Knutsford.
1858. †Hounsfield, James. *Hemsworth, Pontefract.*
1884. †Houston, William. Legislative Library, Toronto, Canada.
1883. *Hovenden, Frederick, F.L.S., F.G.S. Glenlea, Thurlow Park-road, West Dulwich, Surrey, S.E.
- Hovenden, W. F., M.A. Bath.
1879. *Howard, D. Hungershall Lodge, Tunbridge Wells.
1883. †Howard, James Fielden, M.D., M.R.C.S. Sandycroft, Shaw.
1886. §Howard, James L., D.Sc. 20 Oxford-road, Waterloo, near Liverpool.
1887. *Howard, S. S. Llanishen Rise, near Cardiff.
1882. †Howard, William Frederick, Assoc.M.Inst.C.E. 13 Cavendish-street, Chesterfield, Derbyshire.
1886. †Howatt, David. 3 Birmingham-road, Dudley.
1876. †Howatt, James. 146 Buchanan-street, Glasgow.
1885. †Howden, James C., M.D. Sunnyside, Montrose, N.B.
1889. §Howden, Robert, M.B. Durham College of Medicine, Newcastle-upon-Tyne.
1857. †Howell, Henry H., F.G.S., Director of the Geological Survey of Scotland. Geological Survey Office, Victoria-street, Edinburgh.
1887. †Howell, J. A. *Edward-street, Werneth, Oldham.*
1868. †HOWELL, Rev. Canon HINDS. Drayton Rectory, near Norwich.
1891. §Howell, Rev. William Charles, M.A. High Cross, Tottenham, Middlesex.
1886. §HOWES, Professor G. B., F.L.S. Royal College of Science, South Kensington, London, S.W.
1884. †Howland, Edward P., M.D. 211 4½-street, Washington, U.S.A.
1884. †Howland, Oliver Aiken. Toronto, Canada.
1865. *HOWLETT, Rev. FREDERICK, F.R.A.S. East Tisted Rectory, Alton, Hants.
1863. †HOWORTH, H. H., M.P., F.S.A. Bentcliffe, Eccles, Manchester.
1883. †Howorth, John, J.P. Springbank, Burnley, Lancashire.
1883. †Hoyle, James. Blackburn.
1887. §HOYLE, WILLIAM E., M.A. Owens College, Manchester.
1888. †Hudd, Alfred E., F.S.A. 94 Pembroke-road, Clifton, Bristol.
1888. †Hudson, C. T., M.A., LL.D., F.R.S. 6 Royal York-crescent, Clifton, Bristol.
1867. *HUDSON, WILLIAM H. H., M.A., Professor of Mathematics in King's College, London. 15 Altenberg-gardens, Clapham Commcn, London, S.W.
1858. *HUGGINS, WILLIAM, D.C.L. Oxon., LL.D. Camb., F.R.S., F.R.A.S. (PRESIDENT). 90 Upper Tulse Hill, Brixton, London, S.W.
1887. †Hughes, E. G. 4 Roman-place, Higher Broughton, Manchester.
1883. †Hughes, Miss E. P. Newnham College, Cambridge.

Year of
Election.

1871. *Hughes, George Pringle, J.P. Middleton Hall, Wooler, Northumberland.
1891. §Hughes, Rev. H. Hawker. Jesus College, Oxford.
1887. †Hughes, John Taylor. Thorley Moor, Ashley-road, Altrincham.
1870. *Hughes, Lewis. Fenwick-court, Liverpool.
1891. §Hughes, Thomas. West Wharf, Cardiff.
1876. *Hughes, Rev. Thomas Edward. Wallfield House, Reigate.
1868. §HUGHES, T. M'K., M.A., F.R.S., F.G.S., Woodwardian Professor of Geology in the University of Cambridge.
1865. †Hughes, W. R., F.L.S., Treasurer of the Borough of Birmingham. Birmingham.
1883. †HULKE, JOHN WHITAKER, F.R.S., F.R.C.S., F.G.S. 10 Old Burlington-street, London, W.
1867. §HULL, EDWARD, M.A., LL.D., F.R.S., F.G.S., Professor of Geology in the Royal College of Science. 20 Arundel-gardens, Notting Hill, London, W.
- *Hulse, Sir Edward, Bart., D.C.L. 47 Portland-place, London, W.; and Breamore House, Salisbury.
1887. *Hummel, Professor J. J. Yorkshire College, Leeds.
1890. §Humphrey, Frank W. 63 Prince's-gate, London, S.W.
1884. *Humphreys, A. W. 45 William-street, New York, U.S.A.
1878. †Humphreys, H. Castle-square, Carnarvon.
1880. †Humphreys, Noel A., F.S.S. Ravenhurst, Hook, Kingston-on-Thames.
1856. †Humphries, David James. 1 Keynsham-parade, Cheltenham.
1862. *HUMPHRY, Sir GEORGE MURRAY, M.D., F.R.S., Professor of Surgery in the University of Cambridge. Grove Lodge, Cambridge.
1877. *HUNT, ARTHUR ROOPE, M.A., F.G.S. Southwood, Torquay.
1891. *Hunt, Cecil Arthur. Southwood, Torquay.
1886. †Hunt, Charles. The Gas Works, Windsor-street, Birmingham.
1891. §Hunt, D. de Vere, M.D. Westbourne-crescent, Sophia-gardens, Cardiff.
1865. †Hunt, J. P. Gospel Oak Works, Tipton.
1884. †HUNT, T. STERRY, M.A., D.Sc., LL.D., F.R.S. Park Avenue Hotel, New York, U.S.A.
1864. †Hunt, W. Folkestone.
1875. *Hunt, William. Northcote, Westbury-on-Trym, Bristol.
1881. †Hunter, F. W. Newbottle, Fence Houses, Co. Durham.
1889. †Hunter, Mrs. F. W. Newbottle, Fence Houses, Co. Durham.
1881. †Hunter, Rev. John. University-gardens, Glasgow.
1884. *Hunter, Michael, jun. Greystones, Sheffield.
1869. *Hunter, Rev. Robert. LL.D., F.G.S. Forest Retreat, Staples-road, Loughton, Essex.
1879. †HUNTINGTON, A. K., F.C.S., Professor of Metallurgy in King's College, London. King's College, London, W.C.
1885. †Huntly, The Most Hon. the Marquis of. Aboyne Castle, Aberdeenshire.
1863. †Huntsman, Benjamin. West Retford Hall, Retford.
1883. *Hurst, Charles Herbert. Owens College, Manchester.
1869. †Hurst, George. Bedford.
1882. †Hurst, Walter, B.Sc. West Lodge, Todmorden.
1861. *Hurst, William John. Drumaness Mills, Ballynahinch, Lisburn, Ireland.
1870. †Hurter, Dr. Ferdinand. Appleton, Widnes, near Warrington. Husband, William Dalla. The Roost, Miles-road, Clifton, Bristol.
1887. †Husband, W. E. 56 Bury New-road, Manchester.
1882. †Hussey, Captain E. R., R.E. 24 Waterloo-place, Southampton.

Year of
Election.

1876. †Hutchinson, John. 22 Hamilton Park-terrace, Glasgow.
 1868. *Hutchison, Robert, F.R.S.E. Barnhill, Brodick, Isle of Arran, N.B.
 Hutton, Crompton. Harescombe Grange, Stroud, Gloucestershire.
 1864. *Hutton, Darnton. 14 Cumberland-terrace, Regent's Park, London,
 N.W.
 1857. †Hutton, Henry D. 17 Palmerston-road, Dublin.
 1887. *Hutton, J. Arthur. 29 Dale-street, Manchester.
 1861. *HUTTON, T. MAXWELL. Summerhill, Dublin.
 1852. †HUXLEY, THOMAS HENRY, Ph.D., LL.D., D.C.L., F.R.S., F.L.S.,
 F.G.S., Professor of Biology in the Royal College of Science,
 London. Hodeslea, Eastbourne.
 Hyde, Edward. Dukinfield, near Manchester.
 1883. †Hyde, George H. 23 Arbour-street, Southport.
 1871. *Hyett, Francis A. Painswick House, Stroud, Gloucestershire.
1882. *TAnson, James, F.G.S. Fairfield House, Darlington.
 Ihne, William, Ph.D. Heidelberg.
 1884. §Iles, George. 7 Brunswick-street, Montreal, Canada.
 1885. †Im-Thurn, Everard F. British Guiana.
 1888. *Ince, Surgeon-Major John, M.D. Montague House, Swanley, Kent.
 1858. †Ingham, Henry. Wortley, near Leeds.
 1876. †Inglis, John, jun. Prince's-terrace, Downhill, Glasgow.
 1891. †Ingram, Lieut.-Colonel C. W. Bradford-place, Penarth.
 1852. †INGRAM, J. K., LL.D., M.R.I.A., Librarian to the University of
 Dublin. 2 Wellington-road, Dublin.
 1885. †Ingram, William, M.A. Gamrie, Banff.
 1886. †Innes, John. The Limes, Alcester-road, Moseley, Birmingham.
 1882. §IRVING, Rev. A., B.A., D.Sc., F.G.S. Wellington College, Woking-
 ham, Berks.
 1888. §Isaac, J. F. V. Freshford House, Freshford, Bath.
 1883. †Isherwood, James. 18 York-road, Birkdale, Southport.
 1881. †Ishiguro, Isoji. Care of the Japanese Legation, 9 Cavendish-square,
 London, W.
 1891. *Ismay, Thomas, H. 10 Water-street, Liverpool.
 1887. §Ito, Tokutaro. 83 Hichikenchio Nichōmé, Nagoya, Aichiken, Japan.
 1886. †Izod, William. Church-road, Edgbaston, Birmingham.
1859. †Jack, John, M.A. Belhelvie-by-Whitecairns, Aberdeenshire.
 1884. †Jack, Peter. People's Bank, Halifax, Nova Scotia, Canada.
 1876. *Jack, William, LL.D., Professor of Mathematics in the University of
 Glasgow. 10 The College, Glasgow.
 1883. *JACKSON, Professor A. H., B.Sc., F.C.S. Care of Messrs. Wm.
 Bowen & Co., Collins-street, Melbourne, Australia.
 1879. †Jackson, Arthur, F.R.C.S. Wilkinson-street, Sheffield.
 1883. *Jackson, Mrs. Esther.* 16 East Park-terrace, Southampton.
 1883. †Jackson, Frank. 11 Park-crescent, Southport.
 1883. *Jackson, F. J. 1 Morley-road, Southport.
 1883. †Jackson, Mrs. F. J. 1 Morley-road, Southport.
 1874. *Jackson, Frederick Arthur. Belmont, Lyme Regis, Dorset.
 1886. §Jackson, George. Clareen, Higher Warberry, Torquay.
 1887. *Jackson, George. 53 Elizabeth-street, Cheetham, Manchester.
 1885. †Jackson, Henry. 19 Golden-square, Aberdeen.
 1866. †Jackson, H. W., F.R.A.S., F.G.S. 67 Ugate, Louth, Lincoln-
 shire.
 1869. §Jackson, Moses. Lansdowne House, Tonbridge.

- Year of
Election.
1863. *Jackson-Gwilt, Mrs. H. Moonbeam Villa, Merton-road, South
Wimbledon, Surrey.
1887. §Jacobson, Nathaniel. Olive Mount, Cheetham Hill-road, Man-
chester.
1874. *Jaffe, John. Edenvale, Strandtown, near Belfast.
1865. *Jaffray, John. Park-grove, Edgbaston, Birmingham.
1891. §James, Arthur P. Grove House, Park-grove, Cardiff.
1891. *James, Charles Henry. 8 Courtland-terrace, Merthyr Tydfil.
1891. *James, Charles Russell. Courtland House, Merthyr Tydfil.
1872. †James, Christopher. 8 Laurence Pountney-hill, London, E.C.
1860. †James, Edward H. Woodside, Plymouth.
1886. †James, Frank. Portland House, Aldridge, near Walsall.
1886. *James, Harry Berkeley, F.R.G.S. 16 Ashburn-place, London, S.W.
1891. §James, Ivor. University College, Cardiff.
1891. §James, John Herbert. Howard House, Arundel-street, Strand,
London, W.C.
1891. §James, John. 24 The Parade, Cardiff.
1891. §James, J. R., L.R.C.P. 158 Cowbridge-road, Canton, Cardiff.
1858. †James, William C. Woodside, Plymouth.
1884. †Jameson, W. C. 48 Baker-street, Portman-square, London, W.
1881. †Jamieson, Andrew, Principal of the College of Science and Arts,
Glasgow.
1887. §Jamieson, G. Auldjo. 37 Drumsheugh-gardens, Edinburgh.
1885. †Jamieson, Patrick. Peterhead, N.B.
1885. †Jamieson, Thomas. 173 Union-street, Aberdeen.
1859. *Jamieson, Thomas F., F.G.S. Ellon, Aberdeenshire.
1889. *JAPP, F. R., M.A., LL.D., F.R.S., Professor of Chemistry in the
University of Aberdeen.
1870. †Jarrold, John James. London-street, Norwich.
1891. §Jasper, Henry. Holmedale, New Park-road, Clapham Park, Lon-
don, S.W.
1886. §Jeffcock, Rev. Prebendary John Thomas, F.S.A. The Rectory,
Wolverhampton.
1891. §Jefferies, Henry. Plas Newydd, Park-road, Penarth.
1855. *Jeffray, John. Winton House, Kelvinside, Glasgow.
1867. †Jeffreys, Howel, M.A., F.R.A.S. Pump-court, Temple, London, E.C.
1885. §Jeffreys, Dr. Richard Parker. Eastwood House, Chesterfield.
1887. §JEFFS, OSMUND W. 12 Queen's-road, Rock Ferry, Cheshire.
1881. †JELLCOE, C. W. A. Southampton.
1864. †Jelly, Dr. W. Aveleanas, 11, Valencia, Spain.
1873. §Jenkins, Major-General J. J. 16 St. James's-square, London, S.W.
1880. *JENKINS, Sir JOHN JONES. The Grange, Swansea.
1891. §Jenkins, Henry C., Assoc.M.Inst.C.E., F.C.S. 99 Iverson-road,
Hampstead, London, N.W.
1852. †Jennings, Francis M., F.G.S., M.R.I.A. Brown-street, Cork.
1872. †Jennings, W. 13 Victoria-street, London, S.W.
1878. †Jephson, Henry L. Chief Secretary's Office, The Castle, Dublin.
Jessop, William, jun. Overton Hall, Ashover, Chesterfield.
1889. †Jevons, F. B., M.A. The Castle, Durham.
1884. †Jewell, Lieutenant Theo. F. Torpedo Station, Newport, Rhode
Island, U.S.A.
1891. §John, E. Cowbridge, Cardiff.
1884. †Johns, Thomas W. Yarmouth, Nova Scotia, Canada.
1884. §Johnson, Alexander, M.A., LL.D., Professor of Mathematics in
McGill University, Montreal. 5 Prince of Wales-terrace, Mont-
real, Canada.
1883. †Johnson, Miss Alice. Llandaff House, Cambridge.

Year of
Election.

1883. †Johnson, Ben. Micklegate, York.
 1871. *Johnson, David, F.C.S., F.G.S. West View, 19 Beulah-hill, Upper Norwood, London, S.E.
 1883. †Johnson, Edmund Litler. 73 Albert-road, Southport.
 1865. *Johnson, G. J. 36 Waterloo-street, Birmingham.
 1888. §Johnson, J. G. Southwood Court, Highgate, London, N.
 1875. †Johnson, James Henry, F.G.S. 73 Albert-road, Southport.
 1872. †Johnson, J. T. 27 Dale-street, Manchester.
 1870. †Johnson, Richard C., F.R.A.S. 46 Jermyn-street, Liverpool.
 1863. †Johnson, R. S. Hanwell, Fence Houses, Durham.
 1881. †Johnson, Samuel George. Municipal Offices, Nottingham.
 1890. *Johnson, Thomas, D.Sc., F.L.S., Professor of Botany in the Royal College of Science, Dublin.
 1887. †Johnson, W. H. Woodleigh, Altrincham, Cheshire.
 1883. †Johnson, W. H. F. Llandaff House, Cambridge.
 1883. †Johnson, William. Harewood, Roe-lane, Southport.
 1861. †Johnson, William Beckett. Woodlands Bank, near Altrincham, Cheshire.
 1883. †Johnston, H. H. Tudor House, Champion Hill, London, S.E.
 1859. †Johnston, James. Newmill, Elgin, N.B.
 1864. †Johnston, James. Manor House, Northend, Hampstead, London, N.W.
 1884. †Johnston, John L. 27 St. Peter-street, Montreal, Canada.
 1883. †Johnston, Thomas. Broomsleigh, Seal, Sevenoaks.
 1884. †Johnston, Walter R. Fort Qu'Appelle, N.W. Territory, Canada.
 1884. *Johnston, W. H. 6 Latham-street, Preston, Lancashire.
 1885. †JOHNSTON-LAVIS, H. J., M.D., F.G.S. Palazzo Caramanico, Chiatomone, Naples.
 1886. †Johnstone, G. H. Northampton-street, Birmingham.
 1864. *Johnstone, James. Alva House, Alva, by Stirling, N.B.
 1876. †Johnstone, William. 5 Woodside-terrace, Glasgow.
 1864. †Jolly, Thomas. Park View-villas, Bath.
 1871. †JOLLY, WILLIAM, F.R.S.E., F.G.S., H.M. Inspector of Schools. St. Andrew's-road, Pollokshields, Glasgow.
 1888. †Jolly, W. C. Home Lea, Lansdowne, Bath.
 1888. †Joly, John. 39 Waterloo-road, Dublin.
 1881. †Jones, Alfred Orlando, M.D. Cardigan Villa, Harrogate.
 1849. †Jones, Baynham. Walmer House, Cheltenham.
 1887. †Jones, Professor D. E., B.Sc. University College, Aberystwith.
 1890. §Jones, Rev. Edward, F.G.S. Osbourne-place, Fairfax-road, Prestwich, Lancashire.
 1891. §Jones, Dr. Evan. Aberdare.
 1891. §Jones, Evan Rowland. Bonnyrigg, Penarth.
 1887. †Jones, Francis. Beaufort House, Alexandra Park, Manchester.
 1891. *Jones, G. Hartwell, M.A., Professor of Latin in University College, Cardiff.
 1883. *Jones, George Oliver, M.A. 5 Cook-street, Liverpool.
 1884. †Jones, Rev. Harry, M.A. 8 York-gate, Regent's Park, London, N.W.
 1877. †Jones, Henry C., F.C.S. Normal School of Science, South Kensington, London, S.W.
 1881. *JONES, J. VIRIAMU, M.A., B.Sc., Principal of the University College of South Wales and Monmouthshire. Cardiff.
 1873. †Jones, Theodore B. 1 Finsbury-circus, London, E.C.
 1880. †Jones, Thomas. 15 Gower-street, Swansea.
 1860. †JONES, THOMAS RUPERT, F.R.S., F.G.S. 10 Uverdale-road, King's-road, Chelsea, London, S.W.
 1883. †Jones, William. Elsinore, Birkdale, Southport.

Year of
Election.

1891. §Jones, William Lester. Llandough, Cardiff.
 1875. *Jose, J. E. 11 Cressington Park, Liverpool.
 1884. †Joseph, J. H. 738 Dorchester-street, Montreal, Canada.
 1891. §Jotham, F. H. Penarth.
 1891. §Jotham, T. W. Penylan, Cardiff.
 1875. *Joule, Benjamin St. John B., J.P. Rothesay, N.B.
 1847. †JOWETT, Rev. B., M.A., Regius Professor of Greek in the University of Oxford. Balliol College, Oxford.
 1879. †Jowitt, A. Hawthorn Lodge, Clarkehouse-road, Sheffield.
 1890. §Jowitt, Benson R. Elmhurst, Newton-road, Leeds.
 1872. †Joy, Algernon. Junior United Service Club, St. James's, London, S.W.
 1848. *Joy, Rev. Charles Ashfield. West Hanney, Wantage, Berkshire.
 1888. †Joyce, Rev. A. G., B.A. St. John's Croft, Winchester.
 1886. †Joyce, The Hon. Mrs. St. John's Croft, Winchester.
 1891. §Joynes, John J. Great Western Colliery, near Coleford, Gloucestershire.
 1848. *Jubb, Abraham. Halifax.
 1870. †JUDD, JOHN WESLEY, F.R.S., F.G.S., Professor of Geology in the Royal College of Science, London. 31 Ennerdale-road, Kew.
 1883. †Justice, Philip M. 14 Southampton-buildings, Chancery-lane, London, W.C.
 1868. *Kaines, Joseph, M.A., D.Sc. 8 Osborne-road, Stroud Green-road, London, N.
 1888. †Kapp, Gisbert. Erba, Wimbledon Park, Surrey.
 1887. †Kay, Miss. Hamerlaund, Broughton Park, Manchester.
 1859. †Kay, David, F.R.G.S. 19 Upper Phillimore-place, Kensington, London, W.
 Kay, John Cunliff. Fairfield Hall, near Skipton.
 1893. †Kearne, John H. Westcliffe-road, Birkdale, Southport.
 1884. †Keefer, Samuel. Brockville, Ontario, Canada.
 1884. §Keefer, Thomas Alexander. Port Arthur, Ontario, Canada.
 1875. †Keeling, George William. Tuthill, Lydney.
 1886. †Keen, Arthur, J.P. Sandyford, Augustus-road, Birmingham.
 1878. *Kelland, William Henry. Grettans, Bow, North Devon.
 1887. †Kellas-Johnstone, J. F. 35 Crescent, Salford.
 1884. †Kellogg, J. H., M.D. Battle Creek, Michigan, U.S.A.
 1864. *Kelly, W. M., M.D. 11 The Crescent, Taunton, Somerset.
 1885. §Keltie, J. Scott, Librarian R.G.S. 1 Savile-row, London, W.
 1887. †Kemp, Harry. 254 Stretford-road, Manchester.
 1884. †Kemper, Andrew C., A.M., M.D. 101 Broadway, Cincinnati, U.S.A.
 1890. §Kempson, Augustus. Care of Capital and Counties Bank, Northampton
 1891. §Kendall, Percy F. 16 Leegate-road, Heaton Moor, Stockport.
 1875. †KENNEDY, ALEXANDER B. W., F.R.S., M.Inst.C.E., Emeritus Professor of Engineering in University College, London. Lawn House, Hampstead-square, London, N.W.
 1884. †Kennedy, George L., M.A., F.G.S., Professor of Chemistry and Geology in King's College, Windsor, Nova Scotia, Canada.
 1876. †Kennedy, Hugh. Redclyffe, Partickhill, Glasgow.
 1884. †Kennedy, John. 113 University-street, Montreal, Canada.
 1884. †Kennedy, William. Hamilton, Ontario, Canada.
 1886. †Kenrick, George Hamilton. Whetstone, Somerset-road, Edgbaston, Birmingham.
 Kent, J. C. Levant Lodge, Earl's Croome, Worcester.

Year of
Election.

1886. §Kenward, James, F.S.A. 280 Hagley-road, Birmingham.
 1857. *Ker, André Allen Murray. Newbliss House, Newbliss, Ireland.
 1876. †Ker, William. 1 Windsor-terrace West, Glasgow.
 1881. †Kermode, Philip M. C. Ramsay, Isle of Man.
 1884. †Kerr, James, M.D. Winnipeg, Canada.
 1887. †Kerr, James. Dunkenhalth, Accrington.
 1883. †Kerr, Dr. John. Free Church Training College, Glasgow.
 1889. †Kerry, W. H. R. Manor House, Poolton, Cheshire.
 1887. †Kershaw, James. Holly House, Bury New-road, Manchester.
 1869. *Kesselmeier, Charles A. Villa 'Mon Repos,' Altrincham,
 Cheshire.
 1869. *Kesselmeier, William Johannes. Villa 'Mon Repos,' Altrincham,
 Cheshire.
 1883. *Keynes, J. N., M.A., D.Sc., F.S.S. 6 Harvey-road, Cambridge.
 1876. †Kidston, J. B. 50 West Regent-street, Glasgow.
 1886. §KIDSTON, ROBERT, F.R.S.E., F.G.S. 24 Victoria-place, Stirling.
 1885. *Kilgour, Alexander. Loirston House, Cove, near Aberdeen.
 1890. §Kimmins, C. W., M.A., D.Sc. Downing College, Cambridge.
 1865. *Kinahan, Sir Edward Hudson, Bart., M.R.I.A. 11 Merrion-square
 North, Dublin.
 1878. †Kinahan, Edward Hudson, jun. 11 Merrion-square North, Dublin.
 1860. †KINAHAN, G. HENRY, M.R.I.A. Geological Survey of Ireland, 14
 Hume-street, Dublin.
 1875. *KINCH, EDWARD, F.C.S. Royal Agricultural College, Cirencester.
 1888. †King, Austin J. Winsley Hill, Limpley Stoke, Bath.
 1888. *King, E. Powell. Wainsford, Lymington, Hants.
 1883. *King, Francis. Alabama, Penrith.
 1875. *King, F. Ambrose. Avonside, Clifton, Bristol.
 1871. *King, Rev. Herbert Poole. The Rectory, Stourton, Bath.
 1855. †King, James. Levernholme, Hurlet, Glasgow.
 1883. *King, John Godwin. Wainsford, Lymington, Hants.
 1870. †King, John Thomson. 4 Clayton-square, Liverpool.
 King, Joseph. Welford House, Greenhill, Hampstead, London,
 N.W.
 1883. *King, Joseph, jun. 6 Wedderburn-road, Hampstead, London, N.W.
 1860. *King, Mervyn Kersteman. 1 Vittoria-square, Clifton, Bristol.
 1875. *King, Percy L. 5 Clifton Park, Bristol.
 1870. †King, William. 5 Beach Lawn, Waterloo, Liverpool.
 1889. §King, Sir William. Stratford Lodge, Southsea.
 1869. †Kingdon, K. Taddiford, Exeter.
 1876. §Kingston, Thomas. The Limes, Clewer, near Windsor.
 1875. §KINGZETT, CHARLES T., F.C.S. Trevena, Amhurst Park, London, N.
 1867. †Kinloch, Colonel. Kirriemuir, Logie, Scotland.
 1870. †Kinsman, William R. Branch Bank of England, Liverpool.
 1860. †KIRKMAN, Rev. THOMAS P., M.A., F.R.S. Croft Rectory, near
 Warrington.
 1875. †Kirsop, John. 6 Queen's-crescent, Glasgow.
 1883. †Kirsop, Mrs. 6 Queen's-crescent, Glasgow.
 1870. †Kitchener, Frank E. Newcastle, Staffordshire.
 1890. *KITSON, Sir JAMES, Bart. Gledhow Hall, Leeds.
 1886. †Klein, Rev. L. Martial. University College, Dublin.
 1869. †Knapman, Edward. The Vineyard, Castle-street, Exeter.
 1886. †Knight, J. M. Bushwood, Wanstead, Essex.
 1883. †Knight, J. R. 32 Lincoln's Inn-fields, London, W.C.
 1888. †Knott, Cargill G., D.Sc., F.R.S.E. Tokio, Japan.
 1872. *Knott, George, LL.B., F.R.A.S. Knowles Lodge, Cuckfield, Hay-
 ward's Heath, Sussex.

Year of
Election.

1887. *Knott, Herbert. Wharf Street Mills, Ashton-under-Lyne.
 1887. *Knott, John F. Staveleigh, Stalybridge, Cheshire.
 1887. †Knott, Mrs. Staveleigh, Stalybridge, Cheshire.
 1837. §Knott, T. B. Ellerslie, Cheadle Hulme, Cheshire.
 1873. *Knowles, George. Moorhead, Shipley, Yorkshire.
 1872. †Knowles, James. *The Hollies, Clapham Common, S.W.*
 1870. †Knowles, Rev. J. L. 103 *Earl's Court-road, Kensington, London, W.*
 1874. †Knowles, William James. Flixton-place, Ballymena, Co. Antrim.
 1883. †Knowlys, Rev. C. Hesketh. The Rectory, Roe-lane, Southport.
 1883. †Knowlys, Mrs. C. Hesketh. The Rectory, Roe-lane, Southport.
 1876. †Knox, David N., M.A., M.B. 24 Elmbank-crescent, Glasgow.
 *Knox, George James. 29 Portland-terrace, Regent's Park, London, N.W.
 1875. *Knubley, Rev. E. P., M.A. Staveley Rectory, Leeds.
 1883. †Knubley, Mrs. Staveley Rectory, Leeds.
 1890. *Krauss, John Samuel. Whitecot, Wilmslow, Cheshire.
 1888. *Kunz, G. F. Care of Messrs. Tiffany & Co., Union-square, New York City, U.S.A.
 1881. †Kurobe, Hiroo. Legation of Japan, 9 Cavendish-square, London, W.
 1870. †Kynaston, Josiah W., F.C.S. Kensington, Liverpool.
 1865. †Kynnersley, J. C. S. The Leveretts, Handsworth, Birmingham.
1858. †Lace, Francis John. Stone Gapp, Cross-hill, Leeds.
 1884. †Lafamme, Rev. Professor J. C. K. Laval University, Quebec, Canada.
 1885. *Laing, J. Gerard. 1 Elm-court, Temple, London, E.C.
 1870. †Laird, H. H. Birkenhead.
 1870. §Laird, John. Grosvenor-road, Claughton, Birkenhead.
 1882. †Lake, G. A. K., M.D. *East Park-terrace, Southampton.*
 1877. †Lake, W. C., M.D. Teignmouth.
 1859. †Lalor, John Joseph, M.R.I.A. City Hall, Cork Hill, Dublin.
 1889. *Lamb, Edmund, M.A. Union Club, Trafalgar-square, London, S.W.
 1887. †Lamb, Horace, M.A., F.R.S., Professor of Pure Mathematics in the Owens College, Manchester. Burton-road, Didsbury, Manchester.
 1887. †Lamb, James. Kenwood, Bowdon, Cheshire.
 1883. †Lamb, W. J. 11 Gloucester-road, Birkdale, Southport.
 1883. †LAMBERT, Rev. BROOKE, LL.B. The Vicarage, Greenwich, Kent, S.E.
 1884. †Lamborn, Robert H. Montreal, Canada.
 1890. †Lampport, Edward Parke. Greenfield Well, Lancaster.
 1884. †Lancaster, Alfred. Fern Bank, Burnley, Lancashire.
 1871. †Lancaster, Edward. Karesforth Hall, Barnsley, Yorkshire.
 1886. †Lancaster, W. J., F.G.S. Colmore-row, Birmingham.
 1877. †Landon, Frederic George, M.A., F.R.A.S. 59 Tresillian-road, St. John's, S.E.
 1883. †Lang, Rev. Gavin. Inverness.
 1859. †Lang, Rev. John Marshall, D.D. Barony, Glasgow.
 1886. *LANGLEY, J. N., M.A., F.R.S. Trinity College, Cambridge.
 1870. †Langton, Charles. Barkhill, Aigburth, Liverpool.
 1865. †LANKESTER, E. RAY, M.A., LL.D., F.R.S., Linacre Professor of Human and Comparative Anatomy in the University of Oxford. 42 Half Moon-street, Piccadilly, London, W.
 1880. *LANSDALE, Rev. HENRY, D.D., F.R.A.S., F.R.G.S. Eyre Cottage, The Grove, Blackheath, London, S.E.
 1884. §Lanza, Professor G. Massachusetts Institute of Technology, Boston, U.S.A.
 1878. †Lapper, E., M.D. 61 Harcourt-street, Dublin.

- Year of
Election.
1886. †*Lapraik, W.* 9 *Malfort-road, Denmark Hill, London, S.E.*
1885. †LAPWORTH, CHARLES, LL.D., F.R.S., F.G.S., Professor of Geology and Mineralogy in the Mason Science College, Birmingham. 13 *Duchess-road, Edgbaston, Birmingham.*
1887. †Larmor, Alexander. *Clare College, Cambridge.*
1881. †Larmor, Joseph, M.A. *St. John's College, Cambridge.*
1883. §Lascelles, B. P. *Harrow.*
1870. *LATHAM, BALDWIN, M.Inst.C.E., F.G.S. 7 *Westminster-chambers, Westminster, S.W.*
1870. †LAUGHTON, JOHN KNOX, M.A., F.R.G.S. 130 *Sinclair-road, West Kensington Park, London, W.*
1891. §Laurie, A. P. *King's College, Cambridge.*
1888. †LAURIE, Colonel R. P., C.B., M.P. 35 *Eaton-place, London, S.W.*
1883. †Laurie, Major-General. *Oakfield, Nova Scotia.*
1870. *Law, Channell. *Ilsham Dene, Torquay.*
1878. †Law, Henry, M.Inst.C.E. 9 *Victoria-chambers, London, S.W.*
1862. †Law, Rev. James Edmund, M.A. *Little Shelford, Cambridgeshire.*
1884. §Law, Robert. 11 *Cromwell-terrace, West Hill Park, Halifax, Yorkshire.*
1870. †Lawrence, Edward. *Aigburth, Liverpool.*
1881. †Lawrence, Rev. F., B.A. *The Vicarage, Westow, York.*
1889. §Laws, W. G., M.Inst.C.E. 5 *Winchester-terrace, Newcastle-upon-Tyne.*
1875. †Lawson, George, Ph.D., LL.D., Professor of Chemistry and Botany. *Halifax, Nova Scotia.*
1885. †Lawson, James. 8 *Church-street, Huntly, N.B.*
1868. *Lawson, M. Alexander, M.A., F.L.S. *Ootacamund, Bombay.*
1853. †Lawton, William. 5 *Victoria-terrace, Derringham, Hull.*
1888. §Layard, Miss Nina F. 11 *Museum-street, Ipswich.*
1856. †Lea, Henry. 38 *Bennett's-hill, Birmingham.*
1883. *Leach, Charles Catterall. *Seghill, Northumberland.*
1883. §Leach, John. *Claremont, Levenshulme, Manchester.*
1875. †Leach, Colonel R. E. *Mountjoy, Phoenix Park, Dublin.*
1870. *Leaf, Charles John, F.L.S., F.G.S., F.S.A. 6 *Sussex-place, Regent's Park, London, N.W.*
1884. *Leahy, John White, J.P. *South Hill, Killarney, Ireland.*
1884. †Learmont, Joseph B. 120 *Mackay-street, Montreal, Canada.*
1847. *LEATHAM, EDWARD ALDAM, M.P. *Whitley Hall, Huddersfield; and 46 Eaton-square, London, S.W.*
1863. †Leavers, J. W. *The Park, Nottingham.*
1884. *Leavitt, Erasmus Darwin. 2 *Central-square, Cambridgeport, Massachusetts, U.S.A.*
1872. †LEBOUR, G. A., M.A., F.G.S., Professor of Geology in the College of Physical Science, *Newcastle-on-Tyne.*
1884. †Leckie, R. G. *Springhill, Cumberland County, Nova Scotia.*
1883. †Lee, Daniel W. *Halton Bank, Pendleton, near Manchester.*
1861. †Lee, Henry, M.P. *Sedgeley Park, Manchester.*
1883. †Lee, J. H. Warburton. *Rossall, Fleetwood.*
1887. *Lee, Sir Joseph Cooksey. *Park Gate, Altrincham.*
1891. §Lee, Mark. 8 *Llandaff-road, Cardiff.*
1884. *Leech, Bosdin T. *Oak Mount, Timperley, Cheshire.*
1887. †Leech, D. J., M.D., Professor of Materia Medica in the Owens College, *Manchester. Elm House, Whalley Range, Manchester.*
1886. *Lees, Lawrence W. *Claregate, Tettenhall, Wolverhampton.*
1882. †Lees, R. W. *Moir-place, Southampton.*
1859. †Lees, William, M.A. *St. Leonard's, Morningside-place, Edinburgh.*
1883. *Leese, Miss H. K. *Fylde-road Mills, Preston, Lancashire.*

Year of
Election.

- *Leese, Joseph. *Fylde-road Mills, Preston, Lancashire.*
 1883. †Leese, Mrs.
 1889. *Leeson, John Rudd, M.D., F.G.S. Clifden House, Twickenham, Middlesex.
 1881. †LE FEUVRE, J. E. Southampton.
 1872. †LEFEVRE, The Right Hon. G. SHAW, M.P., F.R.G.S. 18 Bryanston square, London, W.
 *Lekh, Lieut.-Colonel George Cornwall. High Legh Hall, Cheshire.
 1869. †Le Grice, A. J. Trezeife, Penzance.
 1868. †LEICESTER, The Right Hon. the Earl of, K.G. Holkham, Norfolk.
 1856. †LEIGH, The Right Hon. Lord, D.C.L. 37 Portman-square, London, W.; and Stoneleigh Abbey, Kenilworth.
 1890. §Leigh, Marshall. 22 Goldsmid-road, Brighton.
 1891. §Leigh, W. W. Treharris, R.S.O., Glamorganshire.
 1886. §Leipner, Adolph, Professor of Botany in University College, Bristol. 47 Hampton Park, Bristol.
 1867. †Leishman, James. Gateacre Hall, Liverpool.
 1859. †Leith, Alexander. Glenkindie, Inverkindie, N.B.
 1882. †Lemon, James, M.Inst.C.E. 11 The Avenue, Southampton.
 1867. †Leng, John. 'Advertiser' Office, Dundee.
 1878. †Lennon, Rev. Francis. The College, Maynooth, Ireland.
 1887. *Leon, John T. 38 Portland-place, London, W.
 1874. †Lepper, Charles W. Laurel Lodge, Belfast.
 1884. †Lesage, Louis. City Hall, Montreal, Canada.
 1871. †Leslie, Alexander, M.Inst.C.E. 72 George-street, Edinburgh.
 1890. *Lester, Joseph Henry. 39 March-street, Upper Brook-street, Manchester.
 1883. §Lester, Thomas. Fir Bank, Penrith.
 1880. †LETCHEE, R. J. Lansdowne-terrace, Walters-road, Swansea.
 1887. †Leverkus, Otto. The Downs, Prestwich, Manchester.
 1887. *Levinstein, Ivan. *Villa Newberg, Victoria Park, Manchester.*
 1890. §Levy, J. H. Florence. 12 Abbeville-road South, Clapham Park, London, S.W.
 1879. †Lewin, Colonel, F.R.G.S. Garden Corner House, Chelsea Embankment, London, S.W.
 1870. †LEWIS, ALFRED LIONEL. 54 Highbury-hill, London, N.
 1891. §Lewis, D., J.P. 44 Park-place, Cardiff.
 1891. §Lewis, D. Morgan, M.A. University College, Bangor.
 1891. §Lewis, W. Lyncombe Villa, Cowbridge-road, Cardiff.
 1891. §Lewis, W. 22 Duke-street, Cardiff.
 1891. §Lewis, W. Henry. Bryn Rhos, Llanishen, Cardiff.
 1884. *Lewis, Sir W. T. The Mardy, Aberdare.
 1860. †LIDDELL, The Very Rev. H. G., D.D., Dean of Christ Church, Oxford.
 1887. †Liebermann, L. 54 Portland-street, Manchester.
 1876. †Lietke, J. O. 30 Gordon-street, Glasgow.
 1887. *Lightbown, Henry. Waste Hall, Pendleton, Manchester.
 1862. †LILFORD, The Right Hon. Lord, F.L.S. Lilford Hall, Oundle, Northamptonshire.
 *LIMERICK, The Right Rev. CHARLES GRAVES, Lord Bishop of, D.D., F.R.S., M.R.I.A. The Palace, Henry-street, Limerick.
 1887. †Limpach, Dr. Crumpsall Vale Chemical Works, Manchester.
 1878. †Lincolne, William. Ely, Cambridgeshire.
 1881. *Lindley, William, M.Inst.C.E., F.G.S. 74 Shooters Hill-road, Blackheath, London, S.E.
 1871. †Lindsay, Rev. T. M., M.A., D.D. Free Church College, Glasgow.

- Year of Election.
1876. †Linn, James. Geological Survey Office, India-buildings, Edinburgh.
1883. †Lipscomb, Mrs. Lancelot C. d'A. 95 Elgin-crescent, London, W.
1883. †Lisle, H. Claud. Nantwich.
1882. *Lister, Rev. Henry, M.A. Hawridge Rectory, Berkhamstead.
1888. †Lister, J. J. Leytonstone, Essex, E.
1876. †Little, Thomas Evelyn. 42 Brunswick-street, Dublin.
1881. †Littlewood, Rev. B. C., M.A. Holmdale, Cheltenham.
1861. *LIVEING, G. D., M.A., F.R.S., F.C.S., Professor of Chemistry in the University of Cambridge. Newnham, Cambridge.
1876. *Liversidge, Archibald, F.R.S., F.C.S., F.G.S., F.R.G.S., Professor of Chemistry and Mineralogy in the University of Sydney, N.S.W. Care of Messrs. Trübner & Co., Ludgate Hill, London, E.C.
1864. †Livesay, J. G. Cromartie House, Ventnor, Isle of Wight.
1880. †LLEWELYN, Sir JOHN T. D., Bart. Penllegare, Swansea.
Lloyd, Rev. A. R. Hengold, near Oswestry.
1889. †Lloyd, Rev. Canon. The Vicarage, Rye Hill, Newcastle-upon-Tyne.
1842. Lloyd, Edward. King-street, Manchester.
1865. †Lloyd, G. B., J.P. Edgbaston-grove, Birmingham.
1865. †Lloyd, John. Queen's College, Birmingham.
1886. †Lloyd, John Henry. Ferndale, Carpenter-road, Edgbaston, Birmingham.
1891. *Lloyd, R. J., M.A.D.Litt. 46 Chatham-street Liverpool.
1886. †Lloyd, Samuel. Farm, Sparkbrook, Birmingham.
1865. *Lloyd, Wilson, F.R.G.S. Myvod House, Wednesbury.
1854. *LOBLEY, JAMES LOGAN, F.G.S., F.R.G.S. City of London College, Moorgate-street, London, E.C.
1867. *Locke, John. Whitehall Club, London, S.W.
1863. †LOCKYER, J. NORMAN, F.R.S., F.R.A.S. Royal College of Science, South Kensington, London, S.W.
1886. *Lodge, Alfred, M.A., Professor of Pure Mathematics in the Royal Indian Civil Engineering College, Cooper's Hill, Staines.
1875. *LODGE, OLIVER J., D.Sc., LL.D., F.R.S., Professor of Physics in University College, Liverpool. 21 Waverley-road, Sefton Park, Liverpool.
1889. †Logan, William. Langley Park, Durham.
1876. †Long, H. A. Charlotte-street, Glasgow.
1871. *Long, John Jex. 11 Doune-terrace, Kelvinside, Glasgow.
1883. *Long, William. Thelwall Heys, near Warrington.
1883. †Long, Mrs. Thelwall Heys, near Warrington.
1883. †Long, Miss. Thelwall Heys, near Warrington.
1866. †Longdon, Frederick. Osmaston-road, Derby.
1883. †Longe, Francis D. Coddensham Lodge, Cheltenham.
1883. †Longmaid, William Henry. 4 Rawlinson-road, Southport.
1875. *Longstaff, George Blundell, M.A., M.D., F.C.S., F.S.S. Highlands, Putney Heath, S.W.
1871. †Longstaff, George Dixon, M.D., F.C.S. Butterknowle, Wandsworth, S.W.
1872. *Longstaff, Llewellyn Wood, F.R.G.S. Ridgeland, Wimbledon, Surrey.
1881. *Longstaff, Mrs. Ll. W. Ridgeland, Wimbledon, Surrey.
1883. *Longton, E. J., M.D. Lord-street, Southport.
1861. *Lord, Edward. Adamroyd, Todmorden.
1889. †Lord, Riley. Highfield House, Gosforth, Newcastle-upon-Tyne.
1883. *Louis, D. A., F.C.S. 77 Shirland-gardens, London, W.
1887. *Love, A. E. H. St. John's College, Cambridge.

Year of
Election.

1886. *Love, E. F. J., M.A. The University, Melbourne, Australia.
 1876. *Love, James, F.R.A.S., F.G.S., F.Z.S. 11 Notting Hill-square, London, W.
 1883. §Love, James Allen. 8 Eastbourne-road West, Southport.
 1875. *Lovett, W. Jesse, F.I.C. 75 Clarendon-road, Crumpsall, Manchester.
 1889. †Low, Charles W. 84 Westbourne-terrace, London, W.
 1867. *Low, James F. Monifieth, by Dundee.
 1885. §Lowdell, Sydney Poole. Baldwyn's Hill, East Grinstead, Sussex.
 1891. §Lowdon, John. Hillside, Barry, Cardiff.
 1885. *Lowe, Arthur C. W. Gosfield Hall, Halstead; Essex.
 1861. *LOWE, EDWARD JOSEPH, F.R.S., F.R.A.S., F.L.S., F.G.S., F.R.M.S. Shirenewton Hall, near Chepstow.
 1884. †Lowe, F. J. Elm-court, Temple, London, E.C.
 1886. *Lowe, John Landor, M.Inst.C.E. Engineer's Office, Midland Railway, Derby.
 1850. †Lowe, William Henry, M.D., F.R.S.E. Balgreen, Slateford, Edinburgh.
 1881. †Lubbock, Arthur Rolfe. High Elms, Hayes, Kent.
 1853. *LUBBOCK, The Right Hon. Sir JOHN, Bart., M.P., D.C.L., LL.D., F.R.S., F.L.S., F.G.S. Down, Farnborough, Kent.
 1881. †Lubbock, John B. High Elms, Hayes, Kent.
 1870. †Lubbock, Montague, M.D. 19 Grosvenor-street, London, W.
 1889. †Lucas, John. 1 Carlton-terrace, Low Fell, Gateshead.
 1878. †Lucas, Joseph. Tooting Graveney, London, S.W.
 1889. †Luckley, George. 7 Victoria-square, Newcastle-upon-Tyne.
 1891. *Lucovich, Count A. The Rise, Llandaff.
 1875. †Lucy, W. C., F.G.S. The Winstones, Brookthorpe, Gloucester.
 1881. †Luden, C. M. 4 Bootham-terrace, York.
 1873. †Lumley, J. Hope Villa, Thornbury, near Bradford, Yorkshire.
 1885. †Lumsden, Robert. Ferryhill House, Aberdeen.
 1866. *Lund, Charles. Ilkley, Yorkshire.
 1873. †Lund, Joseph. Ilkley, Yorkshire.
 1850. *Lundie, Cornelius. 32 Newport-road, Cardiff.
 1853. †Lunn, William Joseph, M.D. 23 Charlotte-street, Hull.
 1883. *Lupton, Arnold, M.Inst.C.E., F.G.S., Professor of Mining Engineering in Yorkshire College. 6 De Grey-road, Leeds.
 1874. *LUPTON, SYDNEY, M.A. Grove Cottage, Roundhay, near Leeds.
 1864. *Lutley, John. Brockhampton Park, Worcester.
 1871. †Lyell, Leonard, F.G.S. 92 Onslow-gardens, London, S.W.
 1884. †Lyman, A. Clarence. 84 Victoria-street, Montreal, Canada.
 1884. †Lyman, H. H. 74 McTavish-street, Montreal, Canada.
 1884. †Lyman, Roswell C. 74 McTavish-street, Montreal, Canada.
 1874. †Lynam, James. Ballinasloe, Ireland.
 1885. §Lyon, Alexander, jun. 52 Carden-place, Aberdeen.
 1857. †Lyons, Robert D., M.B., M.R.I.A. 8 Merrion-square West, Dublin.
 1878. †Lyte, Cecil Maxwell. Cotford, Oakhill-road, Putney, S.W.
 1862. *LYTE, F. MAXWELL, F.C.S. 60 Finborough-road, London, S.W.
 1852. †McAdam, Robert. 18 College-square East, Belfast.
 1854. *MACADAM, STEVENSON, Ph.D., F.R.S.E., F.O.S., Lecturer on Chemistry. Surgeons' Hall, Edinburgh; and Brighton House, Portobello, by Edinburgh.
 1876. *MACADAM, WILLIAM IVISON. Surgeons' Hall, Edinburgh.
 1868. †MACALISTER, ALEXANDER, M.D., F.R.S., Professor of Anatomy in the University of Cambridge. Torrisdale, Cambridge.
 1878. †MACALISTER, DONALD, M.A., M.D., B.Sc. St. John's College, Cambridge.

- Year of
Election.
1879. §MacAndrew, James J. Lukesland, Ivybridge, South Devon.
 1883. §MacAndrew, Mrs. J. J. Lukesland, Ivybridge, South Devon.
 1883. §MacAndrew, William. Westwood House, near Colchester.
 1866. *M'Arthur, Alexander, M.P., F.R.G.S. 79 Holland Park, London, W.
 1884. †Macarthur, Alexander. Winnipeg, Canada.
 1884. †Macarthur, D. Winnipeg, Canada.
 1834. MACAULAY, JAMES, A.M., M.D. 25 Carlton-road, Maida Vale,
 London, N.W.
 1840. *MacBrayne, Robert. 65 West Regent-street, Glasgow.
 1884. †McCabe, T., Chief Examiner of Patents. Patent Office, Ottawa, Canada.
 1886. †MacCarthy, Rev. E. F. M., M.A. 93 Hagley-road, Birmingham.
 1887. *MacCarthy, James. Bangkok, Siam.
 1884. *MacCarthy, J. J., M.D. 83 Wellington-road, Dublin.
 1884. †McCausland, Orr. Belfast.
 1891. §McClellan, Frank, M.A. Rusthall House, Tunbridge Wells.
 1876. *M'CLELLAND, A. S. 4 Crown-gardens, Downhill, Glasgow.
 1863. †M'CLINTOCK, Admiral Sir FRANCIS L., R.N., K.C.B., F.R.S.,
 F.R.G.S. United Service Club, Pall Mall, London, S.W.
 1874. †M'Clure, Sir Thomas, Bart. Belmont, Belfast.
 1878. *M'Comas, Henry. Homestead, Dundrum, Co. Dublin.
 1858. †M'Connell, J. E. Woodlands, Great Missenden.
 1883. †McCrossan, James. 92 Huskisson-street, Liverpool.
 1886. †McDonald, John Allen. Hillsboro' House, Derby.
 1884. †MacDonald, Kenneth. Town Hall, Inverness.
 1884. *McDonald, W. C. 891 Sherbrooke-street, Montreal, Canada.
 1878. †McDonnell, Alexander. *St. John's, Island Bridge, Dublin.*
 1884. †MacDonnell, Mrs. F. H. 1433 St. Catherine-street, Montreal, Canada.
 MacDonnell, Hercules H. G. 2 Kildare-place, Dublin.
 1883. †MacDonnell, Rev. Canon J. C., D.D. Misterton Rectory, Lutterworth.
 1878. †McDonnell, James. 32 Upper Fitzwilliam-street, Dublin.
 1884. †Macdougall, Alan. Toronto, Canada.
 1884. †McDougall, John. 35 St. François Xavier-street, Montreal, Canada.
 1881. †Macfarlane, Alexander, D.Sc., F.R.S.E., Professor of Physics in the
 University of Texas. Austin, Texas, U.S.A.
 1871. †M'Farlane, Donald. The College Laboratory, Glasgow.
 1885. †Macfarlane, J. M., D.Sc., F.R.S.E. 15 Scotland-street, Edinburgh.
 1879. †Macfarlane, Walter, jun. 12 Lynedoch-crescent, Glasgow.
 1884. †Macfie, K. N., B.A., B.C.L. Winnipeg, Canada.
 1854. *Macfie, Robert Andrew. Dreghorn, Colinton, Edinburgh.
 1867. *M'Gavin, Robert. Ballumbie, Dundee.
 1855. †MacGeorge, Andrew, jun. 21 *St. Vincent-place, Glasgow.*
 1888. †MacGeorge, James. 67 Marloes-road, Kensington, London, W.
 1884. †MacGillivray, James. 42 Cathcart-street, Montreal, Canada.
 1884. †MacGoun, Archibald, jun., B.A., B.C.L. 19 Place d'Armes, Mont-
 real, Canada.
 1873. †McGowen, William Thomas. Oak-avenue, Oak Mount, Bradford,
 Yorkshire.
 1885. †Macgregor, Alexander, M.D. 256 Union-street, Aberdeen.
 1884. *MACGREGOR, JAMES GORDON, M.A., D.Sc., F.R.S.E., Professor of
 Physics in Dalhousie College, Halifax, Nova Scotia, Canada.
 1886. †McGregor, William. *Kohima Lodge, Bedford.*
 1885. †M'Gregor-Robertson, J., M.A., M.B. 400 Great Western-road,
 Glasgow.
 1876. †M'Grigor, Alexander B., LL.D. 19 Woodside-terrace, Glasgow.
 1867. *M'INTOSH, W. C., M.D., LL.D., F.R.S. L. & E., F.L.S., Professor
 of Natural History in the University of St. Andrews. 2 Abbots-
 ford-crescent, St. Andrews, N.B.

- Year of
Election.
1884. †McIntyre, John, M.D. Odiham, Hants.
1883. †Nack, Isaac A. Trinity-road, Bootle.
1884. †Mackay, Alexander Howard, B.A., B.Sc. The Academy, Pictou,
Nova Scotia, Canada.
1885. §MACKAY, JOHN YULE, M.D. The University, Glasgow.
1873. †McKENDRICK, JOHN G., M.D., F.R.S. L. & E., Professor of Phy-
siology in the University of Glasgow. The University,
Glasgow.
1883. †McKendrick, Mrs. The University, Glasgow.
1880. *Mackenzie, Colin. Junior Athenæum Club, Piccadilly, London, W.
1884. †McKenzie, Stephen, M.D. 26 Finsbury-circus, London, E.C.
1884. †McKenzie, Thomas, B.A. School of Science, Toronto, Canada.
1883. †Mackeson, Henry. Hythe, Kent.
1865. †Mackeson, Henry B., F.G.S. Hythe, Kent.
1872. *Mackey, J. A. 1 Westbourne-terrace, Hyde Park, London, W.
1867. †MACKIE, SAMUEL JOSEPH. 17 Howley-place, London, W.
1884. †McKilligan, John B. 387 Main-street, Winnipeg, Canada.
1887. §Mackinder, H. J., M.A., F.R.G.S. Christ Church, Oxford.
1867. *Mackinlay, David. 6 Great Western-terrace, Hillhead, Glasgow.
1889. †McKinley, Rev. D. 33 Milton-street, West Hartlepool.
1891. §Mackintosh, A. C. Temple Chambers, Cardiff.
1884. *Mackintosh, James B. Consolidated Gas Company, 21st-street, and
Avenue A, New York City, U.S.A.
1850. †Macknight, Alexander. 20 Albany-street, Edinburgh.
1867. †Mackson, H. G. 25 Cliff-road, Woodhouse, Leeds.
1872. *McLACHLAN, ROBERT, F.R.S., F.L.S. West View, Clarendon-road,
Lewisham, S.E.
1873. †McLandsborough, John, M.Inst.C.E., F.R.A.S., F.G.S. Manning-
ham, Bradford, Yorkshire.
1885. *McLAREN, The Hon. Lord, F.R.S.E., F.R.A.S. 46 Moray-place,
Edinburgh.
1860. †Maclaren, Archibald. Summertown, Oxfordshire.
1873. †MacLaren, Walter S. B. Newington House, Edinburgh.
1882. †Maclean, Inspector-General, C.B. 1 Rockstone-terrace, Southampton.
1884. †McLennan, Frank. 317 Drummond-street, Montreal, Canada.
1884. †McLennan, Hugh. 317 Drummond-street, Montreal, Canada.
1884. †McLennan, John. Lancaster, Ontario, Canada.
1862. †Macleod, Henry Dunning. 17 Gloucester-terrace, Campden Hill-
road, London, W.
1868. §M'LEOD, HERBERT, F.R.S., F.C.S., Professor of Chemistry in the
Royal Indian Civil Engineering College, Cooper's Hill, Staines.
1861. *Maclure, John William, M.P., F.R.G.S., F.S.S. Whalley Range,
Manchester.
1883. *McMahon, Major-General C. A. 20 Nevern-square, South Kensing-
ton, London, S.W.
1883. †MacMahon, Captain P. A., R.A., F.R.S., Instructor in Mathematics
at the Royal Military Academy, Woolwich.
1878. *M'Master, George, M.A., J.P. Donnybrook, Ireland.
1862. †Macmillan, Alexander. *Streatham-lane, Upper Tooting, Surrey, S.W.*
1888. †McMillan, Robert. 20 Aubrey-street, Liverpool.
1874. †MacMordie, Hans, M.A. 8 Donegall-street, Belfast.
1867. †McNeill, John. Balhousie House, Perth.
1883. †McNicoll, Dr. E. D. 15 Manchester-road, Southport.
1878. †Macnie, George. 59 Bolton-street, Dublin.
1887. †Maconochie, Archibald White. Care of Messrs. Maconochie Bros.,
Lowestoft.
1883. †Macpherson, J. 44 Frederick-street, Edinburgh.

Year of
Election.

1886. †Macpherson, Lieut.-Colonel J. C., R.E. Ordnance Survey Office, Southampton.
1887. §McRae, Charles, M.A. Science and Art Department, South Kensington, London, S.W.
*MACROBY, EDMUND, M.A. 2 Ilchester-gardens, Prince's-square, London, W.
1883. †McWhirter, William. 170 Kent-road, Glasgow.
1887. †Macy, Jesse. Grinnell, Iowa, U.S.A.
1883. †Madden, W. H. Marlborough College, Wilts.
1883. †Maggs, Thomas Charles, F.G.S. 56 Clarendon-villas, West Brighton.
1868. †Magnay, F. A. Drayton, near Norwich.
1875. *Magnus, Sir Philip, B.Sc. 48 Gloucester-place, Portman-square, London, W.
1878. †Mahony, W. A. 34 College-green, Dublin.
1869. †Main, Robert. The Admiralty, Whitehall, London, S.W.
1887. †Mainprice, W. S. Longcroft, Altrincham, Cheshire.
1885. *Maitland, Sir James R. G., Bart. Stirling, N.B.
1883. §Maitland, P. C. 136 Great Portland-street, London, W.
*Malcolm, Frederick. Morden College, Blackheath, London, S.E.
1881. †Malcolm, Lieut.-Colonel, R.E. 72 Nunthorpe-road, York.
1874. †Malcolmson, A. B. Friends' Institute, Belfast.
1889. †Maling, C. T. 14 Ellison-place, Newcastle-upon-Tyne.
1857. †Mallet, John William, Ph.D., M.D., F.R.S., F.C.S., Professor of Chemistry in the University of Virginia, Albemarle Co., U.S.A.
1887. †MANCHESTER, The Right Rev. the Lord Bishop of, D.D. Bishop's Court, Manchester.
1870. †Manifold, W. H., M.D. 45 Rodney-street, Liverpool.
1885. †Mann, George. 72 Bon Accord-street, Aberdeen.
1888. †Mann, W. J. Rodney House, Trowbridge.
Manning, His Eminence Cardinal. Archbishop's House, Westminster, S.W.
1878. §Manning, Robert. 4 Upper Ely-place, Dublin.
1864. †Mansel-Pleydell, J. C. Whatcombe, Blandford.
1888. †Mansergh, James, M.Inst.C.E. 3 Westminster-chambers, London, S.W.
1891. §Manuel, James. 175 Newport-road, Cardiff.
1889. †Manville, E. 3 Prince's-mansions, Victoria-street, London, S.W.
1887. *March, Henry Colley, M.D. 2 West-street, Rochdale.
1870. †Marcoartu, His Excellency Don Arturo de. Madrid.
1887. †Margetson, J. Charles. The Rocks, Limply, Stoke.
1883. †Marginson, James Fleetwood. The Mount, Fleetwood, Lancashire.
1887. §Markham, Christopher A., F.R.Met.Soc. Spratton, Northampton.
1864. †MARKHAM, CLEMENTS R., C.B., F.R.S., F.L.S., F.R.G.S., F.S.A.
21 Eccleston-square, London, S.W.
1863. †Marley, John. Mining Office, Darlington.
1888. †Marling, W. J. Stanley Park, Stroud, Gloucestershire.
1888. †Marling, Lady. Stanley Park, Stroud, Gloucestershire.
1881. *Marr, John Edward, M.A., F.R.S., F.G.S. St. John's College, Cambridge.
1888. §Marriott, A. S. Manor Lawn, Dewsbury.
1857. †Marriott, William, F.C.S. 8 Belgrave-terrace, Huddersfield.
1887. †Marsden, Benjamin. Westleigh, Heaton Mersey, Manchester.
1887. †Marsden, Joseph. Ardenlea, Heaton, near Bolton.
1884. *Marsden, Samuel. St. Louis, Missouri, U.S.A.
1883. *Marsh, Henry. Cressy House, Woodsley-road, Leeds.
1887. †Marsh, J. E., B.A. The Museum, Oxford.
1864. †Marsh, Thomas Edward Miller. 37 Grosvenor-place, Bath.

- Year of
Election.
1889. *MARSHALL, ALFRED, M.A., Professor of Political Economy in the University of Cambridge. Balliol Croft, Madingley-road, Cambridge.
1882. *MARSHALL, A. MILNES, M.A., M.D., D.Sc., F.R.S., Professor of Zoology in Owens College, Manchester.
1889. †Marshall, Frank, B.A. 31 Grosvenor-place, Newcastle-upon-Tyne.
1881. *Marshall, John, F.R.A.S., F.G.S. Church Institute, Leeds.
1890. †Marshall, John. Derwent Island, Keswick.
1881. †Marshall, John Ingham Fearby. 28 St. Saviourgate, York.
1858. †Marshall, Reginald Dykes. Adel, near Leeds.
1889. *Marshall, Miss Sophie Elise, B.Sc. 38 Percy-gardens, Tynemouth.
1876. †Marshall, Peter. 6 Parkgrove-terrace, Glasgow.
1887. §Marshall, William. Thorncliffe, Dukinfield.
1836. *MARSHALL, WILLIAM BAYLEY, M.Inst.C.E. Richmond Hill, Edgbaston, Birmingham.
1849. *MARSHALL, WILLIAM P., M.Inst.C.E. Richmond Hill, Edgbaston, Birmingham.
1865. §MARTEN, EDWARD BINDON. Pedmore, near Stourbridge.
1883. †Marten, Henry John. 4 Storey's-gate, London, S.W.
1837. *Martin, Rev. H. A. Laxton Vicarage, Newark.
1891. *Martin, Edward P., J.P. Dowlais, Glamorgan.
1848. †Martin, Henry D. 4 Imperial-circus, Cheltenham.
1878. †MARTIN, H. NEWELL, M.A., M.D., D.Sc., F.R.S., Professor of Biology in Johns Hopkins University, Baltimore, U.S.A.
1833. *MARTIN, JOHN BIDDULPH, M.A., F.S.S. 17 Hyde Park-gate, London, S.W.
1834. §Martin, N. H., F.L.S. 85 Osborne-road, Jesmond, Newcastle-upon-Tyne.
1889. *Martin, Thomas Henry, Assoc.M.Inst.C.E. Lyon House, New Barnet, Herts.
1890. §Martindale, William. 19 Devonshire-street, Portland-place, London, W.
- *Martineau, Rev. James, LL.D., D.D. 35 Gordon-square, London, W.C.
1865. †Martineau, R. F. 18 Highfield-road, Edgbaston, Birmingham.
1865. †Martineau, Thomas. 7 Cannon-street, Birmingham.
1886. †MARTINEAU, Sir THOMAS, J.P. West Hill, Augustus-road, Edgbaston, Birmingham.
1883. †Marwick, James, LL.D. Killermont, Maryhill, Glasgow.
1891. §Marychurch, J. G. 46 Park-street, Cardiff.
1878. †Masaki, Taiso. Japanese Consulate, 84 Bishopsgate-street Within, London, E.C.
1891. §Massey, William H. Twyford, R.S.O., Berkshire.
1847. †MASKELYNE, NEVIL STORY, M.A., M.P., F.R.S., F.G.S., Professor of Mineralogy in the University of Oxford. Salthrop, Wroughton, Wiltshire.
1886. †Mason, Hon. J. E. Fiji.
1879. †Mason, James, M.D. Montgomery House, Sheffield.
1885. †Masson, Orme, D.Sc. 58 Great King-street, Edinburgh.
1833. †Mather, Robert V. Birkdale Lodge, Birkdale, Southport.
1837. *Mather, William, M.P., M.Inst.C.E. Salford Iron Works, Manchester.
1890. †Mathers, J. S. 1 Hanover-square, Leeds.
1865. *Mathews, G. S. 32 Augustus-road, Edgbaston, Birmingham.
1889. §Mathews, John Hitchcock. 1 Queen's-gardens, Hyde Park, London, W.
1861. *MATHEWS, WILLIAM, M.A., F.G.S. 60 Harborne-road, Birmingham.

Year of
Election.

1881. †Mathwin, Henry, B.A. Bickerton House, Southport.
 1883. †Mathwin, Mrs. 40 York-road, Birkdale, Southport.
 1865. †Matthews, C. E. Waterloo-street, Birmingham.
 1858. †Matthews, F. C. Mandre Works, Driffield, Yorkshire.
 1885. †MATTHEWS, JAMES. Springhill, Aberdeen.
 1885. †Matthews, J. Duncan. Springhill, Aberdeen.
 1863. †Maughan, Rev. W. Benwell Parsonage, Newcastle-upon-Tyne.
 1890. †Maund, E. A. 294 Regent-street, London, W.
 1865. *MAW, GEORGE, F.L.S., F.G.S., F.S.A. Kenley, Surrey.
 1876. †Maxton, John. 6 Belgrave-terrace, Glasgow.
 1864. *Maxwell, Francis. 4 Moray-place, Edinburgh.
 1887. †Maxwell, James. 29 Princess-street, Manchester.
 *Maxwell, Robert Perceval. Finnebrogue, Downpatrick.
 1883. §May, William, F.G.S., F.R.G.S. Northfield, St. Mary Cray,
 Kent.
 1883. †Mayall, George. Clairville, Birkdale, Southport.
 1884. *Maybury, A. C., D.Sc. 19 Bloomsbury-square, London, W.C.
 1878. *Mayne, Thomas. 33 Castle-street, Dublin.
 1878. †Meath, The Right Rev. C. P. Reichel, D.D., Bishop of. Dundrum
 Castle, Dublin.
 1884. †Mecham, Arthur. 11 Newton-terrace, Glasgow.
 1871. †Meikie, James, F.S.S. 6 St. Andrew's-square, Edinburgh.
 1879. §Meiklejohn, John W. S., M.D. 105 Holland-road, London, W.
 1887. †Meischke-Smith, W. Rivala Lumpore, Salengore, Straits Settle-
 ments.
 1881. *MELDOLA, RAPHAEL, F.R.S., F.R.A.S., F.C.S., F.I.C., Professor of
 Chemistry in the Finsbury Technical College, City and Guilds
 of London Institute. 6 Brunswick-square, London, W.C.
 1867. †MELDRUM, CHARLES, C.M.G., LL.D., F.R.S., F.R.A.S. Port Louis,
 Mauritius.
 1883. †Mellis, Rev. James. 23 Park-street, Southport.
 1879. *Mellish, Henry. Hodsock Priory, Worksop.
 1866. †MELLO, Rev. J. M., M.A., F.G.S. Mapperley Vicarage, Derby.
 1883. §Mello, Mrs. J. M. Mapperley Vicarage, Derby.
 1881. §Melrose, James. Clifton Croft, York.
 1887. †Melvill, J. Cosmo, M.A. Kersal Cottage, Prestwich, Manchester.
 1847. †Melville, Professor Alexander Gordon, M.D. Queen's College, Gal-
 way.
 1863. †Melvin, Alexander. 42 Buccleuch-place, Edinburgh.
 1877. *Menabrea, General Count, LL.D. 14 Rue de l'Elysée, Paris.
 1862. †MENNELL, HENRY T. St. Dunstan's-buildings, Great Tower-street,
 London, E.C.
 1879. §MERIVALE, JOHN HERMAN, M.A., Professor of Mining in the College
 of Science, Newcastle-upon-Tyne.
 1880. †Merry, Alfred S. Bryn Heulog, Sketty, near Swansea.
 1889. *Merz, John Theodore. The Quarries, Newcastle-upon-Tyne.
 1863. †Messent, P. T. 4 Northumberland-terrace, Tynemouth.
 1869. †MIALL, LOUIS C., F.L.S., F.G.S., Professor of Biology in Yorkshire
 College, Leeds.
 1886. †Middlemore, Thomas. Holloway Head, Birmingham.
 1865. †Middlemore, William. Edgbaston, Birmingham.
 1881. *Middlesbrough, The Right Rev. Richard Lacy, D.D., Bishop of,
 Middlesbrough.
 1883. †Middleton, Henry. *St. John's College, Cambridge.*
 1881. †Middleton, R. Morton, F.L.S., F.Z.S. South Pittsburg, Tennessee.
 1889. †Milburn, John D. Queen-street, Newcastle-upon-Tyne.
 1886. †Miles, Charles Albert. Buenos Ayres.

- Year of
Election.
1881. §MILES, MORRIS. Warbourne, Hill-lane, Southampton.
1885. §Mill, Hugh Robert, D.Sc., F.R.S.E. Braid-road, Morningside,
Edinburgh.
1859. †Millar, John, J.P. Lisburn, Ireland.
1889. *Millar, Robert Cockburn. 56 George-street, Edinburgh.
Millar, Thomas, M.A., LL.D., F.R.S.E. Perth.
1876. †Millar, William. Highfield House, Dennistoun, Glasgow.
1876. †Millar, William. Highfield House, Dennistoun, Glasgow.
1882. †Miller, A. J. 12 Cumberland-place, Southampton.
1875. †Miller, George. Brentry, near Bristol.
1884. †Miller, Mrs. Hugh. Lauriston-place, Edinburgh.
1888. †Miller, J. Bruce. Rubislaw Den North, Aberdeen.
1885. †Miller, John. 9 Rubislaw-terrace, Aberdeen.
1886. §Miller, Rev. John. The College, Weymouth.
1861. *Miller, Robert. Cranage Hall, Holmes Chapel, Cheshire.
1876. *Miller, Robert. 1 Lily Bank-terrace, Hillhead, Glasgow.
1884. †Miller, T. F., B.Ap.Sc. Napanee, Ontario, Canada.
1876. †Miller, Thomas Paterson. Cairns, Cambuslang, N.B.
1868. *MILLS, EDMUND J., D.Sc., F.R.S., F.C.S., Young Professor of
Technical Chemistry in the Glasgow and West of Scotland
Technical College, Glasgow. 60 John-street, Glasgow.
1880. †Mills, Mansfeldt H. Old Hall, Mansfield Woodhouse, Mansfield.
1885. †Milne, Alexander D. 40 Albyn-place, Aberdeen.
1882. *MILNE, JOHN, F.R.S., F.G.S., Professor of Mining and Geology in
the Imperial College of Engineering, Tokio, Japan. Ingleside,
Birdhirst Rise, South Croydon, Surrey.
1885. †Milne, J. D. 14 Rubislaw-terrace, Aberdeen.
1885. †Milne, William. 40 Albyn-place, Aberdeen.
1887. †Milne-Redhead, R., F.L.S. Holden Clough, Clitheroe.
1882. †Milnes, Alfred, M.A., F.S.S. 30 Almeric-road, London, S.W.
1888. †Milsom, Charles. 69 Pulteney-street, Bath.
1880. †Minchin, G. M., M.A. Royal Indian Engineering College, Cooper's
Hill, Surrey.
1855. †Mirrlees, James Buchanan. 45 Scotland-street, Glasgow.
1859. †Mitchell, Alexander, M.D. Old Rain, Aberdeen.
1876. †Mitchell, Andrew. 20 Woodside-place, Glasgow.
1883. †Mitchell, Charles T., M.A. 41 Addison-gardens North, Kensington,
London, W.
1883. †Mitchell, Mrs. Charles T. 41 Addison-gardens North, Kensington,
London, W.
1863. †Mitchell, C. Walker. Newcastle-upon-Tyne.
1873. †Mitchell, Henry. Parkfield House, Bradford, Yorkshire.
1885. †Mitchell, Rev. J. Mitford, B.A. 6 Queen's-terrace, Aberdeen.
1868. †Mitchell, John, jun. Pole Park House, Dundee.
1885. †Mitchell, P. Chalmers. Christ Church, Oxford.
1862. *Mitchell, W. Stephen, M.A., LL.B. Kenyon Mansions, Lough-
borough Park, London, S.W.
1879. †MIVART, St. GEORGE, Ph.D., M.D., F.R.S., F.L.S., F.Z.S. Hurst-
cote, Chilworth, Surrey.
1884. †Moat, Robert. Spring Grove, Bewdley.
1885. §Moffat, William. 7 Queen's-gardens, Aberdeen.
1864. †Mogg, John Rees. High Littleton House, near Bristol.
1885. †Moir, James. 25 Carden-place, Aberdeen.
1883. †Mollison, W. L., M.A. Clare College, Cambridge.
1878. †Molloy, Constantine, Q.C. 65 Lower Leeson-street, Dublin.
1877. *Molloy, Rev. Gerald, D.D. 86 Stephen's-green, Dublin.
1884. †Monaghan, Patrick. Halifax (Box 317), Nova Scotia, Canada.

Year of
Election.

1887. *Mond, Ludwig, F.R.S., F.C.S. 20 Avenue-road, Regent's Park, London, N.W.
1891. *Mond, Robert Ludwig, *B.A., F.R.S.E. 20 Avenue-road, Regent's Park, London, N.W.
1853. †Monroe, Henry, M.D. 10 North-street, Sculcoates, Hull.
1882. *Montagu, Samuel, M.P. 12 Kensington Palace-gardens, London, W.
1891. §Montefiore, Arthur, F.G.S., F.R.G.S. 6 Marlborough-road, Bedford Park, London, W.
1872. †Montgomery, R. Mortimer. 3 Porchester-place, Edgware-road, London, W.
1872. †Moon, W., LL.D. 104 Queen's-road, Brighton.
1884. †Moore, George Frederick. 49 Hardman-street, Liverpool.
1881. §Moore, Henry. Collingham, Maresfield-gardens, Fitzjohn's-avenue, London, N.W.
1891. §Moore, John. Lindenwood, Park-place, Cardiff.
1890. §Moore, Major, R.E. School of Military Engineering, Chatham.
*MOORE, JOHN CARRICK, M.A., F.R.S., F.G.S. 113 Eaton-square, London, S.W.; and Corswall, Wigtonshire.
1854. †MOORE, THOMAS JOHN, Cor. M.Z.S. Free Public Museum, Liverpool.
1857. *Moore, Rev. William Prior. The Royal School, Cavan, Ireland.
1877. †Moore, William Vanderkemp. 15 Princess-square, Plymouth.
1871. †MORE, ALEXANDER G., F.L.S., M.R.I.A. 74 Leinster-road, Dublin.
1891. §Morel, P. Lavernock House, near Cardiff.
1881. †MORGAN, ALFRED. 50 West Bay-street, Jacksonville, Florida, U.S.A.
1873. †Morgan, Edward Delmar, F.R.G.S. 15 Roland-gardens, London, S.W.
1891. §Morgan, F. Ruspidge, Newnham.
1885. †Morgan, John. 57 Thomson-street, Aberdeen.
1887. †Morgan, John Gray. 38 Lloyd-street, Manchester.
1891. §Morgan, Sir Morgan. Cardiff.
1882. §Morgan, Thomas. Cross House, Southampton.
1878. †MORGAN, WILLIAM, Ph.D., F.C.S. Swansea.
1889. §Morison, J. Rutherford, M.D. 14 Saville-row, Newcastle-upon-Tyne.
1867. †Morison, William R. Dundee.
1891. §Morley, H. The Gas Works, Cardiff.
1883. *Morley, Henry Forster, M.A., D.Sc., F.C.S. 29 Kylemore-road, West Hampstead, London, N.W.
1889. †MORLEY, The Right Hon. JOHN, LL.D., M.P. 95 Elm Park-gardens, London, S.W.
1881. †Morrell, W. W. York City and County Bank, York.
1880. †Morris, Alfred Arthur Vennor. Wernolau, Cross Inn R.S.O., Carmarthenshire.
1883. †Morris, C. S. Millbrook Iron Works, Landore, South Wales.
*Morris, Rev. Francis Orpen, B.A. Nunburnholme Rectory, Hayton, York.
1883. †Morris, George Lockwood. Millbrook Iron Works, Swansea.
1880. §Morris, James. 6 Windsor-street, Uplands, Swansea.
1883. †Morris, John. 40 Wellesley-road, Liverpool.
1888. †Morris, J. W., F.L.S. The Woodlands, Bathwick Hill, Bath.
1880. †Morris, M. I. E. The Lodge, Penclawdd, near Swansea.
Morris, Samuel, M.R.D.S. Fortview, Clontarf, near Dublin.
1876. †Morris, Rev. S. S. O., M.A., R.N., F.C.S. H.M.S. 'Garnet,' S. Coast of America.

Year of
Election.

1874. †Morrison, G. J., M.Inst.C.E. 5 Victoria-street, Westminster, S.W.
1890. †Morrison, Sir George W. Municipal Buildings, Leeds.
1871. *Morrison, James Darsie. 27 Grange-road, Edinburgh.
1886. †Morrison, John T. Scottish Marine Station, Granton, N.B.
1865. †Mortimer, J. R. St. John's-villas, Driffield.
1869. †Mortimer, William. Bedford-circus, Exeter.
1857. §MORTON, GEORGE H., F.G.S. 209 Edge-lane, Liverpool.
1858. *MORTON, HENRY JOSEPH. 2 Westbourne-villas, Scarborough.
1871. †Morton, Hugh. Belvedere House, Trinity, Edinburgh.
1887. †Morton, Percy, M.A. Iltyd House, Brecon, South Wales.
1886. *Morton, P. F. Hook House, Hook, near Winchfield, Hampshire.
1883. †Moseley, Mrs. Firwood, Clevedon, Somerset.
1891. §Moss, Arthur J., M.B., Penarth, Glamorganshire.
1878. *Moss, JOHN FRANCIS, F.R.G.S. Beechwood, Brincliffe, Sheffield.
1876. §MOSS, RICHARD JACKSON, F.C.S., M.R.I.A. St. Aubin's, Ballybrack, Co. Dublin.
1864. *Mosse, J. R. Conservative Club, London, S.W.
1873. †Mossman, William. Ovenden, Halifax.
1869. §MOTT, ALBERT J., F.G.S. Detmore, Charlton Kings, Cheltenham.
1865. †Mott, Charles Grey. The Park, Birkenhead.
1866. §MOTT, FREDERICK T., F.R.G.S. Birstall Hill, Leicester.
1862. *MOUTAT, FREDERICK JOHN, M.D., Local Government Inspector. 13 Durham-villas, Camden Hill, London, W.
1856. †Mould, Rev. J. G., B.D. Fulmodeston Rectory, Dereham, Norfolk.
1878. *Moulton, J. Fletcher, M.A., Q.C., F.R.S. 57 Onslow-square, London, S.W.
1863. †Mounsey, Edward. Sunderland.
1861. *Mountcastle, William Robert. Bridge Farm, Ellenbrook, near Manchester.
1877. †MOUNT-EDGCOMBE, The Right Hon. the Earl of, D.C.L. Mount-Edgcombe, Devonport.
1850. †Mowbray, John T. 15 Albany-street, Edinburgh.
1887. †Moxon, Thomas B. County Bank, Manchester.
1888. †Moyle, R. E., B.A., F.C.S. The College, Bath.
1884. †Moyses, C. E., B.A., Professor of English Language and Literature in McGill College, Montreal. 802 Sherbrooke-street, Montreal, Canada.
1884. †Moyses, Charles E. 802 Sherbrooke-street, Montreal, Canada.
1876. *Muir, John. 6 Park-gardens, Glasgow.
1874. †MUIR, M. M. PATISON, M.A., F.R.S.E. Caius College, Cambridge.
1876. †Muir, Thomas, M.A., LL.D., F.R.S.E. Beechcroft, Bothwell, Glasgow.
1884. *Muir, William Ker. Detroit, Michigan, U.S.A.
1872. †Muirhead, Alexander, D.Sc., F.C.S. Cowley-street, Westminster, S.W.
1884. *Muirhead-Paterson, Miss Mary. Laurievillie, Queen's Drive, Cross-hill, Glasgow.
1876. *Muirhead, Robert Franklin, M.A., B.Sc. Mason College, Birmingham.
1883. †MULHALL, MICHAEL G. Fancourt, Balbriggan, Co. Dublin.
1883. †Mulhall, Mrs. Marion. Fancourt, Balbriggan, Co. Dublin.
1891. §MÜLLER, F. MAX, M.A., Professor of Comparative Philology in the University of Oxford. Oxford.
1884. *MÜLLER, HUGO, Ph.D., F.R.S., F.C.S. 13 Park-square East, Regent's Park, London, N.W.
1880. †Muller, Hugo M. 1 Grünanger-gasse, Vienna.
- Munby, Arthur Joseph. 6 Fig-tree-court, Temple, London, E.C.

Year of
Election.

1866. †MUNDELLA, The Right Hon. A. J., M.P., F.R.S., F.R.G.S. 16 Eivaston-place, London, S.W.
1876. †Munro, Donald, F.C.S. The University, Glasgow.
1885. †Munro, J. E. Crawford, LL.D., Professor of Political Economy in Owens College, Manchester.
1883. *Munro, Robert, M.A., M.D. 48 Manor-place, Edinburgh.
1872. *Munster, H. Sillwood Lodge, Brighton.
1864. †MURCH, JEROM. Cranwells, Bath.
1864. *Murchison, K. R. Brockhurst, East Grinstead.
1855. †Murdoch, James B. Hamilton-place, Langside, Glasgow.
1890. §Murphy, A. J. Preston House, Leeds.
1889. †Murphy, James, M.A., M.D. Holly House, Sunderland.
1852. †Murphy, Joseph John. Old Forge, Dunmurry, Co. Antrim.
1884. §Murphy, Patrick. Newry, Ireland.
1887. †Murray, A. Hazeldean, Kersal, Manchester.
1869. †Murray, Adam. 78 Manor Road, Brockley, S.E.
1891. §Murray, G.R.M., F.L.S. British Museum (Natural History), South Kensington, London, S.W.
Murray, John, F.G.S., F.R.G.S. 50 Albemarle-street, London, W. ;
and Newsted, Wimbledon, Surrey.
1859. †Murray, John, M.D. Forres, Scotland.
1884. †MURRAY, JOHN, F.R.S.E. 'Challenger' Expedition Office, Edinburgh.
1884. †Murray, J. Clark, LL.D., Professor of Logic and Mental and Moral Philosophy in McGill University, Montreal. 111 McKay-street, Montreal, Canada.
1872. †Murray, J. Jardine, F.R.C.S.E. 99 Montpellier-road, Brighton.
1863. †Murray, William, M.D. 34 Clayton-street, Newcastle-on-Tyne.
1883. †Murray, W. Vaughan. 4 Westbourne-crescent, Hyde Park, London, W.
1874. §Musgrave, James, J.P. Drumglass House, Belfast.
1870. *Muspratt, Edward Knowles. Seaforth Hall, near Liverpool.
1891. §Muybridge, Eadweard. University of Pennsylvania, U.S.A.
1890. *Myres, John L. Swanbourne, Winslow, Buckinghamshire.
1886. §Nagel, D. H., M.A. Trinity College, Oxford.
1890. §Nalder, Francis Henry. 16 Red Lion-street, Clerkenwell, London, E.C.
1876. †Napier, James S. 9 Woodside-place, Glasgow.
1872. †Nares, Admiral Sir G. S., K.C.B., R.N., F.R.S., F.R.G.S. St. Bernard's, Maple-road, Surbiton.
1887. †Nason, Professor Henry B., Ph.D., F.C.S. Troy, New York, U.S.A.
1886. §Neale, E. Vansittart. 14 City-buildings, Corporation-street, Manchester.
1887. §Neild, Charles. 19 Chapel Walks, Manchester.
1883. *Neild, Theodore, B.A. Dalton Hall, Manchester.
1887. †Neill, Joseph S. Claremont, Broughton Park, Manchester.
1887. †Neill, Robert, jun. Beech Mount, Higher Broughton, Manchester.
1855. †Neilson, Walter. 172 West George-street, Glasgow.
1876. †Nelson, D. M. 11 Bothwell-street, Glasgow.
1888. †Nelson, The Right Rev. the Bishop of, D.D. Nelson, New Zealand.
1886. †Nettlefold, Edward. 51 Carpenter-road, Edgbaston, Birmingham.
1868. †Nevill, Rev. H. R. The Close, Norwich.
1866. *Nevill, The Right Rev. Samuel Tarratt, D.D., F.L.S., Bishop of Dunedin, New Zealand.

Year of
Election.

1889. †Neville, F. H. Sidney College, Cambridge.
 1857. †Neville, John, M.R.I.A. Roden-place, Dundalk, Ireland.
 1869. †Nevins, John Birkbeck, M.D. 3 Abercromby-square, Liverpool.
 1842. New, Herbert. Evesham, Worcestershire.
 1889. *Newall, H. Frank. Madingley Rise, Cambridge.
 1891. *Newell, W. H. A. 10 Plasterton-gardens, Cardiff.
 1886. †Newbolt, F. G. Edenhurst, Addlestone, Surrey.
 1842. *NEWMAN, Professor FRANCIS WILLIAM. 15 Arundel-crescent,
 Weston-super-Mare.
 1889. §Newstead, A. H. L. Roseacre, Epping.
 1860. *NEWTON, ALFRED, M.A., F.R.S., F.L.S., Professor of Zoology and
 Comparative Anatomy in the University of Cambridge. Mag-
 dalene College, Cambridge.
 1872. †Newton, Rev. J. 125 Eastern-road, Brighton.
 1883. †Nias, Miss Isabel. 56 Montagu-square, London, W.
 1882. †Nias, J. B., B.A. 56 Montagu-square, London, W.
 1867. †Nicholl, Thomas. Dundee.
 1875. †Nicholls, J. F. City Library, Bristol.
 1866. †NICHOLSON, Sir CHARLES, Bart., M.D., D.C.L., LL.D., F.G.S.,
 F.R.G.S. The Grange, Totteridge, Herts.
 1867. †NICHOLSON, HENRY ALLEYNE, M.D., D.Sc., F.G.S., Professor of
 Natural History in the University of Aberdeen.
 1887. *Nicholson, John Carr. Moorfield House, Headingley, Leeds.
 1884. †Nicholson, Joseph S., M.A., D.Sc., Professor of Political Economy in
 the University of Edinburgh. Eden Lodge, Newbattle-terrace,
 Edinburgh.
 1883. †Nicholson, Richard, J.P. Whinfield, Hesketh Park, Southport.
 1887. †Nicholson, Robert H. Bouchier. 21 Albion-street, Hull.
 1881. †Nicholson, William R. Clifton, York.
 1887. †Nickson, William. Shelton, Sibson-road, Sale, Manchester.
 1885. §Nicol, W. W. J., M.A., D.Sc., F.R.S.E. Mason Science College,
 Birmingham.
 1878. †Niven, Charles, M.A., F.R.S., F.R.A.S., Professor of Natural
 Philosophy in the University of Aberdeen. 6 Chanonry, Aber-
 deen.
 1886. †Niven, George. Erkingholme, Coolhurst-road, London, N.
 1877. †Niven, James, M.A. King's College, Aberdeen.
 1874. †Nixon, Randal C. J., M.A. Royal Academical Institution, Belfast.
 1884. †Nixon, T. Alcock. 33 Harcourt-street, Dublin.
 1863. *NOBLE, Captain ANDREW, C.B., F.R.S., F.R.A.S., F.C.S. Elswick
 Works, Newcastle-upon-Tyne.
 1879. †Noble, T. S., F.G.S. Lendal, York.
 1886. §Nock, J. B. Mayfield, Chester-road, Sutton Coldfield.
 1887. †Nodal, John H. The Grange, Heaton Moor, near Stockport.
 1870. †Nolan, Joseph, M.R.I.A. 14 Hume-street, Dublin.
 1882. †Norfolk, F. 16 Carlton-road, Southampton.
 1863. §NORMAN, Rev. Canon ALFRED MERLE, M.A., D.C.L., F.R.S., F.L.S.
 Burnmoor Rectory, Fence Houses, Co. Durham.
 1888. †Norman, George. 12 Brock-street, Bath.
 1865. †NORRIS, RICHARD, M.D. 2 Walsall-road, Birchfield, Birming-
 ham.
 1872. †Norris, Thomas George. Gorphwysfa, Llanrwst, North Wales.
 1883. *Norris, William G. Coalbrookdale, Shropshire.
 1881. §North, Samuel William, M.R.C.S., F.G.S. 84 Micklegate, York.
 1881. †North, William, B.A., F.C.S. 84 Micklegate, York.
 1863. *Northbourne, The Right Hon. Lord, F.G.S. 6 Whitehall-gardens,
 London, S.W.

Year of
Election.

- *NORTHWICK, The Right Hon. Lord, M.A. 7 Park-street, Grosvenor-square, London, W.
 NORTON, The Right Hon. Lord, K.C.M.G. 35 Eaton-place, London, S.W.; and Hamshall, Birmingham.
 1886. †Norton, Lady. 35 Eaton-place, London, S.W.; and Hamshall, Birmingham.
 1868. †NORWICH, The Hon. and Right Rev. J. T. PELHAM, D.D., Lord Bishop of. Norwich.
 1861. †Noton, Thomas. Priory House, Oldham.
 Nowell, John. Farnley Wood, near Huddersfield.
 1883. †Nunnerley, John. 46 Alexandra-road, Southport.
 1887. §Nursey, Perry Fairfax. 161 Fleet-street, London, E.C.
 1883. *Nutt, Miss Lilian. Rosendale Hall, West Dulwich, London, S.E.
1882. §Obach, Eugene, Ph.D. 2 Victoria-road, Old Charlton, Kent.
 O'Callaghan, George. Tallas, Co. Clare.
 1888. †O'Connell, Major-General P. 2 College-road, Lansdowne, Bath.
 1878. †O'Connor Don, The. Clonalis, Castlereagh, Ireland.
 1883. †Odgers, William Blake, M.A., LL.D. 4 Elm-court, Temple, London, E.C.
 1858. *ODLING, WILLIAM, M.B., F.R.S., F.C.S., Waynflete Professor of Chemistry in the University of Oxford. 15 Norham-gardens, Oxford.
1884. †Odium, Edward, M.A. Pembroke, Ontario, Canada.
 1857. †O'Donnovan, William John. 54 Kenilworth-square, Rathgar, Dublin.
 1877. †Ogden, Joseph. 13 Hythe-villas, Limes-road, Croydon.
 1885. †Ogilvie, Alexander, LL.D. Gordon's College, Aberdeen.
 1876. †Ogilvie, Campbell P. Sizewell House, Leiston, Suffolk.
 1885. †OGILVIE, F. GRANT, M.A., B.Sc. Heriot Watt College, Edinburgh.
 1891. §Ogilvie, Graeme. 4 Great George-street, Westminster, S.W.
 1859. †Ogilvy, Rev. C. W. Norman. Baldovan House, Dundee.
 *Ogle, William, M.D., M.A. The Elms, Derby.
 1884. †O'Halloran, J. S., F.R.G.S. Royal Colonial Institute, Northumberland-avenue, London, W.C.
1881. †Oldfield, Joseph. Lendal, York.
 1887. †Oldham, Charles. Syrian House, Sale, near Manchester.
 1853. †OLDHAM, JAMES, M.Inst.C.E. Cottingham, near Hull.
 1885. †Oldham, John. River Plate Telegraph Company, Monte Video.
 1863. †Oliver, Daniel, F.R.S., F.L.S., Emeritus Professor of Botany in University College, London. Royal Gardens, Kew, Surrey.
 1887. †Oliver, F. W., D.Sc. 10 Kew Gardens-road, Kew, Surrey.
 1883. †Oliver, J. A. Westwood. The Liberal Club, Glasgow.
 1883. §Oliver, Samuel A. Bellingham House, Wigan, Lancashire.
 1889. §Oliver, Professor T., M.D. Eldon-square, Newcastle-upon-Tyne.
 1882. §Olsen, O. T., F.R.A.S., F.R.G.S. 116 St. Andrew's-terrace, Grimsby.
 *OMMANNEY, Admiral Sir ERASMUS, C.B., LL.D., F.R.S., F.R.A.S., F.R.G.S. 29 Connaught-square, Hyde Park, London, W.
1880. *Ommanney, Rev. E. A. 123 Vassal-road, Brixton, London, S.W.
 1887. †O'Neill, Charles. Glen Allan, Manley-road, Alexandra Park, Manchester.
 1872. †Onslow, D. Robert. New University Club, St. James's, London, S.W.
1883. †Oppert, Gustav, Professor of Sanskrit. Madras.
 1867. †Orchar, James G. 9 William-street, Forebank, Dundee.
 1883. †Ord, Miss Maria. Fern Lea, Park-crescent, Southport.
 1883. †Ord, Miss Sarah. Fern Lea, Park-crescent, Southport.

- Year of Election.
1880. †O'Reilly, J. P., Professor of Mining and Mineralogy in the Royal College of Science, Dublin.
1861. †Ormerod, Henry Mere. Clarence-street, Manchester; and 11 Woodland-terrace, Cheetham Hill, Manchester.
1858. †Ormerod, T. T. Brighouse, near Halifax.
1883. †Orpen, Miss. 58 Stephen's-green, Dublin.
1884. *Orpen, Major R. T., R.E. Gibraltar.
1884. *Orpen, Rev. T. H., M.A. Binnbrooke, Cambridge.
1838. Orr, Alexander Smith. 57 Upper Sackville-street, Dublin.
1873. †Osborn, George. 47 Kingscross-street, Halifax.
1887. †O'Shea, L. J., B.Sc. Firth College, Sheffield.
- *OSLER, A. FOLLETT, F.R.S. South Bank, Edgbaston, Birmingham.
1865. *Osler, Henry F. Coppy Hill, Linthurst, near Bromsgrove, Birmingham.
1869. *Osler, Sidney F. *Chesham Lodge, Lower Norwood, Surrey, S.E.*
1884. †Osler, William, M.D., Professor of the Institutes of Medicine in McGill University, Montreal, Canada.
1884. †O'Sullivan, James, F.C.S. 71 Spring Terrace-road, Burton-on-Trent.
1882. *Oswald, T. R. Castle Hall, Milford Haven.
1881. *Ottewell, Alfred D. 83 Siddals-road, Derby.
1882. †Owen, Rev. C. M., M.A. St. George's, Edgbaston, Birmingham.
1889. *Owen, Alderman H. C. Compton, Wolverhampton.
- OWEN, Sir RICHARD, K.C.B., M.D., D.C.L., LL.D., F.R.S., F.L.S., F.G.S., Hon. F.R.S.E. Sheen Lodge, Mortlake, Surrey, S.W.
1888. *Owen, Thomas. 8 Alfred-street, Bath.
1877. †Oxland, Dr. Robert, F.C.S. 8 Portland-square, Plymouth.
1891. †Pady, Samuel. Llantrisant House, Llantrisant.
1889. †Page, Dr. F. 1 Saville-place, Newcastle-upon-Tyne.
1883. †Page, George W. Fakenham, Norfolk.
1883. †Page, Joseph Edward. 12 Saunders-street, Southport.
1872. *Paget, Joseph. Stuffynwood Hall, Mansfield, Nottingham.
1884. †Paine, Cyrus F. Rochester, New York, U.S.A.
1875. †Paine, William Henry, M.D., F.G.S. Stroud, Gloucestershire.
1870. *PALGRAVE, R. H. INGLIS, F.R.S., F.S.S. Belton, Great Yarmouth.
1883. †Palgrave, Mrs. R. H. Inglis. Belton, Great Yarmouth.
1889. †PALMER, Sir CHARLES MARK, Bart., M.P. Grinkle Park, Yorkshire.
1873. †Palmer, George, M.P. The Acacias, Reading, Berks.
1878. *Palmer, Joseph Edward. Howth, co Dublin.
1887. *Palmer, Miss Mary Kate. Kilburn House, Sherwood, Notts.
1866. †Palmer, William. Kilbourne House, Cavendish Hill, Sherwood, Nottinghamshire.
1872. *Palmer, W. R. 1 The Cloisters, Temple, E.C.
- Palmes, Rev. William Lindsay, M.A. Naburn Hall, York.
1890. †Pankhurst, R. M., LL.D. 8 Russell-square, London, W.C.
1883. †Pant, F. J. Van der. Clifton Lodge, Kingston-on-Thames.
1886. †Panton, George A., F.R.S.E. 73 Westfield-road, Edgbaston, Birmingham.
1884. †Panton, Professor J. Hoyes, M.A., F.G.S. Ontario Agricultural College, Guelph, Ontario, Canada.
1883. †Park, Henry. Wigan.
1883. †Park, Mrs. Wigan.
1880. *Parke, George Henry, F.L.S., F.G.S. St. John's, Wakefield, Yorkshire.

Year of
Election.

1863. †Parker, Henry. Low Elswick, Newcastle-upon-Tyne.
 1874. †Parker, Henry R., LL.D. Methodist College, Belfast.
 1886. †Parker, Lawley. Chad Lodge, Edgbaston, Birmingham.
 1853. †Parker, William. Thornton-le-Moor, Lincolnshire.
 1891. §Parker, William Newton, Ph.D., F.Z.S. Professor of Biology in
 University College, Cardiff.
 1865. *Parkes, Samuel Hickling, F.L.S. 6 St. Mary's-row, Birmingham.
 1864. †Parkes, William. 23 Abingdon-street, Westminster, S.W.
 1879. §Parkin, William, F.S.S. The Mount, Sheffield.
 1887. §Parkinson, James. Station-road, Turton, Bolton.
 1859. †Parkinson, Robert, Ph.D. Yewbarrow House, Grange-over-Sands.
 1841. Parnell, Edward A., F.C.S. Ashley Villa, Swansea.
 1862. *Parnell, John, M.A. Hadham House, Upper Clapton, London, N.E.
 1883. †Parson, T. Cooke, M.R.C.S. Atherston House, Clifton, Bristol.
 1877. †Parson, T. Edgecombe. 36 Torrington-place, Plymouth.
 1865. *Parsons, Charles Thomas. Norfolk-road, Edgbaston, Birmingham.
 1878. †Parsons, Hon. C. A. Elvaston Hall, Newcastle-upon-Tyne.
 1878. †Parsons, Hon. and Rev. R. C. 10 Connaught-place, London, W.
 1883. †Part, Isabella. Rudleth, Watford, Herts.
 1875. †Pass, Alfred C. Rushmere House, Durdham Down, Bristol.
 1881. §Patchitt, Edward Cheshire. 128 Derby-road, Nottingham.
 1884. *Paton, David. Johnstone, Scotland.
 1883. *Paton, Henry, M.A. 15 Myrtle-terrace, Edinburgh.
 1884. *Paton, Hugh. 992 Sherbrooke-street, Montreal, Canada.
 1883. †Paton, Rev. William. The Ferns, Parkside, Nottingham.
 1887. †Paterson, A. M., M.D. Owens College, Manchester.
 1871. *Patterson, A. Henry. 3 New-square, Lincoln's Inn, London, W.C.
 1884. †Patterson, Edward Mortimer. Fredericton, New Brunswick, Canada.
 1876. §Patterson, T. L. Belmont, Margaret-street, Greenock.
 1874. †Patterson, W. H., M.R.I.A. 26 High-street, Belfast.
 1889. †Pattinson, H. L., jun. Felling Chemical Works, Felling-upon-Tyne.
 1863. †PATTINSON, JOHN, F.C.S. 75 The Side, Newcastle-upon-Tyne.
 1863. †Pattinson, William. Felling, near Newcastle-upon-Tyne.
 1867. §Pattison, Samuel Rowles, F.G.S. 11 Queen Victoria-street, London,
 E.C.
 1864. †Pattison, Dr. T. H. London-street, Edinburgh.
 1879. *Patzer, F. R. Stoke-on-Trent.
 1863. †PAUL, BENJAMIN H., Ph.D. 1 Victoria-street, Westminster, S.W.
 1863. †PAVY, FREDERICK WILLIAM, M.D., F.R.S. 35 Grosvenor-street,
 London, W.
 1887. †Paxman, James. Hill House, Colchester.
 1887. *Payne, Miss Edith Annie. Hatchlands, Cuckfield, Hayward's Heath.
 1881. †Payne, J. Buxton. 15 Mosley-street, Newcastle-upon-Tyne.
 1877. *Payne, J. C. Charles. Botanic-avenue, The Plains, Belfast.
 1881. †Payne, Mrs. Botanic-avenue, The Plains, Belfast.
 1866. †Payne, Dr. Joseph F. 78 Wimpole-street, London, W.
 1888. *Paynter, J. B. Hendford Manor House, Yeovil.
 1886. †Payton, Henry. Eversleigh, Somerset-road, Birmingham.
 1876. †Peace, G. H. Monton Grange, Eccles, near Manchester.
 1879. †Peace, William K. Moor Lodge, Sheffield.
 1885. †Peach, B. N., F.R.S.E., F.G.S. Geological Survey Office, Edin-
 burgh.
 1883. †Peacock, Ebenezer. 8 Mandeville-place, Manchester-square, Lon-
 don, W.
 1875. †Peacock, Thomas Francis. 12 South-square, Gray's Inn, London,
 W.C.

- Year of Election.
1881. *PEARCE, HORACE, F.R.A.S., F.L.S., F.G.S. The Limes, Stourbridge.
1886. *Pearce, Mrs. Horace. The Limes, Stourbridge.
1888. §Pearce, Rev. R. J., D.C.L., Professor of Mathematics in the University of Durham. 7 South Bailey, Durham.
1884. †Pearce, William. Winnipeg, Canada.
1886. †Pearsall, Howard D. 3 Cursitor-street, London, E.C.
1877. †Pearse, J. Walter. Brussels.
1881. †Pearse, Richard Seward. Southampton.
1883. †Pearson, Arthur A. Colonial Office, London, S.W.
1891. §Pearson, B. Dowlais Hotel, Cardiff.
1883. †Pearson, Miss Helen E. 69 Alexandra-road, Southport.
1881. †Pearson, John. Glentworth House, The Mount, York.
1883. †Pearson, Mrs. Glentworth House, The Mount, York.
1872. *Pearson, Joseph. Grove Farm, Merlin, Raleigh, Ontario, Canada.
1881. †Pearson, Richard. 23 Bootham, York.
1870. †Pearson, Rev. Samuel, M.A. Highbury-quadrant, London, N.
1883. *Pearson, Thomas H. Redclyffe, Newton-le-Willows, Lancashire.
1863. §Pease, H. F. Brinkburn, Darlington.
1889. †Pease, Howard. Enfield Lodge, Benwell, Newcastle-upon-Tyne.
1863. †Pease, Sir Joseph W., Bart., M.P. Hutton Hall, near Guisborough.
1863. †Pease, J. W. Newcastle-upon-Tyne.
1883. †Peck, John Henry. 52 Houghton-street, Southport.
Peckitt, Henry. Carlton Hushwaite, Thirsk, Yorkshire.
1855. *Peckover, Alexander, F.S.A., F.L.S., F.R.G.S. Bank House, Wisbech, Cambridgeshire.
1888. †Peckover, Miss Alexandrina. Bank House, Wisbech, Cambridgeshire.
*Peckover, Algernon, F.L.S. Sibald's Holme, Wisbech, Cambridgeshire.
1885. †Peddie, W. Spring Valley Villa, Morningside-road, Edinburgh.
1884. †Peebles, W. E. 9 North Frederick-street, Dublin.
1883. †Peek, C. E. Conservative Club, London, S.W.
1878. *Peek, William. 16 Belgrave-place, Brighton.
1881. †Peggs, J. Wallace. 21 Queen Anne's-gate, London, S.W.
1884. †Pegler, Alfred. Elmfield, Southampton.
1861. *Peile, George, jun. Shotley Bridge, Co. Durham.
1878. †Pemberton, Charles Seaton. 44 Lincoln's Inn-fields, London, W.C.
1865. †Pemberton, Oliver. 18 Temple-row, Birmingham.
1861. *Pender, Sir John, K.C.M.G. 18 Arlington-street, London, S.W.
1887. §PENDLEBURY WILLIAM H., M.A., F.C.S. 6 Gladstone-terrace, Priory Hill, Dover.
1856. §PENGELLY, WILLIAM, F.R.S., F.G.S. Lamorna, Torquay.
1881. †Penty, W. G. Melbourne-street, York.
1875. †Perceval, Rev. Canon John, M.A., LL.D. Rugby.
1889. †Percival, Archibald Stanley, M.A., M.B. 6 Lovaine-crescent, Newcastle-upon-Tyne.
- *Perigal, Frederick. Cambridge Cottage, Kingswood, Reigate.
1868. *PERKIN, WILLIAM HENRY, Ph.D., F.R.S., F.C.S. The Chestnuts, Sudbury, Harrow, Middlesex.
1884. †Perkin, William Henry, jun., Ph.D., F.R.S., F.C.S., Professor of Chemistry in the Heriot Watt College, Edinburgh.
1864. *Perkins, V. R. Wotton-under-Edge, Gloucestershire.
1885. †Perrin, Miss Emily. 31 St John's Wood Park, London, N.W.
1886. †Perrin, Henry S. 31 St. John's Wood Park, London, N.W.
1886. †Perrin, Mrs. 23 Holland Villas-road, Kensington, London, W.

Year of
Election.

1879. †Perry, James. Rescommon.
 1874. *PERRY, JOHN, M.E., D.Sc., F.R.S., Professor of Engineering and Applied Mathematics in the Technical College, Finsbury. 31 Brunswick-square, London, W.C.
 1883. †Perry, Ottley L., F.R.G.S. Bolton-le-Moors, Lancashire.
 1883. †Perry, Russell R. 34 Duke-street, Brighton.
 1883. †Petrie, Miss Isabella. Stone Hill, Rochdale.
 1871. *Peyton, John E. H., F.R.A.S., F.G.S. 5 Fourth-avenue, Brighton.
 1882. †Pfoundes, Charles. Spring Gardens, London, S.W.
 1886. †Phelps, Colonel A. 23 Augustus-road, Edgbaston, Birmingham.
 1884. †Phelps, Charles Edgar. Carisbrooke House, The Park, Nottingham.
 1884. †Phelps, Mrs. Carisbrooke House, The Park, Nottingham.
 1886. †Phelps, Hon. E. J. American Legation, Members' Mansions, Victoria-street, London, S.W.
 1886. †Phelps, Mrs. Hamshall, Birmingham.
 1863. *PHENÉ, JOHN SAMUEL, LL.D., F.S.A., F.G.S., F.R.G.S. 5 Carlton-terrace, Oakley-street, London, S.W.
 1870. †Philip, T. D. 51 South Castle-street, Liverpool.
 1853. *Philips, Rev. Edward. Hollington, Uttoxeter, Staffordshire.
 1853. *Philips, Herbert. The Oak House, Macclesfield.
 1877. §Phillips, T. Wishart. Dunedin, Wainstead, Essex.
 1863. †Philipson, Dr. 7 Eldon-square, Newcastle-upon-Tyne.
 1889. †Philipson, John. 9 Victoria-square, Newcastle-upon-Tyne.
 1883. †Phillips, Arthur G. 20 Canning-street, Liverpool.
 1862. †Phillips, Rev. George, D.D. Queen's College, Cambridge.
 1887. †Phillips, H. Harcourt, F.C.S. 18 Exchange-street, Manchester.
 1880. §Phillips, John H., Hon. Sec. Philosophical and Archæological Society, Scarborough.
 1883. †Phillips, Mrs. Leah R. 1 East Park-terrace, Southampton.
 1890. §Phillips, R. W., M.A., Professor of Biology in University College, Bangor.
 1883. †Phillips, S. Rees. Wonford House, Exeter.
 1881. †Phillips, William. 9 Bootham-terrace, York.
 PHILPOTT, Right Rev. HENRY, D.D. The Elms, Cambridge.
 1868. †PHIPSON, T. L., Ph.D., F.C.S. 4 The Cedars, Putney, Surrey, S.W.
 1884. *Pickard, Rev. H. Adair, M.A. 5 Canterbury-road, Oxford.
 1883. *Pickard, Joseph William. Lindow Cottage, Lancaster.
 1885. *PICKERING, SPENCER U., M.A., F.R.S. 48 Bryanston-square, London, W.
 1884. *Pickett, Thomas E., M.D. Maysville, Mason County, Kentucky, U.S.A.
 1888. *Pidgeon, W. R. 42 Porchester-square, London, W.
 1871. †Pigot, Thomas F., M.R.I.A. Royal College of Science, Dublin.
 1884. †Pike, L. G., M.A., F.Z.S. 4 The Grove, Highgate, London, N.
 1865. †PIKE, L. OWEN. 201 Maida-vale, London, W.
 1873. †Pike, W. H. University College, Toronto, Canada.
 1857. †Pilkington, Henry M., LL.D., Q.C. 45 Upper Mount-street, Dublin.
 1883. †Pilling, R. C. The Robin's Nest, Blackburn.
 Pim, George, M.R.I.A. Brenanstown, Cabinteely, Co. Dublin.
 1877. †Pim, Joseph T. Greenbank, Monkstown, Co. Dublin.
 1868. †Pinder, T. R. St. Andrew's, Norwich.
 1876. †PIRIE, Rev. G., M.A., Professor of Mathematics in the University of Aberdeen. 33 College Bounds, Old Aberdeen.
 1884. †Pirz, Anthony. Long Island, New York, U.S.A.
 1887. †Pitkin, James. 56 Red Lion-street, Clerkenwell, London, E.C.

- Year of Election.
1875. †Pitman, John. Redcliff Hill, Bristol.
1883. †Pitt, George Newton, M.A., M.D. 34 Ashburn-place, South Kensington, London, S.W.
1864. †Pitt, R. 5 Widcomb-terrace, Bath.
1883. †Pitt, Sydney. 34 Ashburn-place, South Kensington, London, S.W.
1868. †PITT-RIVERS, Lieut.-General A. H. L., D.C.L., F.R.S., F.G.S., F.S.A. 4 Grosvenor-gardens, London, S.W.
1872. †Plant, Mrs. H. W. 28 Evington-street, Leicester.
1869. †PLANT, JAMES, F.G.S. 40 West-terrace, West-street, Leicester.
1842. PLAYFAIR, The Right Hon. Sir LYON, K.C.B., Ph.D., LL.D., M.P., F.R.S. L. & E., F.C.S. 68 Onslow-gardens, South Kensington, London, S.W.
1867. †PLAYFAIR, Lieut.-Colonel Sir R. L., K.C.M.G., H.M. Consul, Algeria. (Messrs. King & Co., Pall Mall, London, S.W.)
1884. *Playfair, W. S., M.D., LL.D., Professor of Midwifery in King's College, London. 31 George-street, Hanover-square, London, W.
1883. *Plimpton, R. T., M.D. 23 Lansdowne-road, Clapham-road, London, S.W.
1857. †Plunkett, Thomas. Ballybrophy House, Borris-in-Ossory, Ireland. †
1861. *POCHIN, HENRY DAVIS, F.C.S. Bodnant Hall, near Conway.
1881. §Pocklington, Henry. 20 Park-row, Leeds.
1888. †Pocock, Rev. Francis. 4 Brunswick-place, Bath.
1846. †POLE, WILLIAM, Mus.Doc., F.R.S., M.Inst.C.E. Athenæum Club, Pall Mall, London, S.W.
- *Pollexfen, Rev. John Hutton, M.A. Middleton Tyas Vicarage, Richmond, Yorkshire.
1891. §Pomeroy, Captain Ralph. 201 Newport-road, Cardiff.
1862. *Polwhele, Thomas Roxburgh, M.A., F.G.S. Polwhele, Truro, Cornwall.
1868. †PORTAL, WYNDHAM S. Malshanger, Basingstoke.
1883. *Porter, Rev. C. T., LL.D. Brechin Lodge, Cambridge-road, Southport.
1886. †Porter, Paxton. Birmingham and Midland Institute, Birmingham.
1866. †Porter, Robert. Highfield, Long Eaton, Nottingham.
1888. †Porter, Robert. Westfield House, Bloomfield-road, Bath.
1883. †Postgate, Professor J. P., M.A. Trinity College, Cambridge.
1863. †Potter, D. M. Cramlington, near Newcastle-upon-Tyne.
1887. †Potter, Edmund P. Hollinhurst, Bolton.
1883. †Potter, M. C., M.A., F.L.S. St. Peter's College, Cambridge.
1883. §Potts, John. Thorn Tree House, Macclesfield.
1886. *POULTON, EDWARD B., M.A., F.R.S., F.L.S. Wykeham House, Oxford.
1873. *Powell, Francis S., M.P., F.R.G.S. Horton Old Hall, Yorkshire; and 1 Cambridge-square, London, W.
1887. *Powell, Horatio Gibbs. Wood Villa, Tettenhall Wood, Wolverhampton.
1883. †Powell, John. Waunarwydd House, near Swansea.
1875. †Powell, William Augustus Frederick. Norland House, Clifton, Bristol.
1887. §Pownall, George H. Manchester and Salford Bank, Mosley-street, Manchester.
1867. †Powrie, James. Reswallie, Forfar.
1855. *Poynter, John E. Clyde Neuk, Uddingston, Scotland.
1883. †POYNTING, J. H., M.A., F.R.S., Professor of Physics in the Mason College, Birmingham. 11 St. Augustine's-road, Birmingham.
1884. §Prance, Courtenay C. Hatherley Court, Cheltenham.

- Year of Election.
1884. *Prankerd, A. A., D.C.L. Brazenose College, Oxford.
1891. §Pratt, Bickerton. Brynderwen, Maindee, Newport, Monmouthshire.
1869. *PREECE, WILLIAM HENRY, F.R.S., M.Inst.C.E. Gothic Lodge, Wimbledon Common, Surrey.
1888. *Preece, W. Llewellyn. Telegraph Department, Midland Railway, Derby.
1884. *Premio-Real, His Excellency the Count of. Quebec, Canada.
1889. §Preston, Alfred Eley. 14 The Exchange, Bradford, Yorkshire.
- *PRESTWICH, JOSEPH, M.A., D.C.L., F.R.S., F.G.S., F.C.S. Shoreham, near Sevenoaks.
1884. *Prevost, Major L. de T. 2nd Battalion Argyll and Sutherland Highlanders.
1856. *PRICE, Rev. BARTHOLOMEW, M.A., F.R.S., F.R.A.S., Sedleian Professor of Natural Philosophy in the University of Oxford. 11 St. Giles's, Oxford.
1882. †Price, John E., F.S.A. 27 Bedford-place, Russell-square, London, W.C.
- Price, J. T. Neath Abbey, Glamorganshire.
1888. †Price, L. L. F. R., M.A., F.S.S. Oriel College, Oxford.
1881. §Price, Peter. 12 Windsor-place, Cardiff.
1875. *Price, Rees. 163 Bath-street, Glasgow.
1891. §Price, William. 40 Park-place, Cardiff.
1875. *Price, William Philip. Tibberton Court, Gloucester.
1876. †Priestley, John. 174 Lloyd-street, Greenheys, Manchester.
1875. †Prince, Thomas. 6 Marlborough-road, Bradford, Yorkshire.
1883. †Prince, Thomas. Horsham-road, Dorking.
1864. *Prior, R. C. A., M.D. 48 York-terrace, Regent's Park, London, N.W.
1846. *PRITCHARD, Rev. CHARLES, D.D., F.R.S., F.G.S., F.R.A.S., Professor of Astronomy in the University of Oxford. 8 Keble-terrace, Oxford.
1889. *Pritchard, Eric Law. 12 Alwyne-place, Canonbury, London, N.
1876. *PRITCHARD, URBAN, M.D., F.R.C.S. 3 George-street, Hanover-square, London, W.
1888. †Probyn, Leslie C. Onslow-square, London, S.W.
1881. §Procter, John William. Ashcroft, Nunthorpe, York.
1863. †Proctor, R. S. Summerhill-terrace, Newcastle-upon-Tyne.
- Proctor, William. Elmhurst, Higher Erith-road, Torquay.
1885. †Profeit, Dr. Balmoral, N.B.
1863. †Proud, Joseph. South Hetton, Newcastle-upon-Tyne.
1884. *Proudfoot, Alexander, M.D. 2 Phillips-place, Montreal, Canada.
1879. *Prouse, Oswald Milton, F.G.S., F.R.G.S. Alvington, Slade-road, Ilfracombe.
1865. †Prowse, Albert P. *Whitchurch Villa, Mannamead, Plymouth.*
1872. *Pryor, M. Robert. Weston Manor, Stevenage, Herts.
1871. *Puckle, Thomas John. 42 Cadogan-place, London, S.W.
1873. †Pullan, Lawrence. Bridge of Allan, N.B.
1867. *Pullar, Robert, F.R.S.E. Tayside, Perth.
1883. *Pullar, Rufus D., F.C.S. Ochil, Perth.
1891. §Pullen, W. W. F. University College, Cardiff.
1842. *Pumphrey, Charles. Southfield, King's Norton, near Birmingham.
1887. §PUMPHREY, WILLIAM. Lyncombe, Bath.
1885. §Purdie, Thomas, B.Sc., Ph.D., Professor of Chemistry in the University of St. Andrews. St. Andrews, N.B.
1852. †Purdon, Thomas Henry, M.D. Belfast.
1881. †Purey-Cust, Very Rev. Arthur Percival, M.A., Dean of York. The Deanery, York.

- Year of
Election.
1882. †Purrott, Charles. West End, near Southampton.
 1874. †PURSER, FREDERICK, M.A. Rathmines, Dublin.
 1866. †PURSER, Professor JOHN, M.A., M.R.I.A. Queen's College, Belfast.
 1878. †Purser, John Mallet. 3 Wilton-terrace, Dublin.
 1884. *Purves, W. Laidlaw. 20 Stafford-place, Oxford-street, London, W.
 1860. *Pusey, S. E. B. Bouverie. Pusey House, Faringdon.
 1883. §Pye-Smith, Arnold. 16 Fairfield-road, Croydon.
 1883. §Pye-Smith, Mrs. 16 Fairfield-road, Croydon.
 1868. †PYE-SMITH, P. H., M.D., F.R.S. 54 Harley-street, W.; and Guy's
 Hospital, London, S.E.
 1879. †Pye-Smith, R. J. 350 Glossop-road, Sheffield.
 1861. *Pyne, Joseph John. The Willows, Albert-road, Southport.
1870. †Rabbits, W. T. Forest Hill, London, S.E.
 1887. §Rabone, John. Penderell House, Hamstead-road, Birmingham.
 1870. †Radcliffe, D. R. Phoenix Safe Works, Windsor, Liverpool.
 1877. †Radford, George D. Mannead, Plymouth.
 1879. †Radford, R. Heber. Wood Bank, Pitsmoor, Sheffield.
 *Radford, William, M.D. Sidmount, Sidmouth.
 1855. *Radstock, *The Right Hon. Lord*. 70 Portland-place, London, W.
 1888. †Radway, C. W. 9 Bath-street, Bath.
 1878. †RAE, JOHN, M.D., LL.D., F.R.S., F.R.G.S. 4 Addison-gardens,
 Kensington, London, W.
 1887. *Ragdale, John Rowland. The Beeches, Whitefield, Manchester.
 1864. †Rainey, James T. St. George's Lodge, Bath.
 Rake, Joseph. Charlotte-street, Bristol.
 1885. †Ramsay, Major. Straloch, N.B.
 1863. †RAMSAY, ALEXANDER, F.G.S. 2 Cowper-road, Acton, Middlesex, W.
 1884. †Ramsay, George G., LL.D., Professor of Humanity in the University
 of Glasgow. 6 The College, Glasgow.
 1884. †Ramsay, Mrs. G. G. 6 The College, Glasgow.
 1861. †Ramsay, John. Kildalton, Argyllshire.
 1889. †Ramsay, Major R. G. W. Bonnyrigg, Edinburgh.
 1867. *Ramsay, W. F., M.D. 109 Sinclair-road, West Kensington Park,
 London, W.
 1876. *RAMSAY, WILLIAM, Ph.D., F.R.S., F.C.S., Professor of Chemistry in
 University College, London, W.C.
 1883. †Ramsay, Mrs. 12 Arundel-gardens, London, W.
 1887. †Ramsbottom, John. Fernhill, Alderley Edge, Cheshire.
 1873. *Ramsden, William. Bracken Hall, Great Horton, Bradford,
 Yorkshire.
 1835. *Rance, Henry. 6 Ormonde-terrace, Regent's Park, London, N.W.
 1869. *Rance, H. W. Henniker, LL.D. 10 Castletown-road, West Ken-
 sington, London, S.W.
 1865. †Randel, J. 50 Vittoria-street, Birmingham.
 1868. *Ransom, Edwin, F.R.G.S. Ashburnham-road, Bedford.
 1863. §Ransom, William Henry, M.D., F.R.S. The Pavement, Nottingham.
 1861. †Ransome, Arthur, M.A., M.D., F.R.S. Devisdale, Bowdon,
 Manchester.
 Ransome, Thomas. Hest Bank, near Lancaster.
 1872. *Ranyard, Arthur Cowper, F.R.A.S. 11 Stone-buildings, Lincoln's
 Inn, London, W.C.
 1889. §Rapkin, J. B. Sidcup, Kent.
 Rashleigh, Jonathan. 3 Cumberland-terrace, Regent's Park, London,
 N.W.
 1864. †Rate, Rev. John, M.A. Lapley Vicarage, Penkridge, Staffordshire.
 1870. †Rathbone, Benson. Exchange-buildings, Liverpool.

- Year of Election.
1870. †Rathbone, Philip H. Greenbank Cottage, Wavertree, Liverpool.
1870. †Rathbone, R. R. Beechwood House, Liverpool.
1874. †RAVENSTEIN, E. G., F.R.G.S., F.S.S. 91 Upper Tulse-hill, London, S.W.
Rawdon, William Frederick, M.D. Bootham, York.
1889. †Rawlings, Edward. Richmond House, Wimbledon Common, Surrey.
1870. †Rawlins, G. W. The Hollies, Rainhill, Liverpool.
1866. *RAWLINSON, Rev. Canon GEORGE, M.A. The Oaks, Precincts, Canterbury.
1855. *RAWLINSON, Major-General Sir HENRY C., Bart., G.C.B., LL.D., F.R.S., F.R.G.S. 21 Charles-street, Berkeley-square, London, W.
1887. †Rawson, Harry. Earlswood, Ellesmere Park, Eccles, Manchester.
1875. §RAWSON, Sir RAWSON W., K.C.M.G., C.B., F.R.G.S. 68 Cornwall-gardens, Queen's-gate, London, S.W.
1886. †Rawson, W. Stepney, M.A., F.C.S. 68 Cornwall-gardens, Queen's-gate, London, S.W.
1883. †Ray, Miss Catherine. Mount Cottage, Flask-walk, Hampstead, London, N.W.
1868. *RAYLEIGH, The Right Hon. Lord, M.A., D.C.L., LL.D., Sec.R.S., F.R.A.S., F.R.G.S., Professor of Natural Philosophy in the Royal Institution, London. Terling Place, Witham, Essex.
1883. *Rayne, Charles A., M.D., M.R.C.S. Queen-street, Lancaster.
- *Read, W. H. Rudston, M.A., F.L.S. 12 Blake-street, York.
1870. †READE, THOMAS MELLARD, F.G.S. Blundellsands, Liverpool.
1884. §Readman, J. B., D.Sc., F.R.S.E. 4 Lindsay-place, Edinburgh.
1852. *REDFERN, Professor PETER, M.D. 4 Lower-crescent, Belfast.
1863. †Redmayne, Giles. 20 New Bond-street, London, W.
1889. †Redmayne, J. M. Harewood, Gateshead.
1889. †Redmayne, Norman. 26 Grey-street, Newcastle-upon-Tyne.
1888. †Rednall, Miss Edith E. Ashfield House, Neston, near Chester.
1890. *Redwood, Boverton, F.R.S.E., F.C.S. 4 Bishopsgate-street Within, London, E.C.
Redwood, Isaac. Cae Wern, near Neath, South Wales.
1891. §Reece, Lewis Thomas. Somerset House, Roath, Cardiff.
1861. †REED, Sir EDWARD J., K.C.B., M.P., F.R.S. 75 Harrington-gardens, London, S.W.
1889. †Reed, Rev. George. Bellingham Vicarage, Bardon Mill.
1891. *Reed, Thomas A. Merchants' Exchange, Cardiff.
1891. §Rees, J. Treharne. The Elms, Penarth.
1891. §Rees, Samuel. West Wharf, Cardiff.
1891. §Rees, William. 25 Park-place, Cardiff.
1888. †Rees, W. L. 11 North-crescent, Bedford-square, London, W.C.
1875. †Rees-Mogg, W. Wooldridge. Cholwell House, near Bristol.
1881. *Reid, Arthur S., B.A., F.G.S. Trinity College, Glensalmond, N.B.
1883. *REID, CLEMENT, F.G.S. 28 Jermyn-street, London, S.W.
1889. †Reid, George, Belgian Consul. Leazes House, Newcastle-upon-Tyne.
1876. †Reid, James. 10 Woodside-terrace, Glasgow.
1884. †Reid, Rev. James, B.A. Bay City, Michigan, U.S.A.
1887. *Reid, Walter Francis. Fieldside, Addlestone, Surrey.
1850. †Reid, William, M.D. Cruvie, Cupar Fife.
1881. †Reid, William. 19½ Blake-street, York.
1875. §REINOLD, A. W., M.A., F.R.S., Professor of Physical Science in the Royal Naval College, Greenwich, S.E.
1863. †RENALS, E. 'Nottingham Express' Office, Nottingham.
1891. §Rendell, Rev. J. R. Whinside, Accrington.

Year of
Election.

1885. †Rennett, Dr. 12 Golden-square, Aberdeen.
 1889. *Rennie, George B. Hooley Lodge, Redhill.
 1867. †Renny, W. W. 8 Douglas-terrace, Broughty Ferry, Dundee.
 1883. *Reynolds, A. H. Manchester and Salford Bank, Southport.
 1871. †REYNOLDS, JAMES EMERSON, M.D., D.Sc., F.R.S., V.P.C.S., M.R.I.A.,
 Professor of Chemistry in the University of Dublin. The Laboratory,
 Trinity College, Dublin.
 1870. *REYNOLDS, OSBORNE, M.A., LL.D., F.R.S., M.Inst.C.E., Professor
 of Engineering in Owens College, Manchester. 23 Lady Barn-
 road, Fallowfield, Manchester.
 1858. §REYNOLDS, RICHARD, F.C.S. 13 Briggate, Leeds.
 1887. †Rhodes, George W. The Cottage, Victoria Park, Manchester.
 1883. †Rhodes, Dr. James. 25 Victoria-street, Glossop.
 1890. §Rhodes, J. M., M.D. Ivy Lodge, Didsbury.
 1858. *Rhodes, John. 18 Albion-street, Leeds.
 1877. *Rhodes, John. 360 Blackburn-road, Accrington, Lancashire.
 1888. §Rhodes, John George. Warwick House, 46 St. George's-road,
 London, S.W.
 1884. †Rhodes, Lieut.-Colonel William. Quebec, Canada.
 1877. *Riccardi, Dr. Paul, Secretary of the Society of Naturalists. Via
 Stimate, 15, Modena, Italy.
 1891. §Richards, D. 1 St. Andrew's-crescent, Cardiff.
 1891. §Richards, H. M. 1 St. Andrew's-crescent, Cardiff.
 1889. †Richards, Professor T. W., Ph.D. Cambridge, Massachusetts,
 U.S.A.
 1888. *RICHARDSON, ARTHUR, M.D. University College, Bristol.
 1863. †RICHARDSON, BENJAMIN WARD, M.A., M.D., LL.D., F.R.S. 25
 Manchester-square, London, W.
 1861. †Richardson, Charles. 10 Berkeley-square, Bristol.
 1869. *Richardson, Charles. 4 Northumberland-avenue, Putney, S.W.
 1887. *Richardson, Miss Emma. Conway House, Dunmurry, Co. Antrim.
 1882. §Richardson, Rev. George, M.A. The College, Winchester.
 1884. *Richardson, George Straker. Isthmian Club, 150 Piccadilly,
 London, W.
 1889. §Richardson, Hugh. Sedbergh School, Sedbergh R.S.O., York-
 shire.
 1884. *Richardson, J. Clarke. Derwen Fawr, Swansea.
 1870. †Richardson, Ralph, F.R.S.E. 10 Magdala-place, Edinburgh.
 1889. †Richardson, Thomas, J.P. 7 Windsor-terrace, Newcastle-upon-
 Tyne.
 1881. †Richardson, W. B. Elm Bank, York.
 1861. †Richardson, William. 4 Edward-street, Werneth, Oldham.
 1876. §Richardson, William Haden. City Glass Works, Glasgow.
 1891. §Riches, Carlton H. 21 Dumfries-place, Cardiff.
 1891. §Riches T. Harry. 8 Park-grove, Cardiff.
 1886. §Richmond, Robert. Leighton Buzzard.
 1863. †Richter, Otto, Ph.D. 407 St. Vincent-street, Glasgow.
 1868. †RICKETTS, CHARLES, M.D., F.G.S. 18 Hamilton-square, Birkenhead.
 1877. †Ricketts, James, M.D. St. Helens, Lancashire.
 *RIDDELL, Major-General CHARLES J. BUCHANAN, C.B., R.A., F.R.S.
 Oaklands, Chudleigh, Devon.
 1883. *Rideal, Samuel, D.Sc., F.C.S., F.G.S. 41 Carlyle-square, London, S.W.
 1862. †Ridgway, Henry Ackroyd, B.A. Bank Field, Halifax.
 1861. †Ridley, John. 19 Belsize-park, Hampstead, London, N.W.
 1889. §Ridley, Thomas D. Coatham, Redcar.
 1884. †Ridout, Thomas. Ottawa, Canada.
 1863. *Rigby, Samuel. Fern Bank, Liverpool-road, Chester.

Year of
Election.

1881. *Rigg, Arthur. 71 Warrington-crescent, London, W.
 1883. *RIGG, EDWARD, M.A. Royal Mint, London, E.
 1883. †Rigg, F. F., M.A. 32 Queen's-road, Southport.
 1883. *Rigge, Samuel Taylor, F.S.A. Balmoral-place, Halifax.
 1873. †Ripley, Sir Edward, Bart. Acacia, Apperley, near Leeds.
 *RIPON, The Most Hon. the Marquis of, K.G., G.C.S.I., C.I.E., D.C.L.,
 F.R.S., F.L.S., F.R.G.S. 9 Chelsea Embankment, London,
 S.W.
 1867. †Ritchie, John. Fleuchar Craig, Dundee.
 1867. †Ritchie, William. Emslea, Dundee.
 1889. †Ritson, U. A. 1 Jesmond-gardens, Newcastle-upon-Tyne.
 1869. *Rivington, John. Babbicombe, near Torquay.
 1888. †Robb, W. J. Firth College, Sheffield.
 1854. †Robberds, Rev. John, B.A. Battledown Tower, Cheltenham.
 1869. *ROBBINS, JOHN, F.C.S. 57 Warrington-crescent, Maida Vale,
 London, W.
 1878. †Roberts, Charles, F.R.C.S. 2 Bolton-row, London, W.
 1887. *Roberts, Evan. 3 Laurel-bank, Alexandra-road, Manchester.
 1859. †Roberts, George Christopher. Hull.
 1870. *ROBERTS, ISAAC, F.R.S., F.R.A.S., F.G.S. Crowborough, Sussex.
 1891. §Roberts, Rev. J. Crossby, F.R.G.S. 41 Derby-road, East Park,
 Nottingham.
 1883. †Roberts, Ralph A. 4 Colville Mansions, Powis-terrace, London, W.
 1881. †Roberts, R. D., M.A., D.Sc., F.G.S. 1 Field-court, Gray's Inn,
 London, W.C.
 1879. †Roberts, Samuel. The Towers, Sheffield.
 1879. †Roberts, Samuel, jun. The Towers, Sheffield.
 1883. †ROBERTS, Sir WILLIAM, M.D., F.R.S. 8 Manchester-square,
 London, W.
 1868. *ROBERTS-AUSTEN, W. CHANDLER, C.B., F.R.S., F.C.S., Chemist to
 the Royal Mint, and Professor of Metallurgy in the Royal Col-
 lege of Science, London. Royal Mint, London, E.
 1883. †Robertson, Alexander. Montreal, Canada.
 1859. †Robertson, Dr. Andrew. Indego, Aberdeen.
 1884. †Robertson, E. Stanley, M.A. 43 Waterloo-road, Dublin.
 1871. †Robertson, George, M.Inst.C.E., F.R.S.E. Athenæum Club, Lon-
 don, S.W.
 1883. †Robertson, George H. Plas Newydd, Llangollen.
 1883. †Robertson, Mrs. George H. Plas Newydd, Llangollen.
 1876. †Robertson, R. A. Newthorn, Ayton-road, Pollokshields, Glasgow.
 1888. *Robins, Edward Cookworthy, F.S.A. 46 Berners-street, Oxford-
 street, London, W.
 1886. *Robinson, C. R. 27 Elvetham-road, Birmingham.
 1886. †Robinson, Edward E. 56 Dovey-street, Liverpool.
 1861. †Robinson, Enoch. Dukinfield, Ashton-under-Lyne.
 1852. †Robinson, Rev. George. Beech Hill, Armagh.
 1887. †Robinson, Henry. 7 Westminster-chambers, London, S.W.
 1887. †Robinson, James. Akroydon Villa, Halifax, Yorkshire.
 1861. †ROBINSON, JOHN, M.Inst.C.E. Atlas Works, Manchester.
 1888. §Robinson, John. Engineer's Office, Barry Dock, Cardiff.
 1863. †Robinson, J. H. 6 Montallo-terrace, Barnard Castle.
 1878. †Robinson, John L. 198 Great Brunswick-street, Dublin.
 1876. †Robinson, M. E. 6 Park-circus, Glasgow.
 1887. §Robinson, Richard. Bellfield Mill, Rochdale.
 1881. †Robinson, Richard Atkinson. 195 Brompton-road, London, S.W.
 1875. *Robinson, Robert, M.Inst.C.E., F.G.S. Beechwood, Darlington.
 1884. †Robinson, Stillman. Columbus, Ohio, U.S.A.

Year of
Election.

1863. †Robinson, T. W. U. Houghton-le-Spring, Durham.
 1891. §Robinson, William, Assoc.M.Inst.C.E., Professor of Engineering in University College, Nottingham.
 1888. §Robottom, Arthur. 3 St. Alban's-villas, Highgate-road, London, N.W.
 1870. *Robson, E. R. Palace Chambers, 9 Bridge-street, Westminster, S.W.
 1876. †Robson, Hazleton R. 14 Royal-crescent West, Glasgow.
 1872. *Robson, William. Marchholm, Gillsland-road, Merchiston, Edinburgh.
 1885. §Rodger, Edward. 1 Claremont-gardens, Glasgow.
 1885. *Rodriguez, Epifanio. 12 John-street, Adelphi, London, W.C.
 1872. †Rodwell, George F. Marlborough College, Wiltshire.
 1866. †Roe, Thomas. Grove-villas, Sitchurch.
 1867. †Rogers, James S. Rosemill, by Dundee.
 1890. *Rogers, L. J., M.A., Professor of Mathematics in Yorkshire College, Leeds. 13 Beech Grove-terrace, Leeds.
 1883. †Rogers, Major R. Alma House, Cheltenham.
 1882. §Rogers, Rev. Saltren, M.A. Gwennap, Redruth, Cornwall.
 1883. †Rogers, Thomas Stanley, LL.B. 77 Albert-road, Southport.
 1884. *Rogers, Walter M. Lamowa, Falmouth.
 1886. †Rogers, W. Woodbourne. Wheeley's-road, Edgbaston, Birmingham.
 1889. †Rogerson, John. Croxdale Hall, Durham.
 1876. †ROLLIE, Sir A. K., M.P., B.A., LL.D., D.C.L., F.R.A.S., Hon. Fellow K.C.L. Thwaite House, Cottingham, East Yorkshire.
 1876. †ROMANES, GEORGE JOHN, M.A., LL.D., F.R.S., F.L.S. St. Aldate's, Oxford.
 1891. §Rönnfeldt, W. 43 Park-place, Cardiff.
 1869. †Roper, C. H. Magdalen-street, Exeter.
 1872. *Roper, Freeman Clarke Samuel, F.L.S., F.G.S. Palgrave House, Eastbourne.
 1881. *Roper, W. O. Eadenbreck, Lancaster.
 1855. *ROSCOE, Sir HENRY ENFIELD, B.A., Ph.D., LL.D., D.C.L., M.P., F.R.S., F.C.S. 10 Bramham-gardens, London, S.W.
 1883. *Rose, J. Holland, M.A. Aboyne, Bedford Hill-road, Balham, London, S.W.
 1885. †Ross, Alexander. Riverfield, Inverness.
 1874. †Ross, Alexander Milton, M.A., M.D., F.G.S. Toronto, Canada.
 1857. †Ross, David, LL.D. 32 Nelson-street, Dublin.
 1887. †Ross, Edward. Marple, Cheshire.
 1880. †Ross, Captain G. E. A., F.R.G.S. 8 Collingham-gardens, Cromwell-road, London, S.W.
 1872. †Ross, James, M.D. Tenterfield House, Waterfoot, near Manchester.
 1859. *Ross, Rev. James Coulman. Wadworth Hall, Doncaster.
 1869. *ROSSE, The Right Hon. the Earl of, K.P., B.A., D.C.L., LL.D., F.R.S., F.R.A.S., M.R.I.A. Birr Castle, Parsonstown, Ireland.
 1891. §Roth, H. Ling. Lightcliffe, Leeds.
 1865. *Rothera, George Bell. 17 Waverley-street, Nottingham.
 1876. †Rottenburgh, Paul. 13 Albion-crescent, Glasgow.
 1884. *Rouse, M. L. 343 Church-street, Toronto, Canada.
 1861. †ROUTH, EDWARD J., M.A., D.Sc., F.R.S., F.R.A.S., F.G.S. St. Peter's College, Cambridge.
 1861. †Rowan, David. Elliot-street, Glasgow.
 1883. †Rowan, Frederick John. 134 St. Vincent-street, Glasgow.
 1887. †Rowe, Rev. Alfred W., M.A., F.G.S. Felstead, Essex.
 1881. †Rowe, Rev. G. Lord Mayor's Walk, York.
 1865. †Rowe, Rev. John. 13 Hampton-road, Forest Gate, Essex.

- Year of
Election.
1877. †**ROWE**, J. **BROOKING**, F.L.S., F.S.A. 16 Lockyer-street, Plymouth.
1890. †**Rowley**, Walter, F.S.A. Alderhill, Meanwood, Leeds.
1855. ***ROWNEY**, THOMAS H., Ph.D., F.C.S., Professor of Chemistry in Queen's College, Galway. Salerno, Salthill, Galway.
1881. ***Rowntree**, Joseph. 37 St. Mary's, York.
1881. ***ROWNTREE**, J. S. The Mount, York.
1862. †**Rowsell**, Rev. Evan Edward, M.A. Hambleton Rectory, Godalming.
1876. †**Roxburgh**, John. 7 Royal Bank-terrace, Glasgow.
1883. †**Roy**, Charles S., M.D., F.R.S., Professor of Pathology in the University of Cambridge. Trinity College, Cambridge.
1885. †**Roy**, John. 33 Belvidere-street, Aberdeen.
1888. †**Roy**, Parbati Churn, B.A. Calcutta, Bengal, India.
1875. ***RÜCKER**, A. W., M.A., F.R.S., Professor of Physics in the Royal College of Science, London. (GENERAL TREASURER) 19 Gledhow-gardens, South Kensington, London, S.W.
1869. §**RUDLER**, F. W., F.G.S. The Museum, Jermyn-street, London, S.W.
1882. †**Rumball**, Thomas, M.Inst.C.E. 8 Queen Anne's-gate, London, S.W.
1884. §**Runtz**, John. Linton Lodge, Lordship-road, Stoke Newington, London, N.
1887. §**Ruscoe**, John, F.G.S. Ferndale, Gee Cross, near Manchester.
1847. †**RUSKIN**, JOHN, M.A., D.C.L., F.G.S. Brantwood, Coniston, Ambleside.
1889. §**Russell**, The Right Hon. Earl. Amberley Cottage, Maidenhead.
1875. ***Russell**, The Hon. F. A. R. Pembroke Lodge, Richmond Park, Surrey.
1884. †**Russell**, George. 13 Church-road, Upper Norwood, London, S.E.
1890. §**Russell**, J. A., M.B. Woodville, Canaan-lane, Edinburgh.
1883. ***Russell**, J. W. 10 Fyfield-road, Oxford.
- Russell**, John. 39 Mountjoy-square, Dublin.
1852. ***Russell**, Norman Scott. Arts Club, Hanover-square, London, W.
1876. §**Russell**, R., F.G.S. 1 Sea View, St. Bees, Carnforth.
1886. †**Russell**, Thomas H. 3 Newhall-street, Birmingham.
1852. ***RUSSELL**, WILLIAM J., Ph.D., F.R.S., F.C.S., Lecturer on Chemistry in St. Bartholomew's Medical College. 34 Upper Hamilton-terrace, St. John's Wood, London, N.W.
1886. †**Rust**, Arthur. Eversleigh, Leicester.
1883. ***Ruston**, Joseph, M.P. Monk's Manor, Lincoln.
1889. †**Rutherford**, Rev. Dr. 6 Eldon-square, Newcastle-upon-Tyne.
1891. §**Rutherford**, George. Garth House, Taff's Well, Cardiff.
1871. §**RUTHERFORD**, WILLIAM, M.D., F.R.S., F.R.S.E., Professor of the Institutes of Medicine in the University of Edinburgh.
1887. †**Rutherford**, William. 7 Vine-grove, Chapman-street, Hulme, Manchester.
- Rutson**, William. Newby Wiske, Northallerton, Yorkshire.
1879. †**Ruxton**, Vice-Admiral Fitzherbert, R.N., F.R.G.S. 41 Cromwell-gardens, London, S.W.
1875. †**Ryalls**, Charles Wager, LL.D. 3 Brick-court, Temple, London, E.C.
1889. §**Ryder**, W. J. H. 52 Jesmond-road, Newcastle-upon-Tyne.
1886. †**Ryland**, F. *Augustus-road, Edgbaston, Birmingham.*
1865. †**Ryland**, Thomas. The Redlands, Erdington, Birmingham.
1861. ***RYLANDS**, THOMAS GLAZEBROOK, F.L.S., F.G.S. Highfields, Thelwall, near Warrington.

Year of
Election.

1883. *Sabine, Robert. 3 Great Winchester-street-buildings, London, E.C.
 1883. †Sadler, Robert. 7 Lulworth-road, Birkdale, Southport.
 1871. †Sadler, Samuel Champernowne. Purton Court, Purton, near Swindon,
 Wiltshire.
 1885. §Saint, W. Johnston. 11 Queen's-road, Aberdeen.
 1866. *St. Albans, His Grace the Duke of. Bestwood Lodge, Arnold, near
 Nottingham.
 1886. §St. Clair, George, F.G.S. 127 Bristol-road, Birmingham.
 1887. *SALFORD, the Right Rev. the Bishop of. Bishop's House, Salford.
 1881. †Salkeld, William. 4 Paradise-terrace, Darlington.
 1857. †SALMON, Rev. GEORGE, D.D., D.C.L., LL.D., F.R.S., Provost of
 Trinity College, Dublin.
 1883. †Salmond, Robert G. The Nook, Kingswood-road, Upper Norwood,
 S.E.
 1873. *Salomons, Sir David, Bart. Broomhill, Tunbridge Wells.
 1883. †Salt, Shirley H., M.A. 73 Queensborough-terrace, London, W.
 1872. †SALVIN, OSBERT, M.A., F.R.S., F.L.S. Hawksfold, Haslemere.
 1887. †Samson, C. L. Carmona, Kersal, Manchester.
 1861. *Samson, Henry. 6 St. Peter's-square, Manchester.
 1861. *Sandeman, Archibald, M.A. Garry Cottage, Perth.
 1883. †Sandeman, E. 53 Newton-street, Greenock.
 1878. †Sanders, Alfred, F.L.S. 2 Clarence-place, Gravesend, Kent.
 1883. *Sanders, Charles J. B. Pennsylvania, Exeter.
 1834. †Sanders, Henry. 185 James-street, Montreal, Canada.
 1883. †Sanderson, Deputy Surgeon-General Alfred. East India United
 Service Club, St. James's-square, London, S.W.
 1872. †SANDERSON, J. S. BURDON, M.D., LL.D., D.C.L., F.R.S., Professor
 of Physiology in the University of Oxford. 64 Banbury-road,
 Oxford.
 1883. †Sanderson, Mrs. Burdon. 64 Banbury-road, Oxford.
 Sandes, Thomas, A.B. Sallow Glin, Tarbert, Co. Kerry.
 1886. §Sankey, Percy E. Hill House, Lyndhurst, Kent.
 1886. †Sauborn, John Wentworth. Albion, New York, U.S.A.
 1886. †Saundby, Robert, M.D. 83A Edmund-street, Birmingham.
 1868. †Saunders, A., M.Inst.C.E. King's Lynn.
 1886. †Saunders, C. T. Temple-row, Birmingham.
 1881. †SAUNDERS, HOWARD, F.L.S., F.Z.S. 7 Radnor-place, London, W.
 1883. †Saunders, Rev. J. C. Cambridge.
 1846. †SAUNDERS, TRELAWNEY W., F.R.G.S. 3 Elmfield on the Knowles,
 Newton Abbot, Devon.
 1884. †Saunders, William. Experimental Farm, Ottawa, Canada.
 1891. §Saunders, W. H. R. Llanishen, Cardiff.
 1884. †Saunderson, C. E. 26 St. Famille-street, Montreal, Canada.
 1887. §Savage, Rev. E. B., M.A., F.S.A. St. Thomas' Parsonage, Douglas,
 Isle of Man.
 1871. §Savage, W. D. Ellerslie House, Brighton.
 1883. †Savage, W. W. 109 St. James's-street, Brighton.
 1883. †Savery, G. M., M.A. The College, Harrogate.
 1872. *Sawyer, George David, F.R.M.S. 55 Buckingham-place, Brighton.
 1887. §SAYCE, Rev. A. H., M.A., D.D. Queen's College, Oxford.
 1884. †Sayre, Robert H. Bethlehem, Pennsylvania, U.S.A.
 1883. *Scarborough, George. Holly Bank, Halifax, Yorkshire.
 1884. †Searth, William Bain. Winnipeg, Manitoba, Canada.
 1868. §Schacht, G. F. 1 Windsor-terrace, Olifton, Bristol.
 1879. *SCHÄFER, E. A., F.R.S., M.R.C.S., Professor of Physiology in Uni-
 versity College, London. Croxley Green, Rickmansworth.
 1883. †Schäfer, Mrs. Croxley Green, Rickmansworth.

Year of
Election.

1888. §SCHARFF, ROBERT F., Ph.D., B.Sc. Keeper of the Natural History Museum Department of Science and Art, Dublin.
1880. *Schemmann, Louis Carl. Hamburg. (Care of Messrs. Allen Everitt & Sons, Birmingham.)
1842. Schofield, Joseph. Stubley Hall, Littleborough, Lancashire.
1887. †Schofield, T. Thornfield, Talbot-road, Old Trafford, Manchester.
1883. †Schofield, William. Alma-road, Birkdale, Southport.
1885. §Scholes, L. 49 Dover-street, Higher Crumpsall, Manchester.
1888. †Scholey, J. Cranefield. 30 Sussex-villas, Kensington, London, W.
1887. †Schorlemmer, Carl, LL.D., F.R.S., Professor of Organic Chemistry in the Owens College, Manchester. Victoria Park, Manchester.
- SCHUNCK, EDWARD, Ph.D., F.R.S., F.C.S. Oaklands, Kersal Moor, Manchester.
1873. *SCHUSTER, ARTHUR, Ph.D., F.R.S., F.R.A.S., Professor of Physics in the Owens College, Manchester.
1887. †Schwabe, Colonel G. Salis. Portland House, Higher Crumpsall, Manchester.
1847. *SCLATER, PHILIP LUTLEY, M.A., Ph.D., F.R.S., F.L.S., F.G.S., F.R.G.S., Sec.Z.S. 3 Hanover-square, London, W.
1883. *SCLATER, WILLIAM LUTLEY, B.A., F.Z.S. 3 Hanover-square, London, W.
1867. †SCOTT, ALEXANDER. Clydesdale Bank, Dundee.
1881. *Scott, Alexander, M.A., D.Sc. 4 North Bailey, Durham.
1882. †Scott, Colonel A. de C., R.E. Ordnance Survey Office, Southampton.
1878. *Scott, Arthur William, M.A., Professor of Mathematics and Natural Science in St. David's College, Lampeter.
1881. §Scott, Miss Charlotte Angus. Lancashire College, Whalley Range, Manchester.
1889. §SCOTT, D. H., M.A., Ph.D., F.L.S. The Laurels, Bickley, Kent.
1885. †Scott, George Jamieson. Bayview House, Aberdeen.
1886. †Scott, Robert. 161 Queen Victoria-street, London, E.C.
1857. *SCOTT, ROBERT H., M.A., F.R.S., F.G.S., F.R.Met.S., Secretary to the Council of the Meteorological Office. 6 Elm Park-gardens, London, S.W.
1861. §Scott, Rev. Robert Selkirk, D.D. 16 Victoria-crescent, Dowanhill, Glasgow.
1884. *Scott, Sydney C. 15 Queen-street, Cheapside, London, E.C.
1869. †Scott, William Bower. Chudleigh, Devon.
1881. *Scrivener, A. P. Haglis House, Wendover.
1883. †Scrivener, Mrs. Haglis House, Wendover.
1890. §Searle, G. F. C., B.A. Peterhouse, Cambridge.
1859. †Seaton, John Love. The Park, Hull.
1880. †SEDGWICK, ADAM, M.A., F.R.S. Trinity College, Cambridge.
1880. †SEEBOHM, HENRY, F.R.G.S., F.L.S., F.Z.S. 22 Courtfield-gardens, London, S.W.
1861. *SEELEY, HARRY GOVIER, F.R.S., F.L.S., F.G.S., F.R.G.S., F.Z.S., Professor of Geography in King's College, London. 25 Palace Gardens-terrace, Kensington, London, W.
1891. §Selby, Arthur L., M.A., Assistant Professor of Physics in University College, Cardiff.
1855. †Seligman, H. L. 27 St. Vincent-place, Glasgow.
1879. §Selim, Adolphus. 21 Mincing-lane, London, E.C.
1885. §Semple, Dr. United Service Club, Edinburgh.
1887. §Semple, James C., M.R.I.A. 64 Grosvenor-road, Rathmines, Dublin.
1873. †Semple, R. II., M.D. 8 Torrington-square, London, W.C.

Year of
Election.

1888. §Senior, Alfred, M.D., Ph.D., F.C.S. Thornfield, Harold-road, London, S.E.
 1858. *Senior, George, F.S.S. Old Whittington, Chesterfield.
 1888. *Sennett, Alfred R., A.M.Inst.C.E. Temple-chambers, Victoria Embankment, London, E.C.
 1870. *Sephton, Rev. J. 90 Huskisson-street, Liverpool.
 1883. †Seville, Miss M. A. Blythe House, Southport.
 1875. †Seville, Thomas. Blythe House, Southport.
 1891. §Seward, Edwin. 55 Newport-road, Cardiff.
 1868. †Sewell, Philip E. Catton, Norwich.
 1891. §Shackell, E. W. 191 Newport-road, Cardiff.
 1888. †Shackles, Charles F. Hornsea, near Hull.
 1883. †Shadwell, John Lancelot. 17 St. Charles-square, Ladbroke Grove-road, London, W.
 1871. *Shand, James. Parkholme, Elm Park-gardens, London, S.W.
 1867. †Shanks, James. Dens Iron Works, Arbroath, N.B.
 1881. †Shann, George, M.D. Petergate, York.
 1869. *Shapter, Dr. Lewis, LL.D. 1 Barnfield-crescent, Exeter.
 1878. †SHARP, DAVID, M.A., M.B., F.R.S., F.L.S. Museum of Zoology, Cambridge.
 Sharp, Rev. John, B.A. Horbury, Wakefield.
 1886. †Sharp, T. B. French Walls, Birmingham.
 *Sharp, William, M.D., F.R.S., F.G.S. Horton House, Rugby.
 Sharp, Rev. William, B.A. Mareham Rectory, near Boston, Lincolnshire.
 1883. †Sharples, Charles H., F.C.S. 7 Fishergate, Preston.
 1870. †Shaw, Duncan. Cordova, Spain.
 1865. †Shaw, George. Cannon-street, Birmingham.
 1887. *Shaw, James B. Holly Bank, Cornbrook, Manchester.
 1870. †Shaw, John. 21 St. James's-road, Liverpool.
 1891. §Shaw, Joseph. 1 Temple-gardens, London, E.C.
 1887. §Shaw, Saville. College of Science, Newcastle-upon-Tyne.
 1883. *SHAW, W. N., M.A., F.R.S. Emmanuel House, Cambridge.
 1883. †Shaw, Mrs. W. N. Emmanuel House, Cambridge.
 1883. †Sheard, J. 42 Hoghton-street, Southport.
 1891. §Sheen, Dr. Alfred. 23 Newport-road, Cardiff.
 1884. †Sheldon, Professor J. P. Downton College, near Salisbury.
 1878. †Shelford, William, M.Inst.C.E. 35A Great George-street, Westminster, S.W.
 1865. †Shenstone, Frederick S. Sutton Hall, Barcombe, Lewes.
 1881. †SHENSTONE, W. A. Clifton College, Bristol.
 1885. †Shepherd, Rev. Alexander. Ecclesmechen, Uphall, Edinburgh.
 1863. †Shepherd, A. B. 17 Great Cumberland-place, Hyde Park, London, W.
 1885. †Shepherd, Charles. 1 Wellington-street, Aberdeen.
 1890. §Shepherd, J. Care of J. Redmayne, Esq., Grove House, Headingley, Leeds.
 1883. †Shepherd, James. Birkdale, Southport.
 1883. §Sherlock, David. Rahan Lodge, Tullamore, Dublin.
 1883. §Sherlock, Mrs. David. Rahan Lodge, Tullamore, Dublin.
 1883. †Sherlock, Rev. Edgar. Bentham Rectory, *via* Lancaster.
 1888. *Shickle, Rev. C. W., M.A. Langridge Rectory, Bath.
 1886. †Shield, Arthur H. 35A Great George-street, London, S.W.
 1883. *Shillitoe, Buxton, F.R.C.S. 2 Frederick-place, Old Jewry, London, E.C.
 1867. †Shinn, William C. 39 Varden's-road, Clapham Junction, Surrey, S.W.
 1887. *SHIPLEY, ARTHUR E., M.A. Christ's College, Cambridge.
 1889. †Shipley, J. A. D. Saltwell Park, Gateshead.

Year of
Election.

1885. †Shirras, G. F. 16 Carden-place, Aberdeen.
 1883. †Shone, Isaac. Pentrefelin House, Wrexham.
 1870. *SHOOLBRED, JAMES N., M.Inst.C.E., F.G.S. 1 Westminster-chambers,
 London, S.W.
 1888. †Shoppee, C. H. 22 John-street, Bedford-row, London, W.C.
 1888. §Shoppee, G. A., M.A., LL.D. 61 Doughty-street, London,
 W.C.
 1875. †SHORE, THOMAS W., F.C.S., F.G.S. Hartley Institution, South-
 ampton.
 1882. †SHORE, T. W., M.D., B.Sc., Lecturer on Comparative Anatomy at
 St. Bartholomew's Hospital. Sunny Bank, Church-lane,
 Hornsey, London, N.
 1889. †Sibley, Walter K., B.A., M.B. 7 Harley-street, London, W.
 1883. †Sibly, Miss Martha Agnes. Flook House, Taunton.
 1883. *Sidebotham, Edward John. Erlesdene, Bowdon, Cheshire.
 1883. *Sidebotham, James Nasmyth. Parkfield, Altrincham, Cheshire.
 1877. *Sidebotham, Joseph Watson. Erlesdene, Bowdon, Cheshire.
 1885. *SIDGWICK, HENRY, M.A., Litt.D., D.C.L., Professor of Moral Philo-
 sophy in the University of Cambridge. Hillside, Chesterton-
 road, Cambridge.
 Sidney, M. J. F. Cowpen, Newcastle-upon-Tyne.
 1873. *Siemens, Alexander. 7 Airlie-gardens, Campden Hill, London, W.
 1878. †SIGERSON, Professor GEORGE, M.D., F.L.S., M.R.I.A. 3 Clare-
 street, Dublin.
 1859. †Sim, John. Hardgate, Aberdeen.
 1871. †Sime, James. Craigmount House, Grange, Edinburgh.
 1862. †Simms, James. 138 Fleet-street, London, E.C.
 1874. †Simms, William. The Linen Hall, Belfast.
 1876. †Simon, Frederick. 24 Sutherland-gardens, London, W.
 1887. *Simon, Henry. Darwin House, Didsbury, near Manchester.
 1847. †Simon, Sir John, K.C.B., D.C.L., F.R.S., F.R.C.S., Consulting
 Surgeon to St. Thomas's Hospital. 40 Kensington-square,
 London, W.
 1866. †Simons, George. The Park, Nottingham.
 1871. *SIMPSON, ALEXANDER R., M.D., Professor of Midwifery in the Uni-
 versity of Edinburgh. 52 Queen-street, Edinburgh.
 1883. †Simpson, Byron R. 7 York-road, Birkdale, Southport.
 1887. †Simpson, F. Estacion Central, Buenos Ayres.
 1867. †Simpson, G. B. Seafield, Broughty Ferry, by Dundee.
 1859. †Simpson, John. Maykirk, Kincardineshire.
 1863. †Simpson, J. B., F.G.S. Hedgefield House, Blaydon-on-Tyne.
 1857. †SIMPSON, MAXWELL, M.D., LL.D., F.R.S., F.C.S., Professor of
 Chemistry in Queen's College, Cork.
 1883. †Simpson, Walter M. 7 York-road, Birkdale, Southport.
 Simpson, William. Bradmore House, Hammersmith, London, W.
 1887. †Sinclair, Dr. 268 Oxford-street, Manchester.
 1874. †Sinclair, Thomas. Dunedin, Belfast.
 1870. *Sinclair, W. P., M.P. Rivelyn, Prince's Park, Liverpool.
 1864. *Sircar, The Hon. Mahendra Lal, M.D., C.I.E. 51 Sankaritola, Cal-
 cutta.
 1879. †Skertchly, Sydney B. J., F.G.S. 3 Loughborough-terrace, Carshal-
 ton, Surrey.
 1883. †Skillicorne, W. N. 9 Queen's-parade, Cheltenham.
 1885. †Skinner, Provost. Inverurie, N.B.
 1888. §SKRINE, H. D., J.P., D.L. Claverton Manor, Bath.
 1870. §SLADEN, WALTER PERCY, F.G.S., F.L.S. 13 Hyde Park-gate, Lon-
 don, S.W.

Year of
Election.

1873. †Slater, Clayton. Barnoldswick, near Leeds.
 1889. §Slater, Matthew B., F.L.S. Malton, Yorkshire.
 1884. †Slattery, James W. 9 Stephen's-green, Dublin.
 1877. †Sleeman, Rev. Philip, L.Th., F.R.A.S., F.G.S. Clifton, Bristol.
 1891. §Slocombe, James. Redland House, Fitzalan, Cardiff.
 1884. †Slooten, William Venn. Nova Scotia, Canada.
 1849. †Sloper, George Elgar. Devizes.
 1860. †Sloper, S. Elgar. Winterton, near Hythe, Southampton.
 1867. †Small, David. Gray House, Dundee.
 1887. §Small, E. W., M.A., F.G.S. 11 Arthur-street, Nottingham.
 1887. §Small, William. Cavendish-crescent North, The Park, Nottingham.
 1881. †Smallshan, John. 81 Manchester-road, Southport.
 1885. †Smart, James. Valley Works, Brechin, N.B.
 1889. *Smart, William. Nunholme, Dowanhill, Glasgow.
 1858. †Smeeton, G. H. Commercial-street, Leeds.
 1876. §Smellie, Thomas D. 213 St. Vincent-street, Glasgow.
 1877. †Smelt, Rev. Maurice Allen, M.A., F.R.A.S. Heath Lodge, Cheltenham.
 1890. §Smethurst, Charles. Palace House, Harpurhey, Manchester.
 1876. †Smieton, James. Panmure Villa, Broughty Ferry, Dundee.
 1876. †Smieton, John G. 3 Polworth-road, Coventry Park, Streatham, London, S.W.
 1867. †Smieton, Thomas A. Panmure Villa, Broughty Ferry, Dundee.
 1857. †Smith, Aquilla, M.D., M.R.I.A. 121 Lower Baggot-street, Dublin.
 1872. *Smith, Basil Woodd, F.R.A.S. Branch Hill Lodge, Hampstead Heath, London, N.W.
 1874. *Smith, Benjamin Leigh, F.R.G.S. Oxford and Cambridge Club, Pall Mall, London, S.W.
 1887. †Smith, Bryce. Rye Bank, Chorlton-cum-Hardy, Manchester.
 1873. †Smith, C. Sidney College, Cambridge.
 1887. *Smith, Charles. 739 Rochdale-road, Manchester.
 1889. *Smith, Professor C. Michie, B.Sc., F.R.S.E., F.R.A.S. Christian College, Madras.
 1865. †SMITH, DAVID, F.R.A.S. 40 Bennett's-bill, Birmingham.
 1886. †Smith, Edwin. 33 Wheeley's-road, Edgbaston, Birmingham.
 1886. *Smith, Mrs. Emma. Hencotes House, Hexham.
 1886. †Smith, E. Fisher, J.P. The Priory, Dudley.
 1886. †Smith, E. O. Council House, Birmingham.
 1866. *Smith, F. C. Bank, Nottingham.
 1887. §Smith, Rev. F. J., M.A. Trinity College, Oxford.
 1855. †Smith, George. Port Dundas, Glasgow.
 1885. †Smith, Rev. G. A., M.A. 91 Fountainhall-road, Aberdeen.
 1860. *Smith, Heywood, M.A., M.D. 18 Harley-street, Cavendish-square, London, W.
 1870. †Smith, H. L. Crabwall Hall, Cheshire.
 1889. *Smith, H. Llewellyn, B.A., B.Sc., F.S.S. 49 Beaumont-square, London, E.
 1888. †Smith, H. W. Owens College, Manchester.
 1885. †Smith, Rev. James, B.D. Manse of Newhills, N.B.
 1876. *Smith, J. Guthrie. 54 West Nile-street, Glasgow.
 1874. †Smith, John Haigh. 77 Southbank-road, Southport.
 Smith, John Peter George. Sweyney Cliff, Coalport, Iron Bridge, Shropshire.
 1871. †Smith, J. William Robertson, M.A., Lord Almoner's Professor of Arabic in the University of Cambridge.
 1883. †Smith, M. Holroyd. Fern Hill, Halifax.
 1837. Smith, Richard Bryan. Villa Nova, Shrewsbury.

Year of
Election.

1885. †SMITH, ROBERT H., M.Inst.C.E., Professor of Engineering in the
Mason Science College, Birmingham.
1870. †Smith, Samuel. Bank of Liverpool, Liverpool.
1866. †Smith, Samuel. 33 Compton-street, Goswell-road, London, E.C.
1873. †Smith, Swire. Lowfield, Keighley, Yorkshire.
1867. †Smith, Thomas. Dundee.
1867. †Smith, Thomas. Poole Park Works, Dundee.
1859. †Smith, Thomas James, F.G.S., F.C.S. Hornsea Burton, East York-
shire.
1884. †Smith, Vernon. 127 Metcalfe-street, Ottawa, Canada.
1885. *Smith, Watson. University College, London, W.C.
1887. †Smith, Dr. Wilberforce. 14 Stratford-place, London, W.
1852. †Smith, William. Eglinton Engine Works, Glasgow.
1875. *Smith, William. Sundon House, Clifton, Bristol.
1876. †Smith, William. 12 Woodside-place, Glasgow.
1883. †SMITHELLS, ARTHUR, B.Sc., Professor of Chemistry in the Yorkshire
College, Leeds.
1883. †Smithson, Edward Walter. 13 Lendal, York.
1883. †Smithson, Mrs. 13 Lendal, York.
1882. §Smithson, T. Spencer. Facit, Rochdale.
1874. †Smoothy, Frederick. Bocking, Essex.
1850. *SMYTH, CHARLES PIAZZI, F.R.S.E., F.R.A.S. Clova, Ripon.
1883. †Smyth, Rev. Christopher. Firwood, Chalford, Stroud.
1874. †Smyth, Henry. Downpatrick, Ireland.
1878. §Smyth, Mrs. Isabella. Wigmore Lodge, Cullenswood-avenue,
Dublin.
1857. *SMYTH, JOHN, jun., M.A., F.C.S., F.R.M.S., M.Inst.C.E.I. Milltown,
Banbridge, Ireland.
1888. *SNAPE, H. LLOYD, D.Sc., Ph.D., F.C.S., Professor of Chemistry in
University College, Aberystwith.
1888. †Snell, Albion T. Messrs. Immisch & Co., London, N.W.
1887. †Snell, Rev. Bernard J., M.A. 5 Park-place, Broughton, Man-
chester.
1878. †Snell, H. Saxon. 22 Southampton-buildings, London, W.C.
1889. †Snell, W. H. Lamorna, Oxford-road, Putney, S.W.
1879. *SOLLAS, W. J., M.A., D.Sc., F.R.S., F.R.S.E., F.G.S., Professor of
Geology in the University of Dublin. Trinity College, Dublin.
Sorby, Alfred. The Rookery, Ashford, Bakewell.
1859. *SORBY, H. CLIFTON, LL.D., F.R.S., F.G.S. Broomfield, Sheffield.
1879. *Sorby, Thomas W. Storthfield, Sheffield.
1888. †Sorley, Professor W. R. University College, Cardiff.
1886. †Southall, Alfred. Carrick House, Richmond Hill-road, Birmingham.
1865. *Southall, John Tertius. Parkfields, Ross, Herefordshire.
1859. †Southall, Norman. 44 Cannon-street West, London, E.C.
1887. §Sowerbutts, Eli, F.R.G.S. Market-place, Manchester.
1883. †Spanton, William Dunnett, F.R.C.S. Chatterley House, Hanley,
Staffordshire.
1890. †Spark, F. R. 29 Hyde-terrace, Leeds.
1863. *Spark, H. King, F.G.S. Startforth House, Barnard Castle.
1889. †Spence, Faraday. 67 Grey-street, Hexham.
1869. *Spence, J. Berger. 31 Lombard-street, London, E.C.
1887. †Spencer, F. M. Fernhill, Knutsford.
1881. †Spencer, Herbert E. Lord Mayor's Walk, York.
1884. §Spencer, John, M.Inst.M.E. Globe Tube Works, Wednesbury.
1889. *Spencer, John. Newburn, Newcastle-upon-Tyne.
1861. †Spencer, John Frederick. 28 Great George-street, London, S.W.
1891. *Spencer, Richard Evans. 6 Working-street, Cardiff.

- Year of Election.
1863. *Spencer, Thomas. The Grove, Ryton, Blaydon-on-Tyne, Co. Durham.
1875. †Spencer, W. H. *Richmond Hill, Clifton, Bristol.*
1864. *Spicer, Henry, B.A., F.L.S., F.G.S. 14 Aberdeen Park, High-bury, London, N.
1864. *SPILLER, JOHN, F.C.S. 2 St. Mary's-road, Canonbury, London, N.
1878. §Spottiswoode, George Andrew. 3 Cadogan-square, London, S.W.
1864. *Spottiswoode, W. Hugh, F.C.S. 41 Grosvenor-place, London, S.W.
1854. *SPRAGUE, THOMAS BOND, M.A., F.R.S.E. 26 St. Andrew-square, Edinburgh.
1883. †Spratling, W. J., B.Sc., F.G.S. Maythorpe, 74 Wickham-road, Brockley, S.E.
1853. †Spratt, Joseph James. *West-parade, Hull.*
1888. †Spreat, John Henry. Care of Messrs. Vines & Froom, 75 Alders-gate-street, London, E.C.
1834. *Spruce, Samuel, F.G.S. Beech House, Tamworth. Square, Joseph Elliot. 147 Maida Vale, London, W.
1877. †SQUARE, WILLIAM, F.R.C.S., F.R.G.S. 4 Portland-square, Plymouth.
- *Squire, Lovell. 6 Heathfield-terrace, Chiswick, Middlesex.
1890. †Stables, James. *Lane Ends, Horsham.*
1888. *Stacy, J. Sargeant. 7 and 8 Paternoster-row, London, E.C.
1858. *STAINTON, HENRY T., F.R.S., F.L.S., F.G.S. Mountsfield, Lewis-ham, S.E.
1884. †Stancoffe, Frederick. Dorchester-street, Montreal, Canada.
1833. *Stanford, Edward, jun., F.R.G.S. Thornbury, Bromley, Kent.
1865. †STANFORD, EDWARD C. C., F.C.S. Glenwood, Dalmaur, N.B.
1881. *Stanley, William Ford, F.G.S. Cumberlow, South Norwood, Surrey, S.E.
1883. †Stanley, Mrs. Cumberlow, South Norwood, Surrey, S.E.
- Stapleton, M. H., M.B., M.R.I.A. 1 Mountjoy-place, Dublin.
1883. †Stapley, Alfred M. Marion-terrace, Crewe.
1876. †Starling, John Henry, F.C.S. The Avenue, Erith, Kent.
- Staveley, T. K. Ripon, Yorkshire.
1873. *Stead, Charles. Saltaire, Bradford, Yorkshire.
1881. †Stead, W. H. Orchard-place, Blackwall, London, E.
1881. †Stead, Mrs. W. H. Orchard-place, Blackwall, London, E.
1884. †Stearns, Sergeant P. U.S. Consul-General, Montreal, Canada.
1891. §Steeds, A. P. 15 St. Helen's-road, Swansea.
1873. †Steinthal, G. A. 15 Hallfield-road, Bradford, Yorkshire.
1887. †Steinthal, Rev. S. Alfred. 81 Nelson-street, Manchester.
1887. †Stelfox, John L. 6 Hilton-street, Oldham, Manchester.
1884. †Stephen, George. 140 Drummond-street, Montreal, Canada.
1884. †Stephen, Mrs. George. 140 Drummond-street, Montreal, Canada.
1884. *Stephens, W. Hudson. Lowville (P.O.), State of New York, U.S.A.
1879. *STEPHENSON, Sir HENRY, J.P. The Glen, Sheffield.
1870. *Stevens, Miss Anna Maria. 23 Elm Grove-terrace, London-road, Salisbury.
1891. *Stephens, Miss Gulielma. Girtups, Bridport.
1880. *Stevens, J. Edward, LL.B. 10 Cleveland-terrace, Swansea.
1886. †Stevens, Marshall. Highfield House, Urmston, near Manchester.
1863. *STEVENSON, JAMES C., M.P., F.C.S. Westoe, South Shields.
1889. †Stevenson, T. Shannon. Westoe, South Shields.
1882. †Steward, Rev. C. E., M.A. *The Polygon, Southampton.*
1890. *Steward, Rev. Charles J., F.R.M.S. Somerleyton Rectory, Lowes-toft.
1885. *Stewart, Rev. Alexander, M.D., LL.D. Heathcot, Aberdeen.

Year of
Election.

1887. *Stewart, A. H. New College, Oxford.
 1864. †STEWART, CHARLES, M.A., F.L.S. St. Thomas's Hospital, London, S.E.
 1885. †Stewart, David. Banchory House, Aberdeen.
 1886. *Stewart, Duncan. 12 Montgomerie-crescent, Kelvinside, Glasgow.
 1887. †Stewart, George N. Physiological Laboratory, Owens College, Manchester.
 1875. *Stewart, James, B.A., F.R.C.P.Ed. Dunmurry, Sneyd Park, near Clifton, Gloucestershire.
 1876. †Stewart, William. Violet Grove House, St. George's-road, Glasgow.
 1867. †Stirling, Dr. D. Perth.
 1876. †STIRLING, WILLIAM, M.D., D.Sc., F.R.S.E., Professor of Physiology in the Owens College, Manchester.
 1867. *Stirrup, Mark, F.G.S. Stamford-road, Bowdon, Cheshire.
 1865. *Stock, Joseph S. St. Mildred's, Walmer.
 1890. †Stockdale, R. The Grammar School, Leeds.
 1883. *STOCKER, W. N., M.A., Professor of Physics in the Royal Indian Engineering College. Cooper's Hill, Staines.
 1854. †Stoess, Le Chevalier Ch. de W. (Bavarian Consul). Liverpool.
 1845. *STOKES, Sir GEORGE GABRIEL, Bart., M.P., M.A., D.C.L., LL.D., D.Sc., F.R.S., Lucasian Professor of Mathematics in the University of Cambridge. Lensfield Cottage, Cambridge.
 1887. †Stone, E. D., F.C.S. The Depleach, Cheadle, Cheshire.
 1862. †STONE, EDWARD JAMES, M.A., F.R.S., F.R.A.S., Director of the Radcliffe Observatory, Oxford.
 1886. †Stone, J. B. The Grange, Erdington, Birmingham.
 1886. †Stone, J. H. Grosvenor-road, Handsworth, Birmingham.
 1874. †Stone, J. Harris, M.A., F.L.S., F.C.S. 11 Sheffield-gardens, Kensington, London, W.
 1888. †STONE, JOHN. 15 Royal-crescent, Bath.
 1876. †Stone, Octavius C., F.R.G.S. Springfield, Nuneaton.
 1883. †Stone, Thomas William. 189 Goldhawk-road, Shepherd's Bush, London, W.
 1857. †STONEY, BINDON B., LL.D., F.R.S., M.Inst.C.E., M.R.I.A., Engineer of the Port of Dublin. 14 Elgin-road, Dublin.
 1878. *Stoney, G. Gerald. 69 Seventh-avenue, Heaton, Newcastle-upon-Tyne.
 1861. *STONEY, GEORGE JOHNSTONE, M.A., D.Sc., F.R.S., M.R.I.A. 9 Palmerston Park, Dublin.
 1876. §Stopes, Henry, F.G.S. Kenwyn, Cintra Park, Upper Norwood, S.E.
 1883. §Stopes, Mrs. Kenwyn, Cintra Park, Upper Norwood, S.E.
 1887. †Storer, Edwin. Woodlands, Crumpsall, Manchester.
 1887. *Storey, H. L. Caton, near Lancaster.
 1873. §Storr, William. The 'Times' Office, Printing-house-square, London, E.C.
 1884. §Storrs, George H. Fern Bank, Stalybridge.
 1859. §Story, Captain James Hamilton. 17 Bryanston-square, London, W.
 1888. *Stothert, Percy K. Audley, Park-gardens, Bath.
 1874. †Stott, William. Scar Bottom, Greetland, near Halifax, Yorkshire.
 1871. *STRACHEY, Lieut.-General RICHARD, R.E., C.S.I., F.R.S., F.R.G.S., F.L.S., F.G.S. 69 Lancaster-gate, Hyde Park, London, W.
 1881. †Strahan, Aubrey, M.A., F.G.S. Geological Museum, Jermyn-street, London, S.W.
 1876. †Strain, John. 143 West Regent-street, Glasgow.
 1863. †Straker, John. Wellington House, Durham.
 1889. §Straker, Captain Joseph. Dilston House, Riding Mill-on-Tyne.
 1882. †Strange, Rev. Cresswell, M.A. Edgbaston Vicarage, Birmingham.

- Year of
Election.
1881. †Strangways, C. Fox, F.G.S. Geological Museum, Jermyn-street,
London, S.W.
1889. §Streatfield, H. S. The Limes, Leigham Court-road, Streatham,
S.W.
*Strickland, Charles. 21 Fitzwilliam-place, Dublin.
1879. †Strickland, Sir Charles W., K.C.B. Hildenley-road, Malton.
1884. †Stringham, Irving. The University, Berkeley, California, U.S.A.
1859. †Stronach, William, R.E. Ardmellie, Banff.
1883. §Strong, Henry J., M.D. Whitgift House, Croydon.
1867. †Stronner, D. 14 Princess-street, Dundee.
1887. *Stroud, Professor H., M.A., D.Sc., College of Science, Newcastle-
upon-Tyne.
1887. *Stroud, William, D.Sc., Professor of Physics in the Yorkshire Col-
lege, Leeds.
1876. *STRUTHERS, JOHN, M.D., LL.D., Emeritus Professor of Anatomy in
the University of Aberdeen. 24 Buckingham Terrace, Edin-
burgh.
1878. †Strype, W. G. Wicklow.
1876. *Stuart, Charles Maddock. High School, Newcastle, Staffordshire.
1872. *Stuart, Rev. Edward A., M.A. 116 Grosvenor-road, Highbury New
Park, London, N.
1886. †Stuart, G. Morton, M.A. East Harptree, near Bristol.
1884. †Stuart, Dr. W. Theophilus. 183 Spadina-avenue, Toronto, Canada.
1888. *Stubbs, Rev. Elias T., M.A. 4 Springfield-place, Bath.
1885. §Stump, Edward C. 26 Parkfield-street, Moss-lane East, Manchester.
1879. *Styring, Robert. 3 Hartshead, Sheffield.
1891. *Sudborough, J. J. 111 Stratford-road, Birmingham.
Sullivan, H. N., F.R.G.S. King-street, Newcastle-upon-Tyne.
1883. †Summers, William, M.P. Sunnyside, Ashton-under-Lyne.
1884. †Sumner, George. 107 Stanley-street, Montreal, Canada.
1887. †Sumpner, W. E. 37 Pennyfields, Poplar, London, E.
1888. †Sunderland, John E. Bark House, Hatherlow, Stockport.
1883. †Sutcliffe, J. S., J.P. Beech House, Bacup.
1873. †Sutcliffe, J. W. Sprink Bank, Bradford, Yorkshire.
1873. †Sutcliffe, Robert. Idle, near Leeds.
1863. †Sutherland, Benjamin John. Thurso House, Newcastle-upon-Tyne.
1862. *SUTHERLAND, GEORGE GRANVILLE WILLIAM, Duke of, K.G.,
F.R.S., F.R.G.S. Stafford House, London, S.W.
1886. †Sutherland, Hugh. Winnipeg, Manitoba, Canada.
1884. †Sutherland, J. O. Richmond, Quebec, Canada.
1863. †SUTTON, FRANCIS, F.C.S. Bank Plain, Norwich.
1889. †Sutton, William. Esbank, Jesmond, Newcastle-upon-Tyne.
1891. §Swainson, George, F.L.S. North Drive, St. Anne's-on-Sea, Lan-
cashire.
1881. †Swales, William. Ashville, Holgate Hill, York.
1876. †Swan, David, jun. Braeside, Maryhill, Glasgow.
1881. §Swan, Joseph Wilson, M.A. Lauriston, Bromley, Kent.
1861. *Swan, Patrick Don S. Kirkcaldy, N.B.
1862. *SWAN, WILLIAM, LL.D., F.R.S.E., Emeritus Professor of Natural
Philosophy in the University of St. Andrews. Ardchapel,
Helensburgh, N.B.
1879. †Swanwick, Frederick. Whittington, Chesterfield.
1883. †Sweeting, Rev. T. E. 50 Roe-lane, Southport.
1887. §Swinburne, James. 49 Queen's-road, Wimbledon, Surrey.
1870. *Swinburne, Sir John, Bart., M.P. Capheaton, Newcastle-upon-
Tyne.
1885. †Swindells, Miss. Springfield House, Ilkley, Yorkshire.

- Year of Election.
1887. *Swindells, Rupert, F.R.G.S. Wilton Villa, The Firs, Bowdon, Cheshire.
1873. *Swinglehurst, Henry. Hincaster House, near Milnthorpe.
1890. §Swinhoe, Colonel C. Avenue House, Oxford.
1891. §Swinnerton, R. W., Assoc.M.Inst.C.E. Amrasti, Berar, India.
1889. §Sworn, Sidney A., B.A., F.C.S. 152 Railton-road, Herne Hill, London, S.E.
1883. †Sykes, Alfred. Highfield, Huddersfield.
1873. †Sykes, Benjamin Clifford, M.D. St. John's House, Cleckheaton.
1887. *Sykes, George H., M.A., M.Inst.C.E., F.S.A. 17 Albert-square, Clapham, London, S.W.
1890. §Sykes, Joseph. 113 Beeston-hill, Leeds.
1862. †Sykes, Thomas. Cleckheaton.
1887. *Sykes, T. H. Cheadle, Cheshire.
- SYLVESTER, JAMES JOSEPH, M.A., D.C.L., LL.D., F.R.S., Savilian Professor of Geometry in the University of Oxford. Oxford.
1870. †SYMES, RICHARD GLASCOTT, B.A., F.G.S., Geological Survey of Ireland. 14 Hume-street, Dublin.
1885. †Symington, Johnson, M.D. 2 Greenhill Park, Edinburgh.
1881. *Symington, Thomas. Wardie House, Edinburgh.
1859. §SYMONS, G. J., F.R.S., Sec.R.Met.Soc. 62 Camden-square, London, N.W.
1855. *SYMONS, WILLIAM, F.C.S. Dragon House, Bilbrook, near Taunton.
1886. §Symons, W. H., F.I.C., F.R.M.S. 130 Fellows-road, Hampstead, London, N.W.
1872. †Syngge, Major-General Millington, R.E., F.R.G.S. United Service Club, Pall Mall, London, S.W.
1865. †Tailyour, Colonel Renny, R.E. Newmanswalls, Montrose, N.B.
1877. *TAIT, LAWSON, F.R.C.S. The Crescent, Birmingham.
1871. †TAIT, PETER GUTHRIE, F.R.S.E., Professor of Natural Philosophy in the University of Edinburgh. George-square, Edinburgh.
1867. †Tait, P. M., F.S.S. *Hardwicke House, Hardwicke-road, Eastbourne.*
1890. †Talbot, Rev. E. S. The Vicarage, Leeds.
1891. §Tamblyn, James. Glan Llynvi, Maesteg, Bridgend.
1891. §Tanner, Colonel H. C. O. The Red House, Petersfield.
1890. §TANNER, H. W. LLOYD, M.A., Professor of Mathematics and Astronomy in University College, Cardiff.
1883. §Tapscott, R. L., F.G.S. 62 Croxteth-road, Liverpool.
1878. †TARPEY, HUGH. Dublin.
1861. *Tarratt, Henry W. Moseley, Owl's-road, Boscombe, Bournemouth.
1857. *Tate, Alexander. Longwood, Whitehouse, Belfast.
1870. †Tate, A. Norman, F.C.S. 9 Hackins Hey, Liverpool.
1890. †Tate, Thomas, F.G.S. 5 Eldon-mount, Woodhouse-lane, Leeds.
1858. *Tatham, George, J.P. Springfield Mount, Leeds.
1886. †Taunton, Richard. *Brook Vale, Witton.*
1878. *Taylor, A. Claude. North Circus-street, Nottingham.
1884. *Taylor, Rev. Charles, D.D. St. John's Lodge, Cambridge.
- Taylor, Frederick. Laurel Cottage, Rainhill, near Prescott, Lancashire.
1887. §Taylor, G. H. Holly House, 235 Eccles New-road, Salford.
1874. †Taylor, G. P. Students' Chambers, Belfast.
1887. §Taylor, George Spratt, F.C.S. 13 Queen's-terrace, St. John's Wood, London, N.W.
1881. *Taylor, H. A. 25 Collingham-road, South Kensington, London, S.W.
1884. *Taylor, H. M., M.A. Trinity College, Cambridge.

Year of
Election.

1882. *Taylor, Herbert Owen, M.D. 17 Castlegate, Nottingham.
 1887. †TAYLOR, Rev. Canon ISAAC, D.D. Settrington Rectory, York.
 1879. †Taylor, John. Broomhall-place, Sheffield.
 1861. *Taylor, John, M.Inst.C.E., F.G.S. 29 Portman-square, London, W.
 1873. †TAYLOR, JOHN ELLOR, Ph.D., F.L.S., F.G.S. The Mount,
 Ipswich.
 1881. *Taylor, John Francis. Holly Bank House, York.
 1865. †Taylor, Joseph. 99 Constitution-hill, Birmingham.
 1888. †Taylor, Michael W., M.D. Hatton Hall, Penrith.
 1876. †Taylor, Robert. 70 Bath-street, Glasgow.
 1878. †Taylor, Robert, J.P., LL.D. Corballis, Drogheda.
 1884. *Taylor, Miss S. Oak House, Shaw, near Oldham.
 1881. †Taylor, Rev. S. B., M.A. Whixley Hall, York.
 1888. †Taylor, S. Leigh. Birklands, Westcliffe-road, Birkdale, Southport.
 1870. †Taylor, Thomas. Aston Rowant, Tetsworth, Oxon.
 1887. †Taylor, Tom. Grove House, Sale, Manchester.
 1883. †Taylor, William, M.D. 21 Crockherbtown, Cardiff.
 1884. †Taylor-Whitehead, Samuel, J.P. Burton Closes, Bakewell.
 1858. †Teale, Thomas Pridgin, M.A., F.R.S. 38 Cookridge-street, Leeds.
 1885. †Teall, J. J. H., M.A., F.R.S., F.G.S. 28 Jermyn-street, London,
 S.W.
 1869. †Teesdale, C. S. M. Whyke House, Chichester.
 1879. †Temple, Lieutenant George T., R.N., F.R.G.S. The Nash, near
 Worcester.
 1880. †TEMPLE, Sir RICHARD, Bart., G.C.S.I., C.I.E., D.C.L., LL.D.,
 M.P., F.R.G.S. Athenæum Club, London, S.W.
 1863. †Tennant, Henry. Saltwell, Newcastle-upon-Tyne.
 1889. §Tennant, James. Saltwell, Gateshead.
 1882. §Terrill, William. 42 St. George's-terrace, Swansea.
 1881. †Terry, Sir Joseph. Hawthorn-villa, York.
 1883. †Tetley, C. F. The Brewery, Leeds.
 1883. †Tetley, Mrs. C. F. The Brewery, Leeds.
 1887. †Tetlow, T. 273 Stamford-street, Ashton-under-Lyne.
 1882. *Thane, George Dancer, Professor of Anatomy in University College,
 Gower-street, London, W.C.
 1885. †Thin, Dr. George, 22 Queen Anne-street, London, W.
 1871. †Thin, James. 7 Rillbank-terrace, Edinburgh.
 1871. †THISELTON-DYER, W. T., C.M.G., M.A., B.Sc., Ph.D., F.R.S., F.L.S.
 Royal Gardens, Kew.
 1835. Thom, John. Lark-hill, Chorley, Lancashire.
 1870. †Thom, Robert Wilson. Lark-hill, Chorley, Lancashire.
 1891. §Thomas, Alfred, M.P. Pen-y-lan, Cardiff.
 1871. †Thomas, Ascanius William Nevill. Chudleigh, Devon.
 1891. §Thomas, A. Garrod, M.D., J.P. Clytha Park, Newport, Mon-
 mouthshire.
 1875. *THOMAS, CHRISTOPHER JAMES. Drayton Lodge, Redland, Bristol.
 1891. *Thomas, Miss Clara. Llwynmadoc, Garth, R.S.O.
 1891. §Thomas, Edward. 282 Bute-street, Cardiff.
 1891. §Thomas, E. Franklen. Dan-y-Bryn, Radyr, near Cardiff.
 1883. †Thomas, Ernest C., B.A. 13 South-square, Gray's Inn, Lon-
 don, W.C.
 1884. †THOMAS, F. WOLFERSTAN. Molson's Bank, Montreal, Canada.
 Thomas, George. Brislington, Bristol.
 1875. †Thomas, Herbert. Ivor House, Redland, Bristol.
 1869. †Thomas, H. D. Fore-street, Exeter.
 1881. §THOMAS, J. BLOUNT. Southampton.
 1869. †Thomas, J. Henwood, F.R.G.S. Custom House, London, E.C.

- Year of
Election.
1891. §Thomas, John Tubb, L.R.C.P. Eastfields, Newport, Monmouthshire.
1880. *Thomas, Joseph William, F.C.S. Drumpellier, Brunswick-road, Gloucester.
1883. †Thomas, P. Bossley. 4 Bold-street, Southport.
1883. §Thomas, Thomas H. 45 The Walk, Cardiff.
1883. †Thomas, William. Lan, Swansea.
1886. †Thomas, William. 109 Tettenthal-road, Wolverhampton.
1886. §Thomason, Yeoville. 9 Observatory-gardens, Kensington, London, W.
1875. †Thompson, Arthur. 12 St. Nicholas-street, Hereford.
1891. *Thompson, Beeby, F.C.S., F.G.S. 55 Victoria-road, Northampton.
1887. §Thompson, C. 15 Patshull-road, Kentish Town, London, N.W.
1883. †Thompson, Miss C. E. Heald Bank, Bowdon, Manchester.
1891. §Thompson, Charles F. Penhill Close, near Cardiff.
1882. †Thompson, Charles O. Terre Haute, Indiana, U.S.A.
1888. *Thompson, Claude M., M.A., Professor of Chemistry in University College, Cardiff.
1885. †Thompson, D'Arcy W., B.A., Professor of Physiology in University College, Dundee. University College, Dundee.
1883. *Thompson, Francis. Lynton, Haling Park-road, Croydon.
1891. §Thompson, G. Carslake. Park-road, Penarth.
1859. †Thompson, George, jun. Pitmedden, Aberdeen.
Thompson, Harry Stephen. Kirby Hall, Great Ouseburn, Yorkshire.
1870. †Thompson, Sir Henry. 35 Wimpole-street, London, W.
1889. †Thompson, Henry. 2 Eslington-terrace, Newcastle-upon-Tyne.
1883. *Thompson, Henry G., M.D. 8 Addiscombe-villas, Croydon.
Thompson, Henry Stafford. Fairfield, near York.
1891. §Thompson, H. M. Whitley Batch, Llandaff.
1891. §Thompson, H. Wolcott. 9 Park-place, Cardiff.
1883. *Thompson, Isaac Cooke, F.L.S., F.R.M.S. Woodstock, Waverley-road, Liverpool.
1891. §Thompson, J. Tasham. 23 Charles-street, Cardiff.
1891. §Thompson, John. 62 Upper Tulse Hill, London, S.W.
1861. *Thompson, Joseph. Riversdale, Wilmslow, Manchester.
1876. *Thompson, Richard. Dringcote, The Mount, York.
1883. †Thompson, Richard. Branley Mead, Whalley, Lancashire.
1874. †Thompson, Robert. Walton, Fortwilliam Park, Belfast.
1876. †Thompson, Sylvanus Phillips, B.A., D.Sc., F.R.S., F.R.A.S., Professor of Physics in the City and Guilds of London Institute, Finsbury Technical Institute, E.C.
1884. †Thompson, Sydney de Courcy. 16 Canonbury-park South, London, N.
1883. *Thompson, T. H. Heald Bank, Bowdon, Manchester.
1863. †Thompson, William. 11 North-terrace, Newcastle-upon-Tyne.
1867. †Thoms, William. Magdalen-yard-road, Dundee.
1850. *Thomson, James, M.A., LL.D., D.Sc., F.R.S. L. & E. 2 Florentine-gardens, Hillhead-street, Glasgow.
1889. *Thomson, James, jun., M.A. 2 Florentine-gardens, Hillhead-street, Glasgow.
1868. §Thomson, James, F.G.S. 26 Leven-street, Pollokshields, Glasgow.
1876. †Thomson, James R. Mount Blow, Dalmuir, Glasgow.
1890. §Thomson, J. Arthur. 30 Royal-circus, Edinburgh.
1883. †Thomson, J. J., M.A., F.R.S., Professor of Experimental Physics in the University of Cambridge. Trinity College, Cambridge.
1871. *Thomson, John Millar, F.C.S., Professor of Chemistry in King's College, London. 53 Prince's-square, London, W.
1886. †Thomson, Joseph. Thornhill, Dumfries-shire.

Year of
Election.

1863. †Thomson, Murray. 44 Victoria-road, Gipsy Hill, London, S.E.
 1847. *Thomson, Sir WILLIAM, M.A., LL.D., D.C.L., Pres.R.S., F.R.S.E.,
 F.R.A.S., Professor of Natural Philosophy in the University of
 Glasgow. The University, Glasgow.
 1877. *Thomson, Lady. The University, Glasgow.
 1874. §Thomson, WILLIAM, F.R.S.E., F.C.S. Royal Institution, Manchester.
 1880. §Thomson, William J. Ghyllbank, St. Helens.
 1871. †Thornburn, Rev. David, M.A. 1 John's-place, Leith.
 1886. §Thornley, J. E. Lyndon, Bickenhill, near Birmingham.
 1887. †Thornton, John. 3 Park-street, Bolton.
 1867. †Thornton, Thomas. Dundee.
 1883. §Thorowgood, Samuel. Castle-square, Brighton.
 1845. †Thorp, Dr. Disney. Lypiatt Lodge, Suffolk Lawn, Cheltenham.
 1881. †Thorp, Fielden. Blossom-street, York.
 1871. †Thorp, Henry. Briarleigh, Sale, near Manchester.
 1881. *Thorp, Josiah. 87 Selborne-street, Liverpool.
 1864. *Thorp, William, B.Sc., F.C.S. 24 Crouch Hall-road, Crouch End,
 London, N.
 1871. †THORPE, T. E., Ph.D., F.R.S.L. & E., F.C.S., Professor of Chem-
 istry in the Royal College of Science, South Kensington,
 London, S.W.
 1883. §Threlfall, Henry Singleton. 12 London-street, Southport.
 1883. †Thresh, John C., D.Sc. *The Willows, Buxton.*
 1868. †THUILLIER, General Sir H. E. L., R.A., C.S.I., F.R.S., F.R.G.S.
 Tudor House, Richmond Green, Surrey.
 1889. †Thys, Captain Albert. 9 Rue Briderode, Brussels.
 1870. †Tichborne, Charles R. C., LL.D., F.C.S., M.R.I.A. Apothecaries'
 Hall of Ireland, Dublin.
 1873. *TIDDEMAN, R. H., M.A., F.G.S. 28 Jermyn-street, London, S.W.
 1885. §TIDY, CHARLES MEYMOTT, M.D. 3 Mandeville-place, Cavendish-
 square, London, W.
 1874. †TILDEN, WILLIAM A., D.Sc., F.R.S., F.C.S., Professor of Chemistry
 and Metallurgy in the Mason Science College, Birmingham.
 1873. †Tilghman, B. C. Philadelphia, U.S.A.
 1883. †Tillyard, A. I., M.A. Fordfield, Cambridge.
 1883. †Tillyard, Mrs. Fordfield, Cambridge.
 1865. †Timmins, Samuel, J.P., F.S.A. Hill Cottage, Fillongley, Coventry.
 1876. †Todd, Rev. Dr. Tudor Hall, Forest Hill, London, S.E.
 1891. §Todd, Richard Rees. Portuguese Consulate, Cardiff.
 1889. §Toll, John M. Monkton Lodge, Anfield, Liverpool.
 1887. †Tolmé, Mrs. Melrose House, Higher Broughton, Manchester.
 1857. †Tombe, Rev. Canon. Glenealy, Co. Wicklow.
 1888. †Tomkins, Rev. Henry George. Park Lodge, Weston-super-Mare.
 1864. *TOMLINSON, CHARLES, F.R.S., F.C.S. 7 North-road, Highgate,
 London, N.
 1887. †Tonge, Rev. Canon. Chorlton-cum-Hardy, Manchester.
 1887. †Tonge, James. Woodbine House, West Houghton, Bolton.
 1865. †Tonks, Edmund, B.C.L. Packwood Grange, Knowle, Warwickshire.
 1865. *Tonks, William Henry. The Rookery, Sutton Coldfield.
 1873. *Tookey, Charles, F.C.S. Royal School of Mines, Jermyn-street,
 London, S.W.
 1887. †Topham, F. 15 Great George-street, London, S.W.
 1861. *Topham, John, A.I.C.E. 53 Annandale-road, Vanbrugh Hill, Lon-
 don, S.E.
 1872. *TOPLEY, WILLIAM, F.R.S., F.G.S., A.I.C.E. Geological Survey
 Office, Jermyn-street, London, S.W.
 1886. †Topley, Mrs. W. Hurstbourne, Elgin-road, Croydon.

Year of
Election.

1875. †Torr, Charles Hawley. St. Alban's Tower, Mansfield-road, Sherwood, Nottingham.
1886. †Torr, Charles Walker. Cambridge-street Works, Birmingham.
1884. †Torrance, John F. Folly Lake, Nova Scotia, Canada.
1884. *Torrance, Rev. Robert, D.D. Guelph, Ontario, Canada.
- Towgood, Edward. St. Neot's, Huntingdonshire.
1873. †Townend, W. H. Heaton Hall, Bradford, Yorkshire.
1875. †Townsend, Charles. Avenue House, Cotham Park, Bristol.
1883. †Townsend, Francis Edward. 19 Aughton-road, Birkdale, Southport.
1861. †Townsend, William. Attleborough Hall, near Nuneaton.
1877. †Tozer, Henry. Ashburton.
1876. *TRAIL, Professor J. W. H., M.A., M.D., F.L.S. University of Aberdeen, Old Aberdeen.
1883. †TRAILL, A., M.D., LL.D. Ballylough, Bushmills, Ireland.
1870. †TRAILL, WILLIAM A. Giant's Causeway Electric Tramway, Portrush, Ireland.
1875. †Trapnell, Caleb. Severnleigh, Stoke Bishop.
1868. †TRAQUAIR, RAMSAY H., M.D., F.R.S., F.G.S., Keeper of the Natural History Collections, Museum of Science and Art, Edinburgh.
1891. §Trayes, Valentine. The Hill, Abergavenny.
1884. †Trechmann, Charles O., Ph.D., F.G.S. Hartlepool.
1868. †Trehane, John. Exe View Lawn, Exeter.
1891. §Treharne, J. Ll. 92 Newport-road, Cardiff.
- Trench, F. A. Newlands House, Clondalkin, Ireland.
1883. †Trendell, Edwin James, J.P. Abbey House, Abingdon, Berks.
1884. †Trenham, Norman W. 18 St. Alexis-street, Montreal, Canada.
1884. §Tribe, Paul C. M. 44 West Oneida-street, Oswego, New York, U.S.A.
1879. †Trickett, F. W. 12 Old Haymarket, Sheffield.
1877. †TRIMEN, HENRY, M.B., F.R.S., F.L.S. Peradeniya, Ceylon.
1871. †TRIMEN, ROLAND, F.R.S., F.L.S., F.Z.S. Colonial Secretary's Office, Cape Town, Cape of Good Hope.
1860. §TRISTRAM, Rev. HENRY BAKER, D.D., LL.D., F.R.S., F.L.S., Canon of Durham. The College, Durham.
1884. *Trotter, Alexander Pelham. 22 Cottesmore-gardens, Victoria-road, Kensington, London, W.
1885. §TROTTER, COUTTS, F.G.S., F.R.G.S. 17 Charlotte-square, Edinburgh.
1891. §Trounce, W. J. 67 Newport-road, Cardiff.
1887. *Trouton, Frederick T. Trinity College, Dublin.
1869. †Troyte, C. A. W. Huntsham Court, Bampton, Devon.
1885. *Tubby, A. H. Guy's Hospital, London, S.E.
1847. *Tuckett, Francis Fox. Frenchay, Bristol.
1888. †Tuckett, William Fothergill, M.D. 18 Daniel-street, Bath.
- Tuke, James H. Bancroft, Hitchin.
1871. †Tuke, J. Batty, M.D. Cupar, Fifeshire.
1887. †Tuke, W. C. 29 Princess-street, Manchester.
1883. †TUPPER, The Hon. Sir CHARLES, Bart., G.C.M.G., C.B., High Commissioner for Canada. 9 Victoria-chambers, London, S.W.
1855. †Turnbull, John. 37 West George-street, Glasgow.
1871. †Turnbull, William, F.R.S.E. Menslows, Jedburgh, N.B.
1891. §Turner, Miss E. R. Ipswich.
1882. †Turner, G. S. 9 Carlton-crescent, Southampton.
1883. †Turner, Mrs. G. S. 9 Carlton-crescent, Southampton.
1888. †Turner, J. S., J.P. Granville, Lansdowne, Bath.
1886. *TURNER, THOMAS, A.R.S.M., F.C.S., F.I.C. Mason Science College, Birmingham.

Year of
Election.

1863. *TURNER, Sir WILLIAM, M.B., LL.D., D.C.L., F.R.S. L. & E., Professor of Anatomy in the University of Edinburgh. 6 Eton-terrace, Edinburgh.
1890. §Turpin, G. S., M.A., D.Sc. 2 St. James's-terrace, Nottingham.
1883. †Turrell, Miss S. S. High School, Redland-grove, Bristol.
1884. *Tutin, Thomas. The Orchard, Chellaston, Derby.
1884. *Tweddell, Ralph Hart. Meopham Court, Gravesend, Kent.
1886. *Twigg, G. H. Church-road, Moseley, Birmingham.
1847. †TWISS, Sir TRAVERS, Q.C., D.C.L., F.R.S., F.R.G.S. 3 Paper-buildings, Temple, London, E.C.
1888. §Tyack, Llewellyn Newton. University College, Bristol.
1882. §Tyer, Edward. Horneck, Fitzjohn's-avenue, Hampstead, London, N.W.
1865. §TYLOR, EDWARD BURNETT, D.C.L., LL.D., F.R.S., Keeper of the University Museum, Oxford.
1858. *TYNDALL, JOHN, D.C.L., LL.D., Ph.D., F.R.S., F.G.S., Hon. Professor of Natural Philosophy in the Royal Institution, London. Hind Head House, Haslemere, Surrey.
1883. †Tyre, Thomas, F.C.S. Garden-wharf, Battersea, London, S.W.
1861. *Tysoe, John. 28 Heald-road, Bowdon, near Manchester.
1884. *Underhill, G. E., M.A. Magdalen College, Oxford.
1888. †Underhill, H. M. 7 High-street, Oxford.
1886. †Underhill, Thomas, M.D. West Bromwich.
1885. §Unwin, Howard. Newton-grove, Bedford Park, Chiswick, London.
1883. §Unwin, John. Park-crescent, Southport.
1883. §Unwin, William Andrews. The Briars, Freshfield, near Liverpool.
1876. *UNWIN, W. C., F.R.S., M.Inst.C.E., Professor of Engineering at the Central Institute, City and Guilds of London. 7 Palace-gate Mansions, Kensington, London, W.
1887. †Upton, Francis R. Orange, New Jersey, U.S.A.
1872. †Upward, Alfred. 11 Great Queen-street, Westminster, London, S.W.
1876. †Ure, John F. 6 Claremont-terrace, Glasgow.
1859. †Urquhart, W. Pollard. Craigston Castle, N.B.; and Castlepollard, Ireland.
1866. †Urquhart, William W. Rosebay, Broughty Ferry, by Dundee.
1880. †USSHER, W. A. E., F.G.S. 28 Jermyn-street, London, S.W.
1885. †Vachell, Charles Tanfield, M.D. 38 Charles-street, Cardiff.
1887. *Valentine, Miss Anne. The Elms, Hale, near Altrincham.
1888. †Vallentin, Rupert. 18 Kimberley-road, Falmouth.
1884. †Van Horne, W. C. Dorchester-street West, Montreal, Canada.
1883. *VanSittart, The Hon. Mrs. A. A. Haywood House, Oakfield-road, Bromley, Kent.
1886. †VARDY, Rev. A. R., M.A. King Edward's School, Birmingham.
1868. †Varley, Frederick H., F.R.A.S. Mildmay Park Works, Mildmay-avenue, Stoke Newington, London, N.
1865. *VARLEY, S. ALFRED. 5 Gayton-road, Hampstead, London, N.W.
1870. †Varley, Mrs. S. A. 5 Gayton-road, Hampstead, London, N.W.
1869. †Varwell, P. Alphington-street, Exeter.
1884. †Vasey, Charles. 112 Cambridge-gardens, London, W.
1875. †Vaughan, Miss. Burlton Hall, Shrewsbury.
1883. †Vaughan, William. 42 Sussex-road, Southport.
1881. §VELEY, V. H., M.A., F.C.S. 22 Norham-road, Oxford.
1873. *VERNEY, Captain EDMUND H., R.N., F.R.G.S. Rhianva, Bangor, North Wales.
1883. *Verney, Mrs. Rhianva, Bangor, North Wales.

Year of
Election.

- Verney, Sir Harry, Bart. Lower Claydon, Buckinghamshire.
1883. †VERNON, H. H., M.D. York-road, Birkdale, Southport.
1864. *VICARY, WILLIAM, F.G.S. The Priory, Colleton-crescent, Exeter.
1890. *Villamil, Major R. de, R.E. Care of Messrs. Cox & Co., 16 Charing Cross, London, S.W.
1868. †Vincent, Rev. William. Postwick Rectory, near Norwich.
1883. *Vines, Sydney Howard, M.A., D.Sc., F.R.S., F.L.S., Professor of Botany in the University of Oxford. Headington Hill, Oxford.
1856. †VIVIAN, EDWARD, M.A. Woodfield, Torquay.
- *VIVIAN, Sir H. HUSSEY, Bart., M.P., F.G.S. Park Wern, Swansea; and 27 Belgrave-square, London, S.W.
1891. §Vivian Stephen. Llantrisant.
1886. *Wackrill, Samuel Thomas, J.P. Leamington.
1860. †Waddingham, John. Guiting Grange, Winchcombe, Gloucestershire.
1890. §Wadsworth, George Henry. 3 Southfield-square, Bradford, Yorkshire.
1888. †Wadworth, H. A. Devizes, Wiltshire.
1890. §Wager, Harold W. T. 18 Consort-terrace, St. John's-road, Leeds.
1891. §Wailles, T. W. 23 Richmond-road, Cardiff.
1884. †Wait, Charles E., Professor of Chemistry in the University of Tennessee. Knoxville, Tennessee, U.S.A.
1886. †Waite, J. W. The Cedars, Bestcot, Walsall.
1870. †WAKE, CHARLES STANILAND. Welton, near Brough, East Yorkshire.
1884. †Waldstein, Charles, M.A., Ph.D. Cambridge.
1891. §Wales, H. T. Pontypridd.
1873. †Wales, James. 4 Mount Royd, Manningham, Bradford, Yorkshire.
1891. §Walford, Edward, M.D. Thanet House, Cathedral-road, Cardiff.
1882. *Walkden, Samuel. The Thorne, Bexhill, near Hastings, Sussex.
1890. §Walker, A. T. Headingley, Leeds.
1885. †Walker, Mr. Baillie. 52 Victoria-street, Aberdeen.
1885. †Walker, Charles Clement, F.R.A.S. Lillieshall Old Hall, Newport, Shropshire.
1883. §Walker, Mrs. Emma. 18 Lendal, York.
1883. †Walker, E. R. Pagefield Ironworks, Wigan.
- Walker, Frederick John. The Priory, Bathwick, Bath.
1883. †Walker, George. 11 Hamilton-square, Birkenhead, Liverpool.
1866. †Walker, H. Westwood, Newport, by Dundee.
1890. †Walker, Dr. James. 8 Windsor-terrace, Dundee.
1885. †WALKER, General J. T., C.B., R.E., LL.D., F.R.S., F.R.G.S. 13 Cromwell-road, London, S.W.
1866. *WALKER, JOHN FRANCIS, M.A., F.C.S., F.G.S., F.L.S. 45 Bootham, York.
1855. †WALKER, JOHN JAMES, M.A., F.R.S. 12 Denning-road, Hampstead, London, N.W.
1881. †Walker, John Sydenham. 83 Bootham, York.
1867. *Walker, Peter G. 2 Airlie-place, Dundee.
1886. *Walker, Major Philip Billingsley. Sydney, New South Wales.
1866. †Walker, S. D. 38 Hampden-street, Nottingham.
1884. †Walker, Samuel. Woodbury, Sydenham Hill, London, S.E.
1888. §Walker, Sydney F. 195 Severn-road, Cardiff.
1887. †Walker, T. A. 15 Great George-street, London, S.W.
1883. †Walker, Thomas A. 66 Leyland-road, Southport.
1891. §Walker, T. W. Hunslet, Leeds.
- Walker, William. 47 Northumberland-street, Edinburgh.
1881. *Walker, William. 18 Lendall, York.

- Year of Election.
1883. †Wall, Henry. 14 Park-road, Southport.
1863. †WALLACE, ALFRED RUSSEL, D.C.L., F.L.S., F.R.G.S. Corfe View, Parkstone, Dorset.
1887. *Waller, Augustus, M.D. Weston Lodge, 16 Grove End-road, London, N.W.
1862. †Wallich, George Charles, M.D., F.L.S., F.R.G.S. 26 Addison-road North, Notting Hill, London, W.
1886. †Walliker, Samuel. Grandale, Westfield-road, Edgbaston, Birmingham.
1889. *Wallis, Arnold J., M.A. 5 Belvoir-terrace, Cambridge.
1883. †Wallis, Rev. Frederick. Caius College, Cambridge.
1884. †Wallis, Herbert. Redpath-street, Montreal, Canada.
1886. †Wallis, Whitworth, F.S.A. Westfield, Westfield-road, Edgbaston, Birmingham.
1883. †Walmesley, Oswald. Shevington Hall, near Wigan.
1887. †Walmsley, J. Winton, Patricroft, Manchester.
1891. §Walmsley, Professor R. M., D.Sc. Heriot Watt College, Edinburgh.
1883. †Walmsley, T. M. Cleveland, Chorley-road, Heaton, Bolton.
1862. †WALPOLE, The Right Hon. SPENCER HORATIO, M.A., D.C.L., F.R.S. Ealing, Middlesex, W.
1881. †Walton, Thomas, M.A. Oliver's Mount School, Scarborough.
1863. †Wanklyn, James Alfred. 7 Westminster-chambers, London, S.W.
1884. †Wanless, John, M.D. 88 Union-avenue, Montreal, Canada.
1887. †Ward, A. W., M.A., Litt.D., Principal of Owens College, Manchester.
1874. §Ward, F. D., J.P., M.R.I.A. Clonaver, Strandtown, Co. Down.
1881. §Ward, George, F.C.S. Buckingham-terrace, Headingley, Leeds.
1879. †WARD, H. MARSHALL, M.A., F.R.S., F.L.S., Professor of Botany in the Royal Indian Civil Engineering College, Cooper's Hill, Egham.
1890. †Ward, Alderman John. Moor Allerton House, Leeds.
1874. §Ward, John, F.S.A. Lenoxvale, Belfast.
1887. §WARD, JOHN, F.G.S. 23 Stafford-street, Longton, Staffordshire.
1857. †Ward, John S. Prospect Hill, Lisburn, Ireland.
1880. *Ward, J. Wesley. Red House, Ravensbourne Park, Catford, S.E.
1884. *Ward, John William. Newstead, Halifax.
1883. †Ward, Thomas, F.C.S. Arnold House, Blackpool.
1887. †Ward, Thomas. Brookfield House, Northwich.
1882. †Ward, William. Cleveland Cottage, Hill-lane, Southampton.
1867. †Warden, Alexander J. 23 Panmure-street, Dundee.
1858. †Wardle, Thomas. Leek Brook, Leek, Staffordshire.
1884. §Wardwell, George J. Rutland, Vermont, U.S.A.
1887. *Waring, Richard S. Pittsburg, Pennsylvania, U.S.A.
1878. §WARINGTON, ROBERT, F.R.S., F.C.S. Harpenden, St. Albans, Herts.
1882. †Warner, F. W., F.L.S. 20 Hyde-street, Winchester.
1884. *Warner, James D. 199 Baltic-street, Brooklyn, U.S.A.
1875. †Warren, Algernon. 6 Windsor-terrace, Clifton, Bristol.
1887. †WARREN, Major-General Sir CHARLES, R.E., K.C.B., G.C.M.G., F.R.S., F.R.G.S. Athenæum Club, London, S.W.
1856. †Washbourne, Buchanan, M.D. Gloucester.
1875. *Waterhouse, Lieut.-Colonel J. 40 Hamilton-terrace, London, N.W.
1870. †Waters, A. T. H., M.D. 29 Hope-street, Liverpool.
1875. †Watherston, Rev. Alexander Law, M.A., F.R.A.S. The Grammar School, Hinckley, Leicestershire.
1881. §Watherston, E. J. 12 Pall Mall East, London, S.W.
1887. †Watkin, F. W. 46 Auriol-road, West Kensington, London, W.

- Year of
Election.
1884. †Watson, A. G., D.C.L. Uplands, Wadhurst, Sussex.
1886. *Watson, C. J. Botteville-road, Acock's Green, Birmingham.
1888. †Watson, C. Knight, M.A. Society of Antiquaries, Burlington House, London, W.
1885. §Watson, Deputy Surgeon-General G. A. Hendre, Overton Park, Cheltenham.
1882. †WATSON, Rev. H. W., D.Sc., F.R.S. Berkeswell Rectory, Coventry.
1887. †Watson, J. Beauchamp. Gilt Hall, Carlisle.
1884. †Watson, John. Queen's University, Kingston, Ontario, Canada.
1889. †Watson, John, F.I.C. 19 Bloomfield-terrace, Gateshead.
1859. †WATSON, JOHN FORBES, M.A., M.D., F.L.S. India Museum, Exhibition-road, London, S.W.
1863. †Watson, Joseph. Bensham-grove, Gateshead.
1863. †Watson, R. Spence, LL.D., F.R.G.S. Bensham-grove, Gateshead.
1867. †Watson, Thomas Donald. 23 Cross-street, Finsbury, London, E.C.
1879. *WATSON, WILLIAM HENRY, F.C.S., F.G.S. Analytical Laboratory, The Folds, Bolton.
1882. †Watt, Alexander. 89 Hartington-road, Sefton Park, Liverpool.
1884. †Watt, D. A. P. 284 Upper Stanley-street, Montreal, Canada.
1869. †Watt, Robert B. E., F.R.G.S. Ashley-avenue, Belfast.
1888. †WATTS, B. H. 10 Rivers-street, Bath.
1891. *Watts, E. Hannay, F.R.G.S. Springfield, Newport, Monmouthshire.
1875. *WATTS, JOHN, B.A., D.Sc. Merton College, Oxford.
1884. *Watts, Rev. Robert R. Stourpaine Vicarage, Blandford.
1870. §Watts, William, F.G.S. Oldham Corporation Waterworks, Pie-thorn, near Rochdale.
1873. *WATTS, W. MARSHALL, D.Sc. Giggleswick Grammar School, near Settle.
1883. §Watts, W. W., M.A., F.G.S. 14 Hume-street, Dublin.
1859. †Waugh, Edwin. New Brighton, near Liverpool.
1891. §Waugh, James. Higher Grade School, Howard-gardens, Cardiff.
1869. †Way, Samuel James. Adelaide, South Australia.
1883. †Webb, George. 5 Tenterden-street, Bury, Lancashire.
1871. †Webb, Richard M. 72 Grand-parade, Brighton.
1890. §Webb, Sidney. 4 Park-village East, London, N.W.
1866. *WEBB, WILLIAM FREDERICK, F.G.S., F.R.G.S. Newstead Abbey, near Nottingham.
1886. §WEBBER, Major-General C. E., C.B. 17 Egerton-gardens, London, S.W.
1891. §Webber, Thomas. 25 Queen-street Arcade, Cardiff.
1859. †Webster, John. Edgehill, Aberdeen.
1834. †Webster, Richard, F.R.A.S. 6 Queen Victoria-street, London, E.C.
1882. *Webster, Sir Richard Everard, Q.C., M.P. Hornton Lodge, Hornton-street, Kensington, London, S.W.
1889. *Webster, William, F.C.S. 50 Lee Park, Lee, Kent.
1884. *Wedekind, Dr. Ludwig, Professor of Mathematics at Karlsruhe. Karlsruhe.
1889. †Weeks, John G. Bedlington.
1890. §Weiss, F. Ernest, B.Sc., F.L.S. Birch Bank, Christchurch-road, Hampstead, London, N.W.
1886. †Weiss, Henry. Westbourne-road, Birmingham.
1865. †Welch, Christopher, M.A. United University Club, Pall Mall East, London, S.W.
1876. *WELDON, W. F. R., M.A., F.R.S., Professor of Comparative Anatomy and Zoology in University College, London. 30A Wimpole-street, London, W.

Year of
Election.

1880. *Weldon, Mrs. 30A Wimpole-street, London, W.
 1881. §Wellcome, Henry S. First Avenue Hotel, Holborn, London, W.C.
 1879. §WELLS, CHARLES A., A.I.E.E. Bridge House, Lewes.
 1881. §Wells, Rev. Edward, B.A. West Dean Rectory, Salisbury.
 1883. †Welsh, Miss. Girton College, Cambridge.
 1887. *Welton, T. A. Rectory House-grove, Clapham, London, S.W.
 1850. †Wemyss, Alexander Watson, M.D. St. Andrews, N.B.
 1881. *Wenlock, The Right Hon. Lord. 8 Great Cumberland-place, London, W.; and Escrick Park, Yorkshire.
 Wentworth, Frederick W. T. Vernon. Wentworth Castle, near Barnsley, Yorkshire.
 1864. *Were, Anthony Berwick. Hensingham, Whitehaven, Cumberland.
 1886. §Wertheimer, J., B.A., B.Sc., F.C.S. Merchant Venturers' School, Bristol.
 1865. †Wesley, William Henry. Royal Astronomical Society, Burlington House, London, W.
 1853. †West, Alfred. Holderness-road, Hull.
 1853. †West, Leonard. Summergangs Cottage, Hull.
 1853. †West, Stephen. Hessle Grange, near Hull.
 1882. §Westlake, Ernest, F.G.S. 2 Ridgeway-road, Redhill.
 1882. †Westlake, Richard. Portswood, Southampton.
 1863. †Westmacott, Percy. *Whickham, Gateshead, Durham.*
 1875. *Weston, Sir Joseph D., M.P. Dorset House, Clifton Down, Bristol.
 1860. †WESTWOOD, JOHN O., M.A., F.L.S., Professor of Zoology in the University of Oxford. Oxford.
 1882. §WETHERED, EDWARD, F.G.S. 5 Berkeley-place, Cheltenham.
 1884. †Wharton, E. R., M.A. 4 Broad-street, Oxford.
 1885. *WHARTON, Captain W. J. L., R.N., F.R.S., F.R.G.S. Florys, Prince's-road, Wimbledon Park, Surrey.
 1888. †Wheatcroft, William G. 6 Widcombe-terrace, Bath.
 1853. †Wheatley, E. B. Cote Wall, Mirfield, Yorkshire.
 1866. †Wheatstone, Charles C. 19 Park-crescent, Regent's Park, London, N.W.
 1884. †Wheeler, Claude L., M.D. 251 West 52nd-street, New York City, U.S.A.
 1883. *Wheeler, George Brash. Elm Lodge, Wickham-road, Beckenham, Kent.
 1878. *Wheeler, W. H., M.Inst.C.E. Boston, Lincolnshire.
 1888. §Whelen, John Leman. 73 Fellows-road, London, N.W.
 1883. †Whelpton, Miss K. Newnham College, Cambridge.
 1888. *Whidborne, Miss Alice Maria. Charanté, Torquay.
 1888. *Whidborne, Miss Constance Mary. Charanté, Torquay.
 1879. *WHIDBORNE, Rev. GEORGE FERRIS, M.A., F.G.S. St. George's Vicarage, Battersea Park-road, London, S.W.
 1873. †Whipple, George Matthew, B.Sc., F.R.A.S. Kew Observatory, Richmond, Surrey.
 1884. †Whischer, Arthur Henry. Dominion Lands Office, Winnipeg, Canada.
 1874. †Whitaker, Henry, M.D. 33 High-street, Belfast.
 1883. *Whitaker, T. Savile Heath, Halifax.
 1859. *WHITAKER, WILLIAM, B.A., F.R.S., F.G.S. Geological Survey Office, Jermyn-street, London, S.W.; and 33 East Park-terrace, Southampton.
 1886. †Whitcombe, E. B. Borough Asylum, Winson Green, Birmingham.
 1886. †White, Alderman, J.P. Sir Harry's-road, Edgbaston, Birmingham.
 1876. †White, Angus. Easdale, Argyllshire.

Year of
Election.

1886. † White, A. Silva, F.R.G.S., Secretary to the Royal Scottish Geographical Society, Edinburgh.
1883. † White, Charles. 23 Alexandra-road, Southport.
1882. † White, Rev. George Cecil, M.A. Nutshalling Rectory, Southampton.
1885. * White, J. Martin. Spring Grove, Dundee.
1873. † White, John. Medina Docks, Cowes, Isle of Wight.
1859. † WHITE, JOHN FORBES. 311 Union-street, Aberdeen.
1883. † White, John Reed. Rossall School, near Fleetwood.
1865. † White, Joseph. Regent's-street, Nottingham.
1869. † White, Laban. Blandford, Dorset.
1884. † White, R. 'Gazette' Office, Montreal, Canada.
1859. † White, Thomas Henry. Tandragee, Ireland.
1877. * White, William. 9 The Paragon, Blackheath, London, S.E.
1883. * White, Mrs. 9 The Paragon, Blackheath, London, S.E.
1886. † White, William. The Ruskin Museum, Sheffield.
1861. * Whitehead, John B. Ashday Lea, Rawtenstall, Manchester.
1861. * Whitehead, Peter Ormerod. 99 New John-street West, Birmingham.
1883. † Whitehead, P. J. 6 Cross-street, Southport.
1871. † Whitelaw, Alexander. 1 Oakley-terrace, Glasgow.
1884. † Whiteley, Joseph. Huddersfield.
1881. † Whitfield, John, F.C.S. 113 Westborough, Scarborough.
1866. † Whitfield, Samuel. Eversfield, Eastnor-grove, Leamington.
1852. † Whitla, Valentine. Beneden, Belfast.
- Whitley, Rev. Canon C. T., M.A., F.R.A.S. Bedlington Vicarage, Northumberland.
1891. § Whitmell, Charles Thomas. 47 Park-place, Cardiff.
1857. * WHITTY, Rev. JOHN IRWINE, M.A., D.C.L., LL.D. 40 Kingswood-road, Penge, London, S.E.
1887. † Whitwell, William. Overdene, Saltburn-by-the-Sea.
1874. * Whitwill, Mark. Redland House, Bristol.
1883. † Whitworth, James. 88 Portland-street, Southport.
1870. † WHITWORTH, Rev. W. ALLEN, M.A. Glenthorne-road, Hammer-smith, London, W.
1888. † Wickham, Rev. F. D. C. Horsington Rectory, Bath.
1865. † Wiggin, Henry, M.P. Metchley Grange, Harborne, Birmingham.
1886. † Wiggin, Henry A. The Lea, Harborne, Birmingham.
1885. † Wigglesworth, Alfred. Gordondale House, Aberdeen.
1883. † Wigglesworth, Mrs. Ingleside, West-street, Scarborough.
1881. * Wigglesworth, Robert. Beckwith Knowle, near Harrogate.
1878. † Wigham, John R. Albany House, Monkstown, Dublin.
1883. † Wigner, G. W. Plough-court, 37 Lombard-street, London, E.C.
1889. * Wilberforce, L. R., M.A. Trinity College, Cambridge.
1881. † WILBERFORCE, W. W. Fishergate, York.
1887. † Wild, George. Bardsley Colliery, Ashton-under-Lyne.
1887. * Wilde, Henry, F.R.S. The Hurst, Alderley Edge, Manchester.
1887. † Wilkinson, C. H. Slaithwaite, near Huddersfield.
1857. † Wilkinson, George. Temple Hill, Killiney, Co. Dublin.
1886. * Wilkinson, J. H. Corporation-street, Birmingham.
1879. † Wilkinson, Joseph. York.
1887. * Wilkinson, Thomas Read. The Polygon, Ardwick, Manchester.
1872. † Wilkinson, William. 168 North-street, Brighton.
1890. † Willans, J. W. Kirkstall, Leeds.
1859. † Willet, John, M.Inst.C.E. 35 Albyn-place, Aberdeen.
1872. † WILLETT, HENRY, F.G.S. Arnold House, Brighton.
1891. § Williams, Arthur J., M.P. Coedymwstwr, near Bridgend.

Year of
Election.

1861. *Williams, Charles Theodore, M.A., M.B. 2 Upper Brook-street,
Grosvenor-square, London, W.
1887. †Williams, E. Leader, M.Inst.C.E. The Oaks, Altrincham.
1883. *Williams, Edward Starbuck. Ty-ary-graig, Swansea.
1861. *Williams, Harry Samuel, M.A., F.R.A.S. 6 Heathfield, Swansea.
1883. †Williams, Rev. H. A. The Ridgeway, Wimbledon, Surrey.
1857. †Williams, Rev. James. Llanfairinghornwy, Holyhead.
1888. †Williams, James. Bladud Villa, Entryhill, Bath.
1891. §Williams, J. A. B., M.Inst.C.E. The Cedars, Llandaff-road, Cardiff.
1887. †Williams, J. Francis, Ph.D. Salem, New York, U.S.A.
1888. *Williams, Miss Katherine. Llandaff House, Pembroke-vale, Clifton,
Bristol.
1875. *Williams, M. B. Killay House, near Swansea.
1879. †WILLIAMS, MATTHEW W., F.C.S. Queenwood College, Stock-
bridge, Hants.
1891. §Williams, Morgan. 5 Park-place, Cardiff.
1886. †Williams, Richard, J.P. Brunswick House, Wednesbury.
1883. †Williams, R. Price. North Brow, Primrose Hill, London, N.W.
1883. †Williams, T. H. 2 Chapel-walk, South Castle-street, Liverpool.
1883. §Williams, T. Howell. 58 Lady Margaret-road, London, N.W.
1888. †Williams, W. Cloud House, Stapleford, Nottinghamshire.
1877. *WILLIAMS, W. CARLETON, F.C.S. Firth College, Sheffield.
1865. †Williams, W. M. Stonebridge Park, Willesden.
1883. †Williamson, Miss. Sunnybank, Ripon, Yorkshire.
1850. *WILLIAMSON, ALEXANDER WILLIAM, Ph.D., LL.D., D.C.L., F.R.S.,
F.C.S., Corresponding Member of the French Academy. High
Pitford, Haslemere.
1857. †WILLIAMSON, BENJAMIN, M.A., F.R.S. Trinity College, Dublin.
1876. †Williamson, Rev. F. J. Ballantrae, Girvan, N.B.
1863. †Williamson, John. South Shields.
- WILLIAMSON, WILLIAM C., LL.D., F.R.S., Professor of Botany
in Owens College, Manchester. 4 Egerton-road, Fallowfield,
Manchester.
1883. †Willis, T. W. 51 Stanley-street, Southport.
1882. †Willmore, Charles. Queenwood College, near Stockbridge, Hants.
1859. *Wills, The Hon. Sir Alfred. Chelsea Lodge, Tite-street, London,
S.W.
1886. †Wills, A. W. Wylde Green, Erdington, Birmingham.
1886. †Wilson, Alexander B. Hollywood, Belfast.
1885. †Wilson, Alexander H. 2 Albyn-place, Aberdeen.
1878. †Wilson, Professor Alexander S., M.A., B.Sc. 124 Bothwell-street,
Glasgow.
1859. †Wilson, Alexander Stephen. North Kinmundy, Summerhill, by
Aberdeen.
1876. †Wilson, Dr. Andrew. 118 Gilmore-place, Edinburgh.
1874. †WILSON, Colonel Sir C. W., R.E., K.C.B., K.C.M.G., D.C.L.,
F.R.S., F.R.G.S. Ordnance Survey Office, Southampton.
1850. †Wilson, Sir Daniel. Toronto, Canada.
1876. †Wilson, David. 124 Bothwell-street, Glasgow.
1890. †Wilson, Edmund. Denison Hall, Leeds.
1863. †Wilson, Frederic R. Alnwick, Northumberland.
1847. *Wilson, Frederick. 73 Newman-street, Oxford-street, London, W.
1875. †Wilson, George Fergusson, F.R.S., F.C.S., F.I.S. Heatherbank,
Weybridge Heath, Surrey.
1874. *Wilson, George Orr. Dunardagh, Blackrock, Co. Dublin.
1863. †Wilson, George W. Heron Hill, Hawick, N.B.
1883. *Wilson, Henry, M.A. Farnborough Lodge, R.S.O., Kent.

- Year of
Election.
1879. † Wilson, Henry J. 255 Pitsmoor-road, Sheffield.
1885. † Wilson, J. Dove, LL.D. 17 Rubislaw-terrace, Aberdeen.
1886. † Wilson, J. E. B. Woodslee, Wimbledon, Surrey.
1890. § Wilson, J. Mitchell, M.D. 51 Hall Gate, Doncaster.
1865. † WILSON, Rev. JAMES M., M.A., F.G.S. Clifton College, Bristol.
1884. † Wilson, James S. Grant. Geological Survey Office, Sheriff Court-buildings, Edinburgh.
1879. † Wilson, John Wycliffe. Eastbourne, East Bank-road, Sheffield.
1876. † Wilson, R. W. R. St. Stephen's Club, Westminster, S.W.
1847. * Wilson, Rev. Sumner. Preston Candover Vicarage, Basingstoke.
1883. † Wilson, T. Rivers Lodge, Harpenden, Hertfordshire.
1861. † Wilson, Thos. Bright. 4 Hope View, Fallowfield, Manchester.
1887. § Wilson, W., jun. Hillock, Terpersie, by Alford, Aberdeenshire.
1871. * Wilson, William E. Daramona House, Rathowen, Ireland.
1861. * WILTSHIRE, Rev. THOMAS, M.A., F.G.S., F.L.S., F.R.A.S., Assistant Professor of Geology and Mineralogy in King's College, London. 25 Granville-park, Lewisham, London, S.E.
1877. † Windeatt, T. W. Dart View, Totnes.
1886. § WINDLE, BERTRAM C. A., M.A., M.D., Professor of Anatomy in Queen's College, Birmingham.
1887. † Windsor, William Tessimond. Sandiway, Ashton-on-Mersey.
1886. † Winter, George W. 55 Wheeley's-road, Edgbaston, Birmingham.
1863. * WINWOOD, Rev. H. II., M.A., F.G.S. 11 Cavendish-crescent, Bath.
1888. † WODEHOUSE, E. R., M.P. 56 Chester-square, London, S.W.
1883. † Wolfenden, Samuel. Cowley Hill, St. Helens, Lancashire.
1884. † Womack, Frederick, Lecturer on Physics and Applied Mathematics at St. Bartholomew's Hospital. 68 Abbey-road, London, N.W.
1881. * Wood, Alfred John. 5 Cambridge-gardens, Richmond, Surrey.
1883. § Wood, Mrs. A. J. 5 Cambridge-gardens, Richmond, Surrey.
1863. * Wood, Collingwood L. Freeland, Forgandenny, N.B.
1861. * Wood, Edward T. Blackhurst, Brinscall, Chorley, Lancashire.
1883. † Wood, Miss Emily F. Egerton Lodge, near Bolton, Lancashire.
1875. * Wood, George William Rayner. Singleton, Manchester.
1878. † WOOD, Sir H. TRUEMAN, M.A. Society of Arts, John-street, Adelphi, London, W.C.
1883. * WOOD, JAMES, LL.D. Grove House, Scarisbrick-street, Southport.
1881. § WOOD, John, B.A., F.R.A.S. Wharfedale College, Boston Spa, Yorkshire.
1883. * Wood, J. H. Woodbine Lodge, Scarisbrick New-road, Southport.
1886. † Wood, Rev. Joseph. Carpenter-road, Birmingham.
1883. † Wood, Mrs. Mary. Care of E. P. Sherwood, Esq., Holmes Villa, Rotherham.
1864. † Wood, Richard, M.D. Driffield, Yorkshire.
1890. * Wood, Robert H., M.Inst.C.E. 15 Bainbrigge-road, Headingley, Leeds.
1871. † Wood, Provost T. Barleyfield, Portobello, Edinburgh.
1850. † Wood, Rev. Walter. Elie, Fife.
1865. * Wood, William, M.D. 99 Harley-street, London, W.
1872. § Wood, William Robert. Carlisle House, Brighton.
- * Wood, Rev. William Spicer, M.A., D.D. Higham, Rochester.
1863. * WOODALL, JOHN WOODALL, M.A., F.G.S. St. Nicholas House, Scarborough.
1884. † Woodbury, C. J. H. 31 Devonshire-street, Boston, U.S.A.
1883. † Woodcock, Herbert S. The Elms, Wigan.
1884. † Woodcock, T., M.A. 150 Cromwell-road, London, S.W.
1884. † Woodd, Arthur B. Woodlands, Hampstead, London, N.W.

- Year of Election.
1850. *Woodd, Charles H. L., F.G.S. Roslyn House, Hampstead, London, N.W.
1888. *Woodiwiss, Alfred. Belair, Trafalgar-road, Birkdale, Southport.
1888. *Woodiwiss, Mrs. Alfred. Belair, Trafalgar-road, Birkdale, Southport.
1872. †Woodman, James. 26 Albany-villas, Hove, Sussex.
- *WOODS, EDWARD, M.Inst.C.E. 6B Victoria-street, Westminster, London, S.W.
1883. †Woods, Dr. G. A., F.R.S.E., F.R.M.S. Carlton House, 57 Hoghton-street, Southport.
- WOODS, SAMUEL. 1 Drapers'-gardens, Throgmorton-street, London, E.C.
1888. †Woodthorpe, Colonel. Messrs. King & Co., 45 Pall Mall, London, S.W.
1887. *WOODWARD, ARTHUR SMITH, F.G.S., F.L.S. 183B King's-road, Chelsea, London, S.W.
- *WOODWARD, C. J., B.Sc. 97 Harborne-road, Birmingham.
1886. †Woodward, Harry Page, F.G.S. 129 Beaufort-street, London, S.W.
1866. †WOODWARD, HENRY, LL.D., F.R.S., F.G.S., Keeper of the Department of Geology, British Museum (Natural History), Cromwell-road, London, S.W.
1870. †WOODWARD, HORACE B., F.G.S. Geological Museum, Jermyn-street, London, S.W.
1881. †Wooler, W. A. Sadberge Hall, Darlington.
1884. *Woolcock, Henry. Rickerby House, St. Bees.
1890. §Woolcombe, Robert Lloyd, M.A., LL.D., F.S.S., M.R.I.A. 14 Waterloo-road, Dublin.
1877. †Woolcombe, Surgeon-Major Robert W. 14 Acre-place, Stoke, Devonport.
1883. *Woolley, George Stephen. 69 Market-street, Manchester.
1856. †Woolley, Thomas Smith, jun. South Collingham, Newark.
1874. †Workman, Charles. Ceara, Windsor, Belfast.
1878. †Wormell, Richard, M.A., D.Sc. Roydon, near Ware, Hertfordshire.
1863. *Worsley, Philip J. Rodney Lodge, Clifton, Bristol.
1855. *Worthington, Rev. Alfred William, B.A. Stourbridge, Worcestershire.
- Worthington, James. Sale Hall, Ashton-on-Mersey.
1856. †Worthy, George S. 2 Arlington-terrace, Mornington-crescent, Hampstead-road, London, N.W.
1884. †Wragge, Edmund. 109 Wellesley-street, Toronto, Canada.
1879. †Wrentmore, Francis. 34 Holland Villas-road, Kensington, London, S.W.
1883. *Wright, Rev. Arthur, M.A. Queen's College, Cambridge.
1883. *Wright, Rev. Benjamin, M.A. Sandon Rectory, Chelmsford.
1890. †Wright, Dr. C. J. Virginia-road, Leeds.
1871. §WRIGHT, C. R. A., D.Sc., F.R.S., F.O.S., Lecturer on Chemistry in St. Mary's Hospital Medical School, Paddington, London, W.
1857. †WRIGHT, E. PERCEVAL, M.A., M.D., F.L.S., M.R.I.A., Professor of Botany and Director of the Museum, Dublin University. 5 Trinity College, Dublin.
1886. †Wright, Frederick William. 4 Full-street, Derby.
1884. †Wright, Harrison. Wilkes' Barré, Pennsylvania, U.S.A.
1876. †Wright, James. 114 John-street, Glasgow.
1874. †Wright, Joseph. Cliftonville, Belfast.
1865. †Wright, J. S. 168 Brearley-street West, Birmingham.
1884. †Wright, Professor R. Ramsay, M.A., B.Sc. University College, Toronto, Canada.

- Year of Election.
1831. WRIGHT, T. G., M.D. 91 Northgate, Wakefield.
1876. †Wright, William. 31 Queen Mary-avenue, Glasgow.
1871. †WRIGHTSON, THOMAS, M.Inst.C.E., F.G.S. Norton Hall, Stockton-on-Tees.
1887. †Wrigley, Rev. Dr., M.A., M.D., F.R.A.S. 15 Gauden-road, London, S.W.
1876. †WUNSCH, EDWARD ALFRED, F.G.S. Carharrack, Scorrier, Cornwall.
1867. †Wylie, Andrew. Prinlaws, Fifeshire.
1883. †Wyllie, Andrew. 1 Leicester-street, Southport.
1885. †Wyness, James D., M.D. 53 School-hill, Aberdeen.
1871. †Wynn, Mrs. Williams. Cefn, St. Asaph.
1862. †WYNNE, ARTHUR BEEVOR, F.G.S. Geological Survey Office, 14 Hume-street, Dublin.
1875. †Yabbcicom, Thomas Henry. 37 White Ladies-road, Clifton, Bristol.
- *Yarborough, George Cook. Camp's Mount, Doncaster.
1865. †Yates, Edwin. Stonebury, Edgbaston, Birmingham.
1883. §Yates, James. Public Library, Leeds.
1867. †Yeaman, James. Dundee.
1887. †Yeats, Dr. Chepstow.
1884. †Yee, Fung. Care of R. E. C. Fittock, Esq., Shanghai, China.
1877. †Yonge, Rev. Duke. Puslinch, Yealmpton, Devon.
1891. §Yorath, Alderman T. V. Cardiff.
1884. †York, Frederick. 87 Lancaster-road, Notting Hill, London, W.
1891. §Young, Alfred C., F.C.S. 64 Tyrwhitt-road, St. John's, London, S.E.
1886. *YOUNG, A. H., M.B., F.R.C.S., Professor of Anatomy in Owens College, Manchester.
1884. †Young, Frederick. 5 Queensberry-place, London, S.W.
1884. †Young, Professor George Paxton. 121 Bloor-street, Toronto, Canada.
1876. †YOUNG, JOHN, M.D., Professor of Natural History in the University of Glasgow. 38 Cecil-street, Hillhead, Glasgow.
1885. †Young, R. Bruce. 8 Crown-gardens, Dowanhill, Glasgow.
1886. §Young, R. Fisher. New Barnet, Herts.
1883. *YOUNG SYDNEY, D.Sc., Professor of Chemistry in University College, Bristol.
1887. §Young, Sydney. 29 Mark-lane, London, E.C.
1890. §Young, T. Graham, F.R.S.E. Westfield, West Calder, Scotland.
1868. †Youngs, John. Richmond Hill, Norwich.
1886. †Zair, George. Arden Grange, Solihull, Birmingham.
1886. †Zair, John. Merle Lodge, Moseley, Birmingham.

CORRESPONDING MEMBERS.

- Year of
Election.
1887. Cleveland Abbe. Weather Bureau, Department of Agriculture, Washington, United States.
1881. Professor G. F. Barker. University of Pennsylvania, Philadelphia, United States.
1870. Professor Van Beneden, LL.D. Louvain, Belgium.
1887. Professor A. Bernthsen, Ph.D. Mannheim, L 7, 6A, Germany.
1880. Professor Ludwig Boltzmann. München.
1887. His Excellency R. Bonghi. Rome.
1887. Professor Lewis Boss. Dudley Observatory, Albany, New York, United States.
1884. Professor H. P. Bowditch, M.D. Boston, Massachusetts, United States.
1890. Professor Brentano. Maximilian-platz, Munich.
1884. Professor George J. Brush. Yale College, New Haven, United States.
1887. Professor J. W. Bruhl. Freiburg.
1887. Professor G. Capellini. Royal University of Bologna.
1887. Professor J. B. Carnoy. Louvain.
1887. H. Caro. Mannheim.
1861. Dr. Carus. Leipzig.
1887. F. W. Clarke. United States Geological Survey, Washington, United States.
1855. Professor Dr. Ferdinand Cohn. The University, Breslau, Prussia.
1881. Professor Josiah P. Cooke. Harvard University, United States.
1873. Professor Guido Cora. 74 Corso Vittorio Emanuele, Turin.
1880. Professor Cornu. L'École Polytechnique, Paris.
1870. J. M. Crafts, M.D. L'École des Mines, Paris.
1876. Professor Luigi Cremona. The University, Rome.
1889. W. H. Dall. United States Geological Survey, Washington, United States.
1862. Wilhelm Delffs, Professor of Chemistry in the University of Heidelberg.
1864. M. Des Cloizeaux. Rue Monsieur, 13, Paris.
1872. Professor G. Dewalque. Liège, Belgium.
1890. Professor V. Dwelshauvers-Dery. Liège.
1870. Dr. Anton Dohrn. Naples.
1876. Professor Alberto Eccher. Florence.
1874. Dr. W. Feddersen. Leipzig.
1886. Dr. Otto Finsch. Bremen.
1887. Professor R. Fittig. Strasburg.
1872. W. de Fonvielle. 50 Rue des Abbesses, Paris.
1886. Professor E. Frémy. L'Institut, Paris.
1887. Professor Dr. Anton Fritsch. The University, Prague.

Year of
Election.

1881. *C. M. Gariel, Secretary of the French Association for the Advancement of Science. 4 Rue Antoine Dubois, Paris.*
1866. Dr. Gaudry. Paris.
1861. Dr. Geinitz, Professor of Mineralogy and Geology. Dresden.
1884. Professor J. Willard Gibbs. Yale College, New Haven, United States.
1884. Professor Wolcott Gibbs. Harvard University, Cambridge, Massachusetts, United States.
1889. G. K. Gilbert. United States Geological Survey, Washington, United States.
1870. William Gilpin. Denver, Colorado, United States.
1889. Professor Gustave Gilson. Louvain.
1889. A. Gobert. 214 Chaussée de Charleroi, Brussels.
1876. Dr. Benjamin A. Gould. Cambridge, Massachusetts, United States.
1884. Major A. W. Greely. Washington, United States.
1862. Dr. D. Bierens de Haan, Member of the Royal Academy of Sciences, Amsterdam. Leiden, Holland.
1876. Professor Ernst Haeckel. Jena.
1889. Horatio Hale. Clinton, Ontario, Canada.
1881. Dr. Edwin H. Hall. Baltimore, United States.
1872. Professor James Hall. Albany, State of New York.
1889. Dr. Max von Hantken. Budapesth.
1887. Fr. von Hefner-Alteneck. Berlin.
1877. Professor H. L. F. von Helmholtz. Berlin.
1887. Professor W. His. Leipzig.
1887. S. Dana Horton. New York.
1881. Professor A. A. W. Hubrecht, LL.D., C.M.Z.S. Utrecht.
1887. Dr. Oliver W. Huntington. Harvard University, Cambridge, Massachusetts, United States.
1884. Professor C. Loring Jackson. Harvard University, Cambridge, Massachusetts, United States.
1867. Dr. Janssen, LL.D. The Observatory, Meudon, Seine-et-Oise.
1876. Dr. W. J. Janssen. Villa Frisia, Aroza, Graubünden, Switzerland.
1881. W. Woolsey Johnson, Professor of Mathematics in the United States Naval Academy. Annapolis, United States.
1887. Professor C. Julin. Liège.
1876. Dr. Giuseppe Jung. 7 Via Principe Umberto, Milan.
1877. M. Akin Károly. 92 Rue Richelieu, Paris.
1862. Aug. Kekulé, Professor of Chemistry. Bonn.
1884. Professor Dairoku Kikuchi, M.A. Imperial University, Tokio, Japan.
1873. Dr. Felix Klein. The University, Leipzig.
1874. Professor Dr. Knoblauch. The University, Halle, Germany.
1856. Professor A. Kölliker. Würzburg, Bavaria.
1887. Professor Dr. Arthur König. Physiological Institute, University, Berlin.
1887. Professor Krause. Göttingen.
1877. Dr. Hugo Kronecker, Professor of Physiology. The University, Bern, Switzerland.
1887. Lieutenant R. Kund. German African Society, Berlin.
1887. Professor A. Ladenburg. Breslau.
1887. Professor J. W. Langley. Michigan, United States.
1882. Professor S. P. Langley, LL.D., Secretary of the Smithsonian Institution. Washington, United States.
1887. Professor Count Solms Laubach. Strasburg.
1887. Dr. Leeds, Professor of Chemistry at the Stevens Institute, Hoboken, New Jersey, United States.
1872. M. Georges Lemoine. 76 Rue d'Assas, Paris.

Year of
Election.

1887. Professor A. Lieben. Vienna.
 1883. Dr. F. Lindemann, Professor of Mathematics in the University of Königsberg.
 1877. Dr. M. Lindemann, Hon. Sec. of the Bremen Geographical Society. Bremen.
 1887. *Professor G. Lippmann. Paris.*
 1887. Professor Dr. Georg Lunge. The University, Zurich.
 1871. Professor Jacob Lüroth. The University, Freiburg, Germany.
 1871. Dr. Lütken. Copenhagen.
 1887. Dr. Henry C. McCook. Philadelphia, United States.
 1867. Professor Mannheim. Rue de la Pompe, 11, Passy, Paris.
 1881. Professor O. C. Marsh. Yale College, New Haven, United States.
 1867. Professor Ch. Martins, Director of the Jardin des Plantes. Montpellier France.
 1887. Dr. C. A. Martius. Berlin.
 1890. Professor E. Mascart, Membre de l'Institut. 176 Rue de l'Université, Paris.
 1887. Professor D. Mendeléef. St. Petersburg.
 1887. Professor N. Menschutkin. St. Petersburg.
 1887. Professor Lothar Meyer. Tübingen.
 1884. Albert A. Michelson. Cleveland, Ohio, United States.
 1848. Professor J. Milne-Edwards. Paris.
 1887. Dr. Charles Sedgwick Minot. Boston, Massachusetts, United States.
 1877. Professor V. L. Moissenet. L'École des Mines, Paris.
 1864. Dr. Arnold Moritz. The University, Dorpat, Russia.
 1887. E. S. Morse. Peabody Academy of Science, Salem, Massachusetts, United States.
 1889. Dr. F. Nansen. Christiania.
 1866. *Chevalier C. Negri, President of the Italian Geographical Society. Turin, Italy.*
 1864. Herr Neumayer. Deutsche Seewarte, Hamburg.
 1884. Professor Simon Newcomb. Washington, United States.
 1869. Professor H. A. Newton. Yale College, New Haven, United States.
 1887. Professor Noelting. Mühlhausen, Elsass.
 1890. Professor W. Ostwald. Leipzig.
 1889. Professor A. S. Packard. Brown University, Providence, Rhode Island, United States.
 1890. Maffeo Pantaleoni, Director of the Royal Superior School of Commerce. Bari.
 1887. Dr. Pauli. Höchst-on-Main, Germany.
 1890. Professor Otto Pettersson. Stockholm.
 1857. Gustave Plarr, D.Sc. 22 Hadlow-road, Tunbridge, Kent.
 1870. Professor Felix Plateau. 64 Boulevard du Jardin Zoologique, Gand.
 1884. Major J. W. Powell, Director of the Geological Survey of the United States. Washington, United States.
 1887. Professor W. Preyer. The University, Berlin.
 1887. Professor N. Pringsheim. The University, Berlin.
 1886. Professor Putnam, Secretary of the American Association for the Advancement of Science. Harvard University, Cambridge, Massachusetts, United States.
 1887. Professor G. Quincke. Heidelberg.
 1868. L. Radlkofer, Professor of Botany in the University of Munich
 1886. Rev. A. Renard. Royal Museum, Brussels.
 1872. Professor Victor von Richter. Victoria-strasse, 9, Breslau.
 1873. Professor Baron von Richthofen. The University, Berlin.
 1887. Dr. C. V. Riley. Washington, United States.

Year of
Election.

1890. A. Lawrence Rotch. Boston, Massachusetts, United States.
 1881. Professor Henry A. Rowland. Baltimore, United States.
 1887. M. le Marquis de Saporta. Aix-en-Provence, Bouches du Rhône.
 1857. Baron Herman de Schlagintweit-Sakiunlinski. Jaegersberg Castle,
 near Forchheim, Bavaria.
 1883. Dr. Ernst Schröder. Karlsruhe, Baden.
 1874. Dr. G. Schweinfurth. Cairo.
 1846. Baron de Selys-Longchamps. Liège, Belgium.
 1872. Professor Carl Semper. Wurzburg, Bavaria.
 1873. Dr. A. Shafarik. Prague.
 1861. Dr. Werner von Siemens. Berlin.
 1849. *Dr. Siljeström. Stockholm.*
 1876. Professor R. D. Silva. L'École Centrale, Paris.
 1887. Ernest Solvay. Brussels.
 1888. Dr. Alfred Springer. Cincinnati, Ohio, United States.
 1866. Professor Steenstrup. Copenhagen.
 1889. Professor G. Stefanescu. Bucharest.
 1881. Dr. Cyparissos Stephanos. The University, Athens.
 1881. Professor Sturm. Münster, Westphalia.
 1871. Dr. Joseph Szabó. Pesth, Hungary.
 1870. Professor Tchebichef, Membre de l'Académie de St. Pétersbourg.
 1884. Professor Robert H. Thurston. Sibley College, Cornell University,
 Ithaca, New York, United States.
 1864. Dr. Otto Torell, Professor of Geology in the University of Lund,
 Sweden.
 1887. Dr. T. M. Treub. Java.
 1887. Professor John Trowbridge. Harvard University, Cambridge, Massa-
 chusetts, United States.
 Arminius Vámbéry, Professor of Oriental Languages in the University
 of Pesth, Hungary.
 1890. Professor J. H. Van't Hoff. Amsterdam.
 1889. *Wladimir Vernadsky, Keeper of the Mineralogical Museum, University
 of St. Petersburg.*
 1887. Professor John Vilanova. Madrid.
 1886. M. Jules Vuylsteke. 80 Rue de Lille, Menin, Belgium.
 1887. Professor H. F. Weber. Zurich.
 1887. Professor L. Weber. Kiel.
 1887. Professor August Weismann. Freiburg.
 1887. Dr. H. C. White. Athens, Georgia, United States.
 1881. Professor H. M. Whitney. Beloit College, Wisconsin, United
 States.
 1887. Professor E. Wiedemann. Leipzig.
 1874. Professor G. Wiedemann. Leipzig.
 1887. Professor R. Wiedersheim. Freiburg.
 1887. Professor J. Wislicenus. Leipzig.
 1887. Dr. Otto N. Witt. 33 Lindenallee, Westend-Charlottenburg, Berlin.
 1876. Professor Adolph Wüllner. Aix-la-Chapelle.
 1887. Professor C. A. Young. Princeton College, United States.
 1887. Professor F. Zirkel. Leipzig.

LIST OF SOCIETIES AND PUBLIC INSTITUTIONS

TO WHICH A COPY OF THE REPORT IS PRESENTED.

GREAT BRITAIN AND IRELAND.

- | | |
|--|---|
| <p>Admiralty, Library of the.
 Anthropological Institute.
 Arts, Society of.
 Asiatic Society (Royal).
 Astronomical Society (Royal).
 Belfast, Queen's College.
 Birmingham, Midland Institute.
 Brighton Public Library.
 Bristol Philosophical Institution.
 Cambridge Philosophical Society.
 Cardiff, University College of South
 Wales.
 Chemical Society.
 Civil Engineers, Institution of.
 Cornwall, Royal Geological So-
 ciety of.
 Dublin, Geological Survey of Ireland.
 —, Royal College of Surgeons in
 Ireland.
 —, Royal Geological Society of
 Ireland.
 —, Royal Irish Academy.
 —, Royal Society of.
 Dundee, University College.
 East India Library.
 Edinburgh, Royal Society of.
 —, Royal Medical Society of.
 —, Scottish Society of Arts.
 Exeter, Albert Memorial Museum.
 Geographical Society (Royal).
 Geological Society.
 Geology, Museum of Practical.
 Glasgow Philosophical Society.
 —, Institution of Engineers and Ship-
 builders in Scotland.
 Greenwich, Royal Observatory.
 Kew Observatory.
 Leeds, Mechanics' Institute.</p> | <p>Leeds, Philosophical and Literary So-
 ciety of.
 Linnean Society.
 Liverpool, Free Public Library and
 Museum.
 —, Royal Institution.
 London Institution.
 Manchester Literary and Philosophical
 Society.
 —, Mechanics' Institute.
 Mechanical Engineers, Institution of.
 Meteorological Office.
 Meteorological Society (Royal).
 Newcastle-upon-Tyne, Literary and
 Philosophical Society.
 —, Public Library.
 Norwich, The Free Library.
 Nottingham, The Free Library.
 Oxford, Ashmolean Society.
 —, Radcliffe Observatory.
 Physicians, Royal College of.
 Plymouth Institution.
 Royal Engineers' Institute, Chatham.
 Royal Institution.
 Royal Society.
 Royal Statistical Society.
 Salford, Royal Museum and Library.
 Sheffield, Firth College.
 Southampton, Hartley Institution.
 Stonyhurst College Observatory.
 Surgeons, Royal College of.
 United Service Institution.
 University College.
 Wales (South), Royal Institution.
 War Office, Library of the.
 Yorkshire Philosophical Society.
 Zoological Society.</p> |
|--|---|

EUROPE.

Berlin	Die Kaiserliche Akademie der Wissenschaften.	Milan	The Institute.
—	Royal Academy of Sciences.	Modena	Royal Academy.
Bonn	University Library.	Moscow	Society of Naturalists.
Brussels	Royal Academy of Sciences.	—	University Library.
Charkow	University Library.	Munich	University Library.
Coimbra	Meteorological Observatory.	Naples	Royal Academy of Sciences.
Copenhagen ...	Royal Society of Sciences.	Nicolaieff.....	University Library.
Dorpat, Russia...	University Library.	Paris	Association Française pour l'Avancement des Sciences.
Dresden	Royal Museum.	—	Geographical Society.
Frankfort	Natural History Society.	—	Geological Society.
Geneva.....	Natural History Society.	—	Royal Academy of Sciences.
Göttingen	University Library.	—	School of Mines.
Graz.....		Pultova	Imperial Observatory.
Halle	Leopoldinisch-Carolinische Akademie.	Rome	Accademia dei Lincei.
Harlem	Société Hollandaise des Sciences.	—	Collegio Romano.
Heidelberg	University Library.	—	Italian Geographical Society.
Helsingfors	University Library.	—	Italian Society of Sciences.
Kasan, Russia ...	University Library.	St. Petersburg .	University Library.
Kiel	Royal Observatory.	—	Imperial Observatory.
Kiev.....	University Library.	Stockholm	Royal Academy.
Lausanne.....	The Academy.	Turin	Royal Academy of Sciences.
Leyden	University Library.	Utrecht	University Library.
Liège	University Library.	Vienna.....	The Imperial Library.
Lisbon	Academia Real des Sciences.	—	Central Anstalt für Meteorologie und Erdmagnetismus.
		Zurich.....	General Swiss Society.

ASIA.

Agra	The College.	Calcutta	Presidency College.
Bombay	Elphinstone Institution.	—	Hooghly College.
—	Grant Medical College.	—	Medical College.
Calcutta	Asiatic Society.	Ceylon.....	The Museum, Colombo.
		Madras.....	The Observatory.
		—	University Library.

AFRICA.

Cape of Good Hope . . . The Royal Observatory.

AMERICA.

Albany	The Institute.	Ottawa	Geological Survey of Canada.
Boston.....	American Academy of Arts and Sciences.	Philadelphia...	American Medical As- sociation.
California	The University.	—	American Philosophical Society.
Cambridge	Harvard University Library.	—	Franklin Institute.
Kingston	Queen's University.	Toronto	The Observatory.
Manitoba	Historical and Scien- tific Society.	Washington...	The Naval Observa- tory.
Montreal	McGill College.	—	Smithsonian Institution.
—	Council of Arts and Manufactures.	—	United States Geolo- gical Survey of the Territories.
New York	Lyceum of Natural History.		

AUSTRALIA.

Adelaide	The Colonial Government.
Brisbane	Queensland Museum.
Victoria	The Colonial Government.

NEW ZEALAND.

Canterbury Museum.

12 OCT. 92



ALBEMARLE STREET, LONDON.

May, 1891.

MR. MURRAY'S
GENERAL LIST OF WORKS.

- ALBERT MEMORIAL. A Descriptive and Illustrated Account of the National Monument at Kensington. Illustrated by numerous Engravings. By DOYNE C. BELL. With 24 Plates. Folio. 12l. 12s.
————— HANDBOOK. 16mo. 1s.; Illustrated, 2s. 6d.
- ABBOTT (REV. J.). Memoirs of a Church of England Missionary in the North American Colonies. Post 8vo. 2s.
- ABERCROMBIE (JOHN). Enquiries concerning the Intellectual Powers and the Investigation of Truth. Fcap. 8vo. 3s. 6d.
- ACLAND (REV. C.). Manners and Customs of India. Post 8vo. 2s.
- ACWORTH (W. M.). The Railways of England. With 56 Illustrations. 8vo. 14s.
————— The Railways of Scotland. Map. Crown 8vo. 5s.
————— The Railways and the Trader. A Sketch of the Railway Rates Question in Theory and Practice. Crown 8vo. 6s.
- ÆSOP'S FABLES. A New Version. By REV. THOMAS JAMES. With 100 Woodcuts, by TENNIEL and WOLFE. Post 8vo. 2s. 6d.
- AGRICULTURAL (ROYAL) JOURNAL.
- AINGER (A. C.). Latin Grammar. [See ERON.]
————— An English-Latin Gradus, or Verse Dictionary. On a New Plan, with carefully Selected Epithets and Synonyms. Intended to Simplify the Composition of Latin Verses. Crown 8vo. (450 pp.) 9s.
- ALICE (PRINCESS); GRAND DUCHESS OF HESSE. Letters to H.M. THE QUEEN. With a Memoir by H.R.H. Princess Christian. Portrait. Crown 8vo. 7s. 6d., or Original Edition, 12s.
- AMBER-WITCH (THE). A most interesting Trial for Witchcraft. Translated by LADY DUFF GORDON. Post 8vo. 2s.
- AMERICA (THE RAILWAYS OF). Their Construction, Development, Management, and Appliances. By Various Writers. With an Introduction by T. M. COOLEY. With 200 Illustrations. Large 8vo. 31s. 6d.
————— [See BATES, NADAILLAC, RUMBOLD.]
- APOCRYPHA: With a Commentary Explanatory and Critical. By Dr. Salmon, Prof. Fuller, Archdeacon Farrar, Archdeacon Gifford, Canon Rawlinson, Dr. Edersheim, Rev. J. H. Lupton, Rev. C. J. Ball Edited by HENRY WACE, D.D. 2 vols. Medium 8vo. 50s.
- ARGYLL (DUKE OF). Unity of Nature. 8vo. 12s.
————— Reign of Law. Crown 8vo. 5s.
- ARISTOTLE. [See GROTE.]
- ARTHUR'S (LITTLE) History of England. By LADY CALLCOFF. *New Edition, continued to 1878.* With Woodcuts. Fcap. 8vo. 1s. 6d.
————— HISTORY OF FRANCE, from the Earliest Times to the Fall of the Second Empire. With Woodcuts. Fcp. 8vo. 2s. 6d.
- AUSTIN (JOHN). GENERAL JURISPRUDENCE; or, The Philosophy of Positive Law. Edited by ROBERT CAMPBELL. 2 Vols. 8vo. 32s.
————— STUDENT'S EDITION, compiled from the above work, by ROBERT CAMPBELL. Post 8vo. 12s.
————— Analysis of. By GORDON CAMPBELL. Post 8vo. 6s.

- AUSTRALIA.** [See LUMHOLTZ.]
- BABER (E. C.).** Travels in W. China. Maps. Royal 8vo. 5s.
- BAINES (THOMAS).** Greenhouse and Stove Plants, Flowering and Fine-Leaved. Palms, Ferns, and Lycopodiums. With full details of the Propagation and Cultivation. 8vo. 8s. 6d.
- BARKLEY (H. C.).** Five Years among the Bulgarians and Turks between the Danube and the Black Sea. Post 8vo. 10s. 6d.
- Bulgaria Before the War. Post 8vo. 10s. 6d.
- My Boyhood. Woodcuts. Post 8vo. 6s.
- Ride through Asia Minor and Armenia. With Sketches of the Character, Manners, and Customs of both the Mussulman and Christian Inhabitants. Crown 8vo. 10s. 6d.
- BARROW (JOHN).** Life of Sir Francis Drake. Post 8vo. 2s.
- BATES (H. W.).** Records of a Naturalist on the Amazons during Eleven Years' Adventure and Travel. Illustrations. Post 8vo. 7s. 6d.
- BATTLE ABBEY ROLL.** [See CLEVELAND.]
- BEACONSFIELD'S (LORD)** Letters, and "Correspondence with his Sister," 1830—1852. Portrait. Crown 8vo. 2s.
- BEATRICE, H.R.H. PRINCESS.** Adventures in the Life of Count George Albert of Erbach. A True Story. Translated from the German. Portraits and Woodcuts. Crown 8vo. 10s. 6d.
- BECKETT (SIR EDMUND).** "Should the Revised New Testament be Authorised?" Post 8vo. 6s.
- BELL (DOYNE C.).** Notices of the Historic Persons buried in the Chapel of the Tower of London. Illustrations. Crown 8vo. 14s.
- BENJAMIN (S. G. W.).** Persia & the Persians. Illustrations. 8vo. 24s.
- BENSON (ARCHBISHOP).** The Cathedral; its necessary place in the Life and Work of the Church. Post 8vo. 6s.
- BERKELEY (HASTINGS).** Wealth and Welfare: an Examination of Recent Changes in the Production and Distribution of Wealth in the United Kingdom. Crown 8vo. 6s.
- BERTRAM (JAS. G.).** Harvest of the Sea: an Account of British Food Fishes, Fisheries and Fisher Folk. Illustrations. Post 8vo. 9s.
- BIBLE COMMENTARY. EXPLANATORY AND CRITICAL.** With a REVISION of the TRANSLATION. By BISHOPS and CLERGY of the ANGLICAN CHURCH. Edited by Canon F. C. COOK, M.A.
- THE OLD TESTAMENT. 6 VOLS. Medium 8vo. 6l. 15s.
- | | |
|--------------------------------|---------------------------------|
| Vol. I. } GENESIS—DEUTERONOMY. | Vol. IV. } JOB—SONG OF SOLOMON. |
| 30s. | 24s. |
| Vol. II. } JOSHUA—KINGS. | Vol. V. 20s. ISAIAH—JEREMIAH. |
| 20s. | |
| Vol. III. } KINGS II.—ESTHER. | Vol. VI. } EZEKIEL—MALACHI. |
| 16s. | 25s. |
- THE NEW TESTAMENT. 4 VOLS. Medium 8vo. 4l. 14s.
- | | |
|--|----------------------------------|
| Vol. I. } ST. MATTHEW—ST. LUKE. | Vol. III. } ROMANS—PHILEMON. |
| 18s. | 28s. |
| Vol. II. } ST. JOHN.—ACTS OF THE APOSTLES. | Vol. IV. } HEBREWS — REVELATION. |
| 20s. | 28s. |
- THE APOCRYPHA. By Various Writers. Edited by HENRY WACE, D.D. 2 vols. Medium 8vo. 50s.
- THE STUDENT'S EDITION. Abridged and Edited by REV. J. M. FULLER, M.A. 6 Vols. Crown 8vo. 7s. 6d. each.
- OLD TESTAMENT. 4 VOLS. NEW TESTAMENT. 2 VOLS.

- BIGG-WITHER (T. P.).** Pioneering in South Brazil; Three Years of Forest and Prairie Life in the Province of Parana. Illustrations. 2 vols. Crown 8vo. 24s.
- BIRD (ISABELLA).** Hawaiian Archipelago; or Six Months among the Palm Groves, Coral Reefs, and Volcanoes of the Sandwich Islands. Illustrations. Crown 8vo. 7s. 6d.
- A Lady's Life in the Rocky Mountains. Illustrations. Post 8vo. 7s. 6d.
- The Golden Chersonese and the Way Thither. Illustrations. Post 8vo. 14s.
- Unbeaten Tracks in Japan: Including Visits to the Aborigines of Yezo and the Shrines of Nikko and Isé. Illustrations. Crown 8vo. 7s. 6d.
- BLACKIE (C.).** Geographical Etymology; or, Dictionary of Place Names. Third Edition. Crown 8vo. 7s.
- BLUNT (REV. J. J.).** Undesigned Coincidences in the Writings of the Old and New Testaments, an Argument of their Veracity. Post 8vo. 6s.
- History of the Christian Church in the First Three Centuries. Post 8vo. 6s.
- The Parish Priest; His Duties, Acquirements, and Obligations. Post 8vo. 6s.
- BOOK OF COMMON PRAYER.** Illustrated with Coloured Borders, Initial Letters, and Woodcuts. 8vo. 18s.
- BORROW (GEORGE).** The Bible in Spain; or, the Journeys and Imprisonments of an Englishman in an attempt to circulate the Scriptures in the Peninsula. Portrait. Post 8vo. 2s. 6d.
- The Zincali. An Account of the Gipsies of Spain; Their Manners, Customs, Religion, and Language. Post 8vo. 2s. 6d.
- Lavengro; The Scholar—The Gypsy—and the Priest. Post 8vo. 2s. 6d.
- Romany Rye. A Sequel to Lavengro. Post 8vo. 2s. 6d.
- WILD WALES: its People, Language, and Scenery. Post 8vo. 2s. 6d.
- Romano Lavo-Lil. With Illustrations of the English Gypsies; their Poetry and Habitations. Post 8vo. 5s.
- BOSWELL'S** Life of Samuel Johnson, LL.D. Including the Tour to the Hebrides. Edited by Mr. CROKER. *Seventh Edition.* Portraits. 1 vol. Medium 8vo. 12s.
- BOWEN (LORD JUSTICE).** Virgil in English Verse, Eclogues and Æneid, Books I.—VI. Map and Frontispiece. 8vo. 12s.
- BRADLEY (DEAN).** Arthur Penrhyn Stanley; Biographical Lectures. Crown 8vo. 3s. 6d.
- BREWER (REV. J. S.).** The Reign of Henry VIII.; from his Accession till the Death of Wolsey. Illustrated from Original Documents. Edited by JAMES GAIRDNER. With Portrait. 2 vols. 8vo. 30s.
- The Endowments and Establishment of the Church of England. Edited by LEWIS T. DIBDIN, M.A., Barrister-at-Law. Post 8vo. 6s.
- BRIDGES (MRS. F. D.).** A Lady's Travels in Japan, Thibet, Yarkand, Kashmir, Java, the Straits of Malacca, Vancouver's Island, &c. With Map and Illustrations from Sketches by the Author. Crown 8vo. 15s.

BRITISH ASSOCIATION REPORTS. 8vo.

*• The Reports for the years 1831 to 1875 may be obtained at the Offices of the British Association.

Glasgow, 1876, 2s.	York, 1881, 2s.	Birmingham, 1886, 2s.
Plymouth, 1877, 24s.	Southampton, 1882, 24s.	Manchester, 1887, 24s.
Dublin, 1878, 24s.	Southport, 1883, 24s.	Bath, 1888.
Sheffield, 1879, 24s.	Canada, 1884, 24s.	Newcastle-upon-Tyne, 1889.
Swansea, 1880, 24s.	Aberdeen, 1885, 24s.	

BROADFOOT (MAJOR W., R.E.) Record of his Services in Afghanistan, the Punjab, and on the N. W. Frontier of India. Compiled from his papers and those of Lords Ellenborough and Hardinge. Maps. 8vo. 15s.

BROCKLEHURST (T. U.) Mexico To-day: A Country with a Great Future. With a Glance at the Prehistoric Remains and Antiquities of the Montezumas. Plates and Woodcuts. Medium 8vo. 21s.

BRUCE (Hon. W. N.) Life of Sir Charles Napier. [See **NAPIER.**]

BRUGSCH (PROFESSOR) A History of Egypt under the Pharaohs. Derived entirely from Monuments. A New and thoroughly Revised Edition. Edited by M. BRODRICK. Maps. 1 Vol. 8vo.

BULGARIA. [See **BARKLEY, HUH, MINCHIN.**]

BUNBURY (SIR E. H.) A History of Ancient Geography, among the Greeks and Romans, from the Earliest Ages till the Fall of the Roman Empire. Maps. 2 Vols. 8vo. 21s.

BURBIDGE (F. W.) The Gardens of the Sun: or A Naturalist's Journal in Borneo and the Sulu Archipelago. Illustrations. Cr. 8vo. 14s.

BURCKHARDT'S Cicerone; or Art Guide to Painting in Italy. New Edition, revised by J. A. CROWE. Post 8vo. 6s.

BURGES (SIR JAMES BLAND, BART.) Selections from his Letters and Papers, as Under-Secretary of State for Foreign Affairs. With Notices of his Life. Edited by JAMES HUTTON. 8vo. 15s.

BURGON (DEAN) A Biography Illustrated by Extracts from his Letters and Early Journals E. MEYRICK GOULBURN, D.D. Portraits. 2 Vols. 8vo.

————— The Revision Revised: (1.) The New Greek Text; (2.) The New English Version; (3.) Westcott and Hort's Textual Theory. Second Edition. 8vo. 14s.

————— Lives of Twelve Good Men. Martin J. Routh, H. J. Rose, Chas. Marriott, Edward Hawkins, Saml. Wilberforce, R. L. Cotton, Richard Gresswell, H. O. Coxe, H. L. Mansel, Wm. Jacobson, C. P. Eden, C. L. Higgins. New Edition. With Portraits. 1 Vol. 8vo. 1fs.

BURN (COL.) Dictionary of Naval and Military Technical Terms, English and French—French and English. Crown 8vo. 15s.

BUTTMANN'S LEXILOGUS; a Critical Examination of the Meaning of numerous Greek Words, chiefly in Homer and Hesiod. By Rev. J. R. FISHLAKE. 8vo. 12s.

BUXTON (CHARLES) Memoirs of Sir Thomas Fowell Buxton, Bart. Portrait. 8vo. 16s. *Popular Edition.* Fcap. 8vo. 5s.

————— Notes of Thought. With a Biographical Notice. *Second Edition.* Post 8vo. 5s.

————— (SYDNEY C.) A Handbook to the Political Questions of the Day; with the Arguments on Either Side. Seventh Edition. 8vo. 8s.

————— Finance and Politics, an Historical Study. 1783—1885. 2 Vols. 26s.

————— Handbook to the Death Duties. Post 8vo. 3s. 6d.

BYRON'S (LORD) LIFE AND WORKS:—

LIFE, LETTERS, AND JOURNALS. By THOMAS MOORE. One Volume, Portraits. Royal 8vo. 7s. 6d.

LIFE AND POETICAL WORKS. *Popular Edition*. Portraits. 2 Vols. Royal 8vo. 15s.

POETICAL WORKS. *Library Edition*. Portrait. 6 Vols. 8vo. 45s.

POETICAL WORKS. *Cabinet Edition*. Plates. 10 Vols. 12mo. 30s.

POETICAL WORKS. *Pocket Ed.* 8 Vols. 16mo. In a case. 21s.

POETICAL WORKS. *Popular Edition*. Plates. Royal 8vo. 7s. 6d.

POETICAL WORKS. *Pearl Edition*. Crown 8vo. 2s. 6d. Cloth. 3s. 6d.

CHILDE HAROLD. With 80 Engravings. Crown 8vo. 12s.

CHILDE HAROLD. 16mo. 2s. 6d.

CHILDE HAROLD. Vignettes. 16mo. 1s.

CHILDE HAROLD. Portrait. 16mo. 6d.

TALES AND POEMS. 16mo. 2s. 6d.

MISCELLANEOUS. 2 Vols. 16mo. 5s.

DRAMAS AND PLAYS. 2 Vols. 16mo. 5s.

DON JUAN AND BEPPO. 2 Vols. 16mo. 5s.

CAILLARD (E. M.). Electricity; The Science of the 19th Century. A Sketch for General Readers. With Illustrations. Crown 8vo. 7s. 6d.

————— The Invisible Powers of Nature. Some Elementary Lessons in Physical Science for Beginners. Post 8vo. 6s.

CAMPBELL (LORD). Autobiography, Journals and Correspondence. By Mrs. Hardcastle. Portrait. 2 Vols. 8vo. 30s.

————— Lord Chancellors and Keepers of the Great Seal of England. From the Earliest Times to the Death of Lord Eldon in 1838. 10 Vols. Crown 8vo. 6s. each.

————— Chief Justices of England. From the Norman Conquest to the Death of Lord Tenterden. 4 Vols. Crown 8vo. 6s. each.

————— (THOS.) Essay on English Poetry. With Short Lives of the British Poets. Post 8vo. 3s. 6d.

CAREY (Life of). [See GEORGE SMITH.]

CARLISLE (BISHOP OF). Walks in the Regions of Science and Faith—a Series of Essays. Crown 8vo. 7s. 6d.

————— The Foundations of the Creed. Being a Discussion of the Grounds upon which the Articles of the Apostles' Creed may be held by Earnest and Thoughtful Minds in the 19th Century. 8vo. 14s.

CARNARVON (LORD). Portugal, Galicia, and the Basque Provinces. Post 8vo. 3s. 6d.

CAVALCASELLE'S WORKS. [See CROWE.]

CESNOLA (GEN.). Cyprus; its Ancient Cities, Tombs, and Temples. With 400 Illustrations. Medium 8vo. 50s.

CHAMBERS (G. F.). A Practical and Conversational Pocket Dictionary of the English, French, and German Languages. Designed for Travellers and Students generally. Small 8vo. 6s.

CHILD-CHAPLIN (DR.). Benedicite; or, Song of the Three Children; being Illustrations of the Power, Benevolence, and Design manifested by the Creator in his Works. Post 8vo. 1s.

- CHISHOLM (Mrs.).** Perils of the Polar Seas; True Stories of Arctic Discovery and Adventure. Illustrations. Post 8vo. 6s.
- CHURTON (ARCHDEACON).** Poetical Remains. Post 8vo. 7s. 6d.
- CLARKE (MAJOR G. SYDENHAM),** Royal Engineers. Fortification; Its Past Achievements, Recent Development, and Future Progress. With Illustrations. Medium 8vo. 21s.
- CLASSIC PREACHERS OF THE ENGLISH CHURCH.** Lectures delivered at St. James'. 2 Vols. Post 8vo. 7s. 6d. each.
- CLEVELAND (DUCHESS OF).** The Battle Abbey Roll. With some account of the Norman Lineages. 3 Vols. Sm. 4to. 48s.
- CLIVE'S (LORD) Life.** By REV. G. R. GLEIG. Post 8vo. 3s. 6d.
- CLODE (C. M.).** Military Forces of the Crown; their Administration and Government. 2 Vols. 8vo. 21s. each.
- Administration of Justice under Military and Martial Law, as applicable to the Army, Navy, and Auxiliary Forces. 8vo. 12s.
- COLEBROOKE (SIR EDWARD, BART.).** Life of the Hon. Mountstuart Elphinstone. With Portrait and Plans. 2 Vols. 8vo. 26s.
- COLERIDGE (SAMUEL TAYLOR),** and the English Romantic School. By PROF. BRANDL. With Portrait, Crown 8vo. 12s.
- Table-Talk. Portrait. 12mo. 3s. 6d.
- COLES (JOHN).** Summer Travelling in Iceland. With a Chapter on Askja. By E. D. MORGAN. Map and Illustrations. 18s.
- COLLINS (J. CHURTON).** BOLINGBROKE: an Historical Study. With an Essay on Voltaire in England. Crown 8vo. 7s. 6d.
- COLONIAL LIBRARY.** [See Home and Colonial Library.]
- COOK (Canon F. C.).** The Revised Version of the Three First Gospels, considered in its Bearings upon the Record of Our Lord's Words and Incidents in His Life. 8vo. 9s.
- The Origins of Language and Religion. 8vo. 15s.
- COOKE (E. W.).** Leaves from my Sketch-Book. With Descriptive Text. 50 Plates. 2 Vols. Small folio. 31s. 6d. each.
- (W. H.). History and Antiquities of the County of Hereford. Vol. III. In continuation of Duncumb's History. 4to. £2 12s. 6d.
- Additions to Duncumb's History. Vol. II. 4to. 15s.
- The Hundred of Grimsworth. Part I. 4to. 17s. 6d.
- COOKERY (MODERN DOMESTIC).** Adapted for Private Families. By a Lady. Woodcuts. Fcap. 8vo. 5s.
- COOLEY (THOMAS M.).** [See AMERICA, RAILWAYS OF.]
- CORNEY GRAIN.** By Himself. Post 8vo. 1s.
- COURTHOPE (W. J.).** The Liberal Movement in English Literature. A Series of Essays. Post 8vo. 6s.
- Life and Works of Alexander Pope. With Portraits. 10 Vols. 8vo. 10s. 6d. each.
- CRABBE (REV. G.).** Life & Works. Illustrations. Royal 8vo. s.
- CRAIK (HENRY).** Life of Jonathan Swift. Portrait. 8vo. 18s.
- CRIPPS (WILFRED).** Old English Plate: Ecclesiastical, Decorative, and Domestic, its Makers and Marks. New Edition. With Illustrations and 2010 facsimile Plate Marks. Medium 8vo. 21s.
- *.* Tables of the Date Letters and Marks sold separately. 5s.

- CROKER** (RT. HON. J. W.). Correspondence and Journals, relating to the Political and Social Events of the first half of the present Century. Edited by LOUIS J. JENNINGS, M.P. Portrait. 3 Vols. 8vo. 46s.
- Progressive Geography for Children. 18mo. 1s. 6d.
- Boswell's Life of Johnson. [See BOSWELL.]
- Historical Essay on the Guillotine. Fcap. 8vo. 1s.
- CROWE AND CAVALCASELLE**. Lives of the Early Flemish Painters. Woodcuts. Post 8vo, 7s. 6d.; or Large Paper 8vo, 15s.
- Life and Times of Titian, with some Account of his Family. Illustrations. 2 Vols. 8vo. 21s.
- Raphael; His Life and Works. 2 Vols. 8vo. 33s.
- CUMMING** (R. GORDON). Five Years of a Hunter's Life in the Far Interior of South Africa. Woodcuts. Post 8vo. 6s.
- CUNDILL** (MAJOR J. P.), R.A., and **HAKE** (C. NAPIER). Researches on the Power of Explosives. Translated and Condensed from the French of M. BERTHELOT. With Illustrations. 8vo.
- CURRIE** (C. L.). An Argument for the Divinity of Jesus Christ. Translated from the French of the ABBÉ EM. BOUGAUD. Post 8vo. 6s.
- CURTIUS** (PROFESSOR) Student's Greek Grammar, for the Upper Forms. Edited by DR. WM. SMITH. Post 8vo. 6s.
- Elucidations of the above Grammar. Translated by EVELYN ABBOT. Post 8vo. 7s. 6d.
- Smaller Greek Grammar for the Middle and Lower Forms. Abridged from the larger work. 12mo. 3s. 6d.
- Accidence of the Greek Language. Extracted from the above work. 12mo. 2s. 6d.
- Principles of Greek Etymology. Translated by A. S. WILKINS and E. B. ENGLAND. New Edition. 2 Vols. 8vo. 28s.
- The Greek Verb, its Structure and Development. Translated by A. S. WILKINS, and E. B. ENGLAND. 8vo. 12s.
- CURZON** (HON. ROBERT). Visits to the Monasteries of the Levant. Illustrations. Post 8vo. 7s. 6d.
- CUST** (GENERAL). Warriors of the 17th Century—Civil Wars of France and England. 2 Vols. 16s. Commanders of Fleets and Armies. 2 Vols. 18s.
- Annals of the Wars—18th & 19th Century. With Maps. 9 Vols. Post 8vo. 5s. each.
- DAVY** (SIR HUMPHRY). Consolations in Travel; or, Last Days of a Philosopher. Woodcuts. Fcap. 8vo. 3s. 6d.
- Salmonia; or, Days of Fly Fishing. Woodcuts. Fcap. 8vo. 3s. 6d.
- DE COSSON** (MAJOR E. A.). The Cradle of the Blue Nile; a Journey through Abyssinia and Soudan. Map and Illustrations. 2 Vols. Post 8vo. 21s.
- Days and Nights of Service with Sir Gerald Graham's Field Force at Suakim. Plan and Illustrations. Crown 8vo. 14s.
- DENNIS** (GEORGE). The Cities and Cemeteries of Etruria. 20 Plans and 200 Illustrations. 2 Vols. Medium 8vo. 21s.
- (ROBERT). Industrial Ireland. Suggestions for a Practical Policy of "Ireland for the Irish." Crown 8vo. 6s.
- The Baronetage of Great Britain; a History, a Criticism, and a Vindication. Including all ascertained Facts as to the Foundation of the Order, with Curious Particulars as to the varied Fortunes of certain Titles and their Holders, and Thoughts on the Degeneracy of the Order.

DARWIN'S (CHARLES) Life and Letters, with an autobiographical Chapter. Edited by his Son, FRANCIS DARWIN, F.R.S. Portraits. 3 Vols. 8vo. 36s.

————— An Illustrated Edition of the Voyage of a Naturalist Round the World in H.M.S. Beagle. With Views of Places Visited and Described. By R. T. PRITCHETT. 100 Illustrations. Medium 8vo. 21s.

JOURNAL OF A NATURALIST DURING A VOYAGE ROUND THE WORLD. Popular Edition. With Portrait. 3s. 6d.

ORIGIN OF SPECIES BY MEANS OF NATURAL SELECTION. Library Edition. 2 vols. 12s.; or popular Edition. 6s.

DESCENT OF MAN, AND SELECTION IN RELATION TO SEX. Woodcuts. Library Ed. 2 vols. 15s.; or popular Ed. 7s. 6d.

VARIATION OF ANIMALS AND PLANTS UNDER DOMESTICATION. Woodcuts. 2 Vols. 15s.

EXPRESSIONS OF THE EMOTIONS IN MAN AND ANIMALS. With Illustrations. 12s.

VARIOUS CONTRIVANCES BY WHICH ORCHIDS ARE FERTILIZED BY INSECTS. Woodcuts. 7s. 6d.

MOVEMENTS AND HABITS OF CLIMBING PLANTS. Woodcuts. 6s.

INSECTIVOROUS PLANTS. Woodcuts. 9s.

CROSS AND SELF-FERTILIZATION IN THE VEGETABLE KINGDOM. 9s.

DIFFERENT FORMS OF FLOWERS ON PLANTS OF THE SAME SPECIES. 7s. 6d.

POWER OF MOVEMENT IN PLANTS. Woodcuts.

THE FORMATION OF VEGETABLE MOULD THROUGH THE ACTION OF WORMS. Illustrations. Post 8vo. 6s.

LIFE OF ERASMUS DARWIN. Portrait. Crown 8vo. 7s. 6d.

FACTS AND ARGUMENTS FOR DARWIN. By FRITZ MULLER. Woodcuts. Post 8vo. 6s.

DERBY (EARL OF). Iliad of Homer rendered into English Blank Verse. With Portrait. 2 Vols. Post 8vo. 10s.

DERRY (BISHOP OF). Witness of the Psalms to Christ and Christianity. Crown 8vo. 9s.

DICEY (PROF. A. V.). England's Case against Home Rule. Crown 8vo. 7s. 6d.

————— Why England Maintains the Union. A popular rendering of the above. By C. E. S. Fcap. 8vo. 1s.

DOG-BREAKING. [See HUTCHINSON.]

DÖLLINGER (DR.). Studies in European History, being Academic Addresses. Translated by MARGARET WARRE. Portrait. 8vo. 14s.

DRAKE'S (SIR FRANCIS) Life, Voyages, and Exploits, by Sea and Land. By JOHN BARROW. Post 8vo. 2s.

DRINKWATER (JOHN). History of the Siege of Gibraltar, 1779-1783. With a Description of that Garrison. Post 8vo. 2s.

DU CHAILLU (PAUL B.). Land of the Midnight Sun; Illustrations. 2 Vols. 8vo. 36s.

————— The Viking Age. The Early History, Manners, and Customs of the Ancestors of the English-speaking Nations. With 1,300 Illustrations. 2 Vols. 8vo. 42s.

————— Equatorial Africa and Ashango Land. Adventures in the Great Forest of Equatorial Africa, and the Country of the Dwarfs. Popular Edition. With Illustrations. Post 8vo. 7s. 6d.

- DUFFERIN (LORD).** Letters from High Latitudes; a Yacht Voyage to Iceland. Woodcuts. Post 8vo. 7s. 6d.
- Speeches and Addresses in India, 1884—8. 8vo. 9s.
- (LADY). Our Viceregal Life in India, 1884—1888. Portrait. 2 vols. Crown 8vo. 24s. Popular Edition. Post 8vo. 7s. 6d.
- DUNCAN (COL.).** History of the Royal Artillery. 2 Vols. 8vo. 18s.
- English in Spain; or, The Story of the War of Succession, 1834-1840. 8vo. 16s.
- DÜRER (ALBERT);** his Life and Work. By DR. THAUSING. Edited by F. A. EATON. Illustrations. 2 Vols. Medium 8vo. 42s.
- EASTLAKE (SIR C.).** Contributions to the Literature of the Fine Arts. With Memoir by LADY EASTLAKE. 2 Vols. 8vo. 24s.
- EDWARDS (W. H.).** Voyage up the River Amazon, including a Visit to Para. Post 8vo. 2s.
- ELLESMERE (LORD).** Two Sieges of Vienna by the Turks. Post 8vo. 2s.
- ELLIS (W.).** Madagascar Revisited. 8vo. 16s.
- Memoir. By His Son. Portrait. 8vo. 10s. 6d.
- (ROBINSON). Poems and Fragments of Catullus. 16mo. 5s.
- ELPHINSTONE (HON. M.).** History of India—the Hindoo and Mahomedan Periods. Edited by PROFESSOR COWELL. Map. 8vo. 18s.
- Rise of the British Power in the East. A Continuation of his History of India in the Hindoo and Mahomedan Periods. Maps. 8vo. 16s.
- Life of. [See COLEBROOKE.]
- (H. W.). Patterns for Ornamental Turning. Illustrations. Small 4to. 15s.
- ELTON (CAPT.).** Adventures among the Lakes and Mountains of Eastern and Central Africa. Illustrations. 8vo. 21s.
- ELWIN (REV. WARWICK).** The Minister of Baptism. A History of Church Opinion from the time of the Apostles, especially with reference to Heretical and Lay Administration. 8vo. 12s.
- ENGLAND.** [See ARTHUR—BREWER—CROKER—HUME—MARKHAM—SMITH—and STANHOPE.]
- ESSAYS ON CATHEDRALS.** Edited by DEAN HOWSON. 8vo. 12s.
- ETON LATIN GRAMMAR.** For use in the Upper Forms. By FRANCIS HAY RAWLINS, M.A., and WILLIAM RALPH INGE, M.A. Crown 8vo. 6s.
- ELEMENTARY LATIN GRAMMAR. For use in the Lower Forms. Compiled by A. C. AINGER, M.A., and H. G. WINTLE, M.A. Crown 8vo. 3s. 6d.
- PREPARATORY ETON GRAMMAR. Abridged from the above Work. By the same Editors. Crown 8vo. 2s.
- FIRST LATIN EXERCISE BOOK, adapted to the Elementary and Preparatory Grammars. By the same Editors. Crown 8vo. 2s. 6d.
- FOURTH FORM OVID. Selections from Ovid and Tibullus. With Notes by H. G. WINTLE. Post 8vo. 2s. 6d.
- ETON HORACE.** The Odes, Epodes, and Carmen Sæculare. With Notes. By F. W. CORNISH, M.A. Maps. Crown 8vo. 6s.
- EXERCISES IN ALGEBRA, by E. P. ROUSE, M.A., and ARTHUR COCKSHOTT, M.A. Crown 8vo. 3s.
- ARITHMETIC. By REV. T. DALTON, M.A. Crown 8vo. 3s.
- EXPLOSIVES.** [See CUNDILL.]

- FERGUSSON (JAMES).** History of Architecture in all Countries from the Earliest Times. A New and thoroughly Revised Edition. With 1,700 Illustrations. 5 Vols. Medium 8vo
Vols. I. & II. Ancient and Mediæval. 63s.
III. Indian & Eastern. 31s. 6d. IV. Modern. 2 Vols. 31s. 6d.
- FITZGERALD (Bishop).** Lectures on Ecclesiastical History, including the origin and progress of the English Reformation, from Wicliffe to the Great Rebellion. With a Memoir. 2 Vols. 8vo. 21s.
- FITZPATRICK (WILLIAM J.).** The Correspondence of Daniel O'Connell, the Liberator. With Portrait. 2 Vols. 8vo. 36s.
- FLEMING (PROFESSOR).** Student's Manual of Moral Philosophy. With Quotations and References. Post 8vo. 7s. 6d.
- FLOWER GARDEN.** By REV. THOS. JAMES. Fcap. 8vo. 1s.
- FORD (ISABELLA O.).** Miss Blake of Monkshalton. A Novel. Crown 8vo. 5s.
- FORD (RICHARD).** Gatherings from Spain. Post 8vo. 3s. 6d.
- FORSYTH (WILLIAM).** Hortensius; an Historical Essay on the Office and Duties of an Advocate. Illustrations. 8vo. 7s. 6d.
- FORTIFICATION.** [See CLARKE.]
- FRANCE (HISTORY OF).** [See ARTHUR—MARKHAM—SMITH—STUDENTS'—TOCQUEVILLE.]
- FRENCH IN ALGIERS; The Soldier of the Foreign Legion— and the Prisoners of Abd-el-Kadir.** Post 8vo. 2s.
- FRERE (MARY).** Old Deccan Days, or Hindoo Fairy Legends current in Southern India, with Introduction by Sir BARTLE FRERE. With Illustrations. Post 8vo. 5s.
- GALTON (F.).** Art of Travel; or, Hints on the Shifts and Contrivances available in Wild Countries. Woodcuts. Post 8vo. 7s. 6d.
- GAMBIER PARRY (T.).** The Ministry of Fine Art to the Happiness of Life. Revised Edition, with an Index. 8vo. 14s.
- GEOGRAPHY.** [See BUNBURY—CROKER—RAMSAY—RICHARDSON—SMITH—STUDENTS'.]
- GEOGRAPHICAL SOCIETY'S JOURNAL.** (1846 to 1881.)
SUPPLEMENTARY PAPERS. Royal 8vo.
Vol. I., Part i. Travels and Researches in Western China. By E. COLBOURNE BABER. Maps. 5s.
Part ii.—1. Recent Geography of Central Asia; from Russian Sources. By E. DELMAR MORGAN. 2. Progress of Discovery on the Coasts of New Guinea. By C. B. MARKHAM. Bibliographical Appendix, by E. C. RYE. Maps. 5s.
Part iii.—1. Report on Part of the Ghilzi Country, &c. By Lieut. J. S. BROADFOOT. 2. Journey from Shiraz to Jashk. By J. R. PREECE. 2s. 6d.
Part iv.—Geographical Education. By J. S. KELTIE. 2s. 6d.
Vol. II., Part i.—1. Exploration in S. and S.W. China. By A. R. COLQUHOUN. 2. Bibliography and Cartography of Hispaniola. By H. LING ROTH. 3. Explorations in Zanzibar Dominions by Lieut. C. STEWART SMITH, R.N. 2s. 6d.
Part ii.—A Bibliography of Algeria, from the Expedition of Charles V. in 1541 to 1887. By SIR R. L. PLAYFAIR. 4s.

- GEORGE (ERNEST).** The Mosel; Twenty Etchings. Imperial 4to. 42s.
 ——— Loire and South of France; Twenty Etchings. Folio. 42s.
- GERMANY (HISTORY OF).** [See MARKHAM.]
- GIBBON'S** History of the Decline and Fall of the Roman Empire. Edited with notes by MILMAN, GUIZOT, and Dr. WM. SMITH. Maps. 8 Vols. 8vo. 60s. Student's Edition. 7s. 6d. (See STUDENT'S.)
- GIFFARD (EDWARD).** Deeds of Naval Daring; or, Anecdotes of the British Navy. Fcap. 8vo. 3s. 6d.
- GILBERT (JOSIAH).** Landscape in Art: before the days of Claude and Salvator. With 150 Illustrations. Medium 8vo. 30s.
- GILL (CAPT.).** The River of Golden Sand. A Journey through China to Burmah. Edited by E. C. BABER. With MEMOIR by Col. YULE, C.B. Portrait, Map, and Illustrations. Post 8vo. 7s. 6d.
 ——— (MRS.). Six Months in Ascension. An Unscientific Account of a Scientific Expedition. Map. Crown 8vo. 9s.
- GLADSTONE (W. E.).** Rome and the Newest Fashions in Religion. 8vo. 7s. 6d.
 ——— Gleanings of Past Years, 1843-78. 7 Vols. Small 8vo. 2s. 6d. each. I. The Throne, the Prince Consort, the Cabinet and Constitution. II. Personal and Literary. III. Historical and Speculative. IV. Foreign. V. and VI. Ecclesiastical. VII. Miscellaneous.
- GLEIG (G. R.).** Campaigns of the British Army at Washington and New Orleans. Post 8vo. 2s.
 ——— Story of the Battle of Waterloo. Post 8vo. 3s. 6d.
 ——— Narrative of Sale's Brigade in Afghanistan. Post 8vo. 2s.
 ——— Life of Lord Clive. Post 8vo. 3s. 6d.
 ——— Sir Thomas Munro. Post 8vo. 3s. 6d.
- GOLDSMITH'S (OLIVER) Works.** Edited with Notes by PETER CUNNINGHAM. Vignettes. 4 Vols. 8vo. 30s.
- GOMM (F.M. SIR WM.).** His Letters and Journals. 1799 to 1815. Edited by F.C. Carr Gomm. With Portrait. 8vo. 12s.
- GORDON (SIR ALEX.).** Sketches of German Life, and Scenes from the War of Liberation. Post 8vo. 3s. 6d.
 ——— (LADY DUFF). The Amber-Witch. Post 8vo. 2s.
 See also ROSS.
 ——— The French in Algiers. Post 8vo. 2s.
- GORE (Rev. CHARLES, Edited by).** Lux Mundi. A Series of Studies in the Religion of the Incarnation. By various Writers. 8vo. 14s.
- GOULBURN (DEAN).** Three Counsels of the Divine Master for the conduct of the Spiritual Life:—The Commencement; The Virtues; The Conflict. Cheap Edition (424 pp.). Crown 8vo. 9s.
- GRAMMARS.** [See CURTIUS—ETON—HALL—HUTTON—KING EDWARD—LEATHES—MAETZNER—MATTHIÆ—SMITH.]
- GREECE (HISTORY OF).** [See GROTE—SMITH—STUDENTS']

GROTE'S (GEORGE) WORKS :—

HISTORY OF GREECE. From the Earliest Times to the Death of Alexander the Great. *New Edition.* Portrait, Map, and Plans, 10 Vols. Post 8vo. 5s. each. (*The Volumes may be had Separately.*)

PLATO, and other Companions of Socrates. 3 Vols. 8vo. 45s.; or, *New Edition*, Edited by ALEX. BAIN. 4 Vols. Crown 8vo. 5s. each.

ARISTOTLE. 8vo. 12s.

PERSONAL LIFE. Portrait. 8vo. 12s.

MINOR WORKS. Portrait. 8vo. 14s.

— (MRS.). A Sketch. By LADY EASTLAKE. Crown 8vo. 6s.

GUILLEMARD (F. H.), M.D. The Voyage of the Marchesa to Kamschatka and New Guinea. With Notices of Formosa and the Islands of the Malay Archipelago. *New Edition.* With Maps and 150 Illustrations. One volume. Medium 8vo. 21s.

HAKE (G. NAPIER) on Explosives. [See CUNDILL.]

HALL'S (T. D.) School Manual of English Grammar. With Illustrations and Practical Exercises. 12mo. 3s. 6d.

— Primary English Grammar for Elementary Schools. With numerous Exercises, and graduated Parsing Lessons. 16mo. 1s.

— Manual of English Composition. With Copious Illustrations and Practical Exercises. 12mo. 3s. 6d.

— Child's First Latin Book, comprising a full Practice of Nouns, Pronouns, and Adjectives, with the Verbs. 16mo. 2s.

HALLAM'S (HENRY) WORKS :—

THE CONSTITUTIONAL HISTORY OF ENGLAND, from the Accession of Henry the Seventh to the Death of George the Second. *Library Edition*, 3 Vols. 8vo. 30s. *Cabinet Edition*, 3 Vols. Post 8vo. 12s. *Student's Edition*, Post 8vo. 7s. 6d.

HISTORY OF EUROPE DURING THE MIDDLE AGES. *Library Edition*, 3 Vols. 8vo. 30s. *Cabinet Edition*, 3 Vols. Post 8vo. 12s. *Student's Edition*, Post 8vo. 7s. 6d.

LITERARY HISTORY OF EUROPE DURING THE 15TH, 16TH, AND 17TH CENTURIES. *Library Edition*, 3 Vols. 8vo. 30s. *Cabinet Edition*, 4 Vols. Post 8vo. 16s. [Portrait. Fcap. 8vo. 3s. 6d.]

HART'S ARMY LIST. (*Published Quarterly and Annually.*)

HAY (SIR J. H. DRUMMOND). Western Barbary, its Wild Tribes and Savage Animals. Post 8vo. 2s.

HAYWARD (A.). Sketches of Eminent Statesmen and Writers, 2 Vols. 8vo. 28s.

— The Art of Dining. Post 8vo. 2s.

— A Selection from his Correspondence. Edited with an Introductory account of Mr. Hayward's Early Life. By H. E. CARLISLE. 2 vols. Crown 8vo. 24s.

HEAD'S (SIR FRANCIS) WORKS :—

THE ROYAL ENGINEER. Illustrations. 8vo. 12s.

LIFE OF SIR JOHN BURGOYNE. Post 8vo. 1s.

RAPID JOURNEYS ACROSS THE PAMPAS. Post 8vo. 2s.

STOKERS AND POKERS; or, the L. and N. W. R. Post 8vo. 2s.

HEBER'S (BISHOP) Journals in India. 2 Vols. Post 8vo. 7s.

— Poetical Works. Portrait. Fcap. 8vo. 3s. 6d.

HERODOTUS. A New English Version. Edited, with Notes and Essays by CANON RAWLINSON, SIR H. RAWLINSON and SIR J. G. WILKINSON. Maps and Woodcuts. 4 Vols. 8vo. 48s.

HERRIES (RT. HON. JOHN). Memoir of his Public Life. By his Son, Edward Herries, C.B. 2 Vols. 8vo. 24s.

FOREIGN HAND-BOOKS.

- HAND-BOOK—TRAVEL-TALK.** English, French, German, and Italian. New and Revised Edition. 18mo. 3s. 6d.
- **DICTIONARY:** English, French, and German. Containing all the words and idiomatic phrases likely to be required by a traveller. Bound in leather. 16mo. 6s.
- **HOLLAND AND BELGIUM.** Map and Plans. 6s.
- **NORTH GERMANY and THE RHINE,**—The Black Forest, the Hartz, Thüringerwald, Saxon Switzerland, Rügen, the Giant Mountains, Taunus, Odenwald, Elsass, and Lothringen. Map and Plans. Post 8vo. 10s.
- **SOUTH GERMANY AND AUSTRIA.**—Wurtemberg, Bavaria, Austria, Tyrol, Styria, Salzburg, the Dolomites, Hungary, and the Danube, from Ulm to the Black Sea. Maps and Plans. Two Parts. Post 8vo. 12s.
- **SWITZERLAND, Alps of Savoy, and Piedmont.** In Two Parts. Maps and Plans. Post 8vo. 10s.
- **FRANCE, Part I.** Normandy, Brittany, the French Alps, the Loire, Seine, Garonne, and Pyrenees. Maps and Plans. 7s. 6d.
- **FRANCE, Part II.** Central France, Auvergne, the Cevennes, Burgundy, the Rhone and Saone, Provence, Nimes, Arles, Marseilles, the French Alps, Alsace, Lorraine, Champagne, &c. Maps and Plans. Post 8vo. 7s. 6d.
- **THE RIVIERA.** Provence, Dauphiné. The Alpes Maritimes, Avignon, Nimes, Arles, Marseilles, Toulon, Cannes, Grasse, Nice, Monaco, Mentone, Bordighera, San Remo, Alassto, Savona, &c.; Grenoble, Grande Chartreuse. Maps and Plans. 8vo. 5s.
- **MEDITERRANEAN**—its Principal Islands, Cities, Seaports, Harbours, and Border Lands. For Travellers and Yachtsmen, with nearly 50 Maps and Plans. Two Parts. Post 8vo. 21s.
- **ALGERIA AND TUNIS.** Algiers, Constantine, Oran, Tlemcen, Bougie, Tebesa, Biskra, the Atlas Range. Maps and Plans. Post 8vo. 12s.
- **PARIS, and Environs.** Maps and Plans. 3s. 6d.
- **SPAIN, Madrid, The Castiles, The Basque Provinces, Leon, The Asturias, Galicia, Estremadura, Andalusia, Ronda, Granada, Murcia, Valencia, Catalonia, Aragon, Navarra, The Balearic Islands, &c. &c.** Maps and Plans. Two Parts. Post 8vo. 20s.
- **PORTUGAL, Lisbon, Oporto, Cintra, Mafra, Madeira, the Azores, Canary Islands, &c.** Map and Plan. 12s.
- **NORTH ITALY, Turin, Milan, Cremona, the Italian Lakes, Bergamo, Brescia, Verona, Mantua, Vicenza, Padua, Ferrara, Bologna, Ravenna, Rimini, Piacenza, Genoa, the Riviera, Venice, Parma, Modena, and Romagna.** Maps and Plans. Post 8vo. 10s.
- **CENTRAL ITALY, Florence, Lucca, Tuscany, The Marshes, Umbria, &c.** Maps and Plans. Two Parts. Post 8vo. 10s.
- **ROME AND ITS ENVIRONS.** 50 Maps and Plans. 10s.
- **SOUTH ITALY AND SICILY, including Naples and its Environs, Pompeii, Herculaneum, Vesuvius; Sorrento; Capri; Amalfi, Paestum, Pozzuoli, Capua, Taranto, Bari; Brindisi and the Roads from Rome to Naples; Palermo, Messina, Syracuse, Catania, &c.** Two Parts. Maps. Post 8vo. 12s.
- **NORWAY, Christiania, Bergen, Trondhjem.** The Fjelds and Fjords. Maps and Plans. Post 8vo. 9s.
- **SWEDEN, Stockholm, Upsala, Gothenburg, the Shores of the Baltic, &c.** Maps and Plans. Post 8vo. 6s.

- HAND-BOOK—DENMARK**, Sleswig, Holstein, Copenhagen, Jutland, Iceland. Maps and Plans. Post 8vo. 6s.
- **RUSSIA, ST. PETERSBURG, MOSCOW, POLAND, and FINLAND.** Maps and Plans. Post 8vo. 18s.
- **GREECE**, the Ionian Islands, Athens, the Peloponnesus, the Islands of the Ægean Sea, Albania, Thessaly, Macedonia, &c. In Two Parts. Maps, Plans, and Views. Post 8vo. 24s.
- **TURKEY IN ASIA—CONSTANTINOPLE**, the Bosphorus, Dardanelles, Brousa, Plain of Troy, Crete, Cyprus, Smyrna, Ephesus, the Seven Churches, Coasts of the Black Sea, Armenia, Euphrates Valley, Route to India, &c. Maps and Plans. Post 8vo.
- **EGYPT.** The Course of the Nile through Egypt and Nubia, Alexandria, Cairo, Thebes, Suez Canal, the Pyramids, Sinai, the Fyoom, &c. Maps and Plans. Post 8vo.
- **HOLY LAND—SYRIA, PALESTINE,** Peninsula of Sinai, Edom, Syrian Deserts, Petra, Damascus; and Palmyra. Maps and Plans. Post 8vo. 20s.
. Map of Palestine. In a case. 12s.
- **BOMBAY—Poonah, Beejapoor, Kolapoor, Goa, Jubulpoor, Indore, Surat, Baroda, Ahmedabad, Somnauth, Kurrachee, &c.** Map and Plans. Post 8vo. 15s.
- **MADRAS—Trichinopoli, Madura, Tinnevely, Tuticorin, Bangalore, Mysore, The Nilgiris, Wynaad, Ootacamund, Calicut, Hyderabad, Ajanta, Elura Caves, &c.** Maps and Plans. Post 8vo. 16s.
- **BENGAL—Calcutta, Orissa, British Burmah, Rangoon, Moulmein, Mandalay, Darjiling, Dacca, Patna, Benares, N.-W. Provinces, Allahabad, Cawnpore, Lucknow, Agra, Gwalior, Naini Tal, Delhi, &c.** Maps and Plans. Post 8vo. 20s.
- **THE PANJAB—Amraoti, Indore, Ajmir, Jaypur, Rohtak, Saharanpur, Ambala, Lodiana, Lahore, Kulu, Simla, Sialkot, Feshawar, Rawul Pindi, Attock, Karachi, Sibi, &c.** Maps. 15s.
- **INDIA.** A Practical Guide for Travellers through the Principal Routes in Bengal, Bombay, Madras, Punjab, &c., and to the Summer Resorts Simla, Darjeeling, Mahabaleshwar, Matheran, Mt. Abo, &c. In One Volume. Maps and Plans. Post 8vo.

ENGLISH HAND-BOOKS.

- HAND-BOOK—ENGLAND AND WALES.** An Alphabetical Hand-Book. Condensed into One Volume for the Use of Travellers. With a Map. Post 8vo. 12s.
- **LONDON.** Maps and Plans. 16mo. 3s. 6d.
- **ENVIRONS OF LONDON** within a circuit of 20 miles. 2 Vols. Crown 8vo. 21s.
- **ST. PAUL'S CATHEDRAL.** 20 Woodcuts. 10s. 6d.
- **EASTERN COUNTIES,** Chelmsford, Harwich, Colchester, Maldon Cambridge, Ely, Newmarket, Bury St. Edmunds, Ipswich, Woodbridge, Felixstowe, Lowestoft, Norwich, Yarmouth, Cromer, &c. Map and Plans. Post 8vo.
- **CATHEDRALS of Oxford, Peterborough, Norwich, Ely, and Lincoln.** With 90 Illustrations. Crown 8vo. 21s.
- **KENT,** Canterbury, Dover, Ramsgate, Sheerness, Rochester, Chatham, Woolwich. Maps and Plans. Post 8vo. 7s. 6d.
- **SUSSEX,** Brighton, Chichester, Worthing, Hastings, Lewes, Arundel, &c. Maps and Plans. Post 8vo. 6s.

- HAND-BOOK—SURREY AND HANTS**, Kingston, Croydon, Reigate, Guildford, Dorking, Winchester, Southampton, New Forest, Portsmouth, ISLE OF WIGHT, &c. Maps and Plans. Post 8vo. 10s.
- BERKS, BUCKS, AND OXON**, Windsor, Eton, Reading, Aylesbury, Uxbridge, Wycombe, Henley, Oxford, Blenheim, the Thames, &c. Maps and Plans. Post 8vo. 9s.
- WILTS, DORSET, AND SOMERSET**, Salisbury, Chippenham, Weymouth, Sherborne, Wells, Bath, Bristol, Taunton, &c. Map. Post 8vo. 12s.
- DEVON**, Exeter, Ilfracombe, Linton, Sidmouth, Dawlish, Teignmouth, Plymouth, Devonport, Torquay. Maps and Plans. Post 8vo. 7s. 6d.
- CORNWALL**, Launceston, Penzance, Falmouth, the Lizard, Land's End, &c. Maps. Post 8vo. 6s.
- CATHEDRALS of Winchester, Salisbury, Exeter, Wells, Chichester, Rochester, Canterbury, and St. Albans.** With 130 Illustrations. 2 Vols. Crown 8vo. 36s. St. Albans separately. 6s.
- GLOUCESTER, HEREFORD, AND WORCESTER**, Cirencester, Cheltenham, Stroud, Tewkesbury, Leominster, Ross, Malvern, Kidderminster, Dudley, Evesham, &c. Map. Post 8vo. 9s.
- CATHEDRALS of Bristol, Gloucester, Hereford, Worcester, and Lichfield.** With 50 Illustrations. Crown 8vo. 16s.
- NORTH WALES**, Bangor, Carnarvon, Beaumaris, Snowdon, Llanberis, Dolgelly, Conway, &c. Maps. Post 8vo. 7s.
- SOUTH WALES**, Monmouth, Llandaff, Merthyr, Vale of Neath, Pembroke, Carmarthen, Tenby, Swansea, The Wye, &c. Map. Post 8vo. 7s.
- CATHEDRALS OF BANGOR, ST. ASAPH, Llandaff, and St. David's.** With Illustrations. Post 8vo. 15s.
- NORTHAMPTONSHIRE AND RUTLAND—**Northampton, Peterborough, Towcester, Daventry, Market Harborough, Kettering, Wellingborough, Thrapston, Stamford, Uppingham, Oakham. Maps. Post 8vo. 7s. 6d.
- DERBY, NOTTS, LEICESTER, STAFFORD**, Matlock, Bakewell, Chatsworth, The Peak, Buxton, Hardwick, Dove Dale, Ashborne, Southwell, Mansfield, Retford, Burton, Belvoir, Melton Mowbray, Wolverhampton, Lichfield, Walsall, Tamworth. Map. Post 8vo.
- SHROPSHIRE AND CHESHIRE**, Shrewsbury, Ludlow, Bridgnorth, Oswestry, Chester, Crewe, Alderley, Stockport, Birkenhead. Maps and Plans. Post 8vo. 6s.
- LANCASHIRE**, Warrington, Bury, Manchester, Liverpool, Burnley, Clitheroe, Bolton, Blackburne, Wigan, Preston, Rochdale, Lancaster, Southport, Blackpool, &c. Maps & Plans. Post 8vo. 7s. 6d.
- THE ENGLISH LAKES**, in Cumberland, Westmoreland, and Lancashire; Lancaster, Furness Abbey, Ambleside, Kendal, Windermere, Conistow, Keswick, Grasmere, Ulswater, Carlisle, Cockermouth, Penrith, Appleby, &c. Maps. Post 8vo. 7s. 6d.
- YORKSHIRE**, Doncaster, Hull, Selby, Beverley, Scarborough, Whitby, Harrogate, Ripon, Leeds, Wakefield, Bradford, Halifax, Huddersfield, Sheffield. Map and Plans. Post 8vo. 12s.
- CATHEDRALS of York, Ripon, Durham, Carlisle, Chester, and Manchester.** With 60 Illustrations. 2 Vols. Cr. 8vo. 21s.
- DURHAM AND NORTHUMBERLAND**, Newcastle, Darlington, Stockton, Hartlepool, Shields, Berwick-on-Tweed, Morpeth, Tynemouth, Coldstream, Alnwick, &c. Map. Post 8vo. 10s.
- LINCOLNSHIRE**, Grantham, Lincoln, Stamford, Sleaford, Spalding, Gainsborough, Grimsby, Boston. Maps and Plans. Post 8vo. 7s. 6d.
- WARWICKSHIRE.** Map. Post 8vo.
- HERTS, BEDS AND HUNTS.**

- HAND-BOOK—SCOTLAND**, Edinburgh, Melrose, Kelso, Glasgow, Dumfries, Ayr, Stirling, Arran, The Clyde, Oban, Inverary, Loch Lomond, Loch Katrine and Trossachs, Caledonian Canal, Inverness, Perth, Dundee, Aberdeen, Braemar, Skye, Caithness, Ross, Sutherland, &c. Maps and Plans. Post 8vo. 9s.
- **IRELAND**, Dublin, Belfast, the Giant's Causeway, Donegal, Galway, Wexford, Cork, Limerick, Waterford, Killarney, Bantry, Glengariff, &c. Maps and Plans. Post 8vo. 10s.
- HICKSON (DR. SYDNEY J.)**. A Naturalist in North Celebes; a Narrative of Travels in Minakassa, the Sangir and Talant Islands, with Notices of the Fauna, Flora, and Ethnology of the Districts visited. Map and Illustrations. 8vo. 16s.
- HISLOP (STEPHEN)**. [See SMITH, GEORGE.]
- HOBSON (J. A.)**. [See MUMMERY.]
- HOLLWAY (J. G.)**. A Month in Norway. Fcap. 8vo. 2s.
- HONEY BEE**. By REV. THOMAS JAMES. Fcap. 8vo. 1s.
- HOOK (DEAN)**. Church Dictionary. A Manual of Reference for Clergymen and Students. New Edition, thoroughly revised. Edited by WALTER HOOK, M. A., and W. R. W. STEPHENS, M. A. Med. 8vo. 21s.
- **(THEODORE) Life**. By J. G. LOCKHART. Fcap. 8vo. 1s.
- HOPE (A. J. BERESFORD)**. Worship in the Church of England. 8vo, 9s.; or, *Popular Selections from*, 8vo, 2s. 6d.
- **WORSHIP AND ORDER**. 8vo. 9s.
- HOPE-SCOTT (JAMES)**, Memoir. [See ORNSBY.]
- HORACE**; a New Edition of the Text. Edited by DEAN MILMAN. With 100 Woodcuts. Crown 8vo. 7s. 6d.
- [See ETON.]
- HOUGHTON'S (LORD) Monographs**. Portraits. 10s. 6d.
- **POETICAL WORKS**. Portrait. 2 Vols. 12s.
- **(ROBERT LORD) Stray Leaves**. Crown 8vo.

HOME AND COLONIAL LIBRARY. A Series of Works adapted for all circles and classes of Readers, having been selected for their acknowledged interest, and ability of the Authors. Post 8vo. Published at 2s. and 3s. 6d. each, and arranged under two distinctive heads as follows:—

CLASS A.

HISTORY, BIOGRAPHY, AND HISTORIC TALES.

- | | |
|---|--|
| SIEGE OF GIBRALTAR . By JOHN DRINKWATER. 2s. | THE WAYSIDE CROSS . By CAPT. MILMAN. 2s. |
| THE AMBER-WITCH . By LADY DUFF GORDON. 2s. | SKETCHES OF GERMAN LIFE . By SIR A. GORDON. 3s. 6d. |
| CROMWELL AND BUNYAN . By ROBERT SOUTHEY. 2s. | THE BATTLE OF WATERLOO . By REV. G. R. GLEIG. 3s. 6d. |
| LIFE OF SIR FRANCIS DRAKE . By JOHN BARROW. 2s. | AUTOBIOGRAPHY OF STEPFENS . 2s. |
| CAMPAIGNS AT WASHINGTON . By REV. G. R. GLEIG. 2s. | THE BRITISH POETS . By THOMAS CAMPBELL. 3s. 6d. |
| THE FRENCH IN ALGIERS . By LADY DUFF GORDON. 2s. | HISTORICAL ESSAYS . By LORD MAHON. 3s. 6d. |
| THE FALL OF THE JESUITS . 2s. | LIFE OF LORD CLIVE . By REV. G. R. GLEIG. 3s. 6d. |
| LIFE OF CONDE . By LORD MAHON. 3s. 6d. | NORTH WESTERN RAILWAY . By SIR F. B. HEAD. 2s. |
| SALE'S BRIGADE . By REV. G. R. GLEIG. 2s. | LIFE OF MUNRO . By REV. G. R. GLEIG. 3s. 6d. |
| THE SIEGES OF VIENNA . By LORD ELLESMERE. 2s. | |

CLASS B.

VOYAGES, TRAVELS, AND ADVENTURES.

- JOURNALS IN INDIA. By BISHOP HEBER. 2 Vols. 7s.
- TRAVELS IN THE HOLY LAND. By IRBY and MANGLES. 2s.
- MOROCCO AND THE MOORS. By J. DRUMMOND HAY. 2s.
- LETTERS FROM THE BALTIC. By A LADY. 2s.
- NEW SOUTH WALES. By Mrs. MEREDITH. 2s.
- THE WEST INDIES. By M. G. LEWIS. 2s.
- SKETCHES OF PERSIA. By SIR JOHN MALCOLM. 3s. 6d.
- MEMOIRS OF FATHER RIPA. 2s.
- TYPEE AND OMOO. By HERMANN MELVILLE. 2 Vols. 7s.
- MISSIONARY LIFE IN CANADA. By REV. J. ABBOTT. 2s.
- LETTERS FROM MADRAS. By A LADY. 2s.
- HIGHLAND SPORTS. By CHARLES ST. JOHN. 3s. 6d.
- PAMPAS JOURNEYS. By F. B. HEAD. 2s.
- GATHERINGS FROM SPAIN. By RICHARD FORD. 3s. 6d.
- THE RIVER AMAZON. By W. H. EDWARDS. 2s.
- MANNERS & CUSTOMS OF INDIA. By REV. C. ACLAND. 2s.
- ADVENTURES IN MEXICO. By G. F. RUXTON. 3s. 6d.
- PORTUGAL AND GALICIA. By LORD CARNARVON. 3s. 6d.
- BUSH LIFE IN AUSTRALIA. By REV. H. W. HAYGARTH. 2s.
- THE LIBYAN DESERT. By BAYLE ST. JOHN. 2s.
- SIERRA LEONE. By A LADY. 3s. 6d.

* * * Each work may be had separately.

- HUHN (A. VON). The Struggle of the Bulgarians for National Independence: A History of the War between Bulgaria and Servia in 1885, under PRINCE ALEXANDER. With Map. Crown 8vo. 9s.
- HUME (The Student's). A History of England, from the Invasion of Julius Cæsar to the Revolution of 1688. New Edition, revised, corrected, and continued to the Treaty of Berlin, 1878. By J. S. BREWER, M.A. With 7 Coloured Maps & 70 Woodcuts. Post 8vo. 7s. 6d.
- * * * Sold also in 3 parts. Price 2s. 6d. each.
- HUNNEWELL (JAMES F.). England's Chronicle in Stone; Derived from Personal Observations of the Cathedrals, Churches, Abbeys, Monasteries, Castles, and Palaces, made in Journeys through the Imperial Island. With Illustrations. Medium 8vo. 24s.
- HUTCHINSON (GEN.). Dog Breaking, with Odds and Ends for those who love the Dog and the Gun. With 40 Illustrations. Crown 8vo. 7s. 6d. * * * A Summary of the Rules for Gamekeepers. 1s.
- HUTTON (H. E.). Principia Græca; an Introduction to the Study of Greek, Comprehending Grammar, Delectus, and Exercise-book, with Vocabulary. Sixth Edition. 12mo. 3s. 6d.
- (JAMES). James and Philip van Artevelde. Two remarkable Episodes in the Annals of Flanders; with a description of the state of Society in Flanders in the 14th Century. Cr. 8vo. 10s. 6d.
- HYMNOLOGY, DICTIONARY OF. [See JULIAN.]
- ICELAND. [See COLES—DUFFERIN.]
- INDIA. [See BROADFOOT—DUFFERIN—ELPHINSTONE—HAND-BOOK—SMITH—TEMPLE—MONIER WILLIAMS—LYALL.]
- IRBY AND MANGLES' Travels in Egypt, Nubia, Syria, and the Holy Land. Post 8vo. 2s.
- JAMES (F. L.). The Wild Tribes of the Soudan: with an account of the route from Wady Halfa to Dongola and Berber. With Chapter on the Soudan, by SIR S. BAKER. Illustrations. Crown 8vo. 7s. 6d.
- JAMESON (Mrs.). Lives of the Early Italian Painters—and the Progress of Painting in Italy—Cimabue to Bassano. With 50 Portraits. Post 8vo. 12s.

- JANNARIS (PROF. A. N.).** A Pocket Dictionary of the Modern Greek and English Languages, as actually Written and Spoken. Being a Copious Vocabulary of all Words and Expressions Current in Ordinary Reading and in Everyday Talk, with Especial Illustration by means of Distinctive Signs, of the Colloquial and Popular Greek Language, for the Guidance of Students and Travellers. Fcap. 8vo.
- JAPAN.** [See BIRD—MOUNSEY—REED.]
- JENNINGS (L. J.).** Field Paths and Green Lanes: or Walks in Surrey and Sussex. Popular Edition. With Illustrations. Cr. 8vo. 6s.
[See also CROKER.]
- JERVIS (REV. W. H.).** The Gallican Church, from the Concordat of Bologna, 1516, to the Revolution. With an Introduction. Portraits. 2 Vols. 8vo. 28s.
- JESSE (EDWARD).** Gleanings in Natural History. Fcp. 8vo. 3s. 6d.
- JOHNSON'S (DR. SAMUEL) Life.** [See BOSWELL.]
- JULIAN (REV. JOHN J.).** A Dictionary of Hymnology. A Companion to Existing Hymn Books. Setting forth the Origin and History of the Hymns contained in the Principal Hymnals, with Notices of their Authors. Medium 8vo.
- JUNIUS' HANDWRITING** Professionally investigated. Edited by the Hon. E. TWISLETON. With Facsimiles, Woodcuts, &c. 4to. £3 3s.
- KENDAL (MRS.)** Dramatic Opinions. Post 8vo. 1s.
- KERR (ROBT.).** The Consulting Architect: Practical Notes on Administrative Difficulties. Crown 8vo. 9s.
- KING EDWARD VIth's Latin Grammar.** 12mo. 3s. 6d.
First Latin Book. 12mo. 2s. 6d.
- KIRKES' Handbook of Physiology.** Edited by W. MORRANT BAKER and V. D. HARRIS. With 500 Illustrations. Post 8vo. 14s.
- KUGLER'S HANDBOOK OF PAINTING.**—The Italian Schools, A New Edition, revised. By Sir HENRY LAYARD. With 200 Illustrations. 2 vols. Crown 8vo. 30s.
- The German, Flemish, and Dutch Schools. New Edition revised. By Sir J. A. CROWE. With 60 Illustrations. 2 Vols. Crown 8vo. 24s.
- LANE (E. W.).** Account of the Manners and Customs of Modern Egyptians. With Illustrations. 2 Vols. Post 8vo. 12s.
- LAWLESS (HON. EMILY).** Major Lawrence, F.L.S.: a Novel. 8 Vols. Crown 8vo. 31s. 6d. Cheap Edition, 6s.
Plain Frances Mowbray, etc. Crown 8vo. 6s.
- LAYARD (Sir A. H.).** Nineveh and its Remains. With Illustrations. Post 8vo. 7s. 6d.
Nineveh and Babylon: Discoveries in the Ruins, with Travels in Armenia, Kurdistan, &c. Illustrations. Post 8vo. 7s. 6d.
Early Adventures in Persia, Babylonia, and Susiana, including a residence among the Bakhtiyari and other wild tribes, before the discovery of Nineveh. Portrait, Illustrations and Maps. 2 Vols. Crown 8vo. 24s.
- LEATHES (STANLEY).** Practical Hebrew Grammar. With the Hebrew Text of Genesis i.—vi., and Psalms i.—vi. Grammatical Analysis and Vocabulary. Post 8vo. 7s. 6d.
- LENNEP (REV. H. J. VAN).** Missionary Travels in Asia Minor. With Illustrations of Biblical History and Archæology. 2 Vols. Post 8vo. 24s.
Modern Customs and Manners of Bible Lands, in Illustration of Scripture. Illustrations. 2 Vols. 8vo. 21s.

- LESLIE (C. R.). Handbook for Young Painters. Illustrations. Post 8vo. 7s. 6d.
- LETO (POMPONIO). Eight Months at Rome during the Vatican Council. 8vo. 12s.
- LETTERS FROM THE BALTIC. By LADY EASTLAKE. Post 8vo. 2s.
 ——— MADRAS. By MRS. MAITLAND. Post 8vo. 2s.
 ——— SIERRA LEONE. By MRS. MELVILLE. 3s. 6d.
- LEVI (LEONE). History of British Commerce; and Economic Progress of the Nation, from 1763 to 1873. 8vo. 18s.
 ——— The Wages and Earnings of the Working Classes in 1893-4. 8vo. 3s. 6d.
- LEWIS (T. HAYTER). The Holy Places of Jerusalem. Illustrations. 8vo. 10s. 6d.
- LEX SALICA; the Ten Texts with the Glosses and the Lex Emendata. Synoptically edited by J. H. HERSELS. With Notes on the Frankish Words in the Lex Salica by H. KEEN, of Leyden. 4to. 42s.
- LIDDELL (DEAN). Student's History of Rome, from the earliest Times to the establishment of the Empire. Woodcuts. Post 8vo. 7s. 6d.
- LIND (JENNY), THE ARTIST, 1820—1851. Her early Art-life and Dramatic Career. From Original Documents, Letters, Diaries, &c., in the possession of MR. GOLDSCHMIDT. By CANON H. SCOTT HOLLAND, M.A., and W. S. ROCKSTRO. With Portraits and Illustrations. 2 Vols. 8vo. 32s.
- LINDSAY (LORD). Sketches of the History of Christian Art. 2 Vols. Crown 8vo. 24s.
- LISPINGS from LOW LATITUDES; or, the Journal of the Hon. Impulsia Gushington. Edited by LORD DUFFERIN. With 24 Plates. 4to. 21s.
- LIVINGSTONE (DR.). First Expedition to Africa, 1840-56. Illustrations. Post 8vo. 7s. 6d.
 ——— Second Expedition to Africa, 1858-64. Illustrations. Post 8vo. 7s. 6d.
 ——— Last Journals in Central Africa, to his Death. By REV. HORACE WALLER. Maps and Illustrations. 2 Vols. 8vo. 15s.
 ——— Personal Life. By Wm. G. Blaikie, D.D. With Map and Portrait. 8vo. 6s.
- LOCKHART (J. G.). Ancient Spanish Ballads. Historical and Romantic. Translated, with Notes. Illustrations. Crown 8vo. 5s.
 ——— Life of Theodore Hook. Fcap. 8vo. 1s.
- LONDON: Past and Present; its History, Associations, and Traditions. By HENRY B. WHEATLEY, F.S.A. Based on Cunningham's Handbook. Library Edition, on Laid Paper 3 Vols. Medium 8vo. 3l. 3s.
- LOUDON (MRS.). Gardening for Ladies. With Directions and Calendar of Operations for Every Month. Woodcuts. Fcap. 8vo. 3s. 6d.
- LUMHOLTZ (DR. C.). Among Cannibals; An Account of Four Years' Travels in Australia, and of Camp Life among the Aborigines of Queensland. With Maps and 120 Illustrations. Medium 8vo. 24s.
- LUTHER (MARTIN). The First Principles of the Reformation, or the Three Primary Works of Dr. Martin Luther. Portrait. 8vo. 12s.
- LYALL (SIR ALFRED C.), K.C.B. Asiatic Studies; Religious and Social. 8vo. 12s.
- LYELL (SIR CHARLES). Student's Elements of Geology. A new Edition, entirely revised by PROFESSOR P. M. DUNCAN, F.R.S. With 600 Illustrations. Post 8vo. 9s.
 ——— Life, Letters, and Journals. Edited by his sister-in-law, MRS. LYELL. With Portraits. 2 Vols. 8vo. 30s.

- LYNDHURST (LORD). [See MARTIN.]
- McCLINTOCK (SIR L.). Narrative of the Discovery of the Fate of Sir John Franklin and his Companions in the Arctic Seas. With Illustrations. Post 8vo. 7s. 6d.
- MACDONALD (A.). Too Late for Gordon and Khartoum. With Maps and Plans. 8vo. 12s.
- MACGREGOR (J.). Rob Roy on the Jordan, Nile, Red Sea, Genesareth, &c. A Canoe Cruise in Palestine and Egypt and the Waters of Damascus. With 70 Illustrations. Crown 8vo. 7s. 6d.
- MACKAY (THOMAS). The English Poor. A Sketch of their Social and Economic History; and an attempt to estimate the influence of private property on character and habit. Crown 8vo. 7s. 6d.
- A Plea for Liberty: an Argument against Socialism and Socialistic Legislation. Essays by various Writers. With an Introduction by HERBERT SPENCER. Edited by THOMAS MACKAY. 8vo. 12s.
- MAHON (LORD). [See STANHOPE.]
- MAINE (SIR H. SUMNER). Ancient Law: its Connection with the Early History of Society, and its Relation to Modern Ideas. 8vo. 9s.
- Village Communities in the East and West. 8vo. 9s.
- Early History of Institutions. 8vo. 9s.
- Dissertations on Early Law and Custom. 8vo. 9s.
- I.—Popular Government. II.—Democracy. III.—Age of Progress. IV.—The United States. 8vo. 7s. 6d.
- International Law. 8vo. 7s. 6d.
- MALCOLM (SIR JOHN). Sketches of Persia. Post 8vo. 3s. 6d.
- MARCO POLO. [See YULE.]
- MARKHAM (MRS.). History of England. From the First Invasion by the Romans, continued down to 1880. Woodcuts. 12mo. 3s. 6d.
- History of France. From the Conquest of Gaul by Julius Cæsar, continued down to 1878. Woodcuts. 12mo. 3s. 6d.
- History of Germany. From its Invasion by Marius to the completion of Cologne Cathedral. Woodcuts. 12mo. 3s. 6d.
- (CLEMENS R.). A Popular Account of Peruvian Bark and its introduction into British India. With Maps. Post 8vo. 14s.
- MARSH (G. P.). Student's Manual of the English Language. Edited with Additions. By DR. WM. SMITH. Post 8vo. 7s. 6d.
- MARTIN (SIR THEODORE). Life of Lord Lyndhurst. With Portraits. 8vo. 16s.
- MASTERS in English Theology. Lectures by Eminent Divines. With Introduction by Canon Barry. Post 8vo. 7s. 6d.
- MATTHIÆ'S GREEK GRAMMAR. Abridged by BLOMFIELD. Revised by E. S. CROOKE. 12mo. 4s.
- MAUREL'S Character, Actions, and Writings of Wellington. Fcap. 8vo. 1s. 6d.
- MELVILLE (HERMANN). Marquesas and South Sea Islands. 2 Vols. Post 8vo. 7s.
- MEREDITH (MRS. C.). Notes & Sketches of N. S. Wales. Post 8vo. 2s.
- MEXICO. [See BROCKLEHURST—RUXTON.]
- MICHAEL ANGELO, Sculptor, Painter, and Architect. His Life and Works. By C. HEATH WILSON. Illustrations. 8vo. 16s.

- MILLER (WM.).** A Dictionary of English Names of Plants applied among English-speaking People to Plants, Trees, and Shrubs. In Two Parts. Latin-English and English-Latin. Medium 8vo. 12s.
- MILMAN'S (DEAN) WORKS:—**
- HISTORY OF THE JEWS,** from the earliest Period down to Modern Times. 3 Vols. Post 8vo. 12s.
- EARLY CHRISTIANITY,** from the Birth of Christ to the Abolition of Paganism in the Roman Empire. 8 Vols. Post 8vo. 12s.
- LATIN CHRISTIANITY,** including that of the Popes to the Pontificate of Nicholas V. 9 Vols. Post 8vo. 36s.
- HANDBOOK TO ST. PAUL'S CATHEDRAL.** Woodcuts. 10s. 6d.
- QUINTI HORATII FLACCI OPERA.** Woodcuts. Sm. 8vo. 7s. 6d.
- FALL OF JERUSALEM.** Fcap. 8vo. 1s.
- (BISHOP, D.D.) Life. With a Selection from his Correspondence and Journals. By his Sister. Map. 8vo. 12s.
- MILNE (DAVID, M.A.).** A Readable Dictionary of the English Language. Etymologically arranged. Crown 8vo. 7s. 6d.
- MINCHIN (J. G.).** The Growth of Freedom in the Balkan Peninsula. With a Map. Crown 8vo. 10s. 6d.
- MISS BLAKE OF MONKSHALTON.** By ISABELLA FORD. A New Novel. Crown 8vo. 5s.
- MIVART (ST. GEORGE).** Lessons from Nature; as manifested in Mind and Matter. 8vo. 15s.
- The Cat. An Introduction to the Study of Backboned Animals, especially Mammals. With 200 Illustrations. Medium 8vo. 30s.
- MOGGRIDGE (M. W.).** Method in Almsgiving. A Handbook for Helpers. Post 8vo. 3s. 6d.
- MOORE (THOMAS).** Life and Letters of Lord Byron. [See BYRON.]
- MOTLEY (JOHN LOTHROP).** The Correspondence of. With Portrait. 2 Vols. 8vo. 30s.
- History of the United Netherlands: from the Death of William the Silent to the Twelve Years' Truce, 1609. Portraits. 4 Vols. Post 8vo. 6s. each.
- Life and Death of John of Barneveld. With a View of the Primary Causes and Movements of the Thirty Years' War. Illustrations. 2 Vols. Post 8vo. 12s.
- MUMMERY (A. F.) AND J. A. HOBSON.** The Physiology of Industry: Being an Exposure of certain Fallacies in existing Theories of Political Economy. Crown 8vo. 6s.
- MUNRO'S (GENERAL) Life and Letters.** By REV. G. R. GLEIG. Post 8vo. 3s. 6d.
- MUNTHE (AXEL).** Letters from a Mourning City. Naples during the Autumn of 1884. Translated by MAUDE VALERIE WHITE. With a Frontispiece. Crown 8vo. 6s.
- MURCHISON (SIR RODERICK).** And his Contemporaries. By ARCHIBALD GEIKIE. Portraits. 2 Vols. 8vo. 30s.
- MURRAY (JOHN).** A Publisher and his Friends: Memoir and Correspondence of the late John Murray, with an Account of the Origin and Progress of the House, 1768—1843. By SAMUEL SMILES, LL.D. With Portraits. 2 Vols. 8vo. 32s.
- MURRAY (A. S.).** A History of Greek Sculpture from the Earliest Times. With 130 Illustrations. 2 Vols. Medium 8vo. 36s.
- MURRAY'S MAGAZINE.** A New Home and Colonial Monthly Periodical. 1s. Vol. I. to Vol. VIII. 8vo. 7s. 6d. each.
- * * * Forwarded Monthly on receipt of an annual subscription of 13s.

- NADAILLAC (MARQUIS DE).** Prehistoric America. Translated by N. D'ANVERS. With Illustrations. 8vo. 16s.
- NAPIER (GENERAL SIR CHARLES).** His Life. By the Hon. WM. NAPIER BRUCE. With Portrait and Maps. Crown 8vo. 12s.
- (GENERAL SIR GEORGE T.). Passages in his Early Military Life written by himself. Edited by his Son, GENERAL WM. C. E. NAPIER. With Portrait. Crown 8vo. 7s. 6d.
- (SIR WM.). English Battles and Sieges of the Peninsular War. Portrait. Post 8vo. 5s.
- NASMYTH (JAMES).** An Autobiography. Edited by Samuel Smiles, LL.D. with Portrait, and 70 Illustrations. Post 8vo, 6s.; or Large Paper, 16s.
- The Moon: Considered as a Planet, a World, and a Satellite. With 26 Plates and numerous Woodcuts. New and Cheaper Edition. Medium 8vo. 21s.
- NEW TESTAMENT.** With Short Explanatory Commentary. By ARCHDEACON CHURTON, M.A., and the BISHOP OF ST. DAVID'S. With 110 authentic Views, &c. 2 Vols. Crown 8vo. 21s. bound.
- NEWTN (SAMUEL).** First Book of Natural Philosophy; an Introduction to the Study of Statics, Dynamics, Hydrostatics, Light, Heat, and Sound, with numerous Examples. Small 8vo. 3s. 6d.
- Elements of Mechanics, including Hydrostatics, with numerous Examples. Small 8vo. 8s. 6d.
- Mathematical Examples. A Graduated Series of Elementary Examples in Arithmetic, Algebra, Logarithms, Trigonometry, and Mechanics. Small 8vo. 8s. 6d.
- NIMROD;** On the Chace—Turf—and Road. With Portrait and Plates. Crown 8vo. 5s. Or with Coloured Plates, 7s. 6d.
- NORRIS (W. E.).** Marcia. A Novel. 3 Vols. Crown 8vo. 31s. 6d.
- NORTHCOTE'S (SIR JOHN)** Notebook in the Long Parliament. Containing Proceedings during its First Session, 1640. Edited, with a Memoir, by A. H. A. Hamilton. Crown 8vo. 9s.
- O'CONNELL (DANIEL).** [See FITZPATRICK.]
- ORNSBY (PROF. R.).** Memoirs of J. Hope Scott, Q.C. (of Abbotsford). With Selections from his Correspondence. 2 vols. 8vo. 24s.
- OTTER (R. H.).** Winters Abroad: Some Information respecting Places visited by the Author on account of his Health. Intended for the Use and Guidance of Invalids. 7s. 6d.
- OVID LESSONS.** [See ETON.]
- OWEN (LIEUT.-COL.).** Principles and Practice of Modern Artillery. With Illustrations. 8vo. 15s.
- OXENHAM (REV. W.).** English Notes for Latin Elegiacs; with Prefatory Rules of Composition in Elegiac Metre. 12mo. 3s. 6d.
- PAGET (LORD GEORGE).** The Light Cavalry Brigade in the Crimea. Map. Crown 8vo 10s. 6d.
- PALGRAVE (R. H. I.).** Local Taxation of Great Britain and Ireland. 8vo. 5s.
- PALLISER (MRS.).** Mottoes for Monuments, or Epitaphs selected for General Use and Study. With Illustrations. Crown 8vo. 7s. 6d.
- PANKHURST (E. A.).** The Wisdom of Edmund Burke: Being Selections from his Speeches and Writings. Fcp. 8vo. 6s.

- PARIS (DR.).** Philosophy in Sport made Science in Earnest; or, the First Principles of Natural Philosophy inculcated by aid of the Toys and Sports of Youth. Woodcuts. Post 8vo. 7s. 6d.
- PARKER (C. S.), M.P.** [See PEEL.]
- PEEL'S (SIR ROBERT) Memoirs.** 2 Vols. Post 8vo. 15s.
- Life of: Early years; as Secretary for Ireland, 1812-18, and Secretary of State, 1822-27. Published by his Trustees, Viscount Hardinge and Right Hon. Arthur Wellesley Peel. Edited by CHARLES STUART PARKER, M.P. With Portrait. 8vo. 16s.
- PENN (RICHARD).** Maxims and Hints for an Angler and Chess-player. Woodcuts. Fcap. 8vo. 1s.
- PERCY (JOHN, M.D.). METALLURGY.** Fuel, Wood, Peat, Coal, Charcoal, Coke, Fire-Clays. Illustrations. 8vo. 30s.
- Lead, including part of Silver. Illustrations. 8vo. 30s.
- Silver and Gold. Part I. Illustrations. 8vo. 30s.
- Iron and Steel. A New and Revised Edition, with the Author's Latest Corrections, and brought down to the present time. By H. BAURMAN, F.G.S. Illustrations. 8vo.
- PERRY (REV. CANON).** History of the English Church. See STUDENTS' Manuals.
- PHILLIPS (SAMUEL).** Literary Essays from "The Times." With Portrait. 2 Vols. Fcap. 8vo. 7s.
- POLLOCK (C. E.).** A Book of Family Prayers. Selected from the Liturgy of the Church of England. 16mo. 3s. 6d.
- POPE'S (ALEXANDER) Life and Works.** With Introductions and Notes, by J. W. CROKER, REV. W. ELWIN, and W. J. COURTHOPE. 10 Vols. With Portraits. 8vo. 10s. 6d. each.
- PORTER (REV. J. L.).** Damascus, Palmyra, and Lebanon. Map and Woodcuts. Post 8vo. 7s. 6d.
- PRAYER-BOOK (BEAUTIFULLY ILLUSTRATED).** With Notes, by REV. THOS. JAMES. Medium 8vo. 18s. cloth.
- PRINCESS CHARLOTTE OF WALES.** Memoir and Correspondence. By LADY ROSE WEIGALL. With Portrait. 8vo. 8s. 6d.
- PRITCHARD (CHARLES, D.D.).** Occasional Thoughts of an Astronomer on Nature and Revelation. 8vo. 7s. 6d.
- PSALMS OF DAVID.** With Notes Explanatory and Critical by Dean Johnson, Canon Elliott, and Canon Cook. Medium 8vo. 10s. 6d.
- PUSS IN BOOTS.** With 12 Illustrations. By OTTO SPECKTER. 16mo. 1s. 6d. Or coloured, 2s. 6d.
- QUARTERLY REVIEW (THE).** 8vo. 6s.
- RAE (EDWARD).** Country of the Moors. A Journey from Tripoli to the Holy City of Kairwan. Etchings. Crown 8vo. 12s.
- The White Sea Peninsula. Journey to the White Sea, and the Kola Peninsula. Illustrations. Crown 8vo. 15s.
- (GEORGE). The Country Banker; His Clients, Cares, and Work, from the Experience of Forty Years. Crown 8vo. 7s. 6d.
- RAMSAY (PROF. W. M.).** The Historical Geography of Asia Minor. With 6 Maps, Tables, &c. 8vo. 18s.
- RASSAM (HORMUZD).** British Mission to Abyssinia. Illustrations. 2 Vols. 8vo. 28s.
- RAWLINSON'S (CANON) Five Great Monarchies of Chaldaea, Assyria, Media, Babylonia, and Persia.** With Maps and Illustrations. 3 Vols. 8vo. 42s.
- Herodotus, a new English Version. See page 12.
- (SIR HENRY) England and Russia in the East; a Series of Papers on the Condition of Central Asia. Map. 8vo. 12s.

- REED (Sir E. J.)** *Japan: Its History, Traditions, and Religions.* With Narrative of a Visit in 1879. Illustrations. 2 Vols. 8vo. 28s.
- REJECTED ADDRESSES (THE).** By JAMES AND HORACE SMITH. Woodcuts. Post 8vo. 3s. 6d.; or *Popular Edition*, Fcap. 8vo. 1s.
- RICARDO'S (DAVID) Works.** With a Notice of his Life and Writings. By J. R. McCULLOCH. 8vo. 16s.
- RIPA (FATHER).** *Residence at the Court of Peking.* Post 8vo. 2s.
- ROBERTSON (CANON).** *History of the Christian Church, from the Apostolic Age to the Reformation, 1517.* 8 Vols. Post 8vo. 6s. each.
- ROBINSON (W.).** *English Flower Garden. An Illustrated Dictionary of all the Plants used, and Directions for their Culture and Arrangement.* With numerous Illustrations. Medium 8vo. 15s.
- *The Vegetable Garden; or, the Edible Vegetables, Salads, and Herbs cultivated in Europe and America.* By M. VILMORIN-ANDRIEU. With 750 Illustrations. 8vo. 15s.
- *Sub-Tropical Garden. Illustrations.* Small 8vo. 5s.
- *Parks and Gardens of Paris, considered in Relation to other Cities.* 350 Illustrations. 8vo. 18s.
- *Wild Garden; or, Our Groves and Gardens made Beautiful by the Naturalization of Hardy Exotic Plants.* With 90 Illustrations. 8vo. 10s. 6d.
- *God's Acre Beautiful; or, the Cemeteries of the Future.* With 8 Illustrations. 8vo. 7s. 6d.
- ROMANS, St. Paul's Epistle to the.** With Notes and Commentary by E. H. GIFFORD, D.D. Medium 8vo. 7s. 6d.
- ROME (HISTORY OF).** [See GIBBON—INGE—LIDDELL—SMITH—STUDENTS'.]
- ROMILLY (HUGH H.).** *The Western Pacific and New Guinea.* 2nd Edition. With a Map. Crown 8vo. 7s. 6d.
- ROSS (MRS.)** *The Land of Manfred, Prince of Tarentum and King of Sicily: Rambles in remote parts of S. Italy, with special reference to their Historical associations.* Illustrations. Crown 8vo. 10s. 6d.
- RUMBOLD (SIR HORACE).** *The Great Silver River: Notes of a Residence in the Argentine Republic.* Second Edition, with Additional Chapter. With Illustrations. 8vo. 12s.
- RUXTON (GEO. F.).** *Travels in Mexico; with Adventures among Wild Tribes and Animals of the Prairies and Rocky Mountains.* Post 8vo. 3s. 6d.
- ST. JOHN (CHARLES).** *Wild Sports and Natural History of the Highlands of Scotland.* Illustrated Edition. Crown 8vo. 15s. *Cheap Edition*, Post 8vo. 3s. 6d.
- (BAYLE). *Adventures in the Libyan Desert.* Post 8vo. 2s.
- ST. MAUR (MRS. ALGERNON), LADY SEYMOUR.** *Impressions of a Tenderfoot, during a Journey in search of Sport in the Far West.* With Map and Illustrations. Crown 8vo. 12s.
- SALES (SIR ROBERT) Brigade in Afghanistan.** With an Account of the Defence of Jellalabad. By Rev. G. R. GLEIG. Post 8vo. 2s.
- SALMON (PROF. GEO., D.D.).** *An Introduction to the Study of the New Testament, and an Investigation into Modern Biblical Criticism, based on the most recent Sources of Information.* Crown 8vo. 9s.
- *Lectures on the Infallibility of the Church.* Post 8vo. 9s.

- SCEPTICISM IN GEOLOGY; and the Reasons for it.** An assemblage of facts from Nature combining to refute the theory of "Causes now in Action." By VERIFIER. Woodcuts. Crown 8vo. 6s.
- SCHARF (GEORGE).** Authentic Portraits of Mary, Queen of Scots. An attempt to distinguish those to be relied upon from others indiscriminately bearing her name, and to dispel the confused ideas that have so long prevailed respecting her personal appearance. With Illustrations. Large 8vo.
- SCHLIEMANN (DR. HENRY).** Ancient Mycenæ. Illustrations. Medium 8vo. 50s.
- Ilios; the City and Country of the Trojans, With an Autobiography. Illustrations. Imperial 8vo. 50s.
- Troja: Results of the Latest Researches and Discoveries on the site of Homer's Troy, and other sites made in 1892. Illustrations. Medium 8vo. 42s.
- Tiryns: A Prehistoric Palace of the Kings of Tiryns, discovered by excavations in 1884-5. With Illustrations. Medium 8vo. 42s.
- SCHREIBER (LADY CHARLOTTE).** English Fans and Fan Leaves. Collected and Described. With 160 Plates. Folio. 7l. 7s.
- Foreign Fans and Fan Leaves. French, Italian, and German, chiefly relating to the French Revolution, Collected and Described. 150 Plates. Folio. 7l. 7s.
- SCOTT (SIR GILBERT).** The Rise and Development of Mediæval Architecture. With 400 Illustrations. 2 Vols. Medium 8vo. 42s.
- SHAIRP (PRINCIPAL) AND HIS FRIENDS,** By Professor WM. KNIGHT, of St. Andrews. With Portrait. 8vo. 15s.
- SHAW (T. B.).** Manual of English Literature. Post 8vo. 7s. 6d.
- Specimens of English Literature. Selected from the Chief Writers. Post 8vo. 5s.
- (ROBERT). Visit to High Tartary, Yarkand, and Kashgar. With Map and Illustrations. 8vo. 16s.
- SMILES' (SAMUEL, LL.D.) WORKS:—**
- BRITISH ENGINEERS; from the Earliest Period to the Death of the Stephenson.** Illustrations. 5 Vols. Crown 8vo. 7s. 6d. each.
- GEORGE STEPHENSON.** Post 8vo. 2s. 6d.
- JAMES NASMYTH.** Portrait and Illustrations. Post 8vo. 6s.
- SCOTCH NATURALIST (THOS. EDWARD).** Illustrations. Post 8vo. 6s.
- SCOTCH GEOLOGIST (ROBERT DICK).** Illustrations. 8vo. 12s.
- SELF-HELP.** With Illustrations of Conduct and Perseverance. Post 8vo. 6s.
- CHARACTER.** A Book of Noble Characteristics. Post 8vo. 6s.
- THRIFT.** A Book of Domestic Counsel. Post 8vo. 6s.
- DUTY.** With Illustrations of Courage, Patience, and Endurance. Post 8vo. 6s.
- INDUSTRIAL BIOGRAPHY.** Iron-Workers and Tool-Makers. 6s.
- MEN OF INVENTION.** Post 8vo. 6s.
- LIFE AND LABOUR; or, Characteristics of Men of Culture and Genius.** Post 8vo. 6s.
- THE HUGUENOTS; Their Settlements, Churches, and Industries in England and Ireland.** Crown 8vo. 7s. 6d.
- BOY'S VOYAGE ROUND THE WORLD.** Illustrations. Post 8vo. 6s.

SIEMENS (SIR WM.), C.E. Life of. By WM. POLE, C.E. Portraits. 8vo. 16s.

——— The Scientific Works of: a Collection of Papers and Discourses. Edited by E. F. BAMBER, C.E. Vol. i.—Heat and Metallurgy; ii.—Electricity, &c.; iii.—Addresses and Lectures. Plates. 3 Vols. 8vo. 12s. each.

SIERRA LEONE. By MRS. MELVILLE. Post 8vo. 3s. 6d.

SIMMONS (CAPT.). Constitution and Practice of Courts-Martial. 8vo. 15s.

SMEDES (SUSAN DABNEY). A Southern Planter. Memoirs of Thomas Dabney. With Prefatory Note by MR. GLADSTONE. Post 8vo. 7s. 6d.

SMITH (DR. GEORGE) Student's Manual of the Geography of British India, Physical and Political. Maps. Post 8vo. 7s. 6d.

——— Life of Dr. Somerville of Glasgow, late Evangelist in India, Africa, Australia, Canada, and Chief Countries of Europe (1813—1859). Portrait. Post 8vo. 9s.

——— Life of Wm. Carey, D.D., 1761—1834. Shoemaker and Missionary. Professor of Sanscrit, Bengalee and Marathee at the College of Fort William, Calcutta. Illustrations. Post 8vo. 7s. 6d.

——— Life of Stephen Hislop, Pioneer, Missionary, and Naturalist in Central India, 1844—1863. Portrait. Post 8vo. 7s. 6d.

——— (PHILIP). History of the Ancient World, from the Creation to the Fall of the Roman Empire, A.D. 476. 3 Vols. 8vo. 31s. 6d.

——— (R. BOSWORTH). Mohammed and Mohammedanism. Crown 8vo. 7s. 6d.

SMITH'S (DR. WM.) DICTIONARIES:—

DICTIONARY OF THE BIBLE; its Antiquities, Biography, Geography, and Natural History. Illustrations. 3 Vols. 8vo. 105s.

CONCISE BIBLE DICTIONARY. Illustrations. 8vo. 21s.

SMALLER BIBLE DICTIONARY. Illustrations. Post 8vo. 7s. 6d.

CHRISTIAN ANTIQUITIES. Comprising the History, Institutions, and Antiquities of the Christian Church. Illustrations. 2 Vols. Medium 8vo. 3l. 13s. 6d.

CHRISTIAN BIOGRAPHY, LITERATURE, SECTS, AND DOCTRINES; from the Times of the Apostles to the Age of Charlemagne. Medium 8vo. Now complete in 4 Vols. 6l. 16s. 6d.

GREEK AND ROMAN ANTIQUITIES. Including the Laws, Institutions, Domestic Usages, Painting, Sculpture, Music, the Drama, &c. Third Edition, Revised and Enlarged. 2 Vols. Medium 8vo. 31s. 6d. each.

GREEK AND ROMAN BIOGRAPHY AND MYTHOLOGY. Illustrations. 3 Vols. Medium 8vo. 4l. 4s.

GREEK AND ROMAN GEOGRAPHY. 2 Vols. Illustrations. Medium 8vo. 56s.

ATLAS OF ANCIENT GEOGRAPHY—BIBLICAL AND CLASSICAL. Folio. 6l. 6s.

CLASSICAL DICTIONARY OF MYTHOLOGY, BIOGRAPHY, AND GEOGRAPHY. 1 Vol. With 750 Woodcuts. 8vo. 18s.

SMALLER CLASSICAL DICT. Woodcuts. Crown 8vo. 7s. 6d.

SMALLER DICTIONARY OF GREEK AND ROMAN ANTIQUITIES. Woodcuts. Crown 8vo. 7s. 6d.

SMITH'S (DR. WM.) DICTIONARIES—*continued.*

COMPLETE LATIN-ENGLISH DICTIONARY. With Tables of the Roman Calendar, Measures, Weights, Money, and a Dictionary of Proper Names. 20th Edition. 8vo. 16s. [7s. 6d.]

SMALLER LATIN-ENGLISH DICTIONARY. 31st Edition. 12mo.

COPIOUS AND CRITICAL ENGLISH-LATIN DICTIONARY. 5th Edition. 8vo. 16s.

SMALLER ENGLISH-LATIN DICTIONARY. 14th Edit. 12mo. 7s. 6d.

SMITH'S (DR. WM.) ENGLISH COURSE:—

SCHOOL MANUAL OF ENGLISH GRAMMAR, WITH COPIOUS EXERCISES, Appendices and Index. Post 8vo. 3s. 6d.

PRIMARY ENGLISH GRAMMAR, for Elementary Schools, with carefully graduated Parsing Lessons. 16mo. 1s.

MANUAL OF ENGLISH COMPOSITION. With Copious Illustrations and Practical Exercises. 12mo. 3s. 6d.

PRIMARY HISTORY OF BRITAIN. 12mo. 2s. 6d.

SCHOOL MANUAL OF MODERN GEOGRAPHY, PHYSICAL AND Political. Post 8vo. 5s.

A SMALLER MANUAL OF MODERN GEOGRAPHY. 16mo. 2s. 6d.

SMITH'S (DR. WM.) FRENCH COURSE:—

FRENCH PRINCIPIA. Part I. A First Course, containing a Grammar, Delectus, Exercises, and Vocabularies. 12mo. 3s. 6d.

APPENDIX TO FRENCH PRINCIPIA. Part I. Containing additional Exercises, with Examination Papers. 12mo. 2s. 6d.

FRENCH PRINCIPIA. Part II. A Reading Book, containing Fables, Stories, and Anecdotes, Natural History, and Scenes from the History of France. With Grammatical Questions, Notes and copious Etymological Dictionary. 12mo. 4s. 6d.

FRENCH PRINCIPIA. Part III. Prose Composition, containing Hints on Translation of English into French, the Principal Rules of the French Syntax compared with the English, and a Systematic Course of Exercises on the Syntax. 12mo. 4s. 6d. [Post 8vo. 6s.]

STUDENT'S FRENCH GRAMMAR. With Introduction by M. Littré.

SMALLER GRAMMAR OF THE FRENCH LANGUAGE. Abridged from the above. 12mo. 3s. 6d.

SMITH'S (DR. WM.) GERMAN COURSE:—

GERMAN PRINCIPIA. Part I. A First German Course, containing a Grammar, Delectus, Exercise Book, and Vocabularies. 12mo. 3s. 6d.

GERMAN PRINCIPIA. Part II. A Reading Book; containing Fables, Anecdotes, Natural History, and Scenes from the History of Germany. With Questions, Notes, and Dictionary. 12mo. 3s. 6d.

PRACTICAL GERMAN GRAMMAR. Post 8vo. 3s. 6d.

SMITH'S (DR. WM.) ITALIAN COURSE:—

ITALIAN PRINCIPIA. Part I. An Italian Course, containing a Grammar, Delectus, Exercise Book, with Vocabularies, and Materials for Italian Conversation. 12mo. 3s. 6d.

ITALIAN PRINCIPIA. Part II. A First Italian Reading Book, containing Fables, Anecdotes, History, and Passages from the best Italian Authors, with Grammatical Questions, Notes, and a Copious Etymological Dictionary. 12mo. 3s. 6d.

SMITH'S (DR. WM.) LATIN COURSE:—

THE YOUNG BEGINNER'S FIRST LATIN BOOK: Containing the Rudiments of Grammar, Easy Grammatical Questions and Exercises, with Vocabularies. Being a Stepping-stone to Principia Latina, Part I. 12mo. 2s.

SMITH'S (DR. WM.) LATIN COURSE—*continued*.

THE YOUNG BEGINNER'S SECOND LATIN BOOK: Containing an easy Latin Reading Book, with an Analysis of the Sentences, Notes, and a Dictionary. Being a Stepping-stone to Principia Latina, Part II. 12mo. 2s.

PRINCIPIA LATINA. Part I. First Latin Course, containing a Grammar, Delectus, and Exercise Book, with Vocabularies. 12mo. 3s. 6d.

* * * In this Edition the Cases of the Nouns, Adjectives, and Pronouns are arranged both as in the ORDINARY GRAMMARS and as in the PUBLIC SCHOOL PRIMER, together with the corresponding Exercises.

APPENDIX TO PRINCIPIA LATINA. Part I.; being Additional Exercises, with Examination Papers. 12mo. 2s. 6d.

PRINCIPIA LATINA. Part II. A Reading-book of Mythology, Geography, Roman Antiquities, and History. With Notes and Dictionary. 12mo. 3s. 6d.

PRINCIPIA LATINA. Part III. A Poetry Book. Hexameters and Pentameters; Eclog. Ovidiana; Latin Prosody. 12mo. 3s. 6d.

PRINCIPIA LATINA. Part IV. Prose Composition. Rules of Syntax, with Examples, Explanations of Synonyms, and Exercises on the Syntax. 12mo. 3s. 6d.

PRINCIPIA LATINA. Part V. Short Tales and Anecdotes for Translation into Latin. 12mo. 3s.

LATIN-ENGLISH VOCABULARY AND FIRST LATIN-ENGLISH DICTIONARY FOR PHÆDRUS, CORNELIUS NEPOS, AND CÆSAR. 12mo. 3s. 6d.

STUDENT'S LATIN GRAMMAR. For the Higher Forms. A new and thoroughly revised Edition. Post 8vo. 6s.

SMALLER LATIN GRAMMAR. New Edition. 12mo. 3s. 6d.

TACITUS, GERMANIA, AGRICOLA, and FIRST BOOK OF THE ANNALS. 12mo. 3s. 6d.

SMITH'S (DR. WM.) GREEK COURSE:—

INITIA GRÆCA. Part I. A First Greek Course, containing a Grammar, Delectus, and Exercise-book. With Vocabularies. 12mo. 3s. 6d.

APPENDIX TO INITIA GRÆCA. Part I. Containing additional Exercises. With Examination Papers. Post 8vo. 2s. 6d.

INITIA GRÆCA. Part II. A Reading Book, Containing Short Tales, Anecdotes, Fables, Mythology, and Grecian History. 12mo. 3s. 6d.

INITIA GRÆCA. Part III. Prose Composition. Containing the Rules of Syntax, with copious Examples and Exercises. 12mo. 3s. 6d.

STUDENT'S GREEK GRAMMAR. For the Higher Forms. Post 8vo. 6s.

SMALLER GREEK GRAMMAR. 12mo. 3s. 6d.

GREEK ACCIDENCE. 12mo. 2s. 6d.

PLATO, Apology of Socrates, &c. With Notes. 12mo. 3s. 6d.

SMITH'S (DR. WM.) SMALLER HISTORIES:—

SCRIPTURE HISTORY. Maps and Woodcuts. 16mo. 3s. 6d.

ANCIENT HISTORY. Woodcuts. 16mo. 3s. 6d.

ANCIENT GEOGRAPHY. Woodcuts. 16mo. 3s. 6d.

MODERN GEOGRAPHY. 16mo. 2s. 6d.

GREECE. With Coloured Map and Woodcuts. 16mo. 3s. 6d.

ROME. With Coloured Maps and Woodcuts. 16mo. 3s. 6d.

CLASSICAL MYTHOLOGY. Woodcuts. 16mo. 3s. 6d.

ENGLAND. With Coloured Maps and Woodcuts. 16mo. 3s. 6d.

ENGLISH LITERATURE. 16mo. 3s. 6d.

SPECIMENS OF ENGLISH LITERATURE. 16mo. 3s. 6d.

- SOMERVILLE (MARY).** Physical Geography. Post 8vo. 9s.
 ———— Connexion of the Physical Sciences. Post 8vo. 9s.
 ———— (DR., OF GLASGOW). [See SMITH, GEORGE.]
- SOUTH (JOHN F.).** Household Surgery; or, Hints for Emergencies. With Woodcuts. Fcap. 8vo. 3s. 6d.
- SOUTHEY (ROBT.).** Lives of Bunyan and Cromwell. Post 8vo. 2s.
- STANHOPE'S (EARL) WORKS:—**
 HISTORY OF ENGLAND FROM THE REIGN OF QUEEN ANNE TO THE PEACE OF VERSAILLES, 1701-83. 9 Vols. Post 8vo. 5s. each.
 LIFE OF WILLIAM PITT. Portraits. 3 Vols. 8vo. 36s.
 MISCELLANIES. 2 Vols. Post 8vo. 13s.
 BRITISH INDIA, FROM ITS ORIGIN TO 1783. Post 8vo. 3s. 6d.
 HISTORY OF "FORTY-FIVE." Post 8vo. 3s.
 HISTORICAL AND CRITICAL ESSAYS. Post 8vo. 3s. 6d.
 RETREAT FROM MOSCOW, AND OTHER ESSAYS. Post 8vo. 7s. 6d.
 LIFE OF BELISARIUS. Post 8vo. 10s. 6d.
 LIFE OF CONDÉ. Post 8vo. 3s. 6d.
 STORY OF JOAN OF ARC. Fcap. 8vo. 1s.
 ADDRESSES ON VARIOUS OCCASIONS. 16mo. 1s.
 [See also WELLINGTON.]
- STANLEY'S (DEAN) WORKS:—**
 SINAI AND PALESTINE. Coloured Maps. 8vo. 12s.
 BIBLE IN THE HOLY LAND; Extracts from the above Work. Woodcuts. Post 8vo. 3s. 6d.
 EASTERN CHURCH. Plans. Crown 8vo. 6s.
 JEWISH CHURCH. From the Earliest Times to the Christian Era. Portrait and Maps. 3 Vols. Crown 8vo. 18s.
 CHURCH OF SCOTLAND. 8vo. 7s. 6d.
 EPISTLES OF ST. PAUL TO THE CORINTHIANS. 8vo. 18s.
 LIFE OF DR. ARNOLD. Portrait. 2 Vols. Cr. 8vo. 12s.
 CANTERBURY. Illustrations. Crown 8vo. 6s.
 WESTMINSTER ABBEY. Illustrations. 8vo. 15s.
 SERMONS PREACHED IN WESTMINSTER ABBEY. 8vo. 12s.
 MEMOIR OF EDWARD, CATHERINE, AND MARY STANLEY. Cr. 8vo. 9s.
 CHRISTIAN INSTITUTIONS. Crown 8vo. 6s.
 ESSAYS ON CHURCH AND STATE; 1850—1870. Crown 8vo. 6s.
 SERMONS TO CHILDREN, including the Beatitudes, the Faithful Servant, &c. Post 8vo. 3s. 6d.
 [See also BRADLEY.]
- STEBBING (WM.).** Some Verdicts of History Reviewed. 8vo. 12s.
- STEPHENS (REV. W. R. W.).** Life and Times of St. John Chrysostom. A Sketch of the Church and the Empire in the Fourth Century. Portrait. 8vo. 7s. 6d.
- STREET (G. E.), R.A.** Gothic Architecture in Brick and Marble. With Notes on North of Italy. Illustrations. Royal 8vo. 26s.
 ———— Memoir of. By ARTHUR E. STREET. Portrait. 8vo. 15s.
- STUART (VILLIERS).** Egypt after the War. With Descriptions of the Homes and Habits of the Natives, &c. Coloured Illustrations and Woodcuts. Royal 8vo. 31s. 6d.

STUDENTS' MANUALS. Post 8vo. 7s. 6d. EACH VOLUME :—

- HUME'S HISTORY OF ENGLAND from the Invasion of Julius Cæsar to the Revolution in 1688. Revised, and continued to the Treaty of Berlin, 1878. By J. S. BREWER, M.A. Coloured Maps and Woodcuts. Or in 3 parts, price 2s. 6d. each.
. Questions on the above Work, 12mo. 2s.
- HISTORY OF MODERN EUROPE, from the fall of Constantinople to the Treaty of Berlin, 1878. By R. LODGE, M.A.
- OLD TESTAMENT HISTORY; from the Creation to the Return of the Jews from Captivity. Woodcuts.
- NEW TESTAMENT HISTORY. With an Introduction connecting the History of the Old and New Testaments. Woodcuts.
- EVIDENCES OF CHRISTIANITY. By H. WACE, D.D. [*In the Press.*]
- ECCLESIASTICAL HISTORY; a History of the Christian Church. By PHILIP SMITH, B.A. With numerous Woodcuts. 2 Vols. PART I. A.D. 30—1003. PART II., 1003—1614.
- ENGLISH CHURCH HISTORY. By CANON PERRY. 3 Vols. *First Period*, A.D. 596—1509. *Second Period*, 1509—1717. *Third Period*, 1717—1884.
- ANCIENT HISTORY OF THE EAST; Egypt, Assyria, Babylonia, Media, Persia, Asia Minor, and Phœnicia. By PHILIP SMITH, B.A. Woodcuts.
- GEOGRAPHY. By CANON BEVAN. Woodcuts.
- HISTORY OF GREECE; from the Earliest Times to the Roman Conquest. By WM. SMITH, D.C.L. Woodcuts.
. Questions on the above Work, 12mo. 2s.
- HISTORY OF ROME; from the Earliest Times to the Establishment of the Empire. By DEAN LIDDELL. Woodcuts.
- GIBBON'S DECLINE AND FALL OF THE ROMAN EMPIRE. Woodcuts.
- HALLAM'S HISTORY OF EUROPE during the Middle Ages.
- HALLAM'S HISTORY OF ENGLAND; from the Accession of Henry VII. to the Death of George II.
- HISTORY OF FRANCE; from the Earliest Times to the Fall of the Second Empire. By H. W. JEEVIS. With Coloured Maps and Woodcuts.
- ENGLISH LANGUAGE. By GEO. P. MARSH.
- ENGLISH LITERATURE. By T. B. SHAW, M.A.
- SPECIMENS OF ENGLISH LITERATURE. By T. B. SHAW. 5s.
- MODERN GEOGRAPHY; Mathematical, Physical and Descriptive. By CANON BEVAN, M.A. Woodcuts.
- GEOGRAPHY OF BRITISH INDIA. Political and Physical. By GEORGE SMITH, LL.D. Maps.
- MORAL PHILOSOPHY. By WM. FLEMING.
- STURGIS (JULIAN). Comedy of a Country House. 6s.
- SUMNER'S (BISHOP) Life and Episcopate during 40 Years. By Rev. G. H. SUMNER. Portrait. 8vo. 14s.
- SWAINSON (CANON). Nicene and Apostles' Creeds; Their Literary History; together with some Account of "The Creed of St. Athanasius." 8vo. 16s.
- TEMPLE (SIR RICHARD). India in 1880. With Maps. 8vo. 16s.
- Men and Events of My Time in India. 8vo. 16s.
- Oriental Experience. Essays and Addresses delivered on Various Occasions. With Maps and Woodcuts. 8vo. 16s.
- THIBAUT'S (ANTOINE) Purity in Musical Art. With Prefatory Memoir by W. H. Gladstone, M.P. Post 8vo. 7s. 6d.

- THOMAS (SIDNEY GILCHRIST), Inventor; Memoir and Letters.
 Edited by R. W. BURNIE. Portraits. Crown 8vo. 9s.
- THORNHILL (MARK). The Personal Adventures and Experiences
 of a Magistrate during the Rise, Progress, and Suppression of the Indian
 Mutiny. With Frontispiece and Plan. Crown 8vo. 12s.
- TITIAN'S LIFE AND TIMES. With some account of his
 Family, from unpublished Records. By CROWE and CAVALCASELLE.
 Illustrations. 2 Vols. 8vo. 21s.
- TOCQUEVILLE'S State of Society in France before the Revolution,
 1789, and on the Causes which led to that Event. 8vo. 12s.
- TOZER (REV. H. F.). Highlands of Turkey, with Visits to Mounts
 Ida, Athos, Olympus, and Pelion. 2 Vols. Crown 8vo. 24s.
- Lectures on the Geography of Greece. Post 8vo. 9s.
- TRISTRAM (CANON). Great Sahara. Illustrations. Crown 8vo. 15s.
- Land of Moab: Travels and Discoveries on the East
 Side of the Dead Sea and the Jordan. Illustrations. Crown 8vo. 15s.
- TWINING (REV. THOS.). Recreations and Studies of a Country
 Clergyman of the Last Century. 2 Vols. Crown 8vo. 9s. each.
- (LOUISA). Symbols and Emblems of Early and
 Mediæval Christian Art. With 500 Illustrations. Crown 8vo. 6s.
- TYLOR (E. B.). Researches into the Early History of Mankind,
 and Development of Civilization. 3rd Edition. 8vo. 12s.
- Primitive Culture: the Development of Mythology,
 Philosophy, Religion, Art, and Custom. 2 Vols. 8vo.
- UNIVERSITY EXTENSION MANUALS. Edited by PRO-
 FESSOR WM. KNIGHT (St. Andrew's). A series of Manuals dealing
 with Literature, Science, Philosophy, History, Art, &c. Crown 8vo.
 Prospectus with full particulars will be forwarded on application.
- VIRCHOW (PROFESSOR). The Freedom of Science in the
 Modern State. Fcap. 8vo. 2s.
- WACE (REV. HENRY), D.D. The Principal Facts in the Life of
 our Lord, and the Authority of the Evangelical Narratives. Post 8vo. 6s.
- Christianity and Morality. Boyle Lectures for 1874 and
 1875. Seventh Edition. Crown 8vo. 6s.
- WALES (H. R. H. THE PRINCE OF). Speeches and Addresses
 during Twenty-five Years, 1863-1888. Edited by DR. JAMES MACAULAY.
 With Portrait. 8vo. 12s.
- WATKINS (ARCHDEACON). The Bampton Lecture, 1890:
 Modern Criticism, considered in its relation to the Fourth Gospel.
 8vo. 15s.
- WELLINGTON (DUKE OF). Notes of Conversations with the
 late Earl Stanhope. 1831-1851. Crown 8vo. 7s. 6d.
- Despatches in India, Denmark, Portugal, Spain,
 the Low Countries, and France. 8 Vols. 8vo. 8l. 8s.
- Supplementary Despatches, relating to India,
 Ireland, Denmark, Spanish America, Spain, Portugal, France, Congress
 of Vienna, Waterloo and Paris. 15 Vols. 8vo. 20s. each.
- Civil and Political Correspondence. 4 Vols. I. to
 VIII. 8vo. 20s.
- Speeches in Parliament. 2 Vols. 8vo. 42s.
- WESTCOTT (CANON B. F.). The Gospel according to St. John, with
 Notes and Dissertations (Reprinted from the Speaker's Commentary).
 8vo. 10s. 6d.
- WHARTON (CAPT. W. J. L.), R.N. Hydrographical Surveying:
 being a description of the means and methods employed in constructing
 Marine Charts. With Illustrations. 8vo. 15s.
- WHITE (W. H.). Manual of Naval Architecture, for the use of
 Naval Officers, Shipbuilders, and Yachtsmen, &c. Illustrations. 8vo. 24s.

- WHYMPER (EDWARD).** Travels amongst the Great Andes of the Equator. With 140 Original Illustrations, drawn by F. BARNARD, A. CORBOULD, F. DADD, W. E. LAPWORTH, W. H. OVERREND, P. SKELTON, E. WAGNER, E. WILSON, JOSEPH WOLF, and others. Engraved by the Author. With Maps and Illustrations. Medium 8vo. 21s. To range with "Scrambles amongst the Alps."
- Supplementary Appendix to the above. With 61 Figures of New Genera and Species. Illustrations. Medium 8vo. 15s.
- How to Use the Aneroid Barometer. With numerous Tables. 2s. 6d.
- WILBERFORCE'S (BISHOP)** Life of William Wilberforce. Portrait. Crown 8vo. 6s.
- (SAMUEL, D.D.), Lord Bishop of Oxford and Winchester; his Life. By CANON ASHWELL, and R. G. WILBERFORCE. Portraits. 3 Vols. 8vo. 15s. each.
- WILKINSON (SIR J. G.).** Manners and Customs of the Ancient Egyptians, their Private Life, Laws, Arts, Religion, &c. A new edition. Edited by SAMUEL BIRCH, LL.D. Illustrations. 3 Vols. 8vo. 84s.
- Popular Account of the Ancient Egyptians. With 500 Woodcuts. 2 Vols. Post 8vo. 12s.
- WILLIAMS (SIR MONIER).** Brahmanism and Hinduism, Religious Thought and Life in India as based on the Veda. 8vo. 10s. 6d.
- Buddhism; its connection with Brahmanism and Hinduism, and in its contrast with Christianity. With Illustrations, 8vo. 21s.
- WINTLE (H. G.).** Ovid Lessons. 12mo, 2s. 6d. [See ETON.]
- WOOD'S (CAPTAIN)** Source of the Oxus. With the Geography of the Valley of the Oxus. By COL. YULE. Map. 8vo. 12s.
- WORDS OF HUMAN WISDOM.** Collected and Arranged by E. S. With a Preface by CANON LIDDON. Fcap. 8vo. 3s. 6d.
- WORDSWORTH (BISHOP).** Greece; Pictorial, Descriptive, and Historical. With an Introduction on the Characteristics of Greek Art, by GEO. SCHARF. New Edition revised by the Rev. H. F. TOZER, M.A. With 400 Illustrations. Royal 8vo. 31s. 6d.
- (CHARLES), Bishop of St. Andrews. The Collects of the Church of England, together with certain Psalms and Hymns appropriate to the Principal Festivals, rendered into Latin Verse. Crown 8vo, gilt edges, 5s.
- YORK (ARCHBISHOP OF).** Collected Essays. Contents.—Synoptic Gospels. Death of Christ. God Exists. Worth of Life. Design in Nature. Sports and Pastimes. Emotions in Preaching. Defects in Missionary work. Limits of Philosophical Enquiry. Crown 8vo. 9s.
- YORK-GATE LIBRARY (Catalogue of).** Formed by Mr. SILVER. An Index to the Literature of Geography, Maritime and Inland Discovery, Commerce and Colonisation. Compiled by E. A. PETHERICK. 2nd Edition. Royal 8vo. 42s.
- YOUNGHUSBAND (CAPT. G. J.).** The Queen's Commission: How to Prepare for it; how to Obtain it, and how to Use it. With Practical Information on the Cost and Prospects of a Military Career. Intended for Cadets, Subalterns, and Parents. Crown 8vo. 6s.
- YULE (COLONEL).** The Book of Ser Marco Polo, the Venetian, concerning the Kingdoms and Marvels of the East. Illustrated by the Light of Oriental Writers and Modern Travels. With Maps and 80 Plates. 2 Vols. Medium 8vo.
- and A. C. BURNELL. A Glossary of Anglo-Indian Colloquial Words and Phrases, and of Kindred Terms; Etymological, Historical, Geographical, and Discursive. Medium 8vo. 36s.
- (A. F.). The Cretan Insurrection. Post 8vo. 2s. 6d.



