

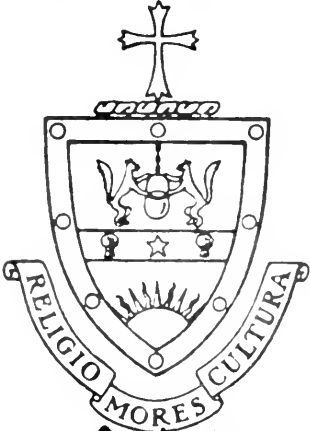

University of Scranton  
The Library



Gift of  
Roger J. Howell

*R. Howell*

For Reference

Not to be taken from this room



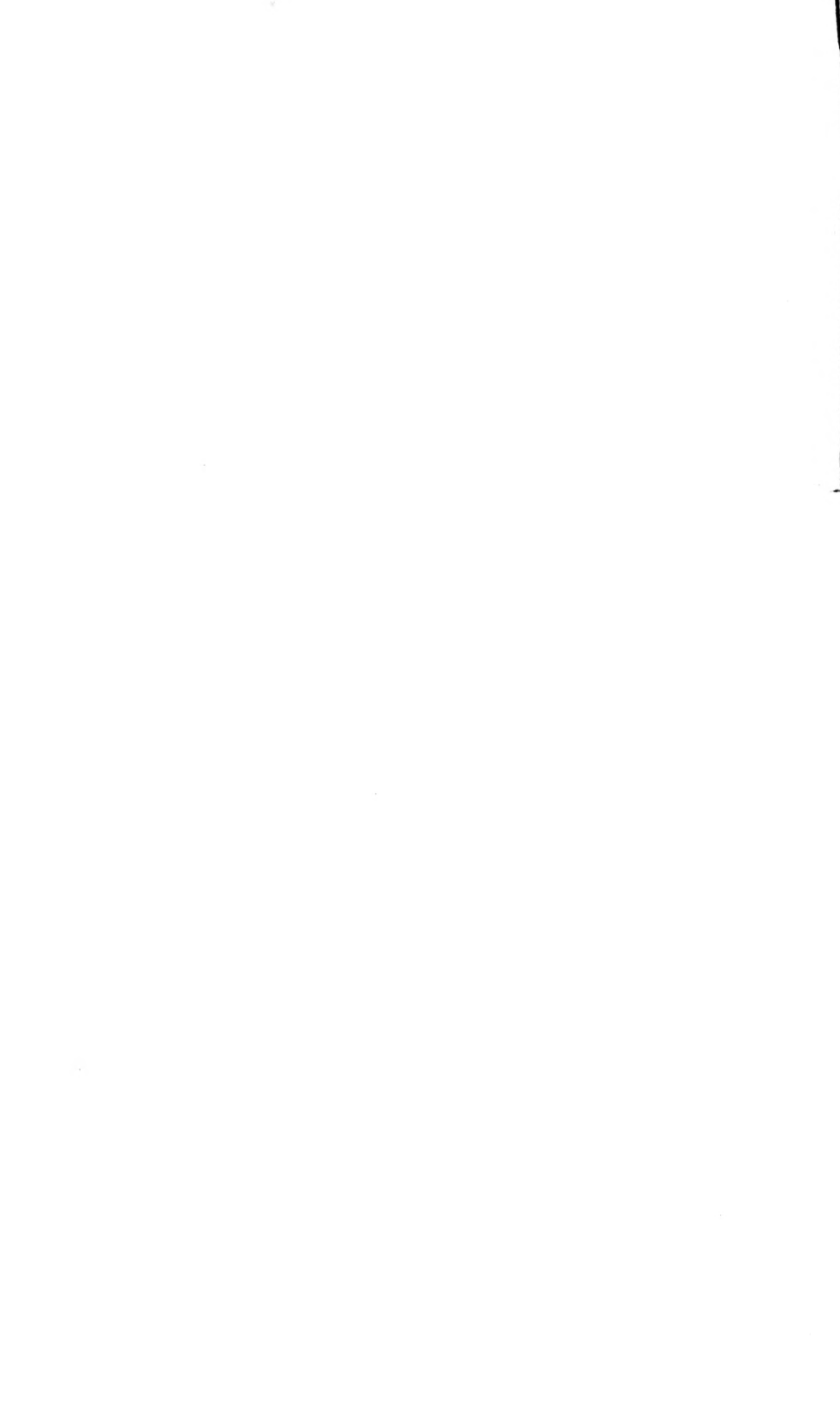





REPORTS

OF THE

INSPECTORS OF COAL MINES

OF PENNSYLVANIA.

1894.

With a summary of coal production, etc., prepared by the  
Bureau of Industrial Statistics, Department of  
Internal Affairs.

CLARENCE M. BUSCH,  
STATE PRINTER OF PENNSYLVANIA,  
1895.



1  
2  
3  
4  
5  
6  
7  
8  
9  
10

11  
12



## CONTENTS.

|   | <i>Page.</i> |
|---|--------------|
| Report of the Inspector of the First Anthracite District, . . . . .   | 1            |
| Report of the Inspector of the Second Anthracite District, . . . . .  | 65           |
| Report of the Inspector of the Third Anthracite District, . . . . .   | 83           |
| Report of the Inspector of the Fourth Anthracite District, . . . . .  | 117          |
| Report of the Inspector of the Fifth Anthracite District, . . . . .   | 181          |
| Report of the Inspector of the Sixth Anthracite District, . . . . .   | 223          |
| Report of the Inspector of the Seventh Anthracite District, . . . . . | 261          |
| Report of the Inspector of the Eighth Anthracite District, . . . . .  | 279          |
| Report of the Inspector of the First Bituminous District, . . . . .   | 305          |
| Report of the Inspector of the Second Bituminous District, . . . . .  | 341          |
| Report of the Inspector of the Third Bituminous District, . . . . .   | 371          |
| Report of the Inspector of the Fourth Bituminous District, . . . . .  | 399          |
| Report of the Inspector of the Fifth Bituminous District, . . . . .   | 415          |
| Report of the Inspector of the Sixth Bituminous District, . . . . .   | 451          |
| Report of the Inspector of the Seventh Bituminous District, . . . . . | 475          |
| Report of the Inspector of the Eighth Bituminous District, . . . . .  | 501          |
| Report of the Inspector of the Ninth Bituminous District, . . . . .   | 515          |
| Report of the Inspector of the Tenth Bituminous District, . . . . .   | 543          |



REPORTS  
OF THE  
INSPECTORS OF MINES.  
COMMUNICATION.

Department of Internal Affairs,  
Harrisburg, April 28, 1895.

To His Excellency Daniel H. Hastings, Governor of Pennsylvania:

Sir: In compliance with the requirements of the Act of June 30, 1885, relative to the Mine Inspectors' Reports of the Anthracite and Bituminous coal regions, and of the Act of April 23, 1889, and of June 2, 1891, I have the honor to present to you for transmission to the General Assembly the reports of the Inspectors of this Commonwealth for the year 1894.

Very respectfully yours,  
ISAAC B. BROWN,  
Secretary of Internal Affairs.



## MINING STATISTICS.

---

The aggregate production of coal for 1894 in the anthracite and bituminous districts was 85,306,389 tons, a decrease of 5,295,072 tons from the production of 1893. This decrease was caused partly by the business depression and partly by a strike in the bituminous region that was in progress from April until August. The production of anthracite coal was 45,506,179 tons as against 47,179,563 tons in 1893, a reduction of 1,673,384 tons. The bituminous production was 39,800,210 tons as against 43,421,989 tons in 1893, a reduction of 3,621,688 tons.

While the production shows this great falling off, the total number of employes in and about the mines has increased. The number employed during 1894 was 226,872 as against 219,821 in 1893, an increase of 16,051. This seeming incongruity can best be explained by the reduced number of days the mines were in operation during 1894. In the anthracite region Luzerne county leads with a production of 17,243,928 tons as against 18,253,144 tons in 1893. Lackawanna county comes next with a production of 11,170,382 tons as against 11,667,550 tons in 1893. Schuylkill county is third in order with a production of 9,985,092 tons as against 9,992,085 tons in 1893, a slight reduction. The average annual production of coal in the anthracite region per employe was as follows:

|             |           |
|-------------|-----------|
| 1894, ..... | 326 tons. |
| 1893, ..... | 342 tons. |
| 1892, ..... | 352 tons. |
| 1891, ..... | 360 tons. |
| 1890, ..... | 281 tons. |

---

In the bituminous region, where, as we have already remarked, a strike was in progress for several months, and where the general depression in all kinds of business caused a diminution in the coal production of 3,621,688 tons as compared with 1893, the hard times were felt to a greater degree than in the anthracite region. As usual, Westmoreland county leads in production with 7,739,080 tons as against 7,583,346 tons in 1893. Fayette county comes second with a production of 6,684,153 tons as against 6,105,845 tons in 1893. Alle-

gheny county is third in production with 6,415,611 tons as against 6,984,510 ton in 1893. In coke production Fayette county stands first, with 3,426,791 tons as against 3,011,054 tons in 1893; Westmoreland second, with 1,937,128 tons as against 1,700,889 tons in 1893. The average annual coal production in the bituminous region per employe for the last five years was as follows:

|            |           |
|------------|-----------|
| 1894,..... | 462 tons. |
| 1893,..... | 531 tons. |
| 1892,..... | 590 tons. |
| 1891,..... | 564 tons. |
| 1890,..... | 609 tons. |

The following is a summary of the fatal accidents that occurred in and about the mines in the anthracite region for the last five years:

|            |     |
|------------|-----|
| 1894,..... | 439 |
| 1893,..... | 455 |
| 1892,..... | 396 |
| 1891,..... | 427 |
| 1890,..... | 378 |

In the bituminous region the fatal accidents for the same period were as follows:

|            |     |
|------------|-----|
| 1894,..... | 124 |
| 1893,..... | 131 |
| 1892,..... | 133 |
| 1891,..... | 237 |
| 1890,..... | 146 |

The non-fatal accidents in the anthracite region for the same period were as follows:

|            |       |
|------------|-------|
| 1894,..... | 919   |
| 1893,..... | 1,069 |
| 1892,..... | 1,023 |
| 1891,..... | 1,003 |
| 1890,..... | 1,011 |

The non-fatal accidents in the bituminous region for the same period were as follows:

|            |     |
|------------|-----|
| 1894,..... | 357 |
| 1893,..... | 346 |
| 1892,..... | 393 |
| 1891,..... | 314 |
| 1890,..... | 379 |

The percentage of fatal and non-fatal accidents for the number employed during the last five years in the anthracite and bituminous regions was as follows:

#### Anthracite Region.

| <i>Fatal Accidents.</i>  | <i>Non-Fatal Accidents.</i> |
|--------------------------|-----------------------------|
| 1894, 1 to 318 employes. | 1894, 1 to 152 employes.    |
| 1893, 1 to 303 employes. | 1893, 1 to 129 employes.    |
| 1892, 1 to 327 employes. | 1892, 1 to 127 employes.    |
| 1891, 1 to 288 employes. | 1891, 1 to 122 employes.    |
| 1890, 1 to 311 employes. | 1890, 1 to 116 employes.    |

#### Bituminous Region.

| <i>Fatal Accidents.</i>    | <i>Non-Fatal Accidents.</i> |
|----------------------------|-----------------------------|
| 1894, 1 to 695 employes.   | 1894, 1 to 241 employes.    |
| 1893, 1 to 1,624 employes. | 1893, 1 to 236 employes.    |
| 1892, 1 to 592 employes.   | 1892, 1 to 200 employes.    |
| 1891, 1 to 312 employes.   | 1891, 1 to 235 employes.    |
| 1890, 1 to 458 employes.   | 1890, 1 to 177 employes.    |

The percentage of fatal and non-fatal accidents in the two regions for the period of five years, for the number of tons mined, was as follows:

#### Anthracite Region.

| <i>Fatal Accidents.</i>   | <i>Non-Fatal Accidents.</i> |
|---------------------------|-----------------------------|
| 1894, 1 for 103,658 tons. | 1894, 1 for 49,517 tons.    |
| 1893, 1 for 103,691 tons. | 1893, 1 for 44,134 tons.    |
| 1892, 1 for 115,511 tons. | 1892, 1 for 44,817½ tons.   |
| 1891, 1 for 103,923 tons. | 1891, 1 for 44,253½ tons.   |
| 1890, 1 for 106,260 tons. | 1890, 1 for 39,729 tons.    |

#### Bituminous Region.

| <i>Fatal Accidents.</i>    | <i>Non-Fatal Accidents.</i> |
|----------------------------|-----------------------------|
| 1894, 1 for 320,969½ tons. | 1894, 1 for 111,485 tons.   |
| 1893, 1 for 331,465 tons.  | 1893, 1 for 125,497 tons.   |
| 1892, 1 for 350,199 tons.  | 1892, 1 for 118,515½ tons.  |
| 1891, 1 for 176,319 tons.  | 1891, 1 for 138,081½ tons.  |
| 1890, 1 for 273,420 tons.  | 1890, 1 for 107,609½ tons.  |

## Production of coal and coke in tons.

| DISTRICTS.         | Coal.         |                |                |                |                | Coke. |       |       |       |       |
|--------------------|---------------|----------------|----------------|----------------|----------------|-------|-------|-------|-------|-------|
|                    | 1891.         | 1892.          | 1893.          | 1894.          | 1895.          | 1891. | 1892. | 1893. | 1894. | 1895. |
| <i>Anthracite.</i> |               |                |                |                |                |       |       |       |       |       |
| First, .....       | 5,907,331     | **6,292,131.34 | **5,854,638.50 | **9,481,376    | **8,932,235.07 | ..... | ..... | ..... | ..... | ..... |
| Second, .....      | 5,674,329.09  | **5,636,475.19 | **6,013,537.19 | .....          | **5,229,027.03 | ..... | ..... | ..... | ..... | ..... |
| Third, .....       | 5,631,962     | **5,624,914.87 | **5,959,730.09 | **6,127,094.15 | **6,067,708.75 | ..... | ..... | ..... | ..... | ..... |
| Fourth, .....      | 7,162,961.05  | **8,053,768.35 | **7,439,965.02 | **5,623,697.65 | **5,776,699.08 | ..... | ..... | ..... | ..... | ..... |
| Fifth, .....       | 6,192,227     | **6,229,658.50 | **6,842,724.19 | **5,893,964.07 | **6,311,864.17 | ..... | ..... | ..... | ..... | ..... |
| Sixth, .....       | 6,349,631     | 6,674,807      | **6,287,366.06 | **6,492,964.16 | 4,129,622      | ..... | ..... | ..... | ..... | ..... |
| Seventh, .....     | 5,494,825     | **5,588,892.88 | **5,841,678.17 | **5,395,030.08 | 12,576,190     | ..... | ..... | ..... | ..... | ..... |
| Eighth, .....      | 3,241,315     | **3,142,504.63 | **3,066,092    | 3,631,967      | 3,631,967      | ..... | ..... | ..... | ..... | ..... |
| Total, .....       | 45,506,179.14 | 47,175,562.25  | 45,738,373.90  | 44,376,179.55  | 40,166,327.50  | ..... | ..... | ..... | ..... | ..... |
| <i>Bituminous.</i> |               |                |                |                |                |       |       |       |       |       |
| First, .....       | 5,282,181     | 4,876,307      | 4,269,437      | 3,918,665      | **3,818,802.61 | ..... | ..... | ..... | ..... | ..... |
| Second, .....      | 6,424,633     | 1,635,398.25   | **8,932,246.50 | 6,753,614      | **6,976,787.35 | ..... | ..... | ..... | ..... | ..... |
| Third, .....       | 2,641,120     | 3,224,130      | **3,297,814.25 | **3,122,550.50 | 2,987,743      | ..... | ..... | ..... | ..... | ..... |
| Fourth, .....      | 4,296,396     | 4,850,122      | **3,606,142.36 | **3,834,245.25 | **3,773,612.94 | ..... | ..... | ..... | ..... | ..... |
| Fifth, .....       | 3,998,348     | 3,629,759      | 7,360,101      | 5,123,891      | 6,153,183      | ..... | ..... | ..... | ..... | ..... |
| Sixth, .....       | 2,984,088     | 3,146,284      | 7,990,158      | 6,656,036      | 5,866,184      | ..... | ..... | ..... | ..... | ..... |
| Seventh, .....     | 4,238,825     | 4,435,416      | 5,897,942      | 4,843,174      | 4,572,325      | ..... | ..... | ..... | ..... | ..... |
| Eighth, .....      | 3,454,978     | 5,043,478      | 6,811,725      | 6,011,559      | 6,337,323      | ..... | ..... | ..... | ..... | ..... |
| Ninth, .....       | 4,699,811     | 4,814,178      | .....          | .....          | .....          | ..... | ..... | ..... | ..... | ..... |
| Tenth, .....       | 1,882,520     | 2,775,116      | .....          | .....          | .....          | ..... | ..... | ..... | ..... | ..... |
| Total, .....       | 39,800,210    | 43,421,838.25  | 46,576,576.11  | 41,787,644.75  | 40,784,993.90  | ..... | ..... | ..... | ..... | ..... |
| Grand total, ..... | 85,396,389.14 | 96,601,461.50  | 92,314,950.01  | 86,163,824.70  | 80,950,331.40  | ..... | ..... | ..... | ..... | ..... |

\* Decimals indicate twentieths of a ton.

\*\* Decimals indicate hundredths of a ton.

Production of this district was obtained by adding six per cent. to the total shipments.

† First and Second Anthracite Districts reported together for 1891.



*Number of employes in and about the mines. Number of fatal and non-fatal accidents.—Continued.*

| DISTRICTS.         | Number of Employes. |         |         |         |         | Total Accidents. |       |       |       |       | Non-Fatal Accidents. |       |       |       |       |
|--------------------|---------------------|---------|---------|---------|---------|------------------|-------|-------|-------|-------|----------------------|-------|-------|-------|-------|
|                    | 1894.               | 1893.   | 1892.   | 1891.   | 1890.   | 1894.            | 1893. | 1892. | 1891. | 1890. | 1894.                | 1893. | 1892. | 1891. | 1890. |
|                    |                     |         |         |         |         |                  |       |       |       |       |                      |       |       |       |       |
| <i>Anthracite.</i> |                     |         |         |         |         |                  |       |       |       |       |                      |       |       |       |       |
| First.             | 16,914              | 15,637  | 14,121  | *23,974 | 23,620  | 47               | 57    | 55    | *69   | 64    | 98                   | 96    | 115   | *215  | 241   |
| Second.            | 15,927              | 14,429  | 14,111  | .....   | 15,759  | 41               | 35    | 33    | ..... | 40    | 143                  | 173   | 181   | ..... | 174   |
| Third.             | 18,965              | 15,779  | 15,020  | 17,354  | 18,947  | 51               | 67    | 50    | ..... | 109   | 195                  | 178   | 163   | ..... | 208   |
| Fourth.            | 22,763              | 22,750  | 21,206  | 19,411  | 14,214  | 71               | 77    | 83    | 96    | 52    | 227                  | 221   | 180   | 183   | 134   |
| Fifth.             | 18,381              | 17,540  | 16,277  | 14,961  | 18,255  | 58               | 58    | 48    | 52    | 36    | 35                   | 99    | 110   | 115   | 97    |
| Sixth.             | 20,109              | 17,872  | 20,698  | 19,270  | 18,149  | 73               | 69    | 54    | 68    | 39    | 54                   | 139   | 120   | 93    | 121   |
| Seventh.           | 19,121              | 19,197  | 18,437  | 18,235  | 8,789   | 78               | 77    | 43    | 58    | 17    | 76                   | 119   | 101   | 153   | 36    |
| Eighth.            | 10,734              | 10,777  | 10,417  | 9,740   | .....   | 29               | 27    | 23    | 28    | ..... | 40                   | 44    | 53    | 68    | ..... |
| Total.             | 139,695             | 128,921 | 129,797 | 123,055 | 117,763 | 439              | 445   | 396   | 427   | 378   | 919                  | 1,069 | 1,023 | 1,003 | 1,011 |
| <i>Bituminous.</i> |                     |         |         |         |         |                  |       |       |       |       |                      |       |       |       |       |
| First.             | 11,175              | 10,114  | 9,393   | 8,188   | 6,780   | 25               | 25    | 24    | 20    | 15    | 101                  | 77    | 87    | 51    | 77    |
| Second.            | 12,148              | 10,993  | 12,004  | 11,583  | 11,702  | 18               | 14    | 25    | 131   | 20    | 23                   | 25    | 41    | 33    | 51    |
| Third.             | 6,734               | 6,112   | 6,297   | 6,118   | 5,379   | 9                | 3     | 2     | 8     | ..... | 12                   | 25    | 26    | 34    | 29    |
| Fourth.            | 9,628               | 8,293   | 6,597   | 6,767   | 5,805   | 11               | 5     | 6     | 6     | ..... | 20                   | 42    | 74    | 16    | 22    |
| Fifth.             | 7,619               | 6,683   | 10,381  | 10,275  | 9,868   | 13               | 12    | 23    | 25    | 59    | 17                   | 44    | 71    | 42    | 37    |
| Sixth.             | 6,944               | 6,323   | 12,211  | 11,560  | 9,823   | 13               | 12    | 14    | 12    | 15    | 17                   | 15    | 21    | 20    | 24    |
| Seventh.           | 9,844               | 9,398   | 10,619  | 9,210   | 8,364   | 9                | 9     | 25    | 17    | 9     | 47                   | 44    | 56    | 49    | 53    |
| Eighth.            | 8,160               | 9,423   | 11,277  | 10,222  | 9,132   | 13               | 20    | 11    | 14    | 24    | 17                   | 31    | 77    | 64    | 86    |
| Ninth.             | 9,270               | 8,754   | .....   | .....   | .....   | 11               | 15    | ..... | ..... | ..... | 40                   | 35    | ..... | ..... | ..... |
| Tenth.             | 5,247               | 5,697   | .....   | .....   | .....   | 2                | 4     | ..... | ..... | ..... | 17                   | 25    | ..... | ..... | ..... |
| Total.             | 86,177              | 81,800  | 78,789  | 73,923  | 66,944  | 154              | 131   | 133   | 297   | 146   | 357                  | 246   | 393   | 314   | 379   |
| Grand total.       | 225,872             | 219,821 | 208,586 | 196,978 | 184,707 | 593              | 586   | 529   | 694   | 524   | 1,276                | 1,415 | 1,416 | 1,317 | 1,399 |

\* First and Second Anthracite Districts reported together for 1891.

*Table showing production of anthracite coal by counties, and number of employes in and about the mines.*

| Counties.             | Tons of Coal. |               |               |               |               | Number of Employes. |         |         |         |         |
|-----------------------|---------------|---------------|---------------|---------------|---------------|---------------------|---------|---------|---------|---------|
|                       | 1884.         | 1893.         | 1892.         | 1891.         | 1890.         | 1884.               | 1893.   | 1892.   | 1891.   | 1890.   |
| Carbon, .....         | 1,580,395     | 1,510,280.50  | 1,497,542.85  | 1,191,158.50  | 1,268,541.45  | 5,391               | 4,413   | 3,848   | 3,212   | 3,232   |
| Columbia, .....       | 586,527       | 741,630.74    | 850,486.85    | 751,558.15    | 599,404       | 2,011               | 2,654   | 2,624   | 2,757   | 2,219   |
| Dauphin, .....        | 896,637       | 641,723.12    | 639,879.85    | 623,538.70    | 577,490       | 2,092               | 2,094   | 2,101   | 2,125   | 2,243   |
| Lackawanna, .....     | 11,17,982.00  | 11,410,553.95 | 11,410,553.95 | 10,184,347.70 | 9,374,579.25  | 20,629              | 20,021  | 27,223  | 24,490  | 25,116  |
| Lehigh, .....         | 17,240,628.65 | 18,253,141.53 | 17,724,508.70 | 17,729,559.65 | 15,895,672.75 | 52,991              | 51,392  | 47,044  | 46,825  | 43,376  |
| Northumberland, ..... | 3,882,669     | 3,731,404.63  | 3,724,334.70  | 3,579,328.25  | 3,688,547     | 13,870              | 14,487  | 15,832  | 19,437  | 13,586  |
| Schuykill, .....      | 9,485,662     | 9,762,083.37  | 9,564,534.60  | 9,328,111.50  | 9,045,215.85  | 31,666              | 33,611  | 32,049  | 29,866  | 28,157  |
| Sullivan, .....       | 70,418        | 74,099.65     | 74,099.65     | 68,831.35     | 63,745        | .....               | 307     | 293     | 229     | 247     |
| Susquehanna, .....    | 413,578       | 571,356.19    | 457,622.50    | 359,712.45    | 351,350.45    | 1,012               | 1,045   | 993     | 823     | 639     |
| Wayne, .....          | .....         | .....         | .....         | 3,450.10      | .....         | .....               | .....   | .....   | 18      | .....   |
| Total, .....          | 45,596,179.14 | 47,179,563.25 | 45,738,373.90 | 44,376,179.95 | 40,166,327.50 | 139,695             | 138,021 | 129,797 | 123,035 | 177,763 |

*Table showing production of bituminous coal and coke by counties, and number of employes in and about the mines.*

| Counties.     | Tons of Coal. |               |               |               |               |
|---------------|---------------|---------------|---------------|---------------|---------------|
|               | 1894.         | 1896.         | 1892.         | 1891.         | 1890.         |
| Allergheny.   | 6,415,611     | 6,894,510.25  | 7,227,370.15  | 6,216,423     | 6,377,654.33  |
| Armstrong.    | 577,928       | 300,222       | 349,561.75    | 299,945       | 385,720       |
| Beaver.       | 135,752       | 151,346       | 188,379       | 133,114       | 101,786       |
| Bedford.      | 288,753       | 490,416       | 565,760       | 413,537       | 319,917       |
| Elkh.         | 269,211       | 170,144       | 278,495       | 218,955       | 298,196       |
| Bradford.     | 25,474        | 42,739        | 53,317        | 68,697        | 125,707       |
| Butler.       | 134,334       | 160,443       | 132,040.50    | 160,273       | 152,448       |
| Cambria.      | 3,995,261     | 3,377,459     | 3,289,194     | 3,273,078     | 2,526,001     |
| Cameron.      | 174,548       | 1,259,351     | 372,431.61    | 490,300       | 375,566.11    |
| Centre.       | 401,088       | 772,622       | 788,873.25    | 739,068       | 485,658       |
| Clarion.      | 4,156,310     | 6,081,324     | 6,631,013.18  | 6,706,015.80  | 6,549,546.33  |
| Clearfield.   | 100,000       | 94,582        | 92,242        | 131,619       | 158,000       |
| Clinton.      | 515,070       | 617,878       | 726,852.19    | 739,958       | 766,917       |
| Elk.          | 6,684,153     | 6,105,845     | 7,791,330     | 5,755,200     | 6,790,277     |
| Fayette.      | 187,070       | 291,739       | 350,005       | 277,938       | 325,822       |
| Greene.       | 405,878       | 638,667       | 638,667       | 529,628       | 315,968       |
| Huntingdon.   | 3,467,481     | 3,072,297     | 3,682,771.38  | 3,600,052.45  | 3,147,332     |
| Indiana.      | 135,411       | 197,277       | 119,539       | 172,197.50    | 136,687       |
| Jefferson.    | 80,160        | 53,192        | 37,000        | 15,737        | 11,483.50     |
| Lawrence.     | 19,844        | 486,049       | 442,632.75    | 573,770       | 491,835       |
| Lycoming.     | 297,662       | 483,770       | 423,179       | 441,070       | 275,554       |
| McKean.       | 434,188       | 90,538        | 964,756       | 993,259       | 873,406       |
| Mercer.       | 684,627       | 942,252       | 2,726,941     | 2,407,837     | 2,471,210.78  |
| Potter.       | 3,373,778     | 3,414,444     | 8,696,964.35  | 7,695,867.95  | 7,398,841.85  |
| Somerset.     | 7,729,080     | 7,583,346     | 8,696,964.35  | 7,695,867.95  | 7,398,841.85  |
| Sullivan.     | 39,800,210    | 43,421,808.25 | 46,576,576.11 | 44,787,644.75 | 40,784,003.90 |
| Tioga.        |               |               |               |               |               |
| Washington.   |               |               |               |               |               |
| Westmoreland. |               |               |               |               |               |
| Total.        | 39,800,210    | 43,421,808.25 | 46,576,576.11 | 44,787,644.75 | 40,784,003.90 |

Table showing production of bituminous coal and coke by counties, and number of employes in and about the mines.—  
Continued.

| Counties     | Tons of Coke. |              |              |              |              |        | Number of Employes. |        |        |        |  |  |
|--------------|---------------|--------------|--------------|--------------|--------------|--------|---------------------|--------|--------|--------|--|--|
|              | 1894          | 1893.        | 1892.        | 1891.        | 1890.        | 1894.  | 1893.               | 1892.  | 1891.  | 1890.  |  |  |
| Allegheny    | 6,099         | 2,000        | 12,060       | 10,392       | 9,645        | 15,345 | 14,351              | 15,447 | 12,365 | 11,915 |  |  |
| Armstrong    | 6,556         | 109          | .....        | 11,314.59    | 14,012       | 1,294  | 632                 | 740    | 573    | 779    |  |  |
| Beaver       | 80            | .....        | .....        | 58           | .....        | 455    | 265                 | 467    | 294    | 214    |  |  |
| Bedford      | 6,016         | 2,000        | 25,576       | 1,759        | 78,291       | 845    | 967                 | 851    | 842    | 527    |  |  |
| Blair        | N,290         | 33,981       | 104,117      | 79,252       | 84,137       | 707    | 538                 | 635    | 624    | 631    |  |  |
| Bradford     | .....         | .....        | .....        | .....        | .....        | 90     | 83                  | 122    | 169    | 295    |  |  |
| Buher        | .....         | .....        | .....        | .....        | .....        | 461    | 328                 | 256    | 242    | 285    |  |  |
| Camberg      | 47,717        | 122,219      | 217,803      | 333,939      | 4,729        | 7,048  | 6,691               | 5,672  | 3,229  | 4,399  |  |  |
| Cameron      | .....         | .....        | .....        | .....        | .....        | .....  | .....               | .....  | .....  | .....  |  |  |
| Centre       | 15,069        | 83,236       | 27,600       | 62,376.06    | 42,855       | 647    | 2,416               | 729    | 858    | 538    |  |  |
| Charlton     | .....         | .....        | .....        | .....        | .....        | 1,021  | 1,626               | 1,488  | 1,346  | 985    |  |  |
| Clearfield   | 15,374        | 131,900      | 165,598      | 157,733      | 194,308      | 9,733  | 10,883              | 10,639 | 10,188 | 9,251  |  |  |
| Cleburn      | .....         | .....        | .....        | .....        | .....        | 151    | 180                 | 173    | 290    | 195    |  |  |
| Elk          | N,257         | 29,421       | 17,181       | 2,500        | 4,861.10     | 1,297  | 1,332               | 1,243  | 1,365  | 1,303  |  |  |
| Fayette      | 3,426,751     | 3,011,054    | 4,268,825    | 3,654,311    | 3,938,623    | 12,566 | 11,185              | 11,621 | 11,076 | 10,312 |  |  |
| Greene       | .....         | .....        | .....        | .....        | .....        | 689    | 630                 | 668    | 597    | 629    |  |  |
| Huntingdon   | .....         | .....        | .....        | .....        | .....        | 700    | 873                 | 1,021  | 822    | 691    |  |  |
| Indiana      | 3,259         | 35,629       | 40,234       | 27,251       | 27,251       | 6,342  | 4,274               | 5,574  | 5,623  | 4,395  |  |  |
| Jefferson    | 219,657       | 25,473       | 394,494      | 433,932      | 312,798      | 494    | 460                 | 267    | 368    | 283    |  |  |
| Lawrence     | .....         | .....        | .....        | .....        | .....        | 166    | 118                 | 60     | .....  | .....  |  |  |
| Lyscoming    | .....         | .....        | .....        | .....        | .....        | 42     | 39                  | 44     | 31     | 28     |  |  |
| McKean       | .....         | .....        | .....        | .....        | .....        | 1,137  | 1,010               | 1,112  | 1,098  | 973    |  |  |
| Mercer       | .....         | .....        | .....        | .....        | .....        | .....  | .....               | .....  | .....  | .....  |  |  |
| Potter       | 5,927         | 3,353        | 11,745       | 26,657       | 20,270       | .....  | .....               | .....  | .....  | .....  |  |  |
| Somerset     | .....         | .....        | .....        | .....        | .....        | 867    | 677                 | 554    | 576    | 433    |  |  |
| Sullivan     | 450           | 984          | 1,033        | 1,982        | 2,140        | 337    | .....               | .....  | .....  | .....  |  |  |
| Tioga        | .....         | .....        | .....        | .....        | .....        | 2,207  | 2,250               | 2,221  | 1,969  | 2,014  |  |  |
| Washington   | 1,957,128     | 1,790,883.90 | 2,920,454.87 | 2,185,096    | 3,011,039.75 | 6,968  | 7,113               | 5,502  | 4,550  | 4,311  |  |  |
| Westmoreland | 5,729,241     | 5,540,296.90 | 7,891,620.37 | 6,591,542.56 | 8,431,140.85 | 14,570 | 13,016              | 13,083 | 12,958 | 11,658 |  |  |
| Total        | 86,177        | 81,807       | 78,789       | 73,923       | 66,944       | .....  | .....               | .....  | .....  | .....  |  |  |

*Days in operation of Anthracite Collieries.*

| Name of Colliery.         | Name of Operator.                        | 1888. | 1889.  | 1891.  | 1892.  | 1893.  | 1894.  |
|---------------------------|--|-------|--------|--------|--------|--------|--------|
| Austin.                   | Austin Coal Company.                     | 297   | 191.80 | 172.10 | 71     | 163.50 | 149.9  |
| Anchor.                   | Philadelphia & Reading Coal and Iron Co. | 270   | 224.50 | 232.20 | 176.60 | 188.50 | 173.4  |
| Archbold.                 | Delaware, Lackawanna & Western R. R. Co. | 270   | 224.50 | 232.20 | 196.60 | 168.50 | 162.90 |
| Alden.                    | do.                                      | 226   | 133.20 | 169.40 | 177.20 | 175.80 | 171.30 |
| Avondale.                 | do.                                      | 241½  | 222.15 | 199.30 | 201.80 | 225.60 | 172.50 |
| Alaska shaft.             | do.                                      | 163   | 199.60 | 223.60 | 257    | 172.50 | 172.50 |
| Avoca.                    | do.                                      | 17    | 258.80 | 205    | 178.35 | 171.05 | 73.40  |
| Amora.                    | do.                                      | 17    | 268.50 | 196.50 | 192.65 | 178    | 178    |
| Abbott slope.             | Philadelphia & Reading Coal and Iron Co. | 146   | 138.70 | 202.20 | 195.20 | 179.50 | 163.3  |
| Alaska.                   | do.                                      | 197   | 215.10 | 213    | 243.45 | 206.95 | 180.6  |
| Albright washery.         | Buck Mountain Coal Company.              | 223   | 237.25 | 231.50 | 225    | 184.90 | 167    |
| Buck Mountain.            | do.                                      | 254   | 172.70 | 253.85 | 213.70 | 225    | 184.90 |
| Budler.                   | Bear Ridge Coal Company.                 | 235   | 167.55 | 210.30 | 240.25 | 116.55 | 194.45 |
| Ben Franklin.             | do.                                      | 197½  | 56.30  | 148.20 | 237.10 | 216.75 | 193.85 |
| Big Mountain.             | Dooley & Baumgardner.                    | 224   | 188.45 | 161.05 | 171.20 | 180.45 | 179.70 |
| Big Mt. No. 1.            | Patterson, Lewellyn & Co.                | 210   | 177.40 | 224.10 | 249.75 | 224.25 | 218    |
| Bear Ridge No. 2.         | Bear Ridge Coal Company.                 | 214   | 222    | 171    | 220    | 214    | 210.65 |
| Big Mine Run.             | do.                                      | 290   | 237.25 | 231.50 | 220    | 206.75 | 193.40 |
| Brenzel.                  | Jeremiah Taylor & Co.                    | 254   | 172.70 | 253.85 | 213.70 | 225    | 184.90 |
| Bear Valley.              | Brenzel & Cleaver.                       | 235   | 167.55 | 210.30 | 240.25 | 116.55 | 194.45 |
| Burnside.                 | Philadelphia & Reading Coal and Iron Co. | 197½  | 56.30  | 148.20 | 237.10 | 216.75 | 193.85 |
| Bast.                     | do.                                      | 224   | 188.45 | 161.05 | 171.20 | 180.45 | 179.70 |
| Bear Run.                 | do.                                      | 210   | 177.40 | 224.10 | 249.75 | 224.25 | 218    |
| Boston Run.               | do.                                      | 214   | 222    | 171    | 220    | 214    | 210.65 |
| Buckville.                | do.                                      | 290   | 237.25 | 231.50 | 225    | 206.75 | 193.40 |
| Beechwood.                | Waddel & Walters.                        | 386   | 147.30 | 135.90 | 185.3  | 174.90 | 174.4  |
| Bennet.                   | Haddock & Steel.                         | 119   | 143.90 | 208.20 | 180.1  | 187.80 | 174.4  |
| Black Diamond.            | Rutler Coal Company.                     | 221   | 143.90 | 208.20 | 180.80 | 180.1  | 187.80 |
| Boston.                   | Delaware, Lackawanna & Western R. R. Co. | 235   | 196.75 | 201.50 | 172    | 208.75 | 208.75 |
| Bellevue shaft and slope. | do.                                      | 243   | 226.50 | 189.74 | 206.25 | 216.50 | 216.50 |
| Bridge.                   | do.                                      | 289½  | 239.80 | 195    | 208.75 | 168.20 | 157    |
| Brisban.                  | Delaware, Lackawanna & Western R. R. Co. | 287   | 235.25 | 195    | 208.75 | 168.20 | 157    |
| Blandford.                | Northwestern Coal Company.               | 227   | 159.50 | 183.25 | 160.50 | 188    | 166    |
| Baltimore slope.          | Delaware and Hudson Canal Company.       | 243   | 226.50 | 189.74 | 206.25 | 216.50 | 216.50 |
| Baltimore tunnel.         | do.                                      | 289½  | 239.80 | 195    | 208.75 | 168.20 | 157    |
| Baltimore tunnel.         | do.                                      | 287   | 235.25 | 195    | 208.75 | 168.20 | 157    |
| Breaker No. 1.            | Susquehanna Coal Company.                | 227   | 159.50 | 183.25 | 160.50 | 188    | 166    |
| Breaker No. 2.            | Babylon Coal Company.                    | 227   | 159.50 | 183.25 | 160.50 | 188    | 166    |
| Breaker No. 3.            | do.                                      | 227   | 159.50 | 183.25 | 160.50 | 188    | 166    |
| Breaker No. 1.            | Kingston Coal Company.                   | 227   | 159.50 | 183.25 | 160.50 | 188    | 166    |
| Breaker No. 2.            | do.                                      | 227   | 159.50 | 183.25 | 160.50 | 188    | 166    |
| Boston mines.             | Delaware and Hudson Canal Company.       | 227   | 159.50 | 183.25 | 160.50 | 188    | 166    |

## Days in operation of Anthracite Collieries—Continued.

| Name of Colliery.                       | Name of Operator.                         | 1888. | 1889.  | 1890.  | 1891.  | 1892.  | 1893.  | 1894.  |
|---|---|-------|--------|--------|--------|--------|--------|--------|
| Beaver Meadow.                          | Coxe Bro. & Co.,                          | 238   | 309    | 268    | 285    | 221    | 210    | 210    |
| Beaver Brook.                           | do.                                       | 161   | 218    | 211.40 | 224    | 226.6  | 237.20 | 204    |
| Black Ridge.                            | do.                                       | 152   | 276    | 175    | 19.60  | 234.85 |        |        |
| Black Diamond.                          | Schwenk, Robertson & Co.,                 | 203   | 149.50 | 130    | 19.60  |        |        |        |
| Bellmont.                               | S. S. Biddle & Co.,                       |       |        |        |        |        |        |        |
| Bellmont mines.                         | W. W. Watkins & Son,                      |       |        | 53     | 248    | 194    | 222.70 | 117.5  |
| Blackwood.                              | L. V. Coal Company,                       |       |        |        |        | 112.3  | 205.30 | 183    |
| Blue Ridge.                             | Blue Ridge Coal Company,                  |       |        | 126.50 | 198.80 |        |        |        |
| Babylon.                                | H. J. Brennan & Bro.,                     | 127   | 127    | 201.50 | 200.75 | 207.25 | 120    | 154.25 |
| Barnum.                                 | Pennsylvania Coal Company,                | 213   | 165    |        |        |        |        |        |
| Breaker No. 10—Shaft Nos. 9, 10, 10     | do.                                       |       | 171    |        |        |        |        |        |
| Breaker No. 11—Shaft Nos. 5, 6 and 11.  | do.                                       | 220½  | 187    | 189.25 | 212    | 222.75 | 184.25 |        |
| Bernic drift—2 drifts.                  | Pennsylvania Coal Company.                |       |        |        |        |        |        |        |
| Breaker No. 8—Shaft Nos. 1 and 8.       | do.                                       | 180½  | 112    | 222.50 | 188.50 | 222.45 | 223.80 | 179.5  |
| Black Diamond shaft.                    | do.                                       | 267   | 222.50 | 223.75 | 232.60 | 227.50 | 228.80 | 180.50 |
| Bennett shaft.                          | Andrew Langdon,                           | 262½  | 214.10 |        |        |        |        |        |
| Breaker No. 6.                          | Susquehanna Coal Company,                 | 195   |        |        |        |        |        |        |
| Belmonts tunnel.                        | do.                                       | 219   |        |        |        |        |        |        |
| Brennan's tunnel.                       | Frisbie & Co.,                            | 219   |        |        |        |        |        |        |
| Butler slope and tunnel.                | S. B. Bennett,                            | 257   | 213    |        |        |        |        |        |
| Boston slope and drift and two tunnels. | Nelson Cowen,                             | 222   | 95     |        |        |        |        |        |
| Buffalo tunnel.                         | do.                                       | 222   |        |        |        |        |        |        |
| Buttalo tunnel.                         | Delaware and Hudson Canal Company,        | 197   | 53     |        |        |        |        |        |
| Baltimore slope No. 2.                  | do.                                       | 235   |        | 21.25  | 173    | 203.00 | 159.80 | 178    |
| Back Ridge.                             | do.                                       | 124   | 199.60 | 168.80 | 192.45 | 289    | 285.50 |        |
| Brookside.                              | Philadelphia & Reading Coal and Iron Co., | 297   |        | 283    | 209    |        |        |        |
| Breaker No. 2—Harvey slope.             | do.                                       |       | 159.40 | 236    |        |        | 51.50  |        |
| Bunker Hill No. 1.                      | Susquehanna Coal Company,                 |       |        |        |        |        |        | 179.5  |
| Butler and Chapman shafts.              | Pennsylvania Coal Company,                |       |        |        |        |        |        | 223.80 |
| Baltimore No. 3.                        | Butler Mine Company, Limited,             |       |        |        |        |        |        | 180.50 |
| Buttwood.                               | Delaware and Hudson Canal Company,        |       |        |        |        |        |        | 50     |
| Bell.                                   | Parrish Coal Company,                     |       |        |        |        |        |        | 122    |
| Broad Mountain washery.                 | Gorman & Co.,                             |       |        |        |        |        |        | 204    |
| Black Heath.                            | Broad Mountain Coal Company,              |       |        |        |        |        |        | 208.4  |
| Colliery No. 5.                         | Jones Bros.,                              | 187   | 58     | 200    | 224.15 | 202.5  | 236.90 | 208.4  |
| Chamberlain.                            | Lehigh Coal and Navigation Company,       |       |        |        |        |        |        |        |
| Colliery No. 6.                         | Thompson, Heath & Company,                | 100   | 201    |        | 170    | 202.5  | 236.90 | 208.4  |
| Clark tunnel.                           | Lehigh Coal and Navigation Company,       | 214   | 180    | 175.90 | 182.50 | 210.50 | 178    | 146.20 |
| Columbia shaft and tunnel.              | Clark Tunnel Coal Company,                |       | 209.25 | 207.75 | 208    |        |        |        |
| Clifford shaft and slope.               | Old Forge Coal Company, Limited,          |       |        | 199.50 |        |        |        |        |
| Cranberry.                              | A. Fardoe & Co.,                          |       |        |        |        |        |        | 218.00 |
| Colerain.                               | Charles Shoener,                          |       |        |        |        | 203.2  | 218.00 | 173.3  |
| Chapman.                                | Butler Mine Company, Limited,             |       |        |        |        | 222    | 176.90 |        |
| Centralla and Lehigh.                   | Dr. G. M. Prevost,                        |       |        |        |        |        |        |        |

|   |      |        |        |        |        |        |        |
|---|------|--------|--------|--------|--------|--------|--------|
| Cross Creek Nos. 1 and 2,                 | 290  | 118.37 | 137.50 | 258.75 | 249.75 | 256    | 198    |
| Cross Creek No. 3,                        | 163  | 205    | 180    | 139.75 | 236.80 | 221.05 | 189.7  |
| Cameron,                                  | 190  |        |        |        | 216    | 199.50 | 198.75 |
| Cambridge,                                |      |        |        |        |        |        |        |
| Cuyler,                                   |      |        |        |        |        |        |        |
| S. M. Heaton & Co.,                       |      |        |        |        |        |        |        |
| Clifford,                                 |      |        |        |        |        |        |        |
| Common,                                   |      |        |        |        |        |        |        |
| Philadelphia & Reading Coal and Iron Co., |      |        |        |        |        |        |        |
| do.                                       |      |        |        |        |        |        |        |
| Delaware and Hudson Canal Company,        | 241  |        |        | 194.50 |        |        |        |
| do.                                       | 222  |        |        | 172.50 |        |        |        |
| Clear Spring Coal Company,                | 224½ | 165    | 192.60 | 202.25 | 220.05 | 231.70 | 191.10 |
| Hillside Coal Company,                    | 209½ | 90     | 191.25 | 211.25 | 193    | 196    | 159    |
| Delaware, Lackawanna & Western R. R. Co., | 216  | 143.60 | 172.10 | 200.40 | 180.3  | 183.50 | 126.5  |
| do.                                       | 214  | 139.90 | 105.50 |        | 182.2  | 181.90 | 172.9  |
| do.                                       | 214  | 134.39 | 57     | 185    | 170.70 | 136.90 | 167.7  |
| Lackawanna Iron and Coal Company,         | 229  | 158.40 | 189.20 | 184.70 | 210    | 224    | 194.3  |
| Delaware and Hudson Canal Company,        | 265  |        |        | 210.50 | 219.75 | 272.75 | 180    |
| Church Coal Company, Limited,             | 150  | 145    | 161    | 152    | 39     |        | 222    |
| Delaware and Hudson Canal Company,        | 206  | 229.50 | 144    | 98.75  | 154.25 | 227    |        |
| A. Pardee & Co.,                          | 219  | 213    | 262    | 274    | 156.6  |        | 163.7  |
| do.                                       | 211  | 248    |        |        | 227.1  | 249.50 | 214.6  |
| Lehigh Coal and Navigation Company,       |      |        |        |        | 240.7  | 235.7  | 212.8  |
| do.                                       |      |        |        |        |        |        |        |
| Smith & Keiser,                           |      |        |        | 137.75 |        |        |        |
| Excelsior Coal Company,                   |      |        | 277    | 285    | 246    | 268.25 | 219    |
| Lewis A. Riley & Co.,                     | 219  | 211.35 | 185    | 199.70 | 260    | 247.80 | 186    |
| Joseph Brady,                             | 200  |        |        |        | 197.80 | 173.70 | 142    |
| I., C. & N. Company,                      |      |        |        |        | 215.2  | 247.10 | 137.5  |
| do.                                       |      | 234.25 | 224.50 |        | 221.25 | 215.50 | 177.75 |
| Shaefer, Bickel & Co.,                    |      | 147    | 148.75 | 211.25 |        | 192.80 | 150    |
| Chamberlain Coal Company,                 |      |        |        |        |        | 89.40  | 127    |
| William Essler,                           |      |        |        |        |        |        | 313    |
| Charles Parrish & Co.,                    |      |        |        |        |        |        | 60.5   |
| Delaware and Hudson Canal Company,        | 114  | 225    | 214.75 | 221.50 | 223.75 | 224.75 | 188.50 |
| Pennsylvania Anthracite Coal Company,     | 122  | 164    | 194    | 293.80 | 68     | 174.50 | 90.1   |
| Dolph Coal Company, Limited,              | 183  | 168.50 | 155    | 144.50 |        |        |        |
| Pennsylvania Coal Company,                |      |        |        |        | 232.75 | 225    | 160.5  |
| Delaware and Hudson Canal Company,        | 241  | 233.75 | 225.50 | 230.25 | 232.75 | 225    | 160.5  |
| do.                                       | 200  | 146.80 | 184.80 | 191.70 | 185.8  | 185.10 | 178.1  |
| Delaware, Lackawanna & Western R. R. Co., | 197  | 151.70 | 203.40 | 191.50 | 180.9  | 180.9  | 172.5  |
| do.                                       |      |        |        |        | 180.9  | 185.90 |        |
| L. & W. E. Coal Company,                  |      |        |        |        |        |        |        |
| do.                                       | 241  | 157.70 |        |        |        |        |        |
| Lehigh Valley Coal Company,               | 200  | 192.45 | 193.85 | 220.75 | 234.35 | 215.40 | 205.75 |
| Coxe Bros. & Co.,                         | 225½ | 231.90 | 237.05 | 235.60 | 199.35 | 171.10 | 139.70 |
| Oliver Diston,                            | 621  |        |        |        | 255    | 281    |        |
| John Lawrence,                            | 240  | 204.85 | 241.10 | 264    | 170    | 211.55 | 106    |
| Denning & Bro.                            | 200  |        |        |        |        |        | 970    |

## Days in operation of Anthracite Collieries—Continued.

| Name of Colliery.   | Name of Operator.                        | 1888.   | 1889.  | 1891.  | 1892.  | 1893.  | 1894.  |
|---|--|---------|--------|--------|--------|--------|--------|
| Driftion Nos. 1 and 2   | Coxe Bros. & Co.                         | 255     | 401    | 287    | 252    | 228    | 212    |
| Derringer & Gowen   | do.                                      | 374     | 212    | 235    | .....  | .....  | 215    |
| Eberlyse  | Ebervale Coal Company.                   | .....   | .....  | .....  | .....  | 223    | .....  |
| Enterprise  | H. C. Roberts & Co.                      | .....   | .....  | .....  | .....  | 223    | .....  |
| East Easton   | William G. Payne & Co.                   | 145     | 156    | 222.83 | 225.69 | 167.49 | 114.50 |
| Empire No. 1  | Charles Parrish & Co.                    | .....   | 198.25 | 212.15 | 180.40 | .....  | 119.50 |
| Empire No. 4  | Excelsior Coal Mining Company.           | 272     | 265.80 | 257    | 249.30 | 217.10 | 221    |
| Excelsior   | do.                                      | .....   | .....  | .....  | .....  | .....  | .....  |
| Eagle Vein  | George W. Johns & Bro.                   | 245     | 244.75 | 225.05 | 229.75 | 209.05 | 169.7  |
| Elmwood   | Philadelphia & Reading Coal and Iron Co. | 249     | 233.56 | 212.73 | 181.20 | 156.35 | 171.7  |
| Elmwood   | do.                                      | 325     | 227    | 212.40 | 205    | 213.60 | 186.4  |
| Elmwood   | do.                                      | 35      | 162    | 196    | 178    | 3.20   | .....  |
| East Hill shaft   | do.                                      | 283     | 187.45 | 143.60 | 193.70 | 176.60 | 84.35  |
| East Franklin   | do.                                      | 215 1/2 | .....  | .....  | .....  | .....  | .....  |
| Exter   | Lehigh Valley Coal Company.              | 259     | 226.50 | 178    | 219.59 | .....  | .....  |
| Enterprise  | A. Langdon.                              | 250 1/2 | .....  | .....  | .....  | .....  | .....  |
| Enterprise  | Florence Coal Company.                   | 254     | 291    | 184.90 | 188.70 | 204.80 | 162.30 |
| Elmwood   | Delaware and Hudson Canal Company.       | .....   | 132    | 88.75  | 222    | 220.25 | .....  |
| Eddy Creek  | Jones, Simpson & Co.                     | 239     | 218.50 | .....  | .....  | .....  | .....  |
| Eaton mines.  | Edgerton Coal Company, Limited.          | 263     | 183.90 | 291    | 208.2  | 195    | 167.6  |
| Edgerton  | do.                                      | .....   | .....  | .....  | .....  | .....  | .....  |
| East Sugar Loaf No. 5   | Linderman, Skeer & Co.                   | 263     | 243.40 | .....  | .....  | 195    | .....  |
| Eagle   | Thomas Crocker.                          | .....   | .....  | .....  | .....  | 251.1  | 220    |
| Evans   | Evans Mine Company.                      | 246 1/2 | 198    | 237    | 240.75 | 213.50 | .....  |
| Eric  | Hillside Coal and Iron Company.          | 241 1/2 | 166.05 | .....  | .....  | .....  | 177    |
| Empire  | Lackawanna and Wilkes-Barre Coal Co.     | .....   | .....  | 139.50 | 222.75 | .....  | .....  |
| Elk Hill Coal and Iron Company                                    | do.                                      | .....   | .....  | .....  | .....  | .....  | .....  |
| East End  | A. Pardee & Co.                          | .....   | .....  | .....  | .....  | .....  | .....  |
| East Crystal Ridge  | Coxe Bros. & Co.                         | 234     | 391    | 279    | .....  | 30.60  | 151    |
| Eckley No. 1  | do.                                      | .....   | 277    | 279    | .....  | 270    | .....  |
| Eckley No. 5  | do.                                      | .....   | .....  | .....  | .....  | .....  | .....  |
| Ebervale Nos. 1 and 3   | Linderman, Skeer & Co.                   | 233     | 217.30 | 192.40 | 194    | 211    | 165    |
| East Sugar Loaf No. 1   | do.                                      | 253     | 237.10 | 216    | 194    | 211    | 165    |
| East Sugar Loaf No. 2   | do.                                      | .....   | .....  | .....  | 196    | .....  | .....  |
| East Sugar Loaf No. 3   | do.                                      | .....   | .....  | .....  | 196    | .....  | 108    |
| East Sugar Loaf No. 5   | do.                                      | 252     | .....  | 243.30 | 194    | 211    | 165    |
| East Sugar Loaf No. 6   | do.                                      | .....   | .....  | .....  | .....  | .....  | .....  |
| Enterprise  | do.                                      | .....   | .....  | .....  | .....  | .....  | .....  |
| Elletts, Arth.  | Thomas Baumgardner & Co.                 | 197     | 15     | .....  | .....  | .....  | .....  |
| East Lehigh   | Philadelphia & Reading Coal and Iron Co. | 84      | 263    | 278    | 257    | 250    | 273    |
| East Boston shaft   | John R. Davis.                           | 255     | 267    | 130    | 230    | 200    | 143    |
| East breaker—Tunnel No. 1; slope No. 4; shaft No. 7; shaft No. 8. | Mitchell & Shepley.                      | 229     | 214    | .....  | .....  | .....  | .....  |
| Eckley No. 10.  | Pennsylvania Coal Company.               | 247 1/2 | .....  | 286    | .....  | .....  | 203    |
| .....   | Coxe Bros. & Co.                         | 159     | 319    | .....  | .....  | .....  | .....  |
| .....   | .....                                    | 247     | .....  | .....  | .....  | .....  | .....  |



|                                      |   |      |        |        |        |        |        |
|--------------------------------------|---|------|--------|--------|--------|--------|--------|
| Enterprise, .....                    | Enterprise Coal Company, .....                  | 168  | 213    | 204    | 271.70 | 227    | 217    |
| Evans, .....                         | Miscellaneous, .....                            |      |        |        |        |        | 132.6  |
| East Ridge, .....                    | East Ridge Coal Company, .....                  |      |        |        |        | 10     |        |
| Franklin, .....                      | R. R. Morgan, superintendent, .....             |      |        |        |        |        | 83.5   |
| Filer, .....                         | F. Flier and T. Livey, .....                    | 223  | 239    | 239    | 111    | 246    | 263    |
| Furnace, .....                       | Philadelphia & Reading Coal and Iron Co., ..... |      |        |        |        |        |        |
| Forestville, .....                   | do, .....                                       |      |        |        |        |        |        |
| Forty Fort, .....                    | Wyoming Valley Coal Company, .....              | 219½ | 218.50 | 246.80 | 188.10 | 216.75 | 220.80 |
| Fuller, .....                        | Delaware, Lackawanna & Western R. R. Co., ..... | 270  | 219    | 215.75 | 244    | 217.25 | 148    |
| Forest City, .....                   | Hillside Coal and Iron Company, .....           | 177  | 178.25 | 35     |        |        | 113.25 |
| Fair Lawn, .....                     | Fair Lawn Coal Company, Limited, .....          | 252½ |        |        |        |        |        |
| Filers slope, now Mt. Jessup, .....  | Griffiths, Thomas & Co., .....                  | 243  | 190.50 | 122.15 | 194.50 | 170.25 | 104.25 |
| Franklin, .....                      | do, .....                                       | 151  | 92.50  | 82     | 97     | 214    | 217    |
| Frisbie Coal Company, .....          | Jessup Coal Company, .....                      | 249  | 211    | 195    | 198.90 | 205    | 222    |
| Friable slope, .....                 | do, .....                                       |      |        |        |        | 204.80 | 60     |
| Flowers Field, .....                 | do, .....                                       | 149  | 143    | 182    | 229    | 175    | 249.20 |
| Feger Ridge, .....                   | John Murrin, .....                              |      |        |        |        | 84     |        |
| Fall Brook tunnel, .....             | Burler Coal Company, .....                      |      |        |        |        |        |        |
| Fernwood shaft, .....                | Forestville Coal Company, .....                 |      |        |        |        |        | 294.00 |
| Fernwood Coal Company washery, ..... | P. McBrearty & Peffer, .....                    |      |        |        |        |        | 162    |
| Glen, .....                          | W. A. M. Grier, .....                           |      |        |        |        |        |        |
| Glen City, .....                     | H. J. Toudy, .....                              | 236  | 132.60 | 223.80 | 211.10 |        |        |
| Greenback, .....                     | J. C. Hayden & Co., .....                       |      |        |        |        |        |        |
| Greenon, .....                       | Philadelphia & Reading Coal and Iron Co., ..... | 15   | 217.90 | 24.60  | 225.20 | 161.80 | 156.60 |
| George Fales, .....                  | do, .....                                       |      |        |        |        |        | 97.3   |
| Grand, .....                         | do, .....                                       |      |        |        |        | 201.95 | 139    |
| Good Spring, .....                   | do, .....                                       | 242  | 251.25 | 238.05 | 286    | 297    | 203.05 |
| Gilberton, .....                     | do, .....                                       | 122  | 96     | 167    | 221    | 210.95 | 258.10 |
| Glendon, .....                       | do, .....                                       |      |        |        |        | 210    | 174.3  |
| Glendower, .....                     | do, .....                                       |      |        |        |        |        | 196.35 |
| Glendale, .....                      | Glendale Coal Company, .....                    |      |        |        |        |        | 190.1  |
| Greenwood, .....                     | Pennsylvania Anthracite Coal Company, .....     | 183½ |        | 139.30 | 155    |        |        |
| Green Ridge, .....                   | O. S. Johnson, .....                            | 272  | 226.50 | 215    | 226.75 | 58.6   | 211.90 |
| Grassy Island, .....                 | Grassy Island Coal Company, Limited, .....      | 290  | 295    | 19.30  |        | 225½   | 215.90 |
| Grassy Island, .....                 | Delaware and Hudson Canal Company, .....        | 252  | 136.50 | 210.50 | 202.50 |        | 188.2  |
| Grand Tunnel No. 3, .....            | Susquehanna Coal Company, .....                 | 237  |        |        |        | 224.50 | 225.2  |
| Gaylord, .....                       | Kingston Coal Company, .....                    | 210  | 172.50 | 161.75 | 239    |        |        |
| Gowen, .....                         | Coxe Bros. & Co., .....                         | 621  |        |        |        | 245.55 | 241.65 |
| Grand Mammoth, .....                 | Philadelphia & Reading Coal and Iron Co., ..... | 227  | 233.60 | 235.35 | 243.40 | 281    | 139.65 |
| Garfield, .....                      | Garfield Coal Company, Limited, .....           | 235  | 89.80  |        |        | 207.85 | 246.80 |
| Greenwood shaft, .....               | Hillside Coal and Iron Company, .....           | 296  | 186    | 176.35 | 244.75 | 217    | 206.9  |
| Greenwood shaft, .....               | Theo. Oliver, .....                             | 243  | 242    | 232    | 254    | 250    | 174.25 |
| Greenwood No. 13, .....              | do, .....                                       |      |        |        |        | 213    | 159    |
| Greenwood, .....                     | Pennsylvania Coal Company, .....                |      |        | 197    |        |        |        |
| Cypsy Grove, .....                   | do, .....                                       |      |        |        |        | 237.75 | 196.50 |
| Gypsy Grove No. 2, .....             | Greenwood Coal Company, Limited, .....          |      |        |        |        | 249    | 157    |
| Greenwood No. 1, .....               | do, .....                                       |      |        |        |        |        | 163.6  |
| Greenwood No. 2, .....               | Greenwood No. 1, .....                          |      |        |        |        |        | 145.8  |
| Howard, .....                        | Tyler M. Turk & Co., .....                      |      |        |        |        | 164.80 | 124.20 |
| Hollenbach, .....                    | Robert L. Poole, .....                          |      |        |        |        |        |        |
| Hillman, .....                       | H. L. Hillman, .....                            | 228  | 146.20 |        |        |        |        |

## Days in operation of Anthracite Collieries—Continued.

| Name of Colliery.                     | Name of Operator.                               | 1888. | 1889.  | 1891.  | 1892.  | 1893.  | 1894. |
|---------------------------------------|---|-------|--------|--------|--------|--------|-------|
| Humbolt, .....                        | Linderman, Steer & Co., .....                   | 249   | 243.90 | 247.65 | 184    | 215.30 | 1894. |
| Hazleton, .....                       | A. Pardee & Co., .....                          | 208   | 183.20 | 176    | 144.8  | 202.50 | 1892. |
| Hartford No. 6, .....                 | Charles Parrish & Co., .....                    | 229   | 204.70 | 177    | 191.8  | 243.50 | 1891. |
| Hillside Coal and Iron Company, ..... | J. Langdon & Co., .....                         | 213   | 225.20 | 180.40 | 193.90 | 219.85 | 1893. |
| Henry Clay No. 1, .....               | Philadelphia & Reading Coal and Iron Co., ..... | 200   | 179.30 | 39.99  | 194.90 | 169.50 | 1894. |
| Hammond, .....                        | Delaware, Lackawanna & Western R. R. Co., ..... | 191   | 162.50 | 24.45  | 172.5  | 190.70 | 1893. |
| Holten, .....                         | do, .....                                       | 213   | 132.50 | 164.70 | 195.90 | 179.60 | 1894. |
| Hyde Park, .....                      | do, .....                                       | 204½  | 82     | 180.45 | 78.10  | 111.10 | 1892. |
| Henry E., .....                       | Lehigh Valley Coal Company, .....               | 215   | 149.50 | 55.35  | 192.40 | 179.95 | 1893. |
| Heidelberg, .....                     | do, .....                                       | 223   | 128.65 | 230.40 | 187.5  | 212.70 | 1892. |
| Heidelberg shaft, .....               | do, .....                                       | 252   | 225    | 138.10 | 149.3  | 37.90  | 1893. |
| Haistead, .....                       | A. Pardee & Co., .....                          | 210   | 231    | 202    | 173    | 180    | 1891. |
| Hillman vein, .....                   | G. E. Markle & Co., .....                       | 182   | 191    | 200    | 197    | 132    | 1893. |
| Hullman vein No. 2, .....             | do, .....                                       | 198   | 215.50 | 230    | 21     | 224    | 1894. |
| Hartford or Jersey, .....             | do, .....                                       | 270   | 203    | 225    | 218.7  | 351    | 1892. |
| Hollenback, .....                     | Lackawanna and Western Coal Company, .....      | 200   | 203    | 219    | 198.4  | 506.50 | 1892. |
| Hazleton No. 3, .....                 | do, .....                                       | 198   | 265    | 260    | 233.7  | 563.90 | 1890. |
| Hazleton No. 6, .....                 | do, .....                                       | 200   | 265    | 262    | 185.5  | 512.70 | 1891. |
| Highland No. 1, .....                 | do, .....                                       | 200   | 265    | 262    | 149.3  | 37.90  | 1893. |
| Highland No. 2, .....                 | do, .....                                       | 200   | 265    | 262    | 173    | 180    | 1891. |
| Highland No. 5, .....                 | do, .....                                       | 200   | 265    | 262    | 197    | 132    | 1893. |
| Hollywood, .....                      | do, .....                                       | 198   | 215.50 | 230    | 21     | 224    | 1894. |
| Hazle Brook, .....                    | do, .....                                       | 270   | 203    | 225    | 218.7  | 351    | 1892. |
| Honey Brook No. 1, .....              | Lackawanna & Western Bituminous Coal Co., ..... | 200   | 203    | 219    | 198.4  | 506.50 | 1892. |
| Honey Brook No. 2, .....              | do, .....                                       | 198   | 265    | 260    | 233.7  | 563.90 | 1890. |
| Honey Brook No. 4, .....              | do, .....                                       | 200   | 265    | 262    | 185.5  | 512.70 | 1891. |
| Honey Brook No. 5, .....              | do, .....                                       | 200   | 265    | 262    | 149.3  | 37.90  | 1893. |
| Harwood, .....                        | do, .....                                       | 200   | 265    | 262    | 173    | 180    | 1891. |
| Hickory Ridge, .....                  | Pardee Sons' Co., .....                         | 200   | 265    | 262    | 197    | 132    | 1893. |
| Hazel Dell, .....                     | Philadelphia & Reading Coal and Iron Co., ..... | 200   | 265    | 262    | 21     | 224    | 1894. |
| Hickory Swamp, .....                  | Lewis A. Riley & Co., .....                     | 200   | 265    | 262    | 21     | 224    | 1894. |
| Herbine, .....                        | Union Coal Company, .....                       | 41½   | 89     | 164.25 | 198    | 211.25 | 1891. |
| Hooker, .....                         | J. K. Seigfried, .....                          | 297   | 235    | 215    | 268.25 | 152    | 1892. |
| Hooker, .....                         | Wren & Lessig, .....                            | 214   | 250    | 203    | 229    | 241    | 1893. |
| Hampton shaft, .....                  | Delaware, Lackawanna & Western R. R. Co., ..... | 159   | 142.80 | 189.30 | 188    | 186.10 | 1891. |
| Hunt shaft, .....                     | do, .....                                       | 194½  | 119    | 176    | 216    | 212.20 | 1892. |
| Henry Clay, .....                     | Philadelphia & Reading Coal and Iron Co., ..... | 287   | 267.15 | 243.45 | 216    | 212.20 | 1893. |
| Hickory Ridge, .....                  | Union Coal Company, .....                       | 209½  | 175.50 | 195.70 | 216    | 212.20 | 1894. |
| Honey Brook No. 2, .....              | Lackawanna & Western Bituminous Coal Co., ..... | 193   | 249    | 200.75 | 216    | 212.20 | 1895. |
| Hoyle shaft, .....                    | Pennsylvania Coal Company, .....                | 193   | 249    | 200.75 | 216    | 212.20 | 1896. |
| Hazleton, .....                       | A. Pardee & Co., .....                          | 193   | 249    | 200.75 | 216    | 212.20 | 1897. |
| Hazleton No. 1, .....                 | Lehigh Valley Coal Company, .....               | 193   | 249    | 200.75 | 216    | 212.20 | 1898. |

|                           |   |     |        |        |        |        |        |        |
|---------------------------|---|-----|--------|--------|--------|--------|--------|--------|
| Hazleton No. 2,           | do.                                       | 243 | 194.50 | 243.55 | 297.50 | 994.90 | 131.85 | 38.2   |
| Hazleton No. 3,           | do.                                       | 243 | 194.50 | 243.55 | 297.50 | 994.90 | 131.85 | 42.1   |
| Hazleton No. 5,           | do.                                       | 243 | 194.50 | 243.55 | 297.50 | 994.90 | 131.85 | 18.1   |
| Indian Ridge,             | Philadelphia & Reading Coal and Iron Co.  | 243 | 194.50 | 243.55 | 297.50 | 994.90 | 131.85 | 175.80 |
| Jersey No. 1,             | Lackawanna and Western Coal Company,      | 243 | 194.50 | 243.55 | 297.50 | 994.90 | 131.85 | 117.50 |
| Jersey No. 2,             | do.                                       | 243 | 194.50 | 243.55 | 297.50 | 994.90 | 131.85 | 133.3  |
| Jersey No. 3,             | do.                                       | 243 | 194.50 | 243.55 | 297.50 | 994.90 | 131.85 | 196.1  |
| Jersey No. 4,             | do.                                       | 243 | 194.50 | 243.55 | 297.50 | 994.90 | 131.85 | 179.25 |
| John Jermyan,             | do.                                       | 243 | 194.50 | 243.55 | 297.50 | 994.90 | 131.85 | 185    |
| Jones, Simpson & Co.,     | do.                                       | 243 | 194.50 | 243.55 | 297.50 | 994.90 | 131.85 | 206.75 |
| Jedd No. 3,               | G. E. Markle & Co.,                       | 243 | 194.50 | 243.55 | 297.50 | 994.90 | 131.85 | 156.3  |
| Jedd No. 4,               | do.                                       | 243 | 194.50 | 243.55 | 297.50 | 994.90 | 131.85 | 9.6    |
| Kline,                    | do.                                       | 243 | 194.50 | 243.55 | 297.50 | 994.90 | 131.85 | 105    |
| Kohinoor,                 | John L. Kline,                            | 243 | 194.50 | 243.55 | 297.50 | 994.90 | 131.85 | 157    |
| Kohleys Run,              | Richard Heskischer & Co.,                 | 243 | 194.50 | 243.55 | 297.50 | 994.90 | 131.85 | 250.7  |
| Keystone,                 | Thomas Coal Company,                      | 243 | 194.50 | 243.55 | 297.50 | 994.90 | 131.85 | 250.7  |
| Knickerbocker,            | do.                                       | 243 | 194.50 | 243.55 | 297.50 | 994.90 | 131.85 | 186    |
| Keystone,                 | do.                                       | 243 | 194.50 | 243.55 | 297.50 | 994.90 | 131.85 | 178.7  |
| Kohinoor,                 | Hillside Coal and Iron Company,           | 243 | 194.50 | 243.55 | 297.50 | 994.90 | 131.85 | 148.25 |
| Katmia,                   | do.                                       | 243 | 194.50 | 243.55 | 297.50 | 994.90 | 131.85 | 181.5  |
| Kaska William,            | do.                                       | 243 | 194.50 | 243.55 | 297.50 | 994.90 | 131.85 | 17.7   |
| Keckline,                 | Alliance Coal Company,                    | 243 | 194.50 | 243.55 | 297.50 | 994.90 | 131.85 | 30.6   |
| Keystone slope and drift, | P. O'Connor,                              | 243 | 194.50 | 243.55 | 297.50 | 994.90 | 131.85 | 161.20 |
| Katydild tunnel,          | do.                                       | 243 | 194.50 | 243.55 | 297.50 | 994.90 | 131.85 | 157.25 |
| King,                     | do.                                       | 243 | 194.50 | 243.55 | 297.50 | 994.90 | 131.85 | 249.10 |
| Kidder,                   | do.                                       | 243 | 194.50 | 243.55 | 297.50 | 994.90 | 131.85 | 246    |
| Lehigh No. 8,             | Lehigh Coal and Navigation Company,       | 243 | 194.50 | 243.55 | 297.50 | 994.90 | 131.85 | 247.15 |
| Lehigh No. 10,            | do.                                       | 243 | 194.50 | 243.55 | 297.50 | 994.90 | 131.85 | 221.05 |
| Lehigh No. 11,            | do.                                       | 243 | 194.50 | 243.55 | 297.50 | 994.90 | 131.85 | 168.05 |
| Lehigh No. 12,            | do.                                       | 243 | 194.50 | 243.55 | 297.50 | 994.90 | 131.85 | 215    |
| Lehigh No. 13,            | do.                                       | 243 | 194.50 | 243.55 | 297.50 | 994.90 | 131.85 | 215    |
| Lehigh No. 3,             | Swartz, Oliver & Co.,                     | 243 | 194.50 | 243.55 | 297.50 | 994.90 | 131.85 | 239    |
| Lehigh No. 9,             | Miscellaneous,                            | 243 | 194.50 | 243.55 | 297.50 | 994.90 | 131.85 | 219    |
| Lehigh No. 4,             | do.                                       | 243 | 194.50 | 243.55 | 297.50 | 994.90 | 131.85 | 218    |
| Lehigh No. 5,             | do.                                       | 243 | 194.50 | 243.55 | 297.50 | 994.90 | 131.85 | 250    |
| Lang Cliffe,              | do.                                       | 243 | 194.50 | 243.55 | 297.50 | 994.90 | 131.85 | 116    |
| Louise drifts,            | do.                                       | 243 | 194.50 | 243.55 | 297.50 | 994.90 | 131.85 | 25.50  |
| Little Mine Run,          | Raub Coal Company,                        | 243 | 194.50 | 243.55 | 297.50 | 994.90 | 131.85 | 194.20 |
| Lance No. 11,             | Pfeiffer & Garity,                        | 243 | 194.50 | 243.55 | 297.50 | 994.90 | 131.85 | 35.70  |
| Luke Fuller,              | Chas. Parrish & Co.,                      | 243 | 194.50 | 243.55 | 297.50 | 994.90 | 131.85 | 167.55 |
| Locust Spring,            | Mineral Railroad and Mining Company,      | 243 | 194.50 | 243.55 | 297.50 | 994.90 | 131.85 | 247.80 |
| Locust Run,               | do.                                       | 243 | 194.50 | 243.55 | 297.50 | 994.90 | 131.85 | 164    |
| Lawrence,                 | do.                                       | 243 | 194.50 | 243.55 | 297.50 | 994.90 | 131.85 | 166    |
| Leggets Creek,            | do.                                       | 243 | 194.50 | 243.55 | 297.50 | 994.90 | 131.85 | 210.15 |
| Lackawanna Coal Company,  | Lawrence, Markle & Co.,                   | 243 | 194.50 | 243.55 | 297.50 | 994.90 | 131.85 | 294    |
| Laurel Run,               | do.                                       | 243 | 194.50 | 243.55 | 297.50 | 994.90 | 131.85 | 277.4  |
| Laws,                     | Lackawanna Coal Company,                  | 243 | 194.50 | 243.55 | 297.50 | 994.90 | 131.85 | 274.10 |
| Lance No. 11,             | do.                                       | 243 | 194.50 | 243.55 | 297.50 | 994.90 | 131.85 | 221.50 |
| Laurel Hill,              | Pennsylvania Coal Company,                | 243 | 194.50 | 243.55 | 297.50 | 994.90 | 131.85 | 185.5  |
| Lansford No. 4,           | Lackawanna & Western Bituminous Coal Co., | 243 | 194.50 | 243.55 | 297.50 | 994.90 | 131.85 | 174.95 |
| Lansford No. 5,           | A. Pardee & Co.,                          | 243 | 194.50 | 243.55 | 297.50 | 994.90 | 131.85 | 203.70 |
| Lansford No. 6,           | do.                                       | 243 | 194.50 | 243.55 | 297.50 | 994.90 | 131.85 | 252.30 |
| Lansford No. 6,           | Lehigh Coal and Navigation Company,       | 243 | 194.50 | 243.55 | 297.50 | 994.90 | 131.85 | 196.5  |
| Lansford No. 6,           | do.                                       | 243 | 194.50 | 243.55 | 297.50 | 994.90 | 131.85 | 187.80 |
| Lansford No. 6,           | do.                                       | 243 | 194.50 | 243.55 | 297.50 | 994.90 | 131.85 | 105.7  |
| Lansford No. 6,           | do.                                       | 243 | 194.50 | 243.55 | 297.50 | 994.90 | 131.85 | 298.60 |

## Days in operation of Anthracite Collieries—Continued.

| Name of Colliery.    | Name of Operator.                        | 1888. | 1889.  | 1891.  | 1892.  | 1893.  | 1894.  |
|----------------------|--|-------|--------|--------|--------|--------|--------|
| Lansford No. 9.      | Lehigh Coal and Navigation Company.      |       | 257.40 |        |        |        |        |
| Lansford No. 1.      | do.                                      |       | 273.29 |        |        |        |        |
| Lytle.               | Newport Coal Company.                    |       |        | 175.37 | 306    |        | 313    |
| Lee.                 | Pardee Bros. & Co.                       |       | 192.20 | 29.50  | 181.29 | 192.55 | 100.45 |
| Latimer No. 2.       | do.                                      | 144   | 103    | 72.50  | 210    | 248.69 |        |
| Latimer No. 3.       | do.                                      | 300   | 212.50 | 255.60 | 250.1  | 246.10 | 209.8  |
| Lawrence.            | Lawrence & Brown.                        |       | 259    |        | 194.25 | 248    | 223.3  |
| Loeast Mountain.     | W. J. Lloyd.                             | 229½  | 238.40 | 247.10 | 215.39 | 206.35 | 180    |
| Loeast Gap.          | Philadelphia & Reading Coal and Iron Co. | 227   | 87.50  |        |        |        |        |
| Lancaster.           | Smith & Kaiser.                          | 223   | 201.40 | 195.70 | 198.15 | 181.29 | 151    |
| Logan.               | Lewis A. Riley & Co.                     |       | 208    |        |        |        | 223.7  |
| Lincold.             | Philadelphia & Reading Coal and Iron Co. |       |        | 258.21 |        |        |        |
| Lehigh No. 1.        | Lehigh Coal and Navigation Company.      |       |        |        |        |        |        |
| Lackawanna.          | Lackawanna Coal Company.                 |       |        |        |        |        |        |
| Lawrence.            | Conn H Coal Company.                     |       |        |        |        |        |        |
| Latimer No. 1.       | Pardee Bros. & Co.                       |       |        |        |        |        | 192    |
| Little Diamond.      | John A. Lawrence & Co.                   |       |        |        |        |        | 80.5   |
| Mountain.            | John Bergan.                             |       |        |        |        |        | 226    |
| Mine Hill.           | P. J. Courtenay.                         |       | 42.45  | 22.80  |        |        | 215    |
| Midvale slope.       | Lehigh Valley Coal Company.              | 13    | 30     | 103.90 | 183.5  | 124.65 | 136.50 |
| Malby.               | Calb S. Malby.                           |       |        | 71.50  | 192.29 | 167.23 | 163.19 |
| Mt. Pleasant.        | Pardee, Sons & Co.                       |       |        |        | 155    | 200.45 | 135    |
| Mt. Lookout shaft.   | Mt. Lookout Coal Company.                |       |        | 225.40 | 180    | 211.55 | 122    |
| Monitor.             | George Johns & Bro.                      | 217   | 186.85 | 163    | 180    | 201    | 169.3  |
| Merriam.             | Philadelphia & Reading Coal and Iron Co. | 225¼  | 238.50 | 182    |        | 204    | 107    |
| Mahany City.         | do.                                      |       |        |        |        |        |        |
| Morning Star tunnel. | John A. Hutchins & Co.                   |       |        |        |        |        |        |
| Mine Hill 5A.        | Philadelphia & Reading Coal and Iron Co. |       |        |        | 158.5  | 264    | 192.1  |
| Maple Hill.          | do.                                      |       |        |        |        |        |        |
| Mt. Carmel shaft.    | do.                                      |       |        |        |        | 216.55 |        |
| Meadow Brook shaft.  | do.                                      | 231½  | 187.70 | 226    | 212    | 215.39 |        |
| Marville.            | William Connell & Co.                    | 168   | 95.25  | 74.50  | 144.3  | 162.12 | 132.4  |
| Marvine.             | Delaware, Lackawanna & Western R. R. Co. | 274   | 229    | 221.50 | 238.25 | 238.14 | 181.75 |
| Mineral Spring.      | Lehigh Valley Coal Company.              | 192   | 41.50  | 16.60  |        |        |        |
| Mill Creek.          | Delaware and Hudson Canal Company.       | 228   | 221    | 141    | 221    | 15.75  | 4      |
| Mosler.              | Butler Coal Company.                     | 249   | 79     | 58.20  |        |        |        |
| Mt. Pleasant.        | William T. Smith.                        | 228   | 72     | 211.90 | 213.7  | 214.13 | 199    |
| Moffit.              | Dodson Coal Company.                     | 233   | 210.80 | 177    | 166.40 | 175.45 | 148.67 |
| Morea.               |  |       |        | 226    | 244    | 248.70 | 166.4  |
| Milnesville.         |  | 208   | 213.50 | 223    | 227.2  | 294    | 297    |
| Mt. Pleasant.        |  | 194   | 172    | 192    |        |        |        |
| Monitor.             | Philadelphia & Reading Coal and Iron Co. | 251   | 108.05 | 169.95 | 193.39 |        |        |
| Mt. Carmel.          | Thomas M. Righter & Co.                  | 231½  | 175.90 | 257    | 193.29 | 179.40 | 168    |

|  |      |        |        |        |        |        |
|--|------|--------|--------|--------|--------|--------|
| Morris Ridge.....                        | 269  | 242    | 198.59 | 194.89 | 209.50 | 188.20 |
| Middle Creek shaft.....                  | 228  | 277    | 138    | 170    | 202    | 187.50 |
| Monitor.....                             |      |        |        |        |        | 42.3   |
| Middle Lehigh.....                       |      |        |        |        |        |        |
| Meadow Brook tunnel.....                 | 234½ | 223    | 205    | 210    | 211.4  | 208.25 |
| Manville shaft.....                      | 125  | 179.50 | 183.10 | 191.40 |        | 68     |
| Midvalley.....                           |      | 90     | 77     | 73.50  |        | 156    |
| Mt. Vernon.....                          |      |        |        |        | 81     |        |
| Murry & Jackson shaft.....               |      |        |        | 294    | 204.25 |        |
| Mahoney Jig House.....                   |      |        |        |        | 213.20 |        |
| Morning Star.....                        |      |        |        |        | 180    |        |
| Mifflin.....                             |      |        |        |        |        |        |
| Mills blow shaft.....                    | 291  | 217    | 192.10 |        | 265.6  | 193.20 |
| Marshwood slope and tunnel.....          |      | 217    | 193    | 248    |        | 162.50 |
| Mill Creek.....                          | 129  |        |        | 187    | 202    | 161.30 |
| Mt. Jessup slope.....                    |      | 186    | 91.40  | 171.50 | 238.25 | 149.7  |
| Mild and tunnel.....                     |      |        | 221.50 | 216.50 | 181.89 | 228.25 |
| Murray's.....                            |      |        |        |        | 100    | 100    |
| Mountain Lake L. & C. Co.....            |      |        |        |        |        |        |
| Midvalley No. 2.....                     |      |        |        |        |        |        |
| Moosic Mountain.....                     |      |        |        |        |        |        |
| Mount Hope.....                          |      |        |        |        |        |        |
| No. 1.....                               |      |        |        |        |        |        |
| No. 11.....                              |      |        |        |        |        |        |
| No. 12.....                              |      |        |        |        |        |        |
| Nottingham No. 15.....                   |      |        | 171.90 | 225.95 |        | 211.7  |
| North Franklin No. 2.....                | 187  | 148.85 | 98.30  | 227.65 | 149.59 | 262.45 |
| North Ashland.....                       | 217  | 139.90 | 272.18 | 195.70 | 203.70 | 196.45 |
| North Mahanoy.....                       | 222½ | 247.50 | 165.50 | 214.10 | 213.29 | 141.00 |
| National slope and shaft.....            | 234  |        | 183.10 | 191.40 | 212    | 298.25 |
| Nottingham.....                          | 217  | 177.75 |        |        | 132.75 | 162½   |
| No. 10 shaft.....                        |      |        |        |        | 216.45 |        |
| Newport.....                             | 224  | 212    | 204.29 |        | 127.30 |        |
| No. 3.....                               | 168  | 126    | 134    |        | 224.75 | 201    |
| No. 6.....                               |      |        |        |        |        | 156.25 |
| No. 13 shaft.....                        |      |        |        |        |        |        |
| New-booming No. 3.....                   |      |        |        |        |        |        |
| North Laurel Ridge.....                  | 151  | 272    |        |        |        |        |
| New Tipton.....                          | 219  | 563    | 224    |        |        |        |
| Shafts Nos. 1 and 8.....                 | 455  | 322.75 | 177.77 | 246    | 218.45 | 200.75 |
| Nos. 1 and 1 shafts.....                 | 254  | 185.65 | 188.05 | 57.43  | 274.20 | 290.95 |
| Nos. 2 and 3 shafts.....                 | 203  | 129.50 | 191.25 | 176    | 10.30  | 250.90 |
| Nos. 1 and 2.....                        | 224  | 198.50 | 181.50 |        | 214.50 | 202.75 |
| No. 5.....                               | 227  | 224.25 |        |        | 192.75 | 176    |
| No. 7.....                               | 227  | 224.25 |        |        | 208    |        |
| No. 8.....                               | 227  | 182.35 |        |        | 206.25 |        |
| Newellson.....                           | 199  | 244.50 | 30.25  | 293.75 | 270.25 | 206.25 |
| New Toston.....                          | 246  |        |        |        | 214    | 106    |
| New Town.....                            |      |        |        |        |        | 146.25 |
| Natick.....                              |      |        |        |        |        |        |
| Nos. 5 and 6.....                        | 200  |        |        |        | 207    |        |
| No. 1 shaft and White Bridge tunnel..... | 221  | 205.75 |        |        |        | 180    |

## Days in operation of Anthracite Collieries—Continued.

| Name of Colliery.                      | Name of Operator.                         | 1888. | 1889.  | 1890.  | 1891.  | 1892.  | 1893.  | 1894.  |
|--|---|-------|--------|--------|--------|--------|--------|--------|
| No. 3 shaft mlns.                      | Delaware and Hudson Canal Company.        |       | 203.75 |        |        |        |        | 178.75 |
| No. 9 and 10 shafts,                   | Pennsylvania Coal Company.                |       |        |        |        |        |        | 154.25 |
| No. 11 shaft and tunnel,               | Pennsylvania Coal Company.                |       |        |        |        |        |        | 154.75 |
| Nos. 5, 6 and 11 shafts,               | Pennsylvania Coal Company.                |       |        |        |        |        |        | 156.25 |
| No. 3 colliery,                        | Susquehanna Coal Company.                 |       |        |        |        |        |        | 216.75 |
| No. 2 shaft—No. 4 slope,               | do.                                       |       |        |        |        |        |        | 216.80 |
| No. 6 shaft—No. 6 slope; No. 6 tunnel, | do.                                       |       |        |        |        |        |        | 194.65 |
| No. 8,                                 | Lehigh Coal and Navigation Company.       |       |        |        |        |        |        | 259    |
| Newcastle washery,                     | F. B. Palm,                               |       |        | 53.80  | 223.40 | 253    | 223    | 259    |
| Ontario shaft,                         | New York and Scranton Coal Company,       | 156   | 196    | 217    | 226    | 229    | 185.80 | 196.6  |
| Otto,                                  | Philadelphia & Reading Coal and Iron Co., | 210   | 173.50 | 207    | 220    | 224    | 206.25 | 157    |
| Old Forge slopes Nos. 1 and 2,         | Pennsylvania Coal Company.                | 215   | 146    | 186.10 | 188.30 | 154.1  | 187.80 | 179.3  |
| Oxford,                                | Delaware, Lackawanna & Western R. R. Co., |       |        | 204    | 241    | 243    | 190    | 209    |
| Oak Hill,                              | Leisnering & Co.,                         | 250   | 122.75 | 42.75  | 226.75 | 222    | 215.14 | 168.25 |
| Olyphant No. 2,                        | Delaware and Hudson Canal Company.        |       |        |        | 36     | 239    | 254    | 225    |
| Oneida,                                | Coxe Eros. & Co.,                         | 197   | 218    |        |        |        | 189.90 |        |
| Oakdale No. 1,                         | do.                                       | 206   | 242    |        |        |        |        |        |
| Oakdale No. 2,                         | do.                                       | 287   |        | 219    | 289    | 290    | 274.65 |        |
| Ontario No. 1 mine,                    | Philadelphia & Reading Coal and Iron Co., |       |        | 120    | 369.40 |        |        | 169.7  |
| Oakdale washery,                       | Philadelphia & Reading Coal and Iron Co., |       |        |        |        |        |        | 216    |
| Oakley,                                | Louis Lorenz & Sons,                      |       |        |        | 40.50  | 147.39 | 161.20 | 151.90 |
| Phoenix,                               | Harry W. Bellman,                         |       |        |        |        |        |        |        |
| Pennsylvania,                          | Pennsylvania Coal Company.                |       |        |        |        |        |        |        |
| Peerless,                              | Pennsylvania Coal Company.                |       |        |        |        |        |        |        |
| Pennsylvania,                          | Crinkshank & Emmes,                       |       |        |        |        |        |        |        |
| Pioneer,                               | Mineral Railroad and Mining Company.      |       |        |        | 25     |        | 212    | 221    |
| Patterson,                             | Kautner, Vaughn & Co.,                    |       |        |        | 205.10 | 200    | 217    | 22.20  |
| Pettibone,                             | Patterson Ore Mining Company,             |       |        |        | 221    |        | 217    | 93.7   |
| Pittsboro,                             | Delaware, Lackawanna and Western,         |       |        |        |        |        |        |        |
| Primrose,                              | Primrose Coal Company,                    |       |        | 221    | 120.10 | 133.90 | 87.95  | 175    |
| Potts,                                 | Philadelphia & Reading Coal and Iron Co., |       |        |        |        |        |        |        |
| Preston Nos. 1 and 2,                  | do.                                       |       |        |        |        |        |        |        |
| Preston No. 3,                         | do.                                       | 235   |        |        | 152.40 | 191.70 | 182.85 | 186    |
| Prospect,                              | do.                                       |       |        |        |        | 196.45 | 177.15 |        |
| Plank Ridge,                           | Lehigh Valley Coal Company,               |       |        |        |        |        |        |        |
| Pottsville,                            | Philadelphia & Reading Coal and Iron Co., |       |        |        |        |        |        |        |
| Pine Forest,                           | do.                                       |       |        |        |        |        |        |        |
| Phoenix Park No. 2,                    | do.                                       | 240   | 219    | 39     | 229    | 189    | 206.35 | 186.6  |
| Phoenix Park No. 3,                    | do.                                       |       |        |        |        |        |        |        |
| Pyne,                                  | do.                                       |       |        |        |        |        |        |        |
| Pancoast,                              | Pancoast Coal Company, Limited,           |       |        | 198    | 114    | 209    | 199.20 | 202.2  |
| Powderly,                              | Delaware and Hudson Canal Company.        | 226   | 199.50 | 186.80 | 189.70 | 185.1  | 182.09 | 169.3  |
| Prospect,                              | Delaware and Hudson Canal Company.        | 248   | 210.25 | 186.50 | 228.75 | 182.75 | 206.50 | 179.75 |
|  | Lehigh Valley Coal Company.               | 224   | 178    | 195.30 | 205.75 | 223.25 | 202.75 | 163.15 |

|                                   |      |        |        |        |        |        |
|-----------------------------------|------|--------|--------|--------|--------|--------|
| Pine Ridge, .....                 | 253½ | 236.50 | 234    | 209.25 | 248.75 | 211.50 |
| Pierce shaft, and sic'g, .....    | 146½ | 102.20 | 72.60  | 147.90 | 146.5  | 89.70  |
| Plymouth No. 2, .....             | 183  | 150    |        |        |        |        |
| Plymouth No. 3, .....             | do.  | do.    |        |        |        |        |
| Plymouth No. 4, .....             | do.  | do.    |        |        |        |        |
| Plymouth No. 5, .....             | do.  | do.    |        |        |        |        |
| Parrish, .....                    | 247  | 202.60 | 205.20 | 205.95 | 160.40 | 172.35 |
| Pond Creek, .....                 | 212  | 273    | 138    | 177.40 |        | 113.65 |
| Packer No. 2, .....               | 167½ | 76.50  | 152.45 | 151.20 | 209.80 | 155.40 |
| Packer No. 3, .....               | 219½ | 159.35 | 99.55  | 173.50 | 205.80 | 196.05 |
| Packer No. 4, .....               | 175  | 167.85 | 148.15 | 149.20 | 89.20  | 187    |
| Packer No. 5, .....               | 186  | 133.95 | 175.10 | 150.95 | 87.60  | 189.25 |
| Park No. 1, .....                 | 244  | 199.10 | 190.03 | 212.90 | 177.80 | 172.40 |
| Park No. 2, .....                 | 276  | 191    |        |        | 292.50 | 82.2   |
| Primrose, .....                   | 255  | 191    |        |        |        |        |
| Peenless, .....                   | 267  | 207.15 |        | 243.45 |        |        |
| Pennsylvania, .....               | 213  | 216.50 | 189.25 | 287.75 | 281.80 | 241.40 |
| Phoenix No. 3, .....              |      |        |        |        |        | 264    |
| Palmer vein, .....                | 52   | 183    |        |        |        | 154    |
| Peach Orchard, .....              |      |        |        |        | 200    |        |
| Pine Dale, .....                  |      |        |        |        |        |        |
| Peach Mountain, .....             |      |        |        |        | 194.4  | 161.10 |
| Pinebrook shaft, .....            | 303  | 182.60 | 205.30 | 184.50 |        | 174.8  |
| Peckville tunnel, .....           |      | 172    | 179    | 231    | 229    | 164.60 |
| Providence shaft, .....           |      |        |        |        |        | 198.7  |
| Providence shaft, .....           |      |        |        |        |        | 266.50 |
| Pine Ridge shaft, .....           |      |        |        |        |        | 201.75 |
| Palmer washery, .....             |      |        |        |        |        | 206    |
| Pine Dale washery, .....          |      |        |        |        |        | 170    |
| Pine Hill, .....                  |      |        |        |        |        |        |
| Rausch Gap, .....                 | 531  | 27.85  | 179.37 | 225.45 | 192.85 | 164.65 |
| Reliance, .....                   | 187  |        | 50     | 165    | 210    | 190.85 |
| Richmond, .....                   | 151  |        |        |        |        | 222.20 |
| Richmonds, .....                  | 265  | 254.50 | 186.50 | 212    | 232    | 216.50 |
| Racket brook, .....               |      |        |        |        |        | 189.10 |
| Ravine, .....                     |      |        |        |        | 150    | 218    |
| Red Ash, .....                    |      |        |        |        | 151    | 225.30 |
| Riverside shaft, .....            |      |        |        | 6.90   |        | 158.2  |
| Ranville, .....                   |      |        |        |        |        |        |
| Red Ash No. 1, .....              |      | 178.15 | 171.50 | 188.80 | 186    | 192.80 |
| Red Ash No. 2, .....              |      | 175    | 169.90 | 200.75 | 178.35 | 184.20 |
| Reynolds, .....                   | 214  | 177    | 220.05 | 194.75 | 180    | 183.85 |
| Royal Oak, .....                  |      |        |        |        |        | 116.75 |
| Rephlet, .....                    |      |        |        |        |        |        |
| Rush Brook shaft, .....           |      | 212    | 139    | 191.40 | 200    | 141    |
| Reserve, .....                    |      |        | 240    | 215    |        | 55     |
| Richmond No. 4, .....             |      |        |        |        |        | 252.3  |
| Richards, .....                   |      |        |        |        |        | 234    |
| Roberts, .....                    |      |        |        |        |        | 78.25  |
| Ralfe, .....                      |      |        |        |        |        | 199.5  |
| Reynolds washery, .....           |      |        |        |        |        | 175    |
| Short Mountain, .....             | 992  | 272.25 |        |        | 306.50 | 67     |
| Lykens Valley Coal Company, ..... |      |        |        |        |        | 264    |

## Days in operation of Anthracite Collieries—Continued.

| Name of Colliery.   | Name of Operator.                         | 1888. | 1889.  | 1890.  | 1891.  | 1892.  | 1893.  | 1894.  |
|---|---|-------|--------|--------|--------|--------|--------|--------|
| Spring Mountain for 1885 and following years: Nos. 1 and 2 for 1886, 1887, 1888 and 1889; Nos. 1 and 4. | J. C. Hayden & Co.,                       | 385   | 463    | 467    | 439    | 207.1  | 218.50 | 189    |
| Susquehanna No. 1,  | Susquehanna Coal Company,                 |       |        | 214    | 214.05 |        | 232.95 | 212.15 |
| Susquehanna No. 2,  | do.                                       |       |        | 118.90 | 108.15 |        | 243.55 |        |
| Susquehanna No. 3,  | do.                                       |       |        | 211    | 149.75 | 222    | 108.35 |        |
| Susquehanna Nos. 1 and 4 tunnel,  | do.                                       |       |        | 214.05 | 264.65 | 222    |        |        |
| Susquehanna No. 1 George vein,  | do.                                       |       |        | 214.05 | 264.65 | 222    |        |        |
| Susquehanna No. 1 Forge vein,   | do.                                       |       |        | 214.05 | 264.65 | 222    |        |        |
| Susquehanna No. 1 Lee vein,   | do.                                       |       |        | 222.55 | 270.80 | 254    |        |        |
| Susquehanna No. 2 shaft,  | do.                                       |       |        | 222.55 | 270.80 | 254    |        |        |
| Susquehanna No. 4 slope,  | do.                                       |       |        | 205.70 | 219.95 | 216    | 219.05 |        |
| Susquehanna No. 6 shaft,  | do.                                       |       |        | 205.70 | 219.95 | 216    |        |        |
| Susquehanna No. 6 slope,  | do.                                       |       |        | 205.70 | 219.95 | 216    |        |        |
| Susquehanna No. 6 tunnel,   | do.                                       |       |        | 205.70 | 219.95 | 216    |        |        |
| Salern,   | Salem Coal Company,                       |       |        | 198.50 | 192.20 | 188.10 |        | 115.70 |
| Sugar Notch No. 9,  | Charles Parrish & Co.,                    |       |        |        |        |        |        |        |
| Sugar Notch No. 10,   | do.                                       |       |        |        |        |        |        |        |
| Stuartville,  | do.                                       |       |        |        |        |        |        |        |
| Stirling,   | Wm. Montelius,                            |       |        |        |        |        |        |        |
| Staffordshire,  | Kendrick & Co.,                           |       |        |        |        |        | 194.55 | 172.5  |
| Shenandoah City,  | Jones, Ward & Oliver,                     | 251   | 24.45  | 209.80 | 191.15 |        | 182.45 |        |
| Schuykill,  | Philadelphia & Reading Coal and Iron Co., | 213½  | 217.75 | 219.95 | 231.80 | 207.6  | 194.40 |        |
| Spring Brook,   | do.                                       |       |        |        |        |        | 223.80 | 192.6  |
| Sibley shaft and slope,   | Wm. E. Colburne,                          | 212   | 178    | 180.85 | 211.60 |        |        |        |
| Sloan,  | Fillett, McClure & Co.,                   | 210   | 138.50 | 195.50 | 134.70 | 182.1  |        |        |
| Shaft No. 13 shaft and slope,   | Delaware, Lackawanna & Western R. R. Co., | 212   | 173    | 206.25 | 199.75 |        |        |        |
| Shaft No. 2, Dunmore,   | Pennsylvania Coal Company,                | 181   |        |        |        |        |        |        |
| Shafts Nos. 3 and 4, Dunmore,   | do.                                       |       |        |        |        |        |        |        |
| Shaft No. 5, Dunmore,   | do.                                       |       |        |        |        |        |        |        |
| Screens, Dunmore,   | do.                                       |       |        |        |        |        |        |        |
| Spencers, Dunmore,  | do.                                       | 208   | 160.90 | 181.50 | 182.75 | 169½   | 210.25 | 158.5  |
| Schooley,   | do.                                       | 197   | 187    |        |        | 180    | 58     | 106.7  |
| Shafts Nos. 1 and 2,  | A. D. & F. M. Spencer,                    |       |        |        |        |        |        |        |
| Shafts Nos. 1 and 8,  | Butler Coal Company,                      |       |        |        |        |        | 164.90 | 157.36 |
| Shaft No. 7,  | Pennsylvania Coal Company,                |       |        |        |        |        |        |        |
| Shafts Nos. 5, 6 and 11,  | do.                                       |       |        | 83.50  | 216.25 |        |        |        |
| Shafts Nos. 9 and 10,   | do.                                       |       |        | 215.25 | 200.75 |        |        |        |
| Shaft No. 4,  | do.                                       | 171   |        | 208.50 | 196.25 |        |        |        |
| Shaft slope and tunnel No. 14,  | do.                                       | 249   |        | 215.25 | 200.75 |        |        |        |
| Slope No. 2,  | do.                                       |       |        |        | 198    |        |        |        |
| Slope No. 4,  | do.                                       |       |        |        | 200.75 |        |        |        |
| Stanton,  | Lackawanna & Western Bituminous Coal Co., | 195½  | 159.65 | 90.60  |        | 160.39 | 175.70 |        |





## Days in operation of Anthracite Collieries—Continued.

| Name of Colliery.                      | Name of Operator.                         | 1888. | 1889.  | 1890.  | 1891.  | 1892.  | 1893.  | 1894.  |
|--|---|-------|--------|--------|--------|--------|--------|--------|
| Screen building                        | Lehigh Coal and Navigation Company.       |       |        |        |        |        |        | 304.5  |
| Spring Mountain No. 4.                 | Lehigh Valley Coal Company.               |       |        |        |        |        |        | 290.30 |
| Sebastopol.                            | Joseph H. Demming.                        |       |        |        |        |        |        | 277    |
| Tremont.                               | Peter Laux.                               |       |        |        |        | 219.50 |        | 182.2  |
| Tunnel Ridge.                          | Joseph B. Cole.                           | 218   | 189.90 | 166.35 | 216.25 |        |        |        |
| Tunnel.                                | do.                                       | 250   | 222.70 | 245.45 | 241.90 | 186.85 | 211.65 | 180.5  |
| Turkey Run.                            | Philadelphia & Reading Coal and Iron Co., | 193   | 193.70 | 190.00 | 184.80 | 212    | 115.25 | 150.15 |
| Thomaston.                             | do.                                       | 231   | 163.70 | 196.50 | 181.80 | 182.1  | 189.30 | 160    |
| Taylor.                                | Delaware, Lackawanna & Western R. R. Co., |       |        |        |        |        |        |        |
| Tunnel No. 1.                          | Pennsylvania Coal Company.                | 67    |        |        | 221    | 191    | 189.10 | 186.90 |
| Twin.                                  | Butler Coal Company.                      | 200   | 278    | 227    | 303    | 222    | 211    | 27     |
| Tomhicken.                             | Coxe Bros. & Co.                          |       |        |        |        |        |        |        |
| Treskow.                               | Philadelphia & Reading Coal and Iron Co., | 67½   | 190.10 | 255    | 264    |        | 216.55 | 230    |
| Tunnel Ridge.                          | Tripp Coal Co.                            |       |        | 255    |        |        | 270    | 31.5   |
| Tripp & Co.                            | Beard & Farber.                           |       |        |        |        | 265.4  | 274.60 | 230.2  |
| Tamaqua.                               | Upper Lehigh Coal Company.                | 215   | 253    | 264.10 | 246.80 |        |        |        |
| Upper Lehigh Nos. 1, 2, 5, 6, 7 and 8. | do.                                       | 206   | 227    | 246.20 | 219.70 |        |        |        |
| Upper Lehigh No. 4.                    | do.                                       | 250½  | 227    | 233    | 224.75 | 229½   | 217.50 | 176.4  |
| Von Storch shaft and slope.            | Delaware and Hudson Canal Company.        | 240   |        |        |        |        | 39.25  | 164.3  |
| Vulcan.                                | Vm. L. Williams.                          |       |        |        |        |        |        | 240    |
| Venus washery.                         | Davis Bros.                               |       |        | 224.50 | 210.50 |        |        |        |
| Wilson Creek tunnel mines.             | Delaware and Hudson Canal Company.        |       |        |        |        |        | 212.75 | 257    |
| West Hazel Dell.                       | Vm. Pfeiffer.                             |       |        | 282.40 | 303.75 | 205.25 | 166.90 | 119    |
| Williamstown.                          | Summit Branch R. R. Company.              | 303   | 290.40 | 196.30 | 190.90 |        | 254    | 256½   |
| Waunamie No. 18.                       | Chas. Parrish & Co.                       |       |        |        | 58     |        |        |        |
| William Penn.                          | E. N. G. Brooke.                          |       |        |        |        |        |        |        |
| West Side Coal Company.                | Philadelphia & Reading Coal and Iron Co., | 248   | 227.15 | 248.85 | 245.35 | 212.45 | 157.40 | 158.9  |
| West Shenandoah.                       | do.                                       |       |        |        |        |        |        |        |
| Wadeville shaft.                       | do.                                       |       |        |        |        |        |        |        |
| West Brookside.                        | do.                                       |       | 382    |        |        |        |        | 230    |
| Wilcox.                                | Richard Cartwright.                       |       |        | 215.25 | 200    | 220    | 209¾   | 184.75 |
| White Oak slope and drift.             | Delaware and Hudson Canal Company.        | 253½  | 220.50 | 116.30 | 169.85 | 165.25 |        | 160.45 |
| Wyoming.                               | Lehigh Valley Coal Company.               | 192   | 112.50 | 146.27 | 187.00 | 196.90 | 164.45 | 186.40 |
| Warrior Run.                           | do.                                       | 207   | 106.20 | 221.90 | 227.30 | 278.10 | 170.50 | 243.80 |
| West End.                              | do.                                       | 280   | 271.15 | 221.90 | 227.30 | 278.10 | 170.50 | 243.80 |
| Wanamie.                               | Lackawanna & Western Bituminous Coal Co., | 215   | 170.30 | 196.30 | 190.90 | 188.65 |        |        |
| William Penn.                          | Vm. Penn Coal Company.                    | 262   | 227    | 242    | 222    | 222    |        |        |
| West Lehigh.                           | Dunkleberger & Co.                        | 228   | 258    | 147    | 121    | 222    | 250    | 235    |
| Winton.                                | S. V. Winton.                             |       |        |        |        | 155.8  |        |        |
| Wolf Creek Diamond.                    | do.                                       |       |        |        |        |        |        |        |
| Watkin's slope and tunnel.             | Watkin's Tunnel Company.                  | 43    |        |        |        |        |        |        |
| Woodward.                              | Delaware, Lackawanna & Western R. R. Co., | 97½   | 135.90 | 185.60 | 184.70 | 185.50 | 193.50 | 167    |
| W. M. Weeks.                           | do.                                       |       |        |        | 210    |        |        |        |



*Days in operation of Bituminous Collieries.*

| Name of Colliery.        | Name of Operator.                               | 1888. | 1889.  | 1890. | 1891. | 1892. | 1894. |
|--------------------------|---|-------|--------|-------|-------|-------|-------|
| American.                | F. H. Cousin.                                   | 149   |        | 222   |       |       |       |
| Alleghippa.              | Balley, Wilson & Co.,                           |       |        | 211½  | 163½  |       | 142½  |
| Amity.                   | J. C. Fisher & Co.,                             |       | 122    | 213   | 230   | 149   | 185   |
| Allison's.               | John Allison,                                   | 290   | 125    | 250   | 201   | 149   | 185   |
| Allegheny.               | Allegheny Coal Company,                         | 217½  | 205    | 225   | 248½  | 165½  |       |
| Antrom Nos. 1, 2, and 3. | Fall Brook Coal Company,                        | 212   | 235    | 197   | 218   | 173   | 194   |
| Arnold Nos. 1, 2, and 3. | Blossburg Coal Company,                         | 226   | 191    | 183½  | 260½  | 248¼  |       |
| Archer.                  | Lang & Davidson,                                |       | 175    | 170   | 240   | 206   | 80    |
| Arxley.                  | Hunt & Gaultier,                                | 314   | 313    | 315   | 313   | 313   | 223   |
| Alleghippa.              | Balley, Wilson & Co.,                           | 132½  |        |       |       |       |       |
| Amity.                   | J. C. Fisher & Co.,                             | 187   |        |       |       |       |       |
| Atlantic.                | Berwind, White & Co.,                           | 323   | 421    | 230   | 255   | 244   | 146   |
| Atlanta.                 | Welsh & Epley.                                  |       | 173    | 281   |       |       | 171   |
| Alice.                   | J. M. Schoonmaker,                              | 222   | 286    |       |       |       |       |
| Alexandria.              | Alexandria Coal Company,                        | 201½  | 314    | 294   | 256   | 236   | 185   |
| Amesville.               | J. M. Bigley,                                   | 201   | 200    | 240   | 106   | 144   | 81    |
| Arnold.                  | Arnold Co-operating Coal Company.               | 300   | 216    |       |       |       |       |
| American.                | Thomas Hackert & Co.,                           |       |        | 185   |       |       |       |
| Ameo.                    | Washington Coal Company,                        | 229   | 192    | 290   | 100   | 150   | 112   |
| Alto Hays.               | Stockdale Coal Company,                         | 135   | 155    | 176   | 171   | 80    | 66    |
| Albany.                  | W. S. B. Hays,                                  | 208   | 196    | 247   | 244   | 244   | 69    |
| Archa.                   | Showden & Hoeg,                                 |       |        |       | 42    | 119   | 162   |
| Acher.                   | Acher Mining Company,                           | 105   |        |       |       | 218   | 107   |
| Anchor.                  | Penn Manufacturing and Supply Company,          | 109   | 165    |       | 211   | 130   | 150½  |
| Ailes.                   | Atlas Coke Company, Limited,                    | 250   | 265    | 231   | 200   | 180   | 150   |
| Anchor.                  | Hirst & Luke,                                   |       |        |       | 161   |       |       |
| Anchor.                  | Clearfield Consolidated Coal Company,           | 29    |        |       | 247½  |       | 217   |
| Ashted.                  | Lake Erie Gas Coal and Coke Company.            | 153   | 220    | 201   | 202   | 250   |       |
| Ashted.                  | Berwind, White & Co.,                           | 198   |        |       |       |       |       |
| Atlanta No. 1.           | Atlanta Coal Company,                           |       |        |       |       |       |       |
| Atlanta No. 2.           | do.   |       |        |       |       |       |       |
| Allison.                 | Jonathan Allison,                               | 221   | 156    | 251   | 160   | 200   | 111   |
| Anderson.                | D. M. Anderson,                                 | 251½  | 168.50 | 191   | 226   | 276   | 184   |
| Agne.                    | Acme Mining Company,                            |       |        |       |       |       |       |
| Adrian Mines 1 and 2.    | Rochester and Pittsburgh Iron and Coal Company, | 235   | 233    | 241   | 248   | 282   | 246   |
| Ashman.                  | Medora Coal Company,                            | 67    | 170    | 187   |       |       |       |
| Alexander.               | Alder Run Coal and Coke Company,                | 123   | 150    | 220½  | 146   | 285   | 270   |
| Aldor Run.               | Avondale M. F. and Gas Company,                 | 26    |        |       |       |       | 59    |
| Avondale.                | Ablon Coal Company,                             | 214   | 256.50 | 245   | 239   | 150   | 156   |
| Ablon.                   | Ablon Coal Company,                             | 45    | 241    | 200   |       |       | 219   |
| Atlas.                   | Cambridge Iron Company,                         | 36    |        | 225   |       |       |       |

|  |      |     |     |     |     |      |      |
|--|------|-----|-----|-----|-----|------|------|
| Amshry, .....  | 94   | 233 | 252 | 242 | 340 | 205  | 170  |
| Avonmore, .....  |      | 115 | 254 | 200 | 220 | 142  | 103  |
| Allen, .....   |      |     | 91  | 38  | 215 | 65   | 170  |
| Apollo, .....  |      | 205 | 279 | 198 | 271 | 263  | 230  |
| Adelaide, .....  |      | 250 |     |     |     |      |      |
| Allison, .....   |      | 209 | 221 | 184 | 118 | 250  | 137  |
| Acme, .....  |      |     |     |     |     | 276  |      |
| Apollo No. 2, .....                                      |      |     |     |     |     | 247½ |      |
| Arnot Nos. 3, 4 and 5, .....                             |      |     |     |     |     | 80   |      |
| Alpha, .....   |      |     |     |     |     | 160  | 82   |
| Ashcroft, .....  |      |     |     |     |     |      | 42   |
| Anchor, .....  |      |     |     |     |     |      | 157½ |
| Arnot Nos. 3, 4 and 5, .....                             |      |     |     |     |     |      | 147  |
| Antrim Nos. 1 and 5, .....                               |      |     |     |     |     |      |      |
| Adrian Nos. 1 and 2, .....                               |      |     |     |     |     |      |      |
| Anchor, .....  |      |     |     |     |     |      | 201  |
| A. J. Haws, .....  |      |     |     |     |     |      | 21   |
| Allison, .....   |      |     |     |     |     |      | 301  |
| Acme, .....  |      |     |     |     |     |      | 129  |
| Atlantic No. 2, .....                                    |      |     |     |     |     |      | 193  |
| Buffalo, .....   |      |     |     |     |     |      | 159  |
| Teale, .....   |      | 88  |     |     | 150 |      |      |
| Banner Nos. 1 and 2, .....                               |      |     |     |     | 100 |      |      |
| Big Chief, .....   |      |     |     | 200 | 219 | 223  | 80   |
| Bellevue, .....  |      | 130 | 75  |     |     |      | 206  |
| Bear Rock, .....   |      |     |     |     |     | 200  |      |
| Blackburn, .....   |      |     |     |     | 75  | 200  | 160  |
| Bellwood, .....  |      |     |     |     |     |      |      |
| Buck's Run, .....  |      |     |     | 137 | 29  | 62   |      |
| Buena Vista, .....                                       |      |     |     | 86  | 32  |      |      |
| Blythe, .....  |      |     |     |     |     |      |      |
| Bowden, .....  |      |     | 144 | 166 | 156 | 180  |      |
| Big Soldier Run, .....                                   |      |     |     |     |     |      |      |
| Lower Hill, .....  |      |     | 288 | 253 | 273 | 246  | 165  |
| Beagle, .....  |      |     | 182 | 200 | 500 | 198  | 87   |
| Beeh, Cliff, .....                                       |      |     |     |     |     |      |      |
| Berham, .....  |      |     |     |     | 205 | 170  |      |
| Barnes, .....  | 181  | 225 | 257 | 175 | 53½ |      |      |
| Black Diamond, .....                                     | 152  | 180 | 196 | 164 | 160 | 142  | 83   |
| Bugdad, .....  | 267  | 241 | 280 | 279 | 289 | 277  | 245  |
| Baltimore and Ohio, .....                                |      |     | 365 | 365 | 365 | 364  | 365  |
| Beaver, .....  | 150½ | 230 | 256 | 267 | 264 |      |      |
| Barley Nos. 1, 2, 3 and 4, .....                         | 250  | 228 | 211 |     |     | 231  |      |
| Beechtree Nos. 1 and 2, .....                            | 200  | 223 | 287 | 247 | 232 | 222  |      |
| Blaine's Run, .....                                      |      |     |     |     |     |      |      |
| Leon's Creek, .....                                      | 330  | 224 | 240 | 240 | 200 |      |      |
| Bedford, .....   |      |     | 95  |     |     |      |      |
| Bedford Coal and Iron Company, .....                     | 204  | 200 | 302 | 302 | 270 |      | 165  |
| Bedford Iron and Coal Company, .....                     |      |     | 290 | 295 | 290 | 250  | 160  |
| Bonwell, .....   |      |     |     |     |     |      |      |
| Reed Brothers, .....                                     |      |     |     |     |     |      |      |
| Cambria Coal and Coke Company, .....                     |      |     |     |     |     |      |      |
| Allen Coal Company, .....                                |      |     |     |     |     |      |      |
| Maher Coal and Coke Company, .....                       |      |     |     |     |     |      |      |
| H. C. Friel Coke Company, .....                          |      |     |     |     |     |      |      |
| John Allison, .....                                      |      |     |     |     |     |      |      |
| Acme Coal Company, .....                                 |      |     |     |     |     |      |      |
| Maher Coal and Coke Company, .....                       |      |     |     |     |     |      |      |
| Bloss Coal Company, .....                                |      |     |     |     |     |      |      |
| Knight & Co., .....                                      |      |     |     |     |     |      |      |
| A. & J. Leonard, .....                                   |      |     |     |     |     |      |      |
| Bloss Coal Company, .....                                |      |     |     |     |     |      |      |
| Fall Brook Coal Company, .....                           |      |     |     |     |     |      |      |
| Rochester and Pittsburgh Coal and Iron Company, .....    |      |     |     |     |     |      |      |
| Cambria Coal Mining Company, .....                       |      |     |     |     |     |      |      |
| A. J. Haws & Son, .....                                  |      |     |     |     |     |      |      |
| Cook & Sons, .....                                       |      |     |     |     |     |      |      |
| O. P. Jones, .....                                       |      |     |     |     |     |      |      |
| Berwind-White Company, .....                             |      |     |     |     |     |      |      |
| J. J. Statter, .....                                     |      |     |     |     |     |      |      |
| John M. Fisher, .....                                    |      |     |     |     |     |      |      |
| J. Blythe & Co., .....                                   |      |     |     |     |     |      |      |
| Redeue Coal Company, .....                               |      |     |     |     |     |      |      |
| Bear Rock Coal Company, .....                            |      |     |     |     |     |      |      |
| Foster Clark & Co., .....                                |      |     |     |     |     |      |      |
| Mumhall Brothers, .....                                  |      |     |     |     |     |      |      |
| H. B. Hays & Bro., .....                                 |      |     |     |     |     |      |      |
| South West Coal Company, .....                           |      |     |     |     |     |      |      |
| Blythe & Co., .....                                      |      |     |     |     |     |      |      |
| Charlton Valley Coal and Coke Com-<br>pany, .....        |      |     |     |     |     |      |      |
| Red Lewis & Yates, .....                                 |      |     |     |     |     |      |      |
| A. J. Schultz, .....                                     |      |     |     |     |     |      |      |
| Reedle Brothers, .....                                   |      |     |     |     |     |      |      |
| Imperial Coal Company, .....                             |      |     |     |     |     |      |      |
| Scott & Co., .....                                       |      |     |     |     |     |      |      |
| Maroon Mining and Manufacturing Co., .....               |      |     |     |     |     |      |      |
| Ellet, Sudler & Co., .....                               |      |     |     |     |     |      |      |
| Bagdad Coal Company, .....                               |      |     |     |     |     |      |      |
| V. F. Stillwagon, .....                                  |      |     |     |     |     |      |      |
| McC & Patterson, .....                                   |      |     |     |     |     |      |      |
| Towanda Coal Company, .....                              |      |     |     |     |     |      |      |
| Rochester and Pittsburgh Iron and Coal<br>Company, ..... |      |     |     |     |     |      |      |
| J. M. Elliott, .....                                     |      |     |     |     |     |      |      |
| L. H. Smith & Co., .....                                 |      |     |     |     |     |      |      |
| Bedford Coal and Iron Company, .....                     |      |     |     |     |     |      |      |
| Bedford Iron and Coal Company, .....                     |      |     |     |     |     |      |      |
| Reed Brothers, .....                                     |      |     |     |     |     |      |      |

## Days in operation of Bituminous Collieries—Continued.

| Name of Colliery.              | Name of Operator.                                 | 1888. | 1889. | 1891. | 1892. | 1893. | 1894. |
|--------------------------------|---|-------|-------|-------|-------|-------|-------|
| Brown, .....                   | William Sweet & Brown, .....                      | 187   |       |       |       |       |       |
| Belle-Vernon, .....            | H. K. Myers, .....                                |       | 26    | 240   | 150   |       |       |
| Bellevue, .....                | Bellevue Coal Company, .....                      |       |       | 102   |       |       |       |
| Blackburn, .....               | Foster, Clarke & Co., .....                       |       |       |       |       |       | 160   |
| Bellwood, .....                | Munhall Brothers, .....                           | 110   | 105   |       |       |       |       |
| Bock's Run, .....              | H. B. Hays & Bro., .....                          | 145   | 84    |       |       |       |       |
| Reading, .....                 | Reading Brothers, .....                           | 222   | 210   | 198   | 243   | 227   | 200   |
| Buena Vista, .....             | South West Coal Company, .....                    | 175   |       |       |       |       |       |
| Blythe No. 1, .....            | Blythe Coal Company, .....                        |       | 40    |       |       |       | 149   |
| Bridgeville, .....             | A. J. Shuttle, .....                              | 145   | 188   | 174   | 230   | 177   |       |
| Black Diamond, .....           | W. J. Jackson, .....                              | 80    | 196   |       | 200   | 160   | 69    |
| Fuckey, .....                  | J. C. Cochran estate, .....                       | 237   | 290   | 212   | 283   | 335   | 562   |
| Bessemer, .....                | McClure & Co., .....                              |       | 175   |       | 139   |       | 264   |
| Black Diamond, .....           | W. H. Brown & Sons, .....                         | 178   | 112   | 170   | 105   | 205   | 170   |
| Fanner, .....                  | J. M. Risher, .....                               | 175   | 170   | 158   | 152   | 170   |       |
| Beale, .....                   | Patterson & Sautters, .....                       |       | 261   | 40    | 265   | 175   | 185   |
| Rowman, .....                  | Eli Leonard, .....                                | 200   |       | 200   |       |       |       |
| Beaumont, .....                | Beaver Coal and Coke Company, .....               |       |       |       | 225   | 180   | 200   |
| Beaver, .....                  | James Clayton, .....                              |       | 240   | 246   | 110   | 221   | 181   |
| Beaver Falls, .....            | Scott & Co., .....                                | 160   | 165   | 193   | 268   | 200   | 194   |
| Baker, .....                   | Breckinridge Coal Company, .....                  |       |       | 280   | 220   |       | 70    |
| Breckenridge, .....            | Curtis' estate, .....                             |       |       |       | 301   | 205   | 290   |
| Bethel, .....                  | B. D. Morgan & Co., .....                         | 200   | 200   | 240   | 300   | 280   | 251   |
| Berlin, .....                  | Jacob Graff, .....                                |       |       | 142   | 240   |       | 200   |
| Bloomington No. 4, .....       | Benton Coal Company, .....                        | 300   |       |       | 195   |       |       |
| Blairsville, .....             | do, .....   |       |       |       |       |       | 304   |
| Benton No. 2, .....            | R. A. Jackson, .....                              |       |       |       | 504   |       | 200   |
| Benton No. 1, .....            | Bell Bridge Coal Company, .....                   |       |       |       | 210   |       | 210   |
| Black Diamond, .....           | Beech Grove Coal Company, .....                   |       |       |       | 138   |       | 141   |
| Bell Ridge, .....              | Bower Hill Imperial Coal Company, .....           | 200   |       | 200   |       | 90    |       |
| Beech Grove, .....             | Gumbert & Huey, .....                             | 110   | 130   |       |       |       |       |
| Bower Hill, .....              | Baltic Coal Company, .....                        | 178   |       |       | 204   | 177   | \$3   |
| Bellevue, .....                | Thomas Taylor, .....                              | 254   | 251½  | 236¼  | 200   | 180   |       |
| Battle, .....                  | S. M. Shipman & Co., .....                        | 200   |       | 247   | 200   | 263   | 215   |
| Black Diamond, .....           | Stoner & Co., .....                               | 225   | 90    |       | 160   | 164   |       |
| Brier Ridge, .....             | Youghloughy Coal Company, .....                   |       |       | 33    | 258   | 68    |       |
| Boone, .....                   | McClure & Co., .....                              | 259   | 210   |       |       |       |       |
| Buffalo, .....                 | Youghloughy and Ashabula Coal Com-<br>pany, ..... |       |       |       |       |       |       |
| Bessemer and Rising Sun, ..... | Buffalo Creek Coal Company, .....                 | 188   | 202   | 158   |       |       | 48    |
| Blythe, .....                  |   |       |       |       |       |       |       |



## Days in operation of Bituminous Collieries—Continued.

| Name of Colliery.        | Name of Operator.                     | 1888. | 1889. | 1890. | 1891. | 1892. | 1893. | 1894. |
|--------------------------|---------------------------------------|-------|-------|-------|-------|-------|-------|-------|
| Continental No. 2,       | Sonnan Coal Company,                  |       | 179   |       |       |       |       | 73    |
| Chess,                   | Graham & Bell,                        |       |       |       |       |       |       |       |
| Coal Ridge,              | Gray & Bell,                          |       |       |       |       |       |       |       |
| Cornell & Werling,       | W. H. Brown's Sons,                   |       | 263   |       | 274   | 247   | 187   | 187   |
| Cherry,                  | Morris McCue,                         |       | 175   |       |       | 200   | 243   |       |
| Camp Hill,               | David M. Steene,                      |       | 157   |       |       |       |       |       |
| Cooks,                   | J. V. H. Cooke,                       |       |       |       |       |       |       |       |
| Clark,                   | Clark, Lewis & Co.,                   | 142   | 218   | 232   | 230   | 239   | 248   | 124   |
| Clinton,                 | Clinton Coal Company,                 | 200   | 242   | 248   | 253   | 210   | 200   | 98    |
| Carver,                  | Carver Coal Company,                  | 230   | 246   | 240   | 255   | 198   | 203   | 169   |
| Chestnut Ridge,          | Filler, Westerman & Co.,              |       |       |       |       |       | 250   |       |
| Clayton,                 | W. F. Clayton,                        |       |       |       |       |       |       |       |
| Chisholm,                | Mercer Mining and Manufacturing Co.,  | 178   | 99    |       | 240   | 250   |       | 195   |
| Church Hill,             | Church Hill Coal Company,             |       | 95    |       |       | 263   | 171   | 134   |
| Crescent,                | Lambirth Mining Company,              |       | 208   |       |       |       |       |       |
| Cameron,                 | Cameron Coal Company,                 |       |       |       |       |       |       |       |
| Clermont,                | Buffalo Coal Company,                 |       |       |       |       |       |       |       |
| Coal Glen,               | Jefferson Coal Company,               | 200   | 181   | 256   | 246   | 243   | 153   | 169   |
| Coal Brook,              | J. R. Torrance & Co.,                 | 250   | 280   | 284   | 261   | 90    |       |       |
| Cora,                    | J. M. Newmyer & Son,                  | 213   | 278   | 281   | 261   | 98    |       |       |
| Charissa,                | James Cochran & Son,                  |       | 280   | 250   | 255   | 261   | 207   | 200   |
| Connellsville,           | P. & C. Gas Coal Company,             | 281   | 274   |       |       |       |       |       |
| Casselman,               | Casselman Coal Company,               | 300   | 298   |       | 290   | 290   | 270   | 130   |
| Cochran,                 | James Cochran,                        |       |       |       |       |       |       |       |
| C. & E. L. Coal Company, | C. & E. L. Coal Company,              | 212   | 256   | 233   | 243   | 250   |       |       |
| Carbon,                  | E. P. Jenkins,                        | 300   | 200   | 283   | 181   | 115   | 167   |       |
| Cushon,                  | do,                                   | 75    |       | 283   | 282   | 311   | 170   | 254   |
| Comemaugh,               | do,                                   | 198   |       | 277   | 281   | 240   | 313   | 243   |
| Cambria,                 | Langdon & Co.,                        |       |       | 205   |       |       | 125   |       |
| Cambden,                 | Geo. Lysle & Sons,                    |       |       |       |       |       |       |       |
| Coal Run,                | Coal Run Coal Company,                |       |       | 200   |       |       |       |       |
| Castle Shannon,          | Castle Shannon Coal Company,          |       |       |       |       |       |       |       |
| Conard,                  | T. E. Thropp,                         | 275   | 250   |       | 103   | 176   | 107   | 84    |
| Chess,                   | Gray & Bell,                          |       |       |       |       |       |       |       |
| Clark,                   | Clark, Lynt & Co.,                    |       |       |       |       |       |       |       |
| Cato,                    | Cato Mining Company,                  |       |       |       |       |       |       |       |
| Cherry,                  | Morris McCue,                         | 160   | 214   |       |       | 190   | 120   | 52    |
| Camp Hill,               | David Steen,                          | 208   | 275   |       |       |       |       |       |
| Champion,                | Dennithorne & Rowland,                |       |       |       |       | 105   | 130   |       |
| Cornell & Werling,       | W. H. Brown & Sons,                   |       |       |       |       |       |       |       |
| Creedmoor shaft,         | Ohio and Pennsylvania Coal Company,   |       |       |       |       | 75    | 204   | 135   |
| Cambria,                 | Clearfield Consolidated Coal Company, |       |       |       |       |       |       |       |
| Coal Ridge,              | Gray & Bell,                          |       | 217   |       |       | 186   |       |       |



|                                    |       |       |       |       |       |       |
|------------------------------------|-------|-------|-------|-------|-------|-------|
| Columbia Nos. 1 and 2              | 507   | 374   | 217   | 275   | 266   | 292   |
| Colorado                           | 207   | 173   | 285   | 275   | 266   | 188   |
| Coaldale No. 3                     | 287   | 225   | 296   | 231   | 207   | 145   |
| Coaldale No. 4                     | 58    | 58    | 216   | 175   | 150   | 127   |
| Coaldale No. 5                     | 286   | 224   | 275   | 230   | 190   | 152   |
| Catawact                           | 220   | 225   | 275   | 189   | 130   | 134   |
| Central                            | 248   | 225   | 252   | 149   | 120   | 186   |
| Columbia No. 1                     | ..... | ..... | 232   | 187   | 132   | 186   |
| Coal Centre                        | ..... | ..... | ..... | ..... | ..... | 200   |
| Crossland                          | ..... | ..... | ..... | ..... | ..... | 167   |
| Columbian                          | ..... | ..... | ..... | ..... | ..... | 159   |
| Continental No. 1                  | ..... | ..... | ..... | ..... | ..... | 71    |
| Colorado No. 2                     | ..... | ..... | ..... | ..... | ..... | 40    |
| Cambria Nos. 1, 2, and 3           | ..... | ..... | ..... | ..... | ..... | 133   |
| Prescent No. 2                     | ..... | ..... | ..... | ..... | ..... | 226   |
| Church Hill                        | ..... | ..... | ..... | ..... | ..... | 249   |
| Catsburg                           | ..... | ..... | ..... | ..... | ..... | 245   |
| Catfish Run                        | 228   | 38    | 174   | 278   | 200   | 248   |
| Caledonia                          | ..... | ..... | ..... | ..... | ..... | 180   |
| Coal Bluff                         | 165   | 150   | 265   | 60    | 275   | 115   |
| Cedar Hill                         | 166   | 157   | 229   | 205   | 170   | 200   |
| Columbia No. 2                     | ..... | ..... | ..... | ..... | ..... | 180   |
| Cranberry                          | 218   | ..... | 115   | ..... | ..... | 155   |
| Caledonia                          | ..... | ..... | ..... | ..... | ..... | ..... |
| Cascade                            | ..... | ..... | ..... | ..... | ..... | ..... |
| Clinton                            | ..... | ..... | ..... | ..... | ..... | ..... |
| Cumberland                         | ..... | ..... | ..... | ..... | ..... | ..... |
| Cumberland                         | ..... | ..... | ..... | ..... | ..... | ..... |
| Cooke                              | ..... | ..... | ..... | ..... | ..... | ..... |
| Chevington                         | ..... | ..... | ..... | ..... | ..... | ..... |
| Castle Shannon                     | ..... | ..... | ..... | ..... | ..... | ..... |
| Catawact                           | ..... | ..... | ..... | ..... | ..... | ..... |
| Central                            | ..... | ..... | ..... | ..... | ..... | ..... |
| Cuba                               | ..... | ..... | ..... | ..... | ..... | ..... |
| Cliff                              | ..... | ..... | ..... | ..... | ..... | ..... |
| Cedar Hill                         | ..... | ..... | ..... | ..... | ..... | ..... |
| Carondelet                         | ..... | ..... | ..... | ..... | ..... | ..... |
| Chippew                            | ..... | ..... | ..... | ..... | ..... | ..... |
| Champion                           | ..... | ..... | ..... | ..... | ..... | ..... |
| Co-operative                       | ..... | ..... | ..... | ..... | ..... | ..... |
| Columbia No. 3                     | ..... | ..... | ..... | ..... | ..... | ..... |
| Climax                             | ..... | ..... | ..... | ..... | ..... | ..... |
| Calumet                            | ..... | ..... | ..... | ..... | ..... | ..... |
| Carlton                            | ..... | ..... | ..... | ..... | ..... | ..... |
| Clinton                            | ..... | ..... | ..... | ..... | ..... | ..... |
| Claridge                           | ..... | ..... | ..... | ..... | ..... | ..... |
| Cuyahoga                           | ..... | ..... | ..... | ..... | ..... | ..... |
| Cymbria                            | ..... | ..... | ..... | ..... | ..... | ..... |
| Columbus No. 4                     | ..... | ..... | ..... | ..... | ..... | ..... |
| Centre                             | ..... | ..... | ..... | ..... | ..... | ..... |
| Catharine                          | ..... | ..... | ..... | ..... | ..... | ..... |
| J. L. Mitchell & Co.               | ..... | ..... | ..... | ..... | ..... | ..... |
| White & Jackson                    | ..... | ..... | ..... | ..... | ..... | ..... |
| Holt & Chipman                     | ..... | ..... | ..... | ..... | ..... | ..... |
| do                                 | ..... | ..... | ..... | ..... | ..... | ..... |
| Berwind-White & Co.                | ..... | ..... | ..... | ..... | ..... | ..... |
| L. C. Helms                        | ..... | ..... | ..... | ..... | ..... | ..... |
| do                                 | ..... | ..... | ..... | ..... | ..... | ..... |
| J. L. Mitchell                     | ..... | ..... | ..... | ..... | ..... | ..... |
| P. J. Forsythe & Co.               | ..... | ..... | ..... | ..... | ..... | ..... |
| Atlas Coke Company                 | ..... | ..... | ..... | ..... | ..... | ..... |
| Jos. H. Reilly & Co.               | ..... | ..... | ..... | ..... | ..... | ..... |
| John T. Morton                     | ..... | ..... | ..... | ..... | ..... | ..... |
| Jackman & Ellsworth                | ..... | ..... | ..... | ..... | ..... | ..... |
| United Collieries Company          | ..... | ..... | ..... | ..... | ..... | ..... |
| Lambirth Mining Company            | ..... | ..... | ..... | ..... | ..... | ..... |
| McCullum & Co.                     | ..... | ..... | ..... | ..... | ..... | ..... |
| Louis Staib                        | ..... | ..... | ..... | ..... | ..... | ..... |
| Catfish Run Coal Company           | ..... | ..... | ..... | ..... | ..... | ..... |
| T. J. Wood                         | ..... | ..... | ..... | ..... | ..... | ..... |
| M. and P. Coal Company             | ..... | ..... | ..... | ..... | ..... | ..... |
| L. W. Morgan                       | ..... | ..... | ..... | ..... | ..... | ..... |
| J. L. Mitchell                     | ..... | ..... | ..... | ..... | ..... | ..... |
| Sharon Coal Company, Limited       | ..... | ..... | ..... | ..... | ..... | ..... |
| Caledonia Coal Company             | ..... | ..... | ..... | ..... | ..... | ..... |
| Kaul & Hall                        | ..... | ..... | ..... | ..... | ..... | ..... |
| N. W. Mining and Exchange Company  | ..... | ..... | ..... | ..... | ..... | ..... |
| B. F. Kelster & Co.                | ..... | ..... | ..... | ..... | ..... | ..... |
| Cumberland Coal and Mining Company | ..... | ..... | ..... | ..... | ..... | ..... |
| H. and B. T. M. R. R. and Coal Co. | ..... | ..... | ..... | ..... | ..... | ..... |
| J. W. Cooke                        | ..... | ..... | ..... | ..... | ..... | ..... |
| do                                 | ..... | ..... | ..... | ..... | ..... | ..... |
| P. and C. S. R. R.                 | ..... | ..... | ..... | ..... | ..... | ..... |
| Berwind-White C. M. Company        | ..... | ..... | ..... | ..... | ..... | ..... |
| T. C. Helms                        | ..... | ..... | ..... | ..... | ..... | ..... |
| Edward Miller                      | ..... | ..... | ..... | ..... | ..... | ..... |
| J. M. Fisher                       | ..... | ..... | ..... | ..... | ..... | ..... |
| Bradford Leach & Co.               | ..... | ..... | ..... | ..... | ..... | ..... |
| E. C. Furlong & Son                | ..... | ..... | ..... | ..... | ..... | ..... |
| Albion Coal Company                | ..... | ..... | ..... | ..... | ..... | ..... |
| T. J. Wood                         | ..... | ..... | ..... | ..... | ..... | ..... |
| Co-operative Coal Company          | ..... | ..... | ..... | ..... | ..... | ..... |
| Mitchell & Lazar                   | ..... | ..... | ..... | ..... | ..... | ..... |
| Climax Coal Company                | ..... | ..... | ..... | ..... | ..... | ..... |
| Calumet Coke Company               | ..... | ..... | ..... | ..... | ..... | ..... |
| Carlton Coal Company               | ..... | ..... | ..... | ..... | ..... | ..... |
| H. C. Friel Coal Company           | ..... | ..... | ..... | ..... | ..... | ..... |
| Claridge Gas Coal Company          | ..... | ..... | ..... | ..... | ..... | ..... |
| H. C. Friel Coal Company           | ..... | ..... | ..... | ..... | ..... | ..... |
| Cymbria Coal Company               | ..... | ..... | ..... | ..... | ..... | ..... |
| Mitchell Coke and Coal Company     | ..... | ..... | ..... | ..... | ..... | ..... |
| Centre Coal and Coke Company       | ..... | ..... | ..... | ..... | ..... | ..... |
| Blair Bros.                        | ..... | ..... | ..... | ..... | ..... | ..... |







|                                  |     |     |         |     |         |
|----------------------------------|-----|-----|---------|-----|---------|
| Founroy.                         | 128 | 209 | 309     | 174 | 92      |
| Frick                            | 281 |     |         |     |         |
| Franklin and Clinton,            | 81  | 288 | 262     | 174 | 92      |
| Frog Hill,                       | 150 | 232 | 264     |     |         |
| Fairview,                        | 150 | 248 | 268     | 217 | 99      |
| Fayette,                         | 288 | 273 | 257     |     |         |
| Foster,                          | 200 | 262 | 256     | 87  | 113     |
| Fisher,                          |     |     | 194     | 206 |         |
| Fox,                             | 300 |     |         |     |         |
| Federal Spring,                  | 200 | 175 |         |     |         |
| Fort Pitt,                       | 150 | 150 |         |     |         |
| Franklin Nos. 1 and 2,           | 162 | 188 | 180     |     |         |
| Fairmount No. 4,                 | 47  |     | 230     | 174 |         |
| Furnace                          |     |     |         |     |         |
| Fort Hill,                       | 285 | 295 | 300     | 175 | 275     |
| Fairchance,                      | 307 | 280 | 294     | 273 | 263     |
| Fenn,                            | 250 |     | 300     |     | 200     |
| Franklin Nos. 1 and 2,           | 257 | 226 | 218     |     | 111     |
| Ferrisdale,                      | 174 | 212 | 131     | 106 | 218     |
| Fayette City,                    | 204 | 293 | 287     | 300 | 256     |
| Forest,                          |     | 29  |         | 300 |         |
| Fountain,                        | 165 | 281 | 240     | 122 | 118     |
| Federal,                         |     |     | 284     | 251 |         |
| Ferguson,                        |     |     | 285     |     |         |
| First Pool Mng. Gas-Coal Company |     |     | 284     |     |         |
| No. 1,                           |     | 185 | 202     | 270 | 200     |
| Fountain,                        | 100 |     | 45      |     |         |
| Fidelity,                        |     | 60  | 207 1/2 | 167 | 121 1/2 |
| Fulton,                          |     | 57  | 50      | 70  | 35      |
| Fulton,                          |     |     | 221     |     |         |
| Fawcett,                         |     | 130 |         |     | 118     |
| Foster,                          |     | 70  |         |     | 82      |
| Flanagan run,                    |     |     |         |     | 96      |
| Freeport,                        |     |     |         |     | 113     |
| Fairmont,                        |     |     |         |     | 142     |
| Forest Nos. 1 and 2,             |     |     |         | 6   |         |
| Fair Play,                       |     |     |         |     | 70      |
| Fairmount No. 5,                 |     |     |         |     | 170     |
| Fall Brook Nos. 2 and 6,         |     |     |         |     | 197     |
| Federal,                         |     |     |         |     | 197     |
| Ficks,                           |     |     |         |     | 76      |
| Grampan,                         |     |     |         |     |         |
| Grant,                           |     |     | 90      | 183 |         |
| Grant Springs,                   |     |     |         |     |         |
| Glendale,                        |     | 203 |         |     |         |
| Glass House,                     |     |     |         |     |         |
| Gamersall,                       | 228 | 260 | 245     | 300 | 70      |
| Glen,                            | 312 | 317 | 313     | 566 | 278     |
| Gaines Nos. 1 and 2,             |     | 128 |         |     |         |
| Gautier,                         |     |     |         | 284 | 120     |
| Gauley,                          |     |     |         |     |         |
| Griffiths,                       |     |     |         |     |         |
| Glennore,                        |     |     |         |     |         |
| Glennore Coal Co.,               |     | 62  |         |     | 50      |

## Days in operation of Bituminous Collieries—Continued.

| Name of Colliery          | Name of Operator.                    | 1888. | 1889.  | 1890. | 1891. | 1892. | 1893. | 1894. |
|---------------------------|--------------------------------------|-------|--------|-------|-------|-------|-------|-------|
| Gallitzin shaft.          | McCoy & Taylor,                      | 219   | 186    | 280   | 255   | 279   | 138   | 110   |
| Great Bend.               | Great Bend Coal Company,             | 391   | 462    | 201½  | 223   | 246   | 278   | 59    |
| Great Bend No. 3.         | do.                                  |       |        |       | 189   |       |       |       |
| Glen White.               | Glen White Coal Company,             | 310   | 279    | 300   | 275   | 300   | 225   |       |
| Great Bend No. 1.         | Great Bend Coal Company,             |       |        |       | 214   |       |       |       |
| Green Springs.            | Thos. Fawcett,                       |       |        |       | 275   |       |       |       |
| Ghem.                     | Ghem Coal Company,                   |       |        |       | 214   |       |       |       |
| Glendale.                 | Gregg Bros.,                         |       |        |       | 132   |       |       | 107   |
| Glass House.              | Glass-House Coal Company,            |       |        |       |       | 263   | 165   |       |
| Glenshaw.                 | Spencer & Co.,                       |       |        | 283   | 309   | 292   | 292   |       |
| Grant.                    | Grant Coal Company,                  | 125   | 141    | 180   | 218   | 182   | 204   | 117   |
| Glenshaw.                 | Wm. Morris & Co.,                    | 275   | 471    | 180   | 219   | 250   | 216   | 142   |
| Grass Flat No. 4.         | Clearfield Bituminous Coal Company,  |       |        |       | 276½  | 216   | 224   |       |
| Gazzam No. 1.             | do.                                  | 159   | 186    | 268   | 255   | 245   | 255   |       |
| Gazzam No. 4.             | do.                                  |       |        |       | 245½  | 255   | 255   |       |
| Greensburg No. 1.         | Greensburg Coal Company,             | 300   | 254    | 297   | 254   | 163   | 190   | 190   |
| Greensburg No. 2.         | do.                                  |       |        |       |       | 172   | 187   | 249   |
| Graver.                   | New York and Cleveland Coal Company, |       |        |       | 203   |       |       |       |
| Globe.                    | Globe Coal Company,                  | 189   | 192    | 238   | 203   |       |       |       |
| Gilmore.                  | Altmyer & Maltzberger,               | 190   | 90     | 150   | 243½  | 129   |       |       |
| Gosford.                  | Gosford Coal and Mining Company,     | 275   | 290    | 295   | 294   | 275   | 290   | 250   |
| Grace.                    | W. J. Rainey,                        |       |        |       | 240   | 181   |       | 153   |
| Glenshaw.                 | W. Morris & Co.,                     |       |        | 256   | 240   |       |       |       |
| Glendale.                 | J. Z. W. Cook,                       |       |        |       | 100   |       |       | 223   |
| Glen Fisher.              | Elk Coal and Coke Company,           |       |        |       | 100   |       | 240   |       |
| Glenshaw.                 | Glenshaw Coal Company,               | 275   | 300    |       |       |       | 296   |       |
| Grass Flat No. 10.        | Clearfield Bituminous Coal Company,  |       |        |       |       |       |       |       |
| Grass Flat No. 11.        | do.                                  | 249   |        |       | 301   | 290   |       |       |
| Glen Fisher.              | Standard Coal and Coke Company,      |       |        |       |       |       |       |       |
| Goss Run.                 | do.                                  |       |        |       |       |       |       |       |
| Gastonville.              | Pittsburgh and Chicago Gas Coal Co., | 179   | 136    | 268   | 166   | 217   | 180½  | 138½  |
| Great Bluff.              | Isaac Taylor,                        | 146   | 250    | 260   | 225   | 296   | 176   | 92    |
| Grassy Run.               | Grassy Run Coal Company,             | 130   | 147.50 | 142   | 197   | 183   | 184   | 117   |
| Gwin.                     | Gwin & Son,                          |       |        |       | 220   |       | 50    |       |
| Gurnee Nos. 1, 2 and 3.   | Gaines Coal Company,                 |       |        | 197   | 225   | 211½  | 204   | 204   |
| Gallitzin shaft.          | Mitchell & Layer,                    | 293   | 212    | 229   | 220   | 213   | 201   | 117   |
| Glen Ritchey.             | Bloomington Coal Company,            | 242   |        |       |       |       |       |       |
| Gulon.                    | do.                                  | 129   | 167    | 200   | 200   | 100   | 243   | 35    |
| Grindstone shaft.         | Redstone Oil, Coke and Coal Company, |       |        |       | 162   | 183   |       | 253   |
| Germania.                 | Turnbull & Foster,                   | 107   | 140    |       | 162   |       |       | 148   |
| Gassman or C. & J. No. 1. | Cumberland and Summit Coal Company,  |       |        |       |       |       |       | 148   |
| Gassman or C. & J. No. 2. | do.                                  |       | 100    |       |       |       |       | 148   |
| Gracetton.                | McCreary Coal and Coke Company,      |       |        |       |       |       | 265   | 181   |

|                           |                                    |      |       |      |     |     |     |
|---------------------------|------------------------------------|------|-------|------|-----|-----|-----|
| Grindstone                | Redstone Oil and Coke Company.     | 110  | 75    | 244  | 297 | 175 | 85  |
| Geartiant                 | Thos J. Lee & Co. Limited.         | 168  | 175   | 60   |     |     | 175 |
| Grampian No. 2            | R. C. Fishburn & Co.               | 118  | 63    |      |     |     | 108 |
| Guffy                     | Youghiogheny River C. Co.          |      |       |      |     |     | 141 |
| Greenwood Nos. 1, 2 and 3 | Glenwood Coal Company.             |      |       |      |     |     | 171 |
| Greenfield                | J. S. Neal                         |      |       |      |     |     |     |
| Gilmore                   | Heirs of John Gilmore.             |      |       |      |     |     |     |
| Girfield                  | J. S. Neal                         |      |       |      |     |     |     |
| Grant                     | Indiana Coal and Coke Company      |      |       |      |     |     | 289 |
| Grisb                     | Gilpin Coal Company.               |      |       |      |     |     | 240 |
| Grant                     | W. L. Scott Company.               |      |       |      |     |     | 137 |
| Glen                      |                                    |      |       |      |     |     | 68  |
| Glen, White.              | Glen White Coal Company.           |      |       |      |     |     | 200 |
| Glen                      | A. H. & A. G. Hicks                |      |       |      | 80  |     |     |
| Hildale                   | Hildale Coal Company.              | 295  | 189   | 246  |     |     | 145 |
| Horner & Roberts.         | Horner & Roberts.                  |      | 76.50 | 216½ |     |     |     |
| Hays Street Run.          | Hays' Estate                       |      | 150   | 95   |     | 72  |     |
| Hastings                  | W. J. Morgan                       |      |       |      |     | 297 | 126 |
| Harding shaft.            | C. E. Harding                      |      |       |      |     |     |     |
| Hickory slope.            | Hazard Wood & Co.                  | 156  | 145   |      |     |     |     |
| Himes.                    | James Clayton                      |      |       |      |     |     |     |
| Hill Farm.                | Dunbar Furnace Company             | 252  | 275   | 141  |     | 202 | 274 |
| Hoblitzel                 | Baltimore and Cumberland Coal Co.  |      |       |      |     |     |     |
| Hagen & Whyel.            | Hagan & Whyel                      |      |       |      |     |     |     |
| Henry Clay.               | H. C. Frielk Coke Company.         | 193  | 289   | 265  | 198 | 262 | 198 |
| Haw's shaft.              | A. J. Hays                         | 220  | 201   | 246  | 313 | 306 | 240 |
| Harvey O'Neil.            | O'Neil Co.                         | 165  | 201   | 121¾ | 201 | 148 | 178 |
| Horner & Roberts No. 3.   | Horner & Roberts.                  |      |       |      |     |     |     |
| Hays Street Run.          | Hays' Estate                       | 120  |       |      |     |     |     |
| Hastings slope.           | Penn Coal Company.                 | 180  | 120   | 230  | 134 | 166 | 230 |
| Hawks Run.                | James & Mill.                      | 293  |       |      |     |     |     |
| Harrison.                 | J. L. Lutz & Co.                   |      |       |      |     |     |     |
| Hampton.                  | Hempden Coal Company.              | 204  | 245   | 86   | 210 | 200 | 168 |
| Hempfield.                | Hempden Coal Company.              | 312  | 252   | 252  | 264 | 216 | 246 |
| Hecla.                    | Hecla Coke Company. Limited.       | 259½ | 285   | 234  | 192 | 274 | 220 |
| Hecla Nos. 1 and 2.       | McCure & Co., do.                  | 222  | 272   | 280  | 152 | 286 | 222 |
| Hazzlet Nos. 1 and 2.     | do.                                |      |       |      |     |     |     |
| Hall.                     | John W. Hall & Son.                | 247  | 283   | 290  |     |     |     |
| Hardscrabble.             | Brady's Bend Mining Company.       |      |       |      |     |     |     |
| Hamilton.                 | Powers & Brown.                    | 103  | 264   | 278  | 263 | 243 | 145 |
| Hocking.                  | Locking Coal Company.              | 295  | 229   | 270  | 147 | 88  | 70  |
| Home.                     | Stauffer & Wiley.                  |      |       |      |     |     |     |
| Horse Shoc.               | Altoona Coal Company.              |      |       |      |     |     |     |
| Hays Street Nos. 2 and 3. | H. C. Bergman, Trustee.            |      |       |      |     |     |     |
| Hanson.                   |                                    | 260  | 240   |      |     |     | 125 |
| Hamilton.                 | Cacran & Hamilton.                 | 250  | 163   | 210  | 170 | 200 | 72  |
| Huntingdon.               | Ed. Gould.                         |      |       |      |     |     |     |
| Hudson.                   | C. P. Averton & Son.               | 92   | 214   | 255  | 293 |     | 120 |
| Hastings.                 | Chess Creek Coal and Coke Company. | 124  |       |      |     |     |     |
| Harriet Lane.             | Zyeth & Langdon Coal Company.      |      |       |      |     |     |     |
| Hill.                     | Hill Coal Company.                 |      |       |      |     |     | 116 |
| Hites.                    | McPettridge Bros., Coal Company.   |      | 25    | 103  | 291 | 205 | 221 |

*Days in operation of Bituminous Collieries—Continued.*

| Name of Colliery.             | Name of Operator.                            | 1888. | 1889. | 1890. | 1891. | 1892.   | 1893. | 1894.   |
|-------------------------------|--|-------|-------|-------|-------|---------|-------|---------|
| Hegarty, .....                | Coal Run Coal Company, .....                 |       |       | 92    |       |         |       |         |
| Highland, .....               | John Walton, .....                           |       |       | 110   | 252   | 196     | 146   | 61      |
| Helvetia, .....               | A. Islein, .....                             |       |       |       | 265   | 312 3/4 | 361   | 193 1/2 |
| Horner & Roberts No. 4, ..... | Horner & Roberts, .....                      |       |       |       |       | 120     |       |         |
| Hackett's, .....              | Hackett Coal and Coke Company, .....         |       |       |       |       |         |       | 113     |
| Henrietta, .....              | Henrietta Coal Mining Company, .....         |       |       |       |       | 60      | 220   |         |
| Hicks, .....                  | .....  |       |       |       |       | 180     | 103   | 160     |
| Henderson, .....              | .....  |       |       |       |       | 164     | 198   | 121     |
| Hallville, .....              | Delaney Gould, .....                         |       |       |       | 90    | 260     |       |         |
| Hazel Dell, .....             | .....  |       | 296   | 377   |       | 284     | 283   | 171     |
| Henry Bros., .....            | Kaull & Hall, .....                          |       |       |       |       |         | 181   | 226     |
| Hursts, .....                 | Henry Bros., .....                           |       |       |       |       |         | 98    | 167     |
| Henrietta No. 2, .....        | W. P. Hursel & Co., .....                    |       |       |       |       |         | 270   | 184     |
| Hickman, .....                | Henrietta Coal Mining Company, .....         |       |       |       |       |         | 188   | 100     |
| Homestead, .....              | H. K. Witek & Co., .....                     |       |       |       |       |         | 240   |         |
| Hughes, .....                 | Reese Bros., .....                           |       |       |       |       |         | 275   | 240     |
| Harvey Slope, .....           | Richard Hughes, .....                        |       |       |       |       |         | 178   |         |
| Holts, .....                  | Lehigh Mining Company, .....                 |       |       |       |       |         | 206   |         |
| Hecla No. 2 shaft, .....      | Hill & Buck, .....                           |       |       |       |       |         |       | 114     |
| Hosletter, .....              | Hecla Coal Company, .....                    |       |       |       |       |         |       | 180     |
| Haddon, .....                 | Haddon Coal Company, .....                   |       |       |       |       |         |       | 300     |
| Henry Bros., .....            | Henry Bros., .....                           |       |       |       |       |         |       | 151     |
| H. P. O'Neill, .....          | H. P. O'Neill, .....                         |       |       |       |       |         |       | 168     |
| Harts, .....                  | Thomas Hart, .....                           |       |       |       |       |         |       | 40      |
| Ingliside, .....              | Hill & Buck, .....                           |       |       |       |       |         |       | 181     |
| Ivill, .....                  | Hecla Coal Company, .....                    | 250   | 225   | 130   | 257   | 210     | 190   | 210     |
| Idlewood, .....               | James Jones, .....                           |       |       |       |       | 250     | 103   | 213     |
| Isabella, .....               | Phoenix Gas and Coal Company, .....          |       |       |       |       | 250     | 140   |         |
| Irvona No. 1, .....           | Isabella Furnace Company, .....              | 106   | 200   | 300   | 300   | 250     | 180   | 168     |
| Irvona, .....                 | Irvona Coal Company, .....                   | 252   | 204   | 177   | 240   | 223     | 140   | 76      |
| Imperial, .....               | Phoenix Coal Company, .....                  |       |       |       |       |         |       |         |
| International, .....          | Imperial Coal Company, .....                 | 95    |       |       |       |         |       | 73      |
| Idlewood, .....               | International Coal and Mining Company, ..... | 165   |       |       |       |         |       |         |
| Irvona No. 2, .....           | Steward, Lewis and Dickson, .....            | 70    | 75    | 86    | 240   | 233     |       |         |
| Indiana, .....                | Irvona Coal Company, .....                   |       |       |       |       |         |       |         |
| Indiana Branch, .....         | International Coal and Mining Company, ..... |       |       |       |       |         |       |         |
| Instanter, .....              | .....  |       | 90    |       |       |         |       |         |
| Idlewood, .....               | Buffalo Coal Company, .....                  |       |       | 276   | 295   | 287     | 276   | 241     |
| Jones, .....                  | T. D. Steen, .....                           |       |       |       |       |         |       | 160     |
| Juniata, .....                | Thos. Jones, .....                           |       |       |       |       |         |       |         |
| Jones & Laughlin, .....       | Juniata Coke Company, .....                  |       |       |       | 256   | 269     | 251   | 207     |
| J. C. Shipman, .....          | Jones & Laughlin, .....                      |       |       |       |       |         |       |         |
|                               | J. C. Martin, .....                          |       | 251   | 280   |       | 257     | 264   |         |



|                        |  |     |      |     |     |     |      |
|------------------------|--|-----|------|-----|-----|-----|------|
| Jumbo,                 | T. B. Robbins,                           | 57  | 87   | 252 | 255 | 210 | 265  |
| Jackson,               | Jackson Coal Company,                    |     |      | 140 | 292 | 192 | 265  |
| Jones,                 | George Jones & Co.,                      |     |      |     | 90  | 200 | 275  |
| James O'Neill,         | James O'Neill,                           | 350 | 254  |     |     |     |      |
| Jumbo,                 | Jumbo Coal and Coke Company,             | 300 | 240  | 237 | 150 |     |      |
| Jackson,               | Jackson Mines Company,                   | 146 | 136½ | 156 | 70  | 82½ | 80   |
| Jefferson,             | Foster, Clark & Wood,                    | 238 | 230  |     |     |     |      |
| Junction,              | Joseph Laughrey & Co.,                   | 202 |      |     |     |     |      |
| Jumbo,                 | Jumbo Coal and Coke Company,             |     |      |     |     |     |      |
| Jefferson,             | Adams & Co.,                             |     |      | 125 | 129 | 269 | 122  |
| Jumbo,                 | Pittsburgh Consolidated Coal Company,    |     |      |     |     |     |      |
| Knob,                  | Knob Coal Company,                       | 190 | 238  | 220 | 244 | 100 | 179  |
| Keystone,              | Keystone Coal Company,                   | 250 | 240  |     | 76  | 220 | 188  |
| Kyle Farm,             | Bliss & Marshall,                        | 175 | 249  | 195 | 251 | 117 | 248  |
| Keightley,             | Fountainhill Mining Co.,                 |     |      |     |     |     |      |
| Karbaus,               | Berwind-White & Co.,                     | 130 | 275  | 280 | 250 |     | 204  |
| Keystone Nos 1 and 2,  | W. H. Brown & Sons,                      | 200 | 210  |     | 234 |     |      |
| Keystone,              | Keystone Coal and Coke Company,          | 265 | 240  | 257 | 184 | 187 | 59   |
| Kelster,               | Union Coal and Coke Company,             | 58  | 209  | 180 |     | 110 |      |
| Kittanning,            | Kittanning Iron Company, Limited,        |     |      |     |     |     |      |
| Kittanning,            |  |     |      |     |     |     |      |
| Keightley,             | H. C. Cord,                              | 176 | 253  | 275 | 179 | 158 | 70   |
| Kyer,                  | Kyer Coal and Coke Company,              | 174 | 268  | 250 |     |     |      |
| Karns,                 | W. C. Molley & Co.,                      | 119 | 268  | 253 |     |     |      |
| Keystone,              | Pittsburgh & Fairport Coal and Coke Co., |     |      |     |     |     |      |
| Keystone Nos. 1 and 2, | Keystone Coal Company,                   | 3   | 121¼ | 230 | 132 | 59  | 215  |
| Kentuck,               | Fryburger & Butterworth,                 |     | 255  | 206 | 208 | 164 | 155½ |
| Kettle Creek,          | Kettle Creek Coal Company,               |     |      |     |     |     |      |
| Kelly's mine,          | Kelly Bros.,                             | 256 |      | 24  | 226 | 167 | 124  |
| Knox Run,              | C. Bt. Coal Company,                     | 33  | 283  | 130 | 140 | 170 | 165  |
| Kearney,               | Joseph E. Thropp,                        |     | 89   | 90  |     | 240 | 214  |
| Kecks,                 | Woodland Coal Company,                   |     |      |     |     | 275 | 182  |
| Krebs,                 | Listy Mining and Manufacturing Co.,      |     |      |     |     | 200 |      |
| Kelly's,               |  |     |      |     |     | 291 | 126  |
| Knoxville,             |  |     |      |     |     | 85  | 85   |
| Kelly's,               |  |     |      |     |     | 70  | 145  |
| Keystone,              | Turner Coal, Coke and Mining Company,    |     |      |     |     | 70  | 80   |
| Kurtz,                 | Kurtz & Rhin,                            |     |      |     |     | 140 | 176  |
| Kokomo,                | Edwards & Son,                           |     |      |     |     | 80  | 220  |
| Kings,                 | J. King,                                 | 150 | 80   | 201 | 190 | 220 | 176  |
| Lower Walton,          | Joseph Walton & Co.,                     |     | 232  | 162 | 80  | 64  |      |
| Loudon,                | Fall Creek Coal Company,                 |     | 100  | 162 |     | 140 | 240  |
| Lovedale,              | John A. Wood & Sons,                     |     |      |     |     |     |      |
| Legler's,              | Henry Floersheim,                        |     |      | 245 |     |     |      |
| Laurel Hill,           | W. P. Rend,                              |     |      |     |     |     |      |
| Long Run,              | Northwestern Coal and Iron Company,      |     |      |     |     |     |      |
| Leechburg Nos 2 and 3, | do.                                      |     | 268  | 280 | 240 | 266 |      |
| Leechburg No. 4,       | do.                                      |     |      |     | 314 | 280 | 239  |
| Leechburg,             | Pierce Coal Company, Limited,            | 185 | 190  | 151 | 103 | 116 |      |
| Lackawanna,            | Long Valley Coal Company,                | 193 | 283  | 228 | 206 | 168 | 134  |
| Long Valley,           | Long Valley Coal and Iron Company,       | 275 | 157  | 193 | 252 | 185 | 235  |
| Leisensong No. 1,      | Cornellsville Coal and Iron Company,     | 260 | 273  | 120 | 250 | 250 | 175  |
| Leisensong No. 2,      | do.                                      |     | 218  |     |     |     |      |

O\*

## Days in operation of Bituminous Collieries—Continued.

| Name of Colliery.        | Name of Operator.                       | 1888. | 1889. | 1890. | 1891. | 1892. | 1893. | 1894. |
|--------------------------|---|-------|-------|-------|-------|-------|-------|-------|
| Leisenring No. 3.        | Robert Hogsett.                         | 275   | 304   | 276   | 297   | 256   | 146   | 213   |
| Lemont.                  | Latrobe Coal Works.                     | 285   | 284   | 306   | 284   | 277   | 183   | 234   |
| Lovedale.                | John A. Wood & Sons.                    | 154   | 400   | 275   | 275   | 303   | 223   | 176½  |
| Laurel Hill.             | W. P. Rend.                             | 310   | 236   | 210   | 119   | 230   | 250   | 230   |
| Lake Shore.              | Lake Shore Gas-Coal Company.            | 248   | 257   | 261   | 237   | 192   | 216   | 37    |
| Lorraine.                | Reakirt Bros.                           | 248   | 236   | 210   | 119   | 124   | 220   | 160   |
| Leland.                  | Toni's, Taylor & Williams.              | 250   | 257   | 261   | 237   | 197   | 218   | 234   |
| Logan Ridge.             | H. J. Smith & Co.                       | 250   | 257   | 261   | 237   | 197   | 218   | 234   |
| Logan.                   | H. J. Smith & Co.                       | 250   | 257   | 261   | 237   | 197   | 218   | 234   |
| Laurel Run Nos. 1 and 2. | H. Liveright & Co.                      | 250   | 257   | 261   | 237   | 197   | 218   | 234   |
| Lippincott.              | Nuttall, Bacon & Co.                    | 258   | 261   | 143   | 198   | 143   | 178   | 185   |
| Lancashire Nos. 1 and 2. | Hostetter Coke Company.                 | 258   | 261   | 144   | 198   | 294½  | 280   | 191   |
| Larimer.                 | T. Barnes & Bros.                       | 258   | 261   | 144   | 198   | 294½  | 280   | 191   |
| Larimer Coke Works.      | Westmoreland Coal Company.              | 258   | 261   | 144   | 198   | 294½  | 280   | 191   |
| Little Pittsburg.        | Carnegie Bros. & Co., Limited.          | 258   | 261   | 144   | 198   | 294½  | 280   | 191   |
| Little Redstone.         | R. E. Schrents & Co.                    | 258   | 261   | 144   | 198   | 294½  | 280   | 191   |
| Little Alps.             | James Rutherford.                       | 200   | 182   | 150   | 153   | 182   | 168   | 143   |
| Leechburg No. 1.         | James Underwood.                        | 200   | 182   | 150   | 153   | 182   | 168   | 143   |
| Leechburg No. 2.         | Leechburg Coal and Coke Company.        | 200   | 182   | 150   | 153   | 182   | 168   | 143   |
| Leechburg No. 3.         | do.                                     | 200   | 182   | 150   | 153   | 182   | 168   | 143   |
| Leith.                   | Chicago and Connellsville Coke Company. | 275   | 272   | 297   | 290   | 258   | 93    | 234   |
| Lemont No. 2.            | Robert Hogsett.                         | 275   | 272   | 297   | 290   | 258   | 93    | 234   |
| Loyalhanna shaft.        | Loyalhanna Coal and Coke Company.       | 245   | 240   | 250   | 232   | 272   | 220   | 234   |
| Leesdale.                | Gregg Bros.                             | 192   | 148   | 140   | 198   | 225   | 210   | 175   |
| Laurel Run No. 1.        | Nuttall, Bacon & Co.                    | 230   | 229   | 229   | 256   | 215   | 196   | 196   |
| Lancashire No. 1.        | do.                                     | 209   | 200   | 200   | 200   | 290   | 290   | 290   |
| Lancashire No. 2.        | do.                                     | 209   | 184   | 218   | 319   | 275   | 275   | 327   |
| Lancashire No. 3.        | do.                                     | 150   | 242   | 235   | 185   | 211   | 80    | 103   |
| Lugers' slope.           | T. Barnes & Bro.                        | 150   | 242   | 235   | 185   | 211   | 80    | 103   |
| Lemon.                   | A. B. & G. W. Luiger.                   | 285   | 240   | 300   | 291   | 211   | 46    | 95    |
| Lockport.                | Blair Iron and Coal Company.            | 285   | 240   | 300   | 291   | 211   | 46    | 95    |
| Leechburg No. 4.         | Lockport Coal and Coke Company.         | 309   | 238   | 281   | 281   | 58    | 197   | 120   |
| Leisenring No. 3.        | Leechburg Coal and Coke Company.        | 259   | 154   | 300   | 311   | 116   | 116   | 116   |
| Large.                   | Connellsville Coke and Iron Company.    | 259   | 154   | 300   | 311   | 116   | 116   | 116   |
| Lilly.                   | R. B. Large.                            | 70    | 183   | 177   | 177   | 137   | 176   | 111   |
| Leathertwood.            | Lilly Coal Company.                     | 70    | 183   | 177   | 177   | 137   | 176   | 111   |
| Lucas Hill.              | Leatherwood Coal Company.               | 109   | 68    | 180   | 117   | 202   | 126   | 126   |
| Larimer.                 | L. V. Coal Company.                     | 175   | 68    | 180   | 117   | 126   | 126   | 126   |
| Leander slope.           | Larimer Coke Works.                     | 175   | 68    | 180   | 117   | 126   | 126   | 126   |
| Langlead.                | Leander & Co.                           | 175   | 68    | 180   | 117   | 126   | 126   | 126   |
| Lewis.                   | Langlead.                               | 175   | 68    | 180   | 117   | 126   | 126   | 126   |
| Lynn.                    | Lewis & Co.                             | 175   | 68    | 180   | 117   | 126   | 126   | 126   |
|                          | Hanna Bros.                             | 350   | 166   | 166   | 301   | 185   | 175   | 160   |

|   |  |      |     |      |     |  |     |      |
|---|--|------|-----|------|-----|--|-----|------|
| Lucesco.                                      |  |      |     |      |     |  | 156 |      |
| Lancashire No. 4.                             | Anneston Coal Company.                         |      |     |      |     |  | 125 |      |
| Lancashire No. 5.                             | Evans & Co.                                    |      |     |      |     |  | 100 | 300  |
| Lorne.  | Fred C. Todd & Co.                             |      |     |      |     |  | 50  |      |
| Loyalhanna No. 2.                             | Loyalhanna Coal and Coke Company.              |      |     |      |     |  |     | 88   |
| Lake Erie.                                    | Lake Erie Coal Company.                        |      |     |      |     |  |     | 145  |
| Longhead.                                     | Martin Coke Company.                           |      |     |      |     |  |     | 252  |
| Lemont No. 1.                                 | McChure Coke Company.                          |      |     |      |     |  |     | 241  |
| Laurel Hill No. 2.                            | W. P. Rend & Co.                               |      |     |      |     |  |     | 160  |
| Laurel Hill No. 4.                            | W. P. Rend & Co.                               |      |     |      |     |  |     | 175  |
| Leedsdale.                                    | S. E. Gregg.                                   |      |     |      |     |  |     | 130  |
| Lane.   | F. C. Todd & Co.                               | 171  | 248 | 203  |     |  |     | 82   |
| Milesville.                                   | Robert Jenkins.                                | 200  | 253 | 230  |     |  |     | 148  |
| Midway.                                       | George Crawford.                               |      |     |      |     |  |     | 164  |
| McCormell.                                    | J. C. Martin.                                  |      |     |      | 900 |  |     |      |
| Mansfield Nos. 1 and 3.                       | Joseph McCormell.                              | 142  |     | 202  |     |  |     | 133  |
| Mansfield No. 2.                              | Mansfield Coal and Coke Company.               | 240  | 213 | 197  |     |  |     | 139  |
| Montour's.                                    | do.  |      |     |      |     |  |     |      |
| Mineral.                                      | Imperial Coal Company.                         |      |     |      |     |  |     |      |
| Mineral Ridge Nos. 1 and 2.                   | J. F. Mansfield.                               |      |     |      |     |  |     |      |
| Morris Run Nos. 1, 2 and 3.                   | Mineral Ridge Coal Company.                    | 192  | 202 | 250  |     |  |     | 139  |
| Morgan.                                       | Morris Run Coal Mining Company.                | 278  | 289 | 224  |     |  |     | 100  |
| Morrill.                                      | H. C. Frick Coal Company.                      | 291  | 223 | 216  |     |  |     | 230  |
| Millwood.                                     | Cambria Iron Company.                          | 311  | 140 | 200  |     |  |     | 180  |
| Monastery.                                    | Millwood Coal Company.                         | 197  | 283 | 285  |     |  |     | 119  |
| M. Saxman.                                    | H. C. Frick & Co.                              | 262  | 301 | 286  |     |  |     | 110  |
| Munson's.                                     | M. Saxman & Co.                                |      |     |      |     |  |     |      |
| Martindale.                                   | Munson Coal Company.                           | 230  |     | 204  |     |  |     |      |
| Monroe slope.                                 | J. C. Martin & Co.                             |      |     |      |     |  |     |      |
| Mentzer.                                      | Galitzin Coal Company.                         |      |     |      |     |  |     |      |
| Minersville.                                  | E. W. Mentzer.                                 |      |     |      |     |  |     |      |
| Milesville.                                   | R. H. Powell & Sons.                           | 100  |     | 295  |     |  |     | 289  |
| Mansfield No. 2.                              | Roda Maher.                                    | 158  |     | 279  |     |  |     | 256  |
| Mansfield No. 3.                              | Robert Jenkins.                                | 204½ | 200 | 204½ |     |  |     | 211  |
| Madison.                                      | Mansfield Coal and Coke Company.               |      |     |      |     |  |     |      |
| McCormell.                                    | do.  |      |     |      |     |  |     |      |
| Morrisdale Nos. 8, 10, 11, 12, 13, 14 and 15. | Madison Gas Coal Company.                      |      | 87  |      |     |  |     | 293¾ |
| Moshannon.                                    | Joseph McCormell.                              | 219  | 155 | 147  |     |  |     | 173  |
| Manmoth.                                      | R. B. Wigton & Sons.                           | 242  | 241 | 238  |     |  |     | 93   |
| Manor Shaft.                                  | Moshannon Coal Company.                        | 239  | 251 | 190  |     |  |     | 254  |
|   | N. Y. & Westmoreland Gas, Coal & Coke Company. |      |     |      |     |  |     |      |
| Mullin.                                       | 125  | 133  |     |      |     |  |     |      |
| Manor Valley.                                 | Mullin, Stryker & Co.                          | 150  | 225 | 210  |     |  |     |      |
| Mutual Nos. 1 and 2.                          | Manor Valley Gas Coal Company.                 | 260  |     |      |     |  |     |      |
| M. Graver.                                    | Mutual M. and M. Company.                      | 281  | 235 | 220  |     |  |     | 45   |
| Mayfield.                                     | New York and Cleveland Gas Coal Co.            |      |     |      |     |  |     |      |
| Merchaut.                                     | McChure & Company.                             | 248  | 250 | 207  |     |  |     | 197  |
| Midway.                                       | David Bowdler.                                 |      |     |      |     |  |     |      |
| Mineral Ridge.                                | Midway Block Company.                          | 300  |     | 186  |     |  |     | 165  |
|   | Mineral Coal Company.                          | 249  | 192 | 208  |     |  |     | 270  |



|                              |  |       |       |        |       |       |
|------------------------------|--|-------|-------|--------|-------|-------|
| New Catsburgh, .....         | Louis Staib, .....                           | ..... | ..... | .....  | 70    | 150   |
| New Eagle, .....             | Campbell & Co., .....                        | ..... | ..... | .....  | 205   | 167   |
| New Coal Bluff, .....        | Peters Creek and Monger, Gas Coal Co., ..... | ..... | ..... | 110    | 151   | 133   |
| New Hamilton, .....          | National Coal Company, .....                 | ..... | ..... | 225    | ..... | ..... |
| National, .....              | J. E. Read, .....                            | ..... | ..... | 229    | ..... | ..... |
| New Castle, .....            | Virginia Coal Company, .....                 | ..... | 155   | .....  | ..... | ..... |
| New Virginia, .....          | Brown & Cochran, .....                       | ..... | 262   | 275    | 250   | 200   |
| Nelly, .....                 | National Coal Company, .....                 | ..... | 286   | 185    | 271   | 262   |
| National, .....              | Westmoreland Coal Company, .....             | ..... | ..... | .....  | 233   | 80    |
| North Side, .....            | do, do, .....                                | ..... | 271   | 283    | 295   | 256   |
| No. 1 A and B shafts, .....  | do, do, .....                                | ..... | 244   | 280    | 299   | 311   |
| No. 2 and 3, .....           | do, do, .....                                | ..... | 271   | 242    | 267   | 217   |
| No. 4, .....                 | do, do, .....                                | ..... | ..... | .....  | 232   | 120   |
| National No. 1, .....        | Philadelphia Coal and Coke Company, .....    | ..... | ..... | .....  | 66    | ..... |
| New Catsb, .....             | Pittsburgh C. and M. Company, .....          | ..... | ..... | .....  | ..... | ..... |
| National No. 2, .....        | Philadelphia Coal and Coke Company, .....    | ..... | ..... | .....  | ..... | ..... |
| New Virginia, .....          | Perkins & Co., .....                         | ..... | ..... | .....  | ..... | ..... |
| Neshannock, .....            | Peroch & Gibson, .....                       | ..... | 122   | 190    | ..... | ..... |
| Natrona, .....               | Pennsylvania Salt Manufacturing Co., .....   | ..... | 300   | 293    | 305   | 306   |
| Nickel Plate, .....          | J. D. Sauter, .....                          | ..... | 182   | .....  | 295   | 240   |
| No. 3 drift and shaft, ..... | S. W. Coal and Coke Company, .....           | ..... | ..... | .....  | 236   | 142   |
| National, .....              | Whitmer Coal and Coke Company, .....         | ..... | 183   | 235    | 285   | ..... |
| Nixon, .....                 | Chartiers Valley Coal Company, .....         | ..... | 200   | 136    | 186   | 171   |
| New Hampshire, .....         | Whitehead & Co., .....                       | ..... | 95    | .....  | 203   | 158   |
| Nottingham, .....            | Henry Floresheim, .....                      | ..... | ..... | 77     | 272   | 170   |
| North Webster, .....         | J. D. Sauters, .....                         | ..... | ..... | 207    | ..... | 230   |
| New Pardee, .....            | R. E. Large, .....                           | ..... | ..... | .....  | 237   | 167   |
| North Western, .....         | Magoe & Lingle, .....                        | ..... | ..... | .....  | 96    | 96    |
| No. 3 shaft, .....           | Pittsburgh and Belle Vernon Coal Co., .....  | ..... | ..... | .....  | 210   | 130   |
| No. 4 shaft, .....           | S. W. Connellsville Coke Company, .....      | ..... | ..... | .....  | 152   | 182   |
| Nellie, .....                | do, do, .....                                | ..... | ..... | .....  | ..... | 210   |
| Old Eagle, .....             | E. Statler, .....                            | ..... | ..... | .....  | ..... | 228   |
| Ormsby & Bausman, .....      | W. H. Brown's Sons, .....                    | ..... | ..... | 241½   | ..... | 150   |
| Oak Ridge, .....             | Keeling Coal Company, .....                  | ..... | ..... | .....  | 157   | 140   |
| Oak Ridge Nos 1 and 2, ..... | Oak Ridge Coal Company, .....                | ..... | ..... | 191    | 229   | 138   |
| Ormsby slope, .....          | Oak Ridge Mining Company, .....              | ..... | 141   | 209    | 138   | 221   |
| Ormsby shaft, .....          | L. M. Ormsby & Co., .....                    | ..... | 138   | 187    | ..... | 85    |
| Ocean No. 1, .....           | Ormsby Coal Company, Limited, .....          | ..... | 315   | 245    | 209   | 77    |
| Ocean No. 2, .....           | Wm. Sweet, .....                             | ..... | ..... | 62     | 244½  | 147   |
| Old Eagle, .....             | W. H. Brown & Sons, .....                    | ..... | 155   | .....  | 160   | 217   |
| Oliphant, .....              | Frick Coke Company, .....                    | ..... | ..... | 256    | 245   | 287   |
| Oliver, .....                | Oliver Coke and Furnace Company, .....       | ..... | ..... | .....  | 300   | ..... |
| Oneida, .....                | .....  | ..... | ..... | 235    | 70    | ..... |
| Ormsby, .....                | Birmingham Coal Company, .....               | ..... | 200   | 300    | 290   | 256   |
| Ocean No. 2, .....           | Oak Ridge Coal Company, .....                | ..... | 223   | 250    | 261   | 170   |
| Ocean No. 3, .....           | Youghiogheny Coal Company, .....             | ..... | 230   | 250    | 241   | 300   |
| Ocean No. 4, .....           | do, do, .....                                | ..... | ..... | .....  | ..... | ..... |
| Ocean No. 1, .....           | do, do, .....                                | ..... | 97    | 93     | 174   | 87    |
| Oak Hill No. 4, .....        | Yough River Coal Company, .....              | ..... | 258   | 227    | 195   | 201   |
| O. I. C., .....              | New York and Cleveland Gas Coal Co., .....   | ..... | 256   | 223.50 | 75¼   | 265   |
|                              | .....  | ..... | ..... | 208    | 144   | 143   |



|                              |   |         |         |         |         |         |
|------------------------------|---|---------|---------|---------|---------|---------|
| Phoenix, .....               | J. R. Orvils & Co., .....                                     | 287     | 153     | 301     | 320     | 228     |
| Penn., .....                 | Yeakirt Bros., .....  | 287     | 185     | 160     | 200     | 80      |
| Plum Creek, .....            | New York and Cleveland Gas Coal Co., .....                    | 287     | 270 1/4 | 269 1/2 | 250     | 205 1/4 |
| Port Royal, .....            | Port Royal Coal and Coke Company, .....                       | 288     | 288     | 288     | 288     | 288     |
| Penn Gas Coal Run, .....     | Penn Gas Coal Company, .....                                  | 288 1/2 | 249     | 249     | 249     | 249     |
| Painter, .....               | Lambert, Scott & Co., .....                                   | 215     | 217     | 217     | 211 1/2 | 145     |
| Penn Gas No. 1, .....        | Penn Gas Coal Company, .....                                  | 212     | 212     | 262     | 262     | 153 1/4 |
| Penn Gas No. 2, .....        | do., .....  | 212     | 232     | 231 1/4 | 210     | 157     |
| Penn Gas No. 3, .....        | do., .....  | 212     | 225     | 233 1/4 | 204 1/2 | 157     |
| Penn Gas No. 4, .....        | do., .....  | 212     | 206     | 203     | 203 1/4 | 157     |
| Port Royal, .....            | Port Royal Coal and Coke Company, .....                       | 252 1/2 | 83      | 290 1/2 | 246     | 171 1/4 |
| Penn., .....                 | Penn Coal Company, Limited, .....                             | 241     | 250 1/4 | 246     | 246     | 206 1/4 |
| Pennsville, .....            | A. H. Sterrick, .....   | 217     | 288     | 246     | 246     | 88      |
| Plumer, .....                | Pittsburgh and Connellsville Gas Coal and Coke Company, ..... | 196     | 253     | 153     | 88      | 48      |
| Plummer, .....               | H. C. Fick & Co., .....                                       | 274     | 271     | 315     | 92      | 167     |
| Farrish, .....               | Dunbar Furnace Company, .....                                 | 140     | 149     | 158     | 158     | 158     |
| Prospect, .....              | R. H. Powell & Son, .....                                     | 108     | 245     | 140     | 140     | 140     |
| Pine Run Nos. 1 and 2, ..... | James Lynn & Co., .....                                       | 248     | 136     | 200     | 200     | 200     |
| Pacific, .....               | Jakes Erie Gas Coal Company, .....                            | 190     | 165     | 215     | 276     | 264     |
| Pioneer, .....               | Standard Coal Company, .....                                  | 80      | 80      | 214     | 214     | 191     |
| Penny, No. 1, .....          | Benny Coal Company, .....                                     | 291     | 291     | 291     | 291     | 291     |
| Penn., No. 2, .....          | Berwind-White Coal Mining Company, .....                      | 311     | 254     | 249     | 208     | 133     |
| Pacific No. 2, .....         | do., .....  | 332     | 425     | 300     | 260     | 295     |
| Pardoe, .....                | Duncan, Lingle & Co., .....                                   | 285     | 290     | 300     | 300     | 295     |
| Philadelphia, .....          | W. J. Rayney, .....   | 270     | 223     | 203     | 206     | 277     |
| Paul, .....                  | Chartiers Block Coal Company, .....                           | 140     | 270     | 206     | 277     | 230     |
| Powers Nos. 2 and 3, .....   | Bell, Lewis and Yates Coal Mining Co., .....                  | 140     | 225     | 60      | 177     | 121     |
| Pine Run, .....              | G. J. Magee, .....  | 140     | 255     | 153     | 183     | 158     |
| Pleasant Valley, .....       | Pine Hill and Cumberland Coal Company, .....                  | 140     | 200     | 252     | 39      | 150     |
| Pardee No. 1, .....          | G. J. Magee, .....  | 140     | 269     | 247     | 183     | 149     |
| Pine Hill, .....             | Robbins Coal and Coke Company, .....                          | 140     | 300     | 214     | 130     | 130     |
| Pardee No. 2, .....          | G. J. Magee, .....  | 140     | 39      | 157     | 157     | 157     |
| Pine Creek, .....            | G. M. H. Good, .....  | 140     | 59      | 180     | 180     | 180     |
| Pardee No. 3, .....          | E. W. Metzger, .....  | 140     | 92      | 211     | 211     | 92      |
| Pluton, .....                | George Pierce & Bros., .....                                  | 140     | 92      | 82      | 82      | 200     |
| Plain, .....                 | R. F. Wigton & Sons, .....                                    | 140     | 218     | 218     | 218     | 190     |
| Pieree, .....                | Pan handle Coal Company, .....                                | 140     | 160     | 160     | 160     | 150     |
| Fatton No. 1, .....          | Robbins Coal and Coke Company, .....                          | 140     | 250     | 250     | 250     | 162     |
| Pan Handle, .....            | Pittsburgh Fuel No. 2, .....                                  | 140     | 49      | 49      | 49      | 126     |
| Pine Creek No. 2, .....      | Karl & Hall, .....  | 140     | 110     | 110     | 110     | 126     |
| Pine Creek No. 3, .....      | Morris Liveright, .....                                       | 140     | 150     | 150     | 150     | 126     |
| Pardee No. 4, .....          | J. W. Painter Coal Company, .....                             | 140     | 125     | 125     | 125     | 144     |
| Perks, .....                 | Queen Coal Company, .....                                     | 140     | 114     | 114     | 132     | 144     |
| Plaine, .....                | Henry Rebka, .....  | 140     | 178     | 178     | 178     | 144     |
| Pioneer, .....               | Wm. Robbins & Co., .....                                      | 140     | 240     | 240     | 240     | 176     |
| Painter and Cornhill, .....  | W. J. Shodgrass & Co., .....                                  | 140     | 240     | 240     | 240     | 176     |
| Queen No. 1, .....           | J. D. Risher, .....   | 140     | 240     | 240     | 240     | 176     |
| Queen No. 2, .....           | Bell, Lewis & Yates, .....                                    | 140     | 240     | 240     | 240     | 176     |
| Queen No. 3, .....           | do., .....  | 140     | 240     | 240     | 240     | 176     |
| Rankin, .....                | do., .....  | 140     | 240     | 240     | 240     | 176     |
| Robbins, .....               | do., .....  | 140     | 240     | 240     | 240     | 176     |
| Rock Run, .....              | do., .....  | 140     | 240     | 240     | 240     | 176     |
| Risher, .....                | do., .....  | 140     | 240     | 240     | 240     | 176     |
| Rock Run, .....              | do., .....  | 140     | 240     | 240     | 240     | 176     |
| Robbster Mine, .....         | do., .....  | 140     | 240     | 240     | 240     | 176     |

*Days in operation of Bituminous Collieries—Continued.*

| Name of Colliery.             | Name of Operator.                               | 1888. | 1889. | 1890. | 1891. | 1892. | 1893. | 1894. |
|-------------------------------|---|-------|-------|-------|-------|-------|-------|-------|
| Rist, .....                   | H. C. Frick Coke Company, .....                 | 278   | 289   | 265   | 187   | 265   | 261   | 223   |
| Rock Point, .....             | Rock Point Coal Company, .....                  |       |       |       | 131   | 311   | 280   | 251   |
| Rolling Mill, .....           | Cambria Iron Company, .....                     |       |       |       | 298   | 208   | 271   |       |
| Ridge View, .....             | D. C. George & Co., .....                       | 65    |       |       |       |       |       |       |
| Risher, .....                 | J. D. Risher, .....                             |       |       | 126   |       |       |       |       |
| Robbins, .....                | Wm. Robbins & Co., .....                        | 153½  |       |       |       | 195   |       |       |
| Rock Run, .....               | Wm. Snodgrass & Co., .....                      | 140   |       |       | 115   | 114   |       |       |
| Rankin, .....                 | John Perry & Co., .....                         | 30    |       |       |       |       |       |       |
| Reading, .....                | H. Liveright & Co., .....                       | 268   | 259   | 100   | 51    | 216   |       |       |
| Rothrock, .....               | R. L. Wigton & Sons, .....                      | 226   | 266   | 195   | 161   | 189   | 192   |       |
| Republic, .....               | Republic Coal Company, .....                    | 100   | 112   | 86    |       |       |       |       |
| Rostraver, .....              | Wm. Schrader, .....                             | 254   | 270   | 266   | 208   | 100   | 254   | 225   |
| Riverview, .....              | Riverview C. and M. Company, .....              |       | 141   |       |       |       | 190   | 244   |
| Red Bank, .....               | Alex. Reynolds's Sons, .....                    | 190   | 225   | 214   | 204   | 180   | 165   |       |
| Rimerton, .....               | Murray & Butler, .....                          |       | 169   | 205   | 205   | 108   |       |       |
| Richland No. 1, .....         | Morrison & Stevens, .....                       |       | 160   |       |       |       |       |       |
| Rocky Ridge, .....            | Seaman, .....                                   |       |       |       |       |       |       | 146   |
| Ridgway Bishop, .....         | Ridgway Bishop Coal Company, .....              |       |       |       |       | 84    | 240   |       |
| Redstone, .....               | Redstone Coke Company, Limited, .....           | 289   | 288   | 271   | 192   | 260   | 272   | 229   |
| Rainbow, .....                | Rainbow Coal and Coke Company, .....            | 280   | 260   | 225   | 275   | 250   | 250   | 110   |
| Rolling Mill, .....           | Wm. H. Everson & Co., .....                     |       |       |       |       |       |       | 274   |
| Robertsdale, .....            | Rockhill Iron and Coal Company, .....           | 246   | 258   | 297   | 254   | 208   | 233   | 129   |
| Rinehart, .....               | F. H. Rinehart, .....                           |       |       |       |       |       |       |       |
| Rubus, .....                  | Cresson and Clearfield Coal and Coke Co., ..... |       |       |       |       |       |       |       |
| Red Run, .....                | Red Run Coal Company, .....                     |       | 285   | 303   | 260   | 252   | 279   | 231¾  |
| Rubino, .....                 | Cresson and Clearfield Coal and Coke Co., ..... |       |       | 216   |       |       |       |       |
| Redstone shaft, .....         | Redstone OH Company, .....                      | 40    | 204   | 216   | 158   |       |       |       |
| Ramey, .....                  | Thomas Farnes, .....                            |       | 262   | 215   | 278   |       |       |       |
| Retort A No. 1, .....         |   |       |       |       |       | 250   | 263   |       |
| Roy, .....                    |   |       |       |       |       |       |       |       |
| Royale, .....                 | Royale Coal Company, .....                      |       |       |       |       |       |       | 54    |
| Richland, .....               | Evans-Bell Mining Co., .....                    |       |       |       |       |       |       | 101   |
| Rising sun, .....             | McClure Coke Company, .....                     |       |       |       |       |       |       | 96    |
| Royal slope, .....            | O. F. Jones & Co., .....                        |       |       |       |       |       |       | 132   |
| Summer No. 1, .....           | Luikens, Haupt & Co., .....                     |       | 40    |       |       |       | 65    |       |
| Stockdale, .....              | Venture Coal Company, .....                     |       |       |       |       |       |       |       |
| Stones, .....                 | Wm. Stone's heirs, .....                        |       | 209   | 190   |       |       |       |       |
| Star, .....                   | Frank Mankedick, .....                          |       |       |       |       |       | 208   | 155   |
| Summer Hill, .....            | Frank Armstrong, .....                          |       |       | 300   |       |       | 212   | 148   |
| Shupe & Co., .....            | Shupe & Co., .....                              |       |       |       |       |       |       |       |
| Smith, .....                  | Smith & Co., .....                              |       |       | 270   | 200   | 300   | 252   | 77    |
| State Line, .....             | State Line Coal Company, .....                  |       |       |       |       |       |       |       |
| Stoneboro Nos. 2 and 3, ..... | Mercer Coal and Iron Company, .....             |       |       |       |       |       | 196   |       |



|  |     |        |     |      |      |     |     |
|--|-----|--------|-----|------|------|-----|-----|
| Specus, .....                            | 200 | 350    | 340 | 298  | 175  | 240 | 39  |
| Star, .....                              | 241 | 264    | 285 | 259  | 273  | 240 | 199 |
| Sligo Branch, .....                      |     |        |     |      |      |     |     |
| St. Mary's Nos. 1, 2 and 3, .....        |     |        | 303 | 308  | 300  | 286 |     |
| St. Mary's No. 5, .....                  |     |        |     |      | 300  | 296 |     |
| St. Mary's Nos. 1 and 2, .....           |     |        | 273 | 223  | 253  | 228 | 266 |
| Summit Nos. 1, 2, 3 and Jimtown, .....   | 282 | 584    | 273 | 278  | 245  | 157 |     |
| Sterling Nos. 1, 2, 3 and Jimtown, ..... | 280 |        | 241 | 230  | 285  | 245 | 170 |
| Snow Shoe, .....                         | 260 | 194    | 296 | 210  | 225  | 157 |     |
| Stewart Iron Company, .....              | 300 |        | 68  | 290  | 100  | 95  | 200 |
| Smith, .....                             |     |        |     |      | 220  | 200 | 131 |
| Strickler, .....                         | 140 | 200    | 254 | 220  |      |     |     |
| St. Clair, .....                         |     |        |     |      |      |     |     |
| Spartan, .....                           |     |        |     |      |      |     |     |
| Smittle, .....                           | 240 | 216    |     |      |      |     |     |
| Stineman, .....                          | 290 |        | 194 | 238  | 209  |     | 218 |
| South Fork, .....                        | 163 | 161    | 250 | 240  | 200  | 170 | 240 |
| Sonnan No. 1, .....                      | 240 | 288    | 250 | 267  | 290  | 198 | 240 |
| Sonnan No. 2, .....                      | 250 | 207    | 230 | 147  | 302  | 221 | 100 |
| Standard, .....                          | 250 | 260    | 250 | 313  | 386  | 300 | 243 |
| Summit, .....                            |     |        |     |      |      |     |     |
| Stones, .....                            | 56  |        |     |      |      |     |     |
| Summer Hill, .....                       | 49  | 245    |     | 215  | 228  |     |     |
| Smythe, .....                            |     |        |     |      |      |     |     |
| Star, .....                              | 230 |        |     | 190  | 185  | 135 |     |
| Stirling Nos 1 and 2, .....              | 558 | 370    | 350 | 236  | 251  | 158 | 60  |
| Stirling colliery No. 2, .....           |     |        | 153 | 219  | 200  | 147 | 89  |
| Sugar Camp Nos. 1, 2 and 3, .....        |     |        |     |      |      |     |     |
| Summersville No. 5, .....                |     |        |     |      |      |     |     |
| Summersville, .....                      |     |        |     |      |      |     |     |
| Stirling No. 4, .....                    | 130 |        | 83  | 208  | 195  |     |     |
| Shaner, .....                            |     |        | 272 | 216  | 202  | 210 |     |
| Stirling No. 10, .....                   |     |        | 169 | 142  | 182½ | 166 | 165 |
| Sandy Lick, .....                        |     | 180    |     |      | 245  | 19  |     |
| South Side, .....                        |     |        | 140 | 130  |      | 100 |     |
| Smithton Nos. 1 and 2, .....             | 224 | 200.50 | 126 | 269  | 33½  | 150 |     |
| Standard Nos. 1 and 2, .....             | 240 | 237    | 218 | 274  | 236  | 65  | 27  |
| Spring Hill, .....                       | 280 | 275    | 248 | 193  | 258  | 264 | 279 |
| S. H. Smith, .....                       | 260 | 240    | 313 | 301  | 306  |     |     |
| Standard, .....                          |     |        |     |      |      |     |     |
| Sonnan shaft, .....                      |     |        |     |      |      |     |     |
| Staffordshire, .....                     |     |        |     |      |      |     |     |
| Sandy Creek Nos. 1 and 2, .....          | 194 | 254    | 263 | 239½ | 278½ | 158 |     |
| Stony Hill, .....                        |     | 283    | 229 | 223  |      |     |     |
| Snow Hill, .....                         | 191 | 211    | 270 | 233  | 164  | 139 | 179 |
| Stoneboro No. 2, .....                   | 211 | 223    | 271 | 268½ | 211  | 175 | 124 |
| Stoneboro No. 3, .....                   | 205 | 221    | 253 | 237½ | 195  |     | 96  |
| St. Mary's Nos. 1, 2 and 3, .....        | 300 | 297    |     |      |      |     | 244 |
| Salisbury, .....                         |     |        |     |      |      |     |     |
| Stirling No. 6, .....                    |     |        | 192 | 74   | 144  |     |     |
| Statler, .....                           |     |        |     |      |      |     |     |
| Stirling Nos. 8 and 9, .....             | 150 | 150    |     | 269  | 280  | 250 | 200 |
| St. Charles, .....                       |     |        |     |      |      | 251 | 144 |
| St. Charles, .....                       |     |        |     |      |      |     |     |
| St. C. Stineman, .....                   |     |        |     |      |      |     |     |

## Days in operation of Bituminous Collieries—Continued.

| Name of Colliery.               | Name of Operator.                     | 1888. | 1890.  | 1891. | 1892. | 1893. | 1894.  |
|---------------------------------|---------------------------------------|-------|--------|-------|-------|-------|--------|
| Soman shaft,                    | Hughes & Shoemaker,                   | 250   | 240    | 240   | 232   | 203   |        |
| Street Run,                     | J. D. Risher,                         | 140   | 263    |       |       | 174   |        |
| Sawford No. 2,                  | Sanford & Co.,                        | 124   | 150.50 |       |       |       | 1533.4 |
| Sawden,                         | Pittsburgh and Chicago Gas Coal Co.,  | 159   | 249    |       | 300   |       | 65     |
| Sugar Camp No. 1,               | Lehigh Valley Coal Company,           |       | 246    |       | 129½  |       | 65     |
| Sugar Camp No. 3,               | do,                                   |       | 246    |       | 129½  |       |        |
| Sugar Camp No. 8,               | do,                                   |       |        |       |       |       |        |
| Summersville Nos. 1 and 2,      | Berwind-White Coal Mining Company,    | 140   | 156    |       | 194   | 152   |        |
| Stobbski,                       |                                       | 78    |        |       |       |       | 40     |
| Standard,                       | Crumby & Skillep,                     |       | 190    | 220   | 156   |       | 65     |
| Stony Hill,                     | Standard Coal Company,                | 200   |        | 210   | 141   | 220   | 128    |
| Soldier Run Nos. 1 and 2,       | John M. Dixon,                        | 286   | 382    |       |       |       |        |
| Shawmut,                        | Ball, Lewis & Yates Coal Mining Co.,  |       |        | 215   | 209   | 123   | 185    |
| Sugar Camp No. 4,               | Shawmut Coal Company,                 |       | 258    |       | 249   |       |        |
| Sharon,                         | Lehigh Valley Coal Company,           |       |        |       |       |       |        |
| Springfield,                    |                                       |       |        |       | 33    | 44    | 100    |
| Sarah,                          | Douglas Coal Company,                 | 171   |        |       |       |       |        |
| Schuykill,                      | Schuykill Coal Company,               | 279   |        | 223   |       |       |        |
| Sugar Camp Nos. 1, 2, 3 and 11, | Lehigh Valley Coal Company,           |       |        | 48    | 168   |       | 149    |
| Streets' Run,                   | Harrison Gray Coal Company,           | 31    |        |       |       |       |        |
| Sugar Camp Nos. 4 and 5,        | Lehigh Valley Coal Company,           | 60    |        |       |       |       |        |
| Stewart,                        | Beech Creek Coal and Coke Company,    |       |        |       |       |       |        |
| Snow Shoe mines,                | Kelly Bros.,                          | 151   | 75     |       | 230   | 267.1 | 300    |
| Spring Hill,                    | J. D. Boyd Co.,                       | 111   | 118    | 202   | 251   | 214   | 203    |
| Stocks,                         | H. K. Wick & Co.,                     |       | 155    | 278   | 213   | 190   |        |
| Stout,                          | Stoep & Nimmo,                        |       | 222    | 204   | 147   |       | 153    |
| Stearns,                        | Robert Smith,                         |       | 275    |       | 172   | 171½  | 144    |
| Shepler,                        | Ball, Lewis & Yates,                  |       | 289    | 294   |       | 288.5 | 300    |
| Smith,                          | Livingstone Coal Company,             |       | 144    | 261   |       | 215   | 175    |
| Sprague,                        | Stirling Coal Company,                |       | 156    | 86    |       |       |        |
| String No. 1,                   | Lehigh Valley Coal Company,           |       | 121    |       |       |       |        |
| String No. 2,                   | Stirling Coal Company,                |       |        |       |       |       |        |
| Sugar Camp No. 1,               | Stirling Coal Company,                | 226   |        |       |       |       |        |
| String No. 3,                   | Lehigh Valley Coal Company,           | 46    |        |       |       |       |        |
| Sugar Camp No. 3,               | do,                                   | 212   |        |       |       |       |        |
| Snider,                         | John Snider, Sr.,                     |       | 117    | 225   | 215   | 228   | 221    |
| Scottdale 1 and S. Company,     | Youghiogheny River Coal Company,      |       | 158    | 236   | 240   | 282   | 269    |
| Southwest,                      | Cumberland and Elk Lick Coal Company, | 255   | 190    | 208   | 50    | 179   | 194    |
| South Grassy Run,               | Brown & Cochran,                      |       | 233    |       |       | 206¾  |        |
| Schmingsrove,                   | McCleary Coke Company,                |       |        | 120   |       | 208   |        |
| Superior Nos. 1 and 2,          |                                       |       | 287    | 302   | 250   |       |        |

|   |   |     |     |     |     |         |
|---|---|-----|-----|-----|-----|---------|
| Starbardshire, . . . . .                | Youghiogheny River Coal Company, . . . . .      | 65  | 140 | 220 | 240 | 216     |
| Sandy Run, . . . . .                    | Sterling Coal Company, . . . . .                | 200 | 232 | 100 |     |         |
| Stearling No. 3, . . . . .              | Pittsburgh and Chicago Gas Coal Co., . . . . .  |     |     |     |     |         |
| Shawls, . . . . .                       | Cumberland and Elk Lick Coal Company, . . . . . |     |     |     |     | 197 1/2 |
| Shawnee, . . . . .                      | Summit Coal Company, . . . . .                  |     |     |     |     | 232 1/4 |
| Shawnee No. 2, . . . . .                | W. H. Piper & Co., . . . . .                    |     |     |     |     | 20      |
| Shawnee No. 11, . . . . .               | Stirling Coal Company, . . . . .                |     |     |     |     | 228     |
| Shawnee No. 12, . . . . .               | do. . . . .                                     |     |     |     |     | 115     |
| Sprithou No. 2, . . . . .               | Waverly Coal and Coke Company, . . . . .        |     |     |     |     | 143     |
| Starr or Towell, . . . . .              | Stonesburg Coal Company, . . . . .              |     |     |     |     | 80      |
| Stirling, . . . . .                     | West Park Coal Company, . . . . .               |     |     |     |     | 180     |
| Stooks No. 2, . . . . .                 | Sterling Mining Company, . . . . .              |     |     |     |     | 145     |
| Standard, . . . . .                     | J. D. Boyd Coal Company, . . . . .              |     |     |     |     | 120     |
| Summersville Nos. 1, 2 and 3, . . . . . | Standard Coal Company, . . . . .                |     |     |     |     | 150     |
| Turkey, . . . . .                       | Somersville and Buchanan, . . . . .             |     | 405 | 90  |     |         |
| Tip-Top, . . . . .                      | J. L. Turner, . . . . .                         | 220 | 262 |     | 300 | 305     |
| Tyone and Washington, . . . . .         | H. C. Frick Coke Company, . . . . .             | 382 | 246 |     | 310 | 70      |
| Trotter, . . . . .                      | Laughlin & Co., . . . . .                       | 501 | 300 | 189 | 296 | 243     |
| Turner, . . . . .                       | H. C. Frick Coke Company, . . . . .             |     |     | 310 |     |         |
| Turner, . . . . .                       | J. M. Turner, . . . . .                         |     |     |     | 90  | 355     |
| Turner, . . . . .                       | Thompson's Run Coal Company, . . . . .          |     |     |     |     | 210     |
| Turner, . . . . .                       | Hooper, Spees & Co., . . . . .                  |     |     |     |     |         |
| Turner, . . . . .                       | Clearfield Bituminous Coal Company, . . . . .   | 240 | 73  | 244 |     |         |
| Turner, . . . . .                       | do. . . . .                                     |     |     | 244 |     |         |
| Turner, . . . . .                       | John A. Wood & Sons, . . . . .                  | 112 | 180 | 226 | 125 | 154     |
| Turner, . . . . .                       | Central Coal Company, . . . . .                 |     |     | 226 | 290 |         |
| Turner, . . . . .                       | St. Mary's Coal Company, . . . . .              | 300 | 303 | 89  |     |         |
| Turner, . . . . .                       | J. W. Cook, . . . . .                           |     |     | 75  |     |         |
| Tyone, . . . . .                        | Laughlin & Co., Limited, . . . . .              | 172 | 164 | 251 |     | 292     |
| Tab Hill Mine, . . . . .                | Fairview Coal Company, . . . . .                | 187 | 212 | 235 | 208 | 86      |
| Thomas Mine, . . . . .                  | Thomas & Shihl, . . . . .                       | 220 | 223 | 235 | 204 | 223     |
| Tipton, . . . . .                       | J. M. Turner, . . . . .                         | 282 | 85  | 272 | 238 | 93      |
| Tyler, . . . . .                        | do. . . . .                                     |     | 240 |     |     | 100     |
| Troy, . . . . .                         | R. E. Wigton & Son, . . . . .                   |     | 230 | 260 | 155 | 78      |
| Taylor, . . . . .                       | Isaac Taylor & Co., . . . . .                   |     |     | 116 | 137 | 196     |
| Upper Walton, . . . . .                 | Joseph Walton & Co., . . . . .                  | 220 | 90  |     |     | 100     |
| Union Coal and Coke Mine, . . . . .     | Union Coal and Coke Company, . . . . .          | 86  | 178 | 207 | 280 | 148     |
| Uniondale, . . . . .                    | J. M. Reid, . . . . .                           | 270 | 280 | 189 | 184 | 76      |
| Union, . . . . .                        | United Coal and Coke Company, . . . . .         |     |     |     | 194 | 79      |
| Union, . . . . .                        | do. . . . .                                     |     |     |     | 188 |         |
| Union, . . . . .                        | McCure & Co., . . . . .                         | 247 | 281 | 209 | 583 | 150     |
| Union, . . . . .                        | Snowden & Simpson, . . . . .                    | 180 | 245 |     | 556 | 46      |
| Union Valley, . . . . .                 | J. D. Boyd & Co., . . . . .                     | 260 | 228 | 130 |     | 101     |
| Union No. 1, . . . . .                  | Henry Floresheim, . . . . .                     | 238 | 283 | 175 | 147 | 101     |
| Union No. 2, . . . . .                  | Urey Ridge Coal Company, . . . . .              |     |     |     | 147 | 106     |
| Union No. 3, . . . . .                  | Gray & Bell, . . . . .                          |     |     | 209 |     | 154     |
| Venture, . . . . .                      | David A. Anderson, . . . . .                    |     | 216 |     | 231 | 193     |
| Venetia, . . . . .                      |   |     |     |     |     |         |







---

---

# ANTHRACITE MINE DISTRICTS.

---

---

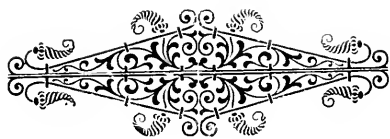



# FIRST ANTHRACITE DISTRICT.

(LACKAWANNA AND SUSQUEHANNA COUNTIES.)

---

Scranton, Pa., April 15, 1895.

Hon. Isaac B. Brown,

Secretary of Internal Affairs, Harrisburg, Pa.

Sir: I have the honor of herewith transmitting to you my annual report as Inspector of Mines for the First Anthracite District, for the year 1894.

The total number of tons of coal produced was 5,907,251 or 294,880 tons less than the production of 1893.

The fatal accidents were 47, the non-fatal 98, making four fewer of the former than occurred in the previous year, and an increase of two of the latter for the same period.

Twenty-four wives were made widows and eighty-three children made fatherless by the accidents.

There were 125,686 tons of coal produced per life lost, against 121,630 in 1893. The number of tons of coal produced per accident, fatal and non-fatal, was 40,746.

The average number of days worked was 171.9 against 195.3 in 1893.

There has been no material change in the general condition of the mines during the year, except in a few cases where air shafts have been sunk to improve the ventilation.

In addition to the usual tabulated statements, the report contains brief descriptions of improvements, also of the majority of the fatal accidents, with brief notes on the cause of many of them, together with some remarks on the system of "robbing pillars" in this district, and a description of the Lackawanna mine fire and the successful rescue of the fourteen men who were in the mine at the time.

Respectfully submitted,

EDWARD RODERICK,

Inspector.

## Total Quantity of Coal Produced During the Year 1894.

|   |                  |
|---|------------------|
| Delaware and Hudson Canal Company,.....                       | 2,029,522        |
| Hillside Coal and Iron Company, .....                         | 829,097          |
| Delaware, Lackawanna and Western Railroad Com-<br>pany, ..... | 403,322          |
| Lackawanna Coal Company, .....                                | 279,649          |
| Pennsylvania Coal Company, .....                              | 241,254          |
| Edgerton Coal Company, .....                                  | 203,175          |
| North West Coal Company, .....                                | 222,011          |
| Pancoast Coal Company, .....                                  | 203,838          |
| John Jermyn, .....  | 177,338          |
| New York and Scranton Coal Company, .....                     | 177,151          |
| Jones, Simpson & Co., .....                                   | 212,873          |
| Elk Hill Coal and Iron Company, .....                         | 226,716          |
| Miscellaneous Coal Companies, .....                           | 701,304          |
| <b>Total, .....</b>   | <b>5,907,251</b> |

**NUMBER OF FATAL ACCIDENTS AND QUANTITY OF COAL PRODUCED PER  
LIFE LOST.**

| Names of Companies.                                      | Number<br>of fatal<br>acci-<br>dents. | Number of<br>tons of coal<br>produced<br>per life lost |
|--|---------------------------------------|--|
| Delaware and Hudson Canal Company, .....                 | 9                                     | 225,502  |
| Hillside Coal and Iron Company, .....                    | 7                                     | 118,442  |
| Delaware, Lackawanna and Western Railroad Company, ..... | 4                                     | 160,851  |
| North West Coal Company, .....                           | 3                                     | 74,001   |
| Lackawanna Coal Company, .....                           | 3                                     | 93,217   |
| Blue Ridge Coal Company, .....                           | 3                                     | 50,297   |
| Jones, Simpson & Co., .....                              | 3                                     | 70,958   |
| New York and Scranton Coal Company, .....                | 4                                     | 41,288   |
| Elk Hill Coal and Iron Company, .....                    | 6                                     | 37,786   |
| Miscellaneous coal companies, .....                      | 5                                     | 254,880  |
| <b>Total and average, .....</b>                          | <b>47</b>                             | <b>127,686</b>   |

**NAMES OF COMPANIES AND NUMBER OF FATAL AND NON-FATAL ACCIDENTS  
AND TONS OF COAL PRODUCED PER ACCIDENT.**

| Names of Companies.                                      | Number of accidents fatal and non-fatal. | Number of tons of coal produced per accident. |
|--|--|---|
| Delaware and Hudson Canal Company, .....                 | 40                                       | 50,761  |
| Hillside Coal and Iron Company, .....                    | 26                                       | 31,888  |
| Delaware, Lackawanna and Western Railroad Company, ..... | 8  | 50,415  |
| Northwest Coal Company, .....                            | 6  | 37,003  |
| Lackawanna Coal Company, .....                           | 5  | 55,930  |
| Blue Ridge Coal Company, .....                           | 7  | 21,517  |
| Jones, Simpson & Co., .....                              | 3  | 70,958  |
| Edgerton Coal Company, .....                             | 5  | 40,635  |
| New York and Scranton Coal Company, .....                | 6  | 29,525  |
| Elk Hill Coal and Iron Company, .....                    | 10                                       | 22,672  |
| Mt. Jessup Coal Company, .....                           | 6  | 17,680  |
| John Jermyn, .....                                       | 10                                       | 17,734  |
| Pancoast Coal Company, .....                             | 5  | 49,767  |
| Miscellaneous coal companies, .....                      | 8  | 85,232  |
|  | <b>145</b>                               | <b>40,746</b>                                 |

**Number of Employes and Average Number of Tons Produced per  
Employee.**

|  |               |
|--|---------------|
| Delaware and Hudson Canal Company,.....                  | 5,066         |
| Hillside Coal and Iron Company, .....                    | 2,140         |
| Delaware, Lackawanna and Western Railroad Company, ..... | 916           |
| Lackawanna Coal Company, . . . . .                       | 609           |
| Pennsylvania Coal Company, .....                         | 695           |
| Edgerton Coal Company, .....                             | 459           |
| North West Coal Company, .....                           | 556           |
| Pancoast Coal Company, .....                             | 661           |
| John Jermyn, .....                                       | 528           |
| New York and Scranton Coal Company, .....                | 536           |
| Jones, Simpson & Co., .....                              | 733           |
| Elk Hill Coal and Iron Company, .....                    | 437           |
| Miscellaneous Coal Companies, .....                      | 2,678         |
| <b>Total, .....</b>                                      | <b>16,014</b> |

Number of tons of coal produced per employe, ..... **368.8**

## CLASSIFICATION OF ACCIDENTS.

| Causes of Accidents.                     | Killed or fatally injured. | Injured.  | Total.     |
|--|----------------------------|-----------|------------|
| By falls of coal and bone, .....         | 11                         | 9         | 20         |
| By falls of ordinary roof rock, .....    | 12                         | 26        | 38         |
| By falls of bell-shaped rocks, .....     | 7                          | 2         | 9          |
| By falling down shafts, .....            | 3                          | 1         | 4          |
| By premature explosion of blast, .....   | 1                          | 11        | 12         |
| By explosions of gas, .....              |                            | 2         | 2          |
| By cars inside, .....                    | 6                          | 27        | 33         |
| By cars outside, .....                   | 2                          | 1         | 3          |
| Kicked by mules, .....                   | 2                          | 1         | 3          |
| Struck by flying coal from blasts, ..... |                            | 3         | 3          |
| By explosions of powder, .....           | 1                          | 2         | 3          |
| By falls of dividing rock, .....         |                            | 2         | 2          |
| Miscellaneous, inside, .....             |                            | 3         | 3          |
| Miscellaneous, outside, .....            | 2                          | 8         | 10         |
| <b>Total, .....</b>                      | <b>47</b>                  | <b>98</b> | <b>145</b> |

## OCCUPATION OF PERSONS KILLED AND INJURED.

| Occupation.                 | Killed or fatally injured. | Injured.  | Total.     |
|-----------------------------|----------------------------|-----------|------------|
| Miners, .....               | 15                         | 33        | 48         |
| Miners' laborers, .....     | 16                         | 27        | 43         |
| Drivers, .....              | 7                          | 10        | 17         |
| Runners, .....              |                            | 8         | 8          |
| Door tenders, .....         | 1                          | 6         | 7          |
| Company laborers, .....     |                            | 5         | 5          |
| Footmen, .....              |                            | 1         | 1          |
| Headmen, .....              |                            | 2         | 2          |
| Slate pickers, .....        | 4                          | 1         | 4          |
| Shaft sinkers, .....        | 1                          |           | 2          |
| Driver boss, .....          | 1                          |           | 1          |
| Stable boss, .....          |                            | 1         | 1          |
| Rock man, .....             | 1                          | 1         | 2          |
| Locomotive firemen, .....   | 1                          |           | 1          |
| Locomotive engineers, ..... |                            | 1         | 1          |
| Plane men, .....            |                            | 1         | 1          |
| Carpenters, .....           |                            | 1         | 1          |
| <b>Total, .....</b>         | <b>47</b>                  | <b>98</b> | <b>145</b> |

## NATIONALITY OF PERSONS KILLED AND INJURED.

|                                  | Irish.    | American. | Polish.   | Austrians. | Russians. | Italian. | German.  | Slovakish. | English.  | Welsh.    | Haytian. | Hungarian. | Greek.   | Total.     |
|----------------------------------|-----------|-----------|-----------|------------|-----------|----------|----------|------------|-----------|-----------|----------|------------|----------|------------|
| Killed or fatally injured, ..... | 8         | 2         | 13        | 2          | 1         | 2        | 2        | 2          | 7         | 6         |          | 2          |          | 47         |
| Injured, .....                   | 26        | 18        | 13        | 5          | 1         |          | 4        | 3          | 9         | 9         | 1        | 2          | 1        | 98         |
| <b>Total, .....</b>              | <b>34</b> | <b>20</b> | <b>26</b> | <b>7</b>   | <b>2</b>  | <b>2</b> | <b>6</b> | <b>5</b>   | <b>16</b> | <b>15</b> | <b>1</b> | <b>10</b>  | <b>1</b> | <b>145</b> |

## Improvements of 1894.

## Delaware and Hudson Canal Company.

At the Leggetts Creek shaft a new plane 500 feet long, with a sectional area of 112 square feet and a grade of one in fifteen, was completed.

At the Marvine the Clark vein which is five feet 6 inches thick and of very good quality was opened up. The second opening slope which was begun in 1893 was completed from the 14-foot vein to the surface, a distance of 384 feet.

It has an area of 98 square feet and a grade of "one in four." It is also used for a down cast for air.

At the Grassy Island mine a new plane 400 feet long on a grade of 12 degrees was completed.

A new tunnel was driven from the surface to the number 2 vein at White Oak. It is 507 feet long.

The vein here is 3 feet 6 inches thick.

A new fan is also in course of erection to ventilate all the White Oak workings.

At Coal Brook, near the face of the present workings, a new shaft was sunk a distance of 87 feet, for the purpose of ventilation.

A new tunnel was also driven at this mine from the surface to the bottom coal, cutting a five-foot vein at a distance of 100 feet.

#### Lackawanna Coal Company.

A tunnel 550 long having a sectional area of 84 square feet was driven by this company from the surface to the lower Dunmore vein, which is four and one-half feet thick.

A shaft for the purpose of ventilation was also sunk from the surface to this vein, a distance of 190 feet.

#### Delaware, Lackawanna and Western Railroad Company.

At Storr's mine, a tunnel 6x12 and 750 feet long was driven from the "big" vein to the Diamond.

A new plane 450 feet long on a grade of 11 degrees was also made.

At Storrs No. 3 two new planes were made, one 450, the other 500 feet long.

#### John Jermyn.

At Jermyn No. 3 a tunnel is being driven north across the measure. It is now 600 feet long and is expected to go 900 feet more to cut the lower Dunmore vein.

The coal from this new opening will be brought to the surface through the slope.

A shaft through which the tunnel workings will be ventilated has been sunk to the vein, a distance of 120 feet.

The vein at this point is reported seven feet thick and of good quality.

A new plane 450 feet long has also been made in this mine. It has a pitch of 12 degrees.

### Pennsylvania Coal Company.

A new shaft 12x24 feet and 55 feet deep was sunk by this company. It is used as an air shaft and also for hoisting coal from the third Dunmore vein, which is five feet thick. An exhaust fan 17½ feet in diameter, with a five-foot face, run by a horizontal engine having 14x26 cylinder has been put in.

A new tunnel was also driven from the surface to the second Dunmore vein which vein is also five feet thick.

### Elk Hill Coal and Iron Company.

Completed the sinking of their Richmond No. 3 shaft from the 14-foot vein to the Clark. Also sunk their second opening from 14-foot to Clark vein, a distance of 160 feet. Dimensions 10x12 feet.

### Moosic Mount Coal Company.

A new shaft was sunk by this company from the surface to the Lower Dunmore vein, a distance of 175 feet. Dimensions 14x20½.

The vein here is three feet eight inches thick.

They also drove a tunnel from the surface to the same vein, a distance of 1,000 feet. Dimensions 6x12 feet.

The tunnel will be connected with the shaft workings in course of time. In the meantime a new air shaft has been sunk to ventilate the tunnel workings.

Waddell & Son sunk a new air shaft to the Archbald vein. Depth 98 feet. Area 120 square feet.

### Pancoast Coal Company.

This company sunk their main hoisting shaft, also their man shaft from the bottom split of the "14-foot" to the Clark vein, a distance of 160 feet. Dimensions of the former 10x34 feet; of the latter 10x14 feet. They are opening up the Clark vein, which is of excellent quality, and runs from five to five and a half feet thick.

---

Hillside Coal and Iron Company,

Scranton, Pa., April 10, 1895.

Mr. Edward Roderick,

Inspector of Mines, Scranton, Pa.:

Dear Sir: The following is a statement asked for about the drum and fan, the drawing of which I gave you some time ago:

The drum with fan attached, as shown in adjoining illustration, is for the purpose of handling coal on self-acting planes without the use of a brake, except for the purpose of holding up the trip when it ar-



*Front view*

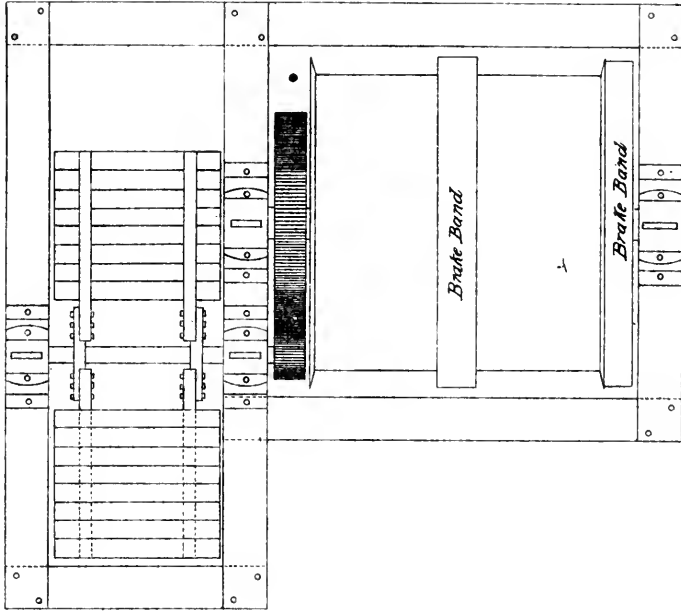

# DRUM AND FAN

IN USE ON NO 1 GRAVITY PLANE

GLENWOOD COLLIERY

MAYFIELD, PA.

SCALE  $\frac{1}{2}'' = 12'$

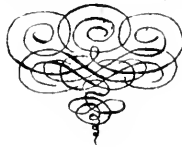

*Montrose, Barnard, Esq. Pittsford, Conn. & Iron Co.  
Scranton, Pa.*



A  
Grid View

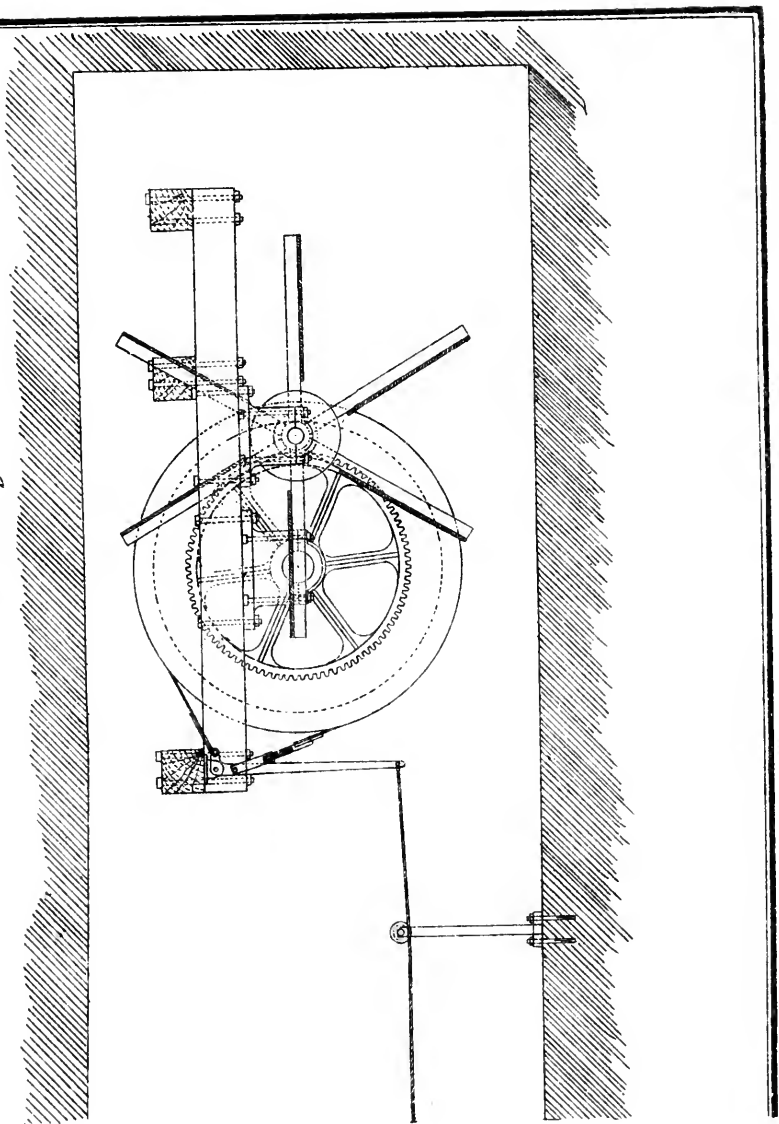



rives at the foot. This is now in use at the Hillside Coal and Iron Company's Glenwood colliery.

The plane is 1,100 feet long with a grade of 28 feet to the hundred. The trip consists of five mine cars, each containing 5,600 pounds of coal. The rope used is 1 1/8 steel with hemp center. The speed of the trip is about 1,100 feet per minute, or about 12 1/2 miles per hour. While the trip is run, no brakes are used, although there are two on the drum to be used in an emergency.

The drum is the ordinary type 8 feet in diameter, with three spiders, as are commonly used on balance planes. On the drum shaft there is a 90 cog steel gear which runs with an 18 cog gear on the fan shaft. The fan is eleven feet outside diameter with six blades each, being 4 feet by 4 feet 6 inches, made of three-quarter-inch pine flooring. The arms of the fan are 4x4 inch oak attached to spider, as shown on the sketch.

This was introduced by Mr. M. M. Walsh the inside foreman at Glenwood colliery.

Very truly yours,

MONTROSE BARNARD.

Engr. H. C. & I. Co.

### Pillar Robbing.

The robbing of pillars has been and is being done in several of the mines of this district previous to their abandonment.

The veins in which this work has been going on during the year run from three to fourteen feet thick and are all perfectly flat or nearly so. Veins of this kind are, in my opinion, the safest, most convenient and economical to do "robbing" in, and especially so when the veins are not very deep in the ground, as is the case in most of the mines in this locality. It is true that every occupation in the coal mines, as well as other callings, has its own peculiar danger which must at all times be cautiously guarded against so as to avoid as far as possible serious or fatal accidents.

The dangers of pillar robbing in most cases are no greater than those of ordinary coal mining, but the general belief is that they are greatly in excess of those of mining. But this is not correct so far as this district is concerned, for where pillars are taken out carefully and systematically in flat veins, the proportion of accidents to the number of tons produced in this way is far less than by the ordinary every day methods of mining.

During the year not one person lost his life by a fall of roof where pillars were being taken out, but three were killed by falls of top coal while thus engaged.

Two of these were instantly crushed to death at the North West Coal Company's slope by a fall of top coal on the gangway road, which occurred while they were in the act of trying to bar it down.

The other met his death at Edgerton, also by a fall of top coal in which a shot had recently been fired, which had failed to blow it down, but had shattered it so badly that it fell by its own weight shortly after the unfortunate man had reached the face.

Coal is being taken from the pillars in many of the mines of this district by three different methods.

In the first place, when the gangways in certain parts of a mine have been driven to the boundary line, and the breasts have all been worked to their limit, if robbing is to be done at all, it is usually commenced as soon as the solid coal has been exhausted, and while the roads are still intact.

The work is commenced on the inside pillar at the face of the furthest breast. Sometimes two or even three of the innermost blocks or sections of pillars are removed simultaneously, but not, however, before the breasts on either side of the pillar to be removed have been carefully and securely propped or timbered.

Breasts, as a rule, are driven from three to seven hundred feet in length and sometimes longer than this, with cross-cuts from one to the other through the pillar every fifty or sixty feet. The width of the breasts varies from seven to ten yards according to the nature and condition of the roof and thickness of vein, and the pillars run from five to eight yards as a general thing.

After the removal of the upper "stumps" or sections has been accomplished, holes are then bored with an auger in the props "stood" to ensure safety before the "robbing" began, and giant powder or other explosive is placed in the holes and blasted by an electric battery or other efficient means. This operation brings on a fall of roof, which usually breaks off close to the pillar next to be removed, and thus taking off the "squeeze" from the surrounding pillars; when robbing is again commenced and the same process repeated and continued until the gangway is reached.

If the vein is thick, and the top coal has been left up on the gangway when being driven, it is now taken down and loaded and this part of the mine is abandoned.

Secondly, where the roof is very bad and it is not desired to bring on a fall or cave-in to the surface, and if the cross-cuts have been driven regularly every sixty feet, and only a portion of the coal is to be taken from the pillars, it is the rule in such cases to take a block of twenty feet from the centre, leaving on each side a "stump" of twenty feet. In mines where the pillars are large and uniform, and where it is not practicable to take them all out, a "skip" of two or

three yards is very frequently taken off from the gangway road to the face of the breasts, leaving from five to six yards of solid pillar, the entire length of the breasts to support the overlying roof and thus avoid bringing on a general "squeeze," which would in all probability let in large quantities of water from the strata as well as from the surface which would again have to be pumped out, and thus entail expense and much inconvenience.

Where robbing is commenced in drifts which have been driven in under the mountains, they are known as water-level workings, from which the water flows out as freely as it flows in, and over which there are no valuable properties, it is done with the intention of making as clean a sweep of the coal as is consistent with safety. With this object in view the work is commenced at the furthest end of the workings. The first thing done, as said before, is to stand a goodly number of props to secure the surrounding roof, and also to serve as indicators of approaching danger from falls.

The roof in shallow mines in the vicinity where pillows are being taken out is supported entirely by these props until such time as two or more "stumps" or blocks of pillars have been removed. This done, a cave-in is now brought on by blasting out the props and the former operations renewed and thus continued until all available coal has been removed.

As previously stated, the number of accidents that occur while robbing pillars in veins, such as I have mentioned, are fewer in proportion to the number of tons mined than by the ordinary, every day methods of mining coal. About half a million tons of coal were obtained from pillars in this district during the year 1894, and not one person was killed by a fall of rock while thus employed.

However, on the 27th of September, four men at the old slope of the North West Coal Company miraculously escaped from being instantly crushed to death by an extensive fall of roof which occurred while they were engaged in taking out a pillar. The miners were the most experienced in the mine, and for this reason were employed at this particular work.

About noon on this day John Wilce, the man who had charge of this work, called his principal miner's attention to the condition of a crack or water seam that was running up perpendicularly through the rock roof. Wilce thought the seam had opened somewhat during the day, but J. J. Fanning, the miner whom he consulted, and who is a very careful, intelligent and practical man, said he did not think there was any change in its condition, and went about his work, paying no further attention to it.

He and another miner named W. B. Mitchell, along with their two laborers were busily engaged loading a car which was to have been

their last from this pillar, when they heard the roof "working" at a point about sixty feet outside of where they were employed.

At the same moment, so they say, it began to fall in large flakes. Realizing their awful situation and knowing it would mean instant death to them to try to escape by running out the gangway. They instantly made their way through a cross-cut leading into a chamber, the pillars of which were intact.

Here, close against the face of this chamber, they were compelled to stay and in dreadful suspense listen to the thunderous sounds of the falling masses of rock, expecting every moment to be their last as the fall came nearer and nearer to them.

At last, when within ten feet of where they were closely huddled together, the falling ceased, and with it the fear of instant death that had been for half an hour or more staring them in the face.

This was about three o'clock, Thursday, September 27. Soon after willing and eager hands were hard at work to recover, as all supposed, the dead bodies of the unfortunate men.

It was thought by all that they had been caught and instantly crushed to death near the car which they were loading. But this fear was happily dispelled when, about 11 o'clock on Friday, the men at work heard a faint rap; but failing after many successive efforts to get a second sound from them, many again feared that they were surely dead.

However, during Friday and Friday night the work of rescue was carried bravely on with all possible dispatch, and by Saturday morning a narrow passage seventy feet in length had been made through the fallen rock, going as it suited them best, sometimes on top of the fall, then again between large flakes of rock, and oftentimes burrowing their way through where the most speed could be made with the least labor.

The car which the men were known to have been loading when the fall occurred was reached about 8 o'clock Saturday morning, but no trace of the men was to be seen here.

It was not long after this that one of the workmen again rapped on the rock and received a response from one of the entombed men. The rescuers, now assured that at least one of them was alive, redoubled their efforts. About three o'clock in the afternoon sufficient headway had been made so that a conversation could be held with the prisoners, and it was now learned that all four were alive and uninjured.

This was joyful news and their rescue was an assured fact and but a matter of a few hours when they would be rescued from their uncomfortable situation alive and safe.

The work of rescue from now on was pushed with increased force.

No unnecessary risks, however, were taken, yet the work was urged with all possible speed, with the utmost care, precaution, system and safety to all who were engaged in the dangerous task.

About 9.45 P. M. the entombed men were reached and safely rescued, after having been shut off from the world for fifty-five hours.

A physician was at hand and after they had been given some light food and stimulants according to his directions they were conveyed to their homes and families, and in a few days were all at work again after a most thrilling and awful experience. A close and careful examination of the surroundings revealed the immediate cause of so sudden and extensive a fall. At a point sixty or seventy feet outside of where the men had been working during the day, the water seam running up into the roof had been noticed and watched for several days for any indications of opening. Another seam of a similar nature was brought to view during the day by blasting the coal from the pillar. This also ran up into the roof and parallel with the first discovered, thus leaving a mass of roof seventy feet wide and about one hundred feet long with a loose end on the lower side, supported by props and several "stumps" of pillars which would have been sufficient support had it not in one solid body moved down toward the end that was broken off and thus dislodged the props and crushed the pillars which had been left as supports for it.

Water cracks are frequently met with in the roof of the shallow mines of this locality, and when it becomes necessary to remove the pillars in such places, it is done with all care and precaution, so as to guard against any possible danger. Sometimes, however, long immunity from injury in this kind of work, as in any other, leads men to over confidence, and to taking unnecessary risks, causing them to have frequent narrow escapes, and finally resulting in their death.

---

### Lackawanna Mine Fire.

About half past ten o'clock on the night of December 28, a fire which for a time seriously threatened the lives of fourteen men, was discovered in the Lackawanna Coal Company's shaft by David Myles, a miner, who was on his way into the mine, being on the eleven o'clock shift. He got as far as the main door near the foot of the hoisting shaft, and on opening it discovered dense volumes of smoke coming out of the main gangway.

He hastened with all possible speed to the surface and gave the alarm. Soon after Outside Foreman William Harper and mine foreman John Berkheiser, together with a large force of workmen were

on the scene. They first went down the main shaft to ascertain, if possible, where the fire was, but failed to go any further in the gangway than to the main door.

They then returned to the surface and hurried to the air shaft, about 2,700 feet distant in a northeasterly direction. Here they found the ladders covered with ice. This was removed as rapidly as possible, and the way was clear to descend into the mine. The foreman and his assistants carefully descended into the shaft and soon learned that the slope engine house, located about two hundred feet from the foot of the air shaft was a seething mass of flames, and the smoke backing up through a cross-cut into the main intake was carried by the air down into the workings where the men were known to be.

The Inspector, who had been sent for in an hour after the fire was discovered, now arrived at the mine and at once descended to the scene of the fire.

After a hasty consultation with Foreman Berkheiser and David C. Evans, his assistant, it was decided that there was but one thing to be done to save the lives of the men, and that was, to prevent as quickly as possible, with what means we had at hand, the smoke from going into where they were. To accomplish this end, all efforts were now directed. In the first place it was necessary to construct a brattice across the main inlet below the hole through which the smoke was issuing in a great volume, notwithstanding that the fan had been speeded up to its extreme limit, with very good results.

The object of the brattice was to divert the course of the air from the main inlet to the cross-cut from where the smoke was coming, and thus force it to the main road, and thence to the up-cast. While material was being obtained for the brattice an effort was made to close the cross-cut with rock, but this was ineffective, as the smoke forced its way through it.

In a short time, however, the brattice cloth was on hand and very promptly placed in position with good results, as the volume of smoke forcing its way back was greatly reduced.

It was now three o'clock in the morning and as yet no water of any account had been obtained.

The Excelsior Hose Company of Olyphant was sent for as soon as the fire was discovered and responded with commendable promptness, but found when they arrived that they could do nothing, as the hydrant within two hundred feet of the air shaft was frozen and useless, and the nearest one to it was one thousand feet away with only 800 feet of hose at hand. Word was now sent to the man in charge of the Peckville Hose Company's hose, and the terrible situation of the men in the mine described to him. Yet, for some rea-



son he sternly refused to give up the hose to aid in fighting the fire in an effort to save fourteen precious lives.

On his refusal to listen to an appeal for the hose, word was hastily sent to the Eagle Hose Company, of Priceburgh, Pa., but in the meantime the boiler fires at the air shaft were damped, and a two-inch hose connected to the boiler injector, and soon a small but valuable stream of water was being thrown on the fire. Half an hour later the Priceburgh hose arrived and was promptly put to good service by the firemen, who worked bravely in an atmosphere six degrees below zero.

The smoke was soon prevented from going to the men, and in about an hour afterward the men who were thought to have been suffocated many hours before, came walking out to meet those in search of them, who eagerly grasped their hands and rejoiced to see them, who, as it were, came through the very jaws of death uninjured and apparently none the worse for their most thrilling experience of seven hours.

The origin of the fire has not been definitely ascertained, but it is generally supposed to have started from the mine lamp of Frank McCabe, one of the engineers, who had occasion to go into the engine house to seek some bolts to repair a pump, and in looking around for these a spark must have fallen from his lamp into some cotton waste, or else by looking on a lower shelf of a closet in which such things were kept he set fire to the upper one. Not finding what he was looking for, he immediately left for the shaft on the outside of the mine, and on returning to the scene of his operations he detected strong odors of smoke coming out of the gangway, and a few minutes later discovered the engine house in which he had been half an hour previous a roaring mass of flames. Now occurred an act of bravery and heroism not surpassed even on the battlefields, but which cannot be fully comprehended nor appreciated by any save those conversant with the scene and circumstances.

McCabe, who when he first discovered the fire could have made his escape, but instead, chose to sacrifice this opportunity, and without a moment's hesitation and after informing Frank Bennie, the other engineer, of the fire, they both hastened to the remote parts of the mine to warn their fellow men of the great danger which threatened them, and took their chances with them of ever coming out of the mine alive.

To this brave and noble act, the cool headedness and intelligence of Patrick Brennan, Charles Williams and William Evans, is due the saving of their own lives and the lives of nine others who were in the mines with them. This shows the importance of having intelligent men in mines at all times. The story of their awful experience

as told by themselves is as follows: "As soon as we learned of the fire we dropped our tools and our first thought was of escaping through the air shaft, and towards this we wended our way. The smoke was quite thick and made some of us sick. The nearer we came to the shaft the denser the smoke became and we soon learned that we could not make our way out in that direction. We now held a consultation and decided to make our way back to the furthest parts of the mine, and to leave all doors open behind us, knowing as we did that there was no danger of any accumulation of gas, and that the air in these remote parts would remain pure for several hours at least. The doors being left open, the smoke laden air would return by the shortest route to the up-cast and we would in this way escape it.

We were not here long, however, before one of the party who went out the gangway to explore, returned with the news that the smoke was gradually settling towards us, but that it was not as thick as it had been. We now concluded that something had to be done at once to prevent the smoke from coming to us.

So we began to build a wall across the heading with the material we had convenient. We soon had this in place and felt that we were comparatively safe for some hours at least, and living in hopes that we would yet be rescued.

For several hours we remained behind this barricade in dreadful suspense, thinking of home and dear ones, and suffering intensely from cold, as the most of us had escaped, leaving our heavier garments behind.

About half-past four o'clock in the morning we ventured out along the gangway and found to our great joy that the smoke had disappeared. We continued on our course and soon found ourselves rejoicing with those who had worked all night to rescue us." It surely was a very happy ending of what at one time threatened to be one of the saddest accidents in this locality.

The men having been rescued, all efforts were then directed to extinguishing the fire. More hose was obtained and soon after the men were able to get down on the main gangway, inside of where the fire was raging, and in a very short time had it under control, and it was entirely extinguished by eight o'clock Sunday morning, December 30. During the entire time spent in fighting the fire, no one was permitted to take any unnecessary risks, but on the other hand, every precaution was constantly exercised to prevent accidents by fire and falls of rock, which so frequently occur when the roof in the vicinity of a fire is cooling off and contracting.

#### Mine Foreman's Examination.

The Board of Examiners of applicants for mine foremen's certificates of qualification, consisting of A. P. Patten, Superintendent

Vaughan Richards and James E. Morrison, miners, together with the District Inspector, held its examination at Carbondale, Pa., on the tenth and eleventh of July.

Those who were recommended to receive mine foremen's certificates were the following:

W. G. Noyles, Nanticoke.  
 David C. Evans, Olyphant.  
 Andrew Kennedy, Olyphant.  
 John T. Lynch, Carbondale.  
 Peter Pinkney, Dunmore.  
 W. H. Jenkins, Scranton.  
 L. M. Evans, Scranton.  
 David M. Jones, Peckville.  
 M. M. Hughes, Plymouth.  
 John J. Walsh, Mayfield.  
 J. A. Kearney, Archbald.  
 S. J. Jennings, Forest City.

Those who received assistant mine foremen certificates were:

James B. Williams, Olyphant.  
 Thos. P. Lally, Mayfield.  
 George Barron, Scranton.  
 W. J. Williams, Priceburgh.  
 Luther Edwards, Scranton.  
 Christopher Campbell, Scranton.  
 Absalom G. Jones, Scranton.  
 William Hodgson, Scranton.  
 Thos. G. Edwards, Scranton.  
 William G. Richards, Scranton.  
 Andrew Nicholas, Scranton.  
 Morgan Morgan, Scranton.  
 Joseph T. Moore, Priceburgh.  
 James Clark, Carbondale.  
 D. J. Richards, Peckville.  
 W. H. Chapman, Peckville.  
 Reuben Morgan, Dickson City.  
 Gomer Parry, Dickson City.  
 Alonzo D. Richards, Winton.  
 John S. Evans, Throop.

---

### Description of Fatal Accidents.

#### Accidents by Cars.

At the Lackawanna Coal Company's shaft on the third of January, a Polish laborer, 32 years of age, named John Mankoska, was struck

by a trip of loaded cars while walking on a gravity plane and instantly killed. It was his first day in this mine and from the evidence of John Berkheiser, the mine foreman, it was learned that he had quit work between three and four o'clock and started on his way home. A plane 1,200 feet long has to be traveled before reaching the shaft level gangway on which a trip of five cars was hoisted every half hour. No person was permitted to travel this way while cars were in motion, special orders to this effect having been issued by the foreman and the writer to the headman four months previous to this accident.

At the head of this plane there is a safety hole made in the rib in which the headman kept his oil and he had been in there putting some oil into a small can from a larger one just a few minutes previous to hearing of the accident. Mankoska being a stranger in the mine, and therefore not accustomed to its rules, must have passed during the headman's short absence and walked down the plane about 800 feet, and hearing the noise of cars stepped to one side to let them pass. It would seem from the foot prints made in the culm on one side of the plane that after the empty trip had passed up he walked to the centre of the down track before the loaded trip had passed and was struck, knocked down and dragged about 200 feet before his body was discovered by the footman in a horribly mangled condition. Patrick Cowley, the headman, stated that he had not been ten feet away from the head of the plane during the day. He had neither seen the man go down nor did he know anything of his being on the plane until he was informed by the footman that a man had been killed thereon.

Enoch Thomas, the footman, stated that from the place where he gives the signal to hoist he can see a light at a distance of 500 or 600 feet up the plane, but that he saw no light before nor after giving the rap to hoist, and knew nothing of any one's being on the plane until he heard a shout from the man as he was struck.

#### Car Accident.

Michael Yeudets and Joseph Wavra, two company laborers employed loading culm at the Forest City breaker, were fatally injured by a runaway car on a culm plane on the 10th day of January. The accident was caused by the breaking of a hook, as a car filled with ashes was nearing the head. The former died from his injuries in about four hours; the latter lived until the seventeenth of the month.

In my examination made on the following day I learned from the footman that the two men had been repeatedly told to keep away from the foot of this plane when a car was ascending or descending

upon it. Instead of doing as they had been told, they began to load a culm car directly at the foot of the plane while a loaded car was being hoisted thereon.

When the car had reached within a few feet of the top, the hook broke and the car dashed to the bottom and struck the two unfortunate men before they could get out of the way.

John F. Gallagher, the outside foreman, stated that he had many times given orders to all who worked under the breaker to keep away from the foot when cars were being hoisted on this plane.

J. D. Caryl, the outside superintendent, also stated that the above was a well known standing order, which was frequently repeated by himself as he passed under the breaker. Had these men not violated an established rule adopted to insure their safety they in all probability would have been uninjured by the breaking of the hook.

David Reese, a Welsh driver, 19 years of age, was fatally injured at Storr's No. 2 on the first day of May by falling under a trip of two cars.

I made an investigation on the following day, and learned from Thomas Williams, an old man whose duty it was to tend a door nearby where the accident occurred, that young Reese a few seconds before he was hurt was standing on the right side of the track where there is five feet of space between the track and the rib.

He had stopped his trip here for a short time to wait for orders to "pull out." Having received word to start, he shouted at the mule, who, instead of starting began to balk and turned around and got between the first car and the rib. Reese shouted to Amos Hamfield, the runner, who was standing at the rear end of the trip, to drive the mule back. He did so, then sat on the bumper of the rear car.

The mule started and the boy attempted to step across the stretcher to the left side, and must have stumbled and fallen under the cars or between them and the rib on the left, which was very close at this point.

He was taken from under the car as quickly as possible by Williams and Hamfield and in a short time placed in a car, where he died on the way to the foot of the shaft.

At Storrs No. 3 shaft, on the eleventh day of June, an Irish Company laborer 30 years of age, named Michael J. Walsh, was instantly killed by falling under a loaded car.

In my investigation made on the following day it was found that his work was that of timber man, but for three or four days had filled the place of a runner who was ill.

At the time he was killed he was engaged in running a car out of a chamber. John Smith, the laborer whose car he was running, and who was present when the accident occurred, stated that Walsh had

put in one sprag, then took hold of the latch on the car door to pull, while Smith was pushing at the rear of the car to keep it from "sticking," as the grade was hardly heavy enough to carry one sprag at this point. When the car advanced to a heavier grade Walsh attempted to get ahead of it to put on a "front wheeler" when it reached a certain point.

It was evident from the position in which he was found that when he made an effort to pass ahead of the car that he stepped on the rail, fell and was caught and instantly killed.

William Lewis, a driver, who was sitting about thirty feet from where Walsh was killed, said that the runner had put in a "hind wheeler," but fearing the car would "stick," took hold of the latch and began pulling until the car struck the iron road, when he tried to get ahead of it, but stumbled and fell under the car.

On the twenty-third of June, Joseph Brillka, a Slavish locomotive fireman, 19 years of age, was fatally injured near the Blue Ridge-breaker by falling under a trip of loaded cars. From the evidence of John Kearney, the locomotive engineer, I learned that the fireman was in the habit of coupling cars on a "fly," or while they were in motion. The trip of cars being drawn from the shaft became uncoupled near the breaker and Brillka got on the front bumper of the head car of the section yet coupled to the engine. He stood on this and when the sections came together he put one foot on the bumper of each car, stooped to pick up the coupling, and while in this act fell under the cars and was fatally injured, dying the same day.

He, it seems, had been repeatedly warned not to do this, but having escaped injury many times before, thought he could still further continue this dangerous practice, but this time failed.

Bartly Ambersavage, a young Polish driver, was fatally injured at the Pancoast shaft on the twenty-seventh of September. The boy was coming out of the gangway to the foot of the slope with a trip of loaded cars, and according to his own statement, his light went out and in some way he slipped and fell on the rail. The cars passed over his leg near the hip, nearly severing it from his body. He was otherwise severely injured internally and died in a few hours.

At the Lackawanna shaft on the thirtieth day of October a Hungarian laborer 24 years of age, whose name was Michael Oniffrey, was instantly killed by being squeezed between a car and the rib.

I visited the scene and made an investigation of the particulars. The cause of this accident was not difficult to discover. The chamber from which the car was being run was very steep, necessitating the sanding of both rails to within a foot of the wheels of the car.

This had been done and when the runner came up for the car, the laborer went to the side of it to pull the blocks from under the

wheels. As soon as they had been removed the car started, but one rail having been sanded a few inches further up than the other caused the rear end of the car to tip and leave the track. In jumping the track it was thrown against the rib, where it caught the laborer and squeezed him to death in an instant.

It was plainly evident that it was the grit of the dry sand on the rail that caused this car to leave the track, and the fact that one rail had been sanded further up than the other caused it to slew to one side, for had both rails been sanded evenly, the car would then simply tip up and fall back again on the track. This was purely an unforeseen accident.

#### Accidents by Falls of Rock.

A visit was made to the Lackawanna shaft on the eighth of February to investigate the accident that occurred there on the seventh whereby a German laborer twenty-two years of age, named Joseph Trunel, was instantly killed by a fall of rock.

Joseph McHugh was turning a breast from the gangway. He had placed a set of timber across the gangway at this point to support the roof, also a prop had been placed in the breast not far from the gangway track. McHugh fired a shot and knocked out this prop, and without first ascertaining the condition of the rock, which lately had been supported by the prop, he began to make preparations to stand another. Just as he stepped away to get his drill, a piece of rock in the shape of a large "bell" fell, struck Trunel on the head, breaking his neck.

There is no doubt but that this accident could have been avoided had McHugh carefully examined the rock before getting ready to stand a prop. As it is, another young life has been brought to an early end by the lack of proper appreciation of danger on the part of the miner in charge.

On the twentieth of March John Walkroski, a Polish miner, 35 years of age, was instantly killed by a fall of rock at Forest City slope.

On my arrival on the scene I learned from the miner working the next breast that Walkroski fired a shot about five minutes before his death. The coal from this shot knocked out two props from under a loose piece of rock. Soon after, he began clearing away the coal from where these props had been, without first making an examination of the roof, and while at this work the rock (which was something similar in shape to a bell) fell on his head causing his instant death.

The rock was ten feet long and eight feet wide, running from a feathered edge to about two feet thick at the centre.

At the Glenwood shaft, on the sixth day of June, John Murko, a Polish laborer aged thirty-four years, was fatally injured by a fall of slanty rock, dying from his injuries later in the day.

I made a careful investigation and found that deceased had been employed in a chamber worked by two miners named Larky Durkin and Joe Griffith. From the evidence of these two men it would appear that a shot had been fired a few minutes before the fall took place.

By this shot a prop which had been supporting the rock at the inside edge had been displaced, but whether or not any other props had been removed by the shot is not known, but four were seen lying on the ground after the fall occurred.

An examination of the roof had been made by one of the miners after this shot had been fired, and it was said to have been safe. Shortly after this, and while the miner was yet in the face, the driver who was standing nearby waiting to pull up a car, hooked his mule to the pulley chain and pulled the car to the face, the laborer in the meantime blocking it, and while at this work he was caught under the edge of a mass of a rock measuring twenty-two feet in length and six feet in width, tapering to a thin edge on all sides from a thickness of two feet and a half at the centre.

The roof in this locality was very bad, necessitating much propping and careful watching, which was being done at all places, and in this chamber many props had been placed to support the roof; three were under this slab and to all appearances it was very safely secured.

But while it is not known whether more than one of the above props had been removed, it is my opinion that if some of them had not been entirely displaced they must have been loosened by the flying coal from the recently fired shot, thus giving the rock a start to fall.

One of the miners was in the act of putting up a prop when the fall occurred and came very nearly being caught also. As far as I could see, no blame could be attached to any one for this accident, and it can only be said to be one of these unfortunate occurrences that take place when no one suspects any danger.

George Deacle, an English rockman, aged 21 years, was fatally injured at the Marvine shaft on the nineteenth of June, dying in a short time after.

I made a careful investigation of this affair on the following day and learned that deceased had been employed as chargeman over a gang of workmen who were engaged loading rock at the foot of the shaft.

A slab of rock which measured 11 feet long, 18 inches wide at one end, and 31-2 feet at the other, about 5 inches thick at the centre,



tapering to a thin edge on all sides, had been loose for sometime. His attention had been called to it by the chargeman of the previous shift and hence he was well aware of its dangerous condition. It was also asserted that he had been told to stand a prop under it, but he neglected to do so, and continued to work under it until it fell on him. However, there was conflicting evidence concerning the cause of the accident, and it was decided to institute further inquiries into the case. The coroner was notified and held an inquest at the Inspector's office on the twenty-seventh of June. Twenty-seven witnesses were examined, and from the evidence the jury rendered the following verdict:

We, the undersigned, find that the death of George Deacle was caused by a fall of rock in the Marvine shaft and was due to his own neglect in disobeying orders he received to stand a prop in the dangerous place.

We do also find that the contractor, Henry Miller, was in no way to blame for the fatal accident.

T. I. DUFFY,  
MARTIN McCORMICK,  
F. E. HODGSON,  
F. W. EDWARDS,  
WILLIAM H. SMITH,  
WILLIAM MURTON,

Jury.

Peter Belena, a Polish miner, aged 28, was fatally injured at the Ontario on the twenty-ninth day of June by a fall of roof. I visited the scene of accident and made diligent inquiry as to its cause, and learned from one George Smith that Belena was firing a shot and that he and his laborer had, as they supposed, retired to a place of safety, along with Geo. Smith and his laborer, to await the explosion of the blast.

The first squib missed fire; Belena then went back to the hole and put in another. He then went back to his place of safety to await results.

The four men were standing in a recently abandoned chamber, near to the gangway road when the shot went off, the concussion of which shook a large piece of fire clay roof down on them.

Three of them escaped as by a miracle, while one was caught under the main portion of the mass, which was triangular in shape, measuring five feet at the base and six feet on the other two sides. It was twenty inches thick. This may be called purely an accident. Yet men should at all times look and examine the roof to make sure of its condition when they have cause to go under it.

An accident occurred at Storrs No. 2 on the eleventh day of July whereby a Welsh miner 41 years of age, named David Morgan, lost

his life by a fall of rock. I learned from those who reached the scene shortly after it had taken place, that the deceased had discovered this loose piece of rock, and was in the act of getting out from under it, but slipped on the bottom slate and fell on his back the moment the slab fell, the edge of which struck him on the top of the head nearly severing it in two.

It measured five feet in length, was three feet and a half wide, and four inches thick. The roof in this place was very "shelly" and a great many props had been placed under it to insure its safety.

As yet no prop could have been placed under the piece that fell, as it was too close to the face. It could, however, very readily have been taken down if discovered in time. The miner had very recently fired a shot, but his laborer did not know whether or not he had examined the roof afterward.

On the second day of October Thomas Wooley, an English miner, 47 years of age, was fatally injured by a fall of rock at Storrs No. 1 mine. An investigation made on the following day revealed that Wooley was in the act of standing a prop to secure this piece when it fell upon him.

This man's attention had previously been called to the slab, but he had neglected to put a prop under it. The roof in this part of the mine is of a slaty and slippery nature, requiring careful watching and good propping.

This chamber was very well timbered from where he got killed to the branch, and there was some half dozen props lying in the chamber when the fall occurred, and there was no reason why a prop should not have been placed under this slab when his attention was first called to it.

And I can only remark that this is another fatality added to the many that occur through oversights on the part of the miner. The slab which ended this man's life measured five and one-half feet by seven feet, and was from three to eight inches thick.

The roof was only seven feet from the rail, making a safe height to work in, and if proper care were exercised and frequent examinations made of the roof, accidents of this nature would very soon be reduced.

At Forest City slope, on the ninth of October, an accident occurred whereby a Polish laborer 33 years of age named Michael Macoviski was instantly crushed to death by a fall of roof at the face of a chamber. On the tenth I investigated the cause of this occurrence and learned that the chamber was very well propped to within ten or eleven feet of the face. The roof was very "slippy," and constant vigilance seems the only way to prevent accidents in such places. The laborer stood within a few feet of the face of the chamber, and

was in the act of loading a car when a slab of rock five by seven feet six inches thick fell and caused the poor fellow's death.

The slab could not very well have been propped as it was too close to the face, but could very readily have been taken down had it been discovered in time, but it escaped detection, only to fall with fatal results a few hours later.

I think if this miner had been in the habit of making a careful examination of the roof after each blast in all probability he would have noticed this loose slab and would have prevented this sad occurrence.

John Manton, an English miner, 36 years of age, met instant death at the Marvine shaft on October 30 by a fall of rock. On the following day I went to the scene of this sad occurrence and soon discovered that it was a purely unforeseen accident.

Manton was known as a very careful and competent miner. He had discovered that the roof in his place was somewhat "drummy" by carefully sounding it, and had taken the precaution against the danger by placing two props within six feet of each other under the part which appeared to be bad.

He, however, had been deceived, as it was discovered later on that he had put the props, one on the inside the other on the outside of the treacherous bell-shaped rock, which fell on him while sitting between the props, waiting for the smoke of a recently fire shot to clear away. The rock which caused his death was less than six feet one way and seven the other, resembling the roots of a huge tree with a short piece of the trunk attached thereto.

This was one of those unavoidable accidents that are so frequently caused by the treacherous formations which exist in the roof of so many of the mines in this locality.

Michael Gownley, an American driver, 15 years of age, was instantly killed by a fall of rock at the Jones, Simpson & Co.'s shaft on the thirtieth day of October.

The particulars in this case, as found upon investigation, are as follows: Young Gownley had received a powder keg from one of the nearby miners and had gone into the face of a gangway for the purpose of hiding it from the other boys. M. J. Dean, a good, practical miner, along with some other men, were taking down some top coal at a point about seventy feet from the face of the gangway. Two of these men were here loading a car and when young Gownley came back he stood a few feet away talking to them about the keg which he had just hidden, when, without the least warning whatever, a piece of rock fell from the roof and crushed his young life out in an instant.

M. J. Dean, the miner who had charge of this work, stated that he had carefully examined the roof just a few minutes before the fatal

fall occurred and was satisfied it was perfectly safe. This roof is a sandstone mixture and usually is very safe, but here it was wet and very "seamy," and, as was afterwards discovered, the piece that fell was entirely cut off or detached from the roof proper by a water crack or mud seam, and after the coal had been removed from under it the water gradually worked it loose until it fell, with this sad result.

Andrew Botscavish, a Polish miner 28 years of age, was instantly killed at the Clifford on the seventh of December. Investigation showed that deceased, a few minutes before the accident, had fired a shot in the coal which failed to do its work.

Botscavish was in the act of "working out" this shot when a slab of rock from the roof gave way and crushed him to the ground.

The vein is only three feet thick and the unfortunate stood with his back against the rock when it fell.

He was not cut or bruised in any way, but was literally squeezed to death by the weight of a rock about seven feet long, four feet wide and fifteen inches thick at the centre, tapering to a feather edge on all sides.

The man had sounded it and said it was safe, but either from a lack of proper knowledge of the nature of such roof, or for the want of care, this man lost his life in a very simple manner.

William Lewis, a Welsh miner 59 years of age, instantly lost his life on the seventh of November at the Powderly slope. It seems that both miner and laborer were aware of the dangerous condition of the roof, and with the intention of shaking it down had put a strong hole in the coal pitching towards the roof. This, however, only had the effect of loosening the coal which the laborer afterward tried to remove by barring.

While the laborer was thus engaged, the miner was standing on one side watching the roof for any signs of moving, when, without the slightest warning, it fell and a part of about four feet square struck the poor old man and at once caused his death. It might be said that with a little more precaution on the part of this miner the accident might have been prevented, but it is my opinion that he misjudged the condition of the roof where he was standing, and the piece which killed him fell very unexpectedly, and caught him while watching for another's safety.

At any rate, it was a very sad accident to an old and experienced miner.

The Mt. Jessup slope was the scene of an accident on the fourteenth of November which resulted in the death of a Polish laborer aged 20 years named Joseph Peartross. On visiting the scene I learned that the miner had just begun to drive a cross-cut. A shot

had just been fired here, and after waiting for a few minutes for the smoke to clear away, the laborer started for the face, followed by the miner, and when within a few feet of the face, a piece of rock measuring four and one-half feet by thirteen and from eight to ten inches thick fell, struck the laborer and instantly killed him; the miner narrowly escaped the same fate. Props had been placed in a row across the chamber within six feet of the face of bottom coal, and to within four feet of the edge of the slab of rock which fell. The miner had discovered the opening, but never for a moment thought that the rock would break off so short. In my opinion this is another of those sad accidents which take place where least looked for, and oftentimes to the most experienced miners.

At the Blue Ridge, on November thirtieth, Michael Bartasoviski, a Slavish miner 28 years of age, was fatally injured by a fall of roof at the face of his chamber.

On inquiry as to how this accident occurred I learned that a shot had just been fired, by which two props had been knocked out from under a large slab of fire-clay.

Bartasoviski was on his way back to the chamber, and was picking up the coal which had been thrown back on the road by the shot and had reached within a few feet of the face without paying any attention to the condition of the roof.

His laborer shouted to him that the roof was "cracking," to whom he replied by saying, "I guess roof all right." No sooner had this remark been made than the large slab of fire clay which had been supported by the props recently displaced fell, injuring him so severely that he died in the ambulance on his way to the hospital.

James Morrison, an Irish miner 52 years of age, was fatally injured by a fall of rock at the Forest City shaft on October first.

On the following day I went to the scene of accident and after diligent inquiry learned that the foreman and his assistant had given this man orders to put up a set of timber to secure the roof over his chamber road.

Before putting up the set he placed a prop under this loose piece of rock to insure his own safety while preparing a place for the timber. When he had placed the two legs in position and was about to put up the collar he discovered that the prop which he had recently placed under this rock was in the way of the collar, and had to be removed before the collar could be put upon the legs.

Learning this, he asked his laborer to hand him a hammer with which he knocked out the prop, but had no sooner done so than the rock which it had been supporting fell, with fatal results.

#### Accidents by Falls of Coal.

On January first an Irish miner 40 years of age, named John Mulherin, was instantly killed at Richmond No. 3 by a small fall of coal

and rock. I went to the scene on the following day and after taking the testimony of the foreman, who had been in this man's chamber but a short time previous to the accident, and after carefully examining the place, I concluded that he had lost his life by his own recklessness.

After firing a shot in the top coal and trimming down all that came with little effort, he began to pry down a dangerous looking piece which was a mixture of coal and rock. Failing to accomplish this promptly with pick and drill, he left it standing for the time being and went to work under it.

He fastened his drilling machine in the bottom coal directly under this piece and while stooping to pick up a drilling bit this overhanging piece of top coal and rock fell, striking him on the back of his head breaking his neck.

Dominio Collosie, an Italian laborer 25 years of age, was instantly killed at Edgerton drift by a fall of coal on February second. I went to the scene and learned that the chamber in which he was killed was being worked by another Italian named Anthony Tale-rack, who stated to me that he had examined the coal which fell some two hours before the fall occurred and said it was safe.

The coal at this place, being within twenty feet of the surface, is very brittle, with water cracks running all through it, making it very treacherous. The bench of coal which fell was only eight inches thick, a slab of which fell measuring 8x6 feet. The edge of this struck Collosie on the back of the head while in a stooping position and broke his neck.

The Blue Ridge Coal Company's shaft was the scene of an accident on March twenty-second which caused the death of a young miner named Arthur Cochran. I went to the chamber where deceased had been employed and carefully examined the roof and top coal.

I found that there were "slips" in the roof running down through the top and bottom coal which had been visible for more than fifteen feet.

On the right side of the chamber no slips were to be seen and here a prop had been placed to support the top coal, the intention being to keep it up for a roof, as it was thought to be stronger and safer to work under than the fire clay above it. The top coal had been taken down near the centre of the chamber, but had been left up for ten or twelve feet on the left rib.

At the hindermost end of this strip of coal, deceased had fired a shot some thirty minutes before his death. During this half hour he and his laborer had been sitting some distance from the face and conversing about some matters in which they were interested. When they had concluded their conversation Cochran went to the face of his own chamber and on his arrival his laborer asked him what kind of

a hole did it make." He replied that it made a "Jim Dandy," after which his laborer started for the gangway to see if the driver was coming in and Cochran began to work out the loose coal without paying any attention to the condition of the coal above him.

He had, however, just began to work out the bottom when he heard the top coal also beginning to "work" or crack and realizing his danger made an attempt to run from under it, but before he could reach a place of safety it was down on him, crushing him so badly about the head and body that he died in the ambulance on his way home.

Patrick Powers, an Irish miner 53 years of age, was instantly killed by a fall of top coal and "buck" at Jermyn No. 1 shaft on May twenty-second.

I made a careful investigation on the day following and found that deceased was at the time of his death engaged working out some bottom coal which had been loosened by a shot fired on the previous day. The "fourteen-inch" and "buck" were fastened together at this point, no "smooth" being visible between them, though many "slips" could be seen running through them both. Powers had on the previous day worked out the bottom coal for a distance of four or five feet, and on the day of the accident had again, the first thing in the morning, begun to remove what had been shattered by the "last shot" of the day before, and that, as his fellow miner stated, before making a proper examination of the coal above him.

While he was thus engaged the top coal fell and instantly crushed him to death.

The accident which occurred at the Marvine shaft on May twenty-ninth, whereby an English miner 42 years of age, named William Cawley, was fatally injured, was carefully investigated by me on the day of its occurrence. I found that deceased had been engaged driving a "proving hole," which was about twelve feet wide and about the same height.

The coal was somewhat free, but not dangerously so, and the roof was very smooth and apparently safe. Cawley, as his laborer stated, had sounded the roof during the morning and had said it was safe, but notwithstanding all the care and precaution taken it fell in a few hours after he had made his examination and almost instantly caused his death.

The slab which fell was eighteen feet long, eight feet wide at one end and three feet at the other.

It increased from three inches in thickness at one end to eight inches at the other. Cawley was known as a very careful and practical miner who never knowingly took any unnecessary risks, but on the other hand took every precaution to insure his own, as well as the safety of those working with him.

Jermyn No. 1 shaft was the scene of an accident on July twenty-first which instantly ended the life of a Polish laborer 23 years of age, named George Sharrick. I visited the scene shortly after and found the chamber to be one of the safest in the mine.

The roof was good and solid throughout, but as an extra precaution props were being systematically placed in the chamber. The top coal, or as it is better known in this region, the "14-inch," had been squared even with the face on the previous day.

Daniel Donovan, the miner who worked on the side of the chamber where the man was killed, said that he had fired two or three shots on this side during the preceding day, and had, as he thought, carefully trimmed down all loose material, but it seems that that which fell and ended the life of this man had escaped his notice, it being so small and so close to the face of the chamber.

It measured but sixteen inches on the longest side, eight inches thick and seven inches wide, and only fell some four feet before striking the unfortunate man on the head. However, it instantly broke his neck.

The two miners, named Daniel Donovan and Thomas Williams, respectively, are careful men and the condition of their chamber gave evidence of this, but as above stated, this small piece in some way or other escaped their notice to fall a few hours later with fatal result to their laborer.

At the "Sturges shaft," on September eleventh, George Smith, a Polish laborer aged 20 years was instantly killed by a fall of top coal.

In the investigation it was learned that the foreman had visited the chamber in which the accident occurred about 10 o'clock on this day, and had made an examination of the top coal, and while it did not appear dangerous, he thought it advisable to have it taken down.

He therefore gave the miner orders to blast it down at once. The miner, whose name is Mike Roscosky, said he would do so immediately; the foreman then left him to proceed on his journey through the mine.

The miner, however, did not do as he had been ordered at this time, but later drilled a hole in the top coal, but instead of firing it as he should have done, kept on working for some time afterwards on the bottom coal. A little later on he and the laborer were loading a car and while thus engaged this top coal fell and instantly caused the laborer's death.

In reply to an inquiry why he had not fired the hole in the top coal, he said that it was his intention to have done so as soon as the car was loaded, and that he was trying to scrape up enough coal to load the car when the fall occurred. Nothing can be said of this, but that another life has been lost through the gross negligence of an indifferent and careless miner.



Adam Clupeck, a Hungarian laborer 26 years of age, met instant death by a fall of top coal at the Simpson slope on October twenty-second. I made an examination of this accident shortly after it occurred, and found the chamber a very safe one in every particular; the roof was solid sand rock and very secure. The vein is fourteen feet high, split into three benches, the bottom coal being mined first, the top coal taken out afterward.

The miner had just fired a shot in the rib in the bottom coal, and had gone back a short distance from the face to put some oil into his lamp.

The laborer in the meantime, fearing no danger from the top coal, went back to the face to prepare some coal for the next car. He, however, no sooner reached a spot near the face, than a piece of coal from the middle bench, about fifteen inches square, fell, striking him on the right temple and causing his death instantly.

The men had been at work but a short time when the accident occurred. The piece which did the fatal work must have been shaken to the point of falling by the shot just fired, and was so small that it could not very readily be discovered, nor even suspected of being dangerous.

However, there is no doubt that if this miner had carefully examined his place on the morning before commencing to work in it, he would in all likelihood have discovered the small, dangerous piece of coal and would have taken it down and thus would have prevented this fatality.

At the Edgerton drift, on November third, an Italian laborer 33 years old, whose name was Frank Bruin, was instantly killed by a fall of top coal.

Inquiries made on the following day revealed that the miner and laborer went to the face of the chamber immediately after firing a shot in the top coal which failed to bring it down.

The miner, without first making an examination of this, began to work under it. In a few minutes, however, it fell without any warning, severely injuring the miner and instantly killing the laborer.

This place was apparently perfectly safe and with precaution on the part of the miner the accident would not have occurred.

But, notwithstanding that men may be working in a safe place, the conditions at the face change with each succeeding shot and often times become very dangerous and if the miner is not extremely cautious at this time he may get caught by a fall when least expected.

On November twenty-eighth, about one o'clock in the afternoon, an accident occurred at the Simpson slope of the Northwest Coal Company, which resulted in the death of a German miner named Frederick Rhine, aged 42 years, and his laborer, Anthony Paulby, an Austrian 30 years of age. In a few hours I was on the scene, and

soon learned that a large fall of top coal had taken place on the first lift, on the east side of the new slope, where pillars were being "robbed."

When I arrived, I found that the work of recovering the bodies of the unfortunate men was well under way, directed by J. L. Crawford, W. I. White, J. G. Shepherd and Thos. Jenkins, the foreman.

An examination of the surroundings was made and all was found safe to proceed with the work of recovering the bodies. About seven o'clock in the evening the laborer was discovered buried under large pieces of coal and some slabs of rock which had moved down from the top of a fall which had been brought on several days previous to this fall of coal.

The work of recovering this body was necessarily slow, owing to the size of the coal which lay upon him and which had to be broken by pick and wedge, as blasting could not be done without further mutilation of the body. It was released at ten o'clock and at once taken to his home.

Before Rhine's body could be taken out, some loose pieces of rock had to be removed, as they were not safe for the men to work under. This was soon accomplished by blasting and the work of recovering the body of Rhine began.

His body was discovered about 12.30 o'clock, in a stooping position close to the rib on the lower side of the gangway buried under two feet of loose coal, and was removed in half an hour.

While the work of rescue was being performed, I carefully examined the only persons present who knew anything of the sad affair.

Charles Curtis, for whom these men were working, stated that "Rhine, who was my brother-in-law, had been employed by me on the strength of his knowledge and practical experience as a miner. He was also a very careful man and one who thoroughly understood his work. I went into his place about five minutes before the fall occurred, and asked him how he was making out, to which remark he replied "all right." At this time he and his laborer were barring down a piece of top coal which was in the shape of an arch, between the coal and the lower side and that which fell upon them from the upper side of the gangway.

There was a "slip" running diagonally across the gangway and up through the top coal, behind which Rhine had drilled and tamped a hole ready to fire, and was trying to break this arch so that the hole would have a better chance to cut. Curtis said, after asking him how he was making out, "I went out of the gangway, but had not been absent but a minute or two when the second laborer came running after me, telling me that both men had been killed.

"I heard the fall, but thought they had barred it down and were safe, but it must have fallen so quickly that escape was impossible.

"As soon as possible I hurried to the scene, made an examination of the roof and found it all right. I then went over the fall and shouted 'Fred.' but received no answer. I listened for a moment, and heard the groans of the dying laborer and directed the men where to find him.

"The coal which fell on the men had been standing on three props on the upper side of the track, and was to have been left there as a "stump pillar," but when they broke the small arch, which was about ten inches wide, and five or six thick the coal slid off the prop and covered them up."

Another person examined on this occasion was David Cushine, Jr. He said that some twenty or twenty-five minutes before the fall he was in there and at that time Rhine was tamping a hole on the left side in the top coal. After tamping it, both men took each a drill and went barring at the coal which fell on them later.

This was a sad and deplorable accident, caused, perhaps, by a want of sufficient care and cautious examination of the top coal, or by overconfidence in the safe condition of the same.

And it may be said that Rhine, old and experienced as he was, trusted (as many had done before him) once too often to his own judgment, and that, without making an examination, thought he was perfectly safe in trying to break what appeared an insignificant arch of coal and bone, but what afterwards proved to have been the only support to the mass of coal that resulted so disastrously to himself and his laborer. After making as complete and thorough an examination of this case as was possible, there was no doubt in my mind as to how the accident had occurred, and I deemed any further inquiries by the coroner utterly unnecessary, hence did not notify this officer to hold an inquest.

#### Accident from Falling Down Shaft.

John Naughton, an Irish laborer, 50 years of age, was instantly killed at Richmond No. 3 February thirteenth by falling down a shaft.

The circumstances are as follows: James Hawley, a driver, Miles McDonell, miner, and John Naughton, with a mule were on a descending carriage in the shaft.

Hawley's evidence is as follows: "I was trying to back the mule into the mule cage which stood on the carriage, but could not do so. A Hungarian took hold of the bridle and tried to back him in, but failed. After this, McDonell and Naughton took hold of the bridle and succeeded in putting the mule in the cage, when the headman gave the signal to slack off. The carriage started with its load, three men and a mule. When within thirty feet of the bottom of the shaft the mule became unruly and bucked up against the chains that were

holding the cage on the carriage. This caused the mule cage to swing around, striking Naughton and forcing him off the carriage down the shaft."

Miles McDonell's evidence was identical with the above. In answer to an inquiry whether he knew that it was against the foreman's strict orders for any one but the driver to get on the carriage with a mule, he said he knew that the orders were not to go, and furthermore it was in direct violation of this rule that we got on, but did not think of any danger nor of anything but of assisting the boy to handle the mule.

It was the headman's duty to prevent these men from getting on, but he failed to do so.

Stanley Romel, a doortender, aged 14 years, was instantly killed by falling down the Jermyn No. 3 air shaft on May thirty-first.

I learned, upon investigation, that the boy, with others, was coming up on a carriage, and when within one hundred feet of the top he inquired of another small boy named John Moore whether or not they were near the landing; the young fellow replied that they were, and a moment afterwards he saw Romel fall, and before he could take hold of him he was passing down between the carriage and the side of the shaft, at the bottom of which, very shortly after, the body was found very badly mangled.

It is supposed that the boy, not having been accustomed to riding up a shaft, became dizzy and fell with above sad results.

An accident occurred at the Leggetts Creek shaft on March twenty-sixth, to James Gallagher, an American driver boss, 26 years of age, which resulted in his death three days later.

Shortly after it occurred I went to the scene and learned from several persons that Gallagher came up the main shaft, went to the blacksmith's shop, got a light, and went directly to the air shaft. In a tunnel leading from the surface to the air shaft he was met by the footman and two doortenders who had just come up on the carriage.

The footman rapped the carriage back and remained at the head of the shaft until the safety gate, which is operated by the carriage, came back to its proper place. He then started for outside and met Gallagher about fifty feet from the head of the shaft, whom he hailed by saying, "Hello, Jim," and passed on. A few minutes later word was received that Gallagher had fallen down the shaft from the tunnel to the Diamond vein, where he was picked up seriously, and as afterwards proved, fatally injured.

Failing, after diligent inquiry, to decide as to how he came to fall, and after receiving notice of his death, the coroner was notified and an inquest held.

The jury's verdict was that Gallagher came to his death by an accident at the Leggetts Creek shaft.

#### Kicked by Mules.

An examination of the circumstances connected with the death of William Scott, an American driver boy, which occurred at the Leggetts Creek on January fifth, revealed the following facts, as seen by an eye witness of the sad occurrence. George Green, who was within two feet of the boy when he received the fatal kick, stated that deceased was standing giving him (Green) a light. After giving Green a light he shouted to the mule to start up and the same moment he received a kick from the mule on the left side in the region of the heart that caused him to fall forward on his face into the ditch. Green lifted the boy's head from the ditch and placed it on a plank on the side of the rail and ran for more help; he met another young boy who hurried with him to the scene and they together raised him from the ditch. Other help soon arrived and the poor boy was without any delay hoisted to the surface and conveyed to the engine house, where he soon died, without regaining consciousness.

On May twenty-eighth, at the Ontario tunnel, Phillip Ingoldsby, an Irish driver 17 years of age, was fatally injured by a kick from a mule.

All that could be learned about this affair was that he was driving a mule on the head of a plane and at the time of the accident was walking behind him and striking him on the rump with a small stick when the mule kicked him in the abdomen.

He did not seem to be seriously injured at the time, and walked home after being accompanied to the mouth of the tunnel by his brother. He went home and did not complain of pain anywhere but in the region of the abdomen. No one thought, however, that he was seriously injured, for on the following day he arose from his bed, walked around the house for some time, then retired and died in a few minutes.

#### Breaker Accident.

On September twenty-seventh an accident occurred at the Ontario breaker which resulted in the instant death of a slate picker named Byron Evans, 12 years of age.

I made a thorough investigation of this affair and learned from the breaker boss who found the young boy's body in a schute leading into the mud screen, that it was this boy's duty to sit on the side of a schute to scrape down the coal as it became clogged.

About a month previous to this occurrence a new set of scrapers had been put in position to scrape the coal from a schute to the mud screen.

They were in a remote part of the breaker and none but the foreman and oiler ever had occasion to go near them. This boy, however, got to where they were and was caught and killed by them, in what manner no one knows, as no one was present when the accident took place.

Since making the investigation, I have learned that it was a habit of this boy's to stand on these scrapers and ride to a certain point and then jump off. Whether this is true or not, something of this nature caused the accident, for he could not have gotten into the scrapers without first climbing over the schute heading to them, or else by going around by another way.

#### Accident from Premature Blast.

On July sixteenth, William Williams, a Welsh miner, 50 years of age, was fatally injured at the Leggetts Creek shaft by the premature explosion of a blast.

I visited the scene on the following day and learned from the foreman (who had questioned the dead man's laborer at the time of the accident) that deceased a few minutes before he was killed had gotten ready to fire a shot in the bottom bench of coal, which was about one foot thick and very wet.

The first squib failed to put off the shot; then, after waiting a moment, the miner and his laborer went back to the face together. The miner took another squib, cut about one-half of the match off, then lit and placed it in the barrel which was pitching an angle of thirty degrees. At that instant the blast exploded while he was yet standing, or perhaps more properly, leaning over it. The coal struck him in the face and literally smashed it into fragments.

He, however, lived to be taken home, but never regained consciousness. It can only be said of this that it was a sad case caused, perhaps, by being in too much of a hurry for fear of losing a few inches of powder in a "wet hole."

A person can hardly believe that any sane man would take such an unreasonable risk. Yet such are very frequently taken. Sometimes the person may be somewhat excited and led on by over confidence in his own ability to escape unhurt he takes useless and often times fatal chances.

Again, he may be a man well up in years, having worked the greater portion of his life in the mines, and perhaps enjoyed immunity from injury that is remarkable, and to all appearance has grown accustomed and indifferent to the dangers that daily surround him. Such a one is sometimes the victim of his own imprudence.

### Fatal Accident from Explosion of Powder.

Investigation made by me of the fatal accident which occurred at Jones, Simpson & Co.'s shaft on May thirty-first revealed that the victim, a Polish laborer aged 28 years, and named John Polaski, went back from the face of the breast to put a cotton in his lamp, and on his way went to a powder keg containing about twenty-six inches of powder in a paper bag.

He had a lamp on his head, and while in the act of looking into the keg a spark from his lamp fell into the powder, causing it to explode.

His clothes instantly took fire and before the flames could be extinguished he was severely burned and died on the following day.

---

Inquest notes of testimony taken before J. A. Kelly, coroner, and Mr. Edward Roderick, Mine Inspector, at the court house at Scranton, March 9, 1894, in the matter of the accident at Richmond No. 3 shaft, on March 6, 1894, whereby Richard Hughes, Albert Richards, Thomas Holwell and James Northey lost their lives.

#### Coroner's Jury:

Vaughan Richards, William Morton, John Sykes, James J. Fahey, John J. Loftus and Jacob Ferber.

Mr. John Lumax called for examination and after being duly sworn by the coroner testified as follows:

#### Examination.

By the Coroner:

Q. What is your occupation, Mr. Lumax?

A. Miner.

Q. How long have you been one?

A. For the last twenty-four or twenty-five years.

Q. Where do you work?

A. At Richmond's.

Q. Were you working in the shaft the morning the men were killed and on that shift?

A. Yes, sir.

Q. What time did it occur?

A. As near as I can think, about 4.10 or 4.15 Tuesday morning last.

Q. Describe to the jury the nature of that accident as you saw it on that morning.

A. All I can tell is that there was no hopes of saving the men when I left there.

Q. What was the nature of the chunk? How far from the bottom did it fall?

A. Just over the rail about eight feet.

Q. Were the men buried under this piece fully?

A. Yes, sir.

Q. How many were there?

A. Three men completely under it.

Q. Where was the fourth man?

A. He was on the other side of the rock opposite.

Q. There were three who escaped?

A. Yes.

Q. What was their relative positions to the other men?

A. One stood drilling a hole.

Q. How far was he away from the fall?

A. Two or three feet.

Q. Is there any gangway or opening at the bottom?

A. No, sir.

Q. Did they ever use the safety holes there?

A. No, sir.

Q. Were there holes there for that purpose?

A. No, sir.

Q. Should there have been?

A. I think there ought to have been holes there.

Q. Were you at the bottom of this vein which you were sinking?

A. Yes, sir.

Q. Is there any projections or slabs at all along the perpendicular or is it wider at the bottom?

A. Only just where the men were working undermining it with their picks.

Q. Were you informed by the chargeman of the previous shift, of the dangerous condition of this piece?

A. No, sir.

Q. Was any man on your shift?

A. Not as I am aware of. I didn't hear it.

Q. How many shots were fired that night?

A. Two shots only. We ran two holes only to one shot.

Q. What is the usual way in firing these holes, by battery?

A. Yes, sir.

Q. Whose duty is it to look after the place after a shot is fired?

A. The chargeman's.

Q. Who was the chargeman of your shift?

A. Thomas Holwell.

Q. Well, does he always look after the loose material?

A. No, sir.

Q. Did he ever do it?

A. No, sir; not while I was there; he used to leave that to me.

Q. Did you do it on the night before the shot was fired?

A. Yes, sir.



Q. Did you notice anything loose?

A. No, sir.

Q. Did you examine it closely?

A. As closely as I could.

Q. How long after you went down did the other men go down to work?

A. As soon as they saw that everything was safe.

Q. I would like the jury to understand, Mr. Lumax, how this bucket is suspended; is there much rope between the carriage and the bucket?

A. About 60 feet, as far as I can judge. When the bucket is at the bottom of the pit the carriage is 60 feet above.

Q. Do the buntings go down as far as the slides?

A. Yes, sir.

Q. And the slides go down below the buntings?

A. No; just even.

Q. And the projections on the side of the shaft were protected by these slides?

A. Yes, sir.

Q. How many men were allowed to ride in the bucket?

A. Four men.

Q. Do more than four ever ride in the bucket?

A. When anything is the matter, five may ride in it.

Mr. John Connelly sworn.

By the Coroner:

Q. What is your occupation?

A. A sinker.

Q. Where do you work?

A. Richmond's.

Q. How long have you been a sinker?

A. Ever since I was 12 years old.

Q. Were you working on the morning of this accident?

A. Yes, sir.

Q. Well, you may tell your experience of that morning to the jury.

A. I knew nothing about the ground being bad and I did not hear anything of it.

Q. Were no remarks at all passed?

A. Not that I knew of.

Q. Did you hear Holwell say anything of this ground being bad?

A. No, sir.

Q. How many blasts took place that night?

A. Two holes.

Q. How was the gas ignited?

A. I cannot answer that.

Q. Was it ignited when the fall took place in the first place?

A. No, sir.

Q. There must have been some one who took a lamp and went in where the gas was, or there would have been no gas?

A. I don't know.

Q. Did you consider the place perfectly safe?

A. I thought it was as safe as it ever was.

Q. Never thought it would require being secured by beams?

A. No, sir.

Q. Were you working when the men were killed?

A. Yes, sir; within a few feet of them.

Q. What time do you take supper when you are on the 11 o'clock shift?

A. About 2 or 3 o'clock.

Q. How many men were down the shaft?

A. Eight.

Q. Were you on that shift?

A. Yes, sir.

Q. Were you down?

A. Yes, sir.

Q. Did you think it needed timbering?

A. I don't know. I thought it was the chargeman's place to look after that.

Q. Was it the chargeman who went down to examine the place?

A. I could not tell.

Q. Did you have a substitute?

A. I don't know; somebody went down.

Q. Did he go down ahead of you?

A. Yes, sir.

John Langstone, sworn.

By the Coroner:

Q. What is your occupation?

A. I work on rock.

Q. Work most of the time sinking?

A. Yes, sir.

Q. How long have you worked at that?

A. Six months.

Q. What did you work at before that?

A. A miner.

Q. Were you down in this shaft the morning these men were killed?

A. Yes, sir.

Q. Suppose you tell the jury what you saw that morning?

A. I did not see anything but the concussion on the bottom; that's all I could see; the men were underneath it.

Q. The men were underneath the chunk, you say?

A. Yes, sir.

Q. Do you know Alexander Turner?

A. Yes, sir.

Q. Does he work on your shift?

A. No, sir; I work on the shift Tom Holwell works on.

Q. Do you know anything about Alex. Turner having given a warning instruction to your chageman?

A. I heard them talk, but we never paid any attention to what they were saying.

Q. Did Thomas Holwell tell you men what Turner told him?

A. No, sir.

Q. Didn't tell any of the men?

A. Not to my knowledge.

Q. Did this piece that fell out, killing these men, give any warning?

A. No, sir.

Q. How was the fall undermined; was it picked out or blasted out?

A. It was picked out.

Q. Who were picking it out?

A. Connolly and two of the men who were killed and another man.

Q. Did you notice them sounding this piece before they began to pick?

A. No, sir.

Q. It looked to be solid; you never suspected it of being bad?

A. No, sir; I did not.

Q. The chageman never made any remark about it?

A. No, sir.

Q. Where did you see Holwell and the chageman have the conversation?

A. In the shanty where they shift.

Q. How far is that from the head of the shaft?

A. Not very far.

Q. About how many feet?

A. Twenty-five or thirty feet; I don't know exactly.

Q. You are positive you saw them talking?

A. Yes, sir.

Q. What were they saying?

A. I don't know.

Mr. C. Dodan sworn.

By the Coroner

Q. What is your occupation?

A. Miner and shaft sinker, between rock and coal; always followed those my whole lifetime.

Q. Where are you working now?

A. Richmond's

Q. How long have you been in this work sinking?

A. About three or four years.

Q. Were you there the morning of the accident at the bottom of the shaft?

A. Yes, sir.

Q. Can you tell the jury what your experience was that morning?

A. I can tell nothing but that we loaded the coal and the rock came down. It was what they call a roll bottom, the bottom falling first and the top afterwards, and I nearly got caught.

Q. Did anybody ever tell you it was loose?

A. Nothing about it.

Q. Who was your chargeman?

A. Thomas Holwell.

Q. Did Holwell usually tell you if there was anything dangerous?

A. No, sir; he never had occasion. No, sir; he never told us anything that I remember.

Q. Do you know whether or not Thomas Holwell's attention was called to this piece by the chargeman of the other shift, Turner?

A. I could not say.

Q. Did you see Turner and Holwell have any conversation?

A. No, sir; I did not see them speak.

Q. They might have done so without your attention being called to it?

A. Yes, sir; but if he told him anything, I never heard him.

Q. Did Holwell ever make any remark to you?

A. No, sir; I didn't see anything dangerous. This rock was above our reach; we were loading the coal and picking out what was loose and were loading our last bucket, and our chargeman was ready to go up, just at that moment it came down.

Q. How long before it fell did you fire?

A. It was nearly an hour, for the water was up, then we got supper and loaded fifteen or twenty buckets before it came down.

Q. Did Tom Holwell undermine this place with a pick?

A. No, sir.

Q. Is the coal hard or soft?

A. It is soft coal.

Mr. George Barron sworn.

By the Coroner:

Q. What do you work at, Mr. Barron?

A. Worked at rock for the last six weeks.

Q. How long have you been sinking?

A. Six weeks.

Q. You were a miner before that?

A. Yes, sir.

Q. That is all the experience you have had in sinking, is it?

A. Oh, I have been from one place to the other.

Q. Were you down in this shaft the morning that these men were killed?

A. Yes, sir.

Q. Suppose you tell what you saw that day?

A. I went down the first time and saw the rock but could not see any men. I went down the second time and found some of them; in the afternoon I went down again and helped to get two of them out.

Q. How many shots were fired in your shift?

A. One round; five holes.

Q. Did you do considerable picking after these shots were fired?

A. Yes, sir; we did quite a little picking.

Q. Do you know whether or not Turner called the attention of your shift to the dangerous condition of this rock?

A. Yes, sir; he did. He did not call our attention to it, but he did the next.

Q. Well, did every man on the shift know the danger of it just as well as Turner?

A. Yes, sir; I knew the danger of it when I left the shaft.

Q. And did Turner call your attention to it?

A. He didn't call mine, because probably he thought it was safe.

Q. You didn't consider it dangerous after you left your shift?

A. It was dangerous after that.

Q. Do you know whether the chargeman of your shift called the attention of the chargeman of the other shift to it?

A. Yes, sir; I made it my business that night to go and tell the man about these blowers.

Q. Are you sure the blowers were extinguished before you left the mines?

A. Yes, sir.

Q. Whose business is it to see that the blowers are extinguished?

A. The chargeman's, of course.

Q. He has the power to deputize any other man to do it if he sees fit?

A. Yes.

Q. You say that Chargeman Turner called the attention of Chargeman Holwell of the dangerous condition of this piece?

A. Yes, sir.

Q. Were you present when he told Holwell?

A. I was going home with Turner. I walked a short distance with him and he told me the conversation they had.

Q. And Turner never called his men's attention to it at all before he came up?

A. No, sir.

Q. Why did Mr. Turner warn Chargeman Holwell of this danger at the top of the shaft, when you say he thought it was perfectly safe before he came up?

A. It was perfectly safe.

Q. Did you think that it would require timber?

A. Yes, sir.

Q. Whose duty was it to see that it was timbered?

A. The succeeding shift.

Q. Suppose the succeeding shift was not notified and failed to at once discover the danger of it?

A. A man has to go and examine a place before he puts men to work.

Q. After your men come up from shaft duty, is it necessary for men to go down and inspect the work?

A. Yes, sir.

Q. Is it always carried out?

A. It ought to be.

Q. Do you know if it was done that day?

A. I do not know; I was not working that day on Holwell's shift, but Turner examined our shift.

Q. What did you mean when you stated in your testimony that you thought it was perfectly safe when you left the shaft, and then why do you think it required timber, if it was safe it would not require timber?

A. No, sir; but I said he took the coal from underneath it.

Q. Could you swear that it would not have fallen if they had not been working at it?

A. I don't believe it could.

Q. You are positive about that?

A. I have got that much judgment, I think.

Q. Who told you that they worked under that rock?

A. Mr. Lumax, I think it was.

Q. When did he tell you?

A. The same day.

By Mr. Roderick:

Q. What part of the shaft did you load the coal from?

A. The south.

Q. How near to the rib did you put these two holes?

A. Near the rib.

Q. You do not know whether these two holes undermined the rib or not?

A. No, sir; I don't think they did. On the side of the shaft where the cave was, there was only one hole.

By the Coroner:

Q. How long before this accident occurred did you have an explosion?

A. We didn't have an explosion.

Q. Did you have any shots or blasts in this shaft on that night?

A. Yes.

Q. How long before?

A. Two hours.

Q. How many men were down the shaft?

A. Eight men.

Q. You knew the danger of this as well as Chargeman Turner?

A. Yes, sir.

Q. Did you all know it?

A. Yes, sir; I guess so.

Q. You told two or three of the men and you knew Turner told Holwell?

A. I am most certain.

Q. Did you think it ought to have been propped up?

A. Yes, sir.

Q. Why didn't Turner prop it up?

A. Because he didn't have a chance.

Q. You claimed before, that it was safe before Turner left the shaft and did not require propping?

A. Yes, sir.

By Juror Fahey:

Q. In a shaft you cannot prop anything, can you?

A. We cannot prop it; we can timber it.

Q. When you warned these men, did you call their attention to the propping or timbering of this place?

A. No, sir; it was not my business.

Q. You didn't do that?

A. No, sir.

Mr. Alexander Turner, sworn.

By the Coroner:

Q. What's your occupation?

A. Foreman of the opposite shift.

Q. How long have you worked as foreman?

A. Since last August.

Q. Were you working in the shaft where this disaster occurred?

A. Yes, sir; Richmond's shaft.

Q. Were you foreman of the opposite shift?

A. Yes, sir.

Q. Mr. Turner, when you got through with your shift, was there

any information to the foreman of the opposite shift about any danger in sinking this shaft?

A. I told Mr. Holwell to keep his lamp on the east side of the shaft. She was hot. "She was hot as hell" were the words I used, and that there was a seam in the rock and he could examine it, and if he thought it needed it, to put a bunting in.

Q. I would like you to explain to the jury what you mean by a bunting?

A. It is a timber crossing from one side of the shaft to the other. He then started off and said "I will fix it."

Q. Why didn't you put the bunting in?

A. I didn't think it needed it.

Q. But you warned him of the danger?

A. I told him to look at it and if he thought it needed it to put it in.

Q. What end of the shaft did this fall come on?

A. The whole side on the north side of the shaft.

Q. Who stood there when you were talking with Holwell?

A. I don't think there was anybody.

Q. Did you tell anybody that you told Holwell this?

A. Yes, sir; I did.

Q. Whom did you tell?

A. I told James Connolly and I told George Barron.

By Mine Inspector Roderick:

Q. How many times did you fire that night?

A. Once.

Q. How many holes did you fire?

A. Five holes.

Q. Were they near the rib?

A. Two or three feet from the rib.

Q. Pointing toward the rib?

A. No, sir; toward the centre of the shaft.

Q. How deep did you put them?

A. Four feet.

Q. Did you load all the coal?

A. Yes, sir, all; with the exception of a strip which run across the shaft.

Q. Was the coal left there intentionally to support this rock?

A. No, sir; it was not.

Q. Is it customary in sinking a shaft to put sump holes fifteen feet apart?

A. The holes were four feet deep, five feet from the edge of the shaft; that would leave fourteen feet between the two sump holes.

Q. Is that a good method of mining, to put fourteen feet between the two sump holes?



A. We didn't know how deep it was, to get to the bottom of the vein.

Q. How many holes had been fired in the coal by you before this shift?

Q. How many cars did you load on Monday night?

A. I think six. Friday night we loaded ten and the shift before we loaded seven.

Q. Those holes didn't cut to the rib?

A. No, sir.

Q. How early in your shift did you notice this piece to be dangerous?

A. In the fore part of the shift.

Q. Did you examine it carefully and discover any seams?

A. I could not discover any seams at all only one that came up from the bottom.

Q. Did Holwell usually trim up and timber a good deal?

A. Yes.

Q. He did more than you did?

A. No, sir; I don't think he ever put in more timber than I did. I don't know that he put in as much as I did there.

Q. How far from the top of the coal was this rock out?

A. Five or six feet.

Mr. Joseph Connolly, sworn.

By the Coroner:

Q. What do you work at?

A. Sinker.

Q. How long have you been a sinker?

A. Since the first of July.

Q. Did you work in this shaft where the accident occurred?

A. Yes, sir.

Q. Were you working on the morning the accident occurred there?

A. No, sir.

Q. Were you working on the shift before that?

A. Yes.

Q. Did you notice any danger at all at the bottom of the shaft?

A. I noticed that rock.

Q. Did you suspect any danger?

A. No, sir; if I had seen any danger I would not have worked there.

Q. What was the appearance of the rock when you left?

A. It was secure and all right

Q. Did any one on your shift have any conversation about this piece before you left the bottom of the shaft?

A. We were told not to go on that side of the shaft.

Q. Who was it told you?

A. Tom Holwell.

Q. Who told him?

A. Turner.

Q. How do you know?

A. I was there.

Q. Was anybody else there?

A. Yes: with the exception of Reynolds, all Holwell's shift were present.

Q. Were any of Holwell's men saved?

A. Yes: John Lumax.

Q. When you came up, did you hear Mr. Turner speak of the danger of this piece of rock?

A. He didn't say anything about danger at all; he told us to open up on one side.

Q. Why?

A. Because he was going to look after that matter himself.

Q. What time did this accident occur?

A. I don't know; I was in bed.

Q. Did you hear any more remarks passed about the condition of this rock?

A. During my shift we were going to put a stick to it, if we had time.

Q. Was it undermined during your shift?

A. No, sir.

Q. And you thought it perfectly safe?

A. Yes, sir.

Q. You knew that if the coal was taken out it would drop?

A. It had a chance to drop.

Q. Where did the conversation take place between Holwell and Turner?

A. In the shanty outside.

Mr. Vincent Reynolds, sworn.

By the Coroner:

Q. What shift were you on?

A. Turner's.

Q. Did anybody inform you as to a conversation they had when they came up from the shaft?

A. No, sir.

Q. No remarks passed about this piece of rock?

A. Not that I know of.

Q. Was there any conversation at all during your shift about this piece of rock?

A. Not that I heard.

Mr. Luke Kelly, sworn.

By the Coroner:

Q. What do you work at?

A. Driver boss.

Q. You work in Providence shaft, where this disaster occurred?

A. Yes, sir.

Q. Tell the jury all that you know about this accident.

A. I came there the morning of the accident about 5:30, I believe, and went down the shaft. The gas was burning and the water was a little up, but I could see nobody and came back up again. Some one made the suggestion to set a charge of dynamite over it and it might quench the gas. They did so, and it broke the stone, and I went down and found a man and took him up in the bucket with me.

Q. Who was that man?

A. Richard Hughes. I went down again, several times, and succeeded in getting another man up.

Q. What are your chief duties—to simply look after the drivers?

A. Anything I am told.

Q. You are not supposed to inspect this work before the men go to work?

A. No.

Mr. Patrick Rodgers, sworn.

By the Coroner:

Q. State to the jury what you know about this accident?

A. All I know is that I heard a noise in the shaft; didn't know what it was. When the gas went off they commenced hollowing.

Q. What is your occupation?

A. Headman.

Q. Did you hear the men moan or call out below?

A. I heard the men hollow to slack the bucket, and then I knew there was something wrong.

Q. What was the signal that was used, a bell or a tube?

A. A bell; of course we had a speaking tube.

Q. Is that all you know about it?

A. Yes, sir.

Mr. Thomas Naughton, sworn.

By the Coroner:

Q. What do you work at?

A. Track laying.

Q. Do you work in this shaft?

A. I work in the fourteen; I did work in the sinking shaft.

Q. Do you know anything about this accident?

A. No; only that I came there and helped to get the men out.

Q. You were not working there at the time of the accident?

A. No, sir.

Mr. A. Aikman, sworn.

By the Coroner:

Q. Do you know anything about this accident?

A. No more than what I heard and saw. I got to the shaft about eight o'clock in the morning. I heard about the accident about 6.20. When I reached the mines I met Mr. Roderick and we went down. Shortly after, preparations were begun to hook the bucket on the opposite side and one of the witnesses that was recently examined entered with another and brought up the body of Mr. Hughes. They were exhausted, and another fresh relay of men went down and brought up the body of Holwell.

Q. Were you in the fourteen foot vein?

A. Yes, sir; I went down the shaft about three o'clock in the afternoon, but the water was up to the foot of the shaft and covered this stone. As far as I could see, the stone that had fallen out was practically covered with water, but I could see the place it had fallen out of, and I could assume the thickness of it on the side of the shaft. (Here he explained on the table how the rock might have fallen out.) There is another course that might be very apt to have loosened the stone, that is there were two holes fired at one time, and it is quite possible that they might have opened it out; and the opening become filled with gas, and in that way it would deceive any man.

By Juror Fahey:

Q. Is it customary to use precaution in sinking a shaft?

A. Yes, sir.

Q. To the best of your judgment, how far would you timber a shaft in sinking?

A. That would entirely depend upon the nature of the surroundings. Because of the strata being of a loose nature it would require to be timbered very close to the bottom.

Mr. Richard Williams, sworn.

By the Coroner:

A. I know nothing more than that Mr. Roderick asked me if I would like to go down, and I went down and examined the place. I am of the same opinion as the other gentlemen.

Mr. Hodgson, sworn.

By the Coroner:

Q. What is your occupation?

A. I am in charge of sinking Paucoast shaft.

Q. How long have you been a sinker?

A. I first started when I was nineteen years of age, and I have done that work off and on ever since.

Q. Have you got anything further you would like to state to the jury?

A. I think Mr. Aikman gave a very good description of it, and I don't think I could add anything to it.

Mr. Hailstone, sworn.

By the Coroner:

Q. You may state as briefly as you can what you know in regard to this accident?

A. I am of the same opinion as Mr. Aikman. Mr. Roderick and I have been in consultation several times about the law being obeyed, and that gentleman wanted to know whether we complied with the law or not; and I say (pointing to Fahey) all precautions necessary were taken, an adequate supply of air was furnished, and I always instructed my chargemen to examine and see that there was no gas standing in the bottom of the shaft, and that was always complied with.

By Juror Fahey:

Q. Was this contract work?

A. No; company work.

Mr. Thomas Grier, sworn.

By the Coroner:

Q. Mr. Grier, is there anything further you can state to the jury?

A. No, sir; only that Mr. Hailstone failed to say that Mr. Roderick had talked to us in regard to the sinking laws, but he said everything was all right, and I think we have lived up to the letter of the law. Mr. Hailstone had failed to find his book on ventilation, and the next morning he got one.

Mr. Patrick Mullin, sworn.

By the Coroner:

Q. Do you know anything about this accident except as to the rescuing of the bodies of those who were killed?

A. No, sir; only that I helped to take them out.

John Howells, on examination, said he also helped to take them out.

Mr. Roderick.

On the thirteenth of February I went to Mr. Hailstone and consulted with him about the law on shaft sinking and was told by him that the law was being obeyed to the letter.

---

The jury's verdict was that these men came to their death by an unforeseen accident. They also thought that the chargemen should be more careful in the discharge of their duties.

TABLE 1.—Showing location, etc., of Collieries in the First Anthracite District.

| Name of Colliery            | Name of operator                        | Location—County       | Name of Superintendent                             | Post-office Address |
|-----------------------------|---|-----------------------|--|---------------------|
| Leggets Creek               | Delaware and Hudson Canal Company       | Seranton, Lack. co.   | A. H. Vandling, general superintendent             | Seranton, Pa.       |
| Marvine                     | do.                                     | do.                   | do.  | do.                 |
| Eddy Creek                  | do.                                     | Olyphant, Lack. co.   | A. Nicol, mine superintendent                      | do.                 |
| Glyphant, No. 2             | do.                                     | do.                   | J. L. Atherton, assistant general supt.            | do.                 |
| Grassy Island               | do.                                     | do.                   | do.  | do.                 |
| White Oak, Nos. 3, 2 and 1  | do.                                     | Archbald, Lacka. co.  | Andrew F. Patten, assistant mine supt.             | Olyphant, Pa.       |
| White oak tunnel            | do.                                     | do.                   | do.  | do.                 |
| Jermyn                      | do.                                     | Jermyn, Lack. co.     | William Powers, assistant general supt.            | Carbondale, Pa.     |
| Powderly                    | do.                                     | do.                   | do.  | do.                 |
| No. 1 slope                 | do.                                     | Carbondale towns P.   | do.  | do.                 |
| No. 1 tunnel                | do.                                     | do.                   | do.  | do.                 |
| No. 3 shaft                 | do.                                     | do.                   | do.  | do.                 |
| Racket Brook                | do.                                     | do.                   | do.  | do.                 |
| Coal Brook tunnel           | do.                                     | do.                   | do.  | do.                 |
| Wilson Creek tunnel         | do.                                     | Fell township         | do.  | do.                 |
| Clinton                     | do.                                     | Vandling              | Chris. Schaefer, chief engineer, D. & H. Canal Co. | Seranton, Pa.       |
| No. 1 shaft                 | Pennsylvania Coal Company               | Dunmore, Lack. co.    | John B. Smith, general superintendent              | Dunmore, Pa.        |
| Gypsy Grove shaft           | do.                                     | do.                   | do.  | do.                 |
| Gypsy Grove drift           | do.                                     | do.                   | George I. Smith, assistant general supt.           | do.                 |
| No. 2 shaft                 | do.                                     | do.                   | do.  | do.                 |
| No. 2 tunnel                | do.                                     | do.                   | James Young, general mine supt.                    | do.                 |
| Murray                      | Murray, Carney & Brown                  | do.                   | M. J. Murray                                       | Throop, Pa.         |
| Pancoat                     | Pancoat Coal Company                    | Throop, Lack. co.     | Charles P. Sanderson                               | Seranton, Pa.       |
| Clifford                    | Hillside Coal and Iron Company          | Forest City, Sus. co. | W. A. May, general superintendent                  | Forest City, Pa.    |
| Forest City shaft and slope | do.                                     | do.                   | Victor L. Peterson, assistant general supt.        | Mayfield, Pa.       |
| Glenwood                    | do.                                     | Mayfield, Lack. co.   | William Walker, assistant general supt.            | do.                 |
| Erie                        | do.                                     | do.                   | do.  | do.                 |
| Keystone drift              | do.                                     | do.                   | Montrose Barnard, chief engineer                   | Seranton, Pa.       |
| Storr's, No. 1              | Delaware Lackawanna & Western R. R. Co. | Dickson City          | W. J. Storr's, general coal agent                  | do.                 |
| Storr's, No. 2              | do.                                     | do.                   | W. H. Storr's, assistant coal agent                | do.                 |
| Storr's, No. 3              | do.                                     | 1st ward, Seranton    | E. Hughes, general mine superintendent             | do.                 |
| Jermyn, No. 3               | John Jermyn                             | Pikeburgh, Pa.        | Thos. W. Phillips, assistant mine supt.            | do.                 |
| Jermyn, No. 4               | do.                                     | do.                   | W. M. Jermyn                                       | do.                 |
| Richmond, No. 3             | Elk Hill Coal and Iron Company          | Seranton, 1st ward    | do.  | do.                 |
| Richmond, No. 4             | do.                                     | Richmondale, Fell tp. | W. H. Richmond, general superintendent             | Dickson City, Pa.   |
| Lackawanna shaft            | Lackawanna Coal Company                 | Blakely               | F. K. Tracy, assistant general supt.               | do.                 |
| Lackawanna tunnel           | do.                                     | do.                   | O. S. Johnson                                      | Seranton, Pa.       |
| Sterrick Creek No. 1 shaft  | Sterrick Creek Coal Company             | Peckville             | John R. Bryden                                     | do.                 |
| Sterrick Creek, No. 2 shaft | do.                                     | do.                   | do.  | do.                 |
| Sterrick Creek tunnel       | do.                                     | do.                   | Eli T. Conner                                      | do.                 |
| Mc. Jessup                  | Mc. Jessup Coal Company                 | Winton, Pa.           | do.  | Winton, Pa.         |
| Marshwood shaft             | Mooste Mountain Coal Company            | Marshwood, Pa.        | Charles V. Ford                                    | Marshwood, Pa.      |

|                                |     |                                     |                   |     |                                     |     |                   |
|--------------------------------|-----|-------------------------------------|-------------------|-----|-------------------------------------|-----|-------------------|
| Marshwood slope, .....         | do. | do.                                 | do.               | do. | do.                                 | do. | do.               |
| Marshwood tunnel, .....        | do. | do.                                 | Peckville,        | do. | do.                                 | do. | Peckville, Pa.    |
| Ontario shaft, .....           | do. | New York and Scranton Coal Company, | do.               | do. | Henry Chapman,                      | do. | Scranton, Pa.     |
| Dolph, .....                   | do. | do.                                 | Winton borough,   | do. | do.                                 | do. | Scranton, Pa.     |
| Blue Ridge shaft, .....        | do. | Dolph Coal Company,                 | Peckville, Pa.,   | do. | W. G. Robertson,                    | do. | do.               |
| Blue Ridge tunnel, .....       | do. | Blue Ridge Coal Company,            | do.               | do. | J. N. Rice,                         | do. | do.               |
| Thomas Waddell, .....          | do. | do.                                 | Winton, Pa.,      | do. | G. W. Waddell,                      | do. | Wilkes-Barre, Pa. |
| Riverside, .....               | do. | Waddell & Son,                      | Archbald, Pa.,    | do. | W. S. Mears,                        | do. | Scranton, Pa.     |
| Jones, Simpson & Co., shaft,   | do. | Riverside Coal Company,             | do.               | do. | Edward S. Jones,                    | do. | Olyphant, Pa.     |
| Jones, Simpson & Co., drift,   | do. | do.                                 | do.               | do. | do.                                 | do. | do.               |
| Simpson No. 1 slope, .....     | do. | North West Coal Company,            | Fell township,    | do. | J. L. Crawford,                     | do. | Scranton, Pa.     |
| Simpson No. 2 slope, .....     | do. | do.                                 | do.               | do. | James G. Shepherd, assistant supt., | do. | Jermyn, Pa.       |
| Edgerton, four drifts, .....   | do. | Edgerton Coal Company,              | Archbald borough, | do. | J. L. Crawford,                     | do. | Scranton, Pa.     |
| Hendricks, three drifts, ..... | do. | do.                                 | Carbondale, Pa.,  | do. | James G. Shepherd, assistant supt., | do. | Jermyn, Pa.       |
| Franklin, .....                | do. | Franklin Coal Company,              | Fell township,    | do. | Ira J. Meigley,                     | do. | Carbondale, Pa.   |
| S. V. White, .....             | do. | Winton Coal Company,                | Winton, Pa.,      | do. | E. M. Morgan,                       | do. | Scranton, Pa.     |
| Pierce, .....                  | do. | Pierce Coal Company,                | do.               | do. | David Morgan,                       | do. | Winton, Pa.       |
| Mt. Vernon, .....              | do. | Mt. Vernon,                         | do.               | do. | do.                                 | do. | do.               |
| Boyer, .....                   | do. | Boyer, Fuller, Vipond & Gilmore,    | Carbondale, Pa.,  | do. | Jonathan Vipond,                    | do. | Scranton, Pa.     |

TABLE No. 2 — Gives the total number of tons of coal mined in each colliery, number of days worked, number of employees, number of persons killed and injured, number of kegs of powder used, etc., in the First Anthracite District for the year ending December 31, 1894.

| Names of Collieries                | Location                   | Total production in tons of coal | Total shipment in tons of coal | Numbers days worked | Number persons employed | Number fatal accidents | Number of non-fatal accidents | Number kegs powder used | Number steam boilers | Number horses and mules | Number mine locomotives |  |
|------------------------------------|----------------------------|----------------------------------|--------------------------------|---------------------|-------------------------|------------------------|-------------------------------|-------------------------|----------------------|-------------------------|-------------------------|--|
|                                    |                            |                                  |                                |                     |                         |                        |                               |                         |                      |                         |                         |  |
| Delaware and Hudson Canal Company. |                            |                                  |                                |                     |                         |                        |                               |                         |                      |                         |                         |  |
| Leggett's Creek, .....             | 1st ward, Scranton, .....  | 199,742                          | 196,778                        | 185.5               | 506                     | 3                      | 6                             | 4,900                   | 24                   | 48                      | .....                   |  |
| Marvine, .....                     | do, .....                  | 167,887                          | 166,199                        | 181.75              | 461                     | 3                      | 6                             | 4,747                   | 21                   | 50                      | .....                   |  |
| Eddy Creek, .....                  | Olyphant, .....            | 240,904                          | 240,306                        | 181                 | 466                     | .....                  | 4                             | 7,704                   | 12                   | 47                      | .....                   |  |
| Olyphant No. 2, .....              | do, .....                  | 119,374                          | 117,253                        | 108.25              | 412                     | .....                  | 2                             | 5,034                   | 15                   | 44                      | .....                   |  |
| Grassy Island, .....               | do, .....                  | 186,719                          | 183,863                        | 188.2               | 428                     | .....                  | 4                             | 5,335                   | 21                   | 47                      | .....                   |  |
| White Oak, .....                   | Archbald, .....            | 190,133                          | 196,256                        | 184.75              | 452                     | .....                  | .....                         | 4,545                   | 6                    | 47                      | 1                       |  |
| Jermyn, .....                      | Jermyn, .....              | 212,969                          | 208,929                        | 174.25              | 564                     | 2                      | .....                         | 4,445                   | 19                   | 40                      | .....                   |  |
| Powderly, .....                    | Carbondale township, ..... | 79,797                           | 79,797                         | 179.75              | 286                     | 1                      | 2                             | 4,101                   | 12                   | 33                      | .....                   |  |
| No. 1 shaft, .....                 | do, .....                  | 67,523                           | 67,523                         | 180                 | 313                     | .....                  | .....                         | 2,818                   | 5                    | 45                      | .....                   |  |
| No. 3 shaft, .....                 | do, .....                  | 23,928                           | 23,928                         | 178.75              | 142                     | .....                  | .....                         | 1,679                   | 12                   | 15                      | .....                   |  |
| Coal Brook, .....                  | do, .....                  | 251,367                          | 251,367                        | 180                 | 702                     | .....                  | .....                         | 8,515                   | 5                    | 92                      | 1                       |  |
| Racket Brook, .....                | do, .....                  | 160,853                          | 160,853                        | 196.25              | 66                      | .....                  | 1                             | .....                   | .....                | 4                       | .....                   |  |
| Clinton, .....                     | Fell township, .....       | 119,226                          | 118,028                        | 177.75              | 298                     | .....                  | 4                             | 5,527                   | 10                   | 33                      | .....                   |  |
|                                    |                            | 2,029,522                        | 2,011,011                      | 181.63              | 5,066                   | 9                      | 31                            | 59,348                  | 171                  | 538                     | 3                       |  |
| Hillside Coal and Iron Company.    |                            |                                  |                                |                     |                         |                        |                               |                         |                      |                         |                         |  |
| Clifford, .....                    | Forest City, .....         | 149,511                          | *239,783                       | 168.75              | 402                     | 1                      | 5                             | 5,720                   | 9                    | 41                      | 1                       |  |
| Forest City, .....                 | do, .....                  | 264,057                          | 146,504                        | 113.25              | 610                     | 5                      | 9                             | 9,131                   | 24                   | 55                      | 2                       |  |
| Glenwood, .....                    | Mayfield, .....            | 293,175                          | 189,431                        | 179                 | 490                     | 1                      | 2                             | 6,477                   | 19                   | 34                      | .....                   |  |
| Erle, .....                        | do, .....                  | 166,333                          | 154,442                        | 177                 | 485                     | .....                  | 3                             | 5,611                   | 21                   | 47                      | 1                       |  |
| Keystone, .....                    | do, .....                  | 46,021                           | 45,086                         | 148.25              | 153                     | .....                  | .....                         | 1,019                   | 2                    | 23                      | .....                   |  |
|                                    |                            | 829,097                          | 768,246                        | 157.25              | 2,140                   | 7                      | 19                            | 27,968                  | 78                   | 260                     | 4                       |  |





Recapitulation. TABLE No. 2.—Continued.

| Names of Collieries                             | Location     | Total production in tons of coal. | Total shipment in tons of coal. | Number days worked. | Number persons employed. | Number fatal accidents. | Number non-fatal accidents. | Number kegs powder used. | Number steam boilers. | Number horses and mules. | Number mine locomotives. |
|---|--------------|-----------------------------------|---------------------------------|---------------------|--------------------------|-------------------------|-----------------------------|--------------------------|-----------------------|--------------------------|--------------------------|
| Delaware and Hudson Canal Company, .....        | .....        | 2,029,522                         | 2,011,011                       | 181,653             | 5,066                    | 9                       | 31                          | 59,348                   | 171                   | 538                      | 3                        |
| Hillside Coal and Iron Company, .....           | .....        | 829,097                           | 708,246                         | 157,225             | 2,140                    | 7                       | 19                          | 27,968                   | 78                    | 290                      | 4                        |
| Delaware, Lackawanna & Western R. R. Co., ..... | .....        | 403,323                           | 386,306                         | 175,4               | 916                      | 4                       | 4                           | 13,227                   | 15                    | 84                       | 2                        |
| Pennsylvania Coal Company, .....                | .....        | 241,254                           | 220,078                         | 164                 | 695                      | .....                   | .....                       | 9,039                    | 28                    | 69                       | 3                        |
| John Jermyn, .....                              | .....        | 177,418                           | 175,577                         | 145.5               | 528                      | 1                       | 9                           | 7,918                    | 24                    | 60                       | .....                    |
| Elk Hill Coal and Iron Company, .....           | .....        | 226,716                           | 209,053                         | 203                 | 437                      | 6                       | 4                           | 7,289                    | 13                    | 29                       | 1                        |
| Miscellaneous Coal Companies, .....             | .....        | 2,000,001                         | 1,922,373                       | 108.3               | 6,232                    | 20                      | 29                          | 79,598                   | 205                   | 592                      | 18                       |
| <b>Total, .....</b>                             | <b>.....</b> | <b>5,907,331</b>                  | <b>5,692,644</b>                | <b>171.9</b>        | <b>16,014</b>            | <b>47</b>               | <b>98</b>                   | <b>263,997</b>           | <b>534</b>            | <b>1,572</b>             | <b>31</b>                |

TABLE 3.—Showing the number of each class of employes at each colliery in the First Anthracite District during the year 1894.

| Name of Collieries  | Occupations of Persons Employed Inside. |         |                   |                  |                      |                        | Occupations of Persons Employed Outside. |                  |                             |                        |                |                        | Grand total inside and outside. |                                |
|---|---|---------|-------------------|------------------|----------------------|------------------------|--|------------------|-----------------------------|------------------------|----------------|------------------------|---------------------------------|--------------------------------|
|   | Inside foremen                          | Miners. | Miners' laborers. | All company men. | Drivers and runners. | Door boys and helpers. | Total inside                             | Outside foremen. | Blacksmiths and carpenters. | Engineers and trimmen. | State pickers. | All other company men. |                                 | Supts' bookkeepers and clerks. |
| <b>Delaware and Hudson Canal Company.</b>                 |   |         |                   |                  |                      |                        |  |                  |                             |                        |                |                        |                                 |                                |
| Leggetts Creek, .....                                     | 1                                       | 109     | 109               | 51               | 70                   | 25                     | 365                                      | 1                | 5                           | 10                     | 72             | 53                     | .....                           | 141                            |
| Marvine, .....  | 1                                       | 108     | 108               | 33               | 72                   | 19                     | 341                                      | 1                | 6                           | 10                     | 53             | 50                     | .....                           | 120                            |
| Eddy Creek, .....   | 2                                       | 115     | 115               | 45               | 70                   | 17                     | 364                                      | 1                | 8                           | 8                      | 50             | 37                     | .....                           | 102                            |
| Olyphant No. 2, .....                                     | 1                                       | 98      | 113               | 36               | 40                   | 28                     | 316                                      | 1                | 4                           | 11                     | 41             | 38                     | 1                               | 96                             |
| Grassy Island, .....                                      | 1                                       | 110     | 139               | 26               | 48                   | 5                      | 310                                      | 1                | 4                           | 12                     | 62             | 39                     | .....                           | 118                            |
| White Oak, .....  | 2                                       | 87      | 133               | 19               | 51                   | 6                      | 298                                      | 2                | 7                           | 4                      | 80             | 60                     | 1                               | 154                            |
| Jermyn, .....   | 1                                       | 182     | 171               | 44               | 40                   | 17                     | 455                                      | 1                | 5                           | 9                      | 50             | 44                     | .....                           | 109                            |
| Powderly, .....   | 1                                       | 168     | 8                 | 34               | 28                   | 11                     | 250                                      | 2                | 2                           | 6                      | 5              | 21                     | 2                               | 36                             |
| No. 1 shaft, .....  | 1                                       | 152     | 40                | 24               | 39                   | 9                      | 265                                      | 1                | 4                           | 3                      | 7              | 32                     | 1                               | 48                             |
| Racket Brook, .....                                       | 1                                       | 53      | 19                | 10               | 21                   | 5                      | 109                                      | 1                | 2                           | 2                      | 6              | 21                     | .....                           | 33                             |
| Coal Brook, .....   | 3                                       | 238     | 101               | 81               | 47                   | 17                     | 487                                      | 1                | .....                       | 2                      | 30             | 32                     | 1                               | 66                             |
| Clinton, .....  | 1                                       | 65      | 65                | 17               | 17                   | 16                     | 173                                      | 1                | 3                           | 7                      | 41             | 43                     | .....                           | 95                             |
|   | 16                                      | 1,485   | 1,102             | 420              | 545                  | 165                    | 3,733                                    | 13               | 54                          | 93                     | 597            | 570                    | 6                               | 1,333                          |
| <b>Delaware, Lackawanna and Western Railroad Company.</b> |   |         |                   |                  |                      |                        |  |                  |                             |                        |                |                        |                                 |                                |
| Storrs Nos. 1 and 2, .....                                | 2                                       | 176     | 176               | 62               | 78                   | 17                     | 511                                      | 1                | 10                          | 10                     | 92             | 80                     | 2                               | 195                            |
| Storrs No. 3, .....                                       | 3                                       | 246     | 251               | 95               | 107                  | 19                     | 721                                      | 1                | 10                          | 10                     | 92             | 80                     | 2                               | 195                            |
|   | 5                                       | 422     | 427               | 157              | 185                  | 36                     | 1,232                                    | 2                | 20                          | 20                     | 184            | 160                    | 4                               | 390                            |
| <b>John Jermyn.</b>                                       |   |         |                   |                  |                      |                        |  |                  |                             |                        |                |                        |                                 |                                |
| Jermyn No. 3, .....                                       | 2                                       | 80      | 80                | 40               | 48                   | 7                      | 257                                      | 1                | 4                           | 8                      | 48             | 16                     | 3                               | 80                             |
| Jermyn No. 4, .....                                       | 1                                       | 42      | 42                | 16               | 18                   | 5                      | 124                                      | 1                | 4                           | 7                      | 30             | 25                     | .....                           | 67                             |
|   | 3                                       | 122     | 122               | 56               | 66                   | 12                     | 381                                      | 2                | 8                           | 15                     | 78             | 41                     | 3                               | 147                            |

TABLE No. 3.—Continued.

| Names of Collieries             | Occupations of Persons Employed Inside. |        |                  |                 |                     |                       | Occupations of Persons Employed Outside. |                  |                            |                       |               |                        | Grand total inside and outside. |                               |                |
|---------------------------------|---|--------|------------------|-----------------|---------------------|-----------------------|--|------------------|----------------------------|-----------------------|---------------|------------------------|---------------------------------|-------------------------------|----------------|
|                                 | Inside foremen                          | Miners | Miners' laborers | All company men | Drivers and runners | Door boys and helpers | Total inside.                            | Outside foremen. | Blacksmiths and carpenters | Engineers and firemen | State pickers | All other company men. |                                 | Supts, bookkeepers and clerks | Total outside. |
| Hillside Coal and Iron Company. |   |        |                  |                 |                     |                       |  |                  |                            |                       |               |                        |                                 |                               |                |
| Clifford, .....                 | 1                                       | 129    | 96               | 12              | 32                  | 5                     | 276                                      | 1                | 5                          | 8                     | 51            | 58                     | 3                               | 126                           | 462            |
| Forest City, .....              | 3                                       | 187    | 187              | 46              | 66                  | 10                    | 489                                      | 1                | 6                          | 11                    | 35            | 53                     | 5                               | 111                           | 610            |
| Erie, .....                     | 2                                       | 130    | 130              | 50              | 58                  | 10                    | 380                                      | 1                | 4                          | 10                    | 46            | 40                     | 4                               | 105                           | 485            |
| Glenwood, .....                 | 2                                       | 125    | 110              | 39              | 60                  | 17                    | 353                                      | 1                | 5                          | 13                    | 73            | 43                     | 2                               | 137                           | 490            |
| Keystone, .....                 | 1                                       | 35     | 55               | 6               | 25                  | .....                 | 102                                      | 1                | 2                          | 2                     | 30            | 15                     | 1                               | 51                            | 153            |
|                                 | 5                                       | 606    | 558              | 153             | 242                 | 42                    | 1,610                                    | 5                | 22                         | 44                    | 235           | 209                    | 15                              | 330                           | 2,140          |
| Elk Hill Coal and Iron Company. |   |        |                  |                 |                     |                       |  |                  |                            |                       |               |                        |                                 |                               |                |
| Richmond No. 3, .....           | 3                                       | 40     | 20               | 10              | 15                  | 4                     | 92                                       | 1                | 4                          | 8                     | 34            | 25                     | 3                               | 75                            | 167            |
| Richmond No. 4, .....           | 2                                       | 60     | 70               | 50              | 25                  | 6                     | 213                                      | 1                | 5                          | 6                     | 30            | 13                     | 2                               | 57                            | 270            |
|                                 | 5                                       | 100    | 90               | 60              | 40                  | 10                    | 305                                      | 2                | 9                          | 14                    | 64            | 38                     | 5                               | 132                           | 437            |
| Pennsylvania Coal Company.      |   |        |                  |                 |                     |                       |  |                  |                            |                       |               |                        |                                 |                               |                |
| No. 2 shaft and tunnel, .....   | 1                                       | 38     | 38               | 7               | 5                   | 2                     | 91                                       | .....            | 1                          | 5                     | 7             | .....                  | .....                           | 13                            | 104            |
| Gypsy Grove, .....              | 1                                       | 113    | 94               | 11              | 35                  | 9                     | 263                                      | 1                | 2                          | 8                     | 32            | 33                     | .....                           | 76                            | 339            |
| No. 1 shaft, .....              | 1                                       | 68     | 41               | 9               | 24                  | 6                     | 149                                      | 1                | 1                          | 8                     | 65            | 28                     | .....                           | 103                           | 252            |
|                                 | 3                                       | 219    | 173              | 27              | 64                  | 17                    | 503                                      | 2                | 4                          | 21                    | 104           | 61                     | .....                           | 192                           | 695            |
| Miscellaneous Coal Companies.   |   |        |                  |                 |                     |                       |  |                  |                            |                       |               |                        |                                 |                               |                |
| Riverside, .....                | 1                                       | 117    | 117              | 13              | 32                  | 13                    | 303                                      | 1                | 3                          | 4                     | 76            | 37                     | 2                               | 123                           | 426            |
| Sterrick Creek, .....           | 2                                       | 125    | 140              | 30              | 40                  | 15                    | 352                                      | 2                | 8                          | 10                    | 116           | 45                     | 3                               | 184                           | 536            |
| Stimson, .....                  | 2                                       | 144    | 140              | 25              | 55                  | 15                    | 381                                      | 2                | 8                          | 14                    | 75            | 71                     | 5                               | 175                           | 556            |
| Edgerton, .....                 | 3                                       | 120    | 117              | 21              | 42                  | 12                    | 315                                      | 2                | 9                          | 6                     | 80            | 42                     | 5                               | 144                           | 459            |
| Ontario, .....                  | 2                                       | 126    | 155              | 27              | 61                  | 11                    | 395                                      | 1                | 9                          | 13                    | 85            | 32                     | 1                               | 141                           | 536            |
| Murray, .....                   | 2                                       | 14     | 14               | 2               | 11                  | 2                     | 45                                       | 1                | .....                      | 2                     | 6             | 8                      | 1                               | 19                            | 64             |

|                             |     |       |       |       |       |     |        |     |     |     |       |       |     |       |        |
|-----------------------------|-----|-------|-------|-------|-------|-----|--------|-----|-----|-----|-------|-------|-----|-------|--------|
| Pancoast, .....             | 2   | 163   | 163   | 81    | 67    | 20  | 496    | 1   | 7   | 12  | 86    | 56    | 3   | 165   | 661    |
| Blue Ridge, .....           | 2   | 151   | 187   | 13    | 94    | 8   | 395    | 1   | 8   | 17  | 97    | 42    | 2   | 198   | 521    |
| Jones, Simpson & Co., ..... | 2   | 259   | 199   | 32    | 38    | 18  | 598    | 1   | 7   | 16  | 108   | 42    | 2   | 133   | 723    |
| Lackawanna, .....           | 3   | 148   | 148   | 37    | 87    | 14  | 457    | 1   | 7   | 16  | 103   | 44    | 0   | 172   | 690    |
| Mt. Jessup, .....           | 1   | 98    | 93    | 31    | 26    | 2   | 251    | 1   | 3   | 5   | 93    | 58    | 0   | 142   | 433    |
| Marshwood, .....            | 1   | 62    | 62    | 6     | 24    | 5   | 190    | 1   | 3   | 5   | 97    | 43    | 1   | 98    | 188    |
| Dolph, .....                | 2   | 98    | 115   | 16    | 44    | 3   | 278    | 2   | 3   | 8   | 97    | 43    | 2   | 160   | 438    |
| Thos. Waddell, .....        | 1   | 12    | 12    | 4     | 3     | 1   | 33     | 1   | 3   | 3   | 20    | 11    | 1   | 39    | 72     |
| Idle during the year, ..... |     |       |       |       |       |     |        |     |     |     |       |       |     |       |        |
| S. V. White, .....          | do. | do.   | do.   | do.   | do.   | do. | do.    | do. | do. | do. | do.   | do.   | do. | do.   | do.    |
| Pierce, .....               | do. | do.   | do.   | do.   | do.   | do. | do.    | do. | do. | do. | do.   | do.   | do. | do.   | do.    |
| Franklin, .....             | do. | do.   | do.   | do.   | do.   | do. | do.    | do. | do. | do. | do.   | do.   | do. | do.   | do.    |
| Boyer, .....                | do. | do.   | do.   | do.   | do.   | do. | do.    | do. | do. | do. | do.   | do.   | do. | do.   | do.    |
| Mt. Vernon, .....           | do. | do.   | do.   | do.   | do.   | do. | do.    | do. | do. | do. | do.   | do.   | do. | do.   | do.    |
| Totals, .....               | 26  | 1,677 | 1,662 | 338   | 584   | 162 | 4,438  | 18  | 100 | 128 | 902   | 523   | 41  | 1,793 | 6,232  |
| Grand totals, .....         | 65  | 4,455 | 3,953 | 1,149 | 1,648 | 407 | 11,692 | 43  | 207 | 325 | 2,162 | 1,522 | 72  | 4,322 | 16,014 |

TABLE No. 4.—List of fatal accidents that occurred in the mines of the First Anthracite District for the year ending December 31, 1894.

| Date of accident. | Name of Person.        | Occupation.        | Age. | Widows. | Number of orphans. | Name of Colliery.        | Location—County.   | Nature and cause of accident.   |
|-------------------|------------------------|--------------------|------|---------|--------------------|--------------------------|--------------------|---|
| Jan. 4.           | John Makoski, .....    | Laborer, .....     | 32   | 1       | .....              | Lackawanna, .....        | Lackawanna, .....  | Instantly killed by being run over by a trip of empty cars on a plane.  |
| Jan. 5.           | Will Scott, .....      | Driver, .....      | 14   | .....   | .....              | Leggett's Creek, .....   | do.                | Instantly killed by a kick from a mule which he was driving.  |
| Jan. 8.           | Anthony Soniska, ..... | Laborer, .....     | 28   | .....   | .....              | Jones, Simpson & Co., .. | do.                | Fatally injured by a fall of "six inch;" died four hours after.   |
| Jan. 10.          | Joseph Wavra, .....    | Laborer, .....     | 44   | 1       | 8                  | Forest City, .....       | Susquehanna, ..... | Fatally injured by a runaway car on culm plane, caused by the breaking of a chain hook; died on the 17th of January.                                |
| Jan. 10.          | Michael Yeudts, .....  | Laborer, .....     | 29   | 1       | 1                  | do.                      | do.                | Fatally injured at the same time as above; died four hours after.   |
| Jan. 31.          | John Mutherlin, .....  | Miner, .....       | 40   | 1       | 1                  | Richmond No. 3, .....    | Lackawanna, .....  | Instantly killed by a fall of top coal at the face of his chamber.  |
| Feb. 1.           | Domnie Collesle, ..... | Laborer, .....     | 35   | 1       | 3                  | Edgerton, .....          | do.                | Fatally injured by a fall of top coal; died on the same day.  |
| Feb. 7.           | Joseph Tremel, .....   | Laborer, .....     | 22   | .....   | .....              | Lackawanna, .....        | do.                | Instantly killed by a fall of top coal and rock at the face of the chamber in which he was working.   |
| Feb. 13.          | John Naughton, .....   | Laborer, .....     | 50   | .....   | .....              | Richmond No. 3, .....    | do.                | Instantly killed by falling down a shaft.   |
| Mar. 6.           | Thomas Holwell, .....  | Rockman, .....     | 37   | 1       | 1                  | do.                      | do.                | Instantly killed by a fall of "bell" shaped rock from the side of the shaft.  |
| Mar. 6.           | Albert Richards, ..... | Rockman, .....     | 30   | .....   | .....              | do.                      | do.                | Killed by the same accident.  |
| Mar. 6.           | James Northey, .....   | Rockman, .....     | 38   | .....   | .....              | do.                      | do.                | Killed by the same accident.  |
| Mar. 6.           | Richard Hughes, .....  | Rockman, .....     | 28   | .....   | .....              | do.                      | do.                | Killed by the same accident.  |
| Mar. 20.          | John Walkoski, .....   | Miner, .....       | 35   | 1       | 5                  | Forest City slope, ..... | Susquehanna, ..... | Instantly killed by a fall of rock while in the act of retanding a prop that had been displaced by a shot fired a few minutes before.               |
| Mar. 22.          | Arthur Cochran, .....  | Miner, .....       | 26   | 1       | .....              | Blue Ridge, .....        | Lackawanna, .....  | Instantly killed by a fall of coal and bone at the face of his chamber while in the act of working out some coal loosened by a recently fired shot. |
| Mar. 26.          | James Gallagher, ..... | Driver boss, ..... | 26   | .....   | .....              | Leggett's Creek, .....   | do.                | Fatally injured by falling down an air shaft; died on the 23th of the same month.   |

|           |                            |                      |    |                             |                    |   |
|-----------|----------------------------|----------------------|----|-----------------------------|--------------------|---|
| May 1,    | David Reese, .....         | Driver, .....        | 19 | Storrs No. 2, .....         | do.                | Fatally injured by falling under loaded trip of cars.   |
| May 22,   | Patrick Powers, .....      | Miner, .....         | 53 | Jermyn No. 1, .....         | do.                | Instantly killed by a fall of buck and "four-teen inch."  |
| May 28,   | Phillip Ingoldsby, .....   | Driver, .....        | 17 | Ontario, .....              | do.                | Fatally injured by a kick from a mule; died on the following day.   |
| May 29,   | William Cawley, .....      | Miner, .....         | 42 | Marvine, .....              | do.                | Instantly killed by a fall of roof.   |
| May 31,   | Stanley Romel, .....       | Door boy, .....      | 14 | Jermyn No. 3, .....         | do.                | Instantly killed by falling down a shaft; he became dizzy and fell from the carriage.   |
| May 31,   | John Poloski, .....        | Miner, .....         | 28 | Jones, Simpson & Co., ..... | do.                | Fatally burned by an explosion of powder, caused by a spark from his lamp falling into the keg.   |
| June 6,   | John Murko, .....          | Laborer, .....       | 34 | Glenwood, .....             | do.                | Fatally injured by a fall of rock.  |
| June 11,  | Michael J. Walsh, .....    | Comp. laborer, ..... | 30 | Storrs No. 3, .....         | do.                | Instantly killed by falling under a car.  |
| June 19,  | George Deacle, .....       | Rockman, .....       | 23 | Marvine, .....              | do.                | Instantly killed by a fall of rock.   |
| June 23,  | Joseph Britlika, .....     | Loco. fireman, ..... | 19 | Blue Ridge, .....           | do.                | Fatally injured by falling under a trip of cars near the breaker.   |
| June 29,  | Peter Belena, .....        | Miner, .....         | 23 | Ontario, .....              | do.                | Instantly killed by a fall of roof.   |
| July 11,  | David Morgan, .....        | Miner, .....         | 41 | Storrs No. 2, .....         | do.                | Instantly killed by a fall of bell-shaped rock at the face of his chamber.  |
| July 16,  | William Williams, .....    | Miner, .....         | 50 | Leggett's Creek, .....      | do.                | Instantly killed by a premature explosion of a blast in the bottom coal.  |
| July 21,  | George Scharrtek, .....    | Laborer, .....       | 23 | Jermyn No. 1, .....         | do.                | Instantly killed by a small fall of top coal and "buck," near the face of the chamber in which he worked.   |
| Sept. 11, | George Smith, .....        | Laborer, .....       | 20 | Sturges, .....              | do.                | Instantly killed by a fall of top coal at the face of the chamber in which he worked.   |
| Sept. 27, | Eartley Ambersavage, ..... | Driver, .....        | 16 | Pancoast, .....             | do.                | Fatally injured by falling under a trip of cars; his light went out and he slipped on the rail.   |
| Sept. 27, | Byron Evans, .....         | Slate picker, .....  | 12 | Ontario, .....              | do.                | Instantly killed by being caught in culm scraper.   |
| Oct. 1,   | James Morrison, .....      | Miner, .....         | 52 | Forest City shaft, .....    | Susquehanna, ..... | Fatally injured by a fall of rock which occurred while he was preparing to put a set of timbers under it.   |
| Oct. 2,   | Thomas Wooley, .....       | Miner, .....         | 47 | Storrs No. 1, .....         | Lackawanna, .....  | Fatally injured by a fall of bell-shaped rock.  |
| Oct. 9,   | Michael Macovskt, .....    | Laborer, .....       | 33 | Forest City slope, .....    | Susquehanna, ..... | Instantly killed by a fall of rock at the face of the chamber.  |
| Oct. 22,  | Adam Clupek, .....         | Laborer, .....       | 26 | Simpson, .....              | Lackawanna, .....  | Instantly killed by the falling of a piece of top coal, about fifteen inches square, which struck him on the temple.  |
| Oct. 33,  | John Manton, .....         | Miner, .....         | 36 | Marvine, .....              | do.                | Instantly killed by a fall of bell-shaped rock, which fell out from between two props, close to one of which he was sitting.  |
| Oct. 30,  | Michael Gownley, .....     | Driver, .....        | 15 | Jones, Simpson & Co., ..... | do.                | Instantly killed by a fall of rock on a gangway road, where men were engaged taking down some roof. There was no traffic on this gangway at the time, and the man stated that the young boy went over the loose rock to hide a powder keg, and when he returned stood for a while talking to the men who were loading the rock, when a "slanting" piece of rock fell on him and killed him. |

TABLE No. 4.—Continued.

| Date of accident | Name of Person.              | Occupation     | Occupation |        |                   | Name of Colliery  | Location—County    | Nature and Cause of Accident.  |
|------------------|------------------------------|----------------|------------|--------|-------------------|-------------------|--------------------|--|
|                  |                              |                | Area.      | Widows | Number of orphans |                   |                    |  |
| Oct. 30.         | Michael Oniffrey, .....      | Laborer, ..... | 24         | .....  | .....             | Lackawanna, ..... | Lackawanna, .....  | Instantly killed by being squeezed between a car and the rib, caused by the car jumping the track.   |
| Nov. 3.          | Frank Brum, .....            | Laborer, ..... | 33         | 1      | 3                 | Edgerton, .....   | do.                | Instantly killed by a fall of top coal.  |
| Nov. 7.          | Anthony Eotscovich, .....    | Miner, .....   | 28         | 1      | 2                 | Clifford, .....   | Susquehanna, ..... | Instantly killed by a fall of rock while he was in the act of barring out some coal which a recently fired shot had shaken.  |
| Nov. 7.          | William Lewis, .....         | Miner, .....   | 59         | 1      | 7                 | Powderly, .....   | Lackawanna, .....  | Instantly killed by a fall of rock at the face of his chamber.   |
| Nov. 14.         | Joseph Peartross, .....      | Laborer, ..... | 20         | .....  | .....             | Mt. Jessup, ..... | do.                | Instantly killed by a fall of bell-shaped rock, close to the face of the chamber where he worked.  |
| Nov. 27.         | Frederick Rhine, .....       | Miner, .....   | 42         | 1      | 3                 | Simpson, .....    | do.                | Instantly killed by a fall of top coal and rock while he was in the act of barring it down.  |
| Nov. 27.         | Anthony Pauby, .....         | Laborer, ..... | 30         | 1      | .....             | do.               | do.                | Instantly killed by the same fall of top coal and rock.  |
| Nov. 30.         | Michael Barlasovitsky, ..... | Miner, .....   | 28         | 1      | 2                 | Blue Ridge, ..... | do.                | Fatally injured by a fall of top rock at the face of his chamber, which occurred shortly after two props had been displaced by a recently fired shot, and which he did not re-place. |



TABLE No. 5.—List of non-fatal accidents that occurred in the mines of the First Anthracite District for the year ending December 31, 1894.

| Date of Accident | Name of Person     | Occupation. | Age. | Name of Colliery.  | Location     | County. | Nature and Cause of Accident  |
|------------------|--------------------|-------------|------|--------------------|--------------|---------|---|
| Jan. 6.          | Joseph Hellich,    | Miner,      | 28   | Marvine,           | Lackawanna,  | .....   | Face cut and leg fractured by a fall of coal.   |
| Jan. 9.          | Patrick Walsh,     | Laborer,    | 34   | Eddy Creek,        | do.          | .....   | Leg fractured; fell and got caught by carriage.   |
| Jan. 11.         | Peter Foley,       | Miner,      | 38   | Riverside,         | do.          | .....   | Cut on body by flying coal from the premature explosion of a blast; he cut off the match of a safety squib to hasten its burning. |
| Jan. 15.         | John Barrett,      | Door boy,   | 15   | Leggett's Creek,   | do.          | .....   | Flesh torn from his leg near the thigh by a loaded car.   |
| Jan. 17.         | George Gerada,     | Miner,      | 36   | Clifford,          | Susquehanna, | .....   | Seriously injured on head and shoulders by a fall of coal.  |
| Jan. 24.         | Frank Sholaski,    | Miner,      | 42   | Jermyn No. 3,      | Lackawanna,  | .....   | Severely cut on head and hands by flying coal from the premature explosion of a blast.  |
| Feb. 3.          | Peter Conway,      | Runner,     | 18   | Marvine,           | do.          | .....   | Thigh dislocated by a car jumping the track and scuffing him.   |
| Feb. 15.         | Michael Moran,     | Runner,     | 18   | Eddy Creek,        | do.          | .....   | Arm fractured by being caught between door post and car.  |
| Feb. 21.         | Henry Smith,       | Driver,     | 18   | Clifford,          | Susquehanna, | .....   | Skull fractured by a kick from a mule.  |
| Feb. 24.         | Peter Coburn,      | Leader,     | 22   | Eddy Creek,        | Lackawanna,  | .....   | Arm squeezed between two bumpers while coupling cars.   |
| Feb. 24.         | John Skauter,      | Laborer,    | 26   | Blue Ridge,        | do.          | .....   | Three ribs fractured and otherwise internally injured by a fall of dividing rock.   |
| Feb. 24.         | Anthony Lombry,    | Miner,      | 52   | Marvine,           | do.          | .....   | Severely cut over left eye by a fall of top coal, which occurred while he was mining out the bottom coal.                         |
| Feb. 28.         | Joseph Burnes,     | Miner,      | 45   | Marvine,           | do.          | .....   | Slightly injured by a fall of top coal while mining out loose coal after a shot.  |
| Mar. 6.          | Joseph Valinski,   | Door boy,   | 14   | Forest City slope, | Susquehanna, | .....   | Ankle dislocated and leg severely bruised; struck by cars.  |
| Mar. 7.          | John Pumb,         | Laborer,    | 29   | Riverside,         | Lackawanna,  | .....   | Head cut and wrist fractured by a fall of slab.   |
| Mar. 7.          | Paniel McLaughlin, | Driver,     | 17   | Jermyn No. 4,      | do.          | .....   | Slightly burned by igniting a small body of gas.  |
| Mar. 10.         | Thomas McHale,     | Driver,     | 18   | olyphant No. 2,    | do.          | .....   | Leg fractured by falling under cars.  |
| Mar. 14.         | John Haggerty,     | Driver,     | 14   | Leggett's Creek,   | do.          | .....   | Two fingers cut off. He fell on the rail and culm car passed over his hand.   |
| Mar. 20.         | Patrick Scambon,   | Miner,      | 24   | Powderly,          | do.          | .....   | Severely bruised by a fall of "middle rock," which occurred while he was in the act of drilling a hole.                           |
| April 9.         | Anthony Coco,      | Miner,      | 40   | Clifford,          | Susquehanna, | .....   | Severely bruised by a fall of rock which occurred while he was standing a prop under it.  |

TABLE No. 5.—Continued.

| Date of Accident | Name of Person.         | Occupation.        | Age. | Name of Colliery         | Location—County.   | Nature and Cause of Accident.   |
|------------------|-------------------------|--------------------|------|--------------------------|--------------------|---|
| April 11,        | John Morgans, .....     | Runner, .....      | 24   | Jermyn No. 4, .....      | Lackawanna, .....  | Slightly burned on face and hands by an explosion of gas.   |
| April 24,        | Daniel Williams, .....  | Miner, .....       | 54   | Grassy Island, .....     | do. ....           | Leg fractured by a piece of coal rolling against it.  |
| April 26,        | George Medewa, .....    | Leader, .....      | 37   | Richmond No. 3, .....    | do. ....           | Arm fractured below the elbow by being caught between bumpers of cars.  |
| April 26,        | Edward Owens, .....     | Miner, .....       | 34   | Forest City shaft, ..... | Susquehanna, ..... | Face cut and back bruised by a fall of rock at the face of his chamber.   |
| May 2,           | Patrick Granahan, ..... | Driver, .....      | 16   | Grassy Island, .....     | Lackawanna, .....  | Both legs fractured by falling under a loaded car.  |
| May 19,          | Henry Rodman, .....     | Runner, .....      | 17   | Clifford, .....          | Susquehanna, ..... | Severely bruised by being squeezed between car and roof.  |
| May 14,          | Thomas Cawley, .....    | Door boy, .....    | 16   | Clifford, .....          | do. ....           | Head injured; struck by a chain hook.   |
| May 19,          | John Skrosky, .....     | Laborer, .....     | 24   | Grassy Island, .....     | Lackawanna, .....  | Toes cut off by fall of small slab from roof.   |
| May 21,          | John Harveth, .....     | Driver, .....      | 18   | Blue Ridge, .....        | do. ....           | Severely injured on head and breast; squeezed between mule and cars.  |
| May 22,          | John Kelley, .....      | Laborer, .....     | 28   | No. 1 shaft, .....       | do. ....           | Severely injured on face by an explosion of powder, which occurred while he was trying to drive the powder back into the hole with an iron bar. |
| May 22,          | William Munley, .....   | Laborer, .....     | 30   | No. 1 shaft, .....       | do. ....           | Injured on face and body by the same accident.  |
| June 4,          | Michael Yunkasky, ..... | Laborer, .....     | 27   | Pancoast, .....          | do. ....           | Head severely injured by a fall of rock.  |
| June 15,         | Edward Williams, .....  | Driver, .....      | 18   | Lackawanna, .....        | do. ....           | Small bone of leg fractured by a fall of slab.  |
| June 21,         | Aaron Herbert, .....    | Miner, .....       | 63   | Leggett's Creek, .....   | do. ....           | Slightly injured by a fall of rock.   |
| June 21,         | George Crabb, .....     | Laborer, .....     | 60   | Leggett's Creek, .....   | do. ....           | Leg fractured and body severely bruised by a fall of rock.  |
| June 22,         | Michael Bilan, .....    | Miner, .....       | 28   | Jermyn No. 3, .....      | do. ....           | Slightly injured by a fall of rock.   |
| June 25,         | Michael Butler, .....   | Door tender, ..... | 73   | Coal Brook, .....        | do. ....           | Leg fractured by being struck by a trip of cars.  |
| June 26,         | Andrew Naskey, .....    | Laborer, .....     | 30   | Erie, .....              | do. ....           | Head, hand and hips severely injured by a fall of rock.   |
| June 26,         | Alfred O'Keefe, .....   | Door tender, ..... | 37   | Simpson, .....           | do. ....           | Severely squeezed between car and rib.  |
| June 27,         | Thomas Cogan, .....     | Miner, .....       | 37   | Simpson, .....           | do. ....           | Slightly injured by a fall of rock in chamber.  |
| June 29,         | William Monk, .....     | Headman, .....     | 23   | Blue Ridge, .....        | do. ....           | Arm fractured; knocked down by a rope.  |
| June 30,         | Hugh Battle, .....      | Laborer, .....     | 30   | Richmond No. 3, .....    | do. ....           | Arm fractured by fall of top coal.  |
| June 30,         | John Gibbons, .....     | Footman, .....     | 59   | Marvine, .....           | do. ....           | Slightly squeezed between two cars.   |
| July 14,         | Jacob Miller, .....     | Miner, .....       | 37   | Storrs No. 1, .....      | do. ....           | Head and back injured by a fall of roof.  |
| July 15,         | David M. Thomas, .....  | Miner, .....       | 32   | Jermyn No. 4, .....      | do. ....           | Back injured and one rib fractured by a fall of roof.   |
| Aug. 1,          | William Thomas, .....   | Rockman, .....     | 32   | Marvine, .....           | do. ....           | Severely injured on head by the premature explosion of a blast.   |

|           |                    |              |    |                    |              |  |
|-----------|--------------------|--------------|----|--------------------|--------------|--|
| Aug. 1.   | Michael Russian,   | Miner,       | 37 | Forest City slope, | Susquehanna, | Rib fractured and thigh severely cut by a fall of rock.  |
| Aug. 4.   | John Frantor,      | Miner,       | 38 | Leggett's Creek,   | Lackawanna,  | Face and arm cut by flying coal from a shot which exploded prematurely.  |
| Aug. 9.   | Robert Clark,      | Miner,       | 38 | Forest City slope, | Susquehanna, | Hips and back injured by a falling sulphur ball.   |
| Aug. 12.  | John Naughton,     | Miner,       | 20 | Richmondale,       | Lackawanna,  | Head and legs injured by a fall of top coal.   |
| Aug. 14.  | Martin Lofton,     | Laborer,     | 20 | Mt. Jessup,        | do.          | Body severely bruised by falling under cars.   |
| Aug. 17.  | John Vedischek,    | Miner,       | 45 | Clinton,           | do.          | Head severely cut by flying coal from a shot.  |
| Aug. 20.  | Frank Middleton,   | Engineer,    | 21 | Forest City,       | Susquehanna, | Scalded by steam from a locomotive boiler; plug blown-in; out.   |
| Aug. 21.  | Michael Corcoran,  | Miner,       | 50 | Riverside,         | Lackawanna,  | Small bone of leg fractured by flying coal from a shot.  |
| Aug. 24.  | Loyal Hurd,        | Laborer,     | 19 | Racket Brook,      | do.          | Leg fractured by being squeezed between car and mule.  |
| Aug. 25.  | Joseph Hudak,      | Driver,      | 19 | Jermy No. 4,       | do.          | Slightly squeezed between car and rib.   |
| Aug. 30.  | William Snaith,    | Driver,      | 16 | Storrs No. 3,      | do.          | Hand bruised and cut by a fall of coal from gob.   |
| Sept. 3.  | Michael O'Boyle,   | Planeman,    | 29 | Grassy Island,     | do.          | Severely injured by being caught between locomotive and mine rail.   |
| Sept. 11. | Patrick McHale,    | Laborer,     | 28 | Storrs No. 3,      | do.          | Injured on foot and body by fall of roof.  |
| Sept. 15. | Theodore Treavick, | Miner,       | 29 | Marshwood,         | do.          | Injured about hips and chest by fall of roof.  |
| Sept. 20. | Ralph Abbott,      | Miner,       | 38 | Pancoast,          | do.          | Ribs fractured and otherwise injured by a premature explosion of a blast.  |
| Sept. 24. | Patrick Gerrity,   | Laborer,     | 27 | Erie,              | do.          | Squeezed between car and rib.  |
| Sept. 28. | Martin McManamy,   | Miner,       | 23 | Leggett's Creek,   | do.          | Severely cut by flying coal from a shot that prematurely exploded.   |
| Sept. 27. | George Young,      | Miner,       | 42 | Clinton,           | do.          | Leg fractured and back severely injured by a fall of rock on the chamber road.   |
| Sept. 27. | Adam Ladusky,      | Laborer,     | 36 | Marshwood,         | do.          | Left arm fractured by a fall of roof.  |
| Sept. 28. | Thomas O'Hara,     | Miner,       | 39 | Eddy Creek,        | do.          | Injured on back by a fall of top coal and bony, while engaged working out a shot in the bottom coal.   |
| Oct. 3.   | William Farrell,   | Laborer,     | 34 | Forest City slope, | Susquehanna, | Severely injured by a fall of rock.  |
| Oct. 3.   | Isaac Davie,       | Helper,      | 19 | Jermy No. 4,       | Lackawanna,  | Arm fractured by being caught under connecting rod on engine.  |
| Oct. 15.  | Michael Seaman,    | Driver,      | 18 | Ontario,           | do.          | Thigh fractured by falling under a trip of cars.   |
| Oct. 17.  | Thos. Pedler,      | Laborer,     | 23 | Wilson Creek,      | do.          | Severely injured on face and body by explosion of a blast.   |
| Oct. 17.  | Stephen Fougher,   | Runner,      | 19 | Ontario,           | do.          | Leg fractured by car jumping the track and striking him.   |
| Oct. 18.  | Michael Mikes,     | Laborer,     | 28 | Lackawanna,        | do.          | Leg fractured by being caught under car.   |
| Oct. 19.  | Thomas Coughlin,   | Runner,      | 24 | Glenwood,          | do.          | Leg, arm and ribs fractured by a fall of top coal and bone, which occurred while in the act of working out some coal that had been shattered by a shot fired a few minutes previously. |
| Oct. 27.  | Henry Hillis,      | Miner,       | 45 | Pancoast,          | do.          | Arm cut off by falling under cars.   |
| Nov. 9.   | Michael Lorus,     | Laborer,     | 33 | Blue Ridge,        | do.          | Leg fractured by falling under a car that he was playing with, which was 100 feet away from his door.  |
| Nov. 2.   | George Roeche,     | Door tender, | 15 | Glenwood,          | do.          | Injured on body by a fall of top coal.   |
| Nov. 3.   | John Benski,       | Miner,       | 49 | Edgerton,          | do.          | Injured on back and leg by a fall of rock while barring out some coal from the face.   |
| Nov. 7.   | Henry Sutter,      | Laborer,     | 35 | Powderly,          | do.          | Bruised on back and hips by a fall of rock which occurred while he and the miner were engaged standing a prop under it.  |
| Nov. 7.   | Alex. Kunarski,    | Laborer,     | 25 | Forest City slope, | Susquehanna, | Finger cut off by being caught between two cars.   |
| Nov. 1.   | Michael Fradusky,  | Runner,      | 26 | Edgerton,          | Lackawanna,  | Leg severely injured by a fall of rock.  |
| Nov. 10.  | Jos-ph Krotofski,  | Laborer,     | 35 | Storrs No. 1,      | do.          |  |

TABLE No. 5. —Continued.

| Date of Accident | Name of Person     | Occupation    | Age | Name of Colliery   | Location—County | Nature and Cause of Accident   |
|------------------|--------------------|---------------|-----|--------------------|-----------------|--|
| Nov. 13,         | Edward Scutt,      | Stable boss,  | 45  | Jermyn No. 4,      | Lackawanna,     | Leg fractured by a car being thrown against it.  |
| Nov. 17,         | Peter Mumley,      | Headman,      | 28  | Richmond No. 3,    | do.             | Bruised by falling some distance down the shaft and striking the descending carriage bonnet, and then falling from that into the car that was on the carriage.                           |
| Nov. 19,         | David Jenkins,     | Laborer,      | 29  | Forest City shaft, | Susquehanna,    | Rib fractured by a fall of rock.   |
| Nov. 21,         | Andrew Burakis,    | Miner,        | 34  | Jermyn No. 4,      | Lackawanna,     | Injured on the back by a fall of rock, which occurred while he was mining out the bottom bench.  |
| Nov. 21,         | Michael Kelley,    | Runner,       | 28  | Hendricks,         | do.             | Severely injured by a fall of rock on the gangway road, while he was preparing to put a prop under it.   |
| Nov. 25,         | Alex. Clune,       | Carpenter,    | 32  | Simpson,           | do.             | Slightly scalded by escaping steam from a pipe which burst.  |
| Nov. 26,         | John Smith,        | Switchman,    | 15  | Forest City shaft, | Susquehanna,    | Leg crushed in a collision between electric motor and empty car.   |
| Nov. 29,         | William Pryor,     | Slate picker, | 13  | Pancoast,          | Lackawanna,     | Fell and broke his arm while climbing around in the breaker.   |
| Dec. 11,         | William Shafer,    | Miner,        | 36  | Olyphant No. 2,    | do.             | Severely injured by a fall of rock while preparing to put a prop under it.   |
| Dec. 12,         | John Matchuck,     | Laborer,      | 26  | Erie,              | do.             | Rib fractured and forced into left lung by a fall of "bony" coal.  |
| Dec. 13,         | Frank Lavni,       | Miner,        | 22  | Clinton,           | do.             | Severely burned on face and hands by an explosion of about six pounds of powder which was ignited by a spark falling from his lamp, which he had on his head when making up some powder. |
| Dec. 13,         | Charles Fries,     | Laborer,      | 23  | Clinton,           | do.             | Severely burned by same explosion of powder.   |
| Dec. 17,         | Michael Mislotski, | Laborer,      | 26  | Mt. Jessup,        | do.             | Leg fractured by being run over by empty car.  |
| Dec. 21,         | John Fertoraitis,  | Miner,        | 35  | Riverside,         | do.             | Leg fractured and body bruised by a fall of bell-shaped rock.  |
| Dec. 23,         | Thomas Lavinko,    | Miner,        | 22  | Mt. Jessup,        | do.             | Arm cut and leg burned by a premature explosion of a blast.  |
| Dec. 28,         | Andrew Down,       | Laborer,      | 29  | Mt. Jessup,        | do.             | Face and hands cut by same accident.   |
| Dec. 28,         | Andrew Rintoufer,  | Laborer,      | 26  | Mt. Jessup,        | do.             | Arm fractured; face, hands and head cut by same accident.  |

# Second Anthracite District.

(LACKAWANNA COUNTY.)

Scranton, Pa., April 1, 1895.

Hon. Isaac B. Brown,

Secretary of Internal Affairs:

Sir: I have the honor of herewith presenting my annual report for the year ending December 31, 1894, in compliance with article 2, section 9 of the Anthracite Mine Law, approved June 2, 1891.

The total quantity of coal mined in the Second Anthracite district was 5,674,579.09 tons; shipped, 5,195,272.08 tons; consumed at collieries, 317,087.19 tons, and sold for local consumption, 158,272.02 tons.

The number of fatal accidents was 41, as a result of which there were left 13 widows and 39 orphans. The number of non-fatal accidents was 141, some of which were of a very slight character.

The quantity of coal mined per life lost was 138,404 tons.

Hereto attached will be found tables giving in detail the statistics required by law.

There were no improvements during the year except what were necessary for the economic working of the collieries.

The following named persons passed a satisfactory examination which entitled them to be recommended to the Secretary of Internal Affairs to have certificates issued qualifying them to hold the position of mine foremen and assistant mine foremen:

Robert E. Owens, mine foreman, Scranton, Pa.

John Connolly, mine foreman, Taylor, Lackawanna county, Pa.

Reese Thomas, mine foreman, Scranton, Lackawanna county, Pa.

Isaac Watkins, mine foreman, Rendham, Lackawanna county, Pa.

Howell G. Reese, mine foreman, Scranton, Lackawanna county, Pa.

Thomas F. Jones, mine foreman, Scranton, Lackawanna county, Pa.

David A. Jones, mine foreman, Minooka, Lackawanna county, Pa.

John T. Davies, mine foreman, Scranton, Lackawanna county, Pa.

Francis E. Cosgrove, mine foreman, Old Forge, Lackawanna county, Pa.

Edmund Davies, mine foreman, Scranton, Lackawanna county, Pa.

Alfred Powell, mine foreman, Scranton, Lackawanna county, Pa.

Charles Hainsworth, assistant mine foreman, Marshwood, Lackawanna county, Pa.

Edward E. Davis, assistant mine foreman, Scranton, Lackawanna county, Pa.

Evan Walters, assistant mine foreman, Scranton, Lackawanna county, Pa.

John Devereaux, assistant mine foreman, Scranton, Lackawanna county, Pa.

Frank J. Campbell, assistant mine foreman, Scranton, Lackawanna county, Pa.

Lewis P. Davis, assistant mine foreman, Scranton, Lackawanna county, Pa.

Daniel Mathias, assistant mine foreman, Scranton, Lackawanna county, Pa.

Respectfully submitted,

PATRICK BLEWITT,

Inspector of Mines.

TABLE NO. 1.—List of accidents resulting in death reported to the Inspector of the Second district of the Wyoming Coal Fields, Lackawanna county, now including a portion of Lackawanna county, State of Pennsylvania, and the causes as shown by his investigations for the year ending 31st day of December, A. D. 1894.

| Date, 1894 | Name                   | Age   | Nationality | Occupation   | Killed | Widows | Orphans | Collinery where accident occurred | Nature or cause of death   |
|------------|------------------------|-------|-------------|--------------|--------|--------|---------|-----------------------------------|--|
| Jan. 17    | Andrew Diskin          | 13    | American    | Slate picker | Killed | .....  | .....   | Greenwood No. 1 breaker           | Killed by falling in machinery; was caught in cog wheel in breaker.  |
| Jan. 22    | Henry Gramatzki        | 21    | Italian     | Laborer      | Killed | .....  | .....   | Jermyn No. 2 shaft mine           | Killed; fell off hoisting carriage while going up the shaft.   |
| Jan. 24    | William Visoski        | 19    | Hungarian   | Laborer      | Killed | .....  | .....   | William A shaft mine              | Killed; fall of top coal.  |
| Jan. 24    | Gorezo Boreno          | 19    | Italian     | Laborer      | Killed | .....  | .....   | Jermyn No. 1 shaft mine           | Killed instantly; fall of roof.  |
| Jan. 24    | John Saneo             | 15    | Hungarian   | Slate picker | Killed | .....  | .....   | Green Ridge breaker               | Killed; caught on journal, or shaft, of breaker machinery.   |
| Feb. 10    | Patrick P. Cook        | 32    | Irish       | Laborer      | Died   | 1      | 6       | Pine Brook shaft mine             | Seriously injured; runaway car on north slope; died same night.  |
| Feb. 21    | David Jones            | 23    | Welsh       | Miner        | Died   | .....  | .....   | Dodge shaft mine                  | Seriously injured by the explosion of a blast; died about 4.06 p. m., same day.  |
| Mar. 22    | Thomas Langan          | 18    | American    | Headman      | Died   | .....  | .....   | Greenwood No. 2 shaft mine        | Injured; fell under a car; died, April 6th, not reported as seriously injured.   |
| Mar. 28    | Christopher Doyle, Jr. | 25    | English     | Miner        | Killed | .....  | .....   | Sibley shaft mine                 | Killed by premature explosion of a blast.  |
| Mar. 30    | William Roberts        | 33    | Welsh       | Footman      | Died   | .....  | .....   | Breshin shaft mine                | Head slightly cut by a piece of coal falling from cartage; died on June 21, over two months after.   |
| April 14   | Peter Macus            | 35    | Italian     | Laborer      | Killed | 1      | 2       | Bunker Hill No. 2 tunnel          | Killed; fall of rock roof.   |
| April 24   | John Himledge          | ..... | Polish      | Laborer      | Killed | .....  | .....   | Austin tunnel mine                | Killed; fall of top coal and roof.   |
| April 24   | John Bengo             | 28    | Hungarian   | Laborer      | Died   | .....  | .....   | Archball shaft mine               | Back seriously injured; fall of roof; died on May 12.  |
| May 2      | Samuel Kenny           | 19    | Polish      | Runner       | Killed | .....  | .....   | Dodge shaft mine                  | Killed; pushed a car down the shaft from Diamond vein; he held on to the top piece of car and it pulled him down with it to the bottom. He notified the others working with him that everything was all right before they pushed the car into the shaft. |
| May 5      | John McQueen           | 55    | Scotch      | Miner        | Died   | 1      | 4       | Old Forge No. 2 shaft mine        | Seriously injured; fall of roof; died in a few minutes after the accident occurred.  |
| May 10     | John Walsh             | 15    | American    | Driver       | Killed | .....  | .....   | Von Storeh slope mine             | Killed; run over by a mine car on slope, while on slope against orders.  |

TABLE No. 1.—Continued.

| Date, 1894 | Name.                 | Age. | Nationality. | Occupation.  | Killed. | Widows. | Orphans. | Colliery where accident occurred. | Nature or cause of death.  |
|------------|-----------------------|------|--------------|--------------|---------|---------|----------|-----------------------------------|--|
| May 11,    | John Scott,           | 42   | American,    | Miner,       | Died,   | 1       | 4        | No. 5 shaft, Dunmore mine.        | Seriously injured; fall of roof; died two hours after.   |
| May 18,    | Sebestjan Theywolski, | 36   | Polish,      | Laborer,     | Killed, | .....   | .....    | Hamilton shaft mine.              | Killed; fall of roof.  |
| May 18,    | Jenkin Josephs,       | 40   | Welsh,       | Miner,       | Killed, | .....   | 1        | Cayuga shaft mine.                | Seriously injured; died in a short time; injury caused by a fall of rock.  |
| May 18,    | Henry Peel,           | 25   | American,    | Laborer,     | Killed, | .....   | 1        | Cayuga shaft mine.                | Seriously injured; struck by a prop on the head; died a few minutes after.   |
| May 21,    | Patrick McNamara,     | 17   | American,    | Driver,      | Killed, | .....   | .....    | Von Storch slope mine.            | Killed instantly; pushed by a mule against a prop; fell and was then run over by cars.   |
| June 15,   | Henry Murray,         | 52   | Irish,       | Miner,       | Died,   | .....   | .....    | Bunker Hill drift mine.           | Seriously injured; fall of top coal; died three hours after.   |
| June 20,   | Michael Sultzer,      | 45   | Swedish,     | Miner,       | Killed, | 1       | 5        | Taylor (Pock Vein) mine.          | Killed; knocked out two props by a blast, while examining roof afterward; it fell on him.  |
| June 22,   | William Evans,        | 24   | Welsh,       | Track layer, | Died,   | .....   | .....    | Cayuga shaft mine.                | Seriously injured about head and back; fall of rock; died that night.  |
| July 12,   | Patrick Gallagher,    | 16   | American,    | Driver,      | Killed, | .....   | .....    | Sibley shaft mine.                | Killed; caught between cars.   |
| July 16,   | John Sepiek,          | 24   | Polish,      | Laborer,     | Killed, | .....   | .....    | Jermyn No. 2 shaft mine.          | Killed; fall of roof.  |
| Sept. 1,   | Thomas Ryan,          | 34   | Irish,       | Miner,       | Died,   | 1       | 5        | Pine Brook shaft mine.            | Seriously injured by a premature blast; died in Moses Taylor hospital.   |
| Sept. 17,  | John C. Thomas,       | 40   | Welsh,       | Miner,       | Died,   | 1       | .....    | Mauville shaft mine.              | Seriously injured; fall of rock; died at 4:30 a. m.  |
| Oct. 20,   | James Doyle,          | 35   | Italian,     | Laborer,     | Died,   | 1       | .....    | Spencer's shaft mine.             | This man was reported slightly injured on the 8th, being burned on the forearm; he died on the 20th.   |
| Nov. 7,    | Robert Murray,        | 19   | American,    | Laborer,     | Killed, | .....   | .....    | Old Forge No. 1 shaft mine.       | Killed; fall of top coal.  |
| Nov. 16,   | Mike Peters,          | 25   | Polish,      | Laborer,     | Died,   | .....   | .....    | Archbald shaft mine.              | Squeezed between loaded trip of cars; he died in Moses Taylor Hospital.  |
| Nov. 28,   | John B. Jones,        | 45   | Welsh,       | Miner,       | Killed, | 1       | .....    | Pine Brook shaft mine.            | Jones and Cawley worked together and Eagan left his chamber to go in where they were working; all of them sat down close to the face of the chamber to smoke, and while in the act of doing so a fall of rock occurred, falling on all of them and killing them. |
| Nov. 28,   | Thomas J. Cawley,     | 28   | Irish,       | Laborer,     | Killed, | .....   | .....    | Pine Brook shaft mine.            | Struck on head by a piece of coal flying from a blast; died about twelve hours after.  |
| Nov. 28,   | Edward Eagan,         | 40   | Irish,       | Laborer,     | Killed, | .....   | .....    | Pine Brook shaft mine.            | Struck on head by a piece of coal flying from a blast; died about twelve hours after.  |
| Dec. 13,   | John Warner,          | 40   | German,      | Miner,       | Died,   | 1       | 1        | Spencer's shaft mine.             | Struck on head by a piece of coal flying from a blast; died about twelve hours after.  |



|          |                   |    |            |          |       |             |        |           |                          |       |                                     |
|----------|-------------------|----|------------|----------|-------|-------------|--------|-----------|--------------------------|-------|-------------------------------------|
| Dec. 15, | Michael Dunn,     | 41 | Irish,     | Miner,   | ..... | Killed,     | 1      | 1         | Sibley shaft mine,       | ..... | Killed by a fall of rock roof       |
| Dec. 17, | Curtis Fresse,    | 27 | American,  | Miner,   | ..... | Killed,     | 1      | 2         | Continental shaft mine,  | ..... | Killed; fall of roof.               |
| Dec. 18, | John Calitz,      | 26 | Hungarian, | Laborer, | ..... | Killed,     | 1      | 1         | Jermyn No. 2 shaft mine, | ..... | Killed; fall of top coal.           |
| Dec. 18, | Aug. Mfentkulecz, | 20 | Hungarian, | Laborer, | ..... | Killed,     | 1      | 1         | Lawrence drift mine,     | ..... | Killed; fall of rock.               |
| Dec. 18, | Thomas Price,     | 16 | American,  | Driver,  | ..... | Killed,     | .....  | .....     | Austin drift mine,       | ..... | Killed; thrown from a mule outside. |
| Dec. 19, | Joe Rutcoski,     | 27 | Polish,    | Miner,   | ..... | Killed,     | .....  | .....     | Greenwood slope mine,    | ..... | Killed; fall of top coal.           |
| Fatal,   | .....             | 41 | American,  | .....    | ..... | 10 equal to | 24.4   | per cent. | Falls of roof,           | ..... | 17 or 41.5 per cent.                |
| Orphans, | .....             | 39 | English,   | .....    | ..... | 1 equal to  | 2.4    | per cent. | Falls of coal,           | ..... | 6 or 14.6 per cent.                 |
| Widows,  | .....             | 13 | Irish,     | .....    | ..... | 6 equal to  | 14.6   | per cent. | Machinery,               | ..... | 2 or 4.9 per cent.                  |
|          |                   |    | Welsh,     | .....    | ..... | 4 equal to  | 9.8    | per cent. | Hoisting carriage,       | ..... | 1 or 2.3 per cent.                  |
|          |                   |    | Italian,   | .....    | ..... | 4 equal to  | 9.8    | per cent. | Killed by cars,          | ..... | 6 or 14.7 per cent.                 |
|          |                   |    | Hungarian, | .....    | ..... | 5 equal to  | 12.2   | per cent. | Powder and blasts,       | ..... | 4 or 9.8 per cent.                  |
|          |                   |    | Polish,    | .....    | ..... | 6 equal to  | 14.6   | per cent. | Miscellaneous,           | ..... | 5 or 12.2 per cent.                 |
|          |                   |    | Scottish,  | .....    | ..... | 1 equal to  | 2.4    | per cent. |                          |       |                                     |
|          |                   |    | Swedish,   | .....    | ..... | 1 equal to  | 2.5    | per cent. |                          |       |                                     |
|          |                   |    | German     | .....    | ..... | 1 equal to  | 2.5    | per cent. |                          |       |                                     |
|          |                   |    |            |          |       | 41 equal to | 100.00 | per cent. |                          |       |                                     |

TABLE NO. 2.—List of serious and non-fatal accidents reported to the Inspector of the Second Anthracite District of Lackawanna county, now including a portion of Lackawanna county, State of Pennsylvania, and the cause as shown by his investigations, for the year ending 31st day of December, A. D. 1894.

| Date, 1894 | Names             | Age | Nationality | Occupation       | Colliery where accident occurred | Nature of accident  |
|------------|-------------------|-----|-------------|------------------|----------------------------------|---|
| Jan. 3     | Samuel T. Jones,  | 17  | Welsh,      | Mine foreman,    | Lawrence Colliery shaft,         | Slightly injured while in the act of examining shaft; fell to the bottom.                     |
| Jan. 3     | John Slater,      | 29  | English,    | Driver,          | Providance Coal Company's shaft, | Injured; was riding on bumpers of car; it struck the head block and threw him off.            |
| Jan. 4     | John Donaske,     | 29  | Polish,     | Laborer,         | Greenwood No. 1 shaft,           | One bone of right leg fractured above ankle; fall of roof.                                    |
| Jan. 7     | William E. Parry, | 34  | Welsh,      | Laborer,         | Greenwood No. 2 shaft,           | Ankle dislocated; fall of roof.   |
| Jan. 11    | George Watkins,   | 27  | Polish,     | Driver,          | West Ridge slope shaft,          | Hips injured; caught between car and rib.   |
| Jan. 11    | Simon White,      | 25  | Polish,     | Miner,           | Van Storch shaft mine,           | Back and loins slightly bruised; fall of top rock.  |
| Feb. 6     | Andrew Boken,     | 26  | Polish,     | Laborer,         | Hampton shaft mine,              | Slightly injured; fall of roof.   |
| Feb. 8     | Patrick Began,    | 25  | Irish,      | Laborer,         | Shaft No. 5, Dunmore mine,       | Right leg fractured; bruised badly; both these men injured by premature explosion of a blast. |
| Feb. 8     | John Golden,      | 35  | English,    | Laborer,         | Mount Pleasant shaft mine,       | Head cut and back bruised; fall of rock.  |
| Feb. 10    | Edward Siverster, | 35  | Welsh,      | Laborer,         | Oxford shaft mine,               | Skull and three ribs fractured; premature explosion of a blast.                               |
| Feb. 10    | John Parry,       | 31  | Welsh,      | Miner,           | Oxford shaft mine,               | Skull and three ribs fractured; premature explosion of a blast.                               |
| Feb. 15    | Charles Burke,    | 30  | Irish,      | Miner,           | Jernyn No. 2 shaft mine,         | Leg fractured; knocked out three incisors by a blast; roof fell while resting; incisors.      |
| Feb. 15    | Martin Moran,     | 35  | Irish,      | Laborer,         | Capouse shaft mine,              | Both these men were slightly injured; fall of a slab of rock.                                 |
| Feb. 15    | Walter Carlen,    | 19  | American,   | Laborer,         | Capouse shaft mine,              | Right foot badly bruised; caught between the cars.  |
| Feb. 16    | Orey Moore,       | 19  | American,   | Asbman,          | Manville Breaker shaft mine,     | Leg fractured in two places and received two scab wounds; caught under cars.                  |
| Feb. 17    | Arthur Williams,  | 16  | Welsh,      | Driver's helper, | Oxford shaft mine,               | Back slightly injured; fall of roof.  |
| Feb. 19    | Thomas P. Evans,  | 42  | Welsh,      | Miner,           | Van Storch shaft mine,           | Injured about hips and legs; fall of top coal.  |
| Feb. 23    | Michael O'Brien,  | 35  | Irish,      | Miner,           | Diamond shaft mine,              | Slightly injured by same fall.  |
| Feb. 23    | Evan Thomas,      | 49  | Welsh,      | Miner,           | Diamond shaft mine,              | Arm slightly injured and toes mashed.   |
| Feb. 26    | John Penock,      | 28  | Hungarian,  | Laborer,         | Green Ridge slope mine,          | Flesh wound of skin; size 10x6 inches.  |
| Mar. 2     | David E. Reese,   | 49  | Welsh,      | Laborer,         | Greenwood No. 1 shaft mine,      | Neck and hands slightly burned; spark from his lamp fell on powder.                           |
| Mar. 5     | John Gallagher,   | 32  | Irish,      | Miner,           | Van Storch shaft mine,           | Three ribs fractured and back injured; fall of bony coal.                                     |
| Mar. 7     | James McAndrew,   | 35  | Irish,      | Miner,           | Bunker Hill drift mine,          | Ankle badly bruised; car ran over it.   |
| Mar. 14    | Roman Cavish,     | 15  | Polish,     | Driver,          | Greenwood No. 1 shaft mine,      | Right leg fractured; fall of rock.  |
| Mar. 21    | John A. Phillips, | 22  | Welsh,      | Miner,           | Capouse shaft mine,              | Finger nearly cut off; a piece of coal fell and caught it on bumper of car.                   |
| Mar. 27    | Llewellen Harris, | 18  | Welsh,      | Driver,          | Diamond "Trip" shaft mine,       |   |

|          |                         |    |                |                |                                   |  |
|----------|-------------------------|----|----------------|----------------|-----------------------------------|--|
| April 5  | James Cannon, .....     | 41 | Irish, .....   | Miner, .....   | Sloan shaft mine, .....           | Injured, "not seriously;" premature explosion of a blast.                                      |
| April 19 | Váragone Stephens, .... | 33 | Hungarian, ..  | Headman, ..... | Austin tunnel mine, .....         | Collar bone fractured; got on moving trip of cars and fell in front of trip.                   |
| April 23 | Abraham Freese, .....   | 26 | American, ..   | Miner, .....   | Capouse shaft mine, .....         | Squeezed between a car and pillar.   |
| April 23 | Evan Morris, .....      | 47 | Welsh, .....   | Footman, ..... | Capouse shaft mine, .....         | Finger on left hand cut off; caught between top rail of car and roof.                          |
| April 24 | Owen Doland, .....      | 18 | Irish, .....   | Runner, .....  | Sloan shaft mine, .....           | Left leg fractured below the knee; got tangled in stretcher and traces and fell under the car. |
| April 25 | Michael Boltan, .....   | 15 | Irish, .....   | Driver, .....  | Greenwood No. 8 drift mine, ..... | Right leg fractured below the knee by runaway car in chamber.                                  |
| April 25 | Daniel Flaherty, .....  | 28 | Irish, .....   | Miner, .....   | Pine Brook shaft mine, .....      | Compound fracture of right arm; struck by flying coal while running away from blast.           |
| May 2    | Thomas J. Thomas, ....  | 31 | Welsh, .....   | Miner, .....   | Cayuga shaft mine, .....          | Slightly injured; fall of roof in face of timber.  |
| May 4    | Pat Cavanaugh, .....    | 32 | Irish, .....   | Laborer, ..... | West Ridge slope mine, .....      | Hips slightly injured; caught between car and prop.  |
| May 4    | Morgan Williams, .....  | 25 | Welsh, .....   | Runner, .....  | Archbald shaft mine, .....        | Arm fractured while spragging; caught between car and prop.                                    |
| May 5    | Joseph Killmarth, ....  | 31 | Irish, .....   | Laborer, ..... | Mount Pleasant shaft mine, .....  | Injured about head and arms by flying coal from premature blast.                               |
| May 8    | Mike Yacks, .....       | 35 | Polish, .....  | Laborer, ..... | Jermyn No. 1 shaft mine, .....    | Thumb cut off; caught while spragging a car on the outside at breaker.                         |
| May 9    | George Sorotsha, .....  | 18 | Polish, .....  | Runner, .....  | Jermyn No. 2 shaft mine, .....    | Hand smashed; caught between car and blocking while getting a car on track.                    |
| May 19   | Petro Hammer, .....     | 17 | Polish, .....  | Runner, .....  | Greenwood No. 2 shaft mine, ..... | Small bone of left arm fractured and back bruised; fall of bony coal.                          |
| May 19   | Richard T. Robbins, ... | 39 | Welsh, .....   | Miner, .....   | Hyde Park shaft mine, .....       | Leg fractured; fall of roof.   |
| May 15   | Magnus O. Nelson, ....  | 25 | Swedish, ..... | Miner, .....   | Diamond shaft mine, .....         | Slightly injured; kicked by a mule.  |
| May 27   | Abe Hughes, .....       | 17 | American, ..   | Driver, .....  | Capouse shaft mine, .....         | Injured slightly; fall of roof.  |
| May 31   | David Shaw, .....       | 22 | English, ..... | Laborer, ..... | Pine Brook shaft mine, .....      | Leg fractured; fall of roof.   |
| May 31   | James Reddington, ....  | 28 | Irish, .....   | Laborer, ..... | Bellevue shaft mine, .....        | Small bone of left leg fractured; struck by a piece of coal flying from a blast.               |
| May 31   | Richard Williams, ..... | 31 | Welsh, .....   | Miner, .....   | Hyde Park shaft mine, .....       | Leg fractured above the ankle; fall of bony coal.  |
| June 1   | Swan Anderson, .....    | 32 | Swedish, ..... | Laborer, ..... | Fyne shaft mine, .....            | Right leg fractured below the knee; fall of top coal.  |
| June 1   | William Emmell, .....   | 44 | German, .....  | Miner, .....   | Greenwood No. 1 shaft mine, ..... | Head cut and back bruised; fall of rock.   |
| June 2   | John Derig, .....       | 29 | Irish, .....   | Laborer, ..... | Hampton shaft mine, .....         | Arms burned; a spark from his lamp fell on cartridge in his hands and exploded it.             |
| June 7   | William Hughes, .....   | 38 | Welsh, .....   | Miner, .....   | Hampden shaft mine, .....         | Both legs fractured; fall of roof.   |
| June 8   | William Goshell, .....  | 30 | Polish, .....  | Laborer, ..... | Dodge shaft mine, .....           | Slightly injured; fall of roof.  |
| June 9   | Peter Zagradi, .....    | 25 | Polish, .....  | Laborer, ..... | West Ridge slope mine, .....      | Injured; struck on head by a piece of coal flying from a blast.                                |
| June 18  | Jonathan Williams, .... | 44 | Welsh, .....   | Miner, .....   | Jermyn No. 2 shaft mine, .....    | Severely injured; fall of soapstone roof.  |
| June 19  | Michael Mashesky, ....  | 34 | Polish, .....  | Laborer, ..... | Dodge shaft mine, .....           | Hip dislocated and cut about the face; fall of slate roof.                                     |
| June 20  | Evan Jones, .....       | 28 | Welsh, .....   | Laborer, ..... | Cayuga shaft mine, .....          | Back and hips injured; fall of rock.   |
| June 22  | Joseph Glisskie, .....  | 24 | Polish, .....  | Laborer, ..... | Manville shaft mine, .....        | Slightly injured on head and right hip; fall of roof.  |
| June 22  | James Brown, .....      | 26 | Irish, .....   | Miner, .....   | Jermyn No. 2 shaft mine, .....    | Injured slightly; he knocked out a prop and while examining roof it fell on him.               |
| June 23  | John Dutchack, .....    | 28 | Hungarian, ..  | Miner, .....   |                                   |  |

TABLE No. 2.—Continued.

| Date, 1894 | Names                | Age | Nationality | Occupation       | Colliery where accident occurred | Nature of accident   |
|------------|----------------------|-----|-------------|------------------|----------------------------------|--|
| June 25,   | Michael Needham,     | 59  | Irish,      | Miner,           | Hampton shaft mine,              | Injured; fall of bony coal from between top and bottom benches.  |
| June 25,   | Henry Gregory,       | 13  | Italian,    | Slate picker,    | Spencer's breaker,               | Piece of flesh torn out of fore part of leg above the knee; caught in screen.  |
| June 26,   | Thomas Stevens,      | 16  | English,    | Driver's helper, | Caponise shaft mine,             | Leg fractured; fall of mule's back.  |
| June 28,   | Peter Rice,          | 30  | Polish,     | Miner,           | Pine Brook shaft mine,           | Seriously burned on arms, legs and face.   |
| June 28,   | Joe Kerwitz,         | 27  | Polish,     | Laborer,         | Pine Brook shaft mine,           | Dangerously burned; spark from lamp fell on cartridge in Peter Rice's hands.   |
| June 29,   | Edward Harris,       | 45  | Welsh,      | Miner,           | Bellevue shaft mine,             | Both slightly burned by an explosion of gas;   |
| June 29,   | James Kelly,         | 35  | Irish,      | Miner,           | Bellevue shaft mine,             | they took down some roof and in falling it forced some gas on to their lamps, causing a slight explosion.                      |
| July 2,    | William Davis,       | 36  | Welsh,      | Laborer,         | Shoan shaft mine,                | Slightly injured on shoulder and right foot; fall of bony coal.  |
| July 2,    | Richard Lewis,       | 72  | Welsh,      | Miner,           | Jermyn No. 1 shaft mine,         | Arm fractured; struck by a piece of coal flying from a blast.  |
| July 3,    | Charles Dixon,       | 32  | English,    | Miner,           | Pine Brook shaft mine,           | All three slightly burned by an explosion of gas.  |
| July 3,    | Sylvester Burns,     | 27  | Polish,     | Laborer,         | Pine Brook shaft mine,           | Back injured; fall of rock roof  |
| July 3,    | Thomas Barrett,      | 17  | Irish,      | Driver's helper, | Pine Brook shaft mine,           | Arm fractured; caught whilst riding on bumper of light car.  |
| July 10,   | David Gould,         | 42  | Welsh,      | Miner,           | Archbald shaft mine,             | Seriously injured; premature explosion of a blast; hand cut and shoulder injured; a prop was knocked out and roof fell on him. |
| July 11,   | Lewis Miller,        | 42  | Welsh,      | Miner,           | Old Forge No. 2 shaft mine,      | Left thigh fractured; fall of roof.  |
| July 18,   | George Jackson,      | 56  | English,    | Miner,           | Old Forge No. 1 shaft mine,      | Right arm badly fractured; car wheel passed over it.   |
| July 21,   | Isaac Evans,         | 42  | Welsh,      | Miner,           | Caponise shaft mine,             | Leg fractured and otherwise injured; fall of roof.   |
| July 24,   | Otto Hiben,          | 22  | German,     | Miner,           | Pine Brook shaft mine,           | Ankle slightly injured; caught between bumpers of two cars.  |
| July 25,   | Charles O. Lemhan,   | 15  | American,   | Driver,          | Archbald shaft mine,             | Face and eyes injured; premature explosion of a blast.   |
| Aug. 3,    | Thomas Nary,         | 27  | Irish,      | Miner,           | Hampton shaft mine,              | Injured; kicked by a mule.   |
| Aug. 6,    | Frank Daniels,       | 26  | Polish,     | Laborer,         | Cayuga shaft mine,               | Breast and shoulder injured; fall of roof.   |
| Aug. 6,    | David Humphreys,     | 32  | Welsh,      | Miner,           | Jermyn No. 1 shaft mine,         | Leg fractured; a piece of rock he was pulling down fell on it.   |
| Aug. 10,   | Thomas Reese,        | 18  | Welsh,      | Driver,          | Diamond Tilly slope mine,        | Slightly injured by a blast.   |
| Aug. 20,   | William A. Phillips, | 23  | Welsh,      | Miner,           | Jermyn No. 2 shaft mine,         | Seriously injured by a blast which exploded while he was tampering a bed.  |
| Aug. 25,   | Joseph Capinos,      | 27  | Hungarian,  | Laborer,         | Jermyn No. 2 shaft mine,         |  |
| Aug. 27,   | Joseph Bigger,       | 30  | Hungarian,  | Laborer,         | Jermyn No. 2 shaft mine,         |  |
| Aug. 27,   | Andrew Balind,       | 25  | Hungarian,  | Miner,           | Jermyn No. 2 shaft mine,         |  |

|           |                           |                  |    |                  |                     |  |   |
|-----------|---------------------------|------------------|----|------------------|---------------------|--|---|
| Aug. 29.  | John L. Sullivan, .....   | Irish, .....     | 36 | Irish, .....     | Miner, .....        | Meadow Brook colliery mine, .....      | Body badly bruised; fall of roof.   |
| Sept. 1.  | Morris Thiel, .....       | German, .....    | 30 | German, .....    | Laborer, .....      | Pine Brook shaft mine, .....           | Seriously injured; premature blast.   |
| Sept. 8.  | Patrick Scott, .....      | Irish, .....     | 27 | Irish, .....     | Laborer, .....      | Capouse shaft mine, .....              | Two fingers cut off; car run over them.   |
| Sept. 10. | William Riley, .....      | Irish, .....     | 17 | Irish, .....     | Teamster, .....     | Ryde Park shaft mine, .....            | Law bone fractured; kicked by a mule.   |
| Sept. 11. | Peter Carroll, .....      | Hungarian, ..... | 25 | Hungarian, ..... | Laborer, .....      | Green Ridge slope mine, .....          | Seriously injured; struck by a trip of cars on plane.   |
| Sept. 11. | Stephen Davis, .....      | Welsh, .....     | 16 | Welsh, .....     | Driver, .....       | Dodge shaft mine, .....                | Injured badly by a runaway trip of cars on plane.   |
| Sept. 12. | Joseph Ambroski, .....    | Polish, .....    | 27 | Polish, .....    | Laborer, .....      | Sloan shaft mine, .....                | Small of back slightly injured; fall of top coal.   |
| Sept. 15. | Patrick Jennings, .....   | Irish, .....     | 22 | Irish, .....     | Footman, .....      | Cayuga shaft mine, .....               | Seriously injured about back and side; fall of rock in Clark vein.  |
| Sept. 21. | Thomas Conely, .....      | Irish, .....     | 50 | Irish, .....     | Rockman, .....      | Green Ridge slope mine, .....          | Injured below the knee; caught between cars.  |
| Sept. 24. | Frank C. Ward, .....      | Irish, .....     | 45 | Irish, .....     | Rockman, .....      | Green Ridge slope mine, .....          | These men were slightly burned by an explosion of gas.  |
| Sept. 24. | James Crane, .....        | Irish, .....     | 45 | Irish, .....     | Rockman, .....      | Green Ridge slope mine, .....          |   |
| Sept. 25. | Watzl Pobbedovitch, ..... | Hungarian, ..... | 30 | Hungarian, ..... | Laborer, .....      | Jermyn No. 2 shaft mine, .....         | Head seriously injured; struck with flying coal from blast.   |
| Sept. 28. | Ernest Genero, .....      | Italian, .....   | 40 | Italian, .....   | Miner, .....        | Meadow Brook shaft mine, .....         | Two fingers of right hand cut off while in the act of spragging a car.  |
| Sept. 28. | Elmer Space, .....        | American, .....  | 15 | American, .....  | Slate picker, ..... | Spencer's breaker, Dunmore mine, ..... | Leg fractured while in the act of unitching his mule.   |
| Oct. 3.   | Ralph Shermack, .....     | German, .....    | 23 | German, .....    | Miner, .....        | British shaft mine, .....              | Body bruised; fall of top coal.   |
| Oct. 4.   | William Samuels, .....    | Welsh, .....     | 46 | Welsh, .....     | Footman, .....      | Oxford shaft mine, .....               | Knee squeezed between two loaded cars.  |
| Oct. 4.   | Jepkin Davis, .....       | Welsh, .....     | 15 | Welsh, .....     | Door boy, .....     | Dodge shaft mine, .....                | Jaw bone broken in two places and several teeth knocked out; kicked by a mule.  |
| Oct. 8.   | John Flaherty, .....      | Irish, .....     | 17 | Irish, .....     | Runner, .....       | Mount Pleasant shaft mine, .....       | Left arm crushed and left leg fractured; fell in front of car and it ran over him.  |
| Oct. 9.   | John Damaske, .....       | Polish, .....    | 22 | Polish, .....    | Laborer, .....      | Greenwood No. 1 shaft mine, .....      | Leg fractured; slipped and fell on floor of chamber.  |
| Oct. 11.  | Dominick Gallagher, ..... | Irish, .....     | 58 | Irish, .....     | Company man, .....  | Dodge shaft mine, .....                | Back injured, not seriously; struck by a trip of cars.  |
| Oct. 11.  | Joseph Devoy, .....       | Italian, .....   | 30 | Italian, .....   | Laborer, .....      | William A shaft mine, .....            | Slightly burned; explosion of gas.  |
| Oct. 12.  | Casper Nelget, .....      | Swedish, .....   | 29 | Swedish, .....   | Prop cutter, .....  | Austn drift mine, .....                | Hand slightly injured; caught in sheave of pulley.  |
| Oct. 20.  | Daniel Sherin, .....      | American, .....  | 19 | American, .....  | Driver, .....       | Green Ridge slope mines, .....         | These boys were slightly burned by an explosion of gas; there is a cavity in the roof on the main hauling road, and if the door is left open which is close to it, for a short time, it allows the gas to accumulate; this was the case, and it caused the explosion. |
| Oct. 20.  | Thomas McMullen, .....    | American, .....  | 16 | American, .....  | Driver, .....       | Green Ridge slope mines, .....         | Cut on right side of head and left arm, and badly bruised on right side of body.  |
| Oct. 20.  | John Moriarity, .....     | American, .....  | 16 | American, .....  | Door boy, .....     | Green Ridge slope mines, .....         | Leg fractured; a piece of soapstone rolled over on it.  |
| Oct. 20.  | John Kerrigan, .....      | American, .....  | 16 | American, .....  | Door boy, .....     | Green Ridge slope mines, .....         |   |
| Oct. 22.  | Mart. Ferguson, .....     | Irish, .....     | 50 | Irish, .....     | Miner, .....        | Manville shaft mine, .....             |   |
| Oct. 25.  | Peter Bourke, .....       | Irish, .....     | 40 | Irish, .....     | Miner, .....        | Jermyn No. 2 shaft mines, .....        |   |
| Oct. 31.  | John Maleski, .....       | Polish, .....    | 33 | Polish, .....    | Laborer, .....      | Continental shaft mine, .....          | Bone in right arm fractured by a piece of coal falling from top of car on it.   |
| Nov. 6.   | Paolo Mascollin, .....    | Italian, .....   | 35 | Italian, .....   | Miner, .....        | William A colliery shaft mine, .....   | Leg fractured; fall of rock.  |
| Nov. 7.   | Thomas McNally, .....     | Irish, .....     | 25 | Irish, .....     | Miner, .....        | Old Forge No. 1 shaft mine, .....      | Seriously injured; fall of top coal.  |
| Nov. 10.  | Thomas Ferguson, .....    | Irish, .....     | 25 | Irish, .....     | Miner, .....        | Dodge shaft mine, .....                | Cut on back of head; struck by coal flying from blast.  |
| Nov. 14.  | James Shields, .....      | Irish, .....     | 35 | Irish, .....     | Miner, .....        | West Ridge slope mine, .....           | Leg fractured; fall of bony coal.   |

TABLE No. 2.—Continued.

| Date 1894 | Names               | Age   | Nationality. | Occupation.      | Colliery where accident occurred | Nature of accident.   |
|-----------|---------------------|-------|--------------|------------------|----------------------------------|---|
| Nov. 16,  | Patrick Logan,      | 29    | Irish,       | Miner,           | Diamond shaft mine,              | Both of these men were slightly burned by explosion of gas.                       |
| Nov. 16,  | James Walsh,        | 18    | American,    | Laborer,         | Diamond shaft mine,              | Foot injured; caught between bumper of car and rail.                              |
| Nov. 17,  | James Narush,       | 15    | Polish,      | Door boy,        | Diamond Tripp shaft mine,        | Badly burned by gas. He was notified of the danger by the fire boss.              |
| Nov. 19,  | Stanley Mosinsky,   | 40    | Polish,      | Laborer,         | William shaft mine,              | Bruised badly; caught by a fall of roof.  |
| Nov. 19,  | John Condon,        | 22    | Irish,       | Runner,          | Lawrence tunnel mine,            | Slightly injured; fall of roof.   |
| Nov. 26,  | Patrick Gilbride,   | 26    | Irish,       | Miner,           | Cayuga shaft mine,               | Severely injured; fall of rock.   |
| Nov. 27,  | George Galorschock, | 31    | Polish,      | Miner,           | Providence shaft mine,           | Left hip fractured by a runaway car out of chamber on to main road.               |
| Nov. 28,  | Walter Malia,       | 17    | Irish,       | Driver,          | Mount Pleasant shaft mine,       | Injured by same runaway.  |
| Nov. 28,  | Michael Cluning,    | 15    | Irish,       | Driver's helper, | Mount Pleasant shaft mine,       | Compound fracture of left arm; premature explosion of a blast.                    |
| Nov. 28,  | Michael Lavericks,  | 40    | Polish,      | Miner,           | Jermyn No. 1 shaft mine,         | Leg fractured; caught under descending car-riage in shaft.                        |
| Nov. 30,  | Sydney Bone,        | 25    | English,     | Footman,         | Dickson shaft mine,              | Injured by a piece of roof falling on him.  |
| Dec. 1,   | Martin Shannon,     | 55    | Irish,       | Miner,           | Hampton shaft mine,              | Side slightly bruised; fall of top coal.  |
| Dec. 3,   | Henry Lewis,        | 40    | English,     | Miner,           | Jermyn No. 1 shaft mine,         | Two toes crushed and ankle sprained; caught by a mine car.                        |
| Dec. 7,   | John O'Hara,        | 35    | American,    | Miner,           | Spencer's shaft mine,            | Small bone above the ankle in left leg fractured; fall of roof.                   |
| Dec. 7,   | William Halford,    | 33    | Welsh,       | Miner,           | Mount Pleasant shaft mine,       | Arm fractured above the wrist; struck by a piece of coal falling down the shaft.  |
| Dec. 13,  | John Miller,        | 29    | Polish,      | Footman,         | Dodge shaft mine,                | Right leg fractured above the knee and back bruised; fall of top coal.            |
| Dec. 18,  | David Griffiths,    | 40    | Welsh,       | Miner,           | Pyne shaft mine,                 | Leg fractured; struck by flying coal from blast; he ignited the squib by mistake. |
| Dec. 19,  | James Murphy,       | 35    | Irish,       | Miner,           | West Ridge slope mine,           | Legs seriously injured; struck by coal flying from blast.                         |
| Dec. 20,  | Thomas Davis,       | 21    | Polish,      | Laborer,         | Cayuga shaft mine,               | Slightly injured; fell in front of moving car.                                    |
| Dec. 21,  | Andrew Mascom,      | 17    | Polish,      | Driver,          | Lawrence drift mine's,           | Slightly injured; fell in front of moving car.                                    |
| Dec. 21,  | Thomas Deville,     | 50    | Irish,       | Laborer,         | Manville shaft mine,             | Split his foot with an axe while in the act of setting a collar in place.         |
| Dec. 22,  | Stephen Nechel,     | ..... | German,      | Laborer,         | Austin drift mine,               | Leg injured; car jumped the track and caught his foot.                            |
| Dec. 29,  | John Roche,         | 16    | American,    | Driver,          | Meadow Brook mine,               | .....   |

There were 141 non-fatal accidents.

There were 27 persons who had their legs fractured.  
 There were 11 persons who had their arms fractured.  
 There were 103 persons who were slightly injured.

Total, 141.

TABLE No. 3.—Showing the number of each class of employes at each colliery in the Second Anthracite District, during the year 1895.

| Names of Collieries.                               | Occupations of Persons Employed Inside. |              |                   |                  |                      |                        |               |                  |                            |                         | Occupations of Person Employed Outside. |                        |           |                |              |  |  | Grand total inside and outside. |
|--|---|--------------|-------------------|------------------|----------------------|------------------------|---------------|------------------|----------------------------|-------------------------|---|------------------------|-----------|----------------|--------------|--|--|---------------------------------|
|  | Occupations of Persons Employed Inside. |              |                   |                  |                      |                        |               |                  |                            |                         | Occupations of Person Employed Outside. |                        |           |                |              |  |  |                                 |
|  | Inside foremen.                         | Miners.      | Miners' laborers. | All company men. | Drivers and runners. | Door boys and helpers. | Total inside. | Outside foremen. | Backsmiths and car-penter. | Engineers and fire-men. | State pickers.                          | All other company men. | Drivers.  | Total outside. |              |  |  |                                 |
| Delaware, Lackawanna and Western Railroad Company. |   |              |                   |                  |                      |                        |               |                  |                            |                         |   |                        |           |                |              |  |  |                                 |
| Archibald shaft mine, .....                        | 2                                       | 125          | 125               | 48               | 47                   | 10                     | 356           | 2                | 17                         | 10                      | 115                                     | 44                     | 8         | 196            | 552          |  |  |                                 |
| Belleveue shaft mine, .....                        | 1                                       | 102          | 102               | 28               | 47                   | 8                      | 289           | 2                | 15                         | 12                      | 95                                      | 44                     | 2         | 170            | 459          |  |  |                                 |
| Brisbin shaft mine, .....                          | 1                                       | 36           | 36                | 13               | 20                   | 4                      | 110           | 1                | 9                          | 8                       | 89                                      | 46                     | 3         | 137            | 479          |  |  |                                 |
| Cayuga shaft mine, .....                           | 1                                       | 112          | 117               | 33               | 46                   | 13                     | 322           | 1                | 19                         | 8                       | 90                                      | 28                     | 2         | 148            | 467          |  |  |                                 |
| Central shaft and Sloan breaker, .....             | 1                                       | 111          | 111               | 36               | 56                   | 4                      | 319           | 1                | 13                         | 15                      | 68                                      | 73                     | 7         | 177            | 663          |  |  |                                 |
| Continental shaft mine, .....                      | 1                                       | 118          | 148               | 58               | 53                   | 15                     | 386           | 1                | 10                         | 10                      | 82                                      | 50                     | 7         | 160            | 483          |  |  |                                 |
| Dodge shaft mine, .....                            | 1                                       | 109          | 110               | 42               | 48                   | 13                     | 323           | 1                | 12                         | 11                      | 65                                      | 33                     | 5         | 132            | 417          |  |  |                                 |
| Tripps slope and shaft mine, .....                 | 3                                       | 145          | 137               | 37               | 42                   | 23                     | 407           | 1                | 20                         | 12                      | 62                                      | 67                     | .....     | 152            | 669          |  |  |                                 |
| Holden shaft mine, .....                           | 1                                       | 35           | 36                | 13               | 13                   | .....                  | 98            | 1                | 5                          | 4                       | 73                                      | 22                     | 1         | 132            | 430          |  |  |                                 |
| Hampton shaft mine, .....                          | 2                                       | 101          | 102               | 27               | 42                   | 8                      | 282           | 1                | 7                          | 9                       | 79                                      | 49                     | 4         | 149            | 390          |  |  |                                 |
| Hyde Park shaft mine, .....                        | 1                                       | 94           | 94                | 37               | 51                   | 6                      | 284           | 1                | 10                         | 7                       | 61                                      | 25                     | 3         | 106            | 386          |  |  |                                 |
| Manville shaft mine, .....                         | 2                                       | 97           | 101               | 23               | 42                   | 10                     | 280           | 1                | 5                          | 6                       | 62                                      | 39                     | 3         | 106            | 306          |  |  |                                 |
| Oxford shaft mine, .....                           | 2                                       | 93           | 97                | 30               | 35                   | 20                     | 277           | 1                | 18                         | 7                       | 83                                      | 30                     | 2         | 121            | 308          |  |  |                                 |
| Pyne shaft mine, .....                             | 1                                       | 113          | 119               | 39               | 35                   | 9                      | 316           | 1                | 10                         | 8                       | 88                                      | 41                     | 2         | 158            | 468          |  |  |                                 |
| Taylor shaft and drift mine, .....                 | 2                                       | 104          | 108               | 34               | 35                   | 12                     | 295           | 1                | 12                         | 11                      | 90                                      | 37                     | 7         | 158            | 453          |  |  |                                 |
| <b>Total, .....</b>                                | <b>25</b>                               | <b>1,689</b> | <b>1,657</b>      | <b>633</b>       | <b>659</b>           | <b>166</b>             | <b>4,629</b>  | <b>17</b>        | <b>188</b>                 | <b>139</b>              | <b>1,124</b>                            | <b>633</b>             | <b>62</b> | <b>2,153</b>   | <b>6,772</b> |  |  |                                 |
| Miscellaneous Coal Companies.                      |   |              |                   |                  |                      |                        |               |                  |                            |                         |   |                        |           |                |              |  |  |                                 |
| Austin drift, .....                                | 3                                       | 79           | 132               | 23               | 26                   | 3                      | 295           | 1                | 4                          | 7                       | 70                                      | 29                     | 2         | 113            | 379          |  |  |                                 |
| Dickson shaft, .....                               | 1                                       | 105          | 103               | 35               | 52                   | 8                      | 394           | 1                | 4                          | 9                       | 48                                      | 51                     | .....     | 113            | 417          |  |  |                                 |
| Von Storch shaft, .....                            | 1                                       | 132          | 115               | 67               | 129                  | 17                     | 461           | .....            | 9                          | 14                      | 46                                      | 66                     | 3         | 138            | 599          |  |  |                                 |
| Capouse shaft, .....                               | 2                                       | 150          | 152               | 53               | 67                   | 27                     | 451           | 1                | 9                          | 6                       | 122                                     | 25                     | 3         | 165            | 616          |  |  |                                 |
| Pine Brook shaft, .....                            | 2                                       | 115          | 119               | 62               | 50                   | 41                     | 380           | 1                | 3                          | 7                       | 112                                     | 32                     | 2         | 162            | 552          |  |  |                                 |

TABLE No. 3. — Continued.

| Names of Collieries             | Occupations of Persons Employed Inside. |         |                   |                 |                     |                        | Occupations of Persons Employed Outside. |                 |                             |                          |                |                        | Grand total inside and outside. |          |
|---------------------------------|---|---------|-------------------|-----------------|---------------------|------------------------|--|-----------------|-----------------------------|--------------------------|----------------|------------------------|---------------------------------|----------|
|                                 | Inside foremen.                         | Miners. | Miners' laborers. | All company men | Drivers and runners | Door boys and helpers. | Total inside.                            | Outside foremen | Blacksmiths and carpenters. | Engineers and draftsmen. | State pickers. | All other company men. |                                 | Drivers. |
| Mount Pleasant shaft, .....     | 2                                       | 113     | 113               | 34              | 73                  | 26                     | 361                                      | 1               | 5                           | 8                        | 100            | 53                     | 4                               | 171      |
| Green Ridge slope, .....        | 1                                       | 90      | 90                | 29              | 60                  | 12                     | 282                                      | 1               | 5                           | 5                        | 63             | 30                     | 1                               | 108      |
| Shaft No. 5, Dumore, .....      | 1                                       | 112     | 104               | 13              | 38                  | 11                     | 279                                      | 1               | 1                           | 1                        | 60             | 32                     | .....                           | 95       |
| Bunker Hill drift, .....        | 1                                       | 42      | 42                | 5               | 7                   | 3                      | 100                                      | 1               | 2                           | 2                        | 14             | 13                     | .....                           | 32       |
| Old Forge No. 1 shaft, .....    | 3                                       | 160     | 159               | 25              | 79                  | 9                      | 435                                      | 1               | 5                           | 13                       | 65             | 41                     | 4                               | 129      |
| Old Forge No. 2 shaft, .....    | 1                                       | 72      | 60                | 15              | 27                  | 8                      | 182                                      | .....           | 5                           | 4                        | .....          | .....                  | 3                               | 12       |
| Meadow Brook shaft, .....       | 1                                       | 69      | 60                | 12              | 20                  | 6                      | 168                                      | 1               | 4                           | 5                        | 60             | 25                     | .....                           | 96       |
| National shaft, .....           | 1                                       | 140     | 130               | 12              | 36                  | 7                      | 325                                      | 1               | 1                           | 10                       | 75             | 35                     | 3                               | 131      |
| William A. shaft, .....         | 1                                       | 85      | 78                | 11              | 25                  | 6                      | 206                                      | 1               | 4                           | 4                        | 70             | 30                     | .....                           | 108      |
| Lawrence shaft, .....           | 2                                       | 127     | 127               | 24              | 44                  | 22                     | 346                                      | 1               | 6                           | 9                        | 65             | 65                     | 3                               | 149      |
| Greenwood No. 1 shaft, .....    | 1                                       | 41      | 41                | 17              | 33                  | 5                      | 117                                      | 1               | 2                           | 5                        | 17             | 17                     | .....                           | 40       |
| Greenwood No. 2 shaft, .....    | 1                                       | 143     | 139               | 35              | 52                  | 12                     | 353                                      | 1               | 4                           | 10                       | 112            | 41                     | .....                           | 172      |
| Jermyn No. 1 shaft, .....       | 1                                       | 130     | 125               | 32              | 56                  | 8                      | 312                                      | 1               | 4                           | 6                        | 72             | 37                     | 5                               | 124      |
| Jermyn No. 2 shaft, .....       | 1                                       | 60      | 60                | 40              | 33                  | 6                      | 250                                      | 1               | 3                           | 7                        | 104            | 26                     | .....                           | 141      |
| Sibley shaft, .....             | 1                                       | 72      | 72                | 30              | 32                  | 9                      | 217                                      | 3               | 4                           | 7                        | 47             | 44                     | 2                               | 108      |
| West Ridge slope, .....         | .....                                   | .....   | .....             | .....           | .....               | .....                  | .....                                    | .....           | .....                       | .....                    | .....          | .....                  | .....                           | .....    |
| Stanger's shaft, .....          | .....                                   | .....   | .....             | .....           | .....               | .....                  | .....                                    | .....           | .....                       | .....                    | .....          | .....                  | .....                           | .....    |
| Thompson Local Coal Sale, ..... | .....                                   | .....   | .....             | .....           | .....               | .....                  | .....                                    | .....           | .....                       | .....                    | .....          | .....                  | .....                           | .....    |
| Columbia breaker, .....         | .....                                   | .....   | .....             | .....           | .....               | .....                  | .....                                    | .....           | .....                       | .....                    | .....          | .....                  | .....                           | .....    |
| Providence Coal Company, .....  | 1                                       | 63      | 25                | 14              | 42                  | 13                     | 158                                      | 1               | 4                           | 7                        | 30             | 11                     | 1                               | 54       |
| Total, .....                    | 32                                      | 2,198   | 2,103             | 602             | 1,014               | 261                    | 6,211                                    | 21              | 103                         | 153                      | 1,393          | 766                    | 44                              | 2,480    |
| Grand total, .....              | 5                                       | 3,787   | 3,760             | 1,136           | 1,673               | 427                    | 10,840                                   | 28              | 97                          | 292                      | 2,517          | 1,399                  | 96                              | 4,632    |

\*Returned with Bellevue shaft.

\*Abandoned May 31, 1894.



TABLE No. 4.—Giving the total number of tons of coal mined, shipped, consumed and sold, at each colliery, number of days worked, number of persons employed, number of persons fatally injured, the number of widows and orphans left, the number of keys of powder used, the total volume of ventilation and its condition, the number of boilers and their condition when last examined in the Second Anthracite District, for the year ending December 31, 1894.

| Names of collieries                       | Location of collieries in Lackawanna county | By whom operated                       | Names of superintendents and managers.     | Names of outside foremen. |
|---|---|--|--|---------------------------|
| 1. Archbald shaft mine, .....             | Lackawanna township, .....                  | Dela., Lack'a. & Western               | Wm. R. Storrs, general coal agent, ...     | John Fern.                |
| 2. Bellevue shaft mine, .....             | Scranton city, .....                        | do. do.                                | Wm. H. Storrs, assistant coal agent, ...   | B. C. Green.              |
| 3. Bellevue slope mine, .....             | do. do.                                     | do. do.                                | B. Hughes, general mine superintend't,     | do.                       |
| 4. Brisbin shaft mine, .....              | do. do.                                     | do. do.                                | Thos. D. Davies, assistant superint'd't,   | C. H. Evana.              |
| 5. Cayuga shaft mine, .....               | do. do.                                     | do. do.                                | Thos. W. Phillips, assistant superint'd't, | Giles S. Decker.          |
| 6. Central shaft and Sloan breaker, ..... | do. do.                                     | do. do.                                | .....                                      | Fred. Peters.             |
| 7. Continental shaft mine, .....          | Lackawanna township, .....                  | do. do.                                | .....                                      | J. F. Green.              |
| 8. Dodge shaft mine, .....                | do. do.                                     | do. do.                                | .....                                      | S. M. Ives.               |
| 9. Diamond No. 2 shaft mine, .....        | 21st ward, Scranton, .....                  | do. do.                                | .....                                      | Wm. S. Langstaff          |
| 10. Holden shaft mine, .....              | Taylor borough, .....                       | do. do.                                | .....                                      | H. E. Resinger.           |
| 11. Hampton shaft mine, .....             | Lackawanna township, .....                  | do. do.                                | .....                                      | J. H. Hoffman.            |
| 12. Hyde Park shaft mine, .....           | 5th ward, Scranton, .....                   | do. do.                                | .....                                      | E. E. Thomas.             |
| 13. Manville shaft mine, .....            | 13th ward, Scranton, .....                  | do. do.                                | .....                                      | B. B. Atherton.           |
| 14. Oxford shaft mine, .....              | 5th ward, Scranton, .....                   | D. L. & W. R. R. Co., & D. & H. C. Co. | .....                                      | Wm. B. Thomas.            |
| 15. Pyne shaft mine, .....                | Lackawanna township, .....                  | Dela., Lack'a. & Western               | .....                                      | A. Reinhart.              |
| 16. Tripp shaft mine, .....               | 21st ward, Scranton, .....                  | do. do.                                | .....                                      | William S. Langstaff.     |
| 17. Tripp slope mine, .....               | do. do.                                     | do. do.                                | .....                                      | J. P. Cooper.             |
| 18. Taylor shaft mine, .....              | Taylor borough, .....                       | do. do.                                | .....                                      | do.                       |
| 19. Taylor drift mine, .....              | do. do.                                     | do. do.                                | .....                                      | do.                       |
| Miscellaneous Coal Companies.             |   |  |  |                           |
| 20. Austin drift mine, .....              | Old Forge township, .....                   | Austin Coal Company, .....             | S. W. Minard,                              | A. J. Thompson.           |

TABLE NO. 4.—Continued.

| Names of collieries                    | Location of collieries in Lackawanna county. | By whom operated.                        | Names of superintendents and managers.        | Names of outside foremen.    |
|--|--|--|---|------------------------------|
| 21. Dickson shaft mine, .....          | 21 ward, Scranton, .....                     | Delaware and Hudson Canal Company, ..... | A. H. Vandling, general superintendent, ..... | W. McDonnell, .....          |
| 22. Von Storch shaft mine, .....       | do, do, .....                                | do, do, .....                            | J. L. Ahernton, assistant, .....              | Charles W. Zeligler, .....   |
| 23. Capouse shaft mine, .....          | do, do, .....                                | do, do, .....                            | Andrew Nichol, general mine supt., .....      | do, .....                    |
| 24. Pipe Brook shaft mine, .....       | 21st ward, Scranton, .....                   | Lackawanna Iron and Steel Company, ..... | William P. Morgan, .....                      | D. J. Bevans, .....          |
| 25. Mt. Pleasant shaft mine, .....     | 7th ward, Scranton, .....                    | do, do, .....                            | do, .....                                     | Henry A. Hess, .....         |
| 26. Green Ridge slope mine, .....      | 14th ward, Scranton, .....                   | do, do, .....                            | Thomas Sprague, .....                         | Thomas Sprague, .....        |
| 27. Shaft No. 5, Dunmore mine, .....   | Dunmore borough, .....                       | do, do, .....                            | O. S. Johnson, .....                          | Wm. S. Boyd, Sr., .....      |
| 28. Bunker Hill drift mine, .....      | do, do, .....                                | Pennsylvania Coal Company, .....         | John E. Smith, .....                          | Christopher Moffat, .....    |
| 29. Old Forge shaft No. 1 mine, .....  | do, do, .....                                | do, do, .....                            | G. B. Smith, asst.; Jas. Young, asst., .....  | John Mitchell, .....         |
| 30. Old Forge shaft No. 2 mine, .....  | do, do, .....                                | do, do, .....                            | Anthony Horan, assistant, .....               | Richard Howard, .....        |
| 31. Meadow Brook tunnel mine, .....    | do, do, .....                                | William Connell & Co., .....             | do, .....                                     | do, .....                    |
| 32. National shaft mine, .....         | do, do, .....                                | do, do, .....                            | E. H. Ripple, .....                           | do, .....                    |
| 33. Manville shaft mine, .....         | do, do, .....                                | do, do, .....                            | do, .....                                     | do, .....                    |
| 34. Lawrence shaft mine, .....         | 13th ward, Scranton, .....                   | D. & H. C. Co. & D. L. & W. R. Co, ..... | A. H. Vandling, general superintendent, ..... | E. B. Ahernton, .....        |
| 35. Greenwood No. 1 shaft mine, .....  | Old Forge township, .....                    | The Connell Coal Company, .....          | William Connell, .....                        | P. J. Judge, .....           |
| 36. Greenwood No. 2 shaft mine, .....  | Lackawanna twp., .....                       | do, do, .....                            | do, .....                                     | W. J. Brown, .....           |
| 37. Jermyn No. 1 shaft mine, .....     | do, do, .....                                | Greenwood Coal Company, Limited, .....   | John Lovering, .....                          | T. J. McCarthy, .....        |
| 38. Jermyn No. 2 shaft mine, .....     | do, do, .....                                | do, do, .....                            | do, .....                                     | T. R. Lovering, .....        |
| 39. Sibley shaft mine, .....           | Old Forge township, .....                    | Jermyn & Co., .....                      | J. J. Jermyn, .....                           | Joseph Merritt, .....        |
| 40. West Ridge slope mine, .....       | do, do, .....                                | Ellrott, McClure & Co., .....            | Samuel Baker, assistant, .....                | William E. Merritt, .....    |
| 41. Spencer's shaft mine, .....        | 2d ward, Scranton, .....                     | West Ridge Coal Company, .....           | James C. McClure, .....                       | W. F. Courtwright, .....     |
| 42. Tripps local coal sale mine, ..... | Dunmore borough, .....                       | Providence Coal Company, .....           | E. A. Clark, .....                            | B. F. Filmore, .....         |
| 43. .....                              | do, do, .....                                | A. D. and F. M. Spencer, .....           | A. D. and F. M. Spencer, .....                | J. F. Niecey, .....          |
| 44. .....                              | 21st ward, Scranton, .....                   | do, do, .....                            | do, .....                                     | A. D. & F. M. Spencer, ..... |
| 45. .....                              | do, do, .....                                | do, do, .....                            | do, .....                                     | do, .....                    |
| 46. .....                              | do, do, .....                                | do, do, .....                            | do, .....                                     | do, .....                    |

TABLE No. 4.—Continued.

| Names of Collieries                       | Names of mine foremen and assistants.             | Total number of tons of coal produced. | Total number of tons of coal shipped to market. | Total number of tons of coal consumed at mines. | Total number of tons of coal sold at mines. | Total number of kegs of powder used at mines. | Total number of persons employed at each colliery. | Number of days worked. |
|---|---|--|---|---|---|---|--|------------------------|
| 1. Archbald shaft mine, .....             | Joseph D. Lloyd, .....                            | 211,511.10                             | 200,867.10                                      | 9,400   | 1,244                                       | 6,758   | 552  | 173.4                  |
| 2. Bellevue shaft mine, .....             | John Hale and Thos. E. Willkams, assistant, ..... | 223,175.17                             | 208,775.17                                      | 14,400  | .....                                       | 6,794   | 459  | 174.4                  |
| 3. Bellevue slope mine, .....             | David Z. Davies, .....                            | 187,831.07                             | 178,825.07                                      | 9,000   | .....                                       | 4,585   | 479  | 173.10                 |
| 4. British shaft mine, .....              | Frank Zimmerman, .....                            | 197,339.14                             | 178,128.14                                      | 16,000  | .....                                       | 5,026   | 467  | 167.7                  |
| 5. Cayuga shaft mine, .....               | John P. Morgan, .....                             | 252,248.18                             | 234,023.18                                      | 17,000  | .....                                       | 5,271½  | 563  | 172.9                  |
| 6. Central shaft and Sloan breaker, ..... | Lewis Roberts; Henry P. Davies, assistant, .....  | 125,963.13                             | 118,335.13                                      | 5,400   | .....                                       | 3,867   | 483  | 126.5                  |
| 7. Continental shaft mine, .....          | R. H. Williams, .....                             | 156,727.00                             | 144,766.00                                      | 10,000  | .....                                       | 5,406   | 417  | 178.1                  |
| 8. Dodge shaft mine, .....                | E. D. James and Wm. R. Evans, assistant, .....    | 238,331.05                             | 215,802.08                                      | 18,500  | .....                                       | 4,929   | 560  | 172.5                  |
| 9. Diamond No. 2 shaft mine, .....        | James A. Evans; H. G. Davies, assistant, .....    | 53,284.05                              | 48,472.15                                       | 4,000   | .....                                       | 1,709   | 146  | .....                  |
| 10. Holden shaft mine, .....              | H. E. Harris, .....                               | 171,665.08                             | 160,463.08                                      | 8,000   | .....                                       | 3,292   | 431  | 173                    |
| 11. Hampton shaft mine, .....             | Elijah Dager; William W. Harris, assistant, ..... | 97,260.08                              | 91,615.08                                       | 4,300   | .....                                       | 4,250   | 399  | 125.4                  |
| 12. Hyde Park shaft mine, .....           | D. W. Moser; William J. Thomas, assistant, .....  | 51,760.07                              | 42,072.01                                       | 8,000   | .....                                       | 6,126   | 386  | 132½                   |
| 13. Manville shaft mine, .....            | Thomas J. Williams, .....                         | 159,930.06                             | 131,874.06                                      | 7,500   | .....                                       | 5,065   | 398  | 179.3                  |
| 14. Oxford shaft mine, .....              | Reese A. Phillips; D. S. Evans, assistant, .....  | 196,659.10                             | 187,730   | 7,500   | .....                                       | 5,462   | 466  | 169.3                  |
| 15. Pyne shaft mine, .....                | James M. Thomas, .....                            | .....                                  | .....   | .....   | .....                                       | .....   | .....  | .....                  |
| 16. Tripp shaft mine, .....               | H. G. Davies, assistant; James A. Evans, .....    | .....                                  | .....   | .....   | .....                                       | .....   | .....  | .....                  |
| 17. Tripp slope mine, .....               | Sydney Baker, assistant; John R. Johns, .....     | 168,870.08                             | 157,961.08                                      | 7,644   | .....                                       | 4,975   | 453  | 160                    |
| 18. Taylor shaft mine, .....              | do. .....   | .....                                  | .....   | .....   | .....                                       | .....   | .....  | .....                  |
| 19. Taylor drift mine, .....              | do. .....   | .....                                  | .....   | .....   | .....                                       | .....   | .....  | .....                  |
| Total, .....                              | .....   | 2,492,560.08                           | 2,293,715.08                                    | 147,634   | 51,511                                      | 76,577½                                       | 6,782  | .....                  |
| Miscellaneous Coal Companies.             |   |  |   |   |   |   |  |                        |
| 20. Austin drift mine, .....              | James Tasker, .....                               | 68,875                                 | 64,907  | 2,899.99  | 1,968.11                                    | 3,016   | 377  | 149.9                  |
| 21. Dickson shaft mine, .....             | Alex. Aikman, .....                               | 194,028.10                             | 181,426.04                                      | 9,855   | 2,747.06                                    | 5,292   | 417  | 160.5                  |
| 22. Von Storch shaft mine, .....          | Martin Loftus, .....                              | 210,056.10                             | 189,548.15                                      | 15,877.10                                       | 4,630.05                                    | 5,896   | 599  | 176½                   |
| 23. Von Storch slope mine, .....          | do. .....   | .....                                  | .....   | .....   | .....                                       | .....   | .....  | .....                  |
| 24. Canouse shaft mine, .....             | Joseph Reese, .....                               | 248,129                                | 237,087   | 7,000   | 4,042                                       | 8,964   | 616  | 194.3                  |
| 25. Pine Brook shaft mine, .....          | John H. Powell, .....                             | 190,876                                | 175,703   | 7,560   | 16,673                                      | 11,752  | 512  | 174.8                  |

\*Returned with Diamond No. 2 shaft.

TABLE No. 4.—Continued.

| Names of Collieries                     | Names of mine foremen, and assistants          | Total number of tons of coal produced. | Total number of tons of coal shipped to market. | Total number of tons of coal consumed at mines | Total number of tons of coal sold at mines. | Total number of kegs of powder used at mines. | Total number of persons employed at each colliery. | Number of days worked. |
|---|--|--|---|--|---|---|--|------------------------|
| 26. Mount Pleasant shaft mine, .....    | John Van Bergen, .....                         | 162,929                                | 160,294   | 7,700  | 24,935                                      | 8,336   | 532  | 190                    |
| 27. Green Ridge slope mine, .....       | Edward Hughes, .....                           | 155,885.13                             | 140,333.18                                      | 10,500   | 5,051.15                                    | 8,931   | 390  | 210.6                  |
| 28. Shaft No. 5, Dunmore mine, .....    | John W. Reid, .....                            | 122,173                                | 119,702   | 2,471  | .....                                       | 4,821   | 313  | 138.5                  |
| 29. Bunker Hill drift mine, .....       | W. S. Jones, .....                             | 63,989                                 | 61,883  | 2,106  | .....                                       | 1,364   | 132  | 179.5                  |
| 30. Old Forge shaft No. 1 mine, .....   | Patrick A. Sweeney, .....                      | 224,281                                | 219,251   | 5,030  | .....                                       | 7,687   | 564  | 157                    |
| 31. Old Forge shaft No. 2 mine, .....   | Alexander Allen, James Blease, .....           | .....                                  | .....   | .....  | .....                                       | .....   | .....  | .....                  |
| 32. Meadow Brook shaft mine, .....      | S. T. Jones, .....                             | 47,579                                 | 36,529  | 5,000  | 6,050                                       | 1,830   | 195  | 68                     |
| 33. Meadow Brook tunnel mine, .....     | do, .....                                      | .....                                  | .....   | .....  | .....                                       | .....   | .....  | .....                  |
| 34. National shaft mine, .....          | Thomas J. Williams, .....                      | 144,169                                | 132,899   | 6,260  | 5,010                                       | 5,941   | 263  | 192½                   |
| 35. Manville shaft mine, .....          | A. H. Hale, .....                              | 49,609                                 | 45,602.01                                       | .....  | 1,984                                       | 6,785   | 53   | 166                    |
| 36. William A shaft mine, .....         | Robert McCutcheon, .....                       | 241,682                                | 226,998   | 12,700   | .....                                       | 2,347   | 332  | 92.5                   |
| 37. Lawrence shaft mine, .....          | H. J. Brooks, Rowland Davies, assistant, ..... | 74,438                                 | 68,438  | 6,000  | 1,863                                       | 7,869   | 485  | 163.6                  |
| 38. Greenwood No. 1 shaft mine, .....   | David A. Jones, .....                          | 167,467.08                             | 152,604.08                                      | 13,000   | .....                                       | 2,522   | 188  | 145.8                  |
| 39. Greenwood No. 2 shaft mine, .....   | Stephen Johns, .....                           | 56,907.08                              | 52,407.08                                       | 4,500  | 3,542.13                                    | 5,171   | 538  | 133.3                  |
| 40. Jermyn No. 1 shaft mine, .....      | Samuel Baker, .....                            | 169,806.09                             | 151,663.16                                      | 14,600   | .....                                       | 5,171   | 496  | 126.1                  |
| 41. Jermyn No. 2 shaft mine, .....      | Thomas P. Cosgrove, .....                      | 177,068.14                             | 162,468.14                                      | 14,600   | 1,609.08                                    | 4,982   | 391  | 192.6                  |
| 42. Sibley shaft mine, .....            | Thomas H. Jones, .....                         | 108,866.05                             | 92,856.17                                       | 14,400   | 5,136.16                                    | 3,278   | 250  | 193.3                  |
| 43. West Ridge slope mine, .....        | W. H. Hocking, .....                           | 95,359.13                              | 87,677.17                                       | 2,555  | 6,154                                       | 2,738   | 212  | 198.7                  |
| 44. Providence shaft mine, .....        | P. H. Mongan, .....                            | 55,357                                 | 46,703  | 2,400  | .....                                       | 4,325   | 323  | 106.7                  |
| 45. Spencer's shaft mine, .....         | .....  | 83,036.11                              | 72,073.03                                       | 2,400  | .....                                       | .....   | 26   | 230                    |
| 46. Tribb's local coal sale mine, ..... | .....  | 12,500                                 | 12,500  | .....  | .....                                       | .....   | 26   | 225                    |
| Local coal sale mines, .....            | .....  | 2,500                                  | 2,500   | .....  | .....                                       | .....   | 8  | 150                    |
| Columbia breaker, .....                 | .....  | 15,500                                 | 7,500   | .....  | 8,000                                       | .....   | .....  | .....                  |
| Total, .....                            | .....  | 3,181,979.01                           | 2,901,557                                       | 169,453.19                                     | 107,061.02                                  | 120,601                                       | 8,845  | .....                  |
| Grand total .....                       | .....  | 5,674,539.69                           | 5,195,272.08                                    | 317,087.19                                     | 158,272.02                                  | 197,178½                                      | 15,627   | .....                  |

\*Returned on D. L. &amp; W. R. R. report.

TABLE No. 4.—Continued.

| Names of Collieries                 | Number of fatal accidents. | Number of widows. | Number of orphans. | Number of horses and mules. | Number of mine locomotives. | Horse power of locomotives. | Number of persons working in mines. | Number of persons working in air splits. | Total Volume of Air |                     |             | Mode of ventilation | Condition of ventilation. | Number of boilers. | Condition when last examined. |
|-------------------------------------|----------------------------|-------------------|--------------------|-----------------------------|-----------------------------|-----------------------------|-------------------------------------|--|---------------------|---------------------|-------------|---------------------|---------------------------|--------------------|-------------------------------|
|                                     |                            |                   |                    |                             |                             |                             |                                     |  | At intake.          | At face of workings | At outcast. |                     |                           |                    |                               |
| 1. Archbald shaft mine.             |                            |                   |                    | 70                          | 1                           | 94                          | 356                                 | 6  | 137,670             | 132,064             | 142,676     | Fan.....            | Good.                     | 14                 | Good.                         |
| 2. Bellevue shaft mine.             |                            |                   |                    | 83                          | 1                           | 94                          | 289                                 | 8  | 141,890             | 136,453             | 190,448     | Fan.....            | Good.                     | .....              | Good.                         |
| 3. Bellevue slope mine.             |                            |                   |                    | 26                          |                             |                             | 110                                 | 3  | 53,066              | 48,672              | 59,180      | Fan.....            | Good.                     | 24                 | Good.                         |
| 4. Brislin shaft mine.              |                            |                   |                    | 55                          | 1                           | 74                          | 322                                 | 8  | 131,834             | 118,970             | 140,400     | Fan.....            | Good.                     | 17                 | Good.                         |
| 5. Cayuga shaft mine.               |                            |                   |                    | 64                          | 1                           | 94                          | 319                                 | 6  | 83,240              | 77,740              | 96,360      | Fan.....            | Good.                     | 24                 | Good.                         |
| 6. Central shaft and Sloan breaker. |                            |                   |                    | 70                          | 3                           | 262                         | 386                                 | 11                                       | 154,064             | 151,232             | 197,442     | 2 fans.....         | Good.                     | 49                 | Good.                         |
| 7. Continental shaft mine.          |                            |                   |                    | 62                          |                             |                             | 323                                 | 10                                       | 129,990             | 110,390             | 152,860     | Fan.....            | Good.                     | 15                 | Good.                         |
| 8. Dodge shaft mine.                |                            |                   |                    | 70                          | 1                           | 94                          | 285                                 | 9  | 211,897             | 188,374             | 276,047     | Fan.....            | Good.                     | 21                 | Good.                         |
| 9. Diamond No. 2 shaft mine.        |                            |                   |                    | 78                          | 2                           | 174                         | 3                                   | 3  | 86,200              | Old w'ks            | 86,500      | Fan.....            | Good.                     | 55                 | Good.                         |
| 10. Holden shaft mine.              |                            |                   |                    | 45                          |                             |                             | 98                                  | 4  | 165,768             | 99,990              | 131,250     | Fan.....            | Good.                     | 12                 | Good.                         |
| 11. Hampton shaft mine.             |                            |                   |                    | 67                          |                             |                             | 282                                 | 5  | 75,282              | 74,884              | 90,886      | Fan.....            | Good.                     | 16                 | Good.                         |
| 12. Hyde Park shaft mine.           |                            |                   |                    | 33                          |                             |                             | 284                                 | 5  | 112,875             | 98,726              | 169,612     | Fan.....            | Good.                     | 12                 | Good.                         |
| 13. Manville shaft mine.            |                            |                   |                    | 61                          |                             |                             | 280                                 | 6  | 171,182             | 125,461             | 192,707     | 2 fans.....         | Good.                     | 13                 | Good.                         |
| 14. Oxford shaft mine.              |                            |                   |                    | 87                          | 1                           | 94                          | 277                                 | 10                                       | 145,935             | 146,910             | 151,080     | Fan.....            | Good.                     | 19                 | Good.                         |
| 15. Pyne shaft mine.                |                            |                   |                    | 69                          | 1                           | 84                          | 316                                 | 8  | 132,378             | 96,069              | 138,442     | Fan.....            | Good.                     | 22                 | Good.                         |
| 16. Tripp shaft mine.               |                            |                   |                    |                             |                             |                             | 365                                 | 41                                       | 292,500             | 290,350             | 360,000     | Fan.....            | Good.                     | .....              | Good.                         |
| 17. Tripp slope mine.               |                            |                   |                    |                             |                             |                             | 295                                 | 5  | 148,094             | 133,491             | 164,987     | Fan.....            | Good.                     | 22                 | Good.                         |
| 18. Taylor shaft mine.              |                            |                   |                    | 68                          |                             |                             | 17                                  | 1  | 32,485              | 29,327              | 60,710      | Fan.....            | Good.                     | .....              | Good.                         |
| 19. Taylor drift mine.              |                            |                   |                    |                             |                             |                             |                                     |  |                     |                     |             |                     |                           |                    |                               |
| Total.                              |                            |                   |                    | 996                         | 13                          | 1,162                       | .....                               | .....                                    | .....               | .....               | .....       | .....               | .....                     | 340                | .....                         |
| Miscellaneous Coal Companies.       |                            |                   |                    |                             |                             |                             |                                     |  |                     |                     |             |                     |                           |                    |                               |
| 20. Austin drift mine.              |                            |                   |                    | 18                          |                             |                             | 266                                 | 4  | 46,248              | 39,205              | 50,750      | Fan.....            | Good.                     | 4                  | Good.                         |
| 21. Dickson shaft mine.             |                            |                   |                    | 46                          |                             |                             | 304                                 | 7  | 127,770             | 122,482             | 145,340     | Fan.....            | Good.                     | 18                 | Good.                         |
| 22. Von Storch shaft mine.          |                            |                   |                    |                             |                             |                             | 401                                 | 9  | 176,130             | 149,470             | 212,150     | 2 fans.....         | Good.                     | 14                 | Good.                         |
| 23. Von Storch slope mine.          |                            |                   |                    | 84                          |                             |                             | 451                                 | 9  | 190,700             | 201,480             | 236,320     | 2 fans.....         | Good.                     | 15                 | Good.                         |
| 24. Capouse shaft mine.             |                            |                   |                    | 81                          |                             |                             | 367                                 | 9  | 235,821             | 219,584             | 238,820     | 2 fans.....         | Good.                     | 5                  | Good.                         |
| 25. Pipe Brook shaft mine.          |                            |                   |                    | 74                          |                             |                             | 390                                 | 7  | .....               | .....               | .....       | .....               | .....                     | .....              | .....                         |

TABLE No. 4.—Continued.

| Names of Collieries.              | Number of fatal accidents. | Number of widows. | Number of orphans. | Number of horses and mules. | Number of mine locomotives. | Horse power of locomotives. | Number of persons working in mines. | Number of persons working in air splits. | Number of air splits. | Total Volume of Air. |                      |             | Mode of ventilation. | Condition of ventilation. | Number of boilers. | Condition when last examined. |
|-----------------------------------|----------------------------|-------------------|--------------------|-----------------------------|-----------------------------|-----------------------------|-------------------------------------|--|-----------------------|----------------------|----------------------|-------------|----------------------|---------------------------|--------------------|-------------------------------|
|                                   |                            |                   |                    |                             |                             |                             |                                     |  |                       | At intake.           | At face of workings. | At outcast. |                      |                           |                    |                               |
| 26. Mount Pleasant shaft mine.    | .....                      | .....             | .....              | .....                       | .....                       | .....                       | 361                                 | 325                                      | 8                     | 122,225              | 84,940               | 123,375     | 2 fans,....          | Good.                     | 14                 | Good.                         |
| 27. Green Ridge slope mine.       | .....                      | .....             | .....              | .....                       | .....                       | .....                       | 282                                 | 250                                      | 6                     | 75,415               | 102,753              | 102,753     | 1 fan,....           | Good.                     | 15                 | Good.                         |
| 28. Shaft No. 5, Dunmore mine.    | .....                      | .....             | .....              | .....                       | .....                       | .....                       | 278                                 | 266                                      | 6                     | 131,900              | 89,200               | 133,000     | 1 fan,....           | Good.                     | 10                 | Good.                         |
| 29. Funker Hill drift mine.       | .....                      | .....             | .....              | .....                       | .....                       | .....                       | 100                                 | 91                                       | 2                     | 20,600               | 17,700               | 22,300      | Furnace.             | Good.                     | 6                  | Good.                         |
| 30. Old Forge shaft No. 1 mine.   | .....                      | .....             | .....              | .....                       | .....                       | .....                       | 435                                 | 370                                      | 6                     | 106,440              | 95,560               | 111,590     | Fan,....             | Good.                     | 8                  | Good.                         |
| 31. Old Forge shaft No. 2 mine.   | .....                      | .....             | .....              | .....                       | .....                       | .....                       | 129                                 | 123                                      | 3                     | 70,309               | 67,100               | 75,600      | Fan,....             | Good.                     | 5                  | Good.                         |
| 32. Meadow Brook shaft mine.      | .....                      | .....             | .....              | .....                       | .....                       | .....                       | 94                                  | .....                                    | .....                 | .....                | .....                | .....       | .....                | Good.                     | 16                 | Good.                         |
| 33. Meadow Brook tunnel mine.     | .....                      | .....             | .....              | .....                       | .....                       | .....                       | .....                               | .....                                    | .....                 | .....                | .....                | .....       | .....                | Good.                     | 2                  | Good.                         |
| 34. National shaft mine.          | .....                      | .....             | .....              | .....                       | .....                       | .....                       | 205                                 | 205                                      | 5                     | 107,800              | 100,645              | 118,500     | Fan,....             | Good.                     | 17                 | Good.                         |
| 35. Manville shaft mine.          | .....                      | .....             | .....              | .....                       | .....                       | .....                       | 35                                  | .....                                    | .....                 | .....                | .....                | .....       | .....                | Good.                     | 1                  | Good.                         |
| 36. William A. shaft mine.        | .....                      | .....             | .....              | .....                       | .....                       | .....                       | 364                                 | 335                                      | 5                     | 100,245              | 93,625               | 102,435     | Fan,....             | Good.                     | 12                 | Good.                         |
| 37. Lawrence shaft mine.          | .....                      | .....             | .....              | .....                       | .....                       | .....                       | 242                                 | 210                                      | 5                     | 70,100               | 62,360               | 71,240      | Fan,....             | Good.                     | 13                 | Good.                         |
| 38. Greenwood No. 1 shaft mine.   | .....                      | .....             | .....              | .....                       | .....                       | .....                       | 315                                 | 315                                      | 1                     | 136,078              | 111,778              | 109,635     | Fan,....             | Good.                     | 16                 | Good.                         |
| 39. Greenwood No. 2 shaft mine.   | .....                      | .....             | .....              | .....                       | .....                       | .....                       | 80                                  | 140                                      | 3                     | 36,970               | 34,125               | 40,685      | Fan,....             | Good.                     | 6                  | Good.                         |
| 40. Jermyn No. 2 shaft mine.      | .....                      | .....             | .....              | .....                       | .....                       | .....                       | 368                                 | 274                                      | 5                     | 81,830               | 77,834               | 88,213      | Fan,....             | Good.                     | 18                 | Good.                         |
| 41. Sibley shaft mine.            | .....                      | .....             | .....              | .....                       | .....                       | .....                       | 372                                 | 325                                      | 6                     | 111,830              | 88,810               | 114,080     | Fan,....             | Good.                     | 15                 | Good.                         |
| 42. West Ridge slope mine.        | .....                      | .....             | .....              | .....                       | .....                       | .....                       | 48                                  | .....                                    | .....                 | .....                | .....                | .....       | .....                | Good.                     | 13                 | Good.                         |
| 43. Providence shaft mine.        | .....                      | .....             | .....              | .....                       | .....                       | .....                       | 180                                 | .....                                    | .....                 | 113,486              | 102,812              | 115,200     | Fan,....             | Good.                     | 4                  | Good.                         |
| 44. Spencer's shaft mine.         | .....                      | .....             | .....              | .....                       | .....                       | .....                       | 158                                 | .....                                    | .....                 | 50,400               | 22,900               | 64,300      | Fan,....             | Good.                     | 4                  | Good.                         |
| 45. Tripp's local coal sale mine. | .....                      | .....             | .....              | .....                       | .....                       | .....                       | 217                                 | .....                                    | .....                 | 49,480               | 48,760               | 50,620      | Fan,....             | Good.                     | 11                 | Good.                         |
| 46. Local coal sale mines.        | .....                      | .....             | .....              | .....                       | .....                       | .....                       | .....                               | .....                                    | .....                 | .....                | .....                | .....       | .....                | .....                     | .....              | .....                         |
| Columbia breaker.                 | .....                      | .....             | .....              | .....                       | .....                       | .....                       | .....                               | .....                                    | .....                 | .....                | .....                | .....       | .....                | .....                     | .....              | .....                         |
| Total.                            | .....                      | .....             | .....              | .....                       | .....                       | .....                       | .....                               | .....                                    | .....                 | .....                | .....                | .....       | .....                | .....                     | .....              | .....                         |
| Grand total.                      | 41                         | 12                | 20                 | 1,917                       | 19                          | 1,596                       | .....                               | .....                                    | .....                 | .....                | .....                | .....       | .....                | .....                     | 275                | .....                         |
|                                   | .....                      | .....             | .....              | .....                       | .....                       | .....                       | .....                               | .....                                    | .....                 | .....                | .....                | .....       | .....                | .....                     | 615                | .....                         |

# Third Anthracite District.

(LUZERNE COUNTY.)

Pittston, Pa., April 2, 1895.

Hon. Isaac B. Brown,

Secretary of Internal Affairs:

Sir: I have the honor herewith of presenting my annual report as Inspector of Mines of the Third Anthracite District for the year 1894.

The total production of coal in this district was 5,541,952 tons, a decrease of 87,962 tons from that of 1893.

The number of fatal accidents was 51, leaving 26 wives widows, and 67 orphans. The number of non-fatal accidents was 148. The quantity of coal produced per life lost was 108,665 tons.

The report contains the usual tables, with a description of a few of the fatal accidents, and of the improvements in the mines during the year 1894.

Yours very respectfully,

H. McDONALD,  
Inspector of Mines.

## TONS OF COAL MINED DURING THE YEAR 1894.

|  |           |
|--|-----------|
| Pennsylvania Coal Company, .....                         | 1,210,395 |
| Lehigh Valley Coal Company, .....                        | 755,204   |
| Delaware and Hudson Canal Company, .....                 | 286,173   |
| Delaware, Lackawanna and Western Railroad Company, ..... | 149,521   |
| Butler Mine Company, Limited, .....                      | 277,199   |
| Newton Coal Company, .....                               | 331,630   |
| Waddell and Company, .....                               | 151,915   |
| Hillside Coal and Iron Company, .....                    | 105,549   |
| John C. Haddock, .....                                   | 243,657   |
| Clear Spring Coal Company, .....                         | 196,363   |
| Florence Coal Company, .....                             | 80,244    |
| W. G. Payne and Company, .....                           | 105,872   |

|                                      |                  |
|--------------------------------------|------------------|
| Abbott Coal Company, .....           | 9,544            |
| Keystone Coal Company, .....         | 102,964          |
| Avoca Coal Company, .....            | 65,662           |
| Annora Coal Company, .....           | 29,171           |
| John M. Robertson and Company, ..... | 49,426           |
| Langeliffe Coal Company, .....       | 121,314          |
| Stevens Coal Company, .....          | 83,046           |
| Babylon Coal Company, .....          | 244,856          |
| Mount Lookout Coal Company, .....    | 315,462          |
| Forty-Fort Coal Company, .....       | 184,225          |
| Hutchens and Company, .....          | 10,575           |
| Old Forge Coal Company, .....        | 212,009          |
| Raub Coal Company, .....             | 33,942           |
| Algonquin Coal Company, .....        | 186,034          |
| <b>Total, .....</b>                  | <b>5,541,952</b> |

**NUMBER OF FATAL ACCIDENTS AND TONS OF COAL PRODUCED PER  
LIFE LOST.**

| Name of the Operators                                    | Number of<br>lives lost. | Tons of coal<br>mined per<br>life lost. |
|--|--------------------------|---|
| Pennsylvania Coal Company, .....                         | 9                        | 134,488                                 |
| Lehigh Valley Coal Company, .....                        | 7                        | 107,886                                 |
| Delaware and Hudson Canal Company, .....                 | No fatalities.           |   |
| Delaware, Lackawanna and Western Railroad Company, ..... | 1                        | 140,521                                 |
| Butler Mine Company, Limited, .....                      | 3                        | 92,399                                  |
| Newton Coal Company, .....                               | 5                        | 66,326                                  |
| Waddell & Co., .....                                     | 2                        | 75,957                                  |
| Hillside Coal and Iron Company, .....                    | No fatalities.           |   |
| John C. Haddock, .....                                   | No fatalities.           |   |
| Clear Spring Coal Company, .....                         | 1                        | 196,363                                 |
| Florence Coal Company, .....                             | 1                        | 80,244                                  |
| W. G. Payne & Co., .....                                 | 3                        | 35,290                                  |
| Abbott Coal Company, .....                               | No fatalities.           |   |
| Keystone Coal Company, .....                             | 1                        | 102,964                                 |
| Avoca Coal Company, .....                                | 1                        | 65,662                                  |
| Annora Coal Company, .....                               | No fatalities.           |   |
| John M. Robertson & Co., .....                           | No fatalities.           |   |
| Langeliffe Coal Company, .....                           | 1                        | 121,314                                 |
| Stevens' Coal Company, .....                             | 4                        | 24,761                                  |
| Babylon Coal Company, .....                              | 2                        | 122,428                                 |
| Mount Lookout Coal Company, .....                        | 1                        | 315,462                                 |
| Forty Fort Coal Company, .....                           | 5                        | 36,845                                  |
| Hutchins Coal Company, .....                             | No fatalities.           |   |
| Old Forge Coal Company, .....                            | 1                        | 212,009                                 |
| Raub Coal Company, .....                                 | 1                        | 33,942                                  |
| Algonquin Coal Company, .....                            | 2                        | 93,017                                  |
| <b>Total, .....</b>                                      | <b>51</b>                | <b>108,665</b>                          |



**NUMBER OF NON-FATAL ACCIDENTS AND TONS OF COAL MINED PER  
PERSON SERIOUSLY INJURED.**

| Name of the Operators.                                   | Number of persons injured. | Tons of coal mined per person injured. |
|--|----------------------------|--|
| Pennsylvania Coal Company, .....                         | 30                         | 40,346                                 |
| Lehigh Valley Coal Company, .....                        | 38                         | 19,873                                 |
| Delaware and Hudson Canal Company, .....                 | 5                          | 57,234                                 |
| Delaware, Lackawanna and Western Railroad Company, ..... | 2                          | 74,760                                 |
| Butler Mine Company, Limited, .....                      | 6                          | 46,199                                 |
| Newton Coal Company, .....                               | 12                         | 27,635                                 |
| Waddell & Co., .....                                     | 1                          | 151,915                                |
| Hillside Coal and Iron Company, .....                    | 1                          | 105,549                                |
| John C. Haddock, .....                                   | 2                          | 121,828                                |
| Clear Spring Coal Company, .....                         | 3                          | 65,454                                 |
| Florence Coal Company, .....                             |                            |  |
| W. G. Payne & Co., .....                                 | 2                          | 52,936                                 |
| Abbott Coal Company, .....                               |                            |  |
| Keystone Coal Company, .....                             | 1                          | 102,964                                |
| Avoca Coal Company, .....                                |                            |  |
| Annora Coal Company, .....                               |                            |  |
| John M. Robertson & Co., .....                           |                            |  |
| Langeliffe Coal Company, .....                           | 4                          | 30,323                                 |
| Stevens' Coal Company, .....                             | 4                          | 20,761                                 |
| Babylon Coal Company, .....                              | 2                          | 122,427                                |
| Mount Lookout Coal Company, .....                        | 12                         | 26,238                                 |
| Forty Fort Coal Company, .....                           | 5                          | 36,845                                 |
| Hutchins' & Co., .....                                   |                            |  |
| Old Forge Coal Company, .....                            | 8                          | 26,001                                 |
| Raub Coal Company, .....                                 | 1                          | 53,942                                 |
| Algonquin Coal Company, .....                            | 9                          | 20,670                                 |
| Total, .....   | 148                        | 37,445                                 |

**NUMBER OF FATAL AND NON-FATAL ACCIDENTS AND TONS OF COAL  
PRODUCED PER EACH PERSON KILLED OR INJURED.**

| Name of the Operator                                     | Number killed or injured | Tons of coal produced per person killed or injured. |
|--|--------------------------|---|
| Pennsylvania Coal Company, .....                         | 39                       | 31,033  |
| Lehigh Valley Coal Company, .....                        | 45                       | 16,782  |
| Delaware and Hudson Canal Company, .....                 | 5                        | 57,231  |
| Delaware, Lackawanna and Western Railroad Company, ..... | 3                        | 49,840  |
| Butler Mine Company, Limited, .....                      | 9                        | 30,798  |
| Newton Coal Company, .....                               | 17                       | 19,507  |
| Waddell & Co., .....                                     | 3                        | 50,538  |
| Hillside Coal and Iron Company, .....                    | 1                        | 105,549   |
| John C. Haddock, .....                                   | 2                        | 121,828   |
| Clear Spring Coal Company, .....                         | 4                        | 49,090  |
| Florence Coal Company, .....                             | 1                        | 50,244  |
| W. G. Payne & Co., .....                                 | 5                        | 21,174  |
| Abbott Coal Company, .....                               | No injuries.             |   |
| Keystone Coal Company, .....                             | 2                        | 51,482  |
| Avoca Coal Company, .....                                | 1                        | 65,662  |
| Annora Coal Company, .....                               | No injuries.             |   |
| John M. Robertson & Co., .....                           | No injuries.             |   |
| Langeliffe Coal Company, .....                           | 5                        | 24,263  |
| Stevens' Coal Company, .....                             | 8                        | 10,380  |
| Babylon Coal Company, .....                              | 4                        | 61,214  |
| Mount Lookout Coal Company, .....                        | 13                       | 24,266  |
| Forty Fort Coal Company, .....                           | 10                       | 18,422  |
| Hutchins' Coal Company, .....                            | No injuries.             |   |
| Old Forge Coal Company, .....                            | 9                        | 23,556  |
| Raub Coal Company, .....                                 | 2                        | 16,971  |
| Algonquin Coal Company, .....                            | 11                       | 16,912  |
| Total, .....   | 199                      | 27,849  |

## CLASSIFICATION OF FATAL AND NON-FATAL ACCIDENTS.

| Cause of Accidents.                              | Killed or fatally injured. | Seriously injured. |
|--|----------------------------|--------------------|
| By explosions of carburetted hydrogen gas, ..... | 2                          | 24                 |
| By falls of roof and coal, .....                 | 22                         | 42                 |
| Crushed and ran over by mine cars, .....         | 13                         | 38                 |
| By falling down shafts, .....                    | 4                          | 3                  |
| By explosions of powder and blasts, .....        | 3                          | 15                 |
| By miscellaneous causes underground, .....       | 4                          | 14                 |
| By miscellaneous causes on the surface, .....    | 3                          | 12                 |
| Total, .....                                     | 51                         | 148                |

## OCCUPATION OF PERSONS KILLED OR INJURED.

|                                    | Killed. | Injured. |
|------------------------------------|---------|----------|
| Miners, .....                      | 19      | 56       |
| Miners' laborers, .....            | 12      | 35       |
| Drivers and runners, .....         | 6       | 34       |
| Door boys and slate pickers, ..... | 1       | 4        |
| Miscellaneous underground, .....   | 10      | 22       |
| Miscellaneous on surface, .....    | 3       | 7        |
| Total, .....                       | 51      | 148      |

## NATIONALITY OF PERSONS KILLED OR INJURED.

|                                  | Irish. | Welsh. | American. | English. | Scottish. | German. | Swedes. | Hungarian. | Poles. | Italians. | Total. |
|----------------------------------|--------|--------|-----------|----------|-----------|---------|---------|------------|--------|-----------|--------|
| Killed or fatally injured, ..... | 13     | 2      | 9         | 6        | 2         | 3       | 1       | 2          | 13     | 1         | 51     |
| Injured, .....                   | 31     | 10     | 45        | 9        | 1         | 2       | 1       | 11         | 36     | 2         | 148    |
| Total, .....                     | 44     | 12     | 54        | 15       | 3         | 5       | 1       | 13         | 49     | 3         | 199    |

## The Condition of the Mines.

A great number of improvements have been made in and around the mines of this district. A large number of old frame buildings surrounding the fans have been taken down and replaced by substantial brick buildings which give better satisfaction in ventilation and remove the possibility of their taking fire, which has been too often the case with wooden structures. Likewise a number of the collieries have replaced the horizontal steam boiler with the tubular, which gives better satisfaction, both in steam and safety. While there have been very few fatal accidents in the anthracite coal field from boiler explosions, in comparison with other causes in and around the mines, the number of which must be admitted by all who examine these reports, is to an alarming extent, too great. But, never-

theless, such is the case, but would not be if the victims themselves, in the majority of the cases, had taken the ordinary precaution to secure their own safety. By careful examination of the causes of accidents, both fatal and non-fatal in the reports, it is clearly shown that two-thirds of them have taken place through hurry or a disregard of the law.

An article which appeared in the Philadelphia "Press" at the beginning of this year, 1894, shows that while in England coal mining accidents decrease year by year, in our anthracite coal mines they have increased. For fifteen years past the average ratio of miners killed in the United Kingdom to each 1,000 miners employed in the five years ending 1890 was 1.83, in the previous five years 2.04, in the five years ending with 1880, 2.39. Here is a regular continuous decrease, and as the amount of coal mined has increased 30 per cent. in this period of fifteen years, from 131,861,000 tons in 1875, to 181,614,000 tons in 1890, it is clear that a greatly increased output has been secured with constantly increasing safety to miners.

In our anthracite coal mines, a like decrease has not taken place.

The "Colliery Engineer," published in their mining paper accident figures in the anthracite region, collating them from the Inspectors' reports.

In the five years ending with 1892, there were 3.49 deaths to every 1,000 persons employed. In the five years previous, 3.20, and in the five years ending in 1882, 3.32. Instead of a decrease as in Great Britain, here there has been an increase.

It is quite reasonable to suppose that the public would want to know the reasons why such a difference exists. I shall explain, in my opinion, a few of the reasons that cause the great difference between the United Kingdom and the Anthracite coal field in general. In the first place in the method of mining. It is a well known fact that mining coal with picks and then wedging it down, as I understand is principally the way the miner gets his coal down in the British mines, is not so dangerous a method as blasting with powder in whatever form it may be used, as is the custom here. Therefore, accidents from falling coal are not so liable to occur in the former case as in the latter, or the overlying strata are not disturbed, as is frequently the case where powder has been used, often causing a comparatively safe roof to become very dangerous, and occasionally about ready to fall by the time the miner goes back to the face. Another cause is the different size of seams in height. The roof in low veins can be more carefully guarded and inspected by the miner at all times while at work, and dangerous pieces taken down or easily propped.

Another cause, and in my opinion the greatest, is the difference in

the workmen as a whole; not that the educated miner of Britain is any more competent than the educated miner of the anthracite mines of Pennsylvania. The former are men who have been brought up to the occupation of miners, from the lower grades in the mine from the time the law allows them to enter, working either with their fathers or some friend who takes interest in making them competent workmen and look after them until they are able to conduct a place of their own. How different we find it in our coal mines here. It is nothing uncommon to find about two-thirds of the miners and their laborers that cannot speak or understand the English language, the mine foreman directing them by signs how to proceed with their work; or, if they cannot understand by that method, he will bring one of their nationality who can talk a little English to tell them what he wants them to do in their own tongue. By inquiring of the mine boss I find that every miner has a miner's certificate entitling him to mine coal. How men, such as those referred to, get their certificates I do not know, but I do know that the law granting them was one of the worst pieces of legislation that was ever passed for this region, as it has driven competent miners coming to this coal field away, as they refuse to labor for two years with this class of miners before they can have a place for themselves to work. Therefore, they go to other coal fields where this law is not in operation. Then is it any wonder that the accidents do not decrease?

In conclusion, I would say that it might be expected that in a few years this state of affairs would be overcome after these miners had become accustomed to mining, and then a better state of affairs in regard to killed and injured. This should be the case, but those who are fortunate enough to escape death or serious injury and have accumulated some money, go back to the country they came from and a fresh supply arrives and takes their places.

Again, Great Britain fatalities are based on their total output or production of their mines, while in the anthracite mines of Pennsylvania they are based on the prepared coal after passing through the breakers, and not on the total production of the mines. The waste of the anthracite mines, which amounts to about 30 per cent., is not taken into consideration in determining the amount of coal mined to the life lost.

#### Shaw's Standard Gas Testing Instrument.

Four years ago the State furnished this office with one of the above instruments, which I find to be very valuable in determining the per cent. of gas which may be given off by the strata. In several instances to my knowledge the return air current was within two per cent. of the explosion point, which I found by testing the return air on the above instrument, and by giving notice to the mine boss of the con-

dition of the air current another split of air would be furnished, or the intake air current increased in volume so as to reduce the carburetted hydrogen in the current to one and one-half per cent., as was done in the above case.

This instrument is in use at a few of the collieries of this district for making tests of the return air currents, which records are kept in the office at the colliery for reference. It requires very little time to understand the instrument, and to become proficient in making tests with it, and I can recommend it to all coal companies in the anthracite coal field as a valuable instrument in determining the per cent. of gas in the air current.

### Description of Accidents.

The total number of persons killed or seriously injured was 199. Of these, 49 were killed and 150 injured, which number, I am happy to report, is 15 less in the fatal than was reported last year. The causes in the majority of these accidents I have called attention to in my report. The following is a brief account of how they occurred:

Accidents No. 29 and 30. A. G. Mason, age 55 years, division superintendent of the Lehigh Valley Coal Company, and William Wilson, age 40 years, inside foreman of the Exeter Colliery, for the above company, were fatally injured, dying the same day, and Robert S. Mercur, age 26 years, mining engineer, employed by the above company, and Joseph Barrell, age 25 years, instructor in mining in the Lehigh University at Bethlehem, Pa., were seriously injured by falling down the Knight shaft, located in the borough of Exeter, on July twenty-sixth. On the above morning the four above mentioned men, with Jacob Gates, the fire boss of the colliery, got on the carriage of the second opening shaft and were lowered to the Pittston seam to inspect some work that was necessary to be done inside before the colliery would resume work, as the tower over the hoisting shaft was undergoing repairs at this time. Mr. Barrell being on his vacation and at Wilkes-Barre, went down with Mr. Mercur, as above stated, to see the mine; the party arrived safe at the bottom. They had been in the mine about an hour when they came to the foot of the shaft to be hoisted to the top. The signal was given to hoist, but for some reason the engineer did not start immediately to take the cage from the bottom, as a pair of sliding doors over the mouth of the shaft had to be opened to let the cage through, as this was the return airway to the fan, and by looking up the shaft they could tell when the engineer was going to hoist, and while doing so they detected a part of one of the guides out of place twenty-three feet from the bottom. They all got off the carriage and sent

it up empty to see if it would pass the broken guide, which, unfortunately, it did. They then signalled the engineer to slack on again to the bottom, the carriage passing over the displaced guide all right. They then held a consultation in regard to the danger, but came to the conclusion that if Jacob Gates, the fire boss, would get on the cross-head of the carriage to enter the shoes of same, they could pass all right. The signal was given the engineer to hoist, and the risk was taken. When they came to the displaced guide the fire boss entered the top shoe all right, but the bottom shoe of the carriage caught on the broken guide, causing the cage to get out of the conductors and the end of cage got under one of the buntings and broke the uprights of the cage off close below the cross-head, which allowed the cage and four men to fall to the bottom, a distance of 23 feet. The piece of guide which was broken was four feet long and it would not have taken over a half hour to have repaired it and made it safe, but they chose to take the risk with the foregoing result.

Accident No. 33. James A. Bryden, age 62 years, inside foreman for Pennsylvania Coal Company at No. 4 shaft, Pittston, Pa., was killed by an explosion of gas on the morning of September 10, 1894.

On the above morning he had a couple of miners who were going to start work in the Marcy seam, and he went with them to show them the places to begin, as this heading had been abandoned for a number of years and was now about to start up again. The fire boss, Charles Norris, had made his examination in the part of the mine where these men were going to work and found no gas and reported the same to Mr. Bryden, who went with the men and marked off their chambers for them. While he was in this part of the mine he thought he would go through some of the abandoned workings, as he contemplated starting a heading soon to cut off some of the old roads which had fallen. Leaving the men, he proceeded for some distance in until he came to a division; passing through the door he came on the air way which was the return for this split of air which he came in on, and started to go along this gangway, but had proceeded but a short distance when he encountered a body of gas which had accumulated by reason of a recent fall on the heading road and which was ignited by his lamp, as he had an open light with him at the time. In a short time after the explosion parties of men went in search of him and in coming to the division door through which he went the staff was found which he carried, but it was impossible for the men to go further on account of gas which had accumulated after the explosion. Boards and canvas were immediately procured and a temporary brattice erected along the airway road for a distance of 80 or 90 feet, when John B. Law came with the incandescent lamp, which was put on by Alex. Law, and going in advance of the brattice

and over the fall he found the body of Bryden lying on the gangway road. He was severely burned on face and hands, but undoubtedly lost his life by the afterdamp, as he evidently got confused and went the wrong way to a distance of 150 feet from where his staff was found. He was a man of large experience in mining and had for a number of years conducted mines that gave off large quantities of gas.

#### Taking the Water out of the Pettebone and Hallstead Shafts.

In my report of 1893 the Pettebone shaft, operated by the Delaware, Lackawanna and Western Railroad Company, was reported flooded to extinguish a fire caused by an explosion of gas. I therefore wrote Superintendent Benj. Hughes, of the above company, for information in regard to the taking out of the water and likewise to give me the information regarding the flooding of the Hallstead shaft located at Duryea and operated by the above company.

The following information was kindly sent to me for this report:

Scranton, Pa., Jan. 18, 1895.

Mr. B. Hughes, General Inside Superintendent:

Dear Sir: Referring to Mine Inspector McDonald's request for information as to Pettebone and Hallstead.

We commenced hoisting the water at the second opening on May twenty-third, 1894, and hoisted continuously in this shaft, excepting on Sundays, and about thirty days lost for repairs of shaft timbers, etc., until September 22.

A pair of iron tanks fitted to travel on the guides, each of a capacity of 1,175 gallons, and arranged for automatic filling and self emptying, were used. With allowance for leakage, etc., it is estimated that they hoisted 1,100 gallons each trip.

The greatest number of tanks hoisted in one shift of eight hours was 593. During the 75 days of actual hoisting, a total of 65,809 tanks were raised, or a daily average of 877 tanks.

As the water stood at the beginning 320 feet down the shaft, and the total depth is 1,150 feet, the average hoist was 735 feet, and the quantity nearly 1,000,000 gallons every 24 hours.

This hoisting was done with a pair of 30x60 slide valve direct connected engines.

From July 6th to 17th we also hoisted in the main shaft, using wooden tanks placed on the regular carriages, one with a capacity of 530 gallons, the other of 750 gallons, or an average of 750 gallons.

Of these we hoisted a total of 8,194 tanks.

The total water hoisted is estimated from the above data at 78,000,000 gallons. In addition to this, there were pumped from the

dips in the several veins, which would not flow to the tanks, from 5,000,000 to 10,000,000 gallons, making a total of about 85,000,000 gallons corresponding very closely to the amount estimated as put in in 1893.

Regarding the Hallstead. The water started to flow into the mine on the morning of September 21st, 1894, and by night was flowing at from 2,500 to 3,000 gallons per minute. This inflow was caused by a cave which extended over about 10 acres, and the cracks from which were visible on the surface. As the ground affected is all underlain with water bearing gravel through which the cracks extended, it seems probable that the water comes through this gravel, partially from the river and partially from the small streams which disappeared near the cracks on the surface. These streams have been carried in flumes for some distance, and this seems to have decreased the flow in the mines.

In order to handle the water, it was necessary to introduce nine pumps of various sizes, 250 horse power of boilers, lay about 5,000 feet of ten-inch and twelve-inch column pipe, and 6,000 feet of five-inch and six-inch steam pipe, in addition to the pumping plant previously in use at the colliery.

These pumps were started one week after the breaking in of the water and steadily lowered the water which had filled up the workings below, and part of the No. 9 level. The colliery resumed the shipment of coal on November 21, 1894. The flow has decreased so that it does not now average over 1,200 gallons per minute.

### Colliery Improvements During 1894.

Some very important improvements were made at several of the collieries during the year 1894, a few of which are described in detail as follows:

#### Improvements by the Pennsylvania Coal Company.

At No. 10 shaft, Jr., a 20-foot Guibal fan was erected run by a horizontal engine 14x30 inches, under a speed of 50 revolutions and half-inch water gauge, exhausting 75,000 cubic feet of air per minute.

At No. 7 shaft a 20 foot Guibal fan was erected run by a horizontal engine, 16x30 inch, directly connected, which gives very good results.

In the Hoyt shaft the second opening from the red ash to the Marcy seam was driven through the rock strata between the seams on a grade of 27 degrees a distance of 270 feet, with a sectional area of 84 feet.



### Improvements by the Lehigh Valley Coal Company.

At the Oakwood shaft the second opening to the underground slope has been sunk to the red ash seam a distance of 325 feet, with a sectional area of 230 feet.

An underground slope was also sunk in the red ash vein a distance of 614 feet on a grade of four and one-half degrees. This slope opens up a large field of good coal for this colliery.

The Exeter breaker has been remodelled and enlarged and a new tower erected over the hoisting shaft. The shaft has been repaired from the top to the bottom and the inside workings placed in shape for a large transportation of coal. The buildings at the second opening with the shaft have undergone complete repairs.

At the Wyoming Colliery a 15-foot fan was erected on the old opening of the Hillman shaft, which gives very good results; it is run by a horizontal engine 14x24 inch, and driven by belting.

### Improvements by the Old Forge Coal Mining Company.

The Columbia shaft of this company was sunk from the Marcy to the red ash seam, connecting with the workings of their Phoenix shaft and completing the second opening for both shafts.

### Improvements by the Butler Coal Company, Limited.

A slope was sunk by this company on the outcrop of the Marcy vein to a depth of 200 feet on a grade of 18 degrees, sectional area 84 feet. The coal is taken to the breaker by a small locomotive.

### Improvements by the Delaware, Lackawanna and Western Railroad Company.

A tunnel was driven in the Hallstead shaft from the second to the third seam, a distance of 656 feet, area 6x12.

### Improvements by the Algonquin Coal Company

Two underground slopes were sunk in the Pine Ridge shaft, a distance of 1,100 and 300 feet respectively.

### Improvements by John C. Haddock.

In the Black Diamond shaft a tunnel was driven from the Bennett to the eleven foot seam, a distance of 200 feet, area 8x12. An inside gravity plane was built a distance of 1,500 feet for transporting coal to foot of shaft.

### Improvements by the Florence Coal Company.

This company sunk a shaft from the surface to the Marcy seam, a distance of 227 feet. It has a sectional area of 220 feet. The coal is taken to the Elmwood breaker by a small locomotive a distance of 1,933 yards. The second opening has not been completed at this writing.

A 15 foot Guibal fan was erected on one of the compartments of the shaft, which is run by a horizontal engine 12x18 inches.

### Improvements by Robertson and Law.

A new slope was sunk at the Katydid colliery from the surface to the Checker seam, a distance of 200 feet, area 7x9, grade 18 degrees. The coal from this slope is taken 2,000 feet to the breaker by a locomotive. The workings are ventilated by the Consolidated slope fan.

### Improvements by the Babylon Coal Company.

A tunnel was driven from the top to the bottom split of the red ash seam, a distance of 162 feet, area 7x12, to be used for transportation of coal.

### Improvements by the Forty Fort Coal Company.

The "Harry E." shaft of this company was sunk from the eleven foot to the red ash seam a distance of 229 feet, area 22x12 feet. The second opening shaft was sunk to the red ash seam at the same time, and a new 20 foot Guibal fan erected therein, run by a vertical engine directly connected to fan shaft.

### Improvements by the Delaware and Hudson Coal Company.

Two tunnels were driven in the Delaware shaft, one between the Baltimore splits, a distance of 150 feet, the other to the Ross seam, 300 feet in length, to be used for transporting coal. Two air shafts were sunk to a depth of 30 and 50 feet respectively, to air the workings of these tunnels. Two inside slopes are being sunk on a 15 degree pitch and are 160 and 180 feet down at present.

### Improvement by the Mt. Lookout Coal Company.

Electric Power Plant, Mt. Lookout Coal Company, Wyoming, Penna.

The power house containing the generators and engine is a separate brick building forty by thirty feet, situated about two hundred feet from the mouth of the main hoisting shaft and about one hundred feet from the air shaft. The generating plant consists of one M. P. 4, 100 Kilowatt, (135 H. P.) generator, driven at a speed of 650 revolutions per minute and developing 575



Plan of Wiring  
Electric Traction and Pump Circuits.

Mt. Lookout Coal Co.

Wyoming, Pa.

Scale 1/2" = 100 ft.

Galley 22' line ---  
Galley 2nd 22' line ---  
Pump line ---



volts at full load; and one M. P. 4, 20 Kilowatt (27 H. P.) generator, driven at a speed of 675 revolutions per minute and developing 550 volts at full load. Both generators are belted direct to one 16x18 inch single cylinder, automatic high speed engine, built by the J. H. McEwen Manufacturing Co. The engine runs at a speed of 218 revolutions per minute and receives steam at about 100 pounds pressure from the main battery of colliery boilers situated a short distance from the power house. The generators are the standard multi-polar type manufactured by the General Electric Company. A view of the inside of the power house before the smaller generator was installed is shown in Fig. 1.

The larger generator furnishes current for haulage, drilling and pumping in the mine; the smaller one furnishes current for arc and incandescent lighting circuits on the surface; although by the use of suitable switches, the smaller generator can be connected to the pumping line as a reserve power in case of accident to the larger one.

The current for the haulage, pumping and lighting circuits is distributed from two skeleton wood switchboards which are equipped with Weston ammeters and volt meters and Carpenter enamel rheostats. The switches, circuit breakers, lightning arresters, etc., are of the standard type manufactured by the General Electric Company.

The offices, engine and boiler houses, etc., are lighted by 16 c. p. incandescent lamps, while the breaker and surrounding grounds are lighted by 2,000 c. p. arc lights. At present there are fifteen incandescent lamps and twenty arc lights on the surface, although the smaller generator is capable of furnishing current for double this number of lights.

The conductors for the inside lines are suspended in the down cast air shaft, and consist of No. 000 and No. 0000 Siemens lead covered cables for feeders and No. 0 bare wires for returns. The total depth of the air shaft is about 300 feet. From the bottom of the air shaft, the feeder lines are suspended along the main gangways parallel with the trolley wire or through old workings or air ways. The feeder lines in the mine consist of waterproof, rubber covered copper wire. All feeder wires are run on glass insulators attached to roof blocks.

By referring to the map showing the plan of wiring, it will be seen that the feeder line divides at the bottom of the air shaft, one branch supplying current to the trolley wire in the north workings and the other branch supplying current to the trolley wire in the south workings. The pump circuit follows the south branch of the feeder line until it reaches the bottom of a slope at E, where it passes into the main air way. The north branch of the feeder line is connected to the trolley line at D, which is about 300 feet from the bottom of the air shaft:

the south branch is about 1,000 feet long and is connected to the trolley wire at E. No. 0 hard drawn copper wire is used for the trolley lines with bonded rail returns. The trolley wire is suspended to oak roof blocks by a special mining ear which clamps the wire instead of being soldered to it.

The haulage in the north working is done by one General Electric Company's standard T. K. M. 15 locomotive with inside wheels. The locomotive is equipped with two 15 H. P. waterproof motors, single reduction, and is capable of exerting continuously a draw-bar pull of 1,500 pounds on a straight level track at a speed of six miles per hour; at starting it will develop between 3,500 and 4,000 pounds draw-bar pull without slipping its wheels. The total weight of the locomotive is about six and one-half tons. Its extreme dimensions are 11 feet 4 inches long, 57 inches wide and 34 inches high. Fig. 2 gives a view of the locomotive in actual operation.

The total length of the gangway over which the T. M. M. 15 locomotive runs is about 2,800 feet; although, including sidings and turnouts, there is about 3,000 feet of trolley suspended in the north workings. The locomotive is making from 20 to 25 round trips per day, hauling at present 7-car trips. The locomotive is capable, however, of handling about twice this output. The grades on the gangway from A to C on the map, are all against the empties, varying from a level up to 2.8 per cent. as a maximum.

The haulage machinery in the south workings consists of one General Electric T. M. M. 25 locomotive with inside wheels. It is equipped with two 25 horse power single reduction motors and is capable of exerting continuously a draw-bar pull of 2,500 pounds on a straight level track at a speed of 6 miles per hour; at startings, however, it can exert between 4,000 and 5,000 pounds draw-bar pull without slipping its wheels. The total weight of the locomotive is about ten and one-half tons. Its extreme dimensions are as follows: length over all 11 feet 4 inches, width over all 58 inches, height above the rail 34 inches. Fig. 3 shows the locomotive before it was placed underground.

The maximum length of run in the south workings which the locomotive makes is about 1,200 ft., including sidings and turnouts, however, there is about 1,800 feet of wire in the south workings. At present the locomotive is making from 40 to 45 round trips per day, hauling ten-car trips. The trips are made up in the entries, F, G, H and I, as shown on the map; the locomotive pushing in a trip of empties and hauling out a trip of loaded. The heaviest work is done by the locomotive in starting the trip from these entries, as there is a sharp curve and grade against the loaded. The main gangway from E to the branches H and I is rather uneven, the grades averaging from

about one per cent. against the loaded to one per cent. in their favor. The mine cars weigh 3,000 pounds unloaded and about 8,000 pounds loaded, and have a capacity of 69 cubic feet. Eventually, the haulage line in the south workings is to be extended along the gangway from H to K and through a rock tunnel to L, as shown on the map. When this is done, the branches F, G and I are to be abandoned and the locomotive will then make a trip over about 3,500 feet of track, and haul about 400 cars per day from the end of the rock tunnel at L.

The electric pump is located in the workings off the branch I as shown on the map. The pump is of the standard duplex, double acting, piston type, manufactured by the Knowles Pump Works, and is operated by a General Electric Company's waterproof shunt wound motor developing about 15 horse power. The pump is capable of throwing 300 gallons of water against 40 feet head. It has been operating for over a year, doing duty twenty-three hours a day. It requires attention only at starting and stopping and for occasional lubricating. The speed of the pistons is absolutely constant, irrespective of the amount of water thrown, and when the water in slump hole or chambers falls below the mouth of the suction pipe, the pump does not race, and hence demands no attention. Fig. 4 gives a view of the pump in its chamber.

In addition to the electric pumping and hauling machinery, the Mt. Lookout Coal Company are operating two General Electric Company A-4 rotary coal drills. The drills are being used in a low seam in the southeast workings and are run from a circuit taken from the circuit connected to the feeder lines in the main gangway. At present, the length of the circuit from the feeder line is about 1,400 feet. The drills are used in working a three-foot seam of coal and taking up about two feet of slate bottom. In coal the drill makes about six feet per minute with an inch and a half bit, and in slate or boney it can drill about four feet per minute. The weight of each drill complete with post is 160 pounds, the drill itself weighing 100 pounds. A view of one of the drills is given in Fig. 5, where it is set up ready for operation.

#### The Burning of the Annora Breaker.

At 3.30 on the morning of Tuesday, December 4, 1894, the large breaker of the Annora Coal Company, located in the borough of Laffin, was discovered to be on fire and was totally consumed, and all the machinery more or less damaged or destroyed. The last coal put through the breaker was in the month of August, 1894, the colliery then closing down for the remainder of the year. A new company had taken the colliery some time previous to the fire and were

doing some repairs in and around the mine, as the breaker had been placed in working order some time before with the expectation of starting on the first of January, 1895, to prepare and ship coal. How the fire originated is impossible to say, as there were no fires in or around the breaker, nor had there been for some time previous. A new breaker is in course of erection on the site of the old one, which is expected to be ready shortly to prepare and ship coal.



TABLE 1.—Showing location, etc., of collieries in the Third Anthracite District.

| Name of Colliery.                 | Name of Operator.                    | Location—County.               | Name of Superintendent.             | Postoffice Address. |
|-----------------------------------|--------------------------------------|--------------------------------|-------------------------------------|---------------------|
| Barnum shaft No. 1, .....         | Pennsylvania Coal Company, .....     | Marcy township, Luzerne Co.,   | John E. Smith, General Supt., ..... | Dunmore, Pa.        |
| Barnum shaft No. 2, .....         | do, .....                            | do, do, .....                  | do, .....                           | Fittston, Pa.       |
| Barnum shaft No. 3, .....         | do, .....                            | Pittston township, Luz. Co.,   | do, .....                           | Dunmore, Pa.        |
| Laws shaft, .....                 | do, .....                            | Old Forge twp., Lack. Co.,     | do, .....                           | do, .....           |
| Shaft No. 13, .....               | do, .....                            | Hughestown, Luzerne Co.,       | do, .....                           | do, .....           |
| Shaft No. 9, .....                | do, .....                            | do, do, .....                  | do, .....                           | do, .....           |
| Shaft's Nos. 10 and 10 Jr., ..... | do, .....                            | Jenkins township, Luz. Co.,    | do, .....                           | do, .....           |
| Shafts Nos. 1 and 8, .....        | do, .....                            | do, do, .....                  | do, .....                           | do, .....           |
| Slope No. 4, .....                | do, .....                            | do, do, .....                  | do, .....                           | do, .....           |
| Shaft No. 4, .....                | do, .....                            | do, do, .....                  | do, .....                           | do, .....           |
| Shaft No. 7, .....                | do, .....                            | do, do, .....                  | do, .....                           | do, .....           |
| Shaft No. 5, .....                | do, .....                            | do, do, .....                  | do, .....                           | do, .....           |
| Shaft No. 6, .....                | do, .....                            | do, do, .....                  | do, .....                           | do, .....           |
| Shaft No. 11, .....               | do, .....                            | do, do, .....                  | do, .....                           | do, .....           |
| Shaft and Tunnel No. 14, .....    | do, .....                            | do, do, .....                  | do, .....                           | do, .....           |
| Hoyte shaft, .....                | do, .....                            | Plains township, Luzerne Co.,  | W. A. Lathrop, General Supt., ..... | Wilkes-Barre, Pa.   |
| Prospect shaft, .....             | Lehigh Valley Coal Company, .....    | do, do, .....                  | do, .....                           | do, .....           |
| Oakwood shaft, .....              | do, .....                            | do, do, .....                  | do, .....                           | do, .....           |
| Henry shaft, .....                | do, .....                            | do, do, .....                  | do, .....                           | do, .....           |
| Wyoming shaft and slope, .....    | do, .....                            | do, do, .....                  | do, .....                           | do, .....           |
| Exeter shaft, .....               | do, .....                            | Exeter township, Luz. Co.,     | do, .....                           | do, .....           |
| Heldenburg shaft, .....           | do, .....                            | Pittston township, Luz. Co.,   | do, .....                           | do, .....           |
| Heldenburg slope, .....           | do, .....                            | do, do, .....                  | do, .....                           | do, .....           |
| Midvale slope, .....              | do, .....                            | Plains township, Luz. Co.,     | do, .....                           | do, .....           |
| Maltby shaft, .....               | do, .....                            | Maltby township, Luz. Co.,     | do, .....                           | do, .....           |
| Delaware shaft, .....             | do, .....                            | Plains township, Luz. Co.,     | do, .....                           | do, .....           |
| Laurel Run slope, .....           | Delaware and Hudson Canal Company,   | Plains township, Luz. Co.,     | A. H. Vandling, .....               | Scranton, Pa.       |
| Petebone shaft, .....             | do, .....                            | Plains township, Luz. Co.,     | do, .....                           | do, .....           |
| Petebone shaft, .....             | do, .....                            | Kingston township, Luz. Co.,   | W. R. Storrs, General Supt., .....  | do, .....           |
| Hallstead shaft, .....            | do, .....                            | Duryea township, Luz. Co.,     | do, .....                           | do, .....           |
| Twin shaft, .....                 | do, .....                            | Pittston township, Luz. Co.,   | do, .....                           | Pittston, Pa.       |
| Ravine shaft, .....               | Newton Coal Company, .....           | do, do, .....                  | do, .....                           | do, .....           |
| Columbia shaft, .....             | do, .....                            | Duryea township, Luz. Co.,     | do, .....                           | do, .....           |
| Phoenix shaft, .....              | Old Forge Coal Mining Company, ..... | do, do, .....                  | do, .....                           | do, .....           |
| Butler shaft, .....               | do, .....                            | Pittston township, Luz. Co.,   | S. B. Bennett, .....                | do, .....           |
| Schooley shaft, .....             | Butler Mine Company, Limited, .....  | Exeter, Luzerne county, .....  | do, .....                           | do, .....           |
| Perrinwood shaft, .....           | do, .....                            | Pittston township, Luz. Co.,   | do, .....                           | do, .....           |
| Chapman shaft, .....              | do, .....                            | do, do, .....                  | do, .....                           | do, .....           |
| Forty Fort shaft, .....           | do, .....                            | Forty Fort, Luzerne county,    | J. L. Crawford, .....               | Scranton, Pa.       |
| Harry E. Shaft, .....             | do, .....                            | do, do, .....                  | do, .....                           | do, .....           |
| Babylon shaft, .....              | Babylon Coal Company, .....          | Duryea township, Luz. Co.,     | do, .....                           | do, .....           |
| Mount Lookout shaft, .....        | Mount Lookout Coal Company, .....    | Wyoming, Luzerne county, ..... | do, .....                           | do, .....           |
| Bennett shaft, .....              | Thos. Waddell & Co., .....           | Plains township, Luz. Co.,     | Jas. Waddell, .....                 | Kingston, Pa.       |

TABLE 1.—Continued.

| Name of Colliery                | Name of Operator.                     | Location--County.               | Name of Superintendent.  | Postoffice Address. |
|---------------------------------|---------------------------------------|---------------------------------|--------------------------|---------------------|
| Mill Hollow shaft.....          | Thos. Waddell & Co., .....            | Luzerne borough, Luz. Co.,      | Jas. Waddell, .....      | Kingston, Pa.       |
| Black Diamond shaft.....        | John C. Haddock, .....                | do.                             | Jas. E. Davis, .....     | Plymouth, Pa.       |
| Clear Spring shaft.....         | Clear Spring Coal Company, .....      | Pittston, Luzerne county, ..... | J. L. Cake, .....        | Pittston, Pa.       |
| Consolidated shaft and slope... | Hillside Coal and Iron Company, ..... | Avoca, Luzerne county, .....    | W. A. May, .....         | Seranton, Pa.       |
| Elmwood shafts.....             | Florence Coal Company, .....          | Pittston township, Luz. Co.,    | Ell T. Conner, .....     | do.                 |
| East Boston shaft.....          | W. G. Payne & Co., .....              | Kingston township, Luz. Co.,    | E. F. Payne, .....       | Kingston, Pa.       |
| Fairmount shaft.....            | Abhoit Coal Company, .....            | Pittston township, Luz. Co.,    | John T. Jetter, .....    | Towanda, Pa.        |
| Keystone shaft and slope.....   | John M. Robertson & Co., .....        | Plains township, Luz. Co.,      | John M. Robertson, ..... | Wilkes-Barre, Pa.   |
| Katy Dtd slope.....             | Stevens Coal Company, .....           | Avoca township, Luz. Co.,       | David Evans, .....       | Pittston, Pa.       |
| Stevens shaft and slope.....    | Annora Coal Company, .....            | Pittston, Luzerne county, ..... | Wm. C. Allen, .....      | Wilkes-Barre, Pa.   |
| Annora shaft.....               | Langcliffe Coal Company, .....        | Ladlin, Luzerne county, .....   | R. G. Brooks, .....      | Seranton, Pa.       |
| Langcliffe shaft.....           | Avoca Coal Company, .....             | Avoca, Luzerne county, .....    | W. H. Hollister, .....   | Avoca, Pa.          |
| Avoca shaft.....                | John A. Hutchins & Co., .....         | Wyoming, Luzerne county, .....  | John A. Hutchins, .....  | Wyoming, Pa.        |
| Morning Star tunnel.....        | Algonquin Coal Company, .....         | Miners' Mills, Luzerne Co.,     | George T. Maelly, .....  | Wilkes-Barre, Pa.   |
| Plme Ridge shaft.....           | Raub Coal Company, Limited, .....     | Luzerne borough, Luz. Co.,      | C. R. Marcy, .....       | Luzerne bor., Pa.   |
| Louise drifts.....              |                                       |                                 |                          |                     |



TABLE No. 2.—Continued.

| Names of Collieries                           | Location                 | Total production in tons of coal. | Tons of coal consumed at mines. | Tons of coal sold at mines, local sales. | Total shipment in tons of coal. | Number days worked | Number persons employed | Number fatal accidents. | Number non-fatal accidents. | Number kegs powder used. | Number steam boilers. | Number horses and mules. | Number mine locomotives. |
|---|--------------------------|-----------------------------------|---------------------------------|--|---------------------------------|--------------------|-------------------------|-------------------------|-----------------------------|--------------------------|-----------------------|--------------------------|--------------------------|
| Wyoming shaft and slope, Henry breaker, ..... | Plains township, .....   | 76,104                            | Culm, .....                     | 3,380                                    | 76,104                          | 100.45             | 190                     | .....                   | 6                           | 3,463                    | 22                    | 35                       | .....                    |
| Henry shaft, Henry breaker, .....             | do. ....                 | 106,978                           | Culm, .....                     | 3,380                                    | 103,588                         | 100.45             | 346                     | .....                   | 3                           | 3,825                    | 21                    | 54                       | .....                    |
| Maltby shaft, .....                           | Kingston, .....          | 137,534                           | Culm, .....                     | 1,770                                    | 135,764                         | 136.50             | 362                     | 3                       | 9                           | 5,982                    | 24                    | 54                       | .....                    |
| Exeter shaft, .....                           | Exeter, .....            | 70,596                            | Culm, .....                     | 1,948                                    | 68,648                          | 84.55              | 330                     | 2                       | 10                          | 1,092                    | 11                    | 46                       | 1                        |
| Heldeburg shaft, .....                        | Pittston township, ..... | 60,459                            | 9,390                           | 576                                      | 59,493                          | 130                | 313                     | .....                   | 3                           | 2,113                    | 6                     | 25                       | .....                    |
| Heldeburg slope, .....                        | do. ....                 | 76,755                            | 4,932                           | 112                                      | 71,711                          | 154.20             | 272                     | 1                       | 3                           | 1,860                    | 6                     | 23                       | .....                    |
| Total, Lehigh Valley Coal Company, .....      | .....                    | 755,204                           | 14,322                          | 7,799                                    | 733,083                         | 149                | 2,738                   | 7                       | 38                          | 23,270                   | 130                   | 324                      | 4                        |
| Delaware and Hudson Canal Company.            | .....                    | .....                             | .....                           | .....                                    | .....                           | .....              | .....                   | .....                   | .....                       | .....                    | .....                 | .....                    | .....                    |
| Delaware shaft, .....                         | Plains township, .....   | 182,084                           | Culm, .....                     | 3,487                                    | 178,596                         | 188.50             | 408                     | .....                   | 3                           | 4,910                    | 15                    | 43                       | .....                    |
| Laurel Run slope, .....                       | Parsons, .....           | 103,089                           | Culm, .....                     | 2,368                                    | 100,721                         | 181.75             | 385                     | .....                   | 2                           | 3,941                    | 12                    | 85                       | .....                    |
| Total, Delaware and Hudson Canal Co., .....   | .....                    | 286,173                           | .....                           | 5,855                                    | 280,317                         | 185.10             | 793                     | .....                   | 5                           | 7,951                    | 27                    | 128                      | .....                    |
| Newton Coal Company.                          | .....                    | .....                             | .....                           | .....                                    | .....                           | .....              | .....                   | .....                   | .....                       | .....                    | .....                 | .....                    | .....                    |
| Twin shaft, Ravine breaker, .....             | Pittston, .....          | 331,630                           | 17,568                          | 14,574                                   | 299,488                         | 186.90             | 112                     | .....                   | 3                           | 13,464                   | 37                    | 16                       | 4                        |
| Ravine shaft, Ravine breaker, .....           | do. ....                 | 231,630                           | 17,568                          | 14,574                                   | 209,488                         | 186.90             | 876                     | 5                       | 13                          | 13,464                   | 37                    | 16                       | 4                        |
| Total, Newton Coal Company, .....             | .....                    | .....                             | .....                           | .....                                    | .....                           | .....              | .....                   | .....                   | .....                       | .....                    | .....                 | .....                    | .....                    |
| Old Forge Coal Mining Company.                | .....                    | .....                             | .....                           | .....                                    | .....                           | .....              | .....                   | .....                   | .....                       | .....                    | .....                 | .....                    | .....                    |
| Columbia shaft, .....                         | Duryea, .....            | 88,578                            | 4,780                           | 740                                      | 83,958                          | 146.20             | 252                     | .....                   | 2                           | 2,517                    | 8                     | 27                       | .....                    |
| Phoenix shaft, .....                          | do. ....                 | 123,431                           | 5,250                           | .....                                    | 118,181                         | 151.90             | 368                     | 1                       | 6                           | 5,189                    | 8                     | 31                       | .....                    |
| Total, Old Forge Coal Mining Company, .....   | .....                    | 212,009                           | 10,030                          | 740                                      | 201,229                         | 149                | 620                     | 1                       | 8                           | 7,766                    | 16                    | 58                       | .....                    |
| Delaware, Lack. & Western R. R. Co.           | .....                    | .....                             | .....                           | .....                                    | .....                           | .....              | .....                   | .....                   | .....                       | .....                    | .....                 | .....                    | .....                    |
| Hallstead shaft, .....                        | Duryea, .....            | 141,421                           | 17,500                          | 1,973                                    | 121,948                         | 130.40             | 398                     | 1                       | 1                           | 4,822                    | 23                    | 57                       | .....                    |
| Pettebone shaft, .....                        | Kingston township, ..... | 8,100                             | 1,000                           | 520                                      | 6,580                           | 32.20              | 241                     | .....                   | 1                           | 270                      | 27                    | 32                       | .....                    |
| Total, Dela. & Western R. R. Co., .....       | .....                    | 149,521                           | 18,500                          | 2,493                                    | 123,528                         | 130.40             | 639                     | 1                       | 2                           | 5,092                    | 50                    | 89                       | .....                    |

|  |           |        |        |           |        |       |       |       |        |       |       |
|--|-----------|--------|--------|-----------|--------|-------|-------|-------|--------|-------|-------|
| Forty Fort Coal Company.                   |           |        |        |           |        |       |       |       |        |       |       |
| Forty Fort shaft, .....                    | 87,859    | 14,600 | 1,855  | 71,404    | 148    | 420   | 4     | 1     | 3,020  | 17    | 49    |
| Harry E shaft, .....                       | 96,366    | 10,220 | 6,620  | 79,526    | 112    | 471   | 1     | 4     | 3,255  | 8     | 53    |
| Total, Forty Fort Coal Company, .....      | 184,225   | 24,820 | 8,475  | 150,930   | 150    | 891   | 5     | 5     | 6,275  | 25    | 102   |
| Miscellaneous Coal Companies               |           |        |        |           |        |       |       |       |        |       |       |
| Bennett shaft, .....                       | 49,832    | Culm.  | 1,953  | 47,979    | 193.40 | 137   | ..... | ..... | 811    | 6     | 16    |
| Mill Hollow shaft, .....                   | 101,983   | 6,400  | 3,071  | 92,512    | 161.30 | 310   | 2     | 1     | 2,800  | 17    | 27    |
| Black Diamond shaft, .....                 | 243,657   | 12,500 | 10,540 | 220,616   | 295.30 | 469   | ..... | ..... | 8,487  | 23    | 41    |
| Clear Spring shaft, .....                  | 196,263   | Culm.  | 13,872 | 182,491   | 191.10 | 474   | 1     | 3     | 6,164  | 20    | 75    |
| Consolidated shaft and slope, .....        | 105,549   | 3,268  | 1,555  | 100,726   | 159    | 378   | ..... | ..... | 3,431  | 12    | 35    |
| Elmwood shaft, .....                       | 80,244    | 9,000  | 2,543  | 68,701    | 162.30 | 317   | 1     | ..... | 2,694  | 17    | 35    |
| East Boston shaft, .....                   | 105,872   | Culm.  | 4,992  | 100,880   | 114.70 | 487   | 3     | 2     | 3,048  | 25    | 38    |
| Fairmount shaft, .....                     | 9,544     | Culm.  | .....  | 9,544     | 233    | 60    | ..... | ..... | 900    | 6     | 5     |
| Keystone shaft and slope, .....            | 102,964   | 7,200  | 944    | 94,820    | 161.20 | 326   | 1     | 1     | 5,961  | 8     | 43    |
| Avooca shaft, .....                        | 65,662    | Culm.  | 1,265  | 64,397    | 172.50 | 271   | 1     | ..... | 2,589  | 7     | 34    |
| Langellie shaft, .....                     | 121,314   | 5,300  | 1,701  | 114,989   | 192.30 | 410   | 1     | 4     | 4,760  | 9     | 48    |
| Stevens shaft and slope, .....             | 83,046    | Culm.  | 1,701  | 81,345    | 127.70 | 304   | 4     | ..... | 3,982  | 16    | 25    |
| Amora slope, .....                         | 29,171    | Culm.  | .....  | 29,171    | 75.40  | ..... | ..... | ..... | 1,424  | ..... | ..... |
| Katy Did shaft, .....                      | 40,426    | 1,200  | 845    | 47,381    | 157.25 | 144   | ..... | ..... | 7,739  | 3     | 17    |
| Avoca, .....                               | 244,556   | 13,860 | 1,610  | 229,386   | 457    | 502   | 2     | ..... | 7,428  | 13    | 58    |
| Dayton shaft, .....                        | 315,462   | 18,200 | 2,826  | 294,437   | 167.10 | 583   | 1     | 12    | 10,885 | 22    | 96    |
| Mount Lookout shaft, .....                 | 33,942    | .....  | 818    | 32,161    | 119.80 | 133   | 1     | 1     | 1,215  | 2     | 11    |
| Louise drifts, .....                       | 186,034   | Culm.  | 2,846  | 183,187   | 296.50 | 476   | 2     | 9     | 4,742  | 20    | 46    |
| Pine Ridge shaft, .....                    | 10,375    | 75     | 500    | 10,000    | 105    | 15    | ..... | ..... | 450    | 2     | 3     |
| Morning Star tunnel, .....                 | .....     | .....  | .....  | .....     | .....  | ..... | ..... | ..... | .....  | ..... | ..... |
| Total, miscellaneous coal companies, ..... | 2,195,596 | 77,566 | 52,915 | 2,005,114 | 168    | 5,776 | 20    | 42    | 73,508 | 236   | 653   |

Recapitulation.

|  |           |         |        |           |        |        |       |       |         |     |       |
|--|-----------|---------|--------|-----------|--------|--------|-------|-------|---------|-----|-------|
| Pennsylvania Coal Company, .....                         | 1,210,395 | 51,763  | .....  | 1,158,632 | 155    | 3,617  | 9     | 30    | 37,691  | 221 | 395   |
| Rutler Mine Company, .....                               | 277,139   | 13,332  | 3,999  | 259,808   | 195.25 | 1,015  | 2     | 6     | 14,292  | 49  | 82    |
| Lehigh Valley Coal Company, .....                        | 755,204   | 14,822  | 7,799  | 733,083   | 149    | 2,738  | 7     | 38    | 23,270  | 130 | 324   |
| Delaware and Hudson Canal Company, .....                 | 286,173   | .....   | 8,856  | 280,317   | 185.10 | 793    | ..... | ..... | 7,951   | 27  | 128   |
| Newton Coal Company, .....                               | 331,630   | 17,568  | 14,574 | 299,488   | 186.99 | 876    | 5     | 12    | 13,464  | 37  | 16    |
| Old Forge Coal Mining Company, .....                     | 212,009   | 10,030  | 740    | 201,239   | 149    | 620    | 1     | 8     | 7,766   | 16  | 38    |
| Delaware, Lackawanna and Western Railroad Company, ..... | 149,521   | 18,500  | 2,493  | 128,528   | 130.40 | 639    | 1     | 1     | 5,092   | 50  | 89    |
| Forty Fort Coal Company, .....                           | 184,225   | 24,820  | 8,475  | 150,930   | 150    | 891    | 5     | 5     | 6,275   | 25  | 102   |
| Miscellaneous coal companies, .....                      | 2,135,596 | 77,566  | 52,917 | 2,005,114 | 168    | 5,776  | 20    | 42    | 73,508  | 236 | 653   |
| Total by all coal companies, .....                       | 5,541,952 | 227,901 | 96,852 | 5,217,199 | •161   | 16,965 | 51    | 148   | 189,369 | 791 | 1,847 |

•Average time. [Closed down in the month of August, 1894; men working at other collieries. 1, 5, 28,059 pounds of dynamite were reported as having been used in sinking.



|  |   |     |     |     |     |    |       |  |    |    |     |     |       |       |       |     |
|--|---|-----|-----|-----|-----|----|-------|--|----|----|-----|-----|-------|-------|-------|-----|
| Heidelberg shaft, .....                            | 1 | 52  | 54  | 28  | 17  | 2  | 154   |  | 6  | 7  | 84  | 60  | 159   | 313   |       |     |
| Heidelberg shaft, .....                            | 1 | 41  | 38  | 12  | 18  | 3  | 113   |  | 1  | 5  | 113 | 33  | 159   | 272   |       |     |
| Total Lehigh Valley Coal Company,.....             | 9 | 555 | 519 | 242 | 289 | 47 | 1,661 |  | 6  | 59 | 495 | 435 | 1,077 | 2,738 |       |     |
| Delaware and Hudson Canal Company.                 |   |     |     |     |     |    |       |  |    |    |     |     |       |       |       |     |
| Delaware shaft, .....                              | 1 | 86  | 89  | 38  | 28  | 19 | 261   |  | 1  | 4  | 10  | 88  | 43    | 147   | 408   |     |
| Laurel Run slope, .....                            | 1 | 60  | 56  | 29  | 68  | 17 | 241   |  | 1  | 5  | 7   | 90  | 40    | 144   | 385   |     |
| Total Delaware and Hudson Canal Company,...        | 2 | 146 | 145 | 77  | 96  | 36 | 502   |  | 2  | 9  | 17  | 178 | 83    | 291   | 793   |     |
| Butler Mine Company, Limited.                      |   |     |     |     |     |    |       |  |    |    |     |     |       |       |       |     |
| Fernwood shaft, .....                              | 1 | 66  | 48  | 12  | 23  | 2  | 152   |  | 1  | 5  | 3   | 82  | 20    | 112   | 264   |     |
| Chapman shaft, .....                               | 2 | 125 | 75  | 22  | 22  | 3  | 249   |  | 1  | 5  | 15  | 80  | 51    | 153   | 402   |     |
| Butler shaft, .....                                | 5 | 35  | 60  | 26  | 24  | 4  | 214   |  | 1  | 6  | 10  | 80  | 37    | 135   | 349   |     |
| Schooley shaft, .....                              | 8 | 286 | 182 | 60  | 69  | 9  | 615   |  | 16 | 28 | 242 | 108 | 3     | 400   | 1,015 |     |
| Total Butler Mine Company, Limited,.....           | 2 | 185 | 185 | 45  | 69  | 19 | 505   |  | 3  | 15 | 16  | 124 | 95    | 6     | 259   | 764 |
| Newton Coal Company.                               |   |     |     |     |     |    |       |  |    |    |     |     |       |       |       |     |
| Twin shaft, .....                                  | 2 | 41  | 41  | 5   | 16  | 7  | 112   |  |    |    |     |     |       |       | 112   |     |
| Ravine shaft, .....                                | 4 | 226 | 226 | 50  | 85  | 26 | 617   |  | 3  | 15 | 16  | 124 | 95    | 6     | 259   | 876 |
| Total Newton Coal Company, .....                   | 6 | 267 | 267 | 55  | 101 | 33 | 729   |  | 3  | 15 | 16  | 124 | 95    | 6     | 259   | 876 |
| Old Forge Coal Mining Company.                     |   |     |     |     |     |    |       |  |    |    |     |     |       |       |       |     |
| Columbia shaft, .....                              | 1 | 50  | 50  | 18  | 24  | 5  | 148   |  | 1  | 6  | 5   | 60  | 30    | 2     | 104   | 252 |
| Phoenix shaft, .....                               | 1 | 86  | 86  | 14  | 35  | 9  | 231   |  | 1  | 5  | 7   | 85  | 37    | 2     | 137   | 368 |
| Total Old Forge Coal Mining Company,.....          | 2 | 136 | 136 | 32  | 59  | 14 | 379   |  | 2  | 11 | 12  | 145 | 67    | 4     | 241   | 620 |
| Delaware, Lackawanna and Western Railroad Company. |   |     |     |     |     |    |       |  |    |    |     |     |       |       |       |     |
| Hallshead shaft, .....                             | 2 | 69  | 86  | 40  | 26  | 4  | 237   |  | 1  | 25 | 19  | 77  | 45    |       | 161   | 398 |
| Pedehone shaft, .....                              | 1 | 22  | 22  | 52  | 14  | 2  | 132   |  | 1  | 15 | 10  | 48  | 34    |       | 108   | 241 |
| Total Del., Lack. and Western R. R. Co.,.....      | 3 | 101 | 118 | 92  | 50  | 6  | 370   |  | 2  | 40 | 29  | 125 | 82    |       | 269   | 639 |
| Forty Fort Coal Company.                           |   |     |     |     |     |    |       |  |    |    |     |     |       |       |       |     |
| Forty Fort shaft, .....                            | 1 | 65  | 90  | 107 | 26  | 5  | 294   |  | 1  | 4  | 16  | 54  | 48    | 3     | 126   | 429 |
| Harry E. shaft, .....                              | 1 | 115 | 139 | 45  | 39  | 8  | 338   |  | 1  | 5  | 11  | 55  | 58    | 3     | 133   | 471 |
| Total Forty Fort Coal Company, .....               | 2 | 180 | 229 | 152 | 65  | 13 | 632   |  | 2  | 9  | 27  | 109 | 106   | 6     | 259   | 891 |
| Miscellaneous Coal Companies.                      |   |     |     |     |     |    |       |  |    |    |     |     |       |       |       |     |
| Bennett shaft, .....                               | 1 | 27  | 27  | 10  | 18  | 1  | 81    |  | 1  | 5  | 7   | 28  | 12    |       | 53    | 137 |
| Mill Hollow shaft, .....                           | 2 | 83  | 56  | 16  | 40  | 6  | 241   |  | 1  | 4  | 7   | 41  | 40    |       | 108   | 310 |
| Black Diamond shaft, .....                         | 1 | 113 | 78  | 27  | 61  | 19 | 292   |  | 1  | 5  | 15  | 112 | 39    | 4     | 176   | 469 |
| Clear Spring shaft, .....                          | 2 | 39  | 29  | 68  | 71  | 33 | 372   |  | 1  | 4  | 8   | 55  | 32    | 9     | 102   | 474 |
| Consolidated shaft and slope, .....                | 2 | 35  | 79  | 18  | 38  | 2  | 231   |  | 1  | 8  | 10  | 55  | 50    | 3     | 147   | 378 |
| Elmwood shaft, .....                               | 2 | 64  | 64  | 18  | 29  | 2  | 179   |  | 1  | 5  | 8   | 82  | 39    | 3     | 138   | 317 |

TABLE No. 3.—Continued.

| Names of Collieries.                      | Occupation of Persons Employed Inside. |         |                  |                  |                      | Occupation of Persons Employed Outside. |               |                  |                             |                        | Grand total inside and outside. |                |                        |                                 |
|---|--|---------|------------------|------------------|----------------------|---|---------------|------------------|-----------------------------|------------------------|---------------------------------|----------------|------------------------|---------------------------------|
|   | Inside foremen.                        | Miners. | Miners' helpers. | All company men. | Drivers and runners. | Door boys and help.                     | Total inside. | Outside foremen. | Blacksmiths and carpenters. | Engineers and firemen. |                                 | Plate pickers. | All other company men. | Suppl., bookkeepers and clerks. |
| East Boston shaft, .....                  | 2                                      | 120     | 105              | 31               | 45                   | 14                                      | 317           | 1                | 4                           | 10                     | 115                             | 37             | 3                      | 170                             |
| Fairmount shaft, .....                    | 1                                      | 15      | 15               | 22               | 3                    | .....                                   | 56            | 1                | 1                           | 1                      | .....                           | .....          | .....                  | 4                               |
| Keystone shaft and slope, .....           | 1                                      | 60      | 60               | 30               | 41                   | 6                                       | 198           | 1                | 5                           | 6                      | 85                              | 29             | 2                      | 128                             |
| Avoca shaft, .....                        | 1                                      | 80      | 30               | 20               | 36                   | 10                                      | 177           | 1                | 3                           | 4                      | 56                              | 27             | 3                      | 94                              |
| Stevens shaft and slope, .....            | 1                                      | 65      | 60               | 85               | 27                   | 2                                       | 190           | 1                | 5                           | 10                     | 70                              | 25             | 3                      | 114                             |
| Annora slope, .....                       | 1                                      | .....   | .....            | .....            | .....                | .....                                   | .....         | .....            | .....                       | .....                  | .....                           | .....          | .....                  | .....                           |
| Langcliffe shaft, .....                   | 2                                      | 112     | 30               | 36               | 8                    | 8                                       | 300           | 1                | 5                           | 6                      | 69                              | 36             | 2                      | 110                             |
| Katy Did slope, .....                     | 1                                      | 52      | 20               | 4                | 11                   | 4                                       | 92            | 1                | 3                           | 5                      | 22                              | 18             | 3                      | 52                              |
| Babylon shaft, .....                      | 1                                      | 150     | 165              | 25               | 41                   | 10                                      | 392           | 1                | 5                           | 9                      | 31                              | 61             | 3                      | 110                             |
| Mount Lookout shaft, .....                | 1                                      | 184     | 90               | 62               | 60                   | 19                                      | 416           | 1                | 5                           | 15                     | 30                              | 51             | 5                      | 147                             |
| Louise Drifts, .....                      | 1                                      | 30      | 30               | 4                | 14                   | 1                                       | 80            | 1                | 1                           | 2                      | 28                              | 18             | 2                      | 53                              |
| Pine Ridge shaft, .....                   | 1                                      | 80      | 84               | 57               | 54                   | 17                                      | 293           | 1                | 8                           | 17                     | 110                             | 45             | 2                      | 183                             |
| Morning star tunnel, .....                | 1                                      | 3       | 2                | .....            | .....                | .....                                   | 6             | .....            | .....                       | 1                      | 5                               | 2              | 1                      | 9                               |
| Total miscellaneous Coal Companies, ..... | 24                                     | 1,432   | 1,166            | 477              | 625                  | 154                                     | 3,878         | 17               | 78                          | 141                    | 1,048                           | 570            | 44                     | 1,898                           |

Recapitulation.

|   |    |       |       |       |       |     |        |    |     |     |       |       |       |       |
|---|----|-------|-------|-------|-------|-----|--------|----|-----|-----|-------|-------|-------|-------|
| Pennsylvania Coal Company, .....              | 17 | 921   | 941   | 213   | 359   | 115 | 2,655  | 9  | 32  | 90  | 555   | 381   | 14    | 1,051 |
| Burder Mine Company, .....                    | 8  | 286   | 183   | 60    | 69    | 9   | 615    | 3  | 16  | 28  | 242   | 108   | 3     | 400   |
| Lehigh Valley Coal Company, .....             | 9  | 555   | 519   | 242   | 289   | 47  | 1,661  | 6  | 50  | 74  | 495   | 435   | 17    | 1,077 |
| Delaware and Hudson Canal Company, .....      | 2  | 146   | 145   | 77    | 96    | 36  | 502    | 3  | 9   | 17  | 178   | 83    | 2     | 291   |
| Newton Coal Company, .....                    | 4  | 226   | 226   | 59    | 85    | 26  | 617    | 3  | 15  | 16  | 124   | 95    | 6     | 259   |
| Old Forge Coal Mining Company, .....          | 2  | 136   | 136   | 32    | 59    | 14  | 379    | 2  | 11  | 12  | 145   | 67    | 4     | 241   |
| Slave, Lockaving and Western R. R. Co., ..... | 3  | 101   | 118   | 92    | 50    | 6   | 370    | 2  | 40  | 20  | 125   | 82    | ..... | 269   |
| Liberty Port Coal Company, .....              | 2  | 180   | 220   | 152   | 65    | 13  | 632    | 2  | 9   | 27  | 109   | 106   | 6     | 259   |
| Miscellaneous coal companies, .....           | 24 | 1,432 | 1,166 | 477   | 625   | 154 | 3,878  | 17 | 78  | 141 | 1,048 | 570   | 44    | 1,898 |
| Total of all coal companies, .....            | 71 | 3,983 | 3,654 | 1,395 | 1,637 | 420 | 11,220 | 46 | 260 | 455 | 2,991 | 1,927 | 96    | 5,745 |

\*This colliery was shut down in August, 1894; men working in other collieries.



TABLE No. 4.—List of fatal accidents that occurred in and about the mines of the Third Anthracite Mine District, for the year ended December 31, 1894.

| Date of accident. | Number of accident. | Name of Person.   | Occupation.    | Age. | Married. | Number of orphans. | Name of colliery.    | Location—County.   | Nature and cause of accident.  |
|-------------------|---------------------|-------------------|----------------|------|----------|--------------------|----------------------|--------------------|--|
| Jan. 3,           | 1                   | Peter Wasocarnis, | Laborer,       | 43   | M.       | 0                  | Twin shaft,          | Pittston,          | Killed by fall of rock.  |
| Jan. 10,          | 2                   | Patrick Price,    | Miner,         | 60   | M.       | 19                 | No. 8 shaft,         | Hugestown,         | Fatally injured between cars at foot of shaft.   |
| Jan. 24,          | 3                   | James Pasco,      | Fire boss,     | 39   | M.       | 7                  | Maitly shaft,        | Kingston township, | Fatally burned by an explosion of gas; died February 8.  |
| Jan. 31,          | 4                   | Joseph Mesnestz,  | Miner,         | 55   | M.       | 1                  | East Boston shaft,   | do.                | Killed by fall of roof rock  |
| Feb. 3,           | 5                   | John Yates,       | Driver,        | 18   | S.       | 0                  | Maitly shaft,        | do.                | Fatally injured by falling in front of trip of cars while unhitching his mule.                                 |
| Feb. 3,           | 6                   | John Cummings,    | Miner,         | 21   | S.       | 0                  | Elmwood shaft,       | Pittston township, | Killed by fall of top coal while skipping the pillar.  |
| Feb. 7,           | 7                   | Mathew Flaherty,  | Miner,         | 63   | S.       | 0                  | Avoca shaft,         | Avoca,             | Fatally injured by fall of roof rock; he fired a blast knocking out two props and set of timber.               |
| Feb. 8,           | 8                   | Frank Work,       | Miner,         | 49   | M.       | 4                  | East Boston shaft,   | Kingston township, | Fatally injured in the entrance he was driving by a fall of rock; died next day.                               |
| Feb. 10,          | 9                   | Edward Martin,    | Chargeman,     | 52   | M.       | 3                  | Forty Fort shaft,    | do.                | Killed by a rock blast he was firing with a battery; going back it exploded on him.                            |
| Feb. 13,          | 10                  | John Sreek,       | Miner,         | 27   | S.       | 0                  | Twin shaft,          | Pittston,          | Killed by a fall of rock while working out loose coal from a blast.  |
| Feb. 13,          | 11                  | Robert Mulligan,  | Plain footman, | 19   | S.       | 0                  | Mill Hollow breaker, | Luzerne,           | Fatally squeezed between culm cars while riding up the plane; died in the hospital.                            |
| Mar. 3,           | 12                  | John Good,        | Miner,         | 43   | S.       | 0                  | Mill Hollow shaft,   | do.                | Fatally injured by a trip of cars on the heading road while sitting taking off his shoe and died same evening. |
| April 6,          | 13                  | James Sullivan,   | Laborer,       | 23   | S.       | 0                  | Keystone slope,      | Plains township,   | Fatally injured by fall of rock; died same day.  |
| April 18,         | 14                  | Patrick Robinson, | Laborer,       | 19   | S.       | 0                  | Pine Ridge shaft,    | Mhners' Mills,     | Killed by fall of rider coal at head of new plane which they were making.                                      |
| May 18,           | 15                  | James J. Clark,   | Driver boss,   | 26   | M.       | 0                  | Stevens' slope,      | Exeter,            | Killed by a fall of rock on a run while repairing the track.   |
| May 21,           | 16                  | Frank Samel,      | Miner,         | 24   | M.       | 0                  | Hallstead shaft,     | Duryea,            | Killed by fall of rock.  |
| May 21,           | 17                  | Peter Latfer,     | Laborer,       | 28   | S.       | 0                  | Prospect breaker,    | Plains township,   | Fatally injured by being caught between cars at the breaker while eating his dinner on the track.              |

TABLE NO. 4.—Continued.

| Date of accident. | Number of accident. | Name of Person.    | Occupation.      | Age. | Married. | Number of orphans. | Name of colliery.   | Location—County.   | Nature and cause of accident.  |
|-------------------|---------------------|--------------------|------------------|------|----------|--------------------|---------------------|--------------------|--|
| May 29,           | 18                  | Michael Barrett,   | Footman,         | 22   | S.       | .....              | Malby shaft,        | Kingston township, | Fatally injured; he fell into carriage pit under the descending cage and died same day.  |
| May 31,           | 19                  | John Molpsky,      | Door boy,        | 15   | S.       | .....              | Phoenix shaft,      | Duryea,            | Killed by being caught between car and prop.   |
| June 4,           | 20                  | John Mourtshine,   | Footman,         | 30   | M.       | 1                  | Forty Fort shaft,   | Kingston township, | These men were killed by being caught between the hoisting carriage and side of shaft; engineer says the bell was rung to hoist.   |
| June 4,           | 21                  | Paul Herman,       | Footman,         | 21   | S.       | .....              | Forty Fort shaft,   | do.                | Killed by fall of rock; fired a blast in the morning, knocked out a prop and failed to put it up.  |
| June 5,           | 22                  | Patrick Burnes,    | Miner,           | 56   | M.       | 6                  | No. 5 shaft,        | Jenkins township,  | Fatally squeezed between the car and cage; died July 14.   |
| June 11,          | 23                  | Frank Smith,       | Footman,         | 19   | S.       | .....              | Schooby shaft,      | Exeter,            | Fatally injured by being struck by a mine rail he was standing on to bar down coal.  |
| June 25,          | 24                  | Joseph Schavitske, | Miner,           | 42   | M.       | 5                  | Stevens' slope,     | do.                | Killed while going to oil the machinery by slipping into the pony rollers.   |
| June 26,          | 25                  | John Gillon,       | Laborer,         | 35   | W.       | 2                  | Harrum No. 3 shaft, | Marcy township,    | Scalded to death by the bursting of a steam valve while turning it off.  |
| July 9,           | 26                  | Charles Gordon,    | Other,           | 29   | S.       | .....              | Heidelberg breaker, | Pittston township, | Killed by falling from a car bumper on which he was riding.  |
| July 10,          | 27                  | James Bugdal,      | Miner,           | 34   | M.       | 2                  | Forty Fort shaft,   | Kingston township, | These men were fatally injured in the air shaft used for the second opening, by the carriage getting out of the guides and under the bunting, causing the top of the carriage to give way and letting them fall to the bottom of the shaft (see report). |
| July 12,          | 28                  | John Lee,          | Driver,          | 16   | S.       | .....              | Twin shaft,         | Pittston,          | Killed by fall of top coal and rock while skipping a pillar.   |
| July 26,          | 29                  | A. G. Mason,       | Division supt.,  | 55   | M.       | 3                  | Exeter air shaft,   | Exeter,            | Fatally injured by a car coming off the carriage on him.   |
| July 26,          | 30                  | William Wilson,    | Insible foreman, | 40   | M.       | 3                  | Exeter air shaft,   | do.                | Killed by an explosion of gas (see report).  |
| Aug. 7,           | 31                  | John Brisco,       | Miner,           | 37   | M.       | 3                  | Louise tunnel,      | Luzerne,           |  |
| Aug. 16,          | 32                  | Martin Corcoran,   | Laborer,         | 50   | M.       | 1                  | No. 9 shaft,        | Hughestown,        |  |
| Sept. 10,         | 33                  | James A. Bryden,   | Mine foreman,    | 62   | M.       | .....              | Shaft No. 4,        | Pittston,          |  |

|           |    |                       |                     |    |    |       |                           |                         |   |
|-----------|----|-----------------------|---------------------|----|----|-------|---------------------------|-------------------------|---|
| Sept. 25, | 34 | John E. Jones, .....  | Laborer, .....      | 47 | M. | 3     | Langcliffe shaft, .....   | Avoca, .....            | Killed by fall of rock while skipping the pillar along the gangway.                         |
| Oct. 2,   | 35 | John Hallstead, ..... | Runner, .....       | 16 | S. | ..... | Stevens' slope, .....     | Exeter, .....           | Fatally injured by being caught between cars and pillar; died on being taken home.          |
| Oct. 17,  | 36 | Frank Ducket, .....   | Laborer, .....      | 24 | S. | ..... | Babylon shaft, .....      | Duryea, .....           | Fatally injured by being caught between car and pillar.                                     |
| Oct. 23,  | 37 | Charles Allen, .....  | Carpenter, .....    | 40 | S. | ..... | No. 10 trestle, .....     | Hughestown, .....       | Fatally injured; back dislocated by falling from breaker trestling; died November 9.        |
| Oct. 24,  | 38 | George Vinslavage, .. | Miner, .....        | 33 | M. | 1     | Harry E shaft, .....      | Kingston township, ..   | Killed by falling down shaft; tried to get on carriage while it was in motion.              |
| Oct. 25,  | 39 | Benjamin Knight, ..   | Miner, .....        | 50 | M. | ..... | Pine Ridge shaft, .....   | Miners' Mills, .....    | Fatally injured by fall of coal and rock; died on being taken home.                         |
| Oct. 29,  | 40 | Anthony Honina, ..... | Laborer, .....      | 23 | S. | ..... | East Boston shaft, .....  | Kingston township, ..   | Killed by fall of top coal.   |
| Oct. 30,  | 41 | William Maches, ..... | Laborer, .....      | 35 | S. | ..... | Twin shaft, .....         | Pittston, .....         | Killed by fall of rock at face of chamber.  |
| Nov. 9,   | 42 | Michael Hogan, .....  | Miner, .....        | 36 | S. | ..... | No. 4 slope, .....        | Jenkins township, ..... | Fatally injured by fall of top coal while drawing pillars; died same day.                   |
| Nov. 10,  | 43 | Frank Brussa, .....   | Laborer, .....      | 26 | M. | 1     | Babylon shaft, .....      | Duryea, .....           | Fatally injured by fall of top rock; died November 15.                                      |
| Nov. 12,  | 44 | Martin Tierney, ..... | Driver, .....       | 16 | S. | ..... | No. 14 shaft, .....       | Jenkins township, ..... | Fatally injured by a blast in a cross cut; died same day.                                   |
| Nov. 19,  | 45 | Rollin Seleser, ..... | Miner, .....        | 35 | M. | 2     | Schooley shaft, .....     | Exeter, .....           | Killed by a premature explosion of a blast.   |
| Nov. 21,  | 46 | Alex. Barnett, .....  | Miner, .....        | 25 | M. | ..... | Mt. Lookout shaft, .....  | Wyoming, .....          | Killed by car; while dropping it down chain broke.  |
| Nov. 24,  | 47 | James Gaffney, .....  | Headman, .....      | 25 | S. | ..... | Schooley breaker, .....   | Exeter, .....           | Killed by falling down shaft; he tried to cross over the shaft and fell in.                 |
| Dec. 17,  | 48 | William Donohoe, ..   | Miner, .....        | 40 | M. | 3     | Stevens' slope, .....     | do, .....               | Fatally injured; back dislocated by fall of rock; his laborer was injured at the same time. |
| Dec. 20,  | 49 | Anthony Marcinkewicz  | Laborer, .....      | 40 | M. | 2     | Clear Spring shaft, ..... | Pittston, .....         | Killed by fall of top rock.   |
| Dec. 7,   | 50 | John Heffron, .....   | Road cleaner, ..... | 60 | M. | 4     | No. 11 shaft, .....       | Jenkins township, ..... | Fatally injured by having his legs crushed by trip of cars; died January 13, 1886.          |
| Dec. 24,  | 51 | Patrick Cosgrove, ..  | Driver, .....       | 15 | S. | ..... | Twin shaft, .....         | Pittston, .....         | Fatally injured by being run over by trip of cars; died January 8, 1886.                    |

Twenty-six wives were made widows and sixty-seven children orphans by these casualties.

TABLE No. 5.—List of non-fatal accidents that occurred in and about the Mines of the Third Anthracite Mine District, for the year ended December 31, 1894.

| Date of accident. | Number of accident. | Name of Person.    | Occupation.   |          |          | Age. | Married. | Number of children. | Name of Colliery.    | Locality—County.   | Nature and cause of accident.   |
|-------------------|---------------------|--------------------|---------------|----------|----------|------|----------|---------------------|----------------------|--------------------|---|
|                   |                     |                    | Laborer.      | Driver.  | Miner.   |      |          |                     |                      |                    |   |
| Jan.              | 3.                  | Joseph Feterovich. | Laborer.      | Driver.  | Miner.   | 23   | S.       | .....               | Twin shaft.          | Pittston.          | Leg broken and back injured by fall of rock. The same fall killed Wasocarnis.                                     |
|                   | 6.                  | John O. Boyle.     | Driver.       | Miner.   | Miner.   | 21   | S.       | .....               | Phoenix shaft.       | Duryea.            | Kicked in the stomach by a mule.  |
|                   | 9.                  | Valentine Brooks.  | Miner.        | Miner.   | Miner.   | 58   | M.       | .....               | Exeter shaft.        | Exeter.            | Foot and leg painfully bruised by fall of rock.   |
|                   | 11.                 | Jesse Weaver.      | Watchman.     | Laborer. | Driver.  | 40   | M.       | .....               | Phoenix shaft.       | Duryea.            | Ankle dislocated while loading pipe.  |
|                   | 16.                 | Charles Shultz.    | Laborer.      | Driver.  | Driver.  | 28   | S.       | .....               | Twin shaft.          | Pittston.          | Leg broken by fall of rock.   |
|                   | 17.                 | John McAvery.      | Driver.       | Driver.  | Driver.  | 15   | S.       | .....               | Twin shaft.          | Pittston.          | Arm broken by being caught between car and prop.  |
|                   | 17.                 | John Runesky.      | Miner.        | Miner.   | Miner.   | 25   | S.       | .....               | Keystone slope.      | Plains township.   | Leg broken by fall of rock.   |
|                   | 22.                 | Patrick Gallicher. | Laborer.      | Miner.   | Miner.   | 32   | S.       | .....               | Hoyt shaft.          | Jenkins township.  | Face and hand painfully burned by gas.  |
|                   | 25.                 | Barney Sharp.      | Miner.        | Miner.   | Miner.   | 35   | S.       | .....               | Henry shaft.         | Plains township.   | Head and back injured by fall of rider coal.  |
| Feb.              | 1.                  | George Wallace.    | Road Cleaner. | Sinker.  | Miner.   | 65   | M.       | .....               | Laurel Run shaft.    | Parsons.           | Leg broken by being caught between cars while loading lumber.   |
|                   | 15.                 | Owen Roberts.      | Sinker.       | Miner.   | Miner.   | 30   | M.       | 1                   | Harry E. shaft.      | Kingston township. | Skull fractured by piece of rock falling down shaft.  |
|                   | 21.                 | John Hevinsky.     | Miner.        | Miner.   | Miner.   | 30   | M.       | .....               | Butler shaft.        | Pittston township. | Severely bruised by a fall of rock that he was barring down.  |
|                   | 25.                 | Andrew Savage.     | Door boy.     | Miner.   | Miner.   | 14   | S.       | .....               | Mount Lookout shaft. | Wyoming.           | Arm broken by being caught by his door while it was closing.  |
| March             | 27.                 | John Marshall.     | Miner.        | Laborer. | Laborer. | 25   | S.       | .....               | Mount Lookout shaft. | Wyoming.           | Leg broken by fall of rock.   |
|                   | 8.                  | Anthony Rusboskle. | Laborer.      | Laborer. | Laborer. | 23   | S.       | .....               | Louise Tunnel.       | Laizerne.          | Painfully injured by fall of rock.  |
|                   | 12.                 | Paul Lukusky.      | Laborer.      | Driver.  | Miner.   | 49   | M.       | .....               | East Boston shaft.   | Kingston township. | Leg broken by fall of rock.   |
|                   | 12.                 | Evan Thomas.       | Driver.       | Miner.   | Miner.   | 17   | S.       | .....               | Midvale slope.       | Plains.            | Kicked in the abdomen by a mule.  |
|                   | 12.                 | Frank Pulscavage.  | Miner.        | Miner.   | Miner.   | 20   | S.       | .....               | Wyoming shaft.       | Plains.            | Burned by gas caused by breaking the brattice.  |
|                   | 13.                 | Thomas A. Price.   | Miner.        | Miner.   | Miner.   | 42   | M.       | 7                   | Prospect shaft.      | Plains.            | Face severely bruised by a drill while barring down coal.   |
|                   | 13.                 | Stephen Rebovich.  | Slate picker. | Laborer. | Laborer. | 16   | S.       | .....               | Butler breaker.      | Pittston township. | Seriously injured by being caught by culm scrapers.   |
|                   | 14.                 | Anthony Lesheosky. | Miner.        | Laborer. | Laborer. | 37   | M.       | 3                   | Mount Lookout shaft. | Wyoming.           | These men were severely bruised and cut by going back to a blast they were firing, thinking the squib had missed. |
|                   | 14.                 | Anthony Eugon.     | Laborer.      | Laborer. | Laborer. | 24   | S.       | .....               | Mount Lookout shaft. | Wyoming.           |   |



TABLE No. 5.—Continued.

| Date of accident. | Number of accident. | Name of Person.          | Occupation.      | Age. | Married. | Number of children. | Name of Colliery.              | Location—County.         | Nature and cause of accident.   |
|-------------------|---------------------|--------------------------|------------------|------|----------|---------------------|--------------------------------|--------------------------|---|
| June 1.           | 55                  | Alvin Honbaitzer, .....  | Fireman, .....   | 31   | S.       | .....               | Mill Creek slope, .....        | Plains township, .....   | Arm broken by falling from a beam in engine house.  |
| 5.                | 56                  | Charles Fischer, .....   | Miner, .....     | 32   | M.       | 2                   | Hoyle shaft, .....             | Jenkins township, .....  | These four men were burned more or less on face and hands by an explosion of gas in the second opening. They were driving through the rock from the red ash to the Marcy seam, and a small seam of coal had just been cut which gave off considerable gas, which was ignited. |
| 5.                | 57                  | Joseph Fairclough, ..... | Miner, .....     | 22   | M.       | 3                   | Hoyle shaft, .....             | Jenkins township, .....  | Leg severely cut and bruised by being run over by .. car.   |
| 5.                | 58                  | Thomas Hal, .....        | Miner, .....     | 45   | M.       | 3                   | Hoyle shaft, .....             | Jenkins township, .....  | Back and leg bruised by fall of rider coal. Painfully squeezed between car and props.   |
| 5.                | 59                  | Richard Bowden, .....    | Miner, .....     | 35   | M.       | 1                   | Hoyle shaft, .....             | Jenkins township, .....  | Legs broken between car bumpers.  |
| 6.                | 60                  | Joseph Callahan, .....   | Driver, .....    | 15   | S.       | .....               | Hoyle shaft, .....             | Jenkins township, .....  | Ribs broken by fall of rock.  |
| 7.                | 61                  | Peter Paulson, .....     | Miner, .....     | 46   | M.       | 3                   | Prospect shaft, .....          | Plains township, .....   | Arms seriously injured; fell under cars.  |
| 8.                | 62                  | Edward McDonald, .....   | Driver, .....    | 16   | S.       | .....               | Langlife shaft, .....          | Avoca, .....             | Face and hands burned by gas.   |
| 9.                | 63                  | David Thomas, .....      | Driver, .....    | 15   | S.       | .....               | Stevens shaft, .....           | Jenkins township, .....  | Face and hands burned by gas.   |
| 13.               | 64                  | John Hawley, .....       | Miner, .....     | 39   | M.       | 9                   | No. 5 shaft, .....             | Jenkins township, .....  | Wrist broken while coupling cars.   |
| 14.               | 65                  | Alfred Barnes, .....     | Driver, .....    | 17   | S.       | .....               | Babylon shaft, .....           | Jenkins township, .....  | Head and hand cut by fall of rock.  |
| 14.               | 66                  | Michael Doran, .....     | Miner, .....     | 39   | M.       | 4                   | Hoyle shaft, .....             | Jenkins township, .....  | Arm struck falling rock necessitating amputation.   |
| 14.               | 67                  | Patrick Kenney, .....    | Miner, .....     | 42   | M.       | 4                   | Prospect shaft, .....          | Plains township, .....   | Arm bruised between car and roof.   |
| 14.               | 68                  | Joseph Keag, .....       | Loader, .....    | 21   | S.       | .....               | Phoenix breaker, .....         | Duryea, .....            | Squeezed between mule and car.  |
| 15.               | 69                  | George Businski, .....   | Laborer, .....   | 24   | M.       | 1                   | Phoenix shaft, .....           | Duryea, .....            | Severely burned by his lamp while hitching his mule from a car.   |
| 18.               | 70                  | Luke Moran, .....        | Miner, .....     | 49   | M.       | 6                   | Barnum shaft, .....            | Marcy township, .....    | Collar bone fractured between car and mule.   |
| 18.               | 71                  | George Judge, .....      | Laborer, .....   | 25   | M.       | .....               | Heidelberg No. 1, shaft, ..... | Pittston township, ..... | Hand crushed and fingers broken by fall of rock.  |
| 18.               | 72                  | Michael Lonkitus, .....  | Driver, .....    | 24   | S.       | .....               | No. 10 shaft, .....            | Duryea, .....            | While hanging a door he pierced his knee cap with a nail he was driving.  |
| 19.               | 73                  | Wm. John, .....          | Driver, .....    | 17   | S.       | .....               | No. 7 shaft, .....             | Flughestown, .....       | Collar bone broken while prying down rock which fell on him.  |
| 20.               | 74                  | Wm. Moran, .....         | Driver, .....    | 16   | S.       | .....               | No. 7 shaft, .....             | Jenkins township, .....  |   |
| 22.               | 75                  | Owen Prothero, .....     | Miner, .....     | 32   | M.       | 3                   | No. 7 shaft, .....             | Jenkins township, .....  |   |
| 22.               | 76                  | Junius McGuire, .....    | Carpenter, ..... | 39   | M.       | .....               | Heidelberg slope, .....        | Pittston township, ..... |   |
| 23.               | 77                  | Charles Gunton, .....    | Laborer, .....   | 25   | S.       | .....               | Maltby shaft, .....            | Kingston township, ..... |   |

| No. | Name              | Occupation | Age | Sex | Locality                     | Cause of Injury  |
|-----|-------------------|------------|-----|-----|------------------------------|--|
| 23  | John Kinney       | Miner      | 29  | M   | Wyoming shaft,<br>Laws shaft | Eyes injured by premature blast.   |
| 24  | George Duristik   | Miner      | 24  | M   | Wyoming shaft                | Head severely injured by premature blast.  |
| 25  | Michael Ryan      | Laborer    | 26  | M   | Laws shaft                   | Leg broken and otherwise injured by fall of checker coal.  |
| 26  | Charles Beechold  | Driver     | 15  | M   | No. 1 outside                | Painfully bruised by falling over freestelting.  |
| 27  | Wm. McDowell      | Miner      | 21  | M   | Mally shaft                  | These four men were severely injured by a fall of roof rock in the shape of a bell on the heading road while they were putting a severely injured on back. |
| 28  | Thomas Quinnes    | Miner      | 42  | M   | Mally shaft                  | These men were severely injured on back and legs by a fall of fire clay from the roof in the chamber.  |
| 29  | Andrew Dolanich   | Laborer    | 40  | M   | Mally shaft                  | Arm heavily being caught between ears.   |
| 30  | Joseph Melash     | Laborer    | 24  | S   | Mally shaft                  | Leg severely cut between car and pillar.   |
| 31  | Daniel Morgan     | Miner      | 49  | M   | Pine Ridge shaft             | Severely bruised by fall of rock on head-ingley.   |
| 32  | Dennis Grimes     | Miner      | 39  | M   | Pine Ridge shaft             | Slightly bruised by car running over him.  |
| 33  | John Adams        | Runner     | 19  | S   | Pine Ridge shaft             | Leg broken by fall of rider coal.  |
| 34  | Stephen Kaysback  | Driver     | 27  | S   | Mount Lookout shaft          | Arm broken between door and car.   |
| 35  | Peter Gray        | Driver     | 17  | S   | Pine Ridge shaft             | These men were severely bruised and injured by falling down the Exeter second opening shaft with the carriage when Maden and Wilson were killed.           |
| 36  | Martin Cardis     | Laborer    | 33  | S   | Pheonix shaft                | These ribs fractured by a premature blast.   |
| 37  | Con. Ruddy        | Miner      | 40  | S   | Pine Ridge shaft             | Severely injured in the groups by falling under trip of cars.  |
| 38  | Mike Gorman       | Driver     | 16  | S   | Hoyt shaft                   | Leg and knee cap broken by being caught between car bumpers.   |
| 39  | Robt. S. Mercur   | Surveyor   | 26  | S   | Exeter shaft                 | Leg broken by runaway car knocking the door on him.  |
| 40  | Joseph Barrell    | Surveyor   | 25  | S   | Exeter shaft                 | Face and hands burned by powder while making cartridge and leaving his lamp on his head.   |
| 41  | Charles Patrie    | Miner      | 24  | S   | Mally shaft                  | Arm broken by a vicious mule he was leading.   |
| 42  | Frank Zoblonskip  | Miner      | 41  | M   | Mount Lookout shaft          | Face and hand painfully burned by gas.   |
| 43  | John Riley        | Driver     | 17  | S   | Heidelberg slope             | Leg broken while blocking a car that was off the track.  |
| 44  | David Ryan        | Footman    | 24  | M   | Harry F. shaft               | Leg broken by fall of fire clay roof.  |
| 45  | Alfred Hoffron    | Driver     | 15  | S   | No. 4 shaft                  | Painfully cut and bruised by a premature blast.  |
| 46  | Ludwig Hoffman    | Miner      | 25  | S   | Mount Lookout shaft          | Teeth knocked out by a kick from a mule.   |
| 47  | Arthur Jones      | Driver     | 15  | S   | No. 9, breaker               | Alger was painfully cut and bruised on the back and knee, and his laborer had his hips painfully bruised by a fall of rock.                                |
| 48  | Peter Delmoaton   | Miner      | 34  | S   | Schoely shaft                | Leg broken by falling under car.   |
| 49  | Archie Weir       | Miner      | 25  | S   | No. 7 shaft                  | Leg broken by falling under car.   |
| 50  | Stephen Knowls    | Laborer    | 25  | S   | Harry F. shaft               | Face and hand painfully burned by gas.   |
| 51  | Patrick Riley     | Miner      | 48  | M   | Pine Ridge shaft             | Leg broken while blocking a car that was off the track.  |
| 52  | Jas. Kenney       | Miner      | 25  | S   | Pine Ridge shaft             | Leg broken by fall of fire clay roof.  |
| 53  | John McHale       | Footman    | 22  | S   | Pine Ridge shaft             | Painfully cut and bruised by a premature blast.  |
| 54  | Jeremiah Alger    | Miner      | 42  | M   | Langecliff shaft             | Teeth knocked out by a kick from a mule.   |
| 55  | Steve Keenan      | Laborer    | 26  | S   | Langecliff shaft             | Alger was painfully cut and bruised on the back and knee, and his laborer had his hips painfully bruised by a fall of rock.                                |
| 56  | Andrew Bergas     | Driver     | 16  | S   | Clear Spring shaft           | Leg broken by falling under car.   |
| 57  | George Stackhouse | Laborer    | 19  | S   | Exeter breaker               | Leg broken by being caught in a landslide while shoveling sand.  |

TABLE No. 5.—Continued.

| Date of accident | Number of accident | Name of Person.          | Occupation.         | Age.  | Married. | Number of children. | Name of Colliery.          | Location--County.        | Nature and cause of accident.   |
|------------------|--------------------|--------------------------|---------------------|-------|----------|---------------------|----------------------------|--------------------------|---|
| Sept.            | 16, 113            | Andrew Melinsky, .....   | Driver, .....       | 20    | S.       | .....               | Mount Lookout shaft, ..... | Wyoming, .....           | Hips painfully squeezed between cars.                                 |
|                  | 22, 114            | Ira Vanoridan, .....     | Laborer, .....      | 25    | M.       | .....               | Black Diamond shaft, ..... | Luzerne, .....           | Face and hand painfully burned by gas.                                |
|                  | 26, 115            | Andrew Cawley, .....     | Driver, .....       | 17    | S.       | .....               | Delaware shaft, .....      | Plains, .....            | Thigh broken by falling from a car.                                   |
| Oct              | 7, 116             | John Finnerty, .....     | Laborer, .....      | 55    | M.       | .....               | Consolidated slope, .....  | Avoca, .....             | Wrist broken by fall of bony coal.                                    |
|                  | 7, 117             | Jas. Hegan, .....        | Miner, .....        | 42    | M.       | 4                   | Mount Lookout shaft, ..... | Wyoming, .....           | Ribs fractured by coal flying from a blast.                           |
|                  | 4, 118             | Frank Occone, .....      | Laborer, .....      | 25    | M.       | 1                   | Delaware shaft, .....      | Plains township, .....   | Severely burned on face and hands by gas.                             |
|                  | 4, 119             | Joseph Cowash, .....     | Laborer, .....      | 23    | S.       | .....               | Schooley breaker, .....    | Exeter, .....            | Severely bruised by falling from trestle.                             |
|                  | 8, 120             | Thos. Kelly, .....       | Driver, .....       | 15    | S.       | .....               | No. 5 shaft, .....         | Jenkins township, .....  | Leg bruised by falling from a trip of cars.                           |
|                  | 9, 121             | David McGuire, .....     | Runner, .....       | 26    | S.       | .....               | Black Diamond shaft, ..... | Luzerne, .....           | Hips bruised by car jumping the track on him.                         |
|                  | 12, 122            | James Gallagher, .....   | Co. man, .....      | ..... | M.       | 2                   | No. 9 shaft, .....         | Hughestown, .....        | Face and hand burned by gas.  |
|                  | 18, 123            | John Gillespie, .....    | Laborer, .....      | 31    | S.       | .....               | No. 14 tunnel, .....       | Jenkins township, .....  | Leg broken by being caught between car and rib.                       |
|                  | 18, 124            | Joseph Romanapkle, ..... | Miner, .....        | 25    | M.       | .....               | Twin shaft, .....          | Pittston, .....          | Head and face bruised and cut by coal flying from a premature blast.  |
|                  | 22, 125            | Wm. Taruthers, .....     | Laborer, .....      | 21    | S.       | .....               | Mill Hollow shaft, .....   | Luzerne, .....           | Leg broken by fall of coal.   |
|                  | 22, 126            | Alex. McDermott, .....   | Driver, .....       | 16    | S.       | .....               | Stevens' shaft, .....      | Exeter, .....            | Severely bruised by being squeezed between door frame and car.        |
|                  | 25 127             | Mike Saxton, .....       | Miner, .....        | 28    | M.       | 2                   | Harry E. shaft, .....      | Kingston township, ..... | Head painfully injured by fall of rock.                               |
|                  | 29, 128            | Thos. Joice, .....       | Driver, .....       | 15    | S.       | .....               | Clear Spring shaft, .....  | Pittston, .....          | Knee painfully bruised by being kicked by a mule.                     |
|                  | 29, 129            | Henry Linnen, .....      | Footman, .....      | 26    | S.       | .....               | Exeter shaft, .....        | Exeter, .....            | Hand seriously cut and bruised by coal falling down shaft.            |
| Nov.             | 5, 130             | John Farley, .....       | Laborer, .....      | 56    | M.       | 5                   | No. 7 shaft outside, ..... | Jenkins township, .....  | Leg broken by car of rock on dump.                                    |
|                  | 16, 131            | Martin Gilroy, .....     | Plane runner, ..... | 18    | S.       | .....               | No. 4 shaft, .....         | Jenkins township, .....  | Ankle dislocated by falling under car.                                |
|                  | 20, 132            | Wm. Robbins, .....       | Laborer, .....      | 40    | M.       | .....               | Pettebone shaft, .....     | Kingston township, ..... | Small bone of leg broken.   |
|                  | 21, 133            | Frank Steusky, .....     | Miner, .....        | 33    | M.       | .....               | I'hoenix shaft, .....      | Duryea, .....            | Face and eyes injured while drawing charge of powder, which exploded. |
|                  | 21, 134            | Patriek Melvin, .....    | Miner, .....        | 45    | M.       | .....               | Twin shaft, .....          | Pittston, .....          | Face and hand burned by gas.  |
|                  | 22, 135            | Thos. McGuire, .....     | Driver, .....       | 30    | S.       | .....               | Exeter shaft, .....        | Exeter, .....            | Back and shoulder bruised by falling under car.                       |
|                  | 22, 136            | John Guinn, .....        | Miner, .....        | 30    | S.       | .....               | No. 11 shaft, .....        | Jenkins township, .....  | Hip dislocated by fall of rock.                                       |



|     |     |                       |                  |    |    |       |                           |                      |   |
|-----|-----|-----------------------|------------------|----|----|-------|---------------------------|----------------------|---|
| 22. | 137 | John B. Miller, ..... | Miner, .....     | 36 | M. | 2     | Hoyte shaft, ..           | Jenkins township, .. | Face and hands severely cut by a premature blast.                     |
| 26. | 138 | Frank Balaski, .....  | Miner, .....     | 26 | M. | 1     | Exeter shaft, .....       | Exeter, .....        | Head and fingers painfully cut by fall of rock.                       |
| 30. | 139 | Henry Conner, .....   | Carpenter, ..... | 65 | M. | ..... | Exeter breaker, .....     | Exeter, .....        | Severely injured by falling into an empty water tank.                 |
| 1.  | 140 | Sam'l Hore, .....     | Miner, .....     | 24 | S. | ..... | East Boston shaft, .....  | Klingston township,  | Leg broken by fall of top coal.                                       |
| 1.  | 141 | James Frantz, .....   | Plateman, .....  | 23 | S. | ..... | Hiedelberg breaker, ..... | Pittston township,   | Leg painfully cut by being caught between rollers and casing.         |
| 6.  | 142 | Thomas Simmons, ..... | Miner, .....     | 25 | S. | ..... | Mount Lookout shaft, ..   | Wyoming, .....       | Head cut and shoulders bruised by premature blast.                    |
| 7.  | 143 | Michael Kelly, .....  | Miner, .....     | 23 | M. | 3     | Exeter shaft, .....       | Exeter, .....        | Leg and shoulders bruised by fall of rock.                            |
| 10  | 144 | Bryan Quinn, .....    | Miner, .....     | 57 | M. | 6     | No. 13 shaft, .....       | Old Forge township,  | Leg and arm broken by fall of bony coal.                              |
| 10  | 145 | John Swipes, .....    | Laborer, .....   | 28 | M. | 2     | Columbia shaft, .....     | Duryea, .....        | Leg and arm broken by fall of rock.                                   |
| 11. | 146 | Martin Shall, .....   | Laborer, .....   | 33 | M. | 1     | Wyoming shaft, .....      | Plains township, ..  | Leg broken and head severely cut by fall of rock.                     |
| 12. | 147 | John Steed, .....     | Miner, .....     | 45 | S. | ..... | Exeter shaft, .....       | Exeter, .....        | Collar bone injured, caused by prop falling on him while standing it. |
| 17. | 148 | John Kirtskey, .....  | Laborer, .....   | 21 | S. | ..... | Stevens' shaft, .....     | Exeter, .....        | Painfully bruised by fall of rock. His miner was killed by this fall. |

Dec.



# FOURTH ANTHRACITE DISTRICT.

(LUZERNE COUNTY.)

Wilkes-Barre, Pa., April 2, 1895.

Hon. Isaac B. Brown,

Secretary of Internal Affairs:

Sir: I have the honor herewith of presenting my fifteenth annual report as Inspector of Mines for the Fourth district of the anthracite region, for the year 1894.

It contains the usual tables and statistics relating to the accidents, and brief articles on the condition of the mines of each company, with account of their production and names of all the officials.

It also contains information relative to the improvements at the mines and a description of some of the most notable accidents which occurred during the year.

Very respectfully yours,

G. M. WILLIAMS,

Inspector of Mines, Fourth Anthracite District.

## Tons of Coal Mined During the Year 1894.

|  |                     |
|--|---------------------|
| Lehigh and Wilkes-Barre Coal Company, . . . . .              | 1,778,284.40        |
| Delaware and Hudson Canal Company, . . . . .                 | 1,262,838.55        |
| Susquehanna Coal Company, . . . . .                          | 1,365,650.35        |
| Kingston Coal Company, . . . . .                             | 683,813.75          |
| Delaware, Lackawanna and Western Railroad Company, . . . . . | 470,379.45          |
| Lehigh Valley Coal Company, . . . . .                        | 305,261.85          |
| Red Ash Coal Company, . . . . .                              | 212,721.30          |
| Alden Coal Company, . . . . .                                | 193,514.20          |
| Parrish Coal Company, . . . . .                              | 107,519.35          |
| Plymouth Coal Company, . . . . .                             | 193,151.80          |
| West End Coal Company, . . . . .                             | 224,526.95          |
| Hanover Coal Company, . . . . .                              | 67,116.60           |
| Hillman Vein Coal Company, . . . . .                         | 77,306.40           |
| A. J. Davis, . . . . .                                       | 117,824.60          |
| Newport Coal Company, . . . . .                              | 26,005.20           |
| The Reynolds and Moyer Coal Company, . . . . .               | 30,191.40           |
| Kidder Coal Company, . . . . .                               | 46,844.95           |
| <b>Total, . . . . .</b>                                      | <b>7,162,961.10</b> |

## NUMBER OF FATAL ACCIDENTS AND TONS OF COAL MINED PER LIFE LOST.

| Names of Operators.  | Number of lives lost. | Tons of coal mined per life lost. |
|--|-----------------------|-----------------------------------|
| Lehigh and Wilkes-Barre Coal Company, . . . . .            | 17                    | 104,605                           |
| Delaware and Hudson Canal Company, . . . . .               | 2                     | 631,419                           |
| Susquehanna Coal Company, . . . . .                        | 20                    | 68,283                            |
| Kingston Coal Company, . . . . .                           | 21                    | 32,562                            |
| Delaware, Lackawanna & Western Railroad Company, . . . . . | 1                     | 470,379                           |
| Lehigh Valley Coal Company, . . . . .                      | 3                     | 101,753                           |
| Red Ash Coal Company, . . . . .                            | No life lost.         |                                   |
| Alden Coal Company, . . . . .                              | 1                     | 193,514                           |
| Parrish Coal Company, . . . . .                            | No life lost.         |                                   |
| Plymouth Coal Company, . . . . .                           | 1                     | 193,151                           |
| West End Coal Company, . . . . .                           | 2                     | 112,263                           |
| Hanover Coal Company, . . . . .                            | No life lost.         |                                   |
| Hillman Coal Vein Company, . . . . .                       | 3                     | 25,768                            |
| A. J. Davis, . . . . .                                     | No life lost.         |                                   |
| Newport Coal Company, . . . . .                            | No life lost.         |                                   |
| Reynolds & Moyer Coal Company, . . . . .                   | No life lost.         |                                   |
| Kidder Coal Company, . . . . .                             | No life lost.         |                                   |
| <b>Total, . . . . .</b>                                    | <b>*71</b>            | <b>100,886</b>                    |

## NUMBER OF NON-FATAL ACCIDENTS AND TONS OF COAL MINED PER PERSON SERIOUSLY INJURED.

| Names of Operators.  | Number of persons injured. | Tons of coal mined per person injured. |
|--|----------------------------|--|
| Lehigh and Wilkes-Barre Coal Company, . . . . .              | 65                         | 27,358                                 |
| Delaware and Hudson Canal Company, . . . . .                 | 14                         | 90,202                                 |
| Susquehanna Coal Company, . . . . .                          | 48                         | 28,451                                 |
| Kingston Coal Company, . . . . .                             | 28                         | 24,421                                 |
| Delaware, Lackawanna and Western Railroad Company, . . . . . | 21                         | 22,399                                 |
| Lehigh Valley Coal Company, . . . . .                        | 16                         | 19,078                                 |
| Red Ash Coal Company, . . . . .                              | 3                          | 70,907                                 |
| Alden Coal Company, . . . . .                                | 8                          | 24,189                                 |
| Parrish Coal Company, . . . . .                              | 9                          | 11,946                                 |
| Plymouth Coal Company, . . . . .                             | 4                          | 48,287                                 |
| West End Coal Company, . . . . .                             | 5                          | 44,905                                 |
| Hanover Coal Company, . . . . .                              | 1                          | 67,116                                 |
| Hillman Vein Coal Company, . . . . .                         | 3                          | 25,768                                 |
| A. J. Davis, . . . . .                                       | 2                          | 58,912                                 |
| Newport Coal Company, . . . . .                              | None.                      |  |
| The Reynolds & Moyer Coal Company, . . . . .                 | None.                      |  |
| The Kidder Coal Company, . . . . .                           | None.                      |  |
| <b>Totals, . . . . .</b>                                     | <b>*227</b>                | <b>31,554</b>                          |

\*The six fatal and six non-fatal accidents which occurred in new shafts, where no coal was produced, are not included in these tables.

## CLASSIFICATION OF FATAL AND NON-FATAL ACCIDENTS.

| Causes of Accidents.                           | Killed or fatally<br>injured. | Severely injured. |
|--|-------------------------------|-------------------|
| By explosions of fire-damp, . . . . .          | 7                             | 33                |
| By falls of roof and coal, . . . . .           | 44                            | 68                |
| By falling down shafts, . . . . .              | 2                             | . . .             |
| Crushed and run over by mine-cars, . . . . .   | 7                             | 59                |
| By explosions of powder and blasts, . . . . .  | 4                             | 23                |
| By miscellaneous causes underground, . . . . . | 6                             | 27                |
| By miscellaneous causes on surface, . . . . .  | 7                             | 23                |
| Totals, . . . . .                              | 77                            | 233               |

Number of widows, 46; orphans, 182.

## The Collieries of the Fourth District.

During the year 1894 there were forty-three breakers and sixty-six openings at work more or less time, mining and preparing coal for market in the Fourth Anthracite district. An average of 46,789 tons per day worked was produced, making a total production of 7,162,961 tons in an average work of 153.1 days.

The collieries in operation less than 153.1 days were those of the Lehigh and Wilkes-Barre Coal Company. The No. 3 colliery of the Delaware and Hudson Canal Company, which, after working 153 days, was destroyed by fire on the evening of November 15, and remained idle the remainder of the year. The No. 3 colliery of the Susquehanna Coal Company, where the production is not sufficient to keep the breaker working all day owing to the partial exhaustion of the mine. The Gaylord colliery of the Kingston Coal Company, several weeks' idleness caused by the disastrous cave of February 13th. The collieries of the Lehigh Valley Coal Company, the Red Ash Coal Company, the Parrish Coal Company, the Maffet colliery of the Hanover Coal Company, and the Warrior Run colliery of Mr. A. J. Davis.

The Lee colliery of the Newport Coal Company did not work more than 100 days. It was suspended on August 25th, and since then has passed into the possession of another company. The Buttonwood colliery of the Parrish Coal Company is an old mine enlarged and re-opened. It was lying idle since 1866. The shaft was enlarged and sunk to a deeper seam and a new breaker was erected. It began shipping coal in September, 1894, and worked 50 days until the end of the year.

It is thus evident, that if the collieries would work full time their producing capacity would exceed 14,000,000 tons per year.

#### Collieries of the Lehigh and Wilkes-Barre Coal Company.

This company is the largest coal producer in this district. It operated ten collieries, consisting of seven shafts and five slopes in 1894. All are large collieries, having workings of wide extent in several seams. With the exception of No. 16 all are working deep parts of the coal basin, where explosive gases are evolved in large quantities, requiring immense volumes of air currents and great care in the management. They are excellently ventilated and carefully conducted, and liberal provisions are made to insure safety in the event of an accident occurring, which would disable the ventilating fans. No standing gas is permitted to remain in any part of the workings, and where such a large volume of air circulates, no satisfactory excuse can be presented by any foreman for the presence of standing gas.

In gaseous gangways, where the feeders of gas are copious and liable to ignite from blasts, water pipes are laid, with water under high pressure ready to apply immediately to extinguish ignited feeders, and it is frequently done.

The rocks constituting the roof and floor are in most parts strong and tenacious, and not much trouble has yet been caused by heaving and pucking of the bottom rocks. In the localities where the roof requires securing by timber, it is invariably done in a safe, strong and skillful manner. No where can better timbering work be seen than in the mines of this company.

The greatest part of the workings are in large coal seams, but lately they began to work the thin seams and have opened quite extensively in them. Their gangways, airways, and hauling passages are all large, clean and safely constructed, having ample room for the passage of large air currents and for the drivers and runners of the mine cars to travel along in safety.

During the last few years effective improvements have been made, both inside and outside at their collieries, and at this time they are all in highly satisfactory condition. They were employing at the end of the year, 6,673 persons in and about the mines. Seventeen persons were killed and 65 injured during 1894. Most of these were caused by falls of coal in the thick seams. Accidents of this character are much more frequent in thick than in thin seams.

In an average of 121.53 days of work, they produced an average of 14,632 tons per day, or a total of 1,778,284 tons. Of this, 1,700,068 tons were shipped to the markets.

"The Wilkes-Barre Coal and Iron Company was incorporated in

June, 1864, and in January, 1874, it was consolidated with the Honey Brook Coal Company. Then the name was changed to "Lehigh and Wilkes-Barre Coal Company." The organization is conducted under the charter of the Broad Top Mining Company, dated June, 1871, which was absorbed a short time afterwards.

In 1877 the property was placed in the hands of receivers, who continued in control until January, 1882, when the company again obtained possession. It is controlled by the Central Railroad Company of New Jersey, which owns nearly all of the stock and about \$8,000,000 of bonds.

The directors are J. Rogers Maxwell, Edward D. Adams, George F. Baker, James A. Garland, Henry Graves, Calvin Pardee and Charles Parrish.

The officers are J. Rogers Maxwell, president; Geo. F. Baker, vice president; S. M. Williams, second vice president; Henry Graves, Jr., secretary and treasurer; W. C. Johnson, general auditor; P. B. Heilner, general sales agent; L. A. Powelson, assistant general sales agent, and W. T. Wintringham, superintendent of barges.

The Wilkes-Barre Coal and Iron Company was the owner of a large tract of land extending south from the city of Wilkes-Barre on each side of the Susquehanna river. Its property included about 6,000 acres of coal land besides several thousand of timber land. The Honey Brook Coal Company was chartered in 1864 with a capital of \$3,000,000. Its coal fields were very extensive, covering about 8,000 acres located in Luzerne and Schuylkill counties. At present the Lehigh and Wilkes-Barre Coal Company controls by ownership and lease upwards of 40,000 acres of valuable coal lands, a large portion of which is undeveloped. Charles Parrish was president of both the Honey Brook and Wilkes-Barre Companies and for several years retained the same position in the new company, and, during the time the receivers had control of the property, he operated the collieries in the Wilkes-Barre division under a contract.

At the time of the consolidation spoken of, the directors of the Honey Brook Company were Charles Parrish, J. B. McCreary, John Taylor Johnston, J. B. Johnston, Charlemagne Tower, Samuel Bonnell, Jr., and A. L. Mumper. The directors of the Wilkes-Barre Coal and Iron Company were Charles Parrish, John Taylor Johnston, John Leisenring, Samuel Bonnell, Jr., E. W. Clark and Jeremiah Skidmore.

The mining officials at present are Elmer H. Lawall, general superintendent; Morgan R. Morgan, inside superintendent; W. J. Richards, mining engineer; W. H. Herring, outside superintendent; James Pollock, mechanical engineer; offices, Wilkes-Barre, Pa.; David R. Roberts, assistant superintendent, Audenreid, Pa.

A new colliery, to be known as Maxwell No. 20, is under construc-

tion at Ashley. The shaft and breaker will be completed ready to ship coal in a few months, and this is expected to add about 2,500 tons per day to the already large producing capacity of this company.

The following is a list of their collieries and names of the foremen in the Fourth or Wilkes-Barre district.

Hollenback No. 2, Rees W. Morgan, inside foreman; J. A. Connor, outside foreman.

Empire No. 4, D. W. Davies, inside foreman; Thomas Williamson, outside foreman.

South Wilkes-Barre Nos. 3-5, J. F. Jones, inside foreman; T. B. Robinson, outside foreman.

Stanton No. 7, Wm. M. Thomas, inside foreman; Jacob Rhinehart, outside foreman.

Jersey No. 8, S. R. Morgan, inside foreman; C. L. Peck, outside foreman.

Sugar Notch No. 9, H. N. Martin, inside foreman; Thomas Mack, outside foreman.

Lance No. 11, William E. Jones, inside foreman; Dennis Moore, outside foreman.

Nottingham No. 15, James D. James, inside foreman; G. R. Connor, outside foreman.

Reynolds No. 16, James Rowe, inside foreman; J. B. Wolfe, outside foreman.

Wanamie Nos. 18, 19, Richard Lloyd, inside foreman; Thomas C. Carr, outside foreman.

Maxwell No. 20, S. R. Morgan, inside foreman; D. C. Tiffany, outside foreman.

#### Collieries of the Delaware and Hudson Canal Company.

This company operated nine collieries in the Fourth Anthracite district in the year 1894. Four of these are located in Wilkes-Barre and five in the neighborhood of Plymouth. Besides these, two new shafts are about completed, one near the Boston, and one north of the No. 2 shaft, Plymouth, for the purpose of working the lower seams in properties where the old collieries are working the upper seams.

This company employed an average of 3,501 persons in and about their mines during 1894, and worked 179.66 days. They produced 1,262,838 tons of coal, of which 1,243,151 tons was shipped to market. This shows a producing capacity of 6,919 tons per day from their collieries in the Fourth district.

Their mines in the Plymouth division are all, excepting the No. 4, working the Bennett or overlying seams. The No. 4 only has worked in the Red Ash and Ross seams; therefore, only a small proportion of these lower seams is mined.



In their collieries in the Wilkes-Barre division, the workings in the Baltimore seam are nearly exhausted and the coal is mined at present from the Red Ash, Hillman and Kidney seams.

Of all the large coal producers, this company has maintained the best record as to accidents for many years. Last year, in 1894, they had only two fatal and 14 non-fatal accidents in their nine collieries, and mined 631,419 tons per life lost, a remarkably good record.

Their mines all have what is considered a safe roof, or top, excepting portions of the Baltimore No. 3 mine, where the roof in some locations is very bad. In past years there was a bad roof in sections of the Ross seam workings in the No. 4 mine, Plymouth, but it is much safer in the present workings. Taking all their mines in this district, they require much less timbering and propping than the mines of the other large companies.

Hitherto they have been remarkably free from explosive gases in all excepting the Conyngham mine, and this in the last few years is a small colliery since the workings of the Baltimore seam have been filled with water. Occasionally a small accumulation of gas is found in each of their collieries, but the quantity evolving is merely a trifle when compared with the volume emitted in the deepest mines of other companies.

The ventilation is good and fairly conducted in the Wilkes-Barre mines, and while the quantity of air forced into the Plymouth mines is ample for the requirements, it is not as carefully conveyed to the face of the workings as it might be. There is no standing gas anywhere in their mines—the mines that are in operation. The workings of the Baltimore and Conyngham, which are filled to a height of 60 feet with water, may have some, but there is no one working in them.

They have a large area of caved workings which cannot be examined, but it is in sections where no gas has been seen, and no sign of any can be found around its outlines.

This company has a large proportion of experienced miners who have been raised in their employ, and though they worked only 179.66 days at the breaker, more or less work was done every day, nearly, by the miners and inside hands. Fewer accidents occur in proportion to the coal mined during steady daily work than when the work is done intermittently.

The Delaware and Hudson Canal Company was chartered by the New York Legislature April 23, 1823, to construct a canal and railroad from the coal fields of Pennsylvania to the Hudson river at Rondout, N. Y. The canal, extending from Honesdale to Rondout, was completed in October, 1828. The state of New York, in 1827, loaned its credit to the enterprise to the amount of \$500,000 and again in 1829 for \$200,000.

The company is largely engaged in mining and selling coal, but the D. & H. Canal now forms a very small part of its transportation facilities. This company operates a number of railroads aggregating a length of 687.72 miles, together with the Delaware and Hudson Canal from Honesdale to Rondout, a length of 108 miles.

The company's coal lands are scattered for a distance of 40 miles in the Wyoming and Lackawanna valleys, and the headquarters of the coal department is now located in their new railroad depot building at Scranton, Pa.

The first mining operations were in the vicinity of Carbondale, from which place a gravity road was built to carry the coal over the mountains to Honesdale; it was finished in 1829, and the company shipped 7,000 tons in that year.

Altogether they have thirty-three collieries in operation, nine of which are in the Fourth inspection district. This company is notable for its conservative methods of mining and its cautiousness in adopting new devices. The capacity of their breakers is not larger than the producing capacity of the mines, but in most cases is rather less. They are not what is understood as "hustlers," but with their steady motion and safe mining properties, they mine coal cheap with the best record for safety to the employes.

The mining operations are in charge of the following officers: A. H. Vandling, general superintendent coal department; C. H. Scharar, chief engineer mine department; J. L. Atherton, general outside superintendent; Andrew Nichol, general mine superintendent; Andrew P. Patton, assistant mine superintendent Lack. division; W. L. Foote, assistant superintendent Wilkes-Barre division; E. R. Peckens, assistant superintendent Plymouth division, and Alexander Simpson, master mechanic.

The names of the collieries and of the foremen in this district are as follows:

Baltimore No. 2, James Shepherd, inside foreman; Elihu Smith outside foreman.

Baltimore No. 3, William Armstrong, inside foreman; E. M. Bradshaw, outside foreman.

Baltimore tunnel, John C. Williams, inside foreman; Ed. Mackin, outside foreman.

Conyngham, Thomas Stoneham, inside foreman; John Bowers, outside foreman.

Boston, Gwilym P. Evans, inside foreman; Jas. W. Vandling, outside foreman.

Plymouth No. 2, E. H. Rees, inside foreman; E. D. Peckens, outside foreman.

Plymouth No. 3, Job Hablett, inside foreman; Oscar Schnell, outside foreman.

Plymouth No. 4, Edward Hahn, inside foreman; John Dooley, outside foreman.

Plymouth No. 5, D. J. Linskill, inside foreman; J. N. Atherton, outside foreman.

The board of managers of the Delaware and Hudson Canal Company is as follows:

James Roosevelt, Robert M. Olyphant, Wm. H. Tillinghast, Alfred Van SantVoord, James A. Roosevelt, Alexander E. Orr, Cornelius Vanderbilt, Chauncey M. Depew, John A. Stewart, James W. Alexander, James R. Taylor, Benjamin Brewster and Horace G. Young.

President, Robert M. Olyphant, New York city.

Vice President, James Roosevelt, New York city.

Second vice president, Horace G. Young, Albany, New York.

Treasurer, Charles A. Walker, New York city.

Secretary, F. Murray Olyphant, New York city.

General sales agent, Thomas F. Torrey, New York city.

General counsel, David Wilcox, New York city.

General agent of real estate department, C. S. Weston, Scranton, Pa.

Superintendent of coal department, A. H. Vandling, Scranton, Pa.

Superintendent of Pennsylvania division, C. R. Manville, Carbon-  
dale, Pa.

#### Collieries of the Susquehanna Coal Company.

The collieries of this company are located in Nanticoke and Glen Lyon, near the western end of the Wyoming Valley. They had four breakers, supplied with coal from seven mine openings, consisting of two double shafts having four hoisting cages in each, one single shaft having two cages, two slopes, and two level tunnels in operation during the year 1894.

They worked an average of 190.34 days and produced 1,365,660 tons of coal, or 7,174 tons per day. Of this 1,344,192 tons was shipped to market. The number of persons employed in and about the mines were 4,117. There were 20 fatal and 48 non-fatal accidents.

In the No. 3 West Nanticoke mine, though the coal was all taken from pillars, 88,769 tons were mined without one accident. The advancing work of this mine is finished. In the No. 6 tunnel at Glen Lyon, one person only was injured. All the other accidents occurred in and about the other openings. Excepting the two mines named, the operations are in difficult and dangerous ground. The seams are irregular, faulty, and lying deep in the earth, where the volume of fire damp emitted is exceedingly large. The roof is generally bad, requiring a great amount of skillful timbering. The bottom rocks are, in the lowest seams, too soft to sustain the pressure of the pil-

lars and the weight of the strata resting thereon, and is heaving up in the worked out parts, causing much trouble and expense to keep the haulage and ventilating passages open and in good order.

With a view of obviating some of the difficulties peculiar to these mines, the pillar and breast method of mining was changed to a kind of block work. The change was gradually introduced as the workings were driven on during the last four years. It is rather soon to determine the effect of this change, but hitherto there has been no perceptible effect on the number of accidents, as compared with the quantity of coal mined. The future may show better results, and we believe it will.

There are six coal seams simultaneously mined from the openings at Nanticoke, and three in the No. 6 shaft, Glen Lyon, and all are worked by the same method.

All are efficiently ventilated, and considering the great difficulties peculiar to the territory in which they are mining, these mines are kept in good condition. The officials are at all times willing and ready to comply with the requirement of the law and to carry out the suggestions of the Mine Inspector whenever it is necessary in order to secure the safety of the employes. The manager and superintendent have on several occasions urged the Inspector to exercise the freedom of suggesting improvements tending to enhance the safety of the mines, whether or not the law requires it, and this is freely exercised.

The machinery and appliances at the collieries of this company are all strong, efficient and of the most approved character.

The Susquehanna Coal Company is the largest producer of four anthracite mining companies controlled through the ownership of stock, by the Pennsylvania Railroad Company. It was organized March 15, 1869. The mining operations are under the supervision of the following staff:

Irving A. Stearns, manager; George T. Morgan, superintendent; J. H. Bowden, chief mining engineer; W. J. M. Turner, general inside foreman; Michael Magee, assistant outside superintendent. Office, Wilkes-Barre, Pa., and Nanticoke, Pa.

The names of the mines and the foremen are as follows:

Shaft No. 1, Lee seam, Daniel Daniels, inside foreman; James Croop, outside foreman.

Shaft No. 1, Forge seam, David Griffiths, inside foreman; James Croop, outside foreman.

No. 3, West Nanticoke, Lewis Morgan, inside foreman; R. P. Robinson, outside foreman.

Shaft No. 2, Jacob Morgan, inside foreman.

Slope No. 4, John S. Lee, inside foreman.

Shaft No. 6, Isaac Britten, inside foreman; William Morgan, outside foreman.

Tunnel No. 6, Worthy Carver, inside foreman; William Morgan, outside foreman.

Slope No. 6, Thomas R. Williams, inside foreman, William Morgan, outside foreman.

The chief officers of the Susquehanna Coal Company are as follows: George B. Roberts, President.

Isaac J. Wistar, vice president.

George H. Ross, Secretary.

Thomas P. Haviland, Treasurer.

Directors, George B. Roberts, Isaac J. Wistar, John P. Green, A. J. Cassatt, N. P. Shortridge, Henry D. Welsh, William J. Howard, Amos R. Little, Samuel Rea.

#### Collieries of the Kingston Coal Company.

In the year 1863 the collieries now operated by the Kingston Coal Company at Edwardsdale, Pa., were leased and operated by the firm of Waterman and Beaver. They were then under the supervision of the late David Morgan, who, in the year 1868, left the company, and Mr. Daniel Edwards took charge of the operation. In the year 1877 the Kingston Coal Company, Limited, was organized and operated for six years. Then the Gaylord Coal Company was united, and on August 8th, 1883, the Kingston Coal Company was chartered, with a capital stock of one million dollars.

In 1894 they operated three breakers, five shafts and one slope. Four of the shafts are located in Edwardsdale, and one shaft and one slope in Plymouth.

They are working more or less coal from the Red Ash, Ross, Bennett, Cooper and the Lance seams. Each mine has an extensive area of coal land to work from, and an operation of such a length of time has a large area of old workings. Much of this is closed by caves, but there is no gas existing therein, and all is safe.

The production for 1894 was 683,813 tons in a work of 175.98 days, an average of 3,317 tons per day. The number of persons employed was 2,162. The number of accidents was higher than usual, owing to the disaster of February 13 in the Gaylord shaft, an account of which is given in another part of this report. The record of the Kingston Coal Company's accidents is higher than its neighbor's for the last two years, when compared with the quantity of coal mined. In Nos. 1 and 4 shafts, slopes are sunk to the dip, a distance of nearly a mile. The lower workings in these slopes, in the Red Ash seam, have dangerous top, but in the upper seams the roof is generally better. A serious mistake made when sinking these slopes was, that proper precautions were not taken to provide means for an efficient ventilation of the lower workings.

While the quantity of air circulating through these workings is

ample for the few men employed there, the volume is not sufficient for a larger number of workingmen. The attention of the officials was called to this over a year ago, but hitherto only futile attempts have been made to improve it. In July, the writer found that the return air in the slopes of No. 4 shaft was charged with two per cent. of explosive gas, and all had to work by safety lamps until the ventilation was somewhat improved and the air made reliably safe.

The workings to the rise in all the seams are fairly ventilated, and their general condition is satisfactory. The officers of the Kingston Coal Company are as follows:

Daniel Edwards, president and superintendent.

William B. Chamberlain, treasurer.

E. R. Morgan, secretary.

Directors, Daniel Edwards, John C. Bullitt, E. W. Dwight, T. L. Newell and W. B. Chamberlain.

Mr. Daniel Edwards has acted as superintendent since the year 1868. He is assisted by Morgan D. Rosser, who is directly in charge of the Nos. 1 and 4 shafts, and by Gwilym Edwards, who has charge of the Nos. 2 and 3 shafts, and of the Gaylord mine. The names of the mines and of the foremen are as follows:

Shaft No. 1, David M. Jones, inside foreman; Thomas J. Morgan, outside foreman.

Shaft No. 2, Lance vein, Mordecai Dando, inside foreman; William Cook, outside foreman.

Shaft No. 2, Bennett vein, John D. Williams, inside foreman; Geo. W. Edwards, outside foreman.

Shaft No. 3, Richard B. Watkins, inside foreman; Geo. W. Edwards, outside foreman.

Shaft No. 4, John Armstrong, inside foreman; Thos. J. Morgan, outside foreman.

Gaylord, D. W. Morris, inside foreman; Frank Trimble, outside foreman.

Collieries of the Delaware, Lackawanna and Western Railroad Company.

Concerning the history of this company, the following is copied from the "Coal Trade Journal."

"This company, which has a charter antedating the present Constitution of the State of Pennsylvania, is one of the few privileged to carry on coal mining and selling, together with transportation.

This was originally the Ligett's Gap Railroad, incorporated by special act of Pennsylvania Legislature approved April 7, 1832, chartered March 19, 1849; name changed by special act of Pennsylvania Legislature, approved April 14, 1851, to Lackawanna and Western; consolidated April 30, 1853, with the Delaware and Cobbs Gap Rail-

road (chartered December 4, 1850), and name changed to 'Delaware, Lackawanna and Western Railroad Company.' The road was opened from Scranton to Great Bend October 20, 1851, and from Scranton to the Delaware river May 27, 1857. In 1856 a lease was taken of the Warren Railroad, extending from the Delaware river to a junction with the Central Railroad of New Jersey, the latter line being used prior to 1875 as an outlet to the Hudson river.

In 1868 a lease was taken of the Morris and Essex Railroad, which now, with the Warren Railroad, forms this company's line to the Hudson.

In 1855 a perpetual lease was taken of the Cayuga and Susquehanna Railroad. In 1869 a lease was taken of the Oswego and Syracuse Railroad. In 1869 control was obtained of the Syracuse, Binghamton and New York Railroad by the purchase of the major part of its stock. In 1871 the Valley Railroad, extending from Great Bend to Binghamton, was built in order to form a connection with the Syracuse, Binghamton and New York Railroad, the Greene, and the Utica, Chenango and Susquehanna Valley Railroad's leased lines.

In 1873 the Delaware, Lackawanna and Western, and the Lackawanna and Bloomsburg Railroad companies were consolidated. In September, 1881, the company obtained control of the Sussex Railroad of New Jersey by the purchase of a major part of its stock. In October, 1882, a lease was taken of the New York, Lackawanna and Western Railway, which extended the line to Buffalo. Total mileage now operated, 898 miles."

The coal lands of the company are located in Lackawanna and Luzerne counties, Pa. In 1894 it operated 24 collieries, two of which are located in the Fourth district, viz: Avondale and Woodward. The production of these two collieries for the year 1894 was 470,379 tons. Shipments 427,377 tons in a work of 169.15 days. Production per day, 2,780 tons. The number of fatal accidents was one, and of non-fatal, 21. In the Avondale mine both the Red Ash and Ross seams are mined. In the Red Ash seam the workings to the rise from the shaft are nearly exhausted. More or less explosive gas is found in the workings of both seams, but none standing. The roof is generally good and so is the general condition of the mine. In the No. 2 slope the ventilation is hardly adequate for the future workings, but a new air shaft is in process of sinking for the purpose of improving it, and this will be completed during 1895.

The Woodward Colliery began to ship coal in 1888, but it is now a large colliery with extensive working in the Red Ash, Ross, Bennett and Cooper seams. The shafts are over 1,000 feet deep, and, in the Bennett and Red Ash there are deep underground slopes extending from the shaft levels. A large quantity of fire damp is evolved in each seam. The roof is generally fair, except in the Red Ash seam, in

which, at some places it is very bad. At the deepest points of the workings the floor or bottom rock heaves, causing much labor and expense to keep the passages safe and in order. Hundreds of props are broken merely by the upheaval of the bottom rock.

The ventilation is good throughout, and a large, new fan is in course of construction to ensure its efficiency in the future.

The coal department of this company is located at Scranton under the direction of the following officers:

W. R. Storrs, general coal agent.

W. H. Storrs, assistant general coal agent.

A. H. Storrs, superintendent.

John F. Snyder, chief mining engineer.

Benjamin Hughes, general mine superintendent.

Thomas D. Davies, assistant general mine superintendent.

Thomas Phillips, assistant general mine superintendent.

The foremen of the collieries are as follows:

Avondale, Evan J. Evans, inside foreman; T. D. Kingsley, outside foreman.

Woodward, William O. Williams, inside foreman; Wm. Beacham, outside foreman.

Bliss (new colliery), Edwin Rees, inside foreman; Thomas H. Carey, outside foreman.

The officers of the company are as follows:

President, Samuel Sloan, New York.

First Vice President, E. R. Holden, New York.

Second Vice President, W. S. Sloan, New York.

Secretary and Auditor, Fred. F. Chambers, New York.

Treasurer, Fred. H. Gibbons, New York.

Managers, John I. Blair, George Bliss, Eugene Higgins, William W. Astor, William Rockefeller, Henry A. C. Taylor, J. Rogers Maxwell, George F. Baker, James Stillman, Alex. T. Van Nest, Frank Worth, Hamilton McK. Twombly, Harris C. Falmestock, F. W. Vanderbilt.

Officers of transportation department:

W. H. Hallstead, general manager, Scranton, Pa.

G. Bogart, superintendent Delaware, Lackawanna and Western main line, Scranton, Pa.

James Archbald, chief engineer. Scranton, Pa.

#### Collieries of the Lehigh Valley Coal Company.

The Lehigh Valley Coal Company was organized January 11, 1881, to mine and sell coal. In 1884 the property of the Spring Mountain Coal Company was purchased, and on June 1st, 1884, 45,000 acres of land in Centre county, Pa., known as the Snow Shoe property, was also purchased. Since then, various additions have been made to the



property, and it is owned entirely by the Lehigh Valley Railroad Company.

Of the twelve collieries owned and operated by this company in the Wyoming Coal Field, only two are located in the Fourth district, viz: Dorrance and Franklin; both these collieries are located in Wiikes-Barre, Pa.

The production in 1894 was 305,261 tons and the shipment was 280,683. Days worked 151.97, and the number of employes was 931. Three were fatally and 16 seriously injured.

In the Dorrance colliery the Baltimore, Hillman, Bowkley and Abbott seams are being worked. The workings are effectively ventilated by two thirty-foot fans located one on each shaft. The roof is generally good, needing but little work in timbering. The workings across under the Susquehanna river are exceedingly dry and dusty. The greatest need for care is to prevent accumulations of fire damp, for a large quantity is unceasingly evolved, but in this they have hitherto been successful.

The openings of the Franklin colliery are two main slopes, one on the Baltimore seam, from which, by a tunnel through the upper rocks three of the upper seams are also mined. The other slope is sunk from the surface across the strata to the Red Ash seam on a pitch of about 30 degrees. The Red Ash is in two parts, and both are separately mined. Each slope has a separate system of ventilation produced by a fan located on the upcast of each mine. Another fan is soon to be constructed to ventilate the upper seams of the No. 1 slope. The workings of both slopes are in fair condition, the roof is generally good, except in some localities in the Red Ash seam, where careful timbering is required.

The officers in charge of the mining department are:

W. A. Lathrop, general superintendent.

I. R. Moister, division superintendent.

R. S. Mercur, division engineer.

Robert Shoemaker, outside district superintendent, Dorrance colliery.

Joseph J. Jones, inside district superintendent, Dorrance colliery.

Thomas Samuel, mine foreman, Dorrance colliery.

Frank Eicke, outside foreman, Dorrance colliery.

Thomas R. Thomas, general mine foreman, Franklin colliery.

William N. Thomas, mine foreman, Franklin colliery.

Charles Lynn, outside foreman, Franklin colliery.

Principal officers of the company:

E. P. Wilbur, president, Bethlehem, Pa.

Henry S. Drinker, general solicitor and assistant to president.

Charles Hartshorne, first vice president, Philadelphia.

William H. Sayre, second vice president, South Bethlehem, Pa.

John R. Fanshawe, secretary, Philadelphia.

John B. Garrett, treasurer, Philadelphia.

Israel W. Morris, general land agent, Philadelphia.

W. A. Lathrop, general superintendent, Wilkes-Barre, Pa.

Directors, Robert H. Sayre, George H. Myers, Joseph Wharton, Thomas McKean, Beauveau Borie, John B. Garrett, Wm. L. Conyng-  
ham, James I. Blaklee, C. O. Skeer, Charles Hartshorne, W. A. Ing-  
ham, John R. Fell.

#### Collieries of the Miscellaneous Coal Companies.

Beside the collieries commented on in the foregoing articles, there were twelve collieries operated by smaller companies in the Fourth district. These together produced 1,296,722 tons of coal and shipped to market 1,192,806 tons, in an average of 129.76 days of work. They employed 3,890 persons and mined 185,246 tons of coal per life lost. Three of the seven fatal accidents took place in the Hillman vein colliery, two in the West End, and one each in the Alden and Dodson collieries. The Nos. 1 and 2 collieries of the Red Ash Coal Company, the Parrish and Buttonwood, of the Parrish Coal Company, and the Maffet, Warrior Run, Lee and Chauncey, did not have one fatal accident.

These mines are all in safe condition and efficiently ventilated. More or less firedamp is emitted in each, but not in such quantities as we find in the deeper mines. They are working closer to the outcrops where the roof is generally better than in the deeper portions of the basin.

The names of the collieries and of the officers are as follows:

#### Nos. 1 and 2 Red Ash Coal Company.

M. B. Williams, general superintendent, Wilkes-Barre, Pa.

P. H. Ganahan, assistant general superintendent, Wilkes-Barre, Pa.

Daniel J. James, mine foreman No. 1 Red Ash.

Joseph Hopie, outside foreman No. 1 Red Ash.

Timothy Theophilus, mine foreman No. 2 Red Ash.

John Herriotts, outside foreman No. 2 Red Ash.

#### Officers of the Parrish Coal Company.

H. H. Ashley, general superintendent, Plymouth, Pa.

Thomas R. Evans, general mine foreman, Plymouth, Pa.

Parrish colliery, Henry G. Williams, inside foreman, Plymouth, Pa.

Parrish colliery, Thaddens Eddy, outside foreman, Plymouth, Pa.

Buttonwood colliery, Wm. T. Pritchard, inside foreman.

Buttonwood colliery, Merrit Frederick, outside foreman.

## Officers of the Alden Coal Company.

K. M. Smith, general superintendent, Alden, Pa.  
 Wm. H. Bray, mine foreman.  
 William Ohl, outside foreman.

## Officers of the Plymouth Coal Company.

James B. Davies, general superintendent, Plymouth, Pa.  
 John B. Davies, assistant superintendent.  
 Daniel R. Davies, mine foreman.  
 J. C. Young, outside foreman.

## Officers of the Hanover Coal Company.

J. Roberts, Jr., general superintendent, Wilkes-Barre, Pa.  
 Daniel Lewis, general mine foreman.  
 J. Willard Good, mine foreman.  
 Lee Minnick, outside foreman.

## Officers of the Hillman Vein Coal Company.

S. J. Tonkin, general superintendent, Wilkes-Barre, Pa.  
 Hugh Jones, mine foreman.  
 Stanley J. Tonkin, outside foreman.

## Officers of the Warrior Run Colliery.

A. J. Davis, general manager, Wilkes-Barre, Pa.  
 John C. Jones, general superintendent, Peely, Pa.  
 William S. Williams, mine foreman.  
 R. F. Lloyd, outside foreman.

## Officers West End Coal Company.

L. L. Sarge, general superintendent, Shickshinny, Pa.  
 Henry Adams, mine foreman, Shickshinny, Pa.  
 Jonathan Weir, mine foreman, Shickshinny, Pa.  
 W. A. Briggs, outside foreman, Shickshinny, Pa.

## Officers of the Reynolds and Moyer Coal Company.

C. H. Reynolds, general superintendent, Kingston, Pa.  
 M. H. Corgan, mine foreman.

## Colliery Improvements in 1894.

Notwithstanding the depression in the coal trade during 1894, important improvements were made at a number of the collieries of this district, a detailed account of which is given in the following:

## Lehigh and Wilkes-Barre Coal Company.

## Hollenback No. 2 Colliery—

Return airway in rock from the Diamond basin; 12x8x400 feet.

No. 2 Red Ash slope being sunk in coal in the bottom split vein.

Annex on east and west side of breaker for the preparation of stove and chestnut coal.

## South Wilkes-Barre No. 5 Colliery—

No. 1 airshaft has reached the vein; 37x12x650 feet.

Tunnel has been driven from Stanton to Hillman vein.

Rock slope finished from Hillman to Baltimore veins and second openings in rock finished to same.

New fan, 35 feet diameter, has been erected at No. 5 shaft.

Erected 250 horse power Stirling boilers.

Erected 500 horse power National boilers.

Erected 470 feet of 8-inch steam line to fans.

## Sugar Notch No. 9 Colliery—

Main airway enlarged to 90 square feet; 1,050 feet in length.

Ross slope extended in rock 120 yards.

Tunnel, Twin to Ross veins.

## Lance No. 11 Colliery—

Rock slope to Ross veins finished; sunk a distance of 400 feet this year.

No. 2 airshaft completed to Ross vein, and second openings are now being driven to connect with the rock slope workings.

No. 12 plane partly in coal and partly in rock has been finished.

No. 2 slope in coal has been finished.

Erected 250 horse power National boilers.

Erected 430 feet extra steam line to fans.

## Nottingham No. 15 Colliery—

The Ross slope is being extended in rock through the anticlinal.

The Red Ash No. 3 slope is being extended in coal.

Erected one 24 feet by 8 feet Guibal fan on No. 1 airshaft.

Erected 300 horse power Stirling boilers.

Erected 4,000 feet 8-inch steam lines to fans.

## Wanamie No. 18 Colliery—

No. 5 slope is being sunk in coal in the Ross vein.

Two bore holes, 200 feet deep each, have been put down for hoisting and pumping purposes.

No. 19 slope has been sunk in coal almost to the basin.

Erected one pair geared engines, 18x30-inch, with 8x10-foot drums.

Delaware and Hudson Canal Company.

No. 2 Baltimore—

A new double fan was erected,  $17\frac{1}{2}$  feet diameter, enclosed in brick-work, and an underground slope was driven to a depth of 700 feet, which is still being extended.

Boston—

The new shaft was sunk to a depth of 475 feet, and its sinking is continued. It is  $12 \times 33.5$  feet, and has passed through three coal seams.

No. 5 Celliery—

The new shaft was sunk to a depth of 725 feet during 1894, and its sinking was continued. Its size is  $10\frac{1}{2} \times 33$  feet.

Susquehanna Coal Company.

Five new tunnels were driven in the mines of this company:

One  $8 \times 14$  feet and 800 feet in length from the Ross to the Twin seam.

One  $8 \times 14$  feet and 400 feet in length from the Hillman to the Hillman seam.

One  $8 \times 12$  feet and 200 feet in length from the Forge to the Forge seam.

One  $8 \times 14$  feet and 800 feet in length, from the Forge and was unfinished at end of year.

One  $8 \times 14$  feet and 500 feet in length, from the Mills to the Mills seam.

Three of the underground slopes were extended. The No. 10 slope was extended a length of 2,000 feet. No. 12 was extended 500 feet, and No. 13 1,500 feet.

Five new gravity planes were made, varying in length from 200 to 1,500 feet. These improvements open new areas of coal property in each of the seams.

Improvements by the Parrish Coal Company.

The underground slope on the Baltimore seam in the Parrish colliery was extended a distance of 900 feet, making the total length of this slope 2,316 feet.

Improvements by the Alden Coal Company.

A new air shaft was sunk for the Alden colliery from the surface to the Cooper seam, a depth of 612 feet. Its sectional area is 416 square feet. A new fan, 24 feet diameter, is in progress of construction. The engine is  $20 \times 36$  inches, directly connected. This will be applied to ventilate the north basin workings of the property.

### Improvements by the West End Coal Company.

A new slope was opened at the West End colliery on the Red Ash seam and sunk to a depth of 500 feet, having an average grade of 10 degrees. When completed it is expected to be about 3,000 feet in depth.

### Improvements at the Warrior Run Colliery.

A new fan was erected at this colliery to replace an old one. It is 20 feet in diameter, run by an engine 16-inch diameter, directly connected. At a speed of 62 revolutions per minute 86,000 cubic feet of air is exhausted, the water gauge being 1.8 inches.

### The Buttonwood Colliery.

This was an old colliery and was abandoned in 1866 after working but a short time. The Parrish Coal Company re-opened it under a lease from the Lehigh and Wilkes-Barre Coal Company. During the years 1892, 1893 and 1894. The shaft was enlarged to a size of 32x12 feet and sunk through four coal seams, the lowest of which is cut at a depth of 686 feet, which is the present depth of the shaft. They are working the two lower seams, viz: the Hillman and Bennett.

An air shaft was sunk from the surface to the Hillman seam, a depth of 574 feet, having an area of 12x22 feet. The two lower seams are connected also by a tunnel 370 feet in length. A tunnel is being driven to the Kidney seam, which was driven a distance of 42 feet at the end of the year. When this is completed, the workings of the three seams will be connected to the air shaft, which is the second opening.

A new 24-foot fan was erected on the top of the air shaft, run by an engine 20x36 inches, directly connected. At 48 revolutions it is exhausting 93,600 cubic feet of air per minute, with a pressure of .7 inch water gauge.

The new breaker was completed and started to ship coal in September, 1894. It is substantially built and equipped with the best kind of machinery, and every dangerous part is protected by railing or covering, as the law requires. At the shafts and breaker there are three pairs of hoisting engines, aggregating 2,170 horse power.

Concerning the history of the Old Buttonwood colliery and the cause of its abandonment, the following account was kindly furnished by Mr. James E. Roderick, who was in charge at that time.

Stockton, Pa., February 28, 1895.

Mr. G. M. Williams,

Inspector of Coal Mines:

My Dear Sir: Yours of the 26th received. In reply will say that in the early part of 1866 John T. Griffith secured the contract of Buttonwood shaft to put the coal on big cars at so much per ton. Some

time in the summer of that year an explosion of gas took place which shattered the shaft and inside workings, killing all the men in the mine, viz, three. The gas exploded from a furnace located near the bottom of the shaft. During the late fall of 1866 J. T. Griffith was made the general inside superintendent of the Lehigh and Wilkes-Barre Coal Company, and he delegated me (at the time the mine foreman of the Empire shaft) to go to Buttonwood and repair the damage made by said explosion and prepare the place for work. I arranged a new fan, near top of shaft, timbered and relined the shaft from top to bottom, cleared the inside workings of gas, reopened the airways, timbered airways and gangways, etc.; in fact, made the place safe. While doing all that work we used only safety lamps. Afterwards we discarded the safety lamps and worked on for weeks getting the inside ready to start to mine coal. John T. Griffith's contract having been assigned to me.

When we considered everything ready to start work, and being the last day until the breaker would start, we decided to quit early on that day, as the men had worked hard and faithfully while at this dangerous work. We went back to shaft, on cage and were hoisted to the surface. Every person having his naked light on his hat. I stepped off the cage at surface, and went towards engine house, which was only a short distance from shaft. On my way I met Big Bill, the engineer, who was going towards the top of the shaft. Just as I entered the engine house I heard a loud report and looked out, when to my horror, I saw the timbers, top of shaft, fan and everything movable going up into the air. Before I recovered myself two more explosions took place. As soon as possible I ran down to top of shaft, and behold all the men that came up with me (eight in number, and also Big Bill the engineer,) were horribly burned and rolling in the black coal dirt. The only living person whom I remember was with me was James McDade, now of your city. Of the others I only remember Joshua Davies, late of Wilkes-Barre, and Big Bill, the engineer.

You may ask, what caused the explosion? Where did the gas come from?

Undoubtedly the explosion was caused by gas coming in contact with the men's naked lights on the surface, while taking their tools off the cage. Where the gas came from is not so easy to answer, as there was not a lampful of gas in any part of the mine when we came out. Joshua Davies, our fire boss, and a better man could not be found, had made a thorough tour before we left the mine.

In my humble opinion, the gas that caused this explosion came from old workings abandoned and walled in about ninety feet from the bottom of the shaft. I think a fall must have occurred in some

part of these old workings, the force of the air from said fall burst the brick walls about the shaft, allowing this confined gas to escape up through the shaft. During the winter of 1866 and 1867 I was sent again to Buttonwood by J. T. Griffith to take out the pumps, column pipes and pump rods. This was accomplished without any loss of life and but a slight injury to one person. All this work was done without even the aid of a safety lamp—all by sense of feeling and knowing the place perfectly well.

Of the men with me doing this work, I can think of only two, the late John Lewis, Newtown, now Rolling Mine Hill, Wilkes-Barre, and the late William Richard, of Warrior Run, then of Wilkes-Barre.

I think the shaft was sunk in 1859 and 1860.

Very truly,

JAS. E. RODERICK.

### The Revival of the Chauncey Colliery.

The name of this colliery reappears this year among the list of producing collieries. It was abandoned at the close of 1886, the old breaker rotted down, and from appearances, it was permanently abandoned. The Reynolds and Moyer Coal Company, Limited, leased the culm bank and erected a separator. Subsequently a lease on the coal remaining in the old mine was obtained and a small breaker was erected, which started to ship coal at the end of the year 1894. The chief part of the coal production reported this year came from the culm bank, but the old tunnel is being reopened and also the workings of the Ross seam. A small fan was erected to produce ventilation, and the mine will soon be in shape to furnish coal.

### The Maxwell Colliery No. 20.

This is a new colliery being opened by the Lehigh and Wilkes-Barre Coal Company. The sinking of the shaft was started in 1892. Its size is 54x12 feet. In 1893 the sinking was suspended, but it was resumed after a few months. At the end of 1894 the shaft had passed the Baltimore seam and was at a depth of 820 feet. The depth to the Baltimore seam is 648 feet. From this point to the Red Ash seam the size of the shaft is reduced to 37x12 feet. Connections are already made to the Baltimore seam workings, from which tunnels have been driven to work the upper lifts of the Ross and Red Ash seams.

A slope has also been sunk from the surface to a depth of 635 feet on the Hillman seam.

The immensely large breaker is completed and fully equipped with machinery ready to prepare and ship coal as soon as the shaft is completed.



## The Bliss and Auchincloss Nos. 1 and 2 Shafts.

These three shafts are the property of the Delaware, Lackawanna and Western Railroad Company, located in Hanover township, about 8 miles southwest of Wilkes-Barre city. They were started in 1892. The three are of equal size, being 12x43 feet 2 inches. At the close of 1894 the Bliss shaft was completed to the bottom of the Red Ash seam at a depth of 904 feet. The two Auchincloss shafts at this time were at a depth of 851 feet each, and were connected underground by a passage driven in one of the coal seams passed. They are still sinking. A slope is being sunk on the Ross seam from the old Hanover tunnel gangway to effect a second opening in this seam for the Bliss shaft, and the old Hanover slope was reopened on the Baltimore seam, from which a gangway is being driven to make connection in that vein. The pitch in both these slopes, in some parts, is as steep as 55 degrees.

A breaker is in progress of construction at the Bliss shaft which will be completed early in 1895.

The following, furnished by Mr. A. H. Storrs, superintendent, gives a detailed account of the machinery and improvements made at these shafts during 1894:

## Bliss Shaft.

During the early part of 1894 there were put in operation at this new shaft a pair of first motion hoisting engines, and with them the sinking of the last 200 feet of the shaft was done. The shaft sinking is now completed, the Red Ash vein having been reached at a depth of 888 feet, and the work of opening out the several veins is now progressing.

The engines above referred to are a pair of 36-inch diameter by 48-inch stroke slide valve engines, directly connected to a drum shaft 19 inches in diameter and 18½ feet between bearings. On this shaft there are a pair of conical drums 9 feet diameter at small end, and 13 feet diameter at large end, with a cylindrical extension at large end.

One drum is keyed fast to the shaft; the other is fitted with a clutch admitting of the adjustment of the ropes to permit of hoisting in balance from the intermediate veins in the shaft. Each drum will coil 1,269 feet of 1½-inch diameter rope. The engines are fitted with the "Poore" balanced slide valves, and with steam reverse so arranged that the motion of the reversing engine exactly follows that of the hand lever, permitting of linking up if desired.

A novelty for this region is the use of the "Gooch" valve motion, which seems to have peculiar advantages for this service.

Two brakes are provided, one on each drum. These engines have been set in a brick house with iron roof trusses and roof covering.

A slope is being sunk on the Ross vein from the old Espy tunnel gangway to make connection with the Bliss shaft. This is operated by engines on the surface through a bore hole. The two old Espy slopes have been pumped out and gangways are being driven east and west from them.

#### Auchincloss.

At this colliery two new hoisting plants have been installed during the year, and are now being used to complete the shaft sinking.

The shafts are now down about 900 feet each. The engines at the main shaft are a pair of 36-inch by 48-inch slide valve engines, the same as described for Bliss, excepting that the drums will each coil 1,800 feet of  $1\frac{1}{2}$ -inch rope. These drums are of same diameter as those at Bliss, but of wider face.

At the second opening are a pair of 32-inch diameter by 60-inch stroke engines with Corliss valve motion, being the first engines of this type to be used for hoisting in this region. The cut-off on these engines is controlled by a governor which takes control of the engines upon their reaching the maximum speed, about 3,000 feet per minute in the shaft. When running at lower speeds, the engineer has the same control of the engines with throttle and reverse as in the usual slide valve type.

The drums on these engines are conical, 11 feet 8 inches diameter at small end, and 15 feet, 10 inches diameter at the large end, with cylindrical extension at the large end. They will coil 1,800 feet of  $1\frac{1}{2}$ -inch rope each.

One drum is fitted with a clutch, the same as on the "Bliss" engines. As with the others, they are fitted with steam reverse, and two brakes, one of which in this case is operated by steam.

During the early summer, the two shafts at the Auchincloss were walled with concrete, from the rock to the surface, a height in one shaft of somewhat over 100 feet, and in the other of about 80 feet.

The average thickness of these walls is four feet, and the shafts are 12 feet by 43 feet 2 inches inside of walls. The concrete was machine mixed and as many as 1,200 barrels of material, stone, sand and cement were used in 12 hours, making 5 feet height of wall all around the shaft.

#### Breaker No. 3, Delaware and Hudson Canal Company, Destroyed by Fire.

At about seven P. M., Thursday, November 15, 1894, fire was discovered in the pump room at the main No. 3 shaft of the Delaware and Hudson Canal Company, and every effort made to extinguish it failed. The breaker, pump room, engine and boiler houses were

completely consumed, and the machinery was all irreparably damaged.

There were ten men working in the mine, but all escaped through the Boston shaft without injury. The workings of the two mines are connected.

The fan in the second opening was stopped and the hoisting shaft beneath the fire was converted to an up-cast. No smoke entered the mine workings.

The next morning the company made preparations to build a new breaker about 390 feet west of the location of the old one, which is, by this time, about half finished and will be completed in April or May, 1895. The new breaker is to be covered with sheet iron instead of boards. The engine house will be of brick, and only a simple frame will be erected over the shaft.

### A Singular Accident and Happy Escape at the South Wilkes-Barre Colliery.

The New York Retail Coal Dealers' Association visited the Wyoming coal field, about 120 in number, and on Thursday, May 24, under the guidance of the officials of the Lehigh and Wilkes-Barre Coal Company, they started early in the morning to make an examination of the South Wilkes-Barre colliery. After making a cursory examination of the boiler plant, consisting of three batteries of high pressure water tube boilers of 750 horse power and twelve cylindrical boilers, they examined the 35-foot fan and the hoisting engines and outside arrangements. While some were going to see the breaker, the others desired to see the interior workings of the mines.

When ready, nine visitors, in charge of Superintendent Morgan, descended the shaft on the first cage. The second party of nine, in charge of John F. Jones, the mine foreman, was descending, when, to the consternation of all on surface, one of the cylindrical boilers exploded with a loud report. All the hoisting engines and fan at both shafts were instantly made powerless. The flying boiler and debris had broken all the steam pipe lines. Fortunately, Mr. Elmer H. Lowall, the general superintendent, and Mr. W. J. Richards, chief mining engineer, and other officials were at the head of the shaft. Every available man was set to work at once to repair. In fifteen minutes, by plugging a steam pipe, they were able to run the hoisting engines of No. 3, and all the men were hoisted out. The visitors and over 400 workingmen were in the No. 5 shaft, 1,068 feet deep, which is the gassiest mines in the country, and no hope for ventilation for an hour at least.

On losing steam the engineer applied the brake and stopped the descending cage within about 20 feet of the bottom, fortunately oppo-

site a hole through the partition to the ladder way. The foreman led the visitors on to the ladders and to the bottom. He and Superintendent Morgans were there, both cool and experienced. They learned the situation by telephone, and ordered the top men to pour water down the shaft compartments at once. This thought and order saved over 400 lives. It was executed promptly, and the first stream was pouring down in six minutes. The air current had already reversed and would have come to the bottom of the shaft in an explosive condition in fifteen minutes. Messengers had been sent to all parts to call the workmen out, and to see that no lighted lamp was forgotten. The visitors were told to climb the ladders, and every workman, as soon as he came, was sent up the same way.

It was raining heavily, and a large stream of water running down the street was turned into the shaft. It had been utilized once before to flood a fire, and that made it easy to turn in now.

From some cause, at this time, the telephone failed to work, and no information could be obtained on surface as to the situation below, and those who realized the awful situation trembled with fear and anxiety.

There were 56 flights of steps to climb, in 20 feet lengths, having a platform at each length, and a vertical height of 1,068 feet from bottom of shaft to the surface.

In a short time the boys and younger men reached the top, and said that all the men would come up the ladders; that the visitors were on the way climbing courageously. Shortly after, parties came and reported that the water made a good current of air, and that all the men were out of the faces and on the way out.

The officials understood that the small current caused by the falling water could not be sufficient to dilute the gas exuded, and that the air in the returns and up-cast, most probably, was explosive. In about one hour the steam pipe leading to the fan was repaired, but after a consultation of the officials, the Mine Inspector concurring, it was deemed best not to start it until all the men were out. If a lighted feeder existed, an explosion might be caused by starting the fan and thereby moving a body of gas upon the lighted feeder. It was evident that starting the fan without first knowing the condition in the mine would be risky and would not increase the safety of the men, so it was not put in motion. Of course, an explosion might take place from a feeder burning, without starting the fan, or some person might thoughtlessly put his lighted lamp to a crevice in the partition between the ladderway and the up-cast and cause an explosion; but, fortunately, nothing happened and all came out safe. To see the mine foreman, John F. Jones, Superintendent Morgan R. Morgans, and the fire bosses appear on the surface was an assurance that all were out, and it was a happy relief and intense satisfaction to every-

body. It was peculiarly fortunate that the New York coal agents were there, for their presence had been the cause of the presence of all the mine officials. Mr. Lowall, Mr. Richards, Mr. Herring, the general outside superintendent were on the surface, and Morgan R. Morgans and John F. Jones and firebosses were at the foot of the shaft. All were in the best position to cope with this emergency, and all worked well and no mistakes were made.

#### Electricity of Trolley Roads Found in the Mines.

During the latter part of 1894, in the manner described in the following, furnished by the officials of the Lehigh and Wilkes-Barre Coal Company, it was found and determined by elaborate experiments that in all the mines located between the electric railroad and the power plants, the pipes in the mines are charged with the electricity of these roads on its return to the power plant. The explanation and tables of the result of the experiments are here presented:

## Hollenback Colliery, No. 2—NOVEMBER 17, 1894.

| Test | Maximum |        | Minimum |        | Terminals          |             | Location                 | Remarks.   |
|------|---------|--------|---------|--------|--------------------|-------------|--------------------------|--|
|      | Amp.    | Volts. | Amp.    | Volts. | Positive.          | Negative.   |                          |  |
| 1    | 0.50    | 0.50   | 0.50    | 0.50   | Water pipe.        | Steam pipe. | Fog shanty.              | Why does ammeter deflect?<br>Why does polarity change? |
| 2    | 0.75    | 0.75   | 0.75    | 0.75   | Rail in sump.      | Water pipe. | Foot No. 1 slope.        |  |
| 3    | 0.10    | 0.10   | 0.10    | 0.10   | Water pipe.        | Rail.       | First lift, No. 1 slope. |  |
| 4    | 0.30    | 0.30   | 0.10    | 0.10   | do.                | do.         | No. 2 tunnel, east end.  |  |
| 5    | 0.50    | 0.50   | 0.50    | 0.50   | Ditch.             | Water pipe. | No. 2 tunnel, west end.  |  |
| 6    | 0.50    | 0.50   | 0.50    | 0.50   | Water pipe.        | Column.     | Foot shaft.              |  |
| 7    | 0.25    | 0.25   | 0.25    | 0.25   | do.                | Steam pipe. | do.                      |  |
| 8    | 0.10    | 0.10   | 0.10    | 0.10   | Sump through rail. | Water pipe. | Foot No. 2 slope.        |  |
| 9    | 0.10    | 0.10   | 0.10    | 0.10   | Steam pipe.        | do.         | Outside office.          |  |

## South Wilkes-Barre Colliery, No. 5—NOVEMBER 12, 1894.

| Test | Maximum |        | Minimum |        | Terminals                        |                     | Location                           | Remarks   |
|------|---------|--------|---------|--------|----------------------------------|---------------------|------------------------------------|---|
|      | Amp.    | Volts. | Amp.    | Volts. | Positive                         | Negative.           |                                    |   |
| 1    | 12.50   | 2.00   | 0.00    | 0.50   | Steam pipe.                      | Gas pipe.           | Mine foreman's office.             | Short circuit off<br>do<br>do<br>do<br>do<br>do<br>do<br>do<br>do<br>do<br>do<br>do<br>do<br>do<br>do<br>do |
| 2    | 0.50    | 0.10   | 0.00    | 0.10   | Shaw pipe.                       | Shaw pipe.          | Head of shaft.                     |   |
| 3    | 0.50    | 2.25   | 0.10    | 1.75   | Steam pipe pump exhaust.         | Shaw pipe, 4 and 5. | Foot of shaft.                     |   |
| 4    | 0.50    | 2.25   | 0.10    | 2.75   | Ditch.                           | do. 6 and 7.        | Sta. 256, east plane, No. 1.       |   |
| 5    | 0.30    | 0.50   | 0.10    | 0.50   | do.                              | do. 6 and 7.        | No. 1 cut off, west plane, No. 1.  |   |
| 6    | 0.50    | 5.00   | 0.20    | 2.50   | Compressed air pipe.             | Rail.               | Foot Br. No. 26, west shaft level. |   |
| 7    | 0.50    | 5.00   | 0.20    | 3.00   | DOCH.                            | Shaw pipe 3.        | No. 2 tunnel.                      |   |
| 8    | 0.50    | 5.00   | 0.20    | 3.00   | do.                              | do.                 | End No. 3 pipe.                    |   |
| 9    | 0.50    | 6.50   | 0.20    | 2.50   | do.                              | do.                 | Sta. 371, shaft level.             |   |
| 10   | 11.50   | 1.00   | 5.00    | 1.00   | Shaw gas tester.                 | Gas pipe.           | Mine foreman's office.             |   |
| 11   | 0.05    | 2.25   | 0.05    | 2.00   | These tests, 11 to 16 inclusive, |                     |                                    |   |
| 12   | 0.05    | 2.50   | 0.05    | 1.50   | were made at same points as      |                     |                                    |   |
| 13   | 0.05    | 3.00   | 0.05    | 3.00   | tests 3, 4, 5, 7, 8, 9, after    |                     |                                    |   |
| 14   | 0.05    | 5.10   | 0.05    | 5.00   | short circuits were restored     |                     |                                    |   |
| 15   | 0.05    | 5.50   | 0.02    | 2.50   |                                  |                     | Baltimore                          |   |
| 16   | 0.05    | 7.00   | 0.05    | 3.00   |                                  |                     |                                    |   |

|    |      |      |                      |                           |                                 |     |
|----|------|------|----------------------|---------------------------|---------------------------------|-----|
| 17 | 0.10 | 0.10 | Ditch.               | Water pipe.               | Sta. No 261, west gangway.      | do  |
| 18 | 0.05 | 0.05 | Rail.                | do.                       | do.                             | do. |
| 19 | 1.00 | 0.00 | do.                  | do.                       | Sta. 350+2, west gangway.       | do. |
| 20 | 1.00 | 0.25 | do.                  | do.                       | At first lift on slope.         | do. |
| 21 | 0.75 | 0.25 | do.                  | do.                       | do.                             | do. |
| 22 | 0.75 | 0.50 | Ditch.               | Rail.                     | Sta. 62, east gangway.          | do. |
| 23 | 0.50 | 0.50 | do.                  | Stanton No. 7 water pipe. | do.                             | do. |
| 24 | 1.50 | 1.00 | do.                  | Shaw pipe, No. 3.         | End of pipe, No. 3.             | do. |
| 25 | 2.00 | 1.00 | do.                  | do.                       | Where No. 2 turns into heading. | do. |
| 26 | 1.00 | 1.00 | Water pipe.          | do.                       | In No. 5 shaft mainway.         | do. |
| 27 | 1.00 | 0.50 | Cottman pipe.        | do.                       | do.                             | do. |
| 28 | 0.50 | 0.50 | do.                  | do.                       | do.                             | do. |
| 29 | 0.50 | 0.50 | Compressed air pipe. | do.                       | do.                             | do. |
| 30 | 0.50 | 0.50 | Shaw pipe, No. 4.    | do.                       | do.                             | do. |
| 31 | 0.50 | 0.50 | do.                  | do.                       | do.                             | do. |
| 32 | 0.50 | 0.50 | do.                  | do.                       | do.                             | do. |
| 33 | 0.25 | 0.25 | do.                  | do.                       | do.                             | do. |
| 34 | 0.25 | 0.25 | do.                  | do.                       | do.                             | do. |
| 35 | 0.25 | 0.25 | do.                  | do.                       | do.                             | do. |
| 36 | 0.50 | 0.25 | do.                  | do.                       | do.                             | do. |
| 37 | 0.50 | 0.50 | do.                  | do.                       | do.                             | do. |
| 38 | 0.25 | 0.25 | do.                  | do.                       | do.                             | do. |
| 39 | 0.10 | 0.10 | Water pipe.          | do.                       | do.                             | do. |
| 40 | 1.00 | 1.00 | do.                  | do.                       | do.                             | do. |
| 41 | 1.00 | 1.00 | do.                  | do.                       | do.                             | do. |
| 42 | 0.50 | 0.50 | do.                  | do.                       | do.                             | do. |
| 43 | 0.10 | 0.10 | Ditch.               | do.                       | do.                             | do. |
| 44 | 1.50 | 1.00 | do.                  | do.                       | do.                             | do. |
| 45 | 1.00 | 0.50 | do.                  | do.                       | do.                             | do. |
| 46 | 1.00 | 0.50 | Water pipe and rail. | do.                       | do.                             | do. |
| 47 | do.  | do.  | Ditch and rail.      | do.                       | do.                             | do. |
| 48 | do.  | do.  | do.                  | do.                       | do.                             | do. |
| 49 | do.  | do.  | do.                  | do.                       | do.                             | do. |
| 50 | do.  | do.  | do.                  | do.                       | do.                             | do. |

| Test. | Maximum.     |        | Minimum. |        | Terminals.  |             | Location                    | Remarks |
|-------|--------------|--------|----------|--------|-------------|-------------|-----------------------------|---------|
|       | Amp.         | Volts. | Amp.     | Volts. | Positive.   | Negative.   |                             |         |
| 1     | 0.10         | 0.10   | 0.10     | 0.10   | Water pipe. | Water pipe. | Fifth east, 700' from slope |         |
| 2     | 0.19         | 0.10   | 0.10     | 0.10   | Rail.       | do.         | do.                         |         |
| 3     | 0.10         | 0.10   | 0.10     | 0.10   | do.         | do.         | Fourth east, head mainway   |         |
| 4     | 1.00         | 1.00   | 1.00     | 1.00   | do.         | do.         | No. 2 Tunnel at peg shanty  |         |
| 5     | No our rent. | 0.50   | 0.50     | 0.50   | do.         | do.         | Stable.                     |         |
| 6     | 0.50         | 0.50   | 0.50     | 0.50   | do.         | do.         | Stable at foot shaft.       |         |
| 7     | 0.10         | 0.10   | 0.10     | 0.10   | do.         | do.         | Outside office.             |         |

*Empire Colliery, No. 4—NOVEMBER 21, 1894.*

*Stanton Colliery, No. 7—NOVEMBER 21, 1894.*

| Test | Maximum.     |        | Minimum. |        | Terminals.         |                    | Location.                     | Remarks.  |
|------|--------------|--------|----------|--------|--------------------|--------------------|-------------------------------|---|
|      | Amp.         | Volts. | Amp.     | Volts. | Positive.          | Negative.          |                               |   |
| 1    | 0.25         | 0.25   | 0.25     | 0.25   | Rail.              | Water pipe.        | Basin gangway                 | N. B.—Change in polarity.<br>{ No. 1 water pipe comes down<br>old manway from surface.<br>{ No. 2 comes down shaft. |
| 2    | 0.50         | 0.50   | 0.50     | 0.50   | Ditch.             | do.                | do.                           |   |
| 3    | 1.00         | 1.00   | 1.00     | 1.00   | Rail.              | do.                | No. 4 plane east.             |   |
| 4    | 0.50         | 0.50   | 0.50     | 0.50   | do.                | do.                | No. 4 plane head.             |   |
| 5    | No cur rent. |        |          |        | Water pipe, No. 1. | Rail.              | Slope east, No. 8 tunnel      |   |
| 6    | do.          |        |          |        | do.                | do.                | Slope head.                   |   |
| 7    | 0.50         | 0.50   | 0.50     | 0.50   | Water pipe, No. 2. | Water pipe, No. 1. | do.                           |   |
| 8    | 0.50         | 0.50   | 0.50     | 0.50   | Ditch.             | do.                | do.                           |   |
| 9    | No cur rent. |        |          |        | do.                | do.                | Stable.                       |   |
| 10   | 0.25         | 0.25   | 0.25     | 0.25   | Steam pipe.        | Water pipe.        | Engine house, head air shaft. |   |
| 11   | 0.25         | 0.25   | 0.25     | 0.25   |                    |                    |                               |   |

*Jersey, No. 8 and Sugar Notch, No. 9—NOVEMBER 19, 1894.*

|   |              |      |      |      |                            |              |  |                                   |
|---|--------------|------|------|------|----------------------------|--------------|--|-----------------------------------|
| 1 | 0.75         | 0.75 | 0.75 | 0.75 | Rail.                      | Pump.        | Fifth West Balto., No. 8 colliery.             | Wet air moving slowly.            |
| 2 | 1.00         | 1.00 | 1.00 | 1.00 | Ditch.                     | do.          | do.  | do.                               |
| 3 | 4.00         | 4.00 | 2.00 | 2.00 | Rail.                      | Water pipe.  | Sixth West Balto., No. 8 colliery.             | Dry air moving quickly in face.   |
| 4 | 2.00         | 2.00 | 1.00 | 1.00 | do.                        | do.          | do.  | Pump, air slower here at cut-off  |
| 5 | 0.75         | 0.75 | 0.75 | 0.75 | do.                        | do.          | No. 6 tunnel koss, No. 8 colliery.             | Dry air moving quickly at tunnel. |
| 6 | 1.50         | 1.50 | 1.50 | 1.50 | do.                        | do.          | Sixth West Balto., No. 8 colliery.             | Damp air moving medium opp.       |
| 7 | 3.00         | 3.00 | 1.00 | 1.00 | do.                        | do.          | Seventh West Balto., sta. 888, No. 8 colliery. | Shaft.                            |
| 8 | 2.00         | 2.00 | 1.00 | 1.00 | do.                        | do.          | Seventh West Balto., sta. 790, No. 8 colliery. | Dry air moving quickly near face. |
| 1 | 1.30         | 1.30 | 0.50 | 0.50 | Rail.                      | Water pipe.  | No. 4 tunnel Red Ash, No. 9 colliery.          | Wet, mouth of tunnel.             |
| 2 | 1.00         | 1.00 | 1.00 | 1.00 | Ditch.                     | do.          | do.  | do.                               |
| 3 | No cur rent. |      |      |      | Rail and speaking tube.    | do.          | Third east on slope, No. 9 colliery.           | Dry.                              |
| 4 | do.          |      |      |      | do.                        | do.          | do.  | do.                               |
| 5 | do.          |      |      |      | Steam pipe and water pipe. | do.          | Third west on slope, No. 9 colliery.           | Dry at "Cameron" pump.            |
| 6 | 0.75         | 0.75 | 0.75 | 0.75 | Column.                    | Water pipe.  | Shaft level, near No. 9 colliery.              |                                   |
| 7 | 0.15         | 0.15 | 0.15 | 0.15 | Rail.                      | do.          | Fire boss shanty, No. 9 colliery.              |                                   |
| 8 | 0.10         | 0.10 | 0.10 | 0.10 | do.                        | do.          |  |                                   |
| 9 | 0.10         | 0.10 | 0.10 | 0.10 | Ditch.                     | Column pipe. |  |                                   |



*Lance Colliery, No. 11—NOVEMBER 15, 1894.*

|    |              |      |  |  |  |  |  |  |  |  |                                |
|----|--------------|------|--|--|--|--|--|--|--|--|--------------------------------|
| 1  | No cur rent. |      |  |  |  |  |  |  |  |  | Slope engine house.            |
| 2  | do.          |      |  |  |  |  |  |  |  |  | do                             |
| 3  | do.          |      |  |  |  |  |  |  |  |  | Office.                        |
| 4  | do.          |      |  |  |  |  |  |  |  |  | Boiler house.                  |
| 5  | do.          |      |  |  |  |  |  |  |  |  | Shaft engine house             |
| 6  | do.          |      |  |  |  |  |  |  |  |  | do                             |
| 7  | 0 10         | 2.00 |  |  |  |  |  |  |  |  | do                             |
| 8  | No cur rent. |      |  |  |  |  |  |  |  |  | Boiler house.                  |
| 9  | 5.50         | 2.50 |  |  |  |  |  |  |  |  | No. 224 Main street, Plymouth. |
| 10 | 0.50         | 0.50 |  |  |  |  |  |  |  |  | Fire boss office.              |
| 11 | 0.50         | 0.50 |  |  |  |  |  |  |  |  | do.                            |
| 12 | 0.10         | 3.00 |  |  |  |  |  |  |  |  | Eighth east gangway.           |
| 13 | 0 10         | 3.00 |  |  |  |  |  |  |  |  | do.                            |
| 14 | No cur rent. |      |  |  |  |  |  |  |  |  | do.                            |
| 15 | 0.10         | 0.10 |  |  |  |  |  |  |  |  | Fifth west gangway.            |
| 16 | 0.10         | 0.10 |  |  |  |  |  |  |  |  | Second west gangway.           |
| 17 | 0.10         | 0.10 |  |  |  |  |  |  |  |  | Foot air shaft.                |

Highest when cars are on grade.

Variable

Shocks are reported here, but no such could be detected on this date.

*Nottingham Colliery, No. 15—NOVEMBER 16, 1894.*

|    |              |      |      |  |  |  |  |  |  |  |                                 |   |
|----|--------------|------|------|--|--|--|--|--|--|--|---------------------------------|---|
| 1  | 1.50         | 3.00 | 0.00 |  |  |  |  |  |  |  | Outside office.                 | Max. when car is opposite creek.        |
| 2  | 0.50         | 3.00 | 0.00 |  |  |  |  |  |  |  | Empty truck at shop.            | do                                      |
| 3  | 0.20         | 2.00 | 0.00 |  |  |  |  |  |  |  | Nottingham crossing.            | Max. when car is going down toward Axon |
| 4  | No cur rent. |      |      |  |  |  |  |  |  |  | Below Nottingham crossing.      |   |
| 5  | 0.10         | 0.10 | 0.10 |  |  |  |  |  |  |  | Manway red ash slope, second W. |   |
| 6  | 0.25         | 0.25 | 0.25 |  |  |  |  |  |  |  | do.                             | third W.                                |
| 7  | 0.50         | 0.50 | 0.50 |  |  |  |  |  |  |  | do.                             | do.                                     |
| 8  | 0.50         | 0.50 | 0.50 |  |  |  |  |  |  |  | do.                             | fourth W.                               |
| 9  | 0.50         | 0.50 | 0.50 |  |  |  |  |  |  |  | do.                             | do.                                     |
| 10 | 0.50         | 0.50 | 0.50 |  |  |  |  |  |  |  | do.                             | do.                                     |
| 11 | 0.50         | 0.50 | 0.50 |  |  |  |  |  |  |  | do.                             | do.                                     |
| 12 | 0.50         | 0.50 | 0.50 |  |  |  |  |  |  |  | do.                             | do.                                     |
| 13 | No cur rent. |      |      |  |  |  |  |  |  |  | do.                             | do.                                     |
| 14 | 0.50         | 0.50 | 0.50 |  |  |  |  |  |  |  | do.                             | do.                                     |
| 15 | 0.10         | 0.10 | 0.10 |  |  |  |  |  |  |  | Track plane, second east.       |   |
| 16 | No cur rent. |      |      |  |  |  |  |  |  |  | Ross slope, second west.        |   |
| 17 | 0.10         | 0.10 | 0.10 |  |  |  |  |  |  |  | R ss slope, head.               |   |
| 18 | No cur rent. |      |      |  |  |  |  |  |  |  | Foot ash slope, head.           |   |

Am-meter not deflected

*Washington Colliery, No. 16—NOVEMBER 17, 1894.*

| Test | Maximum.     |        | Minimum |        | Terminals.           |             | Location              | Remarks                |
|------|--------------|--------|---------|--------|----------------------|-------------|-----------------------|------------------------|
|      | Amp.         | Volts. | Amp.    | Volts. | Positive             | Negative    |                       |                        |
| 1    | 0.10         | 0.10   |         | 0.10   | Steam pipe,          | Water pipe, | Outside office,       | Wet dry                |
| 2    | 0.10         | 0.10   |         | 0.10   | do.                  | Rail,       | Near head rock slope, | do.                    |
| 3    | No cur rent. |        |         |        | D. L. & W. R. track, | Ditch,      | Near breaker,         | do.                    |
| 4    | 0.10         | 0.10   |         | 0.10   | Steam pipe,          | Water pipe, | Walter house          | 100 feet east of slope |
| 5    | 0.30         | 0.30   |         | 0.30   | Ditch,               | Water pipe, | No. 3 tunnel east,    | 100 feet west of slope |
| 6    | 0.10         | 0.10   |         | 0.10   | Ditch and rope,      | Water pipe, | Head of Ross slope,   |                        |
| 7    | No cur rent. |        |         |        | Ditch,               | Rail,       | do.                   |                        |
| 8    | 0.50         | 0.50   |         | 0.50   | do.                  | do.         | Foot of Ross slope    |                        |
| 9    | 0.50         | 0.50   |         | 0.50   | Ditch,               | Steam pipe, | Pez shanty.           |                        |
| 10   | No cur rent. |        |         |        |                      |             |                       |                        |

*Wanamie, No. 18—NOVEMBER 22, 1894.*

|   |              |      |  |      |             |             |                       |              |
|---|--------------|------|--|------|-------------|-------------|-----------------------|--------------|
| 1 | 0.50         | 0.50 |  | 0.50 | Ditch,      | Water pipe, | On found out gangway, | Near stable. |
| 2 | 0.10         | 0.10 |  | 0.10 | Rail,       | Steam pipe, | Head No. 6 slope,     |              |
| 3 | 0.10         | 0.10 |  | 0.10 | Ditch,      | do.         | Pump room,            |              |
| 4 | 0.10         | 0.10 |  | 0.10 | Rail,       | Rope,       | No. 2 slope,          |              |
| 5 | No cur rent. |      |  |      | Steam pipe, | Water pipe, | Outside office        |              |

### Possible Gas Explosion Due to Trolley Currents.

While engaged in installing the pipes of the Shaw mine signaling apparatus at South Wilkes-Barre No. 5 colliery, one of the workmen reported that he had received an electrical shock. He was standing in water at the time at a point 8,000 feet from the foot of the shaft, and had placed his ear to the pipes in order to listen for a signal. Experiments were then made with an ordinary magnetic needle, which proved conclusively the existence of an electrical current. The current was traced to the foot of the shaft and from the shaft to the surface to the operating room of the signaling apparatus. A bell of high resistance having been connected between the pipes of the Shaw system and the Wilkes-Barre Gas Company's mains, a strong current was found to be passing, and in order to determine its origin a number of tests were made in the vicinity. At a dwelling 500 feet distant from the colliery the pipes of the Crystal Spring Water Company and the Wilkes-Barre Gas Company were used as the poles and a strong current shown. Here the water pipe was positive to the gas pipe negative. This test proved that the current originated outside the colliery, and the indications were that it was due to leakage from the lines of the Wilkes-Barre and Wyoming Valley Traction Company. The Traction Company's electrician having been notified, after visiting and testing various portions of the mine, also arrived at this conclusion.

South Wilkes-Barre No. 5 colliery is located between the Traction Company's power house and the Ashley Trolley line. In constructing this Ashley line the bonding was negligently done, iron wire being used, which became corroded and broken, leaving the rails without other connections than that furnished by the fish plates. The current returning from the cars west of Parrish street escapes at these joints, and naturally passes to the water and gas pipes laid in the streets.

At the corner of Hazle and Parrish streets, the water and gas mains on Parrish street afford a short circuit and the line of least resistance for the current to pass to the Nanticoke Trolley line, from which point the current is carried through the rails of the latter line to the power house. The water pipes used to feed the boilers and carry water into the South Wilkes-Barre mines are connected with the Parrish street mains, consequently a portion of the current passes into these branch lines and is carried through the boilers to the engines and other machinery connected with them, while part passes into the water lines entering the mines. As these pipes are laid in the ground, a large part of the current escapes to the earth. The Shaw signaling apparatus is connected to the boilers through the steam pipes and receives a large part of the current. In order to deter-

mine the extent of these currents, a Western volt meter and an ammeter were secured, and a series of experiments were made embracing the entire extent of the mine. A table showing these tests accompanies this report. An examination of the table will show that between the pipes of the operating room of the Shaw system and the Wilkes-Barre Gas Company's pipes, a current of from 6 to  $12\frac{1}{2}$  amperes was found, with a difference of potentials of from  $\frac{1}{2}$  to 2 volts. The tests made in the mine between the Shaw pipes and the water in the ditch as the poles, showed a current of less than one ampere, with a difference of potentials of from one-tenth to six and one-half volts. As the mine is exceedingly gaseous, it was deemed advisable to take immediate steps to remove, as far as possible, any danger that might be liable to arise from this unexpected source. When the ventilating current is in proper shape, the electricity can do no harm, but should the air in any part of the mine become explosive, these pipes charged with electricity would be a source of great danger, as a spark caused by an imperfect contact of the pipes would be the means of igniting the gas, which would result in disaster. The currents with high potentials were all found in the Shaw pipes. These pipes are perfectly insulated, in order to aid their sound-carrying properties, as signaling from the mine is one of the main features of the apparatus.

The pipes are suspended their entire length by hooks driven in wooden plugs or collars, thus making them excellent conductors.

In order to cut off this current, some insulating material will be inserted in each line at the level of the head of the shaft. This will not only prevent the escape current of the Traction Company from passing into the mine, but will also prevent any danger from lightning. All pipes in the mine where a current could be detected have been short circuited wherever possible, and their ends grounded. This provision should be sufficient to guard against all possible danger.

On the outside, the Traction Company have re-banded the rails on the Ashley line with heavy copper wire and have agreed to run a return wire from Hazle street down Parrish street to their power house. By this arrangement they hope to prevent any serious escape of the current.

Tests have been made at all the other collieries, and the current found has been too small to deflect the needle of the ammeter. With the exception of Lance, Maxwell and South Wilkes-Barre, the difference in potential has not exceeded one volt.

At Maxwell colliery, at the faces of the sixth and seventh west gangways, a difference of potential of from two to four volts was found. This colliery is also in the electric field between the Traction Company's power house and the Ashley line, and the workings are

very gaseous. In order to lessen the current, short circuits of copper wire have been laid.

At Lance colliery, on the eighth east gangway, a distance of 5,000 feet from the foot of the shaft, a current of one-tenth of an ampere, and a potential of three volts was found. The water pipe and the water running in the ditch along the side of the gangway were the poles used. This colliery is in the electric field between the Traction Company's Plymouth line and the power house at Wilkes-Barre, and has also been short circuited with copper wire, a short circuit being offered by the rails of the Delaware and Hudson Canal Company across the flats.

The leakage will be stopped when the Traction Company have completed their short line to Plymouth.

These electric currents are unexpected dangers and their early detection has probably averted serious consequences. The railroad people are co-operating with us in every way to remove the danger.

In addition to the currents from the trolley lines, it is probable that electricity is generated by the action of the acid water in the mines on the rails, etc., in the same manner as it is generated in a battery.

#### The Annual Examination of Applicants for Certificates of Qualification.

The examination of applicants for certificates of qualification was held in the Central school building, Wilkes-Barre, Pa., on June 20 and 21, 1894.

The board of examiners was G. M. Williams, Inspector of Mines, Charles M. Conyngham, operator, Daniel J. Rees and Anthony Wirt, miners.

Thirty-four applicants were examined for mine foreman certificates, and the following named passed the required standard:

John Maxwell, Joseph Lewis, H. G. Evans and Fred Badman, of Plymouth, Pa.

William A. Wallace, Luzerne borough.

John E. Williams, Fred. Nichols, Charles Poad, Wm. May, John H. Mathews, Rees J. Morris, Benjamin J. Thomas, Richard D. Roberts, Benjamin James, Edward Clocker, John D. Joseph, David J. Jones, of Wilkes-Barre, Pa.

Madoc Thomas, Edwardsdale, Pa.

David R. Jones, Glen Lyon, Pa.

Patrick J. Moore, Peely, Pa.

Sixty-eight were recommended for certificates of qualification for assistant mine foreman.

Each person who had the lawful experience and was able to read

and write the necessary reports was recommended to have a certificate as assistant mine foreman. After an experience of several years, the writer is convinced that to put fire bosses and assistant foreman through an examination before a board representing the State does no good, and is a cause of futile expense to the applicants and to the State.

### The Accidents of 1894.

The number of fatal accidents in 1894 was 71 in collieries producing coal and six in new shafts in process of sinking. The quantity of coal mined per life lost was 100,886 tons of marketable coal.

It takes the same proportion of labor and risk to mine and prepare the waste that goes to culm heaps at the breakers and to mine and store the refuse in the mines, which in many seams is fully ten per cent. of the total quantity of material mined, except that the latter is not hauled out. We hear it often stated that anthracite mining is excessively dangerous, and comparing the amount of coal produced per life lost with the production in the bituminous region, the comparison appears unfavorable.

The bituminous seams are all thin, the coal is all marketable, and nearly the material mined and hauled is coal accounted for in the total production, while in the anthracite the seams are nearly all thick, the coal has to be mined by blasting, and not two-thirds of the material mined is accounted as product. All the culm also goes to the dump. The quantity of fuel used to generate steam at the anthracite mines is perhaps five times as great as at the bituminous ones, and this is not accounted for in the production. This all combines to make the production per life lost in the anthracite mines appear much less than it is if fairly compared with the production in bituminous mines.

An examination of the record for 1894 in this district shows that only four persons were fatally injured and 23 non-fatally directly by the use of powder; but of the 44 killed and 68 injured by falls of roof and coal the largest number was indirectly caused by blasting. To return to the face of a breast in a thick seam immediately after firing a blast is fraught with danger, for accidents from falls of coal or roof frequently occur; a very large number happen thus. Props are suddenly displaced, the coal support is abruptly torn from under the roof, and large pieces of coal, frequently more than half loosened, are left hanging and fall just when the miner returns. Thus the disruptible effect of blasting is the cause of more than half the accidents from falls in our anthracite mines. If all the miners were to wait five minutes after firing a blast before returning to work, a large proportion of the accidents by falls of roof and coal would be averted.

Seven were fatally injured and thirty-three seriously by explosions of gas. This class of accidents are less excusable than a large number caused by falls. The safeguards against explosions are so well known that if they were strictly executed no explosion would take place. Nearly every accident of this class is the direct result of some one's carelessness in disobeying well known regulations. In this class of accidents the innocent frequently suffer through the carelessness of others.

The mine cars are prolific sources of accidents, the most of which might be averted if the boys could be persuaded to exercise more care, but it seems to be an innate desire in a boy to be daring and venturesome, and in his recklessness he is often caught and injured.

The accidents of all classes could be reduced by a more effective discipline, by an effective enforcement of well known rules, and by a stricter regard for the proper qualifications of the persons employed to do the various kinds of work. All this depends on the foremen, and all the foremen have not had the power and natural executive ability to compel obedience to the rules.

#### Disaster at the Gaylord Colliery.

At about 2.15 A. M., Tuesday, February 13, 1894, an extensive area of the workings of the Gaylord colliery of the Kingston Coal Company at Plymouth, Pa., collapsed, closing the workings in each seam from the Red Ash to the surface, and thirteen workmen were buried nearly under the centre of the mass. No one escaped, and no one can explain how these thirteen experienced men were so suddenly entrapped.

On Monday morning, February 12th, George Picton discovered a squeeze in the workings of the Ross seam. On examination he suspected that the base and origin of the squeeze was beneath, in the Red Ash seam, and sent his son, Thomas Picton, and another person to make an examination in the old workings of said seam. They went down and found the breasts on the third lift west of Plane cracking and showing a decided indication of a troublesome squeeze. (This point is indicated by the letter C on the accompanying map.) This part of the Red Ash seam workings had been finished and abandoned for seven years and only about eighty car loads of coal remained to be mined in the seam altogether at this time, and that from a place above the head of the plane.

After a consultation, Messrs. Gwilym Edwards, superintendent, and George Picton, general foreman, decided to have a row of props set to support the pillar on the west side of the plane just above the third lift. (At A; see map), and a party of sixteen men were selected and sent for to execute the work. The mine was idle and the men had to be summoned from their homes. Four laborers were there

already or came earlier than the others, viz: Henry Williams, Robert Williams, Eli Culver and John Soley. The mine foreman, Thomas Picton, was in charge. He showed these four men the place and told them to clean along the rib to make room for the props. After working there awhile and hearing ominous cracking in the pillars and coal falling in the breasts west of them, they became afraid and decided to leave and go home.

On reaching the foot of the shaft, they met the other party of men coming in with props and tools in charge of Thomas Picton. The latter asked, where they were going, and they answered that they were afraid, and would go home. All right, answered Picton, if you are afraid, you better go. This was shortly after six o'clock P. M. Three men had been left outside to cut props and ten went to work setting the props up.

At 10.30 they were using the timber up, six more of the party went outside to help in getting more props. It was a cold, stormy night, but by fifteen minutes of twelve they had cut the necessary supply and sent them down the shaft. Then they went into the engine house to warm themselves. John D. Jones, the night engineer, asked them if there was much danger there and they replied that there was no danger at all; that the four laborers who went home were unnecessarily alarmed. At about 12.10 they all descended the shaft.

At 1.30 A. M. George Brace, the stable boss, accompanied by Thomas Leyshon, came up the shaft for plank to make cap-pieces. They sent six oak planks eight feet long, one and one-half inches thick down the shaft, and Thomas Leyshon descended the shaft on the same cage, and Brice went home.

At 2.15 A. M., about three-quarters of an hour after Leyshon descended the shaft, the engineer felt a concussion of air, and the speaking tube whistle blew a long, loud whistle. He immediately gave alarm by blowing the steam whistle. George Picton, William Edwards and a number of miners responded in a short time, and went down the shaft and attempted to go up the plane, and succeeded in going up a distance of about 400 feet, where the place was crushing and threatening to close in upon them. They shouted, but heard no reply. Lest the missing men had gone up the plane and were groping in the darkness of the open workings above the plane, parties were sent to enter above from the manway at the outerop. They, after a search for several hours, came out satisfied that the men were not there. Every open space above and below and around the caved workings was searched without avail. Shouting and tapping brought no response. By noon all hopes of saving the men had vanished and work was promptly commenced to reopen







the plane. It was over 1,600 feet in length, and the thirteen missing men had been working at about the middle of it.

The plane had been operated after Leyshon descended, for the cars of timber attached to the rope at the bottom and the planks he took down had been hoisted up to the point where the men were at work.

George Bræce was in the mine with the men till near 1.15 A. M., and he says that all appeared safe when he left. He was at the top of the plane at midnight, and saw no sign of a fall. When coming out he noticed the roof cracking about 100 feet below the men, and he called to Picton and told him. Picton replied, "It is all right; hurry and send us cap-pieces." He and Leyshon went outside and asked the engineer what time it was, and the engineer said it was 1.30 A. M. The planks were taken down and placed on the car and hoisted up to the middle of the plane, and the cave took place at 2.15 A. M. Evidently the plane was clear of all obstruction when it was operated, and this shows that the final crush was sudden and without the usual warning.

The dotted line on map shows the outlines of the caved workings. The men were working at A, and all the bodies were found in the space between A and B. The farthest had not gone more than 240 feet in his flight for life. All were covered by the coal crushed in from the pillars. About 600 feet of the plane had to be reopened to find all the bodies, and then the workings of this seam were abandoned. Work was continued incessantly day and night until all the bodies were found, and each was found as follows:

Peter McLaughlin, on face, head down the plane, March 13, at 1.30 A. M.

Michael Welsh, stooping in a running position, March 14, 4 A. M.

Thomas J. Jones, crushed down on face by a fall of rock, March 15, P. M.

Richard Davies, stooping, in running position, March 16, 10.30 A. M.

James Kingdom, lying on face, head down plane, March 23, 5 A. M.

Thomas Cole, lying on face, head down plane, March 24, 6.30 P. M.

Thomas Leyshon, lying on face, head down plane, March 28, 3.45 P. M.

Thomas Merriman, lying on face, head down plane, March 30, 2.45 P. M.

Joseph Olds, lying on face, head down plane, April 1, 7.45 A. M.

John D. Morris, lying with head down the plane, April 2, 4.30 A. M.

John Hamer, lying with head down the plane, April 2, 10.45 A. M.

Daniel W. Morgan, lying head up the plane, April 5, 10.30 P. M.

Thomas H. Picton, lying across the plane, April 6, 10 A. M.

All were within a short distance of each other in a distance of 200 feet, and all except one, who was under rock, covered by loose coal crushed from the pillars. The mine foreman, Thomas H. Picton, and Daniel W. Morgan had gone only a few feet from the place where they were working, and it is evident from the position that they were found in, that they were in the act of running down the plane when caught.

The Red Ash seam in this section of the mine was twenty feet thick, and although the pillars were large, it is most probable that, during the seven years idleness, enough had scaled off in some of the old breasts to make the pillars too weak to sustain the pressure. It is also probable that the squeeze had been progressing for some time before it was discovered.

An inquest was held on the death of the victims of this disaster by the deputy coroner and a jury of experienced men, and they rendered the following verdict:

"We, the jury, do say that Thos. H. Picton (and the others) came to their death through an error of judgment on their part, or on the part of the person or persons in charge of the party who lost their lives, thereby remaining too long in a place that, as appears to the jury, must have been plainly dangerous for some hours prior to the cave. The cause of the cave is, in our judgment, due to the inefficient size of the pillars left in the Red Ash seam, which were further reduced in size by the chipping of the pillars due to atmospheric causes and to the shocks caused by shots or blasts in the overlying vein. The jury recommend that the next Legislature so amend the present mine laws, if that be possible, so as to prevent miners and laborers from going or being sent into such places as make possible such catastrophies as that under consideration."

JOHN E. PERKINS,

Deputy Coroner.

A. REES,

D. S. DAVIS,

AUSTIN GINLEY,

JOHN E. MALONEY,

REES JONES,

P. B. NEALON,

Jury.

TABLE 1.—Showing location of collieries in the Fourth Anthracite District.

| Name of Colliery.                | Name of operator.                        | Location—Luzerne county. | Name of superintendent.  | Postoffice address. |  |               |  |                                   |
|----------------------------------|--|--------------------------|--|---------------------|--|---------------|--|-----------------------------------|
| 1. Hollenbach, .....             | Lehigh and Wilkes-Barre Coal Co., .....  | Wilkes-Barre, .....      | Elmer H. Lawall, general manager; Wm. J. Richards, chief mining engineer; Morgan R. Morgans, inside superintendent; W. H. Herring, outside superintendent. | Wilkes-Barre, Pa.   |  |               |  |                                   |
| 2. Empire, .....                 | do. do. do.                              | do. do. do.              |  |                     |  |               |  |                                   |
| 3. Stanton, Wilkes-Barre, .....  | do. do. do.                              | do. do. do.              |  |                     |  |               |  |                                   |
| 4. Jersey No. 8, .....           | do. do. do.                              | Ashley, .....            |  |                     |  |               |  |                                   |
| 5. Maxwell No. 29, .....         | do. do. do.                              | do. do. do.              |  |                     |  |               |  |                                   |
| 7. Shaft No. 3, .....            | do. do. do.                              | Sugar Notch, .....       |  |                     |  |               |  |                                   |
| 8. Lance No. 1, .....            | do. do. do.                              | Plymouth, .....          |  |                     |  |               |  |                                   |
| 9. Nottingham No. 1, .....       | do. do. do.                              | do. do. do.              |  |                     |  |               |  |                                   |
| 10. Reynolds, No. 16, .....      | do. do. do.                              | Wanamie, .....           |  |                     |  |               |  |                                   |
| 11. Wanamie Nos. 18 & 19 .....   | do. do. do.                              | Wilkes-Barre, .....      |  |                     |  |               |  |                                   |
| 12. Baltimore shaft No. 2, ..... | Delaware and Hudson Canal Company, ..... | do. do. do.              |  |                     | A. H. Vaniline, general manager; C. H. Scharar, chief mining engineer. | Scranton, Pa. |  |                                   |
| 13. Baltimore shaft No. 3, ..... | do. do. do.                              | do. do. do.              |  |                     |  |               |  |                                   |
| 14. Baltimore tunnel, .....      | do. do. do.                              | do. do. do.              |  |                     |  |               |  |                                   |
| 15. Conyngham, .....             | do. do. do.                              | Plymouth, .....          |  |                     |  |               |  |                                   |
| 16. Boston, .....                | do. do. do.                              | do. do. do.              |  |                     |  |               |  |                                   |
| 17. No. 2 Plymouth, .....        | do. do. do.                              | do. do. do.              |  |                     |  |               |  |                                   |
| 18. No. 3 Plymouth, .....        | do. do. do.                              | do. do. do.              |  |                     |  |               |  |                                   |
| 19. No. 4 Plymouth, .....        | do. do. do.                              | do. do. do.              |  |                     |  |               |  |                                   |
| 20. No. 5 Plymouth, .....        | do. do. do.                              | do. do. do.              |  |                     |  |               |  |                                   |
| 21. Colliery No. 3, .....        | Susquehanna Coal Company, .....          | West Nanticoke, .....    |  |                     |  |               | Irving A. Stearns, general manager; J. H. Bowden, chief mining engineer; George T. Morgan, general superintendent.<br>Daniel Edward, general manager.<br>do. do. do.<br>do. do. do.<br>W. R. Storrs, general manager; W. H. Stairs, general outside superintendent; John F. Snyder, chief mining engineer; E. Hughes, general inside superintendent. | Wilkes-Barre and Nanticoke, ..... |
| 22. Colliery No. 5, .....        | do. do. do.                              | Nanticoke, .....         |  |                     |  |               |  |                                   |
| 23. Colliery No. 6, .....        | do. do. do.                              | Glen Lyon, .....         |  |                     |  |               |  |                                   |
| 24. Colliery No. 7, .....        | do. do. do.                              | Nanticoke, .....         |  |                     |  |               |  |                                   |
| 25. Nos. 1 and 4 shafts, .....   | Kingston Coal Company, .....             | Edwardstale, .....       |  |                     |  |               |  |                                   |
| 26. Nos. 2 and 3 shafts, .....   | do. do. do.                              | do. do. do.              |  |                     |  |               |  |                                   |
| 27. Gaylord, .....               | do. do. do.                              | do. do. do.              |  |                     |  |               |  |                                   |
| 28. Avondale, .....              | Del. Lack. & Western Railroad Co., ..... | Plymouth township, ..... |  |                     |  |               |  |                                   |
| 29. Woodward, .....              | do. do. do.                              | do. do. do.              |  |                     |  |               |  |                                   |
| 30. Bliss, .....                 | do. do. do.                              | Hanover township, .....  |  |                     |  |               |  |                                   |
| 31. Auchincloss, .....           | do. do. do.                              | do. do. do.              |  |                     |  |               |  |                                   |
| 32. Dorrance, .....              | Lehigh Valley Coal Company, .....        | Wilkes-Barre, .....      | W. A. Lathrop, .....   | Wilkes-Barre, Pa.   |  |               |  |                                   |
| 33. Franklin, .....              | do. do. do.                              | do. do. do.              |  |                     |  |               |  |                                   |
| 34. No. 1 Red Ash, .....         | Red Ash Coal Company, .....              | Wilkes-Barre twp., ..... |  |                     |  |               |  |                                   |
| 35. No. 2 Red Ash, .....         | do. do. do.                              | do. do. do.              |  |                     |  |               |  |                                   |
| 36. Alden, .....                 | Alden Coal Company, .....                | Alden, .....             |  |                     |  |               |  |                                   |
| 37. Dodson, .....                | Plymouth Coal Company, .....             | Plymouth, .....          |  |                     |  |               |  |                                   |
| 38. Parrish, .....               | Parrish Coal Company, .....              | do. do. do.              |  |                     |  |               |  |                                   |
| 39. Buttonwood, .....            | do. do. do.                              | Hanover township, .....  |  |                     |  |               |  |                                   |
| 40. West End, .....              | West End Coal Company, .....             | Mocanqua, .....          |  |                     |  |               |  |                                   |
| 41. Lee, .....                   | Newport Coal Company, .....              | Newport township, .....  |  |                     |  |               |  |                                   |
| 42. Maffet, .....                | Hanover Coal Company, .....              | Sugar Notch, .....       | John Conyngham, Charles Parrish, Jacob Roberts, Jr., S. J. Tonkin, A. J. Davis, .....  | Wilkes-Barre, Pa.   |  |               |  |                                   |
| 43. Hillman vein, .....          | Hillman Vein Coal Company, .....         | Wilkes-Barre, .....      |  |                     |  |               |  |                                   |
| 44. Warrior Run, .....           | A. J. Davis, .....                       | Warrior Run, .....       |  |                     |  |               |  |                                   |
|                                  |  |                          |  |                     |  |               |  |                                   |

TABLE No. 2.—(Gives the total number of tons of coal mined and tons of coal shipped in each colliery, number of days worked, number of employes, number of persons killed and injured, number of kegs of powder used, &c., in the Fourth Anthracite Mining District, for the year ending December 31, 1894.

| Names of Collieries                          | Location.          | Total production in tons of coal. | Total shipment in tons of coal. | Number of days worked. | Number of persons employed. | Number of fatal accidents. | Number non-fatal accidents. | Number of kegs powder used. | Number steam boilers. | Number horses and mules. | Number mine locomotives. |
|--|--------------------|-----------------------------------|---------------------------------|------------------------|-----------------------------|----------------------------|-----------------------------|-----------------------------|-----------------------|--------------------------|--------------------------|
| <b>Lehigh and Wilkes-Barre Coal Company.</b> |                    |                                   |                                 |                        |                             |                            |                             |                             |                       |                          |                          |
| 1. Hollenbach No. 2.                         | Wilkes-Barre.      | 125,228.90                        | 105,377.65                      | 124.20                 | 527                         | 1                          | 7                           | 4,172                       | 39                    | 5                        | .....                    |
| 2. Empire No. 4.                             | do.                | 181,537.65                        | 178,907.55                      | 119.23                 | 771                         | .....                      | 12                          | 4,615                       | 30                    | 77                       | 2                        |
| 3. South Wilkes-Barre No. 5.                 | do.                | 284,145.90                        | 255,011.90                      | 137.10                 | 769                         | 1                          | 11                          | 6,796                       | 48                    | 77                       | 1                        |
| 4. Stanton No. 7.                            | do.                | 173,033.95                        | 163,696.35                      | 125.05                 | 676                         | 3                          | 9                           | 3,594                       | 31                    | 73                       | 1                        |
| 5. Jersey No. 8.                             | Ashley.            | 87,074.30                         | 81,882.80                       | 117.90                 | 415                         | 2                          | 3                           | 2,332                       | 23                    | 68                       | 1                        |
| 6. Sugar Notch No. 9.                        | Sugar Notch.       | 138,493.15                        | 136,381.65                      | 115.70                 | 624                         | .....                      | 6                           | 5,148                       | 20                    | 80                       | .....                    |
| 7. Lance No. 11.                             | Plymouth.          | 166,152.35                        | 164,472.35                      | 115.60                 | 736                         | .....                      | 8                           | 4,698                       | 54                    | 101                      | 2                        |
| 8. Nottingham No. 15.                        | do.                | 337,476.85                        | 331,138.85                      | 125.25                 | 1,900                       | 3                          | 8                           | 7,862                       | 34                    | 103                      | .....                    |
| 9. Reynolds No. 16.                          | do.                | 114,364.35                        | 114,498.60                      | 116.75                 | 529                         | .....                      | 1                           | 3,122                       | 3                     | 77                       | 2                        |
| 10. Wanamle Nos. 18 and 19.                  | Wanamle.           | 170,543.60                        | 168,701.10                      | 119                    | 632                         | 2                          | .....                       | 5,250                       | 30                    | 91                       | 2                        |
| <b>Totals.</b>                               |                    | <b>1,778,284.40</b>               | <b>1,700,068.90</b>             | <b>121.53</b>          | <b>6,673</b>                | <b>17</b>                  | <b>65</b>                   | <b>48,530</b>               | <b>283</b>            | <b>740</b>               | <b>11</b>                |
| <b>Delaware and Hudson Canal Company.</b>    |                    |                                   |                                 |                        |                             |                            |                             |                             |                       |                          |                          |
| 11. Baltimore No. 2.                         | Wilkes-Barre.      | 102,008.10                        | 102,908.10                      | 176                    | 387                         | .....                      | 2                           | 4,587                       | 18                    | 27                       | .....                    |
| 12. Baltimore No. 3.                         | do.                | 99,482.90                         | 99,482.90                       | 180.50                 | 587                         | 1                          | 1                           | 3,988                       | 24                    | 19                       | .....                    |
| 13. Baltimore tunnel.                        | do.                | 126,477.85                        | 123,677.45                      | 188.25                 | 517                         | .....                      | 2                           | 4,324                       | 24                    | 48                       | 2                        |
| 14. Conyngham.                               | do.                | 122,708.05                        | 120,296.95                      | 222                    | 352                         | .....                      | 3                           | 4,286                       | 28                    | 33                       | .....                    |
| 15. Boston.                                  | Plymouth township. | *152,407.60                       | 145,957.00                      | 166                    | 324                         | .....                      | .....                       | 2,885                       | 24                    | 48                       | .....                    |
| 16. Shaft No. 2.                             | Plymouth.          | 193,409.65                        | 183,409.65                      | 175.25                 | 402                         | .....                      | 6                           | 4,617                       | 40                    | 63                       | .....                    |
| 17. Shaft No. 3.                             | do.                | 167,302.95                        | 166,456.95                      | 153                    | 443                         | 1                          | .....                       | 6,136                       | 21                    | 61                       | .....                    |
| 18. Shaft No. 4.                             | do.                | 150,851.45                        | 150,851.45                      | 180.50                 | 440                         | .....                      | .....                       | 4,959                       | 15                    | 61                       | .....                    |
| 19. Shaft No. 5.                             | do.                | 147,290                           | 140,202.75                      | 175.50                 | 359                         | .....                      | .....                       | 4,142                       | 21                    | 69                       | 1                        |
| <b>Totals.</b>                               |                    | <b>1,262,838.55</b>               | <b>1,243,151.80</b>             | <b>179.66</b>          | <b>3,501</b>                | <b>2</b>                   | <b>14</b>                   | <b>39,504</b>               | <b>215</b>            | <b>429</b>               | <b>3</b>                 |

|   |                              |              |              |       |    |    |        |     |     |    |  |  |
|---|------------------------------|--------------|--------------|-------|----|----|--------|-----|-----|----|--|--|
| Susquehanna Coal Company.                   |                              |              |              |       |    |    |        |     |     |    |  |  |
| 20.   | Shaft No. 1, Breaker No. 7.  | 471,102.50   | 212.15       | 1,395 | 7  | 15 | 46     | 190 | 7   |    |  |  |
| 21.   | Slope No. 2, Breaker No. 7.  | 88,769.20    | 136.75       | 147   | 1  | 1  | 12     | 22  | 1   |    |  |  |
| 22.   | No. 3 colliery.              |              |              |       | 4  | 4  | 30,655 | 93  | 4   |    |  |  |
| 23.   | No. 2 shaft, Breaker No. 5.  | 457,163.70   | 216.80       | 1,394 | 6  | 12 |        |     |     |    |  |  |
| 24.   | No. 4 slope, Breaker No. 5.  |              | 1,344,192.85 |       | 2  | 11 |        |     |     |    |  |  |
| 25.   | No. 6 shaft, Breaker No. 6.  |              |              | 1,181 | 2  | 4  |        | 66  | 118 | 2  |  |  |
| 26.   | No. 6 shaft, Breaker No. 6.  | 348,624.95   | 195.65       | 1,181 | 2  | 4  |        |     |     |    |  |  |
| 27.   | No. 6 tunnel, Breaker No. 6. |              |              |       | 1  | 1  |        |     |     |    |  |  |
| Totals.                                     |                              | 1,365,660.35 | 1,344,192.85 | 4,117 | 20 | 48 | 30,655 | 217 | 445 | 14 |  |  |
| Kingston Coal Company.                      |                              |              |              |       |    |    |        |     |     |    |  |  |
| 28.   | Shaft No. 1, Breaker No. 4.  | 240,620.50   | 181.85       | 818   | 1  | 7  | 7,248  | 62  | 92  |    |  |  |
| 29.   | Shaft No. 4, Breaker No. 4.  |              |              |       | 4  | 8  |        |     |     |    |  |  |
| 30.   | Shaft No. 2, Breaker No. 2.  | 348,302.65   | 596.45       | 966   | 3  | 3  | 9,858  | 43  | 56  | 3  |  |  |
| 31.   | Shaft No. 3, Breaker No. 2.  |              |              |       | 7  | 7  |        |     |     |    |  |  |
| 22  | Gaylord shaft and slope.     | 94,890.55    | 139.65       | 348   | 13 | 3  | 3,925  | 31  | 57  |    |  |  |
| Totals.                                     |                              | 683,813.70   | 668,528.85   | 2,162 | 21 | 28 | 21,031 | 136 | 245 | 3  |  |  |
| Delaware, Lackawanna & Western Railroad Co. |                              |              |              |       |    |    |        |     |     |    |  |  |
| 33.   | Avondale.                    | *140,489.25  | 171.30       | 464   |    | 7  | 3,700  | 50  | 54  | 1  |  |  |
| 34.   | Woodward.                    | *239,890.20  | 167          | 1,026 | 1  | 14 | 8,429  | 44  | 104 | 2  |  |  |
| Totals.                                     |                              | 470,379.45   | 427,377.45   | 1,499 | 1  | 21 | 12,129 | 94  | 158 | 3  |  |  |
| Lehigh Valley Coal Company.                 |                              |              |              |       |    |    |        |     |     |    |  |  |
| 35.   | Dorrance.                    | 144,899.10   | 135,823.85   | 375   | 1  | 10 | 3,222  | 21  | 45  | 1  |  |  |
| 36.   | Franklin.                    | 190,362.75   | 144,859.75   | 566   | 2  | 6  | 4,245  | 37  | 55  | 1  |  |  |
| Totals.                                     |                              | 305,262.85   | 280,683.60   | 941   | 3  | 16 | 7,467  | 58  | 100 | 2  |  |  |
| Red Ash Coal Company.                       |                              |              |              |       |    |    |        |     |     |    |  |  |
| 37.   | Red Ash No. 1.               | 56,530.80    | 127.95       | 324   |    | 1  | 2,890  | 15  | 20  | 1  |  |  |
| 38.   | Red Ash No. 2.               | 116,190.50   | 123.40       | 587   |    | 2  | 3,463  | 8   | 35  |    |  |  |
| Totals.                                     |                              | 212,721.30   | 209,732.30   | 711   |    | 3  | 6,353  | 23  | 55  | 1  |  |  |
| Parrish Coal Company.                       |                              |              |              |       |    |    |        |     |     |    |  |  |
| 39.   | Parrish.                     | 83,278.55    | 113.65       | 384   |    | 3  | 2,492  | 34  | 50  |    |  |  |
| 40.   | Buttonwood.                  | 24,240.80    | 50           | 254   |    | 6  | 695    | 4   | 17  |    |  |  |
| Totals.                                     |                              | 107,519.35   | 104,887.85   | 638   |    | 9  | 3,188  | 38  | 67  |    |  |  |

\* These contain the estimated amount of coal used to produce steam at the mines.

TABLE No. 2.—Continued.

| Names of Collieries                 | Location.          | Total production in tons of coal. | Total shipment in tons of coal. | Number of days worked. | Number of persons employed. | Number of fatal accidents. | Number non-fatal accidents. | Number of kegs powder used. | Number steam boilers. | Numbers horses and mules. | Number mine locomotives. |
|-------------------------------------|--------------------|-----------------------------------|---------------------------------|------------------------|-----------------------------|----------------------------|-----------------------------|-----------------------------|-----------------------|---------------------------|--------------------------|
| Miscellaneous Coal Companies        |                    |                                   |                                 |                        |                             |                            |                             |                             |                       |                           |                          |
| 41. Alden Coal Company.             | Albion.            | *193,514.20                       | 183,731.15                      | 153.04                 | 629                         | 1                          | 8                           | 5,473                       | 19                    | 67                        | .....                    |
| 42. Dodson Plymouth Coal Company.   | Plymouth.          | *193,151.80                       | 170,661.80                      | 295.75                 | 457                         | 1                          | 4                           | 6,330                       | 34                    | 37                        | .....                    |
| 43. Maifet, Hanover Coal Company.   | Sugar Notch.       | 67,116.60                         | 66,412.80                       | 148.67                 | 224                         | .....                      | 1                           | 1,757                       | 22                    | 67                        | .....                    |
| 44. West End Coal Company.          | Mocanaqua.         | *224,326.35                       | 201,901.59                      | 243.89                 | 560                         | 2                          | 5                           | 5,894                       | 14                    | 21                        | .....                    |
| 45. Hillman Veth Coal Company.      | Wilkes-Barre.      | *117,826.40                       | 54,068.15                       | 156.25                 | 239                         | 3                          | 3                           | 2,827                       | 12                    | 21                        | .....                    |
| 46. Warrior Run, A. J. Davls.       | Warrior Run.       | *117,826.40                       | 101,663.68                      | 186.40                 | 343                         | .....                      | 2                           | 3,050                       | 30                    | 18                        | .....                    |
| 47. Lee, Newport Coal Company.      | Newport township.  | 26,065.20                         | 25,815.29                       | 100.45                 | .....                       | .....                      | .....                       | 6                           | 9                     | .....                     | .....                    |
| 48. Chauncey, The Reynolds & Moyer. | Plymouth township. | 30,191.40                         | 30,121.49                       | .....                  | 48                          | .....                      | .....                       | .....                       | 2                     | 5                         | .....                    |
| 49. Kidder Coal Company.            | Wilkes-Barre.      | *46,844.95                        | 43,911.15                       | 219.10                 | 21                          | .....                      | .....                       | .....                       | .....                 | .....                     | .....                    |
| Totals.                             | .....              | 376,482.10                        | 878,186.75                      | 181.79                 | 2,541                       | 7                          | 23                          | 26,317                      | 142                   | 245                       | 3                        |

## Recapitulation.

|  |              |              |        |        |       |     |         |       |       |       |
|--|--------------|--------------|--------|--------|-------|-----|---------|-------|-------|-------|
| Lehigh and Wilkes-Barre Coal Company.              | 1,778,284.40 | 1,790,068.59 | 121.33 | 6,573  | 17    | 65  | 48,550  | 282   | 740   | 11    |
| Delaware and Hudson Coal Company.                  | 1,262,833.55 | 1,213,151.80 | 179.06 | 3,501  | 2     | 14  | 39,504  | 215   | 429   | 3     |
| Susquehanna Coal Company.                          | 1,365,660.35 | 1,344,192.85 | 190.34 | 4,117  | 20    | 48  | 30,665  | 217   | 445   | 4     |
| Kingston Coal Company.                             | 683,813.70   | 688,288.85   | 175.98 | 2,490  | 21    | 28  | 21,031  | 136   | 245   | 3     |
| Delaware, Laekawanna and Western Railroad Company. | 470,379.45   | 427,377.45   | 169.15 | 1,490  | 1     | 21  | 12,129  | 94    | 158   | 2     |
| Lehigh Valley Coal Company.                        | 395,251.85   | 280,683.69   | 151.37 | 531    | 3     | 16  | 7,467   | 58    | 109   | 2     |
| Red Ash Coal Company.                              | 212,721.39   | 200,732.39   | 125.67 | 711    | ..... | 3   | 6,353   | 23    | 56    | 11    |
| Farrish Coal Company.                              | 107,519.35   | 104,887.85   | 81.82  | 638    | ..... | 9   | 3,458   | 67    | ..... | ..... |
| Miscellaneous Coal Companies.                      | 376,482.10   | 878,186.75   | 181.79 | 2,541  | 7     | 23  | 26,317  | 142   | 245   | 3     |
| Grand totals.                                      | 7,162,461.35 | 6,856,810.35 | 153.10 | 92,764 | 71    | 227 | 195,154 | 1,296 | 2,484 | 39    |

\*All these contain the estimated amount of coal used to produce steam at the mines. In addition to the above number of accidents there were six fatally injured and six seriously injured in new openings in process of sinking, viz: Bliss, two killed and two injured. Archibless, one killed and one injured. Hanover slope, two killed. Maxwell, one fatally injured and two seriously hurt. South Wilkes-Barre air-shaft, one killed. Adding these makes the total number killed 77, and the total number injured 233.



TABLE NO. 3.—Showing the number of employees at each colliery in the Fourth Anthracite District, during the year 1894.

| Names of Collieries.                 | Occupations of Persons Employed Inside. |         |                   |                  |                      |                        |               | Occupations of Persons Employed Outside. |                             |                        |                |                        |   |                |                                 |
|--------------------------------------|---|---------|-------------------|------------------|----------------------|------------------------|---------------|--|-----------------------------|------------------------|----------------|------------------------|---|----------------|---------------------------------|
|                                      | Inside foremen.                         | Miners. | Miners' laborers. | All company men. | Drivers and runners. | Door boys and helpers. | Total inside. | Outside foremen.                         | Blacksmiths and carpenters. | Engineers and firemen. | State pickers. | All other company men. | Superintendents, book-keepers and clerks. | Total outside. | Grand total inside and outside. |
| Lehigh and Wilkes-Barre Coal Company |   |         |                   |                  |                      |                        |               |  |                             |                        |                |                        |   |                |                                 |
| 1. Hollenback No. 2.                 | 1                                       | 139     | 42                | 40               | 43                   | 19                     | 294           | 1  | 5                           | 17                     | 121            | 68                     | 1   | 223            | 527                             |
| 2. Empire No. 4.                     | 1                                       | 180     | 160               | 65               | 56                   | 24                     | 518           | 1  | 1                           | 17                     | 150            | 81                     | 1   | 253            | 771                             |
| 3. South Wilkes-Barre.               | 1                                       | 172     | 166               | 93               | 70                   | 57                     | 518           | 1  | 8                           | 27                     | 177            | 89                     | 3   | 250            | 769                             |
| 4. Stanton No. 7.                    | 1                                       | 123     | 127               | 45               | 35                   | 25                     | 383           | 1  | 1                           | 26                     | 188            | 69                     | 3   | 292            | 676                             |
| 5. Jersey No. 8.                     | 1                                       | 103     | 87                | 42               | 35                   | 58                     | 293           | 1  | 2                           | 16                     | 98             | 58                     | 3   | 178            | 416                             |
| 6. Sugar Notch No. 9.                | 1                                       | 148     | 135               | 48               | 36                   | 32                     | 407           | 1  | 7                           | 17                     | 136            | 57                     | 2   | 220            | 624                             |
| 7. Lance No. 1.                      | 1                                       | 130     | 125               | 100              | 91                   | 33                     | 480           | 1  | 6                           | 18                     | 175            | 54                     | 2   | 256            | 736                             |
| 8. Nottingham No. 15.                | 1                                       | 249     | 132               | 119              | 71                   | 22                     | 611           | 1  | 8                           | 26                     | 130            | 86                     | 2   | 386            | 1,000                           |
| 9. Reynolds No. 14.                  | 1                                       | 242     | 104               | 50               | 48                   | 23                     | 323           | 1  | 4                           | 12                     | 130            | 46                     | 1   | 194            | 523                             |
| 10. Wabanic Nos. 14 and 19.          | 3                                       | 182     | 130               | 28               | 80                   | 17                     | 410           | 1  | 6                           | 21                     | 130            | 63                     | 1   | 222            | 632                             |
| Totals.                              | 14                                      | 1,518   | 1,193             | 637              | 585                  | 252                    | 4,199         | 10                                       | 55                          | 195                    | 1,530          | 660                    | 15  | 2,474          | 6,673                           |
| Delaware and Hudson Canal Company.   |   |         |                   |                  |                      |                        |               |  |                             |                        |                |                        |   |                |                                 |
| 11. Baltimore No. 2.                 | 1                                       | 54      | 74                | 36               | 29                   | 10                     | 224           | 1  | 5                           | 8                      | 119            | 29                     | 1   | 163            | 387                             |
| 12. Baltimore No. 3.                 | 1                                       | 70      | 80                | 26               | 45                   | 3                      | 215           | 1  | 6                           | 18                     | 107            | 40                     | 1   | 172            | 387                             |
| 13. Baltimore tunnel.                | 1                                       | 80      | 80                | 38               | 44                   | 10                     | 253           | 1  | 5                           | 16                     | 91             | 47                     | 3   | 164            | 417                             |
| 14. Coningham.                       | 1                                       | 68      | 68                | 29               | 37                   | 16                     | 219           | 1  | 5                           | 16                     | 80             | 40                     | 1   | 143            | 362                             |
| 15. Boston.                          | 1                                       | 70      | 70                | 33               | 20                   | 10                     | 204           | 1  | 5                           | 14                     | 58             | 40                     | 2   | 120            | 324                             |
| 16. Shaft No. 2 Plymouth.            | 1                                       | 42      | 97                | 32               | 37                   | 9                      | 268           | 1  | 5                           | 15                     | 69             | 42                     | 2   | 134            | 402                             |
| 17. Shaft No. 3 Plymouth.            | 2                                       | 103     | 167               | 47               | 45                   | 32                     | 336           | 1  | 4                           | 14                     | 104            | 55                     | 32  | 107            | 443                             |
| 18. Shaft No. 4 Plymouth.            | 1                                       | 102     | 102               | 49               | 54                   | 21                     | 329           | 1  | 5                           | 10                     | 59             | 34                     | 2   | 111            | 440                             |
| 19. Shaft No. 5 Plymouth.            | 1                                       | 72      | 72                | 59               | 30                   | 14                     | 248           | 1  | 5                           | 9                      | 38             | 36                     | 2   | 91             | 329                             |
| Totals.                              | 10                                      | 731     | 740               | 349              | 341                  | 125                    | 2,296         | 9  | 45                          | 120                    | 676            | 340                    | 15  | 1,295          | 3,591                           |

TABLE No. 3.—Continued.

| Names of Collieries.                          | Occupations of Persons Employed Inside. |         |                   |                  |                      |                        |               | Occupations of Persons Employed Outside. |                             |                        |                |                        |  |                |                                 |
|---|---|---------|-------------------|------------------|----------------------|------------------------|---------------|--|-----------------------------|------------------------|----------------|------------------------|--|----------------|---------------------------------|
|   | Inside foremen.                         | Miners. | Miners' laborers. | All company men. | Drivers and runners. | Door boys and helpers. | Total inside. | Outside foremen.                         | Blacksmiths and carpenters. | Engineers and firemen. | State pickers. | All other company men. | Superintendents, bookkeepers and clerks. | Total outside. | Grand total inside and outside. |
| Susquehanna Coal Company.                     |   |         |                   |                  |                      |                        |               |  |                             |                        |                |                        |  |                |                                 |
| 20. No. 1 shaft.                              | 2                                       | 271     | 440               | 179              | 114                  | 97                     | 1,102         | 1  | 9                           | 29                     | 137            | 114                    | 2  | 292            | 1,395                           |
| 21. No. 2 shaft.                              | 1                                       | 18      | 37                | 7                | 9                    | .....                  | 72            | 1  | 3                           | 3                      | 33             | 35                     | .....                                    | 75             | 147                             |
| 22. No. 3 shaft.                              | 2                                       | 272     | 435               | 159              | 135                  | 59                     | 1,066         | 1  | 37                          | 34                     | 120            | 134                    | 2  | 328            | 1,394                           |
| 23. No. 4 shaft.                              | 3                                       | 296     | 320               | 126              | 127                  | 38                     | 920           | 1  | 9                           | 20                     | 127            | 103                    | 1  | 261            | 1,181                           |
| 24. No. 5 shaft.                              | .....                                   | .....   | .....             | .....            | .....                | .....                  | .....         | .....                                    | .....                       | .....                  | .....          | .....                  | .....                                    | .....          | .....                           |
| 25. No. 6 slope.                              | .....                                   | .....   | .....             | .....            | .....                | .....                  | .....         | .....                                    | .....                       | .....                  | .....          | .....                  | .....                                    | .....          | .....                           |
| 26. No. 6 tunnel.                             | .....                                   | .....   | .....             | .....            | .....                | .....                  | .....         | .....                                    | .....                       | .....                  | .....          | .....                  | .....                                    | .....          | .....                           |
| 27. No. 6 tunnel.                             | .....                                   | .....   | .....             | .....            | .....                | .....                  | .....         | .....                                    | .....                       | .....                  | .....          | .....                  | .....                                    | .....          | .....                           |
| Totals.                                       | 8                                       | 858     | 1,242             | 471              | 388                  | 194                    | 3,161         | 4  | 58                          | 86                     | 417            | 386                    | 5  | 956            | 4,117                           |
| Kingston Coal Company.                        |   |         |                   |                  |                      |                        |               |  |                             |                        |                |                        |  |                |                                 |
| 28. Shaft No. 1, Breaker No. 4.               | 2                                       | 70      | 60                | 48               | 25                   | 25                     | 230           | 3  | 12                          | 18                     | 186            | 75                     | 3  | 297            | 818                             |
| 29. Shaft No. 3, Breaker No. 4.               | 2                                       | 100     | 80                | 43               | 44                   | 22                     | 291           | 1  | 3                           | 16                     | 174            | 117                    | 2  | 325            | 906                             |
| 30. Shaft No. 2, Breaker No. 2.               | 3                                       | 241     | 204               | 96               | 83                   | 44                     | 671           | 1  | 12                          | 7                      | 73             | 37                     | 1  | 122            | 348                             |
| 31. Shaft No. 3.                              | 1                                       | 101     | 40                | 23               | 39                   | 12                     | 226           | 1  | 3                           | .....                  | .....          | .....                  | .....                                    | .....          | .....                           |
| 32. Gaylord.                                  | .....                                   | .....   | .....             | .....            | .....                | .....                  | .....         | .....                                    | .....                       | .....                  | .....          | .....                  | .....                                    | .....          | .....                           |
| Totals.                                       | 8                                       | 512     | 384               | 220              | 191                  | 103                    | 1,418         | 7  | 28                          | 41                     | 433            | 229                    | 6  | 744            | 2,162                           |
| Delaware, Lackawanna and Western Railroad Co. |   |         |                   |                  |                      |                        |               |  |                             |                        |                |                        |  |                |                                 |
| 33. Avondale.                                 | 1                                       | 102     | 102               | 55               | 40                   | 11                     | 311           | 1  | 12                          | 11                     | 77             | 52                     | .....                                    | 153            | 464                             |
| 34. Woodward.                                 | 1                                       | 245     | 279               | 62               | 121                  | 55                     | 772           | 1  | 15                          | 12                     | 106            | 118                    | .....                                    | 253            | 1,026                           |
| Totals.                                       | 2                                       | 347     | 381               | 117              | 171                  | 66                     | 1,084         | 2  | 27                          | 24                     | 183            | 170                    | .....                                    | 406            | 1,490                           |

| Lehigh Valley Coal Company.                              |   |     |     |     |     |    |       |   |    |    |     |     |    |     |       |
|--|---|-----|-----|-----|-----|----|-------|---|----|----|-----|-----|----|-----|-------|
| 55. Dorrance .....                                       | 2 | 82  | 94  | 29  | 50  | 11 | 269   | 1 | 11 | 17 | 42  | 32  | 4  | 107 | 376   |
| 36. Franklin .....                                       | 1 | 120 | 95  | 43  | 53  | 16 | 328   | 1 | 10 | 18 | 120 | 65  | 3  | 227 | 555   |
| Totals, .....  | 3 | 202 | 189 | 73  | 103 | 27 | 597   | 2 | 21 | 35 | 172 | 97  | 7  | 334 | 931   |
| Red Ash Coal Company.                                    |   |     |     |     |     |    |       |   |    |    |     |     |    |     |       |
| 37. Red Ash No. 1 .....                                  | 1 | 82  | 82  | 21  | 22  | 12 | 220   | 1 | 4  | 7  | 49  | 41  | 2  | 104 | 324   |
| 38. Red Ash No. 2 .....                                  | 1 | 93  | 93  | 14  | 38  | 11 | 250   | 1 | 5  | 4  | 69  | 56  | 2  | 137 | 387   |
| Totals, .....  | 2 | 175 | 175 | 35  | 60  | 23 | 470   | 2 | 9  | 11 | 118 | 97  | 4  | 241 | 711   |
| Parrish Coal Company.                                    |   |     |     |     |     |    |       |   |    |    |     |     |    |     |       |
| 39. Parrish .....  | 1 | 67  | 72  | 59  | 19  | 12 | 231   | 1 | 5  | 25 | 67  | 52  | 3  | 152 | 384   |
| 40. Buttonwood .....                                     | 1 | 52  | 36  | 33  | 15  | 9  | 146   | 1 | 5  | 10 | 49  | 41  | 2  | 108 | 254   |
| Totals, .....  | 2 | 119 | 109 | 92  | 34  | 21 | 377   | 2 | 10 | 35 | 116 | 93  | 5  | 261 | 638   |
| Miscellaneous Coal Companies.                            |   |     |     |     |     |    |       |   |    |    |     |     |    |     |       |
| 41. Alden Coal Company, .....                            | 1 | 120 | 117 | 53  | 58  | 29 | 378   | 1 | 11 | 10 | 156 | 67  | 6  | 251 | 629   |
| 42. Dodson Plymouth Coal Company, .....                  | 1 | 75  | 95  | 79  | 50  | 21 | 321   | 1 | 5  | 10 | 80  | 37  | 3  | 136 | 457   |
| 43. Maffet Hanover Coal Company, .....                   | 2 | 50  | 49  | 15  | 17  | 3  | 136   | 1 | 3  | 7  | 38  | 36  | 3  | 88  | 224   |
| 44. West End Coal Company, .....                         | 2 | 140 | 169 | 21  | 44  | 5  | 381   | 2 | 7  | 16 | 35  | 35  | 4  | 179 | 560   |
| 45. Hillman Vein Coal Company, .....                     | 1 | 62  | 62  | 24  | 11  | 14 | 173   | 1 | 2  | 7  | 44  | 28  | 3  | 85  | 239   |
| 46. Warrior Run, A. J. Davis, .....                      | 1 | 101 | 76  | 30  | 18  | 15 | 241   | 1 | 5  | 10 | 61  | 23  | 2  | 102 | 343   |
| 47. Lee, Newport Coal Company, * .....                   |   |     |     |     |     |    |       |   |    |    |     |     |    |     |       |
| 48. Chauncey, The Reynolds and Moyer Coal Company, ..... | 1 | 4   | 11  |     |     |    | 16    | 1 | 2  | 2  | 13  | 13  | 1  | 32  | 48    |
| 49. Kidder Coal Company,   .....                         |   |     |     |     |     |    |       |   |    |    | 5   | 12  | 2  | 21  | 21    |
| Total, .....   | 9 | 552 | 579 | 222 | 198 | 87 | 1,647 | 9 | 35 | 63 | 492 | 271 | 24 | 894 | 2,541 |

*Recapitulation.*

|  |    |       |       |       |       |     |        |    |     |     |       |       |       |       |        |
|--|----|-------|-------|-------|-------|-----|--------|----|-----|-----|-------|-------|-------|-------|--------|
| Lehigh and Wilkes-Barre Coal Company, .....          | 14 | 1,518 | 1,195 | 637   | 585   | 252 | 4,199  | 10 | 55  | 185 | 1,530 | 666   | 18    | 2,474 | 6,673  |
| Delaware and Hudson Canal Company, .....             | 10 | 731   | 740   | 349   | 341   | 125 | 2,296  | 9  | 45  | 120 | 976   | 340   | 15    | 1,205 | 2,501  |
| Susquehanna Coal Company, .....                      | 8  | 868   | 1,242 | 471   | 388   | 194 | 3,101  | 4  | 58  | 86  | 417   | 386   | 5     | 956   | 4,117  |
| Kingston Coal Company, .....                         | 8  | 642   | 384   | 210   | 191   | 103 | 1,418  | 7  | 28  | 41  | 432   | 229   | 6     | 744   | 2,162  |
| Delaware, Lackawanna and Western Railroad Co., ..... | 3  | 317   | 381   | 117   | 171   | 66  | 1,084  | 2  | 24  | 24  | 183   | 170   | ..... | 406   | 1,490  |
| Lehigh Valley Coal Company, .....                    | 3  | 202   | 185   | 73    | 103   | 27  | 597    | 2  | 21  | 35  | 172   | 97    | 7     | 334   | 931    |
| Red Ash Coal Company, .....                          | 2  | 175   | 175   | 35    | 60    | 23  | 470    | 2  | 9   | 11  | 118   | 97    | 4     | 241   | 711    |
| Parrish Coal Company, .....                          | 2  | 119   | 109   | 92    | 34    | 21  | 377    | 2  | 10  | 35  | 116   | 93    | 5     | 261   | 638    |
| Miscellaneous coal companies, .....                  | 9  | 552   | 579   | 222   | 198   | 87  | 1,647  | 9  | 35  | 63  | 492   | 271   | 24    | 894   | 2,541  |
| Totals, .....  | 58 | 5,014 | 4,992 | 2,216 | 2,071 | 898 | 15,219 | 47 | 288 | 610 | 4,137 | 2,349 | 84    | 7,515 | 22,764 |

There were 308 persons employed in new shafts not accounted for in this table, adding which would show the total number of employees to be 23,102.  
 \*Not working at the end of the year.  
 ||Culm bank separator.

TABLE NO. 4.—List of fatal accidents that occurred in and about the mines of the Fourth Anthracite Mine District, for the year ended December 31, 1894.

| Date of accident. | Number of accident. | Name of Person          | Occupation.         | Age. | Widow. | Number of orphans. | Name of Colliery.          | Location—Luzerne County. | Nature and Cause of Accident.   |
|-------------------|---------------------|-------------------------|---------------------|------|--------|--------------------|----------------------------|--------------------------|---|
| Jan 27,           | 1                   | John Day, .....         | Door tender,.....   | 17   | .....  | .....              | Shaft No. 6, .....         | Glen Lyon, .....         | Fatally crushed between cars when away from his door. Died Jan. 29, 1894.   |
| Feb. 3,           | 2                   | Frank Polochko, .....   | Laborer, .....      | 26   | .....  | .....              | Shaft No. 3, .....         | Plymouth, .....          | Fatally crushed by a fall of rock at face of working place; died same day.  |
| 5,                | 3                   | Thomas J. Hughes,.....  | Miner, .....        | 50   | 1      | 6                  | Shaft No. 4, .....         | Edwardsdale, .....       | Killed by a fall of top while in the act of tamping a hole for blasting; his laborer was also hurt badly.   |
| 7,                | 4                   | Louis Tumbler, .....    | Miner, .....        | 50   | .....  | .....              | Hillman Vein, .....        | Wilkes-Barre, .....      | Instantly killed by a blast; it exploded before he had moved when igniting the match.   |
| 9,                | 5                   | August Brodoski, .....  | Laborer, .....      | 26   | .....  | .....              | Slope No. 6, .....         | Glen Lyon, .....         | Instantly killed by a fall of slate from the top bench of coal in the breast.   |
| 9,                | 6                   | August Sheffer, .....   | Driver, .....       | 19   | .....  | .....              | Shaft No. 1, G seam, ..... | Nanticoke, .....         | A piece of strap iron penetrated his body when riding on front of car; died Feb. 17.  |
| 13,               | 7                   | Peter McLaughlin, ..... | Miner, .....        | 37   | 1      | 3                  | .....                      | .....                    | All these men were engaged setting props up against the pillar on No. 1 gravity plane; a squeeze was found to exist somewhere about three hundred feet west of this plane, and extending over two or three lifts; it was in the Red Ash seam, which is twenty feet in thickness; it was believed that the pillar on the west side of the plane would stay the squeeze until the cave would break down, and these men were taken there to set props and lagging to strengthen the pillar; Thomas Picton; they commenced work at about seven o'clock in the evening and at 2.15 A. M. of Tuesday, Feb. 13, the cave occurred, and caught all the men under; not one es- |
| 13,               | 8                   | Michael Welsh, .....    | Miner, .....        | 38   | 1      | 6                  | .....                      | .....                    |   |
| 13,               | 9                   | Thomas J. Jones, .....  | Miner, .....        | 49   | 1      | 6                  | .....                      | .....                    |   |
| 13,               | 10                  | Richard Davies, .....   | Runner, .....       | 23   | 1      | 1                  | .....                      | .....                    |   |
| 13,               | 11                  | James Kingdon, .....    | Miner, .....        | 33   | 1      | 2                  | .....                      | .....                    |   |
| 13,               | 12                  | Thomas Cole, .....      | Miner, .....        | 34   | W.     | .....              | .....                      | .....                    |   |
| 13,               | 13                  | Thomas Leyshon, .....   | Miner, .....        | 29   | 1      | 2                  | Gaylord, .....             | Plymouth, .....          |   |
| 13,               | 14                  | Thomas Merriman, .....  | Plane Runner, ..... | 30   | .....  | .....              | .....                      | .....                    |   |

|           |                         |                     |    |   |    |                        |                        |  |  |  |   |
|-----------|-------------------------|---------------------|----|---|----|------------------------|------------------------|--|--|--|---|
| 13,       | Joseph Olds, .....      | Miner, .....        | 43 | 1 | 5  |                        |                        |  |  |  |   |
| 13,       | John D. Morris, .....   | Miner, .....        | 39 | 1 | 5  |                        |                        |  |  |  |   |
| 13,       | John Hamer, .....       | Miner, .....        | 30 | 1 | 2  |                        |                        |  |  |  |   |
| 13,       | Daniel W. Morgan, ..... | Miner, .....        | 51 | 1 | 10 |                        |                        |  |  |  |   |
| 13,       | Thomas Pickett, .....   | Mine foreman, ..... | 34 | 1 |    |                        |                        |  |  |  |   |
| 13,       | John Capton, .....      | Co. laborer, .....  | 36 | 1 |    | Shaft No. 1, .....     | Plymouth, .....        |  |  |  | Instantly killed by falling from the Lance vein down the shaft, landing upon a pump; fell forty feet, being struck by a moving surface; died March 26.  |
| 26,       | Barney Callahan, .....  | Co. laborer, .....  | 70 | 1 | 5  | Stanton breaker, ..... | Wilkes-Barre, .....    |  |  |  | Severely injured by being struck by a falling body of coal; died March 26.  |
| 26,       | John Campbell, .....    | Miner, .....        | 55 | 1 | 10 | Jersey No. 8, .....    | Ashley, .....          |  |  |  | Fatally hurt by a fall of top body coal when in the act of cutting a prop out, died same day.   |
| March 5,  | Edward Wilkins, .....   | Laborer, .....      | 24 |   |    | Shaft No. 6, .....     | Glen Lyon, .....       |  |  |  | Killed by a fall of coal when he was in a stooping posture mining under it.   |
| 7         | John Birkenhead, .....  | Miner, .....        | 40 | 1 | 6  | Hillman vein, .....    | Wilkes-Barre, .....    |  |  |  | Went into an abandoned breast and fired a body of gas; was fatally burned; died the next day.   |
| 15,       | James Kelley, .....     | Miner, .....        | 41 | 1 | 5  | Shaft No. 5, .....     | S. Wilkes-Barre, ..... |  |  |  | Fatally injured by a fall of coal when standing on a ladder drilling a hole; died the same day.   |
| 15,       | John Slaney, .....      | Slate picker, ..... | 38 | 1 | 5  | Breaker No. 4, .....   | Edwardsdale, .....     |  |  |  | Twenty men were engaged, some pulling by a rope and others pushing two gondola cars, which ran too far under the breaker. Slaney was between the two cars and stumbled; on falling he grabbed Proloski and Brudna, and all fell under the car; the two named first were killed and Brudna was severely injured.   |
| 15,       | Mike Proposki, .....    | No employee, .....  | 35 | 1 | 5  | Breaker No. 4, .....   | Edwardsdale, .....     |  |  |  | John J. Thomas, miner, and two laborers were severely burned by an explosion of gas in a breast on Red Ash seam on night shift; Poleski died in a few hours and Stofski died in a week after; the gas gathered while they were all down in the gangway resting, and they went up with a naked light and fired it. |
| 20,       | John Poleski, .....     | Laborer, .....      | 28 |   |    | Nottingham, .....      | Plymouth, .....        |  |  |  | Fatally injured; dynamite exploded while he was thawing it in a tin can over his lamp; died April 20.   |
| 20,       | Joseph Stofski, .....   | Laborer, .....      | 25 |   |    | Nottingham, .....      | Plymouth, .....        |  |  |  | While shoveling coal in the No. 7 chamber he was drawn in and suffocated.   |
| April 13, | Anthony Bogden, .....   | Miner, .....        | 28 | 1 |    | Shaft No. 2, .....     | Nantcooke, .....       |  |  |  |   |
| 14,       | John Fovitzza, .....    | Slate picker, ..... | 43 | 1 |    | Breaker No. 5, .....   | Nantcooke, .....       |  |  |  |   |

TABLE NO. 4.—Continued.

| Date of accident. | Number of accident. | Name of Person.   | Occupation.    | Age. | Widow. | Number of orphans. | Name of Colliery.   | Location—Lazern-County. | Nature and Cause of Accident.  |
|-------------------|---------------------|-------------------|----------------|------|--------|--------------------|---------------------|-------------------------|--|
| April 19,         | 32                  | William Good,     | Laborer,       | 35   |        |                    | North shaft No. 1,  | Nanticoke,              | Instantly killed by a large three-sided piece of rock falling on him at face of gangway.   |
| 20,               | 33                  | Michael Demskie,  | Laborer,       | 34   |        |                    | Shaft No. 2,        | Nanticoke,              | Instantly killed; struck by a descending car when walking up the slope.  |
| 25,               | 34                  | John Judge,       | Miner,         | 58   |        |                    | Shaft No. 2,        | Edwardsdale,            | Killed by a fall of roof. He was told that it was dangerous, and asked by a friend to pull it down, but he did not heed him.   |
| 25,               | 35                  | Simon Rytkavitch, | Laborer,       | 27   |        |                    | Nottingham,         | Plymouth,               | Instantly killed by a fall of boney roof in Ross Vein gangway. Wladystan Faust was painfully injured by the same fall.   |
| 27,               | 35                  | Wesley Stair,     | Ass't foreman, | 46   | 1      | 2                  | Slope No. 18,       | Wanamie,                | Severely injured by a runaway car on slope; died May 15.   |
| May 4,            | 37                  | David Edwards,    | Machinist,     | 43   | 1      | 5                  | Nottingham breaker, | Plymouth,               | Killed at about 11 A. M. while stopping for an instant on the track. A car of ashes pushed by two men struck him down and crushed him, killing him instantly.                                      |
| 16,               | 38                  | August Zetterman, | Miner,         | 56   | 1      | 1                  | Shaft No. 1,        | Edwardsdale,            | Fatally injured by the fall of a large pan-shaped piece of rock; died within half an hour.   |
| 28,               | 39                  | John E. Edwards,  | Brattice man,  | 34   | 1      | 3                  | Nottingham,         | Plymouth,               | Severely burned in an abandoned breast by an explosion of gas; died May 31.  |
| 31,               | 40                  | Adam Herman,      | Sinker,        | 40   | 1      | 2                  | Bliss,              | Hanover twp.,           | While the shaft were working at the bottom and one half inches down in the cone, causing a loaded bucket to drop back, killing both men. The bucket is supposed to have fallen about seventy feet. |
| 31,               | 41                  | William Baker,    | Sinker,        | 35   |        |                    | Bliss,              | Hanover twp.,           | Killed by a fall of bony coal. The miner called to warn him, but he moved under instead of away.   |
| 31,               | 42                  | Frank Pandish,    | Laborer,       | 24   |        |                    | Nottingham,         | Plymouth,               |  |

|      |     |    |                   |          |       |                        |       |               |       |   |
|------|-----|----|-------------------|----------|-------|------------------------|-------|---------------|-------|---|
| June | 6,  | 43 | John Fahold,      | Laborer, | ..... | Nottingham,            | ..... | Plymouth,     | ..... | Instantly killed by a fall of coal in a top coal breast. The miner narrowly escaped the same fate.  |
|      | 7,  | 44 | John Condrack,    | Miner,   | ..... | Nottingham,            | ..... | Plymouth,     | ..... | Killed by a fall of coal in cross-heading when he was returning from next breast.   |
|      | 9,  | 45 | John McGinnis,    | Miner,   | ..... | Franklin,              | ..... | Wilkes-Barre, | ..... | Instantly killed by a blast; was returning, thinking the squib had missed.  |
|      | 14, | 46 | Stephen Rouelt,   | Miner,   | ..... | Slope No. 6,           | ..... | Glen Lyon,    | ..... | Instantly killed by a blast; it fired when he was applying light to the match.  |
|      | 15, | 47 | Thomas Gibbons,   | Miner,   | ..... | Shaft No. 2,           | ..... | Edwardsdale,  | ..... | Fatally injured by a fall of rock from roof at face of breast; died on reaching home.   |
|      | 25, | 48 | Frank Marowack,   | Laborer, | ..... | West End,              | ..... | Mocanaqua,    | ..... | Instantly killed by a saddle-shaped piece of rock falling from roof.  |
| July | 6,  | 49 | John Richercher,  | Miner,   | ..... | Shaft No. 4,           | ..... | Edwardsdale,  | ..... | Killed by a fall of coal when he was barring down an under piece.   |
|      | 7,  | 50 | EVAN E. ADAMS,    | Miner,   | ..... | Slope No. 4,           | ..... | Nanticoke,    | ..... | When engaged putting up double timbers a large mass of shelly coal fell, discharging eight pairs of the timbers and covering these three men, killing them almost instantly. Two other persons were injured at the same time. |
|      | 7,  | 51 | Joseph Waslack,   | Laborer, | ..... | Slope No. 4,           | ..... | Nanticoke,    | ..... | Killed by a fall of rock at face of breast; it fell from a height of fifteen feet. Was in the act of re-standing a prop when the roof fell and killed him.  |
|      | 7,  | 52 | George Haney,     | Laborer, | ..... | Slope No. 4,           | ..... | Nanticoke,    | ..... | Instantly killed at face of breast by a fall of rock from roof.   |
|      | 16, | 53 | Michael Zubeck,   | Laborer, | ..... | Franklin,              | ..... | Wilkes-Barre, | ..... | Fatally burned by an explosion of gas; he fired a hole which blocked the roadway and stopped the circulation of air; in going up the other man-way with naked light fired the gas which had accumulated; he died August 2.    |
|      | 17, | 54 | Marmduke Lumsden, | Miner,   | ..... | Baltimore shaft No. 3, | ..... | Wilkes-Barre, | wp.   | Fatally injured by a fall of rock. He and Andrew Miller were standing a prop when the rock knocked the prop and the men down. Hussa died on the way to the hospital.  |
|      | 19, | 55 | Lewis Rewanski,   | Miner,   | ..... | Shaft No. 2,           | ..... | Nanticoke,    | ..... | Fatally injured by an explosion of gas which took place in a mysterious and unexplained manner. He died the same night.   |
|      | 24, | 56 | John Pasolowski,  | Miner,   | ..... | Stanton,               | ..... | Wilkes-Barre, | ..... | He fired a blast in a cross-cut and the coal knocked the block from under the car, leaving it run down. He was walking up and was struck down and killed.   |
| Aug. | 11, | 57 | John Hussa,       | Laborer, | ..... | West End,              | ..... | Mocanaqua,    | ..... | Fatally injured by a fall of coal; died the same night.   |
|      | 16, | 58 | John Fentlock,    | Miner,   | ..... | Shaft No. 1 north,     | ..... | Nanticoke,    | ..... | Fatally injured by an explosion of gas which took place in a mysterious and unexplained manner. He died the same night.   |
|      | 18, | 59 | Peter C. Walton,  | Miner,   | ..... | Slope No. 4,           | ..... | Nanticoke,    | ..... | He fired a blast in a cross-cut and the coal knocked the block from under the car, leaving it run down. He was walking up and was struck down and killed.   |
|      | 29, | 60 | John A. Edwards,  | Miner,   | ..... | Jersey No. 8,          | ..... | Ashley,       | ..... | Fatally injured by a fall of coal; died the same night.   |

TABLE No. 4.—Continued.

| Date of accident | Number of accident | Name of Person.   | Occupation.  | Age. | Widow. | Number of orphans. | Name of Colliery.  | Location—Luzerne County. | Nature and Cause of Accident  |
|------------------|--------------------|-------------------|--------------|------|--------|--------------------|--------------------|--------------------------|---|
| Sept 12,         | 61                 | Carl Crapper,     | Laborer,     | 37   | 1      | 4                  | Stanton,           | Wilkes-Barre,            | Found killed under a pile of coal which had rushed from the battery of a pitching breast.   |
| 13,              | 62                 | John Delaney,     | Boat tender, | 53   | .....  | .....              | Dodson,            | Plymouth,                | Killed by being struck by a trip of cars on the underground slope.  |
| 25,              | 63                 | Thomas Griffiths, | Jig tender,  | 19   | .....  | .....              | Breaker No. 2,     | Edwardsburg,             | Killed; fell in some unknown manner so that his head was crushed between belt and pulley.   |
| Oct 1,           | 62                 | Peter Lavelle,    | Miner,       | 52   | 1      | 4                  | Hollenback,        | Wilkes-Barre,            | Killed by a premature blast. Had stopped in after quitting time and was found dead at 7 P. M.   |
| 5,               | 65                 | John Winsel,      | Miner,       | 30   | 1      | 2                  | North No. 1 shaft, | Nanticoke,               | Killed by a long trough-like piece of rock falling on him when working on the night shift.  |
| 25,              | 66                 | Hugh Smiley,      | Co. laborer, | 22   | .....  | .....              | South No. 1 shaft, | Nanticoke,               | Was engaged lining the shaft on night shift, and when the cage was being hoisted he fell off and was killed. There were several other persons on the cage who saw him fall.   |
| 30,              | 67                 | George Stanga,    | Laborer,     | 29   | 1      | 3                  | Allen,             | Allen,                   | Killed by a fall of rock from a slip near the face of breast when helping the miner to tamp a hole.   |
| 31,              | 68                 | William Buckland, | Co. laborer, | 35   | 1      | 2                  | Hanover slope,     | Hanover twp.,            | When engaged cleaning a section of the airway which was full of dirt, and rising on a pitch of about 60 degrees, the dirt rushed upon them and killed both.   |
| 31,              | 69                 | Walter Jones,     | Co. laborer, | 42   | 1      | 5                  | Hanover slope,     | Hanover twp.,            | Their bodies were carried across through the heading into the slope which was full of mud and water. Jones' body was not found until about 6 A. M., Nov. 4; Dennis Flannery was slightly hurt by the same accident. |
| 31,              | 70                 | George Jones,     | Sinker,      | 49   | .....  | .....              | Auchincloss No. 2, | Hanover township,        | Killed by a piece of rock falling from side of shaft  |



|         |    |                         |                    |               |       |                     |                     |   |
|---------|----|-------------------------|--------------------|---------------|-------|---------------------|---------------------|---|
| Nov. 1. | 71 | Thomas R. Davies, ..... | Miner, .....       | 32            | 1     | Shaft No. 2, .....  | Nantcoke, .....     | Compound fracture of leg caused by a fall of coal; died Nov. 4.                                       |
| 7.      | 72 | John McLaughlin, .....  | Driver, .....      | 19            | ..... | Maxwell, .....      | Ashley, .....       | Kicked on abdomen by a mule when on surface. He walked home but he died on Nov. 9.                    |
| 9.      | 73 | Charles Frank, .....    | Laborer, .....     | 27            | ..... | Slope No. 18, ..... | Wannamie, .....     | Killed by a fall of coal while he and the miner were shovelling coal back from the face of breast.    |
| 20.     | 74 | Charles Klugg, .....    | Door tender, ..... | 16            | ..... | Hillman Vein, ..... | Wilkes-Barre, ..... | In attempting to board a car on front end he slipped and fell under. The car ran over and killed him. |
| 22.     | 75 | William Lucas, .....    | Miner, .....       | 43            | 1     | Woodward, .....     | Plymouth twb, ..... | Fatally injured by a fall of coal at face of breast; died in a few hours after.                       |
| 28.     | 76 | John Kollinofski, ..... | Laborer, .....     | 17            | ..... | Slope No. 4, .....  | Nantcoke, .....     | Instantly killed by a fall of roof. The miner and another man narrowly escaped.                       |
| Dec. 3. | 77 | Stephen Valko, .....    | Laborer, .....     | 32            | 1     | Dorraine, .....     | Wilkes-Barre, ..... | Fatally burned by an explosion of gas. Two others were more or less burned at the same time.          |
|         |    |                         |                    | Totals, ..... |       |                     |                     |   |
|         |    |                         |                    | 45            |       |                     |                     |   |
|         |    |                         |                    | 182           |       |                     |                     |   |

6

*Recapitulation of Fatal Accidents.*

| Occupation.                       | Number. | Nationality.     | Number. | Cause of Accidents.                        | Number. |
|-----------------------------------|---------|------------------|---------|--|---------|
| Miners, .....                     | 34      | American, .....  | 5       | By explosion of fire damp, .....           | 7       |
| Laborers, .....                   | 20      | Welsh, .....     | 17      | By falls of roof and coal, .....           | 44      |
| Drivers and runners, .....        | 3       | Irish, .....     | 11      | By falling down shafts, .....              | 2       |
| Door tenders, .....               | 3       | English, .....   | 8       | By mine cars underground, .....            | 7       |
| Mine foremen, .....               | 2       | Polish, .....    | 21      | By explosions of powder and blasts, .....  | 4       |
| Shaft sinkers and hook-men, ..... | 3       | German, .....    | 5       | By miscellaneous causes underground, ..... | 6       |
| Company men, .....                | 5       | Hungarian, ..... | 8       | By miscellaneous causes on surface, .....  | 7       |
| Outside men, .....                | 7       | Scottish, .....  | 1       |  |         |
|                                   |         | Swedish, .....   | 1       |  |         |
| Totals, .....                     | 77      | Totals, .....    | 77      | Totals, .....                              | 77      |

TABLE No. 5.—List of non-fatal accidents that occurred in and about the mines of the Fourth Anthracite Mine District, for the year ended December 31, 1894.

| Date of accident. | Number of accident. | Name of person.       | Occupation.       |       | Age.  | Married. | Number of children.       | Name of colliery.     | Location—Luzerne county.  | Nature and cause of accident. |
|-------------------|---------------------|-----------------------|-------------------|-------|-------|----------|---------------------------|-----------------------|---|-------------------------------|
|                   |                     |                       |                   |       |       |          |                           |                       |   |                               |
| Jan. 3,           | 1                   | Mike Shellagofski, .. | Laborer, .....    | 31 M. | 1     | .....    | Alden, .....              | do.                   | Both painfully burned on face and hands by an explosion of gas; manway was allowed to close, which prevented circulation of air, and a body of gas accumulated. |                               |
| 3,                | 2                   | Mike Ruhnick, .....   | Laborer, .....    | 29 M. | 2     | .....    | do.                       | .....                 | Arm fractured and face and legs bruised by a premature blast; gas ignited the squib.  |                               |
| 4,                | 3                   | George Ward, .....    | Miner, .....      | 32    | ..... | .....    | Farrish, .....            | Plymouth, .....       | Leg fractured; caught between a car and the gob.  |                               |
| 5,                | 4                   | David E. Rees, .....  | Laborer, .....    | 24    | ..... | .....    | Shaft No. 1, north, ..... | Nanticoke, .....      | Face painfully bruised by a fall of coal. He was assisting the miner to pry it down.  |                               |
| 9,                | 5                   | Robert Deacon, .....  | Laborer, .....    | 26 M. | 3     | .....    | Shaft No. 3, .....        | DeWardsdale, .....    | Deeply cut on leg; axe slipped when cutting timber in yard.   |                               |
| 15,               | 6                   | Alfred Merriman, ..   | Timber cutter, .. | 48 M. | ..... | .....    | Nottingham breaker, ..    | Plymouth, .....       | Two ribs fractured, struck by a moving car.   |                               |
| 15,               | 7                   | John Tinner, .....    | Driver, .....     | 17    | ..... | .....    | Shaft No. 9, .....        | Sugar Notch, .....    | Injured about hips and head by a fall of rock; not seriously.   |                               |
| 15,               | 8                   | John Kaulkie, .....   | Miner, .....      | 40 M. | 4     | .....    | West End, .....           | Mocanaqua, .....      | Painfully injured by a premature blast.   |                               |
| 17,               | 9                   | William Suckot, ..... | Miner, .....      | 27    | ..... | .....    | Douison, .....            | Plymouth, .....       | Collar bone fractured and injured about chest; caught between false cage and timber.  |                               |
| 19,               | 10                  | Charles Van Loon, ..  | Ticket boss, ..   | 57 M. | 5     | .....    | Breaker No. 5, .....      | do.                   | Painfully injured; struck by a spragg when spragging car.   |                               |
| 19,               | 11                  | John Prossack, .....  | Driver, .....     | 18    | ..... | .....    | Shaft No. 6, .....        | Glen Lyon, .....      | Severe scalp wound and bruised on shoulder by a fall of coal.   |                               |
| 25,               | 12                  | George Novick, .....  | Laborer, .....    | 40 M. | 2     | .....    | Avondale, .....           | Plymouth township, .. | Face severely scalded by steam when making a joint of boiler steam pipe.  |                               |
| 29,               | 13                  | David W. Jones, ..... | Miner, .....      | 50 M. | ..... | .....    | Woodward, .....           | do.                   | Nose fractured by a kick from a rock; the miner, Thomas J. Hughes, was killed by the same fall.   |                               |
| Feb. 5,           | 14                  | James Colbert, .....  | Fireman, .....    | 23 M. | 1     | .....    | Nottingham breaker, ..    | Plymouth, .....       |   |                               |
| 5,                | 15                  | William Rees, .....   | Driver, .....     | 16    | ..... | .....    | Lanes No. 11, .....       | do.                   |   |                               |
| 5,                | 16                  | Louis _____, .....    | Laborer, .....    | 21    | ..... | .....    | Shaft No. 4, .....        | Edwardsdale, .....    |   |                               |

|          |    |                          |                     |    |       |       |                           |                          |   |
|----------|----|--------------------------|---------------------|----|-------|-------|---------------------------|--------------------------|---|
| 6.       | 17 | Thomas C. Davies, ..     | Miner, .....        | 41 | M.    | 4     | Hollenbach, .....         | Wilkes-Barre, .....      | Painfully hurt; squeezed about hips between fractures.  |
| 8.       | 18 | Henry Davies, .....      | Miner, .....        | 41 | ..... | ..... | Lance No. 11, .....       | Plymouth, .....          | Leg fractured by a fall of coal. He tried the coal down.  |
| 8.       | 19 | Phillip Cobisky, .....   | Laborer, .....      | 20 | ..... | ..... | Gaylord breaker, .....    | do.                      | Head cut off; stuck it between end of screen and union wheel.   |
| 9.       | 20 | William Zimmerman, ..    | Miner, .....        | 50 | M.    | 5     | Dodson, .....             | do.                      | Both slightly burned on hands and face; ignited a small accumulation of gas in a heading when returning after firing a blast. |
| 9.       | 21 | George Zimmerman, ..     | Laborer, .....      | 18 | ..... | ..... | do.                       | do.                      |   |
| 17.      | 22 | Samuel Cummings, ..      | Carpenter, .....    | 15 | ..... | ..... | South shaft No. 1, .....  | Nanticoke, .....         | Painfully bruised on head and side; caught when coupling cars.  |
| 19.      | 23 | George Onitus, .....     | Miner, .....        | 34 | ..... | ..... | Hollenbach, .....         | Wilkes-Barre, .....      | Face and right hand burned by an explosion of a small quantity of gas.  |
| 21.      | 24 | Joseph O'Honnell, .....  | Miner, .....        | 42 | ..... | ..... | Jersey No. 8, .....       | Ashley, .....            | Severely injured about face and hands by a premature blast.   |
| 23.      | 25 | Mike Bouanko, .....      | Loader, .....       | 20 | ..... | ..... | Breaker No. 6, .....      | Gen Lyon, .....          | Hand crushed when coupling railroad cars; thumb amputated.  |
| 24.      | 26 | Michael Myofski, .....   | Miner, .....        | 52 | M.    | 7     | Tunnel No. 6, .....       | do.                      | Leg fractured by a fall of top rock.  |
| 27.      | 27 | John Cannon, .....       | Miner, .....        | 21 | ..... | ..... | Avondale, .....           | Plymouth township, ..... | Back painfully injured by a fall of boy.  |
| 27.      | 28 | William Robinson, ..     | Laborer, .....      | 23 | ..... | ..... | South Wilkes-Barre, ..... | Wilkes-Barre, .....      | Severely cut about head; blast exploded prematurely, having ignited from a blow.  |
| 27.      | 29 | George Cook, .....       | Driver, .....       | 16 | ..... | ..... | South Shaft No. 1, .....  | Nanticoke, .....         | Thigh fractured by falling under cars.  |
| March 1, | 30 | Charles Shakuski, .....  | Laborer, .....      | 50 | M.    | 4     | Avondale, .....           | Plymouth township, ..... | Hip fractured by a piece of coal thrown from a blast.   |
| 3.       | 31 | Casper Mottomas, .....   | Laborer, .....      | 38 | M.    | 1     | West Emf, .....           | Mocannaqua, .....        | Jaw and nose broken; struck by ears running on surface.   |
| 5.       | 32 | David Lewis, .....       | Englwoer, .....     | 27 | M.    | ..... | Woodward breaker, .....   | Plymouth township, ..... | Ankle dislocated. He slid down into one of the pockets in the breaker.  |
| 12.      | 33 | John Holopko, .....      | Miner, .....        | 38 | M.    | 3     | Nottingham, .....         | Plymouth, .....          | Fell from a ladder and his ankle was dislocated.  |
| 15.      | 34 | Robert Jones, .....      | Sinker, .....       | 35 | M.    | 6     | Maxwell No. 20, .....     | Ashley, .....            | Leg fractured in two places and bruised on back; a large piece of rock rolled on him.   |
| 15.      | 35 | John Brudna, .....       | Slate picker, ..... | 31 | M.    | ..... | Breaker No. 4, .....      | Edwardsdale, .....       | Severely injured by falling under a moving railroad car at the breaker.   |
| 19.      | 36 | William Arnyl, .....     | Miner, .....        | 23 | ..... | ..... | Warrior Run, .....        | Warrior Run, .....       | Severely burned on face, arms and body by an explosion of powder.   |
| 29.      | 37 | John J. Thomas, .....    | Miner, .....        | 45 | M.    | 3     | Nottingham, .....         | Plymouth, .....          | Severely burned by an explosion of gas.   |
| 29.      | 38 | John Lj-welyn, .....     | Miner, .....        | 30 | M.    | 3     | Dorrance, .....           | Wilkes-Barre, .....      | One bone of arm fractured by being caught between a car and rib.  |
| April 3, | 39 | James Flannery, .....    | Driver, .....       | 16 | ..... | ..... | South Shaft No. 1, .....  | Nanticoke, .....         | Thigh fractured by falling under cars.  |
| 5,       | 40 | Joseph Beckin, .....     | Driver, .....       | 18 | ..... | ..... | Slope No. 4, .....        | do.                      | Arm fractured and best bruised by falling under cars.   |
| 6.       | 41 | Joseph Cavinski, .....   | Miner, .....        | 45 | M.    | 4     | Shaft No. 1, G seam, ..   | do.                      | Compound fracture of leg by a fall of top coal.   |
| 6.       | 42 | Ignats Stovitzkie, ..... | Miner, .....        | 28 | M.    | 2     | Shaft No. 1, North, ..... | do.                      | Leg broken by a fall of slate from roof.  |
| 9.       | 43 | Paul Lloydy, .....       | Miner, .....        | 32 | M.    | 9     | Avondale, .....           | Plymouth township, ..... | Head and back injured by a fall of roof; not seriously.   |
| 10.      | 44 | Stanley Ghevanski, ..... | Laborer, .....      | 31 | M.    | 1     | Shaft No. 2, .....        | Nanticoke, .....         | Leg broken by fall of slate; was in the act of putting a prop under it.   |

TABLE No. 5.—Continued.

| Date of accident. | Number of accident. | Name of person.            | Occupation.        | Age. | Married. | Number of children. | Name of colliery.         | Location—Luzerne county. | Nature and cause of accident.  |
|-------------------|---------------------|----------------------------|--------------------|------|----------|---------------------|---------------------------|--------------------------|--|
| April 10,         | 45                  | Peter Butcavitz, .....     | Miner, .....       | 36   | M.       | 3                   | Shaft No. 1, South, ..... | Nanticoke, .....         | Both <b>more</b> or <b>less</b> burned on face and hands by an explosion of gas; barring coal down caused the gas to descend on their lamps.<br><b>The first</b> severely hurt about his eyes and the <b>second</b> slightly injured; when firing a blast gas feeders caught fire and when the miner was assisting them in extinguishing the burning feeder the blast exploded, injuring the <b>two</b> laborers as stated.<br><b>Slightly</b> injured; the <b>miner</b> was thawing dynamite in a tin can over his lamp and it exploded; the <b>miner</b> was fatally injured.<br><b>Leg</b> broken; struck by a piece of coal thrown from a blast.<br><b>Arm</b> broken; struck by a running car.<br><b>Ankle</b> broken by a premature blast; match too short.<br><b>Severely</b> squeezed between a car and a prop.<br><b>Shoulder</b> dislocated by a fall of slate; had an attack of pneumonia and died April 28th.<br><b>Back</b> painfully bruised by a fall of top coal.<br><b>Hand</b> painfully crushed between railroad cars and chute.<br><b>Fatally</b> injured by a fall of roof. Simon Ritkewick was killed at the same time.<br><b>Ankle</b> fractured by being caught under a moving car.<br><b>Nose</b> fractured and back bruised by a fall of coal. |
|                   | 46                  | Valentine Poshinski, ..... | Laborer, .....     | 26   | .....    | .....               | do. ....                  | do. ....                 |  |
| 11,               | 47                  | John Wolfe, .....          | Laborer, .....     | 23   | M.       | 2                   | Slope No. 4, .....        | do. ....                 | .....  |
|                   | 48                  | August Bamba, .....        | Laborer, .....     | 32   | M.       | 4                   | do. ....                  | do. ....                 |  |
| 13,               | 49                  | Merian Gososki, .....      | Laborer, .....     | 33   | M.       | 2                   | Shaft No. 2, .....        | do. ....                 | .....  |
|                   | 50                  | Stiney Smith, .....        | Laborer, .....     | 26   | .....    | .....               | Red Ash No. 2, .....      | Wilkes-Barre twp., ..... |  |
| 17,               | 51                  | Daniel Davies, .....       | Footman, .....     | 24   | M.       | .....               | Conyngham, .....          | Wilkes-Barre, .....      | .....  |
|                   | 52                  | Joseph Romanski, .....     | Miner, .....       | 23   | .....    | .....               | Shaft No. 9, .....        | Sugar Notch, .....       |  |
| 20,               | 53                  | Frank Cupick, .....        | Driver, .....      | 18   | .....    | .....               | Red Ash No. 2, .....      | Wilkes-Barre twp., ..... | .....  |
|                   | 54                  | Dennis Erislin, .....      | Timberman, .....   | 50   | M.       | 6                   | Gaylord, .....            | Plymouth, .....          |  |
| 24,               | 55                  | Wm. Dougherty, .....       | Miner, .....       | 27   | .....    | .....               | Baltimore tunnel, .....   | Wilkes-Barre, .....      | .....  |
|                   | 56                  | Robert Watkins, .....      | Loader, .....      | 20   | .....    | .....               | Nottingham breaker, ..... | Plymouth, .....          |  |
| 26,               | 57                  | Wlardystan Faust, ..       | Laborer, .....     | 40   | M.       | 1                   | Nottingham, .....         | do. ....                 | .....  |
|                   | 58                  | Frederick Trevarthin, ..   | Door tender, ..... | 15   | .....    | .....               | Slope No. 6, .....        | Glen Lyon, .....         |  |
| May 2,            | 59                  | Rhinarid Boyer, .....      | Miner, .....       | 35   | M.       | .....               | North Shaft No. 1, .....  | Nanticoke, .....         | .....  |

| No. | Name               | Occupation    | Age | Sex | Shaft No.             | Township          | Location | Accident Description   |
|-----|--------------------|---------------|-----|-----|-----------------------|-------------------|----------|--|
| 4   | William Davies     | Driver        | 19  | M   | Slope No. 4           | do.               | do.      | Arm and side injured by a kick from a mule.  |
| 5   | William Roberts    | Runner        | 19  | M   | Baltimore shaft No. 3 | Wilkes-Barre twp. | do.      | Leg fractured and bruised on body by being struck by cars on the slope.                                      |
| 9   | William Roberts    | Runner        | 23  | M   | Shaft No. 3           | Edwardsdale       | do.      | Arm injured by being caught between car and top of gangway.  |
| 10  | Thomas Austin      | Miner         | 34  | M   | Stanton               | Wilkes-Barre      | do.      | Face and hands slightly burned by an explosion of gas.   |
| 11  | Hector Morton      | Driver        | 18  | M   | Slope No. 6           | Glen Lyon         | do.      | Severely hurt on back of head by a kick from a mule.   |
| 17  | Morgan Rees        | Miner         | 48  | M   | South shaft No. 1     | Nanticoke         | do.      | Hip fractured by a fall of coal.   |
| 17  | John Reid          | Driver        | 19  | M   | Lance No. 11 breaker  | Plymouth          | do.      | Finger crushed and body bruised by falling under a car.  |
| 18  | James Watkins      | Miner         | 35  | M   | Shaft No. 4           | Edwardsdale       | do.      | Both were more or less burned by an explosion of gas. The roof fell and drove the gas down upon their lamps. |
| 22  | Archie McDonald    | Laborer       | 30  | M   | do                    | do.               | do.      | Arm fractured by a fall of top slate.  |
| 22  | Adolph Knofo       | Miner         | 28  | M   | Slope No. 4           | Nanticoke         | do.      | Leg severely lacerated and small bone fractured by falling under cars.                                       |
| 23  | Watkin Thomas      | Driver        | 16  | M   | Shaft No. 2           | Plymouth          | do.      | Leg severely injured by falling under cars.  |
| 24  | George Spare       | Driver        | 19  | M   | Reynolds No. 16       | do.               | do.      | Leg severely injured by falling into chute.  |
| 26  | James Butler       | Slate picker  | 13  | M   | Lance Breaker No. 11  | do.               | do.      | Arm broken by a fall of top coal.  |
| 29  | Ignatz Shinakez    | Laborer       | 44  | M   | West End              | Mocanagua         | do.      | Severely cut on face by a kick from a mule.  |
| 2   | John Smith         | Door tender   | 16  | M   | Empire                | Wilkes-Barre      | do.      | Arm crushed under cars, necessitating amputation.  |
| 2   | John Moran         | Door tender   | 16  | M   | Shaft No. 2           | Edwardsdale       | do.      | Severely bruised; car ran through his door and knocked him down under it.                                    |
| 6   | Ernest LeGrand     | Doortender    | 15  | M   | Stanton               | Wilkes-Barre      | do.      | Thigh fractured by being crushed between cars.   |
| 6   | Joseph Shopkofsky  | Driver        | 17  | M   | Shaft No. 2           | Nanticoke         | do.      | Severely cut on head by fall of top coal.  |
| 7   | Thomas M. Lewis    | Miner         | 43  | M   | Shaft No. 9           | Sugar Notch       | do.      | Thigh painfully bruised by being struck by a car.  |
| 8   | Andrew Baltuser    | Miner         | 27  | M   | Stanton               | Wilkes-Barre      | do.      | Jaw broken by a kick from a mule.  |
| 9   | John Prusick       | Driver        | 18  | M   | Shaft No. 6           | Glen Lyon         | do.      | Thigh painfully bruised by a collar of timber falling on him.  |
| 11  | John D. Jones      | Miner         | 50  | M   | Nottingham            | Plymouth          | do.      | Severely injured about head and shoulder by a fall of bone.  |
| 11  | William Savage     | Miner         | 27  | M   | Empire                | Wilkes-Barre      | do.      | Severely squeezed about chest and hips between cars.   |
| 12  | Patrick Devers     | Driver boss   | 24  | M   | Woodward              | Plymouth township | do.      | Both wrists broken and severely cut on head by a fall on surface.  |
| 12  | Jonathan VanFossen | Laborer       | 45  | M   | Bliss                 | Hanover township  | do.      | Leg broken by being struck by a pipe.  |
| 13  | Charles Dare       | Laborer       | 63  | M   | Shaft No. 1           | Edwardsdale       | do.      | Ankle fractured by being crushed between a car and rib.  |
| 14  | Andrew Mosier      | Comp. laborer | 23  | M   | Shaft No. 6           | Glen Lyon         | do.      | Leg broken by jumping from a ladder upon which he was prying down coal.                                      |
| 14  | John Gallagher     | Miner         | 28  | M   | Dorrance              | Wilkes-Barre      | do.      | He brushed the gas upon his lamp.  |
| 18  | George Monchoski   | Miner         | 40  | M   | Warrior Run           | Warrior Run       | do.      | Thigh fractured and badly injured about back and hips by a fall of coal.                                     |
| 19  | Edward Lanning     | Miner         | 45  | M   | Empire                | Wilkes-Barre      | do.      | Injured on head and leg by being crushed between cars.   |
| 19  | George Tarley      | Driver        | 19  | M   | Baltimore tunnel      | do.               | do.      |  |

June

TABLE No. 5.—Continued.

| Date of accident. | Number of accident. | Name of person.     | Occupation.   | Age. | Married. | Number of children. | Name of colliery.      | Location—Luzerne county. | Nature and cause of accident.   |
|-------------------|---------------------|---------------------|---------------|------|----------|---------------------|------------------------|--------------------------|---|
| June 19,          | 31                  | Robert Rowlands,    | Runner,       | 19   | .....    | .....               | Franklin,              | Wilkes-Barre,            | Leg fractured; car jumped track and struck him.   |
| 20,               | 52                  | John Corine,        | Miner,        | 55   | M.       | .....               | Shaft No. 3,           | South Wilkes-Barre,      | When descending the shaft at 6.30 a. m., the engineer lost control of the engine, causing the cage to strike at the bottom scum hard as to painfully injure these four men. |
| 20,               | 53                  | Charles O'Donnell,  | Miner,        | 30   | M.       | .....               | do,                    | do,                      | Cut and bruised by a fall of rock.  |
| 20,               | 54                  | Patrick McBride,    | Laborer,      | 33   | M.       | .....               | do,                    | do,                      | Leg fractured; car jumped the track and struck him.   |
| 20,               | 55                  | Frank Kewskke,      | Laborer,      | 25   | .....    | .....               | do,                    | do,                      | Leg broken by a fall of rock. Frank Mar-cowick was killed at the same time.   |
| 20,               | 96                  | Adam Savaski,       | Miner,        | 25   | M.       | .....               | do,                    | Edwardsdale,             | Painfully squeezed between a car and rib.   |
| 21,               | 37                  | Andrew S. Sasavage, | Laborer,      | 21   | M.       | .....               | Jersey No. 8,          | Ashey,                   | Leg injured by a fall of rock.  |
| 23,               | 98                  | William Keating,    | Driver,       | 20   | .....    | .....               | Shaft No. 2,           | Edwardsdale,             | Collar bone fractured by being crushed between a car and rib.   |
| 25,               | 39                  | Michael Sbroski,    | Miner,        | 52   | M.       | 2                   | West End,              | Mocanauqua               | Severely injured by cars running upon him.  |
| 25,               | 100                 | Nicholas Moore,     | Driver,       | 19   | .....    | .....               | Shaft No. 3,           | South Wilkes-Barre,      | Severely kicked on face by a mule.  |
| 26,               | 101                 | Charles Connors,    | Miner,        | 35   | .....    | .....               | Shaft No. 1,           | Edwardsdale,             | Skin scraped off back of his hand by being caught between crank and bed-plate.  |
| 27,               | 102                 | George Thomas,      | Headman,      | 23   | M.       | 2                   | Corynsham,             | Wilkes-Barre,            | Compound fracture of leg; caught between cars.  |
| 27,               | 103                 | David J. Williams,  | Booster,      | 15   | .....    | .....               | South shaft No. 1,     | Nanticoke,               | Leg fractured; a block of wood fell on him.   |
| 27,               | 104                 | William Thomas,     | Driver,       | 18   | .....    | .....               | Woodward,              | Plymouth township,       | Deep flesh wound on leg by being caught between car and door.   |
| 27,               | 105                 | Anthony Haas,       | Slate picker, | 16   | .....    | .....               | Dorrance breaker,      | Wilkes-Barre,            | Slightly hurt by a fall of cld; died of pneumonia June 30.  |
| 27,               | 106                 | Charles Kiserer,    | Footman,      | 20   | .....    | .....               | Woodward,              | Plymouth township,       | Cut on face and hands; blast fired when he was approaching, thinking it had "missed."   |
| 28,               | 107                 | Griffith J. Owen,   | Timberman,    | 30   | M.       | 2                   | Stanton,               | Wilkes-Barre,            | Bruised and cut by a fall of coal; was barring it down.   |
| 28,               | 108                 | Patrick Kieky,      | Door tender,  | 15   | .....    | .....               | Woodward,              | Plymouth township,       |   |
| 27,               | 109                 | Evan Rees,          | Miner,        | 48   | M.       | 1                   | Shaft No. 4,           | Edwardsdale,             |   |
| July 2,           | 110                 | John Roskey,        | Miner,        | 40   | M.       | .....               | Baltimore shaft No. 2, | Wilkes-Barre,            |   |
| 3,                | 111                 | Paniel McCabill,    | Miner,        | 38   | M.       | .....               | Dorrance,              | Wilkes-Barre,            |   |

| No.         | Name                      | Position            | Age | Sex | Marital | Occupation                  | Location                  | Cause of Injury  |
|-------------|---------------------------|---------------------|-----|-----|---------|-----------------------------|---------------------------|--|
| 6, 112      | George Umlah, .....       | Runner, .....       | 17  | M.  | 3       | Shaft No. 3, .....          | South Wilkes-Barre, ..... | Two fingers crushed between car wheel and block  |
| 7, 113      | George Van Fossen, .....  | Miner, .....        | 34  | M.  | 3       | Slope No. 4, .....          | Nanticoke, .....          | Slightly injured; arm painfully injured; caused by a large fall of coal crushing men with the timbers. Three other men were killed by the same fall.   |
| 7, 114      | Anthony Yazarick, .....   | Laborer, .....      | 34  | M.  | 1       | do. ....                    | do. ....                  | Withdrew the powder from a missed shot and it fired, burning him severely on face and hands.   |
| 7, 115      | Andrew Petulas, .....     | Miner, .....        | 22  | M.  | .....   | Shaft No. 9, .....          | Sugar Notch, .....        | Fell from a car when putting up a collar and fractured some of his ribs.   |
| 7, 116      | Iago Jones, .....         | Co. miner, .....    | 52  | M.  | 3       | Jersey No. 8, .....         | Ashley, .....             | Bruised and cut by a premature blast.  |
| 11, 117     | James Askew, .....        | Miner, .....        | 46  | M.  | 6       | Parrish, .....              | Plymouth, .....           | Leg fractured; caught between cars.  |
| 16, 118     | Charles Hazlet, .....     | Laborer, .....      | 25  | M.  | .....   | Nottingham, .....           | do. ....                  | Severely injured on head and back by a fall of roof.   |
| 17, 119     | George Brace, .....       | Stable boss, .....  | 28  | M.  | .....   | Gaylord, .....              | do. ....                  | Collar bone fractured by a fall of top rock.   |
| 17, 120     | George Sargan, .....      | Miner, .....        | 48  | M.  | 4       | Slope No. 4, .....          | Nanticoke, .....          | Leg broken; barred coal down and it rolled upon him.   |
| 20, 121     | John Skelin, .....        | Miner, .....        | 24  | M.  | .....   | Shaft No. 6, .....          | Glen Lyon, .....          | Leg fractured by a fall of roof.   |
| 21, 122     | William Winesvitch, ..... | Miner, .....        | 42  | M.  | .....   | do. ....                    | do. ....                  | Arm broken while playing during noon hour in the breaker.  |
| 25, 123     | Frank Gelonka, .....      | Laborer, .....      | 28  | M.  | .....   | Alden, .....                | Plymouth township, .....  | Small bone of arm fractured and side bruised by a fall of fireclay.  |
| 25, 124     | Amos Reid, .....          | Slate picker, ..... | 12  | M.  | .....   | Woodward breaker, .....     | do. ....                  | Jaw fractured by a kick from a mule.   |
| 26, 125     | Arthur Delh, .....        | Laborer, .....      | 24  | M.  | .....   | Buttonwood, .....           | Hanover township, .....   | Leg severely bruised by a car running over it.   |
| 26, 126     | William J. Rosser, .....  | Timberman, .....    | 23  | M.  | .....   | Dorraine, .....             | Wilkes-Barre, .....       | Injured about ribs; prop rolled from a car upon him.   |
| 30, 127     | Edward Smith, .....       | Driver, .....       | 16  | M.  | .....   | Alden, .....                | Alden, .....              | Injured about hips by being crushed between cars.  |
| 31, 128     | Michael Frenchal, .....   | Driver, .....       | 17  | M.  | .....   | Dorraine, .....             | Wilkes-Barre, .....       | Foot severely cut; face and hands burned; caused by same explosion of gas at 1.30 p. m. in the Hillman seam.   |
| 31, 129     | Evan Davies, .....        | Footman, .....      | 43  | M.  | .....   | Empire, .....               | do. ....                  | Severe bruise on thigh by being crushed between cars.  |
| AUG. 1, 130 | Thomas J. Lewis, .....    | Miner, .....        | 52  | M.  | 5       | Buttonwood, .....           | Hanover township, .....   | Thigh fractured by falling under cars.   |
| 1, 131      | Robert H. Roberts, .....  | Miner, .....        | 31  | M.  | 1       | do. ....                    | do. ....                  | Painfully injured about hips by a fall of coal.  |
| 3, 132      | John Curran, .....        | Footman, .....      | 23  | M.  | .....   | Woodward, .....             | Plymouth township, .....  | Severely cut on head by a fall of rock.  |
| 8, 133      | Stanley Kasula, .....     | Driver, .....       | 17  | M.  | 4       | Franklin, .....             | Wilkes-Barre, .....       | Leg fractured. The other three were more or less bruised; they were all in an empty car riding down the slope, which has a pitch of twenty-five degrees and has a double track. The ascending cars were off the track and collided with the cars carrying the men; the cars turned on their side and threw the men out, resulting as stated. |
| 9, 134      | Harvey Faubt, .....       | Miner, .....        | 34  | M.  | 4       | Slope No. 4, .....          | Nanticoke, .....          | Skull fractured by being struck by a piece of board which came loose and fell.   |
| 9, 135      | Paul Raiser, .....        | Laborer, .....      | 30  | M.  | 2       | do. ....                    | do. ....                  | Severely injured by a premature blast.   |
| 9, 136      | Joseph Grozovage, .....   | Laborer, .....      | 23  | M.  | .....   | Franklin, Rock slope, ..... | Wilkes-Barre, .....       |  |
| 9, 137      | George Look-savage, ..... | Miner, .....        | 25  | M.  | .....   | do. ....                    | do. ....                  |  |
| 9, 138      | Jacob Petrice, .....      | Laborer, .....      | 30  | M.  | .....   | do. ....                    | do. ....                  |  |
| 9, 139      | John Sherkoskle, .....    | Laborer, .....      | 45  | M.  | .....   | do. ....                    | do. ....                  |  |
| 10, 140     | Peter Schrader, .....     | Laborer, .....      | 48  | M.  | .....   | Hollenback breaker, .....   | do. ....                  |  |
| 13, 141     | James Trawley, .....      | Miner, .....        | 39  | M.  | .....   | Shaft No. 2, .....          | Plymouth, .....           |  |

TABLE No. 5. —Continued.

| Date of accident. | Number of accident | Name of person.       | Occupation.        | Age. | Married. | Number of children. | Name of colliery.          | Location—Luzerne county. | Nature and cause of accident.  |
|-------------------|--------------------|-----------------------|--------------------|------|----------|---------------------|----------------------------|--------------------------|--|
| Aug.              | 13, 142            | Edward Howard, ....   | Slate picker,..... | 13   | .....    | .....               | Lance No. 11 breaker,..... | Plymouth, .....          | Spine injured by falling down a flight of steps while playing.               |
|                   | 13, 143            | Patrick McHugh, ....  | Laborer, .....     | 20   | .....    | .....               | do. ....                   | do. ....                 | End of three fingers crushed by being caught while coupling cars.            |
|                   | 14, 144            | James Rourke, .....   | Miner, .....       | 37   | M.       | 6                   | Shaft No. 2, .....         | do. ....                 | Leg fractured by fall of coal.   |
|                   | 16, 145            | Adam Ptee, .....      | Driver, .....      | 16   | .....    | .....               | Empire, .....              | Wilkes-Barre, .....      | Arm severely lacerated by falling under cars.                                |
|                   | 22, 146            | John Eahr, .....      | Miner, .....       | 40   | M.       | 2                   | Dodson, .....              | Plymouth, .....          | Painfully burned by an explosion of gas when driving a cross-cut.            |
|                   | 26, 147            | Edward Storey, .....  | Laborer, .....     | 27   | M.       | 2                   | Slope No. 4, .....         | Nanticoke, .....         | Slightly injured on his back and about the hips by a fall of top bone.       |
|                   | 24, 148            | Thomas R. Evans, ..   | Miner, .....       | 37   | M.       | 3                   | Empire, .....              | Wilkes-Barre, .....      | Severely injured about back and hips by a fall of slate.                     |
|                   | 24, 149            | Edward Garvey, .....  | Sinker, .....      | 43   | M.       | 6                   | Bliss, .....               | Hanover township,....    | A drill fell on his leg and fractured it.                                    |
|                   | 27, 150            | Samuel Pockman, ...   | Driver, .....      | 18   | .....    | .....               | Empire, .....              | Wilkes-Barre, .....      | Squeezed between car and timber when riding on front end of car.             |
|                   | 31, 151            | George Mills, .....   | Driver, .....      | 19   | .....    | .....               | Stanton breaker, .....     | do. ....                 | Severely cut above his eye by a kick from mule.                              |
| Sept.             | 4, 152             | James Vert, .....     | Driver, .....      | 17   | .....    | .....               | Shaft No. 1, South, .....  | Nanticoke, .....         | Wrist fractured; crushed between a mule and prop.                            |
|                   | 4, 153             | John Lynch, .....     | Miner, .....       | 46   | M.       | 3                   | Alden, .....               | Alden, .....             | Severely injured by mine cars running upon him.                              |
|                   | 6, 151             | Alfred Dobieck, ..... | Laborer, .....     | 37   | .....    | .....               | Woodward, .....            | Plymouth township, ..    | Leg fractured by a fall of roof.   |
|                   | 6, 153             | Anthony Klapouski, .. | Laborer, .....     | 40   | .....    | .....               | do. ....                   | do. ....                 | Arms and face slightly burned by an explosion of gas.                        |
|                   | 6, 156             | Mike Shimpko, .....   | Laborer, .....     | 27   | M.       | .....               | Breaker No. 2, .....       | Plymouth, .....          | Severely injured by falling under a culm car.                                |
|                   | 10, 167            | Conrad Bush, .....    | Door tender,....   | 14   | .....    | .....               | Alden, .....               | Alden, .....             | Arm fractured by being jammed between a car and door.                        |
|                   | 12, 158            | George Smith, .....   | Laborer, .....     | 31   | .....    | .....               | Shaft No. 9, .....         | Sugar Notch, .....       | Burned by an explosion of gas; went into his working place before the miner. |
|                   | 12, 159            | Mike Hubiecki, .....  | Miner, .....       | 56   | M.       | 1                   | Slope No. 6, .....         | Glen Lyon, .....         | Leg fractured by a fall of top coal.   |



|     |     |                          |                     |    |    |       |                           |                           |   |
|-----|-----|--------------------------|---------------------|----|----|-------|---------------------------|---------------------------|---|
| 13. | 160 | Thomas Moore, .....      | Miner, .....        | 33 | M. | 3     | Stanton, .....            | Wilkes-Barre, .....       | Moore was severely burned and Alexitis slightly burned by an explosion of gas. A blast caused a rush of coal from the face of pitching breast, which brought gas down upon their lamps when they were going up. |
| 13. | 161 | Joseph Alexitis, .....   | Miner, .....        | 37 | M. | 4     | do.                       | do.                       |   |
| 13. | 162 | James Catley, .....      | Driver, .....       | 33 | M. | 2     | Shaft No. 3, .....        | South Wilkes-Barre, ..... | Severely wounded on scalp by a fall of rock.  |
| 14. | 163 | Ed. T. Williams, .....   | Co. miner, .....    | 36 | M. | 2     | Shaft No. 1, North, ..... | Nanticoke, .....          | Severely cut on leg by falling under cars. Severely wounded on scalp by a fall of rock.   |
| 14. | 164 | Robert Smith, .....      | Co. laborer, .....  | 20 | M. | ..... | do.                       | do.                       | Thigh fractured by being crushed by a car. Painfully hurt by a fall of top bone. He had tried to pry it down and failed.  |
| 15. | 165 | Thomas Maher, .....      | Laborer, .....      | 18 | M. | ..... | do.                       | Plymouth, .....           | Severely crushed between a mule and car. Both bones of leg fractured; fall rope missed a pulley and struck him on the leg. Thigh fractured by a fall of top slate.  |
| 15. | 166 | John Frishinski, .....   | Driver, .....       | 16 | M. | 7     | Shaft No. 5, .....        | Glen Lyon, .....          | Leg painfully bruised by a fall of coal.  |
| 15. | 167 | William Fugh, .....      | Mine foreman, ..... | 38 | M. | ..... | Shaft No. 1, .....        | Edwardsdale, .....        | Severely hurt about hips and shoulders by being crushed between cars.   |
| 18. | 168 | Frank Grogofski, .....   | Laborer, .....      | 27 | M. | 1     | Shaft No. 6, .....        | Glen Lyon, .....          | Several ribs fractured by being struck by a piece of coal thrown from a blast.  |
| 20. | 169 | Alex. Malick, .....      | Miner, .....        | 31 | M. | 1     | Shaft No. 2, .....        | Nanticoke, .....          | Compound fracture of leg; caused by a fall of roof.   |
| 24. | 170 | Thomas Bevan, .....      | Runner, .....       | 21 | M. | ..... | Empire, .....             | Wilkes-Barre, .....       | Leg fractured by being caught between locomotive and cars. He had no business there.  |
| 24. | 171 | David T. Davies, .....   | Miner, .....        | 35 | M. | 6     | Stanton, .....            | do.                       | Leg fractured by a fall of rock; returned too soon after blasting.  |
| 28. | 172 | George Bokofski, .....   | Laborer, .....      | 37 | M. | ..... | Woodward, .....           | Plymouth township, .....  | Hips squeezed and bruised by being caught between a car and rib.  |
| 1.  | 173 | James Mangantulle, ..... | Slate picker, ..... | 14 | M. | ..... | South Wilkes-Barre, ..... | Wilkes-Barre, .....       | Severely cut on chin by a kick from a mule.   |
| 1.  | 174 | Albert Kresky, .....     | Miner, .....        | 32 | M. | 3     | West End, .....           | Mocanaqua, .....          | While stepping away from falling rock his leg caught and was fractured.   |
| 4.  | 175 | William Trigg, .....     | Driver, .....       | 18 | M. | ..... | Buttonwood, .....         | Hanover township, .....   | Both were painfully burned by an explosion of gas. A door was left open too long and gas accumulated unknown to the men and it fired from their lamps.  |
| 8.  | 176 | Thomas Merrifield, ..... | Driver, .....       | 16 | M. | ..... | Empire, .....             | Wilkes-Barre, .....       | Severely injured by a fall of rock. He neglected to replace two discharged props.   |
| 11. | 177 | William Petkofski, ..... | Timberman, .....    | 29 | M. | ..... | Slope No. 6, .....        | Glen Lyon, .....          | Collar bone fractured and bruised on body by a premature blast.   |
| 11. | 178 | Wm. McMannagan, .....    | Laborer, .....      | 25 | M. | ..... | Hillman vein, .....       | Wilkes-Barre, .....       | Leg broken and back hurt by a fall of rock on face and pulled down.   |
| 11. | 179 | David Laker, .....       | Laborer, .....      | 17 | M. | ..... | do.                       | do.                       | Burned on face and hand by hot gas from under the boilers.  |
| 11. | 180 | Adolph Revinski, .....   | Miner, .....        | 30 | M. | 1     | Maffet, .....             | Sugar Notch, .....        | Leg broken; machine-bar fell on him.  |
| 13. | 181 | Charles Rumphry, .....   | Miner, .....        | 53 | M. | 5     | Conyngham, .....          | Wilkes-Barre, .....       | Back severely injured by a fall of bony coal.   |
| 19. | 182 | Patrick Graven, .....    | Miner, .....        | 30 | M. | 3     | Shaft No. 3, .....        | Edwardsdale, .....        | Ankle dislocated; foot caught between rope and rail at head of plane.   |
| 20. | 183 | John A. Morgan, .....    | Fireman, .....      | 28 | M. | ..... | South Wilkes-Barre, ..... | Wilkes-Barre, .....       |   |
| 23. | 184 | Ivor Davies, .....       | Sinker, .....       | 23 | M. | ..... | Auchincloss, .....        | Hanover township, .....   |   |
| 24. | 185 | John Svitleski, .....    | Laborer, .....      | 28 | M. | ..... | Shaft No. 1, South, ..... | Nanticoke, .....          |   |
| 24. | 186 | Joseph Bryant, .....     | Door tender, .....  | 15 | M. | ..... | Shaft No. 2, .....        | Edwardsdale, .....        |   |

Oct.

TABLE No. 5.—Continued.

| Date of accident. | Number of accident. | Name of person.          | Occupation.         | Age   | Married. | Number of children. | Name of colliery.                | Location—Luzerne county. | Nature and cause of accident.  |
|-------------------|---------------------|--------------------------|---------------------|-------|----------|---------------------|----------------------------------|--------------------------|--|
|                   |                     |                          |                     |       |          |                     |                                  |                          |  |
| Oct. 26,          | 187                 | William Amos, .....      | Door tender, .....  | 59    | M.       | 2                   | Hollenback, .....                | Wilkes-Barre, .....      | Compound fracture of leg; car jumped the track and ran upon him; leg afterwards amputated.   |
| 29,               | 188                 | George Porter, .....     | Footman, .....      | 23    | .....    | .....               | North shaft No. 1, .....         | Nanticoke, .....         | Leg broken by being caught between a car and stop-block.   |
| 30,               | 189                 | Frank Hocker, .....      | Driver, .....       | 16    | .....    | .....               | Slope No. 4, .....               | do. ....                 | Leg broken by falling under moving cars, when getting off the front end.   |
| Nov. 1,           | 190                 | James Hammil, .....      | Miner, .....        | 53    | M.       | 2                   | Maxwell, .....                   | Ashley, .....            | Two fingers cut off and cut on leg. While car on track it slipped, catching his fingers and leg between it and track rail. Knee severely squeezed between cars when in the act of coupling them. |
| 3,                | 191                 | George Smith, .....      | Driver's helper, 17 | ..... | .....    | .....               | Empire, .....                    | Wilkes-Barre, .....      | Arm fractured; caught under car wheel.   |
| 3,                | 192                 | Joseph Setter, .....     | Driver, .....       | 16    | .....    | .....               | Shaft, No. 6, .....              | Glen Lyon, .....         | Both bones in leg fractured; crushed by mine cars on the inside slope.   |
| 6,                | 193                 | William Richards, .....  | Miner, .....        | 23    | M.       | 1                   | Shaft No. 1, .....               | Edwardsdale, .....       | Severely burned on face and hands by an explosion of gas.  |
| 7,                | 194                 | Anthony Barknoski, ..... | Miner, .....        | 33    | M.       | .....               | Dorrance, .....                  | Wilkes-Barre, .....      | Spine severely injured by a fall of rock.  |
| 9,                | 195                 | John Walters, .....      | Miner, .....        | 33    | M.       | 4                   | Red Ash No. 1, .....             | do. ....                 | Fell off a stone wall twenty-six feet high, when playing and was severely injured.   |
| 12,               | 196                 | Morris Stamford, .....   | Slate picker, ..... | 13    | .....    | .....               | Avondale breaker, .....          | Plymouth township, ..... | Hand badly crushed by being caught on cars—fall by a piece of falling rock.  |
| 13,               | 197                 | Patrick Doran, .....     | Laborer, .....      | 37    | M.       | 2                   | Shaft No. 9, .....               | Sugar Notch, .....       | Fired a charge of powder by turning it in a hole and was severely injured.   |
| 16,               | 198                 | Roland Spollock, .....   | Miner, .....        | 24    | .....    | .....               | Shaft No. 3, .....               | Edwardsdale, .....       | Arm and hand severely injured by a premature blast.  |
| 17,               | 199                 | John B. Thomas, .....    | Miner, .....        | 39    | M.       | 4                   | Hollenback, .....                | Wilkes-Barre, .....      | Collar bone fractured and otherwise bruised by a fall of heavy coal.   |
| 19,               | 200                 | Thomas Jones, .....      | Miner, .....        | 34    | M.       | 2                   | Avondale, .....                  | Plymouth township, ..... | Shoulder bone fractured by a fall of roof.   |
| 20,               | 201                 | William Gregory, .....   | Laborer, .....      | 32    | M.       | 3                   | Woodward, .....                  | do. ....                 | Foot severely crushed when hoisting a piece of rock by the rope to the bucket  |
| 20,               | 202                 | Hugh Leslie, .....       | Sinker, .....       | 39    | M.       | .....               | S. Wilkes-Barre air shaft, ..... | Hanover township, .....  | It slipped and caught his foot.  |
| 20,               | 203                 | Andrew Balogu, .....     | Laborer, .....      | 23    | M.       | 1                   | Dorrance, .....                  | Wilkes-Barre, .....      | Skull fractured by a fall of top rock.   |

|                  |  |                          |          |                    |                                    |                             |   |
|------------------|--|--------------------------|----------|--------------------|------------------------------------|-----------------------------|---|
| 21, 22, 23       | Henry Bultz,<br>Stephen Miklo,           | Door tender,<br>Laborer, | 16<br>32 | M. 1               | North No. 1 shaft,<br>Shaft No. 3, | Nanticoke,<br>Edwardsdale,  | Severely injured by falling under cars.<br>Back painfully injured by a fall of rock.<br>Both severely injured by a fall of coal and slate. They were working on night shift and tried to finish loading their coal before pulling the dangerous rock down, but it fell.   |
| 22, 26, 27       | Dennis Murphy,<br>Francis Genlock,       | Miner,<br>Laborer,       | 50<br>30 | M. 7<br>M. 1       | Woodward,<br>do.                   | Plymouth township<br>do.    | Both painfully burned by an explosion of gas through the carelessness of parties in the gangway adjacent to them; they being in the airway, the flames entered their place through the cross heading.<br>Foot painfully injured. Had it too far out when the cage was descending and it was caught.                                   |
| 26, 28, 29       | John Hughes,<br>Alex. Dembosky,          | Miner,<br>Laborer,       | 37<br>25 | M. 5               | Shaft No. 4,<br>do.                | Edwardsdale,<br>do.         | Two severe cuts on head and otherwise bruised by a fall of coal at face of gangway.   |
| 28, 29           | Richard Davis,                           | Footman,                 | 18       | .....              | Lance No. 11,                      | Plymouth,                   | Both burned on face and hands by an explosion of gas. It accumulated when a door was open and fired from their safety lamps when they were walking against the current after closing the door. Stephen Valiko was fatally burned at the same time.  |
| 30, 31           | Daniel D. Williams,                      | Miner,                   | 38       | W. ....            | South Wilkes-Barre,                | Wilkes-Barre,               | Leg broken and head and shoulder injured by a fall of roof.   |
| 3, 212, 3, 213   | Peter A. Peterson,<br>Edmund Murphy,     | Miner,<br>Driver,        | 37<br>17 | M. 4<br>S. ....    | Dorrance,<br>do.                   | do.<br>do.                  | Leg fractured by a fall of coal.<br>Face and hands more or less burned by an explosion of a small quantity of gas.<br>Face and hands burned by an explosion of gas. Happened in an abandoned breast.<br>Leg fractured by a piece of coal falling on it.   |
| 4, 214           | John Roslofski,                          | Laborer,                 | 26       | M. 2               | Avondale,                          | Plymouth township,          | Two fingers blown off while tampering with a dynamite cap which exploded. Both were burned by an explosion of gas. Were using naked lights and standing on the return side, when putting up brattice to remove a body of gas, and it was fired. Face, hands and arm burned by a burning gas feeder darting from a pile of loose coal. |
| 5, 215, 6, 216   | Alex. Meliskie,<br>John Eynck,           | Miner,<br>Laborer,       | 38<br>30 | M. 3<br>M. 1       | Shaft No. 6,<br>Alden,             | Glen Lyon,<br>Alden,        | Severely cut on head and face bruised by being struck by a piece of coal from a blast.  |
| 7, 217           | John Nytt-hack,                          | Miner,                   | 29       | M. 3               | do.                                | do.                         | Leg fractured; ear jumped track and crushed him against the rib.<br>Severely injured by a fall of rock while working coal from under it.<br>Severely injured by a fall of fire clay.<br>Leg fractured; ear jumped track at head block and struck him.   |
| 8, 218           | Frank Trescott,                          | Miner,                   | 56       | M. 5               | South No. 1 shaft,                 | Nanticoke,                  |   |
| 10, 219          | Thomas Morgan,                           | Runner,                  | 22       | S. ....            | Empire,                            | Wilkes-Barre,               |   |
| 10, 220, 10, 221 | Thomas A. Jones,<br>David J. Davies,     | Miner,<br>Laborer,       | 35<br>27 | M. 2               | Buttwood,<br>do.                   | Hanover township,<br>do.    |   |
| 11, 222          | John E. Jones,                           | Miner,                   | 27       | M. 1               | Parrish,                           | Plymouth,                   |   |
| 11, 223          | John Burns,                              | Miner,                   | 45       | M. 3               | Shaft No. 2,                       | do.                         |   |
| 13, 224          | Thomas Price,                            | Runner,                  | 38       | S. ....            | Lance No. 11,                      | do                          |   |
| 14, 225          | James Harvey,                            | Miner,                   | 36       | M. 2               | Shaft No. 3,                       | Edwardsdale,                |   |
| 15, 226, 15, 227 | Alexander Gardener,<br>John Tru-hinkski, | Miner,<br>Door tender,   | 34<br>11 | M. ....<br>S. .... | Hillman vein,<br>Shaft No. 6,      | Wilkes-Barre,<br>Glen Lyon, |   |

Dec.

TABLE No. 5.—Continued.

| Date of accident. | Number of accident. | Name of Person.        | Occupation.    | Age. | Married. | Number of children. | Name of colliery.      | Location—Luzerne county. | Nature and cause of accident.  |
|-------------------|---------------------|------------------------|----------------|------|----------|---------------------|------------------------|--------------------------|--|
| Dec. 20,          | 228                 | Barney Dugan, .....    | Miner, .....   | 38   | M.       | 7                   | Baltimore No. 2, ..... | Wilkes-Barre, .....      | Injured by a premature blast. Both were burned by an explosion of gas. They fired the gas which they entered their place in the morning, the place having been reported safe by the first boss. Painfully bruised by a blast. It fired when he was returning, thinking it had missed. Right leg cut off; while running a car down from its breast his leg was caught under the wheels. |
| 21,               | 229                 | Goetlip Grampay, ..... | Miner, .....   | 50   | M.       | 4                   | Hollenback, .....      | do. ....                 | They fired the gas which they entered their place in the morning, the place having been reported safe by the first boss. Painfully bruised by a blast. It fired when he was returning, thinking it had missed. Right leg cut off; while running a car down from its breast his leg was caught under the wheels.  |
| 21,               | 230                 | Ignatz Blucack, .....  | Laborer, ..... | 45   | M.       | 4                   | do. ....               | do. ....                 | They fired the gas which they entered their place in the morning, the place having been reported safe by the first boss. Painfully bruised by a blast. It fired when he was returning, thinking it had missed. Right leg cut off; while running a car down from its breast his leg was caught under the wheels.  |
| 22,               | 231                 | Stanley Gorse, .....   | Miner, .....   | 36   | S.       | .....               | Shaft No. 4, .....     | Edwardsdale, .....       | Painfully bruised by a blast. It fired when he was returning, thinking it had missed. Right leg cut off; while running a car down from its breast his leg was caught under the wheels.   |
| 24,               | 232                 | August Kogals, .....   | Laborer, ..... | 57   | M.       | 5                   | Empire, .....          | Wilkes-Barre, .....      | Right leg cut off; while running a car down from its breast his leg was caught under the wheels.   |
| 31,               | 233                 | John Puderowski, ..... | Laborer, ..... | 25   | S.       | .....               | Stanton, .....         | do. ....                 | Leg bruised by coal rolling upon it.   |

## Recapitulation.

| Occupation.                      | Number. | Nationality.         | Number. | Causes of Accidents.                       | Number. |
|----------------------------------|---------|----------------------|---------|--|---------|
| Miners, .....                    | 57      | American, .....      | 22      | By explosions of firedamp, .....           | 63      |
| Laborers, .....                  | 52      | Welsh, .....         | 30      | By falls of roof and coal, .....           | 58      |
| Drivers and runners, .....       | 39      | Irish, .....         | 36      | By mine cars, underground, .....           | 59      |
| Head and footmen, .....          | 7       | Polish, .....        | 69      | By explosions of powder and blasts, .....  | 93      |
| Door tenders, .....              | 11      | English, .....       | 19      | By miscellaneous causes underground, ..... | 23      |
| Company men, .....               | 11      | German, .....        | 14      | By miscellaneous causes on surface, .....  | 27      |
| Shaft sinkers and rockmen, ..... | 4       | Hungarian, .....     | 9       | .....                                      | .....   |
| Outside men, .....               | 22      | Miscellaneous, ..... | 4       | .....                                      | .....   |
| Totals, .....                    | 233     | .....                | 233     | .....                                      | 233     |

# FIFTH ANTHRACITE DISTRICT.

(LUZERNE AND CARBON COUNTIES.)

---

Hazleton, May 1, 1895.

Hon. Isaac B. Brown,

Secretary of Internal Affairs:

Sir: I have the honor of herewith submitting my annual report as Inspector of Coal Mines for the Fifth Anthracite District, for the year ending December 31, A. D. 1894.

The tables will show that during the year 6,132,627 tons of coal were mined in the district; being 106,441 tons less than the production of 1893.

The number of lives lost in the mining and preparation of this coal was 58, being the same number as in 1893, leaving 30 wives widows and 66 fatherless children in this and foreign lands.

The number of non-fatal accidents was 95, or a decrease of four from the number of like accidents for the year previous.

Embodied in table No. 4 will be found two fatalities that occurred on the clay strippings under contractors, by which two wives were left widows and seven children orphans.

The tables show that a life was lost in some manner for each 105,735 tons of coal mined; also, that a non-fatal accident is reported for each 64,554 tons of coal mined; and an accident, fatal or non-fatal is reported for each 40,082 tons of coal mined. They also show a fatal accident for each 316.6 persons employed, a non-fatal accident to each 193.3 persons employed, and a fatality or non-fatality to one of each 120 persons employed.

A brief description of some improvements at the collieries is given, together with some remarks on the accidents, fatal and serious, together with some remarks on the fatal dynamite explosion at Stockton.

According to their new policy during the year, the Lehigh Valley

Coal Company has by the expiration of leases became the operators of collieries on their lands at Hazleton and Jeansville operated formerly by A. Pardee & Co., and J. C. Haydon & Co. Owing to the change occurring November 1, 1894, there are 1,421 persons who worked at these collieries for A. Pardee & Co., and 874 who worked for J. C. Haydon & Co. who are reported also by the Lehigh Valley Coal Company in tables Nos. 2 and 3. The live stock (horses and mules) and boilers and mine locomotives are thus twice enumerated in table No. 2.

Yours very respectfully,

JOHN M. LEWIS,  
Inspector of Mines.

---

Tonnage Mined in Fifth Anthracite District for Year 1894.

|   |             |
|---|-------------|
| A. Pardee & Co., .....                      | 436,070     |
| The Cross Creek Coal Company, .....         | 1,091,966   |
| Lehigh Coal and Navigation Company, .....   | 835,542     |
| G. B. Markle & Co., .....                   | 555,782     |
| Linderman & Skeer, .....                    | 464,553     |
| A. S. Van Wickle, .....                     | 560,310     |
| Lehigh Valley Coal Company, .....           | 275,936     |
| J. C. Haydon & Co., .....                   | 244,784     |
| Upper Lehigh Coal Company, .....            | 309,470     |
| Pardee Bros & Co., .....                    | 322,624     |
| Calvin Pardee & Co., .....                  | 122,092     |
| Pardee Sons & Co., .....                    | 208,920     |
| C. M. Dodson & Co., .....                   | 210,018     |
| M. S. Kemmerer & Co., .....                 | 191,264     |
| Lehigh and Wilkes-Barre Coal Company, ..... | 165,978     |
| John S. Wentz & Co., .....                  | 86,000      |
| The Evans Mining Company, .....             | 51,318      |
|   | <hr/>       |
| Total tonnage, .....                        | 6,132,627   |
|   | <hr/> <hr/> |

NUMBER OF FATALITIES AND TONS OF COAL MINED PER LIFE LOST BY  
EACH COMPANY.

| Names of Operators.                           | Number of lives lost. | Tons of coal mined<br>per life lost. |
|---|-----------------------|--------------------------------------|
| A. Pardee & Co., . . . . .                    | 7                     | 62,581                               |
| The Cross Creek Coal Company, . . . . .       | 6                     | 181,994                              |
| Lehigh Coal and Navigation Company, . . . . . | 7                     | 119,363                              |
| G. B. Markle & Co., . . . . .                 | 3                     | 185,261                              |
| Linderman & Skeer, . . . . .                  | 11                    | 42,232                               |
| A. S. Van Wickle, . . . . .                   | 6                     | 93,385                               |
| Lehigh Valley Coal Company, . . . . .         | 1                     | 275,936                              |
| J. C. Haydon & Co., . . . . .                 | . . .                 | . . .                                |
| Upper Lehigh Coal Company, . . . . .          | 2                     | 154,735                              |
| Pardee Bros. & Co., . . . . .                 | 6                     | 53,771                               |
| Calvin Pardee & Co., . . . . .                | 3                     | 40,697                               |
| Pardee Sons & Co., . . . . .                  | 4                     | 52,230                               |
| C. M. Dodson & Co., . . . . .                 | 1                     | 210,018                              |
| M. S. Kemmerer & Co., . . . . .               | . . .                 | . . .                                |
| Lehigh & Wilkes-Barre Coal Company, . . . . . | 1                     | 165,978                              |
| John S. Wentz & Co., . . . . .                | . . .                 | . . .                                |
| The Evans Mining Company, . . . . .           | . . .                 | . . .                                |
| Total fatalities, . . . . .                   | 58                    | 105,735                              |

NUMBER OF NON-FATAL ACCIDENTS AND TONS OF COAL MINED PER PERSON  
INJURED BY EACH COMPANY.

| Names of Operators.                           | Number of persons<br>injured. | Tons of coal mined<br>per person injured. |
|---|-------------------------------|---|
| A. Pardee & Co., . . . . .                    | 22                            | 19,821                                    |
| The Cross Creek Coal Company, . . . . .       | 6                             | 181,994                                   |
| Lehigh Coal and Navigation Company, . . . . . | . . .                         | . . .                                     |
| G. B. Markle & Co., . . . . .                 | 9                             | 61,753                                    |
| Linderman & Skeer, . . . . .                  | 15                            | 30,970                                    |
| A. S. Van Wickle, . . . . .                   | 2                             | 280,155                                   |
| Lehigh Valley Coal Company, . . . . .         | 8                             | 34,492                                    |
| J. C. Haydon & Co., . . . . .                 | 9                             | 27,198                                    |
| Upper Lehigh Coal Company, . . . . .          | 4                             | 77,367                                    |
| Pardee Bros. & Co., . . . . .                 | 6                             | 53,771                                    |

NUMBER OF NON-FATAL ACCIDENTS AND TONS OF COAL MINED PER PERSON  
INJURED BY EACH COMPANY—Continued.

| Names of Operatives.                          | Number of persons<br>injured. | Tons of coal mined<br>per person injured. |
|---|-------------------------------|---|
| Calvin Pardee & Co., . . . . .                | 4                             | 30,523                                    |
| Pardee Sons & Co., . . . . .                  | 3                             | 69,640                                    |
| C. M. Dodson & Co., . . . . .                 | 2                             | 105,009                                   |
| M. S. Kemmerer & Co., . . . . .               | 2                             | 95,632                                    |
| Lehigh & Wilkes-Barre Coal Company, . . . . . | 3                             | 55,326                                    |
| John S. Wentz & Co., . . . . .                | .                             | .   |
| The Evans Mining Company, . . . . .           | .                             | .   |
| Total non-fatal accidents, . . . . .          | 95                            | 64,554                                    |

NUMBER OF FATAL AND NON-FATAL ACCIDENTS AND TONS OF COAL MINED  
PER PERSON KILLED OR INJURED.

| Names of Operators.                            | Number of persons<br>killed or injured. | Tons of coal mined<br>per person killed or<br>injured. |
|--|---|--|
| A. Pardee & Co., . . . . .                     | 29                                      | 15,037   |
| The Cross Creek Coal Company, . . . . .        | 12                                      | 90,997   |
| Lehigh Coal and Navigation Company, . . . . .  | 7                                       | 119,363  |
| G. B. Markle & Co., . . . . .                  | 12                                      | 46,315   |
| Linderman & Skeer, . . . . .                   | 26                                      | 17,867   |
| A. S. Van Wickle, . . . . .                    | 8                                       | 70,039   |
| Lehigh Valley Coal Company, . . . . .          | 9                                       | 30,659   |
| J. C. Haydon & Co., . . . . .                  | 9                                       | 27,198   |
| Upper Lehigh Coal Company, . . . . .           | 6                                       | 51,578   |
| Pardee Bros. & Co., . . . . .                  | 12                                      | 26,885   |
| Calvin Pardee & Co., . . . . .                 | 7                                       | 17,442   |
| Pardee Sons & Co., . . . . .                   | 7                                       | 29,846   |
| C. M. Dodson & Co., . . . . .                  | 3                                       | 70,006   |
| M. S. Kemmerer & Co., . . . . .                | 2                                       | 95,632   |
| Lehigh & Wilkes Barre Coal Company, . . . . .  | 4                                       | 41,499   |
| John S. Wentz & Co., . . . . .                 | .                                       | .  |
| The Evans Mining Company, . . . . .            | .                                       | .  |
| Total fatal and non-fatal accidents, . . . . . | 153                                     | 40,082   |



## NATIONALITY OF PERSONS INJURED FATALLY AND NON-FATALLY.

| Nature of Accident.        | Hungarian. |    | Irish. | German. | Polish. | Italian. | Austrian. | English. | Welsh. | Scotch. | Swedish. | Totals. |
|----------------------------|------------|----|--------|---------|---------|----------|-----------|----------|--------|---------|----------|---------|
|                            |            |    |        |         |         |          |           |          |        |         |          |         |
| Fatalities, . . . . .      | 22         | 16 | 4      | 4       | 4       | 4        | 3         | 1        |        |         |          | 58      |
| Non-fatalities, . . . . .  | 24         | 18 | 17     | 4       | 13      | 8        | 5         | 12       | 2      | 1       | 1        | 95      |
| Total accidents, . . . . . | 46         | 34 | 21     | 8       | 17      | 12       | 8         | 3        | 2      | 1       | 1        | 153     |

## CLASSIFICATION OF FATAL AND NON-FATAL ACCIDENTS.

| Causes of Accidents.                                     | Number killed. | Number injured. | Totals. |
|--|----------------|-----------------|---------|
|  |                |                 |         |
| By explosion of C. H <sup>4</sup> gas, . . . . .         | 1              | 1               | 2       |
| By falls of coal, roof and sides, . . . . .              | 17             | 33              | 50      |
| By falls of coal, rock and clay on strippings, . . . . . | 4              | 1               | 5       |
| By mine cars, . . . . .                                  | 6              | 16              | 22      |
| By cars on the surface, . . . . .                        | 9              | 15              | 24      |
| By machinery inside and outside, . . . . .               | 3              | 7               | 10      |
| By explosions of powder, . . . . .                       | 10             | 2               | 12      |
| By premature blasts, . . . . .                           | 5              | 9               | 14      |
| By miscellaneous causes inside and outside, . . . . .    | 3              | 11              | 14      |
| Total from all causes, . . . . .                         | 58             | 95              | 153     |

COMPARATIVE STATEMENT, SHOWING NUMBER OF TONS OF COAL MINED PER FATAL ACCIDENT, NUMBER OF PERSONS EMPLOYED PER LIFE LOST, AND NUMBER OF FATALITIES PER THOUSAND EMPLOYEES IN THE FIFTH ANTHRACITE DISTRICT, FOR THE PAST FIFTEEN YEARS.

| Years.  | Number of tons of coal mined in each year, <i>vs.</i> | Number of fatal accidents. | Number of tons of coal mined per fatal accident. | Number of persons employed. | Number employed per life lost. | Number of deaths per thousand persons employed. |
|---------|---|----------------------------|--|-----------------------------|--------------------------------|---|
| 1880    | 4,298,764   | 26                         | 165,337  | 10,255                      | 394.42                         | 2.535   |
| 1881    | 5,037,948   | 47                         | 107,190  | 11,386                      | 242.25                         | 4.127   |
| 1882    | 5,360,497   | 40                         | 134,012  | 12,298                      | 307.45                         | 3.252   |
| 1883    | 5,666,767   | 38                         | 149,125  | 13,598                      | 337.84                         | 2.794   |
| 1884    | 5,274,227   | 40                         | 131,885  | 14,299                      | 357.47                         | 2.797   |
| 1885    | 5,535,544   | 42                         | 131,798  | 14,224                      | 338.66                         | 2.952   |
| 1886    | 5,333,518   | 35                         | 152,386  | 14,140                      | 404.00                         | 2.475   |
| 1887    | 3,961,594   | 15                         | 264,106  | 14,096                      | 939.73                         | 1.064   |
| 1888    | 4,892,514   | 32                         | 152,891  | 14,448                      | 451.50                         | 2.215   |
| 1889    | 5,655,196   | 46                         | 122,939  | 14,686                      | 319.26                         | 3.132   |
| 1890    | 5,776,699   | 52                         | 111,090  | 14,421                      | 277.33                         | 3.606   |
| 1891    | 5,803,964   | 53                         | 109,509  | 14,961                      | 282.28                         | 3.548   |
| 1892    | 5,842,721   | 48                         | 121,725  | 16,277                      | 339.19                         | 2.949   |
| 1893    | 6,239,068   | 58                         | 107,570  | 17,540                      | 302.48                         | 3.307   |
| 1894    | 6,132,627   | 58                         | 105,734  | 18,361                      | 316.57                         | 3.159   |
| Totals. | 80,811,648  | 630                        | 128,272  | 214,900                     | 357.13                         | 2.935   |

COMPARATIVE STATEMENT SHOWING THE NUMBER AND CAUSES OF FATALITIES IN THE FIFTH ANTHRACITE DISTRICT FOR THE PAST FIFTEEN YEARS.

| Cause of accidents.                              | Years. |       |       |       |       |       |       |       |       |       |       |       |       |       |       | Totals. |
|--|--------|-------|-------|-------|-------|-------|-------|-------|-------|-------|-------|-------|-------|-------|-------|---------|
|  | 1880.  | 1881. | 1882. | 1883. | 1884. | 1885. | 1886. | 1887. | 1888. | 1889. | 1890. | 1891. | 1892. | 1893. | 1894. |         |
| By water from old workings,.....                 | .....  | ..... | ..... | ..... | ..... | ..... | ..... | ..... | ..... | ..... | ..... | 9     | ..... | 3     | ..... | 12      |
| Asphyxiated by gases,.....                       | .....  | ..... | ..... | ..... | ..... | ..... | ..... | ..... | ..... | ..... | ..... | 6     | ..... | ..... | ..... | 6       |
| By explosion of C. H. 4 gas,.....                | .....  | 3     | 1     | ..... | ..... | 1     | 1     | 1     | ..... | 1     | 1     | ..... | ..... | 1     | 1     | 11      |
| By falls of coal roof and sides,.....            | 12     | 24    | 24    | 18    | 10    | 19    | 13    | 6     | 14    | 22    | 19    | 16    | 25    | 18    | 21    | 261     |
| By cars inside and on the surface,.....          | 7      | 11    | 8     | 11    | 17    | 8     | 5     | 3     | 6     | 11    | 19    | 6     | 15    | 15    | 15    | 157     |
| By blasts and explosions of powder,.....         | 2      | 1     | 1     | 1     | 3     | 3     | 2     | 2     | 4     | 4     | 1     | 4     | 2     | 11    | 15    | 56      |
| By machinery inside and outside,.....            | 1      | 4     | 1     | 2     | 2     | 3     | 1     | 1     | 2     | ..... | 7     | 5     | 3     | 4     | 3     | 39      |
| By boiler explosions,.....                       | .....  | ..... | ..... | ..... | ..... | 3     | 1     | 1     | ..... | 4     | ..... | 1     | ..... | ..... | ..... | 10      |
| By miscellaneous causes inside and outside,..... | 4      | 4     | 5     | 6     | 8     | 5     | 12    | 1     | 6     | 4     | 5     | 6     | 3     | 6     | 3     | 78      |
| Totals,.....                                     | 26     | 47    | 40    | 38    | 40    | 42    | 35    | 15    | 32    | 46    | 52    | 53    | 48    | 58    | 58    | 630     |

Colliery Improvements in the Fifth Anthracite District During the  
Year 1894.

Lehigh Coal and Navigation Company.

Colliery No. 4—A trial slope opening a lift of ninety yards on the Mammoth vein, making the third lift below water level, has been sunk, finding the vein fifty feet in thickness and very good coal, on a regular pitch of seventy degrees.

Turnouts, a pump house with capacious pump, and airways connecting with a new ventilating fan, 21 feet in diameter, have been made for the purpose of developing this new lift in the best manner possible. A slope to meet and connect with present main hoisting slope has been located carefully and is being on line up the pitch.

The pumping capacity of top pumping station has been increased 2,058 gallons per minute.

Colliery No. 6.—The Mammoth vein, fifty feet in thickness, of good quality, on a pitch of forty-five degrees south, was cut by the tunnel from No. 6 shaft at a distance of 900 feet from the shaft on the second lift below water level. The air connections have been completed and gangways east and west are being driven in the "Crack" vein, a small vein underlying the Mammoth vein, with ten yards of intervening rock, preparatory to tapping the water in the abandoned first lift below water level.

Screen Building—Here the steam power has been increased by the erection of two additional batteries of Babcock and Wilcox high pressure boilers, giving an increase of 440 horse power to the plant erected in 1893. A system of mud tanks which make it possible for the water which has been used to clean coal to be pumped back and used over again, has also been erected.

G. B. Markle.

The new Jeddo No. 4 breaker erected in 1893 was put in operation February 1, 1894, and the coal which formerly was prepared there and at Jeddo No. 3 was all put through the new breaker, allowing the abandonment of Jeddo No. 3.

This company have also erected and enclosed a new set of boilers at their Highland No. 5 colliery.

Upper Lehigh Coal Company.

Slope No. 2—A new Worthington pump 20x12x15-inch, and a line of column pipe 550 feet long have been placed in this slope.

A new slope was sunk to the east gangway of No. 1 slope and con-

tinued about 25 yards down to the basin known as No. 1 basin, in which the east gangway is now being driven. The 2,500 feet of railroad necessary for transportation of coal from this slope to No. 2 breaker has been graded and built.

At No. 3 slope a new second opening has been completed.

#### A. S. Van Wickle.

Coleraine Colliery—At this colliery, since it has passed into the hands of Mr. Van Wickle, improvements have been the desire of the proprietor and the end and aim of the management. Some of the noted ones are, a new boiler plant for supplying steam to the coal breaker and hoisting engines and pumps at No. 1 slope.

Two new mine locomotives for use on the strippings and for transporting coal to the breaker.

The breaker enlarged and improved in every way.

New openings to develop the Primrose vein, which has been cut and found in good workable condition; also, second openings have been provided for this vein.

A commodious residence for the superintendent, convenient to the colliery, the same for the mine foreman and outside foreman, have been erected; also many new houses for the comfort of the increased number of employes.

A new pleasantly located and conveniently planned office has also been erected during the year.

#### Pardee Bros. & Co.

Lattimer No. 3.—At this colliery there has been an addition made to the breaker in the form of a shaft tower through which all the coal is hoisted from the surface level to the top of the breaker by means of two automatic dumping cages, which, by reason of the elevation being increased, is delivered on the plates much higher than formerly and thus allows the slate rock and bone to be picked out as it comes from the mines and stripping, thus aiding very much in the preparation of the coal before it goes to the rolls and into the screens and jigs and picking schutes, which renders it possible to handle more coal with the same men and machinery.

Many contemplated improvements were nipped in the bud by reason of the poor state of trade, and many more were spoiled by the flooding of the mines by a rainstorm which began on Friday, May 18, and continued until Monday, May 21, filling up many of the subterranean slopes and causing a period of idleness varying from one or two days to a month and more at all the mines of the district. The extra expense of getting out this unexpected inflow of water and the other expense of preparing against the mines being again flooded,

by digging ditches and canals and erecting flumes large enough to carry the surface water into the different creeks and water courses. These needed improvements were made, while some contemplated ones were left for another year.

#### Examination of Applicants for Certificates of Qualification as Mine Foremen and Assistant Mine Foremen.

The annual examination of applicants for certificates of qualification as mine foremen and assistant mine foremen for this district was held in the public school building on Pine street in the city of Hazleton, on June 12th and 13th, 1894.

The board of school controllers of the city granted the request of the boards of examiners for the use of the building.

The board of examiners was composed of E. L. Bullock, of Beaver Brook, superintendent, George McGee, of Freeland, and Thomas Thompson, of Hazleton, miners, together with the Mine Inspector of the district.

The board recommended the following named persons to Hon. Thos. J. Stewart, Secretary of Internal Affairs, as having passed the examination satisfactorily, and certificates of qualification as mine foremen were issued to them:

Adam Lesser, Upper Lehigh.  
 John J. McGuines, Lattimer Mines.  
 Evan L. Jenkins, Nesquehoning.  
 Patrick Quinn, Drifton.  
 Samuel Tinner, Stockton.  
 Richard Airy, Stockton.  
 Frank Carter, Milnesville.

The following named persons were recommended to receive certificates of qualification as assistant mine foremen.

Alfred Radley, Stockton.  
 David M. Emmanuel, Nesquehoning.  
 William Curtis, Summit Hill.  
 Albert Haughton, Summit Hill.  
 William Purdy, Hazleton.  
 William Cooper, Hazleton.  
 Henry Hawke, Hazleton.  
 John Richards, Hazleton.  
 Robert Robertson, Hazleton.  
 Henry Smith, Hazleton.  
 Thomas H. Blackwell, Hazleton.

### Review of Fatal Accidents of 1894 and Their Causes.

During the past year there were 58 fatal accidents in and about the mines and coal strippings of this district, many of which were due to the want of proper judgment and the recklessness of the victims themselves, and some of which were caused by the lack of judgment in persons employed with the victims.

By falls of roof coal and sides in the mines and on the strippings 21 lives were lost, or 36.2 per cent. of the whole number of fatalities.

By cars inside and outside 15 lives were ended, being 25.9 per cent. of the total fatalities.

Explosions of powder killed 10 persons, or 17.2 per cent. Premature blast proved fatal to 5 persons, or 8.6 per cent. Machinery, inside and outside the mines, caused 3 fatalities, or 5.2 per cent., an explosion of C. H. 4 gas caused one person's death or 1.7 per cent., while 3 persons, or 5.2 per cent., lost their lives from miscellaneous causes.

A brief description of each accident and the cause of death is given in the table No. 4; a fuller description of some of them, and of the "Stockton Disaster" follows; the numbers used correspond to those of table No. 4.

No. 1—At Hazleton mine breaker, January 3, Edward Devinney, American, loader, 21 years old, was, by the slipping of his brake-iron thrown off and in front of loaded cars, and both legs were so badly crushed and his arm torn under the wheels as to cause his death at the hospital the same day. It being an idle day for the mines, the breaker was run for the purpose of recleaning some cars of condemned coal. Devinney and another young man were running down three cars, the last not being coupled, and Devinney was standing between the first and second cars, which began to move away from the third, when the other young man (George Henderschedt) motioned to Devinney to put on the brakes, which he did, and when the cars came together Henderschedt heard him crying out, and, stopping the cars, found him under the second car holding on to the axle, while the wheels rested on his legs. He was gotten out as soon as possible and taken to the hospital where all that could be done to alleviate his pain and help him was done, but nothing could prevent his death, which resulted from his injuries the same night.

No. 2—Charles Martin, American, miner, 24 years old, single, at colliery No. 5, February 6, was fatally injured internally in the breast, in which he worked. He had fired a hole in a roll of rock which ran across the breast, and going up to the face, began to work with his pick around the rock when a large piece fell from the roll and squeezed him about the thighs and injured him internally, as before stated.

He was taken to the Hazleton hospital, where he expired February 11. This was a sad case, as the accident occurred when he was working alone, his partner being sick that day, and he, on account of his approaching marriage, was loath to lose a day at that time.

No. 3—At Beaver Meadow Colliery, February 14, John Rapschock, Hungarian, slate loader, 23 years old, single, was fatally crushed under the slate cars near the bank where they were dumped. In going out to the dump he rode on the side of the locomotive, and when the dump was reached the locomotive ran on one track while the cars were supposed to be spragged by him and run in on a branch road. When the engineer ran his locomotive away from the slate cars and stopped, he was horrified to see Rapschock under the cars between the rails being pushed along by the cars and crushed under the cross-pieces of truck against the sills and branch rails. He must have tried to cross the track in front of the cars after getting off the locomotive.

His death followed at the hospital the same night and it was certainly due to want of care on his own part.

No. 4—At Beaver Brook colliery, February 19, Andrew Leshko, Hungarian, loader, 43 years old, wife and two children, was so badly injured that he died an hour and a half after at his home. He had two gondolas loaded, and wishing to run them down the road, he procured a bar and began to use it on the hind wheel of the first car, standing between the cars and astride of the rail, when he, working with the bar started the first car and jerked the second forward. It ran against his heel and pinned him fast between the flange of the wheel and sill, and before the cars were stopped the wheels had run over his leg from heel to thigh. He certainly need not have stood as he did to do the starting work.

No. 5—Michael Trifcan, Italian, laborer, 24 years old, single, at Highland No. 2, February 24, was injured about shoulders and legs by a fall of dividing slate and coal which fell on him while he was drilling a hole under it in the bottom coal, while his miner, who had brought him in on this, which was an idle day, to help prepare coal for the next working day, was preparing a charge for the hole. He was apparently not seriously injured, yet the same afternoon, while waiting at the Freeland station for a train to take him to the hospital at Hazleton, he died. It was one of the coldest days of the winter, and the exposure may have hastened his death.

No. 7—At Hollywood stripping, April 3, Erasmus Powel, Hungarian, stripping miner, 43 years old, having wife and three children, had his skull fractured by coal falling from a pillar alongside of which he, with the men in his charge, was engaged in cleaning the clay out of the old breast so that the pillar could be robbed back

down the pitch and loaded up out of the schute of the old breast. One of the laborers warned him that the pillar top showed signs of falling, and in going to a place of safety he ran directly under a large piece of coal. He died of his injuries two hours later.

No. 9—George Stenge, Hungarian, slate picker, 17 years old, employed at the top of plane to screen building at Hauto, April 12, was killed by being run over by Barney truck on plane down which he rode on the truck against a trip of loaded cars. In getting off, his left leg was run over by hind wheel of truck, and he, on being thrown or rolling into middle of road, the heavy hoisting rope attached to the truck struck him on the head, causing almost instant death.

His riding down the plane was in violation of rule 16, article XII of the mine law, and yet I have cause to think it was not the first time he had been guilty of the offense, and that he was not the only offender, but I am glad to say that discipline has been revived, and there is now no riding down the planes allowed, even on the empty cars.

No. 10—John Conlon, Irish, miner, 58 years of age, wife, no children under 16 years old, employed at No. 1 stripping Lattimer, April 25, was struck on the head by a small piece of top coal which fell on him from a bridge of coal between two pillars between which the road ran. Cars being scarce, he came out from his working place, and while talking to some other men, the coal fell and struck him on top of the head, rendering him unconscious. The men revived him with some water and after sitting down awhile he walked to his home, washed himself and went to bed, where he became unconscious and died about seven hours after the accident.

No. 14—Upper Lehigh No. 4 slope, in what is locally named the "Q" vein, May 7th, Martin Sisino, Austrian, laborer, 19 years old, single, while throwing tamping into a hole for his miner, John Wargo, was instantly killed by the powder exploding and throwing the coal out against him. Wargo was very seriously burned about the face, and his eyesight destroyed temporarily. The cause of the explosion was the presence of a band of sulphur in the coal through which the drill passed, and from which no doubt a spark was struck by the butt end of the drill in tamping.

No. 16—At Coleraine colliery, No. 2 slope, May 17, Thomas Mulherin, American, miner, 40 years old, married, was fatally injured by fall of top slate at top of manway which he was getting ready to extend, and by falling down said manway a distance of 60 feet. He had cut the coal out from under this clod with a shot he fired on the rib, and as he was cutting holes in the bottom slate to stand the manway props, the clod fell, but whether the piece struck him and knocked him down the manway, or in trying to avoid the falling clod



he lost his balance and fell down, is not clearly known, as the laborer who was on the other side of the breast could not tell whether the clod had struck him or not, but knew he had fallen down the manway after, and he gave the alarm. Henry Spohr, going up the manway, found him lying on his back with his head down the pitch. He was taken out, but died soon after reaching the surface. He left a widow and four children.

No. 19—Joseph Wolff, German, miner, 44 years old, wife but no children, employed at No. 8 slope, Hazleton mine, was instantly killed on June 9th by a fall of top coal in the face of his breast. He and his partner had drilled a hole in the top coal and fired it, but it did not bring the top part down. Wolff went up under it while his partner was loading the buggy. The partner warned him that the piece was bad, and advised him to bar it down by standing on one side of it, but he said Maier was afraid and climbed up on top of the bottom and sat down under it. Maier asked him three times to come out from under it, as the slips were working, but he only made light of it, and the coal fell on him, crushing his head against the bottom coal and killing him instantly. He was the victim of his own foolhardiness.

No. 24—At Drifton slope No. 1, June 23, John Plahita, Hungarian, special laborer, 25 years old, single, was killed instantly by being struck by a trip of three runaway loaded cars in the inside slope. The runaway was caused by the rope breaking when the cars were about 125 feet from foot of the slope. He, with the roadman, was at the foot fixing a latch on the branch, and had he staid where he was or followed the roadman into the gangway he would have been unhurt, but, becoming excited he ran right into the danger by trying to cross the foot of slope and was caught by the cars striking two other cars at the bottom and throwing them against him.

No. 27—At East Sugar Loaf No. 2, July 12, John Mulligan, American, assistant ticket boss, 18 years old. While the loaded car was standing on the plane to the breaker at the dump, as the car would not to be dumped for some time, he went below the car to clean out a small hole or pocket that caught the coal from the cars. He was throwing the coal into the dump when the loaded car started back, and one of the other persons employed about the dumps gave a warning cry, but before he got safely out of the pocket, which was between the rails, the car struck him and rolled him down the plane and the wheels passed over his legs, injuring him so terribly that he died while being conveyed in the company's ambulance to his home. I made an investigation on the same day, and also ordered an inquest, which was held.

While the engineer testified very positively that he had received

the signal to let back the empty car from the dump, the testimony of the three persons employed with Mulligan was that neither of them had given any signal or been in position to give one, and the loaded car was silent proof of this fact. The jury's verdict was "That the said John Mulligan came to his death at No. 2 colliery, Stockton, on Thursday, July 12, A. D. 1894, by being struck on an inclined plane by a loaded car; said accident being caused by carelessness or negligence on the part of the engineer in lowering said car."

It was also apparent from the testimony that the pocket could have been cleaned just as well when the car was at the foot of the plane and so need not have been cleaned by Mulligan while the cars were standing over it.

Nos. 28 and 29—At No. 4 slope, "Cranberry," in the lower lift, July 14, Michael Tomka, miner, 33 years old, married, and John Andrego, laborer, 35 years old, married, were instantly killed by the premature explosion of a blast which they were preparing to fire. These two men were employed driving a cross-heading from the west gangway to the sump, and had drilled a hole with a machine in the west rib of this cross-heading, and Tomka had made the charge of powder for it and gone in with it, and, according to the evidence of Thomas Louden, the miner who was in charge of the gangway, and the last person to see Tomka alive, he had about time to have reached the hole and put the powder in preparatory to tamping it, when there was an explosion and all the lights were extinguished. Louden procured a light and inquired for Tomka and looked in the heading to which he usually retreated when firing for him, and not finding him, went into his working place and found him and his laborer both dead. Andrego the laborer was 25 feet from where the hole was drilled, while Tomka was about 8 feet from the hole. From the fact that Mr. Louden was sure he detected the fumes of dynamite powder when he went into their place, he thought that, as the place was narrow (6 feet wide) and the coal hard to blow, Tomka may have put a stick of dynamite powder and a cap in the back end of his cartridge, and, having the open end of the cap pointing outward when he pushed his needle back with the powder into the hole, it entered the cap and caused the explosion. And this, I think, is the only satisfactory explanation.

Tomka left a wife and four children, and Andrego left a wife and two children in Hungary. Andrego, the laborer, held a miner's certificate and had been in this coal region for some years, and then returned to Hungary and married and came here the second time seeking his fortune, only to reach this untimely end.

Fatal Explosion of Powder in West No. 1 Slope, Linderman & Skeer,  
at Stockton.

At about 7 o'clock A. M., Tuesday, July 17, 1894, eight persons were instantly killed by an explosion of Atlas Powder at the foot of the subterranean shaft from the Mammoth vein to the Wharton vein in the west No. 1 slope of Linderman & Skeer, at Stockton. They were Charles O'Donnell, footman, American; Andrew Sabol, Hungarian, miner; John Pirimbo, Hungarian, loader; John Kasheda, Hungarian, loader; John Brizyon, Hungarian, loader; John Krinock, Hungarian, loader; John Mateofski, Hungarian, miner; Anthony Norcavitz, Pole, loader.

The miners and loaders were employed in the Mammoth vein, to which a tunnel is cut back from the foot of the subterranean shaft, in robbing what would be known as the third lift of the Mammoth vein of the west No. 1 slope, and as usual were on this morning taking to their several schutes the powder, fuse and caps which would be required through the day to start the batteries; the miners having brought back the night previous what had not been used the day before.

The powder, fuse and caps were all brought from the magazine on the surface by Charles O'Donnell, the footman, in order to avoid all danger of explosions on the slope, or in the shaft, by reason of careless handling of the caps and sticks of powder by the men while riding down the slope with it, or in the shaft on the cage. He kept them under lock and key in a box near the foot, when not distributing them to the men.

On this morning, while he was giving out to the men the powder, fuse and caps they each made request for, in some way an explosion was caused and every one present killed.

There are many theories as to what was the cause of the explosion, one being that one of the men had dropped fire from his lamp or pipe into a cap; another that some one had been picking at a cap with a lamp picker or horse shoe nail to remove the fine sawdust with which they are sometimes clogged, and still another that one of the men having his powder lying beside him on a bench near the box cut his fuse into lengths and began placing the caps on these lengths of fuse ready for use when required, and in pushing the fuse into the cap twisted the point into the fulminate of the cap and it, exploding near his powder, set it off, and that in turn set off what was in the box nearby. The only thing we know is, there was an explosion caused in some way by some one of the eight persons present, and those of us that remain should take warning and be careful in the handling of these explosives ourselves, and be watchful of others to see that they are careful.

Superintendent James E. Roderick was informed of the explosion and at once went to the slope and entered the mine and was lowered to the foot of the shaft, where the work of recovering the bodies at once began. This was rendered difficult owing to the timber at the foot of the shaft being blown down by the force of the explosion, but by 11 o'clock the bodies were all placed in coverings and these in boxes provided by an undertaker and by 12 o'clock noon they had all been taken to the surface where the undertakers took charge of them.

An inquest was held and the jury rendered a verdict of accidental death for which no blame could be attached to any living person.

TABLE No. 1.—Showing location, etc., of collieries in the Fifth Anthracite District.

| Name of Colliery.              | Name of Operator.                     | Location--County.               | Name of Superintendent.                                    | Postoffice Address.           |
|--------------------------------|---------------------------------------|---------------------------------|--|-------------------------------|
| Hazleton mine, .....           | A. Pardee & Co., .....                | Hazleton, Luzerne, .....        | Frank Pardee, .....  | Hazleton, Luzerne county, Pa. |
| Laurel Hill, .....             | do. ....                              | do. do. ....                    | do. ....   | Hazleton, Luzerne county, Pa. |
| Hazleton No. 3, .....          | do. ....                              | Hazle township, Luzerne, .....  | do. ....   | Hazleton, Luzerne county, Pa. |
| Hazleton No. 6, .....          | do. ....                              | do. do. ....                    | do. ....   | Hazleton, Luzerne county, Pa. |
| South Sugar Loaf, .....        | do. ....                              | do. do. ....                    | do. ....   | Hazleton, Luzerne county, Pa. |
| Stranberry, .....              | do. ....                              | do. do. ....                    | do. ....   | Hazleton, Luzerne county, Pa. |
| East Crystal Ridge, .....      | do. ....                              | do. do. ....                    | do. ....   | Hazleton, Luzerne county, Pa. |
| Drifton Nos. 1 and 2, .....    | The Cross Creek Coal Company, .....   | Drifton, Luzerne, .....         | Alfred Walter, General Man-<br>ager, .....                 | Drifton, Luzerne county, Pa.  |
| Eckley Nos. 2, 6 and 10, ..... | do. ....                              | Eckley, Luzerne, .....          | Edgar Kudlich, General In-<br>side Superintendent, .....   | Drifton, Luzerne county, Pa.  |
| Stockton Nos. 3 and 7, .....   | do. ....                              | Stockton, Luzerne, .....        | Ed. Kudlich, General In-<br>side Superintendent, .....     | Drifton, Luzerne county, Pa.  |
| Beaver Meadow, .....           | do. ....                              | Beaver Meadow, Carbon, .....    | John Rohland, General Out-<br>side Superintendent, .....   | Drifton, Luzerne county, Pa.  |
| Tumblecken, .....              | do. ....                              | Tumblecken, Luzerne, .....      | John Rohland, General Out-<br>side Superintendent, .....   | Drifton, Luzerne county, Pa.  |
| Derringer, .....               | do. ....                              | Derringer, Luzerne, .....       | John Rohland, General Out-<br>side Superintendent, .....   | Drifton, Luzerne county, Pa.  |
| Gowen, .....                   | do. ....                              | Gowen, Luzerne, .....           | John Rohland, General Out-<br>side Superintendent, .....   | Drifton, Luzerne county, Pa.  |
| Colliery No. 1, .....          | Lehigh Coal and Navigation Co., ..... | Nesquehoning, Carbon, .....     | W. D. Zehner, General Super-<br>side Superintendent, ..... | Drifton, Luzerne county, Pa.  |
| Colliery No. 4, .....          | do. ....                              | Summit Hill, Carbon, .....      | W. D. Zehner, General Super-<br>side Superintendent, ..... | Lansford, Carbon county, Pa.  |
| Colliery No. 5, .....          | do. ....                              | do. do. ....                    | Baird Snyder, Jr., Assistant<br>Superintendent, .....      | Lansford, Carbon county, Pa.  |
| Colliery No. 6, .....          | do. ....                              | do. do. ....                    | Baird Snyder, Jr., Assistant<br>Superintendent, .....      | Lansford, Carbon county, Pa.  |
| Colliery No. 9, .....          | do. ....                              | Lansford, Carbon, .....         | Thomas M. Whildin, Inside<br>Superintendent, .....         | Lansford, Carbon county, Pa.  |
| Screen building, .....         | do. ....                              | Hauto, Carbon, .....            | Thomas M. Whildin, Inside<br>Superintendent, .....         | Lansford, Carbon county, Pa.  |
| Jeddo No. 3, .....             | G. B. Markle & Co., .....             | Hazle township, Luzerne, .....  | John Markle, General Man-<br>ager, .....                   | Jeddo, Luzerne county, Pa.    |
| Jeddo No. 4, .....             | do. ....                              | do. do. ....                    | Samuel Dunkerly, Inside Su-<br>perintendent, .....         | Jeddo, Luzerne county, Pa.    |
| Hickland No. 1, .....          | do. ....                              | Foster township, Luzerne, ..... | Samuel Dunkerly, Inside Su-<br>perintendent, .....         | Jeddo, Luzerne county, Pa.    |
| Hickland No. 2, .....          | do. ....                              | do. do. ....                    | Arthur Goedege, Outside Su-<br>perintendent, .....         | Jeddo, Luzerne county, Pa.    |
| Hickland No. 5, .....          | do. ....                              | do. do. ....                    | Arthur Goedege, Outside Su-<br>perintendent, .....         | Jeddo, Luzerne county, Pa.    |
| East Sugar Loaf No. 1, .....   | Linderman & Skeer, .....              | Stockton, Luzerne, .....        | James E. Roderick, General<br>Superintendent, .....        | Stockton, Luzerne county, Pa. |
| East Sugar Loaf No. 2, .....   | do. ....                              | do. do. ....                    | Gomer E. Jones, Inside Su-<br>perintendent, .....          | Stockton, Luzerne county, Pa. |

TABLE No. 1.—Showing location, etc., of collieries in the Fifth Anthracite District—Continued.

| Name of Colliery.           | Name of Operator.                     | Location—County.         | Name of Superintendent.                     | Postoffice Address.              |
|-----------------------------|---------------------------------------|--------------------------|---|----------------------------------|
| East Sugar Loaf No. 5,      | Linderman & Skeer,                    | Stockton, Luzerne,       | John Habel, Outside Superintendent,         | Stockton, Luzerne county, Pa.    |
| East Sugar Loaf Nos. 4 & 5, | do.                                   | do.                      | John Habel, Outside Superintendent,         | Stockton, Luzerne county, Pa.    |
| Milnesville colliery,       | A. S. Wan Wickle,                     | Milnesville, Luzerne,    | D. H. Levan,                                | Milnesville, Luzerne county, Pa. |
| Coharane colliery,          | do.                                   | Beaver Meadow, Carbon,   | W. H. Knacchop,                             | Beaver Meadow, Carbon Co., Pa.   |
| Hazleton No. 1,             | Lehigh Valley Coal Company,           | Hazleton, Luzerne,       | W. A. Lathrop, General Superintendent,      | Wilkes-Barre, Luzerne Co., Pa.   |
| Hazleton No. 2,             | do.                                   | Hazle township, Luzerne, | W. A. Lathrop, General Superintendent,      | Wilkes-Barre, Luzerne Co., Pa.   |
| Hazleton No. 3,             | do.                                   | do.                      | Fred E. Zerby, Division Superintendent,     | Hazleton, Luzerne county, Pa.    |
| Hazleton No. 5,             | do.                                   | Hazleton, Luzerne,       | Fred E. Zerby, Division Superintendent,     | Hazleton, Luzerne county, Pa.    |
| Hazleton No. 6,             | do.                                   | Hazle township, Luzerne, | Fred E. Zerby, Division Superintendent,     | Hazleton, Luzerne county, Pa.    |
| Spring Mountain No. 1,      | do.                                   | Jeanesville, Carbon,     | Fred E. Zerby, Division Superintendent,     | Hazleton, Luzerne county, Pa.    |
| Spring Mountain No. 1,      | do.                                   | Jeanesville, Luzerne,    | Fred E. Zerby, Division Superintendent,     | Hazleton, Luzerne county, Pa.    |
| Spring Mountain No. 1,      | do.                                   | Yorktown, Carbon,        | Col. D. E. Brown, Division Superintendent,  | Hazleton, Luzerne county, Pa.    |
| Spring Mountain No. 4,      | J. C. Haydon & Co.,                   | Jeanesville, Carbon,     | David Macfarlane,                           | Lost Creek, Schuylkill Co., Pa.  |
| Spring Brook colliery,      | do.                                   | Jeanesville, Luzerne,    | A. C. Leisinger,                            | Jeanesville, Luzerne county, Pa. |
| Upper Lehigh Coal Company,  | Pardee Brothers & Co.,                | Upper Lehigh, Luzerne,   | A. W. Drake,                                | Upper Lehigh, Luzerne Co., Pa.   |
| Lattimer No. 1,             | do.                                   | Lattimer mines, Luzerne, | A. W. Drake,                                | Lattimer Mines, Luzerne Co., Pa. |
| Lattimer No. 3,             | do.                                   | do.                      | A. W. Drake,                                | Lattimer Mines, Luzerne Co., Pa. |
| Hollywood colliery,         | Calvin Pardee & Co.,                  | Hollywood, Luzerne,      | A. W. Drake,                                | Lattimer Mines, Luzerne Co., Pa. |
| Hardwood mines,             | Pardee Sons & Co.,                    | Hardwood mines, Luzerne, | E. S. Bullock,                              | Lattimer Mines, Luzerne Co., Pa. |
| Beaver Brook colliery,      | C. M. Bodison & Co.,                  | Hazle township, Luzerne, | Walter Leisenring,                          | Andover, Carbon Co., Pa.         |
| Sandy Run colliery,         | M. S. Kommer & Co.,                   | Sandy Run, Luzerne,      | Elmer H. Lawall, General Superintendent,    | Sandy Run, Luzerne county, Pa.   |
| Honey Brook No. 2,          | Lehigh and Wilkes-Barre Coal Company, | Tresscow, Carbon,        | David E. Roberts, Assistant Superintendent, | Wilkes-Barre, Luzerne Co., Pa.   |
| Honey Brook No. 2,          | Lehigh and Wilkes-Barre Coal Company, | do.                      | Griffith G. Roberts, Inside Superintendent, | Andover, Carbon county, Pa.      |
| Honey Brook No. 2,          | Lehigh and Wilkes-Barre Coal Company, | do.                      | George Richert,                             | Andover, Carbon county, Pa.      |
| Hazle Brook colliery,       | John S. Wentz & Co.,                  | Hazle Brook, Luzerne,    | Thomas J. Evans,                            | Hazle Brook, Luzerne Co., Pa.    |
| The Evans colliery,         | The Evans Mining Company,             | Beaver Meadow, Carbon,   |   | Beaver Meadow, Carbon Co., Pa.   |

Owing to change of operators on November 1st, 1894, the following changes are noted and corrections also in this table through the Lehigh Valley Coal Company, according to the collieries formerly operated by J. C. Haydon & Co. and part of those operated by A. Pardee & Co.

Stockton, Luzerne, changed to Hazleton No. 1, operated by J. C. Haydon & Co.

Spring Brook colliery, changed to Hazleton No. 1, operated by J. C. Haydon & Co.

Hazleton No. 3 remains Hazleton No. 3, but operators change from A. Pardee & Co. to Lehigh Valley Coal Company.

Hazleton No. 6 remains Hazleton No. 6, but operators change from A. Pardee & Co. to Lehigh Valley Coal Company.

Spring Mountain No. 1 remains Spring Mountain No. 1, but operators change from J. C. Haydon & Co. to Lehigh Valley Coal Company.

Spring Mountain No. 4 remains Spring Mountain No. 4, but operators change from J. C. Haydon & Co. to Lehigh Valley Coal Company.

TABLE No. 2.—Gives the total number of tons of coal mined in each colliery, number of days worked, number of employees, number of persons killed and injured, number of kegs of powder used, etc., in the Fifth Anthracite District, for the year ending December 31, 1894.

| Names of Collieries.                       | Location.                      | Total tons of coal. | Total shipment in tons of coal. | Number of days worked. | Number persons employed. | Number fatal accidents. | Number non-fatal accidents. | Number kegs powder used. | Number steam boilers. | Number horses and mules. | Number mine locomotives. | Number of pounds of dynamite used. |
|--|--------------------------------|---------------------|---------------------------------|------------------------|--------------------------|-------------------------|-----------------------------|--------------------------|-----------------------|--------------------------|--------------------------|------------------------------------|
| <b>A. Pardee &amp; Co.</b>                 |                                |                     |                                 |                        |                          |                         |                             |                          |                       |                          |                          |                                    |
| Hazleton mine, .....                       | Hazleton, Luzerne, .....       | 111,884             | 102,284                         | 122 2                  | 767                      | 4                       | 6                           | 2,846                    | 54                    | 75                       | 1                        | .....                              |
| Laurel Hill, .....                         | do, do, .....                  | 54,004              | 47,204                          | 105 7                  | 214                      | .....                   | .....                       | 887                      | .....                 | .....                    | .....                    | .....                              |
| Hazleton No. 3, .....                      | Hazle township, .....          | 54,773              | 47,773                          | 124 9                  | 212                      | .....                   | .....                       | 926                      | 10                    | 31                       | 2                        | .....                              |
| Hazleton No. 6, .....                      | do, do, .....                  | 1,151               | 1,151                           | 25 3                   | 74                       | .....                   | .....                       | 68                       | 12                    | .....                    | .....                    | .....                              |
| South Sugar Loaf, .....                    | do, do, .....                  | 31,402              | 27,402                          | 108 2                  | 924                      | .....                   | .....                       | 887                      | 26                    | 84                       | .....                    | .....                              |
| Cranberry colliery, .....                  | do, do, .....                  | 177,771             | 140,471                         | 173 3                  | 770                      | .....                   | .....                       | 4,716                    | 52                    | 81                       | 5                        | .....                              |
| East Crystal Ridge, .....                  | do, do, .....                  | 20,679              | 17,179                          | 151                    | 150                      | 1                       | .....                       | 850                      | 17                    | 12                       | 1                        | .....                              |
| <b>Totals, .....</b>                       | <b>.....</b>                   | <b>436,970</b>      | <b>385,670</b>                  | <b>131 7</b>           | <b>2,330</b>             | <b>7</b>                | <b>22</b>                   | <b>10,510</b>            | <b>232</b>            | <b>279</b>               | <b>14</b>                | <b>35,725</b>                      |
| <b>The Cross Creek Coal Company.</b>       |                                |                     |                                 |                        |                          |                         |                             |                          |                       |                          |                          |                                    |
| Drifton Nos. 1 and 2, .....                | Drifton, Luzerne, .....        | 290,748             | 251,111                         | 212                    | 737                      | 1                       | 4                           | 6,848                    | 70                    | 109                      | 4                        | 7,623                              |
| Eckley Nos. 2, 6 and 10, .....             | Eckley, Luzerne, .....         | 175,021             | 157,021                         | 905                    | 519                      | 1                       | 1                           | 2,787                    | 22                    | 48                       | 3                        | 11,706                             |
| Stockton Nos. 3 and 7, .....               | Stockton, Luzerne, .....       | 164,498             | 142,320                         | 217                    | 432                      | 2                       | 1                           | 5,332                    | 22                    | 20                       | .....                    | 14,145                             |
| Beaver Meadow, .....                       | Beaver Meadow, Carbon, .....   | 86,842              | 86,842                          | 210                    | 424                      | .....                   | .....                       | 2,711                    | .....                 | 22                       | .....                    | 10,297                             |
| Tomhicken, .....                           | Tomhicken, Luzerne, .....      | 33,170              | 31,170                          | 27                     | 50                       | .....                   | .....                       | 319                      | .....                 | 11                       | .....                    | 3,807                              |
| Derringer and Gowen, .....                 | Derringer & Gowen, Luz., ..... | 286,875             | 277,381                         | 215                    | 729                      | .....                   | .....                       | 5,975                    | 24                    | 109                      | .....                    | 8,876                              |
| <b>Totals, .....</b>                       | <b>.....</b>                   | <b>1,091,906</b>    | <b>952,471</b>                  | <b>208 8</b>           | <b>2,881</b>             | <b>6</b>                | <b>6</b>                    | <b>20,766</b>            | <b>152</b>            | <b>338</b>               | <b>19</b>                | <b>59,728</b>                      |
| <b>Lehigh Coal and Navigation Company.</b> |                                |                     |                                 |                        |                          |                         |                             |                          |                       |                          |                          |                                    |
| Colliery No. 1, .....                      | Nesquehoning, Carbon, .....    | 274,467             | 274,476                         | 212 8                  | 672                      | .....                   | .....                       | 4,260                    | 15                    | 109                      | 1                        | 22,756                             |
| Colliery No. 4, .....                      | Summit Hill, Carbon, .....     | 166,222             | 154,354                         | 121 5                  | 364                      | 1                       | .....                       | 780                      | 29                    | 66                       | .....                    | 2,206                              |
| Colliery No. 5, .....                      | do, do, .....                  | 153,574             | 137,292                         | 208 4                  | 264                      | 1                       | .....                       | 1,050                    | 6                     | 41                       | .....                    | 5,282                              |
| Colliery No. 6, .....                      | do, do, .....                  | .....               | .....                           | 208 4                  | 211                      | 1                       | .....                       | .....                    | 25                    | .....                    | .....                    | 1,139                              |

TABLE No. 2—Continued.

| Names of Collieries.          | Location.                 | Total production in tons of coal. | Number of days worked. | Number persons employed. | Number fatal accidents. | Number non-fatal accidents. | Number kegs powder used. | Number steam boilers. | Number horses and mules. | Number mine locomotives. | Number of pounds of dynamite used. |
|-------------------------------|---------------------------|-----------------------------------|------------------------|--------------------------|-------------------------|-----------------------------|--------------------------|-----------------------|--------------------------|--------------------------|------------------------------------|
| Colliery No. 9.               | Lansford, Carbon.         | 241,178                           | 214.6                  | 400                      | 1                       | .....                       | 300                      | 13                    | 68                       | ..                       | 7,500                              |
| Screen building.              | Hanto, Carbon.            | .....                             | 304.5                  | 286                      | 2                       | .....                       | .....                    | 5                     | .....                    | 4                        | .....                              |
| Totals.                       | .....                     | 835,542                           | 221.6                  | 2,197                    | 7                       | .....                       | 6,600                    | 114                   | 275                      | 18                       | 51,525                             |
| G. E. Markle & Co.            |                           |                                   |                        |                          |                         |                             |                          |                       |                          |                          |                                    |
| Jeddo No. 3.                  | Hazle township, Luzerne.  | 5,260                             | 3,965                  |                          | .....                   | .....                       | 1,754                    | 72                    | 33                       | 5                        | 23,009                             |
| Jeddo No. 4.                  | do.                       | 167,442                           | 127,037                | 362                      | .....                   | 3                           | .....                    | .....                 | .....                    | .....                    | .....                              |
| Highland No. 1.               | Foster township, Luzerne. | 60,678                            | 47,903                 | 184                      | .....                   | .....                       | 873                      | 21                    | 24                       | .....                    | 1,094                              |
| Highland No. 2.               | do.                       | 88,395                            | 74,401                 | 294                      | 1                       | 2                           | 2,253                    | 23                    | 28                       | 1                        | 2,065                              |
| Highland No. 5.               | do.                       | 232,909                           | 225,609                | 457                      | 2                       | 1                           | 5,421                    | 12                    | 50                       | .....                    | 3,028                              |
| Totals.                       | .....                     | 555,752                           | 477,915                | 1,297                    | 3                       | 9                           | 10,301                   | 128                   | 135                      | 6                        | 28,195                             |
| Lhoderman & Skeer.            |                           |                                   |                        |                          |                         |                             |                          |                       |                          |                          |                                    |
| East Sugar Loaf No. 1.        | Stockton, Luzerne.        | .....                             | 165                    | 85                       | 8                       | .....                       | 513                      | 22                    | .....                    | 1                        | .....                              |
| East Sugar Loaf No. 2.        | do.                       | 464,553                           | 362,894                | 585                      | 3                       | 2                           | 2,603                    | 54                    | 131                      | 1                        | .....                              |
| East Sugar Loaf No. 6.        | do.                       | .....                             | 165                    | 134                      | .....                   | .....                       | 1,146                    | 38                    | .....                    | 1                        | .....                              |
| East Sugar Loaf Nos. 4 and 5. | do.                       | .....                             | 168                    | 336                      | .....                   | .....                       | 3,418                    | 38                    | .....                    | 1                        | .....                              |
| Totals.                       | .....                     | 464,553                           | 362,894                | 1,060                    | 11                      | 15                          | 7,710                    | 112                   | 131                      | 4                        | 41,197                             |
| A. S. Van Winkle.             |                           |                                   |                        |                          |                         |                             |                          |                       |                          |                          |                                    |
| Milnesville colliery.         | Milnesville, Luzerne.     | 425,794                           | 374,709                | 1,072                    | 3                       | .....                       | 3,356                    | 60                    | 96                       | 4                        | 252,405                            |
| Coleraine colliery.           | Beaver Meadow, Carbon.    | 134,516                           | 118,510                | 641                      | 3                       | .....                       | 5,508                    | 39                    | 70                       | 4                        | 11,675                             |
| Totals.                       | .....                     | 560,310                           | 493,219                | 1,713                    | 6                       | 2                           | 6,864                    | 99                    | 166                      | 8                        | 29,075                             |

||This breaker discontinued after February 1st, 1894.



| Lehigh Valley Coal Company.      |         |         |       |       |   |       |     |     |    |
|----------------------------------|---------|---------|-------|-------|---|-------|-----|-----|----|
| Hazleton No. 1.                  | 46,848  | 55,613  | 57.9  | 729   | 3 | 178   | 75  | 72  | 2  |
| Hazleton No. 2.                  | 14,661  | 12,175  | 48.2  | 213   | 1 | 457   | 25  | 29  |    |
| Hazleton No. 3.                  | 17,338  | 41,835  | 42.1  | 379   | 1 | 189   | 20  | 33  | 1  |
| Hazleton No. 4.                  | 5,881   | 4,497   | 18.1  | 389   | 1 | 139   | 26  | 39  | 1  |
| Hazleton No. 5.                  |         |         |       | 8     |   |       | 19  | 1   | 1  |
| Hazleton No. 6.                  |         |         |       |       |   |       | 21  | 33  | 1  |
| Spring Mountain No. 1.           | 27,766  | 25,578  | 33    | 517   | 1 | 193   | 51  | 33  | 1  |
| Spring Mountain No. 2.           | 28,119  | 25,049  | 35.3  | 438   | 1 | 187   | 45  | 36  | 2  |
| Spring Mountain No. 3.           | 13,953  | 121,821 | 141.7 | 387   | 1 | 2,761 | 48  | 31  | 2  |
| Spring Mountain No. 4.           |         |         |       |       |   |       |     |     |    |
| Spring Brook colliery.           |         |         |       |       |   |       |     |     |    |
| Totals.                          | 275,936 | 277,478 | 47.8  | 2,965 | 1 | 4,179 | 266 | 274 | 10 |
| J. C. Haydon & Co.               |         |         |       |       |   |       |     |     |    |
| Spring Mountain No. 1.           | 118,521 | 198,217 | 176   | 414   | 5 | 895   | 58  | 45  | 3  |
| Spring Mountain No. 4.           | 126,262 | 113,800 | 165   | 460   | 1 | 1,795 | 47  | 47  | 5  |
| Totals.                          | 244,783 | 312,018 | 169.7 | 874   | 6 | 2,610 | 75  | 92  | 8  |
| Upper Lehigh Coal Company.       |         |         |       |       |   |       |     |     |    |
| Upper Lehigh colliery.           | 399,470 | 296,839 | 230.2 | 659   | 2 | 5,799 | 53  | 79  | 5  |
| Pardee Bros. & Co.               |         |         |       |       |   |       |     |     |    |
| Lattimer No. 1.                  | 154,075 | 151,860 | 192   | 672   | 4 | 7,723 | 394 | 117 | 7  |
| Lattimer No. 3.                  | 168,549 | 146,324 | 599.8 | 640   | 2 |       | 34  |     |    |
| Totals.                          | 322,624 | 277,184 | 299.9 | 1,292 | 6 | 7,723 | 72  | 117 | 7  |
| Calvin Pardee & Co.              |         |         |       |       |   |       |     |     |    |
| Hollywood colliery.              | 122,092 | 100,159 | 217.2 | 390   | 3 | 4,030 | 26  | 33  | 1  |
| Pardee, Sons & Co.               |         |         |       |       |   |       |     |     |    |
| Harwood colliery.                | 298,929 | 167,496 | 570.6 | 862   | 4 | 7,557 | 59  | 58  | 1  |
| C. M. Dabson & Co.               |         |         |       |       |   |       |     |     |    |
| Deaver Brook colliery.           | 210,018 | 182,319 | 294   | 525   | 1 | 3,441 | 55  | 52  | 1  |
| M. S. Kemmeter & Co.             |         |         |       |       |   |       |     |     |    |
| Sandy Run colliery.              | 191,264 | 175,362 | 24    | 426   | 2 | 2,970 | 31  | 66  | 2  |
| Lehigh and Wilkes-Barre Coal Co. |         |         |       |       |   |       |     |     |    |
| Honey Brook No. 2.               | 165,978 | 152,892 | 7.60  | 602   | 1 | 8,596 | 49  | 39  | 2  |

J. C. Haydon & Co. operated these collieries up to November 1st, 1891, from that date the Lehigh Valley Coal Company operated the collieries.

TABLE No. 2—Continued.

| Names of Collieries.                | Location.                        | Total production in tons of coal. | Total shipment in tons of coal. | Number of days worked. | Number persons employed. | Number fatal accidents. | Number non-fatal accidents. | Number kegs powder used. | Number steam boilers. | Number horses and mules. | Number mine locomotives. | Number of pounds of dynamite used. |
|-------------------------------------|----------------------------------|-----------------------------------|---------------------------------|------------------------|--------------------------|-------------------------|-----------------------------|--------------------------|-----------------------|--------------------------|--------------------------|------------------------------------|
| John S. Wentz & Co.                 |                                  |                                   |                                 |                        |                          |                         |                             |                          |                       |                          |                          |                                    |
| Hazle Brook colliery.               | Hazle Brook, Luzerne, ...        | 86,990                            | 78,147                          | 162                    | 335                      | .....                   | .....                       | 4,454                    | 18                    | 26                       | .....                    | 5,576                              |
| The Evans Mining Company.           |                                  |                                   |                                 |                        |                          |                         |                             |                          |                       |                          |                          |                                    |
| The Evans colliery.                 | Beaver Meadow, Carbon, ...       | 51,318                            | 46,318                          | 192.6                  | 999                      | .....                   | .....                       | 1,620                    | 6                     | 13                       | .....                    | 6,790                              |
|                                     |                                  | 6,132,627                         | 5,313,100                       | 196.2                  | 18,361                   | 58                      | 95                          | 112,890                  | 1,415                 | 1,912                    | 94                       | 1,906,758                          |
| <i>Recapitulation.</i>              |                                  |                                   |                                 |                        |                          |                         |                             |                          |                       |                          |                          |                                    |
| *A. Pardee & Co.,                   | Hazleton, .....                  | 436,670                           | 385,670                         | 134.7                  | 2,339                    | 7                       | 27                          | 10,510                   | 232                   | 270                      | 14                       | 37,750                             |
| The Cross Creek Coal Company        | Drifton, .....                   | 1,091,966                         | 922,471                         | 298.8                  | 2,881                    | 6                       | 6                           | 29,766                   | 182                   | 338                      | 16                       | 57,128                             |
| Lehigh Coal and Navigation Company, | Lansford, .....                  | 835,642                           | 762,690                         | 221.6                  | 2,197                    | 7                       | .....                       | 6,660                    | 112                   | 275                      | 18                       | 31,321                             |
| G. B. Markle & Co.,                 | Jeddo, .....                     | 556,782                           | 477,915                         | 132.6                  | 1,297                    | 3                       | 19                          | 10,301                   | 128                   | 135                      | 6                        | 38,136                             |
| Linderman & Steer,                  | Stockton, .....                  | 494,523                           | 399,894                         | 165.9                  | 1,090                    | 11                      | 5                           | 7,710                    | 442                   | 131                      | 4                        | 41,191                             |
| A. S. Van Winkle,                   | Milnesville and Coleraine, ..... | 590,310                           | 483,219                         | 247.1                  | 1,713                    | 6                       | .....                       | 5,864                    | 39                    | 166                      | 8                        | 291,055                            |
| *Lehigh Valley Coal Company,        | Hazleton, etc., .....            | 275,926                           | 237,478                         | 47.8                   | 2,965                    | 1                       | 8                           | 4,179                    | 296                   | 274                      | 10                       | 13,826                             |
| J. C. Hayden & Co.,                 | Jeanesville, .....               | 244,784                           | 222,017                         | 169.7                  | 874                      | .....                   | .....                       | 1,210                    | 73                    | 92                       | 8                        | 16,363                             |
| Upper Lehigh Coal Company,          | Upper Lehigh, .....              | 399,479                           | 236,859                         | 239.2                  | 659                      | 1                       | 1                           | 5,709                    | 83                    | 117                      | 5                        | 37,753                             |
| Parlee Bros. & Co.,                 | Lattimer Mines, .....            | 322,694                           | 273,194                         | 203.9                  | 1,292                    | 6                       | .....                       | 5,423                    | 72                    | 117                      | 7                        | 124,400                            |
| Calvin Pardee & Co.,                | Hollywood, .....                 | 122,092                           | 100,159                         | 217.2                  | 390                      | 3                       | .....                       | 4,029                    | 29                    | 23                       | 1                        | 12,650                             |
| Pardee, Sons & Co.,                 | Harwood Mines, .....             | 298,926                           | 167,456                         | 210.6                  | 892                      | 4                       | 3                           | 5,697                    | 52                    | 58                       | 4                        | 5,396                              |
| C. M. Doolson & Co.,                | Aure-ried, .....                 | 210,018                           | 152,319                         | 294                    | 525                      | 1                       | .....                       | 4,441                    | 55                    | 52                       | 4                        | 1,466                              |
| M. S. Kemmerer & Co.,               | Sandy Run, .....                 | 191,294                           | 178,362                         | 245                    | 426                      | .....                   | .....                       | 4,220                    | 31                    | 66                       | .....                    | 13,799                             |
| Lehigh and Wilkes-Barre Coal Co.,   | Achenreid, .....                 | 165,978                           | 152,892                         | 250                    | 496                      | 1                       | .....                       | 8,696                    | 43                    | 59                       | .....                    | 5,233                              |
| John S. Wentz & Co.,                | Hazle Brook, .....               | 86,990                            | 78,147                          | 162                    | 335                      | .....                   | .....                       | 1,620                    | 6                     | 13                       | .....                    | 6,790                              |
| The Evans Mining Co.,               | Beaver Meadow, .....             | 51,318                            | 46,318                          | 192.6                  | 999                      | .....                   | .....                       | 1,620                    | 6                     | 13                       | .....                    | 6,790                              |
| Grand totals for all operators.     |                                  | 6,132,627                         | 5,313,100                       | 196.2                  | 18,361                   | 58                      | 95                          | 112,890                  | 1,415                 | 1,912                    | 96                       | 1,906,758                          |

\* By change in operators at some collieries during the year. some men, machinery and live stock are enumerated twice in the tables: yet the grand totals are correct.

† Average.

TABLE NO. 3.—Showing the number of employes at each colliery in the Fifth Anthracite District during the year 1894.

| Names of Collieries.                       | Occupations of Persons Employed Inside. |         |                   |                  |                      |                        | Occupations of Persons Employed Outside. |                  |                             |                        |                |                        |                                 |                |                                 |
|--|---|---------|-------------------|------------------|----------------------|------------------------|--|------------------|-----------------------------|------------------------|----------------|------------------------|---------------------------------|----------------|---------------------------------|
|  | Inside foremen.                         | Miners. | Miners' laborers. | All company men. | Drivers and runners. | Poor boys and helpers. | Total inside.                            | Outside foremen. | Blacksmiths and carpenters. | Engineers and firemen. | State pickers. | All other company men. | Sup'rs, bookkeepers and clerks. | Total outside. | Grand total inside and outside. |
| <b>A. Pardee &amp; Co.</b>                 |   |         |                   |                  |                      |                        |  |                  |                             |                        |                |                        |                                 |                |                                 |
| Hazleton mine, .....                       | 4                                       | 147     | 105               | 39               | 47                   | 6                      | 348                                      | 1                | 6                           | 21                     | 120            | 69                     | 2                               | 219            | 567                             |
| Laurel Hill, .....                         | 2                                       | 52      | 45                | 27               | 17                   | 7                      | 150                                      | 1                | 3                           | 20                     | 85             | 47                     | 2                               | 164            | 314                             |
| Hazleton No. 3, .....                      | 2                                       | 35      | 73                | 14               | 10                   | 2                      | 127                                      | 1                | 1                           | 11                     | 41             | 43                     | 1                               | 105            | 242                             |
| Hazleton No. 6, .....                      | 1                                       | 4       | 23                | 4                | 6                    | 1                      | 39                                       | 1                | 1                           | 15                     | 14             | 15                     | .....                           | 35             | 74                              |
| South Sugar Loaf, .....                    | 1                                       | 67      | 15                | 8                | 17                   | 2                      | 110                                      | 1                | 1                           | 11                     | 80             | 19                     | 1                               | 114            | 224                             |
| Cranberry colliery, .....                  | 5                                       | 255     | 94                | 100              | 46                   | 10                     | 510                                      | 1                | 1                           | 24                     | 112            | 99                     | 2                               | 249            | 759                             |
| East Crystal Ridge, .....                  | 2                                       | 38      | 15                | 17               | 8                    | 3                      | 83                                       | 1                | 3                           | 8                      | 45             | 18                     | 1                               | 75             | 159                             |
| Totals, .....                              | 17                                      | 598     | 370               | 210              | 151                  | 31                     | 1,377                                    | 7                | 32                          | 100                    | 504            | 210                    | 9                               | 982            | 2,339                           |
| <b>The Cross Creek Coal Company.</b>       |   |         |                   |                  |                      |                        |  |                  |                             |                        |                |                        |                                 |                |                                 |
| Drifton Nos. 1 and 2, .....                | 7                                       | 247     | 34                | 100              | 41                   | 21                     | 450                                      | 4                | 19                          | 21                     | 172            | 55                     | 6                               | 287            | 737                             |
| Eckley Nos. 2, 6 and 10, .....             | 6                                       | 115     | 33                | 103              | 13                   | 5                      | 275                                      | 2                | 18                          | 26                     | 142            | 57                     | 1                               | 244            | 519                             |
| Stockton Nos. 3 and 5, .....               | 4                                       | 103     | 14                | 44               | 13                   | 8                      | 186                                      | 3                | 14                          | 15                     | 130            | 112                    | 1                               | 296            | 482                             |
| Beaver Meadow, .....                       | 1                                       | 64      | 18                | 38               | 12                   | 2                      | 138                                      | 3                | 11                          | 20                     | 122            | 138                    | 1                               | 286            | 424                             |
| Tombrieken, .....                          | 2                                       | 4       | 5                 | 3                | 1                    | .....                  | 15                                       | .....            | .....                       | .....                  | .....          | .....                  | .....                           | .....          | 20                              |
| Derringer & Gowen, .....                   | 6                                       | 239     | 63                | 90               | 31                   | 15                     | 444                                      | 4                | 30                          | 22                     | 154            | 74                     | 1                               | 285            | 729                             |
| Totals, .....                              | 29                                      | 172     | 167               | 378              | 111                  | 51                     | 1,508                                    | 17               | 94                          | 111                    | 711            | 429                    | 11                              | 1,373          | 2,881                           |
| <b>Lehigh Coal and Navigation Company.</b> |   |         |                   |                  |                      |                        |  |                  |                             |                        |                |                        |                                 |                |                                 |
| Colliery No. 1, .....                      | 9                                       | 173     | 67                | 93               | 35                   | 24                     | 401                                      | 1                | 8                           | 29                     | 92             | 140                    | 1                               | 271            | 672                             |
| Colliery No. 4, .....                      | 7                                       | 50      | 44                | 86               | 29                   | 11                     | 223                                      | 1                | 3                           | 17                     | 72             | 48                     | .....                           | 141            | 364                             |
| Colliery No. 5, .....                      | 3                                       | 48      | 32                | 39               | 9                    | 5                      | 136                                      | 1                | 4                           | 13                     | 54             | 56                     | .....                           | 128            | 264                             |
| Colliery No. 6, .....                      | 3                                       | 58      | 43                | 45               | 13                   | 5                      | 167                                      | 1                | 4                           | 12                     | .....          | 27                     | .....                           | 44             | 211                             |

TABLE NO. 3—Continued.

| Names of Collieries.                | Occupations of Persons Employed Inside. |         |                   |                  |                      |                        | Occupations of Persons Employed Outside. |                  |                             |                        |                |                        | Grand total inside and outside. |                                 |
|-------------------------------------|---|---------|-------------------|------------------|----------------------|------------------------|--|------------------|-----------------------------|------------------------|----------------|------------------------|---------------------------------|---------------------------------|
|                                     | Inside foremen.                         | Miners. | Miners' laborers. | All company men. | Drivers and runners. | Door boys and helpers. | Total inside.                            | Outside foremen. | Blacksmiths and carpenters. | Engineers and firemen. | State pickers. | All other company men. |                                 | Supts., bookkeepers and clerks. |
| Colliery No. 9, .....               | 2                                       | 67      | 49                | 89               | 18                   | 6                      | 231                                      | 1                | 5                           | 19                     | 78             | 66                     | .....                           | 169                             |
| Screen ridding, .....               |   |         |                   |                  |                      |                        |  | 1                | 4                           | 12                     | 180            | 89                     | .....                           | 286                             |
| Totals, .....                       | 29                                      | 396     | 295               | 352              | 104                  | 51                     | 1,158                                    | 6                | 28                          | 102                    | 476            | 425                    | 1                               | 1,039                           |
| G. B. Markle & Co.                  |   |         |                   |                  |                      |                        |  |                  |                             |                        |                |                        |                                 |                                 |
| Jeddo Nos. 3 and 4, .....           | 1                                       | 17      | 8                 | 84               | 20                   | 6                      | 146                                      | 1                | 12                          | 22                     | 81             | 94                     | 4                               | 216                             |
| Highland No. 1, .....               | 1                                       | 23      | 18                | 25               | 14                   | 5                      | 86                                       | 1                | 9                           | 11                     | 45             | 28                     | 4                               | 98                              |
| Highland No. 2, .....               | 1                                       | 65      | 32                | 18               | 12                   | 7                      | 158                                      | 1                | 9                           | 18                     | 59             | 67                     | 4                               | 158                             |
| Highland No. 5, .....               | 1                                       | 98      | 105               | 25               | 27                   | 12                     | 268                                      | 1                | 9                           | 10                     | 122            | 43                     | 4                               | 189                             |
| Totals, .....                       | 4                                       | 293     | 164               | 152              | 82                   | 30                     | 636                                      | 4                | 40                          | 62                     | 207            | 262                    | 16                              | 661                             |
| Linderman & Skoer.                  |   |         |                   |                  |                      |                        |  |                  |                             |                        |                |                        |                                 |                                 |
| East Sugar Loaf No. 1, .....        | .....                                   | 13      | 12                | 26               | 6                    | 2                      | 60                                       | 1                | 2                           | 6                      | .....          | 16                     | .....                           | 25                              |
| East Sugar Loaf No. 2, .....        | 1                                       | 107     | 107               | 45               | 24                   | 3                      | 287                                      | 1                | 3                           | 17                     | 132            | 91                     | 4                               | 248                             |
| East Sugar Loaf No. 6, .....        | 1                                       | 26      | 43                | 21               | 10                   | 3                      | 104                                      | 1                | 2                           | 11                     | .....          | 16                     | .....                           | 30                              |
| East Sugar Loaf Nos. 4 and 5, ..... | 1                                       | 116     | 42                | 21               | 16                   | 4                      | 200                                      | 1                | 3                           | 12                     | 61             | 57                     | 2                               | 135                             |
| Totals, .....                       | 3                                       | 262     | 205               | 113              | 56                   | 12                     | 651                                      | 4                | 10                          | 46                     | 103            | 180                    | 6                               | 429                             |
| A. S. Van Winkle.                   |   |         |                   |                  |                      |                        |  |                  |                             |                        |                |                        |                                 |                                 |
| Minesville colliery, .....          | 1                                       | 21      | 19                | 42               | 6                    | .....                  | 89                                       | 26               | 27                          | 34                     | 116            | 770                    | 10                              | 983                             |
| Coleraine colliery, .....           | 4                                       | 73      | 55                | 131              | 32                   | 2                      | 297                                      | 4                | 11                          | 27                     | 79             | 225                    | 6                               | 344                             |
| Totals, .....                       | 5                                       | 94      | 74                | 173              | 38                   | 2                      | 386                                      | 30               | 38                          | 61                     | 186            | 996                    | 16                              | 1,327                           |

## Lehigh Valley Coal Company.

|                              |    |       |       |       |       |       |       |   |       |       |       |       |       |       |       |
|------------------------------|----|-------|-------|-------|-------|-------|-------|---|-------|-------|-------|-------|-------|-------|-------|
| Hazleton No. 1, .....        | 2  | 256   | 58    | 87    | 41    | 5     | 449   | 1 | 127   | 21    | 139   | 165   | 2     | 280   | 729   |
| Hazleton No. 2, .....        | 1  | 82    | 23    | 24    | 11    | 3     | 144   | 1 | 3     | 5     | 56    | 33    | 1     | 99    | 243   |
| Hazleton No. 3, .....        | 1  | 28    | 19    | 24    | 4     | 1     | 77    | 1 | 5     | 9     | 77    | 104   | 1     | 197   | 274   |
| Hazleton No. 5, .....        | 1  | 109   | 18    | 47    | 12    | 5     | 192   | 1 | 19    | 16    | 66    | 74    | 1     | 177   | 369   |
| Hazleton No. 6, .....        | 2  | ..... | ..... | ..... | ..... | ..... | ..... | 2 | ..... | ..... | ..... | ..... | 3     | ..... | 8     |
| Spring Mountain No. 1, ..... | 2  | 46    | 24    | 59    | 29    | ..... | 160   | 1 | 11    | 18    | 53    | 272   | ..... | 357   | 517   |
| Spring Mountain No. 4, ..... | 2  | 68    | 64    | 59    | 25    | 5     | 214   | 1 | 19    | 17    | 62    | 121   | ..... | 224   | 438   |
| Spring Brook colliery, ..... | 1  | 92    | 93    | 15    | 16    | 1     | 218   | 1 | ..... | ..... | ..... | ..... | ..... | 169   | 287   |
| Totals, .....                | 10 | 681   | 299   | 308   | 138   | 20    | 1,456 | 7 | 69    | 112   | 531   | 778   | 11    | 1,569 | 2,965 |

## J. C. Haydon &amp; Co.

|                              |   |    |    |    |    |   |     |   |    |    |       |     |       |     |     |
|------------------------------|---|----|----|----|----|---|-----|---|----|----|-------|-----|-------|-----|-----|
| Spring Mountain No. 1, ..... | 2 | 37 | 39 | 16 | 27 | 2 | 123 | 1 | 16 | 15 | ..... | 269 | ..... | 291 | 414 |
| Spring Mountain No. 4, ..... | 2 | 57 | 59 | 25 | 20 | 4 | 158 | 2 | 13 | 17 | 67    | 291 | ..... | 392 | 460 |
| Totals, .....                | 4 | 94 | 89 | 41 | 47 | 6 | 281 | 3 | 23 | 32 | 139   | 410 | ..... | 583 | 874 |

## Upper Lehigh Coal Company.

|                              |   |     |     |    |    |   |     |       |    |    |     |    |   |     |     |
|------------------------------|---|-----|-----|----|----|---|-----|-------|----|----|-----|----|---|-----|-----|
| Upper Lehigh colliery, ..... | 4 | 124 | 149 | 41 | 51 | 2 | 371 | ..... | 20 | 52 | 110 | 97 | 6 | 288 | 659 |
|------------------------------|---|-----|-----|----|----|---|-----|-------|----|----|-----|----|---|-----|-----|

## Pardee Brothers &amp; Co.

|                       |   |    |     |     |    |   |     |   |    |    |     |     |       |     |       |
|-----------------------|---|----|-----|-----|----|---|-----|---|----|----|-----|-----|-------|-----|-------|
| Lattimer No. 1, ..... | 2 | 19 | 98  | 61  | 8  | 4 | 192 | 2 | 19 | 12 | 158 | 267 | ..... | 460 | 652   |
| Lattimer No. 3, ..... | 2 | 15 | 86  | 58  | 10 | 4 | 173 | 1 | 23 | 6  | 180 | 253 | ..... | 465 | 646   |
| Totals, .....         | 4 | 34 | 184 | 119 | 18 | 8 | 367 | 3 | 42 | 18 | 338 | 520 | ..... | 925 | 1,292 |

## Calvin Pardee &amp; Co.

|                           |   |    |    |     |   |       |     |       |   |    |    |    |     |   |     |     |
|---------------------------|---|----|----|-----|---|-------|-----|-------|---|----|----|----|-----|---|-----|-----|
| Hollywood colliery, ..... | 1 | 12 | 25 | 105 | 5 | ..... | 148 | ..... | 1 | 10 | 12 | 87 | 130 | 2 | 242 | 790 |
|---------------------------|---|----|----|-----|---|-------|-----|-------|---|----|----|----|-----|---|-----|-----|

## Pardee Sons &amp; Co.

|                      |   |     |     |    |    |    |     |   |    |    |     |     |   |     |     |
|----------------------|---|-----|-----|----|----|----|-----|---|----|----|-----|-----|---|-----|-----|
| Harwood mines, ..... | 5 | 246 | 148 | 25 | 22 | 17 | 463 | 1 | 13 | 17 | 233 | 133 | 2 | 399 | 862 |
|----------------------|---|-----|-----|----|----|----|-----|---|----|----|-----|-----|---|-----|-----|

## C. M. Doolson &amp; Co.

|                              |   |    |     |    |    |   |     |   |    |    |     |     |   |     |     |
|------------------------------|---|----|-----|----|----|---|-----|---|----|----|-----|-----|---|-----|-----|
| Beaver Brook colliery, ..... | 2 | 75 | 165 | 29 | 18 | 8 | 228 | 2 | 11 | 22 | 115 | 140 | 7 | 297 | 525 |
|------------------------------|---|----|-----|----|----|---|-----|---|----|----|-----|-----|---|-----|-----|

TABLE No. 3—Continued.

| Names of Collieries.                  | Occupations of Persons Employed Inside. |         |                   |                  |                      |                        | Occupations of Persons Employed Outside. |                  |                             |                           |                |                        |                                 |                |                                 |
|---------------------------------------|---|---------|-------------------|------------------|----------------------|------------------------|--|------------------|-----------------------------|---------------------------|----------------|------------------------|---------------------------------|----------------|---------------------------------|
|                                       | Inside foremen.                         | Miners. | Miners' laborers. | All company men. | Drivers and runners. | Boor boys and helpers. | Total inside.                            | Outside foremen. | Blacksmiths and carpenters. | Boilermakers and firemen. | State pickers. | All other company men. | Supts., bookkeepers and clerks. | Total outside. | Grand total inside and outside. |
| M. S. Kennermer & Co.                 |   |         |                   |                  |                      |                        |  |                  |                             |                           |                |                        |                                 |                |                                 |
| Sandy Run colliery, .....             | 2                                       | 54      | 85                | 26               | 22                   | 1                      | 216                                      | 2                | 6                           | 13                        | 70             | 110                    | 3                               | 210            | 426                             |
| Lehigh and Wilkes-Barre Coal Company. |   |         |                   |                  |                      |                        |  |                  |                             |                           |                |                        |                                 |                |                                 |
| Honey Brook No. 2, .....              | 2                                       | 48      | 29                | 321              | 15                   | .....                  | 415                                      | 1                | 1                           | 27                        | 67             | 83                     | 2                               | 187            | 602                             |
| John S. Wentz & Co.                   |   |         |                   |                  |                      |                        |  |                  |                             |                           |                |                        |                                 |                |                                 |
| Hazle Brook colliery, .....           | 1                                       | 80      | 21                | 26               | 24                   | 1                      | 159                                      | 5                | 14                          | 129                       | 20             | 20                     | 5                               | 176            | 335                             |
| The Evans Mining Company.             |   |         |                   |                  |                      |                        |  |                  |                             |                           |                |                        |                                 |                |                                 |
| The Evans colliery, .....             | 1                                       | 68      | 49                | 14               | 10                   | .....                  | 142                                      | 1                | 4                           | 5                         | 22             | 32                     | 3                               | 67             | 209                             |
| Grand total for all operators, .....  | 114                                     | 3,841   | 2,598             | 2,424            | 913                  | 252                    | 9,992                                    | 95               | 432                         | 812                       | 4,160          | 5,026                  | 109                             | 10,694         | 20,656                          |
| Enumerated twice in table, .....      | 14                                      | 399     | 350               | 134              | 144                  | 24                     | 1,065                                    | 8                | 42                          | 100                       | 466            | 603                    | 11                              | 1,230          | *2,295                          |
| Net totals for all operators, .....   | 100                                     | 3,462   | 2,048             | 2,290            | 769                  | 228                    | 8,927                                    | 87               | 410                         | 713                       | 3,733          | 4,423                  | 98                              | 9,464          | 18,361                          |

## Recapitulation.

|   |    |     |     |     |     |    |       |    |    |     |     |     |    |       |       |
|---|----|-----|-----|-----|-----|----|-------|----|----|-----|-----|-----|----|-------|-------|
| A. Pardee & Co., .....                    | 17 | 598 | 270 | 210 | 151 | 31 | 1,577 | 1  | 22 | 100 | 504 | 310 | 9  | 902   | 1,439 |
| The Cross Creek Coal Company, .....       | 29 | 772 | 167 | 378 | 111 | 51 | 1,508 | 17 | 94 | 111 | 711 | 429 | 11 | 1,373 | 2,881 |
| Lehigh Coal and Navigation Company, ..... | 20 | 396 | 275 | 352 | 104 | 51 | 1,538 | 6  | 28 | 102 | 476 | 426 | 1  | 1,009 | 2,177 |
| G. E. Markle & Co., .....                 | 4  | 562 | 164 | 152 | 83  | 30 | 635   | 4  | 40 | 62  | 397 | 272 | 16 | 661   | 1,257 |

\*Owing to change of operators.

|   |     |       |       |       |     |       |       |       |       |     |       |       |       |        |
|---|-----|-------|-------|-------|-----|-------|-------|-------|-------|-----|-------|-------|-------|--------|
| Linderman & Sheer, .....                    | 2   | 292   | 295   | 113   | 56  | 12    | 651   | 4     | 10    | 4   | 155   | 186   | 432   | 1,060  |
| A. S. Van Winkle, .....                     | 5   | 94    | 74    | 173   | 38  | 12    | 256   | 30    | 38    | 61  | 186   | 966   | 1,327 | 1,713  |
| Lehigh Valley Coal Company, .....           | 10  | 651   | 269   | 308   | 138 | 20    | 1     | 476   | 7     | 115 | 791   | 478   | 1,599 | 2,965  |
| J. C. Haydon & Co., .....                   | 4   | 194   | 189   | 41    | 47  | 6     | 281   | 3     | 22    | 32  | 129   | 419   | 503   | 874    |
| Upper Lehigh Coal Company, .....            | 4   | 173   | 149   | 119   | 51  | 2     | 371   | 3     | 20    | 72  | 110   | 37    | 288   | 673    |
| Carbide Brothers & Co., .....               | 4   | 74    | 84    | 119   | 18  | 8     | 367   | 3     | 42    | 18  | 628   | 526   | 925   | 1,292  |
| Garvin Brothers & Co., .....                | 1   | 12    | 25    | 19    | 22  | ..... | 148   | 1     | 16    | 12  | 87    | 129   | 242   | 390    |
| Pardee Sons & Co., .....                    | 5   | 245   | 164   | 57    | 42  | 17    | 492   | 1     | 13    | 17  | 229   | 133   | 389   | 862    |
| C. M. Bodson & Co., .....                   | 2   | 73    | 104   | 56    | 28  | 4     | 278   | 3     | 11    | 52  | 115   | 149   | 297   | 525    |
| M. S. Kemmell & Co., .....                  | 2   | 73    | 87    | 56    | 39  | 8     | 278   | 2     | 6     | 39  | 70    | 116   | 210   | 426    |
| Lehigh and Wilkes-Barre Coal Company, ..... | 2   | 48    | 291   | 321   | 15  | 7     | 217   | 2     | 7     | 27  | 67    | 83    | 157   | 992    |
| John S. Wentz & Co., .....                  | 1   | 80    | 31    | 26    | 24  | ..... | 159   | ..... | ..... | 14  | 129   | 29    | 176   | 363    |
| The Evans Mining Company, .....             | 1   | 68    | 49    | 11    | 10  | ..... | 142   | ..... | ..... | 5   | 22    | 32    | 67    | 269    |
| Totals for all operators, .....             | 100 | 3,462 | 2,048 | 2,290 | 793 | 228   | 8,897 | 87    | 410   | 713 | 3,733 | 4,323 | 9,464 | 18,361 |

TABLE No. 4.—List of fatal accidents that occurred in the mines of the Fifth Anthracite District for the year ending December 31, 1894

| Date of accident. | Number of accident. | Name of Person.        | Occupation.            | Age.     | Whitens. | Number of orphans. | Name of colliery.           | Location—county.                | Nature and cause of accident.   |
|-------------------|---------------------|------------------------|------------------------|----------|----------|--------------------|-----------------------------|---------------------------------|---|
| Jan. 3,           | 1                   | Edward Dwinney, ...    | Loader,                | ..... 21 | .....    | .....              | Hazleton mine, .....        | Hazleton, Luzerne, .....        | Fatally injured; in running loaded cars of coal his brakeiron slipped and he was thrown under the wheels and had both legs crushed from which injuries he died at the hospital same day.  |
| Feb. 6,           | 2                   | Charles Martin, .....  | Miner, .....           | ..... 24 | .....    | .....              | Colliery No. 5, .....       | Lansford, Carbon, .....         | Fatally injured in working out a shot in a roll of rock in his breast, a piece of rock fell on him, injuring him internally, causing death at hospital, February 11.  |
| 14,               | 3                   | John Ranschock, ....   | Loader, .....          | ..... 23 | .....    | .....              | Beaver Meadow, .....        | Beaver Meadow, Carbon, .....    | Injured fatally; in going out to the dump he rode on front end of loco motive and in switching the same cars he fell in front of them between the rails and was crushed under them about the head and body and died at hospital same day. |
| 19,               | 4                   | Andrew Leshko, .....   | Loader, ....           | ..... 43 | 1        | 2                  | Beaver Brook, .....         | Hazle township, Luzerne, .....  | Fatally crushed under loaded gondola car; in starting two cars with a bar, stepped between and front wheel caught his foot and ran on him till it rested on his thigh; died from his injuries in a short time.                            |
| 24,               | 5                   | Michael Trifcan, ..... | Laborer, .....         | ..... 24 | .....    | .....              | Highland No. 2 slope, ..... | Foster township, Luzerne, ..... | Injured about head and shoulders by a fall of top coat and slate while drilling a hole under the same; died same afternoon at Freeland, while waiting for train to take him to hospital.  |
| 28,               | 6                   | Martin Piscoe, .....   | Stripping miner, ..... | ..... 24 | 1        | 1                  | Hollywood colliery, ...     | Hollywood, Luzerne, .....       | Struck and fatally injured by a piece of rock from bank over pillar between Hollywood and Minesville workings while at work in stripping; died of his injuries same day.  |



|         |    |                     |       |       |                           |                             |  |
|---------|----|---------------------|-------|-------|---------------------------|-----------------------------|--|
| Apr. 3, | 7  | Stripping miner, 43 | 1     | 3     | Hollywood colliery, ...   | Hollywood, Luzerne, .....   | Skull fractured by fall of coal from pillar on stripping while engaged in removing clay from old breast preparatory to removing said pillar; died two hours after the accident.  |
| 4,      | 8  | Slate picker, 14    | ..... | ..... | Breaker, Colliery No. 4.  | Summit Hill, Carbon, .....  | Killed; climbed through a belt which was in motion and was caught and crushed between belt-wheel and floor, and drawn through a small hole in floor, allowing his dead body to fall to floor below, where it was found by slate loaders. |
| 12,     | 9  | Slate picker, 17    | ..... | ..... | Screen Building, .....    | Hauto, Carbon, .....        | Killed; he rode down the plane on the Barney truck and, falling under the wheel, was thrown into middle of road under holisting rope, which struck and mangled him so that he died.  |
| 25,     | 10 | Miner, 58           | 1     | ..... | Lattimer No. 1, .....     | Lattimer Mines, Luzerne..   | Fatally injured; struck on head by piece of coal falling from bridge of top coal on stripping; he walked home, washed himself, went to bed, became unconscious and died seven hours after.   |
| 25,     | 11 | Miner, 40           | 1     | 2     | Hazleton mine, .....      | Hazleton, Luzerne, .....    | Fatally burned by an explosion of C. H. 4 gas in his breast, which he ignited with his own lamp; the gas was back in the top and was brought down with a fall of coal; died of burns and injuries at hospital April 21.                  |
| 26,     | 12 | Roll feeder, 13     | ..... | ..... | Lattimer breaker, No. 1.  | Lattimer Mines, Luzerne,    | Fatally injured; fell into rolls he was attending and from which he must have taken the cover off; right leg crushed at thigh; died at hospital same day.  |
| May 1,  | 13 | Stripping miner, 40 | 1     | 4     | Milnesville colliery, ... | Milnesville, Luzerne, ..... | Skull fractured by falling down coal bank in trying to take a rolling rock from stripping; died May 4.   |
| 7,      | 14 | Laborer, 19         | ..... | ..... | Upper Lehigh No. 4...     | Upper Lehigh, Luzerne, ...  | Killed by an explosion of powder in a hole which he and his miner were tamping, when air was struck in some way, John Wargo, the miner, was also seriously injured.  |
| 10,     | 15 | Driver, 19          | ..... | ..... | Lattimer No. 3 slope, ..  | Lattimer Mines, Luzerne,    | Instantly killed by a fall of top coal in gangway at turnout, while men were engaged in preparing to secure the top, it fell.  |
| 15,     | 16 | Miner, 49           | 1     | 4     | Coleraine colliery, ....  | Beaver Meadow, Carbon,      | Fatally injured by being struck by fall of slate at top of manway of breast, causing him to fall down the manway; died of injuries one hour after.   |

TABLE NO. 4—Continued.

| Date of accident. | Name of Person.            | Occupation.            | Age. | Widows. | Number of orphans. | Name of colliery.           | Location—county.               | Nature and cause of accident.  |
|-------------------|----------------------------|------------------------|------|---------|--------------------|-----------------------------|--------------------------------|--|
| May 25,           | Frank Rososki, .....       | Miner, .....           | 38   | 1       | 3                  | Eckley No. 2 slope, .....   | Eckley, Luzerne, .....         | Fatally injured by top coal falling on him while drilling a hole in it; died six hours after.  |
| June 6,           | Andrew Fedor, .....        | Miner, .....           | 27   | 1       | 1                  | Harwood No. 5 slope, .....  | Harwood Mines, Luzerne, .....  | Killed by fall of coal from slip on high side of gangway as he was preparing to set a prop in front of slip.   |
| 9,                | Joseph Wolff, .....        | Miner, .....           | 44   | 1       | 1                  | Hazleton mine, .....        | Hazleton, Luzerne, .....       | Killed; fall of top coal under which he went after firing a shot, and of which he was warned by his partner, fell on him.  |
| 12,               | William H. Retalick, ..... | Miner, .....           | 48   | 1       | 1                  | Colemaine colliery, .....   | Beaver Meadow, Carbon, .....   | Fatally injured by piece of clod fall at face of his breast while preparing a blast; died shortly after.   |
| 16,               | Charles Farhman, .....     | Locie patcher, .....   | 18   | .....   | .....              | Screen Building, .....      | Hanto, Carbon, .....           | Fatally injured; struck by cross bar and link by slipping and falling between the rails in carelessly crossing in front of locomotive; died in a few minutes.                              |
| 20,               | John Hudock, .....         | Outside laborer, ..... | 25   | .....   | .....              | Lattimer striping, .....    | Lattimer Mines, Luzerne, ..... | Leg crushed by car of rock running over him on plane while helping to replace car on road; died at hospital same day.  |
| 22,               | John Burke, .....          | Miner, .....           | 25   | .....   | .....              | Milnesville colliery, ..... | Milnesville, Luzerne, .....    | Killed by rock flying from a blast fired to break a rock on top of car, and of which he did not hear the warning, as he came out of the gangway past the car just when the blast exploded. |
| 23,               | John Flahita, .....        | Special laborer, ..... | 25   | .....   | .....              | Driffton No. 1 slope, ..... | Driffton, Luzerne, .....       | Killed by runaway cars on inside slope through rope breaking. When warned he ran across bottom of slope instead of going in gangway with other men.  |

|          |    |                          |                      |       |       |       |  |                            |  |
|----------|----|--------------------------|----------------------|-------|-------|-------|--|----------------------------|--|
| July 2,  | 25 | Louis Julian, .....      | Miner, .....         | 32    | 1     | 2     | Harwood No. 4 slope,...                              | Harwood Mines, Luzerne,    | Fatally injured by rushing of pillar which he was engaged in robbing, crushing him under the coal; died at hospital the same day.  |
| 8,       | 26 | George Mashinko, ...     | Driver, .....        | 31    | ..... | ..... | East Sugar Loaf No. 2,                               | Stockton, Luzerne, .....   | Killed; head squeezed between moving timber car and gangway leg while trying to sprag the car.   |
| 12,      | 27 | John Mulligan, .....     | As't ticket boss, 18 | ..... | ..... | ..... | Breaker, East Sugar Loaf, No. 5                      | Stockton, Luzerne, .....   | Fatally crushed by loaded car being run back while he was cleaning coal out of hole below the dump on plane. Engineer claims he received signal to let car back; Mulligan died the same day.   |
| 14,      | 28 | Michael Tomka, ...       | Miner, .....         | 33    | 1     | 4     | Cranberry No. 4 slope,                               | Hazle township, Luzerne,   | Both of these men were instantly killed by the premature explosion of a blast they were preparing to fire, which exploded while they were tamping, or preparing to tamp t; from information received, I believe they had, besides blasting powder, some dynamite and a cap in the charge.  |
| 14,      | 29 | John Andregio, .....     | Laborer, .....       | 35    | 1     | 2     | Cranberry No. 4 slope,                               | Hazle township, Luzerne,   | These eight (8) men were instantly killed by an explosion of dynamite (Atlas powder) while they were receiving the same for their day's work from Footman O'Donnell at the bottom of subterranean shaft from Mammoth to Wharton vein, to which point he brought it, and kept it under lock and key. How the explosion was caused is a mystery, as no one else was present. |
| 17,      | 30 | Charles O'Donnell,...    | Footman, .....       | 25    | 1     | ..... | East Sugar Loaf, .....                               | Stockton, Luzerne, .....   | Pelvis fractured by being squeezed between prop on high side of gangway and car in trying to get on front end trip beside the driver; died of injuries at hospital August 14.  |
| 17,      | 31 | John Erimbo, .....       | Leader, .....        | 22    | ..... | ..... | West No. 1, .....                                    | Stockton, Luzerne, .....   | Fatally injured by a fall of top coal while examining it after a blast, died at hospital same day.   |
| 17,      | 32 | Andrew Sathel, .....     | Miner, .....         | 38    | 1     | ..... | Bottom of shaft, from Mammoth to Wharton vein, ..... | Stockton, Luzerne, .....   | Fatally injured by flying coal from a blast to which he returned after the explosion of the other one of two which he ignited at the same time; died of his injuries same day.   |
| 17,      | 33 | John Kashola, .....      | Leader, .....        | 21    | ..... | ..... | .....  | Stockton, Luzerne, .....   | Killed by fall of top coal after firing shot to start coal down while examining it. He was employed in robbing pillars along the gangway.  |
| 17,      | 34 | John Krzywan, .....      | Leader, .....        | 27    | 1     | ..... | .....  | Stockton, Luzerne, .....   | Instantly killed by fall of top coal and dividing slate on side of gangway when the slate was being taken off.   |
| 17,      | 35 | John Krimeck, .....      | Leader, .....        | 25    | 1     | ..... | .....  | Stockton, Luzerne, .....   |  |
| 17,      | 36 | John Matcofski, .....    | Miner, .....         | 24    | 1     | 2     | .....  | Stockton, Luzerne, .....   |  |
| 17,      | 37 | Anthony Noreavitz, ..... | Leader, .....        | 25    | ..... | ..... | .....  | Stockton, Luzerne, .....   |  |
| Aug. 10, | 38 | John Muterash, .....     | Pat'r & runner, 26   | ..... | ..... | ..... | Beaver Meadow, .....                                 | Beaver Meadow, Carbon,...  |  |
| 17,      | 39 | Christian Lerche, ...    | Miner, .....         | 32    | 1     | 4     | Hazleton mine, .....                                 | Hazleton, Luzerne, .....   |  |
| 20,      | 40 | John Clark, .....        | Miner, .....         | 45    | 1     | 7     | Harwood No. 5 slope,                                 | Harwood Mines, Luzerne,    |  |
| 20,      | 41 | Andrew Brennan, ...      | Miner, .....         | 34    | 1     | 4     | Colliery No. 9, Spring tunnel,                       | Summit Hill, Carbon, ..... |  |
| 31,      | 42 | John Baraska, .....      | Laborer, .....       | 27    | ..... | ..... | Spring Brook colliery, ..                            | Yorktown, Carbon, .....    |  |

TABLE No. 4—Continued.

| Date of accident. | Number of accident. | Name of Person.                   | Occupation.      | Age. | Widows. | Number of orphans. | Name of colliery.         | Location—county.           | Nature and cause of accident.  |
|-------------------|---------------------|-----------------------------------|------------------|------|---------|--------------------|---------------------------|----------------------------|--|
| Sept. 7,          | 43                  | Samuel Winters, ....              | Stripping miner, | 50   | 1       | 3                  | Hollywood colliery, ...   | Hollywood, Luzerne, .....  | Killed by fall of coal from pillar which he was passing on retreating from a borehole blast which exploded and barred the coal so that it fell on him.   |
| 10,               | 44                  | Daniel Gillespie, .....           | Miner, .....     | 48   | 1       | 2                  | Harwood No. 4 slope, ...  | Harwood Mines, Luzerne,    | Spine fractured by a fall of heavy coal in his breast that fell while he was working out at shot in cross heading with a pick; died at hospital October 23.  |
| 25,               | 45                  | Constantine McHugh, Driver, ..... | Driver, .....    | 25   | .....   | .....              | Coleraine colliery, ..... | Beaver Meadow, Carbon, ... | Head squeezed between rib on high side of pitch-road and an empty car on the front end of which he was riding up, driving the team. An access formed on his brain which, with pneumonia, caused his death October 4. |
| 25,               | 46                  | William Taylor, .....             | Driver, .....    | 23   | .....   | .....              | East Sugar Loaf No. 2,    | Stockton, Luzerne, .....   | Fatally squeezed between car from which he jumped and a log on high side of gangway. Several ribs were fractured and forced into his lungs, causing death soon after reaching home.                                  |
| 29,               | 47                  | Anthony Arkovich, ...             | Driver, .....    | 15   | .....   | .....              | East Crystal Ridge, ...   | Hazle township, Luzerne,   | While riding out of tunnel on front end of car his mule kicked him and he fell between the rails. The car in passing over him fractured his spine, causing his death at the hospital October 1.                      |
| Oct. 9,           | 48                  | John Orlich, .....                | Outside r/d'm'n, | 35   | .....   | .....              | Lattimer stripping, ...   | Lattimer Mines, Luzerne,   | Fatally injured; in attempting to unhook a rope from an empty car at foot of plane he fell when rope stopping, jerked the cars back and they crushed him; died at hospital same day.                                 |

|          |    |                            |                         |                       |                            |   |                                    |                             |
|----------|----|----------------------------|-------------------------|-----------------------|----------------------------|---|------------------------------------|-----------------------------|
| 49,      | 49 | Patrick Elliott, .....     | Switch tender, 16 ..... | Colliery No. 5, ..... | Summit Hill, Carbon, ..... | Fatally crushed under trip of loaded cars in front of which he fell when unhooking locomotive from them while both were moving for the purpose of changing off with the icicle hollower for making a flying switch. He had this trip to the breaker; died same day. |                                    |                             |
| Nov. 5,  | 50 | Dominick Graff, .....      | Miner, .....            | 5                     | Highland No. 5, .....      | Foster township, Luzerne,   |                                    |                             |
| 6,       | 51 | Cornelius Gallagher, ..... | Miner, .....            | 48                    | 1                          | 3   | Stockton No. 3, .....              | Stockton, Luzerne, .....    |
| 19,      | 52 | Frank Public, .....        | Miner, .....            | 44                    | 1                          | 2   | Colliery No. 6, .....              | Summit Hill, Carbon, .....  |
| 19,      | 53 | Patrick McHugh, .....      | Machinist, .....        | 29                    | .....                      | .....   | Lattimer No. 2 slope, ..           | Lattimer Mines, Luzerne,    |
| 27,      | 54 | John Jacobs, .....         | Stripping miner, 36     | 1                     | 3                          | Stockton strippings, ..   | Stockton, Luzerne, .....           | .....                       |
| Dec. 12, | 55 | Michael Kenedy, .....      | Outside laborer, 23     | .....                 | .....                      | .....   | Milnesville stripping, ..          | Milnesville, Luzerne, ..... |
| 17,      | 56 | Frank Verbitzka, .....     | Laborer, .....          | 28                    | 1                          | 2   | Upper Lehigh No. 4, ..             | Upper Lehigh, Luzerne, ..   |
| 18,      | 57 | John Myorna, .....         | Outside laborer, 40     | 1                     | .....                      | .....   | Highland No. 5 breaker,            | Hazle township, Luzerne,    |
| 20,      | 58 | Andrew Marrlek, .....      | Ash wheeler, .....      | 38                    | .....                      | .....   | Honey Brook No. 2,<br>No. 7 slope, | Trescow, Carbon, .....      |

Total mine fatalities, 58; widows, 30; orphans under 16 years old, 66.

Fatally injured; he stood on a ladder to bar down top coal in his breast; a piece falling broke in the ladder; throwing him towards face of breast, when another piece fell and struck him on the head, causing death shortly after.

Injured internally by top coal falling on him while he was tampering a bottom hole under it in opening his breast; died at his home the next day.

Fatally burned by an explosion of black powder, caused by his filling a cartridge and keeping his lighted lamp on his head instead of removing it to a safe distance; died at St. Luke's hospital December 9.

Killed by being thrown off a car by obstruction on slope and fell to the bottom of the slope which pitched seventy degrees. He was dead when other men from car reached him.

Killed by fall of top coal from pillar in the middle bench and was drilling a bottom hole when top coal fell.

Skull fractured by flying coal from a blast he was watching instead of remaining in the back of safety where he had been; died next day.

Received fatal injuries by fall of roof rock as he, with two miners, were loading out near pillar they were robbing out, the same day.

Struck in back when coal in pocket being drawn down into and covering with the coal through not hearing the warning given to him by a boy that the loaders were drawing top coal out.

Killed; loaded cars of pea coal for boiler house ran over him by his trying to change the catches of branch in front of them while they were in motion.

TABLE NO. 4.—Fatal accidents in strippings under contractors during year 1894.

| Date of accident. | Name of person.         | Occupation.      | Age. | Widows. | Number of orphans. | Name of colliery.       | Location—county.           | Nature and cause of accident.   |
|-------------------|-------------------------|------------------|------|---------|--------------------|-------------------------|----------------------------|---|
| Feb. 24.          | 1 Michael Fitzcoe, .... | Outside laborer. | 31   | 1       | 1                  | Honey Brook No. 2, ..   | Trescow, Carbon, .....     | Killed by an explosion of dynamite, caused by his carrying a pail with the powder too near a fire and setting covering on fire. |
| Dec. 4.           | 2 John Davidick, .....  | Outside laborer. | 42   | 1       | 6                  | Upper Lehigh No. 5,.... | Upper Lehigh, Luzerne,.... | Killed by fall of clay bank back under which he went for his shovel after being warned out by foreman.                          |

Total stripping fatalities, 2; widows, 2; orphans under 16 years old, 7.

## Recapitulation of mine fatalities in Table No. 4

| Occupation.                         | Number killed. | Per cent. | Nationality.     | Number killed. | Per cent. | Causes of fatalities.                        | Number. | Per cent. |
|-------------------------------------|----------------|-----------|------------------|----------------|-----------|--|---------|-----------|
| Miners, .....                       | 19             | 22.8      | Hungarian, ..... | 22             | 27.9      | By explosion of C. H. 4 gas.                 | 1       | 1.7       |
| Mine laborers, .....                | 12             | 20.7      | American, .....  | 16             | 27.6      | By falls of roof coal and shales.            | 4       | 20.7      |
| Footmen, .....                      | 1              | 1.7       | Irish, .....     | 4              | 6.9       | By falls of coal and clay on strippings.     | 4       | 6.9       |
| Drivers and trainers, .....         | 1              | 1.7       | German, .....    | 4              | 6.9       | By cars on the surface.                      | 6       | 10.4      |
| Stripping miners, .....             | 6              | 10.4      | Polish, .....    | 4              | 6.9       | By machinery, inside and outside.            | 9       | 15.5      |
| Outside laborers and loaders, ..... | 8              | 13.8      | Austrian, .....  | 3              | 3.7       | By premature blasts.                         | 19      | 11.2      |
| Assistant ticket boss, .....        | 1              | 1.7       | English, .....   | 1              | 1.7       | By miscellaneous causes, inside and outside. | 6       | 8.6       |
| Patchers and switch tenders, .....  | 2              | 3.4       | Totals, .....    | 58             | 100.0     | Totals, .....                                | 58      | 100.0     |
| Machinists, .....                   | 2              | 3.4       |                  |                |           |  |         |           |
| Slate pickers, .....                | 2              | 3.4       |                  |                |           |  |         |           |

TABLE No. 5.—List of non-fatal accidents that occurred in the mines of the Fifth Anthracite District for the year ending December 31, 1894.

| Date of accident. | Number of accident. | Name of Person.        | Occupation.         | Age. | Married or single. | Name of Colliery.                    | Location—County.             | Nature and Cause of Accident.  |
|-------------------|---------------------|------------------------|---------------------|------|--------------------|--------------------------------------|------------------------------|--|
| Jan. 4.           | 1                   | Frank Dougherty, ..... | Oiler, .....        | 14   | S.                 | No. 4 slope Lattimer No. 3 colliery. | Latimer, Luzerne, .....      | Leg fractured below knee by being struck by bar which he used to start the air compressor with being caught and thrown against him by the fly wheel. |
| 11.               | 2                   | Hugh McMonigle, .....  | Runner, .....       | 17   | S.                 | Highland No. 5, .....                | Foster twp., Luzerne, .....  | Leg bruised; after uncoupling cars he stepped between them, when another trip bumped them together squeezing him.                                    |
| 11.               | 3                   | John Fosher, .....     | Driver, .....       | 24   | S.                 | Slope No. 2, Harwood colliery.       | Harwood, Luzerne, .....      | Leg fractured below knee; knocked down and injured by mine cars in tunnel.   |
| 24.               | 4                   | John Bachisko, .....   | Laborer, .....      | 38   | M.                 | Hollywood colliery, .....            | Hollywood, Luzerne, .....    | Compound fracture of two bones in his foot; rock he was splitting on slight pitch fell on him and broke.   |
| Feb. 12.          | 5                   | Angelo Scarbene, ..... | Out. laborer, ..... | 30   | S.                 | Lattimer No. 1 colliery, .....       | Latimer, Luzerne, .....      | Head injured; fell over trestle in pushing buggy.  |
| 14.               | 6                   | Nimrod Norris, .....   | Laborer, .....      | 28   | M.                 | Spring Mountain No. 1, .....         | Jeansville, Carbon, .....    | Head and shoulders badly contused by fall of coal in breast in which he was employed.  |
| 15.               | 7                   | Patrick Boyle, .....   | Miner, .....        | 44   | M.                 | East Sugar Loaf No. 6, .....         | Stockton, Luzerne, .....     | Back injured by fall of coal from slip in face of breast while barring down after blast.   |
| 20.               | 8                   | James McNates, .....   | Pumpman, .....      | 29   | M.                 | Highland No. 2, .....                | Foster twp., Luzerne, .....  | Right arm lacerated and contused by being caught in machinery of pump while oiling it.   |
| 20.               | 9                   | James Fray, .....      | Out. laborer, ..... | 34   | .....              | Spring Mountain No. 1, .....         | Jeansville, Carbon, .....    | Right foot crushed and left leg contused by being caught in rolls while cleaning this part.  |
| 21.               | 10                  | John Swanik, .....     | Laborer, .....      | 34   | M.                 | No. 2 slope, Harwood, .....          | Harwood, Luzerne, .....      | Back and ribs injured by rock falling on him while barring down coal at face of breast.  |
| 22.               | 11                  | Dennis Ferry, .....    | Miner, .....        | 54   | M.                 | No. 4 slope Upper Lehigh, .....      | Upper Lehigh, Luzerne, ..... | Jawbone and one rib fractured by a piece of top coal falling on him while he was barring it down.  |

TABLE No. 5.—Continued.

| Date of accident. | Number of accident. | Name of Person.          | Occupation.        | Age. | Married or single. | Name of Colliery.                | Location—County.          | Nature and Cause of Accident.   |
|-------------------|---------------------|--------------------------|--------------------|------|--------------------|----------------------------------|---------------------------|---|
| Feb. 23,          | 12                  | Carmine Parish, .....    | Out. laborer,..... | 37   | S.                 | Stripping, Highland No. 2, ..... | Foster twp., Luzerne,.... | Leg fractured at hip and above knee by a fall of frozen clay from bank.   |
| 24,               | 13                  | John Kaleshewski, .....  | Miner, .....       | 43   | M.                 | East Sugar Leaf No. 5,.....      | Stockton, Luzerne, .....  | Leg fractured below knee by coal flying through the cross headrest from shot fired in second breast away from him and striking him in rebound.              |
| 28,               | 14                  | John Carr, .....         | Laborer, .....     | 24   | S.                 | Jeddo No. 4, .....               | Hazle twp., Luzerne,....  | Head and side contused; shipped and fell thirty-four feet on 60 degree pitch while fixing manway of breast.   |
| March 6,          | 15                  | Anthony McHale, .....    | Foot man, .....    | 22   | S.                 | No. 8 slope, .....               | Hazleton, Luzerne, ...    | McHale's both legs were fractured and both legs by runaway car on slope, caused by chain breaking.  |
| 6,                | 16                  | William Phillips, .....  | Driver, .....      | 29   | S.                 | Hazleton mine, .....             | Hazleton, Luzerne, ...    | Head cut, body contused and leg fractured by top coal under which he was working falling on him.  |
| 7,                | 17                  | Stanley Novack, .....    | Miner, .....       | 34   | M.                 | Drifton slope No. 1, .....       | Drifton, Luzerne, .....   | Ward received two large scalp wounds and Kennedy was cut on the arms and body by coal flying from a blast in neighboring breast, of which they were warned. |
| 8,                | 18                  | Frank Ward, .....        | Miner, .....       | 50   | M.                 | South Sugar Leaf, .....          | Hazle twp., Luzerne, ..   | Leg fractured by fall of slate at face of gangway while he was loading his car.   |
| 8,                | 19                  | Cornelius Kennedy, ..... | Miner, .....       | 45   | S.                 | South Sugar Leaf, .....          | Hazle twp., Luzerne, ..   | Leg fractured in two places by piece of coal falling on him through the breaking up of a large piece by another workman.                                    |
| 8,                | 20                  | John Dorvin, .....       | Laborer, .....     | 23   | S.                 | Sandy Run colliery, .....        | Sandy Run, Luzerne,....   | Back and shoulder contused; top coal fell on him while he was trimming down after shot.   |
| 10,               | 21                  | Andrew Murak, .....      | Out. laborer,....  | 40   | S.                 | Stripping, Jeddo No. 4,.....     | Hazle twp., Luzerne,....  | Wrist fractured; arm caught under box of slate car while engaged in dumping the same.   |
| 12,               | 22                  | Henry Spencer, .....     | Miner, .....       | 22   | M.                 | Hazleton mine, .....             | Hazleton, Luzerne, .....  |   |
| 13,               | 23                  | William Johnson, .....   | Out. laborer,....  | 18   | S.                 | Honey Brook No. 2, .....         | Trescow, Carbol, .....    |   |



|       |    |                         |                     |    |      |  |                              |   |
|-------|----|-------------------------|---------------------|----|------|--|------------------------------|---|
| 14.   | 24 | John McHugh, .....      | Outside driver,.... | 20 | S.   | Honey Brook No. 2, .....               | Trescow, Carbon, .....       | Fingers crushed; in turning switch he fell over it.   |
| 20.   | 25 | Michael Rustia, .....   | Laborer, .....      | 30 | S.   | Highland No. 5, .....                  | Foster twp., Luzerne,....    | Leg fractured between thigh and knee by a piece of coal rolling down the pit against him while loading buggy in breast.   |
| April | 6. | William Phillips, ..... | Driver, .....       | 20 | S.   | No. 8 slope, Hazleton mine, .....      | Hazleton, Luzerne, .....     | Injured by coal and dirt thrown from roadway car on slope.  |
| 12.   | 27 | Adam Koch, .....        | Driver, .....       | 23 | S.   | Hazleton mine, .....                   | Hazleton, Luzerne, .....     | Shoulders and chest contused; squeezed while crossing between cars while in motion.   |
| 13.   | 28 | Michael Casper, .....   | Oiler, .....        | 26 | M.   | East Sugar Loaf No. 5, .....           | Stockton, Luzerne, .....     | Leg fractured below knee; struck by car which mule started unexpectedly.  |
| 14.   | 29 | Jacob Martonlo, .....   | Miner, .....        | 28 | S.   | Cranberry colliery, .....              | Hazle twp., Luzerne,....     | Leg fractured by being caught by rush of coal in his breast.  |
| 17.   | 30 | George Moser, .....     | Miner, .....        | 51 | M.   | Cranberry colliery, .....              | Hazle twp., Luzerne,....     | Shoulder bruised and hands lacerated by fall of coal.   |
| 20.   | "  | Hermann Griff, .....    | Miner, .....        | 25 | S.   | No. 4 slope Cranberry, .....           | Hazle twp., Luzerne,....     | Injured by coal flying from a blast which he fired; he failed to reach a place of safety before it exploded.  |
| 28.   | 32 | Michael Rusinko, .....  | Miner, .....        | 25 | S.   | Hazleton No. 3 slope, .....            | Hazleton, Luzerne, .....     | Leg fractured by coal in scabute striking him.  |
| 28.   | 33 | Andrew Samyon, .....    | Laborer, .....      | 20 | S.   | East Sugar Loaf No. 6, .....           | Stockton, Luzerne, .....     | Knee injured by being struck by piece of coal that rolled down the slope while he was hitching car at bottom.   |
| 30.   | 34 | Daniel Singer, .....    | Miner, .....        | 38 | M.   | Sandy Run colliery, .....              | Sandy Run, Luzerne,....      | Injured internally by being struck by an old prop, which fell while he was engaged in timbering near it.  |
| May   | 4. | Michael Cesneska, ..... | Miner, .....        | 28 | S.   | East Sugar loaf No. 5, .....           | Stockton, Luzerne, .....     | Leg fractured by piece of coal rolling from face of gangway which he was re-opening.  |
| 7.    | 36 | John Wargo, .....       | Miner, .....        | 25 | S.   | No. 4 slope, Upper Lehigh, .....       | Upper Lehigh, Luzerne, ..... | While tamping hole with his laborer, Martin Sisino, the drill struck fire and exploded the charge, killing Sisino and burning and lacerating Wargo terribly about chest and face. |
| 7.    | 37 | Charles MumeY, .....    | Slate picker,....   | 13 | .... | Hollywood breaker, .....               | Hollywood, Luzerne, ...      | Leg fractured by jig conveyors, into which he slipped while oiling them.  |
| 8.    | 38 | John Husogte, .....     | Out. laborer,....   | 24 | S.   | Stripping at East Crystal Ridge, ..... | Hazle twp., Luzerne,....     | Large toe on right foot crushed so as to necessitate amputation, by rock at which he was barring falling on his foot.   |
| 10.   | 39 | Mario Chirio, .....     | Out. laborer,....   | 40 | M.   | Spring Mountain stripping, .....       | Jeanville, Luzerne,....      | Leg fractured by falling down off of sloping rock on which he was working.  |
| 11.   | 40 | Balco Kaseltza, .....   | Out. laborer,....   | 50 | M.   | Jeddo No. 4 breaker, .....             | Hazle twp., Luzerne, ...     | Six ribs were fractured, chest and thigh bruised by railroad men running cars of condemned coal against one at which he was working.  |

TABLE No. 5.—Continued.

| Date of accident. | Number of accident. | Name of Person.         | Occupation.         | Age.  | Married or single. | Name of Colliery.                 | Location—County.             | Nature and Cause of Accident.  |
|-------------------|---------------------|-------------------------|---------------------|-------|--------------------|-----------------------------------|------------------------------|--|
| May 15.           | 41                  | Joseph Kokoskey, .....  | Laborer, .....      | 30    | M.                 | Honey Brook No. 2, No. 14 slope.  | Tressow, Carbon, .....       | Index finger severed and right hand badly bruised by jump of coal rolling down chute while he was loading his car. |
| 16.               | 42                  | George Schlicher, ..... | Miner, .....        | 29    | M.                 | Gowen No. 1, Derringer colliery.  | Gowen, Luzerne, .....        | Left leg fractured and lacerated below the knee by a falling fifty yards from first in face of gangway.            |
| 22.               | 43                  | John Cannon, .....      | Miner, .....        | ..... | .....              | Highland No. 5 slope, .....       | Foster twp., Luzerne, .....  | Ankle fractured by buggy box striking him on the knee in unloading, the buggy not securely fastened.               |
| 30.               | 44                  | Anton Sobiski, .....    | Driver, .....       | 22    | S.                 | No. 4 slope, Harwood colliery.    | Harwood mines, Luz., .....   | Arm lacerated by falling against coal.   |
| 31.               | 45                  | Thomas Craves, .....    | Laborer, .....      | 21    | S.                 | E. Sugar Loaf, No. 2 slope, ..... | Stockton, Luzerne, .....     | Head body bruised by mule kicking him.   |
| June 6.           | 46                  | Hugh McDwyer, .....     | Miner, .....        | 50    | M.                 | Hazleton No. 3 slope, .....       | Hazle twp., Luzerne, .....   | Squeezed about the hip between loaded cars on curve at bottom of the hoisting slope.                               |
| 9.                | 47                  | Joseph Wishinski, ..... | Laborer, .....      | 33    | M.                 | Upper Lehigh No. 7, .....         | Upper Lehigh, Luzerne, ..... | Right hip and thigh bruised by slate falling while he was under it, after having just fired two blasts under it.   |
| 9.                | 48                  | Henry Bachman, .....    | Company man, .....  | 48    | M.                 | No. 4 Cranberry, .....            | Hazle twp., Luzerne, .....   | Left arm fractured below the elbow by a fall of top coal.  |
| 13.               | 49                  | John Petrovich, .....   | Laborer, .....      | 25    | S.                 | Spring Brook No. 2, .....         | Yorktown, Carbon, .....      | Pelvis fractured; caught between loaded cars which he was driving and prop on high side of gangway.                |
| 13                | 50                  | Frank Starasko, .....   | Miner, .....        | 28    | S.                 | E. Sugar Loaf No. 5, .....        | Stockton, Luzerne, .....     | Left leg fractured below knee by fall of top coal in breast.   |
| 14.               | 51                  | John Hoffman, .....     | Slate picker, ..... | 14    | S.                 | Eckley breaker, .....             | Eckley, Luzerne, .....       | Burned and injured about face and body by explosion of powder while drilling out a missed hole in coal.            |
|                   |                     |                         |                     |       |                    |                                   |                              | Leg so badly crushed as to necessitate amputation, by falling into rolls while away from his working place.        |

|         |                             |                               |    |     |                                   |                              |  |
|---------|-----------------------------|-------------------------------|----|-----|-----------------------------------|------------------------------|--|
| 14.     | John Dominski, .....        | Laborer, .....                | 35 | M.  | Spring Brook colliery, .....      | Yorktown, Carbon, .....      | Leg fractured below knee by dividing stone which fell on him after he and his miner failed to bar it down. Right leg very badly bruised between bumpers of moving cars while trying to couple them.  |
| 16.     | Hugh Boyle, .....           | Out. patcher, .....           | 14 | S.  | Spring Brook colliery, .....      | Yorktown, Carbon, .....      | Left leg badly bruised between knee and ankle in trying to couple loaded cars while they were in motion. Back severely contused by fall of bony top coal in his breast.  |
| 19.     | Edwin Fulmer, .....         | Out. locomotive helper, ..... | 11 | S.  | Spring Brook colliery, .....      | Yorktown, Carbon, .....      | Injured slightly about the legs by the premature explosion of a blast that he was helping to tamp.   |
| 19.     | Michael Zimmerman, .....    | Miner, .....                  | 31 | M.  | No. 1 slope, Cranberry, .....     | Hazle twp., Luzerne, .....   | Back injured and leg fractured in two places by bony coal which fell while he was working under it having failed to bring it down by barring.  |
| 22.     | Peter Tomowajowich, .....   | Laborer, .....                | 26 | M.  | No. 1, Spring Mountain, .....     | Jeanville, Carbon, .....     | Heel crushed by wheel of car passing over it; he fell in front of cars while turning his mule around.  |
| 23.     | Michael Buckley, .....      | Miner, .....                  | 28 | M.  | Beaver Brook, .....               | Hazle twp., Luzerne, .....   | Toes crushed; had his foot on rail and car caught his toes; not a serious injury.  |
| 28.     | Frank Grohman, .....        | Driver, .....                 | 17 | S.  | Highland No. 5 slope, .....       | Foster twp., Luzerne, .....  | Both hands blown off, face cut and eyesight almost totally destroyed by explosion of dynamite while drilling out missed hole in rock; two other men were also slightly injured.  |
| 28.     | Robert Rowland, .....       | Out. driver, .....            | 18 | S.  | Spring Mountain strippings, ..... | Jeanville, Luzerne, .....    | Legs severely bruised by top coal which fell on him while he was engaged in drilling a hole in the stabling, his way to the stable fall off while badly gashed on instep by large lump of coal falling out of his hands while lifting it into car. |
| 30.     | Pasco Grico, .....          | Stripping miner, .....        | 29 | M.  | Hollywood strippings, .....       | Hollywood, Luzerne, .....    | Leg fractured below knee by a piece of coal which fell and caught him between it and a prop.   |
| July 7. | Frank Pirtocki, .....       | Miner, .....                  | 40 | M.  | East Sugar Loaf No. 6, .....      | Stockton, Luzerne, .....     | Leg injured by being struck by piece of coal sliding down the breast when he was going up the same.  |
| 12.     | James McHugh, .....         | Driver, .....                 | 17 | S.  | No. 6 slope, Eckley, .....        | Eckley, Luzerne, .....       | Face and hands injured by explosion of dynamite blast as he was going back to fire other blasts, supposing this had gone off.  |
| 12.     | Michael Korra, .....        | Laborer, .....                | 25 | S.  | East Sugar Loaf No. 2, .....      | Stockton, Luzerne, .....     | Leg crushed by falling under mine car in trying to get on it while it was moving.  |
| 12.     | Andrew Polka, .....         | Laborer, .....                | 20 | S.  | No. 4 slope Upper Lehigh, .....   | Upper Lehigh, Luzerne, ..... | Face and hands slightly burned by an explosion of C.H. gas, which he ignited in his breast with his naked light.   |
| 13.     | Peter Fasgus, .....         | Laborer, .....                | 28 | S.  | East Sugar Loaf No. 4, .....      | Stockton, Luzerne, .....     |  |
| 14.     | Mark Sheridan, .....        | Stripping miner, .....        | 50 | S.  | Lattimer strippings, .....        | Lattimer mines, Luz., .....  |  |
| 23.     | William Probert, Jr., ..... | Slate picker, .....           | 15 | ... | Hollywood breaker, .....          | Hollywood, Luzerne, .....    |  |
| 26.     | Peter Leshefski, .....      | Miner, .....                  | 31 | M.  | East Sugar Loaf No. 2, .....      | Stockton, Luzerne, .....     |  |

TABLE No. 5.—Continued.

| Date of accident. | Number of accident. | Name of Person.           | Occupation.         | Age. | Married or single. | Name of Colliery.            | Location--County.         | Nature and Cause of Accident.   |
|-------------------|---------------------|---------------------------|---------------------|------|--------------------|------------------------------|---------------------------|---|
| July 27,          | 69                  | John J. O. Donnell, ....  | Miner, .....        | 39   | M.                 | Coleraine colliery, .....    | Beaver Meadow, Carbon,    | Leg fractured above the knee and arm cut by piece of rock falling from side of gangway.   |
| 30,               | 70                  | Michael Bittico, .....    | Laborer, .....      | 19   | S.                 | Spring Brook colliery, ..... | Yorktown, Carbon,.....    | Internally injured by falling from a car in riding up the slope.  |
| Aug. 1,           | 71                  | Robert S. Hillhouse, .... | Mine foreman, ..    | 40   | M.                 | Cranberry No. 4 slope,.....  | Hazle twp., Luzerne,....  | Seriously injured about back and chest by being thrown off and under tender truck of small locomotive on the outside road from slope to breaker.          |
| 2,                | 72                  | John Mioski, .....        | Laborer, .....      | 28   | S.                 | Spring Brook No. 1 slope,... | Yorktown Carbon, .....    | Skull fractured by coal flying, from shot which he was firing, and which broke through the collar.  |
| 6,                | 73                  | John R. Erickson, .....   | Slate picker,....   | 14   | ....               | East Crystal Ridge, .....    | Hazle twp., Luzerne,....  | Left leg badly lacerated above and below the knee by falling into elevators in breaker.   |
| 6,                | 74                  | Adam Bitscobe, .....      | Out. laborer, ...   | 24   | S.                 | East Crystal Ridge breaker,  | Hazle twp., Luzerne,....  | Both arms fractured at wrists by falling in man trestle at breaker, twenty-five feet to the ground, while helping to place a derailed buggy on the track. |
| 22,               | 75                  | Alexander McLain, .....   | Driver, .....       | 20   | S.                 | Spring Mountain No. 4,.....  | Jeansville, Luzerne, .... | Arm slightly bruised by falling from a car, his arm having been caught between bumper and spreader.   |
| Sept. 2,          | 76                  | Charles Briesse, .....    | Laborer, .....      | 60   | M.                 | Hazleton No. 3 slope, .....  | Hazle twp., Luzerne,....  | Leg fractured below knee by a piece of coal which fell from the pillar.   |
| 6,                | 77                  | Adam Piller, .....        | Laborer, .....      | 40   | M.                 | E. Sugar Loaf No. 5 slope,.  | Stockton, Luzerne,.....   | Back injured by piece of clod which fell on him while he was loading car.   |
| 7,                | 78                  | Peter Tarla, .....        | Out. laborer,....   | 43   | M.                 | Spring Mountain strippings,  | Jeansville, Luzerne,..... | Toes cut off by moving car under which he slipped in trying to get on it.   |
| 13,               | 79                  | William Quirk, .....      | Stripping miner, .. | 48   | M.                 | Spring Mountain strippings,  | Jeansville, Luzerne,..... | Head severely squeezed between car and face of coal pillar on strippings.   |
| 18,               | 80                  | Frank Nagg, .....         | Car oiler,.....     | 25   | S.                 | Harwood colliery breaker,... | Harwood mines, Luz,...    | Severely squeezed about the hip by stumbling and falling in front of moving loaded car.   |

|          |    |                         |                      |    |    |                               |                              |   |
|----------|----|-------------------------|----------------------|----|----|-------------------------------|------------------------------|---|
| 18,      | 81 | Leon Pety, .....        | Driver, .....        | 20 | S. | East Sugar Loaf No. 6,.....   | Stockton, Luzerne, .....     | Leg fractured by mule falling on him in the stable.   |
| 19,      | 82 | John Ferthel, .....     | Screen tender, ..... | 18 | S. | Beaver Meadow colliery,.....  | Beaver Meadow, Carbon, ..... | Right leg fractured by being struck by an empty car when the D., S. and S. locomotive bumped it with a trip of empty cars.                              |
| 22,      | 83 | Parvonia Savoria, ..... | Out laborer,.....    | 32 | M. | Coleraine strippings, .....   | Coleraine Carbon, .....      | Pelvis fractured by empty stripping car falling, when struck and derailed by a loaded stripping car.  |
| Oct. 1,  | 84 | Joshua Griffiths, ..... | Miner, .....         | 24 | S. | Spring Mountain No. 1,.....   | Jeanville, Carbon, .....     | Leg fractured by being caught between two mine cars in some unexplained manner.   |
| 15,      | 85 | Patrick Boyle, .....    | Miner, .....         | 40 | M. | Hazleton mine No. 1,.....     | Hazleton, Luzerne, .....     | Badly squeezed about the hips, fracturing one thigh by coal breaking off from face of breast and rolling down against him.                              |
| 16,      | 86 | Edward Rodda, .....     | Miner, .....         | 42 | M. | South Sugar Loaf, .....       | Hazle twp., Luzerne,.....    | Right shoulder dislocated, two ribs fractured, also collar bone; squeezed between car and brattice by car running into branch on which he was standing. |
| 25,      | 87 | Michael Quinn, .....    | Loader, .....        | 50 | M. | Lattimer No. 1 colliery,..... | Lattimer mines, Luz,.....    | Collar bone fractured by rush of coal on to car with it.  |
| 31,      | 88 | Ralph Cammeron, .....   | Oiler, .....         | 19 | S. | Lattimer No. 1 breaker,.....  | Lattimer mines, Luz,.....    | Arm fractured and body bruised severely by being caught by coal in machinery and drawn around shaft while oiling at wrong place in breaker.             |
| Nov. 12, | 89 | Frank Gallagher, .....  | Miner, .....         | 47 | M. | East Sugar Loaf No. 5,.....   | Stockton, Luzerne,.....      | Leg fractured at ankle by fall of top coal in his gangway while preparing for set of timber.  |
| 13,      | 90 | William Levish, .....   | Miner, .....         | 40 | M. | East Sugar Loaf No. 2,.....   | Stockton, Luzerne,.....      | Knee joint dislocated by piece of top coal falling and rolling down against him.  |
| 17,      | 91 | Jacob Houser, .....     | Miner, .....         | 33 | M. | Hazleton No. 1 slope, No. 8,  | Hazleton, Luzerne, .....     | Leg fractured below knee by pulley block falling down in his working place.   |
| 19,      | 92 | Otto Eckling, .....     | Door boy, .....      | 15 | S. | Hazleton No. 2, .....         | Hazle twp., Luzerne,.....    | One rib fractured, and seriously bruised by car while trying to unhook mule from it.  |
| 30,      | 93 | John Matthews, .....    | Out laborer,.....    | 28 | M. | Cranberry strippings, .....   | Hazle twp., Luzerne,.....    | Hip badly bruised by falling under baggy while trying to unhook mule from it.   |
| Dec. 12, | 94 | Michael Steffan, .....  | Outside oiler,.....  | 35 | M. | Beaver Brook colliery, .....  | Hazle twp., Luzerne,.....    | Leg severely bruised below knee by being caught between loaded cars when trip bumped into foot of plane.  |
| 17,      | 95 | Robert Thomas, .....    | Miner, .....         | 29 | S. | Driffton No. 2 slope,.....    | Driffton, Luzerne, .....     | Leg fractured above the knee by fall of rock while engaged in loading car under the same.   |

## Non-fatal accidents on stripping.

| Date of accident. | Name of Person.      | Occupation.             | Age. | Married or single. | Name of Colliery.   | Location--County.      | Nature and Cause of Accident.   |
|-------------------|----------------------|-------------------------|------|--------------------|---|------------------------|---|
| Feb. 24, .....    | James Collins, ..... | Stripping fore-<br>man. | 59   | M.                 | Stripping at Honey Brook,<br>No. 2.                                     | Trescow, Carbon, ..... | Seriously injured by explosion of dynamite which laborer caused by taking a box with dynamite, caps and fuse too near a fire while they were preparing the blast. |
| May 11, .....     | John Palletts, ..... | Out laborer, .....      | 38   | M.                 | N. J. Cuyde & Bro., strip-<br>ping of Dick & Co., Honey<br>Brook No. 2. | Trescow, Carbon, ..... | Leg fractured above the knee by being caught between shovel and jack beam of steam shovel by key coming out of main pinion wheel, thus allowing dipper to fall.   |

## Recapitulation.

| Occupation of Persons.     | Number In-<br>jured. | Per cent. | Nationality.     | Number In-<br>jured. | Per cent. | Cause of Accidents.                                     | Number In-<br>jured. | Per cent. |
|----------------------------|----------------------|-----------|------------------|----------------------|-----------|---|----------------------|-----------|
| Mine foremen, .....        | 1                    | 1.1       | Hungarian, ..... | 24                   | 25.3      | By explosions of C.H.H gas, .....                       | 1                    | 1.1       |
| Miners, .....              | 30                   | 31.6      | American, .....  | 18                   | 18.9      | By falls of roof, coal and sides, .....                 | 33                   | 34.7      |
| Mine laborers, .....       | 20                   | 21.0      | Irish, .....     | 17                   | 17.9      | By falls of coal, rock and clay on<br>strippings, ..... | 16                   | 16.8      |
| Company men, .....         | 2                    | 2.1       | Polish, .....    | 13                   | 13.7      | By mine cars, .....                                     | 1                    | 1.1       |
| Footmen, .....             | 1                    | 1.1       | Italian, .....   | 8                    | 8.4       | By cars on surface, .....                               | 15                   | 15.8      |
| Pumpmen, .....             | 1                    | 1.1       | Austrian, .....  | 5                    | 5.2       | By machinery, inside and outside, .....                 | 7                    | 7.3       |
| Runners and drivers, ..... | 10                   | 10.5      | German, .....    | 4                    | 4.2       | By explosions of powder, .....                          | 2                    | 2.1       |
| Door boys, .....           | 1                    | 1.1       | English, .....   | 12                   | 12.5      | By premature blasts, .....                              | 9                    | 9.5       |
| Stripping miners, .....    | 3                    | 3.1       | Welsh, .....     | 1                    | 1.1       | By miscellaneous causes, .....                          | 11                   | 11.6      |
| Outside laborers, .....    | 13                   | 13.7      | Scottish, .....  | 1                    | 1.1       |   |                      |           |
| Outside drivers, .....     | 12                   | 12.5      | Swedish, .....   | 1                    | 1.1       |   |                      |           |
| Locomotive helpers, .....  | 12                   | 12.5      |                  |                      |           |   |                      |           |
| Oilers, .....              | 1                    | 1.1       |                  |                      |           |   |                      |           |
| Slate pickers, .....       | 4                    | 4.2       |                  |                      |           |   |                      |           |
| Totals, .....              | 95                   | 100.0     | Totals, .....    | 95                   | 100.0     | Totals, .....   | 95                   | 100.0     |

# SIXTH ANTHRACITE DISTRICT.

(SCHUYLKILL COUNTY.)

Shenandoah, Pa., March 25, 1895.

Hon. Isaac B. Brown,

Secretary of Internal Affairs:

Sir: As required by section ten of article two of the Act of June 2, 1891, I have the honor of herewith submitting to you my annual report as Inspector of Mines of the Sixth Anthracite District for the year 1894.

The usual tabulated forms are herein contained, giving the names and location of the collieries in the district, the number of tons of coal mined and shipped from each colliery, showing the total production and shipments in tons of 2,240 pounds during the year 1894.

The number of men employed at each description of service is also given, together with the number of fatal and non-fatal accidents, and the nationality of those killed or injured, as well as the number of wives made widows and children made orphans.

Yours very respectfully,

WILLIAM STEIN,  
Inspector of Mines.

## Examination of Applicants for Mine Foreman's Certificates.

The annual examination for mine foreman's certificates in Sixth district was held in Pottsville, July, 1894.

The examiners were William Stein, Mine Inspector; William H. Lewis, superintendent; Fred Hughes, miner, and William McGuire, miner.

The following are the names of the successful candidates: John C. McGinnes, Frackville; David Rennie, Shenandoah; Thomas Harlor, Mahanoy City; Silas Frost, Ellangowan; William Dowling, Ellangowan; Frank Kelly, Yatesville; Lawrence Keating, Gilberton; Edward Goldin, Mahanoy City, who were qualified as mine foremen. Frank Wilkin, Shenandoah; Morgan Bevan, Shenandoah, and Fred erick Weeks, qualified as assistant mine foremen.

I regret to have to report thirteen more fatal accidents than in 1893, but a perusal of the list of the accidents will be sufficient to satisfy those who understand mining that many of the deaths were the result of ignorance, carelessness or foolhardiness.

I am glad to be able to say that the collieries at present in operation are in very good condition, both as regards ventilation and general safety. The operators are very positive in their instructions to their officials to have the collieries well ventilated, well timbered and well drained, and where any danger exists, to cease work until the danger is averted. Notwithstanding we claim that every care is taken to protect the workmen in and about mines, there are those who would try to make the uninitiated believe that mine officials care not for the safety of their workmen.

I herewith assert, without fear of contradiction, that if our workmen would observe the law in the same manner as mine officials do, we would have very few accidents to record. I speak thus from practical experience, and not because I would uphold the assertions of either operator or mine official at the expense of the character of our employes. It is much to be regretted that men are sent to the halls of legislation from mining districts, who by their speech-making try to make their fellows believe that mine officials have only one object in view, and that is to make money, irrespective of safety to the workmen. Improvements have been made during the year at many of the collieries, with a view of still further increasing the safety of the workmen, and not because the law demands these improvements, which goes to show that the producers are desirous of protecting their workmen against any possible danger while going to and from their labor, as well as while at work. I have the opportunity and pleasure of often meeting at our collieries our best mining experts, who are always willing and ready to discuss any subject relative to mining operations which might have for its object the general welfare of the workmen. I notice in particular that Mr. John Veith, general mine superintendent of the Philadelphia and Reading Coal and Iron Company, has decided to drive tunnels through the rock measures from one vein to another twelve feet wide and seven and one-half feet high, instead of ten feet wide and seven and one-half feet high, which not only provides more passing room, but also offers less resistance to the air current while cars are being hauled in and out of the tunnel. Mr. Veith also gives peremptory instructions that where gas is given off to any extent, locked safety lamps must be used, but the workmen have given evidence of their disapproval of these orders to the extent that they will conceal their "miner's lamp" about their person and light them after reaching their places of work. Two lives were sacrificed during the year from this practice, and in order to prevent a repetition of an explosion from this cause, it was even deemed necessary by the mine foreman to search his men for naked lamps, and he took dozens from their persons. About five years ago I visited a colliery in my district; Mr. Veith happened to visit there also; the question of using safety lamps absolutely at this



colliery was talked over, and Mr. Veith gave instructions to the foreman not to allow the use of naked lamps. However, his instructions were violated during the year, which, I am sorry to say, caused the death of three men. More might be said with reference to the causes of fatal accidents in and about our mines, but to those who are practically informed a careful perusal of table 4 will exhibit a very marked carelessness on the part of some of the victims, and a lack of knowledge on the part of others.

**THE FOLLOWING IS THE NUMBER OF ACCIDENTS FATAL AND NON-FATAL AND THE NATIONALITIES OF THOSE KILLED AND INJURED.**

| Injured.                      | Fatal. | Non-Fatal. |
|-------------------------------|--------|------------|
| Americans, . . . . .          | 8      | 10         |
| English, . . . . .            | 7      | 2          |
| Irish, . . . . .              | 19     | 15         |
| Welsh, . . . . .              | 3      | 4          |
| Scotch, . . . . .             | 4      | 4          |
| Germans, . . . . .            | 4      | 2          |
| Poles, . . . . .              | 22     | 45         |
| Hungarians, . . . . .         | 7      | 9          |
| Italians, . . . . .           | 2      | 4          |
| Austrians, . . . . .          | 1      | 2          |
| Totals, . . . . .             | 73     | 94         |
|                               |        |            |
| Trifling accidents, . . . . . |        | 42         |
| Wives left widows, . . . . .  |        | 47         |
| Orphans, . . . . .            |        | 176        |

**TABLE A—Showing Comparative Statements of Fatal Casualties for the Years 1893 and 1894.**

|   | Years. |      |
|---|--------|------|
|   | 1893   | 1894 |
| Explosions of fire damp, . . . . .                  | 1      | 12   |
| Explosions of blasting material, . . . . .          | 3      | 2    |
| Premature explosions, . . . . .                     | 1      | 3    |
| Falls of coal and roof, . . . . .                   | 27     | 23   |
| Crushed by mine cars, . . . . .                     | 14     | 7    |
| Falling down shafts and slopes, . . . . .           | 2      | 2    |
| By coal flying from shots, . . . . .                | 1      | 1    |
| By machinery on surface, . . . . .                  | 4      | 4    |
| Boiler explosions, . . . . .                        | 2      | 4    |
| Suffocated by gas generated by mine fire, . . . . . | 2      | 2    |
| Miscellaneous, . . . . .                            | 5      | 13   |
| Totals, . . . . .                                   | 60     | 73   |

NUMBER OF FATAL ACCIDENTS AND QUANTITY OF COAL PRODUCED PER  
LIFE LOST.

|   | Number of fatal<br>accidents. | Tons of coal pro-<br>duced per fatal<br>accident. |
|---|-------------------------------|---|
| Philadelphia and Reading Coal and Iron Company, . . . . . | 39                            | 92,800  |
| Lehigh Valley Coal Company, . . . . .                     | 9                             | 60,616½   |
| Lehigh and Wilkes-Barre Coal Company, . . . . .           | 7                             | 76,651  |
| Leutz, Lilly & Co., . . . . .                             | 3                             | 75,850  |
| Silverbrook Coal Company, . . . . .                       | 3                             | 81,500  |
| Mill Creek Coal Company, . . . . .                        | 1                             | 283,427   |
| William Penn Coal Co., . . . . .                          | 5                             | 57,392  |
| Coxe Brothers, . . . . .                                  | 2                             | 111,694½  |
| Individual operators, . . . . .                           | 4                             | 92,994  |

TABLE B—Showing Comparative Statement of Non-Fatal Casualties  
for the Years 1893 and 1894.

|  | Years. |      |
|--|--------|------|
|  | 1893   | 1894 |
| Explosions of fire damp, . . . . .         | 28     | 22   |
| Explosions of blasting material, . . . . . | 8      | 1    |
| Premature explosions, . . . . .            | 10     | 8    |
| Falls of coal and roof, . . . . .          | 36     | 23   |
| Crushed by mine cars, . . . . .            | 28     | 20   |
| Falling down shafts and slopes, . . . . .  | 25     | 2    |
| By coal flying from shots, . . . . .       | 1      | 2    |
| By machinery on surface, . . . . .         | 8      | 2    |
| Boiler explosions, . . . . .               | 20     | 1    |
| Miscellaneous, . . . . .                   | 20     | 13   |
| Totals, . . . . .                          | 167    | 94   |

TABLE C—Showing the Quantity of Coal Produced and Shipped During  
the Years 1893 and 1894.

|  | Years.    |           |
|--|-----------|-----------|
|  | 1893      | 1894      |
| Quantity of coal produced in tons of 2,240 lbs., . . . . . | 6,674,807 | 6,340,631 |
| Quantity of coal shipped in tons of 2,240 lbs., . . . . .  | 6,252,493 | 5,888,300 |

TABLE D.—*Comparisons between the years 1893 and 1894.*

|   | Years   |        |
|---|---------|--------|
|   | 1893    | 1894   |
| Number of persons employed, . . . . .                               | 21,872  | 20,109 |
| Tons of coal produced per life lost, . . . . .                      | 111,247 | 86,847 |
| Number of tons of coal produced per each personal injury, . . . . . | 40,826  | 37,963 |
| Ratio of employes per life lost, . . . . .                          | 365     | 274+   |
| Average number of tons of coal produced per employe, . . . . .      | 305     | 315+   |
| Ratio of employes per each personal injury, . . . . .               | 157     | 119+   |

TABLE E.—*Taking the death rate per thousand as a basis of comparison between the different companies and individual operators, we have the following ratio for the year.*

|   | Number of employes. | Number of deaths. | Death rate per thousand. |
|---|---------------------|-------------------|--------------------------|
| Philadelphia and Reading Coal and Iron Company, . . . . . | 11,707              | 39                | 3                        |
| Lehigh Valley Coal Company, . . . . .                     | 1,515               | 9                 | 5+                       |
| Lehigh and Wilkes-Barre Coal Company, . . . . .           | 1,780               | 7                 | 4-                       |
| Lentz, Lilly and Company, . . . . .                       | 1,081               | 3                 | 3-                       |
| Silverbrook Coal Company, . . . . .                       | 573                 | 3                 | 5+                       |
| Mill Creek Coal Company, . . . . .                        | 702                 | 1                 | 1-                       |
| William Penn Coal Company, . . . . .                      | 622                 | 5                 | 8+                       |
| Coxe Brothers, . . . . .                                  | 812                 | 2                 | 2-                       |
| Individual operators, . . . . .                           | 1,317               | 4                 | 3+                       |

COMPARATIVE STATEMENT OF FATAL AND NON-FATAL CASUALTIES AND  
THEIR CAUSES FOR FIVE YEARS.

| Casualties.   | 1890 | 1891 | 1892 | 1893 | 1894 | Total<br>for five<br>years. |
|---|------|------|------|------|------|-----------------------------|
| <i>Fatal.</i>                                       |      |      |      |      |      |                             |
| Explosions of fire damp, . . . . .                  | 3    | 4    | 7    | 1    | 12   |                             |
| Explosions of blasting material, . . . . .          | 1    | 3    |      | 3    | 2    |                             |
| Premature explosions, . . . . .                     | 2    | 6    | 4    | 1    | 3    |                             |
| Falls of coal and roof, . . . . .                   | 22   | 28   | 21   | 27   | 23   |                             |
| Crushed by mine cars, . . . . .                     | 14   | 7    | 9    | 14   | 7    |                             |
| Falling down shafts and slopes, . . . . .           | 6    | 3    |      | 2    | 2    |                             |
| By coal flying from shots, . . . . .                | 2    | 1    |      | 1    | 1    |                             |
| By machinery on surface, . . . . .                  | 2    | 2    | 2    | 4    | 4    |                             |
| Boiler explosions, . . . . .                        | 2    |      |      | 2    | 4    |                             |
| Suffocated by gas generated by mine fire, . . . . . |      |      |      |      | 2    |                             |
| Miscellaneous, . . . . .                            | 12   | 12   | 11   | 5    | 13   |                             |
| Totals of the respective years, . . . . .           | 66   | 66   | 54   | 60   | 73   | 319                         |
| <i>Non-Fatal.</i>                                   |      |      |      |      |      |                             |
| Explosions of fire damp, . . . . .                  | 18   | 10   | 31   | 28   | 22   |                             |
| Explosions of blasting material, . . . . .          | 4    | 5    |      | 8    | 1    |                             |
| Premature explosions, . . . . .                     | 2    | 5    | 4    | 10   | 8    |                             |
| Falls of coal and roof, . . . . .                   | 38   | 31   | 32   | 36   | 23   |                             |
| Crushed by mine cars, . . . . .                     | 12   | 18   | 17   | 28   | 20   |                             |
| Falling down shafts and slopes, . . . . .           |      |      |      |      | 2    |                             |
| By coal flying from shots, . . . . .                | 1    | 3    | 3    | 1    | 2    |                             |
| By machinery on surface, . . . . .                  |      | 2    | 2    | 8    | 2    |                             |
| Boiler explosions, . . . . .                        |      |      |      |      | 1    |                             |
| Miscellaneous, . . . . .                            | 22   | 18   | 23   | 20   | 13   |                             |
| Totals for the respective years, . . . . .          | 97   | 92   | 112  | 139  | 94   | 534                         |

| Years.             | Killed. | Injured. | Total. | Total number of employees. | Number of employees to each casualty. | Number of tons of fatal casualty. | Number of tons of non-fatal casualty. | Ratio of tons of coal to each casualty. | Number of tons of coal mined to each employe. | Total number of tons of coal mined. |
|--------------------|---------|----------|--------|----------------------------|---------------------------------------|-----------------------------------|---------------------------------------|---|---|-------------------------------------|
| 1800, . . . . .    | 66      | 97       | 163    | 19,289                     | 118                                   | 94,491                            | 64,293                                | 38,290                                  | 322   | 6,236,554                           |
| 1891, . . . . .    | 66      | 92       | 158    | 19,427                     | 123                                   | 96,747                            | 69,775                                | 40,628                                  | 329   | 6,419,302                           |
| 1892, . . . . .    | 54      | 122      | 176    | 20,414                     | 116                                   | 118,491                           | 52,313                                | 36,263                                  | 312   | 6,382,346                           |
| 1893, . . . . .    | 60      | 139      | 199    | 21,974                     | 110                                   | 110,597                           | 47,737                                | 38,345                                  | 302   | 6,674,807                           |
| 1894, . . . . .    | 73      | 94       | 167    | 20,169                     | 120                                   | 86,847                            | 67,445                                | 37,963                                  | 305   | 6,339,831                           |
| Totals, . . . . .  | 319     | 544      | 863    | 101,213                    | 587                                   | 507,173                           | 301,563                               | 191,459                                 | 1,271   | 32,052,840                          |
| Average, . . . . . | 63+     | 108+     | 172+   | 20,242+                    | 117+                                  | 101,484+                          | 60,312+                               | 38,291                                  | 256   | 6,410,568                           |

Total number of persons employed inside and outside and their description of service:

Inside.

|                              |       |        |
|------------------------------|-------|--------|
| Inside foreman,.....         | 158   |        |
| Miners, .....                | 4,405 |        |
| Miners' laborers, .....      | 2,459 |        |
| All other company men, ..... | 3,145 |        |
| Drivers and runners, .....   | 807   |        |
| Door boys and helpers, ..... | 253   |        |
|                              | <hr/> |        |
| Total inside, .....          |       | 11,227 |

Outside.

|                                   |       |             |
|-----------------------------------|-------|-------------|
| Outside foreman, .....            | 73    |             |
| Blacksmiths and carpenters, ..... | 378   |             |
| Engineers and firemen, .....      | 756   |             |
| Slate pickers, .....              | 4,582 |             |
| All other company men, .....      | 2,990 |             |
| Superintendents and clerks, ..... | 103   |             |
|                                   | <hr/> |             |
| Total outside, .....              |       | 8,882       |
|                                   |       | <hr/>       |
| Total inside and out, .....       |       | 20,109      |
|                                   |       | <hr/> <hr/> |

Average number of days worked by the various coal companies in this district:

|   |             |
|---|-------------|
| Philadelphia and Reading Coal and Iron Company, | 169         |
| Lehigh Valley Coal Company, .....               | 144.7       |
| Lehigh and Wilkes-Barre Coal Company, .....     | 249.8       |
| Lentz, Lilly and Company, .....                 | 115.9       |
| Silverbrook Coal Company, .....                 | 186         |
| Mill Creek Coal Company, .....                  | 158.8       |
| William Penn Coal Company, .....                | 256½        |
| Coxe Brothers, .....                            | 225         |
| Individual firms, .....                         | 176.3       |
|   | <hr/>       |
| Number of pounds of dynamite used, .....        | 323,148     |
| Number of kegs of powder used, .....            | 154,402     |
| Number of steam boilers in use, .....           | 1,284       |
| Number of horses and mules in use, .....        | 1,962       |
|   | <hr/> <hr/> |

### Hempel's Apparatus for Quick Determination of Gases.

Among the many difficulties presenting themselves in subduing an underground mine fire, none are more dreaded than that of the gases generated by the fire. Among these are carbonic oxide (white damp) and carbonic acid gas (black damp), both of which are poisonous.

Continued breathing of an atmosphere heavily charged with either, will cause death in a short time, while a relatively small percentage of either will cause violent illness, with severe pains.

In an atmosphere containing 0.98 per cent. of carbonic oxide and 0.01 per cent. of carbonic acid, men are unable to work; neither are they able to work in an atmosphere containing 0.32 per cent. of carbonic oxide and 3.77 per cent. of carbonic acid gas. Continued breathing of an atmosphere containing 0.48 per cent. of carbonic oxide and 1.13 per cent. of carbonic acid gas has caused severe sickness. The carbonic oxide is the more dangerous, since it is odorless and tasteless.

At the Packer colliery fire in May last, the apparatus described below gave excellent satisfaction.

It is easily manipulated, thoroughly reliable and quite inexpensive. Richard L. Ogden, A. C., prepared for the Lehigh Valley Coal Company the description and directions for using the apparatus which are here given. The drawings from which the cuts, Figs. I and II, were made, were prepared in the office of Mr. F. E. Zerby, division engineer of the company.

The apparatus used for making determinations of quantity of carbonic acid gas (CO<sub>2</sub>) or black damp, consists of a Hempel-Winkler gas burette and a Hempel simple absorption pipette (Fig. 1).

The gas burette comprises two glass tubes, A and B, of which A is a levelling tube and B a measuring tube of 100 c.c. capacity and graduated to fifths, with stop cocks D and E. The tubes A and B are connected by rubber tubing C, which should be about three and one-half feet long. The pipette consists of glass bulbs G and H and capillary tube M. The connection to burette is made by capillary F, and rubber tubing I and J.

To prepare pipette: Fill bulb G with short rolls of wire gauze of about 1-12 or 1-15 inch mesh. These should be about 1-4-inch in diameter and 3-4-inch long. The absorbent is a solution of one part commercial caustic potash and two parts water. Introduce sufficient of the solution to fill bulb G and capillary M, leaving bulb H entirely empty.

Method of analysis: Disconnect burette from pipette by detaching rubber tubing J. Open stop-cocks D and E. Pour water into levelling tube A until tubes A and B are about half full of water. Raise tube A until B is full of water, and close

stop-cock D; connect gas bag to burette by rubber tubing, taking care to expel air from tubing by passing gas through it before connecting with burette. Open stop-cock D, lower tube A, and after running about 100 c.c. of gas into burette close stop-cock D. Allow three minutes for water to run down walls of burette, then raise or lower, as may be required, tube B, until the water in A and B are at the same level, when gas in burette will be at atmospheric pressure. Note volume of gas in burette reading from the bottom of meniscus, connect pipette to burette by rubber tube I', first filling capillaries M and F, and tubing I and I' with the absorbant by blowing at K, avoiding air bubbles in capillaries, as far as possible. By using a pinch-cock for rubber tube I' when disconnected, capillaries can be kept filled with solution.

Now open stop-cock D, levelling lute A forcing gas over into pipette until water in burette has reached S, then close stop-cock D. The gas is now in contact with the solution and the absorption of the carbonic acid gas will be almost instantaneous. After one minute open stop-cock D, lower lute A and run gas back into burette until the solution has reached rubber lute I', close stop-cock D, allow three minutes for water to run down, bring water in A and B to same level again and read as before. The difference in the two readings will express the amount of carbonic acid gas absorbed, from which calculate the percentage.

Example: Say, reading before passing the gas into pipette is 92.4 c.c. and after running back into burette 84.2 c.c., showing a difference of 8.2 c.c., then  $8.2 \div 92.4$  equals the percentage of gas lost by absorption, showing 8.874 per cent. of carbonic acid gas in the sample.

A single filling of the pipette will safely absorb 6,000 c.c. of carbonic acid gas.

If the gas to be analyzed contains a large percentage of carbonic acid gas, it will add to the accuracy of the results, if the water to be used in the burette is first saturated with the gas. This can be done by filling a suitable flask about half full of water and passing a stream of the gas through it for some time. If, however, repeated analyses of about the same gases are to be made, the water will soon become saturated without this precaution.

In Fig. 11 is shown Hempel's double absorption pipette for the determination of oxygen (O) and carbonic oxide (co) or white damp. To prepare pipette: Pour water through M until it reaches G. Insert a thin glass tube about 40 inches long in rubber connection at L and fasten a small funnel to upper end of tube by means of a piece of rubber tubing. Upon pouring the re-agent into funnel the pressure given it by the long glass tube enables it to quickly pass through the capillary K into bulbs A and B. When bulb B is about two-thirds full of the re-agent, close the rubber connection at L with a pinch-



cock and detach glass tube. Pour water through M until bulb D is about two-thirds full, then shake pipette vigorously for some time to remove all gases absorbable by the re-agent. Connect glass tube again, open pinch-cock and admit enough of the re-agent to fill bulb B. Fill bulb D with water, detach glass tube and allow re-agent to pass from B to A. Connect glass tube again and admit enough re-agent to about half fill the bulb B. Detach glass tube as before and allow re-agent to pass from B to A again. The pipette is now ready for use. If the work has been properly done, tubes K and E and bulb A are filled with the absorbent, the space from B to F with a gas free from oxygen, C and G with water and D with air.\*\*\*\*

It is not essential, however, that the bulbs and tubes should be filled in exactly these proportions, the object being to protect the absorbent from the action of the oxygen in the atmosphere through M.

Absorbent for oxygen: Dissolve 10 grains pyrogallic acid ( $C_6H_6O_3$ ) in 30 c.c. of water, to this add 240 grains of commercial caustic potash (KOH) dissolved in 160 c.c. of water. A single filling of the pipette will safely absorb 400 c.c. of oxygen. Absorbent for carbonic oxide (CO) or white-damp: Dissolve cuprous chloride ( $Cu_2Cl_2$ ) in concentrated hydro-chloride acid (HCl). A single filling of the pipette will safely absorb 700 c.c. of CO. Method of analysis: Same as that given for carbonic acid gas, with this exception, after the gas has been run over from burette to pipette, close pipette securely at N with a pinch cock, detach from burette and shake vigorously for 3 minutes, when the absorption of oxygen or carbonic oxide, as the case may be, will be complete. Connect burette again at N and proceed as directed for carbonic acid gas. A separate pipette is used for each absorbent and the gases should be removed in the following order: Carbonic acid gas, oxygen and carbonic oxide, as the absorbents for both oxygen and carbonic oxide slowly absorb carbonic acid gas, and the absorbent for carbonic oxide slowly absorbs oxygen. Mr. Ogden recommends that the following precautions be taken: (1) All rubber connections be made air-tight. (2) Frequent tests of connections. (3) Do not allow samples of gases to remain long in rubber bag, as gases are rapidly absorbed by vulcanized rubber. (4) Use distilled water for burette where practicable. (5) All apparatus and liquids should be of the same temperature, i.e., that of the room. Avoid changes of temperature in room, as far as possible.

#### Packer No. 5 Colliery Fire.

On the night of April 30-May 1, a fire broke out in the Packer No. 5 colliery of the Lehigh Valley Coal Company near Lost Creek, threatening the destruction of the entire colliery. Its existence was discovered by the night shift men, who on attempting to make their way out in the regular way were met by volumes of smoke, obliging them to re-

treat and make their escape through the outlet in the Holmes vein at the western limit of the workings.

These men at once gave the alarm, notifying the bosses, who quickly organized an exploring party, which entered the mine and attempted to locate the seat of the fire. An examination revealed the fire burning on the West Mammoth slope level gangway somewhere between the tunnel from the seven-foot bed and "breast" No. 56 on this level. The density of the smoke and volumes of gas prevented a closer examination, as it was impossible until an additional supply of fresh air could be had to pass the points referred to.

Learning of the fire on the afternoon of May first, while making an inspection of the Lawrence colliery workings at Mahanoy plane, I at once set out for the colliery, which was reached at 4.15 P. M., where I met Colonel D. P. Brown, division superintendent for the Lehigh Valley Coal Company, with whom I had an interview, during which I learned that two Polish miners Scidor Pranzky and August Leopold had been engaged on the South dip No. 2 counter gangway re-opening it, and as they had been neither seen nor heard of since the fire broke out we surmised which proved correctly, that they were still in the mine.

My first move was to rescue these men alive, if possible, and failing in this, to recover their bodies, and for this purpose I organized a party of six men, picked out by Colonel Brown, with whom I at once proceeded to reach the No. 2 counter gangway through the water level gangway, leaving it at a point above "breast" No. 52 of the slope level. Upon reaching this point, it was found that the gases generated by the fire had filled up all the workings east and west of it, making further progress impossible. It further demonstrated that if the men were still in the counter gangway all hope of rescuing them alive was gone and that they were beyond human aid.

It was supposed by many that Pranzky and Leopold had made their escape and left the region, fearing a prosecution for firing the mine. This opinion, however, was shared neither by myself nor by the officials of the company, and the efforts to recover the bodies of the two men, as well as to extinguish the fire were carried on with all the skill, care and vigor that could be summoned up.

For a correct understanding of the nature of the work and its progress, a brief description of the colliery is necessary.

The Packer No. 5 colliery is situated between the village of Lost Creek and the town of Girardville; the coal beds are developed by a shaft 501 feet deep. Its dimensions are 45 feet long and 14 feet wide, divided into six compartments for hoisting, pumping and up-cast airway. About 4,000 feet east of the No. 5 shaft was situated what was known as the Packer No. 1 (Colorado) colliery; the coal mined at this colliery has, since the demolition of the No. 1 breaker, been brought

on the surface by a locomotive to the No. 5 breaker to be prepared for market. The underground workings of the No. 1 colliery may be considered tributary to that of No. 5 colliery, or in fact so closely identified with each other that they should be considered but one operation, as they really are.

Upon examination of the map accompanying this report it will be observed that the openings on the east consist of a double mouthed tunnel, together with three slopes sunk on the "Mammoth bed." At the bottom of the No. 5 shaft a tunnel has been driven southward to the Buck mountain bed. To comply with the mine law requiring a second outlet from the shaft level, an opening has been driven in the "Mammoth bed" from the shaft level connecting with the west level of No. 1 slope or (No. 1 Colorado). On the west end of the property a shaft has been sunk and a drift driven on the "Holmes bed." From these it will be seen that ample provision had been made in the way of escapement openings in case of accidents. A further examination of the map exhibits an anticlinal axis passing through the property giving to the coal beds a north and south dip, both of which are worked. The ventilating apparatus or fan erected on the top of shaft has a diameter of 20 feet with blades or vanes 6x6 feet; speed of fan ordinarily 90 revolutions per minute, producing 105,000 cubic feet of air per minute.

The points of intake being the crop-falls at Bear Ridge, the water level tunnel and the slopes and the colliery workings were furnished with a plentiful supply of fresh air, the course of the air current was generally speaking westward. A brick and cement wall divided the main tunnel, the west side being used as a transportation way, and the east side as the return airway to bottom of shaft.

The tidal elevations of the several important points are as follows:

|  |          |
|--|----------|
| Top of Packer No. 5 shaft, .....                       | 1,105.37 |
| Bottom of Packer No. 5 shaft, .....                    | 603.80   |
| Mouth of water level tunnel, .....                     | 1,170.39 |
| Top of No. 5 hoisting slope, .....                     | 1,290.39 |
| Bottom of No. 5 hoisting slope, .....                  | 943.53   |
| Top of counter chute (No. 59 $\frac{1}{2}$ ), .....    | 1,083.00 |
| Bottom of counter chute (No. 59 $\frac{1}{2}$ ), ..... | 945.00   |
| Water level gangway at turn, .....                     | 1,184.00 |
| No. 2 counter gangway at turn, .....                   | 1,085.00 |

Active operations, it will be seen, were carried on in four levels, namely, water level, counter gangway, slope level and the shaft level. Mining was also carried on in what is known as the seven-foot plane level from the shaft level.

At ten o'clock on the morning of the first of May a party succeeded in reaching a point about 15 feet east of the fire, which was found

burning in the counter chute driven between breasts Nos. 59 and 60 of the West Mammoth slope level gangway. The counter chute is 240 feet long, ten feet wide and seven feet high, and through it was passed all the coal mined from the "breasts" on the counter gangway. This chute was heavily timbered, and a quantity of cut coal remained in it, affording abundant material to feed a fire. The fire originated, as nearly as could be determined, near the bottom of the counter chute, and had its origin without a question of doubt from a lamp carried by the loader coming in contact with the dry timber in chute while going up to ascertain the quantity of coal he might have to load. The dry condition of the chute timbers added to the rapid progress of the fire, giving it such headway as to make it in the meantime impossible to approach or get in close proximity to it. The distance of the chute from the several openings is as follows: From the No. 5 slope 3,515 feet; from the mouth of the water level tunnel to the top of the chute 4,162 feet; from the bottom of No. 5 shaft 1,335 feet, and from the Holmes vein outlet 2,695 feet. A party attempted to construct a dam in the gangway near the fire to prevent if possible the spread of the fire eastward, but before much could be done in this direction the gases generated from the burning wood and coal compelled them to retreat and the attempt was abandoned.

The Mammoth bed at this point is 33 feet thick and is inclined at an angle of 35 degrees, and every effort was made to hold the fire in check and meanwhile a consultation was had with a view of deciding upon the best plan of action. To this were called a number of mining experts, and the conclusion reached was to fight the fire directly with hose and pipe. Flooding the entire mine and slushing the area covered by the fire were both suggested as methods, but for a number of reasons, the direct method was preferred and the wisdom which characterized the deliberations in concluding to carry out the method agreed upon demonstrated to the satisfaction of all concerned that it was the best. Immediately upon reaching this conclusion all material required was sent for and the most energetic efforts were put forth to subdue the fire. To reach the locality of the fire and be able to remain there and live was the first question to be decided. Some 300 feet west of the counter chute a tunnel had been driven from the seven-foot to the Mammoth bed. On this level and through it, a strong current of fresh air was passing and in order to make it possible to reach the counter chute from this side, a brattice partition was built in the gangway for some distance eastward, and the air-current from tunnel turned into and east on the gangway by means of canvas. The gases, however, became so strong in volume that it was necessary to build an air-tight box 6x6 feet, of two-inch plank

within the gangway eastward to a point near the bottom of the counter chute, which gave very satisfactory results.

Prior to the breaking out of the fire a 4-inch line of gas pipe had been laid from the pump at the bottom of No. 5 shaft through the air side of the tunnel with necessary connections to extend lateral pipes to any of the gangways on the shaft level, while the line extended up to the slope level and through the second outlet in the Mammoth bed. This pipe serves for conducting compressed air to the power drills when tunnels are being driven, while in case of fire it can be quickly connected to the pump and used to convey water. A second line of four-inch pipe was then laid from the pump at the foot of the No. 5 slope along the west gangway, but considerable difficulty was experienced before reaching the foot of counter chute on account of the gases from the fire having filled the openings east and north to the extent that it was dangerous to even approach westward. To clear away the gases (carbonic acid and carbonic oxide) a "brattice" was built in the centre of the "gangway" westward from the pillar between "breasts" Nos. 34 and 35, at the same time closing all the chutes as the work of building the brattice in the gangway advanced westward to the counter chute, which cleared away the gases and enabled the workmen to reach the fire. The "breast" openings north of the slope level were filled with carbonic oxide gas, and to prevent any possible danger to the workmen, it was decided to drain this gas off by means of wooden pipes one foot square inserted through the batteries in breasts Nos. 39 and 41 opened from No. 5 slope west level gangway, crossing overhead and connecting with "breasts" Nos. 14 and 16, opened from No. 5 shaft, east level gangway, and the gases were conducted direct to the shaft fan, a plan which gave excellent results. After these arrangements were completed the work of fighting the fire north of the counter chute was carried on very satisfactorily.

In order to head the fire off and prevent its passing around the end of the saddle on the counter gangway level, a line of four-inch pipe was laid along the water level gangway from the top of the column pipe of the slope pump. A No. 10 Knowles pump was also put in place at the mouth of the drift tunnel and connected with this line. The line left the water level "gangway" at a point above "breast" No. 52, passed down and across this, and into the next "breast" west and thence to the No. 2 counter gangway west to the locality of the fire. Connection was also made with the Girard Water Company's main at Rappahannock, the line coming down the Holmes vein shaft along the Holmes "gangway" and through the tunnel to the Mammoth bed, thence eastwardly to the locality of the fire. This gave four main lines which by means of connections were divided as desired. Valves were fitted to the play pipes at distances sufficiently far from the fire to

make it safe to turn on the water, the ends of the play pipes were always fastened, hence none of the men were required to be near the fire while the water was playing on it, in fact, no one could have remained at these points and lived.

To properly get at the fire the gangway on either side of the chute had to be cleared of the fallen coal and slate as quickly as it cooled. The removal of this material was attended with much danger, since its place was taken by rushes of burning coal from the chute. When a sufficient quantity had been removed and the fire on the gangway extinguished, that in the chute was vigorously attacked and timbering begun to prevent further falls of top. The repeated rushes of live coal down the chute from the head made work there extremely hazardous, and in order to furnish a safe retreat a "manway" was driven along the east "rib" of breast No. 60 through "gob," which was used as a traveling way; entrance to the chute being had through the headings already driven in the pillars between.

Great care had to be exercised in drawing the coal from the chute since the heat had affected the pillars between it and breast No. 60 to such an extent that scaling off had begun. As will be observed by a study of the map, the success of the undertaking depended in cutting off the fire from the head of the chute and preventing it from extending east or west from this point. To attain this object a most vigorous attack was made from above on the counter gangway, which was found to be closed by a mass of burning material which had fallen from the top and sides for a distance of 100 feet east of the chute. The removal of this material, after cooling, required considerable time, as the opening was small in area, which necessitated the use of hand barrows.

The material, after being cooled, was wheeled back and dumped into an old breast opened from the slope level, and as quickly as it was removed and the fire extinguished for some distance, timber was put in place to prevent further falls. As might have been expected, the volume of gas generated by so large a body of burning coal was very great and the heat intense. The quantity of air passing along the water level gangway was owing to the falls, etc., (the main fan being on the opposite side) found to be inadequate, and to remedy this, it was decided to erect a 16-foot forcing fan at the mouth of the water level tunnel. This work was assigned to Mr. George H. Tench, general outside foreman of the York Farm and Blackwood collieries of the same company. The entire work, including the setting of the engine and fan, and making the steam connections was performed in the remarkably short period of eleven and one-half hours, the several parts being entirely dismantled upon their arrival at the mine.

This fan furnished a plentiful supply of air to the counter gangway, but owing to the fact that the currents met, namely that passing

westward along the west slope level gangway, which had by means of a door been turned up breast No. 58 to the counter gangway and the current from the forcing fan on the counter gangway, some difficulty was experienced in regulating them so as to keep both sections of men at work. A severe rain storm set in on the nineteenth of May, continuing for four days. During this time a dam on the shaft level was built to hold the water back and prevent the pump at bottom of shaft being submerged and also the upcast to fan being cut off, but the pressure of water on the dam proved to be more than it could sustain and consequently it broke away, cutting off the exhaust fan as well as drowning the pump. The air-current being cut off, safety had to be sought upon the surface. To recover the pumps at the foot of the shaft, tanks holding 1,500 gallons each were constructed on the cages, and the water was hoisted to surface by this means. As the period of time to clear the shaft workings was problematical, it was decided to erect a 16-foot exhaust fan at the top of the Holmes vein shaft, a spur track was laid from the Lehigh Valley Railroad and a locomotive run upon it to furnish steam to this fan. The nearest steam boilers already erected were a half mile distant from this point. This work was accomplished in 12 hours. After the water had been hoisted from the shaft workings the main fan was again put in operation. Near the head and east of the counter chute will be noticed a triangular block of coal which supported a large area of roof. The probable condition of this when reached, whether still standing or not, gave the officials much concern, for upon its condition much depended. Fortunately it was found intact. A point where it was expected would, and subsequently did give much trouble, was the bottle-shaped breast, the last one on the north dip of the counter gangway, which was without any heading or connection to the other breasts. The fire had worked its way up this about one-half the distance to the face. As rapidly as the burning coal from it was cooled and removed its place was taken by more of the same material. Attempts to drive a pipe through the gob here were not successful, and it was not until a manway had been driven through that much progress against it could be made. It was proposed to drive headings to it from the breast east of it, and through these play a stream upon the fire, and failing in this, to build a dam or dams were suggested so as to flood it. The fire extended to all the headings and gangways in the vicinity which were followed up and the fire in each extinguished. On May 9th the gob in breast No. 60 was discovered to be on fire by reason of the excessive heat coming therefrom, but on account of the gases existing, entrance to this breast was impossible. Pipes, however, were put through the headings and water played on the fire until it was extinguished.

After it was supposed that the fire on the counter gangway had

been extinguished it again broke out and burned fiercely over the new timbering. Streams were directed upon this, but without much effect until draw holes were made and the burning coal drawn down through them. To protect the men from being burned by the hot water falling down on them, a canvas was stretched along the collars of the counter gangway timbers. It being difficult to keep a current of air up to the face of the burning mass, a second canvas was placed one foot below the other. Connection was made with the counter chute and the space between the canvasses served as a return airway. This assisted very much in keeping a good supply of fresh air forward to the men when needed. What fire remained was followed up and extinguished and by July 9th the fire was entirely out. On June 14th the bodies of Franzy and Leopold were recovered by a party under the leadership of Colonel Brown. They were found at the point marked O on the map. Evidences were plenty to point to the fact that they had made no effort to escape, but on the contrary they built a battery to ward off the poisonous gases and seemingly lay down to await the arrival of a rescuing party. Had they attempted to escape, it would at the outset have been possible for them to have passed down breast No. 99 of the south dip slope level gangway, and through this opening gotten out safely. Attempted rescue by this avenue was made useless, after some time had elapsed, owing to the gasses generated from the fire having filled these passages.

Although seventy days' hard work were required to extinguish the fire and the work often attended with great danger from falls, explosions and sickness incurred by the presence of noxious gases, it is almost marvellous that the extinguishing of the fire was accomplished with the loss of but a single life, Mr. George Fishburn, inside foreman of Blackwood colliery, who with other bosses of the company, had been summoned to assist in the work. At about 3 o'clock on the morning of May 19, Mr. Fishburn, who was in charge of the party fighting the fire on the counter gangway, mounted a fall and attempted to change the direction of the nozzle playing into the heading leading into breast No. 61, and while so engaged a piece of coal weighing about 75 pounds fell, striking him on the right side between neck and shoulder. His position at the time was such that the ribs of the left side were broken which penetrated the lung. Mr. Fishburn died before he could be removed to the surface. His death caused universal sorrow, for he was a man of excellent judgment, cool and brave in the face of danger, and his daily intercourse with his men, both here and at Blackwood, he won their esteem. During the time of extinguishing the fire, samples of the surrounding atmosphere were taken from the mine in rubber bags frequently during each day and tested by the "Shaw gas tester," and the "Hempler absorption apparatus," in order to determine exactly the character of



the gases mixing with the air, and to prevent loss of life from the breathing of the noxious gases. The former of these has already been described in these reports. A description and directions for using the latter are included elsewhere in this report. The fact that these instruments were in constant use, increased the confidence of the workmen and assured them that the officials were using every means to protect them against the dangerous gases generated from the fire.

In view of the possibility of danger in setting fire to the timber in dry places, such as this counter chute was, I would suggest that men working in them be obliged to use the Clanay safety lamp and not naked lamps, notwithstanding what the workmen may think to the contrary. During a period of about ten years I have been called upon to assist in extinguishing 17 mine fires. Twelve of these originated from a miner's lamp coming inadvertently in contact with dry timber; the other five originated from a blast igniting the gas.

In extinguishing this mine fire, too much credit cannot be given to Mr. W. A. Lathrop, general superintendent of the Lehigh Valley Coal Company, who was present most of the time personally directing the work. His faith in the successful extinguishing of the fire never wavered, while his presence with his men, sometimes for a whole day, and occasionally a whole night in the mine added greatly to encourage them, while Colonel D. P. Brown, division superintendent, was almost constantly with one or the other of the working parties, as was also Mr. Frederick E. Zerby, division engineer at the time, but now superintendent and engineer of the Hazleton division of the company.

The mine foremen called from the several collieries of the company to assist in the work were Messrs. Price, Heaton, Jones and Irvin, of the Packer collieries, and Messrs. Leckie and Fishburn, of the York Farm and Blackwood collieries. Mr. McKeone being the foreman of the colliery which was on fire. Mr. John J. Williams, inspector for the company, was also summoned to aid in the work. All exhibited excellent judgment and bravery in carrying out the work assigned to them.

Major Heber S. Thompson, superintendent and engineer of the Girard estate, upon whose lands Packer No. 5 colliery is opened, was almost a daily visitor until the fire was extinguished. Also Mr. John B. Granger, mine inspector for the Girard estate. Both of these gentlemen having had much experience with mine fires, the benefit of their excellent judgment was freely given and their suggestions from time to time were of much value.

There is no doubt but that the extinguishing of this fire by the methods used as described in this report, taking into consideration the proportions it had reached in such a short time, and its relative

proximity to other openings, makes it the greatest success in the history of mine fires in the anthracite region, for had the mine been flooded, the bodies of the two unfortunate imprisoned miners would have been consumed and valuable coal property would in all probability have been completely destroyed, before enough of water could have been run into the colliery to have submerged it to water level.

TABLE NO. 1.—Showing location, &c., of collieries in the Sixth Anthracite District for the year ending December 31, 1894.

| Name of colliery.         | Name of operator.                           | Location—Schuylkill county. | Name of superintendent.   | Postoffice address.             |
|---------------------------|---|-----------------------------|---------------------------|---------------------------------|
| Boston Run, .....         | Philadelphia and Reading Coal and Iron Co.  | St. Nicholas, .....         | John Velth, .....         | Pottsville, Schuylkill county.  |
| Bear Run, .....           | do.   | do.                         | do.                       | do.                             |
| Eliangowan, .....         | do.   | Maple Dale, .....           | do.                       | do.                             |
| Elmwood, .....            | do.   | Mahanoj City, .....         | do.                       | do.                             |
| Girard, .....             | do.   | Girardville, .....          | do.                       | do.                             |
| Girard Mammoth, .....     | do.   | Raven Run, .....            | do.                       | do.                             |
| Gilberton, .....          | do.   | Gilberton, .....            | do.                       | do.                             |
| Hammond, .....            | do.   | Girardville, .....          | do.                       | do.                             |
| Indian Ridge, .....       | do.   | Shenandoah, .....           | do.                       | do.                             |
| Knickerbocker, .....      | do.   | Yatesville, .....           | do.                       | do.                             |
| Kohinor, .....            | do.   | Shenandoah, .....           | do.                       | do.                             |
| Mahanoj City, .....       | do.   | Mahanoj City, .....         | do.                       | do.                             |
| North Mahanoj, .....      | do.   | do.                         | do.                       | do.                             |
| St. Nicholas, .....       | do.   | St. Nicholas, .....         | do.                       | do.                             |
| Sufook, .....             | do.   | do.                         | do.                       | do.                             |
| Schuylkill, .....         | do.   | Mahanoj City, .....         | do.                       | do.                             |
| Shenandoah City, .....    | do.   | Shenandoah City, .....      | do.                       | do.                             |
| Turkey Run, .....         | do.   | do.                         | do.                       | do.                             |
| Tunnel Ridge, .....       | do.   | Mahanoj City, .....         | do.                       | do.                             |
| West Bear Ridge, .....    | do.   | Mahanoj Plane, .....        | do.                       | do.                             |
| East Bear Ridge, .....    | do.   | do.                         | do.                       | do.                             |
| Maple Hill, .....         | do.   | St. Nicholas, .....         | do.                       | do.                             |
| Draper, .....             | do.   | Gilberton, .....            | do.                       | do.                             |
| Mahanoj Jig House, .....  | do.   | Mahanoj City, .....         | do.                       | do.                             |
| Packer No. 2, .....       | Lehigh Valley Coal Company, .....           | Lost Creek, .....           | Col. D. P. Brown, .....   | Lost Creek, Schuylkill county.  |
| Packer No. 3, .....       | do.   | Brownsville, .....          | do.                       | do.                             |
| Packer No. 4, .....       | do.   | Lost Creek, .....           | do.                       | do.                             |
| Packer No. 5, .....       | do.   | Rappahannock, .....         | do.                       | do.                             |
| Honey Brook No. 1, .....  | Lehigh and Wilkes-Barre Coal Company, ..... | Audenberg, .....            | David R. Roberts, .....   | Audenberg, Schuylkill county.   |
| Honey Brook No. 5, .....  | do.   | do.                         | do.                       | do.                             |
| Park No. 2, .....         | Lentz Lilly & Co., .....                    | Park Place, .....           | Edward Reese, .....       | Centralia, Columbia county      |
| Springdale, .....         | do.   | do.                         | do.                       | do.                             |
| Silver Brook No. 1, ..... | Silver Brook Coal Company, .....            | Silver Brook, .....         | J. S. Wentz, .....        | Mauch Chunk, Carbon county.     |
| Silver Brook No. 2, ..... | do.   | do.                         | do.                       | do.                             |
| William Penn, .....       | Pennsylvania Coal Company, .....            | Shaft P. O., .....          | W. H. Lewis, .....        | Shaft P. O., Schuylkill county. |
| Back Mountain, .....      | Mill Creek Coal Company, .....              | Buck Mountain, .....        | T. D. Jones, .....        | Hazleton, Luzerne county.       |
| Vulcan, .....             | do.   | do.                         | do.                       | do.                             |
| Kehey's Run, .....        | Thomas Coal Company, .....                  | Shenandoah City, .....      | Thomas Baird, .....       | Shenandoah, Schuylkill county.  |
| Glendon, .....            | Delano Land Company, .....                  | Mahanoj City, .....         | William A. Lathrop, ..... | Wilkes-Barre P. O.              |
| Primrose, .....           | do.   | do.                         | do.                       | do.                             |
| Lawrence, .....           | Gilbert Coal Company, .....                 | Mahanoj Plane, .....        | Walter S. Shaefer, .....  | Pottsville, Schuylkill county.  |
| Cambridge, .....          | Cambridge Coal Company, .....               | Shenandoah City, .....      | John McGlimes, .....      | Frackville, Schuylkill county.  |
| Onelda, .....             | Coxe Bros., .....                           | Nelson City, .....          | F. Kudlich, .....         | Drifton, Luzerne county.        |
| Furnace, .....            | Seaman Bros. & Gerber, .....                | Gilberton, .....            | Mahlon Gerber, .....      | Tamaqua, Schuylkill county.     |



|                          |                 |           |           |        |        |       |       |         |       |       |         |
|--------------------------|-----------------|-----------|-----------|--------|--------|-------|-------|---------|-------|-------|---------|
| Springdale, .....        | do.             | 115,999   | 105,224   | 149,07 | 424    | 2     | 3     | 1,757   | 30    | 50    | 4,050   |
| Silverbrook No. 1, ..... | Silverbrook,    | 75,000    | 68,085    | 171,05 | 205    | 2     | 1     | 1,194   | 28    | 30    | 2,684   |
| Silverbrook No. 2, ..... | do.             | 169,504   | 154,051   | 200,08 | 205    | 1     | 1     | 2,590   | 8     | 30    | 7,168   |
| William Penn, .....      | Shaft,          | 286,564   | 264,441   | 258,05 | 622    | 5     | 1     | 5,625   | 60    | 64    | 8,000   |
| Onella, .....            | Nelson City,    | 222,389   | 192,877   | 225    | 812    | 2     | 4     | 5,426   | 51    | 73    | 8,844   |
| Kehley & Iron, .....     | Shenandoah,     | 401,992   | 379,967   | 258,25 | 270    | 2     | 2     | 3,275   | 24    | 32    | 5,820   |
| Buck Mountaith, .....    | Buck Mountaith, | 148,748   | 135,068   | 153,3  | 329    | 1     | 2     | 3,929   | 26    | 46    | 900     |
| Vulcan, .....            | do.             | 136,752   | 129,379   | 164,3  | 322    | 1     | 4     | 4,036   | 16    | 24    | 2,600   |
| Glendon, .....           | Mahany City,    | 34,065    | 27,227    | 97,03  | 202    | 1     | 1     | 540     | 24    | 26    | .....   |
| Primrose, .....          | do.             | 35,870    | 12,877    | 25,7   | 240    | 1     | 1     | 647     | 22    | 27    | .....   |
| Lawrence, .....          | Mahany Plane,   | 60,486    | 84,487    | 229,3  | 440    | 1     | 4     | 150     | 45    | 35    | 16,050  |
| Cambridge, .....         | Shenandoah,     | 21,082    | 13,624    | 189,7  | 82     | 1     | 1     | 770     | 3     | 5     | 500     |
| Furnace, .....           | Gilberton,      | 45,185    | 43,859    | 263    | 82     | 1     | 1     | 470     | 3     | 8     | 8,000   |
| Mahany Jig House, .....  | Mahany City,    | 48,702    | 48,762    | 250,7  | 106    | ..... | ..... | .....   | 17    | ..... | .....   |
| Yatesville Jig, .....    | Maple Pate,     | 60,305    | 60,305    | .....  | 50     | ..... | ..... | .....   | 6     | ..... | .....   |
| Stoddart washery, .....  | Gilberton,      | .....     | .....     | .....  | .....  | ..... | ..... | .....   | ..... | ..... | .....   |
| Totals, .....            | .....           | 6,340,631 | 5,888,309 | .....  | 20,109 | 73    | 94    | 154,402 | 1,776 | 1,962 | 323,148 |

TABLE No. 3.—Showing the number of employes at each colliery in the Sixth Anthracite District, during the year 1894.

| Names of Collieries. | Occupations of Persons Employed Inside. |         |                   |                  |                      |                        |               | Occupations of Persons Employed Outside. |                             |                        |                |                        |  |                |                                 |
|----------------------|---|---------|-------------------|------------------|----------------------|------------------------|---------------|--|-----------------------------|------------------------|----------------|------------------------|--|----------------|---------------------------------|
|                      | Inside foremen.                         | Miners. | Miners' laborers. | All company men. | Drivers and runners. | Door boys and helpers. | Total inside. | Outside foremen.                         | Blacksmiths and carpenters. | Engineers and firemen. | State pickers. | All other company men. | Superintendents, bookkeepers and clerks. | Total outside. | Grand total inside and outside. |
| Boston Run.          | 6                                       | 76      | 46                | 75               | 15                   | 1                      | 219           | 2  | 5                           | 17                     | 114            | 84                     | 2  | 224            | 443                             |
| Bear Run.            | 6                                       | 70      | 100               | 74               | 18                   | 2                      | 270           | 2  | 19                          | 4                      | 67             | 46                     | 3  | 130            | 400                             |
| Ellangowan.          | 9                                       | 178     | 150               | 82               | 37                   | 11                     | 467           | 2  | 4                           | 21                     | 207            | 97                     | 3  | 349            | 816                             |
| Elmwood.             | 4                                       | 74      | 26                | 55               | 14                   | 3                      | 176           | 1  | 4                           | 12                     | 82             | 41                     | 2  | 142            | 318                             |
| Grand.               | 4                                       | 28      | 18                | 49               | 12                   | 4                      | 116           | 1  | 5                           | 4                      | 82             | 52                     | 2  | 165            | 280                             |
| Grand Mainmoth.      | 2                                       | 41      | 12                | 42               | 9                    | 1                      | 107           | 1  | 6                           | 15                     | 63             | 44                     | 1  | 130            | 237                             |
| Gilberton.           | 6                                       | 109     | 55                | 106              | 8                    | 5                      | 289           | 2  | 8                           | 23                     | 119            | 85                     | 2  | 239            | 528                             |
| Hammond.             | 6                                       | 86      | 23                | 96               | 15                   | 8                      | 276           | 2  | 10                          | 21                     | 169            | 67                     | 2  | 214            | 448                             |
| Indian Ridge.        | 9                                       | 120     | 74                | 39               | 27                   | 7                      | 276           | 2  | 10                          | 22                     | 241            | 107                    | 2  | 384            | 640                             |
| Knickerbocker.       | 6                                       | 129     | 35                | 76               | 10                   | 6                      | 256           | 2  | 8                           | 23                     | 73             | 56                     | 2  | 164            | 453                             |
| Kohinoor.            | 5                                       | 154     | 50                | 46               | 28                   | 8                      | 289           | 2  | 6                           | 21                     | 105            | 41                     | 3  | 178            | 428                             |
| Mahanoy City.        | 3                                       | 108     | 49                | 59               | 23                   | 3                      | 250           | 2  | 6                           | 16                     | 132            | 91                     | 3  | 249            | 381                             |
| North Mahanoy.       | 7                                       | 169     | 106               | 72               | 32                   | 9                      | 332           | 1  | 8                           | 175                    | 84             | 71                     | 1  | 175            | 540                             |
| St. Nicholas.        | 4                                       | 61      | 29                | 52               | 13                   | 6                      | 165           | 2  | 8                           | 15                     | 126            | 92                     | 3  | 245            | 656                             |
| Suffolk.             | 5                                       | 169     | 117               | 95               | 17                   | 8                      | 411           | 2  | 4                           | 7                      | 178            | 116                    | 2  | 327            | 648                             |
| Schuykill.           | 4                                       | 96      | 39                | 56               | 17                   | 9                      | 221           | 1  | 4                           | 12                     | 137            | 37                     | 1  | 127            | 348                             |
| Shenandoah City.     | 5                                       | 150     | 58                | 82               | 24                   | 10                     | 329           | 2  | 6                           | 10                     | 197            | 116                    | 2  | 289            | 618                             |
| Turkey Run.          | 4                                       | 130     | 70                | 56               | 19                   | 12                     | 291           | 2  | 6                           | 10                     | 97             | 60                     | 1  | 176            | 467                             |
| Tunnel Ridge.        | 4                                       | 115     | 21                | 78               | 26                   | 11                     | 255           | 1  | 5                           | 12                     | 98             | 56                     | 2  | 174            | 429                             |
| West Bear Ridge.     | 8                                       | 114     | 87                | 157              | 30                   | 8                      | 404           | 2  | 12                          | 32                     | 175            | 129                    | 2  | 362            | 756                             |
| West Shenandoah.     | 4                                       | 100     | 46                | 42               | 14                   | 5                      | 210           | 2  | 6                           | 14                     | 67             | 59                     | 2  | 130            | 300                             |
| Maple Hill.          | 6                                       | 328     | 109               | 200              | 22                   | 16                     | 681           | 2  | 14                          | 21                     | 259            | 99                     | 2  | 398            | 1,093                           |
| Draper.              | 5                                       | 53      | 56                | 96               | 11                   | 5                      | 226           | 1  | 26                          | 29                     | 67             | 76                     | 3  | 197            | 423                             |
| Mahanoy Jiz House.   | 1                                       | 57      | 33                | 54               | 9                    | 4                      | 158           | 3  | 3                           | 5                      | 52             | 40                     | 3  | 106            | 266                             |
| Packet No. 1.        | 1                                       | 119     | 68                | 58               | 8                    | 1                      | 263           | 1  | 10                          | 13                     | 50             | 51                     | 2  | 198            | 461                             |
| Packet No. 2.        | 1                                       | 72      | 41                | 43               | 13                   | 4                      | 174           | 1  | 9                           | 15                     | 65             | 65                     | 2  | 157            | 331                             |
| Packet No. 3.        | 1                                       | 140     | 66                | 89               | 15                   | 1                      | 313           | 1  | 10                          | 15                     | 56             | 38                     | 1  | 121            | 434                             |
| Packet No. 4.        | 1                                       | 140     | 66                | 89               | 15                   | 1                      | 313           | 1  | 10                          | 15                     | 56             | 38                     | 1  | 121            | 434                             |
| Packet No. 5.        | 2                                       | 158     | 112               | 100              | 64                   | 11                     | 448           | 1  | 9                           | 23                     | 114            | 85                     | 2  | 235            | 683                             |
| Honey Brook No. 4.   | 2                                       | 158     | 112               | 100              | 64                   | 11                     | 448           | 1  | 9                           | 23                     | 114            | 85                     | 2  | 235            | 683                             |

|                           |       |       |       |       |       |       |   |    |    |     |     |       |     |       |
|---------------------------|-------|-------|-------|-------|-------|-------|---|----|----|-----|-----|-------|-----|-------|
| Honey Brook No. 5, .....  | 54    | 48    | 411   | 25    | 5     | 746   | 1 | 14 | 38 | 130 | 165 | 3     | 351 | 1,097 |
| Park No. 2, .....         | 163   | 128   | 71    | 51    | ..... | 427   | 1 | 11 | 21 | 140 | 59  | 4     | 235 | 657   |
| Springdale, .....         | 99    | 33    | 58    | 29    | 5     | 217   | 1 | 0  | 24 | 102 | 57  | 3     | 207 | 424   |
| Silver Brook No. 1, ..... | 42    | 13    | 31    | ..... | ..... | 51    | 2 | 3  | 10 | 70  | 54  | 5     | 344 | 293   |
| Silver Brook No. 2, ..... | 42    | 41    | 45    | 6     | ..... | 127   | 2 | 4  | 8  | 102 | 115 | ..... | 231 | 368   |
| William Penn, .....       | 146   | 132   | 63    | 95    | 16    | 276   | 2 | 16 | 16 | 15  | 30  | 6     | 246 | 622   |
| Buck Mountain, .....      | 139   | 41    | 19    | 21    | ..... | 215   | 1 | 8  | 17 | 84  | 45  | 4     | 158 | 399   |
| Vulcan, .....             | 102   | 54    | 11    | 12    | ..... | 153   | 1 | 8  | 17 | 83  | 37  | 4     | 160 | 353   |
| Kehley's Run, .....       | 70    | 52    | 10    | 10    | ..... | 153   | 1 | 6  | 10 | 40  | 25  | 2     | 120 | 270   |
| Glendon, .....            | 45    | 30    | 30    | 13    | 4     | 123   | 1 | 3  | 8  | 40  | 25  | 2     | 179 | 202   |
| Primrose, .....           | 70    | 16    | 26    | 8     | 8     | 120   | 1 | 5  | 8  | 45  | 25  | 2     | 110 | 240   |
| Lawrence, .....           | 95    | 72    | 76    | 20    | 14    | 279   | 1 | 2  | 29 | 65  | 25  | 2     | 121 | 440   |
| Cambridge, .....          | 26    | 15    | 7     | 4     | ..... | 53    | 2 | 2  | 9  | 12  | 16  | 2     | 29  | 82    |
| Onelda, .....             | 193   | 52    | 87    | 25    | 16    | 383   | 3 | 22 | 31 | 227 | 146 | 2     | 421 | 812   |
| Furnace, .....            | 22    | 16    | 7     | 3     | 2     | 51    | 1 | 3  | 4  | 15  | 8   | 1     | 322 | 583   |
| Mahanoy Jig house, .....  | ..... | ..... | ..... | ..... | ..... | ..... | 3 | 3  | 5  | 52  | 40  | 3     | 106 | ..... |

TABLE No. 4.—List of fatal accidents that occurred in the mines of the Sixth Anthracite District for the year ending December 31, 1894.

| Date of accident. | Name of Person Killed. | Age. | Married or single. | Number of orphans. | Name of colliery.   | Location—Schuylkill county. | Date of investigation. | Nature and cause of accident in brief.  |
|-------------------|------------------------|------|--------------------|--------------------|---------------------|-----------------------------|------------------------|---|
| Jan. 24,          | Richard Ellis,         | 55   | M.                 | 7                  | William Penn,       | Shaft P. Co.,               | Jan. 24,               | Killed while descending the shaft on cage; a piece of the guide became detached and fell on him.  |
| Feb. 12,          | Fred. Daum,            | 25   | S.                 | .....              | Indian Ridge,       | Shenandoah,                 | Feb. 12,               | Killed by being jammed between cars. He ran a loaded car from turnout to dumping car, which followed down on him.   |
| 29,               | John Kikofski,         | 30   | M.                 | 1                  | Indian Ridge,       | Shenandoah,                 | 29,                    | Fatally burned by an explosion of gas and died in hospital same day. He went into a breast which he had just finished, fallen and ignited the gas which had accumulated.  |
| March 2,          | Patrick McLaughlin,    | 21   | S.                 | .....              | Honeybrook No. 4,   | Anderson,                   | Mar. 3,                | Killed between cars and door frame. He sent the door boy out to see if he could roll out, and, instead of waiting for his return, drove out against the door, which was shut.   |
| 3,                | Bertolo Ravina,        | 28   | M.                 | 4                  | Oneida No. 1 slope, | Oneida,                     | 5,                     | Fatally injured and died same day; he was charging a hole and pushing back the dynamic with an inch gas pipe, when the charge exploded.   |
| 12,               | Anthony Horan,         | 52   | M.                 | 7                  | Boston Run,         | St. Nicholas,               | 14,                    | Killed while being hoisted up tender slope; the bell wire broke and coiled around his body, pulling him off the truck. From the evidence produced at the inquest it was quite apparent that some one at the bottom pulled the bell wire violently after the truck had ascended some distance up the slope, breaking the wire. |
| 15,               | Thomas Brennan,        | 32   | M.                 | 4                  | Lawrence,           | Mahanoy Plane,              | 16,                    | Killed by an explosion of gas supposed to have been caused by a shot firing the gas.  |



|           |                          |    |    |       |                                  |                      |           |   |
|-----------|--------------------------|----|----|-------|----------------------------------|----------------------|-----------|---|
| 20,       | William Dennis, .....    | 40 | M. | 1     | North Mahanoy, .....             | Mahanoy City, .....  | 21,       | Killed by being struck by pieces of the fly wheel which burst by his suddenly checking the speed of the engine, which was running at an unusual rate of speed.  |
| 29,       | Joseph Bruno, .....      | 22 | S. | ..... | Honeybrook No. 5, .....          | Audentried, .....    | 30,       | Killed by a fall of rock at No. 8 stripping.  |
| April 17, | George Schuing, .....    | 62 | M. | 4     | Kehley's Run, .....              | Shenandoah, .....    | April 17, | Fatally injured by coal rushing from loose coal in breast; died on the 18th.  |
| 25,       | William Ochobouns, ..... | 21 | S. | ..... | Bear Run, .....                  | St. Nicholas, .....  | 25,       | Fatally injured by what is known as the leg breaker of Mammoth vein; died same day.   |
| May 1,    | Seidor Prauzey, .....    | 26 | S. | ..... | Packer No. 5, No. 1 slope, ..... | Rappahannock, .....  | May 1,    | Suffocated by gas generated from a mine fire; bodies recovered on the 14th of June, 1884.   |
| May 1,    | August Loepel, .....     | 24 | S. | ..... | Packer No. 5, No. 1 slope, ..... | Rappahannock, .....  | May 1,    | Killed by a fall of coal while engaged placing a nozzle to run water on fire at top of counter No. 2, West Mammoth gangway; died a short time after the accident occurred.  |
| 19,       | George Fishburn, .....   | 38 | M. | 4     | Packer No. 5, No. 1 slope, ..... | Rappahannock, .....  | 19,       | Killed by an explosion of gas. He and his buddy had been down on gangway eating dinner, and went up their breast to again commence work, and found the gas rushing down the manways which ignited from Dulton's lamp. |
| 14,       | John Hartenstine, .....  | 35 | M. | 4     | Bear Ridge, .....                | Mahanoy Plane, ..... | 14,       | Fatally injured on the 14th by an explosion of gas; died in Miner's Hospital on the 28th.   |
| 14,       | John Stone, .....        | 42 | M. | 6     | William Penn, .....              | William Penn, .....  | 19,       | Fatally injured on the 14th by an explosion of gas and died on the 19th.  |
| 14,       | David Fisher, .....      | 48 | M. | 4     | William Penn, .....              | William Penn, .....  | 19,       | Fatally injured on the 14th by an explosion of gas; died on the 21st in Miners' Hospital.   |
| 14,       | Michael Reynolds, .....  | 38 | M. | 5     | William Penn, .....              | William Penn, .....  | June 12,  | Fatally injured by being crushed between cars and died from his injuries on the 18th. He was crossing the track between cars.   |
| June 12,  | James Fallon, .....      | 49 | M. | 6     | Ellangowan, .....                | Maple Lake, .....    | June 12,  | Killed by being caught in shearer pulley or rolls and elevators.  |
| 20,       | Thomas Kelly, .....      | 14 | S. | ..... | Bear Ridge, .....                | Mahanoy Plane, ..... | 20,       | Killed by being drawn off shaft cage while being hoisted to surface; his cans were caught in the shaft timber. The cage was up from bottom of shaft thirty-three feet.  |
| 22,       | John Podcavage, .....    | 26 | S. | ..... | Maple Hill, .....                | Maple Dale, .....    | 22,       | Killed by a fall of lony coal. The miner for whom he was working told his laborers to push a car out so that he could stand on it to bar loose coal down, and he allowed center to travel under the loose material.   |
| 22,       | Stimly Center, .....     | 34 | M. | 3     | Maple Hill, .....                | Maple Dale, .....    | 22,       |   |

TABLE NO. 4. — Continued.

| Date of accident. | Name of Person Killed. | Age.  | Married or single. | Number of orphans. | Name of colliery.      | Location—Schuylkill county. | Date of investigation. | Nature and cause of accident in brief.   |
|-------------------|------------------------|-------|--------------------|--------------------|------------------------|-----------------------------|------------------------|--|
| June 23,          | Peter Glesner, .....   | 55    | M.                 | ...                | Girard, .....          | Girardville, .....          | June 23,               | Killed by an explosion of gas at top of airway connecting the second lift with the first lift of Buck Mountain vein, where they were engaged in timbering.   |
| 23,               | George Clark, .....    | 35    | M.                 | 6                  | Girard, .....          | Girardville, .....          | 23,                    | Killed by an explosion of gas at the same place as Glesner lost his life.  |
| 26,               | Samuel Boll, .....     | ..... | M.                 | ...                | Bear Ridge, .....      | Mahanoy Plane, .....        | 26,                    | Fatally injured on the 26th and died on the 27th, by a fall of rock.   |
| 28,               | Thomas Carlin, .....   | ..... | M.                 | 6                  | Draper, .....          | Gilberton, .....            | 28,                    | Fatally injured on the 28th while he was trying to turn a set of timber around, which, in his opinion, was not properly stood by the night shift. The collar and leg swinging out against the collar caught his head between the two collars. He died in a few hours afterwards. |
| July 12,          | Dennis Head, .....     | 32    | M.                 | 5                  | Packer No. 5, .....    | Rappahannock, .....         | July 12,               | Killed by a fall of coal while skipping pillars in No. 4 breast. Holmes west gangway, second lift or counter.  |
| 13,               | John Downet, .....     | 34    | M.                 | 3                  | Knickerbocker, .....   | Yatesville, .....           | 13,                    | Killed by a fall of coal.  |
| 17,               | Christ, McManus, ..... | 22    | S.                 | ...                | Shenandoah City, ..... | Shenandoah, .....           | 17,                    | Killed by a collar falling on him; he was assisting in standing a set of timber when one of the legs shifted, causing the collar to fall on him.   |
| 25,               | George Daddow, .....   | 23    | S.                 | ...                | William Penn, .....    | William Penn, .....         | 25,                    | Killed between car and timber collar while riding up slope No. 1. He, with others, pushed a car in front of the Barney, but the Barney got under the car and Daddow jumped to ring the bell for the engineer to stop, when he was caught.  |
| 29,               | Darby Shields, .....   | 45    | M.                 | 6                  | Packer No. 4, .....    | Brownsville, .....          | 29,                    | Killed by a boiler explosion.  |
| 29,               | John Miller, .....     | 36    | M.                 | 3                  | Packer No. 4, .....    | Brownsville, .....          | 29,                    | Fatally injured and died on the 31 of August.  |
| 29,               | John Molingo, .....    | 27    | M.                 | 2                  | Packer No. 4, .....    | Brownsville, .....          | 29,                    | Fatally injured and died on the 31 of August.  |
| 29,               | John Lawback, .....    | 25    | S.                 | ...                | Packer No. 4, .....    | Brownsville, .....          | 29,                    | Fatally injured and died after being taken home.   |

|          |                           |       |    |                         |                      |          |  |
|----------|---------------------------|-------|----|-------------------------|----------------------|----------|--|
| 31,      | John Gillinskie, .....    | 30    | S. | Ellangowan, .....       | Maple Dale, .....    | 31,      | Burned by powder and died from his injuries August 10.   |
| Aug. 6,  | Jacob Brodebeck, .....    | 41    | M. | Honeybrook No. 4, ..... | Honeybrook, .....    | Aug. 6,  | Fatally injured while unloading timber and died eight hours later. He was lifting timber on a wagon and it fell on him, fracturing his skull.      |
| 7,       | Peter Bubon, .....        | 21    | S. | Honeybrook No. 5, ..... | Honeybrook, .....    | 7,       | Killed by a piece of rock from a blast at strippings.  |
| 16,      | Ed. Reardon, .....        | 14    | S. | Indian Ridge, .....     | Shenandoah, .....    | 16,      | Fatally injured and died on the 17th. He went up to cog gearings of jig scrapers at dinner hour to oil the machinery and was caught in the wheels. |
| 17,      | Mike Fitzsimmons, .....   | 45    | M. | Bear Run, .....         | St. Nicholas, .....  | 17,      | Fatally injured by a fall of coal and died the same day.   |
| 20,      | David Reese, .....        | 39    | M. | Kehley Run, .....       | Shenandoah, .....    | 20,      | Fatally injured by a fall of coal and died the same day.   |
| 24,      | Frank McCormick, .....    | 40    | M. | Gilberton, .....        | Shenandoah, .....    | 24,      | Killed by an explosion of gas.   |
| 24,      | Lewis Ball, .....         | 26    | S. | Gilberton, .....        | Shenandoah, .....    | 24,      | Fatally injured by an explosion of gas; died on August 25.   |
| 24,      | Cornelius Leahy, .....    | ..... | M. | Gilberton, .....        | Gilberton, .....     | 24,      | Fatally injured by an explosion of gas; died on the 25th.  |
| 29,      | Michael Smith, .....      | 32    | M. | Honeybrook No. 4, ..... | Honeybrook, .....    | 29,      | Killed by a fall of coal.  |
| 31,      | Anth. Shilovick, .....    | 30    | M. | Park No. 2 slope, ..... | Park Place, .....    | 31,      | Killed by a fall of slate; he was barring it down and standing under it.   |
| Sept. 4, | Pat Brishin, .....        | 52    | M. | Buck Mountain, .....    | Buck Mountain, ..... | Sept. 4, | Killed by a fall of slate.   |
| 5,       | John Hulker, .....        | ..... | M. | Maple Hill, .....       | Maple Hill, .....    | 5,       | Killed by a premature blast.   |
| 6,       | John Nichter, .....       | 32    | M. | Bear Ridge, .....       | Mahanoy Plane, ..... | 6,       | Fatally injured by a fall of coal; died shortly after the accident.  |
| 11,      | Rich. Barret, .....       | 50    | M. | Packer No. 4, .....     | Brownsville, .....   | 11,      | Killed by a fall of coal. He had fired a blast and did not take down the loose coal.   |
| 17,      | Joseph Popelus, .....     | 30    | S. | Honeybrook No. 4, ..... | Honeybrook, .....    | 17,      | Killed by a fall of coal.  |
| 18,      | Henry Hoffman, .....      | 33    | M. | Tunnel Ridge, .....     | Mahanoy City, .....  | 18,      | Killed by a fall of rock; his death was not known for some hours.  |
| 29,      | Auth. Gival, .....        | 29    | M. | Honeybrook No. 5, ..... | Honeybrook, .....    | 29,      | Fatally injured by a fall of slate and died shortly after reaching home. He was sinking a hole for a prop when the top slate fell.                 |
| Oct. 1,  | Patrick Dwyre, .....      | 60    | M. | North Mahanoy, .....    | Mahanoy City, .....  | Oct. 1,  | Killed by being jammed between gang-way and mine car.  |
| 1,       | Patrick Coune, .....      | 20    | S. | Girard, .....           | Girardville, .....   | 2,       | Killed by a fall of coal.  |
| 2,       | Victor Marchinskie, ..... | 23    | M. | Furnace, .....          | Gilberton, .....     | 3,       | Fatally burned by an explosion of gas and died in the Miners' Hospital on the 25th.  |
| 8,       | Peter Lesowskie, .....    | 35    | M. | Maple Hill, .....       | Gilberton, .....     | 8,       | He and his buddy lighted their naked lamps after the fire boss had visited them.   |
| 18,      | John Buck, .....          | 16    | S. | Maple Hill, .....       | Maple Dale, .....    | 18,      | Smothered from the afterdamp caused by the explosion which cost Lesowski his life.   |
| 18,      | James L. Donovan, .....   | 25    | M. | Shenandoah City, .....  | Shenandoah, .....    | 20,      | Killed by a fall of clod; he had been trying to bar the clod down and, thinking it safe, returned to work, when it fell.                           |

TABLE NO. 4.—Continued.

| Date of accident. | Name of Person Killed.                   | Age.     | Married or single. | Number of orphans. | Name of colliery.                 | Location—Schuylkill county.    | Date of investigation. | Nature and cause of accident in brief.  |
|-------------------|--|----------|--------------------|--------------------|-----------------------------------|--------------------------------|------------------------|---|
| Oct. 22           | Joseph Swalm.                            | 50       | S.                 | 0                  | Bear Run.                         | St. Nicholas.                  | Oct. 24                | Killed by a shot firing on him; did not get to a place of safety.   |
| 23                | Frank Worskey.                           | 30       | S.                 | 0                  | North Mahanoy.                    | Mahanoy City.                  | 22                     | Killed by a fall of slate and coal, No. 2 slope, No. 6 counter breast No. 2.  |
| 25                | Mike Gemjs.                              | 27       | S.                 | 0                  | Onelda.                           | Onelda.                        | 26                     | Killed by falling in breaker rolls. He was stepping across and fell, pushing the cover of rolls off.  |
| 24<br>18          | Adam Wedjinski.<br>Joseph Hissel.        | 30<br>25 | S.<br>S.           | 0<br>0             | Gilberton.<br>Silverbrook No. 2.  | Gilberton.<br>Silverbrook.     | 24<br>19               | Killed by a fall of coal.<br>Smothered in a chute; he stepped on the loose coal just as the man below lifted the brake stick to pull coal and was drawn down. |
| Nov. 5            | Mich. Reduskey.                          | 28       | M.                 | 0                  | Mahanoy City.                     | Mahanoy City.                  | Nov. 5                 | Killed; while standing a prop; it overbalanced and fell on him.   |
| 10                | Francis Wymb.                            | 21       | S.                 | 0                  | Maple Hill.                       | Mahanoy City.                  | 10                     | Killed by being bumped between railroad cars.   |
| 13                | Arth. Gingley.                           | 42       | M.                 | 4                  | Suffolk.                          | St. Nicholas.                  | 13                     | Fatally injured between cars and timber at bottom of slope while attempting to cross from west to east side; died the following day.                          |
| 17<br>18          | Phil Smith.<br>Harrison Hill.            | 30<br>50 | S.<br>M.           | 0<br>5             | Maple Hill.<br>Silverbrook No. 1. | Maple Dale.<br>Silverbrook.    | 17<br>18               | Killed by a fall of coal.<br>Killed by the rope breaking, causing the car to run down the slope, killing him on the turnout.                                  |
| 20                | James Burns.                             | 34       | M.                 | 4                  | Girard Mammoth.                   | Raven Run.                     | 20                     | Killed by a fall of coal from rib in the East Mammoth South Dip underground slope.  |
| 24                | Harry Woods.                             | 4        | M.                 | 6                  | Shenandoah City.                  | Shenandoah.                    | 24                     | Back sprained while lifting a buggy; died on the 2d of December.  |
| 27<br>28          | George Sechittin.<br>Anth. Sweptulavage. | 26<br>38 | M.<br>M.           | 1<br>5             | Springdale.<br>St. Nicholas.      | Mahanoy City.<br>St. Nicholas. | 27<br>28               | Killed by a premature blast.<br>Fatally injured between two box cars while making a coupling; died the same day.  |

Killed while traveling down No. 2 slope, No. 1 colliery. He was caught between the car which was being hoisted and the brattice constructed for an air return. A wife and family are in Hungary. Killed by the cars running down the slope. The men on top of slope failed to hitch the rope to the cars and pushed the two cars over the knuckle.

Dec. 3, 20.

Silverbrook, Mahanoy City.

Silverbrook, No. 1, Springdale.

M. 5 S.

48 M. 20 S.

Dec. 3, 20.

Mike Sham, Elisha Jones.

TABLE No. 5.—List of non-fatal accidents that occurred in the mines of the Sixth Anthracite District for the year ending December 31, 1894.

| Date of accident. | Name of Person Injured.  | Age. | Married. | Number of orphans. |     | Name of Colliery.                                   | Location—Schuylkill county. | Date of investigation. | Nature and Cause of Accident in Brief.   |
|-------------------|--------------------------|------|----------|--------------------|-----|---|-----------------------------|------------------------|--|
|                   |                          |      |          |                    |     |   |                             |                        |  |
| Jan. 9.           | Joseph Youkowskie, ..... | 33   | M.       | ...                | ... | William Penn, .....                                 | Shaft, .....                | Jan. 9.                |  |
| 10.               | Michael Belock, .....    | 27   | M.       | ...                | ... | No. 9 strippings, Honeybrook No. 5, Bear Run, ..... | Audenreid, .....            | 11.                    | Face and hands burned by an explosion of gas. He was putting in plank manway and used a naked light; the fire boss did not see that the gas was removed as required by law. This man is working again. |
| 16.               | Charles Godinsky, .....  | 24   | S.       | ...                | ... | Primrose, .....                                     | St. Nicholas, .....         | 16.                    | Leg fractured truck overbalanced on him.   |
| 16.               | Anthony Shokttis, .....  | 28   | S.       | ...                | ... | Primrose, .....                                     | Mahanoy City, .....         | 16.                    | Left hand blown off. He was tapping a cartridge of dynamite on the rail when it exploded.  |
| 25.               | George Kenan, .....      | 24   | S.       | ...                | ... | Maple Hill, .....                                   | Mahanoy City, .....         | 27.                    | Arm and nose broken by a premature blast, did not give the blast time to explode.  |
| 27.               | Albert Ochlets, .....    | 45   | M.       | 2                  | 2   | Honeybrook No. 5 strippings, Springdale, .....      | St. Nicholas, .....         | 27.                    | Legs seriously injured; a piece of rock fell from face of breast.  |
| 29.               | James A. Well, .....     | 40   | M.       | 4                  | 4   | Springdale, .....                                   | Audenreid, .....            | 29.                    | Five ribs fractured by a clay dumper overturning on him.   |
| Feb. 6.           | William Hobin, .....     | 20   | S.       | ...                | ... | Ellangowan, .....                                   | Mahanoy City, .....         | 29.                    | Arm broken, scalp wounded and shoulder bruised, while going up on side of boilers the hand rail broke, causing him to fall.  |
| 7.                | John Keating, .....      | 27   | S.       | ...                | ... | Lawrence, .....                                     | Maple Dale, .....           | Feb. 8.                | Arm fractured; mule kicked him.  |
| 16.               | Con. O'Daraea, .....     | 39   | S.       | ...                | ... | Lawrence, .....                                     | Mahanoy Plane, .....        | 8.                     | Slightly burned on face and hands by an explosion of gas.  |
| 16.               | William Griffiths, ..... | 17   | S.       | ...                | ... | Park No. 2, .....                                   | Park Place, .....           | 8.                     | Slightly burned on face and hands by an explosion of gas.  |
|                   |                          |      |          |                    |     |   |                             |                        | Arm badly bruised; while assisting to run down a trip of cars, a piece of coal fell off one of the cars, tripping him, and one of the wheels ran over his arm.   |

|         |                  |    |    |                    |                 |         |   |
|---------|------------------|----|----|--------------------|-----------------|---------|---|
| 22      | John O'Brien     | 54 | M. | Maple Hill         | St. Nicholas    | 22      | Leg fractured and head cut; he was nailing down sheet iron when a piece of coal fell on him from face of breast.  |
| 28      | Daniel Dever     | 38 | M. | Honeybrook No. 4   | Audenreid       | 28      | Back injured; he went inside the elevator shaft to put on a bucket, and he was pulled around the spider; he is breaker boss; attending to his duties again.                       |
| March 8 | George Hughes    | 35 | S. | Elmwood            | Mahanoy City    |         | Leg fractured in two places by a fall of coal while timbering a heading.  |
| 9       | Mike McShunus    | 40 | M. | Lawrence           | Mahanoy Plane   | Mar. 9  | Slightly burned by an explosion of gas.   |
| 9       | Joseph Grime     | 32 | M. | Lawrence           | Mahanoy Plane   | 9       | Slightly burned by an explosion of gas.   |
| 9       | Anthony Wogan    | 23 | S. | Lawrence           | Mahanoy Plane   | 9       | Slightly burned by an explosion of gas.   |
| 9       | Joseph Grobin    | 20 | S. | Lawrence           | Mahanoy Plane   | 9       | Slightly burned by an explosion of gas.   |
| 14      | Michael McGrath  | 35 | M. | Bear Ridge         | Mahanoy Plane   |         | Foot pierced by an iron bar while unloading a wagon of coal.  |
| 23      | James Monaghan   | 46 | M. | Packer No. 4       | Lost Creek      | 24      | Slightly burned by an explosion of gas; he was traveling from work and went into 22 breast instead of No. 21, which connects with third lift.                                     |
| 23      | Mike Monaghan    | 48 | M. | Packer No. 4       | Lost Creek      | 24      | Slightly burned at same time and place as James Monaghan.   |
| 24      | George Youritis  | 29 | M  | Packer No. 4       | Lost Creek      | 24      | Leg fractured; mule fell on him.  |
| 26      | John M. Jones    | 47 | M  | Honeybrook No. 4   | Audenreid No. 4 | 25      | Hands and face burned by an explosion; this man was fire boss and was examining the working places in the morning for gas, when he exploded the gas with a naked lamp.            |
| 28      | Thomas Evans     | 19 | S. | Vulcan             | Buck Mountain   |         | Double fracture of left leg; working by night and was lying asleep on low side of gangway, when a piece of rock rolled on him.  |
| April 3 | Joseph Burditt   | 38 | M  | Packer No. 4       | Lost Creek      | April 5 | Jaw bone broken and dislocated by a fall of coal.   |
| 9       | Thomas McCormick | 35 | M  | West Shenandoah    | Shenandoah City | 9       | Breast severely injured; he was traveling down slope in the morning and was caught with the ascending car (con tractor); bumped between cars.                                     |
| 10      | William Smith    | 19 | S. | Buck Mountain      | Buck Mountain   | 11      | Leg fractured; jammed between schute and leg.   |
| 18      | William W. Davis | 57 | S. | West Shenandoah    | Shenandoah      | 13      | Leg fractured by a fall of coal while bar-  |
| 19      | Anton Mateck     | 40 | M  | Onelda No. 1 slope | Onelda          | 21      | Leg fractured by a fall of coal after blast-  |
| May 1   | Charles Bemish   | 36 | S. | Gilberton          | Gilberton       | May 2   | Leg down loose coal after blasting.   |
| 7       | Michael Boyle    | 49 | M  | Onelda No. 2 slope | Onelda          | 9       | Slightly injured on head by a fall of coal.   |
| 9       | William Harley   | 21 | S. | Bear Ridge         | Mahanoy Plane   |         | Small bone of foot fractured by a fall of coal.   |
| 10      | Joseph Lutcavage | 29 | M. | Ellangowan         | Maple Dale      | 12      | Foot injured; was caught in car wheel.  |
| 11      | John Duncavage   | 29 | S. | Packer No. 4       | Lost Cr ck      |         | Back cut, squeezed about hips and legs by a fall of coal.   |
|         |                  |    |    |                    |                 |         | Leg fractured by a fall of coal. He was working for John Petrunsky who allowed him to go to face of breast after blasting without first having examined the face of work himself. |

TABLE No. 5.—Continued.

| Date of accident. | Name of Person Injured.    | Age. | Married. | Number of orphans. | Name of Colliery.           |                              | Date of Investigation. | Nature and Cause of Accident in brief.  |
|-------------------|----------------------------|------|----------|--------------------|-----------------------------|------------------------------|------------------------|---|
|                   |                            |      |          |                    |                             | Location--Schuylkill county. |                        |   |
| May               | William Minney, .....      | 32   | M.       | ...                | Bear Ridge, .....           | Mahanoy Plane, .....         | May                    | Burned on hands by an explosion of gas.<br>Burned on hands and face by an explosion of gas.                                 |
|                   | Michael Ryan, .....        | ...  | ...      | ...                | Bear Ridge, .....           | Mahanoy Plane, .....         | 15                     |   |
| 14                | Edward Ryan, .....         | ...  | ...      | ...                | Bear Ridge, .....           | Mahanoy Plane, .....         | 15                     | Burned on hands and face by an explosion of gas.  |
| 11                | Robert Patton, .....       | ...  | ...      | ...                | Bear Ridge, .....           | Mahanoy Plane, .....         | 15                     | Burned on hands and face by an explosion of gas.  |
| 23                | August Duncavage, .....    | 35   | M.       | ...                | Maple Hill, .....           | St. Nicholas, .....          | 25                     | Hips bruised; he fell between cars while trying to jump on them.  |
| June              | Alexander Morris, .....    | 25   | S.       | ...                | Green Mountain slope, ..... | Audenreid, .....             | June 4                 | Back bruised by a fall of coal while trying to bar it down.   |
|                   | William Brennan, .....     | 36   | S.       | ...                | Green Mountain slope, ..... | Audenreid, .....             | 4                      | Leg fractured and shoulder dislocated; fell down slope 120 feet; rope slipped while he was taking timber down.              |
| 2                 | Mike Napolitano, .....     | 35   | M.       | 2                  | Green Mountain, .....       | Audenreid, .....             | 4                      | Leg fractured and cut about the head and body; fell down slope under the same conditions as Brennan.                        |
| 15                | Thomas Swearn, .....       | 26   | M.       | 1                  | Maple Hill, .....           | St. Nicholas, .....          | 18                     | Body and hands injured by a blast of powder; he shortened the squib, and before he had time to get away the blast exploded. |
| 21                | Lewis Lusk, .....          | 35   | M.       | ...                | Honeybrook No. 5, .....     | Audenreid, .....             | ...                    | Skull fractured by a derrick pole falling on him; the wire rope broke.  |
| 22                | Anthony Vilashensky, ..... | ...  | ...      | ...                | Ellangowan, .....           | Maple Dale, .....            | ...                    | Face and eyes injured by a premature blast.   |
| 27                | William Matuskey, .....    | 24   | S.       | ...                | Elmwood, .....              | Mahanoy City, .....          | ...                    | Face and body injured by a premature blast of dynamite while tamping a hole with iron bars.                                 |
| 28                | Fred Norton, .....         | ...  | ...      | ...                | Elmwood, .....              | Mahanoy City, .....          | ...                    | Leg fractured by a fall of coal.  |
| 4                 | Mike Mokane, .....         | 24   | S.       | ...                | Ellangowan, .....           | Maple Dale, .....            | ...                    | Foot mashed by being bumped between mine and bumper; combing from tip he rolled off the dumper and it ran over him.         |



|     |                     |       |            |                               |                 |         |  |
|-----|---------------------|-------|------------|-------------------------------|-----------------|---------|--|
| 12. | Andrew Mazaniskie.  |       | Gilberton. | Gilberton.                    |                 |         | Injured about face and body; shot fired on him; he went back too soon, thinking the shot had missed.   |
| 29. | James J. Phillip.   | 26 M. | 1          | Springdale.                   | Park Place.     |         | Sight of one eye lost by being struck by a piece of coal.  |
| 6.  | Andrew Carroll.     | 25 S. |            | No. 10 stripping, Honeybrook. | Audenreid.      |         | Leg fractured; a lump of clay rolled down on him from face of stripping.   |
| 7.  | Harry Sell.         | 13    |            | Draper.                       | Gilberton.      |         | Leg fractured; fell from lump coal chute down on old dirt road; he, with other boys, were playing through the breaker at the dinner hour and he jumped into the chute. |
| 9.  | Cornelius Campbell. | 16    |            | Boston Run.                   | St. Nicholas.   |         | Body bruised; fell under dumper while un-litching mule.  |
| 10. | Joe Voluck.         | 27 S. |            | Suffolk.                      | St. Nicholas.   | July    | Leg fractured by fall of coal.   |
| 10. | Geo. Hughes.        | 17    |            | Bear Run.                     | St. Nicholas.   | 10.     | Body and legs squeezed; struck by a car coming in from breaker.  |
| 12. | Joe Horistra.       | 26 S. |            | Turkey Run.                   | Turkey Run.     | 12.     | Head and arm burned by an explosion of gas; left his hat and lamp on platform and went up chute and brushed down the gas on his lamp.                                  |
| 17. | Fred Fry.           | 19 S. |            | Boston Run.                   | Boston Run.     | 17.     | Ankle broken by being jammed between cars.   |
| 17. | Geo. Miller.        | 34 M. | 7          | Packer No. 4.                 | Brownsville.    | 18.     | Burned on face and hands by an explosion of gas.   |
| 17. | Matt Lustiski.      | 28 M. | 4          | Packer No. 4.                 | Brownsville.    | 18.     | Burned on face and hands by an explosion of gas.   |
| 23. | William Richards.   |       |            | Gilberton.                    | Gilberton.      | 23.     | Body badly bruised; he was lighting three shots when one of them exploded, knocking him down the breast and the other two subsequently exploded.                       |
| 24. | William Droy.       | 32 M. |            | Vulcan.                       | Mahanoy City.   | 24.     | Face and hands burned; they had fired a shot and went to fire another with a naked lamp, igniting the gas.   |
| 24. | Siney Quinoskie.    | 30 M. |            | Vulcan.                       | Mahanoy City.   | 24.     | Face and hands burned; they had fired a shot and went to fire another with a naked lamp, igniting the gas.   |
| 29. | Steve Shelsiek.     | 29 M. |            | Packer No. 4.                 | Ramahannock     | 29.     | Body scalded by a boiler explosion.  |
| 2.  | Robert Rosiofskie.  |       |            | Elangowen.                    | Maple Dale.     | Aug. 2. | Head and hips lacerated by a premature blast.  |
| 2.  | Frank Arben.        | 20 S. |            | Vulcan.                       | Mahanoy City.   | 3.      | Body badly bruised; he was squeezed between cars and door.   |
| 10  | Peter Molginskie.   |       |            | Knickerbocker.                | Yatesville.     |         | Face and hands burned; after firing a shot he returned to face of breast without his safety lamp.  |
| H.  | James Laughlin.     | 33 M. | 7          | Honeybrook No. 4.             | Honeybrook.     | 11.     | Jaw bone fractured and loss of one eye by a blast; he hit two holes, one fired and he went back to examine why the other did not explode, when it went off.            |
| 14. | Con Reardon.        |       |            | B. Bear Ridge.                | Mahanoy Plains. | 14.     | Collar bone fractured; caught by cars.   |
| 17. | Michael Knox.       | 29 S. |            | Honeybrook No. 5.             | Honeybrook.     | 1.      | Thigh bone fractured; while assisting in lifting a car on the track, it fell back on him.  |

TABLE No. 5. — Continued.

| Date of accident. | Name of Person Injured. | Age.  | Married. | No. of orphans. | Name of Colliery.          | Location--Schuylkill county. | Date of Investigation. | Nature and Cause of Accident in Brief.   |
|-------------------|-------------------------|-------|----------|-----------------|----------------------------|------------------------------|------------------------|--|
| Aug. 21.          | Adolph Maguir, .....    | 28 M. | .....    | 1               | Lawrence, .....            | Mahanoy Plane, .....         | Aug. 21.               | Leg fractured by being bumped between cars.  |
| 21.               | Thos. Droches, .....    | 28 S. | .....    | .....           | Ellangowan, .....          | Maple Dale, .....            | 23.                    | Arm seriously squeezed between a prop and a fall of top.   |
| 23.               | Anth. Precharto, .....  | 17 S. | .....    | .....           | Honey Brook No. 5, .....   | Honeybrook, .....            | 25.                    | Foot crushed; he fell into the breaker rolls.  |
| 25.               | Michael Turk, .....     | 16 M. | .....    | .....           | Onesida, .....             | Onesida, .....               | 27.                    | Leg crushed between cars.  |
| 30.               | John Wyatt, .....       | 45 M. | .....    | 4               | Kehley's Run, .....        | Shenandoah, .....            | 30.                    | Face and arms injured by a shot firing on him, and at that time to explode.                            |
| Sept. 3.          | Stiney Waminskie, ..... | ..... | .....    | .....           | Turkey Run, .....          | Turkey Run, .....            | Sept. 3.               | Face, arm and hands burned by an explosion of gas.   |
| 3.                | Martin Discavage, ..... | ..... | .....    | .....           | Turkey Run, .....          | Turkey Run, .....            | 3.                     | Face, arm and hands burned by an explosion of gas.   |
| 12.               | Anth. Rtec, .....       | 36 M. | .....    | 3               | Vulcan, .....              | Mahanoy City, .....          | 12.                    | Face and hands burned by an explosion of gas.  |
| Oct. 10.          | Edward Kurtz, .....     | 28 S. | .....    | .....           | Onesida No. 3 slope, ..... | Onesida, .....               | Oct. 10.               | Shoulder bone fractured by being caught between car and brattice.                                      |
| 11.               | James Kane, .....       | 17    | .....    | .....           | Draper, .....              | Gilberton, .....             | 11.                    | Leg fractured by a piece of coal rolling down hoisting slope while in the act of ringing the bell.     |
| 11.               | Wm. Connor, .....       | ..... | .....    | .....           | Turkey Run, .....          | Turkey Run, .....            | 12.                    | Leg fractured by being run over by a mine car.   |
| 12.               | John Hughes, .....      | 31    | .....    | .....           | Gilberton, .....           | Gilberton, .....             | 12.                    | Leg fractured by a fall of coal.   |
| 24.               | Chas. Petkis, .....     | ..... | .....    | .....           | Knickerbocker, .....       | Yatesville, .....            | 24.                    | Leg fractured by a fall of slate.  |
| 25.               | Jos. Charptes, .....    | 29 M. | .....    | 2               | Kehley Run, .....          | Shenandoah, .....            | 25.                    | Leg injured by being struck by a piece of coal in chute.   |
| Nov. 5.           | John James, .....       | ..... | .....    | .....           | Knickerbocker, .....       | Yatesville, .....            | Nov. 5.                | Face and eyes injured by being struck by a piece of coal.  |
| 6.                | Anth. Ludcavage, .....  | 32 M. | .....    | .....           | Vulcan, .....              | Mahanoy City, .....          | 6.                     | Burned on face and hands by an explosion of gas; he went to his place of work and used his naked lamp. |
| 7.                | Nicholas Franz, .....   | ..... | .....    | .....           | Kohinoor, .....            | Shenandoah, .....            | 7.                     | Legs fractured by a fall of coal.  |

|         |                         |            |                               |                       |         |   |
|---------|-------------------------|------------|-------------------------------|-----------------------|---------|---|
| 8.      | Geo. Mullmufskic, ..... | .....      | Gilberton, .....              | Gilberton, .....      | 7.      | Legs fractured by a fall of coal.                               |
| 12.     | Ed. Goodman, .....      | 22 S. .... | Slope H. B., Green Mt., ..... | Green Mountain, ..... | 12.     | Leg fractured by a piece of coal rolling down slope.            |
| 16.     | John Motte, .....       | 28 M. 1    | Oneida No. 2 slope, .....     | Oneida, .....         | 16.     | Leg fractured; a car ran over him.                              |
| 21.     | John Luik, .....        | 28 M. .... | Kehley's Run, .....           | Sbenandoab, .....     | 21.     | Collar bone fractured; a piece from a shot struck him.          |
| 27.     | William McNeill, .....  | 47 M. 6    | Vulcan, .....                 | Mahanoy City, .....   | 27.     | Burned severely by an explosion of gas by his own recklessness. |
| Dec. 4. | Thomas Pfluehard, ..... | 20 .....   | Buck Mountain, .....          | Buck Mountain, .....  | Dec. 4. | Leg fractured by being squeezed between mine cars.              |
| 30.     | Bazilas Vegar, .....    | 22 .....   | Oneida No. 2 slope, .....     | Oneida, .....         | 20.     | Jaws fractured by a fall of coal.                               |

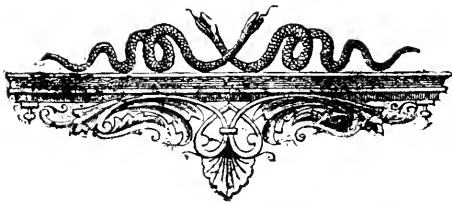

# SEVENTH ANTHRACITE DISTRICT.

(NORTHUMBERLAND, COLUMBIA, SCHUYLKILL AND DAUPHIN COUNTIES.)

---

Shamokin, Penna., March 19, 1895.

Hon. Isaac B. Brown,

Secretary of Internal Affairs, Harrisburg, Penna.:

Sir: I have the honor to present to you the following report for the year 1894:

The quantity of coal produced during the year 1894 was 5,404,823 tons, against 5,288,890.88 tons in 1893, an increase of 115,932.12 tons.

The number of fatal accidents was 78, an increase of 1 over the preceding year. The Henry Clay boiler explosion and the Luke Fidler colliery fire, by which 7 and 5 lives were lost respectively, greatly augmented the fatalities.

The non-fatal accidents were 76, against 119 in 1893, a decrease of 43.

On account of the fatal casualties 32 wives were made widows and 88 children orphans.

Several of the fatal accidents were due to the carelessness on the part of the victims, and in some cases were due to direct violations of law. Three deaths having occurred from jumping on accommodation wagons while in motion on slopes, while several deaths from premature explosions would not have occurred had proper care on the part of the victim been exercised.

Respectfully submitted,

EDWARD BRENNAN,

Mine Inspector.

---

## Examination of Applicants for Mine Foremen Certificates.

An examination was held at Pottsville on July the 12th and 13th. The board consisted of Edward Brennan, Mine Inspector; Andrew Robertson, coal operator, Shamokin; Robert Muir, miner, Mount Carmel, and James Gordon, miner, Ashland.

The following persons passed a successful examination and were recommended to Secretary of Internal Affairs for certificates of qualification:

John T. Thomas, Shamokin.  
Michael Madden, Shamokin.  
Charles F. Long, Wiconisco.  
John Marsh, Wilburton.  
John E. Ambrose, Mount Carmel.  
Andrew Gallagher, Centralia.  
George Schaum, Centralia.  
John Ruffing, Locust Gap.

#### Condition of the Collieries.

There has been considerable improvement in the condition of the collieries in this district, especially with regard to ventilation and things conducive to the safety of the workmen. There are still, however, some two or three collieries where the ventilation is not what it should be, two of the collieries being apparently new where such conditions should not obtain. This is largely due to lack of attention by those in charge. The managers, however, promise to remedy matters as soon as possible. If this is not done, extreme measures will be used to compel them to do so.

#### Improvements Made During the Year.

Owing to the dull condition of the trade, less work was done in the way of improvement than for many years past. The Scott shafts, which were being sunk by the Union Coal Company, were stopped and allowed them to fill up with water until a revival of trade with a greater demand for coal would warrant their completion.

The remodelling of the Bear Valley breaker by the Philadelphia and Reading Coal and Iron Company, and the building of a jig house at Cameron colliery by the Mineral Railroad and Mining Company, were the only improvements of note made during the year.

#### Luke Fidler Colliery Fire.

A most disastrous fire occurred at this colliery on the evening of October 8, between the hours of 7 and 8 o'clock. Irvin Buffington, a carpenter, assisted by John Anderson and Daniel Gallagher, were repairing the air brattices in the No. 1 shaft, (see map), which extends from the No. 10 to the No. 9 seams. The shaft is operated by bore holes from the surface; the construction of it is such that the steam pipes are very close to the air compartment, thus making the brattice and timber in one end of the shaft very dry. For this reason lan-



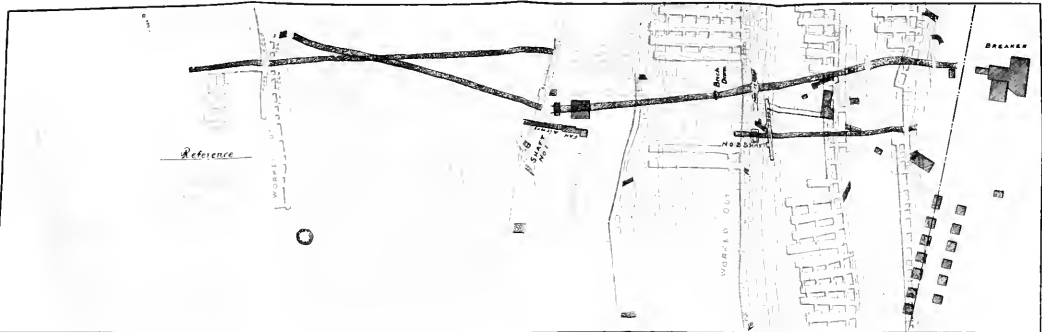

PORTION OF  
 LUKE FIDLER COLLIERY  
 Shamokin Pa, Mar 21, 1895

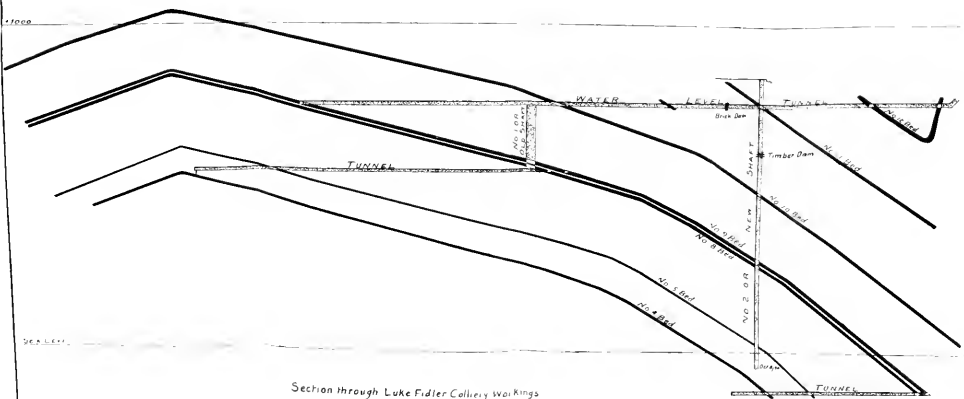

Section through Luke Fidler Colliery Workings



terns, early, were used in making repairs, and for fear of fire even smoking was prohibited. Notwithstanding these rules, Buffington, in direct violation of orders, used a naked light and foolishly placed it against the brattice to look for a leak, thinking to discover it by having the flame draw up through the opening. In doing this he set the brattice on fire, and as every thing was as dry as tinder there was no possible chance of extinguishing it. Discovering this, Buffington went up the shaft, shouldered his tool chest, and started out the tunnel to make his escape, but so rapidly did the flames spread that the fumes overtook him and he paid the penalty of his violation of orders with his life. At the time the fire broke out there were 60 men at work in various parts of the mine. John Anderson, who was in the shaft, with Buffington, not thinking of self, went down, and together with others who went down the new shaft, (see map), notified all the men they could reach to go to the new shaft, which was the most accessible place where they could reach the surface with safety. The colliery, fortunately, is furnished with many avenues of escape, otherwise a greater number of men would have perished. In spite of all efforts, however, four lives were lost. Two of these victims were notified to go to the new shaft, but made a mistake and tried to escape by the traveling-way from the foot of the old shaft to the water-level, (see map), but were overtaken by the fumes from the fire and were lost. Two others in the No. 3 slope could not be reached, despite every effort. So intense was the fire, and so rapidly did it spread, that by no efforts could the bodies of the men be reached, although every human exertion was made.

Owing to the location of the fire, it being at both the top and the bottom of the shaft, thus destroying the return air-way, and the mine generating large quantities of explosive gases, any effort to fight the fire would have been extremely hazardous, if not suicidal. The only recourse left was to seal all the openings and fill the mine with water. This was done by turning in Coal Run creek, and also by pumping all available water into the mine. It required over one billion gallons of water to fill it to water level. As the fire had gotten above water level, dams had to be constructed in the new shaft, also in the main tunnel (see section) in order to raise the water above the fire. This was done successfully, and at this writing the water has been run off from above water level and the fire found to be extinguished. It was found to have gotten above water level about 100 feet, and did more damage than was expected.

The names of the men whose bodies are still in the mine are George Brown, Stany Bober, Mike Kovalis and William Barcavidge.

The work of taking out the water below water level has been commenced, but it will take some time before the bodies can be recovered or the mine operated again.

## Henry Clay Boiler Explosion.

On the morning of October the 11th, at about 7.30 o'clock, one of the most disastrous boiler explosions which has occurred in the history of mining, happened at the Henry Clay colliery. The plant, which was almost a new one, contained 34 cylinder boilers. Twenty-seven of these, without any apparent cause, exploded, killing 7 men and injuring 2, and utterly demolishing the boiler house, besides doing damage to the surrounding buildings. Boiler experts from all sections of the country visited the scene, but none could give any satisfactory reason, or no two agree, as to the cause of the explosion. All agreed, however, that the material in the boilers was first-class, and that the explosion was not due to this cause. A strange thing which may be mentioned was that 15 boilers on one end and 12 on the other, exploded, while 7 in the centre remained in position and did not explode. The closest investigation on the part of the company and also by the coroner's jury, failed to place the cause, consequently it will have to be classed among the many of the strange happenings for which no satisfactory reason can be assigned.

TABLE A—Comparative Statement of Fatal Casualties from Various Causes that Occurred During the Years 1892, 1893 and 1894.

|   | 1892 | 1893 | 1894 |
|---|------|------|------|
| Suffocated by smoke from mine fire, . . . . . |      |      | 5    |
| Explosions of fire damp, . . . . .            | 7    | 5    | 6    |
| Falls of coal and roof, . . . . .             | 16   | 30   | 27   |
| Mine cars and machinery, . . . . .            | 10   | 15   | 12   |
| Falling down slopes and shafts, . . . . .     | 3    |      | 3    |
| Breaking of ropes and chains, . . . . .       | 1    |      |      |
| Explosion of blasting materials, . . . . .    | 5    | 8    | 9    |
| Kicked by mules, . . . . .                    |      | 1    | 1    |
| Falling down schutes, . . . . .               |      |      | 3    |
| Boiler explosions, . . . . .                  |      |      | 7    |
| Miscellaneous, . . . . .                      | 3    | 18   | 5    |
| Totals, . . . . .                             | 45   | 77   | 78   |

TABLE B—Showing Number of Tons of Coal Mined by each Company Number of Fatal Casualties and Number of Tons Mined for each Fatality.

|   | Tons Mined. | Deaths. | Tons Mined per Death. |
|---|-------------|---------|-----------------------|
| Philadelphia and Reading Coal and Iron Company, . . . . . | 2,052,496   | 33      | 62,197                |
| Mineral Railroad and Mining Company, . . . . .            | 431,674     | 10      | 43,167                |
| Summit Branch Railroad Company, . . . . .                 | 392,474     | 11      | 35,679                |
| Lykens Valley Coal Company, . . . . .                     | 306,133     | 2       | 153,066               |
| The Union Coal Company, . . . . .                         | 632,823     | 8       | 79,103                |
| Lewis A. Riley & Co., . . . . .                           | 294,781     | 4       | 73,695                |
| Individual Companies, . . . . .                           | 1,294,442   | 10      | 129,444               |
| Totals, . . . . .   | 5,404,823   | 78      | 576,351               |

NOTE—Average number of tons of coal mined per life lost, 69,293.

TABLE C—Showing the Comparison of Non-Fatal Casualties for the Years 1892, 1893 and 1894.

|   | 1892. | 1893. | 1894. |
|---|-------|-------|-------|
| Falls of coal and roof, . . . . .           | 36    | 42    | 30    |
| Explosions of fire damp, . . . . .          | 16    | 16    | 8     |
| Mine cars and machinery, . . . . .          | 27    | 37    | 27    |
| Explosion of blasting materials, . . . . .  | 5     | 9     | 3     |
| Kicked by mules, . . . . .                  | 2     | 1     | 1     |
| Breaking of ropes and chains, . . . . .     |       |       | 2     |
| Falling down schutes and manways, . . . . . |       |       | 5     |
| Miscellaneous, . . . . .                    | 15    | 14    |       |
| Totals, . . . . .                           | 101   | 119   | 76    |

TABLE D—Showing Comparison of the Quantity of Coal Shipped, the Estimated Quantity Used and Sold at Collieries, and the Total Productions for the Years 1892, 1893 and 1894.

|   | 1892.     | 1893.     | 1894.     |
|---|-----------|-----------|-----------|
| Quantity of coal shipped, . . . . .                     | 5,142,605 | 4,968,273 | 4,973,335 |
| Quantity of coal used and sold at collieries, . . . . . | 322,073   | 320,618   | 431,488   |
| Number of tons produced, . . . . .                      | 5,464,678 | 5,288,891 | 5,404,823 |

TABLE E.—*Showing General Comparisons Between the Years 1892, 1893 and 1894.*

|  | 1892.   | 1893.  | 1894.  |
|--|---------|--------|--------|
| Number of persons employed, . . . . .                      | 18,437  | 19,179 | 19,121 |
| Number of tons of coal mined per life lost, . . . . .      | 121,437 | 68,687 | 69,293 |
| Ratio of employes per life lost, . . . . .                 | 410     | 249    | 245    |
| Number of tons of coal mined per person injured, . . . . . | 54,106  | 44,444 | 71,116 |
| Tons of coal mined per employe, . . . . .                  | 296     | 276    | 283    |

TABLE F.—*Showing the number of persons employed by the several companies and the number of deaths.*

|   | Number of deaths. | Number of employes. |
|---|-------------------|---------------------|
| Philadelphia and Reading Coal and Iron Company, . . . . . | 33                | 6,745               |
| Mineral Railroad and Mining Company, . . . . .            | 10                | 2,285               |
| Summit Branch Railroad Company, . . . . .                 | 11                | 1,020               |
| Lykens Valley Coal Company, . . . . .                     | 2                 | 1,072               |
| The Union Coal Company, . . . . .                         | 8                 | 2,655               |
| Lewis A. Riley and Company, . . . . .                     | 4                 | 1,152               |
| Individual collieries, . . . . .                          | 10                | 4,192               |
| Totals, . . . . .   | 78                | 19,121              |

TABLE I.—Showing location, etc., of collieries in the Seventh Anthracite District for the year ending December 31, 1894.

| Names of Collieries.       | Name of operator.                          | Location—County. | Name of superintendent. | Postoffice address. |
|----------------------------|--|------------------|-------------------------|---------------------|
| Alaska.....                | Philadelphia and Reading Coal and Iron Co. | Northumberland,  | John Veith,             | Pottsville.         |
| Reliance.....              | do.  | do.              | do.                     | do.                 |
| North Ashland.....         | do.  | Columbia,        | do.                     | do.                 |
| East.....                  | do.  | Schuylkill,      | do.                     | do.                 |
| Tunnel.....                | do.  | do.              | do.                     | do.                 |
| Keystone Jig.....          | do.  | do.              | do.                     | do.                 |
| Potts.....                 | do.  | do.              | do.                     | do.                 |
| Merriman.....              | do.  | Northumberland,  | do.                     | do.                 |
| Monitor.....               | do.  | do.              | do.                     | do.                 |
| Leucost Gash.....          | do.  | do.              | do.                     | do.                 |
| Leucost Spring.....        | do.  | do.              | do.                     | do.                 |
| Buck Ridge.....            | do.  | do.              | do.                     | do.                 |
| Big Mountain.....          | do.  | do.              | do.                     | do.                 |
| Peerless.....              | do.  | do.              | do.                     | do.                 |
| Henry Clay.....            | do.  | do.              | do.                     | do.                 |
| Stirling.....              | do.  | do.              | do.                     | do.                 |
| Burnside.....              | do.  | do.              | do.                     | do.                 |
| Bea Valley.....            | do.  | do.              | do.                     | do.                 |
| North Franklin.....        | do.  | do.              | do.                     | do.                 |
| Preston No. 2.....         | do.  | do.              | do.                     | do.                 |
| Preston No. 3.....         | do.  | Schuylkill,      | do.                     | do.                 |
| Lucas Run.....             | do.  | do.              | do.                     | do.                 |
| Mid Valley No. 1.....      | Mid Valley Coal Company.                   | Columbia,        | Frank G. Clements,      | do.                 |
| Mid Valley No. 2.....      | do.  | Northumberland,  | do.                     | Mount Carmel.       |
| Pennsylvania.....          | The Union Coal Company.                    | do.              | John L. Williams,       | do.                 |
| Richards.....              | do.  | do.              | do.                     | Shamokin.           |
| Hickory Ridge.....         | do.  | do.              | do.                     | do.                 |
| Hickory Swamp.....         | do.  | do.              | do.                     | do.                 |
| Excelsior.....             | do.  | do.              | do.                     | do.                 |
| Corbin.....                | Excelsior Coal Company.                    | do.              | Andrew Robertson,       | do.                 |
| Cameron.....               | do.  | do.              | do.                     | do.                 |
| Luke Fuller.....           | Mineral Railroad and Mining Company.       | do.              | Morris Williams,        | do.                 |
| Logan.....                 | do.  | do.              | do.                     | do.                 |
| Centralia.....             | Lewis A. Riley & Co.                       | Columbia,        | Edward Reese,           | Centralia.          |
| Williamstown.....          | do.  | do.              | do.                     | do.                 |
| Short Mountain.....        | Summit Branch Railroad Company.            | Dauphin,         | T. M. Williams,         | Lykens.             |
| Nelson.....                | Lykens Valley Coal Company.                | do.              | do.                     | do.                 |
| Enterprise.....            | J. Langdon & Co., Incorporated.            | Northumberland,  | Harry S. Gay,           | Shamokin.           |
| Enterprise.....            | Enterprise Coal Company.                   | do.              | do.                     | do.                 |
| Mount Carmel.....          | Thomas M. Righter & Co.                    | do.              | Thomas M. Righter,      | Mount Carmel.       |
| Morris Ridge.....          | Morris Ridge Coal Company.                 | Columbia,        | Tobias Bickel,          | do.                 |
| Columbus No. 1.....        | do.  | do.              | E. E. White,            | do.                 |
| Columbus No. 2.....        | do.  | Northumberland,  | George S. Comstock,     | Shamokin.           |
| Colbert.....               | Shearer, Bickel & Co.                      | do.              | M. J. E. J. Phillips,   | Mount Carmel.       |
| .....                      | E. E. White & Alfred White.                | do.              | Henry Vincent,          | Natalie.            |
| Ferndale.....              | Shipman Coal Company.                      | do.              | John Veith,             | Pottsville.         |
| Patterson.....             | Ferndale Coal Company.                     | do.              | do.                     | do.                 |
| George Palms' washery..... | Penn Anthracite Coal Company.              | do.              | Edward Reese,           | Centralia.          |
| Big Mine Run.....          | Philadelphia and Reading Coal and Iron Co. | do.              | do.                     | do.                 |
| .....                      | Lewis A. Riley & Co.                       | Schuylkill,      | do.                     | do.                 |



|                            |           |           |       |        |       |       |         |       |       |       |         |
|----------------------------|-----------|-----------|-------|--------|-------|-------|---------|-------|-------|-------|---------|
| Luke Fidler, .....         | 127,124   | 196,369   | 164   | 900    | 7     | 5     | 3,422   | 20    | 81    | 1     | 23,925  |
| Logan, .....               | 125,016   | 195,483   | 151   | 527    | 2     | 3     | 4,205   | 48    | 44    | 1     | 4,500   |
| Centralia, .....           | 151,695   | 131,220   | 142   | 525    | 2     | 3     | 3,000   | 21    | 72    | 1     | 5,000   |
| Williamstown, .....        | 392,774   | 298,408   | 257   | 1,020  | 11    | 5     | 4,765   | 95    | 153   | 5     | .....   |
| Short Mountain, .....      | 306,132   | 256,307   | 264   | 1,072  | 2     | 2     | 3,244   | 77    | 143   | 5     | .....   |
| do, .....                  | 164,997   | 135,303   | 225   | 548    | 2     | 4     | 3,212   | 19    | 45    | ..... | .....   |
| Nellson, .....             | 108,084   | 96,896    | 217   | 420    | 1     | 5     | 3,877   | 29    | 40    | 2     | .....   |
| Enterprise, .....          | 59,126    | 56,311    | 168   | 223    | 1     | 1     | 993     | 33    | 24    | ..... | .....   |
| Mount Carmel, .....        | 19,576    | 15,015    | 177   | 177    | 1     | 1     | 300     | 21    | 16    | 1     | .....   |
| Morris Ridge, .....        | 102,328   | 92,527    | 127   | 386    | 1     | 1     | 2,680   | 19    | 33    | ..... | .....   |
| Columbus No. 1, .....      | .....     | .....     | ..... | .....  | ..... | ..... | .....   | ..... | ..... | ..... | .....   |
| Columbus No. 2, .....      | .....     | .....     | ..... | .....  | ..... | ..... | .....   | ..... | ..... | ..... | .....   |
| Colbert, .....             | 62,370    | 62,025    | 186   | 194    | ..... | ..... | 2,400   | 9     | 25    | ..... | .....   |
| Ferrdale, .....            | 41,576    | 38,983    | 202   | 179    | 2     | 2     | 1,250   | 10    | 19    | ..... | .....   |
| Patterson, .....           | 239,040   | 224,640   | 221   | 1,095  | 5     | 3     | 10,080  | 21    | 84    | 2     | .....   |
| Geo. Fales' Washery, ..... | 8,939     | 8,939     | 139   | 2      | ..... | ..... | .....   | ..... | ..... | ..... | .....   |
| Big Mine Run, .....        | 18,079    | 18,079    | 77    | 100    | ..... | ..... | 70      | 1     | ..... | ..... | .....   |
| Totals, .....              | 5,404,823 | 4,973,335 | 6,814 | 19,121 | 78    | 76    | 131,992 | 1,096 | 2,103 | 31    | 154,402 |

\*Consolidated with Henry Clay.

TABLE No. 3.—Showing the number of each class of employes at each colliery in the Seventh Anthracite District during the year 1894.

| Names of Collieries. | Occupations of Persons Employed Inside. |                  |                  |                      |                        |               |   | Occupations of Persons Employed Outside. |                        |                |                        |                                  |                |       |                                 |  |  |  |  |  |  |                |  |  |  |  |  |  |
|----------------------|---|------------------|------------------|----------------------|------------------------|---------------|---|--|------------------------|----------------|------------------------|----------------------------------|----------------|-------|---------------------------------|--|--|--|--|--|--|----------------|--|--|--|--|--|--|
|                      | Inside foremen.                         |                  |                  |                      |                        |               |   | Total Inside.                            |                        |                |                        |                                  |                |       | Outside foremen.                |  |  |  |  |  |  | Total Outside. |  |  |  |  |  |  |
|                      | Miners.                                 | Miners laborers. | All company men. | Drivers and runners. | Door boys and helpers. | Total Inside. |   | Blacksmiths and carpenters.              | Engineers and firemen. | State pickers. | All other company men. | Superintendents and bookkeepers. | Total outside. |       | Grand total inside and outside. |  |  |  |  |  |  |                |  |  |  |  |  |  |
| Alaska.              | 3                                       | 206              | 28               | 34                   | 16                     | 359           | 1 | 9  | 19                     | 95             | 65                     | 2                                | 192            | 551   |                                 |  |  |  |  |  |  |                |  |  |  |  |  |  |
| Reliance.            | 4                                       | 177              | 20               | 19                   | 7                      | 253           | 1 | 7  | 16                     | 103            | 47                     | 2                                | 134            | 436   |                                 |  |  |  |  |  |  |                |  |  |  |  |  |  |
| North Ashland.       | 4                                       | 73               | 12               | 104                  | 7                      | 210           | 1 | 6  | 22                     | 109            | 47                     | 1                                | 186            | 396   |                                 |  |  |  |  |  |  |                |  |  |  |  |  |  |
| Dart.                | 9                                       | 87               | 30               | 112                  | 21                     | 275           | 1 | 5  | 21                     | 116            | 73                     | 2                                | 218            | 493   |                                 |  |  |  |  |  |  |                |  |  |  |  |  |  |
| Lunnel.              |   |                  |                  |                      |                        |               |   |  |                        |                |                        |                                  |                |       |                                 |  |  |  |  |  |  |                |  |  |  |  |  |  |
| Keystone Jig.        | 5                                       | 15               | 14               | 40                   | 8                      | 69            | 1 | 7  | 7                      | 35             | 33                     | 1                                | 59             | 59    |                                 |  |  |  |  |  |  |                |  |  |  |  |  |  |
| Potts.               | 8                                       | 37               | 26               | 102                  | 18                     | 271           | 1 | 3  | 17                     | 67             | 43                     | 1                                | 100            | 192   |                                 |  |  |  |  |  |  |                |  |  |  |  |  |  |
| Merriam.             | 2                                       | 73               | 11               | 4                    | 146                    | 1             | 3 | 5  | 17                     | 67             | 52                     | 2                                | 155            | 412   |                                 |  |  |  |  |  |  |                |  |  |  |  |  |  |
| Monitor.             | 2                                       | 128              | 15               | 63                   | 12                     | 298           | 1 | 4  | 5                      | 36             | 33                     | 1                                | 80             | 226   |                                 |  |  |  |  |  |  |                |  |  |  |  |  |  |
| Locust Gap.          | 5                                       | 145              | 17               | 32                   | 12                     | 275           | 2 | 12                                       | 17                     | 81             | 62                     | 2                                | 172            | 403   |                                 |  |  |  |  |  |  |                |  |  |  |  |  |  |
| Locust Spring.       | 5                                       | 67               | 10               | 43                   | 3                      | 135           | 1 | 8  | 17                     | 97             | 70                     | 2                                | 190            | 475   |                                 |  |  |  |  |  |  |                |  |  |  |  |  |  |
| Buck Ridge.          | 5                                       | 67               | 10               | 43                   | 3                      | 135           | 1 | 4  | 17                     | 47             | 26                     | 1                                | 96             | 231   |                                 |  |  |  |  |  |  |                |  |  |  |  |  |  |
| Big Mountain.        |   |                  |                  |                      |                        |               |   |  |                        |                |                        |                                  |                |       |                                 |  |  |  |  |  |  |                |  |  |  |  |  |  |
| Peerless.            |   |                  |                  |                      |                        |               |   |  |                        |                |                        |                                  |                |       |                                 |  |  |  |  |  |  |                |  |  |  |  |  |  |
| Henry Clay.          | 14                                      | 440              | 91               | 236                  | 80                     | 873           | 4 | 25                                       | 45                     | 205            | 210                    | 5                                | 494            | 1,367 |                                 |  |  |  |  |  |  |                |  |  |  |  |  |  |
| Sterling.            | 4                                       | 210              | 96               | 66                   | 23                     | 414           | 1 | 8  | 19                     | 108            | 111                    | 2                                | 242            | 656   |                                 |  |  |  |  |  |  |                |  |  |  |  |  |  |
| Bear Valley.         | 3                                       | 80               | 12               | 47                   | 10                     | 157           | 1 | 14                                       | 17                     | 68             | 57                     | 1                                | 152            | 300   |                                 |  |  |  |  |  |  |                |  |  |  |  |  |  |
| North Franklin.      | 3                                       | 52               | 18               | 25                   | 6                      | 105           | 1 | 7  | 12                     | 59             | 57                     | 1                                | 137            | 249   |                                 |  |  |  |  |  |  |                |  |  |  |  |  |  |
| Preston No. 2.       |   |                  |                  |                      |                        |               |   |  |                        |                |                        |                                  |                |       |                                 |  |  |  |  |  |  |                |  |  |  |  |  |  |
| Preston No. 3.       | 5                                       | 35               | 20               | 65                   | 9                      | 143           | 1 | 7  | 20                     | 63             | 51                     | 1                                | 143            | 286   |                                 |  |  |  |  |  |  |                |  |  |  |  |  |  |
| Locust Run.          |   |                  |                  |                      |                        |               |   |  |                        |                |                        |                                  |                |       |                                 |  |  |  |  |  |  |                |  |  |  |  |  |  |
| Mid Valley No. 1.    | 1                                       | 121              | 19               | 44                   | 15                     | 205           | 1 | 4  | 7                      | 33             | 67                     | 5                                | 117            | 322   |                                 |  |  |  |  |  |  |                |  |  |  |  |  |  |
| Mid Valley No. 2.    | 1                                       | 9                | 13               | 7                    |                        | 39            | 1 | 1  | 4                      |                |                        |                                  | 10             | 49    |                                 |  |  |  |  |  |  |                |  |  |  |  |  |  |
| Pennsylvania.        | 1                                       | 300              | 125              | 140                  | 56                     | 637           | 1 | 9  | 30                     | 75             | 139                    | 3                                | 238            | 875   |                                 |  |  |  |  |  |  |                |  |  |  |  |  |  |
| Richards.            | 2                                       | 213              | 92               | 69                   | 12                     | 382           | 1 | 5  | 12                     | 123            | 101                    | 1                                | 243            | 635   |                                 |  |  |  |  |  |  |                |  |  |  |  |  |  |
| Hickory Ridge.       | 1                                       | 179              | 82               | 119                  | 22                     | 400           | 1 | 6  | 17                     | 65             | 82                     | 1                                | 202            | 612   |                                 |  |  |  |  |  |  |                |  |  |  |  |  |  |
| Hickory Swamp.       | 1                                       | 207              | 47               | 54                   | 26                     | 370           | 1 | 5  | 10                     | 70             | 70                     | 1                                | 163            | 333   |                                 |  |  |  |  |  |  |                |  |  |  |  |  |  |
| Excelsior.           | 4                                       | 148              | 64               | 41                   | 20                     | 289           | 1 | 7  | 4                      | 70             | 70                     | 3                                | 151            | 414   |                                 |  |  |  |  |  |  |                |  |  |  |  |  |  |



|                              |     |       |       |       |     |       |    |     |     |       |       |       |        |
|------------------------------|-----|-------|-------|-------|-----|-------|----|-----|-----|-------|-------|-------|--------|
| Corbin, .....                | 72  | 37    | 19    | 1     | 137 | 2     | 2  | 1   | 34  | 17    | 1     | 37    | 194    |
| Cameron, .....               | 8   | 482   | 81    | 65    | 11  | 1,031 | 1  | 23  | 24  | 156   | 147   | 354   | 1,385  |
| Lake Field, .....            | 4   | 394   | 111   | 145   | 40  | 29    | 1  | 92  | 87  | 132   | 2     | 267   | 900    |
| Logan, .....                 | 2   | 155   | 36    | 75    | 17  | 5     | 1  | 7   | 38  | 57    | 4     | 217   | 737    |
| Centralia, .....             | 2   | 126   | 32    | 86    | 25  | 12    | 1  | 11  | 24  | 129   | 82    | 212   | 727    |
| Williamstown, .....          | 5   | 335   | 146   | 137   | 59  | 13    | 2  | 14  | 59  | 91    | 162   | 311   | 1,029  |
| Short Mountain, .....        | 5   | 278   | 178   | 148   | 98  | 17    | 2  | 16  | 97  | 190   | 116   | 348   | 1,072  |
| Nelson, .....                | 3   | 227   | 46    | 119   | 27  | 3     | 1  | 12  | 15  | 47    | 54    | 132   | 438    |
| Paterprise, .....            | 1   | 137   | 100   | 32    | 33  | 3     | 1  | 5   | 15  | 64    | 26    | 113   | 424    |
| Mount Carmel, .....          | 1   | 57    | 11    | 45    | 6   | 1     | 4  | 7   | 47  | 34    | 3     | 99    | 323    |
| Morris Ridge, .....          | 3   | 40    | 29    | 29    | 7   | 2     | 1  | 7   | 50  | 29    | 2     | 87    | 177    |
| Columbus No. 1, .....        | 3   | 128   | 15    | 98    | 12  | 5     | 1  | 4   | 46  | 55    | 3     | 115   | 386    |
| Columbus No. 2, .....        | 1   | 79    | 12    | 15    | 16  | 4     | 2  | 4   | 50  | 18    | 1     | 82    | 191    |
| Colbert, .....               | 1   | 55    | 26    | 24    | 5   | 1     | 3  | 3   | 32  | 25    | 1     | 68    | 179    |
| Perndale, .....              | 3   | 152   | 322   | 62    | 33  | 11    | 1  | 16  | 138 | 323   | 4     | 510   | 1,995  |
| Patterson, .....             | 1   | 10    | 12    | 12    | 3   | 1     | 1  | 5   | 23  | 2     | 2     | 30    | 9      |
| George Fales' washery, ..... | 1   | 10    | 12    | 12    | 3   | 1     | 1  | 5   | 23  | 2     | 2     | 30    | 9      |
| Big Mine Run, .....          | 1   | 10    | 12    | 12    | 3   | 1     | 1  | 5   | 23  | 2     | 2     | 30    | 9      |
| Totals, .....                | 132 | 5,719 | 2,061 | 3,014 | 872 | 398   | 48 | 331 | 650 | 3,077 | 2,855 | 7,024 | 19,341 |

\*Consolidated with Henry Clay.

TABLE No. 4.—List of fatal accidents that occurred in the mines of the Seventh Anthracite District for the year ending December 31, 1894.

| Date of accident. | Name of Person Injured. | Age.  | Married or single. | Number of orphans. | Name of Colliery. | Location—County. | Nature and Cause of Accident in Brief.   |
|-------------------|-------------------------|-------|--------------------|--------------------|-------------------|------------------|--|
|                   |                         |       |                    |                    |                   |                  |  |
| Jan. 9.           | Charles Dougherty,      | ..... | .....              | .....              | North Ashland,    | Columbia,        | Fell into monkey rolls; died on January 10.  |
| 10.               | William Drange,         | ..... | .....              | .....              | Burnside,         | Northumberland,  | Injured by fall of coal; died on January 12.   |
| 11.               | William Kessler,        | ..... | .....              | .....              | Locust Spring,    | Northumberland,  | Kicked foot against track tongs; died April 25.  |
| 16.               | John Stabinsky,         | ..... | .....              | .....              | Enterprise,       | Northumberland,  | Injured by premature blast; died on January 17.  |
| Feb. 3.           | Edward Zerty,           | 28 S. | .....              | .....              | Short Mountain,   | Dauphin,         | Killed by a fall of slate.   |
| 20.               | Levi Reed,              | 55 M. | .....              | .....              | Williamstown,     | Dauphin,         | Instantly killed by fall of rock.  |
| March 8.          | John Gallagher,         | 35 M. | .....              | .....              | Locust Gap,       | Northumberland,  | Head cut and ribs broken by fall of coal; died March 12.                               |
| 15.               | John Gundrum,           | ..... | .....              | .....              | Alaska,           | Northumberland,  | Leg mashed by fall of top rock; died March 27.   |
| 17.               | Nathan Jones,           | ..... | .....              | .....              | Williamstown,     | Dauphin,         | Killed by falling under a trip of mine cars.   |
| 17.               | William H. Hoffman,     | 27 S. | .....              | .....              | Williamstown,     | Dauphin,         | Killed by a fall of slate.   |
| 21.               | Michael Monahan,        | 48 M. | .....              | .....              | Preston No. 3,    | Schuylkill,      | Killed by being struck by brake stick in chute.  |
| 21.               | Jerry Kreckbaum,        | 22 S. | .....              | .....              | Henry Clay,       | Northumberland,  | Killed by falling down Garfield slope.   |
| April 9.          | John Monchock,          | 35 M. | .....              | .....              | Sterling,         | Northumberland,  | Shot went off before he had time to turn around; killed instantly.                     |
| 12.               | Sebastian Bowers,       | 40 M. | .....              | .....              | Pennsylvania,     | Northumberland,  | Killed by fall of top coal.  |
| 17.               | George Gensel,          | 23 S. | .....              | .....              | Hickory Swamp,    | Northumberland,  | Piece of coal flew from dump chute, hitting him on temple; died a few hours later.     |
| 23.               | William O. Bateman,     | 44 M. | .....              | .....              | Short Mountain,   | Dauphin,         | Killed by a fall of slate.   |
| May 4.            | Thos. D. Morgan,        | 27 M. | .....              | .....              | Williamstown,     | Dauphin,         | Injured by falling down chute; died May 6.   |
| 4.                | Isaac Gottshall,        | 44 M. | .....              | .....              | Sterling,         | Northumberland,  | Leg broken by fall of top slate; died May 24.  |
| 4.                | James Sterling,         | 34 M. | .....              | .....              | Buck Ridge,       | Northumberland,  | Hurt by fall of slate; died June 23.   |
| 9.                | Richard James,          | 57    | .....              | .....              | Williamstown,     | Dauphin,         | Leg and arm broken and bruised about face and head caused by ignited gas; died May 21. |
| 10.               | James Maley,            | 44 M. | .....              | .....              | Merriam,          | Northumberland,  | Killed by being blown down chute from concussion of explosion of gas.                  |
| 13.               | John Consvitch,         | ..... | .....              | .....              | Ferdale,          | Northumberland,  | Fell off car down slope and drowned.   |
| 14.               | John Franks,            | 33 M. | .....              | .....              | Locust Gap,       | Northumberland,  | Killed by explosion of dynamite while charging rock hole.                              |
| 14.               | John Paul,              | 22 M. | .....              | .....              | Locust Gap,       | Northumberland,  | Killed by explosion of dynamite while charging rock hole.                              |
| 16.               | John Gehres,            | 40 S. | .....              | .....              | Morris Ridge,     | Columbia,        | Fatally injured by fall of rock.   |

|     |                           |       |       |                      |                       |  |
|-----|---------------------------|-------|-------|----------------------|-----------------------|--|
| 19, | Caleb Snyder, .....       | 19    | S.    | Richards, .....      | Northumberland, ..... | While in the act of placing hook in chain on car, slipped and fell off trestle, injuring back; died later. |
| 19, | Charles Greif, .....      | 25    | S.    | Logan, .....         | Columbia, .....       | Instantly killed by being bumped between mine cars.  |
| 22, | Joseph Stahman, .....     | 32    | M.    | Patterson, .....     | Northumberland, ..... | Fatally injured by falls on car catching victim under chin and throwing him out of car; died May 23.       |
| 25, | William Rhorback, .....   | 32    | M.    | Hickory Ridge, ..... | Northumberland, ..... | Sufocated by rush of coal from chute.  |
| 2,  | Michael Monaghan, .....   | 32    | M.    | North Ashland, ..... | Columbia, .....       | Killed by a fall of coal.  |
| 7,  | John Stark, .....         | 36    | M.    | Logan, .....         | Columbia, .....       | Instantly killed by fall of top rock.  |
| 22, | David York, .....         | 36    | M.    | Cameron, .....       | Northumberland, ..... | Fatally burned by explosion of powder.   |
| 22, | John Bartollh, .....      | 40    | M.    | Cameron, .....       | Northumberland, ..... | Fatally burned by explosion of powder.   |
| 26, | John J. McHugh, .....     | 40    | M.    | Locust Gap, .....    | Northumberland, ..... | Killed by fall of rock while robbing pillars.  |
| 30, | Anthony Kunkel, .....     | 25    | S.    | Patterson, .....     | Northumberland, ..... | Killed by fall of top coal.  |
| 3,  | John Barnes, .....        | 25    | M.    | Luke Pidler, .....   | Northumberland, ..... | Instantly killed by falling down shaft   |
| 5,  | Michael Zarreck, .....    | 23    | S.    | Ferdale, .....       | Northumberland, ..... | Killed by a fall of rock.  |
| 16, | John Watkeys, .....       | 42    | M.    | Williamstown, .....  | Dauphin, .....        | Fatally burned by explosion of gas.  |
| 16, | Harry Edwards, .....      | 23    | M.    | Henry Clay, .....    | Northumberland, ..... | Fatally burned by gas.   |
| 16, | William Price, .....      | 52    | M.    | Williamstown, .....  | Dauphin, .....        | Killed by an explosion of gas.   |
| 19, | Joseph Raudenbush, .....  | 40    | M.    | Williamstown, .....  | Dauphin, .....        | While riding on outside of car going up slope, car left track, catching men between car and top rock.      |
| 19, | John Llewellyn, .....     | 43    | M.    | Williamstown, .....  | Dauphin, .....        | While riding on outside of car going up slope, car left track, catching men between car and top rock.      |
| 19, | Martin Tate, .....        | 35    | M.    | Williamstown, .....  | Dauphin, .....        | While riding on outside of car going up slope, car left track, catching men between car and top rock.      |
| 24, | Cornick Kozole, .....     | ..... | ..... | Henry Clay, .....    | Northumberland, ..... | Killed by being shot through heading.  |
| 25, | Alex. Washnot, .....      | ..... | ..... | Big Mountain, .....  | Northumberland, ..... | Killed by fall of rock.  |
| 2,  | Frank Adams, .....        | ..... | M.    | Burnside, .....      | Northumberland, ..... | Killed by fall of coal.  |
| 17, | John Sukey, .....         | 20    | S.    | Locust Gap, .....    | Northumberland, ..... | Walked into counter chute and was killed.  |
| 22, | Charles Suskofsky, .....  | 45    | M.    | Pennsylvania, .....  | Northumberland, ..... | Killed by fall of rock.  |
| 25, | Adam Stibitz, .....       | 61    | M.    | Merriam, .....       | Northumberland, ..... | Killed by fall of coal and slate.  |
| 28, | John Shabinski, .....     | ..... | ..... | Peerless, .....      | Northumberland, ..... | Killed by fall of rock.  |
| 10, | John E. Reed, .....       | 32    | M.    | Patterson, .....     | Northumberland, ..... | Killed by falling through trap door in breaker.  |
| 10, | John Barno, .....         | 40    | M.    | Hickory Swamp, ..... | Northumberland, ..... | Instantly killed by fall of top coal.  |
| 18, | Andrew Feather, .....     | 40    | M.    | Luke Pidler, .....   | Northumberland, ..... | Killed by fall of top rock.  |
| 18, | Rees Davis, .....         | 17    | S.    | Williamstown, .....  | Dauphin, .....        | Kicked by a mule; knocked between timber and wagon.  |
| 21, | George Alexza, .....      | ..... | ..... | Centralla, .....     | Columbia, .....       | Killed by a rush of coal caused by explosion of gas.   |
| 8,  | George Brown, .....       | ..... | ..... | Luke Pidler, .....   | Northumberland, ..... | Sufocated by smoke from mine fire.   |
| 8,  | Stanney Pober, .....      | 8     | ..... | Luke Pidler, .....   | Northumberland, ..... | Sufocated by smoke from mine fire.   |
| 8,  | Michael Knowles, .....    | 8     | ..... | Luke Pidler, .....   | Northumberland, ..... | Sufocated by smoke from mine fire.   |
| 8,  | William Barcavidge, ..... | 8     | ..... | Luke Pidler, .....   | Northumberland, ..... | Sufocated by smoke from mine fire.   |
| 8,  | Irvin Buffington, .....   | 8     | ..... | Luke Pidler, .....   | Northumberland, ..... | Sufocated by smoke from mine fire.   |
| 9,  | Michael Horan, .....      | ..... | ..... | Preston No. 3, ..... | Schuylkill, .....     | Killed by rush of coal.  |
| 11, | Dennis Brennan, .....     | ..... | S.    | Henry Clay, .....    | Northumberland, ..... | Cut and bruised by boiler explosion; died Oct. 24.   |
| 11, | William Boyle, .....      | 11    | ..... | Henry Clay, .....    | Northumberland, ..... | Killed by same boiler explosion.   |
| 11, | Thomas Carr, .....        | 11    | ..... | Henry Clay, .....    | Northumberland, ..... | Killed by same boiler explosion.   |

17-11-94

TABLE NO. 4.—Continued.

| Date of occurrence. | Name of Person Injured. | Age.  | Married or single. | Number of orphans. | Name of Colliery. | Location—County. | Nature and Cause of Accident in Brief.             |
|---------------------|-------------------------|-------|--------------------|--------------------|-------------------|------------------|--|
| Oct.                |                         |       |                    |                    |                   |                  |  |
| 11.                 | J. J. Boham             | ..... | M.                 | 2                  | Henry Clay        | Northumberland   | Killed by same boiler explosion.                   |
| 11.                 | William Eschick         | ..... | S.                 | .....              | Henry Clay        | Northumberland   | Killed by same boiler explosion.                   |
| 11.                 | William McLaughlin      | ..... | M.                 | 7                  | Henry Clay        | Northumberland   | Killed by same boiler explosion.                   |
| 23.                 | Andrew Soroko           | 48    | S.                 | .....              | Patterson         | Northumberland   | Killed by fall of coal striking him on head.       |
| 2.                  | Wally Specht            | ..... | S.                 | .....              | Burnside          | Northumberland   | Head crushed while coupling wagons.                |
| 12.                 | W. H. Schae             | 35    | M.                 | .....              | Patterson         | Northumberland   | Killed by fall of top coal.                        |
| 16.                 | Paul Jessen             | ..... | M.                 | .....              | Pennsylvania      | Northumberland   | Premature explosion of a blast.                    |
| 19.                 | William Yonky           | ..... | S.                 | .....              | Cameron           | Northumberland   | Fell down breast and smothered in chute.           |
| 22.                 | Joseph Kehlke           | 48    | S.                 | .....              | Sterling          | Northumberland   | Squeezed between prop and wagon; died November 29. |
| 23.                 | Enoch Novock            | 19    | S.                 | .....              | Columbia No. 1    | Columbia         | Smothered by rush of coal.                         |
| 28.                 | Lewis Lewalle           | 35    | M.                 | .....              | Pennsylvania      | Northumberland   | Struck by trip of cars and run over.               |
| 4.                  | Gwyn Evans              | 41    | M.                 | 7                  | Centralia         | Columbia         | Killed by blast.                                   |
| 6.                  | Andrew Carduff          | ..... | .....              | .....              | East              | Schuylkill       | Killed by premature explosion of blast             |
| 6.                  | M. Ruel Perofski        | ..... | .....              | .....              | Alaska            | Northumberland   | Injured by mine wagons; died December 8.           |

TABLE No. 5.—List of non-fatal accidents that occurred in the mines of the Seventh Anthracite District for the year ending December 31, 1894.

| Date of accident. | Name of Person Injured. | Name of Colliery. | Location—County. | Nature and Cause of Accident in Brief.                      |
|-------------------|-------------------------|-------------------|------------------|---|
| Jan. 8.           | George Zimavitch.       | Big Mountain.     | Northumberland.  | Back hurt by fall of coal.                                  |
| 9.                | Joseph Merouse.         | Burnside.         | Northumberland.  | Back bruised and head cut by fall of coal.                  |
| 10.               | William Drango.         | Burnside.         | Northumberland.  | Body injured by fall of slate.                              |
| 17.               | George Kurtzkey.        | Morris Ridge.     | Columbia.        | Burned by an explosion of gas.                              |
| 19.               | Joseph Strausser.       | Laake Picher.     | Northumberland.  | Burned by an explosion of gas.                              |
| 19.               | Fred Nichols.           | Laake Picher.     | Northumberland.  | Thigh broken by fall of slate.                              |
| 20.               | B. J. Platzer.          | Short Mountain.   | Dauphin.         | Ribs and collar bone broken by fall of slate.               |
| Feb. 1.           | Frank Clutcher.         | Burnside.         | Northumberland.  | Legs broken by fall of slate.                               |
| 1.                | Hiram Holt.             | Buck Ridge.       | Northumberland.  | Head, face and back cut by rush of coal.                    |
| 6.                | Herman Neidig.          | Buck Ridge.       | Northumberland.  | Head broken by timber rolling on same.                      |
| 12.               | George Dengler.         | East.             | Schuylkill.      | Both legs broken and head cut by fall of coal.              |
| 14.               | Wadley Vesnufski.       | Big Mountain.     | Northumberland.  | Head injured by being knocked down chute.                   |
| 20.               | John Donjeskie.         | Meriam.           | Northumberland.  | Leg broken by being struck with ash dumper.                 |
| 24.               | Michael Reno.           | Burnside.         | Northumberland.  | Wagon jumped off track and caught his head between timbers. |
| 28.               | Joseph Rolson.          | Burnside.         | Northumberland.  | Injured by being squeezed between wagons.                   |
| March 3.          | Roger Magaskie.         | Burnside.         | Northumberland.  | Face and hands burned by explosion of gas.                  |
| 10.               | Henry Rhoades.          | Cameron.          | Northumberland.  | Slightly burned by explosion of gas.                        |
| 12.               | George Colbasky.        | Nelson.           | Northumberland.  | Slightly burned by explosion of gas.                        |
| 12.               | Joseph Markett.         | Nelson.           | Northumberland.  | Slightly burned by explosion of gas.                        |
| 13.               | Michael Cartuek.        | Centralia.        | Columbia.        | Slightly burned by explosion of gas.                        |
| 13.               | Michael Carluek, No. 2. | Centralia.        | Columbia.        | Slightly burned by explosion of gas.                        |
| 13.               | Andrew Mulate.          | Centralia.        | Columbia.        | Hand cut by fall of top coal.                               |
| 19.               | Mike Vesaskie.          | Sterling.         | Northumberland.  | Breast and back hurt by striking head against top of slope. |
| 27.               | Joseph Gaskinsky.       | Enterprise.       | Northumberland.  | Leg cut by buggy chain breaking.                            |
| April 4.          | John Sable.             | Sterling.         | Northumberland.  | Hand mashed by being hit with drill.                        |
| 9.                | William Taby.           | Sterling.         | Northumberland.  | Foot hurt by falling under wagon.                           |
| 9.                | John Wheman.            | Sterling.         | Northumberland.  | Injured by drill while in moving car.                       |
| 13.               | William Comfert.        | Pennsylvania.     | Northumberland.  | Leg broken by fall of coal.                                 |
| 14.               | Michael Gobra.          | Laake Picher.     | Northumberland.  | Leg broken by being struck with rope.                       |
| 23.               | Joseph Carr.            | Monitor.          | Northumberland.  | Foot hurt by getting it under wheel of car.                 |
| 23.               | Thomas Fagan.           | Williamstown.     | Dauphin.         |   |

TABLE No. 5—Continued.

| Date of accident. | Name of Person Injured. | Name of Colliery. | Location—County. | Nature and Cause of Accident in Brief.                             |
|-------------------|-------------------------|-------------------|------------------|--|
| April             | 23. Reuben Koppenhaver. | Williamstown.     | Dauphin.         | Back hurt by fall of rock.   |
|                   | 24. Frank Durlon.       | Sterling.         | Northumberland.  | Head hurt by fall of top slate.                                    |
| May               | 8. Dom. Pearcavitch.    | Williamstown.     | Northumberland.  | Hands and face burned by explosion of gas.                         |
|                   | 10. Richard James.      | Williamstown.     | Dauphin.         | Back and hips hurt by fall of slate.                               |
|                   | 14. Henry Arnold.       | Locust Gap.       | Northumberland.  | Injured by explosion of dynamite.                                  |
| June              | 1. John Thomas.         | Bast.             | Schuylkill.      | Hips bruised; squeezed between mine cars.                          |
|                   | 9. Charles Parker.      | Williamstown.     | Dauphin.         | Left arm broken by fall of slate.                                  |
|                   | 23. Enoch Merouse.      | Burnside.         | Northumberland.  | Feet mashed by fall of slate.                                      |
|                   | 27. Martin Miscba.      | Buck Ridge.       | Northumberland.  | Eye hurt; struck by piece of coal.                                 |
|                   | 27. Frank Doyle.        | Enterprise.       | Northumberland.  | Arm broken and back bruised; caught in belt.                       |
|                   | 28. John Peace.         | Cameron.          | Northumberland.  | Leg broken by fall of coal.  |
|                   | 29. Henry Derr.         | Burnside.         | Northumberland.  | Arm broken by mine wagon.  |
|                   | 30. Henry Holsbauch.    | Patterson.        | Northumberland.  | Hurt by fall of top coal.  |
| July              | 5. Harry Zimmerman.     | Northumberland.   | Northumberland.  | Wrist broken by falling through trap door.                         |
|                   | 6. Thomas Donahue.      | Nelson.           | Northumberland.  | Leg broken by being struck by wagon.                               |
|                   | 26. E. D. Bohner.       | North.            | Northumberland.  | Fingers taken off while coupling wagons.                           |
|                   | 28. Harry Schultz.      | Burnside.         | Northumberland.  | Leg broken by fall of coal.  |
|                   | 30. Irvin Ney.          | Hickory Ridge.    | Northumberland.  | Leg broken by slipping on elevator bucket.                         |
| Aug.              | 21. George Markle.      | Patterson.        | Northumberland.  | Head hurt; squeezed between wagon and prop.                        |
|                   | 30. Antoni Vickski.     | Buck Ridge.       | Northumberland.  | Burned by dropping spark in keg of powder.                         |
| Sept.             | 4. Samuel Reed.         | Cameron.          | Northumberland.  | Foot mashed by wagon running over it.                              |
|                   | 10. Felix Stanzl.       | Luke Fidler.      | Northumberland.  | Leg broken by fall of coal.  |
|                   | 18. Enoch Koleski.      | Hickory Ridge.    | Northumberland.  | Leg broken; caught between dumper and locomotive.                  |
|                   | 21. Bartista Pereno.    | Enterprise.       | Northumberland.  | Head hurt and jaw broken; caught between wagon and top of gangway. |
| Oct.              | 3. Matthew Redusky.     | Luke Fidler.      | Northumberland.  | Hips injured; jammed between car and inside of gangway.            |
|                   | 5. Walter Wisapovich.   | Pennsylvania.     | Northumberland.  | Head cut and arm broken; struck by crank on mindless.              |
|                   | 9. John Malan.          | Henry Clay.       | Northumberland.  | Left leg broken by fall of coal.                                   |
|                   | 11. John Fienkerstein.  | Henry Clay.       | Northumberland.  | Cut and bruised by boiler explosion.                               |
|                   | 19. Peter Heck.         | Henry Clay.       | Northumberland.  | Cut and bruised by boiler explosion.                               |

|     |                            |                       |                       |  |
|-----|----------------------------|-----------------------|-----------------------|--|
| 12. | George Wytca, .....        | Enterprise, .....     | Northumberland, ..... | Leg and arm broken and back hurt by fall of coal.                    |
| 17. | John Marafka, .....        | Enterprise, .....     | Northumberland, ..... | Shoulder bone broken by fall of slate.                               |
| 18. | Joseph Molarick, .....     | Hickory Ridge, .....  | Northumberland, ..... | Fingers mashed between wagons.                                       |
| 19. | Harry F. Zimmerman, .....  | Short Mountain, ..... | Dauphin, .....        | Both legs broken by fall of slate.                                   |
| 15. | Albert Jones, .....        | Pennsylvania, .....   | Northumberland, ..... | Face cut and leg bruised by fall of rock.                            |
| 15. | Mike Friday, .....         | Reliance, .....       | Northumberland, ..... | Back injured by fall of coal.  |
| 19. | Harry Foguish, .....       | Hickory Ridge, .....  | Northumberland, ..... | Fingers squeezed between bumper and locomotive.                      |
| 26. | George Ondo, .....         | Patterson, .....      | Northumberland, ..... | Face hurt by fall of coal.   |
| 27. | Mike Murphy, .....         | Locust Spring, .....  | Northumberland, ..... | Head and shoulder hurt and injured internally; struck by mine car.   |
| 3.  | James Culbertson, .....    | Cameron, .....        | Northumberland, ..... | Leg mangled while robbing pillars.                                   |
| 5.  | Joseph Shuttleworth, ..... | Williamstown, .....   | Dauphin, .....        | Shoulder dislocated and cut and body injured by falling down manway. |
| 6.  | John Ljebach, .....        | Bast, .....           | Schuylkill, .....     | Head and body bruised; pushed in screen.                             |
| 10. | James Chester, .....       | Pennsylvania, .....   | Northumberland, ..... | Nipple breaking on steam pipe, burning body.                         |
| 14. | John Schories, .....       | Cameron, .....        | Northumberland, ..... | Badly injured by premature discharge of shot.                        |
| 18. | George Eubish, .....       | Sterling, .....       | Northumberland, ..... | Bruised about body and two ribs broken; caught under wagon.          |





# EIGHTH ANTHRACITE DISTRICT.

(SCHUYLKILL COUNTY.)

---

Pottsville, Pa., March 8th, 1895.

Hon. Isaac B. Brown,

Secretary of Internal Affairs:

Sir: I have the honor of herewith presenting my annual report as Inspector of Mines of the Eighth Anthracite District for the year 1894.

The number of lives lost for the year was 20, leaving 6 wives widows, and 18 children orphans to mourn the loss of husbands and fathers.

The number of serious non-fatal accidents was 40.

The total production of coal was 3,341,315 tons, and quantity shipped to market and sold at mines was 3,088,794 tons. In this report I have added the production of washeries and several small places. Some of them have not a sufficient number of persons employed to bring them under the provisions of the present mining law, yet the figures showing the amount of coal produced by them may be interesting. The report also contains, besides the usual tables, a description of the principal improvements made during the year.

Yours very respectfully,

JOHN MAGUIRE,

Inspector of Mines.

## Condition of Collieries.

The general condition of the collieries in this district at the end of the year as to health and safety of the persons employed therein was satisfactory. During the year a great deal of work has been done in re-opening and taking the water out of mines that had been abandoned many years ago, and allowed to fill. This work requires a great deal of care on the part of the workmen engaged in it, as well as on the part of those in charge, as the openings are generally found to be badly broken down, the airways closed up and inaccessible, with many unseen dangers in the shape of bad top and sides

with broken and rotten supports that are liable to give way when disturbed. And pent up obnoxious gases that are apt to be disturbed as the water leaves the partly obstructed openings are also encountered. I am pleased to say that great care and every precaution for safety has been taken by the workmen, the officials and engineers in charge, and while a great deal of dangerous work has been accomplished, no accidents have occurred from this source. Some of the mines in this district are attaining a great depth, and we constantly meet with increased dangers requiring constant watchfulness on the part of those in charge to successfully meet the ever changing conditions. A mine may be assumed to be perfectly safe to-day, but changes are liable to occur, particularly where there are heavy pitches with robbed out and inaccessible workings above, which will change the conditions in a short time. Several new fans have been erected which improve and increase the air currents where they have been placed. A considerable number of improvements have been made and are being made in the matter of drainage, which is fast becoming a serious question at the deeper mines.

Special care has been taken to see that the machinery in and around breakers is properly guarded, in order that accidents from this cause may be prevented as far as possible.

#### Mine Fire.

At the Lehigh Coal and Navigation Company's No. 11 shaft, about two o'clock on the morning of November 20, 1894, a fire started in the lamp house which was at foot of empty car hoist plane near foot of shaft. It was discovered by the pumpman after all the other night shift men had been hoisted up the shaft. As the shaft was filled with smoke he made his way up the pump hole and gave the alarm. The fan was stopped and a party of men sent down a hole inside to open doors to prevent the smoke from traveling through the inside workings and to shorten the route of the air current. They accomplished their mission, but being overcome by smoke were assisted by a second party and soon revived after getting to pure air. The fan was then started, which soon cleared shaft of smoke and men got down and fought the fire with buckets until pipes were put down the shaft. They also hoisted the 35 mules out in safety. While this was going on, ashes and water were run down the pump hole to seal it and prevent the fire from getting into that opening. The pumps were stopped and water soon raised at bottom of car hoist and prevented the fire from spreading eastward and also prevented the men from getting to fire in that direction. They then fought it from gangway north of shaft, using rafts until water got too high to get under top of gangway. A line of pipe was then run down the airhole,

which is about 300 feet long, pitching from 80 to 87 degrees, and men traveled up and down that hole and fought the fire from western end until it was extinguished. The timber was burned out from apex of plane to near pump hole, a distance of about 100 feet. The vein being nearly vertical, fell very high where timber was burned, which greatly hindered the men in their work.

Work was not resumed by the end of year, but is now in shape to resume again, about six weeks' work having been lost in extinguishing the fire. The officials acted very promptly and vigorously, and too much credit cannot be given to the men under them, as they worked with a will and determination in preventing the spread of a fire that would have been very expensive to the company and would have entailed a great loss of time to the workmen.

### Colliery Improvements Made During the Year 1894.

#### Albright Colliery.

The former owners having sunk the Black Mine slope to a depth of 705 feet from the surface on an average dip of about 38 degrees south, the present owners, The Albright Coal Company, have continued the slope 300 feet deeper on an average dip of about 55 degrees, and opened the third lift at 1,005 feet from surface. They have also continued the slope as a trial slope, 243 feet deeper, striking the basin about 40 feet below tide level. In the third lift they are now driving a tunnel south, which is now in 350 feet and has cut Black Mine vein on north dip; also the Little Tracy near anticlinal, and will be continued to the Salome vein. They are also pumping the water out of the old Salome slope that was abandoned many years ago, and are now down 380 feet from surface. A 16-foot opening running fan has been erected on Black mine airhole. A pair of new engines to hoist coal from Black mine slope, built by the Vulcan Iron Works, 24x48 inches, have been erected. A new breaker containing about 500,000 feet of lumber and fitted with the most approved machinery is nearing completion.

The Williams Coal Company has pumped the water out of the old Spencer and Milnes slopes on the "Sharon" tract, a distance of 650 feet from surface to old level on a dip of about 24 degrees south, and they are now sinking the slope, which is on the "Spohr" or "Lewis" vein, and are now 100 feet below the old level. The vein is in good condition. A small breaker to handle coal while developing, is being erected, after which a larger structure will be built.

Two Vulcan boilers 18 feet long by 6 feet diameter have been erected.

The Lytle Colliery. The pumping of water from the old workings that were abandoned many years ago has been pushed vigorously

during the year. The water in the old Kear Primrose vein slope is out to the fourth lift. There is yet another lift full of water, but as the workings in this are not very extensive, it will not take long to get the water out of it. A tunnel 105 feet long has been driven from the Primrose fourth lift gangway to the Holmes vein, to tap some of the water from the workings of that vein, which were opened from the Mammoth or White Ash vein slope No. 2. The water has been taken out of the White Ash No. 1 slope to the third lift. Then the No. 2 White Ash slope was reopened and is now following the water down in this slope to the Fourth lift, which is the lowest level opened in these slopes. There is yet 90 to 100 feet vertical of water in the White Ash No. 2 at this writing, December 31, which will be out in a week or two. Pumps have been put in the Forestville slope, and the water has been pumped to a depth of 800 feet from surface. There is yet about 350 feet of water in this slope, but the workings of the lower lift are not very extensive. The pumping of the water from these old workings has been retarded a great deal on account of the slopes and openings being closed and badly broken down, making it very expensive and tedious job to re-open them in order to follow the water down with the pumps. Every precaution has been taken in order to conduct the work safely and successfully.

During the year a new lift 276 feet long was sunk in the No. 2 Primrose slope and gangway turned west, making the fourth lift in this slope. A heading from level of this gangway eastward cuts the face of the fourth lift gangway from the Kear Primrose slope. Eight new Vulcan return tubular boilers, 18 feet by 72 inches, have been erected at the White Ash No. 1 slope. Three new Coatesville return flue boilers, 16 feet by 72 inches, have been erected at the Forestville slope. Nearly 11,000 feet of old water level gangways have been reopened and several miles of ditches made on surface to prevent water from going down to lower levels.

Oak Hill Colliery. A new shaft 655 feet deep to level of fourth lift of Primrose No. 2 slope, has been completed. This shaft is 12 feet by 24½ and is divided into three compartments 2 feet seven inches by 12 feet, and the other 8 feet 4 inches by 12 feet, the latter being used for upcast, on which a new 24-foot diameter Guibal fan, driven by a 20x36 inch direct acting engine, has been placed. A tunnel from bottom of shafts connects with Black Heath gangway. The sinking of this shaft makes an available and good outlet for the Black Heath workings, which could not be connected to upper workings on account of anticlinal between them, and it also improves the ventilation of the whole colliery.

Chamberlain Colliery. The water has been taken out of the Lewis vein slope to bottom or third lift gangway, which is about 900 feet

from surface, on an average dip of about 36 degrees south. This slope had been abandoned and filled with water more than thirty years ago, and much difficulty was found in re-opening it to take water out, as the slope and other openings were badly broken down. After getting the water out, a tunnel was driven north, starting 150 feet west of slope on third lift, cutting the Little Tracy vein at 344 feet, and is being continued to the Big Tracy vein. A new lift of 275 feet has been sunk on the Lewis vein slope and gangways in this new lift started. An airhole has been driven 53 feet west of slope connecting the new lift to the old one. The water has also been pumped out of the slope on Little Tracy vein to bottom, a distance of 535 feet from surface, and the slope sunk 136 feet deeper, at which point gangways were started. An air hole has been driven in Little Tracy vein from Lewis vein slope and connected to Little Tracy solpe. Foundations for a new 20-foot diameter fan, to be driven by an 18x36-inch engine, are now being built. A new pair of hoisting engines for Lewis vein slope, 36x60-inch, fitted with steam brake and steam reverse gearing, are in course of erection. Six new Stirling boilers have been erected and a large new breaker fitted with first class machinery is nearly ready for operation.

Kaska William Colliery. The Dodson Coal Company having sunk a trial slope 360 feet deep on top bench of Mammoth vein about 80 feet west of tunnel to top bench, a hole was driven up opposite south end of tunnel and a double track hoisting slope made of it. A new pair of hoisting engines, 26x36-inch, placed in tunnel to hoist coal from this slope gangway, were extended east and west from bottom of slope, and a tunnel 92 feet long driven to bottom bench about 300 feet east of slope on which gangways are being driven.

A tunnel for return air course on level of heading was also driven from top to bottom bench in inside slope. The tunnel west of bottom of shaft that was in about 425 feet has been extended to 1,434 feet, cutting the south dip of North Dale basin, on which gangways are being driven east and west. They have also started to take the water out of the old Northdale slope, which was abandoned many years ago. This water being out will give a new lift of about 500 feet from level of tunnel to slope gangway. A new Jeansville compound duplex pump was put in at bottom of shaft, high pressure cylinders, 42 inches diameter, low pressure 25½ inches diameter, 36-inch stroke, with plungers 12-inch diameter. A hole was bored from surface 500 feet long, 10 inches diameter, in which an 8-inch diameter pipe was placed to carry steam to pumps and inside engines, instead of having steam pipes in shaft. Three new Jeansville boilers, 18x6 feet, have been added to steam plant. A new dirt plane has been

made, and a new pair of engines, 12x18-inch, erected for dirt plane. The breaker has been repaired, remodeled and fitted up with new machinery, and was started in October last.

Morea Colliery. A shaft 12 by 15 feet, divided into two compartments of 7x12 each, was started inside in Mammoth vein, and was sunk 165 feet, cutting through the seven-foot vein, when it was decided to sink the shaft from the surface to where it was started inside. This has been completed, the distance from surface to gangway below being 178 feet, making total depth 343 feet. They expected to sink about 100 feet deeper to cut Buck Mountain vein.

Two new Jeansville boilers have been added to steam plant.

Roberts Colliery. In August last, the Roberts Coal Company took possession of the Schuylkill Valley colliery, lately operated by Lefler, McTurk & Co., and changed the name to Roberts Colliery, and at once began to make repairs and improvements to put the colliery in condition, so that mining could be prosecuted on a larger scale. They have enlarged and retimbered slope which is on Holmes vein 120 feet long on south dip of 54 degrees, and have built a plane and trestle from top of slope to grading, level with top of breaker, and doing away with outside plane hoist. They have started a tunnel at bottom of slope to cross basin to north dip; it is now in 118 feet and has cut the "Church" or "Primrose" vein. They have also built a gravity plane outside to run coal from stripping and upper drifts to breaker. The breaker has also been remodeled and new machinery put in.

East Ridge Colliery. The East Ridge Coal Company took charge of the Kechline or Mine Hill colliery and changed name to East Ridge colliery, and commenced to make improvements with a view of increasing the output. They are building a new breaker, and are sinking a new lift on the "Billy" vein slope, also reopening the old Hill water level tunnel to work the Buck Mountain vein, which was not worked when tunnel was driven. They are also driving gangways on Buck Mountain vein in Conner tunnel.

Greenwood No. 13 Colliery. The breaker of this colliery having been destroyed by fire November 30, 1893, a new breaker has been erected, which was started to prepare coal on 17th of April. A large flue boiler of Baldwin manufacture has been added to steam plant.

Tamaqua Colliery. Messrs. Beard and Farber have erected a new breaker, which was started to work in November. They have also erected a new large locomotive boiler.

Losch, Moore & Co., having leased the old Lorberry colliery, are erecting a new breaker and have a few men opening up work in the old Wheeler tunnel, from which they expect to get their coal by robbing the old Mammoth vein workings.

At the Blackwood colliery, the Lehigh Valley Coal Company has erected a 16-foot double fan on shaft over the Blackwood tunnel,

which takes the place of two fans that were placed higher up the mountain. This new fan improves the ventilation, besides shortening the steam lines and preventing the fumes from mine locomotives from entering the workings.

The Lehigh Coal and Navigation Company has made the following improvements:

At Colliery No. 8 a new dirt plane has been erected 544 feet long, on a pitch of  $18\frac{1}{2}$  degrees, giving a vertical height of 70 feet above old banks. The steam power has been increased by adding two batteries 416 horse power, of Babcock and Wilcox boilers.

At colliery No. 12, a trial slope has been sunk 74 yards below the present level on the Primrose vein, with the view of developing a new lift. A new pump room, 50x20 feet, has been excavated in the top rock of the Primrose vein, and a new Jeansville duplex pump put in place.

A drill hole has been sunk from the surface 315 feet vertical, and an 8-inch steam pipe laid to the new pump.

At the collieries of the Philadelphia and Reading Coal and Iron Company the following improvements have been made:

At Brookside Colliery. The East Brookside slope has been sunk to basin, a distance of 2,327 feet from surface. A tunnel from the No. 5 vein to the No. 4 vein on the No. 4 level has been driven and air-hole driven to surface on the No. 4 vein, on which a new 21-foot diameter fan, driven by a 16x30-inch engine, has been erected to ventilate the East Brookside workings. In the No. 4 slope, the inside or Basin slope has been sunk from the third to the fourth lift, and is still sinking. This slope is sinking eastward along dip of basin, starting at bottom of an inside slope, which is about 800 feet east of the bottom of No. 4 slope. The pitch distance to face of basin slope from surface or top of No. 4 slope is about 3,500 feet, with a vertical depth of about 1,000 feet.

Lincoln Colliery. The No. 1 vein slope has been sunk 737 feet below the fourth lift and is still sinking. The No. 2 vein slope has been sunk 570 feet below the fourth lift and is still sinking, with a view of opening two new lifts in each slope. This colliery is the largest producer in the district, and the improvements now being made will keep it in the front rank for many years. Two new tubular boilers, 18 feet long by 6 feet diameter, have been added to the steam plant, and a tail rope plant is now in course of erection to haul the coal from top of slopes to breaker.

Good Spring Colliery. The tender slope has been sunk 373 feet below the first lift gangway and new lift gangways started. This slope is on the Mammoth vein and tunnels will be driven from new lift north and south to under and overlying veins.

A new screen building has been erected on the site of the old Kalmia colliery breaker, which was put in operation in December to wash coal from the old Kalmia colliery dirt banks. It is fitted up with the most approved machinery.

Middle Creek Shaft. This shaft, having previously been sunk to the Primrose vein at a depth of 597 feet, and the coal on that level having been exhausted, it has been sunk 190 feet deeper, making a total depth from surface of 787 feet. From this new level, tunnels will be driven north and south, cutting the Holmes, Primrose, Mammoth and Buck Mountain seams, which will give this colliery a new lease of life.

Otto Colliery. The workings of the fourth lift of "Nest" or Holmes vein slope being nearly exhausted, with exception of robbing the west "White Ash" or bottom bench of Mammoth vein and the east gangway of Primrose vein, a new lift of 300 feet has been sunk in the Primrose vein slope and a tunnel driven 147 feet long to Holmes vein, on which a hole will be driven to connect main hoisting slope in this vein to the level. This tunnel has been continued 132 feet farther, cutting the "Black Heath" or top bench of Mammoth vein, on which an air hole is being driven to level above. The tunnel will be continued to "White Ash" or bottom bench of Mammoth. A new 12-foot diameter Guibal fan was erected on Primrose vein airhole, which was started on September 15, last, which improves the ventilation, being confined to the Primrose vein and new lift, while the old fan ventilates the old lift only. In the White Ash basin, or bore hole slope, a new self-acting plane has been made at No. 58 breast on south dip plane, west gangway. This plane is 70 yards long.

In the "Meed" drift, a tunnel has been driven from the Primrose vein to the Holmes vein in south dip 190 feet long. A new 12-foot diameter forcing fan has been erected to ventilate the workings of this drift.

Phoenix Park No. 3 Colliery. A new lift, 315 feet, has been sunk in slope which is on Diamond vein, making the fifth lift of this slope. Gangways are being driven on this new lift to take the place of fourth lift gangways, which are driven to boundary and are being robbed back. The breaker has been remodeled, and additional machinery put into it, which increases its capacity.

Glendower Colliery. A hole has been driven to surface a distance of about 900 feet, 50 yards west of hoisting slope, which is intended to be enlarged for a new pumping slope.

In the Taylorville slope, a tunnel 150 feet long has been driven to the Buck Mountain vein, which was found in good condition, and gangways are being driven east and west.



At the Thomaston colliery a plane has been made in the Buck Mountain vein 414 feet long.

At the Pine Forest colliery a trial slope has been sunk on the Buck Mountain vein 100 yards long from water level. Three holes 8 inches diameter have been bored 243 feet long from surface to top of slope. Two of them are being used for hoisting ropes, and the other to take steam down to pumps. At the Eagle Hill colliery a new lift, 107 yards long, has been sunk in the Holmes vein slope, which makes the fifth lift, and is about 1,700 feet from surface. A tunnel 150 feet long has been driven from Holmes to Primrose veins and gangway driven to line of Primrose slope which will be extended to this level. An air tunnel also 150 feet long has been driven from Holmes to Primrose veins on level of heading, for ventilation. A tunnel has been driven north from Holmes vein 610 feet long, cutting the seven foot top and bottom benches of Mammoth and Skidmore veins, which will be continued to the Buck Mountain veins. Gangways are being driven on all veins cut in tunnels, and airholes are being driven, which will make this colliery a large producer when the improvements now under way are completed.

Silver Creek Shaft Colliery. The hoisting shaft of this colliery, which is 914 feet deep to top bench of Mammoth vein, was completed in 1893, at the bottom of which tunnels have been driven north to bottom bench of Mammoth and Skidmore veins and south to Seven-foot vein. A plane was driven on bottom bench of Mammoth, and tunnel driven south 240 feet, cutting the top bench of Mammoth and Seven-foot veins. An airhole on Seven-foot vein, 1,100 feet long, was driven from shaft level, connecting with air shaft, which is 719 feet deep, and which is divided into two compartments, one 10x10 feet, for upcast airway, on which a 21-foot diameter fan with double inlet has been placed to produce ventilation; the other compartment 7x10 feet, is used for lowering and hoisting the men. A traveling way for men has also been made to bottom of upcast shaft. Separate airholes have also been made, connecting each gangway in each vein to upcast. The breaker, which started to prepare coal in November, 1893, is fitted up with first-class machinery and every modern improvement for the preparation of coal. The machinery erected at this colliery is of the best and most substantial order, and special care has been taken in opening and laying out the work, both inside and outside, to secure safety and convenience.

The examination of applicants for certificates of qualification as mine foremen was held at the court house at Pottsville in July, 1894. The board consisted of John Maguire, Inspector; Thomas Doyle, superintendent; James P. Walsh and William H. Willoughby, miners.

The following named persons were recommended by the board to the Secretary of Internal Affairs for certificates of qualification as mine foremen:

Louis Lorenz, Jr., Middleport.  
 Pat. J. Purcell, Heckscherville.  
 John W. Dempsey, Minersville.  
 Mich. Moses, Morea.  
 Elijah Hale, York Farm.  
 John Sheiblehut, Yorkville.  
 Henry Culbert, Joliette.

Table showing quantity of coal produced, number of fatal accidents and number of tons of coal produced per life lost by the different companies and individual firms during the year 1894:

|   | Quantity of coal produced. | Number of fatal accidents. | Quantity of coal produced per life lost. |
|---|----------------------------|----------------------------|--|
| Philadelphia and Reading Coal and Iron Company, . . . . . | 1,822,860                  | 10                         | 182,286                                  |
| Lehigh Coal and Navigation Company, . . . . .             | 603,922                    | 6                          | 100,653 $\frac{2}{3}$                    |
| Lehigh Valley Coal Company, . . . . .                     | 153,159                    | None.                      |  |
| Dodson Coal Company, . . . . .                            | 168,969                    | 1                          | 168,969                                  |
| Lytle Coal Company, . . . . .                             | 36,768                     | 1                          | 36,768                                   |
| Albright Coal Company, . . . . .                          | 47,581                     | 1                          | 47,581                                   |
| Chamberlain Coal Company, . . . . .                       | 1                          | 1                          | 1  |
| Individual firms, . . . . .                               | 508,056                    | None.                      |  |
| Totals, . . . . .   | 3,341,315                  | 20                         | 167,065 $\frac{1}{3}$                    |

Table showing the number of each class of employes in Eighth Anthracite District for 1894:

Inside.

|   |       |
|---|-------|
| Inside foremen and fire bosses, . . . . . | 127   |
| Miners, . . . . .                         | 2,541 |
| Miners' laborers, . . . . .               | 1,011 |
| All other company men, . . . . .          | 2,052 |
| Drivers and runners, . . . . .            | 387   |
| Door boys and helpers, . . . . .          | 163   |
| Total, . . . . .                          | 6,281 |

Outside.

|                                       |       |
|---------------------------------------|-------|
| Outside foremen, . . . . .            | 58    |
| Blacksmiths and carpenters, . . . . . | 228   |
| Engineers and firemen, . . . . .      | 482   |
| Slate pickers, . . . . .              | 1,605 |

|                                   |             |
|-----------------------------------|-------------|
| All other company men, .....      | 2,016       |
| Superintendents and clerks, ..... | 64          |
|                                   | <hr/>       |
| Total, .....                      | 4,453       |
|                                   | <hr/> <hr/> |

## Summary.

|   |                       |
|---|-----------------------|
| Tons of coal produced, .....  | 3,341,315             |
| Tons of coal shipped and sold at mines, .....                                 | 3,088,794             |
| Tons of coal used at mines for steam and other purposes, ..                   | 252,521               |
| Tons of coal produced by washeries which are added to total production, ..... | 234,105               |
| Number of fatal accidents, .....  | 20                    |
| Number of non-fatal accidents, .....  | 40                    |
| Number of wives left widows, .....  | 6                     |
| Number of children made fatherless, .....                                     | 18                    |
| Number of persons employed, .....   | 10,734                |
| Number of kegs of powder used, .....  | 45,296                |
| Number of pounds dynamite used, .....   | 228,987               |
| Number of steam boilers in use, .....   | 771                   |
| Number of horses and mules, .....   | 1,153                 |
| Number of mine locomotives, .....   | 15                    |
| Tons of coal produced per fatal accident, .....                               | 167,065 $\frac{1}{2}$ |
| Tons of coal produced per non-fatal accident, .....                           | 83,532 $\frac{1}{2}$  |
| Tons of coal produced per each employe, .....                                 | 311 $\frac{1}{2}$     |
| Number of mines in operation, .....   | 44                    |
| Number of washeries in operation, .....                                       | 12                    |
| Number of collieries idle, .....  | 4                     |
| Number of collieries doing pumping only,.....                                 | 3                     |
| Small places for local sales, not enumerated in report..                      | 7                     |
|   | <hr/> <hr/>           |

## CLASSIFICATION OF FATAL AND NON-FATAL ACCIDENTS FOR 1894.

| Cause of Accidents.                                  | Fatal. | Non-fatal. | Totals. |
|--|--------|------------|---------|
| Explosions of fire damp, .....                       | 1      | 5          | 6       |
| Falls of coal and roof, .....                        | 6      | 10         | 16      |
| Crushed by mine cars, .....                          | 3      | 4          | 7       |
| By machinery on surface, .....                       | 1      | 5          | 6       |
| By falling down slope, .....                         | 1      | None,      | 1       |
| By blasts and explosion of blasting material, .....  | None,  | 9          | 9       |
| By explosion of boiler, .....                        | None,  | 1          | 1       |
| By steam pipe bursting inside, .....                 | 1      | None,      | 1       |
| By falling from trestle, .....                       | 1      | None,      | 1       |
| Kicked by mule, .....                                | 1      | None,      | 1       |
| By miscellaneous causes inside and on surface, ..... | 5      | 6          | 11      |
|  | <hr/>  | <hr/>      | <hr/>   |
| Total accidents, .....                               | 20     | 40         | 60      |

## Classification and Percentage of Fatal Accidents.

Explosions of fire damp, 1 killed, equal to 5 per cent.  
Falls of coal and roof, 6 killed, equal to 30 per cent.  
Crushed by mine cars, 3 killed, equal to 15 per cent.  
By machinery on surface, 1 killed, equal to 5 per cent.  
By falling down slope, 1 killed, equal to 5 per cent.  
By steam pipe bursting inside, 1 killed, equal to 5 per cent.  
By falling off trestle, 1 killed, equal to 5 per cent.  
Kicked by mule, 1 killed, equal to 5 per cent.  
Miscellaneous causes, 5 killed, equal to 25 per cent.  
Total, 20 killed, equal to 100 per cent.

TABLE No. 1.—Showing location, etc., of collieries in the Eighth Anthracite District.

| Names of Collieries.      | Name of Operator.                          | Location—Schuylkill county. | Name of Superintendent.  | Postoffice Address.           |
|---------------------------|--|-----------------------------|--------------------------|-------------------------------|
| West Brookside, .....     | Philadelphia and Reading Coal and Iron Co. | Tower City, .....           | R. C. Luther, .....      | Pottsville, Schuylkill Co.    |
| Lincoln, .....            | do.  | Lottery, .....              | do.                      | do.                           |
| Kahnia Washery, .....     | do.  | Kohala, .....               | do.                      | do.                           |
| Good Spring, .....        | do.  | Good Spring, .....          | do.                      | do.                           |
| East Franklin, .....      | do.  | Trebout, .....              | do.                      | do.                           |
| Middle Creek, .....       | do.  | Branchdale, .....           | do.                      | do.                           |
| Phoenix Park No. 3, ..... | do.  | Phoenix Park, .....         | do.                      | do.                           |
| Thomaston, .....          | do.  | Hochschersville, .....      | do.                      | do.                           |
| Richardson, .....         | do.  | Glen Carbon, .....          | do.                      | do.                           |
| Blendover, .....          | do.  | Glendower, .....            | do.                      | do.                           |
| Beechwood, .....          | do.  | St. Clair, .....            | do.                      | do.                           |
| Empire Hill, .....        | do.  | St. Clair, .....            | do.                      | do.                           |
| Engle Hill, .....         | do.  | Eagle Hill, .....           | do.                      | do.                           |
| Crack shaft, .....        | do.  | Silver Creek, .....         | do.                      | do.                           |
| Oakdale Washery, .....    | do.  | Glen Carbon, .....          | do.                      | do.                           |
| Wadesville shaft, .....   | do.  | Wadesville, .....           | do.                      | do.                           |
| Phoenix Park No. 2, ..... | do.  | Phoenix Park, .....         | do.                      | do.                           |
| North Brookside, .....    | do.  | Good Spring, .....          | do.                      | do.                           |
| No. 8 colliery, .....     | Lehigh Coal and Navigation Company, .....  | Coaldale, .....             | W. D. Zehner, .....      | Lansford, Carbon county.      |
| No. 10 colliery, .....    | do.  | Rahn township, .....        | do.                      | do.                           |
| No. 11 colliery, .....    | do.  | do.                         | do.                      | do.                           |
| No. 12 colliery, .....    | do.  | do.                         | do.                      | do.                           |
| Morea, .....              | Dodson Coal Company, .....                 | Morea, .....                | Dan. J. Thomas, .....    | Morea, Schuylkill county.     |
| York Farm, .....          | do.  | Middleport, .....           | do.                      | do.                           |
| Kaska-William, .....      | do.  | Yorkville, .....            | W. A. Lathrop, .....     | Wilkes-Barre, Luzerne Co.     |
| Blackwood, .....          | Lehigh Valley Coal Company, .....          | Blackwood, .....            | do.                      | do.                           |
| Greenwood No. 13, .....   | do.  | Tamaqua, .....              | do.                      | Tamaqua, Schuylkill Co.       |
| East Lehigh, .....        | Beddall Bros., .....                       | do.                         | M. A. Gerber, .....      | do.                           |
| West Lehigh, .....        | Dunkleberger & Shepp, .....                | do.                         | John Young, .....        | do.                           |
| Oak Hill, .....           | Leisenring & Co., .....                    | do.                         | Wm. Schwenk, .....       | do.                           |
| Lattle, .....             | Lytle Coal Co., .....                      | Minersville, .....          | D. J. Lewis, .....       | Minersville, Schuylkill Co.   |
| Albright, .....           | Albright Coal Company, .....               | Dawson, .....               | James Archibald, .....   | do.                           |
| Chamberlain, .....        | Chamberlain Coal Company, .....            | St. Clair, .....            | Francis A. Poocek, ..... | Pottsville, Schuylkill Co.    |
| Blissworth, .....         | Davis Bros., .....                         | Broad Mountain, .....       | John H. Davis, .....     | do.                           |
| Venus Washery, .....      | do.  | do.                         | do.                      | St. Clair, Schuylkill county. |
| Roberts, .....            | Roberts Coal Company, .....                | Dark Water, .....           | D. H. Levan, .....       | do.                           |
| Flowers Field, .....      | Geo. U. Sturdivant, .....                  | Wadswille, .....            | G. W. Sturdivant, .....  | Hazleton, Luzerne county.     |
| Orchard, .....            | Taylor, McTurk & Co., .....                | do.                         | Rich White, .....        | Pottsville, Schuylkill Co.    |
| Howard, .....             | do.  | do.                         | do.                      | St. Clair, Schuylkill county. |
| Red Ash, .....            | George Troutman, .....                     | do.                         | G. O. Troutman, .....    | Wade, Schuylkill county.      |
| Mt. Hope, .....           | Linderman & Co., .....                     | St. Clair, .....            | Saml. L. Kynor, .....    | Pottsville, Schuylkill Co.    |
| Eagle, .....              | Thomas Croxton, .....                      | do.                         | Thomas Croxton, .....    | St. Clair, Schuylkill county. |
| Williams, .....           | Williams Coal Company, .....               | Fishbach, .....             | W. T. Smyth, .....       | Pottsville, Schuylkill Co.    |

TABLE No. 1.—Continued.

| Names of Collieries.         | Name of Operator.        | Location—Schuylkill county. | Name of Superintendent. | Postoffice Address.                   |
|------------------------------|--------------------------|-----------------------------|-------------------------|---------------------------------------|
| Mine Hill                    | P. J. Courtenay          | Heckscherville              | P. J. Courtenay         | Minersville, Schuylkill Co.           |
| East Ridge, late Mine Hill   | East Ridge Coal Company  | do                          | do                      | do                                    |
| Bell                         | Gorman & Co.             | Brookville                  | Jos. Gorman             | Port Carbon, Schuylkill Co.           |
| Oakley                       | Louis Lorenz & Sons      | Tuscarora                   | Louis Lorenz            | Middleport, Schuylkill Co.            |
| Oakley                       | Beddall & Burchill       | do                          | Geo. Burchill           | Tuscarora, Schuylkill Co.             |
| Broad Mt. Coal Co. Washery   | Broad Mt. Coal Company   | Dark Water                  | James J. Whims          | St. Clair, Schuylkill county          |
| Rolf Washery                 | Fernwood Coal Company    | Forestville                 | Harry Meyers            | Minersville, Schuylkill Co.           |
| Wolf Creek Washery           | Stoddard Coal Company    | Forestville                 | J. I. Hollenbeck        | Pottsville, Schuylkill Co.            |
| Forestville Coal Co. Washery | Forestville Coal Company | Forestville                 | C. P. Sherk             | Lebanon, Lebanon county               |
| Palmer Washery               | Tyler and McTurk         | New Philadelphia            | Patrick Kelly           | Silver Creek P. O., Schuylkill county |
| Coal Hill Washery            | William Basler           | Middleport                  | Wm. Basler              | Middleport, Schuylkill Co.            |
| Reynolds Washery             | Shindle & Beard          | Walker township             | Geo. M. Christ          | Tamaqua, Schuylkill Co.               |
| Pine Dale Washery            | Priest & Dome            | Middleport                  | do                      | do                                    |
| Woodside Colliery            | Beddow and McCready      | Forestville                 | Harry McCready          | Minersville, Schuylkill Co.           |
| Black Heath Colliery         | James Bros.              | Cass township               | Llewellyn Jones         | do                                    |
| Pine Hill Colliery           | Pine Hill Coal Company   | do                          | Wm. E. Adams            | do                                    |
| Mountain Colliery            | John Bergan              | Heckscherville              | John Bergan             | Heckscherville, Schuylkill county     |
| Sebastapol                   | Joseph H. Denning        | St. Clair                   | Jos. H. Denning         | St. Clair, Schuylkill county          |
| Timofuc                      | Beard & Faber            | Tamaqua                     | Chas. Beard             | Tamaqua, Schuylkill Co.               |
| Little Diamond               | John A. Laurence & Co.   | Minersville                 | W. W. Scott             | Minersville, Schuylkill Co.           |
| Newcastle Washery            | T. B. Palm               | Dark Water                  | F. B. Palm              | Reading, Pa.                          |



TABLE No 2.—Continued.

| Names of Collieries.                 | Location—Schuylkill county. | Total production in tons of coal. | Total shipment in tons of coal. | Number days worked. | Number persons employed. | Number fatal accidents. | Number non-fatal accidents. | Number kegs powder used. | Number steam boilers. | Number horses and mules. | Number mine locomotives. | Pounds of dynamite used. |
|--------------------------------------|-----------------------------|-----------------------------------|---------------------------------|---------------------|--------------------------|-------------------------|-----------------------------|--------------------------|-----------------------|--------------------------|--------------------------|--------------------------|
| West Lehigh,                         | Tamaqua,                    | 17,420                            | 12,849                          | 235                 | 52                       |                         |                             | 410                      | 5                     |                          | 1                        | 1,350                    |
| Oak Hill,                            | Minersville,                | 118,360                           | 107,854                         | 209                 | 317                      |                         | 5                           | 1,922                    | 20                    | 20                       |                          | 9,550                    |
| Lytle,                               | Minersville,                | 36,788                            | 33,499                          | 313                 | 250                      | 1                       |                             | 111                      | 51                    | 18                       |                          | 6,000                    |
| Albright,                            | Lewistown,                  | 47,581                            | 39,511                          | 230                 | 164                      | 1                       | 2                           | 240                      | 10                    | 10                       |                          | 5,000                    |
| Chamberlain,                         | St. Clair,                  |                                   |                                 | 313                 | 274                      | 1                       |                             | 105                      | 6                     |                          |                          | 9,800                    |
| Ellisworth,                          | Broad Mountain,             | 13,990                            | 18,825                          | 273                 | 72                       |                         |                             | 370                      | 2                     |                          |                          | 1,450                    |
| Venus washery,                       | Broad Mountain,             | 21,471                            | 22,891                          | 240                 | 11                       |                         |                             |                          |                       |                          |                          |                          |
| Roberts,                             | Darkwater,                  | 12,529                            | 11,759                          | 190.5               | 68                       |                         |                             | 211                      | 4                     | 9                        |                          |                          |
| Flowersy Field,                      | Wadesville,                 | 3,365                             | 3,199                           | 22                  | 79                       |                         |                             | 150                      | 6                     | 6                        |                          |                          |
| Orehard,                             | Wadesville,                 |                                   |                                 |                     | 4                        |                         |                             |                          | 2                     | 1                        |                          |                          |
| Howard,                              | Wadesville,                 | 1,199                             | 1,079                           | 18                  | 54                       |                         |                             | 40                       | 4                     | 4                        |                          |                          |
| Red Ash,                             | Wadesville,                 | 2,612                             | 3,250                           | 140.25              | 24                       |                         |                             | 145                      | 3                     | 3                        |                          |                          |
| St. Hope,                            | St. Clair,                  | 61,483                            | 56,983                          | 227                 | 133                      |                         |                             | 696                      | 11                    | 10                       | 1                        | 3,775                    |
| Eagle,                               | St. Clair,                  | 3,881                             | 3,331                           | 229                 | 21                       |                         |                             | 150                      | 3                     | 3                        |                          | 270                      |
| Williams,                            | Fishback,                   |                                   |                                 |                     | 56                       |                         |                             | 12                       | 3                     |                          |                          |                          |
| Mine Hill,                           | Heckscherville,             | 2,975                             | 2,975                           | 215                 | 23                       |                         |                             | 85                       | 3                     | 4                        |                          | 500                      |
| East Ridge, late Mine Hill,          | Heckscherville,             |                                   |                                 | 88.5                | 69                       |                         |                             | 110                      | 6                     | 6                        |                          |                          |
| Pell,                                | Brookville,                 | 4,131                             | 3,826                           | 122                 | 18                       |                         |                             | 250                      | 2                     | 2                        |                          | 100                      |
| Oakley,                              | Tuscarora,                  | 3,365                             | 3,365                           | 216                 | 10                       |                         |                             | 50                       | 3                     | 3                        |                          | 25                       |
| Broad Mountain Coal Company washery, | Darkwater,                  | 31,983                            | 34,473                          | 204                 | 39                       |                         |                             |                          |                       |                          |                          |                          |
| Roffe washery,                       | Foresville,                 | 21,826                            | 31,126                          | 175                 | 11                       |                         |                             |                          |                       |                          |                          |                          |
| Wolf Creek washery,                  | Minersville,                | 27,291                            | 25,646                          | 185                 | 48                       |                         |                             |                          |                       |                          |                          |                          |
| Forestville Coal Company washery,    | Forestville,                | 16,962                            | 16,375                          | 162                 | 15                       |                         |                             |                          |                       |                          |                          |                          |
| Palmer washery,                      | New Philadelphia,           | 42,596                            | 42,281                          | 291.75              | 29                       |                         |                             | 49,281                   | 3                     | 1                        | 5                        |                          |
| Coal Hill washery,                   | Middleport,                 | 2,566                             | 2,566                           | 60.5                | 7                        |                         |                             |                          | 1                     | 1                        |                          |                          |
| Reynolds washery,                    | Walker township,            | 1,552                             | 1,284                           | 67                  | 16                       |                         |                             |                          | 2                     | 2                        |                          |                          |
| Pine Dale washery,                   | Middleport,                 | 8,624                             | 8,109                           | 206                 | 6                        |                         |                             |                          |                       |                          |                          |                          |
| Woodside,                            | Forestville,                | 1,571                             | 1,571                           | 133                 | 10                       |                         |                             | 72                       | 3                     | 3                        |                          |                          |
| Black Heath,                         | Cass township,              | 2,879                             | 2,567                           | 234.5               | 9                        |                         |                             |                          |                       |                          |                          |                          |
| Pine Hill,                           | Cass township,              | 2,315                             | 2,145                           | 170                 | 12                       |                         |                             | 40                       | 1                     | 1                        |                          | 200                      |
| Mountain,                            | Heckscherville,             | 2,265                             | 1,715                           | 220                 | 8                        |                         |                             | 21                       | 2                     | 2                        |                          | 250                      |
| Sebastopol,                          | St. Clair,                  | 3,638                             | 3,638                           | 377                 | 16                       |                         |                             | 50                       | 1                     | 1                        |                          |                          |



|  |           |           |          |        |       |       |        |       |       |       |         |
|--|-----------|-----------|----------|--------|-------|-------|--------|-------|-------|-------|---------|
| Tamaqua, .....                         | 760       | 696       | 31.5     | 25     | ..... | 23    | .....  | 1     | ..... | 43    |         |
| Little Diamond, .....                  | 6,747     | 6,047     | 186.5    | 22     | ..... | 199   | .....  | 5     | ..... | 50    |         |
| New Castle washery, .....              | .....     | 5,349     | 259      | 5      | ..... | ..... | .....  | ..... | ..... | ..... |         |
| Seven small places, local sales, ..... | .....     | 1,689     | .....    | 35     | ..... | ..... | .....  | ..... | ..... | ..... |         |
| Totals, .....                          | 3,241,315 | 3,088,794 | 19,179.4 | 10,734 | 29    | 30    | 45,296 | 771   | 1,133 | 15    | 228,987 |

Note.—Shipments from Roberts' colliery include 9,500 tons shipped by Tyler, McTurk & Co., who operated colliery 184½ days, then sold to Roberts Coal Co. Shipments from Red Ash colliery include 792 tons shipped by William Walters, Jr., who operated colliery 431 days, then sold to Troutman & Sons. Shipments from Oakley colliery include 2,367 tons shipped by Lorenz & Sons, who operated colliery 174 days, then sold to Laddal & Burchall. Shipments from Wolf Creek washery include 3,836 tons shipped by Otterbein & Cumming, who operated 59½ days, then sold to Stoddard Coal Company. The Orchard and Howard collieries were purchased by Beaumont Coal Company in May, since which time no shipments have been made.

TABLE No. 3.—Showing the number of each class of employes at each colliery in the Eighth Anthracite District, during the year 1894.

| Names of Collieries.                        | Occupations of Persons Employed Inside. |         |                   |                  |                      |                        | Occupations of Persons Employed Outside. |                  |                             |                     |                |                        | Grand total inside and outside. |  |
|---|---|---------|-------------------|------------------|----------------------|------------------------|--|------------------|-----------------------------|---------------------|----------------|------------------------|---------------------------------|--|
|   | Occupations of Persons Employed Inside. |         |                   |                  |                      |                        | Occupations of Persons Employed Outside. |                  |                             |                     |                |                        |                                 |  |
|   | Inside foremen.                         | Miners. | Miners' laborers. | All company men. | Drivers and runners. | Door boys and helpers. | Total inside.                            | Outside foremen. | Blacksmiths and carpenters. | Bakers and firemen. | State pickers. | All other company men. |                                 | Superintendents, bookkeepers and clerks. |
| West Brookside.                             | 9                                       | 184     | 64                | 208              | 33                   | 14                     | 512                                      | 12               | 36                          | 107                 | 140            | 3                      | 299                             | 811                                      |
| Lincoln.                                    | 6                                       | 233     | 98                | 159              | 28                   | 1                      | 525                                      | 8                | 21                          | 85                  | 45             | 2                      | 213                             | 728                                      |
| Kalmia washery.                             |   |         |                   |                  |                      |                        |  | 1                | 1                           |                     |                |                        | 5                               | 5  |
| Good Spring.                                | 4                                       | 93      | 43                | 42               | 5                    | 5                      | 192                                      | 1                | 11                          | 66                  | 61             | 2                      | 139                             | 331                                      |
| East Franklin.                              |   |         |                   |                  |                      |                        |  |                  |                             |                     |                |                        |                                 | 1  |
| Middle Creek.                               | 2                                       | 14      | 10                | 15               | 1                    | 1                      | 43                                       | 1                | 4                           | 12                  | 17             | 1                      | 45                              | 88                                       |
| Otte.                                       | 9                                       | 144     | 52                | 101              | 22                   | 11                     | 329                                      | 2                | 29                          | 89                  | 85             | 2                      | 224                             | 563                                      |
| Phoenix Park No. 3.                         | 4                                       | 92      | 15                | 35               | 17                   | 4                      | 167                                      | 1                | 9                           | 10                  | 49             | 21                     | 94                              | 261                                      |
| Thomaston.                                  | 6                                       | 86      | 24                | 56               | 10                   | 8                      | 190                                      | 2                | 21                          | 54                  | 46             | 2                      | 130                             | 320                                      |
| Richardson.                                 | 3                                       | 74      | 14                | 61               | 7                    | 11                     | 170                                      | 1                | 11                          | 18                  | 40             | 57                     | 129                             | 299                                      |
| Glendower.                                  | 5                                       | 108     | 33                | 104              | 14                   | 8                      | 272                                      | 3                | 17                          | 53                  | 82             | 2                      | 167                             | 439                                      |
| Beechwood.                                  | 4                                       | 88      | 38                | 68               | 17                   | 10                     | 225                                      | 1                | 3                           | 10                  | 34             | 31                     | 80                              | 305                                      |
| Pine Forest.                                | 7                                       | 116     | 31                | 69               | 11                   | 30                     | 234                                      | 2                | 14                          | 90                  | 59             | 59                     | 173                             | 407                                      |
| Eagle Hill.                                 | 8                                       | 108     | 52                | 72               | 16                   | 11                     | 267                                      | 7                | 17                          | 65                  | 67             | 2                      | 160                             | 427                                      |
| Silver Creek shaft.                         | 5                                       | 172     | 75                | 104              | 15                   | 10                     | 383                                      | 1                | 2                           | 109                 | 48             | 1                      | 222                             | 615                                      |
| Oakdale washery.                            |   |         |                   |                  |                      |                        |  |                  |                             |                     |                |                        | 22                              | 22                                       |
| Wadesville.                                 |   |         |                   |                  |                      |                        |  |                  |                             |                     |                |                        | 9                               | 9  |
| Phoenix Park No. 2.*                        |   |         |                   |                  |                      |                        |  |                  |                             |                     |                |                        |                                 |  |
| North Brookside.                            |   |         |                   |                  |                      |                        |  |                  |                             |                     |                |                        |                                 |  |
| No. 8 Lehigh Coal and Navigation Company.   | 5                                       | 64      | 22                | 159              | 21                   | 11                     | 282                                      | 1                | 7                           | 11                  | 62             | 62                     | 144                             | 426                                      |
| No. 10, Lehigh Coal and Navigation Company. | 6                                       | 73      | 23                | 157              | 27                   | 16                     | 302                                      | 1                | 5                           | 19                  | 108            | 84                     | 217                             | 519                                      |
| No. 11, Lehigh Coal and Navigation Company. | 4                                       | 64      | 27                | 117              | 20                   | 9                      | 241                                      | 1                | 5                           | 15                  | 76             | 77                     | 174                             | 415                                      |
| No. 12, Lehigh Coal and Navigation Company. | 4                                       | 42      | 3                 | 75               | 13                   | 5                      | 142                                      | 1                | 2                           | 14                  | 40             | 17                     | 74                              | 216                                      |
| Morea.                                      | 2                                       | 69      | 13                | 52               | 16                   | 9                      | 161                                      | 2                | 9                           | 15                  | 82             | 129                    | 241                             | 402                                      |
| Kaska-William.                              | 1                                       | 69      | 36                | 21               | 8                    | 7                      | 133                                      | 1                | 10                          | 11                  | 31             | 41                     | 96                              | 229                                      |
| York Farm.                                  | 2                                       | 145     | 40                | 91               | 12                   | 4                      | 294                                      | 2                | 14                          | 15                  | 34             | 101                    | 168                             | 462                                      |
| Blackwood.                                  | 2                                       | 60      | 6                 | 34               | 17                   | 1                      | 120                                      | 1                | 21                          | 11                  | 54             | 80                     | 169                             | 289                                      |
| Greenwood No. 13.                           | 1                                       | 36      | 27                | 5                | 6                    | 6                      | 75                                       | 1                | 2                           | 2                   | 28             | 31                     | 66                              | 141                                      |
| East Lehigh.                                |   |         |                   |                  |                      |                        |  |                  |                             |                     |                |                        | 9                               | 9  |
| West Lehigh.                                | 1                                       | 15      | 3                 | 3                | 3                    | 1                      | 26                                       | 1                | 1                           | 4                   | 4              | 8                      | 26                              | 52                                       |

|   |     |       |       |       |       |       |       |       |       |       |       |       |       |       |        |
|---|-----|-------|-------|-------|-------|-------|-------|-------|-------|-------|-------|-------|-------|-------|--------|
| Oak Hill, .....                         | 4   | 92    | 80    | 31    | 12    | 3     | 222   | 1     | 1     | 14    | 45    | 27    | 3     | 95    | 317    |
| Lyle, .....                             | 2   | 8     | 14    | 89    | ..... | ..... | 118   | 1     | 6     | 36    | 4     | 87    | 3     | 127   | 250    |
| Abright, .....                          | 1   | 30    | 39    | 24    | 2     | ..... | 106   | 3     | 7     | 7     | 7     | 28    | 3     | 68    | 164    |
| Chamberlain, .....                      | 1   | 64    | 42    | 27    | 2     | ..... | 106   | 3     | 7     | 8     | ..... | 177   | 3     | 128   | 274    |
| Ellsworth, .....                        | 1   | 10    | 3     | 14    | 1     | ..... | 29    | 1     | 2     | ..... | 12    | 27    | 1     | 44    | 73     |
| Venus washery, .....                    | 1   | 6     | 8     | 4     | 2     | 1     | ..... | 1     | 3     | 3     | 8     | 10    | ..... | 11    | 68     |
| Roberts, .....                          | 1   | 30    | 10    | 5     | 5     | 1     | 22    | 1     | 3     | 3     | 8     | 4     | 1     | 46    | 111    |
| Flowers, Field, .....                   | 1   | 26    | ..... | ..... | ..... | ..... | 52    | 1     | 1     | 2     | ..... | 1     | ..... | 18    | 70     |
| Orchard, .....                          | 1   | 12    | 1     | 3     | 1     | ..... | 31    | 1     | 1     | 3     | 17    | 1     | ..... | 23    | 54     |
| Howard, .....                           | 1   | 40    | 26    | 11    | 9     | ..... | 37    | 1     | 2     | 0     | 20    | 12    | 2     | 46    | 133    |
| Red Ash, .....                          | 1   | 5     | 4     | ..... | 1     | ..... | 12    | 1     | 1     | 1     | 4     | 2     | ..... | 9     | 21     |
| Mt. Hope, .....                         | 1   | 8     | 13    | 8     | 2     | ..... | 36    | 1     | 1     | 4     | ..... | 5     | ..... | 10    | 36     |
| Eagle, .....                            | 1   | 8     | 4     | 4     | ..... | ..... | 15    | 1     | 2     | 4     | ..... | 4     | ..... | 8     | 23     |
| Williams, .....                         | 1   | 15    | 4     | 6     | 4     | ..... | 30    | 1     | 2     | 1     | 7     | 25    | 1     | 39    | 69     |
| Mine Hill, .....                        | 1   | 7     | ..... | ..... | 1     | ..... | 0     | 1     | 1     | 1     | ..... | ..... | ..... | 9     | 18     |
| East Ridge, Late Mine Hill, .....       | 1   | 2     | 2     | ..... | 1     | ..... | 6     | ..... | ..... | 2     | 10    | 4     | ..... | 4     | 10     |
| Bell, .....                             | 1   | ..... | ..... | ..... | ..... | ..... | ..... | ..... | ..... | ..... | ..... | ..... | ..... | ..... | .....  |
| Oakley, .....                           | 1   | ..... | ..... | ..... | ..... | ..... | ..... | ..... | ..... | ..... | ..... | ..... | ..... | ..... | .....  |
| Broad Mt. Coal Company washery, .....   | 1   | ..... | ..... | ..... | ..... | ..... | ..... | ..... | ..... | ..... | ..... | ..... | ..... | ..... | .....  |
| Roife washery, .....                    | 1   | ..... | ..... | ..... | ..... | ..... | ..... | ..... | ..... | ..... | ..... | ..... | ..... | ..... | .....  |
| Wolf Creek washery, .....               | 1   | ..... | ..... | ..... | ..... | ..... | ..... | ..... | ..... | ..... | ..... | ..... | ..... | ..... | .....  |
| Forestville Coal Company washery, ..... | 1   | ..... | ..... | ..... | ..... | ..... | ..... | ..... | ..... | ..... | ..... | ..... | ..... | ..... | .....  |
| Palmer washery, .....                   | 1   | ..... | ..... | ..... | ..... | ..... | ..... | ..... | ..... | ..... | ..... | ..... | ..... | ..... | .....  |
| Coal Hill washery, .....                | 1   | ..... | ..... | ..... | ..... | ..... | ..... | ..... | ..... | ..... | ..... | ..... | ..... | ..... | .....  |
| Reynolds washery, .....                 | 1   | ..... | ..... | ..... | ..... | ..... | ..... | ..... | ..... | ..... | ..... | ..... | ..... | ..... | .....  |
| Pipe Dale washery, .....                | 1   | ..... | ..... | ..... | ..... | ..... | ..... | ..... | ..... | ..... | ..... | ..... | ..... | ..... | .....  |
| Woodside colliery, .....                | 1   | 2     | 2     | 1     | 1     | ..... | 7     | 1     | ..... | ..... | ..... | ..... | ..... | ..... | .....  |
| Black Heath, .....                      | 1   | 2     | 2     | 1     | 1     | ..... | 4     | ..... | ..... | ..... | ..... | ..... | ..... | ..... | .....  |
| Pine Hill, .....                        | 1   | 2     | 2     | 1     | 1     | ..... | 6     | ..... | ..... | ..... | ..... | ..... | ..... | ..... | .....  |
| Mountain, .....                         | 1   | 2     | ..... | ..... | ..... | ..... | ..... | ..... | ..... | ..... | ..... | ..... | ..... | ..... | .....  |
| Sebastopol, .....                       | 1   | 7     | 4     | ..... | ..... | ..... | 8     | ..... | ..... | ..... | ..... | ..... | ..... | ..... | .....  |
| Tamaqua, .....                          | 1   | 7     | 1     | ..... | 1     | ..... | 0     | 1     | 1     | 1     | 8     | 5     | 1     | 16    | 25     |
| Little Diamond, .....                   | 1   | 3     | 2     | 2     | 1     | ..... | 9     | 1     | 1     | 3     | 5     | 4     | ..... | 14    | 23     |
| New Castle washery, .....               | 1   | ..... | ..... | ..... | ..... | ..... | 5     | ..... | ..... | ..... | ..... | ..... | ..... | ..... | .....  |
| Seven small places, local sales, .....  | 1   | 14    | ..... | ..... | ..... | ..... | 21    | ..... | ..... | ..... | ..... | ..... | ..... | ..... | .....  |
| Totals, .....                           | 127 | 2,541 | 1,011 | 2,052 | 387   | 163   | 6,281 | 58    | 228   | 482   | 1,605 | 2,016 | 64    | 4,453 | 10,734 |

|||rdle.

\*Included in Phoenix Park No. 3.

TABLE No. 4.—List of fatal accidents that occurred in the mines of the Eighth Anthracite District for the year ending December 31, 1894.

| Date of accident. | Name of Person Injured. | Age. | Married or single. |       | Number of orphans. | Name of Colliery.             | Location—Schuylkill county. | Date of investigation. | Nature and Cause of Accident in brief.   |
|-------------------|-------------------------|------|--------------------|-------|--------------------|-------------------------------|-----------------------------|------------------------|--|
|                   |                         |      |                    |       |                    |                               |                             |                        |  |
| Jan. 10,          | Hugh Larkin, .....      | 47   | S.                 | ..... | .....              | Otto, .....                   | Branchdale, .....           | .....                  | Killed by being crushed between mine cars and side of gangway.   |
| 15,               | Manus McGeehan, .....   | 18   | S.                 | ..... | .....              | L. C. Nav. Co. No. 11, ..     | Rahn township, .....        | .....                  | Struck on bowels with bar while starting battery and died next day.  |
| Feb. 1,           | James McGovern, .....   | 43   | S.                 | ..... | .....              | Otto, .....                   | Rahn township, .....        | .....                  | Killed by falling between cog and pinion wheel in breaker.   |
| 20,               | Rufus Clauser, .....    | 29   | M.                 | 5     | .....              | West Hookside, .....          | Tower City, .....           | .....                  | Killed by a piece of rock falling on him at face of gangway.   |
| Mar 28,           | Vincent Stillisk, ..... | 20   | S.                 | ..... | .....              | Morea, .....                  | Morea, .....                | .....                  | A loader, killed by a battery prop breaking, causing coal to rush on him and he was smothered before he could be extricated.   |
| 28,               | John Morgander, .....   | 38   | M.                 | ..... | .....              | Lytte, .....                  | Minersville, .....          | .....                  | Smothered in dirt bank at washery by a rush of dirt falling on him.  |
| May 4,            | Paul Polak, .....       | 35   | M.                 | 2     | .....              | No. 10 coll., L. C. & N. Co., | Coaldale, .....             | May 5,                 | Was engaged at stripping and went back from his place of work to place where coal was being drawn out and was drawn down by a rush of coal; a stone struck him on the head and killed him instantly.   |
| June 20,          | George W. Bolton, ..... | 49   | W.                 | 3     | .....              | Albright, .....               | Llewellyn, .....            | July 2,                | Killed by falling down slope; he was working on second lift and in getting on wagon to go up slope at quitting time he slipped and fell on third lift, bottom.   |
| July 3,           | Thomas Davis, .....     | 21   | S.                 | ..... | .....              | No. 10 coll., L. C. & N. Co., | Coaldale, .....             | July 5,                | A steam pipe burst in south pump room in third lift of slope and scalded him so badly that he died about seven hours after.  |
| 9,                | Frank Melley, .....     | 29   | S.                 | ..... | .....              | No. 3 coll., L. C. & N. Co.,  | Coaldale, .....             | July 10,               | Killed by falling from top of dirt trestle; he rode up plane on loaded bumper, contrary to orders. The car struck head block and he fell from it and over trestle to ground, about seventy feet below. |

|          |                        |    |    |                              |                       |   |
|----------|------------------------|----|----|------------------------------|-----------------------|---|
| 16,      | William Muldowney, ... | 19 | S. | Glendower, .....             | Glendon, .....        | Kicked by a mule July 16th and died on July 28th at Miners' Hospital.   |
| 26,      | John Garland, .....    | 18 | S. | Beechwood, .....             | Mt. Laffe, .....      | Burned by an explosion of gas July 26th and died August 7th.  |
| 31,      | Samuel Heckert, .....  | 28 | S. | West Brookside, .....        | Tower City, .....     | Killed by being struck on head by short piece of prop timber. He was working under rock chute at breaker and was found unconscious and died shortly after being found. The piece of timber supposed to be thrown from chute by some person unknown.                           |
| Aug. 20, | George Lomsha, .....   | 28 | S. | No. 19 coll., L. C. & N. Co. | Coaldale, .....       | Was struck in groin with end of brake stick in chute whilst loading mine car August 17, and died on the 20th.   |
| Oct. 2,  | William Gorman, .....  | 25 | M. | Pine Forest, .....           | St. Clair, .....      | A piece of coal fell on one of his small toes, October 2; lock jaw ensued and he died October 12.   |
| 18,      | Harry Sinton, .....    | 20 | S. | Eagle Hill, .....            | Eagle Hill, .....     | Killed by a fall of rock in breast.   |
| 20,      | John Lidabach, .....   | 27 | S. | Middle Creek shaft, .....    | Tremont, .....        | Struck on the head by a piece of slate; he was engaged at work sinking shaft; at time of accident he had been dressing loose stuff from side of shaft and sat down to rest, when a small piece fell from side which struck him on head, killing him.                          |
| Nov. 12, | Louis Weinsch, .....   | 23 | M. | Chamberlain, .....           | St. Clair, .....      | Was laboring in sinking Lewis vein slope; the sinking car had been chained to a sill while hoisting rope was taken off to hoist from upper level about time car was loaded, a hook or chain broke and wagon caught him between it and face; he died shortly after accident.   |
| 29,      | Thomas Doolin, .....   |    |    |                              | Heckscherville, ..... | He had fired shot in breast, and after returning to face found a piece of coal hanging loose. He warned his son who was working with him to keep from under it. He then went to pull it down when it fell on him, striking him on the head, from which he died on December 6. |
| Dec. 10, | Mahlon Pohl, .....     | 14 | S. | No. 12 coll., L. C. & N. Co. | Coaldale, .....       | Killed by being run over by loaded railroad car at foot of balance blage. He was sent with a message and on his way stopped at foot of blage and jumped on car from which he fell under wheels.   |
|          |                        | 60 | M. | Thomaston, .....             |                       |   |

TABLE No. 5.—List of non-fatal accidents that occurred in the mines of the Eighth Anthracite District for the year ending December 31, 1894.

| Date of accident. | Name of Person Injured. | Age. | Married or single. | Number of children. | Name of Colliery.   | Location—Schuylkill county. | Nature and Cause of Accident in Brief.   |
|-------------------|-------------------------|------|--------------------|---------------------|---------------------|-----------------------------|--|
|                   |                         |      |                    |                     |                     |                             |  |
| Jan. 13.          | Isidor Vahaga,          | 25   | S.                 | ..                  | Blackwood,          | Blackwood,                  | Leg injured by a piece of slate falling on it.   |
| 30.               | George Conner,          | ..   | ..                 | ..                  | Beechwood,          | Blackwood,                  | Injured about body; was kicked by a mule and cars run over him.  |
| Feb 1.            | Hugh Higgins,           | ..   | ..                 | ..                  | Silver Creek,       | Silver Creek,               | Ruptured a blood vessel lifting coal.  |
| 6.                | Rufus Leichert,         | ..   | ..                 | ..                  | East Brookside,     | Tower City,                 | Leg broken by a piece of timber rolling on it.   |
| 7.                | Joseph Reading,         | ..   | ..                 | ..                  | Pine Forest,        | St. Clair,                  | Leg broken; caught between pulley and belt in breaker.   |
| 13.               | Frank Marook,           | ..   | ..                 | ..                  | Morea,              | Morea,                      | Leg hurt by being caught between bumpers of cars.  |
| 14.               | Andrew Ditko,           | ..   | ..                 | ..                  | Morea,              | Morea,                      | Hand injured by a piece of coal rolling down chute.  |
| April 16.         | John Oneal,             | ..   | ..                 | ..                  | Eagle Hill,         | Eagle Hill,                 | Head hurt by a fall of coal.   |
| 30.               | John Crevelling,        | ..   | ..                 | ..                  | Llewellyn,          | Llewellyn,                  | Ankle dislocated and three ribs broken by a large engine shaft rolling on him.                             |
| May 2.            | Fred. Krell,            | ..   | ..                 | ..                  | Greenwood No. 13,   | Tamaqua,                    | Burned by explosion of a charge of powder, the end of which was not closed and spark from lamp fell in it. |
| 14.               | Harry Chusuel,          | 16   | ..                 | ..                  | Morea,              | Morea,                      | Hand lacerated by being caught in jig in breaker.  |
| 8.                | W. Brezinsky,           | ..   | ..                 | ..                  | Oak Hill,           | Minersville,                | Head and back injured by a fall of coal.   |
| 22.               | Mich. Bradley,          | ..   | ..                 | ..                  | Phoenix Park No. 3, | Phoenix Park,               | Leg badly crushed; he fell on track and car ran over one leg.  |
| July 21.          | Andrew Bohoviski,       | 25   | N.                 | ..                  | Oak Hill,           | Minersville,                | Hip dislocated by a fall of coal.  |
| 25.               | James Curry,            | ..   | S.                 | ..                  | Kaska William,      | Middleport,                 | Head and face severely bruised by a fall of bone.  |
| 26.               | Joseph Herst,           | ..   | ..                 | ..                  | Beechwood,          | Blackwood,                  | Burned by an explosion of gas.   |
| Sept. 6.          | Joseph Zamborski,       | ..   | ..                 | ..                  | Morea,              | Morea,                      | Leg fractured by a lump of coal rolling down manway.   |
| 6.                | James Llewellyn,        | ..   | ..                 | ..                  | Morea,              | Morea,                      | Wrist broken; fell between cars while trying to uncouple them.   |
| 19.               | Ferdinand Zamina,       | 25   | S.                 | ..                  | Blackwood,          | Blackwood,                  | Head and body injured by premature explosion of blast.   |
| 25.               | Fredericck Welss,       | 14   | ..                 | ..                  | Albright,           | Llewellyn,                  | Ankle broken; his foot was caught in jig while pushing coal.   |

|      |     |                     |       |                                  |                   |                 |       |  |
|------|-----|---------------------|-------|----------------------------------|-------------------|-----------------|-------|--|
| Oct. | 9,  | Edward Dally,       | ..... | Thomaston,                       | .....             | Heckscherville, | ..... | Three fingers blown off while picking out a duain cap.   |
|      | 15, | Edward Houtz,       | ..... | Lincoln,                         | .....             | Lorberry,       | ..... | Burned by an explosion of gas.   |
|      | 16, | Lincoln Moyer,      | 29    | M. 2                             | Blackwood,        | .....           | ..... | Leg broken in two places by a fall of coal.  |
|      | 18, | Sam. Southam,       | 45    | S.                               | Greenwood No. 13, | .....           | ..... | Back injured by a fall of coal.  |
|      | 25, | James Blimble,      | ..... | No. 12 colliery, L. C. & N. Co., | .....             | Coaldale,       | ..... | Were tamping a hole and some of the powder ran out of hole and ignited on one of their lamps, which fired the shot and both were severely injured.   |
|      | 25, | Arthur Dyer,        | ..... | No. 12 colliery, L. C. & N. Co., | .....             | Coaldale,       | ..... | Leg broken by being knocked from a car he was riding.  |
|      | 25, | Stephen Youcheek,   | ..... | No. 8 colliery, L. C. & N. Co.,  | .....             | Coaldale,       | ..... | Both injured about head and face by coal flying from shot in heading being driven from adjoining heading.  |
| Nov. | 9,  | Adoniah Davis,      | ..... | Morea,                           | .....             | Morea,          | ..... | The miner firing shot claimed that he had repeatedly given signal and thought that they had gone out.  |
|      | 9,  | Henry Welcher,      | ..... | Morea,                           | .....             | Morea,          | ..... | Leg broken by a lump of coal knocking him down chute.  |
|      | 9,  | William Cree,       | 46    | S.                               | Blackwood,        | .....           | ..... | Leg broken by a fall of slate in breast.   |
|      | 9,  | Fred. Simmendinger, | ..... | Lincoln,                         | .....             | Lorberry,       | ..... | Burned by an explosion of gas and injured by coal flying from a shot. Had been told by fire boss to put up brattice to remove gas, but instead fired shot with above result.   |
|      | 13, | Arthur Rich,        | 31    | S.                               | York Farm,        | .....           | ..... | Eye knocked out by a shot in adjoining breast.   |
|      | 17, | Anthony Pitsavage,  | ..... | Richardson,                      | .....             | Glen Carbon,    | ..... | The men who fired the shot had told him to keep hold of heading which was held with a drill hole, until they had fired a shot. He went into heading when the shot was fired, injuring him as above.  |
|      | 26, | George Copeland,    | 40    | M. 7                             | Blackwood,        | .....           | ..... | Fireman, slightly injured by explosion of boiler.  |
|      | 29, | Gabe Reynolds,      | ..... | Silver Creek shaft,              | .....             | Silver Creek,   | ..... | Head and body badly injured by being struck by coal from a shot. Had lit a shot at same time that men in adjoining breast had lit one, which went first. He thought it was his shot that had gone and returned up breast when his shot fired and caught him. |
| Dec. | 4,  | William Oats,       | 14    | .....                            | Thomaston,        | .....           | ..... | Leg cut off below knee; was engaged watching coal going to monkey rolls. He got in chute to nail sheet iron when he slipped and right leg was caught in rolls.   |
|      | 6,  | Dominick Simeroll,  | 35    | M. 4                             | Oak Hill,         | .....           | ..... | Both burned by an explosion of gas in chute they were driving. They were brushing gas out to fire a shot and claim they forced the dump through gauge of safety lamp.  |
|      | 6,  | Mich. Clanderell,   | 23    | S.                               | Oak Hill,         | .....           | ..... | Leg broken by a piece of slate falling on it at face of gangway.   |
|      | 13, | John Ofsinkl,       | 38    | M. 2                             | Oak Hill,         | .....           | ..... | Arm broken and thumb dislocated; was playing with driving shaft of elevators and his mitten caught in key, resulting in above injuries.  |
|      | 20, | Thomas Norton,      | 14    | S.                               | Blackwood,        | .....           | ..... |  |





---

---

# BITUMINOUS MINE DISTRICTS.

---

---

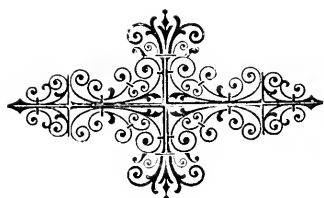

# FIRST BITUMINOUS DISTRICT.

(ALLEGHENY, FAYETTE, WASHINGTON AND WESTMORELAND COUNTIES.)

Monongahela, March 1, 1895.

Hon. Isaac B. Brown, Secretary of Internal Affairs:

Sir: In compliance with an act of the General Assembly of Pennsylvania relating to Bituminous coal mines, approved May 15, 1893, I have the honor to herewith submit my annual report as Inspector of Mines for the First district for the year ending December 31, 1894.

In this report will be found a brief description of each mine in the district. The usual tables are inserted, also additional ones relative to fatal and non-fatal accidents.

By the tables it will be seen that twenty-five persons lost their lives during the year, and eighty-nine were injured. Some of the latter were of a slight nature, while others were very serious. The causes from which they occurred are embodied in the report.

TABLE A.—*Monthly report of fatal and non-fatal accidents.*

| Month.               | Killed. | Widows. | Orphans. | Injured. |
|----------------------|---------|---------|----------|----------|
| January, . . . . .   | 3       | 1       | 2        | 15       |
| February, . . . . .  | 4       | 3       | 7        | 7        |
| March, . . . . .     | 3       | 12      | 8        | 8        |
| April, . . . . .     | 3       | 3       | 9        | 5        |
| May, . . . . .       |         |         |          |          |
| June, . . . . .      |         |         |          | 1        |
| July, . . . . .      | 3       | 3       | 12       | 9        |
| August, . . . . .    | 1       | 1       | 3        | 12       |
| September, . . . . . | 1       | 1       | 5        | 9        |
| October, . . . . .   | 5       | 3       | 4        | 4        |
| November, . . . . .  | 2       |         |          | 10       |
| December, . . . . .  |         |         |          | 9        |
|                      | 25      | 17      | 50       | 89       |

TABLE B.—*Character of fatal accidents.*

|                                      |
|--------------------------------------|
| By premature blast, 1.               |
| By falls of slate, 12.               |
| By falls of coal, 5.                 |
| By falls of coal and slate, 3.       |
| By a fall of horse-back, 1.          |
| By being run over by Dilly trips, 2. |
| By mine cars, 1.                     |

From subsequent investigations into the causes of those fatalities, evidence was not wanting to show that a number of them could have been prevented by the exercise of even ordinary judgment on the part of the unfortunates.

TABLE C.—*Non-fatal accidents and their causes.*

|  |             |
|--|-------------|
| By falls of slate, .....                       | 32          |
| By falls of coal and slate, .....              | 4           |
| By falls of coal, .....                        | 6           |
| By falls of roof coal, .....                   | 7           |
| By falls of "black jack," .....                | 2           |
| By a fall of horse-back, .....                 | 1           |
| By mine cars, .....                            | 19          |
| By fire damp, .....                            | 6           |
| By being struck by posts, .....                | 7           |
| By a premature blast, .....                    | 1           |
| By the ignition of powder and fire damp, ..... | 1           |
| By a runaway mule, .....                       | 1           |
| By a blast blowing through a rib, .....        | 1           |
| By being caught by Dilly line, .....           | 1           |
|  | <hr/>       |
|  | 89          |
|  | <hr/> <hr/> |

TABLE D.

The following statistics are compiled from the operators' annual reports to this office, for the year ending December 31, 1894:

|   |             |
|---|-------------|
| Number of mines in the district employing ten or more persons, ... .. | 74          |
| Number of miners, men, .....  | 8,946       |
| Number of miners, boys, .....   | 427         |
| Number of other persons employed in and about the mines, ... ..       | 1,802       |
|   | <hr/>       |
| Total number employed, .....  | 11,175      |
|   | <hr/> <hr/> |

|   |           |
|---|-----------|
| Production of coal, run of mine, tons, .....                    | 5,282,181 |
| Number of tons of coal shipped, .....                           | 5,277,104 |
| Ratio of tons of coal produced per each person employed, ... .. | 472+      |
| Number of lives lost during the year, .....                     | 25        |
| Ratio of coal produced per each life lost, .....                | 211,287   |
| Ratio of persons employed per each life lost, .....             | 447       |
| Number of persons injured during the year, .....                | 89        |
| Ratio of tons of coal produced per each person injured, .....   | 59,350    |
| Number of persons employed per each non-fatal accident, ... ..  | 125+      |
| Number of days worked during the year, .....                    | 9,103     |
| Number of kegs of powder used in the mines, .....               | 16,387    |
| Total number of horses and mules, .....                         | 542       |
| Number of steam boilers in use in and about the mines, .....    | 117       |
| Number of mine locomotives, .....                               | 5         |

#### Prosecutions for Violation of the Mine Law.

Legal proceedings were brought in six cases against persons for violation of the Act of May 15, 1893, relating to bituminous coal mines, as follows: Four for passing the danger signals before the mine was examined; one for the violation of rule 63, and one for neglect of duty through drunkenness.

#### Passing Danger Signals.

Lewis Anzie and Joseph Smiley, employed in the Washington mine, were charged with passing a danger signal in the above mine on the morning of January 19, before the mine was examined. The case came up before a local justice of the peace, which resulted in the discharge of Smiley, and in Anzie being held for court. The case of Anzie was afterwards compromised on the payment of costs.

Joseph and John Rasma, miners, employed in the Catsburg mine, passed the danger signal on February 25, before the fire boss had made his examination and reported the mine "safe." These persons were tried during the February session of court and a verdict of not guilty rendered, county for the costs.

#### Violation of Rule 63.

Stephen Cowilli, a miner employed in the Manown mine, was charged with firing a blast on January 24, before notifying "all persons who might be endangered thereby." This neglect caused the serious injury of a miner named John Revilli, who worked in an adjacent room.

On Tuesday, February 6, Cowilli was given a hearing before James L. Graham, J. P., of Elizabeth, which resulted in his being remanded to the borough lock-up for a further hearing, but during the night of the day of the hearing, he, in some mysterious manner made his escape.

On February —, I was notified in writing by Samuel O'Neill, attorney or agent for the Fayette City mine, under date of February 1, 1894, that he had discharged his mine foreman, W. C. Gartley, for being intoxicated in the mine. In accordance with section two, article twenty-six, the writer, by petition, called the attention of the court to the matter. On presentation, his honor Judge Ewing set Saturday, March 31, for the hearing, but in the meantime it was postponed until April 2. On that day a preliminary hearing was held in the office of the district attorney at Uniontown, and from the statements of the witnesses it was soon apparent that the Inspector had no case, and the district attorney so informed the writer.

It is proper, and in justice to this office, that a full statement of this suit be given in this report, so as to anticipate any charge being made that it (the suit) was an "ill advised one." On receiving notice of the dismissal of Mine Foreman Gartley, I made inquiries to ascertain on what grounds the charge of drunkenness was based, and as a matter of proof, I was referred to the superintendent and fire boss. Those parties did not hesitate to say that the mine foreman had been intoxicated in the mine on January 30, 1894, and also on the 31st of the same month, and that his condition was such as to render him unfit for his official duties. (In connection with this unfortunate affair an explosion of fire damp occurred in this mine on the morning of the latter date, by which five persons were injured, four of them seriously.)

While the superintendent was somewhat reserved as to the condition of Mr. Gartley on January 30 and 31, he was positive the charge of intoxication was true. There was no such reservation on the part of the fire boss, but on the contrary he let no opportunity pass in trying to impress on the writer's mind that the charges were true and could be easily substantiated, but at the hearing he would not, under oath, make the same statements as he had made previously to the writer, neither would the superintendent.

This change of base was for some cause unknown to the writer. Other witnesses were questioned but the result was the same.

In justice to the mine foreman, W. C. Gartley, I will state that he positively denied that he was intoxicated in the mine or even had intoxicating liquors of any kind during the period named, and that he wanted a full and complete investigation made.

During the national strike among the miners, which was inaug-

urated April 21, and "declared off" June 18, numerous small mines in pools 5, 6, 7 and 8, which had been apparently abandoned some time before, were cleaned up and persons put to work in them again, and others which had heretofore given employment to but one or two persons, were increased to nineteen, in some instances.

The activity in the above mines was caused by the great demand for coal and the good prices offered for it.

On examination of some of these mines, I found them, as regards ventilation in a terrible condition, there being no visible movement of the air current at all, and to make matters worse, the workmen were using as an illuminant an oil which I am informed was taken direct from the wells. This made the atmosphere of the mine so smoky that it was almost impossible for one person to see another. I called the attention of the operators of those mines to what was required by the act relating to bituminous coal mines, and those who did not employ a sufficient number of persons to come under the jurisdiction of this office, I asked to prohibit the use of such oils by the workmen, which was not only injurious to their health, but it increased the dangers incident to the mining of coal.

I also requested them to give some consideration to the ventilation of their mines, so as to make the calling of their miners as pleasant as possible.

The condition of these mines is a good exemplification of what a great many others would be, were it not for the existence of our ventilation act.

### Summary.

The coal produced during the year shows an excess of 405,874 tons over that of 1893. The fatal accidents are, in number, the same as in the year 1893. The non-fatal accidents show an increase of thirty-three. The number of tons of coal produced per each life lost, was 16,235 more than that of the previous year, but the ratio to each non-fatal accident was 29,310 tons less than the year 1893.

By a review of the accidents, fatal and non-fatal, which is given in this report, it will be readily seen that "falls of slate," "falls of coal" and "falls of coal and slate" were responsible for a number more than of all others combined.

We have, in parts of this district, a coal and slate in which slips, fractures, etc., appear at times so unexpectedly that it will not only deceive the inexperienced, but the most practical miner, and when we take into consideration the large number of \*persons engaged in the mining of coal in this district who have very little, if any, prac-

---

\* Hungarian, Italian, Slavish, Polish and Finlanders.

tical knowledge of the work, I am not surprised at the number of accidents which occur.

In concluding my report, I am pleased to say, that the mines of the district are, in a general way, in a better condition than they were in the year previous.

All of which is respectfully submitted,

HENRY LOUTTIT,  
Inspector of Mines.

---

#### Mines Located on the Monongahela Division of the Pennsylvania Railroad.

Charleroi. On my last visit to this mine, its general condition was fair. The mine consists of two face and four cross-headings, the air current of the mine being in two divisions.

To mine the coal, two systems of room work are in use, one of which is the room and pillar, the other double headers. The latter is thirty-nine feet wide, with a road on either side.

During the year they have extended the rope haulage some 1,800 feet into the mine.

Fidelity. On my last examination of this mine, I found the general condition satisfactory.

Allen. This mine was, on my last visit, in a general way satisfactory.

Acme. On the date of my last visit to this mine, I found it in fair condition, with the exception of a few rooms, which were somewhat deficient in ventilation. Those rooms I suggested should be ventilated so as to comply with the law. I have since been informed by the mine foreman that the matter had been attended to.

Courtney. Condition of this mine, on my last visit, fair. Number of persons employed inside, thirty-eight. Cubic feet of air passing at inlet, 9,100.

#### Mines Located on the Pittsburgh and Wheeling Division of the Baltimore and Ohio Railroad.

Gastonville Nos. 1 and 2. The above mines were not in operation at my last visit. Among the improvements made at the latter mine during the year were the sinking of a shaft and the building of a ventilating furnace.

The shaft is six feet in diameter and 120 feet in depth. Previous to the sinking of the shaft, a nine-inch test hole was drilled, which, when finished, was found that owing to its proximity to the main entry, it was practically impossible to place the furnace as originally mapped out. So, to overcome this difficulty as far as possible, the



shaft was commenced and continued on the line of the test hole until within twenty-four feet of the bottom of hole, at which time work on it was suspended. The furnace was then built some 45 feet from the above mentioned entry and the shaft connected with it by a "dumb" drift.

The furnace has a grate surface of 64 square feet. Height below bars, 2 feet; above bars, 4 feet 6 inches; width, 8 feet 3 inches; length of arch, 16 feet, with an elevation of 22 inches.

Anderson. Not in operation on my last visit. In operation 111 days during the year. Total number of employes, 170.

Nottingham. When last examined the ventilation in parts of the mine required improvement.

Eclipse. This mine has been worked in two divisions, but on my last visit they had temporarily abandoned one of them and the whole force of workmen was placed in the other division. The object being to work out this part of the mine as rapidly as possible. The mine was fairly ventilated, but the drainage required improvement.

Snowden. On the date of my last visit to this mine its general condition was satisfactory.

Germania. Condition of mine, on my last visit, fair.

The main headings are driven eight feet wide, with thirty-three feet of coal pillar between them. The mine is worked (with the exception of one entry) on the double entry system.

The parallels are driven twenty-four feet apart and so cut off the main headings as to leave 120 yards between them. From these, the rooms are turned every 33 feet at a width of 6 feet 6 inches; at this width they are driven in 15 feet, and then widened out to 24. When driven up 60 yards they are abandoned and the rib is withdrawn.

Hacket. On my last visit to this mine, the ventilation, in parts of the same, required improvement. The drainage also required attention.

#### Mines Located on the McKeesport and Belle Vernon Division of the Pittsburgh and Lake Erie Railroad.

Cleveland. The general condition of this mine was, when last examined, fair.

North Webster. The condition of this mine, on my last visit, was, in a general way, satisfactory. The inlet air measurement, as shown by the instrument, was 27,080 cubic feet. This air current was in three divisions, neither of which has above the minimum number of feet required by law. Improvements have been made on the inside of the mine to facilitate the haulage. These consist of the making of a new double parting and extending the mechanical haulage some 900 feet.

Shepllar. In the early part of the year the ventilation of this mine was very unsatisfactory. This was owing to the ventilator they used not having enough power to move the air required for the mine. I called the attention of the operators to this state of affairs, and after some delay a larger furnace was commenced and in due time completed. This ventilator should give an ample supply of air if proper attention is given it.

Manown. The coal produced at this mine is all mined by machines. Total number of persons employed inside on my last visit, 166—classified as follows: 16 machine operators, 133 fillers, 9 drivers, 4 day men, 2 trappers and 2 pick men. Mine was in fair condition.

#### Mines on the Monongahela River.

Stony Hill. The condition of this mine in the early part of the year, as regards the ventilation, was not satisfactory. The ventilator used here was a furnace placed quite a distance from the face of the workings, and in a place where the natural surroundings were against it. To increase the air current in the workings of the mine, a shaft was put down at the head of the main entry, and a new furnace placed at the bottom of it.

With an ordinary fire the writer measured 31,600 cubic feet of air passing the outlet. On my last examination of the mine, its general condition was fair.

Coal Centre. The "tail rope" system of haulage has been introduced into this mine during the year, and the following is a general description of the machinery:

The engines are of the most modern design. They are self-contained and have all the latest improvements that are known to the tail rope system. They are most conveniently constructed, most powerful in operation, and beautiful in design. They are rated at 100 horse power, with boilers, ropes, sheaves, rollers and electric signal, the entire system being complete in every particular. The diameter of the cylinders is 14 inches and the length of the stroke 16 inches. There are two cylinders connected to one engine shaft at right angles. Upon this engine shaft is a very strong pinion which carries the power to the drum shaft. There are two drums, each 52 inches in diameter, 30 inches wide on the face, with flanges of sufficient height to carry two miles of three-quarter-inch wire rope. Both of these drums are loose upon the drum shaft and are fitted with hard bronze bushings, a provision made for cheaply renewing the hole in the drum should it become worn any time upon the drum shaft. These drums are driven by means of positive clutches, one for each drum. The positive clutches are fitted upon two heavy keys which are at right angles, set firmly into the drum shaft, the clutches sliding in and out

of gear upon these keys. The clutches are operated by levers extending from the fulcrum, which is very close to the clutch, back to the engineer's position upon the footboard.

Each of these drums is provided with a separate brake and brake band, operated by lever, radius, pawl and ratchet, and is also very convenient for the engineer; all of the levers, throttle, brakes and so on are very convenient to operate from his position.

The arrangement of these drums is most complete, as the drums being loose upon the drum shaft, they can be operated at will. When one drum is hauling the load, the other drum is running loose upon the shaft and is adjusted or held with sufficient friction to keep the tailrope taut by the brake lever at the engineers' stand. The object of this is not only to keep the rope properly tightened, but to keep the trip of mine cars properly stretched on their hitchings, also to prevent the mine cars, on a descending grade, from over-running the front line. This tension, of course, can be operated, slackened or tightened at will. An expert engine runner will regulate the speed of his trip largely by this brake.

The steam plant for operating this machinery consists of two steel cylinder boilers, each boiler 40 inches in diameter, 28 feet long, and is so arranged that one or both boilers can be used at will, there being ample valve provision for shutting the steam off between the boilers and the water supply arrangement as well. The boilers are supplied with water by two injectors; one for each boiler. These boilers are made of steel, 60,000 pounds tensile strength, and were fully tested by hydrostatic pressure to 150 pounds pressure per square inch before they were erected. The plant can be operated quite successfully with one of these boilers in case of an emergency.

The electric signal in connection with this plant is most complete. The battery, bells, switches, insulators, etc., are placed in a cabinet in the engine room close to the engineer, a double line extending through the mine the entire distance or length of the entry in which the plant is placed or operated, and is convenient to the trip rider from his seat on the mine wagon, so that he may operate it, or signal anywhere along the entry to the engineer in the engine house for stopping, starting, pulling backward or forward, as he may wish.

At the present the hauling is done only in the main entry.

However, the arrangement is so complete and is such, that at any time in the future it may be extended so as to haul an indefinite distance, or haul from as many side entries as they may desire.

The length of haulage at the present time is one mile.

The grade fluctuates. The heaviest grade against the load is 4 feet in 500 feet, but in the greater part of the distance, the grade is slightly in favor of the load.

The line of the entry, over which this haulage operates, is practically in the shape of the letter "Z," there being two turns at nearly right angles.

The size of rope used in this mine is three-fourths of an inch in diameter, of crucible cast steel, seven wires, hemp centre.

These engines will haul from 50 to 100 tons at a load in this mine at an average rate of speed of say 600 feet per minute, or greater if necessary. At the present time they haul 40 wagons at one load, and make a round trip in twenty minutes, thus hauling at the rate of 120 mine wagons an hour, or 1,200 mine wagons in 10 hours. These mine wagons, including the load, weigh from 4,200 to 4,500 pounds each.

Owing to the room at the tibble being limited, the machinery was placed back in the ravine between the first and second hill, and is located three-quarters of a mile away from the tibble where the coal is delivered. The pulling out rope passes around a sheave wheel 80 feet from the drum; it passes out through the entry to the tibble at the river, there around a bull wheel and back into the entry to the parting at the inner end of the mine. The tail rope passes around a similar sheave 80 feet from its drum, passing in around a bull wheel at the back end of the parting where the coal is gathered, from there follows the trip out to the tibble at the river. With this location, and the system, as it is designed, it has proved most successful and satisfactory in its operation.

This entire plant was planned, erected and started running, hauling coal in a most satisfactory manner to the company, by J. and J. B. Milholland, of Pittsburgh, Pa., who seem to be the pioneers in this country of wire rope haulage, as they have over 300 of these now running in successful operation, and they are well known builders of hoisting machinery and mine locomotives.

When the mine was examined last, a portion of the "Old Hill" required improvement in ventilation, but the new part of the mine was satisfactory.

Buffalo. In operation only 48 days during the year. Active operations ceased April 21.

Rostraver. Total number of persons employed in and about the mine, 172. The improvement made at this mine during the year consist of a railroad tibble, with the necessary sidings. This gives facilities for shipping the product of the mine either by rail or water, as they may elect.

On my last visit to this mine, the condition was fair.

Little Alps. On the date of my last visit to this mine, I found the general condition fair. The instrument at outlet registered 24,500 cubic feet. Number of persons employed inside, 43.

Mongah. On my first visit to this mine I found the ventilation in parts unsatisfactory, this being caused by the ventilator not having sufficient power. As a remedy they allowed the steam from the engine which operates the electric plant, to exhaust into the upcast shaft. This resulted in an increase in the volume of air moving in the mine, but on examination I found the quantity still inadequate. It was evident that some other means would have to be employed to produce the air required for the mine. A large furnace has since been built, and I am informed that it is giving good results.

Caledonia. This mine was found, as regards ventilation, in fair condition, when last examined.

Champion. Number of persons employed inside, on my last visit, 105; entries being driven, 5; cubic feet of air entering the mine, 19,380.

The mine, with the exception of entries 19 and 20, was in fair condition. The above entries required an increase of air. Suggestions in this direction were given and I have since been informed that they have been complied with.

Milesville. The general condition of this mine, as regards ventilation and drainage, was, on my last visit, fair.

An air course on either side of the main entry was being driven and would, when completed, shorten the air route some 3,000 feet.

These workings will also be used as an airway to split the air into divisions.

Vesta No. 3. This mine was not in operation on my last visit. A few persons were at work, cleaning up and posting their places, with a view of seeking work elsewhere. The mine, I was informed, had been closed down indefinitely. Condition of mine, fair.

Fox (formerly Leonard). When last examined, the mine was not giving employment to a sufficient number of persons for the law to apply to it.

Stonesburg. In operation but 80 days during the year. Persons employed inside, on my last visit, 114. Condition of mine, unsatisfactory as regards ventilation and drainage.

Vigilant. A new ventilating fan, 25 feet diameter, 8 feet wide, was erected at this mine during the year. This ventilator is of the "Vulcan Guibal" type, driven direct by an 18-inch by 30-inch engine, built and erected by the Vulcan Iron Works of Wilkes-Barre, Penna. A recent test of the plant showed a movement of 139,000 cubic feet of air per minute in the air course at the foot of the shaft, which is about two-thirds of the capacity of the fan under favorable conditions. The air courses in the mine were not in the best of condition at the time of the test, but are being changed and enlarged, and when this work is completed the plant will, no doubt, show much better results.

The fan is arranged for both exhausting and blowing, with double inlet air courses. The change from exhaust to blow or the reverse is easily and quickly made by the use of adjustable shutters. When exhausting, one shutter is raised above the cut-off and the other shutter lowered in line with the spiral casing. The doors back of the inlet circles are closed and the doors in the air course at the mouth of the shaft are open. When blowing, this operation is reversed, the engine running in the same direction at all times.

The operators of the mine have furnished the fan with excellent foundations and air courses, and the plant is very creditable to both builders and owners.

The general condition of this mine, when last examined, was satisfactory.

Eclipse.—On my last visit to this mine, I found that some parts of the workings were not sufficiently ventilated. I called the mine foreman's attention to the matter, with the request that the air be increased to the legal limit, which suggestion has been complied with.

Climax.—Condition of mine, on last visit, fair, as regards ventilation, but the drainage required improvement.

Vesta Nos. 1 and 2.—When visited, I found the general condition of each mine satisfactory.

Ella.—On examination of this mine, the general condition was satisfactory.

Among the improvements made at the mine during the year, is a complete electric mining plant. A ventilating fan sixteen feet in diameter has also been erected. This fan should, providing proper attention is given to it, produce all the ventilation required for the mine and for a large extent of territory yet undeveloped.

Knob.—The general condition of this mine was, on my last visit, satisfactory.

Albany.—In operation sixty days during the year. One hundred and seventy-five miners, nine drivers and eighteen other persons were at work on the date of my last examination. On this visit I found the general condition of the mine satisfactory. The outlet air measurement was, as shown by the instrument, 40,000 cubic feet. Water gauge taken near the ventilating fan registered seven-tenths of an inch. Horse power in the air 4.4.

Tremont.—The general condition of this mine was, on my last visit, fair.

Cedar Hill.—On each visit to this mine, I had occasion to complain in regard to the ventilation and drainage. The mine is operated by a co-operative company. No work is being done, except on the pillars and entry "stumps."

**Black Diamond.**—On the last examination of this mine, I found the general condition satisfactory. Work was in progress on a proposed extension of the wire rope haulage. The length at present is 3,900 feet taking the measurement from mine entrance to the return wheel located at the double parting in the interior of the mine. From this point two branches will be put into use. One is 2,200 feet in length, and the other 2,800 feet. The mine has four main and seventeen cross-headings. The air currents are in two divisions and with the completion of an over-cast, which is now being constructed, a third division will be made. As an additional improvement in the sanitary condition of the mine, a face entry is being driven from the up-cast shaft to intersect the cross-headings as they advance, the object being to give each entry a separate air current.

**Washington.**—In parts of this mine, on my last visit, the ventilation and drainage required improvement. To remedy the former, two Clark fans will be erected. Work in this direction has already been commenced. The drainage will also be given attention.

**Fawcett.**—This mine has not been in operation for some years.

**Crescent.**—On the date of my last visit to this mine, only a few persons were at work inside. I made an examination of the workings and found them, in a general way, fairly good.

This mine is now ventilated by a fan placed on top of the shaft, previously used as an up-cast for the Vigilant mine. In the description of the latter mine, the fan is also described and cuts of the same shown.

**Old Eagle.**—The condition of the mine, when last examined, was, in a general way, satisfactory.

**Bunola.**—Number of persons employed inside on the date of my last visit 130. Cubic feet of air passing over furnace was 28,800.

The volume of air was moving in two divisions, but in parts of the mine the velocity was so weak that it would not move the vanes of the Anemometer. To make matters worse, indiscriminate blasting was allowed. This resulted in what little movement there was in the air current being so surcharged with powder smoke that it was somewhat difficult to see surrounding objects. I suggested that the ventilation be increased to the legal quantity and also some action be taken to prevent the unnecessary blasting. I have since been informed that my suggestions have been complied with.

**Jefferson.**—Extensive improvements have been made in and about this mine during the year.

A new tippie which stands four feet higher than the old one has been built and fully equipped with the necessary machinery for the handling of large quantities of coal. The approach to the tippie has

been adjusted so as to form part of the incline, making a total length of the latter of 1,500 feet.

The mechanical haulage has been extended 1,400 feet. To produce the ventilation for the mine, a six foot Clark fan has been erected, which I am informed is giving very good results.

Apollo.—On each visit to this mine during the year, I found reason for calling the attention of the management to some sections of the law, which were not then complied with. This had occurred so frequently that I came to the conclusion that there was a disposition to evade the law relating to bituminous coal mines, and that the only remedy this office had in the matter was to resort to legal proceedings to compel observance; but before it reached that point a change was made, and I hope that the result will be that the mine will be put in condition so that the requirements of the law will be observed.

Catsburg. A complete electric mining machine has been installed at this mine during the year, at a cost I am informed, of twenty-eight thousand dollars. In brief, it consists of one one hundred and sixty horse power engine; also one one hundred horse power generator; seven cutting machines, six of them undermining six feet, and one seven feet.

Condition of mine as regards ventilation and drainage, satisfactory.

Coal Bluff. On my last visit to this mine, the ventilation was, in some of the parts, unsatisfactory. This being a very large mine, it requires a large quantity of air to keep it in good sanitary condition. I take it that this mine should be ventilated by a fan. This I have suggested.

Little Redstone. On the last examination of this mine, I found the ventilation in parts of the same not up to the legal requirements. The making of cut-throughs in the room pillars had been neglected. I called the attention of the officials of the mine to its condition, and I have since been informed that the matter has been attended to, and the cause of complaint removed.

Evil. When last examined, the condition of this mine was in a general way, as regards ventilation and drainage, fair.

Chanoumi. In parts of this mine, when visited last, I found the ventilation inadequate, owing to the improper distribution of the air current. I suggested that it be increased to the legal requirements. This has been done.

Beaumont. In operation 200 days during the year. Total number of persons employed in and about the mine 215. The mine consists of four face and eight cross-headings.

The main heading is driven on the butt of the coal and shows a dip against the load of 48 feet in a distance of 1,900 feet. The en-



tries are all driven eight feet wide. The parallel entries have a coal pillar of fifty feet between them. The blocks are 150 yards. This gives the rooms from either entry a limit of 75 yards.

**Snow Hill.** This mine has been operated by the present company (Alps Coal Company) since the year 1881. The system then in vogue for working the coal was single entry; this continued until 1890 when the double entry plan was adopted. This seems to have proven satisfactory. In 1892 the company erected a ventilating fan, 16 feet in diameter, which, including foundations, etc., cost \$4,000.

During the present year they have extended their wire rope haulage.

The sanitary condition of the mine has been much improved by the air being split into divisions, by a system of locating and building of over-casts. The air current is in three divisions and is so arranged that each pair of entries is ventilated by fresh air.

In addition to the above improvements, a traveling way has been made, and is so located as to leave no excuse for persons to travel on the haulage road. On examination of this mine I found the general condition of the same satisfactory.

**Fayette City.** One of the improvements made at this mine during the year is the installation of mining machines operated by compressed air.

As noted elsewhere, an explosion of fire damp occurred in this mine on the morning of January 31, by which Thornton Hamilton, Samuel White, Thomas Taylor and Charles Mathews were seriously and Louis Dewalt slightly injured. These persons were employed as miners on entry 8, and on the above morning were on their way to work, and when opposite an abandoned and worked out room (No. 23), the gas took fire from a naked light carried by one of the party. This explosion occurred a short time after the fire boss had made his examination and reported the mine "safe." Upon questioning the fire boss in regard to his examination of the mine on that morning, he stated that he found no indication of gas in the above place, and that it was his opinion that a fall had taken place during the interval which occurred between his examination and the time that the injured persons passed, as other persons passed this point with safety after the "danger board" was turned.

When last examined they were employing 144 persons inside, classified as follows: 28 machine men, 105 fillers, and 11 other persons. The air at outlet measured 35,000 cubic feet. The ventilation was, in a general way, fair. In parts of the mine, the drainage required improvement.

**Umpire.** This mine was not operated very extensively during the year; was idle when last visited.

Walton's Upper and Lower Mines. These mines were in fair condition when last examined.

Hilldale. In operation 145 days during the year. Number of persons employed in and about the mines, 153; cubic feet of air passing at outlet, 27,000; condition of mine, fair.

Rock Run. General condition of mine when last examined was fair.

Fulton. In operation but 30 days during the year. Persons employed in and about the mines, 97. On examination, I found the ventilation in parts of the mine very unsatisfactory, the air being very much impregnated with black damp. I suggested that the quantity of air required by law be furnished. This suggestion has been complied with.

Amity. In a general way, this mine was in fair condition when I made my last visit.

New Eagle. On the date of my last visit to this mine, it was idle, owing to some trouble between the operators and employes. During the year the tail rope system of haulage was introduced into the mine. The distance from the return wheel located in the interior of the mine to the one at tippie is 1,300 yards, the engines being 9x14 inches. The ropes used are four-eighths and five-eighths, respectively.

Average number of cars in each trip, 25.

Allequippa. General condition of this mine, on my last visit, was satisfactory.

Banner. In operation 80 days during the year. The principal work being done was entry driving.

On the date of my last visit, two cross headings and two water courses were being driven. The outlet air measurement showed 32,000 cubic feet passing the furnace. General condition of mine, fair.

Stockdale. This mine was operated by Mr. John Crombie until the early part of \*..... From this date until September, it remained idle, when a company of miners leased the place under the name of the Fulton Coal Company. This firm immediately commenced to make such repairs in and about the mines as were deemed necessary. I examined the mine a short time after operations were resumed and found it in a very unsatisfactory condition as regards ventilation and drainage.

Camden. In operation 150 days during the year.

This mine is quite extensive, giving employment, as per last report, to 308 persons.

The original method of working the coal at this mine was by the single entry system, but a few years ago the double entry system was adopted. This, it seems, has given general satisfaction.

---

\* No date given.

The butt headings are driven parallel with each other, leaving a solid pillar of coal 30 feet wide between them. The rooms, or working faces, are turned off of the butt headings thirty-three feet apart. They are driven in 21 feet at a width of 7 feet. They are then widened out 13 feet additional, making a room, its full width, of 21 feet. At this width they are worked up a distance of 75 yards, when the rib is withdrawn.

On my last examination of the mine, I found the general condition fair. The air current at the furnace measured 80,200 cubic feet.

Cliff. On my last examination of this mine, I found it in a satisfactory condition.

Abe Hays. In operation but 66 days during the year. Number of persons employed inside, 70; outside, 4; condition of mine on last examination, satisfactory.

Watson. A complete electric mining plant has been installed in this mine during the year. On my last visit I found it in several places being driven in advance of the air current, which I suggested discontinued and the places ventilated before again being worked. Have since been informed that my suggestions had been complied with. Number of persons employed inside, on my last visit, 136.

Cincinnati. In my annual report for the year 1893, mention was made of a proposed slope to connect with the workings of the mine, so as to have an additional means of ingress and egress. From various causes very little work was done on the slope during the year. I hope, however, to be in a position to reports its completion in my next annual report.

This mine is one of the oldest in the district, and from its very commencement has given off fire damp at times copiously.

As the mine has been very extensively worked, a large number of abandoned workings is the result. These have at various times given trouble, owing to the gas accumulating in them. This was the case during part of the year in an old entry known as "Old 13." The condition of this part of the workings was such as to cause much anxiety to the writer, and how to remove the accumulated fire damp was a subject for serious consideration.

Owing to the position of the workings, it was thought that a current of air could be forced through them, making an outlet of the Buffalo mine shaft, which lies adjacent, but after repeated trials in this direction, it was found that the openings between the two mines were not at a point where the difficulty could be remedied. Several other methods were tried for the purpose of removing the gas, but each in turn proved a failure.

No plan of this part of the workings was known to exist, and al.

our work was on "information received" in regard to the excavated parts. This was anything but reliable, so it will be seen that we were working at a disadvantage.

Stoppings were put up in the entrance leading to the workings of Old 13. After doing this, I notified Inspectors Blick and Connor to meet me at the mine for consultation, with the purpose of forming some plan of action. In the meantime, however, an entry (part of which was driven through part of the upper strata) was started from near the shaft with the object of intersecting an entry known as "Old No. 7.\*" This latter entry was connected with Old 13, and if not closed by falls, a current of air could be forced through the old workings. Fortunately, when holed, the place was sufficiently open to allow a current of air to travel through the entrance at the point before mentioned. These stoppings were then removed and a current of air turned into the place. The accumulated fire damp was so large in volume that it would fire in a safety lamp at the outlet near shaft some 14 days afterwards.

I am pleased to state that this large body of fire damp was removed without any accident whatever.

When examined on December 22, the mine, as regards ventilation and drainage, was in fair condition.

Blyth. On my last examination of this mine, but a few persons were at work inside. Work of an active nature having been suspended owing to the lack of loading facilities.

At the time of my visit, the ventilation was of the continuous current system, but work was being done to comply with the law, regarding the divisions. With this exception, the mine, as a whole, was in satisfactory condition.

Anchor. This is a new opening, located on the east side of the river and nearly opposite the borough of Roscoe, and is operated by A. G. and J. E. Leonard. The mine consists of two main and five cross headings.

On my first visit, after active operations had begun, I found the ventilation in parts of the mine very unsatisfactory. This was, in part, the fault of the person whose duty it was to attend to the furnace. What little air there was circulating through the mine was so mixed with smoke from powder blasts that it was unfit to breathe. This condition necessitated a request that the mine be so ventilated as to conform with the law. This the management promised to do.

A fan 16 feet in diameter has since been put in position, and with proper care should produce all the air required for the mine for some time to come.

---

\* On examination of the mine by Inspector Blick and Conner they agreed that what was being done was for the best under the circumstances.

**Crowthers.** This mine consists of two small drift openings which, when examined last were employing eight and six persons, respectively. The ventilation and drainage required attention.

**Clipper.** On each visit to this mine I had occasion to call the attention of the mine officials to some violation of the act, or non-compliance with its provisions. This was especially the case as regards the ventilation in parts of the mine. The matter of openings was also a subject which required adjustment.

An opening which was to be used as an escapement in cases of emergency was allowed (after being put in a passable condition) to get into such a condition as to be almost impassable for quite a distance. I have requested the officials of the mine to have the cause of complaint removed.

**Chalfant.** This mine is located on Dunlap's creek. When last visited there was not a sufficient number of persons employed to bring it under the provisions of the law.

#### Fatal Accidents.

Mike Humnula, a miner employed in the Tremont mine, was, on January 13, so badly hurt by a premature blast that he lived but 18 hours.

The deceased and Andrew Rando worked together, and previous to the accident they were about to fire a blast in the coal. Humnula placed the squib in position and ignited it and then made his way to a safe position, but after waiting a short time for the blast to fire, the deceased remarked that the squib had gone out and that he would re-light it. This Rando protested against, but no attention was given the warning. The result was that Humnula went and set fire to the squib and before he could get out of the way the explosion occurred, throwing the coal, some of which struck the unfortunate man, with the result as above stated. Humnula was a Finlander, 21 years of age, and single.

Joseph Backo, a miner, was, on January 25th, fatally injured by a fall of slate in Beaumont mine.

This accident occurred in room 5, entry 7, while the deceased was at work "bearing in." Owing to the place being cleaned up by two persons without authority from the mine foreman, I did not get to see the original position of the room after the accident, but from what I could learn, a post which the deceased had under the slate was not in the proper place, and as a consequence was of no practical use. Backo was a single man, 22 years of age, and a Hungarian by birth.

Peter Sonslow, a miner, employed in the Climax mine, was on January 27th, instantly killed by a fall of coal. Frank Toad, Louis Fer-

rick and the deceased were at work drawing entry pillars, between entries 9 and 10.

Ferrick was "bearing in" next to right side of place, Toad on 10 entry and directly opposite to where Sonslow was at work. This was near a break-through and on the corner of pillar a "bearing in" some 12 feet long and about 2 feet 6 inches in depth, coal to the amount of about 60 bushels fell from this and struck Sonslow, with the above result. He was warned of the dangerous condition of the breast at this point by one of his companions, but he answered that it was "all right." Sonslow was a native of Hungary, in which country he left a widow and two children. Deceased was 32 years of age.

Alexander Overand, a miner, 32 years of age, was fatally injured in Ella mine on February 10th by a fall of slate. Deceased and Matthew Dewson worked together and at the time of the accident were engaged in loading a car, when a piece of slate which measured 7 feet long, 2 feet wide and ten inches thick fell, striking Overand, injuring him so badly that death resulted some nine hours after. The slate, I am informed, was examined thirty minutes previous to its falling and was considered at that time "safe." Overand was a native of Scotland. Deceased left a wife and four children.

Thomas Dunn, English, a miner 51 years of age, employed in the Black Diamond mine, was on the 12th day of February instantly killed by a fall of slate. Dunn and a son aged 16 years worked together in the main air course, and while at work loading a car, the slate fell on the deceased. This slate measured 7 feet long, 3 feet wide and 10 inches thick.

On examining the place where the accident occurred, I found that some slate had been taken down on the right side of working place, but on the left side slate had been left up, and from under this the deceased was shovelling coal into a car when the slate fell. This slate showed a slip next to the face, which cut it off from any support at this point. One side rested on the coal pillars but the other side was unsupported and consequently caused the slate to form a leverage on the coal pillars; this made the slate very dangerous.

Taking into consideration the place as seen afterward, it showed an oversight on the part of the deceased that cannot be accounted for. Dunn was an old miner, and as far as practice went, was one of the best in the kind of work he was engaged in. The deceased left a widow and three children.

At Black Diamond mine on the 22d day of February, an accident occurred whereby a driver named John McCahill, an American, was instantly killed by mine cars. McCahill, while moving a trip of four cars on main entry out toward the double parting, was in some mysterious manner thrown under the first car of trip, and when found his

body was lying parallel with the track, face toward centre of entry, the car off the track and resting on the body.

A trapper boy, whose door is located quite a distance from where the body of McCahill was found, says that when deceased passed through his door that he (McCahill) was sitting on the top of the front end of the first car of the trip. From this, and the distance from the body at which the deceased's cap and lamp were found, it is supposed that the cap and lamp were knocked off by coming in contact with the roof, and being in the dark he jumped off the car, and in doing so, either fell or tripped, and before he could recover himself the cars caught him. McCahill left a young widow to mourn his untimely death. Deceased was in his twenty-first year.

Giuseppe Dariguzzie, an Italian miner, 32 years of age, and single, met instant death on February 24th, by a fall of coal in Blyth mine.

Deceased and Minia Davitt worked together in entry 7, room 27, and at the time of the accident were engaged as follows: The former "bearing in" and the latter cleaning the room track. While he was thus engaged the coal fell, striking him, resulting as above. On examination of the place I found that they had fired a butt shot; this did not throw all the coal, but what was left was somewhat loose under this, and on the end of butt Dariguzzie had been at work. Davitt informed the writer that some time previous to the fall of the coal the deceased had tried to get it down but gave it up, and immediately before the deceased started to "bear in" Davitt asked him how the coal was and the answer was "all right," but he was in error, for he had worked but a few moments when coal to the amount of five bushels fell on him.

John Powers, an Irish miner, 44 years of age, was instantly killed by a fall of coal in Gastonville mine No. 2 on March 16.

The deceased and a brother, Thomas, worked together, and at the time of the accident were "bearing in" and loading a car, respectively.

Subsequent examination into the cause of this accident showed that they had a "bearing-in" made in a butt which measured about 10 feet long and some 3 feet deep. To make room to mine it deeper, a small charge of powder had been put in immediately under the "bearing slates," and next to the right rip, but this shot not only loosened the coal below the "slates," but also the whole breast somewhat: in addition to this a middle shot had been fired which shattered the end of the butt, leaving the coal in an extremely dangerous condition. At a point near the end of the butt, the deceased was at work "bearing in," when, without warning, the coal fell. Powers left a widow and seven children.

John Tromasky, a Slavish miner, 30 years of age, was instantly killed by a fall of coal and slate in Acme mine on March 21st.

It seems that the deceased and George Polaski, who worked with him, were "bearing in" on a butt. The latter heard the coal and slate move and called to Tromasky to "look out," but before the unfortunate man could do so the fall took place, resulting as above stated. Tromasky left a widow and one child.

In Champion mine, March 22, Alexander Sabine, an Italian miner, 29 years of age, was so seriously injured by a fall of coal and slate that death resulted 11 days after. Sabine was a single man.

On April 7th an accident occurred in Cliff mine, which resulted in the instant death of a French miner named Henry Dehose, by a fall of "horse-back."

The deceased worked in room 24, entry 18, and had but a few cars to mine to finish the room. For some unknown reason he left his room and started up the entry, and when opposite room 25 he was caught by a fall of horse-back. Inquest held and a verdict of accidental death rendered. Dehose left a widow and seven children.

By Dilly trip, in Gastonville mine No. 1, April 11th, John Misterskey, a Polish miner, 45 years of age, was instantly killed.

This accident occurred near the mine entrance, and from the evidence it seemed that the body was dragged by the trip, some 54 feet. Three cars of the trip were off the track, the body being found under the fifth car.

The trapper who attended a door close by, stated that he saw the deceased in the centre of the entry while the trip was under way, and that he (Misterskey) made no effort to get into a place of safety which he could have done, as, while there was no shelter holes at this point, there was sufficient room between the cars and rib for the trip to pass him under ordinary circumstances. At the point where the trip is supposed to have caught him, there was a space of three feet eight inches, measuring from rail to coal pillar. Verdict of coroner's jury, accidental death. Misterskey left a widow and two children.

In Little Redstone mine, an accident occurred on April 14th whereby John Shock lost his life by a fall of slate. Deceased worked with a brother, and while they were loading a car, a piece of slate measuring 9 feet 6 inches long, 1 foot 6 inches wide, and about 10 inches thick, fell with the result as above stated.

I am informed that it was known to be unsafe previous to its falling, and to make it secure, a post was brought to the place to set, but for some reason unknown to the writer this was not done. Shock left a widow and two children.

Patrick Oates, Irish, a miner, 60 years of age, was fatally injured on July 2d, in Blyth mine by a fall of slate. Lived some 30 hours after.



After a careful examination of the place where the accident occurred, I am of the opinion that it was unavoidable. The room being well posted and the general appearance of the whole showed the work of a practical miner. The slate which fell measured on an average 4 feet long, 2 feet wide and some 10 inches thick, the shape being in the form of what is known in mining parlance as a "pot." Deceased left a widow and eight children.

John Mikula, Slavish, a miner 41 years of age, was fatally injured by a fall of slate in Manown mine on July 3d. Lived some two hours after. Mikula left a widow and two children.

Miko Katuris, Austrian, a miner 38 years of age, was instantly killed by a fall of coal in Ivil mine on July 7th. The deceased and Michael Beckenwish work together in room 12, entry 38. At the time of the accident the deceased was "bearing in" on the end of a butt, while Beckenwish was drilling a hole in the same butt. While this work was being done, part of the coal fell with result as above stated.

These miners were told by a miner who worked in an adjacent room that the coal was loose and that they had better put a sprag under it, but they did not heed the advice. Am informed that the deceased had been in the country but two weeks. The unfortunate man left a widow and two children.

Joseph Battalluh, Italian, a miner, was instantly killed in Ivil mine on August 18th by a fall of coal and slate. The deceased and Stephen La Franka worked together in room 46, entry 36, and at the time of the accident the deceased was loading a car, La Franka being engaged in repairing the room track. While the deceased was loading the coal from the road-head, the coal and slate fell on him, resulting in instant death. Battalluh left a widow and three children.

On September 4th, W. H. Teesdale, English, a miner, 38 years of age, was instantly killed in Eclipse (railroad) mine by a fall of slate. The deceased was driving No. 18 entry, and at the time of the accident was loading a car. A piece of slate was hanging on side of entry, under which the deceased had intended to place a post, he having a post at the face for that purpose, but for some unknown reason he failed to do so. It fell, resulting as above stated.

He left a wife and five children.

John Lenox, Jr., American, a miner 19 years of age and single, was fatally injured on October 5th, in Stockdale mine, by a fall of slate. Lived but six hours after.

John Gilleum, Belgian, miner, aged — years, was on October 8th fatally injured by a fall of slate in room 16, entry 23, Old Eagle mine, and died shortly after. At the time of the accident the deceased was knocking coal from under the slate. A miner who worked in the

next room just a few moments before it fell, told Gilleum to set a post under the slate, but the unfortunate man did not heed the warning, and as a consequence lost his life. Deceased left a widow and two children.

Frank Vielli, French, miner, 30 years of age, was fatally injured by a fall of slate, October 17th, in Nottingham mine. Died some 11 hours after. He left a widow and one child.

John Cutko, Hungarian, miner, 38 years of age, was fatally injured October 22d, in Climax mine, by a fall of coal. Death resulted some 12 hours later.

Deceased and Peter Alexander were engaged in driving a 12-foot place for air. They had put off two blasts in the coal, one on either side, neither of which brought all of the coal down that was undermined, but the remainder, however, was somewhat shattered, and to get it down Cutko commenced to "shear" (cutting the coal vertically) the coal on the right of the place and immediately against the pillar. While at this work, and before he could get to a place of safety, the coal fell, striking Cutko, resulting as above stated. Deceased left a widow and one child.

On the morning of October 24th, Gaspara Chiafia, Italian, was fatally and Frank Benditi seriously injured by being run over by the Dilly trip in Stony Hill mine.

These men were not employed at the mine, but had received a promise of work from Mr. Dixon the operator, and for the purpose of seeing the mine foreman they started toward the mine entrance with a view of entering the same. Mr. Dixon being present and seeing the object of the men, advised them not to enter the mine until the trip came out; this warning they did not heed, but entered the mine, and had not proceeded far until the trip struck them, resulting as above stated. Chiafia was a single man. I was not informed of his age.

John Shannic, Polander, a miner, was on November 12th instantly killed by a fall of slate in room 35, entry 7 of the Allen mine.

Owing to the place having been cleaned up by unauthorized persons before I visited the mine, I can give no report as to its condition immediately after the accident. From what I can learn, the piece of slate which fell on the deceased was from a position near the road-head, and it seems to have been an unavoidable accident. Shannic was 34 years of age and single.

Charles Kulkman, German, a miner, was instantly killed on November 28th, in Gastonville mine No. 2 by a fall of slate.

Kulkman was working in a room pillar. Some time previous to the accident a fall had taken place in this part of the workings and took the "face." The pillar was then "cut-over" some thirteen feet

from edge of fall. This left a block of coal in the above, thirteen feet in length and about eight feet in width. This "block" the deceased wished to take out, but the mine foreman advised him not to make any attempt in that direction, as it would be dangerous, and ordered Kulkman to not work at it at all, but he disobeyed, and the loss of his life was the result.

On examination of the place subsequent to the accident, I found that the deceased had undermined the aforesaid "block" some three feet deep to its entire length.

Some slate (which measured 4 feet long, 3 feet wide and 14 inches thick) had also been "up" on the face next to and immediately opposite the pillar proper. Under this piece the deceased was found.

The time of this man's death is not definitely known, but is supposed to have occurred in the neighborhood of 6.30 P. M., as a fellow miner named Joseph Partman saw him about three-quarters of an hour before the time the body was found.

He was a single man, 28 years of age.

TABLE I.—Showing Location of Collieries in the First Bituminous Mine District.

| Name of Colliery. | Name of Operator.                   | Location—County. | Name of Superintendent. | Postoffice Address.         |
|-------------------|-------------------------------------|------------------|-------------------------|-----------------------------|
| Albion            | C. Jutte & Co.                      | Fayette          | Charles Bradford        | Fayette City.               |
| Albany            | Snowden Gould & Co.                 | do.              | William Seddon          | Brownsville.                |
| Alicor            | A. & J. Leonard                     | do.              | J. E. Leonard           | Roscoe.                     |
| Arcene            | Stockdale Coal Company.             | Washington       | C. H. Braznell          | Monarch.                    |
| Allen             | Allen Coal Company.                 | do.              | C. H. Braznell          | Monarch.                    |
| Anderson          | P. M. Anderson                      | do.              | Thos. E. Robb           | Venita.                     |
| Al-quippa         | W. S. E. Hays                       | do.              | T. S. Hutchinson        | Monongahela.                |
| Amity             | Bailey, Wilson & Co.                | Allegheny        | W. W. Wilson            | Candlen.                    |
| Banola            | S. S. Crump & Co.                   | do.              | S. S. Crump             | No. 8 Wood St., Pittsburgh. |
| Banner            | O'Neil and Peterson                 | do.              | G. W. Peterson          | Banola.                     |
| Blyth             | J. M. Fisher                        | Washington       | James F. Dovey          | Shire Oaks.                 |
| Black Diamond     | Blyth Coal Company.                 | do.              | Thomas C. Cowell        | Spears.                     |
| Beaman            | W. H. Brown Sons.                   | do.              | James S. Lottitt        | Monongahela.                |
| Beaumont          | Beaumont Coal Company.              | do.              | James S. Lottitt        | West Brownsville.           |
| Barfalo           | Corey Gas Coal Company.             | do.              | A. G. Leonard           | Courtney.                   |
| Cincinnati        | C. Jutte & Co.                      | do.              | Henry Boyet             | Monongahela.                |
| Chilf             | J. M. Fisher                        | do.              | William Davis           | Monongahela.                |
| Coal Bluff        | J. M. Fisher                        | do.              | James F. Dovey          | Shire Oaks.                 |
| Cassburg          | J. M. Fisher                        | do.              | James F. Dovey          | Shire Oaks.                 |
| Catsburg          | Catsburg Coal Company.              | do.              | John H. Jones           | Monongahela.                |
| Coal Centre       | P. J. Forsyth & Co.                 | do.              | P. J. Forsyth           | Coal Centre.                |
| Clippert          | Clippert Coal Company.              | do.              | Robert Jack             | Allegheny.                  |
| Courtney          | Mingo Gas Coal Company.             | do.              | Ass't. Thomas A. Watson | Courtney.                   |
| Aladonia          | T. J. Wood                          | do.              | Ellen                   | Ellen.                      |
| Champion          | T. J. Wood                          | do.              | Allen Bradshaw          | Charlton.                   |
| Charlton          | Charlton Coal Company.              | do.              | Jesse K. Johnston       | Charlton.                   |
| Prescott          | California Coal Company.            | do.              | Allen Bradshaw          | California.                 |
| Chimney           | George Lytle Sons.                  | Allegheny        | Robert J. Gregg         | Candlen.                    |
| Chimney           | Pittsburg and Belle Vernon Coal Co. | Fayette          | E. M. Thomas            | Brownsville.                |
| Chimney           | Brownsville Coal Company.           | do.              | J. John Owens           | Brownsville.                |
| Crothers          | Jonas Crothers                      | do.              | W. C. Fishburn          | Coal Centre.                |
| Coal Hill         | Bartia Basenttes                    | do.              | S. T. Crowthers         | Coal Centre.                |
| Cleveland         | B. H. Somers Fuel Company           | do.              | Bartia Basenttes        | Belle Vernon.               |
| Dunlap            | Dunlap Coal Company                 | do.              | W. P. Bates             | Brownsville.                |
| Edgose            | Edgose Coal Company                 | Washington       | Moses Ramage            | California.                 |
| Edgose, River     | Schorre, Seiker & Co.               | do.              | D. E. Blackburn         | Belle Vernon.               |
| Ellas, Railroad   | Ellas Coal Company                  | do.              | B. F. McCannaghey       | California.                 |
| Fayette City      | Sumner O'Neil, Attorney.            | Westmoreland     | John O'Neil             | No. 8 Wood St., Pittsburgh  |
| Fulton            | Fulton Coal Company.                | Fayette          | James O'Neil            | McKeesport.                 |
| Fox               | Fox Coal Company.                   | Allegheny        | T. M. Jones             | Fayette City.               |
| Germantown        | Germantown Coal Company             | Washington       | Goodloe Mitchener       | Millisboro.                 |
| Germantown        | Germantown Coal Company             | do.              | Henry E. Khaloch        | Jones' Station.             |
| Hastonville       | Pittsburg and Chicago Gas Coal Co.  | do.              | C. Frelman              | Roscoe.                     |
| Hackett           | Bayle B. Coal Company.              | do.              | J. S. Van Eman          | Finteyville.                |
| Hildale           | Hildale Coal Company.               | do.              | J. E. Bayle             | Hackett.                    |
| Hill              | James Jones                         | do.              | Even Beede              | Jones' Station.             |
| Hill              | James Jones                         | do.              | T. J. Jones             | Monongahela.                |

|                        |  |                     |                          |                       |
|------------------------|--|---------------------|--------------------------|-----------------------|
| Jefferson, .....       | Thomas Foster & Sons, .....                | Allegheey, .....    | D. B. Foster, .....      | Coal Valley, .....    |
| Knob, .....            | Knob Coal Company, .....                   | Washington, .....   | S. H. Pearsoll, .....    | Brownsville, .....    |
| Little Alps, .....     | Alps Coal Company, .....                   | Fayette, .....      | Joseph Underwood, .....  | Roscoe, .....         |
| Little Redstone, ..... | Little Redstone Coal Company, .....        | do, .....           | John T. Jones, .....     | Gillespie, .....      |
| Milesville, .....      | Robert Jenkins, .....                      | Allegheey, .....    | Robert Jenkins, .....    | Sunny Side, .....     |
| Manown, .....          | Youngingbenny Gas Coal Company, .....      | do, .....           | Lutes Hummel, .....      | Manown, .....         |
| Manowh, .....          | W. H. Brown & Sons, .....                  | do, .....           | James Loutitt, .....     | Monongahela, .....    |
| North Webster, .....   | Webster Gas Coal Company, .....            | Washington, .....   | S. S. Roberts, .....     | Elizabeth, .....      |
| Nottingham, .....      | Henry Florshelm, .....                     | do, .....           | M. F. Delany, .....      | Pinleyville, .....    |
| New Eagle, .....       | M. F. Delany, .....                        | Allegheey, .....    | James Loutitt, .....     | New Eagle, .....      |
| Old Eagle, .....       | W. H. Brown's Sons, .....                  | Westmoreland, ..... | D. G. Jones, .....       | Monongahela, .....    |
| Rostraver, .....       | Rostraver Coal Company, .....              | Allegheey, .....    | James H. Anders, .....   | Lock No. 4, .....     |
| Rock Run, .....        | S. C. Snodgrass, .....                     | do, .....           | James H. Van Eman, ..... | Camden, .....         |
| Snowdon, .....         | Pittsburgh and Chicago Gas Coal Co., ..... | Fayette, .....      | John S. Scott, .....     | Gastonville, .....    |
| Stonesburg, .....      | Alps Coal Company, .....                   | do, .....           | Joseph Underwood, .....  | Travlersburg, .....   |
| Stony Hill, .....      | John H. Dixon, .....                       | Washington, .....   | John N. Dixon, .....     | Roscoe, .....         |
| Shepliar, .....        | Shepliar Gas Coal Company, .....           | do, .....           | James Laird, .....       | California, .....     |
| Stockdale, .....       | Fulton Coal Company, .....                 | Washington, .....   | James Laird, .....       | Webster, .....        |
| Tremont, .....         | John A. Wood & Son, .....                  | Fayette, .....      | S. J. Graham, .....      | Belle Vernon, .....   |
| Umpire, .....          | C. L. Snowden & Co., .....                 | do, .....           | J. J. Simpson, .....     | Brownsville, .....    |
| Vigilant, .....        | California Coal Company, .....             | do, .....           | John A. Powell, .....    | California, .....     |
| Vesta No. 1, .....     | Vesta Coal Company, .....                  | do, .....           | R. B. Loran, .....       | California, .....     |
| Vesta No. 2, .....     | Vesta Coal Company, .....                  | do, .....           | R. E. Loran, .....       | California, .....     |
| Vesta No. 3, .....     | Vesta Coal Company, .....                  | Allegheey, .....    | G. L. Burke, .....       | California, .....     |
| Walton Upper, .....    | Joseph Walton & Co., .....                 | do, .....           | John W. Rike, .....      | West Elizabeth, ..... |
| Walton Lower, .....    | Watson Mining and Manufacturing Co., ..... | do, .....           | John W. Rike, .....      | West Elizabeth, ..... |
| Watson, .....          | Briggs and Flint, .....                    | Fayette, .....      | Charles P. Rankin, ..... | Monongahela, .....    |
| Washington, .....      |  |                     | Thomas S. Briggs, .....  | Monarch, .....        |

TABLE No. 2.—Gives the total number of tons of coal mined in each colliery, number of days worked, number of employees, number of persons killed and injured, number of kegs of powder used, &c., in the First Bituminous Mine District, for the year ending December 31, 1894.

| Names of Collieries. | Location—County. | Total production in tons of coal. | Total shipment in tons of coal. | Number days worked. | Number persons employed. | Number fatal accidents. | Number non-fatal accidents. | Number kegs powder used. | Number steam boilers. | Number horses and mules. | Number of mine locomotives. | Names of Collieries.              |                                 |
|----------------------|------------------|-----------------------------------|---------------------------------|---------------------|--------------------------|-------------------------|-----------------------------|--------------------------|-----------------------|--------------------------|-----------------------------|-----------------------------------|---------------------------------|
|                      |                  |                                   |                                 |                     |                          |                         |                             |                          |                       |                          |                             | Total production in tons of coal. | Total shipment in tons of coal. |
| Appollo.....         | Fayette.....     | 74,021                            | 74,021                          | .....               | 112                      | .....                   | .....                       | 789                      | .....                 | 1                        | .....                       | Appollo.....                      | Fayette.....                    |
| Albany.....          | Fayette.....     | 37,768                            | 37,768                          | 69                  | 176                      | .....                   | .....                       | 208                      | 4                     | 11                       | .....                       | Anchor.....                       | Fayette.....                    |
| Anchor.....          | Fayette.....     | 10,476                            | 10,476                          | 42                  | 63                       | .....                   | .....                       | .....                    | .....                 | 4                        | .....                       | Allen.....                        | Washington.....                 |
| Achier.....          | Washington.....  | 94,247                            | 94,247                          | 112                 | 130                      | .....                   | .....                       | 450                      | .....                 | 9                        | .....                       | Anderson.....                     | Washington.....                 |
| Allen.....           | Washington.....  | 72,468                            | 72,468                          | 103                 | 108                      | .....                   | .....                       | 300                      | .....                 | 8                        | .....                       | Abe Hays.....                     | Washington.....                 |
| Anderson.....        | Washington.....  | 37,578                            | 37,578                          | 111                 | 170                      | .....                   | .....                       | .....                    | 3                     | 10                       | .....                       | Allequippa.....                   | Washington.....                 |
| Abe Hays.....        | Washington.....  | 11,446                            | 11,446                          | 65                  | 74                       | .....                   | .....                       | .....                    | .....                 | 7                        | .....                       | Amity.....                        | Allegheny.....                  |
| Allequippa.....      | Washington.....  | 127,842                           | 127,842                         | 142½                | 286                      | .....                   | .....                       | .....                    | 2                     | 18                       | .....                       | Bannock.....                      | Allegheny.....                  |
| Amity.....           | Allegheny.....   | 104,518                           | 103,018                         | 145                 | 227                      | .....                   | .....                       | 100                      | .....                 | 21                       | .....                       | Black Diamond.....                | Allegheny.....                  |
| Bannock.....         | Allegheny.....   | 58,571                            | 58,571                          | 120                 | 160                      | .....                   | .....                       | 400                      | .....                 | 8                        | .....                       | Beaumont.....                     | Allegheny.....                  |
| Black Diamond.....   | Allegheny.....   | 16,300                            | 16,300                          | 80                  | 69                       | .....                   | .....                       | .....                    | 1                     | 1                        | .....                       | Buffalo.....                      | Allegheny.....                  |
| Beaumont.....        | Allegheny.....   | 116,111                           | 116,111                         | 149                 | 176                      | .....                   | .....                       | 225                      | .....                 | 12                       | .....                       | Cincinnati.....                   | Allegheny.....                  |
| Buffalo.....         | Allegheny.....   | 184,437                           | 184,437                         | 170                 | 228                      | .....                   | .....                       | .....                    | 2                     | 8                        | .....                       | Coal Bluff.....                   | Allegheny.....                  |
| Cincinnati.....      | Allegheny.....   | 40,280                            | 40,280                          | 200                 | 215                      | .....                   | .....                       | .....                    | .....                 | .....                    | .....                       | Cliff.....                        | Allegheny.....                  |
| Coal Bluff.....      | Allegheny.....   | 12,832                            | 12,832                          | 48                  | 67                       | .....                   | .....                       | 389                      | .....                 | 4                        | .....                       | Catsburg.....                     | Allegheny.....                  |
| Cliff.....           | Allegheny.....   | 84,416                            | 84,416                          | 200                 | 196                      | .....                   | .....                       | .....                    | 2                     | 14                       | .....                       | Coal Centre.....                  | Allegheny.....                  |
| Catsburg.....        | Allegheny.....   | 82,396                            | 82,000                          | 149                 | 171                      | .....                   | .....                       | .....                    | .....                 | 11                       | .....                       | Courtney.....                     | Allegheny.....                  |
| Coal Centre.....     | Allegheny.....   | 57,970                            | 57,000                          | 155                 | 181                      | .....                   | .....                       | .....                    | .....                 | 6                        | .....                       | Caedonia.....                     | Allegheny.....                  |
| Courtney.....        | Allegheny.....   | 206,410                           | 206,410                         | 180                 | 225                      | .....                   | .....                       | 600                      | .....                 | 7                        | .....                       | Charleston.....                   | Allegheny.....                  |
| Caedonia.....        | Allegheny.....   | 55,469                            | 55,469                          | 200                 | 104                      | .....                   | .....                       | .....                    | .....                 | 10                       | .....                       | Crescent.....                     | Allegheny.....                  |
| Charleston.....      | Allegheny.....   | 99,033                            | 99,033                          | .....               | 185                      | .....                   | .....                       | .....                    | .....                 | 2                        | .....                       | Carnden.....                      | Allegheny.....                  |
| Crescent.....        | Allegheny.....   | 13,127                            | 13,127                          | .....               | 85                       | .....                   | .....                       | 740                      | .....                 | 10                       | .....                       | Chamax.....                       | Allegheny.....                  |
| Carnden.....         | Allegheny.....   | 46,646                            | 46,646                          | 100                 | 115                      | .....                   | .....                       | .....                    | .....                 | 12                       | .....                       | Chamouni.....                     | Allegheny.....                  |
| Chamax.....          | Allegheny.....   | 96,648                            | 96,648                          | 127                 | 184                      | .....                   | .....                       | .....                    | .....                 | 9                        | .....                       | Crouthers.....                    | Allegheny.....                  |
| Chamouni.....        | Allegheny.....   | 95,220                            | 95,220                          | 133½                | 140                      | .....                   | .....                       | .....                    | .....                 | 10                       | .....                       |                                   |                                 |
| Crouthers.....       | Allegheny.....   | 108,000                           | 108,000                         | 158                 | 194                      | .....                   | .....                       | .....                    | .....                 | 15                       | .....                       |                                   |                                 |
|                      |                  | 70,000                            | 70,000                          | 150                 | 308                      | .....                   | .....                       | .....                    | .....                 | 7                        | .....                       |                                   |                                 |
|                      |                  | 81,641                            | 81,641                          | .....               | 115                      | .....                   | .....                       | .....                    | .....                 | 19                       | .....                       |                                   |                                 |
|                      |                  | 27,572                            | 27,572                          | .....               | 173                      | .....                   | .....                       | .....                    | .....                 | 8                        | .....                       |                                   |                                 |
|                      |                  | 3,420                             | 3,420                           | .....               | 16                       | .....                   | .....                       | .....                    | .....                 | 3                        | .....                       |                                   |                                 |

|                           |           |           |        |    |       |      |
|---------------------------|-----------|-----------|--------|----|-------|------|
| Cedar Hill, .....         | 40,000    | 185       | 34     |    | 75    | 4    |
| Cleveland, .....          | 134,465   | 135       | 215    | 15 | 1,200 | 17   |
| Dunlap, .....             | 87        |           |        |    |       |      |
| Fayette, .....            | 83,600    | 80        |        |    |       | 1    |
| Fayette, .....            | 53,036    | 134       | 207    | 1  | 390   | 2 11 |
| Fayette, .....            | 113,250   | 224       | 124    | 1  |       | 1    |
| Fayette, .....            | 130,313   | 218       | 139    | 1  |       | 2 19 |
| Fayette City, .....       | 9,165     | 35        | 37     | 7  |       | 5 15 |
| Fulton, .....             | 7,098     |           | 59     |    | 300   |      |
| Fulton, .....             | 47,013    | 121½      | 63     |    |       | 2    |
| Fidelity, .....           | 46,263    | 253       | 172    |    | 12½   | 1    |
| Germania, .....           | 76,264    | 138½      | 207    | 3  |       | 1 11 |
| Gasconville, .....        | 61,380    | 113       | 214    |    | 109   |      |
| Haskett, .....            | 66,692    | 145       | 152    |    | 400   |      |
| Hildale, .....            | 94,820    | 213       | 225    | 2  |       | 3 8  |
| Hill, .....               | 47,080    | 80        | 181    |    |       | 3 9  |
| Jefferson, .....          | 102,494   | 188       | 218    |    | 200   | 2 11 |
| Knob, .....               | 21,285    | 79        | 49     |    | 100   |      |
| Little Alps, .....        | 95,977    | 143       | 189    | 1  |       | 2 8  |
| Little Redston, .....     | 34,382    | 148       | 36     |    | 75    | 2 5  |
| Milesville, .....         | 151,617   |           | 200    | 1  | 8     | 6 9  |
| Manown, .....             | 46,927    | 256       | 79     | 3  | 225   | 5    |
| Manonah, .....            | 48,064    | 322       | 138    |    | 50    | 1 6  |
| North Webster, .....      | 93,375    | 203       | 183    | 1  | 2 24  | 14   |
| Nottingham, .....         | 18,000    | 130       | 146    |    |       | 1 6  |
| New Eagle, .....          | 97,951    | 149       | 226    | 1  | 300   | 6 10 |
| Old Eagle, .....          | 63,480    | 225       | 172    |    | 300   | 1 7  |
| Rosstraver, .....         | 73,830    | 144       | 186    |    |       | 10   |
| Rock Run, .....           | 64,938    | 153¾      | 186    |    | 40    | 3 11 |
| Snowden, .....            | 30,366    | 80        | 125    |    |       | 2 9  |
| Stonesburg, .....         | 90,670    | 179       | 151    |    | 360   | 1 1  |
| Snow Hill, .....          | 73,634    | 128       | 146    | 1  |       | 2 8  |
| Stony Hill, .....         | 55,292    | 144       | 136    | 1  |       | 1 1  |
| Sheplea, .....            | 1,370     | 40        | 29     | 1  | 150   |      |
| Skeedale, .....           | 80,064    | 154       | 92     | 1  |       | 2    |
| Trenont, .....            | 28,000    | 96        | 178    | 1  |       | 5 10 |
| Umpire, .....             | 102,000   | 156       | 185    |    | 244   | 2 11 |
| Vigilant, .....           | 220,026   | 290       | 153    |    | 900   | 3 9  |
| Vesta No. 1, .....        | 52,085    | 80        | 80     | 1  | 1,600 | 3 9  |
| Vesta No. 2, .....        | 16,285    | 50        | 88     |    |       | 1 4  |
| Vesta No. 3, .....        | 179,570   | 154       | 386    |    |       | 1 29 |
| Walton, Upper mine, ..... |           |           | 1      |    |       |      |
| Walton, Lower mine, ..... | 68,057    | 186       | 168    |    | 400   | 4 9  |
| Walton, .....             | 132,338   | 233       | 201    |    | 800   | 1 9  |
| Washington, .....         |           |           |        | 8  |       |      |
| <b>Total,</b> .....       | 5,282,481 | 9,105     | 11,175 | 25 | 101   | 158  |
|                           |           | 5,277,104 |        |    |       | 542  |

\*From June 1st to December 31st.

TABLE No. 3.—Showing the number of employes at each colliery in the First Bituminous Mine District, during the year 1894.

| Names of Collieries. | Location—County. | Occupations of Persons Employed Inside. |         |                   |                  |                      | Occupations of Persons Employed Outside. |               |                             |                        |                  | Grand totals—inside and outside. |   |                |
|----------------------|------------------|---|---------|-------------------|------------------|----------------------|--|---------------|-----------------------------|------------------------|------------------|----------------------------------|---|----------------|
|                      |                  | Inside foreman or mine boss.            | Miners. | Miners' laborers. | All company men. | Drivers and runners. | Doorboys and helpers.                    | Total inside. | Blacksmiths and carpenters. | Engineers and firemen. | All company men. |                                  | Superintendent, bookkeepers and clerks. | Total outside. |
| Apollo, .....        | Fayette,         | 1                                       | 85      | 6                 | 1                | 1                    | 101                                      | 1             | 1                           | 1                      | 3                | 8                                | 12                                      | 112            |
| Albany, .....        | do.              | 1                                       | 139     | 5                 | 1                | 10                   | 160                                      | 2             | 1                           | 1                      | 1                | 9                                | 15                                      | 175            |
| Anchor, .....        | do.              | 1                                       | 49      | 8                 | 1                | 4                    | 55                                       | 1             | 1                           | 1                      | 1                | 1                                | 8                                       | 63             |
| Acme, .....          | Washington       | 1                                       | 118     | 1                 | 1                | 6                    | 129                                      | 1             | 1                           | 1                      | 1                | 7                                | 11                                      | 140            |
| Allen, .....         | do.              | 1                                       | 99      | 1                 | 1                | 6                    | 108                                      | 1             | 1                           | 1                      | 1                | 1                                | 10                                      | 108            |
| Anderson, .....      | do.              | 1                                       | 139     | 15                | 1                | 6                    | 158                                      | 5             | 1                           | 1                      | 1                | 5                                | 12                                      | 170            |
| Abe Hays, .....      | do.              | 1                                       | 55      | 1                 | 1                | 7                    | 70                                       | 1             | 1                           | 1                      | 1                | 1                                | 4                                       | 74             |
| Alleghippa, .....    | do.              | 1                                       | 229     | 24                | 1                | 12                   | 265                                      | 1             | 1                           | 1                      | 1                | 18                               | 21                                      | 286            |
| Amity, .....         | Allegheny,       | 1                                       | 170     | 18                | 1                | 16                   | 210                                      | 1             | 1                           | 1                      | 1                | 12                               | 17                                      | 227            |
| Bunola, .....        | do.              | 1                                       | 125     | 10                | 1                | 7                    | 151                                      | 1             | 1                           | 1                      | 1                | 5                                | 14                                      | 160            |
| Banner, .....        | Washington,      | 1                                       | 50      | 1                 | 4                | 4                    | 60                                       | 1             | 1                           | 1                      | 1                | 1                                | 4                                       | 69             |
| Blyth, .....         | do.              | 1                                       | 159     | 3                 | 1                | 8                    | 165                                      | 1             | 1                           | 1                      | 1                | 1                                | 10                                      | 176            |
| Black Diamond, ..... | do.              | 1                                       | 190     | 3                 | 1                | 10                   | 210                                      | 1             | 1                           | 1                      | 1                | 12                               | 18                                      | 228            |
| Beaumont, .....      | do.              | 1                                       | 175     | 15                | 1                | 8                    | 202                                      | 1             | 1                           | 1                      | 1                | 1                                | 13                                      | 215            |
| Buffalo, .....       | do.              | 1                                       | 49      | 3                 | 1                | 3                    | 55                                       | 1             | 1                           | 1                      | 1                | 3                                | 6                                       | 67             |
| Cincinnati, .....    | do.              | 1                                       | 165     | 4                 | 1                | 9                    | 184                                      | 1             | 1                           | 1                      | 1                | 1                                | 12                                      | 196            |
| Chiff, .....         | do.              | 1                                       | 140     | 3                 | 1                | 11                   | 158                                      | 1             | 1                           | 1                      | 1                | 1                                | 13                                      | 171            |
| Coal Bluff, .....    | do.              | 1                                       | 148     | 5                 | 1                | 5                    | 162                                      | 1             | 1                           | 1                      | 1                | 1                                | 19                                      | 181            |
| Catsburg, .....      | do.              | 1                                       | 180     | 6                 | 1                | 8                    | 204                                      | 1             | 1                           | 1                      | 1                | 1                                | 21                                      | 225            |
| Coal Centre, .....   | do.              | 1                                       | 159     | 4                 | 1                | 9                    | 171                                      | 1             | 1                           | 1                      | 1                | 1                                | 14                                      | 185            |
| Clipper, .....       | do.              | 1                                       | 80      | 1                 | 1                | 7                    | 91                                       | 1             | 1                           | 1                      | 1                | 1                                | 13                                      | 104            |
| Courcney, .....      | do.              | 1                                       | 60      | 6                 | 1                | 5                    | 77                                       | 1             | 1                           | 1                      | 1                | 1                                | 8                                       | 85             |
| Caledonia, .....     | do.              | 1                                       | 80      | 10                | 1                | 9                    | 105                                      | 1             | 1                           | 1                      | 1                | 1                                | 10                                      | 115            |
| Champion, .....      | do.              | 1                                       | 140     | 15                | 1                | 10                   | 171                                      | 1             | 1                           | 1                      | 1                | 1                                | 13                                      | 184            |
| Charleot, .....      | do.              | 1                                       | 120     | 4                 | 1                | 5                    | 131                                      | 1             | 1                           | 1                      | 1                | 1                                | 9                                       | 140            |
| Crescent, .....      | do.              | 1                                       | 169     | 12                | 1                | 7                    | 183                                      | 1             | 1                           | 1                      | 1                | 1                                | 11                                      | 194            |
| Cruden, .....        | Allegheny,       | 1                                       | 250     | 1                 | 1                | 15                   | 276                                      | 1             | 1                           | 1                      | 1                | 30                               | 32                                      | 308            |
| Climax, .....        | Fayette,         | 1                                       | 130     | 1                 | 1                | 8                    | 162                                      | 1             | 1                           | 1                      | 1                | 1                                | 12                                      | 175            |
| Crothers, .....      | do.              | 1                                       | 140     | 1                 | 1                | 6                    | 161                                      | 1             | 1                           | 1                      | 1                | 1                                | 12                                      | 173            |
| Cedar Hill, .....    | do.              | 1                                       | 32      | 1                 | 1                | 1                    | 34                                       | 1             | 1                           | 1                      | 1                | 1                                | 3                                       | 36             |
|                      | do.              | 1                                       | 25      | 1                 | 1                | 1                    | 31                                       | 1             | 1                           | 1                      | 1                | 1                                | 3                                       | 34             |



|                   |    |       |     |     |     |     |        |    |     |     |     |        |
|-------------------|----|-------|-----|-----|-----|-----|--------|----|-----|-----|-----|--------|
| Cleveland         | 1  | 180   | 8   | 5   | 9   | 3   | 296    | 1  | 1   | 9   | 3   | 219    |
| Dunlap            | 1  | 175   | 7   | 1   | 10  | 2   | 191    | 2  | 1   | 1   | 12  | 9      |
| Eclipse, River    | 1  | 160   | 6   | 1   | 16  | 4   | 191    | 2  | 2   | 11  | 16  | 297    |
| Eclipse, Railroad | 1  | 100   | 6   | 1   | 6   | 1   | 119    | 2  | 3   | 1   | 10  | 200    |
| Edipse            | 1  | 88    | 1   | 1   | 10  | 2   | 101    | 3  | 4   | 13  | 23  | 134    |
| Fayette City      | 1  | 122   | 15  | 11  | 11  | 1   | 172    | 2  | 6   | 6   | 18  | 167    |
| Fayette           | 1  | 80    | 1   | 1   | 2   | 1   | 89     | 1  | 1   | 1   | 1   | 87     |
| Faxon             | 1  | 20    | 1   | 1   | 2   | 1   | 24     | 1  | 1   | 1   | 1   | 36     |
| Fidelity          | 1  | 50    | 8   | 1   | 5   | 1   | 64     | 1  | 1   | 1   | 1   | 60     |
| Germania          | 1  | 145   | 5   | 1   | 6   | 2   | 162    | 1  | 1   | 6   | 2   | 179    |
| Gastown           | 1  | 170   | 3   | 1   | 11  | 1   | 192    | 1  | 1   | 9   | 15  | 207    |
| Hackett           | 1  | 196   | 1   | 1   | 5   | 1   | 207    | 1  | 1   | 4   | 7   | 214    |
| Hilldale          | 1  | 125   | 4   | 1   | 8   | 1   | 140    | 1  | 1   | 10  | 12  | 173    |
| Ivill             | 1  | 190   | 4   | 1   | 8   | 2   | 207    | 2  | 3   | 10  | 4   | 19     |
| Jefferson         | 1  | 150   | 6   | 1   | 8   | 2   | 168    | 1  | 1   | 10  | 13  | 181    |
| Knob              | 1  | 185   | 3   | 1   | 11  | 1   | 204    | 1  | 2   | 8   | 3   | 14     |
| Little Alps       | 1  | 40    | 1   | 1   | 1   | 1   | 43     | 1  | 1   | 1   | 1   | 49     |
| Little Rodstone   | 1  | 150   | 12  | 1   | 8   | 1   | 174    | 2  | 1   | 10  | 15  | 180    |
| Millsville        | 1  | 80    | 5   | 1   | 4   | 1   | 91     | 1  | 1   | 4   | 2   | 90     |
| Monong            | 1  | 170   | 1   | 1   | 8   | 1   | 184    | 1  | 1   | 8   | 4   | 200    |
| Mongah            | 1  | 60    | 4   | 1   | 7   | 1   | 70     | 1  | 1   | 5   | 1   | 79     |
| North Webster     | 1  | 115   | 6   | 1   | 5   | 1   | 129    | 1  | 1   | 5   | 1   | 8      |
| Nottingham        | 1  | 150   | 13  | 1   | 9   | 1   | 176    | 1  | 1   | 4   | 2   | 183    |
| New Eagle         | 1  | 120   | 10  | 1   | 9   | 1   | 138    | 1  | 1   | 7   | 7   | 146    |
| Old Eagle         | 1  | 180   | 15  | 1   | 9   | 1   | 199    | 2  | 5   | 9   | 1   | 8      |
| Rostraver         | 1  | 170   | 1   | 1   | 5   | 1   | 159    | 1  | 1   | 9   | 1   | 17     |
| Rock Run          | 1  | 150   | 12  | 1   | 8   | 1   | 174    | 1  | 1   | 9   | 2   | 19     |
| Rockwood          | 1  | 150   | 8   | 1   | 8   | 1   | 171    | 1  | 1   | 10  | 3   | 15     |
| Stonesburg        | 1  | 90    | 13  | 1   | 6   | 1   | 114    | 1  | 1   | 8   | 1   | 11     |
| Snow Hill         | 1  | 113   | 15  | 1   | 7   | 1   | 139    | 1  | 1   | 7   | 2   | 12     |
| Stony Hill        | 1  | 125   | 1   | 1   | 7   | 1   | 138    | 1  | 1   | 6   | 1   | 146    |
| Stockdale         | 1  | 16    | 7   | 1   | 6   | 1   | 125    | 1  | 1   | 6   | 1   | 136    |
| Stremont          | 1  | 60    | 1   | 1   | 2   | 1   | 20     | 1  | 1   | 1   | 1   | 29     |
| Umpire            | 1  | 119   | 2   | 1   | 6   | 1   | 73     | 1  | 4   | 12  | 1   | 19     |
| Vigilant          | 1  | 160   | 2   | 1   | 8   | 1   | 166    | 2  | 2   | 7   | 1   | 12     |
| Vesta No. 1       | 1  | 15    | 15  | 1   | 9   | 1   | 109    | 1  | 3   | 11  | 1   | 16     |
| Vesta No. 2       | 1  | 50    | 3   | 1   | 4   | 1   | 126    | 2  | 4   | 9   | 2   | 17     |
| Vesta No. 3       | 1  | 10    | 1   | 1   | 6   | 1   | 80     | 2  | 3   | 4   | 2   | 11     |
| Walton Upper mine | 1  | 320   | 18  | 1   | 19  | 1   | 366    | 1  | 1   | 4   | 2   | 8      |
| Walton Lower mine | 1  | 145   | 3   | 1   | 7   | 1   | 154    | 1  | 2   | 7   | 3   | 14     |
| Watson            | 1  | 170   | 3   | 1   | 9   | 1   | 185    | 1  | 1   | 10  | 4   | 16     |
| Washington        | 1  | 170   | 3   | 1   | 9   | 1   | 185    | 1  | 1   | 10  | 4   | 16     |
| Totals            | 74 | 8,946 | 427 | 291 | 224 | 122 | 10,293 | 96 | 107 | 552 | 127 | 882    |
|                   |    |       |     |     |     |     |        |    |     |     |     | 11,175 |

\*Twenty-eight machine men and scrapers in the above.

TABLE NO. 4.—List of fatal accidents which occurred in and about the mines of the First Bituminous Mine District, for the year ending December 31, 1894.

| Date of accident. | Name of Person.     | Occupation. | Age.  |         |          | Widow.             | Number of orphans. | Name of Colliery. | Location—County.                                  | Nature and Cause of Accident. |
|-------------------|---------------------|-------------|-------|---------|----------|--------------------|--------------------|-------------------|---|-------------------------------|
|                   |                     |             | Male. | Female. | Infants. |                    |                    |                   |   |                               |
| Jan.              | Mike Hunnula.       | Miner.      | 21    | S.      | .....    | Tremont.           | Fayette.           | .....             | Fatally injured by a premature blast              |                               |
| 25                | Joseph Bacho.       | Miner.      | 22    | S.      | .....    | Bearmont.          | Washington.        | .....             | Fatally injured by a fall of slate.               |                               |
| 27                | Peter Sanslow.      | Miner.      | 22    | W.      | 2        | Climax.            | Fayette.           | .....             | Instantly killed by a fall of coal.               |                               |
| 19                | Alexander Overland. | Miner.      | 22    | W.      | 4        | Ella.              | Westmoreland.      | .....             | Fatally injured by a fall of slate.               |                               |
| 12                | Thomas Dunn.        | Miner.      | 51    | W.      | 3        | Black Diamond.     | Washington.        | .....             | Instantly killed by a fall of slate.              |                               |
| 22                | John McCallih.      | Driver.     | 21    | W.      | .....    | Black Diamond.     | Washington.        | .....             | Instantly killed by being run over by cars.       |                               |
| 24                | Giuseppe Darizzie.  | Miner.      | 22    | S.      | .....    | Blyth.             | Washington.        | .....             | Instantly killed by a fall of coal.               |                               |
| Mar.              | John Lowers.        | Miner.      | 44    | W.      | 7        | Gastonville No. 2. | Washington.        | .....             | Killed by a fall of coal.                         |                               |
| 21                | John Trnasky.       | Miner.      | 30    | W.      | 1        | Acme.              | Washington.        | .....             | Instantly killed by a fall of coal and slate.     |                               |
| 22                | Alexander Sabine.   | Miner.      | 29    | S.      | .....    | Champion.          | Washington.        | .....             | Fatally injured by a fall of coal and slate.      |                               |
| April             | Henry Dehose.       | Miner.      | 67    | W.      | 7        | Cliff.             | Washington.        | .....             | Instantly killed by a fall of horseback.          |                               |
| 11                | John Misterskey.    | Miner.      | 45    | W.      | 2        | Gastonville No. 1. | Washington.        | .....             | Instantly killed by being run over by dilly trip. |                               |
| 14                | John Shook.         | Miner.      | ..... | W.      | 2        | Ivli.              | Fayette.           | .....             | Instantly killed by a fall of slate.              |                               |
| July              | Patrick Oates.      | Miner.      | 69    | W.      | 8        | Little Redstone.   | Washington.        | .....             | Fatally injured by a fall of slate.               |                               |
| 3                 | John Mikula.        | Miner.      | 41    | W.      | 2        | Blyth.             | Washington.        | .....             | Fatally injured by a fall of slate.               |                               |
| 7                 | Miko Katusis.       | Miner.      | 33    | W.      | 2        | Manown.            | Washington.        | .....             | Instantly killed by a fall of coal.               |                               |
| Aug.              | Joseph Battalulh.   | Miner.      | ..... | W.      | 3        | Manown.            | Washington.        | .....             | Instantly killed by a fall of coal and slate.     |                               |
| Sept.             | W. H. Teesdale.     | Miner.      | 33    | W.      | 5        | Eclipse, Railroad. | Washington.        | .....             | Instantly killed by a fall of slate.              |                               |
| Oct.              | John Lepox, Jr.     | Miner.      | 19    | S.      | .....    | Stockdale.         | Washington.        | .....             | Fatally injured by a fall of slate.               |                               |
| 17                | Frank Vielli.       | Miner.      | 30    | W.      | 1        | Nottingham.        | Washington.        | .....             | Fatally injured by a fall of slate.               |                               |
| 22                | John Cutko.         | Miner.      | 33    | W.      | 1        | Climax.            | Fayette.           | .....             | Fatally injured by a fall of slate.               |                               |
| 24                | Gaspara Chiffa.     | Miner.      | ..... | S.      | .....    | Stony Hill.        | Fayette.           | .....             | Fatally injured by a dilly trip.                  |                               |
| 12                | John Shanrue.       | Miner.      | ..... | S.      | .....    | Allen.             | Washington.        | .....             | Instantly killed by a fall of slate.              |                               |
| Nov.              | Charles Kulkman.    | Miner.      | 23    | S.      | .....    | Gastonville No. 1. | Washington.        | .....             | Instantly killed by a fall of slate.              |                               |

TABLE NO. 5.—List of non-fatal accidents which occurred in and about the mines of the First Bituminous Mine District for the year ending December 31, 1894.

| Date of accident. | Name of Person.     | Occupation. |         | Age.  | Married. | Number of children. | Name of Colliery. | Location—County. | Nature and Cause of Accident.                           |
|-------------------|---------------------|-------------|---------|-------|----------|---------------------|-------------------|------------------|---|
|                   |                     |             |         |       |          |                     |                   |                  |   |
| Jan. 3.           | Stephen Ubod.       | Miner.      | Miner.  | ..... | .....    | .....               | Chimax.           | Fayette.         | Injured by a blast blowing through coal pillar.         |
| 6.                | John H. Green.      | Miner.      | Miner.  | ..... | .....    | .....               | Cleveland.        | Fayette.         | Leg injured by a fall of roof coal.                     |
| 8.                | Alexander Crawford. | Miner.      | Miner.  | ..... | .....    | .....               | Fayette City.     | Fayette.         | Seriously injured by being run over by empty cars.      |
| 13.               | William Ashley.     | Miner.      | Miner.  | ..... | .....    | .....               | Champlon.         | Washington.      | Leg injured by being struck by dilly line.              |
| 13.               | Joseph Prashow.     | Miner.      | Miner.  | ..... | .....    | .....               | Rostraver.        | Westmoreland.    | Injured by a fall of horseback.                         |
| 13.               | Petro Ratolo.       | Miner.      | Miner.  | ..... | .....    | .....               | Rostraver.        | Westmoreland.    | Injured slightly by a fall of slate.                    |
| 13.               | Frank Rossini.      | Miner.      | Miner.  | ..... | .....    | .....               | Rostraver.        | Westmoreland.    | Leg injured by being caught between loaded cars.        |
| 20.               | John Laverish.      | Driver.     | Driver. | ..... | .....    | .....               | Cleveland.        | Fayette.         | Slightly injured by cars.                               |
| 24.               | John Revilli.       | Miner.      | Miner.  | ..... | .....    | .....               | Manown.           | Allegheny.       | Injured seriously by blast blowing through coal pillar. |
| 30.               | Lethmer Francisola. | Miner.      | Miner.  | ..... | .....    | .....               | Cleveland.        | Fayette.         | Injured by being struck by a post.                      |
| 31.               | Thorion Hamilton.   | Miner.      | Miner.  | ..... | .....    | .....               | Fayette City.     | Fayette.         | Seriously injured by an explosion of fire damp.         |
| 31.               | Thomas Taylor.      | Miner.      | Miner.  | ..... | .....    | .....               | Fayette City.     | Fayette.         | Seriously injured by an explosion of fire damp.         |
| 31.               | Charles Matthews.   | Miner.      | Miner.  | ..... | .....    | .....               | Fayette City.     | Fayette.         | Seriously injured by an explosion of fire damp.         |
| 31.               | Samuel White.       | Miner.      | Miner.  | ..... | .....    | .....               | Fayette City.     | Fayette.         | Seriously injured by an explosion of fire damp.         |
| 31.               | Louis Dewalt.       | Miner.      | Miner.  | ..... | .....    | .....               | Fayette City.     | Fayette.         | Slightly injured by an explosion of fire damp.          |
| Feb. 7.           | Hiram Gore.         | Miner.      | Miner.  | 25    | M        | .....               | Cleveland.        | Fayette.         | Leg injured by a fall of "black Jack."                  |
| 10.               | Joseph Smith.       | Miner.      | Miner.  | ..... | .....    | .....               | Ivli.             | Washington.      | Ankle broken by a fall of coal.                         |
| 20.               | Lawrence Volker.    | Miner.      | Miner.  | ..... | .....    | .....               | Illa.             | Westmoreland.    | Injured by a fall of coal and slate.                    |
| 21.               | Joseph Duppe.       | Miner.      | Miner.  | ..... | .....    | .....               | Nottingham.       | Washington.      | Injured by a fall of coal and slate.                    |
| 22.               | John Rabosa.        | Miner.      | Miner.  | 35    | S        | .....               | Carsburgh.        | Washington.      | Injured by being caught between car and coal pillar.    |
| 24.               | Michael Morgan.     | Miner.      | Miner.  | ..... | .....    | .....               | Cleveland.        | Fayette.         | Severely injured by a fall of slate.                    |

TABLE No. 5—Continued.

| Date of accident. | Name of Person.    | Occupation. | Age.  | Married. | Number of children. | Name of Colliery.  | Location—County. | Nature and Cause of Accident.                            |
|-------------------|--------------------|-------------|-------|----------|---------------------|--------------------|------------------|--|
| Feb. 28,          | John King,         | Miner,      | ..... | .....    | .....               | Cleveland,         | Fayette,         | Injured by a fall of black jack.                         |
| March 9,          | William Brown,     | Miner,      | 25    | M.       | .....               | Allegheny,         | Washington,      | Back injured by a fall of roof coal.                     |
| 8,                | Martin Dadashy,    | Miner,      | ..... | .....    | .....               | Gastonville,       | Washington,      | Injured by a fall of slate.                              |
| 10,               | George Brown,      | Miner,      | ..... | S.       | .....               | Old Eagle,         | Allegheny,       | Injured by being struck by a post.                       |
| 12,               | William Anderson,  | Miner,      | ..... | .....    | .....               | Old Eagle,         | Allegheny,       | Injured slightly by a fall of slate.                     |
| 12,               | Ross,              | Miner,      | ..... | .....    | .....               | Winchmati,         | Washington,      | Injured by an explosion of fire damp.                    |
| 12,               | Andrew Baxter,     | Miner,      | ..... | .....    | .....               | Old Eagle,         | Allegheny,       | Injured by a fall of slate.                              |
| 12,               | William Baxter,    | Miner,      | ..... | .....    | .....               | Old Eagle,         | Allegheny,       | Injured by being struck by a post.                       |
| 17,               | Andrew Garrill,    | Miner,      | 25    | M.       | .....               | Old Eagle,         | Fayette,         | Both legs broken by a fall of slate.                     |
| 22,               | Joseph Falza,      | Miner,      | 35    | S.       | .....               | Chinax,            | Allegheny,       | Thigh broken by being struck by post.                    |
| 16,               | Antonia Levitie,   | Miner,      | ..... | .....    | .....               | Acamp,             | Washington,      | Leg broken by a fall of slate.                           |
| 16,               | Joel Vernon,       | Miner,      | 16    | S.       | .....               | Nottingham,        | Washington,      | Leg broken by a fall of slate.                           |
| 18,               | John Mischeless,   | Miner,      | 24    | S.       | .....               | Vesta No. 1,       | Washington,      | Leg broken by a fall of coal.                            |
| 21,               | Oscar Balza,       | Miner,      | 24    | S.       | .....               | Beaumont,          | Washington,      | Leg fractured by a fall of slate.                        |
| 28,               | Baptist Canzola,   | Miner,      | ..... | .....    | .....               | Chippopot,         | Washington,      | Leg broken by a fall of slate.                           |
| June 6,           | Uriah Thompson,    | Miner,      | 42    | M.       | .....               | Cliff,             | Washington,      | Injured by a fall of slate.                              |
| 7,                | John Wade,         | Miner,      | ..... | .....    | .....               | Cleveland,         | Fayette,         | Slightly injured by a fall of slate.                     |
| 7,                | Jacque Faciphique, | Miner,      | ..... | .....    | .....               | Nottingham,        | Washington,      | Leg broken by a fall of slate.                           |
| 14,               | John Kelly,        | Miner,      | 40    | M.       | .....               | Courney,           | Washington,      | Injured by a fall of coal.                               |
| 14,               | William Brooke,    | Driver,     | ..... | .....    | .....               | Cleveland,         | Fayette,         | Severely injured by being caught between cars.           |
| 11,               | Louis Ellis,       | Miner,      | ..... | .....    | .....               | Alle Hays,         | Washington,      | Severely injured by a fall of slate.                     |
| 12,               | Stimium Chob-skie, | Miner,      | ..... | .....    | .....               | Germania,          | Washington,      | Leg broken in three places by being caught between cars. |
| 17,               | Jacob Jacobsen,    | Miner,      | 50    | M.       | .....               | Coal Bluff,        | Washington,      | Severely injured by a fall of coal.                      |
| 24,               | Thomas Hamilton,   | Miner,      | 38    | M.       | .....               | Washington,        | Fayette,         | Injured by a fall of slate.                              |
| 27,               | Calvert Patterson, | Miner,      | 23    | S.       | .....               | Panola,            | Allegheny,       | Seriously injured by a fall of slate.                    |
| 7,                | Marmiron Reilskey, | Miner,      | 33    | M.       | .....               | Eclipse, Railroad, | Washington,      | Leg broken by being struck by a post.                    |
| 8,                | Henry M. Rulcy,    | Miner,      | ..... | .....    | .....               | Hackett,           | Washington,      | Leg broken by a fall of coal and slate.                  |
| 9,                | Michael Dautch,    | Miner,      | 30    | M.       | .....               | Fayette City,      | Fayette,         | Jaw bone broken by a fall of coal.                       |
| 16,               | Thomas B-dentizer, | Miner,      | 20    | S.       | .....               | Man-own,           | Allegheny,       | Injured slightly by a runaway mule.                      |
| 17,               | Thomas Bell,       | Engineer,   | 38    | M.       | .....               | W-h-sheny,         | Washington,      | Leg broken by the endless hauling line.                  |
| 18,               | James Nolan,       | Miner,      | 21    | S.       | .....               | Cham-ouni,         | Fayette,         | Foot sprained by a runaway car.                          |
| 20,               | Natalie Ritchie,   | Miner,      | 31    | S.       | .....               | Ella,              | Westmoreland,    | Slightly injured by a fall of roof coal.                 |
|                   |                    |             |       |          |                     | Cleveland,         | Fayette,         |  |

|     |                     |                   |    |   |                  |               |   |
|-----|---------------------|-------------------|----|---|------------------|---------------|---|
| 22. | Guzako Shybo-shshe, | Miner,            | 31 | M | Snowden,         | Allegheny,    | Two ribs broken by a fall of slate.                               |
| 23. | Joseph Ohish,       | Miner,            | 28 | M | Hackett,         | Washington,   | Foot injured by a fall of slate; amputated afterwards.            |
| 24. | John Knight,        | Car shifter,      | 18 | S | Cleveland,       | Fayette,      | Two fingers taken off while coupling cars.                        |
| 25. | John O'catskey,     | Miner,            | 30 | M | Hackett,         | Washington,   | Foot bruised by a fall of slate.                                  |
| 26. | Joseph Shepard,     | Miner,            | 30 | M | Charleroi,       | Washington,   | Leg fractured by a fall of slate.                                 |
| 27. | Antonio Vetterillo, | Miner,            | 24 | M | Coal Bluff,      | Washington,   | Leg broken by a fall of coal.                                     |
| 28. | Thomas Johnson,     | Miner,            | 24 | M | Vesta No. 1,     | Washington,   | Slightly injured by a fall of coal.                               |
| 29. | John McDonald,      | Miner,            | 29 | M | Mongah,          | Allegheny,    | Injured by an explosion of powder and gas.                        |
| 30. | John Kennedy,       | Miner,            | 25 | M | New Eagle,       | Washington,   | Slightly injured by a fall of slate.                              |
| 31. | Duncan Boyd,        | Miner,            | 26 | M | Hackett,         | Washington,   | Leg broken by a fall of slate.                                    |
| 32. | Edward McCreedy,    | Miner,            | 22 | S | Shepllar,        | Westmoreland, | Injured by a fall of slate.                                       |
| 33. | Charles Wilson,     | Miner,            | 22 | S | Little Redstone, | Fayette,      | Three ribs broken by a fall of slate.                             |
| 34. | Matthew Bainbridge, | Miner,            | 22 | S | Washington,      | Fayette,      | Right arm and leg broken by a fall of slate.                      |
| 35. | Frank Nutz,         | Miner,            | 22 | S | Anchor,          | Fayette,      | Leg broken by a fall of slate.                                    |
| 36. | Harrison Eiler,     | Miner,            | 48 | M | Manown,          | Allegheny,    | Leg broken by fall of roof coal.                                  |
| 37. | Frank Bennechitt,   | Miner,            | 48 | M | Stony Hill,      | Fayette,      | Seriously injured by being caught by dilly trip.                  |
| 38. | Frank Campbell,     | Driver,           | 32 | M | Shepllar,        | Westmoreland, | Injured by a mine car running over his foot.                      |
| 39. | August Valertine,   | Miner,            | 51 | M | Stockdale,       | Washington,   | Leg broken by a fall of slate.                                    |
| 40. | Henry Thompson,     | Miner,            | 41 | M | Manown,          | Allegheny,    | Arm broken by fall of roof coal.                                  |
| 41. | Jacob Rollison,     | Machine runner,   | 41 | M | New Eagle,       | Washington,   | Injured by a fall of slate.                                       |
| 42. | Walker Stanley,     | Miner,            | 40 | S | Snowden,         | Allegheny,    | Slightly injured by a fall of slate.                              |
| 43. | Pleasant Farbar,    | Miner,            | 40 | S | Snowden,         | Allegheny,    | Throat seriously about head by being struck by a post.            |
| 44. | Frank Jonassa,      | Miner,            | 32 | S | Cleveland,       | Fayette,      | Leg broken by mine car.   |
| 45. | Joseph Cardy,       | Miner,            | 40 | S | Catsburgh,       | Washington,   | Leg broken by a fall of slate.                                    |
| 46. | Thomas Kyle,        | Miner,            | 36 | S | Mongah,          | Allegheny,    | Small bone of arm broken by a fall of roof coal.                  |
| 47. | George Laret,       | Filler,           | 36 | S | Manown,          | Allegheny,    | Small bone of leg broken by a fall of roof coal.                  |
| 48. | R. E. Jones,        | Driver,           | 40 | M | Mongah,          | Allegheny,    | Injured by mine cars.   |
| 49. | John Briggs,        | Driver,           | 40 | M | Washington,      | Fayette,      | Leg injured by empty cars.  |
| 50. | William Carroll,    | Driver,           | 40 | M | Washington,      | Fayette,      | Leg injured by empty cars.  |
| 51. | Thomas Wilding,     | Miner,            | 45 | S | Pearmont,        | Washington,   | Leg injured by falling under cars.                                |
| 52. | Willit Wood,        | Miner,            | 45 | S | Camden,          | Allegheny,    | Leg broken by a fall of coal and slate.                           |
| 53. | Arvy Jones,         | Dilly trip rider, | 45 | M | Coal Centre,     | Washington,   | Leg broken by a dilly trip.                                       |
| 54. | John Campbell,      | Miner,            | 46 | S | Coal Bluff,      | Washington,   | Right arm broken by a fall of slate.                              |
| 55. | Morris Bartolo,     | Miner,            | 46 | S | Little Redstone, | Washington,   | Arms broken by a fall of slate.                                   |
| 56. | Thomas Pace,        | Miner,            | 46 | S | Little Redstone, | Fayette,      | Leg broken by a fall of slate.                                    |
| 57. | Thomas Harvey,      | Miner,            | 46 | S | Washington,      | Fayette,      | Leg bruised by being caught between loaded car and piece of coal. |

Sept.

Oct.

Nov.

Dec.



# SECOND BITUMINOUS DISTRICT.

(ALLEGHENY, INDIANA AND WESTMORELAND  
COUNTIES.)

Irwin, March 2, 1895.

Hon. Isaac B. Brown,

Secretary of Internal Affairs:

Sir: In compliance with the requirements of section 11 of article 10 of the Act of Assembly approved May 15, A. D. 1893, I have the honor of submitting my annual report as Inspector of Mines for the Second Bituminous district for the year ending December 31, 1894.

There are at present 72 mines in the district; 66 of these have been in operation during a part of the year. There was a strike in the Irwin district which continued for three months. There were six mines in Allegheny county on strike from three to five months. The mines in the Latrobe district also suffered from a strike for three months, and the mines have not been in operation much more than half time since the strike, except the Westmoreland Gas Coal Company and the New York and Cleveland Gas Coal Company. There was a very stubborn strike in the coking part of the district, which lasted for months, but during a greater part of this time the mines were running under the protection of the sheriff, and labor was brought to the region from other localities. All the strikes ended very disastrously to the men, and when they were over many of them had to seek new fields of labor, their places having been filled by new men. Since the strike, the mines in the coking part of the district have been running very well.

The mines are still improving, both in ventilation and drainage. There is three or four times as much air at some of the mines as the law calls for, and this quantity is kept sweeping through the mines. Two fans and six furnaces were erected during the year, so that there is but one mine in the district at present which is ventilated by natural means.

A brief description of all the mines is given, with the average quantity of air in circulation per minute in each mine. The burning of impure oil for lighting purposes is still causing some trouble, and

men are complaining that it is impossible to procure a good quality of oil. There is some truth in this, but I believe we will be able to overcome it in a short time. There are 1,155 more persons employed in the district than there were in the year 1893.

The following table shows the number of accidents, their causes, etc., that occurred during the year:

|  | Fatal.    | Non-fatal. |
|--|-----------|------------|
| By falling slate, . . . . .                    | 9         | 22         |
| By falling coal, . . . . .                     | 2         | 4          |
| By mine wagons, . . . . .                      | 3         | 10         |
| By a fall of roof, . . . . .                   | 3         | ..         |
| By being run over on the Dilly road, . . . . . | 1         | ..         |
| By being struck by a post, . . . . .           | ..        | 1          |
| By an iron rail, . . . . .                     | ..        | 2          |
| <b>Totals, . . . . .</b>                       | <b>18</b> | <b>39</b>  |
| Widows by fatalities, . . . . .                | ..        | 9          |
| Orphans by fatalities, . . . . .               | ..        | 16         |

After a careful investigation of these accidents, I found that eight of them were caused by stubbornness, or willful carelessness. Several of the others who were killed had been in the mine only a short time and knew nothing of the danger encountered in mining. Some of them had been warned of the danger a few minutes before they were killed, but they gave no attention to these repeated warnings. Five of the persons killed were English-speaking people. The other thirteen were foreigners.

I regret to have to report an increase of four in the death rate, and eleven of the non-fatal accidents. This, in a great measure, may be attributed to the unskillfulness of a majority of the victims themselves. A strict enforcement of the law and rules by the mine officials would, I believe, lessen the number of accidents. Dangerous places should be visited and inspected, and officials should not try to hide behind the law.

The stricter the officials are, the fewer accidents they will have to report. This much I have discovered in my official capacity, that no matter how often the officials visit the working places, they will always find some one working in danger who needs to be warned and severely reprimanded for his carelessness. One of the most fruitful causes of accidents is from falls of slate, and care should be taken in setting posts. The posts should always be set plumb or on angle with the roof and floor. The cap pieces should always be set across the slips in the slate. The slate should always be posted, no matter how strong it sounds. The coal should be well spragged and all pre-



cautionary measures taken to insure safety. If this were done, there would be fewer accidents to report. I hardly ever visit a mine but I find some one working in danger, and after looking over all the ground, it surprises me very often that there are so few accidents.

The following statistics are a summary of reports from all the mines, as set out in the tables:

|   |           |
|---|-----------|
| Mines in the district, .....  | 72        |
| Mines in the district operated, .....                                     | 66        |
| Number of persons employed inside of mines, .....                         | 9,351     |
| Number of persons employed outside, .....                                 | 2,798     |
| Total number of persons employed, .....                                   | 12,149    |
| Tons of coal mined, of 2,000 pounds each, .....                           | 6,424,633 |
| Tons of coal shipped of 2,000 pounds each, .....                          | 4,000,777 |
| Tons of coke manufactured of 2,000 pounds each, .....                     | 1,225,243 |
| Tons of coal mined for each fatal accident, .....                         | 356,925   |
| Tons of coal mined to each non-fatal accident,.....                       | 164,734   |
| Number of days worked by all of the mines, .....                          | 12,171    |
| Average number of days worked by the sixty-six mines,                     | 184       |
| Number of employes for each fatal accident, .....                         | 675       |
| Number of employes for each non-fatal accident, .....                     | 311       |
| Number of horses and mules in use, .....                                  | 1,055     |
| Number of coke ovens in the district, .....                               | 7,155     |
| Number of mine locomotives in use, .....                                  | 3         |
| Number of kegs of powder reported as used in the<br>mines, .....          | 344       |
| Number of steam boilers in use, .....                                     | 229       |
| Number of pumps in use, .....   | 111       |
| Number of stationary engines used for hoisting and<br>hauling coal, ..... | 68        |

From the foregoing statistics the reader will be able to see that the production of coal has fallen off 211,075 tons, as compared with last year's production. Notwithstanding the decreased production of coal, there were 1,155 more persons employed in the district. This, with the low price of mining, was the cause of the wages of the miners being very low. I know of some men in the district having only \$3.12 to draw for two weeks, and having wives and children to support. How they lived I cannot imagine. Of course, they were Hungarians, and they can live when the American and his family would starve. I have no recollection of the coal trade being in such a deplorable condition as it is now, and the present prospect looks very discouraging. There were three mines in the district that worked less than 100 days. Three worked one-third time. Twelve one-half time, and there were only two mines that worked 300 days.

Coal is mined now for less than it was before the war, and rents and provisions are much higher. The mining law of 1893 is giving great satisfaction and is well observed by the operators. We had a miner from the anthracite region who had a miner's certificate from that region, who opened his safety lamp in one of our gaseous mines. We brought suit against him and he got very indignant and got away before he was arrested. We propose to prosecute every violation of the law, no matter where they come from or what they know. There are 50 per cent. of the mines generating fire damp C. H.-4, and we have had no explosion during the year.

Respectfully submitted,

WILLIAM JENKINS,  
Inspector of Mines.

#### Description of Mines and Improvements in the Second Bituminous District.

**Alexandria Mine.** This mine is in very fair condition, with an average of 28,965 cubic feet of air going out at the outlet per minute. This volume is divided and is fairly distributed throughout the working places. The mine drains are also in fair condition. The outside improvements are a large boiler house and two tubular boilers of 100 horse power each.

Mine foreman, Daniel Campbell.

**Arona Mine.** This mine has been kept in a healthful condition during the year, with an average of 35,670 cubic feet of air going out at the outlet per minute. This volume is well distributed through the working places. The mine drainage is also in good condition. One additional boiler, a haulage engine, and a tail rope system of haulage has been put into the mine.

Mine foreman, William Nesbit.

**Calumet Shaft.** This mine has been kept in a healthful condition during the year, with an average of 46,018 cubic feet of air going in at the inlet per minute. This volume is in three divisions, and is well conducted through the working places. The mine drainage is in very good condition also. An air compressor 7x9 inches, has been erected at the mine, and is used for pumping the water out of the dip workings.

Mine foreman, John Nicholson.

**Carbon Mine.** The condition of this mine is very good, both as regards ventilation and drainage. The average volume of air passing at the inlet per minute is 43,730 cubic feet. This volume is divided into three splits and is well circulated through the working places.

The outside improvements are a coke crusher, having a capacity of seventy-five tons per day.

Mine foreman, Joseph Weightman.

Claride Mine. This mine has been kept in a safe and healthy condition during the year, with an average of 19,748 cubic feet of air passing at the outlet per minute. This volume is in two divisions and is fairly conducted through the working places. The mine drainage is kept in very good condition.

Mine foreman, William Johnston.

Duquesne Mine. This mine has been kept in fair condition, both as regards ventilation and drainage during the year, with an average of 23,120 cubic feet of air passing at the outlet per minute. There are three inlets of air coming into the mine, and this is fairly distributed through the working places.

Mine foreman, Mark James.

Derry Shaft. This mine has been kept in a safe and healthful condition during the year. The average volume of air passing at the inlet per minute is 69,000 cubic feet. This volume is divided into five splits and is well conducted through the working places. The mine drainage is in good condition. Ten flue boilers, size  $5\frac{1}{2} \times 16$  feet, with 57 flues in each boiler, have been erected at the mine.

Mine foreman, John Baker.

Denmark Mine. The condition of this mine has been improved since my last report. An additional inlet has been made, and the fresh air from this inlet is conducted to the face of the working places. The volume of air passing at the inlets per minute is 41,553 cubic feet. This is divided into three splits. The mine drainage is also in very fair condition.

Mine foreman, Edmond Whiteman.

Greensburg Nos. 1 and 2 Mines—

Greensburg No. 1 Mine. This mine has been kept in a safe and healthy condition during the year, with an average of 28,233 cubic feet of air passing at the inlet per minute. This volume is divided into three splits and is well conducted through the working places. The mine drainage is also kept in good condition.

Mine foreman, David Clark.

Greensburg No. 2 Mine. A Murphy fan six feet in diameter, driven by an engine  $10 \times 16$ -inch, has been erected at the mine during the year; also a flue boiler  $4\frac{1}{2} \times 15$  feet to furnish steam for the fan. On my last visit I measured 20,090 cubic feet of air passing at the inlet per minute. This volume is well distributed through the working places. The mine drainage is also in good condition. Mine foreman, John McIntyre.

Gem Mine. This mine has not been in operation a great while during the year, so they have not been able to reach the air shaft with

their heading, and the furnace has not been built yet. The average amount of air passing at the outlet per minute was 7,105 cubic feet. This volume was fairly distributed through the mine. The mine drainage was in good condition. Mine foreman, John Bell.

#### H. C. Frick Coke Company Mines—

Standard No. 2 Shaft. The condition of this mine in regard to safety and healthfulness has been very good during the year. The average volume of air passing at the inlet per minute is 160,408 cubic feet.

This volume is in seven splits and is well conducted through the working places. The mine drainage is also in good condition. On my third visit I measured 165,000 cubic feet per minute passing at the inlet, with the fan making 58 revolutions, and showing a water gauge of 1.2 inches. Mine foreman, Robert Hay.

Mammoth Shaft and Slope. These mines have been kept in very good condition both as regards ventilation and drainage. There was no fire damp C. H. 4 reported in the mine during the year. The average volume of air passing at the inlet per minute was 61,455 cubic feet. This volume is in four splits and is well distributed through the working places. Two additional overcasts have been built of brick and railroad iron; area of each 76 feet and 62 feet. A pumping station has been erected near the foot of the slope, 4,500 feet from the shaft, size 14x50 feet. The roof is taken down to the sand rock and a drill hole 10 inches in diameter and 300 feet in depth was just put down. The water from the dip working is pumped to the surface with a Gorder air pump 12½x24x36 inches. An air line 6 inches in diameter and 4,500 feet long supplies air for this purpose. On my last visit I noticed that the fan was making 54 revolutions per minute, showing a water gauge of 1.2 inches and producing 61,455 cubic feet of air per minute. Mine foreman, James Eaton.

Monastery Slope. This mine has been kept in very good condition during the year, with an average of 35,300 cubic feet of air passing at the outlet per minute. This volume is in three splits and is fairly distributed through the working places. The drainage is also in fair condition. A water line has been laid to the Loyalhanna creek for the purpose of supplying the boilers with water. Mine foreman, George W. Wilkes.

Standard Slope. There has been no work done in the mine except cleaning up and repairing. Mine foreman, Alexander Erskine.

Saint Clair Mine. This mine has been kept in reasonably fair condition during the year. The average volume of air passing at the outlet per minute was 18,500 cubic feet. This volume is fairly distributed through the working places. The mine drainage is also in fair condition. Mine foreman, James Wardly.

## Hostetter-Connellsville Coke Company's Mines—

Whitney Mine. This mine has been kept in a safe and healthful condition during the year, with an average of 52,250 cubic feet of air passing at the inlet per minute. This volume is divided into four splits, and is well conducted through the working places. A bore hole 10 inches in diameter and 185 feet in depth was put down, and a Lafayette steam pump, size 12x24x36 inches, was put in for pumping purposes. The drainage is in good condition. I noticed on my last visit that the fan was making 50 revolutions per minute, showing water gauge of three-tenths of an inch, and producing 60,500 cubic feet of air. Mine foreman, Mathew Laick.

Hostetter Mine. The condition of this mine, both as regards ventilation and drainage is very good. The average volume of air passing at the inlet per minute was 48,333 cubic feet. This volume is divided into five splits and is well conducted through the working places. A boiler house 24x40 feet, and a brick safety lamp house has been erected. On my last visit I noticed that the fan was making 45 revolutions per minute, showing a water gauge of two and a half-tenths, and producing 47,560 cubic feet of air per minute. Mine foreman, George Eustis.

## Hecla Nos. 1 and 2 Shafts—

No. 1 Shaft. This mine has been kept in very good condition during the year, both as regards ventilation and drainage. The average volume of air passing at the inlet per minute is 41,470 cubic feet. This volume is in two divisions, and is well conducted through the working places. Mine foreman, William Dean.

No. 2 Shaft. Three brick stoppings with 13-inch wall have been built between the main intake and outlet to prevent leakage of air. The mine has been kept in very good condition during the year, both as regards ventilation and drainage. The average volume of air passing at the inlet per minute was 52,553 cubic feet. This volume is in several splits and is well circulated through the working places. On my last visit I noticed that the fan was making 25 revolutions per minute, with a water gauge of five-tenths of an inch, and producing 62,440 cubic feet of air. Mine foreman, William Snedden.

Hampton Mine. This mine has been kept in a reasonably fair condition during the year, both as regards ventilation and drainage. The average volume of air passing at the outlet per minute was 23,920 feet. This volume comes in at three inlets and is fairly distributed through the working places. Mine foreman, Edgar Thompson.

Hempfield Mine. This mine has been kept in a reasonably fair condition during the year, with an average of 43,056 cubic feet passing at the inlet per minute. This volume is in three divisions and is

well conducted through the working places. The drainage is also in good condition. Mine foreman, Ralph Dawson.

Isabella Furnace Mine. A twelve-foot diameter fan, size of engine 12x15 inches. The fan is run by belt and has been erected at the mine during the year. The fan was built by Hockensmith & Wagoner, of Irwin, Pa. The fan is giving perfect satisfaction. On my last visit I measured 67,200 cubic feet of air going out at the outlet per minute, with the fan running at 74 revolutions. This fan will produce ample ventilation for the mine. A few changes are needed to conduct the air into the faces of the working places, which will be done as soon as possible. The drainage of the mine is kept in fair condition. Mine foreman, Morris J. Lewis.

Jamison Mine. This mine is in very good condition, both as regards ventilation and drainage. The average amount of air going out at the outlet per minute is 13,510 cubic feet. This volume is fairly distributed through the working places. A pair of double haulage engines have been erected at the mine, size of cylinders, 14x16 inches, and a flue boiler 5x16 feet. Mine foreman, John A. Hart.

Lucesco Mine. This mine has worked very irregular during the year, and did not come under the provisions of the law at all times. I visited the mine four times, and there was from 9 to 44 persons employed in it. A small furnace was built and a Syphon pipe laid for drainage. The mine is in fair condition, with an average of 4,800 cubic feet of air going out at the outlet per minute. Mine foreman, S. U. Phillips.

Lockport Mine. This mine was in operation only a few months during the year. I made three visits to it and on my last visit it was idle. I have generally found the mine in fair condition, with an average of 6,900 cubic feet of air passing at the outlet per minute. Mine foreman, John Walters.

#### Loyalhanna Coal and Coke Company's Mines —

Loyalhanna No. 1 Shaft.—This mine has been kept in a very fair and healthful condition during the year. The average volume of air going in at the inlet per minute is 27,580 cubic feet. This is in three divisions and is fairly conducted through the working places. The mine drainage is also in good condition. Mine foreman, Alexander Park.

Loyalhanna No. 2 Shaft. This is a new opening sunk during the year, situated on the Ligonier Valley Railroad, one and one-fourth miles southwest from Latrobe station in Westmoreland county, and is operated by the Loyalhanna Coal and Coke Company. The coal is reached by a shaft 12x20 feet and 180 feet in depth, which is all timbered with 10x12-inch oak in rectangular sections 4 feet 6 inches from centre to centre, paneled in with 3-inch plank, and divided into

three compartments by 10x12-inch oak buntings. Two are for cage-ways 10 feet 2 inches by 6 feet 4 inches. The other is a water and steam way 10 feet 2 inches by 4 feet 4 inches. Two rings are cut in the shaft rock for the purpose of carrying off the surface water. A pump house has been erected near the bottom of the shaft 160 feet long, 16 feet wide and 10 feet high, timbered with 8x10-inch oak, strongly lagged overhead. Five pumps are placed in this pump house, which are used to pump the water from these shafts, namely, Loyalhanna No. 1, Loyalhanna No. 2 and Pandora.

One "Allison Cataract" pump, 12-inch suction, 12-inch discharge, 6-foot stroke.

One "Allison Cataract" pump, 8-inch suction, 8-inch discharge, 4 foot 6-inch stroke.

One Yough pump, 12-inch suction, 10-inch discharge, 2-foot 6-inch stroke.

One Yough pump, 8-inch suction, 8-inch discharge, 2-foot 6-inch stroke.

One Yough pump, 6-inch suction, 6-inch discharge, 2-foot stroke.

One Barr quadruple pump, 4-inch suction, 3-inch discharge, 1-foot stroke.

The last named pump is used in the shaft to pump the water from the rings to the surface. There are three water lines used in the shaft.

One 18-inch cast iron line.

One 16-inch cast iron line.

One 2-inch wrought iron line.

The steam for these pumps is supplied from boilers on the surface through a 6-inch pipe, and the exhaust is returned through an 8-inch pipe. The outside improvements are a head frame 38 feet in height, which is built of Georgia pine; the guides are of the same material. Substantial trestles and tipples with dumping machinery have been built to load railroad cars. The engine house is 26 feet by 28 feet 6 inches by 14 feet high, built and covered with corrugated steel. One pair of engines, cylinders 14x124 inches, geared, engines 6 feet, grooved drums. The ropes are one and one-fourth-inch steel, fitted to steel cages with bridle chains and safety catches.

A boiler house 30 feet 6 inches by 35 feet, and 14 feet high, built and is covered with corrugated steel. It contains three boilers of 80 horse power each. These boilers supply the steam for hoisting and pumping purposes. Two 22,000 gallon capacity tanks supply the water for boilers, etc., from a 22-foot elevation. A Barr quadruple pump, which is directly connected with the tanks and fire apparatus, is provided for tenement houses. Blacksmith shop and other necessary buildings have been erected.

This mine is ventilated by the 25-foot fan at the Pandora shaft.

There was on my last visit, 25,110 cubic feet of air per minute passing at the shaft. This volume is well conducted through the working places. The mine drainage is also in good condition. Mine foreman, Enoch Bowley.

Pandora Shaft. On my visit to this mine, July 11th, they were just starting up after a long spell of idleness. They were cleaning up and getting the mine in order. I measured 36,400 cubic feet of air passing at the inlet per minute. This volume was fairly distributed through the working places. The mine drainage was also in fair condition. Two 23,000-gallon capacity water tanks, one blacksmith and carpenter shop, and an oil house were built outside. Mine foreman, John Park.

Latrobe Coke Works Mine. This mine has been kept in a healthful and safe condition during the year. The average volume of air passing at the inlet per minute was 31,675 cubic feet. This is divided and is well conducted through the working places. The mine drainage is also in very good condition. Mine foreman, Stephen Arkwright.

#### Graceton Nos. 1 and 2 Mines—

No. 1 Mine. There were 41 persons employed in this mine when I made my last visit on December 31st. The fan was not running, owing to everything having been frozen up. There was a small quantity of air in circulation, however, but not sufficient to move the anemometer. The mine drainage was in good condition.

No. 2 Mine. This mine is in very good condition, both as regards ventilation and drainage. The average volume of air passing at the outlet per minute was 29,400 cubic feet, and this volume is well conducted through the working places. The product of this mine is principally used for coke, and they have erected a German coal washer, which the patentee claims will wash all the impurities out of the coal. Mine foreman, John Lochrie.

M. Saxman Mine. This mine is still ventilated by the natural forces. The operator complained of the hard times, and the mine was only in operation 110 days during the year. The mine is well arranged for a natural current of air, but notwithstanding all this, there are two or three months in the year that we have but very little natural current. Before another year has passed I will see that a fan is erected at the mine. The average volume of air going out at the outlet per minute is 22,295 cubic feet. This is when the weather is favorable. The mine drainage is in first class condition. Mine foreman, John C. Dovey.

Madison Mine. A fan 16 foot in diameter, driven by an engine, cylinder 12x18 inches, which is attached directly to the fan, has been erected. An endless rope haulage engine, cylinder 20x36-inch, and 1½-inch wire rope, also a Lafayette pump, steam cylinder 18x44-inch,



and water cylinder 12x44-inch. The mine is now in very good condition, both as regards ventilation and drainage. The average volume of air passing at the inlet per minute was 32,913 cubic feet. This is fairly distributed through the working places. Mine foreman, Harry Gardner.

**Maier Nos. 1 and 2 Mines —**

No. 1 mine is nearly exhausted; there is nothing left now but ribs and heading stumps. The mine is in fair condition, with an average of 9,600 cubic feet of air passing at the outlet per minute.

No. 2 Mine. A furnace has been built in this mine during the year, which gives very satisfactory results; size of furnace, fire bed 5 feet 2 inches by 6 feet equals 31 square feet, length of arch, 12 feet. The air shaft is 24 feet in depth with a stack on top 26 feet in height. The average volume of air in circulation was 7,140 cubic feet per minute. On my last visit I measured 14,520 cubic feet passing at the outlet per minute, and this volume was well conducted through the working places. The mine drainage was also in very good condition. William Beveridge is foreman of both these mines.

Millwood Shaft. The general condition of this mine has been very good during the year, both as regards ventilation and drainage. The average volume of air passing at the outlet per minute was 23,200 cubic feet.

On my last visit, the fan was making 78 revolutions per minute and showing a water gauge of seven-tenths of an inch, and producing 21,120 cubic feet of air. Mine foreman, Thomas Thomas.

Ocean Shaft. This shaft is located on the Hempfield branch of the Pennsylvania Railroad in Sewickly township, Westmoreland county, and is operated by the Ocean Coal Company, superintendent, F. L. Kimball. The company commenced to sink the shaft on the 26th of May, 1893, and reached the coal at a depth of 279 feet, on October 15th of the same year. Size of shaft, 23x13 feet. It is timbered with 10x12-inch oak timber and lagged with 2-inch plank all through. The girders are 7x8-inch yellow pine. The shaft is divided into three compartments, two for cage-ways and the other for a steam and waterway. The steam and waterway is separated from the other with yellow pine flooring. The roof at the bottom of the shaft is taken down to the sand rock for 125 feet on each side of the shaft, and well timbered with 10x12-inch oak timber. The air shaft was started on September 15th, and reached the coal at 265 feet on the 7th day of January, 1894. This shaft is well timbered with 10x12-inch oak timber and lagged with 2-inch plank. A stairway is fitted up in this shaft for an escape-way in case anything should happen to the hoisting shaft. The air passage in this shaft is 125 feet in area. A 25-foot reversible fan built by Kenny & Co., of Scottdale, was placed on

top of the shaft, and on my last visit I measured at the inlet 60,361 cubic feet per minute passing, with the fan running at 25 revolutions per minute. There are seven overcasts in the mine, and the volume of air is divided into five splits, and is well conducted through the working places. The management propose to ventilate this mine on the split air system, doing away with doors altogether. They have encountered a good deal of water and bad roof in opening out the mine, but I believe that they will soon overcome this trouble.

The outside improvements are substantial, and consist of the following:

An engine house 30x40 feet with a pair of first motion engines coupled at right angles; size of cylinders, 24x36 inches, with conical drums  $6\frac{1}{2}$ x8 feet, built by the Vulcan Iron Works. The head frame is iron and was built by the Pittsburgh Bridge Company. The hoisting ropes are steel one and one-eighth inch. A large equipped boiler house 42x48 feet, with three safety tube boilers, pattern built by Heine Boiler Company of St. Louis, 600 horse power. A blacksmith and carpenter shop are provided; also a large and well appointed office furnished throughout in yellow pine, with two vaults for papers and maps. A large store room 45x80 feet, run by the Ocean Supply Company. Twenty double houses with 12 rooms in each have been built, and ten more are in course of erection. Mine foreman, William Bainbridge.

Ocean Mine. An air shaft has been sunk and a furnace built at this mine during the year. The average volume of air passing at the outlet per minute was 5,313 cubic feet. The mine is a small one and does not come under the provisions of the law very often, so that it gets very little attention from the operator. I have found the mine on several occasions in a rather defective condition, both as regards ventilation and drainage. Mine foreman, Gottlieb Vogel.

Pleasant Valley Mine. An air shaft was sunk 31 feet deep and 7 feet in diameter. The shaft is lined with brick for 28 feet up the shaft for the purpose of keeping the water back and as a protection against fire. A stack 32 feet in height is placed on top of the shaft. A furnace has been built with a fire bed of 6x9 feet, equal to 54 square feet, with an arch 12 feet long. There is a manway on each side of the furnace for protection against fire.

On my last visit I measured 25,000 cubic feet of air passing at the furnace per minute. This volume is in two divisions, and is well conducted through the working places. This quantity could nearly be doubled by firing the furnace up briskly. The mine drainage is in very good condition. Mine foreman, Joseph H. Powell.

#### New York and Cleveland Gas Coal Company Mines—

Oak Hill No. 4 Mine. This mine has been kept in a very healthful condition during the year, with an average of 34,927 cubic feet of air

going out at the outlet per minute. This volume is in four divisions and is well conducted through the working places. The mine drainage is also in good condition. Mine foreman, William P. Owens.

Sandy Creek Mine. This mine is in a healthful condition, and has been kept in that way during the year. The average volume of air going out at the outlet per minute was 29,653 cubic feet. This is fairly conducted through the working places. The drainage is also in fair condition. Mine foreman, Joseph Corbett.

Plum Creek Mine. The general condition of this mine as regards health and safety is very good. The average amount of air passing at the outlet per minute was 24,710 cubic feet. This volume is fairly circulated through the working places. An additional inlet has been made into the mine. The mine drainage is also in very good condition. Mine foreman, William W. Carter.

#### Penn Gas Coal Company Mines—

Penn Gas No. 1 Shaft. This mine has been kept in safe and healthy condition during the year, with an average of 59,383 cubic feet of air passing at the outlet per minute. Each heading is supplied with a fresh split of air, which comes in at the head of each entry. The mine drainage is also in good condition. I noticed that the fan was making 66 revolutions per minute, showing a water gauge of one inch, and producing 59,383 cubic feet of air. Mine foreman, John Bolam.

Penn Gas No. 2 Shaft. This mine has been kept in a safe and healthful condition during the year. The average volume of air passing at the outlet per minute was 45,545 cubic feet. This is divided into three splits and is fairly conducted through the working places. The mine drainage is in good condition. On my last visit I noticed that the fan was making 70 revolutions per minute, showing a water gauge of one and two-tenths inches, and producing 47,600 cubic feet of air. Mine foreman, William Jamison.

Penn Gas Coal Run Mine. The condition of this mine has been very good as regards health and safety during the year. The average volume of air passing at the inlet per minute is 32,573 cubic feet. This volume is divided into two splits and is well conducted through the working places. The mine drainage is also in good condition. Mine foreman, William Rodgers.

Penn Gas No. 4 Mine. This mine has been kept in a fair and healthful condition during the year. The average volume of air passing at the outlet per minute is 33,665 cubic feet. This volume is split into four divisions and is fairly distributed through the working places. The mine drainage is also in fair condition. Mine foreman, John Giles.

**Penn Manor Shaft.** The condition of this mine has been very good as regards health and safety during the year. The average volume of air passing at the inlet per minute is 26,270 cubic feet. This volume is in two divisions and is well conducted through the working places. The mine drainage is also in good condition. Mine foreman, Samuel Ferguson.

**S. H. Smith's Mine.** A furnace has been built and an air shaft sunk at this mine during the year. The air shaft is 25 feet in depth and 7 feet in diameter. Size of furnace, fire bed 36 square feet, length of arch 12 feet. This mine is now well ventilated. The average volume of air passing at the outlet per minute is 15,722 cubic feet. The mine drainage is also in good condition. Mine foreman, Joseph C. Knapper.

**Smith's Mine.** A furnace has been built in this mine during the year, size of furnace, 30 square feet; fire bed, with an arch, 12 feet in length. The air shaft is 40 feet in depth with a stack on top 16 feet in height. The mine is well ventilated now. The average amount of air going out at the outlet per minute is 15,738 cubic feet. The mine drainage is also in good condition. Mine foreman, Roy Gerard.

**Spring Hill No. 2 Mine.** The condition of this mine is very good, both as regards ventilation and drainage. The average volume of air passing at the outlet per minute was 24,060 cubic feet. This is in two divisions and is well conducted through the working places. Mine foreman, William B. Morris.

**Stickler Mine.** A fan was erected at this mine during the year; size of fan, 12 feet in diameter, driven by an engine 10x18 inches. The average volume of air going in now is 26,880 cubic feet per minute. This in two splits and is well conducted through the working places. The mine drainage is also in very good condition. Mine foreman, Alexander Davenport.

**Brick Works Mine.** This mine is situated on the southwest Pennsylvania Railroad, near Hunker Station, and is operated by the Fire Brick Company. Add Leitch is superintendent. They are working the Upper Freeport vein and the fire clay bed below it. I received an anonymous letter from a miner who had worked at the mine, and was discharged, I presume, for trying to get the men out on a strike. He stated that there was fire damp in the mine, and that there was no certificated mine foreman employed. It was true as to the mine-foreman, but I examined the mine very carefully, and there was no sign of fire damp C. H. 4 in either of the mines. I notified the superintendent that if he continued to run coal he must employ a mine foreman and ventilate the mine. He said he only ran a little coal during the strike to supply some of his customers and then stopped.

The Southwest Connellsville Coal and Coke Company Mines—

No. 1 "A" Shaft. This mine has been kept in excellent condition during the year. The average volume of air going in at the inlet per minute is 100,550 cubic feet. This volume is divided into eight separate splits and is well conducted through the working places. The mine drainage is also in good condition. A 25-foot fan ventilates both "A" and "B" shafts. On my last visit I noticed that the fan was running at 54 revolutions per minute, and showing a water gauge of nine-tenths of an inch, and producing 190,400 cubic feet of air per minute. Mine foreman, John Duncan.

No. 1 "B" Shaft. The condition of this mine, both as regards health and safety, has been very good during the year. The average volume of air passing at the inlet per minute is 81,200 cubic feet. This is in several divisions and is well circulated through the working places. The rope haulage has been extended 2,400 feet into the dip workings. Mine foreman, John Whitfield.

Alice No. 2 Mine. This mine has been kept in a safe and healthful condition during the year, with an average of 78,960 cubic feet of air passing at the inlet per minute. This volume is divided into four splits and is well distributed through the working places. The mine drainage is also in good condition. On my last visit I noticed the fan was running at 56 revolutions per minute and showing a water gauge of seven-tenths of an inch, and producing 81,200 cubic feet of air per minute. Mine foreman, William H. Howarth.

No. 3 Shaft. This mine has been kept in very good condition during the year. The average volume of air passing at the inlet per minute is 55,017 cubic feet. This is divided into three splits, and is well conducted through the working places. Another opening has been made across the railroad, and the coal will be hauled to the present shaft; part of the road will be on the surface. The mine drainage is in fair condition. Mine foreman, Robert Hair.

No. 4 Mine. The condition of this mine has been very good during the year, both as regards health and safety. The average volume of air going in at the inlet per minute is 44,920 cubic feet. This volume is in three different splits and is well circulated through the working places. The mine drainage is also kept in good condition. The rope haulage has been extended 800 feet into the dip workings. Mine foreman, Robert Morris.

Turner Mine. An air shaft was sunk at this mine and a furnace erected, size of furnace, firebed 24 square feet. This furnace has been completed since my last visit. The average volume of air going in at the inlet per minute is 8,620 cubic feet. This was fairly distributed and the mine drainage was in fair condition. Mine foreman, J. G. Turner.

Weinman Mine. On my first two visits to this mine, no air measurement could be taken on account of there being no fire in the furnace. The last two visits I measured 3,188 cubic feet of air in circulation per minute. Sometimes I find fewer than ten men employed inside. The mine drainage is always in good condition. Mine foreman, Jacob Weinman.

#### United Coal and Coke Company's Mines—

United No. 1 Shaft. This mine has been kept in safe and healthy condition during the year. The average amount of air going in at the inlet per minute is 11,433 cubic feet. This volume is split into several divisions and is well conducted through the working places. The mine drainage is also in fair condition. Another opening has been made into the mine at the outcrop and is used as a traveling way from the mutual side. Mine foreman, William West.

United No. 2 Mine. A pump house has been erected in the mine and a Gordon pump put in. The water is pumped through a bore hole 14 inches in diameter and 250 feet deep. A new air compressor steam cylinder 18x36 inches, air cylinder 24x36 inches, furnishes the power to pump the water out. A 6-inch diameter air line carries the compressed air to the pump. A new 16-foot steel fan and a brick fan-engine house has been erected. A landing to hold 30 wagons has been made in the dip. The mine is now in very good condition, both as regards ventilation and drainage. The average amount of air passing at the inlet per minute is 49,040 cubic feet. This is well distributed through the working places.

The outside improvements are a boiler, a haulage engine house. Mine foreman, John W. Greaves.

United No. 3 Mine. This mine is in a safe and healthful condition, with an average of 20,160 cubic feet of air passing at the outlet per minute. This is well distributed through the working places. The mine drainage is also in very good condition. Mine foreman, William M. Hart.

Mitchell Mine. This mine is in very fair condition, with an average volume of 7,365 cubic feet of air passing at the outlet per minute, and this is fairly distributed through the working places. The mine drainage is all right. An air shaft 7 feet in diameter and 34 feet deep has been sunk for ventilation, and they intend building a furnace very soon. Mine foreman, Milton Peddicord.

Graff Mine. This is a small mine, situated about one mile from Blairsville, Indiana county, Pa., and is operated by the Indiana Coal Company. The mine came under the provision of the law during the miners' strike in the summer. The ventilation was defective, and I ordered a furnace built. An air shaft was sunk and a furnace will

be built soon. I measured 9,720 cubic feet of air in circulation on one of my visits. Mine foreman, William Hamer.

#### Westmoreland Gas Coal Company's Mines—

**Larimer No. 4 Mine.** The mine has been kept in a reasonably good condition, both as regards ventilation and drainage. The average volume of air going in at the inlet per minute was 64,027 cubic feet. This is divided into seven splits and is fairly conducted through the working places. The endless rope system has been extended several hundred feet further into the mine. This was done in order to take the coal from the mouth of each pair of butt headings. Mine foreman, John Williams.

**Export Mine.** The company moved the ten-foot fan that they had at their South Side mine to the "Export" and erected the same on an air shaft that had been sunk at this time. The fan is used as an exhaust and does very efficient work. The average volume of air passing at the outlet per minute is 33,223 cubic feet. This volume is being coursed around the mine and is receiving a fresh supply from leakage as it passes on, and is fairly distributed through the working places. The mine drainage is in very good condition. Mine foreman, George Carroll.

**Westmoreland Shaft.** This mine has been kept in very fair condition during the year, with an average of 57,860 cubic feet of air passing at the outlet per minute. This is divided into several splits and is fairly distributed through the working places.

The mine drainage is in excellent condition. On my last visit the fan was making 65 revolutions per minute, showing a water gauge of 1.6 inches, and producing 63,420 cubic feet of air. A few days after my visit the fan broke down and the mine had to stop until it was repaired. The 12-foot fan formerly in use was not large enough to ventilate this large mine. Mine foreman, James Thompson.

**South Side Mine.** This mine is ventilated with the return air that comes from Larimer No. 4 mine. The mine is in good condition. There are only a few persons working in it, furnishing custom coal. Mine foreman, John Williams.

TABLE No. 1.—Showing Location, &c., of Collieries in the Second Bituminous Mine District.

| Name of Colliery.         | Name of Operator.                   | Location—County. | Name of Superintendent. | Postoffice Address.            |
|---------------------------|-------------------------------------|------------------|-------------------------|--------------------------------|
| Abert.                    | Arona Gas Coal Company.             | Westmoreland,    | Land Washington.        | Darragh, Westmoreland Co.      |
| Alexandria.               | Alexandria Coal Company.            | do.              | Thomas Donohoe.         | Greensburg, Westmoreland Co.   |
| Arnold.                   | Greensburg Coal Company.            | do.              | J. Howard Patton.       | Greensburg, Westmoreland Co.   |
| Claridge.                 | Carlisle Coal and Coke Company.     | do.              | W. M. Singlet.          | Greensburg, Westmoreland Co.   |
| Carbont.                  | Carlisle Coal and Coke Company.     | do.              | S. M. Hawkins.          | Claridge, Westmoreland Co.     |
| Columet.                  | Columet Coal Company.               | do.              | A. P. Cameron.          | Claridge, Westmoreland Co.     |
| Leamark.                  | Leamark Coal and Coke Company.      | do.              | E. F. Saxman.           | Lattrobe, Westmoreland Co.     |
| Lerry shaft.              | Lerry Coal Company.                 | do.              | W. L. Dixon.            | No. 15 Brushtown Ave., Alle-   |
| Luesque.                  | Corry Coal Company.                 | Allegheny,       | .....                   | gheny, Allegheny county.       |
| Expert.                   | Westmoreland Gas Coal Company.      | Westmoreland,    | A. N. Humphreys.        | Irwin, Westmoreland county.    |
| Frankstown.               | Jacob Wieman Coal Company.          | Allegheny,       | Jacob Wieman.           | Wilkinsburg, Allegheny Co.     |
| Greensburg No. 1.         | Greensburg Coal Company.            | Westmoreland,    | A. W. Jones.            | Greensburg, Westmoreland Co.   |
| Greensburg No. 2.         | Greensburg Coal Company.            | do.              | A. W. Jones.            | Greensburg, Westmoreland Co.   |
| Graceton Nos. 1 and 2.    | McHenry Coal and Coke Company.      | Indiana,         | Harry McHenry.          | Graceton, Indiana Co.          |
| Hecla No. 1.              | The Hecla Coal Company.             | Westmoreland,    | Thomas Laird.           | South West, Westmoreland Co.   |
| Hecla No. 2.              | The Hecla Coal Company.             | do.              | .....                   | South West, Westmoreland Co.   |
| Hempfield.                | Hempfield Coal Company.             | do.              | .....                   | Greensburg, Westmoreland Co.   |
| Hamilton.                 | Hamilton Coal Company.              | Allegheny,       | John S. Stewart.        | Edgewood Park, Allegheny Co.   |
| Isabella Furnace.         | Isabella Furnace Company.           | Westmoreland,    | W. C. Crist.            | Blairsville, Indiana Co.       |
| Jamison.                  | Jamison Coal Company.               | do.              | Thomas S. Jamison.      | Greensburg, Westmoreland Co.   |
| Lutescer Nos. 3 and 4.    | Ell Coal Company.                   | do.              | John H. Stewart.        | Lutesco, Westmoreland Co.      |
| Larver Nos. 3 and 4.      | Westmoreland Gas Coal Company.      | do.              | A. N. Humphreys.        | Irwin, Westmoreland Co.        |
| Loyalhanna No. 1.         | Loyalhanna Coal and Coke Company.   | do.              | John C. Monohet.        | Loyalhanna, Westmoreland Co.   |
| Loyalhanna No. 2.         | Loyalhanna Coal and Coke Company.   | do.              | John C. Monohet.        | Loyalhanna, Westmoreland Co.   |
| Lockport.                 | Lockport Coal and Coke Company.     | do.              | George H. Richards.     | Lockport, Westmoreland Co.     |
| Lattobes Coal Works.      | Lattobes Coal Company.              | do.              | D. W. Jones.            | Lattobes, Westmoreland Co.     |
| Mutual Nos. 2 and 3.      | United Coal and Coke Company.       | do.              | John M. White.          | United, Westmoreland Co.       |
| Marmath Nos. 1 and 2.     | H. C. Frick Coal Company.           | do.              | Charles E. Franks.      | Marmath, Westmoreland Co.      |
| Madison.                  | Madison Gas Coal Company.           | do.              | Thomas Donohoe, Jr.     | Greensburg, Westmoreland Co.   |
| Manastery slope.          | H. C. Frick Coal Company.           | do.              | A. F. Downing.          | Lattrobe, Westmoreland Co.     |
| Milwood shaft.            | Milwood Coal and Coke Company.      | do.              | E. B. Kimball.          | Milwood, Westmoreland Co.      |
| Mithel shaft.             | The Milwood Coal and Coke Company.  | do.              | Jacob Graf.             | Lattrobe, Westmoreland Co.     |
| Mather Nos 1 and 2.       | Indiana Coal Company.               | Indiana,         | Thomas Maher.           | Blairsville, Indiana Co.       |
| Grp.                      | Mahe Coal and Coke Company.         | do.              | William G. Keck.        | Blairsville, Indiana Co.       |
| Nos. 1 "A" and "B" shaft. | Gem Coal and Coke Company.          | Westmoreland,    | William S. Ramsay.      | Kocksburg, Westmoreland Co.    |
| No. 2.                    | South West Connellsville Coke Co.   | do.              | Robert Ramsay, Jr.      | Mt. Pleasant, Westmoreland Co. |
| No. 3.                    | South West Connellsville Coke Co.   | do.              | James A. Cowan.         | Mt. Pleasant, Westmoreland Co. |
| No. 4.                    | South West Connellsville Coke Co.   | do.              | James H. Eaton.         | Tarr's, Westmoreland Co.       |
| Ocean shaft.              | Ocean Coal Company.                 | do.              | F. L. Kimball.          | Alborton, Westmoreland Co.     |
| Oak Hill No. 4.           | Gothleb Vogeles.                    | Allegheny,       | Gothleb Vogeles.        | Rifhton, Westmoreland Co.      |
| Plum Creek.               | New York and Cleveland Gas Coal Co. | do.              | T. B. DeArmit.          | Wilkinsburg, Allegheny Co.     |
| Pleasant Valley.          | New York and Cleveland Gas Coal Co. | do.              | T. B. DeArmit.          | Turtle Creek, Allegheny Co.    |
|                           | New York and Cleveland Gas Coal Co. | Westmoreland,    | F. Z. Schellenberg.     | 520 Penn Ave., Pittsburgh.     |



|                                 |  |                     |                           |                                  |
|---------------------------------|--|---------------------|---------------------------|----------------------------------|
| Pandora shaft, .....            | Loyalhanna Coal and Coke Company, .....      | do.                 | John C. Menoher, .....    | Loyalhanna, Westmoreland Co.     |
| Penn Manor shaft, .....         | F. L. Stephenson, .....                      | do.                 | Samuel P. Ferguson, ..... | Harrison, Clay, Westmoreland Co. |
| Penn Gas No. 1 shaft, .....     | Penn Gas Coal Company, .....                 | do.                 | John F. Wolf, .....       | Irwin, Westmoreland Co.          |
| Penn Gas No. 2 shaft, .....     | Penn Gas Coal Company, .....                 | do.                 | John F. Wolf, .....       | Irwin, Westmoreland Co.          |
| Penn Gas No. 3 shaft, .....     | Penn Gas Coal Company, .....                 | do.                 | John F. Wolf, .....       | Irwin, Westmoreland Co.          |
| Penn Gas No. 4 shaft, .....     | Penn Gas Coal Company, .....                 | do.                 | John F. Wolf, .....       | Irwin, Westmoreland Co.          |
| Penn Gas Coal Run, .....        | Penn Gas Coal Company, .....                 | do.                 | John F. Wolf, .....       | Irwin, Westmoreland Co.          |
| Penn Gas slope, .....           | Penn Gas Coal Company, .....                 | do.                 | John F. Wolf, .....       | Irwin, Westmoreland Co.          |
| Graff, .....                    | Indiana Coal and Coke Company, .....         | Indiana, .....      | John B. Graff, .....      | Blairsville, Indiana Co.         |
| Strickler, .....                | J. A. Strickler Coke Co. (limited), .....    | Westmoreland, ..... | J. A. Strickler, .....    | Wilksburg, Allegheny Co.         |
| Standard No. 1, .....           | H. C. Frick Coke Company, .....              | do.                 | Robert Ramsay, .....      | Mt. Pleasant, Westmoreland Co.   |
| Standard No. 2, .....           | H. C. Frick Coke Company, .....              | do.                 | Robert Ramsay, .....      | Mt. Pleasant, Westmoreland Co.   |
| Standard slope, .....           | H. C. Frick Coke Company, .....              | do.                 | Robert Ramsay, .....      | Mt. Pleasant, Westmoreland Co.   |
| South Side, .....               | Westmoreland Gas Coal Company, .....         | do.                 | A. N. Humphreys, .....    | Irwin, Westmoreland Co.          |
| S. H. Smith, .....              | The Ligonier Coal Company, .....             | do.                 | Joseph C. Knappier, ..... | Leetree, Westmoreland Co.        |
| St. Clair, .....                | St. Clair Coal and Coke Co. (limited), ..... | do.                 | M. A. Preston, .....      | Blairsville, Westmoreland Co.    |
| Smith, .....                    | Gabert Smith, .....                          | Indiana, .....      | Robert Smith, .....       | Blairsville, Indiana Co.         |
| Spring Hill Nos. 1 and 2, ..... | Spring Hill Gas Coal Company, .....          | Allegheny, .....    | E. W. Boyd, .....         | Turtle Creek, Allegheny Co.      |
| Standy Creek, .....             | New York and Cleveland Gas Coal Co., .....   | do.                 | William Fisher, .....     | White Ash, Allegheny Co.         |
| Turner, .....                   | M. Turner, .....                             | Indiana, .....      | J. M. Turner, .....       | Blairsville, Indiana Co.         |
| United No. 1 shaft, .....       | United Coal and Coke Company, .....          | Westmoreland, ..... | John M. White, .....      | United, Westmoreland Co.         |
| United No. 2, .....             | United Coal and Coke Company, .....          | do.                 | F. A. Plotner, .....      | Fern, Westmoreland Co.           |
| United No. 3, .....             | United Coal and Coke Company, .....          | do.                 | John M. White, .....      | United, Westmoreland Co.         |
| Whitney, .....                  | Hunter-Campsville Coke Company, .....        | do.                 | John T. Rusb, .....       | Whitney, Westmoreland Co.        |
| Westmoreland shaft, .....       | Westmoreland Gas Coal Company, .....         | do.                 | A. N. Humphreys, .....    | Irwin, Westmoreland Co.          |
| Weinhard's, .....               | Weinhard Bros., .....                        | Allegheny, .....    | Joseph Weinman, .....     | Wilksburg, Allegheny Co.         |



|   |           |           |           |         |        |       |       |                   |
|---|-----------|-----------|-----------|---------|--------|-------|-------|-------------------|
| Madison.....  | 136,356   | 4,442     | 136,356   | 169 1/2 | 27 1/2 | 2     | 18    | .....             |
| Larimer, Westmoreland county.....                             | 61,522    | .....     | 61,522    | 119     | 175    | 11    | 14    | .....             |
| Larimer, Westmoreland county.....                             | 10,000    | .....     | 10,000    | 181     | 20     | ..... | 1     | .....             |
| Madison, Indiana county.....                                  | 63,516    | .....     | 63,516    | 289     | 55     | ..... | 3     | .....             |
| Wilksburg, Allegheny county.....                              | 5,271     | .....     | 5,271     | 3,881   | 10     | ..... | ..... | .....             |
| Mc. Pleasant, Westmoreland co., No. 1 "A" and "B" shafts..... | 385,560   | 250,092   | .....     | 261     | 665    | 21    | 54    | 630               |
| No. 2.....  | 134,774   | 101,414   | .....     | 260     | 248    | 1     | 31    | 250               |
| No. 3.....  | 102,653   | 62,663    | .....     | 210     | 181    | 1     | ..... | 250               |
| No. 4.....  | 53,027    | 54,407    | .....     | 228     | 140    | 7     | 28    | 151               |
| Ocean shaft.....  | 52,230    | .....     | 52,230    | 210     | 214    | 2     | 5     | .....             |
| Park Hill No. 1.....  | 132,008   | .....     | 132,008   | 111     | 220    | 2     | 14    | .....             |
| Plum Creek.....   | 178,252   | .....     | 178,252   | 261     | 261    | 1     | 13    | 1                 |
| Pleasant Valley.....  | 31,391    | .....     | 31,391    | 121     | 100    | ..... | 6     | .....             |
| Penn Manor shaft.....   | 56,449    | .....     | 56,449    | 153     | 159    | 1     | 4     | 43                |
| Pandora.....  | 22,694    | .....     | 21,524    | 39      | 135    | 5     | 14    | .....             |
| Larimer Coke Works.....                                       | 164,735   | .....     | 160,020   | 153 1/4 | 337    | 8     | 25    | 300               |
| Penn Gas No. 1 shaft.....                                     | 156,795   | .....     | 148,329   | 157     | 332    | 8     | 35    | .....             |
| Penn Gas No. 2 shaft.....                                     | 98,370    | .....     | 97,094    | 133 3/4 | 253    | 1     | 22    | .....             |
| Penn Gas No. 1.....   | 52,959    | .....     | 52,164    | 145     | 115    | 2     | 6     | .....             |
| Penn Gas coal run.....  | 35,595    | .....     | 35,596    | 260     | 35     | ..... | 3     | .....             |
| S. J. Smith.....  | 132,354   | .....     | 132,354   | 260     | 192    | 2     | 10    | .....             |
| Strickler.....  | .....     | .....     | .....     | .....   | .....  | ..... | ..... | .....             |
| Standard slope.....   | .....     | 280,000   | .....     | 279     | 687    | 1     | 18    | 905               |
| South Side.....   | 40,367    | 11,439    | 20,334    | 131     | 102    | 4     | 13    | .....             |
| Saint Clair.....  | 43,750    | .....     | 43,000    | 200     | 128    | 1     | ..... | 128               |
| Spring Hill No. 2.....  | 120,436   | .....     | 120,436   | 158     | 289    | 1     | 18    | .....             |
| Sandy Creek.....  | 37,468    | .....     | 37,308    | 360     | 45     | 1     | 1     | .....             |
| Smith's.....  | 26,000    | .....     | 26,000    | 360     | 27     | ..... | 2     | .....             |
| Turners.....  | 55,956    | 10,835    | 69,714    | 107     | 268    | 7     | 24    | 300               |
| United No. 1 shaft.....                                       | 114,630   | 78,000    | 209       | 241     | 209    | 6     | 26    | 301               |
| United No. 2.....   | 58,618    | 4,023     | 52,584    | 154     | 95     | 1     | 9     | 154               |
| United No. 3.....   | 165,000   | 124,000   | .....     | 230     | 237    | 1     | 4     | 302               |
| Whitney.....  | 220,325   | .....     | 214,576   | 224     | 38     | 12    | 24    | .....             |
| Westmoreland shaft.....                                       | .....     | .....     | .....     | 220     | 42     | ..... | 1     | .....             |
| Westmoreland car shops.....                                   | 6,571     | .....     | 5,586     | 296     | 11     | ..... | 1     | .....             |
| Wilksburg, Allegheny county.....                              | .....     | .....     | .....     | .....   | .....  | ..... | ..... | .....             |
| Totals.....   | 6,424,633 | 4,635,243 | 4,600,177 | 12,171  | 12,149 | 16    | 344   | 229 1,055 3 7,155 |



|  |    |       |     |     |     |     |       |    |     |     |       |     |     |       |        |
|--|----|-------|-----|-----|-----|-----|-------|----|-----|-----|-------|-----|-----|-------|--------|
| Madison, .....                         | 1  | 140   | 13  | 7   | 17  | 9   | 242   | 1  | 4   | 2   | 7     | 52  | 19  | 30    | 272    |
| Monastery slope, .....                 | 1  | 50    | 7   | 1   | 3   | 3   | 111   | 4  | 2   | 1   | 1     | 1   | 1   | 64    | 175    |
| Maier Nos. 1 and 2, .....              | 1  | 49    | 1   | 1   | 3   | 1   | 54    | 1  | 1   | 1   | 1     | 1   | 1   | 1     | 55     |
| Blairsville, Indiana Co., .....        | 1  | 17    | 1   | 1   | 1   | 1   | 13    | 1  | 1   | 1   | 1     | 1   | 1   | 20    | 20     |
| Graceton, Indiana Co., .....           | 2  | 283   | 1   | 39  | 28  | 7   | 390   | 2  | 6   | 16  | 243   | 32  | 6   | 305   | 665    |
| Mt. Pleasant, Westmoreland Co., .....  | 1  | 100   | 5   | 7   | 13  | 1   | 127   | 1  | 2   | 5   | 88    | 22  | 3   | 121   | 245    |
| Mt. Pleasant, Westmoreland Co., .....  | 1  | 70    | 5   | 6   | 13  | 2   | 92    | 1  | 2   | 5   | 98    | 10  | 2   | 89    | 181    |
| Larr's, Westmoreland Co., .....        | 1  | 61    | 4   | 4   | 5   | 1   | 75    | 1  | 3   | 3   | 52    | 4   | 2   | 64    | 140    |
| Alverton, Westmoreland Co., .....      | 1  | 150   | 4   | 21  | 9   | 2   | 183   | 1  | 5   | 4   | 1     | 21  | 2   | 31    | 214    |
| Wernimie, Westmoreland Co., .....      | 1  | 8     | 1   | 1   | 1   | 1   | 10    | 1  | 1   | 1   | 1     | 1   | 1   | 10    | 10     |
| Wilkinsburg, Allegheny Co., .....      | 1  | 260   | 18  | 4   | 14  | 6   | 305   | 1  | 2   | 3   | 1     | 18  | 3   | 27    | 330    |
| Turdie Creek, Allegheny Co., .....     | 2  | 181   | 13  | 8   | 11  | 4   | 228   | 1  | 4   | 2   | 1     | 24  | 2   | 32    | 261    |
| Harrison, Allegheny Co., .....         | 1  | 182   | 3   | 5   | 1   | 1   | 192   | 1  | 1   | 1   | 1     | 5   | 1   | 8     | 100    |
| Harrison City, Westmoreland Co., ..... | 1  | 150   | 5   | 5   | 7   | 3   | 171   | 1  | 1   | 1   | 1     | 1   | 1   | 18    | 189    |
| Manor, Westmoreland Co., .....         | 1  | 133   | 6   | 11  | 9   | 1   | 171   | 1  | 1   | 1   | 1     | 1   | 1   | 16    | 187    |
| Pandora shaft, .....                   | 1  | 257   | 3   | 17  | 26  | 6   | 308   | 1  | 3   | 4   | 4     | 22  | 2   | 29    | 325    |
| Penn Gas No. 1 shaft, .....            | 1  | 140   | 13  | 12  | 18  | 2   | 200   | 1  | 3   | 4   | 1     | 17  | 1   | 24    | 222    |
| Penn Gas No. 2 shaft, .....            | 1  | 146   | 3   | 4   | 6   | 3   | 165   | 1  | 3   | 4   | 1     | 1   | 1   | 24    | 225    |
| Penn Gas No. 4 shaft, .....            | 1  | 146   | 2   | 4   | 6   | 3   | 165   | 1  | 3   | 4   | 1     | 1   | 1   | 24    | 225    |
| Strickler, .....                       | 1  | 75    | 2   | 4   | 8   | 3   | 90    | 1  | 3   | 2   | 1     | 1   | 1   | 14    | 105    |
| Swth. West, Westmoreland Co., .....    | 1  | 75    | 2   | 4   | 8   | 3   | 90    | 1  | 3   | 2   | 1     | 1   | 1   | 14    | 105    |
| Standard slope, .....                  | 1  | 260   | 8   | 91  | 30  | 7   | 409   | 1  | 7   | 13  | 215   | 47  | 4   | 287   | 687    |
| Mt. Pleasant, Westmoreland Co., .....  | 1  | 260   | 8   | 91  | 30  | 7   | 409   | 1  | 7   | 13  | 215   | 47  | 4   | 287   | 687    |
| Standard No. 2 shaft, .....            | 1  | 260   | 8   | 91  | 30  | 7   | 409   | 1  | 7   | 13  | 215   | 47  | 4   | 287   | 687    |
| South Side, .....                      | 1  | 57    | 1   | 1   | 7   | 4   | 79    | 1  | 2   | 3   | 17    | 1   | 1   | 30    | 102    |
| Salut Clair, .....                     | 1  | 27    | 1   | 1   | 3   | 1   | 32    | 1  | 2   | 3   | 17    | 1   | 1   | 30    | 102    |
| S. H. Smith, .....                     | 1  | 90    | 10  | 14  | 6   | 1   | 122   | 1  | 1   | 2   | 1     | 1   | 1   | 6     | 35     |
| Spring Hall No. 2, .....               | 1  | 200   | 30  | 7   | 12  | 1   | 272   | 1  | 3   | 4   | 1     | 27  | 3   | 37    | 128    |
| Sandy Creek, .....                     | 1  | 200   | 30  | 7   | 12  | 1   | 272   | 1  | 3   | 4   | 1     | 27  | 3   | 37    | 128    |
| Smith's, .....                         | 1  | 30    | 9   | 1   | 2   | 1   | 44    | 1  | 3   | 4   | 1     | 1   | 1   | 27    | 289    |
| Turner, .....                          | 1  | 30    | 9   | 1   | 2   | 1   | 44    | 1  | 3   | 4   | 1     | 1   | 1   | 27    | 289    |
| Blairsville, Indiana Co., .....        | 1  | 30    | 9   | 1   | 2   | 1   | 44    | 1  | 3   | 4   | 1     | 1   | 1   | 27    | 289    |
| United, Westmoreland Co., .....        | 1  | 135   | 5   | 9   | 10  | 6   | 158   | 1  | 3   | 6   | 88    | 1   | 1   | 104   | 263    |
| Unitr. No. 1 shaft, .....              | 1  | 125   | 6   | 6   | 15  | 7   | 160   | 2  | 4   | 6   | 61    | 5   | 2   | 81    | 241    |
| United No. 2, .....                    | 1  | 155   | 6   | 1   | 6   | 2   | 165   | 1  | 1   | 1   | 20    | 5   | 2   | 30    | 95     |
| United No. 3, .....                    | 1  | 144   | 10  | 10  | 1   | 1   | 165   | 1  | 2   | 4   | 70    | 12  | 2   | 92    | 267    |
| Whitney, .....                         | 1  | 174   | 12  | 124 | 25  | 13  | 359   | 1  | 3   | 7   | 1     | 14  | 1   | 95    | 385    |
| Westmoreland shaft, .....              | 1  | 174   | 12  | 124 | 25  | 13  | 359   | 1  | 3   | 7   | 1     | 14  | 1   | 95    | 385    |
| Westmoreland Car Shops, .....          | 1  | 7     | 1   | 1   | 1   | 1   | 10    | 1  | 12  | 2   | 1     | 26  | 1   | 42    | 42     |
| Weinman's, .....                       | 1  | 7     | 1   | 1   | 1   | 1   | 10    | 1  | 12  | 2   | 1     | 26  | 1   | 42    | 42     |
| Wilkinsburg, Allegheny Co., .....      | 1  | 7     | 1   | 1   | 1   | 1   | 10    | 1  | 12  | 2   | 1     | 26  | 1   | 42    | 42     |
| Totals, .....                          | 65 | 7,428 | 328 | 622 | 670 | 227 | 9,351 | 54 | 159 | 204 | 1,595 | 653 | 128 | 2,798 | 12,149 |

TABLE No. 4.—List of fatal accidents that occurred in and about the Mines of the Second Bituminous Mine District, for the year ending December 31, 1894.

| Date of accident. | Name of Person.         | Occupation.   | Age. | Widow. | Number of orphans. | Name of Colliery.           | Location—County.    | Nature and Cause of Accident.   |
|-------------------|-------------------------|---------------|------|--------|--------------------|-----------------------------|---------------------|---|
| Jan. 31.          | Michael Jescosky, ..... | Miner, .....  | 25   | 5      | .....              | Whitney, .....              | Westmoreland, ..... | Was fatally injured by a fall of roof in coal as he was taking post out in the gob or goaf. The mine foreman had told him to set some posts and then come outside of them to work; a miner working in the next place had told him not to go back in the gob after the post; notwithstanding these warnings he went and was killed.                |
| Feb. 19.          | Nicolo Bratic, .....    | Miner, .....  | 28   | 1      | 2                  | Larimer No. 4, .....        | Westmoreland, ..... | Was instantly killed by a fall of slate as he was knocking coal; he did not take time to set a post under the slate, and so he was killed by his own carelessness or ignorance of the danger that he was working under.   |
| April 7.          | James Donnelly, .....   | Miner, .....  | 40   | 1      | .....              | Tenn Gas No. 4, .....       | Westmoreland, ..... | Was instantly killed by a fall of slate as he was knocking coal; he did not have any post set under the slate, although he had plenty in the room where he worked. I visited his room ten days before the accident, and noticed that great care should be taken with the slate, and notified him to that effect, but he did not heed the warning. |
| May 30.           | Bernard Needler, .....  | Driver, ..... | 19   | 5      | .....              | Standard No. 2 shaft, ..... | Westmoreland, ..... | Was instantly killed by being caught between wagon and rib; there was no one with him at the time of the accident, and so no one could tell how it came about; but the supposition is that he was driving fast, and that he jumped off to put the brakes on the wagons when he was caught.  |

|          |                   |          |    |      |                     |               |  |
|----------|-------------------|----------|----|------|---------------------|---------------|--|
| June 15, | Michael Shaeffer, | Miner,   | 20 | E.   | Alexandria,         | Westmoreland, | Was instantly killed by a fall of coal; he did not have the coal strapped, which is always necessary in this coal; he had only been a short time in this country, and knew very little of the dangers of mining, and so met his death from the lack of proper knowledge.   |
| July 19, | Prosper Politt,   | Miner,   | 18 | W. S | Larmer No. 4,       | Westmoreland, | Was fatally injured by a fall of slate and died in three hours after; he was leading coal for the purpose of setting a post under the slate; he was a glass worker and had only been in the mine four days, and I suppose he did not understand much about the slate.  |
| 19,      | Thomas Sykes,     | Miner,   | 69 | 1    | Hampton,            | Allegheny,    | Was instantly killed by a fall of slate and roof coal as he was drawing out a post; the place had been standing on a post for several months during the strike, and I suppose the old man did not take the proper care in taking the post out. The coroner held an inquest and a verdict of accidental death was rendered. He was English.                               |
| 25,      | Otto Olson,       | Miner,   | 26 | 1 2  | Carbou,             | Westmoreland, | Was fatally injured by a fall of slate and died in eleven hours after the accident; he had filled a wagon, and in place of taking the slate down he commenced to bear in the coal; he admitted that he ought to have sounded the slate, but it was too late, poor fellow. The coroner held an inquest and rendered a verdict of accidental death. A Swede miner.         |
| 30,      | Edward Englehart, | Trapper, | 14 | S.   | Latrobe Coke Works, | Westmoreland, | Was fatally injured by being run over by an empty trip on the dilly road; this was his first day's trapping at the place. There was shelter hole at the door to him to sit in, but he sat on the track and went to sleep, after being told not to by the mine foreman and roadman; the coroner held an inquest and rendered a verdict of accidental death. American boy. |
| Aug. 16, | Theodore Schmitz, | Driver,  | 25 | S.   | Hostetter,          | Westmoreland, | Was instantly killed by being run over by an empty wagon, as he was taking a trip on the heading; there was no one present when the accident occurred and it is supposed that he slipped and fell under the wagon; he had only been in the mine two months; the coroner held an inquest and rendered a verdict of accidental death.                                      |

TABLE No. 4.—Continued.

| Date of accident. | Name of Person.    | Occupation. | Age. | Widow. | Number of orphans. | Name of Colliery.  | Location—County. | Nature and Cause of Accident.  |
|-------------------|--------------------|-------------|------|--------|--------------------|--------------------|------------------|--|
| Aug. 27.          | Piazza Lorenze.    | Miner.      | 25   | S.     | .....              | Plum Creek.        | Allegheny.       | Was instantly killed by a fall of slate as he was shoveling coal back from under it; there was a clay vein in his room and he had not taken the proper precaution in setting the post in the right place, and he was working under too much slate; the coroner held an inquest and rendered a verdict of accidental death.   |
| Sept. 18.         | William Staynates. | Miner.      | 41   | 1      | .....              | Spring Hill No. 2. | Allegheny.       | Was fatally injured by a fall of slate and died in a short time after; he was knocking coal at the time of the accident; there was a water slip in the slate, but it could not be seen until after the slate fell; if he had sounded the slate he would have discovered that it was loose; the coroner held an inquest and rendered a verdict of accidental death. |
| Oct. 4.           | Stephen Hecarich.  | Miner.      | 23   | S.     | .....              | Alice No. 2.       | Westmoreland.    | Was fatally injured by a fall of roof coal and died in an hour after; at the time of the accident he was taking out a post in a rib. August Jitt warned him not to go after the post but he did and he was caught under tons of roof coal and slate. The coroner held an investigation and rendered a verdict of accidental death.                                 |
| 4.                | William Elker.     | Miner.      | 35   | S.     | .....              | Export.            | Westmoreland.    | Was instantly killed by a fall of roof coal as he was drawing a post out in a rib. Thomas Moore, the man who worked with him, told him not to go back for the post, as it was unsafe, but he was self-willed and back he went, and there were tons of roof and slate fell on him.  |



|  |          |              |  |              |   |
|--|----------|--------------|--|--------------|---|
| <p>8, Andrew Raake, Miner, ..... 26</p>    | <p>1</p> | <p>2</p>     | <p>South West No. 3, ..... Westmoreland,</p> | <p>.....</p> | <p>Was instantly killed by a fall of roof coal as he was taking out a post in a rib. Tony Jiffly was holding a light for him; he saw the danger and told him to come back, but he gave no attention to what he said, and was caught under tons of roof coal and slate; the coroner held an investigation and rendered a verdict of accidental death.</p>  |
| <p>15, Ignatz Glaski, Miner, ..... 57</p>  | <p>1</p> | <p>.....</p> | <p>Larimer No. 4, ..... Westmoreland,</p>    | <p>.....</p> | <p>Was instantly killed by being caught between wagons and rib on the dilly road as he was going home. It was ninety-seven feet from the mouth of the heading to where he crossed to the airway, and there was five feet between the rib and the wagons on the one side, but he did not have sense enough to stay in the mouth of the heading or walk on the safe side until the trip had passed.</p> |
| <p>22, John Schoflock, Miner, ..... 38</p> | <p>1</p> | <p>1</p>     | <p>Mammoth, ..... Westmoreland,</p>          | <p>.....</p> | <p>Was fatally injured by a fall of slate and died in a short time after. He was drawing a rib; this rib had been standing on post for ten months; he worked a day and a half and had only set one post in the brake row. When he should have set a great many; the coroner held an investigation and rendered a verdict of accidental death.</p>   |
| <p>24, John Rhorman, Miner, ..... 33</p>   | <p>1</p> | <p>1</p>     | <p>Denmark, ..... Westmoreland,</p>          | <p>.....</p> | <p>Was fatally injured by a fall of slate and died in one hour after. He was slating the bottom coal after filling a wagon and should have posted the slate or taken it down first; if he had done so, the accident would have not occurred.</p>  |

TABLE NO. 5.—List of non-fatal accidents that occurred in and about the mines of the Second Bituminous Mine District for the year ending December 31, 1894.

| Date of accident | Name of Person      | Occupation | Age | Married | Name of Colliery           | Location—County | Nature and Cause of Accident  |
|------------------|---------------------|------------|-----|---------|----------------------------|-----------------|---|
| Jan. 12          | James H. Heath      | Miner      | 30  | M       | Jamison                    | Westmoreland    | Back severely injured by a fall of slate.                                     |
| Feb. 3           | William March       | Miner      | 19  | S       | Hampton                    | Allegheny       | Leg broken by a fall of slate.  |
| March 3          | John Bruno          | Miner      | 46  | M       | Whitney                    | Westmoreland    | Leg fractured by a fall of slate.   |
| March 17         | Frank Frozner       | Trapper    | 16  | boy     | No. 1 "A" shaft            | Westmoreland    | Leg broken by being caught between wagons.                                    |
| 19               | Mahlon Curry        | Miner      | 39  | S       | Export                     | Westmoreland    | Leg broken by a fall of slate.  |
| 26               | John Freichter      | Miner      | 30  | M       | Hempfield                  | Westmoreland    | Back and hip slightly injured by a fall of slate.                             |
| April 18         | William Dunlop      | Driver     | 23  | S       | Standard No. 2 shaft       | Westmoreland    | Leg broken by being struck by a rail.   |
| May 4            | T. S. Page          | Miner      | 36  | M       | South West No. 4           | Westmoreland    | Ribs injured by being caught between wagons.                                  |
| June 6           | Leo Lemon           | Laborer    | 50  | M       | Standard No. 2 shaft       | Westmoreland    | Collar bone dislocated by being caught by a trip of wagons.                   |
| 8                | Peter Sandy         | Miner      | 48  | M       | Carbon                     | Westmoreland    | Leg broken by a fall of slate.  |
| 8                | David Wardis        | Miner      | 35  | M       | Smith's                    | Indiana         | Shoulder dislocated and head fractured by being caught between wagons.        |
| July 15          | Georgette Francisco | Miner      | 38  | M       | Milwood shaft              | Westmoreland    | Arm and back slightly injured by a fall of slate.                             |
| 20               | Frank Gilbert       | Driver     | ... | S       | Alice No. 2                | Westmoreland    | Leg broken while taking a spring out of a wagon wheel.                        |
| 30               | Valentine Mance     | Miner      | 28  | S       | Larimer No. 4              | Westmoreland    | Thigh broken by a fall of slate.  |
| Aug. 13          | Henry Cradwell      | Trapper    | 13  | boy     | Denmark                    | Westmoreland    | Thigh broken by being caught by a trip of wagons as he was stepping the door. |
| 23               | Joseph Loring       | Miner      | 29  | M       | Claridge                   | Westmoreland    | Back injured by a fall of coal.   |
| 25               | Charles Brown       | Miner      | 56  | M       | Penn Manor shaft           | Westmoreland    | Leg broken by being caught by a fall of slate.                                |
| 31               | Thomas Holdsworth   | Miner      | 28  | M       | Standard No. 2 shaft       | Westmoreland    | Collar bone broken by being struck by a back.                                 |
| Sept. 24         | William Copeland    | Road man   | 41  | M       | South West "B" No. 1 shaft | Westmoreland    | Back severely injured by a fall of slate as he was taking it down.            |
| 26               | George Clark        | Miner      | 28  | S       | Sandy creek                | Allegheny       | Leg broken and side bruised by a fall of slate.                               |

|       |     |                    |              |     |    |                             |               |  |
|-------|-----|--------------------|--------------|-----|----|-----------------------------|---------------|--|
| April | 16. | Henry Huffman.     | Miner.       | 29  | S. | Ocean shaft,                | Westmoreland, | Leg broken by a fall of slate.   |
| Oct.  | 1.  | Harry Maker.       | Dolly rider. | 28  | M. | South West "A" No. 1 shaft. | Westmoreland, | Arm broken, necessitating amputation, by being caught between roof and wagon.                                    |
|       | 17. | John Honyuk.       | Miner.       | 56  | M. | South West "F" No. 1 shaft. | Westmoreland, | Back and hip bruised by being caught by a fall of slate.   |
|       | 19. | Joseph Newbould.   | Miner.       | 49  | M. | Greensburg No. 1.           | Westmoreland, | Leg broken by being caught by a fall of slate.   |
|       | 23. | John Batustiek.    | Miner.       | 33  | M. | Carbon.                     | Westmoreland, | Back severely injured by being caught by a fall of slate.  |
|       | 24. | James Dugan.       | Laborer.     | 49  | M. | Mammoth.                    | Westmoreland, | Leg broken by being caught between wagons as he was dropping them to the rope.                                   |
|       | 25. | William Ashbaugh.  | Driver.      | ... | S. | Penn Gas Coal Run.          | Westmoreland, | An iron rail went through his leg as he was sitting in the wagon seat; the mule trod on the rail and it flew up. |
| Nov.  | 6.  | John Crockett.     | Miner.       | 32  | S. | Ocean shaft.                | Westmoreland, | Hip dislocated by being caught by a fall of coal.  |
|       | 6.  | August Johnson.    | Miner.       | 50  | M. | Penn Gas No. 2 shaft.       | Westmoreland, | Foot mashed by being caught by a fall of slate.  |
|       | 8.  | McHallyory Barkry. | Miner.       | 33  | M. | Mammoth.                    | Westmoreland, | Hip dislocated by being caught by a fall of slate.   |
|       | 21. | W. P. Turney.      | Miner.       | 38  | M. | Denmark.                    | Westmoreland, | Leg broken by being caught by a fall of slate.   |
| Dec.  | 1.  | Robert Watson.     | Miner.       | 18  | S. | Penn Gas Coal Run.          | Westmoreland, | Leg and shoulder slightly injured by being caught by a fall of slate.  |
|       | 5.  | David Smith.       | Driver.      | 21  | S. | Standard No. 2 shaft.       | Westmoreland, | Shoulder bone broken and side injured by being caught between wagon and door.                                    |
|       | 16. | Andrew Monis.      | Miner.       | 57  | M. | Larimer No. 4.              | Westmoreland, | Leg broken and head cut by being caught by a fall of slate.  |
|       | 17. | Meys Premie.       | Miner.       | 25  | S. | Larimer No. 4.              | Westmoreland, | Leg, back and back injured by being caught by a fall of slate.   |
|       | 18. | John Sceupleine.   | Miner.       | 26  | M. | Larimer No. 4.              | Westmoreland, | Back injured by being caught by a fall of slate.   |
|       | 24. | John Keatings.     | Miner.       | 19  | S. | Larimer No. 4.              | Westmoreland, | Leg broken by being caught by a fall of slate.   |
|       | 24. | Oliver Hudspath.   | Miner.       | 34  | M. | Denmark.                    | Westmoreland, | Small bone of leg broken by being caught by a fall of coal.  |
|       | 31. | Richard Pratt.     | Driver.      | 31  | M. | No. 1 "F" shaft.            | Westmoreland, | Compound fracture of the leg caused by being caught between wagon and rib.                                       |



## THIRD BITUMINOUS DISTRICT.

(ALMSTRONG, BUTLER, CLARION, INDIANA, JEFFERSON, LAWRENCE,  
MERCER, WESTMORELAND AND BEAVER COUNTIES.)

Mercer, Pa., March 4, 1895.

Hon. Isaac B. Brown, Secretary of Internal Affairs:

Sir: As required by the eleventh section of article X of the Bituminous mining act, approved May 15, 1893, I herewith submit my annual report for the year ending December 31st, 1894.

Nine persons lost their lives in this district during the year, which is an increase of 200 per cent. over that of last year. The reported number of non-fatal accidents was only twelve, against twenty-six for the year 1893. The almost unequalled record of this district for safety has been broken by the heavy increase in the number of deaths in this unfortunate year. It is hard to account for this sad and sudden change. The very favorable conditions that have existed in and about the mines of the district in the past, are practically unchanged. The methods of mining, together with all the appliances used in mining the coal, remain practically the same now as in the past. The coal seams, with their surrounding strata are unchanged. The same class of workmen, possessing about the same degree of skill and knowledge of mining now as formerly, are still employed in the mines of this district. While at many of the mines in the larger portion of the other districts the non-English speaking races have taken the places of our own English-speaking citizens, such is not the case to any great extent in this district; consequently, we cannot ascribe this great increase in the loss of life to that cause. Only one of the number killed was non-English speaking, and the investigation did not disclose the fact that ignorance was the main factor in causing Potuskey's death, and admitting that he lost his life through his inexperience in mining and his lack of that judgment necessary to protect himself, yet this argument cannot be advanced in extenuation of the others who lost their lives, as they were all men of good, ordinary intelligence (with possibly one exception), and of large practical experience. In the cases of Cormman, Agnew, Davidson and Williard, they practically committed suicide. After the warning these men had of their danger, it would only be reasonable to infer that they did not value their lives very highly. Cormman lay down in front of ten tons of coal which had been undercut almost completely and relieved on all sides. This mass of coal was

hanging without any support, and not a single precautionary measure had been taken by Cornman, so far as I could learn upon investigation. Cornman was told by his son, who was working with him, that the coal was about to fall and warned him to get up from the front of it. It seemed that he did not heed the son's advice.

Agnew had been frequently requested by his partners to be more careful in spragging the undercut coal, but he as good as told them to mind their own business. Davidson also was told by his grandson (a young boy) that he believed the coal was going to fall upon him, and he was so afraid of this occurring that he ran out of the room. Williard did not exercise ordinary prudence. He failed to sprag the mined coal and it fell upon him.

Vogan, who was killed by a fall of roof and coal, was not blessed with any great amount of intelligence, but Morrow was an intelligent miner. Had either of those men taken the ordinary precautions to carefully examine or sound the roof frequently to ascertain its condition, they would not have lost their lives. Four of these unfortunate men lost their lives a few days after they had returned to work after a strike, and they were extremely poor and their families in destitute circumstances, which made them eager to make the best use of their time while in the mines, so as to increase their meagre earnings as much as possible. Taking all of these matters into consideration, we cannot emphasize the fact too strongly that miners, no matter how poor they may be, or what their circumstances are, their first duty is to have their working places made safe, no matter what time it requires to do it. They must be compelled to use all proper and necessary precautions in protecting their lives and limbs. The performance of this duty must not be left optional with the workmen. It must be rigidly enforced by men in authority. The mine official has a great responsibility resting upon him, and if he would do his full duty, fatal accidents, I am confident, would be fewer. The mine foreman must not visit the working places of the miner in a perfunctory way, merely to satisfy the law, as it were, but he must feel it his duty to carry out the full intention of the law by urging the workmen under his charge to use every precaution necessary to protect themselves. By mingling with the miners as the law requires, the mine foreman can soon find out the imprudent and reckless ones, and if he finds any employe trying to evade or disobey his orders as far as carrying out the true spirit of the law is concerned, he should be summarily punished. Discipline must be maintained at all hazards and should a mine foreman fail in carrying out this essential requirement, the sooner he resigns his position, the better it will be for all concerned. I am lead to believe, from personal observation, that too many of the mine foreman do not visit the rooms of the miners as outlined above. Every death caused through neglect, where the

mine official has not performed his full duty, his conscience, if he has such an article, must undergo a trying ordeal. A mine foreman should never accept a position as such unless he intends to carry out the spirit of the mining law; nor should he allow any other official to dictate to him in such a manner as to restrain him from performing his whole duty under the law.

The following table shows the number of fatal and non-fatal accidents and their causes; also the number of wives made widows and children orphaned by these casualties:

| Causes of Accidents, etc., for 1894.         | Fatal. | Non-fatal. | Widows. | Orphans. |
|--|--------|------------|---------|----------|
| By falls of roof, . . . . .                  | 2      | 3          | .       | .        |
| By falls of coal, . . . . .                  | 5      | 6          | .       | .        |
| By mine wagons, . . . . .                    | 1      | 1          | .       | .        |
| By premature explosions of powder, . . . . . | .      | 2          | .       | .        |
| By miscellaneous causes, . . . . .           | 1      | .          | .       | .        |
| Total, . . . . .                             | 9      | 12         | 4       | 12       |

The following is a synopsis of the statistics as compiled from the official returns to this office from the operators of the district for the year:

|  |             |
|--|-------------|
| Number of mines in the district, . . . . .   | 75          |
| Number of miners (men and boys), . . . . .   | 5,310       |
| Number of "day men" employed inside of mines, including mine foremen and trapper boys, . . . . . | 763         |
| Number of "day men" employed outside of the mines, . . . . .                                     | 661         |
| Total number of employes, . . . . .  | 6,734       |
| Number of short tons of coal produced in 1894, . . . . .   | 2,641,120   |
| Decrease of short tons of coal, as compared with 1893, . . . . .                                 | 583,010     |
| Number of short tons of coke manufactured in 1894, . . . . .                                     | 3,488       |
| Number of short tons of coal produced per fatal accident, . . . . .                              | 293,457.77+ |
| Number of short tons of coal produced per non-fatal accident, . . . . .                          | 220,093.33+ |
| Total number of days the mines were in operation in 1894, . . . . .                              | 10,574      |
| Average number of days worked at seventy of the mines, . . . . .                                 | 171+        |

The coal mining industry in this district has been in a very unsatisfactory condition during the year. It will be observed from the tabulated statistics contained in this report that only about fifteen or sixteen of the whole number of mines were in operation three-fourths time, while quite a number were in operation only one-fourth to one-third time. Also, the coal production shows a decrease of over a half a million tons, while the statistics show an increase in the number of persons employed and an increase in the number of mines in the district. It can be very easily understood what the results will be from such a state of affairs. It means greater depression in the coal business and increased misery among the workingmen. Through forced strikes among the workingmen and by reason of the inability of the smaller operators to secure contracts, a "cut-throat" method of reducing prices has been inaugurated, resulting in the complete demoralization of the trade. In the mines where work was to be had, they have been overcrowded with men, and although they spent their time in the mines, their earning power was much depreciated owing to this condition of affairs. Owing to broken time, and the meagre earnings of the miners, great distress has prevailed among them during the year.

It would seem that the large companies or corporations had secured what little trade was going, crowding in a measure the smaller companies and individual operators to the wall; yet, in the face of all this, the small operations are rapidly increasing. One-half of the mines now opened in this district could amply supply the demands of the trade. It does seem strange how everybody who can secure a lease of coal property which requires little capital and apparently less brain to develop, is eager to get into an already demoralized business, knowing if they would give this matter proper thought, that it means disaster to them in the end. A large number of the mines in this district are controlled by men of very limited means, and in too many cases it is hard to get them to realize that it is their duty to have their mines operated by approved systems and in a lawful manner. When improvements are suggested to this class of men, the excuse is offered that they are poor and not able to make them. They also think that because of their lack of means to equip their plants on approved plans, that they ought to be permitted to violate the law, and if lawful authority intervenes, they imagine that the law is being enforced arbitrarily. As a general rule, the Inspectors have very little trouble in having the law complied with, where the management at the mines is intelligent, and the capital ample to have the mines run in a proper manner. I do not wish it to be understood from the foregoing that I am in any way against small companies or individual operators, but no person should go into it unless he is prepared with sufficient capital to do so in a legal and proper manner,



and especially he should never make the lack of means a plea or excuse for violating the laws of this Commonwealth.

Owing to the irregular manner in which many of the mines have been operated in this district during the year, there has been some difficulty in keeping up the details always so necessary to maintain them in good sanitary condition, but where they have been mining reasonably regularly, the same spirit has prevailed among the larger number of the mine officials which has characterized them in the past, namely, that of having the mines in their charge conducted in a lawful manner.

A brief description of the mines, the fatal and non-fatal accidents, and the usual tables containing the statistics of the district, will be found in another part of this report.

All of which is respectfully submitted.

Yours very respectfully,

THOMAS K. ADAMS,

Inspector.

---

### Improvements Made at the Mines of the Third Bituminous District During the Year.

At the Hill Mine in Mercer county, a ventilating shaft was sunk and a furnace built.

The Morgan Coal Company, of Beaver county, opened and equipped a new mine.

The Bagdad Coal and Coke Company made and equipped a new drift opening with tipple and inclined plane connections to take the place of the old Bagdad No. 3 mine.

At Clinton mine, in Lawrence county, a second opening has been provided, also a water course has been made with its outlet by the second opening.

At Keister mine, in Butler county, an air shaft has been sunk and a ventilating furnace built.

At Haddon mine, Armstrong county, a second opening has been provided and a furnace built. New iron has been put on the inclined plane, and repairs to it generally have been made.

At Blackstone mine a substantial furnace has been built and the mine repaired generally.

A small furnace has been built in the Monarch mine.

The Turner Coal and Coke Company opened and equipped a new mine in Butler county.

At Oak Ridge mine new weighing scales were put on the upper

platform at the tippie, and a set of new brakes was provided for the hauling machinery.

At Big Soldier Run mine a 25 feet diameter Guibal fan has been erected and a tubular boiler five and one-half feet in diameter by 16 feet long put in place, with 1,300 feet of five-inch steam pipe to convey the steam to the fan. Eight overcasts were constructed in the mine to carry forward to the workings, eight different currents of air.

At the Sterling Coal Company's new property a new drift opening, fully equipped for shipping coal has been provided. Also, a ventilating fan twelve feet in diameter has been erected.

At Butt's Cannel shaft a second opening has been provided and a fan eight feet in diameter erected.

A fan twelve feet in diameter has been erected at the State Line mine.

An air shaft has been sunk and a small furnace built at the Mahoning mine.

At the Fairmount mine No. 2 for the upper coal seam workings, a fan six feet in diameter has been erected and a new haulage road in the workings of the lower mine has been constructed.

At the Thompson Run mine an air shaft has been sunk and a ventilating furnace built.

A substantial furnace has been built and an air shaft of considerable depth sunk at the Gilpin mine.

The Lake Erie Coal Company made a new drift opening, sunk an air shaft, and built a furnace during the year.

The West Penn Coal Company made a new drift opening and sunk an air shaft. Improvements are located in Butler county.

At the Standard Mine, in Butler county, a second opening has been provided and general repairs have been made to the slope.

### Description of Mines.

#### Mines in Armstrong and Clarion Counties Situated on the Allegheny Valley Railroad.

There are still twelve mines located along this road. While the Kittanning mine has been abandoned for the present, the Eagle mine was opened during the year. The Gosford, now named the Lewis mine, is being operated with only about ten miners. The Rimerton and Monarch mines have done very little work during the year, and in fact they have been entirely shut down for the last few months. Only four of the twelve mines in this division of the district worked over half time during the year, and the greatest number of days worked by any one of the other mines was one hundred and thirty. With the exception of about six weeks' time being lost by a

general strike, the balance of idle time was caused by the operators of this section not being able to compete in the general market with other operators having larger capital and who were more favored by having thicker and possibly pure seams of coal.

Glen. This mine was not in as good sanitary condition at the time of my last visit as it should have been. I was required to stop several miners who were working too far ahead of the ventilating current. I measured only 2,000 cubic feet of air per minute in circulation. The drainage of the mine was excellent.

Pine Creek. The small and inefficient ventilating furnace was not producing over 2,500 cubic feet of air per minute in this mine. Much of this volume of air was being lost before it reached the face of the workings, by leaking through defectively constructed doors and brattices. Parts, also, of Nos. 2 and 3 butt entries are being overtun with a "creep" caused by not leaving pillars of sufficient size and strength.

Mahoning. At the time of my last visit to this mine I found the ventilating current back a considerable distance from the face of the butt entries. However, a new furnace had just been erected and a ventilating shaft sunk, which I have no doubt will add to the volume of air. There was a great lack of judgment displayed in the building of this furnace and in the sinking of the ventilating shaft. Both the diameter of the shaft and the size of the furnace are entirely too small for practical purposes.

Riverview. At date of last visit to this mine, I found it in an excellent sanitary condition. The drainage was very favorable and the ventilation was of sufficient volume and well distributed to the face of the workings. I measured 37,000 cubic feet of air per minute in circulation, with the fan running at sixty revolutions per minute. There is an excellent system of tail-rope haulage in operation at this mine.

Hardscrabble. This mine is being operated in a hap-hazard manner. I did not find any person in charge of it. It is not being operated steadily, only a day or two in a week, and sometimes only that many days per month. At last visit I found water about eighteen inches deep on the main haulage road. Although there is a good furnace in this mine, it would seem from appearances that a fire is not kept in it; however, there was a fair quantity of air circulating through the mine from natural means.

Catfish Rm. At date of my last visit the mine was not in operation, consequently no fire was in the ventilating furnace. I examined the whole of the workings, both in the new and old opening. I measured a natural current of 7,500 cubic feet, and if a fire had been kept in the furnace an ample volume of air would have been circulating throughout all of the workings in the new opening. I noticed that there

had been some neglect in having a sufficient number of doors erected and the brattices repaired, to have the air conveyed close to the working faces.

**Mineral Ridge.** This mine was found to be in a very good condition. The hauling roads and other workings were practically dry, and the volume of air being produced was conveyed close to the face of the most advanced workings. I measured 5,000 cubic feet of air in circulation in the interior workings of the mine.

**Church Hill.** I measured 8,100 cubic feet of air per minute in circulation, which was being very well distributed to the face of each entry. No. 1 butt entry is being overrun with a "squeeze" or "creep" which is the natural effect of not having pillars of sufficient size and strength along the entry. Beyond the squeeze, toward the face of the workings Nos. 1 and 3 butt entries will be connected by a passageway so as to make that part of the works perfectly safe. The drainage and hauling roads have been considerably improved lately.

#### The Mines Located on the Low Grade Division and the Sligo Branch of the Allegheny Valley Railroad.

There are ten mines situated in this division, one less than last year. Cherry Run mine has remained idle during the year. The Keystone, Diamond, Acme and Fairmount No. 5 mines only averaged about one-fourth time during the year. Long Point mine was abandoned early in the year. In describing the condition of Long Point mine in my last year's report, I stated that I found a portion of the coal on fire at the bottom of the ventilating shaft and in said report I gave the names of the mine officials, and Mr. S. U. Phillips is mentioned as the mine foreman. I desire to state, in justice to Mr. Phillips, that he had not yet entered upon his duties as mine foreman at this mine at the date on which I examined it, and from the data I collected at said examination I wrote my report; therefore, he was in no way responsible for the condition of the mine as reported by me. In fact, Mr. Phillips was with me when we found the state of affairs as I reported them, and at my suggestion he remained and helped to extinguish the fire. It was some days after this that Mr. Phillips took charge of this mine.

**Avondale.** This mine was found to be in excellent condition in every respect. At date of my last visit, I measured 9,000 cubic feet of air in circulation, which was being well distributed and conducted to the face of the workings. The drainage was also very good.

**Oak Ridge.** There was in circulation in this mine 28,140 cubic feet of air per minute. The total volume of air was well distributed to the interior workings in each of the two openings. The mine, as a whole, was well drained, insuring healthful working places for the miners and laborers.

New weighing scales were put in place on the upper platform at the tippie of this mine, and a new set of brakes provided for the hauling machinery which is connected with the mine.

Fairmount No. 2. There was 56,500 cubic feet of air well distributed to the face of the workings of this mine at my last inspection. The upper seam of coal produces a large quantity of water, and owing to the floor being of soft clay, the hauling roads at different points are rather muddy. With this exception, it is in very good condition. An additional ventilating fan has been erected to ventilate a territory disconnected from the main body of the workings of the upper mine, which is doing very effective work.

Fairmount No. 5. This mine is only in the experimental stages yet, and the prospecting is going on with about thirty miners. The Lower Freeport coal bed which they are working here is very much faulted, which may cause this mine to be soon abandoned altogether. In fact, mining operations are suspended now at this place.

Star. This mine was not sufficiently ventilated at the time of my last visit, but as there was no new work being driven, and the present workings nearly all on the return towards the ventilating power, the quantity of air will increase as a result of the decrease of friction. I measured 14,850 cubic feet of air in circulation, which was being conveyed well up to the face of the works. The mine was well drained.

Acme. I measured in this mine 12,250 cubic feet of air in circulation, but found it completely shut off from reaching the face of some of the butt entries owing to an extensive fall of roof in the main air-course through which the ventilation for that portion of the mine was conveyed. This defect was being remedied by driving a new air-course around the fall through the solid coal. The drainage was excellent.

Brier Ridge. I measured in this mine about 10,800 cubic feet of air at the furnace, but only about 3,260 cubic feet of this volume was conveyed to the face of the works. There was water over the bed of the main hauling road at one point, which was caused by the valves of the steam pump being out of order. The rope haulage system at this opening is being extended farther into the mine. At what is known as the new opening, the total quantity of air in circulation was insufficient. I measured only 2,700 cubic feet of air at the outlet and only a small portion of this quantity was at the face of the works. It has been claimed that the work being done at this opening was merely for testing purposes, but the extent of the excavation is growing and more men are being put to work here, yet the permanent and necessary improvements promised are still in abeyance..

### Mines Situated at Reynoldsville, Jefferson County.

There was considerable broken time at the five mines located in this region, owing to strikes and a lack of contracts. The mines only averaged about 165 days run during the year.

Big Soldier Run. During my last visit to this very extensive mine, the volume of air was not sufficient. I measured only 47,220 cubic feet of air in circulation and there were nearly six hundred persons employed in the mine, but at that date all the arrangements were completed for the erection of a 25-foot diameter Guibal fan. In fact, this large ventilator arrived at the mine on the date of my last visit and was put in operation a short time afterwards. Also, eight new overcasts have been constructed, thereby allowing the total volume of air to be divided into eight different splits. By the means of these separate currents the several parts of the workings of the mine are ventilated. A tubular boiler five and one-half feet in diameter by sixteen feet long has been erected to supply the motive power for the ventilating machinery. This boiler has been placed beside a nest of other boilers which produce the steam for the hauling machinery, at a distance of about 1,300 feet from the fan. The steam for the fan is conveyed through a pipe five inches in diameter and 1,300 feet long.

Mr. John H. Bell, the mine superintendent, informs me that the fan is now producing 137,600 cubic feet of air per minute, running at 50 revolutions per minute, with a pressure of 1.1 inch water gauge. The size of cylinder of engine driving the fan is 18x30 inches. This mine is now certainly in a splendid sanitary condition.

New Hamilton. I measured 17,600 cubic feet of air per minute in circulation in this mine. This volume of air was reasonably well conducted to the face of the interior workings. Also the drainage of the mine was very good.

The Standard mine was exhausted on the 22d of January, 1895.

Henry Bros. There was being well conveyed to the face of the interior workings of this mine 17,760 cubic feet of air. The ventilation was all that could be desired, as was also the drainage. The sanitary condition of the mine was good.

Sprague. With the exception of the current of air being rather weak near the face of No. 1 entry in the Broadhead opening, all the other workings in the two openings were in excellent condition. In the Broadhead or new opening I measured 24,960 cubic feet of air per minute being produced, which was being well conveyed to the face of the works in this division of the mine. In the old works I measured 26,940 cubic feet of air in circulation, making the total volume of air circulating in the whole mine 51,900 cubic feet. The drainage was excellent.

The Mines in Mercer and Butler Counties Situated on the "Pittsburgh, Shenango and Lake Erie" Railroad.

There are seventeen mines in this division of the district, and with the exception of the Keystone and Enterprise mines, none of them were in operation more than half time. Chisholm did not run at all, and Pardoe was only in operation 22 days during the year. There was a general strike among the miners of this region of several months' duration, which was the principal cause of so much loss of work.

Enterprise. I found this small mine in excellent condition, both as regards ventilation and drainage.

Standard. This mine had been abandoned for a long time, but it resumed operations again during the year. This is a small concern, and is now being operated by P. D. Sherwin. Considerable repairs have been made to the slope and also to the inside of the mine. A second opening has also been sunk. I measured 6,300 cubic feet of air in circulation which was well conducted to the face of the works. The mine was in very good condition.

Keister. An air shaft has been sunk and a small furnace built at this mine during the year. The hauling roads have been corduroyed and the drainage much improved. I measured 8,700 cubic feet of air in circulation, which was being well conducted to the face of the works. The general condition of the mine is very good.

Gomersal. During my last visit to this mine I found the ventilation defective in Nos. 4 and 5 entries, which was caused in a great measure by the water course, which is also being used as an air course, being closed from a fall of roof. I measured 8,280 cubic feet of air being distributed in the mine. The general condition of the mine was not what it should have been.

Lake Erie. This is a new drift opening, situated on the Hilliard branch of the Pittsburgh, Shenango and Lake Erie Railroad in Butler county and operated by the Lake Erie Coal Company. George Findlay is superintendent and mine foreman. This mine was in good condition when last examined.

Keystone. This mine was found to be in very good condition, both in regard to ventilation and drainage. At my last examination I measured 7,700 cubic feet of air in circulation in the workings of the mine.

Spears. I measured 6,240 cubic feet of air per minute in circulation at the inlet, but through leakage this volume was reduced to about 2,500 cubic feet at the extreme end of the works. The quantity of air measured at the face of the workings was not sufficient to insure the healthful condition of the mine. The drainage was reasonably good.

A wire rope system of haulage has been introduced inside of the

mine extending into the workings for a considerable distance and is giving satisfactory results.

Hallville. There was being distributed in the workings of this mine 10,900 cubic feet of air per minute. The mine, both in regard to ventilation and drainage was in fair condition.

Black Diamond Nos. 1 and 2. I found too much water on some parts of the hauling roads in No. 1 mine. The quantity of air in circulation was 11,100 cubic feet and the mine was in very fair condition with the exception noted. There was being circulated in the workings of No. 2, 8,000 cubic feet of air, which was fairly well conducted to the face of the works. This mine was reasonably well drained, and its general condition was good.

Chestnut Ridge. The dip workings on the north west side of the shaft were very wet. The narrow work here was only being driven for prospecting purposes. At the face of these works the air current was not strong enough. There was 6,600 cubic feet at the inlet, but most of this volume was being lost through leakage before it reaches the face of the works in this division of the mine. There were 10,000 cubic feet of air being forced to the southeast side of the mine. The volume was much better distributed to the workings on this side of the mine, although the air was not as pure as it was on the other side. The haulage roads have been considerably improved on the south side of the shaft, but much remains to be done along this line to make the improvements complete.

Jewell. This is a new drift mine, opened in the month of September last and is operated by the West Penn Coal Company with C. A. Jewell, superintendent, and Thomas J. Simpson, mine foreman. The permanent ventilating power has not yet been erected, but an air shaft has been sunk. The mine was in very good condition, however.

#### The Other Mines in Mercer County.

There are six mines in operation in this part of the district. The Lackawannock mine has been abandoned during the year.

Stonchore Nos. 2 and 3. The No. 2 mine was in reasonably good condition. On my last visit I measured about 16,000 cubic feet of air in circulation, while in No. 3 mine I measured 8,500 cubic feet of air which was very well conveyed to the face of the workings. The drainage and the haulage roads in the latter have been very much improved lately.

Carver. The fan shaft was almost closed with ice at the time of my last visit, which was a means of reducing the volume of air in circulation in the mine considerably, but a fair volume was being produced by the exhaust steam from the steam pumps at the main hoisting shaft. At the three inlets I measured a total volume of



17,340 cubic feet of air being produced, which was ventilating the mine fairly well; especially was this the case in the larger portion of the mine. Much of the work in this mine is on the retreat, consequently, where the pillars are being taken out the work and men are greatly scattered, making it hard to maintain an efficient system of ventilation. The mine is a wet one, in consequence of which, some of the entry roads are wet and muddy.

Crusby Slope. I measured at this mine 13,680 cubic feet of air in circulation, but about 4,000 cubic feet was the greatest volume I found near the face of the works in the main split. At some points of the mine the drainage was somewhat defective. The mine was in a reasonably good condition, taking into consideration the number of persons employed therein.

Shenango. During my last visit to this mine I measured 13,000 cubic feet of air in the mine, but only about one-half of this quantity was near the extreme end of the works. The drainage and haulage roads were in much better condition at the time of my last visit than they had been at previous ones. There is much room for improvement in the distribution of the volumes of air in the mine.

Hill. This is a new drift mine operated by the Hill Coal Company, Limited, and is situated in Jackson township. William Jenkins is the superintendent and mine foreman. The mine was not in the best of condition when I last examined it, however, but since my visit, an air shaft has been sunk which has improved the ventilation considerably.

#### Mines Situated in Lawrence and Beaver Counties.

Excelsior. This mine was fairly ventilated as a whole, except in No. 3 entry, where the air current was not near enough to the face of it. I measured 9,100 cubic feet of air in circulation. The drainage in No. 3 entry was very defective, owing to a fall of roof filling up the ditch, thereby damming the water and causing it to cover the roadbed. The mine was only in fair condition.

Rock Point. This mine was in excellent condition, both in regard to ventilation and drainage. A new haulage road was being made in this mine which would shorten the distance and provide a safer and much better passageway, as the old one was being overrun with a bad squeeze or creep. I measured 11,690 cubic feet of air in circulation, which was being well distributed to the face of the works.

Thompson Run. I found this mine in very fair condition, both as regards ventilation and drainage. I measured 8,450 cubic feet of air conveyed reasonably well to the face of the works. A ventilating shaft has been sunk and a furnace built at this mine during the year.

Clinton. I found this mine in good condition. I measured 7,200 cubic feet of air in circulation, which was being taken well up to the face of the works. The drainage of the mine has been much improved by the cutting of a ditch which was extended out to the surface. A second opening has also been provided for the mine during the year.

Baker. This mine was only in fair condition at the time of my last visit. I measured 7,000 cubic feet of air in circulation. The mine was well drained.

Beaver. I measured 11,160 cubic feet of air in circulation which is conveyed well to the face of the works. The mine otherwise was in very good condition.

Cannelton. The coal yet to be taken out of the old mine is all in pillars. At these works a new drift opening has been provided which is connected with the tibble by a long inclined plane. At this new place, much of the old abandoned workings had to be gone through in order to get to the solid coal. The ventilation and drainage of the mine were not up to the standard, but a better system of working will be introduced as soon as solid territory is reached.

Sterling. This mine is in a reasonably good condition, both in regard to ventilation and drainage. I measured 10,560 cubic feet of air in circulation, which is being well conveyed to the face of the works. A twelve-foot diameter ventilating fan has been erected at this mine during the year.

Butt's Cannel Shaft. The general condition of this mine as regards ventilation and drainage is very good. A ventilating shaft and a second opening have been provided, and a ventilating fan has been erected during the year.

State Line. This mine was in excellent condition at the time of last visit. A ventilating fan 12 feet in diameter has been erected during the year.

#### Mines Situated Along the West Penn Railroad in Westmoreland and Armstrong Counties.

There are fourteen mines in this division of the district, and with the exception of the Fairbank, Foster and Apollo, they have been in operation on an average of 252 days during the year which shows a greater average number of days worked than at the mines in any other division in the district. At most of the mines here, the general strike among the miners was of short duration.

Avonmore. I measured 13,500 cubic feet of air being moved through the workings of this mine. An additional furnace will have to be erected in the "dip" workings of this mine, as they are somewhat disconnected from those in the other parts of it. The mine was reasonably well drained, and as a whole, was in good order.

Foster. I found this mine in excellent condition, both as regards ventilation and drainage. I measured 10,000 cubic feet of air in circulation, which was well taken up to the face of the works.

Apollo. This mine has done very little work during the year. About twenty-five persons were employed at the time of my last visit. The ventilating furnace has not yet been built, nor the air shaft sunk, although all the necessary preparations have been completed inside of the mine for the sinking and building of the same.

Pine Run. I measured 12,100 cubic feet of air being produced, but much of this volume was lost by leakage through improperly erected doors before reaching the face of the entries. The drainage was excellent and the other conditions were fairly good.

Bagdad No. 2 and 3. At No. 3 at time of last visit I found the workings in excellent shape. A new drift opening, fully equipped for shipping coal has taken the place of the old mine.

At No. 2 the current of air was not strong enough at the face of some of the butt entries where the pillars were being removed in the old part of this mine, but in the workings in the new opening, I measured 6,750 cubic feet of air which was fully taken up to the face of the entry. This division of the mine was in excellent condition.

Leechburg No. 4. This mine was found to be in excellent condition, both in regard to ventilation and drainage. I measured 9,600 cubic feet of air being produced which was being fully taken up to the extreme end of the works.

Bcal. In this mine I measured 6,400 cubic feet of air in circulation. The air was not near enough to the face of No. 4 entry. Some of the brattices were down in this entry, and the person in charge of the mine had neglected to replace them. The mine was very well drained.

West Penn. I measured 5,500 cubic feet of air in circulation, which was only fairly well conducted to the face of the butt entries. A good deal of brattice cloth was being used on mouth of rooms instead of doors made with boards for conducting the ventilating currents to the face of the works. Brattice cloth is very handy for temporary use, but should never be used for permanent purposes. In fact, even doors made of boards and used to guide ventilating currents, should be dispensed with. The mine was in reasonably good condition.

Blackstone. This mine is in splendid condition, both in regard to ventilation and drainage. The ventilating furnace in course of construction at time of writing my last year's report, was completed early in the year, and is giving very satisfactory results. I measured 13,000 cubic feet of air being produced in the mine which was being conveyed to the face of the workings. The drainage and hauling roads have been much improved during the year.

Haddon. I found this mine in a splendid sanitary condition. It is a small operation, but I measured about 5,670 cubic feet of air near the face of works. The mine was also well drained.

Gilpin. This mine was in a very satisfactory condition in all respects. I measured 8,240 cubic feet of air being produced, and much of this volume was at the face of the workings.

A new ventilating furnace has been built and an air shaft sunk during the year. The size of furnace is seven feet wide and five feet above the grate bars, two and a half feet from grate bars to floor, and an arch fifteen feet long. The depth of air shaft is 80 feet and the diameter six feet.

TABLE 1.—Showing location, etc., of collieries in the Third Bituminous Mine District.

| Name of Colliery.           | Name of Operator.                     | Location—County. | Name of Superintendent. | Postoffice Address.              |
|-----------------------------|---------------------------------------|------------------|-------------------------|----------------------------------|
| Avondale.                   | Avondale Mining and Manufacturing Co. | Clarion.         | James Mitchell.         | Lawsonham, Clarion county.       |
| Apollon.                    | Maher Coal and Coke Company.          | Westmoreland.    | T. G. Cornell.          | Freeport, Armstrong county.      |
| Armore.                     | Armore Coal Company.                  | Armstrong.       | L. W. Hicks.            | Leechburg, Armstrong county.     |
| Aene.                       | Aene Mining Company.                  | Clarion.         | J. W. Hill.             | East Brady, Clarion county.      |
| Black Diamond Nos. 1 and 2. | Butte Sulfith & Co. Company.          | Mercer.          | Frank Flier.            | Mercer, Mercer county.           |
| Butts.                      | Butte Camel Coal Company.             | Beaver.          | George Gould.           | Beaver, Beaver county.           |
| Bagdad Nos. 2 and 3.        | Bagdad Coal and Coke Company.         | Westmoreland.    | Alfred Hicks.           | Leechburg, Armstrong county.     |
| Big Soldier Run.            | Bell Lewis and Yates Coal Mining Co.  | do.              | N. S. Hicks.            | do.                              |
| Baker.                      | L. S. Hoyt & Co.                      | Jefferson.       | John H. Bell.           | Reynoldsville, Jefferson county. |
| Beall.                      | J. G. Beall & Co.                     | Beaver.          | D. D. Lovrie.           | Haydale, Beaver county.          |
| Beaver Falls.               | James Clayton & Co.                   | Armstrong.       | George Knapshiel.       | Leechburg, Armstrong county.     |
| Brier Ridge.                | C. N. Shinton & Co.                   | Beaver.          | James Clayton.          | Beaver Falls, Beaver county.     |
| Beaver.                     | Beaver Coal and Coke Company.         | Clarion.         | John D. Thomas.         | Rimersburg, Clarion county.      |
| Cannelton.                  | Morgan Coal Company.                  | Lawrence.        | H. V. Sator.            | Hoytdale, Beaver county.         |
| Clayton.                    | W. F. Clayton.                        | Beaver.          | W. F. Clayton.          | Cannelton, Beaver county.        |
| Carver.                     | Carver Coal Company.                  | do.              | do.                     | Beaver Falls, Beaver county.     |
| Chestnut Ridge.             | Filler Westernman & Co.               | Meeker.          | Frank Flier.            | Mercer, Mercer county.           |
| Catfish Run.                | Catfish Run Coal Company.             | do.              | Enoch Flier, Jr.        | Grove City, Mercer county.       |
| Clinton.                    | Clinton Coal Company.                 | Clarion.         | Charles Flier.          | Catfish, Clarion county.         |
| Cherry Run.                 | Cherry Run Coal Company.              | Lawrence.        | A. W. Harbison.         | Hoytdale, Beaver county.         |
| Church Hill.                | Church Hill Coal Company.             | Clarion.         | John I. Humphrys.       | Rimersburg, Clarion county.      |
| Diamond.                    | Thomas Mitchell & Son.                | do.              | do.                     | 265 Elm st., Oil City, Ven. co.  |
| Excelsior.                  | Wampum Run Coal Company.              | do.              | George Mitchell.        | Rimersburg, Clarion county.      |
| Eagle.                      | Eagle Coal and Mining Company.        | Lawrence.        | Robert Mehard.          | Wampum, Lawrence county.         |
| Enterprise.                 | P. D. Sherwin.                        | Butler.          | P. D. Sherwin.          | East Brady, Clarion county.      |
| Fairmount No. 2.            | Fairmount Coal and Iron Company.      | Armstrong.       | S. Taylor Sheaffer.     | Karns, Butler county.            |
| Fairmount No. 3.            | do.                                   | Clarion.         | do.                     | New Bethlehem, Clarion co.       |
| Fairbank.                   | R. E. Wigton & Son.                   | Westmoreland.    | J. J. McGonigle.        | do.                              |
| Foster.                     | do.                                   | Indiana.         | do.                     | Saltsburg, Indiana county.       |
| Glen.                       | Gilpin Coal Company.                  | Armstrong.       | N. S. Hicks.            | do.                              |
| Glen.                       | J. R. South.                          | do.              | J. R. South.            | Leechburg, Armstrong county.     |
| Gomersal.                   | Gomersal Coal Company, Limited.       | Butler.          | William Ferguson.       | Manorville, Armstrong county.    |
| Hallville.                  | Grove Coal Company.                   | Mercer.          | D. D. Morris.           | Gomersal, Butler county.         |
| Haddon.                     | Haddon Coal Company.                  | Armstrong.       | N. S. Hicks.            | Grove City, Mercer county.       |
| Hardscrabble.               | Brady's Bend Mining Co., Limited.     | Clarion.         | C. F. Hartwell.         | Leechburg, Armstrong county.     |
| Hill.                       | Hill Coal Company, Limited.           | Mercer.          | Wm. Jenkins.            | Oil City, Venango county.        |
| Henry Brothers.             | Henry Brothers.                       | Jefferson.       | Y. L. Henry.            | Jackson Centre, Mercer county.   |
| Kelster.                    | Union Coal and Coke Co., Limited.     | Butler.          | George E. Stage.        | Rathinell, Jefferson county.     |
| Keystone.                   | Keystone Coal and Mining Company.     | Clarion.         | George E. Stage.        | Freenville, Mercer county.       |
| Keystone.                   | Turner Coal, Coke and Mining Co.      | Butler.          | John L. Turner.         | East Brady, Clarion county.      |
| Lake Erie.                  | Lake Erie Coal Company.               | do.              | do.                     | Feris, Butler county.            |
| Lewis.                      | Lewis Coal Mining Company.            | Armstrong.       | E. A. Mizner.           | Erle, Erie county.               |
| Leechburg Nos. 3 and 4.     | Leechburg Coal and Coke Company.      | Westmoreland.    | Richard Lewis.          | Gastord, Armstrong county.       |
|                             |                                       |                  | A. W. Ashbaugh.         | Leechburg, Armstrong county.     |

TABLE 1.—Continued.

| Name of Colliery. | Name of Operator.                     | Location—County. | Name of Superintendent. | Postoffice Address.              |
|-------------------|---------------------------------------|------------------|-------------------------|----------------------------------|
| Mehard.           | Mehard, Dinsmore & Co.                | Lawrence,        | Robert Mehard,          | Wampum, Lawrence county.         |
| Mineral Ridge.    | T. Y. Skidmore and C. W. H. Eicke.    | Clarion,         | C. W. H. Eicke,         | West Monterey, Clarion co.       |
| Monarch.          | Valley Coal and Mining Company.       | Armstrong,       | R. A. Stehm,            | Kittanning, Armstrong county.    |
| New Hamilton.     | Monarch Coal Company.                 | Clarion,         | C. P. McCafferty,       | East Brady, Clarion county.      |
| Oak Ridge.        | Bell, Lewis and Yates Coal Mining Co. | Jefferson,       | John H. Bell,           | Reynoldsville, Jefferson co.     |
| Ormsby Slope.     | Oak Ridge Coal and Mining Company.    | Armstrong,       | Henry Williams,         | Oak Ridge Station, Arm. co.      |
| Pine Run.         | James Dye.                            | Mercer,          | James Dye,              | Jackson Centre, Mercer county.   |
| Pine Creek.       | Pine Run Coal Company.                | Westmoreland,    | Alfred Hicks,           | Leechburg, Armstrong county.     |
| Penn.             | Gano & Murray.                        | Armstrong,       | John L. Murray,         | Mosgrove, Armstrong county.      |
| Pardoe.           | Penn Coal Company.                    | Lawrence,        | Edwin N. Oehl,          | New Castle, Lawrence county.     |
| Riverview.        | Mercer Coal Company.                  | Mercer,          | W. H. Richards,         | Greenville, Mercer county.       |
| Rock Point.       | Riverview Coal and Mining Company.    | Armstrong,       | James Moore,            | No. 22 Swan st., Buffalo, N. Y.  |
| Royle.            | Rock Point Coal Company.              | Lawrence,        | William Brown,          | Wampum, Lawrence county.         |
| Shenango.         | Royle Coal Company.                   | Butler,          | R. E. Royle,            | Hillaris, Butler county.         |
| Sprague.          | Consumers' Coal and Coke Company.     | Mercer,          | T. C. Whitehead,        | Jackson Center, Mercer co.       |
| Stoneboro No. 1.  | Bell, Lewis and Yates Coal Mining Co. | Jefferson,       | John H. Bell,           | Reynoldsville, Jefferson county. |
| Stoneboro No. 2.  | Mercer Coal and Iron Company.         | Mercer,          | Robert P. Cann,         | Stoneboro, Mercer county.        |
| Stoneboro No. 3.  | Mercer Coal and Iron Company.         | do.              | Robert P. Cann,         | Stoneboro, Mercer county.        |
| Spears.           | Pine Grove Coal Company, Limited.     | Clarion,         | James A. Spears,        | Grove City, Mercer county.       |
| Star No. 4.       | Northwestern Coal and Iron Company.   | Beaver,          | S. Taylor Sheaffer,     | New Bethlehem, Clarion co.       |
| Starling.         | Sterling Mining Company.              | do.              | George Gould,           | East Palestine, Ohio.            |
| Star Line.        | State Line Coal Company.              | Butler,          | Hugh Laughlin,          | do.                              |
| Standard.         | Peter D. Sherwin.                     | do.              | Peter D. Sherwin,       | Euclid, Butler county.           |
| Star of Jewell.   | West Penn Coal Company.               | do.              | C. A. Jewell,           | Grove City, Mercer county.       |
| Thompson Run.     | Thompson Run Coal Company.            | Beaver,          | William Douthett,       | New Castle, Lawrence county.     |
| West Penn.        | West Penn Coal and Coke Company.      | Westmoreland,    | David A. Kistler,       | Leechburg, Armstrong county.     |









TABLE NO. 3.—Showing the number of employes at each colliery in the Third Bituminous Mine District during the year 1894.

| Names of Collieries. | Location—County.             |         | Number of Persons Employed Inside. |                      |                       |               |                             |                        | Number of Persons Employed Outside. |   |                |                                  |  |
|----------------------|------------------------------|---------|------------------------------------|----------------------|-----------------------|---------------|-----------------------------|------------------------|-------------------------------------|---|----------------|----------------------------------|--|
|                      | Inside foreman or mine boss. | Miners. | All company men.                   | Drivers and runners. | Toolboys and helpers. | Total inside. | Blacksmiths and carpenters. | Engineers and firemen. | All company men.                    | Superintendent, bookkeepers and clerks. | Total outside. | Grand totals—inside and outside. |  |
| Avondale             | 1                            | 52      | 4                                  | 1                    | 1                     | 58            | 1                           | 1                      | 1                                   | 5                                       | 17             |                                  |  |
| Avonlea              | 1                            | 92      | 1                                  | 1                    | 1                     | 94            | 1                           | 1                      | 1                                   | 3                                       | 95             |                                  |  |
| Avonmore             | 1                            | 166     | 2                                  | 6                    | 2                     | 171           | 1                           | 1                      | 1                                   | 3                                       | 174            |                                  |  |
| Agrie                | 1                            | 40      | 1                                  | 4                    | 1                     | 46            | 1                           | 1                      | 1                                   | 3                                       | 49             |                                  |  |
| Butts                | 1                            | 33      | 1                                  | 2                    | 1                     | 37            | 1                           | 1                      | 1                                   | 3                                       | 40             |                                  |  |
| Black Diamond No. 1  | 1                            | 60      | 4                                  | 6                    | 2                     | 72            | 2                           | 2                      | 1                                   | 10                                      | 82             |                                  |  |
| Black Diamond No. 2  | 1                            | 79      | 4                                  | 6                    | 2                     | 91            | 2                           | 2                      | 1                                   | 5                                       | 96             |                                  |  |
| Bagdad Nos. 2 and 3  | 2                            | 52      | 2                                  | 0                    | 0                     | 54            | 1                           | 2                      | 4                                   | 7                                       | 61             |                                  |  |
| Blackstone           | 1                            | 82      | 1                                  | 1                    | 1                     | 85            | 1                           | 1                      | 1                                   | 3                                       | 88             |                                  |  |
| Big Soldier Run      | 2                            | 604     | 15                                 | 41                   | 23                    | 750           | 1                           | 3                      | 48                                  | 58                                      | 808            |                                  |  |
| Baker                | 1                            | 70      | 2                                  | 6                    | 4                     | 82            | 1                           | 1                      | 1                                   | 3                                       | 85             |                                  |  |
| Beall                | 1                            | 43      | 1                                  | 2                    | 4                     | 49            | 1                           | 1                      | 1                                   | 3                                       | 52             |                                  |  |
| Beaver Falls         | 1                            | 4       | 1                                  | 1                    | 1                     | 7             | 1                           | 1                      | 1                                   | 3                                       | 10             |                                  |  |
| Brier Ridge          | 1                            | 147     | 2                                  | 4                    | 4                     | 157           | 1                           | 2                      | 1                                   | 3                                       | 160            |                                  |  |
| Beaver               | 1                            | 158     | 5                                  | 1                    | 1                     | 170           | 1                           | 3                      | 3                                   | 177                                     |                |                                  |  |
| Canabon              | 1                            | 26      | 1                                  | 1                    | 1                     | 29            | 1                           | 1                      | 1                                   | 32                                      |                |                                  |  |
| Clayton              | 1                            | 8       | 1                                  | 1                    | 1                     | 11            | 1                           | 1                      | 1                                   | 14                                      |                |                                  |  |
| Carvet               | 1                            | 75      | 1                                  | 1                    | 4                     | 81            | 1                           | 1                      | 1                                   | 84                                      |                |                                  |  |
| Chestnut Ridge       | 1                            | 69      | 5                                  | 4                    | 4                     | 82            | 1                           | 1                      | 1                                   | 89                                      |                |                                  |  |
| Catfish Run          | 1                            | 38      | 1                                  | 2                    | 1                     | 42            | 1                           | 1                      | 1                                   | 45                                      |                |                                  |  |
| Clinton              | 1                            | 35      | 1                                  | 1                    | 1                     | 38            | 1                           | 1                      | 1                                   | 41                                      |                |                                  |  |
| Cherry Run           | 1                            | 94      | 6                                  | 5                    | 3                     | 108           | 1                           | 1                      | 1                                   | 111                                     |                |                                  |  |
| Church Hill          | 1                            | 23      | 4                                  | 2                    | 1                     | 29            | 1                           | 1                      | 1                                   | 32                                      |                |                                  |  |
| Diamond              | 1                            | 29      | 1                                  | 1                    | 1                     | 32            | 1                           | 1                      | 1                                   | 35                                      |                |                                  |  |
| Eagle                | 1                            | 81      | 1                                  | 1                    | 1                     | 84            | 1                           | 1                      | 1                                   | 87                                      |                |                                  |  |
| Excelsior            | 1                            | 69      | 3                                  | 1                    | 1                     | 74            | 1                           | 1                      | 1                                   | 77                                      |                |                                  |  |
| Fairmount No. 1      | 1                            | 15      | 1                                  | 1                    | 1                     | 18            | 1                           | 1                      | 1                                   | 21                                      |                |                                  |  |
| Fairmount No. 2      | 1                            | 300     | 10                                 | 91                   | 8                     | 340           | 6                           | 7                      | 30                                  | 384                                     |                |                                  |  |
| Fairmount No. 3      | 1                            | 25      | 1                                  | 1                    | 1                     | 28            | 1                           | 1                      | 1                                   | 31                                      |                |                                  |  |
| Fairbank             | 1                            | 61      | 2                                  | 2                    | 1                     | 66            | 1                           | 1                      | 1                                   | 69                                      |                |                                  |  |
| Westmoreland         | 1                            | 52      | 1                                  | 1                    | 1                     | 55            | 1                           | 1                      | 1                                   | 58                                      |                |                                  |  |
| Clarion              | 1                            | 92      | 4                                  | 1                    | 1                     | 98            | 1                           | 1                      | 1                                   | 101                                     |                |                                  |  |
| Westmoreland         | 1                            | 34      | 1                                  | 1                    | 1                     | 36            | 1                           | 1                      | 1                                   | 39                                      |                |                                  |  |
| Armstrong            | 1                            | 111     | 2                                  | 2                    | 1                     | 116           | 1                           | 1                      | 1                                   | 119                                     |                |                                  |  |
| Clarion              | 1                            | 37      | 1                                  | 1                    | 1                     | 40            | 1                           | 1                      | 1                                   | 43                                      |                |                                  |  |
| Beaver               | 1                            | 72      | 1                                  | 2                    | 1                     | 76            | 1                           | 1                      | 1                                   | 79                                      |                |                                  |  |
| Mercer               | 1                            | 40      | 1                                  | 2                    | 1                     | 44            | 1                           | 1                      | 1                                   | 47                                      |                |                                  |  |
| Westmoreland         | 1                            | 50      | 1                                  | 1                    | 1                     | 53            | 1                           | 1                      | 1                                   | 56                                      |                |                                  |  |
| Westmoreland         | 1                            | 61      | 1                                  | 1                    | 1                     | 64            | 1                           | 1                      | 1                                   | 67                                      |                |                                  |  |
| Jefferson            | 1                            | 91      | 1                                  | 1                    | 1                     | 94            | 1                           | 1                      | 1                                   | 97                                      |                |                                  |  |
| Beaver               | 1                            | 750     | 4                                  | 23                   | 1                     | 778           | 1                           | 3                      | 48                                  | 808                                     |                |                                  |  |
| Armstrong            | 1                            | 43      | 1                                  | 2                    | 4                     | 49            | 1                           | 1                      | 1                                   | 52                                      |                |                                  |  |
| Beaver               | 1                            | 4       | 1                                  | 1                    | 1                     | 7             | 1                           | 1                      | 1                                   | 10                                      |                |                                  |  |
| Clarion              | 1                            | 147     | 2                                  | 4                    | 4                     | 157           | 1                           | 2                      | 1                                   | 160                                     |                |                                  |  |
| Lawrence             | 1                            | 158     | 5                                  | 1                    | 1                     | 170           | 1                           | 3                      | 3                                   | 177                                     |                |                                  |  |
| Beaver               | 1                            | 26      | 1                                  | 1                    | 1                     | 29            | 1                           | 1                      | 1                                   | 32                                      |                |                                  |  |
| Clayton              | 1                            | 8       | 1                                  | 1                    | 1                     | 11            | 1                           | 1                      | 1                                   | 14                                      |                |                                  |  |
| Mercer               | 1                            | 75      | 1                                  | 1                    | 4                     | 81            | 1                           | 1                      | 1                                   | 84                                      |                |                                  |  |
| Chestnut Ridge       | 1                            | 69      | 5                                  | 4                    | 4                     | 82            | 1                           | 1                      | 1                                   | 89                                      |                |                                  |  |
| Clarion              | 1                            | 38      | 1                                  | 2                    | 1                     | 42            | 1                           | 1                      | 1                                   | 45                                      |                |                                  |  |
| Lawrence             | 1                            | 35      | 1                                  | 1                    | 1                     | 38            | 1                           | 1                      | 1                                   | 41                                      |                |                                  |  |
| Clarion              | 1                            | 94      | 6                                  | 5                    | 3                     | 108           | 1                           | 1                      | 1                                   | 111                                     |                |                                  |  |
| Church Hill          | 1                            | 23      | 4                                  | 2                    | 1                     | 29            | 1                           | 1                      | 1                                   | 32                                      |                |                                  |  |
| Diamond              | 1                            | 29      | 1                                  | 1                    | 1                     | 32            | 1                           | 1                      | 1                                   | 35                                      |                |                                  |  |
| Eagle                | 1                            | 81      | 1                                  | 1                    | 1                     | 84            | 1                           | 1                      | 1                                   | 87                                      |                |                                  |  |
| Excelsior            | 1                            | 69      | 3                                  | 1                    | 1                     | 74            | 1                           | 1                      | 1                                   | 77                                      |                |                                  |  |
| Fairmount No. 1      | 1                            | 15      | 1                                  | 1                    | 1                     | 18            | 1                           | 1                      | 1                                   | 21                                      |                |                                  |  |
| Fairmount No. 2      | 1                            | 300     | 10                                 | 91                   | 8                     | 340           | 6                           | 7                      | 30                                  | 384                                     |                |                                  |  |
| Fairmount No. 3      | 1                            | 25      | 1                                  | 1                    | 1                     | 28            | 1                           | 1                      | 1                                   | 31                                      |                |                                  |  |
| Fairbank             | 1                            | 61      | 2                                  | 2                    | 1                     | 66            | 1                           | 1                      | 1                                   | 69                                      |                |                                  |  |
| Westmoreland         | 1                            | 52      | 1                                  | 1                    | 1                     | 55            | 1                           | 1                      | 1                                   | 58                                      |                |                                  |  |

|                               |    |       |     |     |     |       |    |    |     |     |     |       |
|-------------------------------|----|-------|-----|-----|-----|-------|----|----|-----|-----|-----|-------|
| Forster, .....                | 1  | 43    | 2   | 3   | 1   | 50    | 1  | 2  | 2   | 1   | 6   | 56    |
| Indiana, .....                | 1  | 60    | 2   | 4   | 1   | 66    | 1  | 2  | 3   | 1   | 5   | 71    |
| Armstrong, .....              | 1  | 48    | 2   | 4   | 1   | 55    | 1  | 2  | 3   | 1   | 8   | 63    |
| Armstrong, .....              | 1  | 69    | 2   | 4   | 1   | 77    | 1  | 2  | 3   | 1   | 6   | 83    |
| Butler, .....                 | 1  | 69    | 2   | 8   | 1   | 90    | 1  | 2  | 3   | 1   | 12  | 102   |
| Gomersal, .....               | 1  | 54    | 1   | 3   | 1   | 61    | 1  | 2  | 4   | 1   | 4   | 67    |
| Italyville, .....             | 1  | 54    | 1   | 3   | 1   | 61    | 1  | 2  | 4   | 1   | 4   | 67    |
| Madison, .....                | 1  | 42    | 1   | 3   | 1   | 46    | 1  | 2  | 3   | 1   | 4   | 59    |
| Hardscrabble, .....           | 1  | 41    | 2   | 3   | 1   | 47    | 1  | 2  | 3   | 1   | 5   | 52    |
| Illit, .....                  | 1  | 53    | 1   | 3   | 1   | 66    | 1  | 2  | 3   | 1   | 5   | 68    |
| Jefferson, .....              | 1  | 50    | 1   | 3   | 1   | 65    | 1  | 2  | 4   | 1   | 6   | 71    |
| Henry Bros., .....            | 1  | 89    | 1   | 3   | 1   | 99    | 1  | 2  | 4   | 1   | 10  | 109   |
| Keister, .....                | 1  | 83    | 1   | 3   | 1   | 95    | 1  | 3  | 6   | 1   | 6   | 111   |
| Butler, .....                 | 1  | 30    | 1   | 3   | 1   | 35    | 1  | 3  | 2   | 1   | 4   | 41    |
| Keystone, .....               | 1  | 50    | 2   | 3   | 1   | 57    | 1  | 3  | 3   | 1   | 4   | 61    |
| Clarton, .....                | 1  | 50    | 2   | 3   | 1   | 57    | 1  | 3  | 3   | 1   | 4   | 61    |
| Butler, .....                 | 1  | 62    | 1   | 3   | 1   | 72    | 1  | 2  | 3   | 1   | 5   | 83    |
| Lake Erie, .....              | 1  | 62    | 1   | 3   | 1   | 72    | 1  | 2  | 3   | 1   | 5   | 83    |
| Lewis, .....                  | 1  | 62    | 1   | 3   | 1   | 72    | 1  | 2  | 3   | 1   | 5   | 83    |
| Armstrong, .....              | 1  | 62    | 1   | 3   | 1   | 72    | 1  | 2  | 3   | 1   | 5   | 83    |
| Westmoreland, .....           | 1  | 84    | 1   | 3   | 1   | 91    | 1  | 2  | 3   | 1   | 5   | 100   |
| Leechburg Nos. 3 and 4, ..... | 1  | 84    | 1   | 3   | 1   | 91    | 1  | 2  | 3   | 1   | 5   | 100   |
| Lawrence, .....               | 1  | 84    | 1   | 3   | 1   | 91    | 1  | 2  | 3   | 1   | 5   | 100   |
| Clarton, .....                | 1  | 40    | 1   | 5   | 1   | 44    | 1  | 2  | 6   | 1   | 9   | 54    |
| Armstrong, .....              | 1  | 40    | 1   | 4   | 1   | 47    | 1  | 2  | 7   | 1   | 7   | 54    |
| Mineral Ridge, .....          | 1  | 40    | 1   | 4   | 1   | 47    | 1  | 2  | 7   | 1   | 7   | 54    |
| Maboning, .....               | 1  | 179   | 5   | 10  | 2   | 197   | 1  | 6  | 1   | 8   | 295 |       |
| Monarch, .....                | 1  | 161   | 3   | 10  | 2   | 184   | 2  | 9  | 6   | 1   | 297 |       |
| New Hamilton, .....           | 1  | 161   | 3   | 10  | 2   | 184   | 2  | 9  | 6   | 1   | 297 |       |
| Oak Ridge, .....              | 1  | 62    | 3   | 7   | 2   | 72    | 2  | 2  | 2   | 1   | 86  |       |
| Crumby slope, .....           | 1  | 50    | 1   | 3   | 1   | 55    | 1  | 2  | 3   | 1   | 6   | 61    |
| Pine Run, .....               | 1  | 50    | 1   | 3   | 1   | 55    | 1  | 2  | 3   | 1   | 6   | 61    |
| Westmoreland, .....           | 1  | 50    | 1   | 3   | 1   | 55    | 1  | 2  | 3   | 1   | 6   | 61    |
| Armstrong, .....              | 1  | 51    | 1   | 5   | 2   | 59    | 1  | 4  | 1   | 5   | 70  |       |
| Lawrence, .....               | 1  | 51    | 1   | 5   | 2   | 59    | 1  | 4  | 1   | 5   | 70  |       |
| Merced, .....                 | 1  | 87    | 4   | 9   | 3   | 101   | 3  | 5  | 4   | 1   | 9   | 68    |
| Merced, .....                 | 1  | 87    | 4   | 9   | 3   | 101   | 3  | 5  | 4   | 1   | 9   | 68    |
| Parlow, .....                 | 1  | 108   | 3   | 8   | 3   | 122   | 1  | 1  | 1   | 12  | 134 |       |
| Armstrong, .....              | 1  | 108   | 3   | 8   | 3   | 122   | 1  | 1  | 1   | 12  | 134 |       |
| Lawrence, .....               | 1  | 80    | 2   | 5   | 2   | 88    | 1  | 2  | 2   | 9   | 97  |       |
| Back Point, .....             | 1  | 80    | 2   | 5   | 2   | 88    | 1  | 2  | 2   | 9   | 97  |       |
| Butler, .....                 | 1  | 39    | 1   | 2   | 1   | 41    | 1  | 2  | 2   | 1   | 43  |       |
| Royle, .....                  | 1  | 39    | 1   | 2   | 1   | 41    | 1  | 2  | 2   | 1   | 43  |       |
| Shenango, .....               | 1  | 109   | 3   | 6   | 1   | 118   | 2  | 2  | 4   | 1   | 16  | 127   |
| Stratton, .....               | 1  | 230   | 4   | 17  | 6   | 238   | 1  | 5  | 1   | 8   | 256 |       |
| Stonboro No. 2, .....         | 1  | 98    | 13  | 13  | 1   | 112   | 1  | 1  | 12  | 2   | 17  | 142   |
| Stonboro No. 3, .....         | 1  | 64    | 6   | 6   | 1   | 72    | 1  | 3  | 7   | 1   | 13  | 91    |
| Stonboro No. 4, .....         | 1  | 44    | 2   | 4   | 1   | 52    | 1  | 2  | 3   | 2   | 8   | 60    |
| Stonboro No. 5, .....         | 1  | 169   | 7   | 12  | 3   | 182   | 6  | 3  | 18  | 4   | 31  | 214   |
| Stear, or Jewell, .....       | 1  | 25    | 2   | 2   | 1   | 30    | 2  | 2  | 1   | 1   | 2   | 33    |
| Stear, or Jewell, .....       | 1  | 25    | 2   | 2   | 1   | 30    | 2  | 2  | 1   | 1   | 2   | 33    |
| Standard, .....               | 1  | 32    | 1   | 2   | 1   | 31    | 1  | 2  | 2   | 1   | 4   | 40    |
| Standard, .....               | 1  | 32    | 1   | 2   | 1   | 31    | 1  | 2  | 2   | 1   | 4   | 40    |
| State Lake, .....             | 1  | 75    | 2   | 3   | 1   | 80    | 2  | 2  | 5   | 1   | 8   | 109   |
| Beaver, .....                 | 1  | 41    | 2   | 2   | 1   | 48    | 1  | 2  | 2   | 1   | 11  | 101   |
| Beaver, .....                 | 1  | 41    | 2   | 2   | 1   | 48    | 1  | 2  | 2   | 1   | 11  | 101   |
| West Penn, .....              | 1  | 40    | 1   | 2   | 1   | 44    | 1  | 1  | 3   | 1   | 5   | 49    |
| Standard, .....               | 1  | 89    | 1   | 5   | 3   | 99    | 1  | 2  | 7   | 1   | 9   | 99    |
| Jefferson, .....              | 1  | 89    | 1   | 5   | 3   | 99    | 1  | 2  | 7   | 1   | 9   | 99    |
| Total, .....                  | 71 | 5,310 | 245 | 381 | 166 | 6,073 | 91 | 63 | 403 | 194 | 661 | 6,734 |

TABLE NO. 4.—List of fatal accidents that occurred in and about the mines of the Third Bituminous Mine District for the year ending December 31, 1894.

| Date of death. | Name of Person.         | Occupation.  | Age. | Widow. | Number of orphans. | Name of Colliery. | Location—County.    | Nature and Cause of Accident.  |
|----------------|-------------------------|--------------|------|--------|--------------------|-------------------|---------------------|--|
| March 3,       | Lebbana Williard, ..... | Miner, ..... | 43   | Yes    | 7                  | Fairbank, .....   | Westmoreland, ..... | He was undercutting the coal when it fell upon him; the coal where he was mining was "open and thin" and he had it mined to a considerable depth and width, with no strags set for its support. A large quantity of the mined coal fell upon him, breaking both of his legs and also injuring him internally; he lived only a few hours after having received the injuries. Was fatally injured by a large mass of coal of about ten tons in weight falling upon him; he was working on the night shift, taking out a room rib; the width of this pillar of coal was about fifteen feet, which had been taken out to within six feet of one of the room "cut-throughs." This block of coal was completely undercut, with the exception of a small piece left unmined at the inner corner from the room road at which young Cornman was busily engaged mining out. During this time "C" had finished mining and was lying in front of this loose coal when it fell. Not a sprag was set to this large block of under-cut coal. This was a very serious neglect; Cornman paid a heavy penalty for his carelessness. Morrow met his death almost instantly by a rock measuring nine feet long, two feet wide and sixteen inches thick, falling upon him from the roof of his working place. He was engaged in under-cutting |
| June 25,       | Daniel Cornman, .....   | Miner, ..... | 52   | Yes    | 5                  | Riverview, .....  | Armstrong, .....    |  |
| July 19,       | Charles Morrow, .....   | Miner, ..... | 28   | Yes    | ....               | Lake Erie, .....  | Butler, .....       |  |

the coal in front of the room road; his neck and back were broken. He and his partner had intended to timber the roof in front of the roadway more securely after they were through with taking up the bottom to give sufficient height to their room road. The two fractures from between which the stone dropped, were very close ones, running longitudinally with the road and parallel to each other. These two fractures escaped the observation of the two men and their danger was not fully realized.

Was fatally injured by a large mass of coal falling upon him while he was mining; he lived seven or eight hours after. He and two other miners were engaged at taking a "skip" off a room rib; he had the coal undercut to a depth of four feet and was partially under it mining, when it dropped upon him. Although the coal was somewhat shattered from the effects of previous shots, he had not a sprag set to it for its support, although he had been frequently urged by his partners to do so, he usually answered their friendly requests with these remarks: "I have drawn more pillars than you fellows, and know my business."

Was instantly killed by a fall of coal. At the part of the mine where Davidson was working, a semi long wall system of room being some feet behind the rooms on either side of his, he had an "open end" on each side; he also had a "cut" of coal ten feet wide and four feet deep along his room, open on each end, and completely undercut, without a sprag of any kind set for its support. He was still mining under it when the whole mass fell upon him, crushing him to death. His grandson, a boy about fourteen years of age, was working with him at the time of the accident; the boy told his grandfather that the coal was going to fall upon him, but his warning was not heeded; the boy in fact would not stay in the room, as he was afraid that his grandfather would be killed.

|                                       |                          |                            |                        |
|---------------------------------------|--------------------------|----------------------------|------------------------|
| <p>July 27, James Agnew, .....</p>    | <p>Star No. 4, .....</p> | <p>Miner, ..... 37 Yes</p> | <p>Clarion, .....</p>  |
| <p>Aug. 7, Robert Davidson, .....</p> | <p>Beaver, .....</p>     | <p>Miner, ..... 68 Yes</p> | <p>Lawrence, .....</p> |

TABLE No. 4.—Continued.

| Date of accident | Name of Person.        | Occupation.    | Age. | Widow. | Number of orphans. | Name of Colliery.      | Location—County. | Nature and Cause of Accident.   |
|------------------|------------------------|----------------|------|--------|--------------------|------------------------|------------------|---|
| Sept. 6.         | James Vogan, .....     | Miner, .....   | 33   | No     | .....              | Keister, .....         | Butler, .....    | Was killed by a fall of rock; he was work in a room with his brother, taking down some "out" coal, thus taking the support from the badly fractured rock roof, which fell with the coal. A post was set to part of the rock, but it was not sufficient to sustain the weight and was forced out.  |
| Sept. 8.         | Calvin Carberry, ..... | Driver, .....  | 29   | No     | .....              | New Hamilton, .....    | Jefferson, ..... | Was a driver in Big Soldier Run mine, and it being idle on this date he came over to New Hamilton mine to help his father change his tools from the place where he had been working in the past to a new room in another part of the mine. He rode into the interior of the mine from the change parting on a trip of empty mine wagons, which his companion, Herbert Jones, was taking into the workings. When Jones had taken his trip as far as it was going, they got out of the wagons, Carberry taking a position between the last empty wagon and the only chain pillar, while Jones sat down at the corner of the room pillar; Jones sent the trapper boy into the room with the horse to bring out the loaded wagon; when the loaded car arrived on the cutting it jumped the track, struck the only wagon by the side of which Carberry was standing, crushing him between the coal and chain pillar, killing him almost instantly. |
| Oct. 2.          | Almen Potusky, .....   | Scraper, ..... | 27   | No     | 1                  | Big Soldier Run, ..... | Jefferson, ..... | Was killed by a fall of coal while scrubbing the coal cuttings from a mangle machine. The accident occurred while   |

Potusky was standing shoveling away the offal from the mining machine. A sooty slip was struck in the bearing in, and the two men having continued the mining across the room for some distance to where the coal was open ended, a large mass became disengaged and while falling caught Potusky, crushing him against a room post, killing him almost instantly. Was killed by small coals which had been forced from the seam by a "tight" shot. John Hill had drilled a hole along the rib in the upper corner of his room for the purpose of blasting down some mined coal, but in doing so the hole had too great an angle into the solid rib, consequently when the shot was fired, instead of the mined coal being blown down, it forced off some of the solid coal which was in front of hole on the other side of the rib into the adjoining room and out on to the entry road. This entry angling thirty or forty degrees from the line of butts, and although Hill's room was in a considerable distance, the next or upper room was only about eight or ten feet from the entry. Quitting her having arrived, Pennel was going up No. 7 entry, which leads to the mule stable outside of the mine, with his mule and one mine wagon when he met his death. On passing John Hill's room he called to him, "Hi, Hi", which was understood by said Hill to mean that he could fire his shot. He neither Hill nor Pennel knowing of the hole being so near through in the other side of the room the shots were hit at once. Pennel had just got as far as the mouth of the next room when the shots were exploded, and he was caught just opposite the point of the hole in the rib, and was struck by the flying debris. His death was caused from his ribs having been broken and pressed into his lungs, together with other internal injuries. Peter Schreong, a boy aged 13 years, who was not an employe at this mine, was in the same mine wagon with Pennel when the accident occurred; the boy was very severely but not fatally injured.

Westmoreland, .....

Bagdad No. 2, .....

29 Yes 5

Driver, .....

Dec. 14, Thomas J. Pennel, .....

TABLE No. 5.—List of non-fatal accidents that occurred in and about the mines of the Third Bituminous Mine District for the year ending December 31, 1894.

| Date of accident. | Name of Person.     | Occupation. | Age.  | Married. | Name of Colliery. | Location—County. | Nature and Cause of Accident.           |
|-------------------|---------------------|-------------|-------|----------|-------------------|------------------|---|
| March 2           | Thomas Phillips,    | Miner.      | 19    | S.       | Ormsby slope,     | Meyer,           | Leg broken by a fall of coal and slate. |
| April 5           | Samuel Ginger,      | Miner.      | ..... | .....    | Keystone,         | Earler,          | Back injured by a fall of coal.         |
| July 16           | Michael Kinnor,     | Miner.      | 40    | M.       | Fairmount No. 5,  | Clarion,         | Back injured by a fall of rock.         |
| .....             | John A. Hughey,     | Driver.     | 23    | F.       | Blackstone,       | Westmoreland,    | Collar bone fractured by mine wagons.   |
| Aug. 14           | Cyrus Wilson,       | Miner.      | 28    | M.       | Glen,             | Armstrong,       | Leg injured by fall of coal.            |
| 22                | M. R. Brown,        | Miner.      | 21    | M.       | Brier Ridge,      | Clarion,         | Leg broken by fall of coal.             |
| 23                | Charles Kneppshild, | Miner.      | 14    | F.       | Avonmore,         | Armstrong,       | Injured by fall of coal and slate.      |
| Oct. 23           | William Markel,     | Miner.      | 35    | M.       | Catfish Run,      | Clarion,         | Leg broken by a fall of rock.           |
| Nov. 24           | Jacob Echner,       | Laborer.    | 25    | M.       | Big Soldier Run,  | Jefferson,       | Leg injured by a fall of coal.          |
| Dec. 28           | Hovens Winters,     | Laborer.    | 27    | .....    | Big Soldier Run,  | Jefferson,       | Burned by powder from a premature shot. |
| 28                | Augustus Hope,      | Laborer.    | 30    | S.       | Big Soldier Run,  | Jefferson,       | Burned by powder from a premature shot. |
| Aug. 3            | J. C. Anderson,     | Miner.      | 25    | .....    | Fairmount No. 2,  | Armstrong,       | Badly injured by a fall of shale.       |



## FOURTH BITUMINOUS DISTRICT.

(MCKEAN, POTTER, TIOGA, BRADFORD, SULLIVAN, LYCOMING, CLINTON, CAMERON AND ELK COUNTIES AND ALL THOSE MINES IN CLEARFIELD COUNTY ADJACENT TO THE LOW GRADE DIVISION OF THE ALLEGHENY VALLEY RAILROAD; ALSO THE MINES ADJACENT TO THE CLEARFIELD AND SUSQUEHANNA BRANCH OF THE PENNSYLVANIA RAILROAD; ALSO THE MINES ADJACENT TO THE BUFFALO, ROCHESTER AND PITTSBURG RAILROAD IN JEFFERSON AND CLEARFIELD COUNTIES.)

Blossburg, March, 15, 1895.

Hon. Isaac B. Brown, Secretary of Internal Affairs:

Sir: I herewith submit my annual report as Inspector of Mines for the Fourth Bituminous Coal district of this State, for the year ending December 31, 1894, in compliance with the Act of Assembly of May 15, 1893, together with the usual statistical tables compiled from the operators' annual reports returned to my office.

These returns show a small aggregate decrease in production, due to a general strike of the miners throughout the district during the months of May, June and July. The Kettle Creek mines at Bitumen, however, continued to run throughout the suspension. Five new mines have been opened and three have been worked out and abandoned during the year.

Improvements continue to be made at many of the mines throughout the district, and the operators generally display a disposition to have their mines conform to the requirements of the law.

The number of fatal accidents is greater than last year, which is due in a great measure to ignorance on the part of some, carelessness and disobedience of orders of the mine foreman on the part of others. A large percentage of those killed are of foreign birth, having had no knowledge of coal mining prior to their arrival in this country, and of course know but little of the dangers to be encountered. They consist mostly of Slavonians and Hungarians. The number of fatal accidents is somewhat less than in 1893.

I also append herewith a report from The Cottage State Hospital of this district, showing the number of patients admitted for treatment since the opening of the institution, and other matters relating to its administration up to the beginning of the present year.

Respectfully submitted,

JAMES N. PATTERSON,

Inspector.

## Mining Statistics.

|   |                     |
|---|---------------------|
| Number of mines in the district, .....                        | 65                  |
| Number of tons produced, .....                                | 4,296,596           |
| Number of tons shipped, .....                                 | 3,564,875           |
| Number of tons of coke manufactured, .....                    | 242,810             |
| Number of days worked, .....                                  | 6,099 $\frac{3}{4}$ |
| Number of miners employed, .....                              | 7,742               |
| Number of outside men, .....                                  | 1,294               |
| Total inside and outside, .....                               | 9,036               |
| Number of horses and mules, .....                             | 797                 |
| Number of mine locomotives, .....                             | 24                  |
| Number of steam boilers, .....                                | 86                  |
| Number of coke ovens reported, .....                          | 1,743               |
| Number of kegs of powder used, as per operators report, ..... | 29,041              |
| Number of fatal accidents, .....                              | 11                  |
| Number of non-fatal accidents, .....                          | 20                  |
| Number of tons produced per each fatal accident, .....        | 390,599             |
| Number of tons produced per each non-fatal accident, .....    | 214,599             |

## Classification of Fatal Accidents.

|                            |    |
|----------------------------|----|
| By falls of coal, .....    | 4  |
| By falls of roof, .....    | 6  |
| Caused by mine cars, ..... | 1  |
| <hr/>                      |    |
| Total, .....               | 11 |
| <hr/> <hr/>                |    |

## Classification by Non-fatal Accidents.

|                         |    |
|-------------------------|----|
| By falls of roof, ..... | 9  |
| By falls of coal, ..... | 5  |
| By mine cars, .....     | 4  |
| By mine cage, .....     | 1  |
| Miscellaneous, .....    | 1  |
| <hr/>                   |    |
| Total, .....            | 20 |
| <hr/> <hr/>             |    |

## Tioga County Mines.

Antrim Nos. 1 and 5 are in very good condition, both as to ventilation and drainage. At No. 5 the engine house and boilers which were located at the mouth of the slope, during the year were removed to the tippie, a distance of about 800 feet, thus enabling them to handle the coal much more rapidly. At No. 5 I found 45,900 cubic feet of air in circulation, well distributed throughout the workings. Ventilating fans are used at both mines.

Arnot Nos. 3, 4 and 5 are ventilated by a 20-foot Guibal fan, and the total quantity of air passing through the several divisions was 100,800 cubic feet per minute, as measured at the outlet, and these mines are in fairly good condition.

Fall Brook Nos. 2 and 6 were in good condition. No. 2 is ventilated by a fan, and I found 69,600 cubic feet of air in circulation as measured at the outlet. No. 6 is ventilated by a furnace producing 8,000 cubic feet per minute.

Morris Run Slope is in a very good condition. I found 122,000 cubic feet of air per minute passing at the outlet, well circulated throughout the workings.

Salt Lake. Quite an improvement has been made here. At the new mine, No. 2, a heading has been driven north 1,470 feet from the Fall Brook heading No. 1 to Dougals heading No. 7 to get the coal from the back part of the workings. It reduces the haulage distance fully one-third, and gives a very good grade for both empty and loaded cars. The drainage is fair and ventilation good.

Bear Run Mine. The ventilation has been improved here since my last report. I found 36,900 cubic feet of air in circulation measured at the outlet, fairly well distributed around the workings.

Gurnee Mines had not been working enough miners to be subject to inspection until very recently, but too late to report an examination within the year.

#### Jefferson County Mines.

Adrian No. 2 Slope. They have added a tail-rope for haulage and enlarged the overcasts, increasing the number of splits of air to secure better ventilation. I found 85,000 cubic feet of air in circulation and the mine generally in good condition.

Adrian No. 1 is a drift mine and has not been in operation during the year.

Adrian No. 4 is a drift mine ventilated by furnace, and is nearly worked out.

Eleanora No. 1 was found in good condition, ventilated by a fan, producing 60,900 cubic feet of air per minute at the outlet, circulated well around the workings.

Eleanora No. 2 is a new mine opened during the year. The improvements are first class in every respect. It is thoroughly equipped with compressed air for coal cutting, so as to avoid the use of steam pipes in the mine. They have placed here a first class endless haulage system, have built boiler plants, shops, etc., and are well prepared for a large output.

Walston No. 1 was found in good condition. I found 24,000 cubic feet of air in circulation, well distributed to the face of the workings.

Walston Nos. 2 and 3 are ventilated by the same fan and are in fair condition. The airways have in some parts been enlarged, so as to improve the ventilation and drainage.

Kurtz and Rinn is a new mine opened during the year. They have erected a Clark fan, seven feet in diameter, run by a ten-horse power engine. I found 28,000 cubic feet of air in circulation and the mine in good condition.

Beachtree Nos. 3 and 4. These mines were found in good condition. At No. 3 I found 99,000 cubic feet of air in circulation, and work here is mostly confined to pillars. The tippie and fan house were burned at the time of the suspension during the summer, and have since been rebuilt.

At No. 4 the tail-rope was removed to the Eleanora mine about two years since, and they are now making preparations to replace it with a new one and resume operations.

London Mine. A new fan and boiler have been put in position here, and a mining machine plant constructed. I found 72,000 cubic feet of air in circulation. The old fan is used to ventilate the engine road alone, and the new one to ventilate the workings.

Brock Mines. Have done but little work during the year, and are in good condition.

Clarion Mine No. 1. This mine consists of three separate openings and one tippie. I found 58,000 cubic feet of air in circulation well distributed through the mine, which is in good condition.

Clarion Mine No. 2 consists of three separate openings, one being ventilated by a fan and the other two by a furnace, and the condition of each is good.

Clarion No. 3 consists of a single drift opening, ventilated by a furnace. I found 24,000 cubic feet of air in circulation, and the mine in good condition.

Coal Glen Nos. 1 and 2 consists of two openings and one tippie, with other improvements of a substantial character, completed during the year. I found 58,000 cubic feet of air in circulation at No. 1 and 24,800 cubic feet at No. 2, and both mines were in good condition.

#### Lycoming County Mines.

Red Run Mine. Preparations are being made to extend this mine into a new field at the rear of the old mine. They intend to use the old main heading for a tunnel for carrying the product of the new mine to the old tippie, by rope haulage. They have erected a plant for the manufacture of fire brick from the under clay of the mine.

#### McKean County Mines.

Instanter Mine operates in a small way, with about 42 miners, and the general condition is fair.

Clermont Mine has been idle throughout the year.

## Bradford County Mines.

Long Valley No. 1 has been idle throughout the year.

Long Valley No. 2. They have erected a five-foot Clark fan during the year. I found 44,500 cubic feet of air in circulation, and the mine generally in good condition, except the drainage, which is only fair.

## Clearfield County Mines.

Helvetia Mines Nos. 1 and 2, are ventilated by a 25-foot Guibal fan. Mine No. 1 is almost exhausted. I found 95,000 cubic feet of air in circulation at both mines, and the general condition is very good.

Williamsport Mines were idle on my last visit in December, but the general condition of the mines was good.

Dixon Mine has been exhausted and abandoned during the year.

Brittanic Mine has done but little work during the year.

Cataract mine was not in operation at my last visit, but was in fair condition.

Karthauss Mine is entirely confined to pillar work and is in fair condition.

Sandy Lick Mine. The ventilation is fair. I found 28,500 cubic feet of air in circulation, and the drainage good in some, and defective in other parts of the mine.

Roebster Mine. They have constructed a new slope near the shaft for a traveling way, which will discontinue the use of the hoisting shaft for conveying the miners to and from the mines. This change will shorten the airways and will improve the ventilation very much. I found 82,000 cubic feet of air in circulation. The rope haulage in the mine has been extended 1,500 feet during the year.

Berwind-White Mine. This is a new shaft mine 265 feet in depth to the bottom of the coal. They are still making improvements, which are of a substantial and extensive character, but have shipped no coal during the year. These improvements were quite fully described in my last report.

## Elk County Mines.

Cascade Mines Nos. 5 and 6 are both worked out and abandoned.

Hazel Dell. Is in fairly good condition, with furnace ventilation. I found 10,000 cubic feet of air in circulation.

St. Mary's Mines, four in number, are nearly worked out, and are in fair condition.

Paine Mine is a new mine ventilated by a furnace. Fifty-two miners are employed, and I found 6,000 cubic feet of air in circulation.

Dagus Slope and Dagus Nos. 2 and 3 Mines employ nearly 500 miners. They were found in good condition. Dagus slope is ventilated by a fan and I found 25,000 cubic feet of air in circulation.

Dagus No. 2 is ventilated by a furnace and I found 18,000 cubic feet of air in circulation. Dagus No. 3 is also ventilated by a furnace, where I found 19,000 cubic feet in circulation.

Shawmut Mine consists of four separate openings, and the coal from all passes over the same tippie.

Shawmut No. 4 is a new opening. The main drift is 400 feet with two headings branched off. The air shaft is completed and they have commenced to build a furnace for ventilation. This mine will connect with drift No. 1, which will improve it to the extent of taking the long haul from the last named drift. I found them in fair condition.

Mead Run Mines were found in good condition. They are opening three new drifts around the hill in what is called Roll Hollow. The tram road is laid out around the hill to this point for the purpose of bringing the coal to Mead Run, or Shawmut No. 2 chutes. They are now using a ten-ton locomotive to haul the coal, and the same locomotive will be used to bring the coal from the new openings in the other ravine to the same chute.

Elbow Mine is ventilated by furnace power. I found 12,200 cubic feet of air in circulation, and the general condition of the mine is good.

Glen Fisher Mine. This mine is ventilated by a fan and I found 35,600 cubic feet of air in circulation, well distributed throughout the workings.

#### Clinton County Mines.

Kettle Creek Mines were found in good condition, both as to ventilation and drainage. There are two openings, each of which is ventilated by a separate furnace. At No. 1 furnace I found 33,580 cubic feet of air in circulation, and at No. 2 furnace 30,090 cubic feet, which is well distributed throughout the mines.

#### Sullivan County Mines.

Bernice Mines consist of two openings, an old one and a new one. The old opening is ventilated by a fan, and the new one will be ventilated in the same way when the work is a little more advanced. At the old opening I found at the inlet 33,880 cubic feet of air in circulation, and both openings were found to be in fair condition.

#### Fatal Accidents.

John Landlieskie, a miner, 40 years of age, was instantly killed February 10 by fall of coal. The deceased was taking down back room pillars and had his place undermined four feet deep and fourteen feet long and loose at both ends. He left a wife and two children.

Anthony Leobon, a miner, was instantly killed February 28 in Mead Run mine by a fall of horse-back. He had his room well-timbered, but if he had made a close examination of the roof, he would have discovered its dangerous condition, notwithstanding all the other precautions which had been taken. He was 36 years of age and left a wife and one child.

Joseph Perrin, a miner, 35 years of age, was instantly killed April 10th by fall of roof. The deceased had fired a shot and went back to see what it had done, when the roof fell with the above result. The stone measured nine feet long, four feet wide, and eight inches thick. He left a wife and two children.

Gustav Salin, a miner in Dagus slope, was instantly killed by fall of coal April 17. Deceased was taking out back entry stumps and had it undermined three feet deep and ten feet long and loose on both ends. He was a single man, 40 years of age.

Henry Ricks, a miner, 56 years of age, was fatally injured August 16 by a fall of roof. The deceased and Benjamin Rouse worked together. Mr. Gregory, the mine foreman, informed me that he had ordered him to stand a prop under the loose stone, which he did, but after Mr. Gregory had gone away, he took it out, as he thought it was in his way, when a piece of roof measuring eight feet long, six feet wide and six inches thick, fell and injured him in such a manner that he died nine hours afterwards. He left a widow to mourn his untimely death.

Joseph Mihouski, a miner, was instantly killed August 28 in Morris Run slope by a fall of roof. The deceased was breaking away a room and did not stand a sufficient number of props to secure himself. He was told repeatedly by the mine foreman to stand props, but neglected to heed the warning. Mihouski was a single man, 21 years old.

James Guthrie, a driver, was instantly killed by fall of roof August 28 in Walston No. 2 mine. His trip jumped the track, and when he hitched to the car to pull it on again it knocked out a prop, which caused a piece of stone five feet long, three feet wide and six inches thick to fall upon him. He was a single man 21 years old.

John Hancade, a miner, aged 36, was instantly killed by a fall of slate at Karthaus, September 15. A large piece of slate was loosened by slips on both sides, which is called a "pot hole," and the coal having been taken from the under side of it, it fell. He left a wife and one child.

Andrew Anderson, a miner, 66 years of age, was instantly killed in Antrim No. 1 by a fall of coal while in the act of undermining, after having removed the sprags and blasted the coal. He left an aged wife and five children.

Burt Lingway, a miner, 35 years of age, was instantly killed in Adrian No. 1 by being run over on the dilly road. He had no cause to be on the dilly road, as there was a traveling way independent of that road for the miners to travel on, which was in good condition. He met his death by willfully disobeying orders and violating the rules of the mine. He was 35 years of age and left a wife and six children.

Tony Pickle, a miner, 19 years of age, was instantly killed by fall of roof November 12 in Walston No. 3 mine. He was working an old room contrary to the orders of the mine foreman, and neglected to post the roof and lost his life through his own neglect.

Report from the Cottage State Hospital of the Fourth Bituminous Coal District, located at Blossburg, Pa., submitted by Dr. G. D. Crandall, physician and surgeon in charge.

|   |             |
|---|-------------|
| Number of patients admitted for treatment from February 19, 1891, (date of opening) to March 1, 1892,.... | 52          |
| From March 1, 1892, to March 1, 1893, .....   | 98          |
| From March 1, 1893, to March 1, 1894, .....   | 128         |
| From March 1, 1894, to February 26, 1895, .....   | 226         |
|   | <hr/>       |
| Total admitted, .....   | 504         |
|   | <hr/> <hr/> |

|  |                         |
|--|-------------------------|
| Average number of days that patients were supported in the institution from Feb. 1, 1893, to Feb. 1, 1894,.. | 50 63-112               |
| From Feb. 1, 1894, to Feb. 1, 1895, .....  | 35 3-11                 |
| Number discharged from treatment from Feb. 1, 1894, to Feb. 1, 1895, .....                                   | 216                     |
| Number of patients treated in the institution from Feb. 1, 1893, to Feb. 1, 1894, .....                      | 112                     |
| From Feb. 1, 1894, to Feb. 1, 1895,.....   | 165                     |
| Number treated outside of the institution from Feb. 1, 1893, to Feb. 1, 1894, .....                          | 19                      |
| From Feb. 1, 1894, to Feb. 1, 1895, .....  | 58                      |
| Number of prescriptions compounded from Feb. 1, 1894, to Feb. 1, 1895, .....                                 | 1,145                   |
|  | <hr/> <hr/> <hr/> <hr/> |



TABLE No. 1.—Showing location, etc., of collieries in the Fourth Bituminous Mine District.

| Name of Colliery.        | Name of Operator.                      | Location—County. | Name of Superintendent. | Postoffice Address.          |
|--------------------------|--|------------------|-------------------------|------------------------------|
| Arnot Nos. 3, 4 and 5,   | Bless Coal Company.                    | Tioga,           | R. T. Dodson,           | Arnot,                       |
| Antrim Nos. 1 and 5,     | Fall Brook Coal Company.               | do,              | James Pollock,          | Antrim,                      |
| Adrian No. 1,            | Rochester & Pittsburg Coal & Iron Co., | Jefferson,       | D. Fleming,             | DeLancy,                     |
| Brock Nos. 1, 2 and 3,   | do,                                    | do,              | do,                     | do,                          |
| Bear Run,                | Brock Coal Company.                    | Tioga,           | P. E. Cartwright,       | Ridgway, Elk county.         |
| Brittanic,               | Bloss Coal Company.                    | Clearfield,      | R. T. Dodson,           | Arnot,                       |
| Beachree Nos. 3 and 4,   | Geo. Rees & Co.                        | Jefferson,       | Geo. Rees,              | Karhaus, Clearfield county.  |
| Bernice Mines,           | Rochester & Pittsburg Coal & Iron Co., | Sullivan,        | John W. Ryan,           | Beachree,                    |
| Cascade No. 1,           | State Line and Sullivan Railroad Co.,  | Elk,             | E. O. Blight,           | Towanda, Bradford county.    |
| do, 2,                   | Kaul & Hall,                           | do,              | Andrew Kaul,            | St. Mary's, Elk county.      |
| do,                      | do,                                    | do,              | do,                     | do,                          |
| Cameron,                 | Cameron Coal Company.                  | Cameron,         | D. Robertson,           | Cameron, Cameron county.     |
| Clarion Nos. 1 to 7,     | Northwestern Mining and Exchange Co.,  | Jefferson,       | Northwestern,           | Ridgway, Elk county.         |
| Coal Glen Nos. 1 and 2,  | Jefferson Coal Company.                | do,              | Austin Hlakoslee,       | Coal Glen, Jefferson county. |
| Catawag,                 | Berwind-White Coal Mining Company,     | Clearfield,      | J. A. Crist,            | DuBois, Clearfield county.   |
| Catawag,                 | do,                                    | do,              | A. J. Cook,             | Bellefont, Centre county.    |
| Dixon,                   | Huffalo Coal Company.                  | McKean,          | William Butts,          | Clermont, McKean county.     |
| Paugus Nos. 1 to 10,     | Falls Creek Mining Company.            | Clearfield,      | John Reed,              | DuBois, Clearfield county.   |
| Elchon,                  | Northwestern Mining and Exchange Co.,  | Elk,             | D. Robertson,           | Ridgway, Elk county.         |
| Eleonora,                | Noble Coal Company.                    | do,              | George Mellinger,       | Cartwright, Elk county.      |
| Fall Brook Nos. 2 and 6, | Rochester & Pittsburg Coal & Iron Co., | Jefferson,       | S. A. Rinn,             | Eleonora, Jefferson county.  |
| Gurnee,                  | Fall Brook Coal Company.               | Tioga,           | Anton Harlt,            | Wellshoro, Tioga county.     |
| Glen Fisher,             | Gaines Coal and Coke Company.          | do,              | Patrick C. Smith,       | Gurpee, Tioga county.        |
| Hazel Dell,              | Standard Coal and Coke Company,        | Elk,             | W. M. Harrison,         | Williamsport,                |
| do,                      | Kaul & Hall,                           | do,              | Andrew Kaul,            | St. Mary's, Elk county.      |
| Helvetia Slope,          | do,                                    | do,              | do,                     | do,                          |
| Instantan,               | Adrian Islen.                          | Clearfield,      | John McLeavy,           | Stanley, Clearfield county.  |
| Karhaus,                 | Huffalo Coal Company.                  | McKean,          | John F. Keating,        | Clermont, McKean county.     |
| Kettle Creek No. 1,      | B. W. C. M. Co., Spears & Cowan son's, | Clearfield,      | A. G. Shears,           | Karhaus, Clearfield county.  |
| Kettle Creek No. 2,      | do,                                    | do,              | do,                     | do,                          |
| Kurtz Mine,              | Kettle Creek Coal Company.             | Clinton,         | George L. Miller,       | Bitumen, Clinton county.     |
| Lendon Mine,             | do,                                    | Jefferson,       | George Kurtz,           | Walston, Jefferson county.   |
| Lead Valley,             | Falls Creek Mining Company.            | do,              | John Reed,              | DuBois, Clearfield county.   |
| Mead Run,                | Long Valley Coal Company.              | Bradford,        | E. O. Macfarlane,       | Towanda, Bradford county.    |
| Morris Run Nos. 1 and 2, | Northwestern Mining and Exchange Co.,  | Elk,             | D. Robertson,           | Ridgway, Elk county.         |
| do,                      | Morris Run Coal Mining Company.        | Tioga,           | W. S. Nearing,          | Morris Run, Tioga county.    |
| Palme Mine,              | Kaul & Hall,                           | Elk,             | Andrew Kaul,            | St. Mary's, Elk county.      |
| Red Run,                 | Poll, Lewis & Yates.                   | Clearfield,      | John Reed,              | DuBois, Clearfield county.   |
| Sandy Lick,              | Fall Coal Company.                     | Lycuming,        | Robert Brownlee,        | Ralston, Lycuming county.    |
| Shawmut Nos. 1, 2 and 3, | Poll, Lewis & Yates.                   | Clearfield,      | John Reed,              | DuBois, Clearfield county.   |
| do, 3, 4 & 5,            | Shawmut Coal Company.                  | Elk,             | George Mellinger,       | Cartwright, Elk county.      |
| T. Umehale,              | St. Mary's Coal Company.               | do,              | Joseph Eddy,            | St. Mary's, Elk county.      |
| do,                      | do,                                    | do,              | do,                     | do,                          |
| Williamsport Mines,      | Clearfield Coal Company.               | Clearfield,      | A. K. Jacobs,           | Tyler, Clearfield county.    |
| Walston No. 1,           | Rochester & Pittsburg Coal & Iron Co., | Jefferson,       | Edward L. Robinson,     | Walston, Jefferson county.   |
| Walston No. 2,           | do,                                    | do,              | do,                     | do,                          |
| Walston No. 3,           | do,                                    | do,              | do,                     | do,                          |



|                                  |           |           |        |       |        |       |
|----------------------------------|-----------|-----------|--------|-------|--------|-------|
| Kettle Creek No. 1               | 900,000   | 100,000   | 153½   | 151   | 950    | 28    |
| Kettle Creek No. 2               | 70,000    | 70,000    | 147    | 100   | 1      | 12    |
| Kurtz mine                       | 222,887   | 292,480   | 176    | 300   | 1,700  | 17    |
| Landon mine                      | 27,474    | 27,517    | 134    | 90    | 454    | 19    |
| Long Valley                      | 37,929    | 37,929    | 175    | 91    | 450    | 4     |
| Mead Run                         | 209,861   | 139       | 139    | 769   | 1      | 46    |
| Morris Run Nos. 1 and 2          | 32,000    | 32,000    | 162    | 52    | 1      | 1     |
| Paine mine                       | 308,617   | 568,834   | 176    | 690   | 4      | 2,099 |
| Rochester                        | 80,160    | 79,593    | 231¾   | 105   | 965    | 9     |
| Red Run                          | 97,394    | 97,394    | 185    | 221   | 1      | 15    |
| Sandy Lick                       | 66,741    | 66,741    | 244    | 100   | 42     | 7     |
| Shawmont Nos. 1, 2 and 3         | 5,183     | 41,324    | 240    | 148   | 500    | 12    |
| St. Mary's Nos. 1, 2, 3, 4 and 5 | 405,475   | 510,499   | 199    | 765   | 1,900  | 59    |
| Tannerdale                       |           |           |        | 3     | 2      | 1     |
| Williamsport mines               |           |           |        |       |        |       |
| Walston Nos. 1, 2 and 3          |           |           |        |       |        |       |
| Totals                           | 4,296,795 | 3,564,875 | 6,099¾ | 9,036 | 29,042 | 86    |
|                                  |           | 242,810   |        | 11    | 20     | 797   |
|                                  |           |           |        |       |        | 24    |
|                                  |           |           |        |       |        | 1,643 |

TABLE NO. 3.—Showing the number of each class of employes at each colliery in the Fourth Bituminous Mine District, during the year 1894.

| Names of Collieries.       | Location—County. |             | Occupations of Persons Employed Inside. |         |                   |                  |                      |  |               |                  |                             |                        | Occupations of Persons Employed Outside. |                  |   |                |                                 |  |  |  |  |  |
|----------------------------|------------------|-------------|---|---------|-------------------|------------------|----------------------|--|---------------|------------------|-----------------------------|------------------------|--|------------------|---|----------------|---------------------------------|--|--|--|--|--|
|                            |                  |             | Occupations of Persons Employed Inside. |         |                   |                  |                      | Occupations of Persons Employed Outside. |               |                  |                             |                        | Occupations of Persons Employed Outside. |                  |   |                |                                 | Occupations of Persons Employed Outside. |  |  |  |  |
|                            |                  |             | Inside foreman or mine boss.            | Miners. | Miners' laborers. | All company men. | Drivers and runners. | Door boys and helpers.                   | Total inside. | Outside foremen. | Blacksmiths and carpenters. | Engineers and firemen. | State pickers.                           | All company men. | Superintendents and bookkeepers and clerks. | Total outside. | Grand total inside and outside. |  |  |  |  |  |
| Arnot Nos. 3, 4 and 5.     |                  | Tooga.      | 3                                       | 439     |                   | 19               | 39                   | 18                                       | 520           | 1                | 1                           | 1                      | 69                                       | 26               | 113   | 633            |                                 |  |  |  |  |  |
| Adrian Nos. 1 and 5.       |                  | Tooga.      | 2                                       | 589     | 19                | 10               | 26                   | 10                                       | 556           | 1                | 5                           | 6                      | 58                                       | 4                | 80  | 436            |                                 |  |  |  |  |  |
| Adrian No. 1.              |                  | Jefferson.  |   | 449     |                   | 15               | 36                   | 30                                       | 536           |                  |                             |                        |  | 135              | 51  | 690            |                                 |  |  |  |  |  |
| Adrian No. 2.              |                  | Jefferson.  |   |         |                   |                  |                      |  |               |                  |                             |                        |  |                  |   |                |                                 |  |  |  |  |  |
| Brock Nos. 1, 2 and 3.     |                  | Jefferson.  | 1                                       | 160     |                   | 3                |                      |  | 164           |                  |                             |                        |  |                  |   | 123            |                                 |  |  |  |  |  |
| Bear Run.                  |                  | Tooga.      | 1                                       | 192     | 9                 | 10               | 2                    |  | 213           | 1                | 4                           | 4                      | 19                                       |                  | 28  | 212            |                                 |  |  |  |  |  |
| Britannic.                 |                  | Tooga.      | 1                                       | 21      |                   | 3                |                      |  | 28            |                  |                             |                        |  |                  | 3   | 31             |                                 |  |  |  |  |  |
| Britannic No. 3.           |                  | Clearfield. | 1                                       | 274     |                   | 11               | 14                   | 22                                       | 322           |                  |                             |                        |  |                  | 19  | 341            |                                 |  |  |  |  |  |
| Beachtree No. 3.           |                  | Jefferson.  |   |         |                   |                  |                      |  |               |                  |                             |                        |  |                  |   |                |                                 |  |  |  |  |  |
| Beachtree No. 4.           |                  | Jefferson.  |   |         |                   |                  |                      |  |               |                  |                             |                        |  |                  |   |                |                                 |  |  |  |  |  |
| Bernice mines.             |                  | Sullivan.   | 1                                       | 165     |                   | 5                | 29                   | 9  | 204           | 1                | 5                           | 9                      | 15                                       | 38               | 133   | 337            |                                 |  |  |  |  |  |
| Cascade No. 1.             |                  | Elk.        | 1                                       | 34      | 8                 | 2                | 2                    |  | 47            |                  |                             |                        |  |                  | 47  |                |                                 |  |  |  |  |  |
| Cascade No. 2.             |                  | Elk.        |   |         |                   |                  |                      |  |               |                  |                             |                        |  |                  |   |                |                                 |  |  |  |  |  |
| Cameron.                   |                  | Cameron.    |   |         |                   |                  |                      |  |               |                  |                             |                        |  |                  |   |                |                                 |  |  |  |  |  |
| Carlton Nos. 1 to 7.       |                  | Jefferson.  | 3                                       | 423     |                   | 12               | 32                   | 1  | 472           | 1                | 19                          | 5                      | 59                                       | 3                | 69  | 541            |                                 |  |  |  |  |  |
| Coal Glen Nos. 1 and 2.    |                  | Jefferson.  | 1                                       | 269     |                   | 5                | 9                    |  | 285           | 1                | 2                           | 3                      | 7  | 1                | 16  | 231            |                                 |  |  |  |  |  |
| Catact.                    |                  | Clearfield. | 1                                       | 35      | 2                 |                  | 9                    | 3  | 110           |                  |                             |                        |  | 8                | 12  | 122            |                                 |  |  |  |  |  |
| Clermont.                  |                  | McKean.     |   |         |                   |                  |                      |  |               |                  |                             |                        |  |                  |   |                |                                 |  |  |  |  |  |
| Dixon.                     |                  | Clearfield. |   |         |                   |                  |                      |  |               |                  |                             |                        |  |                  |   |                |                                 |  |  |  |  |  |
| Dagus mines, Nos. 1 to 10. |                  | Elk.        | 3                                       | 408     |                   | 9                | 25                   |  | 445           | 1                | 13                          | 5                      | 29                                       | 2                | 51  | 496            |                                 |  |  |  |  |  |
| Elk.                       |                  | Elk.        | 1                                       | 72      |                   | 3                |                      |  | 79            | 1                | 2                           |                        | 5  | 1                | 9   | 88             |                                 |  |  |  |  |  |
| Elk.                       |                  | Elk.        | 2                                       | 352     |                   | 10               | 36                   | 12                                       | 512           |                  |                             |                        |  | 15               | 20  | 442            |                                 |  |  |  |  |  |
| Eleanora slope.            |                  | Jefferson.  |   |         |                   |                  |                      |  |               |                  |                             |                        |  |                  |   |                |                                 |  |  |  |  |  |
| Eleanora No. 1.            |                  | Jefferson.  | 2                                       | 101     | 15                | 4                | 19                   | 6  | 147           | 2                | 3                           | 1                      | 14                                       |                  | 23  | 170            |                                 |  |  |  |  |  |
| Fall Brook Nos. 2 and 3.   |                  | Tooga.      | 1                                       | 14      |                   | 1                | 1                    |  | 16            |                  |                             |                        |  |                  | 1   | 17             |                                 |  |  |  |  |  |
| Gurnee Nos. 1, 2 and 3.    |                  | Elk.        | 1                                       | 79      | 18                | 2                | 5                    | 3  | 99            | 1                | 2                           | 2                      | 11                                       | 3                | 21  | 129            |                                 |  |  |  |  |  |
| Hazel Dell.                |                  | Elk.        | 1                                       | 57      | 12                | 2                | 6                    |  | 78            |                  |                             |                        | 1  | 2                | 4   | 82             |                                 |  |  |  |  |  |
| Helvetia slope.            |                  | Clearfield. | 2                                       | 206     |                   | 5                | 12                   | 5  | 290           |                  |                             |                        |  |                  | 16  | 306            |                                 |  |  |  |  |  |
| Helvetia No. 1.            |                  | Clearfield. |   |         |                   |                  |                      |  |               |                  |                             |                        |  |                  |   |                |                                 |  |  |  |  |  |
| Instantier.                |                  | McKean.     | 1                                       | 59      |                   | 1                | 3                    |  | 63            |                  |                             |                        |  |                  | 8   | 42             |                                 |  |  |  |  |  |
| Karthaas.                  |                  | Clearfield. | 1                                       | 53      | 1                 |                  | 4                    |  | 58            |                  |                             |                        |  |                  | 1   | 66             |                                 |  |  |  |  |  |

|                                  |            |    |       |    |     |     |     |       |    |     |    |     |     |     |       |       |
|----------------------------------|------------|----|-------|----|-----|-----|-----|-------|----|-----|----|-----|-----|-----|-------|-------|
| Kettle Creek No. 1               | Clinton    | 1  | 107   | 2  | 16  | 15  | 3   | 146   | 2  | 2   | 2  | 2   | 2   | 2   | 5     | 151   |
| Kettle Creek No. 2               | Clinton    | 1  | 85    | 2  | 3   | 7   | 2   | 97    | 1  | 1   | 1  | 1   | 1   | 1   | 3     | 100   |
| Kurtz mine                       | Jefferson  | 1  | 264   | 4  | 15  | 15  | 3   | 286   | 2  | 2   | 2  | 2   | 2   | 2   | 14    | 300   |
| London mine                      | Jefferson  | 1  | 60    | 4  | 7   | 7   | 2   | 74    | 1  | 1   | 1  | 1   | 1   | 1   | 16    | 90    |
| Long Valley                      | Bradford   | 1  | 73    | 2  | 4   | 4   | 1   | 82    | 1  | 1   | 1  | 1   | 1   | 1   | 9     | 91    |
| Mead Run                         | Elk        | 3  | 522   | 26 | 57  | 31  | 31  | 639   | 1  | 8   | 4  | 42  | 9   | 6   | 70    | 709   |
| Morris Run Nos. 1 and 2          | Tioga      | 1  | 48    | 1  | 2   | 2   | 2   | 52    | 1  | 1   | 1  | 1   | 1   | 1   | 52    | 52    |
| Paine mine                       | Elk        | 2  | 500   | 45 | 12  | 45  | 12  | 559   | 1  | 4   | 1  | 1   | 1   | 27  | 600   | 600   |
| Rochester                        | Clearfield | 1  | 104   | 6  | 6   | 6   | 3   | 129   | 1  | 5   | 1  | 1   | 1   | 26  | 166   | 166   |
| Red Run                          | Lycoming   | 1  | 184   | 3  | 14  | 14  | 3   | 204   | 1  | 3   | 1  | 1   | 1   | 11  | 221   | 221   |
| Sandy Lick                       | Clearfield | 1  | 80    | 5  | 5   | 5   | 1   | 90    | 1  | 1   | 1  | 1   | 1   | 4   | 109   | 109   |
| Shawmut Nos. 1, 2 and 3          | Elk        | 1  | 100   | 4  | 9   | 9   | 2   | 116   | 1  | 1   | 1  | 1   | 1   | 24  | 148   | 148   |
| St. Mary's Nos. 1, 2, 3, 4 and 5 | Elk        | 2  | 407   | 16 | 34  | 34  | 31  | 490   | 1  | 6   | 6  | 2   | 2   | 158 | 705   | 705   |
| Williamsport mines               | Clearfield | 1  | 100   | 4  | 9   | 9   | 2   | 116   | 1  | 1   | 1  | 1   | 1   | 24  | 148   | 148   |
| Walston Nos. 1, 2 and 3          | Jefferson  | 2  | 407   | 16 | 34  | 34  | 31  | 490   | 1  | 6   | 6  | 2   | 2   | 158 | 705   | 705   |
| Total                            |            | 50 | 6,622 | 86 | 227 | 534 | 210 | 7,742 | 21 | 117 | 92 | 282 | 564 | 69  | 1,294 | 9,636 |

TABLE NO. 4.—List of fatal accidents which occurred in and about the mines of the Fourth Bituminous Mine District, for the year ending December 31, 1894.

| Date of accident. | Name of Person.   | Occupation. | Age. | Widow. | Number of orphans. | Name of Colliery. | Location—County. | Nature and Cause of Accident.                                      |
|-------------------|-------------------|-------------|------|--------|--------------------|-------------------|------------------|--|
| Feb'y 19,         | John Landlieskie, | Miner,      | 40   | M.     | 2                  | Eleanora,         | Jefferson,       | Instantly killed by fall of coal.                                  |
| 28,               | Anthony Leobin,   | Miner,      | 36   | M.     | 1                  | Meud Run,         | Elk,             | Instantly killed by fall of slate.                                 |
| April 16,         | Joseph Perrin,    | Miner,      | 35   | M.     | 2                  | Walston,          | Jefferson,       | Instantly killed by fall of coal.                                  |
| 17,               | Gustof Sahn,      | Miner,      | 40   | S.     | ...                | Dagus slope,      | Elk,             | Instantly killed by fall of coal.                                  |
| Aug 16,           | Henry Rieks,      | Miner,      | 56   | M.     | ...                | Walston,          | Jefferson,       | Fatally injured by fall of roof; died in about nine hours.         |
| 28,               | Joseph Mihonski,  | Miner,      | 21   | S.     | ...                | Morris Run,       | Tioga,           | Instantly killed by fall of roof.                                  |
| 28,               | James Guthrie,    | Driver,     | 21   | S.     | ...                | No. 2 Walston,    | Jefferson,       | Instantly killed by fall of roof.                                  |
| Sept. 15,         | John Hancock,     | Miner,      | 36   | M.     | 1                  | Karthaus,         | Charfield,       | Instantly killed by fall of roof.                                  |
| Nov. 1,           | Andrew Anderson,  | Miner,      | 66   | M.     | 4                  | Antrim,           | Tioga,           | Instantly killed by fall of coal.                                  |
| 10,               | Port Langway,     | Miner,      | 35   | M.     | 6                  | Adrian,           | Jefferson,       | Instantly killed by being run over by a dilly trip of loaded ears. |
| 12,               | Tony Pickle,      | Miner,      | 19   | S.     | ...                | Walston,          | Jefferson,       | Instantly killed by fall of roof.                                  |

TABLE NO. 5.—*Last of non-fatal accidents that occurred in and about the mines of the Fourth Bituminous Mine District, for the year ending December 31, 1894.*

| Date of accident. | Name of Person.           | Occupation.  | Age.  | Widow. | Name of Colliery.    | Location—County.  | Nature and Cause of Accident.  |
|-------------------|---------------------------|--------------|-------|--------|----------------------|-------------------|--|
| March 23,         | Anton Piekto, .....       | Miner, ..... | ..... | .....  | Shawmut, .....       | Elk, .....        | Two ribs broken and shoulder dislocated by fall of roof.   |
| 26,               | Matthew Catchpold, ....   | Miner, ..... | 22    | S.     | Rochester, .....     | Clearfield, ..... | Seriously injured by crossing under the bottom of the shaft while the cage was descending.   |
| July 16,          | George Moore, .....       | Miner, ..... | 53    | M.     | No. 3 Dagus, .....   | Elk, .....        | His wrist was injured by fall of coal.   |
| 20,               | James Pedlally, .....     | Miner, ..... | 51    | M.     | Morris Run, .....    | Tioga, .....      | Back and legs injured by fall of roof. They were working together and both were injured by the same fall of roof. John received compound fracture of bones of right leg and slight cut in the scalp, and William had his left hip dislocated.  |
| Aug. 27,          | John Williamson, .....    | Miner, ..... | 16    | .....  | No. 1 Walston, ..... | Jefferson, .....  | His hip injured by fall of coal.   |
| 27,               | William Williamson, ..... | Miner, ..... | 13    | .....  | No. 1 Walston, ..... | Jefferson, .....  | His leg injured by fall of coal.   |
| Sept. 3,          | Henry Huntington, .....   | Miner, ..... | 56    | M.     | Eleanora, .....      | Jefferson, .....  | Lost the first joint of third finger of right hand by fall of coal.  |
| 7,                | William Patterson, .....  | Miner, ..... | 54    | M.     | Eleanora, .....      | Jefferson, .....  | Nose was badly broken and severely cut on the back of the head; he was a half mile away from his working place and following the driver when the accident happened. The mule balked and the cars ran back a short distance, when his head was caught between the car and the roof, causing the above mentioned injuries. |
| 18,               | James Goodyear, .....     | Miner, ..... | 15    | .....  | Rochester, .....     | Clearfield, ..... | Arm broken by fall of slate.   |
| 18,               | James Flynn, Jr., .....   | Miner, ..... | 19    | .....  | Rochester, .....     | Clearfield, ..... | Arm broken by being caught between mine car and prop.  |
| Oct. 9,           | Elmer Vaughan, .....      | Miner, ..... | ..... | .....  | Bear Run, .....      | Tioga, .....      | One rib broken by fall of coal.  |
| 9,                | Samuel Davis, .....       | Miner, ..... | ..... | .....  | Bear Run, .....      | Tioga, .....      | Leg broken by fall of coal.  |
| 10,               | Terry Clune, .....        | Miner, ..... | 50    | S.     | Rochester, .....     | Clearfield, ..... | Collar bone broken by fall of coal.  |
| 23,               | Steve Slodisk, .....      | Miner, ..... | 26    | M.     | .....                | .....             | .....  |
| Nov. 10,          | John Diewes, .....        | Miner, ..... | 56    | M.     | Eleanora, .....      | Jefferson, .....  | .....  |

TABLE No. 5.—Continued.

| Date of accident. | Name of Person.       | Occupation.        | Age.   |      | Name of Colliery. | Location—County. | Nature and Cause of Accident.  |
|-------------------|-----------------------|--------------------|--------|------|-------------------|------------------|--|
|                   |                       |                    | Widow. | Age. |                   |                  |  |
| Nov. 16,          | Frank Myers, .....    | Driver, .....      | S.     | 21   | Adrian, .....     | Jefferson, ..... | Frank Myers was injured by mine cars running over his l-g, mutilating it so that amputation was necessary. Redmond was injured by the same trip of cars. Badly bruised by falling in front of a loaded car while letting it down the grade out of his working place. Collar bone broken by fall of coal. Arm broken by falling on platform at foot of plane. |
|                   | Rody Redmond, .....   | Driver, .....      | M.     | 25   | Adrian, .....     | Jefferson, ..... |  |
| 27,               | Morris Griffin, ..... | Miner, .....       |        |      | Arnot, .....      | Tioga, .....     |  |
| Dec. 3            | Isaiah Harmon, .....  | Miner, .....       | M.     | 29   | Bear Run, .....   | Tioga, .....     |  |
|                   | W. H. Minto, .....    | Weighmaster, ..... | S.     | 38   | Bear Run, .....   | Tioga, .....     |  |



# FIFTH BITUMINOUS DISTRICT.

(FAYETTE AND SOMERSET COUNTIES.)

Uniontown, March 16, 1895.

Hon. Isaac B. Brown, Secretary of Internal Affairs:

Sir: In accordance with the requirements of section eleven of article ten of the Act of Assembly approved May 15, 1893, I have the honor herewith to submit to you my annual report as Inspector of Mines for the Fifth Bituminous district for the year ending December 31, 1894. It contains in tabulated form the names of all the mines in the district, their location, the names of operators and superintendents, with their postoffice address, the total production of coal and coke in net tons for each colliery, also the shipments of coal. The number of days worked, number of persons employed and their occupations, and number of fatal and non-fatal accidents, number of kegs of powder used (approximately), number of steam boilers, locomotives, mules, horses, etc. It also shows the causes of the various accidents which occurred during the year, with the number of widows and orphans left by fatalities. I also give a summary of the above for the years 1893 and 1894, for the purpose of comparison, from which it will be seen that one more fatal, and three non-fatal accidents occurred during the year 1894 than occurred during 1893. But while that is the case, it will also be noticed that the total number of persons employed was greater, and that the proportion of accidents to number of persons employed is less than in 1893.

The production of coal is also greater by 278,789 tons than in 1893, and this too, despite the fact that a prolonged strike took place during this year. The total amount of coal mined for 1894 is 3,908,348 net tons. The average number of days worked for the year by the mines in the district is 170.3-4, a little over half-time. Thus, it will be seen that the mines have a producing capacity of about 8,000,000 tons of coal annually.

It is a lamentable fact that notwithstanding all the precautions taken to prevent accidents, at least sixty per cent. of those which have occurred in this district during the year, have been directly due

to the carelessness of the persons injured. It seems that "familiarity" with danger "breeds contempt" for it, and persons take unwarranted risks which must necessarily result in accidents, and no precautionary measures can prevent their occurrence. A number of these accidents have occurred in consequence of some act of the injured which has been in direct violation of law. The above goes to show that neither legislation nor instruction will prevent accidents unless the persons employed in or about the mine will exercise common sense, and take precautions to protect themselves while employed in their dangerous avocation.

While it is true that immunity from accidents cannot be expected, yet every possible precaution should be taken to reduce their number. To do so successfully, all known dangers should be guarded against and removed if possible. One of the greatest dangers met with in this district is the accumulation of explosive gas in the "gob" where pillars have been taken out. Considerable gas is given off from the overlying strata when it is broken by falls, where the coal has been excavated, as in the drawing of pillars. This gas accumulates on the top of these falls in the gob in large quantities, and is only kept in check by the pressure of the air, from mixing in dangerous volumes with the atmosphere of the mine, and is a constant menace to the safety of life and property. In my judgment such a danger ought not to exist when it can be removed, and that it can be removed has been very clearly demonstrated by an experimental bore-hole drilled from the surface into one of these reservoirs of gas at the Oliver mine, which drained off the gas from a gob fall of about ten acres in extent; and gas has not been seen in that part of the mine since, thus demonstrating beyond question the effectiveness of this method of dealing with the danger. In view of the above, it can no longer be said "that large volumes of gas in gob workings cannot be removed," and should an accident ever occur by an explosion of gas, which has thus been allowed to accumulate, there could be no satisfactory excuse offered, but on the contrary the officials who permit such conditions to exist with a knowledge of these facts, would be culpable. The question of expense cannot even be offered as an excuse, for when bore-holes can be drilled at a cost of \$1.00 per foot, the total cost of a bore-hole will not exceed from \$300 to \$400 on an average. This cost, divided by the tonnage in ten acres of coal, will be so small a fractional part of a cent per ton, that the question of cost will not be considered a factor when the increased safety to life and property is taken into consideration.

In another part of this report will be found a detailed description of the work done by the "Stanley Header" mining machine at West Leisenring mine.

I also include as part of my report an opinion of Deputy Attorney General Stranahan relative to qualifications of applicants for mine foreman's certificates.

Two persons were prosecuted for violation of the mining law during the year, viz: Thomas Checks and William Holland. The former for unlocking his safety lamp and lighting it with matches in Leisenring No. 1 mine, the latter for willfully injuring his safety lamp in Grindstone mine, both of which mines are worked exclusively with locked safety lamps. Both were convicted and were each sentenced to two months' imprisonment and two hundred dollars fine, and in default of payment of fine, to two months' additional imprisonment. The fines were not paid in either case, and each of them served the additional two months' imprisonment. These convictions have had an excellent effect upon the persons employed in mines where safety lamps are used, as greater care has since been exercised where safety lamps are used in the mines.

The condition of the mines in the district (with a few exceptions) is very satisfactory. There is a disposition on the part of the majority of the owners to cheerfully comply with the requirements of law. A few, however, seem determined to evade in every possible way the provisions of the law, and will not do anything except they are compelled to. Especially is this the case with reference to the furnishing of some artificial means of producing ventilation in the mines in Somerset county. The mines in this part of the district have in the past been run on very loose methods, consequently the condition of the mines, with regard to ventilation, are such as will require the expenditure of money to put them in shape, and this necessary expense is offered as an excuse for their non-obedience to the law. This excuse will not, however, be entertained, as the mines will be required to be operated in accordance with the law, or otherwise to cease operations.

Accompanying this report are the usual statistical tables. All of which is respectfully submitted.

CHAS. CONNOR,  
Mine Inspector.

## SUMMARY.

|   | 1893.     | 1894.                           |
|---|-----------|---------------------------------|
| Number of mines in the district, . . . . .                          | 60        | 67                              |
| Number of mines operated during the year, . . . . .                 | 55        | 64                              |
| Number of mines idle during the year, . . . . .                     | 5         | 3                               |
| Number of new mines opened, . . . . .                               | 3         | 7                               |
| Number of new mines abandoned during the year, . . . . .            | 1         |                                 |
| Number of persons employed in the mines, . . . . .                  | 4,146     | 4,943                           |
| Number of persons employed outside the mines, . . . . .             | 2,487     | 2,676                           |
| Total number of persons employed, . . . . .                         | 6,633     | 7,619                           |
| Total number of days worked by all the mines, . . . . .             | 9,671     | 10,930                          |
| Average number of days worked by all the mines, . . . . .           | 158       | 170 <sup>3</sup> / <sub>4</sub> |
| Number of tons of coal mined (2,000 lbs.), . . . . .                | 3,629,559 | 3,908,348                       |
| Number of tons of coal shipped (2,000 lbs.), . . . . .              | 599,252   | 669,701                         |
| Number of tons of coke produced (2,000 lbs.), . . . . .             | 2,092,993 | 2,264,971                       |
| Number of tons of coal mined for each fatal accident, . . . . .     | 302,463   | 300,642                         |
| Number of employes for each fatal accident, . . . . .               | 553       | 586                             |
| Number of tons of coal mined for each non-fatal accident, . . . . . | 82,490    | 83,156                          |
| Number of employes for each non-fatal accident, . . . . .           | 151       | 162                             |
| Number of horses and mules in use, . . . . .                        | 581       | 619                             |
| Number of coke ovens built during the year, . . . . .               | 140       | 320                             |
| Number of coke ovens in district, . . . . .                         | 7,276     | 7,517                           |
| Number of mine locomotives in use, . . . . .                        | 7         | 15                              |
| Number of kegs of powder reported as used in mines, . . . . .       | 4,032     | 3,835                           |
| Number of steam boilers in use, . . . . .                           | 175       | 183                             |
| Number of fatal accidents during the year, . . . . .                | 12        | 13                              |
| Number of non-fatal accidents during the year, . . . . .            | 44        | 47                              |
| Number of wives left widows by fatalities, . . . . .                | 11        | 9                               |
| Number of orphans left by fatalities, . . . . .                     | 21        | 22                              |

| Causes of Accidents.                  | 1893.  |            | 1894.  |            |
|---------------------------------------|--------|------------|--------|------------|
|                                       | Fatal. | Non-fatal. | Fatal. | Non-fatal. |
| By falls of roof or slate, . . . . .  | 8      | 15         | 6      | 10         |
| By falls of coal, . . . . .           | 2      | 6          | 1      | 7          |
| By being struck with cage, . . . . .  |        |            | 1      |            |
| By falling down shafts, . . . . .     |        |            | 2      |            |
| By mine wagons, . . . . .             | 2      | 16         | 2      | 23         |
| By gunpowder, . . . . .               |        | 2          | 1      |            |
| By mules and horses, . . . . .        |        | 1          |        | 2          |
| By being struck with posts, . . . . . |        | 1          |        | 1          |
| From miscellaneous causes, . . . . .  |        | 3          |        | 4          |
| Totals, . . . . .                     | 12     | 44         | 13     | 47         |

Attorney General's opinion as to the necessary qualifications for applicants for mine foreman's certificates:

Uniontown, January 31, 1894.

Hon. William U. Hensel, Attorney General, Harrisburg, Pa.:

Dear Sir: On behalf of the examining board for the Fifth Bituminous district, I respectfully ask you to give a decision on the following points:

1st. Must a mine foreman be able to read and write in order to be competent to discharge the duties of mine foreman in accordance with the law?

Article VI, section 8, requires that "he shall enter in a book \* \* a report of the condition of the mine, signed by himself," etc. Also, in article XII, section 1, it is required that the person having charge of a mine shall notify the Mine Inspector of any accident that may occur, etc. Also, article VI, section 5, says, "the mine foreman shall measure the air current \* \* \* and keep a record of such measurements," etc.

In view of the above, can an examining board grant a certificate of competency to a person who cannot read or write?

2d. If a person is unfit to discharge the duties of mine foreman as required by law, because of his inability to read or write, is an examining board bound to examine such person when they have discovered that he is unable to read or write? Article XV, section 2, requires that "the examining board shall examine any person applying thereto as to his competency and qualifications to discharge the duties of mine foreman or fire boss,"

An early reply to the above inquiries will oblige,

Yours respectfully,

CHAS. CONNOR,  
Mine Inspector Fifth Bituminous District.

---

Letter of Attorney General.

Office of the Attorney General,  
Harrisburg, Pa., February 6, 1894.

Charles Connor, Esq., Mine Inspector Fifth Bituminous Coal District,  
Uniontown, Pa.:

My Dear Sir: Your letter of January 31, 1894, on behalf of the examining board for the Fifth Bituminous district, has been received. In this letter you asked to be advised upon three questions. These questions can all be summed up in one: Must a mine foreman and a

fire boss be able to read and write in order to be competent to discharge their duties under the act "relating to bituminous coal mines, and providing for the lives, health, safety and welfare of persons employed therein," approved May 15, 1893. (P. L. 1893, p. 52.)

It is not the province, neither is it the disposition of this Department to interfere in any manner with the duties of your examining board, yet this question, presenting itself as it does, deserves at the hands of the Department more than an ordinary inquiry. -

This act of Assembly is a very important one, and the objects to be obtained by it have been questions of careful study for many years past. The act itself was prepared carefully by practical and experienced men. The duties imposed by it are of a very important character. The persons upon whom these duties are imposed are supposed to be intelligent, practical and experienced men. The law has thrown around all of their duties extreme care. In every section of the act, pertaining especially to the duties of mine foreman and fire boss, great care is taken to require a faithful performance of duty. They are to be men of knowledge and of practical experience. They are not only to have knowledge, but are also required to communicate that knowledge, and this, by the duties assigned to them, is to be done orally as well as in writing.

By article V, section 2, it is said, "The person or persons making such examination shall have received a fire boss certificate of competency required by this act," etc. Article VI, section 8, requires that the mine foreman "shall enter in a book \* \* \* a report of the condition of the mine, signed by himself," etc. Also, in article XII, section 1, it is required that the person having charge of the mine shall notify the Mine Inspector of any accidents that may occur, etc. Also, article VI, section 5, provides that "The mine foreman shall measure the air current \* \* \* and keep a record of such measurements," etc.

It will be observed by a careful examination of this act that the duties required by a mine foreman and fire boss under it are largely personal and require their personal attention and ability to perform them.

It is to be inferred from your letter that persons applying to the examining board for these positions under this act can neither read nor write. It is doubtless true that many persons of large experience and practical knowledge in the operation of bituminous coal mines can neither read nor write, yet the Legislature, in its wisdom, in the adoption of this act, prepared undoubtedly by competent and experienced persons, seems to require, in addition to this knowledge and experience, the intelligent power of imparting it, and directly requires the ability to read as well as to write. If this inability to read

or write should appear in the examination of your board, in the person of any applicant, it would undoubtedly be an evidence of incompetency under this act of assembly, and at the same time would not discredit the practical knowledge and experience of such person.

I repeat that it is not the disposition of this Department to interfere with your duties under this act. The examinations are to be made by the examining board. These persons have been selected to perform this duty in consequence of their superior knowledge and experience in the bituminous coal mines. It would be unwise and improper for this Department in any way to interfere with their duties in this behalf, but it will certainly appear to the examining board that many of the duties required by this act to be performed by the mine foreman and fire boss should be in writing, and under their own personal knowledge and supervision, and not left to be done or performed by others; and after it is so done, they themselves would be unable to read the record so kept by those doing business for them.

It is only in consideration of the importance of this bill and of the great interests at stake under it that this Department undertakes by this letter to make any suggestions whatever in the matter. The examining board will be guided by its own superior judgment in the performance of its duty.

Very truly yours,

(Signed.)

JAS. A. STRANAHAN,  
Deputy Attorney General.

---

#### Description of the "Stanley Header" Machine.

In my last year's report I gave an account of the work done by the "Stanley Header" for a short trial that was made by it as an experiment. I am now in a position to give a more detailed account of the work performed by it at Leisenring No. 2 mine of the H. C. Frick Coke Company. The description was written for the "Colliery Engineer and Metal Miner," and is here reproduced.

The Leisenring No. 2 mine is located at Bute, Fayette county, Pennsylvania, on the Vance Mill branch of the Monongahela division of the Pennsylvania Railroad (P. V. & C. R. R.) It is situated in about the heart of the Connellsville coke region, and is about seven miles from Connellsville and five miles from Uniontown. R. A. Slater is superintendent and Walter O'Malley is underground foreman. The coal is reached through a shaft some 425 feet in depth. Both sides of the shaft have been developed.

It was found that the coal on the "dip" side was much softer than

that on the "rise" side of the shaft. As the headings were driven towards the western outcrop, it was found that the coal became harder. Just before the heading machine was placed in the mine it was impossible to get men to drive these headings at the usual scale rate; the scale called for \$1.12 per 100 bushels of coal, while the Frick Company paid for these headings a minimum price of \$1.80 per 100 bushels and more frequently \$2.00.

After working for some eight years, these headings have advanced nearly a mile and a half from the bottom of the shaft, and about 2,000 feet remained to be driven before they would reach daylight. To drive them out to the crop was the task set for the machine to do.

The workings were so far in, that it was very difficult to properly ventilate this part of the mine, and these headings were to be driven to the outcrop for two purposes:

First. For an upcast or outlet for the ventilation.

Second. For a second safety opening.

The compressor at the works was an old style, straight line, poppet valve compressor, size 20x30 inches. At 85 revolutions per minute it was capable of compressing air to a pressure of 75 pounds. From the compressor, the air was conducted through a four-inch pipe to a receiver some 75 feet away and situated at the top of the shaft. From the receiver a four-inch pipe ran down the shaft 425 feet, and from the bottom it ran into the works about 200 feet. Coupled to this was 4,375 feet of 6-inch pipe; following on this line of six-inch pipe was 700 feet of 3-inch pipe, 600 feet of 2½-inch and 1,500 feet of 2-inch laid in the order given. The reason the pipe was laid in this manner was that before the machine came to the mine the dip workings were kept free from water by pumps driven by compressed air. As the work of the Stanley machine was more in the nature of an experiment, owing to the fact that this seam of coal was considered too soft to mine economically with machines, the Frick Company did not care to go to the expense of repiping the shaft until the success of the machine was demonstrated. The pipe was laid very hurriedly and carelessly. No provision was made for draining the condensed water, and in going over this line of pipe, the writer counted no less than 70 leaks and seven right angle turns. With a pressure of 75 pounds at the compressor, a standing pressure of only 35 pounds could be had at the face. When the machine was running, the mean effective (running) pressure would drop to eight pounds.

At this point new features were met in heading driving with the Stanley. All the work heretofore done by this machine had been in mines where the demand was for a maximum quantity of lump coal, and never before had the machine been required to cut a heading more than six feet in diameter. At Leisenring No. 2, where all the coal is coked, small coal was the most desired.



A new head or cutting had to be designed. Instead of the bifurcated arms, a casting was made, across the face of which were taper sockets for the reception of the cutting tools. These bits were set every nine inches across the face alternating on each side of the center, so that the distance between the concentric circles was four and one-half inches. They were placed so that the center bit led the outside ones by about a foot. This made the cut a conical one, the slack as it was made, sliding back out of the way of the cutter head. After the bits had penetrated to a depth of five or six inches the coal was found to break off, even when the work was on the butts of the coal. More power was necessarily needed to drive this new head, cutting as it did a seven-foot opening and grinding the coal approximately to slack. This was accomplished by an extra back gearing.

The Stanley engines are of the duplex type, size 8x6 inches, making 350 revolutions per minute. Longitudinally through the centre of the machine, a screw shaft runs, attached to the forward end of which is the cutter head. This screw is the device by which the head is fed forward as the cut advances. After six feet has been cut, the head is anchored and the feed nut reversed. By this operation the whole machine is pulled up and the same process is again gone through with. Through the lower section of the machine, an endless chain conveyor is run, which carries the coal as fast as cut to the rear end of the machine and deposits it in mine wagons.

In the operation of the machine, the services of three men are required. One, the foreman, runs the machine and sees that it is kept up, and also as the work progresses, squares up the bottom with a pick. He receives for his work \$2.50 per shift of nine hours. The other two are common laborers, their duty being to shovel the coal into the conveyor as fast as it is mined. They receive \$2.00 each per shift.

In driving 2,254 feet of heading an actual average of 17 feet per shift was made, and 75,150 bushels of coal mined and loaded.

|  |             |
|--|-------------|
| 75,150 bushels cut in 130 shifts, at \$6.50 per shift, . . . . . | \$845 00    |
| Machine repairs, . . . . .                                       | 5 00        |
|  | <hr/>       |
| A total cost of, . . . . .                                       | \$850 00    |
|  | <hr/> <hr/> |
| Cost per foot, . . . . .   | .3775       |
| Cost per 100 bushels coal, . . . . .                             | \$1 13      |
|  | <hr/> <hr/> |

Of these 130 shifts of 9 hours each, only 55 per cent. of the time was consumed in actual cutting or in the operation of the machine.

On this basis, the work should have been completed in 73.1 shifts of 9 hours each.

|   |             |
|---|-------------|
| 75,150 bushels in 73.1 shifts, at \$6.50, ..... | \$475 15    |
| Machine repairs, .....                          | 5 00        |
|   | <hr/>       |
| Total cost, .....                               | \$480 15    |
|   | <hr/> <hr/> |
| Cost per foot, .....                            | \$0 21 1-3  |
| Cost per 100 bushels, .....                     | 64          |
|   | <hr/> <hr/> |

In not driving the parallel, the Frick Company saved:  
Excess rate per 100 bushels of coal in heading over room  
rate was, .....

\$0 80

|  |             |
|--|-------------|
| 1,475 feet—49,170 bushels, at 80 cents, .....  | \$393 36    |
| Break—through every 300 feet through a 30-foot pil-<br>lar—150 feet—5,100 bushels, ..... | 40 80       |
|  | <hr/>       |
| Total, .....   | \$434 16    |
|  | <hr/> <hr/> |

The 2,254 feet that was cut in 130 shifts of nine hours, represents every shift in which any cutting was done, as well as those shifts when the machine was broken down or undergoing repairs. Some days the men would start the machine and cut only a foot or so, when some delay on the part of the mine management would arise, making it an impossibility to get either any more wagons or compressed air for the machine.

The men were on duty 130 shifts of nine hours each. Total, 1,700 hours. The delays during the said time were as follows:

|  | Hours.      |
|--|-------------|
| For empty wagons to load, .....                      | 196.16      |
| For wrecks on haulage after cars left machine, ..... | 85.30       |
| For compressed air, .....                            | 20.08       |
| For pipe and track, .....                            | 47.58       |
| For engineer giving points, .....                    | 20.09       |
| For cutting roof and horse-backs, .....              | 36.00       |
| For sundries, .....                                  | 69.25       |
| For machine break downs, .....                       | 37.50       |
|  | <hr/>       |
| Total, .....   | 511.96      |
| Actual working time, .....                           | 658.04      |
|  | <hr/> <hr/> |

The problem of handling the wagon was quite a serious one. From the end of the rope haulage to the starting point of the machine was a haul of 2,500 feet up a seven per cent. grade. All a team of mules could do was to haul two empty wagons up this grade. The handling of the loaded wagons was as difficult. Often the loaded wagons with all wheels spragged would get away from the driver and tear down the grade and wreck themselves, playing general havoc. No further comment on the other delays is needed, save perhaps it might be well to state that of the thirty-seven and one-half hours chargeable to machine, twenty of these were consumed in sending for and getting to the works a small gear shifter, no extra parts being kept on hand.

A great portion of this work was done during the general miners' strike. During this strike, the only work done at Leisenring No. 2 was in driving these headings by the Stanley machine. The drivers, etc., were naturally disorganized, and it could hardly be expected that the work should have progressed as fast as if the mine had been running at its full capacity.

A distance of 1,475 feet was driven without a parallel. This is remarkable, as Leisenring No. 2 mine is one of the most gaseous in the Connellsville region, the general use of safety lamps being required by law. In this case the parallel was an unnecessary feature, as the heading was driven only for a second opening and as an upcast for the ventilation.

The machine ventilates its heading as it progresses by utilizing the exhaust as a jet blower, sucking up all the dust, etc., into an 8-inch pipe and discharging it at the rear end of the machine. By this device, great distances ahead of the natural ventilation can be driven. Besides the saving in break-throughs, the pillar is kept intact, saving all leakages in the stoppings. Many runs of 31 feet in a shift of nine hours were made and in a few cases 100 bushels of coal have been mined and loaded into the wagons in eighteen minutes.

The heading made was beautiful, being perfectly arched, increasing the strength of the roof. It was perfectly smooth and straight, giving much less friction for the air current.

In doing this work at least 100 "horse-backs" were encountered. They were of a slaty nature, but the machine had no difficulty in cutting them although they frequently occupied half the cross section of the heading. This made an additional saving, for by hand the miners only cut the coal out and are followed by a crew of horse-back men who shoot up the bottom and load the refuse into the wagons. This method is both expensive and dangerous, by reason of the existing fire damp.

Summarizing the advantages of this machine which occur to the writer are:

First. Rapidity of development; great speed attained.

Second. Reduction in cost of heading driving.

Third. Economy in the use of compressed air.

Fourth. Reduction in cost of timber, and improved ventilation, owing to the arched roof, smooth rib, and reduced number of break-throughs.

---

#### Description of Mines in the Fifth Bituminous Inspection District.

Atlas. This mine is operated by the Cambria Iron Company, and is located near Dunbar. The fire which is still burning in the mine is a source of danger, and has to be carefully watched to keep it from spreading. To do this more effectually, new brick stoppings have been built along the side of the manway, the better to exclude the air. Through these walls pipes are inserted, to which can be attached connections from a new three-inch pipe-line 1,600 feet in length, which has been put into the mine during the year, and which is connected to the water cistern outside the mine. Through this pipe-line, water is conveyed into the mine and can be utilized to keep the mine fire under subjection and within definite limits. Every care is exercised to prevent the fire from spreading, also to prevent accidents from that source. A large water sump has been made at the extreme dip workings during the year for the purpose of collecting the water which the mine makes, and also that of adjoining mines (Mahoning and Anchor). Large pumps are located near, which will raise this water through bore-holes to the surface. Various improvements made in the mine during the year have cost an aggregate of over \$1,000. The mine is in good condition as to ventilation and drainage, and is being well looked after.

Mining boss, Chas. R. Trew.

Anchor. Is operated by the Atchison Coke Company, and located near Dunbar. The coal in this mine is nearly all procured from ribs and entry pillars, and is rapidly approaching the mine mouth and will soon be exhausted.

The mine fire which has been burning in this mine for years is left behind in the "gob," and does very little damage, except that black damp and other noxious gases are given off and mix more or less with the air current, but as there is an abundant supply of fresh air being forced into the mine by the fan, the deleterious effects are not felt much. Under the careful supervision of Mr. Duncan, every precaution is taken to insure safety to life and property. At the present rate of mining, the mine will be exhausted in about two years.

Mining boss and superintendent, William Duncan.

Bessie. This is a new mine opened out during the year, and is owned and operated by the Lynn Coal Company, and located on a branch road of the Pemicky Railroad, near Perryopolis, Fayette county.

The improvements consist of a new tippie, with all the most approved appliances for screening and preparing coal for market, a new boiler and engine house, one boiler and a pair of engines.

The opening is a slope, and follows the dip of the coal the grade being about seven feet to the hundred. The main heading will be on the double heading system, and the butt headings will be worked on the three-entry plan. A shaft twenty-eight feet deep has been sunk, on which will be built in the near future a fan of the "Guibal" type. This promises to be a well laid out mine, and under the present management will be well looked after, both as to healthfulness and safety.

Mining boss, Jacob Hauser.

Baugh. This is also a new mine. It has been opened out by the Paugh & Luce Coal Company, and is situated near Perryopolis, on the branch road of the Pemicky Railroad which runs up Washington Run. The opening has been driven diagonally across the dip of seam, and the coal is hauled out by mules. Another opening is being made which will shorten the haul, and also improve the ventilation, which at the present is by natural means. Some artificial means will be adopted when the second opening is completed, which, with other contemplated improvements, will bring the mine within the requirements of the law.

Mining boss, Allan Champ.

Buffalo. Idle all year.

Berlin. Operated by John O. Stoner and located on the Berlin branch of the Baltimore and Ohio Railroad near Berlin, Somerset county. This mine worked 200 days during the year, but most of the time only three men were employed to supply local consumption of coal for domestic purposes in the town of Berlin. Ventilation and drainage fair.

Mining boss, Conrad J. Baker.

Casselman. Situated on the Baltimore and Ohio Railroad at Garrett, Somerset county, and operated by the Casselman Coal Company. This mine was not operated very strongly during the year, working only 130 days and with a greatly diminished force of workmen, producing only 25,000 tons of coal in 1894, as compared with 60,000 tons in 1893. Loss of orders caused by the strike is assigned as the reason for the decreased production.

A stairway was put in the air shaft as a second means of escape. The drainage and ventilation have been improved. A new slope has been put down through the old workings which will shorten and improve the haulage of coal and lessen the cost of operating the mine. Mine generally in good condition and well looked after.

Mining boss, Henry Naylor.

Cumberland. Operated by the Cumberland and Summit Coal Company, and located near Myersdale, Somerset county. This mine is in fair condition as to drainage, but the ventilation is defective. Formerly it was ventilated by natural means, and in order to comply with the law which requires some artificial means of producing ventilation, a "fire basket" was put in at one of the old openings to act as a furnace, but it has proved utterly inadequate to furnish sufficient ventilation for the requirements of the mine. While nominally complying with the law, so far as it relates to artificial means being employed, virtually and actually it depends on natural means to produce what little ventilation is in circulation. At each of my visits I found just a little over the lawful quantity of air per man, but more is needed to remove the dense volumes of powder smoke generated by the excessive use of gunpowder in blasting the coal.

Mine boss and superintendent, Fred. Rowe.

Clarissa. Owned and operated by James Cochran, Sons & Co. This mine is in good condition in every respect. Formerly it was ventilated by natural means, but in order to comply with the law, a large furnace was built at the bottom of air shaft which produces an abundance of air throughout the entire mine.

Mining boss, J. C. Moore.

Chester. Operated by E. A. Humphries & Co. The ventilation in this mine was somewhat defective at the beginning of the year, on account of the power producing the air current being too weak to overcome the resistance of the airways. To remedy this evil, a new air shaft was put down in the interior of the mine, which reduces the distance that the air had to travel about one-half, and consequently gives a greater volume of air in the mine. The mine is now fairly well ventilated, and in other respects it is in good condition.

Mining boss, George Armstrong.

Crossland. This mine is in excellent condition and is looked after in such a manner that complaint is unnecessary. The ventilation is abundant and well distributed around the working places. The haulage roads and drainage is kept in good shape. A new "Guibal" fan has been erected over a new air shaft, which was sunk during the year. The fan is so constructed that it may be used either as a

blower or an exhaust, and gives good results. A new tippie has been built and also coal bins, from which the coal is loaded into a "larry," and the coke ovens are charged by this means, instead of directly from the mine wagons, as was formerly done. Much better results are secured, and valuable time saved by the new arrangements.

Mining boss, David Walters.

Cheat Haven. This is a new mine opened out on the Fairmont, Morgantown and Pittsburgh Division of the Baltimore and Ohio Railroad, and operated by the Cheat Haven Coal Company. It is opened out on the double entry system and is well laid out with a view to large shipments. An air shaft has been sunk and a furnace will probably be built in the near future.

The coal lies up on the hills several hundred feet above the level of railroad and is lowered down from the mines to the tippie by means of a self-acting incline, whereby the loaded mine cars haul up the empty ones. The tippie is well built and has all modern improvements and equipments for the preparing of coal for market. The mine does not at present employ a sufficient number of persons to come under the provisions of the law, and therefore has no mine boss.

Superintendent, Chris Echard.

Edna. This mine only worked 84 days during the year, and was not working at any of my visits, and is now idle again. Its condition was fair as to drainage and ventilation.

Mine boss, H. M. Wilson.

Elm Grove. Operated by W. T. Rainey. This mine is in fair condition, both as to drainage and ventilation. A new slope opening is contemplated as one of the improvements in the near future.

Mining boss, Walter McDonald.

Fairchance. Located near Fairchance and owned and operated by the Fairchance Furnace Company. This mine is a peculiar one, owing to the surface being so thin above the coal seam. On this account numerous falls break through the surface and make it impossible to have any regular system of ventilation. The bottom being a soft fire clay, and the surface water having ready access to the mines, the drainage is at times very bad. A new fan was built during the year and would give good results providing the air current was not cut off so frequently by the numerous falls through to the surface. Upon the whole, however, the men do not suffer for want of air by reason of the great number of falls which all act as air shafts. A new slope is now being worked which will go under thicker surface, and better results will then be obtained.

Mining boss, John N. King.

Ferguson. This mine has only worked part of the year and only with about nine or ten men employed. The mine generally is in fair condition.

Mining boss, Michael McQuade.

Fairview. Operated by the Fairview Coal Company, and located on Grassy Run, Somerset county. The ventilation in this mine is still produced by natural means. I have received promises at each visit to this mine that it should be put in conformity with law, but as yet they have not been fulfilled. There is only one thing that is left to be done under the circumstances, viz: To prosecute the management for violation of the mining law. On my last visit I notified the superintendent to comply with the law before my next visit, and on failure to do so that I would enter proceedings against him. There are no means used to force air into or conduct it around the workings of the mine in any regular, continuous current, but nature is left to do the best she can to supply the deficiency, and when natural means fail, then the men employed in the mine have to suffer for lack of air. The condition of the mine in this respect is a standing disgrace to the management, and a positive injury to the health of the persons employed therein.

Mining boss, Archie Cochrane.

Grindstone. This mine was idle nearly all year, having only worked 30 days. The condition of the mine was such, that when I learned that it had commenced operations again, I at once visited it. It generates large quantities of explosive gases, and knowing that large accumulations of such gases were in the old and abandoned parts of the mine on former visits, I was anxious to know if these gases were still allowed to remain in the mine. On examining the mine I found that the dangers still existed, whereupon I made the following suggestions in writing to Thomas Burtoft, mine foreman, on July 7, 1894:

First. That masonry stoppings be built between main intake and return airways.

Second. That shelter holes be made on main haulage road.

Third. That air crossings be made of incombustible material.

Fourth. That safety lamps be used exclusively in all parts of the mine.

I added, "I expect to hear from you that the above suggestions have been carried out in as short a time as possible." I waited for two weeks, and not receiving any communication from the mine officials relative to the above suggestions, I made arrangements with three of the other Inspectors to visit the mine with me, and on July 24th. Messrs. Louttit, Jenkins and Callaghan, Inspectors of the First, Second and Ninth districts, respectively, and myself, again visited the



mine and found the same dangers to exist, whereupon the officials were again notified as before, and shortly afterwards all of the suggestions were complied with. At this second visit I notified the mine foreman in writing to have all of the standing gas removed as far as practicable within five days, which was done, and the mine was then in a comparatively safe condition. After the safety lamps were introduced into the mine another difficulty arose from the fact that electric wires were distributed throughout the mine to supply power to run mining machines, and such wires and machinery connected therewith were not constructed in such a manner as to insure safety from the emission of sparks into the atmosphere of the mine, as required by law. Under these circumstances (on learning that the machines were still being used in the mine) I at once notified the superintendent to immediately stop all the electric currents from entering the mines, unless they could secure freedom from the emission of sparks into the mine atmosphere as required by law. On receipt of my notification the machines were promptly withdrawn from the mine. Shortly afterwards the mine was shut down and has not again resumed operations.

Mining boss and superintendent, William Gillic.

Great Bluff. This mine was only run for the purpose of supplying coal for domestic purposes and employed only five men during the year, and was therefore not under the provisions of the law.

Grassy Run. Mine in fair condition as to drainage, but not complying with law in regard to ventilation, inasmuch as it has no artificial means to put air in circulation through the mine, although at each visit I found an abundant volume of air passing around the working places which was produced by natural means.

Mining boss and superintendent, John Meagher.

Hamilton. This mine employs only nine persons and does not come under the provisions of the law, and is nearly exhausted. Only a few ribs and entry stumps are to be mined to finish the mine.

Hocking. This mine is located on the Salisbury branch of the B. & O. Railroad, Somerset county. This is one of the many mines in Somerset county which has never adopted any artificial means of producing ventilation, and like all such the ventilation is uncertain and variable, sometimes there is an abundance, and at other times not any at all. The owners were notified to comply with law in this respect, and failure to do so on their part will result in proceedings being entered against them. The drainage and other conditions of the mine were good.

Mining boss, Robert A. Winter.

**Hill Farm.** This mine is operated by the Dunbar Furnace Company. Located near Dunbar. Ventilation is produced by fan and is amply sufficient for the requirements of the mine, but it is not well distributed around the working places. The drainage is also bad in parts of the mine, especially on the manway. The slope is also in a very dangerous condition, from the effects of the fire, which has loosened the strata to such an extent that numerous falls occur, and careful watching is necessary to prevent accidents. Every precaution is used by the mine officials to render it as safe as possible. The mine fire still burns on each side of the slope, hence the temperature of the air on the slope is very high, ranging from 85 to 90 degrees.

Mining boss, Matthew Herron.

**Hurst.** This mine has no second means of escape for the men, except through the furnace shaft. I notified the owners to have another opening made as soon as possible to comply with the law, and not to work more than 20 persons at any one time in the mine until such opening had been made. The air current was not sufficient for the requirements of the mine. I therefore had the superintendent build thirty feet of stack on top of the air shaft, and also to turn the exhaust steam into the shaft, by which means the volume of air was considerably increased. Owing to lack of trade the mine has suspended operations indefinitely.

Mining boss, Jacob Hauser.

**Juniata.** This mine is in good condition in all respects and is well and carefully managed.

Mining boss, John D. Hayden.

**Kyle.** Owned and operated by the H. C. Frick Coke Company. Located near Fairchance. The mine is in good condition as to ventilation, drainage and general safety.

Mining boss, I. W. Rickard.

**Keystone.** Idle all the year.

**Leith.** Owned and operated by the H. C. Frick Coke Co. Located near Uniontown. This is an extensive mine and is in good condition in all respects. The officials are desirous of doing everything to conform to law, and indeed even exceed its requirements in many instances. The mine is well equipped with first class machinery and appliances for the rapid handling of a large output of coal, and is efficiently managed and looked after. A new pipe-line four inches in diameter has been laid from the shaft to a bore-hole (which has been drilled for water) located at the foot of Chestnut Ridge near Hopwood, a distance of about two miles. The water flows from the bore-

hole and runs by gravity to the shaft where it is used in the boilers; also for the coke ovens. This insures a reliable supply of water during dry weather.

Mining boss, Thos. Hooper.

Leisenring No. 1. This mine is in good condition generally, ventilation and drainage being well looked after. A new underground fire proof stable was completed early in the year; also the pump house was arched over with brick and lighted by electricity. Everything about the mine is of a substantial character.

Mining boss, George Roebuck.

Leisenring No. 2. This mine is now in fair condition. On one of my visits I found the air in the headings on north flats very feeble, and the lights burning dimly. This was due to the fact that some doors and stoppings were not in place. Some alterations with reference to the position of doors and the erection of overcasts were made, when the condition of the air was very much improved. The drainage upon the whole is good, as is the condition of the mine generally.

Mining boss, Walter O'Malley.

Leisenring No. 3. This mine was found to be in good condition at each of my visits. The drainage is good, as is also the ventilation. I always found large quantities of explosive gases in the old or abandoned workings where ribs had been drawn, and also in the gob, where ribs were being worked. I am of the opinion that this danger could be obviated by the drilling of bore-holes from the surface through into these "gobs" and the gases allowed to escape through the bore-holes. This mine is kept safe only by the large volumes of air brought to bear upon the gases, and should a breakdown in the ventilating apparatus occur, the mine would soon fill with these explosive gases and become dangerous. Great care is exercised by the management to prevent accidents and the mine is being well looked after.

Mining boss, John Nolan.

Lynn. This mine is in good condition, both as to ventilation and drainage. A new air shaft was sunk 70 feet in depth, on top of which a stack of 30 feet was built. At the bottom of this shaft a furnace was built which produces an abundant volume of air for the requirements of the mine.

Mining boss and superintendent, James Harding.

Langhead. This small mine is in good condition, having an abundant supply of air and is well drained. The coal is being worked on the retreating system, the headings having all been driven to the

boundary before rooms were worked, thus cleaning all the coal as the workings come back. The water is all drained by the adjoining mines, they being to the dip. The mine is well looked after.

Mining boss, James Allen.

Lemont No. 1. Owned and operated by the McClure Coke Company. This mine has a large number of pillar workings which have been left standing for years, and it will be difficult to recover them on account of the numerous falls in the old rooms, and also because the pillars have not been left large enough to allow them to be split. When work is commenced to draw them, a squeeze may be expected to overrun the mine, and large quantities of coal be lost. Gas is generated in the mine in considerable volumes where ribs are being drawn, and great care is required in order to keep it safe. A considerable volume of the intake air was allowed to escape through imperfect stoppings, before reaching the working places of the mine. A volume of 39,500 cubic feet was measured at inlet, while at a point further in the airway (and before it had been split to supply the working places) a volume of only 21,000 cubic feet could be obtained, showing a loss of 18,500 cubic feet by leakage, or nearly one-half. I called attention to this matter and the mine officials promised to have the defect remedied.

Mining boss, James Hart.

Lemont No. 2. This mine is in good condition, having been opened out and worked by the McClure Coke Co., they having retained as the mine boss Mr. Elias Philip during all the time the mine has been operated. It has been carefully looked after, and in consequence its condition is good in every respect. There has been no gouging, but everything has been done by systematic methods. The mine has been well laid out by the engineer in charge and the plans have been faithfully followed. The results show that coke can be made as cheap by proper methods of working a mine, as by haphazard methods which result in great damage to the mine, and also great loss of coal. The mine exceeds the demands of law with reference to healthfulness and safety. I regard this mine as one of the best in my district.

Mining boss, Elias Philips.

Morgan. Operated by Pinnell & Morgan and located on Salisbury branch of the Baltimore and Ohio Railroad, Somerset county. This mine is a new one and employs only ten men, but more men will be employed as the work is developed. The openings have not yet been connected, but are being rapidly pushed, and will soon be in such shape that the ventilation can be conducted up to and around the working places. The mine has only been in operation since September 1, 1894. No mine boss is employed yet.

**Morrell.** This mine is operated by the Cambria Iron Company. The condition of the mine has not been very favorable during a great part of the year. The ventilation was not carried up to the working places but allowed to leak through imperfect canvas doors and stoppings. The drainage was also very bad in parts of mine, sections of main haulage roads being under several inches of water for distances of several hundred yards. The main slope is also in a dangerous condition. The timbers supporting the roof are broken and require to be renewed in quite a number of places to insure safety. Some improvements have been made and others are now being made to put the mine in better condition.

Mine boss, John Yocum.

**Mahoning.** Operated by the Cambria Iron Company. This mine is in good condition both as to ventilation and drainage, and is well looked after.

Mining boss, D. P. Brown.

**Mt. Braddock.** Operated by W. J. Rainey. This mine has been pushing the headings and opening up new workings. The old part of the mine being in bad condition, an effort has been made during the year to develop new work so that the mine could be put into such condition as would conform to the law, and at the same time enable the operator to secure a sufficient quantity of coal to keep the ovens in full blast. If the developments are continued during next year, the mine will be in such condition as will place it amongst the best in the district, instead of being as now regarded, one of the worst. A new air compressor has been built during the year for the purpose of running the mine pumps by air instead of steam as heretofore. Eighteen new dwelling houses have been also erected during the year. The condition of the mine is good as to ventilation and drainage.

Mining boss, J. M. Franklin.

**Nellie.** This mine is in good condition throughout. New brick overcasts have been built and some new splits made in the air current, which have greatly increased the volume of air in circulation in the mine. A new coal crusher has also been erected which crushes the coal before it is put into the coke ovens. It is claimed that a better quality of coke is made by the adoption of this method of treating the coal.

Mining boss, David B. Young.

**Nellie.** This is a new opening which has been made during the year. It is located on the Salisbury branch of the Baltimore and Ohio Railroad in Somerset county and is operated by E. Statler. The mine is being well opened out and if the present methods are continued, a good mine will be the result. At present only nine persons are employed, and consequently no mining boss is required.

Oliphant. Operated by the H. C. Frick Coke Company. Located near Fairchance. This mine is in fair condition. At the beginning of the year the air current was somewhat vitiated on the left side of the slope, owing to black damp from the gob workings being allowed to mix with it, where ribs had been taken out. The direction of the air current was changed, and this defect was remedied and the mine is now in fair condition, both as to ventilation and drainage.

Mining boss, James S. Connor.

Oliver No. 1. Operated by the Oliver Coke and Furnace Co. This mine is in good condition. A new fan has been erected during the year which produces an abundance of air. Several new brick overcasts have been built, and the air current is split into various parts of the mine and conducted into main return airways, which go directly to the upcast shaft and are independent of and have no connection with any of the traveling or haulage roads. By this arrangement, if gas should be given off in dangerous quantities, it can be carried directly out and not be allowed to go to any other part of the mine. An endless rope system of haulage is being put into the mine, which will very much improve the handling of the coal. The stables are also made fire-proof by being lined with brick laid in cement.

Mining boss, C. B. Ross.

Oliver No. 2. Operated by the same company as the Oliver No. 1 mine, and is practically the same mine, as it is ventilated by the same fan and is connected in such a manner by underground railroads that coal can be sent from any part of the workings to either shafts as required. A new iron head-frame has been erected at this shaft, and is equipped with self dumping cages which deliver the coal automatically from the mine wagons into a large iron bin. From this bin the coal is drawn through openings into larries which charge the coal into the coke ovens, 300 in number, which have also been built during the year. The engines and machinery about this plant are of a strong and durable character.

Mine boss, C. B. Ross.

Paul. Operated by W. J. Rainey. This mine is in excellent condition both as to ventilation and drainage. The slope has been regraded to allow the cars to run back into the mine by gravity, and so well has this been done that a very large output of coal can be delivered into the bins in a remarkably short time.

Mining boss, Robert Nelson.

Percy. Operated by the Percy Mining Company. This mine has not run full time during the year, the production being mostly used

to supply coal for the locomotives on the Baltimore and Ohio Railroad. Condition of mine good.

Mining boss, Everhart Shipley.

Pine Hill. Located on Berlin Branch of the Baltimore and Ohio Railroad. Owned and operated by S. Coleman & Son. This is a small mine and is not in very good condition either as to drainage or ventilation. The most of the coal produced during the year was mined when the other mines in Somerset county were on a strike.

Mining boss, Henry Naylor.

Redstone. Operated by the H. C. Frick Coke Company. The condition of this mine is evidence of the fact that it is being looked after by careful and competent persons. The ventilation, drainage and general conditions are good throughout the entire mine.

Mining boss, Elijah Parker.

Stewart. Operated by the Stewart Iron Company, Limited. The condition of this mine is also good. The new workings are being developed by headings in such a manner as to make a squeeze impossible when the ribs are being removed. The management has profited by experience, as quite a large quantity of coal was lost by creeps which were caused by leaving insufficient pillars. Attempts are being made to recover some of this lost coal, but with what success the future will determine.

Mining boss, Isaac G. Roby.

Sniders. This mine is operated entirely for the production of coal for domestic purposes, and except during the winter months, does not employ enough men to bring it under the requirements of law. On the whole it is in fair condition.

Mining boss, Robert Wilson.

Smock Nos. 1 and 2. Operated by J. D. Boyd Coal Company. No. 1 mine is in good shape as to drainage, but the ventilation is not vigorous enough to keep the working places clear of powder smoke. No better results can be hoped for with the present furnace, as it is too small to do the work. No. 2 mine has just been opened out and does not yet come under the provisions of the law.

Mining boss, Ben Holliday.

Statler. The drainage in this mine is good. The ventilation is uncertain and variable, both in quantity and direction, being produced by natural means. A new air shaft has been sunk, at the bottom of which a furnace will be built and better results are anticipated.

Mining boss, Orlando Flesher.

Shaws. This mine is in good condition so far as drainage is con

cerned. The ventilation, however, is not what it should be. This is due to the fact that the furnace is too small for the size of the mine, and is unable to produce air in sufficient quantities to ventilate the workings properly. A fan was at one time about to be erected, but the lack of water to supply boilers to generate steam, caused the plans to be changed, and now a new shaft will be sunk near the face of the present workings and another furnace built of such dimensions as will give an air current sufficient for the mine.

Mine boss, James Philips.

Shaw's Grassy Run. This mine is about exhausted, as all the coal is nearly worked out. A few more months will finish it.

Mining boss, Wm. K. Murray.

Standard. This is an old mine reopened and located on the Berlin branch of the Baltimore and Ohio Railroad. It has not been operated very extensively, however, as there are only ten or twelve men employed. The condition of the mine is not good, as the drainage and ventilation are defective. Since the strike ended only nine men have been reported as being employed, therefore there is no mine boss in charge.

Tub Mill Run. The drainage of this mine is good, but the ventilation is very defective. Notice had been given to the operators to comply with the requirements of law, and provide some artificial means to produce ventilation, but nothing as yet has been done. Excuses were made that the strike had prevented them from doing so. Unless action is taken to comply with law, proceedings will be entered against them.

Mining boss, John Rees.

Thomas. This mine is in fair condition as to drainage, but is not up to the requirements with regard to ventilation.

Mining boss and superintendent, Benjamin Thomas.

Trotter. Operated by the H. C. Frick Coke Company. This mine is in good condition, and like all the Frick Company's mines is kept ahead of the requirements of the law in regard to ventilation.

Mining boss, W. J. Callaghan.

Taylor. This is a new mine and is operated by Isaac Taylor & Co. It is located on a branch of the P. V. & C. Railroad near Vance's Mill. It has not yet employed more than nine men in the mine, consequently no mine boss has been employed.

Uniondale. Idle all year.

Wynn. Operated by the H. C. Frick Coke Company. Located near Fairchance. This mine only worked 31 days during the year. It is



in good condition both as to drainage and ventilation and is well looked after.

Mining boss, Robert Donaldson.

Wheeler. Operated by Cambria Iron Company. Ventilation good, general condition fair. Drainage could be improved, especially on the hauling roads.

Mining boss, Frank Deary.

Washington. Operated by the Washington Coal and Coke Company. This mine has been very rapidly developed, and the workings are very extensive for the time the mine has been operated. At each visit I found the mine in good condition, the air well distributed and abundant in volume. The drainage good and the mine throughout is being well managed and looked after. It is now producing about 2,400 tons of coal daily.

Mining boss, George W. Santimyer.

Walker. Operated by George K. Walker. Located near Elk Lick, Semerser county. This mine is in good condition but requires some artificial means to produce ventilation in order to comply with the law.

Mining boss, Robert Easton.

Yoder. Operated by Cumberland Coal and Mining Co. This is an old mine which has been reopened. The condition of the mine is not good, either with regard to ventilation or drainage. Improvements have and are being made, which when completed will put it in fair shape. This will require time, patience and expense, which are being expended upon it.

Mining boss, Thomas Coulihan.

Youngstown. Operated by the Youngstown Coke Company, Limited. This mine is a very difficult one to operate, owing to the bad roof which is encountered. Explosive gas is also generated largely, and great care has to be exercised to keep it in a safe condition. This is being done by the officials in charge, and despite the difficulties which they have to contend with, its condition is being steadily improved. A change in the method of ventilation is contemplated, and when this is accomplished good results will follow. The air will be greater in volume and better distributed. More or less trouble has been experienced from a partial squeeze which has taken place where ribs have been drawn in parts of mine. This difficulty has to a great extent been overcome, and if the same good management is continued, the mine will in a short time be in a comparatively good condition.

Mining boss, James Exton.

TABLE NO. 1.—Showing location, etc., of collieries in the Fifth Bituminous Mine District.

| Name of Colliery. | Name of Operator.                          | Location—County. | Name of superintendent. | Postoffice; address. |
|-------------------|--|------------------|-------------------------|----------------------|
| Atlas             | Cambria Iron Company.                      | Fayette.         | Martin Meagher.         | Connellsville.       |
| Anchor            | Atchison Coke Company.                     | do.              | William Duncan.         | Dunbar.              |
| Bessie            | Lynn Coal Company.                         | do.              | George Whyel.           | Uniontown.           |
| Beulah            | Baugh & Luce Coal Company.                 | do.              | Isaac Baugh.            | Ferryopolis.         |
| Berlin            | Buffalo Coal and Coke Company.             | Somerset.        | W. F. Childs.           | Meyersdale.          |
| Casselman         | John O. Storer.                            | do.              | Nevin Long.             | Herlin.              |
| Cumberland        | Casselman Coal Company.                    | do.              | William C. Hocking.     | Meyersdale.          |
| Clarissa          | Cumberland and Summit Coal and Coke Co.    | do.              | Frank Rowe.             | do.                  |
| Chester           | James Cochran Sons & Co.                   | Fayette.         | P. S. Cochran.          | Vanderbilt.          |
| Crossland         | F. A. Humphries & Co.                      | do.              | R. J. Humphries.        | Yancker's Mill.      |
| Chest Haven.      | The Atlas Coke Company.                    | do.              | James Henderson.        | Uniontown.           |
| Elm Grove.        | Chest Haven Coal Company.                  | do.              | Chris. Beard.           | Chert Haven.         |
| Fairchance        | W. T. Rainey.                              | Somerset.        | E. H. Reid.             | Scottdale.           |
| Ferguson          | Connellsville and Ursina Coal and Coke Co. | Fayette.         | L. N. Besser.           | Elm Grove.           |
| Fairview          | Fairchance Furnace Company.                | do.              | Robert Lang, Sr.        | Fairchance.          |
| Grindstone        | Dunbar Furnace Company.                    | do.              | Thomas Rag.             | Dunbar.              |
| Grassy Run.       | Fair View Coal Company.                    | Somerset.        | William Gillie.         | Meyersdale.          |
| Hamilton          | Redstone Oil Coal and Coke Company.        | Fayette.         | A. E. Humphries.        | Grindstone.          |
| Hickling          | F. A. Humphries & Co.                      | do.              | John Meagher.           | Dunbar.              |
| Hill Farm.        | Grassy Run Coal Company.                   | Somerset.        | Elk Dick.               | do.                  |
| Junilda.          | Miss Charlotte Cochran.                    | do.              | do.                     | Meyersdale.          |
| Kyle              | Chapman and Hocking Coal Company.          | Fayette.         | Robert Lang, Sr.        | Dunbar.              |
| Leith             | Dunbar Furnace Company.                    | do.              | S. C. Hurst.            | Smock.               |
| Leisenring No. 1. | Hurst & Co. Company.                       | do.              | Adam Nicholson.         | Junataville.         |
| Leisenring No. 2. | Hunt, Cole, Company.                       | do.              | D. R. Anderson.         | Fairchance.          |
| Leisenring No. 3. | H. C. Frick Coke Company.                  | do.              | E. J. Waddell.          | Meyersdale.          |
| Letchford         | Keyston Coal Company.                      | Somerset.        | Harry Whyel.            | Uniontown.           |
| Lemont No. 1.     | H. C. Frick Coke Company.                  | Fayette.         | John A. Besser.         | Leisenring.          |
| Lemont No. 2.     | do.  | do.              | E. A. Humphries.        | West Leisenring.     |
| Mohning           | do.  | do.              | Austin King.            | Fairchance.          |
| Neille            | do.  | do.              | James Harding.          | West Brownsville.    |
| Neille            | do.  | do.              | L. S. Melbowl.          | Fairchance.          |
| Oliphant          | do.  | do.              | M. H. Kerr.             | Lemont Furnace.      |
| Oliphant          | Finnell & Morgan.                          | Somerset.        | L. A. Morgan.           | Meyersdale.          |
| Oliphant          | Cambria Iron Company.                      | Fayette.         | Martin Meagher.         | Connellsville.       |
| Oliphant          | W. J. Rainey.                              | do.              | I. H. Skelly.           | Mt. Braddock.        |
| Oliphant          | Brown & Cochran.                           | do.              | J. R. Staughrey.        | Dunbar.              |
| Oliphant          | E. Staller.                                | do.              | W. Staller.             | Elk Dick.            |
| Oliphant          | H. C. Frick Coke Company.                  | Somerset.        | W. A. Fairhead.         | Oliphant Furnace.    |
| Oliphant          | Oliver Coal and Furnace Company.           | Fayette.         | Fred. C. Kelgley.       | Uniontown.           |









|                            |           |    |       |       |       |       |       |       |       |       |       |       |       |       |
|----------------------------|-----------|----|-------|-------|-------|-------|-------|-------|-------|-------|-------|-------|-------|-------|
| Leiscenting No. 2,         | Fayette,  | 1  | 140   | 26    | 23    | 8     | 198   | 7     | 5     | 35    | 18    | 3     | 129   | 327   |
| Leiscenting No. 3,         | Fayette,  | 1  | 233   | 32    | 20    | 3     | 251   | 6     | 3     | 178   | 1     | 3     | 201   | 492   |
| Lynn,                      | Fayette,  | 1  | 20    | 1     | 2     | 1     | 25    | 1     | 1     | 20    | 1     | 1     | 2     | 27    |
| Laughhead,                 | Fayette,  | 1  | 33    | 1     | 1     | 1     | 38    | 1     | 1     | 30    | 1     | 1     | 2     | 35    |
| Lemont No. 1,              | Fayette,  | 1  | 85    | 3     | 22    | 4     | 128   | 1     | 7     | 55    | 16    | 2     | 84    | 212   |
| Lemont No. 2,              | Fayette,  | 1  | 135   | 3     | 24    | 16    | 182   | 17    | 7     | 70    | 20    | 2     | 116   | 298   |
| Morgan,                    | Somerset, | 1  | 9     | 8     | 22    | 3     | 10    | 3     | 5     | 119   | 11    | 4     | 141   | 371   |
| Morrill,                   | Fayette,  | 1  | 170   | 4     | 2     | 4     | 230   | 3     | 3     | 32    | 1     | 1     | 39    | 86    |
| Mahoning,                  | Fayette,  | 1  | 35    | 4     | 2     | 5     | 47    | 3     | 3     | 32    | 1     | 1     | 39    | 86    |
| Mt. Braddock,              | Fayette,  | 1  | 60    | 6     | 6     | 5     | 73    | 8     | 5     | 50    | 8     | 2     | 73    | 146   |
| Nellie,                    | Fayette,  | 1  | 125   | 15    | 15    | 5     | 151   | 3     | 3     | 70    | 10    | 2     | 88    | 249   |
| Nellie,                    | Somerset, | 8  | ..... | ..... | ..... | ..... | ..... | ..... | ..... | ..... | ..... | ..... | ..... | ..... |
| Oilphant,                  | Fayette,  | 1  | 55    | 5     | 3     | 2     | 71    | 3     | 4     | 50    | 2     | 2     | 60    | 131   |
| Oliver No. 1,              | Fayette,  | 1  | 173   | ..... | 22    | 24    | 226   | 5     | 6     | 92    | 20    | 3     | 127   | 353   |
| Oliver No. 2,              | Fayette,  | 1  | 40    | ..... | 4     | 1     | 50    | ..... | ..... | ..... | ..... | ..... | ..... | ..... |
| Paul,                      | Fayette,  | 1  | 200   | ..... | 20    | 4     | 245   | 4     | 4     | 25    | 18    | 3     | 29    | 274   |
| Percy,                     | Fayette,  | 1  | 5     | ..... | ..... | ..... | ..... | ..... | ..... | ..... | ..... | ..... | ..... | ..... |
| Pine Hill,                 | Somerset, | 1  | 14    | ..... | 1     | ..... | 18    | ..... | ..... | ..... | ..... | ..... | ..... | ..... |
| Redstone,                  | Fayette,  | 1  | 150   | ..... | 17    | 26    | 208   | 7     | 9     | 125   | 20    | 3     | 164   | 372   |
| Stewart,                   | Fayette,  | 1  | 50    | ..... | 4     | ..... | 60    | 2     | 4     | 38    | 4     | 2     | 50    | 110   |
| Snider,                    | Fayette,  | 1  | 9     | ..... | ..... | ..... | 11    | ..... | ..... | ..... | ..... | ..... | ..... | ..... |
| Smock No. 1,               | Fayette,  | 1  | 42    | ..... | 6     | 5     | 55    | 1     | ..... | ..... | ..... | ..... | ..... | ..... |
| Smock No. 2,               | Fayette,  | 1  | 43    | ..... | ..... | ..... | 9     | ..... | ..... | ..... | ..... | ..... | ..... | ..... |
| Statler,                   | Somerset, | 1  | 8     | ..... | ..... | ..... | 49    | ..... | ..... | ..... | ..... | ..... | ..... | ..... |
| Shaws' Grassy Run,         | Somerset, | 1  | 65    | 7     | 4     | 8     | 89    | 1     | ..... | 4     | 6     | 2     | 13    | 102   |
| Standard,                  | Somerset, | 1  | 17    | ..... | ..... | ..... | 20    | 1     | ..... | ..... | ..... | ..... | ..... | ..... |
| Tub Mill Run,              | Somerset, | 1  | 7     | ..... | ..... | ..... | 9     | ..... | ..... | ..... | ..... | ..... | ..... | ..... |
| Thomas,                    | Somerset, | 1  | 33    | 4     | 1     | 4     | 44    | 1     | ..... | ..... | ..... | ..... | ..... | ..... |
| Trotter,                   | Somerset, | 1  | 13    | ..... | ..... | ..... | 15    | ..... | ..... | ..... | ..... | ..... | ..... | ..... |
| Taylor,                    | Fayette,  | 1  | 185   | 14    | 33    | 22    | 256   | 4     | 5     | 170   | 6     | 3     | 188   | 454   |
| Uniondale (idle all year), | Fayette,  | 1  | 8     | ..... | ..... | ..... | 10    | ..... | ..... | ..... | ..... | ..... | ..... | ..... |
| Wynn,                      | Fayette,  | 1  | 28    | ..... | ..... | ..... | 35    | ..... | ..... | ..... | ..... | ..... | ..... | ..... |
| Wheeler,                   | Fayette,  | 1  | 44    | 2     | 5     | 4     | 57    | 1     | 3     | 22    | 2     | 1     | 29    | 64    |
| Washington,                | Fayette,  | 1  | 160   | 1     | 7     | 13    | 184   | 3     | 4     | 20    | 4     | 3     | 34    | 218   |
| Walker,                    | Somerset, | 1  | 25    | ..... | ..... | ..... | 30    | ..... | ..... | ..... | ..... | ..... | ..... | ..... |
| Yoder,                     | Somerset, | 1  | 15    | ..... | ..... | ..... | 17    | ..... | ..... | ..... | ..... | ..... | ..... | ..... |
| Youngstown,                | Fayette,  | 1  | 95    | ..... | 18    | 20    | 139   | 3     | 6     | 72    | 16    | 2     | 99    | 238   |
| Total,                     |           | 56 | 3,797 | 86    | 429   | 456   | 4,943 | 127   | 150   | 1,433 | 363   | 103   | 2,576 | 7,619 |

TABLE NO. 4.—List of fatal accidents that occurred in and about the mines of the Fifth Bituminous Mine District for the year ending December 31, 1894.

| Date of accident. | Name of Person.     | Occupation. | Age. | Widow. | Number of orphans. | Name of colliery. | Location—County. | Nature and Cause of Accident.  |
|-------------------|---------------------|-------------|------|--------|--------------------|-------------------|------------------|--|
| Jan. 26,          | Charles Bellowfar,  | Miner,      | 34   | 1      | 5                  | Leisureing No. 2, | Fayette,         | Killed by fall of coal and rock while engaged drawing pillars.   |
| March 1,          | John Wornick,       | Miner,      | 45   | 1      | .....              | Washington,       | Fayette,         | Caught under cage while crossing from one side of shaft to the other.  |
| 17,               | Andy Fisco,         | Tippelman,  | 35   | 1      | .....              | Leisureing No. 1, | Fayette,         | Killed by falling down the shaft.  |
| April 23,         | John Fink,          | Miner,      | 39   | 1      | 6                  | Trotter,          | Fayette,         | Killed by fall of slate, while drawing posts in removing pillars.  |
| May 7,            | William Golasb,     | Miner,      | 27   | 1      | 1                  | Washington,       | Fayette,         | Killed by coal falling upon him while under-mining; had put no sprages in to protect himself while working.      |
| June 2,           | William Groom,      | Driver,     | 39   | .....  | .....              | Paul,             | Fayette,         | Caught between mine wagon and coal; died in Connellsville Hospital next day.                                     |
| July 2,           | John Gasool,        | Miner,      | 28   | 1      | 3                  | Hurst,            | Fayette,         | Caught by fall of slate from side of heading; died four hours afterward.   |
| 2,                | John Yoskey,        | Fireman,    | 28   | 1      | .....              | Oliver No. 1,     | Fayette,         | Cage struck him at landing, knocking him down the shaft.   |
| Aug. 28,          | Richard Gibbons,    | Miner,      | 43   | 1      | 6                  | Mahoning,         | Fayette,         | Killed while drawing posts by fall of slate and coal in pillar workings.   |
| Oct. 22,          | John Lowe,          | Driver,     | 24   | .....  | .....              | Leith,            | Fayette,         | Caught between rib and mine wagon; died on the 25th.   |
| Nov. 12,          | Mike Washa,         | Miner,      | 32   | 1      | 1                  | Stewart,          | Fayette,         | Killed by fall of slate in working place.  |
| Dec. 12,          | Robert Shanaberger, | Trapper,    | 14   | .....  | .....              | Fairchance,       | Fayette,         | Killed by being struck by coal. While blasting with gun powder; he walked into the room when the shot was fired. |
| 15,               | Bert Cole,          | Miner,      | 17   | .....  | .....              | Redstone,         | Fayette,         | Killed by fall of slate on entry while putting a car on the track.   |



TABLE No. 5.—List of non-fatal accidents that occurred in and about the mines of the Fifth Bituminous Mine District for the year ending December 31, 1894.

| Date of accident. | Name of Person.   | Occupation.      | Age. | Married. | Name of Colliery. | Location—County. | Nature and Cause of Accident.   |
|-------------------|-------------------|------------------|------|----------|-------------------|------------------|---|
| Jan. 2            | John Feischo.     | Miner.           |      |          | Ferguson.         | Fayette.         | Leg badly hurt by cars while walking on slope.  |
| 6                 | Edward Vandeniek. | Miner.           | 24   |          | Leisouring No. 2. | Fayette.         | Foot scraped by coal falling from rig.  |
| 7                 | James Maltz.      | Hoss driver.     | 31   | N.       | Leisouring No. 1. | Fayette.         | Mule fell on him, breaking his leg.   |
| 19                | Gasper Fullerton. | Miner.           | 22   | N.       | Casselman.        | Somerset.        | Hurt by fall of rock from roof.   |
| 25                | S. G. Miller.     | Miner.           | 39   | M.       | Crossland.        | Fayette.         | Collar bone broken in three places by being caught between car and rib.                 |
| Feb. 1            | John Payton.      | Driver.          | 23   | N.       | Leisouring No. 2. | Fayette.         | Squeezed between top of car and cross timber while riding on top of car.                |
| 6                 | Thad. Carter.     | Driver.          | 27   | M.       | Leisouring No. 2. | Fayette.         | Leg splintered by running it through a closed door, while riding on a loaded car.       |
| 12                | James McCloskey.  | Driver.          | 23   | N.       | Leisouring No. 2. | Fayette.         | Slight flesh wound by being caught between car and tail chain.                          |
| 20                | Curtis Humbert.   | Pumper.          | 18   | N.       | Mahoning.         | Fayette.         | Injured internally by falling over the dump.  |
| March 3           | George Hartford.  | Driver's helper. | 41   | N.       | Younstown.        | Fayette.         | Back injured; struck by loaded car.   |
| 6                 | Jacob Miller.     | Driver.          | 20   | M.       | Younstown.        | Fayette.         | Wagon jumped the track, breaking his leg.   |
| April 20          | Lew Bender.       | Trapper.         | 43   | N.       | Trotter.          | Fayette.         | Leg broken and badly cut by car running over it, while attempting to sprag the car.     |
| June 1            | Andrew Craig.     | Miner.           | 46   | M.       | Shaws.            | Somerset.        | Foot hurt by fall of slate.   |
| 5                 | David Maust.      | Driver.          | 23   | N.       | Kyle.             | Fayette.         | Tripped and fell, cutting his head and face badly.                                      |
| July 16           | Peter Hawser.     | Miner.           | 21   | N.       | Hurst.            | Fayette.         | Cut on back of head and ankle sprained by coal bursting out from face of a breast.      |
| Aug. 15           | Major Williams.   | Driver.          | 22   | N.       | Trotter.          | Fayette.         | Squeezed between car and rib; two of his ribs were broken.                              |
| 20                | Nelson Brand.     | Miner.           | 28   | M.       | Hocking.          | Somerset.        | Collar bone and shoulder blade broken by fall of coal while undermining.                |
| 23                | John M. Connor.   | Driver.          | 20   | N.       | Leith.            | Fayette.         | Thigh dislocated by being struck by runaway car; also cut and bruised on head and body. |
| 29                | David Twist.      | Rope rider.      | 19   | N.       | Leith.            | Fayette.         | Ankle sprained and bruised by being struck with rope socket flying from a sheave.       |

TABLE No. 5—Continued.

| Date of accident. | Name of Person.      | Occupation. | Age. | Married. | Name of Colliery. | Location—County. | Nature and Cause of Accident.   |
|-------------------|----------------------|-------------|------|----------|-------------------|------------------|---|
| Aug. 31,          | Albert Guthrie,      | Miner.      | 35   | M.       | Fairchance,       | Fayette,         | Foot severely injured by fall of slate.   |
| Sept. 7,          | Julius Schmitka,     | Driver.     | 28   | S.       | Leisenring No. 3, | Fayette,         | Back hurt by being caught between roof and top of wagon.  |
| 22,               | Paul Horning,        | Miner.      | 24   | M.       | Shaws,            | Somerset,        | Hips hurt by fall of breast coal.   |
| 25,               | Charles Smith,       | Miner.      | 17   | S.       | Junista,          | Fayette,         | Caught between rib and wagon.   |
| 25,               | Ralph Kelly,         | Laucher.    | 36   | M.       | Oliphant,         | Fayette,         | Ribs broken, by being caught between loaded and empty cars.   |
| 29,               | John Ray, Jr.,       | Miner.      | 21   | S.       | Wheeler,          | Fayette,         | Hurt internally by being caught between roof and loaded car, while riding on it.                        |
| 3,                | John Rimmeyock,      | Miner.      | 19   | S.       | Leisenring No. 2, | Fayette,         | Ankle sprained by fall of slate.  |
| 4,                | Andy Elias,          | Miner.      | 44   | M.       | Redstone,         | Fayette,         | Hip severely cut by wagon wheels.   |
| 5,                | John Gray,           | Driver.     | 28   | S.       | Anchor,           | Fayette,         | Wagon jumped the track, crushing his hand between wagon and rib.  |
| 10,               | William Lenhart,     | Driver.     | 21   | M.       | Youngstown,       | Fayette,         | Leg broken by fall of slate.  |
| 19,               | Joseph Yarbormotska, | Miner.      | 26   | M.       | Oliver No. 1,     | Fayette,         | Foot injured between two wagons.  |
| 20,               | Thomas Johns,        | Driver.     | 26   | M.       | Oliver No. 1,     | Fayette,         | Body crushed and bruised by being run over by loaded "larry," on top of coke ovens.                     |
| 22,               | George Reynolds,     | Charger.    | 26   | M.       | Oliver No. 1,     | Fayette,         | Head, back and knee hurt by fall of coal and slate in his working place.                                |
| 24,               | Thomas Terloski,     | Miner.      | 22   | M.       | Oliver No. 1,     | Fayette,         | jaw broken and head bruised by being caught between wagon and post in his room.                         |
| 25,               | John Evans,          | Miner.      | 34   | S.       | Leisenring No. 3, | Fayette,         | Hurt by fall of slate.  |
| 30,               | Steve Rischmofen,    | Miner.      | 30   | S.       | Leisenring No. 1, | Fayette,         | Collar bone broken by being caught between two cars on tippie.  |
| 7,                | James Clark,         | Dumper.     | 30   | M.       | Marrell,          | Fayette,         | Back and shoulder bruised by fall of slate, while drawing ribs.   |
| 10,               | Mike Goldack,        | Miner.      | 30   | M.       | Hill Farm,        | Fayette,         | Struck by a post, dislocating his hip.  |
| 16,               | John Martin,         | Miner.      | 17   | S.       | Leisenring No. 3, | Fayette,         | Hurt by a fall of slate.  |
| 17,               | James Walker,        | Miner.      | 55   | S.       | Palf View,        | Somerset,        | Compound fracture of jaw and loss of thumb and forefinger by being caught between wheels of mine wagon. |
| 20,               | Samuel Twiss,        | Trapper.    | 11   | S.       | Leith,            | Fayette,         |   |

|       |                           |                   |    |    |                          |                  |  |
|-------|---------------------------|-------------------|----|----|--------------------------|------------------|--|
| 21.   | Steve Robbleck, .....     | Blacksmith, ..... | 50 | M. | Oliver No. 1, .....      | Fayette, .....   | While shoeing a horse it fell on him, bruising and spraining his leg severely. |
| 22.   | Samuel Fee, .....         | Miner, .....      | 28 | M. | Oliver No. 1, .....      | Fayette, .....   | Back and side injured by a fall of roof coal while drawing posts in ribs.      |
| 25.   | Frank Meshoprevker, ..... | Driver, .....     | 18 | S. | Shaws, .....             | Somers-et, ..... | Foot hurt by mine car.   |
| 27.   | Charles Hartsock, .....   | Miner, .....      | 17 | S. | Lynn, .....              | Fayette, .....   | Leg broken and severe scalp wound, caused by a fall of slate.                  |
| 10-c. | Edward Shilras, .....     | Driver, .....     | 23 | M. | Trotter, .....           | Fayette, .....   | Both legs broken by being run over by mine wagon.                              |
| 19.   | Joseph Snyder, .....      | Driver, .....     | 21 | S. | Morreb, .....            | Fayette, .....   | Fell from front of wagon while it was in motion; arm severely bruised.         |
| 31.   | John Cuce a, .....        | Miner, .....      | 34 | M. | Lensingring No. 3, ..... | Fayette, .....   | Leg broken by fall of roof coal.   |



# SIXTH BITUMINOUS DISTRICT.

(CAMBRIA, SOMERSET AND INDIANA COUNTIES.)

Johnstown, March 8, 1895.

Hon. Isaac B. Brown,

Secretary of Internal Affairs, Harrisburg, Pa.:

Sir: I have the honor of herewith submitting my annual report as Inspector of Mines of the Sixth Bituminous District for the year ending December 31, 1894. The report shows that the production for the year as compared with 1893 has decreased 159,196 tons, and owing to the long strike of three and a half months in the beginning of the year, the average number of days worked has been decreased from 176 in 1893 to 140 days for this year. The total production for the year 1894 was 2,981,088 tons. The report contains tabulated statements of the fatal and non-fatal accidents, number of employes outside and inside of the mines, etc. Also a brief report on the condition of the ventilation and drainage of each mine in the district; also an article on the improvements made in the methods of mining, hauling, draining and ventilating, which are conducive to increasing the safety and sanitary condition of the collieries.

Yours respectfully,

J. T. EVANS.

## Causes of Accidents.

|                                | Fatal. | Non-fatal. | Widows.   | Orphans.  |
|--------------------------------|--------|------------|-----------|-----------|
| Mine wagons, . . . . .         | 3      | 6          | . . . . . | . . . . . |
| Falls of roof, . . . . .       | 5      | 4          | . . . . . | . . . . . |
| Falls of coal, . . . . .       | 4      | 7          | . . . . . | . . . . . |
| Falling down shafts, . . . . . | 1      | 0          | . . . . . | . . . . . |
| Totals, . . . . .              | 13     | 17         | 7         | 18        |

### Accidents.

The number of accidents have increased somewhat, which was caused by the increased negligence on the part of the unfortunate persons receiving the injuries, and a lack of knowledge in a few of the cases of the way to protect themselves. Of the thirteen fatal accidents reported in the district, eight of them would never have occurred if only a little care and common judgment had been exercised, but in violation of the mine rules, they did that which caused their deaths while everything necessary was at hand to enable them to protect themselves and prevent the accidents. I regret very much to have to comment on the actions of the unfortunate victims who met their death through their own carelessness. It is with great reluctance that I do it, but it is only for the purpose of warning others who may meet with the same fate, if they practice the same methods, namely, trying to load a car before standing a prop when they know there is danger hanging over their heads, or mining under a piece of coal that should be spragged up, and a hundred other little careless acts that are done every day in the mines. It is a lamentable fact that for the want of properly realizing the amount of unnecessary risks that are being taken in our mines, that fully forty per cent. of the accidents occur. It is a large percentage to claim, but it is no exaggeration of what has happened during the last three or four years, and I only hope that all the mine foremen will urge their men to practice more care in the future, and thus enable me to report an improvement and a decreased accident list for 1895.

A remarkable fact in the accidents which proved fatal was that six out of the thirteen were not thought to be even serious, but afterwards they proved fatal.

### Summary.

|  |           |
|--|-----------|
| Number of new mines opened during the year, . . . . .    | 6         |
| Number of mines abandoned, . . . . .                     | 1         |
| Number of mines now in the district, . . . . .           | 81        |
| Number working and reported as producing coal, . . . . . | 71        |
| Total coal production in net tons, . . . . .             | 2,981,088 |
| Total coal shipments in net tons, . . . . .              | 2,645,080 |
| Total production of coke, tons, . . . . .                | 41,662    |
| Average number of days worked for the year, . . . . .    | 140       |
| Number of men employed inside the mines, . . . . .       | 6,401     |
| Number of men employed outside the mines, . . . . .      | 543       |
| Total number employed, . . . . .                         | 6,944     |
| Number employed per each fatal accident, . . . . .       | 554       |
| Number employed per each non-fatal accident, . . . . .   | 408       |
| Number of fatal accidents, . . . . .                     | 13        |

|                                      |        |
|--------------------------------------|--------|
| Number of non-fatal accidents, ..... | 17     |
| Kegs of powder used, .....           | 17,970 |

The following table gives the quantity of coal mined in this district during the last ten years, 1885 to 1894, inclusive; also shows the amount of coal mined per each fatal and non-fatal accident and the average number of persons employed for each fatal and non-fatal accident during that period, with the causes of accidents.

|   |            |
|---|------------|
| Total quantity of coal mined in net tons, .....             | 41,992,857 |
| Total number of fatal accidents, .....                      | 95         |
| Total number of non-fatal accidents, .....                  | 148        |
| Number of tons mined per each fatal accident, .....         | 442,030    |
| Number of tons mined per each non-fatal accident,.....      | 283,735    |
| Number of persons employed per each fatal accident,...      | 809        |
| Number of persons employed per each non-fatal accident, ... | 519        |

Accidents Occurred as Follows:

|                                 | Fatal. | Non-fatal. |
|---------------------------------|--------|------------|
| By falls of coal, .....         | 44     | 64         |
| By falls of rock, .....         | 31     | 31         |
| Mine wagons, .....              | 14     | 42         |
| By machinery, .....             | 2      | 5          |
| Killed by kick from mule, ..... | 1      | 0          |
| By blast, .....                 | 2      | 0          |
| By hauling rope, .....          | 0      | 1          |
| Burned by powder, .....         | 1      | 4          |
| Gas, .....                      | 0      | 1          |
| Totals, .....                   | 95     | 148        |

Summary of Improvements in Mining.

In my report on each mine I have but briefly stated the condition in which I found the drainage and ventilation, and now wish to make some further remarks on the improvements in the methods in mining, hauling, draining and of ventilating the mines, other than those required by the Mining Act, all of which add greatly to the general safety and sanitary condition of the collieries.

There are at least four very important changes noticeable in the manner of opening up and conducting the mines at the present time that I wish to make favorable mention of, as all of them give the very best results as to economy, safety or sanitary conditions. Time and space will not allow me to make remarks on all the bene-

ficial results of these changes, but I will mention one or two principal ones. The first is haulage by machinery, the introduction of which has greatly increased the safety of hauling. In proof of this I would state that during the past three years, about 6,000,000 tons of coal have been taken from the mines of this district by machinery and prior to July 24, 1894, not a single accident had occurred in the moving of this enormous quantity of material. The second is the drainage. In all well opened and conducted mines I observed that special provisions were made for the drainage, and in place of running the water along the main roads or in ditches cut beside them, the parallel or main airway is utilized for drainage and ventilation, which is driven on the lower side instead of the upper side, and the water naturally flows to that point, thereby leaving the hauling roads dry, and in addition to this, it improves the ventilation and gives an opportunity to those in charge of the mine to split the air and carry a fresh current to each section of work without the necessity of having to make the overcast large enough to carry the whole volume of air. Each overcast will require to be of only sufficient size to carry the volume of air for the one split by reason of the driving of this parallel heading on the lower side of the main hauling road. This improvement is made without any additional expense for driving headings, and it reduces the cost of hauling the coal out.

The third is the driving of wider headings for hauling coal over (where the roof permits) as it lessens the risk for drivers, gives larger areas for the air to travel through, keeps the road in better condition, and enables the drivers to do nearly double the work, thus reducing the cost of hauling.

The fourth is possibly one of the greatest and most beneficial changes that has been made in the manner of working mines in recent years, as it contributes most to their economy and safety. It is in pillar drawing, something that was not done at all many years ago, therefore leaving as much as fifty per cent. of the coal in some of the mines that could never be recovered. At others a smaller percentage was left. That most extravagant system, I am glad to say, has entirely been abandoned in our State, and a systematic plan of pillar drawing substituted.

When pillar drawing was first inaugurated, after a room or stall was driven to its destination, the pillar would be left to stand for several months, possibly years, before being drawn, which was a very dangerous and costly practice. Costly on account of the coal losing its gases, and dangerous because the props that were set to keep the roof, or to give warning to the miner before a fall, had become rotten and consequently were of no service in protecting the miner nor in giving warning of approaching danger. The present method is to draw back the pillar immediately on the room reaching



its destination. This gives good coal from the pillars and insures good, solid timbers to protect the miner in his work and is a preventive of creeps as well.

As stated in the beginning of this article, these improvements are some of the many that have been inaugurated, which were not compelled by law, but I claim that they are the results of the passage of the mine laws which compelled conditions that required a little technical knowledge of mining, which was sufficient to create a desire for a more thorough knowledge on the subject. The result will be a continued improvement in the methods of mining, which will eventually reduce the dangers thereof to a minimum. Of course, accidents will occur as long as mining is done through over-confidence, or the neglect, possibly, of some individual. One of the particular dangers of mining is that the lives of so many are in the hands of each individual workman, so that the mistake of one man may cause the death of many, and this is why the discipline in the mines should be more stringent as it would greatly reduce the accident list.

Improvements requiring a large outlay of money have not been very numerous during the past year, yet a few have been made.

The Sterling Coal Company have put in an endless rope haulage at their No. 12 plant, which has a capacity of handling from four to six hundred tons per day. The same company at their No. 8 colliery had a six-inch diameter hole drilled 204 feet deep through which they now pump all their water from the mines by steam power. This was done to replace pumps driven by compressed air. There were also four fans put in during the year to replace furnaces, and three new furnaces put in to replace smaller ones, and quite a number of other improvements, such as second openings, new hauling roads, and self-acting planes, etc., showing a gradual but constant improvement.

#### Condition of Mines.

The "Rolling Mill & Gautier" mines are the property of the Cambria Iron Company. "Haws Shaft" is owned by A. J. Haws & Son. All of them are ventilated by fans and kept in the best of condition as to drainage, ventilation and general safety. The first named mine is one of the largest in the district, employing about three hundred persons inside, and from twenty-five to thirty outside. Although this is a gaseous mine, requiring three fire bosses to look after it, yet the greatest source of danger that is encountered here, is bad roof running through or across the workings, and in places where the cover over the mine is from 450 to 550 feet thick. With the ordinary system of driving rooms, I consider it very danger

ous mining, but I believe that other methods of working can be adopted in this case that would decrease the danger, and I have no doubt they will be put in operation in the future, as those in charge have a desire to see their number of accidents as few as possible; and therefore will introduce some safer method of working in the part of the mine that has the bad roof.

**Conemaugh Mine.** Is located two and a half miles east of Johnstown. The drainage, ventilation and general safety of this mine is excellent.

**Mineral Point Mine** is located about one mile east of Mineral Point. Work has been very dull here during the past year, but they have done a great deal of prospecting on the property to locate the Miller or B seam of coal, which if found in its normal condition, will make this a very valuable property.

**South Fork Mines.** The following collieries are located at this point: Argyle, J. C. Stineman, Euclid, Aurora, Sumner No. 2 and Webster No. 3.

The latter is one of the largest mines in the district, and one of the best equipped. Everything connected with the mine is on the most modern improved plan. They have two complete rope haulages and two inclines in the mine, and the third is now being made.

Two fans are in use for ventilating, one 16 feet and the other 18 feet in diameter. The drainage, ventilation and general condition of the mine are excellent.

Argyle is another mine which I find in excellent condition. It is one of the best furnace ventilated mines in the district, and is ventilated in sections by the erection of well built air bridges to separate the currents.

J. C. Stineman colliery has in use an improved door for conducting the air in its proper course through the mine, that I believe has no equal, especially as a check door. It ought to be put in a proper place, which would be on some level place on the heading, so that the trip could pass through it at an ordinary rate of speed, as the door is opened by the mule and opens either way and will not stand open, but is made to stand square across the heading, which is closed and will stand a very heavy pressure of air before it will open. This is done by a little slot made in part of the hinge fastened to the frame of the door, and a little bevel in that part of the hinge fastened to the door, so that when it is closed it lays in the bottom of this slot. It is a great improvement over the canvas doors on account of their being easily torn down and often through neglect not put up again. This leaves the miner in his room without any means of getting fresh air. This door, if properly made, will last for years.

and as stated before will always be found closed. I therefore find the ventilation of this mine well looked after and its general condition for safety good.

Sumner No. 2. A new fan, 12 feet in diameter, has been put up at this mine during the past year, which has greatly improved its sanitary condition.

Euclid and Aurora mines I find in a good, healthful and safe condition. These are not large collieries, but care is required by those in charge of small as well as large collieries to keep their mines in good shape. When this is neglected in any colliery, it very soon shows a dilapidated condition of things.

Portage Mines. There are nine collieries on this branch, only four of which worked regularly during the past year, the Puritan Shaft, Continental, Lukins Slope and Excelsior.

The first named has run very steady, except during the big strike; the other three have run fairly well. The other mines, Ebuval, Anchor, Caldwell and Continental Nos. 2 and 3, have practically done nothing since the strike. The sanitary condition of the mines that have been running regularly is reasonably good. There is one thing in particular needed in nearly every mine on this branch in their system of mining, and that is to drive their headings wider, so as to give room for ditches along the side of the roadways; not only would it improve the mine, but it would be economy as well.

Each of these mines is ventilated by a fan and has adopted the split system so as to give each section of men a fresh current of air direct from the outside, pure and undiluted, except the Continental No. 1, where the number of men as yet does not compel them to have but one current, as they only employ about fifty or sixty persons, sixty-five being the maximum allowed by law.

The other mines referred to have splits, some of them for each group of twenty-five or thirty men, which is the proper system to ventilate a mine for economy, as well as for the health of the men employed.

Bens Creek Mines. Five mines are worked on this branch, namely, Senman Shaft, Sonman No. 2, Dysert No. 2, Mentzer and Columbia Mine.

The two first named have fans and the shaft is well ventilated and drained, and is in good condition. The Sonman No. 2 has been greatly improved during the past year, and I fully expect in my next report to make very favorable mention of the condition of this mine, as a great effort is being made to get it into good condition, it being a very old mine and difficult to put in good order.

Columbia Mine is ventilated by a furnace and on my last examina-

tion I measured 14,500 cubic feet of air per minute passing into this mine, which was well distributed through the workings.

The Mentzer and Dysert mines I very seldom find in a satisfactory condition, as they are for the greater part of the year dependent on natural ventilation, as a great difference of elevation exists between the two mines. It is a favorable condition for this mode of ventilation, but too much dependence cannot be placed in it, even in the most favorable seasons of the year, summer and winter. The weather is so changeable that under the most favorable circumstances that exist at these mines natural ventilation is a miserable failure. The Dysert No. 2 people have decided to put in a six-foot Stine fan. At the Mentzer mine they will either be required to put in a fan or well built furnace in the spring.

Dunlo Mines. There are three collieries on this branch, two shafts and a drift mine. The latter is mining on the E or Lemon seam, and the shafts on the B or Miller seam.

Henrietta shaft is the property of the Henrietta Coal Company.

Dunlo shaft belongs to the Berwind-White Coal Company.

The latter mine is ventilated by a 16-foot Guibal fan, which has a capacity of double that required for the mine at present, but they intend to increase the capacity of this colliery to 800 or 1,000 tons per day, when more air will be required to keep it in good sanitary condition, hence the propriety of putting in a large fan. As yet the Henrietta people have nothing but exhaust steam from pumps to ventilate their mine with, which is inadequate for the work. A fan is promised for this shaft as soon as a little dispute in reference to the coal territory is settled, which will enable them to select the proper location for the same.

Dunlo mine is a drift opening and ventilated by furnace, and when examined last was found inadequate to the work it had to perform. The drainage is also good and the general condition of the mine first class.

Lilly Mines. There are four mines operated on this branch, Lilly Slope, Standard, Sonman No. 2 and Bear Rock.

The first two are ventilated by fans and on each of my examinations I have found them in good sanitary condition.

The Sonman No. 2 I cannot say the same of, but rather the reverse, as they are endeavoring to ventilate it by a furnace, which is not adequate to the work. A fan has been purchased that is to be erected in this mine, but a new opening is required to enable them, even with the fan, to properly air this colliery. When these improvements are

completed and the fan started, I have no doubt but they will then be able to keep the workings in a condition fit for men to labor in.

The Bear Rock Colliery I found on my last examination to be in a very fair condition as regards drainage and ventilation. A furnace is the only means in use for ventilating, but as the mine is comparatively new, it does the work fairly well so far. Quantity of air measured on last examination was 11,000 cubic feet per minute. Number of men employed, 85.

Cresson Shaft is located at Cresson. The drainage and ventilation here are in a very fair condition, but they have not worked very extensively during the past year. This is a first class hoisting plant, with all modern improvements, including a self-dumping cage.

Gallitzin Shaft and Gallitzin Slope are both located at Gallitzin on the summit of the mountain. The latter is operated by J. L. Mitchell, of Tyrone. The drainage, ventilation and haulage of this mine are in excellent condition. The shaft has not been working very steadily during the past year. Ventilation is fair at this colliery.

Dean No. 4 and No. 5 are located on the Cresson and Coalport Railroad at Frugality. The former is ventilated by fan and the latter by furnace, both of which are kept in good condition as regards ventilation, but there is quite a difficulty in keeping the drainage of these mines up to the standard, on account of the overlying strata being so open, which admits the water in wet weather from the surface, which flows through and out of the mines over the hauling roads, as it is more than the ordinary ditches of a mine can hold. This trouble is only encountered in wet seasons of the year. In all other respects they are kept in good sanitary condition.

Patton mine is located near Coalport, also on the Cresson and Coalport Railroad. The ventilation and drainage are in fair condition. A new furnace has been erected here recently, which will no doubt improve the ventilation. Considerable trouble has been experienced in this mine by a dislocation in the strata which causes great inconvenience to those operating the mine, especially in the haulage. Notwithstanding this trouble, they have kept the sanitary condition of the mine up to the standard.

Oakland No. 2 is located at Coalport and operated by Samuel Hagerly. This colliery has been idle for the last two months; in fact, has worked very little during the past year, having mined only about 4,000 tons. Condition of mine as to ventilation when examined last was a little defective, having just started up after the strike.

Patton Mines. There are six mines located at this point, namely,

Patton, Ashcroft, Columbian, New Pardee, Flanigan Run, and Moshannon. To describe each of these mines would only be a repetition, as all are worked on the same seam of coal and nearly by the same system of mining, but I wish to state that the New Pardee mine is somewhat in advance of the others, particularly in ventilation, having recently put in a twelve-foot fan, which has a capacity of 40,000 cubic feet of air per minute. This enables those in charge to keep the mine in the best sanitary condition. This, I am sorry to say, cannot be said of all the mines where small furnaces are used.

The Ashcroft and Columbian mines have enlarged their furnaces during the past year, but I think it would have been much better to have put in a fan at each.

The Patton mine has a furnace equal in capacity to the work it has to perform.

Flanigan Run mine has no proper means of ventilation and they will either have to enlarge their shaft and furnace, or put in a fan in the early spring to enable them to properly ventilate the mine.

The Moshannon mine is fairly well ventilated, but is poorly drained, no provisions having been made for ditches to carry away the water made in the mine; consequently, in many places it is left to run in the middle of the hauling roads, which is bad and expensive mining in the long run. Since I examined this mine last they report much improvement in the drainage.

Hastings Mines. There are five mines located at this point, namely, Sterling No. 8 and No. 9, Benton No. 1, Oakland and Hastings. The last named mine is well ventilated and drained. It is opened by two drifts about one hundred yards apart, and at a point about two hundred feet from the drift mouth, a shaft has been sunk, and from that point an airway is driven between the two main headings, which gives two main currents of air for the mine, and from each main current, additional splits can be made at a small cost and carried direct to the main return airway at will. This is opening up a mine with some provisions for its future, which, I am sorry to say, is sadly neglected in a majority of the mines, thus causing an unusual expense after a few years' work, to keep and maintain good hauling roads, ventilation, etc.

The Oakland mine is also well ventilated and drained and in good, safe condition.

Benton No. 1 is another mine that I find in first class condition in drainage, ventilation and general safety.

Sterling No. 8 and No. 9. These collieries are working to the dip of the coal seam, and are connected. Being large mines, a fan and furnace are used to ventilate them, No. 8 being very much improved during the past year in every respect, drainage, ventilation and hauling. A fan was put in here during 1893 to replace a furnace, and it is doing excellent work, but a 12-foot fan can not do the work of a 20-foot fan, which should be placed in a mine of this capacity. Arrangements are now being made to sink a shaft at the face of the workings, which will enable the machinery now in use for ventilating to double its capacity as it will shorten the travel of the air one-half. No. 9 on my last examination was having its mining system entirely changed from that of pillar and room to "long wall" work, consequently the ventilating system was somewhat broken up. I expect, when the new system is well established, that it will very much improve the ventilation, and will I hope be an improvement in the system of mining a small seam such as they have here.

Barnesboro Mines. There are located at or near this place five mines now working, and three more about to be started up, Cymbria, Delta, Lancashire No. 3 and No. 4, and Sterling No. 11. I am pleased to state that all of these mines are in good condition as regards ventilation, drainage and general safety, and they can only be improved by putting up fans for ventilating, as each now has a good furnace well looked after by competent persons, but is an expensive mode of ventilating shallow mines.

The Spangler mines are four in number. Benton No. 2, Spangler, Lancashire No. 5 and Sterling No. 12. All of them have well built furnaces by which they produce ventilation for the mines, which are properly attended to. This cannot be said of all mines that produce ventilation by means of furnaces, as they are sadly neglected in some mines, the result of which is defective ventilation.

Elmora mine is located near Carrolltown and is working on the B seam of coal and operated by the Elmora Coal Company. The ventilation and drainage of this mine, when last examined, were found in fairly good condition, but could be improved by putting in a fan, as the furnace is not in a favorable position, especially in the summer time, as there is quite a difference in producing ventilation with a furnace, between summer and winter, so much so that very few of the mines ventilated by furnaces have any surplus air in summer time.

#### Somerset County Mines.

These are all located on the Cambria & Somerset branch of the Baltimore and Ohio Railroad. The Krebs, Hooversville and Bethel mines.

The first named is about two miles north of Somerset Town and is working the C bed of coal. There are only about fifty-five men employed at present, but the mine has a capacity for employing one hundred and fifty to two hundred men if the trade were better. The ventilation and drainage is good, and the general condition of the mine is excellent.

The Oakland mine, when examined last was not in very good condition, but they were then making some improvements in the ventilation by putting in a new shaft and furnace, as the mine had never been in condition for working many men prior to this party taking hold of it. I expect to find it much improved on my next examination. It is now idle and has been so for several months.

Bethel mine is located at Holsopple and supplies coal for the locomotives of this division of the railroad; also ships coal to market. The ventilation, drainage and general condition of this mine are good.

Vintondale Mine. This is a new operation located on the Black Lick branch of the Pennsylvania Railroad about eight miles below Ebensburg. All mining is done here by machinery, electric power is being used, and as stated the plant is new and not developed yet. The intention is to do all the mining by iron miners driven by electricity. All the tippie work is done by machinery driven by electric power, and the haulage will eventually be done by the same power.

Ingleside Mine. This plant is not doing a great deal now, as it was the source of supply for the Johnson & Moxham Mills, and since they have removed their rolling mills to Lorain, Ohio, they require very little coal now, and do not ship any to market. The mine when examined last, was found to be in good condition as to drainage and ventilation.





TABLE No. 1—Continued.

| Name of Colliery.       | Name of Operator.                   | Location--County.         | Name of Superintendent. | Postoffice Address.        |
|-------------------------|-------------------------------------|---------------------------|-------------------------|----------------------------|
| New Pardee.             | Magee & Lingle.                     | Patton, Cambria Co.       | W. C. Lingle.           | Phillipsburg, Centre Co.   |
| Oakland.                | Ashland Coal Company.               | Hooversville, Cambria Co. | John Quin.              | Houtzdale, Clearfield Co.  |
| Oak Ridge.              | Linwiddle, Campbell & Co.           | Hastings, Cambria Co.     | James Campbell.         | Hastings, Cambria Co.      |
| Oakland Colliery No. 2. | Samuel Haggerty.                    | Coalport, Clearfield Co.  | Samuel Haggerty.        | Coalport, Clearfield Co.   |
| Patton.                 | F. G. Patton.                       | Cambria, Cambria Co.      | F. G. Patton.           | Coalport, Clearfield Co.   |
| Puritan.                | Puritan Coal Mining Co.             | Puritan, Cambria Co.      | Joseph Campbell.        | Puritan, P. O. Cambria Co. |
| Patton No. 1.           | R. B. Wigton & Sons.                | Carroitown, Cambria Co.   | John M. Click.          | Phillipsburg, Centre Co.   |
| Patton No. 2.           | R. B. Wigton & Sons.                | Carroitown, Cambria Co.   | John M. Click.          | Phillipsburg, Centre Co.   |
| Richland No. 1.         | Evans Bell Mining Company, Limited. | Dysert, Cambria Co.       | George P. Bell.         | Dysert, Cambria Co.        |
| Rolling Mill.           | C. I. Company.                      | Johustown, Cambria Co.    | W. H. Morris.           | Ahmstow, Cambria Co.       |
| Standard.               | Standard Coal Company, Limited.     | Lilly, Cambria Co.        | R. J. Hughes.           | Ahmstow, Blair Co.         |
| Sonman No. 1.           | W. H. Piper & Co.                   | Ben's Creek, Cambria Co.  | Frank Mortenson.        | Myra P. O., Cambria Co.    |
| Sonman No. 2.           | W. H. Piper & Co.                   | Lilly, Cambria Co.        | Patrick Leahy.          | Lilly P. O., Cambria Co.   |
| Summer No. 1.           | Lukens & Haupt.                     | Portage, Cambria Co.      | R. T. Longwell.         | Portage, Cambria Co.       |
| Summer No. 2.           | Lukens & Haupt.                     | Portage, Cambria Co.      | R. T. Longwell.         | Portage, Cambria Co.       |
| Spangler.               | Summit Coal and Coke Company.       | South Fork, Cambria Co.   | C. F. Frazer.           | Hastings, Cambria Co.      |
| Sterling No. 8.         | Duncan & Spangler.                  | Spangler, Cambria Co.     | J. L. Spangler.         | Hastings, Cambria Co.      |
| Sterling No. 9.         | Duncan & Spangler.                  | Hastings, Cambria Co.     | J. L. Spangler.         | Hastings, Cambria Co.      |
| Sterling No. 11.        | Duncan & Spangler.                  | Hastings, Cambria Co.     | J. L. Spangler.         | Hastings, Cambria Co.      |
| Sterling No. 12.        | Duncan & Spangler.                  | Barnsboro, Cambria Co.    | J. L. Spangler.         | Hastings, Cambria Co.      |
| Sonman shaft.           | Sonman Coal Mining Company.         | Spangler, Cambria Co.     | J. L. Spangler.         | Hastings, Cambria Co.      |
| Stineman.               | Stineman Coal and Coke Company.     | Ben's Creek, Cambria Co.  | Joseph Peterson.        | Myra P. O., Cambria Co.    |
| Vintondale.             | Vintondale Colliery Company.        | South Fork, Cambria Co.   | W. J. Stineman.         | South Fork, Cambria Co.    |
| Williams.               | Williams.                           | Vintondale, Cambria Co.   | C. J. Claiborne.        | Vintondale, Cambria Co.    |
| Webster No. 2.          | John C. Scott & Sons.               | Johustown, Cambria Co.    | W. J. Williams.         | Johnstown, Cambria Co.     |
| Yellow Run.             | B. W. Coal Company.                 | Erendfeld, Cambria Co.    | Phillip Hartman.        | Erendfeld, Cambria Co.     |
|                         |                                     | Dunlo, Cambria Co.        | Thomas Booth.           | Dunlo, Cambria Co.         |

TABLE NO. 2.—Gives the total number of tons of coal mined and tons of coke produced in each colliery, number of days worked, number of employes, number of persons killed and injured, number of keys of powder used, etc., in the Sixth Bituminous Mine District for the year ending December 31, 1894.

| Names of Collieries. | Location—County. | Total production in tons of coal. | Total production in tons of coke. | Number days worked. | Number persons employed. | Number fatal accidents. | Number non-fatal accidents. | Number keys powder used. | Number steam boilers. | Number horses and mules. | Number mine locomotives. | Number coke ovens. |
|----------------------|------------------|-----------------------------------|-----------------------------------|---------------------|--------------------------|-------------------------|-----------------------------|--------------------------|-----------------------|--------------------------|--------------------------|--------------------|
| Argyle               | .....            | 59,494                            | .....                             | 223                 | 115                      | .....                   | 1                           | 569                      | 1                     | 12                       | 1                        | .....              |
| Aurora               | .....            | 20,966                            | .....                             | 150                 | 43                       | .....                   | .....                       | 200                      | .....                 | 7                        | .....                    | .....              |
| Anchor               | .....            | 3,024                             | .....                             | 21                  | 45                       | .....                   | .....                       | 20                       | 1                     | 7                        | 1                        | .....              |
| A. J. Haws           | .....            | 21,484                            | .....                             | 301                 | 40                       | .....                   | .....                       | 120                      | 2                     | 3                        | 1                        | .....              |
| Ashtcroft            | .....            | 31,545                            | .....                             | 82                  | 132                      | 1                       | .....                       | 100                      | .....                 | 6                        | .....                    | .....              |
| Benton No. 1         | .....            | 94,080                            | .....                             | 210                 | 144                      | .....                   | .....                       | 1,000                    | .....                 | 8                        | .....                    | .....              |
| Benton No. 2         | .....            | 24,180                            | .....                             | 200                 | 58                       | .....                   | .....                       | 300                      | .....                 | 2                        | .....                    | .....              |
| Bear Rock            | .....            | 35,935                            | .....                             | 160                 | 90                       | .....                   | .....                       | 175                      | .....                 | 6                        | .....                    | .....              |
| Bethel               | .....            | 20,720                            | .....                             | 251                 | 29                       | .....                   | .....                       | 200                      | .....                 | 5                        | .....                    | .....              |
| Cymbria              | .....            | 39,107                            | .....                             | 104                 | 90                       | .....                   | 1                           | 200                      | .....                 | 6                        | .....                    | .....              |
| Conemaugh            | .....            | 42,283                            | .....                             | 243                 | 65                       | .....                   | .....                       | 435                      | 1                     | 4                        | 1                        | .....              |
| Continental No. 1    | .....            | 5,415                             | .....                             | 40                  | 38                       | .....                   | .....                       | 40                       | .....                 | 3                        | .....                    | 12                 |
| Continental No. 2    | .....            | 17,800                            | .....                             | 73                  | 60                       | .....                   | .....                       | 150                      | 1                     | 7                        | 1                        | .....              |
| Continental No. 3    | .....            | .....                             | .....                             | .....               | .....                    | .....                   | .....                       | .....                    | .....                 | .....                    | .....                    | .....              |
| Continental No. 4    | .....            | .....                             | .....                             | .....               | .....                    | .....                   | .....                       | .....                    | .....                 | .....                    | .....                    | .....              |
| Columbian            | .....            | 33,223                            | .....                             | 122                 | 108                      | .....                   | .....                       | 108                      | .....                 | 9                        | .....                    | .....              |
| Cresson shaft        | .....            | 23,561                            | .....                             | 71                  | 89                       | .....                   | .....                       | 100                      | .....                 | 4                        | .....                    | .....              |
| Caldwell             | .....            | 18,880                            | .....                             | 89                  | 52                       | .....                   | .....                       | 80                       | 3                     | 3                        | 3                        | .....              |
| Dyersert No. 1       | .....            | 2,000                             | .....                             | 80                  | 40                       | .....                   | .....                       | .....                    | .....                 | .....                    | .....                    | .....              |
| Dyersert No. 2       | .....            | 54,769                            | .....                             | 140                 | 130                      | .....                   | .....                       | 260                      | .....                 | 18                       | .....                    | .....              |
| Delta                | .....            | 20,158                            | .....                             | 233                 | 47                       | .....                   | .....                       | 435                      | .....                 | 2                        | .....                    | .....              |
| Delta                | .....            | 45,167                            | .....                             | 130                 | 118                      | .....                   | .....                       | 250                      | .....                 | 3                        | .....                    | .....              |
| Dean No. 3           | .....            | 30,000                            | .....                             | 180                 | 49                       | .....                   | .....                       | 200                      | .....                 | 2                        | .....                    | .....              |
| Dean No. 4           | .....            | 10,000                            | .....                             | 160                 | 175                      | .....                   | .....                       | 600                      | 1                     | 12                       | 1                        | 38                 |
| Dean No. 5           | .....            | 20,000                            | .....                             | 50                  | 51                       | .....                   | .....                       | 100                      | .....                 | 4                        | .....                    | .....              |
| Excelsior            | .....            | 26,800                            | .....                             | 140                 | 75                       | .....                   | .....                       | 100                      | 1                     | 7                        | .....                    | .....              |
| Euclid               | .....            | 27,532                            | .....                             | 203                 | 53                       | .....                   | .....                       | 300                      | .....                 | 4                        | .....                    | .....              |
| Euclid               | .....            | 47,953                            | .....                             | 211                 | 112                      | .....                   | .....                       | 250                      | .....                 | 8                        | .....                    | .....              |
| Elmore               | .....            | 20,000                            | .....                             | 125                 | 70                       | .....                   | .....                       | 100                      | .....                 | 4                        | .....                    | .....              |
| Ebavale              | .....            | 5,500                             | .....                             | 200                 | 10                       | .....                   | .....                       | 40                       | .....                 | 1                        | .....                    | .....              |
| Fenn                 | .....            | 44,432                            | .....                             | 82                  | 147                      | .....                   | .....                       | 240                      | .....                 | 5                        | .....                    | .....              |
| Fianlagin Run        | .....            | 90,608                            | .....                             | 117                 | 250                      | .....                   | .....                       | 361                      | 5                     | 28                       | 4                        | 172                |
| Gallitzin slope      | .....            | .....                             | 24,214                            | .....               | .....                    | .....                   | .....                       | .....                    | .....                 | .....                    | .....                    | .....              |



|                         |           |        |           |       |       |       |       |        |       |       |       |     |
|-------------------------|-----------|--------|-----------|-------|-------|-------|-------|--------|-------|-------|-------|-----|
| Sonnan shaft, .....     | 113,796   | .....  | 111,221   | 181   | 221   | 3     | ..... | 140    | 4     | 21    | ..... |     |
| Stineman, .....         | 185,547   | .....  | 183,749   | 218   | 290   | ..... | 690   | 2      | 33    | 1     | ..... |     |
| Vintondale No. 1, ..... | 4,586     | .....  | 4,586     | 43    | 22    | ..... | 120   | 1      | 2     | 1     | ..... |     |
| Williams, .....         | 4,000     | .....  | 4,000     | 175   | 18    | ..... | ..... | .....  | ..... | ..... | ..... |     |
| Webster No. 3, .....    | 213,485   | .....  | 213,485   | 203   | 338   | ..... | 1,260 | 6      | 22    | 2     | ..... |     |
| Yellow Run, .....       | 14,796    | .....  | 43,766    | 150   | 124   | ..... | 250   | 2      | 6     | 2     | ..... |     |
| Totals, .....           | 2,981,988 | 41,662 | 2,645,080 | 9,350 | 6,944 | 13    | 17    | 17,570 | 72    | 535   | 43    | 684 |



|                               |    |       |       |       |       |       |       |       |       |       |       |       |     |     |     |       |
|-------------------------------|----|-------|-------|-------|-------|-------|-------|-------|-------|-------|-------|-------|-----|-----|-----|-------|
| Flanigan Run, .....           | 1  | 125   | 10    | 2     | 3     | 1     | 142   | ..... | 1     | ..... | 4     | ..... | 5   | 147 |     |       |
| Gallizin shaft, .....         | 1  | 109   | 19    | 4     | 19    | 7     | 201   | ..... | 3     | 4     | 36    | 4     | 2   | 49  |     |       |
| Gaulzer No. 3, .....          | 1  | 179   | 23    | 8     | 23    | 8     | 233   | ..... | 2     | 3     | 50    | 2     | 2   | 250 |     |       |
| Gaulzer No. 4, .....          | 1  | 52    | 3     | 1     | 2     | 1     | 66    | ..... | 1     | ..... | ..... | ..... | 6   | 298 |     |       |
| Henrietta shaft, .....        | 1  | 95    | 16    | ..... | 1     | 3     | 122   | ..... | 2     | 2     | ..... | ..... | 5   | 65  |     |       |
| Hastings, .....               | 1  | 72    | 2     | ..... | 2     | ..... | 78    | ..... | 1     | 1     | 12    | 2     | 1   | 128 |     |       |
| Ingleside, .....              | 1  | 65    | 3     | 1     | 5     | 3     | 78    | ..... | 1     | ..... | ..... | ..... | 17  | 95  |     |       |
| Kokomo, .....                 | 1  | 8     | ..... | ..... | ..... | ..... | 19    | ..... | 1     | ..... | ..... | ..... | 1   | 85  |     |       |
| Krebs, .....                  | 1  | 55    | 2     | 2     | 2     | 1     | 63    | ..... | 1     | ..... | ..... | ..... | 1   | 11  |     |       |
| Lancashire No. 2, .....       | 1  | 50    | 7     | ..... | ..... | ..... | 60    | ..... | 1     | ..... | ..... | ..... | 6   | 69  |     |       |
| Lancashire No. 3, .....       | 1  | 100   | 13    | 1     | 3     | 3     | 123   | ..... | 1     | ..... | ..... | ..... | 4   | 64  |     |       |
| Lancashire No. 5, .....       | 1  | ..... | ..... | ..... | ..... | ..... | 7     | ..... | ..... | ..... | ..... | ..... | 2   | 130 |     |       |
| Lilly slope, .....            | 1  | 48    | 4     | 2     | 4     | 3     | 62    | ..... | 1     | 1     | ..... | ..... | 1   | 9   |     |       |
| Mineral Point, .....          | 1  | 16    | ..... | ..... | ..... | ..... | 19    | ..... | 1     | 1     | ..... | ..... | 3   | 65  |     |       |
| Moshannon, .....              | 1  | 60    | 1     | ..... | ..... | ..... | 66    | ..... | 1     | ..... | ..... | ..... | 2   | 23  |     |       |
| Mertzer, .....                | 1  | 70    | 9     | 3     | 11    | 3     | 97    | ..... | 1     | ..... | ..... | ..... | 5   | 71  |     |       |
| New Pardee, .....             | 1  | 100   | 5     | 1     | 5     | 4     | 116   | ..... | 1     | ..... | ..... | ..... | 7   | 102 |     |       |
| Oak Ridge, .....              | 1  | 57    | 2     | 3     | 3     | 3     | 69    | ..... | 1     | ..... | ..... | ..... | 5   | 123 |     |       |
| Oakland colliery No. 2, ..... | 1  | 18    | 1     | 1     | ..... | ..... | 23    | ..... | 1     | ..... | ..... | ..... | 3   | 74  |     |       |
| Oakland, .....                | 1  | 20    | ..... | ..... | ..... | ..... | 21    | ..... | 1     | ..... | ..... | ..... | 4   | 26  |     |       |
| Puritan, .....                | 1  | 29    | 1     | ..... | ..... | ..... | 33    | ..... | 1     | ..... | ..... | ..... | 3   | 28  |     |       |
| Patton No. 1, .....           | 1  | 154   | 15    | 4     | 12    | 2     | 188   | ..... | 1     | 2     | ..... | ..... | 10  | 56  |     |       |
| Patton No. 2, .....           | 1  | 127   | 3     | 6     | 1     | ..... | 144   | ..... | 2     | ..... | ..... | ..... | 3   | 147 |     |       |
| Richland, .....               | 1  | 18    | 3     | 1     | 2     | ..... | 25    | ..... | ..... | ..... | ..... | ..... | 3   | 27  |     |       |
| Rolling Mill, .....           | 2  | 211   | 28    | 22    | 29    | 13    | 296   | ..... | 4     | 8     | ..... | ..... | 24  | 330 |     |       |
| Standard, .....               | 1  | 44    | 7     | 4     | 6     | 2     | 64    | ..... | 1     | ..... | ..... | ..... | 2   | 66  |     |       |
| Sonnan No. 1, .....           | 1  | 130   | 19    | 4     | 13    | 6     | 173   | ..... | 2     | 2     | ..... | ..... | 10  | 182 |     |       |
| Sonnan No. 2, .....           | 1  | 92    | 9     | 5     | 19    | 3     | 139   | ..... | 1     | ..... | ..... | ..... | 8   | 188 |     |       |
| Sumner No. 1, .....           | 1  | 80    | 12    | 1     | 6     | ..... | 100   | ..... | 1     | ..... | ..... | ..... | 7   | 167 |     |       |
| Sumner No. 2, .....           | 1  | 49    | 1     | 1     | 5     | ..... | 57    | ..... | 1     | 2     | ..... | ..... | 3   | 64  |     |       |
| Spangler, .....               | 1  | 45    | 2     | 1     | 1     | ..... | 50    | ..... | 1     | ..... | ..... | ..... | 3   | 53  |     |       |
| Sterling No. 8, .....         | 2  | 350   | 8     | 15    | 11    | 9     | 395   | ..... | 5     | 4     | ..... | ..... | 19  | 414 |     |       |
| Sterling No. 9, .....         | 1  | 80    | 2     | 2     | 2     | 2     | 89    | ..... | 1     | ..... | ..... | ..... | 4   | 93  |     |       |
| Sterling No. 11, .....        | 1  | 70    | 2     | 2     | 4     | 2     | 81    | ..... | 1     | ..... | ..... | ..... | 3   | 84  |     |       |
| Sterling No. 12, .....        | 2  | 180   | 3     | 4     | 20    | 2     | 211   | ..... | 2     | ..... | ..... | ..... | 10  | 221 |     |       |
| Sonnan shaft, .....           | 1  | ..... | ..... | ..... | ..... | ..... | 13    | ..... | 2     | 2     | ..... | ..... | 9   | 92  |     |       |
| Vintondale No. 1, .....       | 1  | ..... | ..... | ..... | ..... | ..... | 17    | ..... | ..... | ..... | ..... | ..... | 1   | 18  |     |       |
| Williams, .....               | 1  | 12    | 2     | ..... | ..... | ..... | 21    | ..... | ..... | ..... | ..... | ..... | 2   | 17  |     |       |
| Webster No. 3, .....          | 1  | 221   | 58    | 11    | 29    | 10    | 321   | ..... | 3     | ..... | ..... | ..... | 17  | 338 |     |       |
| Whelan, .....                 | 1  | 210   | 30    | 6     | 23    | 2     | 272   | ..... | 1     | 2     | ..... | ..... | 18  | 290 |     |       |
| Yellow Run shaft, .....       | 1  | 92    | 2     | 5     | 6     | 3     | 109   | ..... | 2     | ..... | ..... | ..... | 15  | 124 |     |       |
| Totals, .....                 | 71 | 5,293 | 427   | 169   | 497   | 134   | 6,501 | ..... | 6     | 77    | 44    | 98    | 213 | 107 | 543 | 6,944 |

TABLE NO. 4.—List of fatal accidents that occurred in and about the mines of the Sixth Bituminous Mine District for the year ending December 31, 1894.

| Date of accident. | Name of Person. | Occupation. | Age. | Widow. | Number of orphans. | Name of Colliery.  | Location—County.       | Nature and Cause of Accident.   |
|-------------------|-----------------|-------------|------|--------|--------------------|--------------------|------------------------|---|
| Feb. 1.           | Samuel Talbot.  | Driver.     | 25   | .....  | .....              | Dean No. 4.        | Frugality, Cambria Co. | He started down the heading with his trip of two wagons, but the driver ahead flagged him to stop, and he put on his front brake and jumped off to the wrong side and was struck by the hind car on the back, which injured his spinal cord. He was taken to the hospital and died there in a few days after. |
| March 7.          | Charles Lohr.   | Miner.      | 18   | .....  | .....              | Rolling Mill mine. | Johnstown, Cambria Co. | Head bruised and hurt internally, causing his death in a few days, by a fall of bony or slate, which fell on him while he was loading a wagon of coal in his place.   |
| June 5.           | George Weible.  | Miner.      | 56   | .....  | .....              | Rolling Mill mine. | Johnstown, Cambria Co. | Contrary to orders, he was taking coal off of the pillar, and that brought down a piece of slate which struck him on the back, dislocating the spinal cord, causing death inside of a week.   |
| July 17.          | Dennis Dunn.    | Miner.      | 47   | Yes    | 5                  | Gautier mine.      | Johnstown, Cambria Co. | Was injured internally; at first he was not thought dangerously, but he died the next day. A shot had been fired in the roof by the opposite shift which had left a piece of loose rock, which fell on him while he was tamping a hole in the coal.   |
| 24.               | Steve Hays.     | Greaser.    | 26   | .....  | .....              | Rolling Mill mine. | Johnstown, Cambria Co. | Injured internally, causing death. This young man was employed to grease the rollers on the dilly road, and was forbidden to ride on the trip, but contrary to orders he jumped on a loaded   |



|          |                        |                |    |       |                          |                                 |   |
|----------|------------------------|----------------|----|-------|--------------------------|---------------------------------|---|
| Aug. 10. | John Hadok, .....      | Miner, .....   | 35 | Yes   | Sterling No. 8, .....    | Hastings, Cambria Co., .....    | trip, and either fell off or jumped off and got under the trip of loaded wagons, which caused his injuries. Killed by a fall of coal. The coal had been loosened by a blast, and he lay under this loose coal after blasting it without putting any sprag under it to keep it from falling. This was a case of negligence or a lack of knowledge of the danger.   |
| Oct. 2.  | John Dobets, .....     | Miner, .....   | 36 | ..... | Sonman shaft, .....      | Ben's Creek, Cambria Co., ..... | This man was killed by his own carelessness. Having mined his coal about five feet under, he then put in a blast which did not bring down the coal; he then lay under it again to undermine it further in without putting any sprags under it, and it fell upon him, killing him instantly. Caused by a fall of bony or slate. It was a slip behind the bony that could not be seen, and it let the fall down and injured his back, killing him almost instantly. |
| Aug. 16. | Greshan Gogno, .....   | M.ner, .....   | 33 | Yes   | Standard, .....          | Lally, Cambria Co., .....       | Hurt internally, causing death, by a fall of bony, while loading a wagon of coal.   |
| Oct. 3.  | Adam Wllemberch, ..... | Miner, .....   | 50 | Yes   | Rolling Mill mine, ..... | Johnstown, Cambria Co., .....   | Was squeezed to death between a loaded wagon and the roof, caused by him jumping on between the wagons instead of walking beside them. He kept on the trip until it reached the knuckle of the plane, where he was caught between roof and the loaded car.  |
| 25.      | Bert Meyers, .....     | Driver, .....  | 22 | Yes   | Sonman shaft, .....      | Ben's Creek, Cambria Co., ..... | Was riding on cage and jumped off at first landing when the cage was in motion, and fell back in the shaft and was killed instantly.  |
| Nov. 12. | W. F. Paul, .....      | Laborer, ..... | 19 | ..... | Henrietta shaft, .....   | Dunlo, Cambria Co., .....       | Was killed by a fall of coal, caused by not spragging up the coal according to the mine rules.  |
| 17.      | William Brown, .....   | Miner, .....   | 50 | Yes   | Ashcroft mine, .....     | Patton, Cambria Co., .....      | Killed by a fall of coal. After leaving in blocks of coal to hold up that which was undermined, he lay under the coal to mine out the coal block that held up the fall, and let several tons down, killing him instantly.   |
| Dec. 20. | John Maggla, .....     | Miner, .....   | 30 | Yes   | Sonman shaft, .....      | Ben's Creek, Cambria Co., ..... |   |

TABLE No. 5.—List of non-fatal accidents that occurred in and about the mines of the Sixth Bituminous Mine District for the year ending December 31, 1894.

| Date of accident. | Name of Person.  | Occupation. | Age.  | Married. | Number of children. | Name of Colliery.    | Location—Cambria county. | Nature and Cause of Accident.   |
|-------------------|------------------|-------------|-------|----------|---------------------|----------------------|--------------------------|---|
| March 13.         | George Pride.    | Miner.      | 27    | Yes      | .....               | Dean No. 4 shaft.    | Frugality.               | Leg broken by fall of rock.   |
| April 17.         | William Robison. | Miner.      | 50    | Yes      | .....               | Dean No. 4 shaft.    | Frugality.               | Leg broken by fall of coal.   |
| June 29.          | Thomas Soltis.   | Miner.      | 44    | Yes      | .....               | Rolling Mill mine.   | Johnstown.               | Slight fracture of arm, caused by a fall of coal.   |
| July 18.          | George Bogle.    | Brakeman.   | 18    | .....    | .....               | Rolling Mill mine.   | Johnstown.               | Arm fractured, necessitating amputation, caused by the trip jumping the track.  |
| Aug. 14.          | James Cullen.    | Miner.      | 42    | Yes      | .....               | J. C. Stineman mine. | South Fork.              | Collar bone broken; caused by a fall of coal, which fell from a slip that could not be detected by him. A pure accident.  |
| Sept. 20.         | S. M. Spencer.   | Miner.      | 60    | Yes      | .....               | Cymbria mine.        | Earnsboro.               | Arm broken, by a fall of rock.  |
| Oct. 19.          | John Pabb.       | Miner.      | 22    | .....    | .....               | Yellow Run shaft.    | Dunio.                   | Collar bone broken; caused by a fall of coal, from his neglect to sprag it up. These men worked together, and after mining a large piece of coal and firing four shots in it, which failed to bring it down, they foolishly lay down under it to mine again, and it fell on them, hurting them badly on body and arms, but not dangerously. Severely crushed between loaded wagon and roof. |
| Nov. 18.          | Grossman Joe.    | Miner.      | ..... | .....    | .....               | Henrietta shaft.     | Dunio.                   | Leg broken by slipping in jumping on his trip and being caught between wagon and a prop on the side.  |
| Nov. 13.          | John Scobson.    | Miner.      | ..... | .....    | .....               | Henrietta shaft.     | Dunio.                   | Foot crushed so badly that it had to be amputated, caused by running a trip down over a grade, and the wagon jumped the track and his foot was caught between the trip of cars and a prop, crushing it almost flat.   |
| Nov. 23.          | Albert Shofield. | Driver.     | 19    | .....    | .....               | Argyle mine.         | South Fork.              | .....   |
| Nov. 24.          | George Myers.    | Driver.     | 14    | .....    | .....               | Sonnan shaft.        | Ben's Creek.             | .....   |
| Dec. 5.           | William Loos.    | Driver.     | 26    | .....    | .....               | Mashannon mine.      | Patton.                  | .....   |

|                              |               |          |                          |                  |  |
|------------------------------|---------------|----------|--------------------------|------------------|--|
| 15. Edward Vansmitski, ....  | Driver, ..... | 16 ..... | Rolling Mill mine, ..... | Johnstown, ..... | Leg badly fractured by falling beneath the front wheel of a moving car which he tried to pass; tripping on the rail caused him to fall.            |
| 21. Stanislaus Dranski, .... | Miner, .....  | 29 ..... | Rolling Mill mine, ..... | Johnstown, ..... | Back badly hurt by a fall of bony. His place was well propped, but the bony broke very short in a space of about six feet. It was a pure accident. |

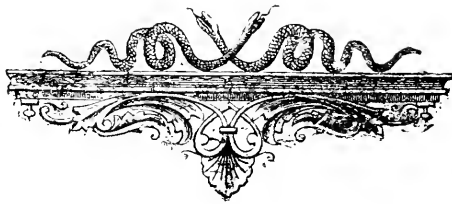

# SEVENTH BITUMINOUS DISTRICT.

(ALLEGHENY, WASHINGTON AND BEAVER COUNTIES.)

Idlewood, March 24, 1895.

Hon. Isaac B. Brown, Secretary of Internal Affairs:

Sir: In compliance with the Act of Assembly approved May 15, 1893, I have the honor of presenting to you my report of the inspection of coal mines in the Seventh Bituminous District, for the year ending December 31, 1894.

I am pleased to state that under the beneficent influence of the act of 1893 the sanitary condition of the mines is being raised to a higher degree of perfection both as regards ventilation and other matters pertaining to the health and safety of the employes. And I may venture to assert without fear of contradiction, that the condition of the greater number of our mines, considered from a sanitary point of view, is far in advance of what they were a few years past. In some few cases where it had been the custom to move along in a kind of "go as you please" style, the stringent but wise provisions of the above act were only accepted and complied with after much urging, and then very reluctantly, and very probably, in some few cases, it will require constant pressure from without to prevent a relaxation or turning back to the old make-shift methods and loose discipline of the past.

Nine persons lost their lives in and about the mines during the year, as against twenty-one for the previous year. This is a very low death rate for this section when we take into consideration the dangerous nature of the slate immediately overlying the coal bed in nearly all the mines in this district, and also from the fact that a very large proportion of the persons employed in our mines are not practical miners. This large decrease in the list of fatal accidents is probably due in a large measure to the wise provisions embodied in article V of the present mining law, which require that in all mines wherein explosive gas has been discovered, "every working place, without exception, shall be examined immediately before the men enter to their work." A number of instances have been brought to my notice where the person making these periodical examinations have discovered extremely dangerous conditions in the working places from loose roof and slate, and have notified the mine foreman

of the nature and location of the danger, who, in turn, proceeded immediately to the point indicated and caused the dangers to be removed, or proper safeguards made use of for protection, which had it not been discovered and attended to at once in the manner above described, would undoubtedly in some cases have resulted in loss of life.

The number of non-fatal injuries during the year was forty-seven, or an increase of three over those of the previous year.

Of the nine persons killed, it would appear that the loss of three lives was purely accidental and four men lost their lives for want of the exercise of proper care on their own part. One life was lost because the person killed had not the least idea of any of the dangers surrounding the miners' occupation and knew not what to do in order to protect himself, while one fatality occurred by reason of the fact that the safety appliances on top of the shaft were not kept in repair and in good working order, as required by law; or, in other words, the accident was in the main due to a violation of law on the part of the mine officials.

The above fatalities have deprived five wives and twenty-five children of husbands and fathers. Three of the widows and seven of the orphans are residents of foreign countries.

The total production of coal for the year is 196,591 tons less than that of last year. This small decrease in the production is much less than was anticipated in view of the general depression in business, and of the fact that operations at nearly all of the mines were suspended for about two months in the early part of the shipping season. The suspension was caused through a dispute between the operators and the miners about the price of mining.

The total number of people employed in the district is about 446 more than were employed last year.

The market value of the product and the wages of the miners at the present time are far too low. Fair profit on invested capital is out of the question, and in most cases those of the miners who are American citizens are unable to purchase a sufficiency of the ordinary necessities of life, and in many cases extreme destitution prevails among them and so long as the labor market continues to be overcrowded, as at present, with unskilled foreign labor, we do not anticipate much improvement in the miner's condition for some time to come.

A description of the cause of each fatality and of the general condition, and improvements made in the various mines of the district, together with the statistical tables and other necessary information will be found in their proper places in this report.

Yours respectfully,

**JAMES BLICK.**

|   |           |
|---|-----------|
| Total production run of mine coal in tons of 2,000 pounds . . . . . | 4,238,825 |
| Total production in tons of coke, . . . . .                         | 6,000     |
| Number of mines in district, . . . . .                              | 72        |
| Number of employes inside, . . . . .                                | 9,115     |
| Number of employes outside, . . . . .                               | 729       |
| Total number of employes, . . . . .                                 | 9,844     |
| Number of persons killed in and about the mines, . . . . .          | 9         |
| Number of non-fatal injuries, . . . . .                             | 47        |
| Number of wives made widows by above fatalities, . . . . .          | 5         |
| Number of orphans from same cause, . . . . .                        | 25        |
| Number of tons of coal produced per life lost, . . . . .            | 470,981   |
| Number of tons of coal produced per person injured, . . . . .       | 90,188    |
| Number of persons employed per life lost, . . . . .                 | 1,094     |
| Number of persons employed per non-fatal injury, . . . . .          | 209       |
| Number of horses and mules in use, . . . . .                        | 588       |
| Number of steam boilers in use, . . . . .                           | 121       |

Cause of Accidents.

|   | Fatal. | Non-fatal. | Widows. | Orphans. |
|---|--------|------------|---------|----------|
| By falls of coal, roof and slate, . . . . . | 7      | 34         | 4       | 22       |
| By explosion of gas, . . . . .              | 1      | 3          | 1       | 1        |
| By mine wagons, . . . . .                   | 1      | 7          | 1       | 1        |
| By miscellaneous causes, . . . . .          | 1      | 3          | 1       | 3        |
| Totals, . . . . .                           | 9      | 47         | 5       | 25       |

Description and General Condition of the Mines in the Seventh District During the Year 1894.

Mines on and Near the Monongahela River.

Bellwood. Is in very favorable condition. On each inspection made during the year the workings were found to be well ventilated, and the health and safety of the employes appear to be well cared for. Quite a large quantity of black damp is given off from the old workings during the summer season, which requires a brisk and constant air current to prevent an accumulation of this noxious gas. Quantity of air in circulation, when last measured, 36,960 feet per minute.

Calhoun. Is a small operation, employing during the winter season about eighteen men. Ventilation is produced by a small furnace which was passing 10,200 feet of air per minute when last measured. Condition of mine is favorable. The product is sold in the town of Homestead, principally for domestic use.

Knoxville. Is also a small operation. Frequently there is not more than nine men employed, except for a few weeks in the winter season. They have a small ventilating furnace which will give sufficient air current if properly attended to.

Streets Run. On my last visit to this mine the inside conditions were only reasonably good. The quantity of air passing at the furnace was 13,600 feet per minute. This volume of air is ample for all purposes if properly distributed, but I found that most of this air current was passing directly from one of the inlets to the furnace, and was of no benefit to the working parts of the mine. Probably the mine foreman was not directly to blame for this state of affairs, for upon investigation I found that some laborers working upon the street car line in the near vicinity, had thrown open one of the pit mouths which the mine foreman had partially closed up, and he had not detected this until the date of my examination of the mine.

Hays Street Run Nos. 2 and 3, and the Beck's Run mines have been idle throughout the year, but there is some prospect of operations being resumed in the near future.

First Pool. This mine is now in first class condition. A 25-foot Vulcan fan has been provided to produce the ventilation; this fan is giving good results. Volume of air passing, when last measured, 103,000 feet per minute; speed of fan, 50 revolutions; water gauge one inch. The Harrison type of mining machines have been introduced into the mine during the past year, and they appear to be working very successfully. Fire damp is generated in different parts of the mine, but there is a good, sweeping air current passing through all sections of the workings, which carries away all noxious gases as fast as generated, and it may be said that the health and safety of the employes is pre-eminently considered in the general management of the mine.

Walton. At the time of my last visit the general conditions were favorable, excepting that the distribution of the air current through the workings needed some little improvement. Some parts of the workings were receiving more air than was needed, while other parts were rather inadequately supplied. Quantity of air passing in the return air-way 48,000 feet per minute.

Ormsby. They have built a furnace which has improved the ventilation, and the general condition of the mine is satisfactory. Fire damp is sometimes generated very freely in the advanced parts of the workings, which requires constant care and a brisk air current in

---



order to keep on the safe side. Quantity of air in circulation when last measured, 31,700 feet per minute. Number of persons employed inside, 119.

Castle Shannon. Is in a fairly good condition. Quantity of air passing at the outlet, 23,000 feet per minute, the same being fairly well distributed to the working parts of the mine. The only defect noticed was that some of the room pillars were not cut through for ventilation at the proper distances.

#### Mines on the Little Saw Mill Run Railroad.

Enterprise. Was on each visit found in good condition. In one section of the mine they are mining out a large number of old pillars which were overlooked or left standing in position several years ago. In this section, large volumes of black damp are generated, and considerable difficulty has been experienced in propelling a sufficient volume of air current to the face of workings to keep them in a healthful condition; but generally speaking, fairly good results have been obtained. Quantity of air passing at the outlet 93,000 feet per minute, well distributed through the different sections of the workings.

Venture. After much urging a 20-foot Vulcan fan has been provided to produce ventilation, and since this fan has been in operation, the mine has been found in fairly good condition. Quantity of air passing at the outlet 40,000 feet per minute. This quantity can be increased to about 60,000 feet per minute if found to be necessary.

Fox. Is in much better condition than formerly. They have provided a ten-foot fan which was passing 17,000 feet of air per minute when last measured. This volume of air is ample for present requirements if properly conducted to the working places, but the airways and inside arrangements in general are rather crude and insufficient.

#### Mines on the Pan Handle Railroad.

Idlewood. Is in somewhat better condition than formerly. The air is conducted forward to face of mine much better than in the past. Drainage is not very good and the roadways in some places are wet and muddy. Quantity of air passing at the outlet 14,000 feet per minute.

Grant. They have built a new stack on the top of furnace shaft which has had the effect of adding power to the furnace, and increasing the volume of air in circulation through the workings. General condition of the mine is reasonably good. Quantity of air passing at outlet, when last measured, 16,500 feet per minute.

Fort Pitt. Has been in operation only a few weeks during the year. When last visited the general condition inside was favorable. Quar

tity of air in circulation 11,000 feet per minute. The mine is not in operation at the present time, and I understand that it is abandoned for the time being.

Champion. The inside conditions of this mine are reasonably good. They have opened a new pit-mouth into a separate coalfield of small extent, and are now driving entries and mining considerable coal therefrom. A small furnace has been erected to ventilate this territory apart from the main workings. This furnace was producing 7,400 feet of air per minute, and the other furnace in the old section of workings was producing 17,200 feet per minute when last measured.

Nickel Plate. On my first visit the ventilation was inadequate. The cause of this defect was on account of the new ventilating furnace not being properly completed. I directed that certain changes be made in its construction, which were made at once, and which proved to be very beneficial, nearly doubling the volume of air in circulation. At the time of my last visit the mine was not in operation, but the general inside conditions were favorable. Quantity of air passing, 30,000 feet per minute.

The territory being developed by this mine is perforated in all directions with oil wells and requires careful engineering to keep clear of them. Sometimes oil is found penetrating through the coal strata into the mine, but not to the same extent as formerly, and it may be said that all of the territory surrounding the mines in this vicinity is in the same condition as at this one.

Black Diamond. This is only a small operation, employing about 60 miners. The inside conditions are reasonably good. Quantity of air moving through the workings when last measured, 6,600 feet per minute.

Midway. During the early part of the year the ventilation was far below the requirements, but they have since provided a twelve-foot fan and the condition of the mine is now satisfactory in all respects. Quantity of air in circulation when last measured, 28,600 feet per minute.

Primrose. Is in favorable condition. They have, during the year, made a separate traveling way running parallel with the main tunnel, so that it is no longer necessary for the men to use the dilly road in passing to and from their work. Quantity of air passing at the outlet, when last measured, 32,000 feet per minute, the same being pretty well distributed to the working parts of the mine in several air splits, by means of air bridges which are being placed where necessary.

Jumbo. Is not in as good condition as it should be. The quantity of air passing at the outlet when last measured was 55,000 feet per minute. This volume would be nearly sufficient for all purposes if properly distribute, but the inside arrangements for ventilation are

not up to the requirements. Some parts of the workings are well supplied with air, while other parts do not receive a sufficient supply. This defect could be easily remedied by a judicious system of air-splits, and by erecting permanent air-tight stoppings between main intake and return airways to prevent leakage. They have a main intake air shaft near the face of the workings, and with skillful management all parts of the mine could be well ventilated and the total amount of air in circulation materially increased. At the present time I understand that improvements in the line above suggested are under way.

Brier Hill. The general condition of this mine is satisfactory. They have made a new dilly road through the main body of the workings which intersected the airways at several points, causing a slight disarrangement of the ventilation for the time being, but this will be overcome in the near future, and the dilly road will be used as a main inlet to carry the air forward to face of mine. Quantity of air passing when last measured, 52,800 feet per minute.

Laurel Hill Mines Nos. 1, 2 and 4. Considerable improvement has been made at the No. 1 mine during the year. They are at the present time making a traveling and air way from the main pit-mouth into the body of the mine, running parallel to the main hauling road. When this is completed it will make a decided improvement in the ventilation, and the men will have a traveling road to and from their work independent of the main dilly road. They have also provided a twenty-foot Vulcan fan, which is capable of producing upwards of 60,000 feet of air per minute. Before this fan was provided the ventilation was below the requirements.

The No. 2 mine has not been run to its full capacity for more than about two months during the year. At the present time they are only driving entries and making general repairs. A new twenty-foot Vulcan fan has also been provided at this mine which will, under present conditions, produce about 70,000 feet of air per minute, so that the mine is well supplied with fresh air; but other conditions are not by any means satisfactory. Very little skill has been displayed by the management hitherto, but the mine has not been in operation long and there is a large field of coal yet undeveloped, and with permanent skillful management in the future, past mistakes may be rectified to a great extent.

The inside conditions of No. 4 mine are not of the best. The quantity of air passing at the inlet when last measured was 75,600 feet per minute. (This air is produced by a twenty-five-foot Brazil fan.) But one section of the workings was not receiving a sufficient volume of air-current. This defect was due to a large portion of the air having leaked through the old workings into the return airway, instead of passing into the working parts of the mine, but they were making

arrangements to build a new main overcast over the main hauling road to change the direction of the air current. This would enable them to conduct the air from the inlet to the face of mine, and would remove the above defect in the ventilation. I notice that man-holes were needed on the main hauling and traveling way, which I told them to make at once.

From the above description it will be noticed that each mine is provided with good ventilating machines, and if the mines are not properly ventilated the blame will rest with the inside management. The great lack hitherto has been the want of permanent skillful management which should be vested in the hands of a qualified general manager, one who is well versed in the practical science of mining, without which a property of this extent cannot be operated to good advantage.

Willow Grove. Has only been in operation about four months during the year. When last visited the conditions were reasonably good. Quantity of air at outlet, 36,000 feet per minute.

Star. Is in rather poor condition. Only about thirty men are employed taking out pillars, and from present indications the mine will be abandoned in the near future. Quantity of air passing in return airway, 5,000 feet per minute.

Pine Ridge. Is a new mine opened during the present year. The workings are not sufficiently advanced for a general description; only a few men are employed driving entries.

National. Is in a reasonably good condition. Quantity of air passing, 16,900 feet per minute. On my last visit I found that the traveling way was not in good condition and the men were using the dilly road to travel to and from their work. I ordered them to clear up and drain the traveling way so that the men could use it, and also told them to make man-holes on the hauling roads where the men have to travel. They are advancing toward old workings containing a large body of water and I instructed the mine foreman not to approach too near the line of the old works until he was ready to tap and drain off the water, which will be some time in the future after they have driven to the outcrop for a natural water way. I also cautioned him to use the drill for protection where necessary.

Oak Ridge. The conditions of this mine are considerably improved since last report. They have enlarged the old airway near to the furnace and made new connection near face of mine, so that all the air produced by the furnace can now be conducted to the face of the workings. Quantity of air passing when last measured 14,600 feet per minute.

Boyd. Is in fairly good order. Volume of air passing in return air way when last measured, 20,000 feet per minute, being reasonably well distributed to the working parts of the mine.

Mansfield and Erie. Is in somewhat better condition than formerly, but very great improvement is still necessary before the conditions will satisfy legal requirements. A more powerful ventilating apparatus is needed, which the operators have promised to supply, but it takes them a long time to fulfill their promises; however, the matter is becoming urgent and will have to be attended to unless the number of employes is reduced.

On my last visit I noticed that the escapeway leading from the mine to the outside was not in good condition, and several other details in the management were not properly attended to. Quantity of air passing when last measured, 8,190 feet per minute.

#### Mines on the Chartiers Valley Railroad.

Mansfield No. 2. The workings of this mine are very extensive and it requires close and constant daily attention to keep all parts of the workings in good order, but on each examination I have found the general conditions very favorable. Quantity of air in circulation when last measured, 70,000 feet per minute.

Nixon. The condition of this mine is also fairly good, so far as it can be made. In one part of the mine the roof is exceedingly soft, and mining the coal with safety to the employes is a difficult operation, requiring very close attention on the part of the miner and mine officials. However, the new territory now being developed is out of the danger and in safe, solid ground. All parts of the workings are reasonably well ventilated. Quantity of air passing when last measured, 40,000 feet per minute.

Leasdale. Most of the coal contained within the boundary lines of this mine is now worked out and they are now working into a field of coal formerly owned by the operator of the Nixon mine. In order to reach this coal field it was necessary to open a new roadway through part of the old workings of the above mine, which took considerable time and expense to accomplish. The old part of the mine is well supplied with air, but the new workings where the ventilation is produced by the ventilator of the Nixon mine, is short of the required amount of air current, and it will be necessary for them to sink a shaft and erect a furnace for the proper ventilation of this part of the mine. Quantity of air passing in the new workings, 4,800 feet per minute; number of men employed, about 20.

Summer Hill. Is in fair condition. Quantity of air in circulation, 37,000 feet per minute, but the mode of distributing this air is not the best. In fact, there is some difficulty experienced in trying to give each section of the mine a fair share of air supply when the power of the ventilator is inadequate to the requirements, and when the main inlet is located at a point remote from the workings; both of which conditions exist in this mine. It is the intention

to sink a shaft at the face of the workings for an inlet of the air-current, and if this will not suffice, then a more powerful fan will be provided. I must say in justice to the operator and manager, that they are at all times anxious to do all that is necessary to keep the mine in a safe, healthful condition.

**Bower Hill.** The general conditions of this mine are favorable, but on my last examination I notice that the road leading to the second outlet was not in good condition, but they are now driving to the outcrop for a new escapeway at the face of the mine. Quantity of air in circulation, 24,000 feet per minute.

**Bridgeville.** The ventilation in this mine during the past summer has been far below the requirements, but they are now erecting a 16-foot Vulcan fan. When this fan is set in motion the mine will be well supplied with fresh air for many years to come. Quantity of air passing near face of entries, when last measured, 4,500 feet per minute. The mine has run very irregularly the greater part of the year.

**Hasting's Slope.** They have sunk a shaft about eighty feet deep at the face of the mine. This shaft will be used as an inlet for the air current. Stairs will also be put in one compartment for an escapeway for the mine. Quantity of air passing, when last measured, 11,000 feet per minute, but the time is not very far distant when a more powerful ventilation will be required.

**Boon.** Is in reasonably good order. Air in circulation, when last measured, 18,000 feet per minute.

**Allison.** Is in very fair condition. All parts of the workings are supplied with plenty of fresh air, and I have not found it necessary to make any complaints about the condition of the mine during the year. Quantity of air passing, 16,560 feet per minute.

**Enterprise.** During the earlier part of the year, the air current passing through the face of the workings was inadequate, but on my last visit I found that matters were much improved and the ventilation in general was fully up to the requirements. Parts of the mine are very wet, and there can be no relief from this defect until they tap and drain away the water from the old mine adjoining, which was abandoned and allowed to fill with water a number of years ago. Quantity of air passing, 16,500 feet per minute.

**Northwestern.** They have lately driven a new slope for a traveling way into and from the mine. Taking all things into consideration, the condition of the mine at the present time is favorable. Quantity of air passing through the workings, 15,500 feet per minute.

**Morgan.** At the time of my last visit the workings on the south side of mine were short of air-current, but other parts of the mine were in reasonably good condition. Quantity of air passing at the outlet 32,250 feet per minute.

Standard. When last visited was found in a very favorable condition, excepting in one pair of entries where the ventilation was not up to the requirements. This defect was due to the slow speed at which the fan was being driven at this time. Quantity of air passing, 29,800 feet per minute. The capacity of the fan, if driven at an average speed, is about 50,000 feet per minute.

Creedmore. The general conditions are favorable, but the details in the inside management could be and should be improved. For instance, there should be several air bridges erected so as to dispense with several doors now found on the main face entries, the use of which is detrimental to a constant flow of air-current to the face of the mine. This difficulty would in a great measure be overcome by providing the air bridges. This mine is opened into a large, valuable coal property, and the general lay and conditions of the coal field are very favorable for first class ventilation, and with ordinary skillful management in opening out and developing the property, all ventilating doors could have been dispensed with. Quantity of air in circulation, when the fan is run at an average speed, 48,000 feet per minute.

Ridgeway Bishop. Is in fairly good order. Quantity of air passing at the inlet, when last measured, 37,800 feet per minute, being fairly well distributed to the different sections of workings. Drainage is also reasonably well provided for.

#### Mines on the P. C. & Y. Railroad.

Pan Handle. Several overcasts have been built during the year to distribute the air current on the split system, but at the time of my last visit I observed that the air current was not moving with sufficient velocity to keep the workings in a healthful condition. This defect was due to the neglect of the fan engineer in not running the fan to the proper speed. I ordered them to run the fan up to a safe average speed, after which I measured 34,800 feet of air per minute passing at the outlets. If this volume of air is maintained and properly distributed, it is quite sufficient for present needs.

Essen. A 20-foot Guibal fan has been provided and is now in operation, so that the former defect in the ventilation has been removed, and all parts of the mine are now well supplied with plenty of fresh air. Other conditions are also favorable. Quantity of air passing when last measured, 63,000 feet per minute.

Beadling. The condition of this mine during the past year was not satisfactory, but they have now provided a 25-foot Vulcan fan to produce the ventilation. This fan is one of the best in the district, and the foundations and general mode of its construction and erection are very substantial. Quantity of air passing at the face of mine

since the fan has been set in motion is about 40,000 cubic feet per minute. There should be two air-bridges provided so as to give each section of workings a proportionate share of fresh air, and the airways near the shaft should be enlarged. When these improvements are completed there need be no further complaint about a lack of ventilation, for the fan will produce upwards of 100,000 cubic feet of air per minute if necessary. At the present time they are erecting a mining plant, and in the near future the coal will be undermined with machines of the Harrison type, driven by compressed air.

Essen Nos. 2 and 3. The small six-foot Champion fan formerly in use at Essen No. 1 mine has been removed to the No. 2 mine, but its power is too limited to be of any permanent benefit. At the last measurement it was producing 15,000 feet of air per minute and the general condition of the mine was favorable.

The condition of the No. 3 mine has been considerably improved since my last report, but the ventilation is still below the requirements. They are now driving an entry to intersect a point at the face of the mine where a shaft will be sunk, to be used as an inlet for air. When this is done it will cause a great improvement in the ventilation, especially in the summer season when it will be most needed. Quantity of air passing when last measured, 27,000 feet per minute.

Pittsburgh Fuel No. 2. At this mine they have a habit of turning rooms in advance of the air current. On one of my visits to the mine I found ten rooms in advance of the air way in one of the entries, and twelve men working them in an atmosphere that would quickly destroy the strongest constitution, and as I had previously ordered a number of men out of the mine who were working under the same conditions and also cautioned the manager not to repeat the offense, and seeing that my previous caution had been ignored, I considered it my duty to institute legal proceedings against the inside manager to compel him to comply with the requirements of the mining law, and to give proper attention to the health and safety of the employes under his charge. At the time of my last visit to the mine (after instituting the above legal proceedings) I observed that the conditions were much improved and that ventilation was then being distributed reasonably well through the working parts of the mine. Quantity of air passing at the outlet 19,000 feet per minute.

O. I. C. This mine, when last inspected, was found in reasonably good condition. Quantity of air passing at the outlet, 15,000 feet per minute, fairly well distributed to the face of the workings.

Federal. Is in favorable condition. Quantity of air passing when last measured, 46,000 feet per minute. This volume of air is ample for all purposes if properly distributed.

Federal Spring. At the time of my last visit I observed that some



parts of the mine were not well supplied with ventilation, while in other parts there was more air passing than was necessary. I suggested to the manager that he give more attention to the distribution of the air current so that all parts of the workings might be supplied with plenty of fresh air. Quantity of air passing at the outlet 17,500 feet per minute.

Beachmount. Is not in the best of condition. The roadways are wet and muddy, and parts of the mine are not well supplied with ventilation. The workings are so much cut up and intersected, that it is a difficult matter to conduct the air-current forward to the face of some of the entries in sufficient quantities to maintain a pure, healthful atmosphere. Quantity of air passing at the outlet when last measured, 15,600 feet per minute.

Hickman. At the time of my last visit I observed that the air current in parts of the mine was defective. Since that time they have driven to the outcrop at the face of the mine, and this opening will, in the future be of great benefit to the ventilation. The mine has been in operation only for about four months during the year. Quantity of air passing at the outlet, 30,000 feet per minute.

Moon Run. This is the only mine opened on the Moon Run Railroad and is a very extensive operation. The inside developments are a fair representation of the science of mining as it should be. All of the new developments are being conducted on the three-entry system, and in the near future about 500 men will be employed in the new sections of workings, and the ventilation conducted through the same without the use of doors, which will insure a constant flow of air current to the face of the workings which will have an important bearing on the health and safety of the workmen and will be quite a step in advance of any other mine in the district. Hitherto the ventilation has been produced by furnace power, but it is now the intention to provide one, and probably two, fans and have them erected ready for use during the coming spring. The outside equipments are also very substantial and well adapted for handling a large tonnage. Total volume of air in circulation at the outlets when last measured, 66,400 feet per minute.

Beech Cliff and Montour. Both of these mines are located on the Montour Run Railroad. When last visited each mine was found in pretty good condition. Quantity of air passing in the Cliff mine when last measured, 20,800 feet per minute, and 26,000 feet per minute were passing in the Montour mine, but this mine was not in operation at the time, consequently the furnace was not being fired to its full capacity.

#### Mines West of the Allegheny River.

Pine Creek. On each visit made to this mine I found that the air current was not conducted forward to the face of the entries as well

as it might and should have been, but when last inspected they were replacing the lumber stoppings between main intake and return airways with masonry. This work, when completed, will prevent leakage and cause more air to pass to the face of the workings. Quantity of air at inlet, 26,000 feet per minute.

Hite. Is in pretty good condition. Quantity of air in return airway, 12,100 feet per minute, the same being pretty well conducted to the face of workings. They have sunk a shaft at face of mine which will be used in future for drainage and ventilation.

West Tarentum. This mine has been run for years as a country bank, and it is only recently that they have been employing a sufficient number of men to bring them under the provisions of the law. When visited the mine was in poor condition. The ventilation at face of mine was defective and there was no second outlet provided. I requested them to take steps to comply with the law at once. Quantity of air at outlet, 7,000 feet, produced by a fire basket.

Brakenridge. Is in good order. Quantity of air passing at the outlet, when last measured, 19,000 feet per minute.

Natrona. The conditions of this mine are favorable. All parts of the workings are generally well supplied with fresh air. Quantity of air passing at the inlet, 17,200 feet per minute.

Freeport. Is a small operation. Very little coal has been mined during the year. The condition of the mine, as regards ventilation, is away behind the times, but when they again commence operations, matters must be improved and they will be expected to comply with the legal requirements.

#### Description of Fatal Accidents in the Seventh Bituminous District During the Year 1894.

William Wright, a colored miner, 27 years of age and single, was killed by slate falling upon him in the Boyd mine, on March 5th. He was working in a room in company with another miner. They were aware of the dangerous condition of the slate and were in the act of setting a prop to protect themselves when the accident occurred. The men had without doubt been working for some time in extreme danger, not having sufficient props set under the slate to prevent it from falling, and they had no spare timbers in the room at this time.

Peter Kroneberger, miner, 44 years of age, was killed by a fall of slate in the Walton mine on March 31st. This man was mining coal in a room. The piece of slate which fell upon him would weigh about 1,500 pounds and was disconnected on one side by a free, natural slip in the strata which could not be seen until after the slate had fallen. On the opposite side from the natural slip the slate was cut loose by the roof having been taken down over the roadway.

The deceased was loading a car at the time of the accident, and in all probability he had examined the slate and found it to be unsafe, for he had taken a prop forward, presumably for the purpose of using it, but had deferred doing so until after he had finished loading his car, which delay proved to be fatal. The deceased was spoken of as being a very careful, industrious man, and his untimely death leaves eight children without father or mother. The man was working alone in his room and had been dead for some time before any one knew of it. He was discovered by a driver who was passing along the entry and who observed smoke escaping from the room, which appeared to be produced from burning linen, and upon going into the room to investigate found the man under the slate and his clothing nearly all burnt from the body, it having taken fire from his pit lamp after the slate had fallen upon him.

Frank Gusryouski, miner, 22 years of age and single, was fatally injured by being crushed between car and side of entry. This man was walking along the entry to his working place. On this entry there were rooms turned every way 24 feet which were all unobstructed, and instead of stepping into one of these rooms for the trip to pass, the man continued on his course until he met the trip of full cars, and then tried to pass between the cars and side of entry where the space between cars and side was not more than six inches, consequently he received injuries which proved fatal three weeks after the occurrence. The man had only been employed in the mines for a few days and had no idea of the dangers connected with the miner's occupation. The accident occurred in the Northwestern mine on April 9th, and death resulted on the 27th.

Mike Rodocay, miner, 28 years of age, leaves widow and two orphans in Austria, was killed by fall of slate in the Essen No. 3 mine on August 9th. This man had fired a blast in the coal alongside of a clay vein, and then went under the draw slate to throw back the coal dislodged by the shot. The slate was cut loose by a slip from the clay vein, which could readily have been seen. But it was evident that the man made no examination or he could have detected the danger if he had been a practical miner. Very probably his knowledge of mining was not sufficient to enable him to ascertain whether he was working in danger or not. The fire boss reported the room in a safe condition when he made his morning examination, but the blast in the coal was fired after that time.

Joseph Brusko, miner, aged 32, leaves widow and two orphans in Italy, was fatally injured by a fall of coal in the Primrose mine on August 4th. He died in the hospital two days afterward. Two Italians were working together in a room and upon investigation it would seem that they had undermined a quantity of coal and had

set a sprag under the coal for protection while under-cutting the same, and that one of the men commenced to take out the sprag preparatory to firing a blast while the other man was still undermining beneath the coal, and as soon as the sprag was taken out the coal suddenly fell upon the man, causing fatal injuries.

Frank Deitrich, miner, 39 years of age, leaves widow and three orphans, was instantly killed by fall of rock in the Pine Creek mine on August 21st. The deceased and another man were working together in a room, and both of them being practical miners, the room was well timbered. The piece of rock which fell would weigh about five tons and was surrounded by a free slip which intersected in the roof about four feet above the coal. This slip could not be seen until the roof had fallen. There were two props set under the piece of loose rock, but owing to its centre of gravity being unsupported the props were thrown out by the giving way of the rock. The men had fired two shots in the coal just previous to the accident, and it would appear that the shots had broken through the roof coal and penetrated into the slip in the rock, which had the effect of liberating it, but by reason of the roof coal not being broken down, the effects of the shot in the upper roof were not visible. As before stated, the room was well timbered and bore evidence of care and skill on the part of the miners, and the occurrence may be regarded as purely accidental.

Thomas Christian, miner, 43 years of age, leaves widow and seven orphans, was fatally injured by fall of slate in the Creedmore mine on October 6th, and died on October 8th. This man was loading coal after the mining machine in the main face entry. He had just finished loading the last car of coal from a shot fired the previous day. He had been loading from under a quantity of overhanging slate, part of which he had taken down just before the accident, and the remainder he had left standing. He said it sounded solid and appeared to be safe, nevertheless it fell upon him, causing injuries as above stated. He was a practical miner, well qualified to judge as to whether his working place was safe or not, and I would likely be justified in coming to the conclusion that the occurrence was purely accidental.

Carl Cramer, miner, 50 years of age and single, was fatally injured by slate falling upon him in the Standard mine on December 10th. He died in the hospital on December 14th. This man was turning a room and had only driven it about four feet from the entry. He had fired a blast which broke down the coal, and broke into a natural slip in the overhanging slate and left it in a dangerous condition. He then loaded the coal dislodged by the shot and had commenced to undermine the coal preparatory to another blast, and it would appear that he had given no attention to the slate to see whether it was

safe or not, and while under-cutting the coal, the loose slate suddenly fell upon him with fatal results. The place was reported safe by the fire boss when he made his morning examination, but the shot was fired and the danger developed subsequent to that time. The deceased had only worked one day in this mine.

Martin Macek, laborer, 40 years of age, leaves widow and three orphans in Austria, was killed on December 22d, by falling down the shaft at the Laurel Hill No. 2 mine. This man was employed on the tipple outside the mine, part of his duty being to assist in taking the full cars from the cage and putting the empty cars back. He had been employed at this work for about eight days, and on this occasion he pushed the empty car to the wrong side of the shaft instead of pushing it to the opposite side where the cage was up, and from which point he had just previously taken the full car. The consequence of this mistake was that he pushed the empty car into the shaft and both the car and the man fell to the bottom, a distance of ninety feet. Death was instantaneous. His neck was dislocated, one leg was broken in two places, and the body otherwise bruised. He should, as was the custom, have stopped with the car some distance back from the shaft for the purpose of oiling the wheels, and have pushed another car on the cage which was standing on the right track ready to be put on, but almost any person is liable to make a mistake of this nature and there is no reason why such a mistake should result in loss of life or even personal injury, and if the safety gates on top of the shaft had been in working order the accident would not have occurred, for they would have prevented the car from being pushed into the shaft. I found upon investigation before the coroner's jury that the safety gate had been out of repair and not in use for about ten days and this fact was well known to the mine officials, who were censured by the coroner's jury for their negligence in the matter. The law requires that safety gates be provided and that they be kept in good repair, and the fact that they were out of repair is a violation of the law on the part of the mine officials, and legal proceedings will be instituted.

TABLE 1.—Showing location, etc., of Collieries in the Seventh Bituminous Mine District for 1894.

| Name of Colliery.            | Name of Operator.                      | Location—County.          | Name of Superintendent.         | Postoffice Address.                    |
|------------------------------|--|---------------------------|---------------------------------|--|
| Allison.                     | Cook & Sons.                           | Washington.               | R. M. Cook.                     | McGovern, Pittsburg.                   |
| Bower Hill.                  | Alex. Demister.                        | Allegheny.                | V. M. Delamater.                | Imperial.                              |
| Beach Cliff.                 | Imperial Coal Company.                 | Allegheny.                | John Munhall.                   | Munhall.                               |
| Bellwood.                    | Munhall Brothers.                      | Allegheny.                | Julius Emsoll.                  | Roshan Mills.                          |
| Becks Run.                   | F. G. Burchman, as trustee.            | Allegheny.                | Wm. Beadling.                   | Beadling.                              |
| Reading.                     | Reading Brothers.                      | Allegheny.                | Wm. Beadling.                   | Bridgeville.                           |
| Bridgeville.                 | A. J. Shulte.                          | Allegheny.                | Jessi H. Sanford.               | Carnegie.                              |
| Boyd.                        | Loyd Coal Company.                     | Allegheny.                | J. G. McMichael.                | Hickman.                               |
| Beachmount.                  | Beachmount Coal Company.               | Allegheny.                | E. T. Hitchman.                 | Canonburg.                             |
| Bron.                        | Canonburg Coal Company, Limited.       | Washington.               | J. D. Sauters.                  | McDonald.                              |
| Brier Hill.                  | Patterson and Sauters.                 | Washington.               | G. W. Schluederberg.            | Penn Building, Pittsburg.              |
| Black Diamond.               | Brakenridge Coal Company.              | Washington.               | Alfred Hicks.                   | Leechburg, Pa.                         |
| Brakenridge.                 | Midway Block Coal Company.             | Allegheny.                | E. J. Reamer.                   | Pittsburg.                             |
| Castle Shannon.              | Pittsburg and Castle Shannon R. R. Co. | Allegheny.                | G. W. Schluederberg.            | Penn Building, Pittsburg.              |
| Champion.                    | Robbins Coal Mining Company.           | Allegheny.                | T. S. Hutchison.                | Monongahela, Pa.                       |
| Colloony.                    | W. S. B. Hays.                         | Allegheny.                | James Boyle.                    | Third ave. and Fry st., P. O. B. Cech. |
| Cherry.                      | Morris, McCue & Co.                    | Allegheny.                | James Watkins.                  | Banksville.                            |
| Credmore.                    | Ohio and Pennsylvania Coal Company.    | Washington.               | Beecher Hartley.                | First, Essen; second, Federal.         |
| Enterprise.                  | Hartley & Marshall.                    | Allegheny.                | Thomas Renshaw and Wm. Baldwin. | Arden.                                 |
| Essen Nos. 1, 2 and 3.       | Essen Coal Company.                    | Allegheny.                | John Porter.                    | Federal.                               |
| Enterprise No. 2.            | Pittsburg and Bellevorn Coal Co.       | Washington.               | Wm. Baldwin.                    | Freeport, Pa.                          |
| Federal.                     | Charters Block Coal Company.           | Allegheny.                | T. G. Cornell.                  | Thirty-sixth ward, Pittsburg.          |
| Freeport.                    | Freeport Coal Company.                 | Allegheny.                | Thomas Fox.                     | Hickman.                               |
| Fox.                         | Thomas Fox.                            | Allegheny.                | R. P. Grist.                    | Penn Building, Pittsburg.              |
| Federal Spring.              | Federal Coal Company.                  | Allegheny.                | G. W. Schluederberg.            | Carnegie.                              |
| First Pool.                  | First Pool Monongahela Gas, Coal Co.   | Allegheny.                | George Z. Hoosack.              | Hickman.                               |
| Fort Pitt.                   | Fort Pitt Coal Company.                | Allegheny.                | R. P. Grist.                    | Hope Church.                           |
| Grant.                       | W. L. Scott Company.                   | Allegheny.                | W. J. Morgan.                   | Bridgeville.                           |
| Hickman.                     | Federal Coal Company.                  | Allegheny.                | G. H. McPetridge.               | Hite.                                  |
| Hays street Nos. 2 and 3.    | H. G. Burchman, as trustee.            | Allegheny.                | T. D. Steen.                    | Idlewood.                              |
| Hastings slope.              | Slope Mines Coal Company.              | Allegheny.                | G. W. Schluederberg.            | Penn Building, Pittsburg.              |
| Hite.                        | McPetridge Brothers.                   | Allegheny.                | John Rend.                      | McDonald.                              |
| Idlewood.                    | T. D. Steen.                           | Allegheny.                | Thos. Gregg.                    | John.                                  |
| Jumbo.                       | Pittsburg Consolidated Coal Company.   | Washington.               | V. M. Delamater.                | Imperial.                              |
| Knoxville.                   | W. P. Rend & Co.                       | Allegheny and Washington. | Paul E. Boden.                  | Carnegie.                              |
| Laurel Hill Nos. 1, 2 and 4. | S. B. Gregg.                           | Allegheny.                | Wm. Bald.                       | Telephone Building, Pittsburg.         |
| Leadale.                     | Imperial Coal Company.                 | Allegheny.                | G. W. Schluederberg.            | Penn Building, Pittsburg.              |
| Montours.                    | Mansfield Coal Company.                | Allegheny.                |                                 |  |
| Mansfield No. 2.             | Mansfield Coal and Coke Company.       | Allegheny.                |                                 |  |
| Mansfield and Emps.          | Pittsburg Fuel Company.                | Allegheny.                |                                 |  |
| Midway.                      | Midway Block Coal Company.             | Washington.               |                                 |  |

|                             |  |                   |                             |                                      |
|-----------------------------|--|-------------------|-----------------------------|--------------------------------------|
| Moon Run, .....             | Moon Run Coal Company, .....               | Allegheny, .....  | N. F. Sanford, .....        | Moon Run, .....                      |
| Morgan, .....               | Steen & Greiner, .....                     | Allegheny, .....  | J. S. Brown, .....          | Morgan, .....                        |
| National, .....             | National Coal Company, Limited, .....      | Allegheny, .....  | A. A. Hadden, .....         | Nobleston, .....                     |
| Nixon, .....                | Alex. Black Coal Company, .....            | Allegheny, .....  | W. H. Linsley, .....        | Joint, .....                         |
| Natrona, .....              | Pennsylvania Salt Manufacturing Co., ..... | Allegheny, .....  | .....                       | Natrona, .....                       |
| Northwestern, .....         | Pittsburgh and Bellevue Coal Co., .....    | Allegheny, .....  | Peter Watkins, .....        | Bridgeville, .....                   |
| Nickel Plate, .....         | J. D. Sauters, .....                       | Allegheny, .....  | J. D. Sauterson, .....      | McDonald, .....                      |
| Ormsby, .....               | Keeling Coal Company, .....                | Allegheny, .....  | Peter Keeling, .....        | Josephine street, Pittsburg, .....   |
| Oak Ridge, .....            | Oak Ridge Coal Company, Limited, .....     | Allegheny, .....  | G. W. Schluenderberg, ..... | Penn Building, Pittsburg, .....      |
| O. I. C., .....             | W. J. Steen, .....                         | Allegheny, .....  | Harry Bates, .....          | Woodville, .....                     |
| Pine Creek, .....           | Robbins Coal and Coke Company, .....       | Allegheny, .....  | G. W. Schluenderberg, ..... | Penn Building, .....                 |
| Pan Handle, .....           | Francis Mankedick, .....                   | Allegheny, .....  | T. W. Jones, .....          | Sturgeon, .....                      |
| Pittsburg Fuel No. 2, ..... | Pan Handle Coal Company, .....             | Allegheny, .....  | Wm. Bald, .....             | Essen, .....                         |
| Primrose, .....             | Pittsburg Consolidated Coal Company, ..... | Allegheny, .....  | G. W. Schluenderberg, ..... | Telephone Building, Pittsburg, ..... |
| Ridgeway Bishop, .....      | Ridgeway Bishop Coal Company, .....        | Washington, ..... | W. R. Wilson, .....         | Penn Building, Pittsburg, .....      |
| Streets Run, .....          | Harrison Gas Coal Company, .....           | Allegheny, .....  | W. L. Nancarrow, .....      | Carnegie .....                       |
| Summer Hill, .....          | Frank Armstrong, .....                     | Allegheny, .....  | Frank Armstrong, .....      | Hope Church, .....                   |
| Star, .....                 | Francis Mankedick, .....                   | Allegheny, .....  | .....                       | Pittsburg, .....                     |
| Standard, .....             | Standard Coal Company, .....               | Allegheny, .....  | James Collins, .....        | Sturgeon, .....                      |
| Venture, .....              | Saw Mill Run Coal Company, .....           | Allegheny, .....  | E. N. Wildman, .....        | Pan Handle, .....                    |
| Walton, .....               | Joseph Walton & Co., .....                 | Allegheny, .....  | John M. Kapp, .....         | 30 West Carson st., Pittsburg, ..... |
| Willow Grove, .....         | Willow Grove Mining Company, .....         | Allegheny, .....  | G. W. Schluenderberg, ..... | Rodman Mills, .....                  |
| West Tarentum, .....        | McFetridge Brothers, .....                 | Allegheny, .....  | Wm. McFetridge, .....       | Penn Building, Pittsburg, .....      |
| .....                       | .....                                      | .....             | .....                       | Hite, .....                          |

TABLE No. 2.—(Gives the total number of tons of coal mined and tons of coke produced in each colliery, number of days worked, number of employes, number of persons killed and injured, number of kegs of powder used, etc., in the Seventh Bituminous Mine District, for the year ending December 31, 1894.

| Names of Collieries.  | Location—County.                  |                                   |                                 |                     |                          |                         |                             |                          |                       |                          |                          |                    |
|-----------------------|-----------------------------------|-----------------------------------|---------------------------------|---------------------|--------------------------|-------------------------|-----------------------------|--------------------------|-----------------------|--------------------------|--------------------------|--------------------|
|                       | Total production in tons of coal. | Total production in tons of coke. | Total shipment in tons of coal. | Number days worked. | Number persons employed. | Number fatal accidents. | Number non-fatal accidents. | Number kegs powder used. | Number steam boilers. | Number horses and mules. | Number mine locomotives. | Number coke ovens. |
| Allison.....          | 62,402                            |                                   | 62,402                          | 126                 | 127                      |                         | 5                           | 75                       |                       | 10                       |                          |                    |
| Bower Hill.....       | 25,363                            |                                   | 25,363                          | 37                  | 178                      |                         |                             |                          |                       | 3                        |                          |                    |
| Bellwood.....         | 107,800                           |                                   | 107,800                         | 200                 | 230                      |                         | 1                           |                          |                       | 13                       |                          |                    |
| Beading.....          | 12,882                            |                                   | 12,882                          | 201                 | 236                      |                         |                             | 400                      |                       | 11                       |                          |                    |
| Beach Cliff.....      | 33,954                            |                                   | 33,954                          | 102                 | 126                      |                         |                             |                          |                       | 6                        |                          |                    |
| Bridgeville.....      | 23,620                            |                                   | 23,620                          | 102                 | 126                      |                         | 2                           |                          |                       | 6                        |                          |                    |
| Boyl.....             | 47,624                            |                                   | 47,624                          | 240                 | 322                      |                         | 12                          | 6                        |                       | 12                       |                          |                    |
| Beach Mount.....      | 77,130                            |                                   | 77,130                          | 160                 | 117                      |                         | 1                           |                          |                       | 3                        |                          |                    |
| Boon.....             | 70,984                            |                                   | 70,984                          | 167                 | 193                      |                         |                             |                          |                       | 12                       |                          |                    |
| Epier Hill.....       | 75,792                            |                                   | 75,792                          | 127                 | 75                       |                         |                             |                          |                       | 3                        |                          |                    |
| Black Diamond.....    | 42,600                            |                                   | 42,600                          | 290                 | 48                       |                         |                             | 350                      |                       | 9                        |                          |                    |
| Brakenridge.....      | 42,941                            |                                   | 42,941                          | 200                 | 128                      |                         |                             |                          |                       | 11                       |                          |                    |
| Castle Shannon.....   | 94,864                            |                                   | 92,664                          | 129                 | 165                      |                         | 1                           |                          |                       | 11                       |                          |                    |
| Champion.....         | 75,588                            |                                   | 74,293                          | 187                 | 128                      |                         |                             |                          |                       | 4                        |                          |                    |
| Colony.....           | 4,044                             |                                   | 4,044                           | 219                 | 10                       |                         |                             |                          |                       | 30                       |                          |                    |
| Creedmore.....        | 68,783                            |                                   | 68,002                          | 135                 | 134                      |                         | 4                           | 460                      |                       | 8                        |                          |                    |
| Enterprise.....       | 107,370                           |                                   | 107,370                         | 139                 | 285                      |                         | 1                           | 312                      |                       | 13                       |                          |                    |
| Essen No. 1.....      | 91,157                            |                                   | 90,383                          | 117                 | 264                      |                         |                             |                          |                       | 2                        |                          |                    |
| Essen No. 2.....      | 65,342                            |                                   | 65,220                          | 131                 | 177                      |                         | 1                           |                          |                       | 8                        |                          |                    |
| Essen No. 3.....      | 80,405                            |                                   | 80,133                          | 116                 | 287                      |                         | 1                           |                          |                       | 15                       |                          |                    |
| Enterprise No. 2..... | 26,097                            |                                   | 26,097                          | 82                  | 94                       |                         |                             | 90                       |                       | 2                        |                          |                    |
| Federal.....          | 28,665                            |                                   | 28,665                          | 72                  | 145                      |                         | 2                           |                          |                       | 6                        |                          |                    |
| Freeport.....         | 2,236                             |                                   | 2,236                           | 56                  | 122                      |                         |                             | 29                       |                       | 1                        |                          |                    |
| Fox.....              | 13,425                            |                                   | 13,425                          | 250                 | 32                       |                         |                             |                          |                       | 1                        |                          |                    |
| Federal Spring.....   | 58,263                            |                                   | 58,263                          | 124                 | 166                      |                         | 1                           |                          |                       | 11                       |                          |                    |
| First Pool.....       | 255,026                           |                                   | 252,476                         | 200                 | 339                      |                         | 2                           |                          |                       | 3                        |                          |                    |
| Fort Pitt.....        | 7,560                             |                                   | 7,560                           | 72                  | 42                       |                         |                             |                          |                       | 17                       |                          |                    |
| Grant.....            | 45,828                            |                                   | 45,828                          | 137                 | 169                      |                         | 1                           |                          |                       | 14                       |                          |                    |
| Hickman.....          | 26,800                            |                                   | 26,800                          | 100                 | 108                      |                         |                             |                          |                       | 10                       |                          |                    |
| Hastings slope.....   | 53,770                            |                                   | 53,770                          | 207                 | 81                       |                         |                             |                          |                       | 8                        |                          |                    |



|                              |             |           |           |       |       |    |
|------------------------------|-------------|-----------|-----------|-------|-------|----|
| Hite, .....                  | Allegheny.  | 42,300    | 297       | 84    | 635   | 15 |
| Idlewood, .....              | Allegheny.  | 23,250    | 150       | 65    | ..... | 7  |
| Jumbo, .....                 | Washington. | 129,688   | 478       | 199   | ..... | 10 |
| Laurel Hill No. 1, .....     | Allegheny.  | 116,000   | 240       | 245   | ..... | 16 |
| Laurel Hill No. 2, .....     | Washington. | 42,462    | 149       | 50    | 2,000 | 14 |
| Laurel Hill No. 4, .....     | Allegheny.  | 129,305   | 175       | 248   | ..... | 31 |
| Leasdale, .....              | Allegheny.  | 13,606    | 51        | ..... | 3     | 9  |
| Montours, .....              | Allegheny.  | 56,038    | 138       | ..... | 175   | 26 |
| Mansfield No. 2, .....       | Allegheny.  | 171,000   | 133       | 372   | ..... | 4  |
| Mansfield and Erle, .....    | Allegheny.  | 27,500    | 167       | ..... | 2     | 9  |
| Midway, .....                | Washington. | 38,912    | 165       | ..... | 40    | 22 |
| Moon Run, .....              | Allegheny.  | 285,486   | 189       | 520   | ..... | 8  |
| Morgan, .....                | Allegheny.  | 74,050    | 182       | ..... | 3     | 4  |
| North Western, .....         | Allegheny.  | 48,918    | 182       | 198   | 600   | 20 |
| National, .....              | Allegheny.  | 50,163    | 132       | 112   | 200   | 6  |
| Natrona, .....               | Allegheny.  | 46,215    | 132       | 119   | ..... | 5  |
| Nixon, .....                 | Allegheny.  | 57,632    | 187       | ..... | 3     | 4  |
| Nickel Plate, .....          | Allegheny.  | 61,884    | 142       | 155   | 200   | 4  |
| Ormsby, .....                | Allegheny.  | 43,834    | 131       | 141   | ..... | 12 |
| Oak Ridge, .....             | Allegheny.  | 56,324    | 187       | ..... | 2     | 13 |
| C. I. C., .....              | Allegheny.  | 30,160    | 143       | 87    | ..... | 9  |
| Fan Handle, .....            | Allegheny.  | 76,464    | 151       | ..... | 1     | 4  |
| Pine Creek, .....            | Allegheny.  | 51,147    | 130       | 168   | ..... | 6  |
| Primrose, .....              | Washington. | 77,478    | 190       | ..... | 2     | 6  |
| Pittsburgh Fuel No. 2, ..... | Allegheny.  | 41,000    | 202       | 117   | ..... | 8  |
| Ridgeway Bishop, .....       | Washington. | 107,049   | 150       | 126   | ..... | 7  |
| Streets' Run, .....          | Allegheny.  | 34,364    | 149       | 278   | 60    | 6  |
| Summer Hill, .....           | Allegheny.  | 111,422   | 148       | ..... | 1     | 12 |
| Star, .....                  | Allegheny.  | 39,120    | 155       | ..... | ..... | 3  |
| Standard, .....              | Allegheny.  | 77,500    | 150       | 179   | ..... | 10 |
| Venture, .....               | Allegheny.  | 110,000   | 154       | 190   | 90    | 6  |
| Wilton, .....                | Allegheny.  | 111,181   | 146       | 326   | ..... | 9  |
| Willow Grove, .....          | Allegheny.  | 56,802    | 129       | 146   | ..... | 12 |
| West Trenton, .....          | Allegheny.  | 7,919     | 308       | 13    | 112   | 6  |
| Totals, .....                |             | 4,228,825 | 10,389    | 9,844 | 5,887 | 1  |
|                              |             | 6,000     | 4,002,534 | 121   | 588   | 2  |
|                              |             |           |           | 9     | 47    | 51 |

\*Locomotive use.

\*\*Local trade.

|| Home use.



|                              |    |       |       |     |     |       |       |       |       |     |       |     |       |     |       |
|------------------------------|----|-------|-------|-----|-----|-------|-------|-------|-------|-----|-------|-----|-------|-----|-------|
| Hickman, .....               | 1  | 175   | ..... | 8   | 7   | 4     | 166   | ..... | 1     | 2   | ..... | 5   | 1     | 8   | 188   |
| Hastings slope, .....        | 1  | 65    | ..... | 2   | 5   | 4     | 73    | ..... | 1     | 2   | ..... | 2   | 1     | 7   | 81    |
| Hite, .....                  | 1  | 60    | 6     | 6   | 1   | 1     | 77    | ..... | 1     | 1   | ..... | 4   | 1     | 8   | 84    |
| Idlewood, .....              | 1  | 50    | 3     | 1   | 15  | ..... | 60    | ..... | 1     | 1   | ..... | 2   | 1     | 7   | 69    |
| Jumbo, .....                 | 1  | 145   | 10    | 8   | 12  | ..... | 178   | ..... | 1     | 5   | ..... | 14  | 1     | 21  | 199   |
| Laurel Hill No. 1, .....     | 2  | 150   | 29    | 10  | 21  | ..... | 210   | ..... | 1     | 3   | ..... | 8   | 22    | 35  | 245   |
| Laurel Hill No. 2, .....     | 1  | 30    | 3     | 3   | 3   | ..... | 40    | ..... | 1     | 5   | ..... | 1   | 5     | 10  | 59    |
| Laurel Hill No. 4, .....     | 1  | 200   | 4     | 6   | 14  | ..... | 228   | ..... | 1     | 2   | ..... | 9   | 8     | 20  | 248   |
| Leasdale, .....              | 1  | 40    | ..... | 2   | 3   | ..... | 46    | ..... | 1     | 1   | ..... | 3   | 1     | 5   | 51    |
| Montours, .....              | 1  | 125   | 2     | 3   | 9   | ..... | 141   | ..... | 1     | 2   | ..... | 1   | 2     | 3   | 153   |
| Mansfield No. 2, .....       | 1  | 310   | 12    | 8   | 14  | ..... | 349   | ..... | 6     | 4   | ..... | 11  | 2     | 23  | 372   |
| Mansfield and Erle, .....    | 1  | 56    | 5     | 10  | 5   | ..... | 78    | ..... | 1     | 2   | ..... | 3   | 1     | 8   | 86    |
| Midway, .....                | 1  | 60    | 10    | 6   | 4   | ..... | 82    | ..... | 1     | 1   | ..... | 1   | 1     | 10  | 62    |
| Moon Run, .....              | 1  | 480   | ..... | 3   | 50  | 5     | 509   | ..... | ..... | 4   | ..... | 15  | 2     | 21  | 530   |
| Morgan, .....                | 1  | 165   | 12    | 1   | 5   | 3     | 187   | ..... | ..... | 2   | ..... | 6   | 1     | 11  | 198   |
| North Western, .....         | 1  | 90    | 2     | 1   | 6   | 2     | 102   | ..... | 1     | 2   | ..... | 3   | 2     | 10  | 112   |
| National, .....              | 1  | 100   | ..... | 3   | 4   | 2     | 110   | ..... | ..... | 1   | ..... | 1   | 1     | 9   | 119   |
| Natrona, .....               | 1  | 40    | 4     | 3   | 9   | 1     | 58    | ..... | ..... | 1   | ..... | 1   | 2     | 7   | 65    |
| Nixon, .....                 | 1  | 135   | ..... | 2   | 8   | ..... | 146   | ..... | 1     | 3   | ..... | 4   | ..... | 9   | 155   |
| Nickel Plate, .....          | 1  | 145   | 15    | 8   | 10  | 2     | 181   | ..... | ..... | 1   | ..... | 8   | 2     | 14  | 195   |
| Ormsby, .....                | 1  | 94    | 9     | 1   | 7   | 1     | 119   | ..... | 1     | 5   | ..... | 4   | 11    | 22  | 141   |
| Oak Ridge, .....             | 1  | 70    | ..... | 2   | 5   | 1     | 79    | ..... | ..... | 2   | ..... | 1   | 4     | 8   | 87    |
| O. I. C., .....              | 1  | 80    | ..... | 1   | 5   | ..... | 87    | ..... | 1     | 1   | ..... | 3   | 1     | 6   | 93    |
| Pan Handle, .....            | 1  | 130   | 3     | 2   | 6   | 1     | 143   | ..... | ..... | 1   | ..... | 2   | 4     | 8   | 151   |
| Pine Creek, .....            | 1  | 80    | 4     | 3   | 6   | ..... | 94    | ..... | ..... | 2   | ..... | 1   | 10    | 14  | 108   |
| Primrose, .....              | 1  | 90    | 5     | 3   | 8   | 2     | 109   | ..... | 1     | 1   | ..... | 1   | 4     | 8   | 117   |
| Pittsburgh Fuel No. 2, ..... | 1  | 90    | 10    | 10  | 7   | 1     | 119   | ..... | ..... | 1   | ..... | 3   | 1     | 7   | 156   |
| Ridgeway Bishop, .....       | 1  | 240   | 6     | 2   | 8   | 3     | 260   | ..... | 1     | 3   | ..... | 9   | 2     | 18  | 278   |
| Street's Run, .....          | 1  | 55    | 6     | 1   | 3   | 1     | 67    | ..... | ..... | 1   | ..... | 2   | 1     | 6   | 73    |
| Summer Hill, .....           | 1  | 225   | ..... | 3   | 10  | 1     | 246   | ..... | ..... | 4   | ..... | 6   | ..... | 12  | 252   |
| Star, .....                  | 1  | 44    | ..... | 1   | 4   | ..... | 50    | ..... | ..... | 1   | ..... | 2   | ..... | 3   | 53    |
| Standard, .....              | 1  | 150   | 2     | 6   | 11  | ..... | 160   | ..... | 1     | 2   | ..... | 2   | 4     | 10  | 170   |
| Venture, .....               | 2  | 145   | 7     | 6   | 5   | 5     | 176   | ..... | 1     | 4   | ..... | 6   | 1     | 14  | 190   |
| Walton, .....                | 2  | 279   | ..... | 4   | 17  | 2     | 304   | ..... | 1     | 4   | ..... | 12  | 1     | 22  | 326   |
| Willow Grove, .....          | 1  | 100   | 15    | 2   | 1   | 2     | 137   | ..... | ..... | 2   | ..... | 8   | 1     | 13  | 140   |
| West Tarentum, .....         | 1  | 9     | ..... | 1   | 1   | ..... | 12    | ..... | ..... | 1   | ..... | 1   | ..... | 1   | 13    |
| Totals, .....                | 72 | 7,869 | 363   | 219 | 486 | 106   | 9,115 | ..... | 32    | 117 | 116   | 399 | 65    | 729 | 9,844 |

32-11-94

TABLE No. 4.—List of fatal accidents that occurred in and about the mines of the Seventh Bituminous Mine District for the year ending December 31, 1894.

| Date of accident. | Name of Person.   | Occupation. | Age. | Widow. | Number of orphans. | Name of Colliery.  | Location—County. | Nature and Cause of Accident.   |
|-------------------|-------------------|-------------|------|--------|--------------------|--------------------|------------------|---|
| March 5.          | William Wright.   | Miner.      | 27   | .....  | .....              | Boyd.              | Allegheny.       | Killed by a fall of slate in his working place.                         |
| 31.               | Peter Kronberger. | Miner.      | 44   | .....  | 8                  | Walton.            | Allegheny.       | Killed by a fall of slate in his room.                                  |
| April 3.          | Frank Gustyouski. | .....       | 22   | .....  | .....              | North Western.     | Allegheny.       | Received fatal injuries by being crushed between car and side of entry. |
| Aug. 4.           | Joseph Brusko.    | Miner.      | 32   | 1      | 2                  | Primrose.          | Washington.      | Fatally injured by coal falling upon him in his room.                   |
| 9.                | Mike Radocay.     | Miner.      | 39   | 1      | 3                  | Essen No. 3.       | Allegheny.       | Killed by fall of slate in his working place.                           |
| 21.               | Frank Detreich.   | Miner.      | 38   | 1      | 2                  | Pine Creek.        | Allegheny.       | Killed by fall of rock in his working place.                            |
| Oct. 6.           | Thomas Christian. | Miner.      | 43   | 1      | 7                  | Creedmore.         | Washington.      | Killed by fall of slate in his working place.                           |
| Dec. 10.          | Karl Kramer.      | Miner.      | 36   | .....  | .....              | Standard.          | Allegheny.       | Fatally injured by a fall of slate in his working place.                |
| 22.               | Martin Macek.     | Laborer.    | 40   | 1      | 3                  | Laurel Hill No. 2. | Washington.      | Killed by falling down a shaft.   |

TABLE No. 5.—List of non-fatal accidents that occurred in and about the mines of the Seventh Bituminous Mine District for the year ending December 31, 1894.

| Date of accident. | Name of Person.     | Occupation.  | Age.  | Married. | Number of children. | Name of Colliery.  | Location—County. | Nature and Cause of Accident.  |
|-------------------|---------------------|--------------|-------|----------|---------------------|--------------------|------------------|--|
| Jan'y. 6.         | E. Stocker.         | Miner.       | ..... | .....    | .....               | Laurel Hill No. 1. | Allegheny.       | He made an attempt to get on the dilly trip while in motion and fell under the cars, receiving serious injury. |
| 29.               | Thomas Joyce.       | Miner        | 43    | Yes      | .....               | Creedmore.         | Washington.      | Head injured by a fall of roof coal.   |
| 30.               | Prosper Florist.    | Miner.       | 45    | Yes      | .....               | Nickel Plate.      | Allegheny.       | Slightly injured by a fall of coal and slate.  |
| Feb'y. 1.         | Frederick Dunn.     | Miner.       | 27    | No.      | .....               | Delwood.           | Allegheny.       | Leg and arm injured by fall of slate.  |
| 2.                | Peter Oats.         | Miner.       | 58    | Yes      | .....               | Creedmore.         | Washington.      | Leg broken by fall of slate in his working place.  |
| 7.                | William Stone.      | Miner.       | 68    | Yes      | .....               | Nickel Plate       | Allegheny.       | Leg and three ribs broken by fall of slate in his room.  |
| Mar. 9.           | Peter Ruffing.      | Miner.       | 40    | No.      | .....               | Primrose.          | Washington.      | Back seriously injured by fall of slate in his room.   |
| 17.               | Wm. Brown.          | Miner.       | ..... | .....    | .....               | Allison.           | Washington.      | Leg broken by fall of slate.   |
| 20.               | Daniel O'Neil.      | Minor boy.   | 17    | .....    | .....               | Enterprise.        | Allegheny.       | Foot seriously injured by fall of slate; necessitating amputation.   |
| April 8.          | August Wise.        | Miner.       | 26    | Yes      | .....               | Mansfield No. 2.   | Allegheny.       | Foot injured by fall of slate.   |
| 19.               | Pat. Dinmen.        | Miner.       | ..... | Yes      | .....               | Essen No. 1.       | Allegheny.       | Head seriously injured by a prop which was forced out of position by the weight of the roof.                   |
| 12.               | Peter McCaffery.    | Miner.       | 68    | Yes      | .....               | Mansfield No. 2.   | Allegheny.       | Leg injured by fall of roof; he was taking out props.  |
| June 27.          | Seyern Betney.      | Miner.       | 34    | Yes      | .....               | Bridgeville.       | Allegheny.       | Ankle broken by fall of slate.   |
| 29.               | Edward Favorite.    | Miner.       | 23    | No.      | .....               | Grant.             | Allegheny.       | Leg broken by fall of slate.   |
| July 3.           | John Smith.         | Miner.       | 48    | Yes      | .....               | Laurel Hill No. 4. | Allegheny.       | Back seriously injured by fall of slate.   |
| 6.                | Charcoal Gieghardi. | Miner.       | 47    | Yes      | .....               | Allison.           | Washington.      | Ankle dislocated by fall of roof coal.   |
| 6.                | Samuel Buckinham.   | .....        | 38    | Yes      | .....               | Allison.           | Washington.      | Seriously injured by being crushed between car and side of entry.  |
| 6.                | Joseph Stewart.     | Miner boy.   | 15    | .....    | .....               | Standard.          | Allegheny.       | Back injured by fall of slate.   |
| 9.                | John Cochran.       | Mule driver. | 26    | Yes      | .....               | Laurel Hill No. 1. | Allegheny.       | Hand injured by coal car (outside of mine).  |
| 10.               | Bernard Bowd.       | Laborer.     | 52    | Yes      | .....               | Bridgeville.       | Allegheny.       | Leg broken by railroad car at the tippie.  |
| 12.               | John Lamie.         | Miner.       | 53    | Yes      | .....               | Laurel Hill No. 4. | Allegheny.       | Leg broken by fall of slate.   |
| 13.               | Samuel Burcher.     | Miner.       | 23    | No.      | .....               | Laurel Hill No. 4. | Allegheny.       | Shoulder dislocated by fall of slate.  |
| 21.               | Lewis Krows.        | Miner boy.   | 16    | .....    | .....               | First Pool.        | Allegheny.       | Leg broken by fall of coal and slate.  |

TABLE No. 5.—Continued.

| Date of accident. | Name of Person.         | Occupation.        | Age.  | Married. | Number of children. | Name of Colliery.        | Location—County.  | Nature and Cause of Accident.   |
|-------------------|-------------------------|--------------------|-------|----------|---------------------|--------------------------|-------------------|---|
|                   |                         |                    |       |          |                     |                          |                   |   |
| Aug. 8.           | Genero Gozerraro, ..... | Miner, .....       | 58    | No.      | .....               | Federal Spring, .....    | Allegheny, .....  | Leg broken by fall of slate.  |
| 9.                | Mathew Conoraw, .....   | Miner, .....       | 67    | No.      | .....               | Laurel Hill No. 1, ..... | Allegheny, .....  | Hand injured by coal cars.  |
| 11.               | Michael Barnes, .....   | Miner, .....       | 27    | No.      | .....               | Laurel Hill No. 2, ..... | Allegheny, .....  | Leg broken by coal cars; he was pushing a car out of his room and came in contact with a full car on the entry. |
| 13.               | Andy Tott, .....        | Miner, .....       | 34    | Yes      | .....               | Bishop, .....            | Washington, ..... | Leg broken and foot crushed by fall of coal.  |
| 16.               | Samuel Jacomo, .....    | Miner, .....       | 20    | No.      | .....               | Moon Run, .....          | Allegheny, .....  | Leg broken by fall of slate.  |
| 17.               | Harry Nutting, .....    | Miner, .....       | 21    | No.      | .....               | Creedmore, .....         | Washington, ..... | Leg seriously injured, necessitating amputation.  |
| 21.               | Glaries Dururs, .....   | Miner, .....       | 30    | Yes      | .....               | Nixon, .....             | Allegheny, .....  | Injured by gas explosion after a roof fall in his room.   |
| 21.               | Cesera Vetella, .....   | Miner, .....       | 25    | No.      | .....               | Beachmount, .....        | Allegheny, .....  | Two ribs broken and beal injured by fall of slate.  |
| 22.               | John Nelerda, .....     | Miner, .....       | 43    | Yes      | .....               | Moon Run, .....          | Allegheny, .....  | Seriously injured by fall of slate in his room.   |
| 25.               | John Battishlos, .....  | Miner, .....       | 45    | No.      | .....               | Laurel Hill No. 1, ..... | Allegheny, .....  | Slightly injured by dilly trip.   |
| 28.               | Leon Guraux, .....      | Miner, .....       | 21    | No.      | .....               | Champion, .....          | Allegheny, .....  | Foot injured by fall of slate.  |
| 30.               | Mike Skalney, .....     | Miner, .....       | ..... | .....    | .....               | Moon Run, .....          | Allegheny, .....  | Leg broken and back seriously injured by fall of slate.   |
| Sept. 5.          | Chas. Porter, .....     | Miner, .....       | 35    | No.      | .....               | Beach Cliff, .....       | Allegheny, .....  | Leg broken by fall of slate.  |
| 14.               | Mike Venard, .....      | Miner, .....       | 45    | Yes      | .....               | Northwestern, .....      | Allegheny, .....  | Injured by fall of slate.   |
| 18.               | James Matze, .....      | Miner, .....       | 45    | Yes      | .....               | Laurel Hill No. 1, ..... | Allegheny, .....  | Seriously injured by fall of coal in his room.  |
| 19.               | Gabriel Bususki, .....  | Miner, .....       | ..... | .....    | .....               | Federal, .....           | Allegheny, .....  | Were slightly injured by gas explosion in their working place.  |
| 19.               | John Cloni, .....       | Miner, .....       | ..... | .....    | .....               | Federal, .....           | Allegheny, .....  | Back slightly injured by fall of slate.   |
| 19.               | Louis Phipps, .....     | Miner, .....       | 34    | Yes      | .....               | Creedmore, .....         | Washington, ..... | Leg broken by fall of roof coal.  |
| 27.               | Louis Manzanla, .....   | Miner, .....       | 27    | Yes      | .....               | Standard, .....          | Allegheny, .....  | Leg injured by fall of slate.   |
| 5.                | F. Cospari, .....       | Miner, .....       | 27    | Yes      | .....               | First Pool, .....        | Allegheny, .....  | Back injured by fall of slate.  |
| 18.               | Andy Rimer, .....       | Miner, .....       | 37    | No.      | .....               | Nixon, .....             | Allegheny, .....  | Leg broken by fall of slate.  |
| 27.               | Herman Guss, .....      | Miner, .....       | 42    | No.      | .....               | Nixon, .....             | Allegheny, .....  | Leg broken by fall of slate.  |
| 22.               | Robert C. Smith, .....  | Male driver, ..... | 22    | No.      | .....               | Laurel Hill No. 1, ..... | Allegheny, .....  | Head and face seriously injured by being kicked by a mule.  |
| Dec. 18.          | John Kurtz, .....       | Male driver, ..... | 35    | Yes      | .....               | Ormsby, .....            | Allegheny, .....  | Hand injured by coal cars.  |

# \* EIGHTH BITUMINOUS DISTRICT.

(CENTRE, CLEARFIELD AND JEFFERSON COUNTIES.)

Johnstown, March 16, 1895.

Hon. Isaac B. Brown,

Secretary of Internal Affairs, Harrisburg, Pa.:

Sir: In compliance with the requirements of section 11 of article 10 of the Bituminous Mining Act, approved May 15, 1893, we herewith submit the annual report of the inspection of mines of the Eighth Bituminous district.

The report will not be as complete as it should be, as we were not able to get sufficient data to report on the condition of each mine, but enough is had to enable us to report on the general condition of the mines of the district, which shows a gradual improvement in the drainage, ventilation and safety of the collieries, and a desire by the majority of the operators to make improvements, and thus bring their mines up to the proper sanitary condition.

Several fans have been put in and quite a number of air shafts sunk and new furnaces erected to improve the ventilation.

The report shows a production of 3,404,078 net tons, a decrease as compared with 1893 of 1,639,400 tons as reported from mines, and a decrease in the average number of days worked from 172 in 1893 to 119 days for 1894, which shows about the same average output each day worked as in 1893. The number of fatal accidents during the year was twelve, a decrease of eight from 1893. The non-fatal accidents were 41, an increase of nine, yet they were not of a very serious nature, but in the reports received from the mine foremen on the causes of accidents, much complaint is made of the carelessness of the injured in not complying with the mine rules, by failing to secure their safety with the means at hand and in not being at their post of duty in several cases when injured.

The report is complete, with the one exception, as stated, that we could not get sufficient data to report on the condition of each mine

---

\*The mine inspector of this district, Mr. D. H. Thomas, having died January 27, 1895, this report was prepared by Mine Inspectors Josiah T. Evans and Roger Hampson of the adjoining districts.

separately. It contains the usual tables showing the coal and coke production, number of employes inside and outside, number of accidents with their causes, etc.

|   |           |
|---|-----------|
| Number of mines reported, .....                     | 81        |
| Number of mines reported producing coal, .....      | 77        |
| Total production in net tons of coal, .....         | 3,454,078 |
| Total shipments in net tons of coal, .....          | 3,382,396 |
| Total production in net tons of coke, .....         | 13,302    |
| Average number of days worked, .....                | 119       |
| Total number of persons employed, .....             | 8,160     |
| Number employed inside the mines, .....             | 7,686     |
| Number of horses and mules, .....                   | 837       |
| Number of steam boilers, .....                      | 100       |
| Number of stationary engines, .....                 | 71        |
| Number of fatal accidents, .....                    | 12        |
| Number of tons mined per fatal accident, .....      | 287,840   |
| Number of persons employed per fatal accident,..... | 680       |

#### Accidents and Their Causes.

|                                | Fatal. | Non-fatal. |
|--------------------------------|--------|------------|
| By mine wagons, .....          | 3      | 12         |
| By falls of coal, .....        | 2      | 17         |
| By falls of rock, .....        | 5      | 7          |
| By hauling rope, .....         | 0      | 1          |
| Kicked by mule, .....          | 0      | 2          |
| Scalded by steam, .....        | 0      | 1          |
| Caught by hoisting cage, ..... | 1      | 1          |
| Burned by powder, .....        | 1      | 0          |
| Total, .....                   | 12     | 41         |

J. T. EVANS,

R. HAMPSON.

#### Report of the Cottage State Hospital at Philipsburg, Centre County, for 1894.

|   |    |
|---|----|
| Total number of patients treated during the year, ... | 89 |
| Miners and children of miners, .....                  | 60 |
| Persons of other occupations, .....                   | 29 |
| Patients discharged, .....                            | 80 |
| Number of deaths, .....                               | 3  |
| Miners, .....   | 7  |
| Railroad employes, .....                              | 2  |



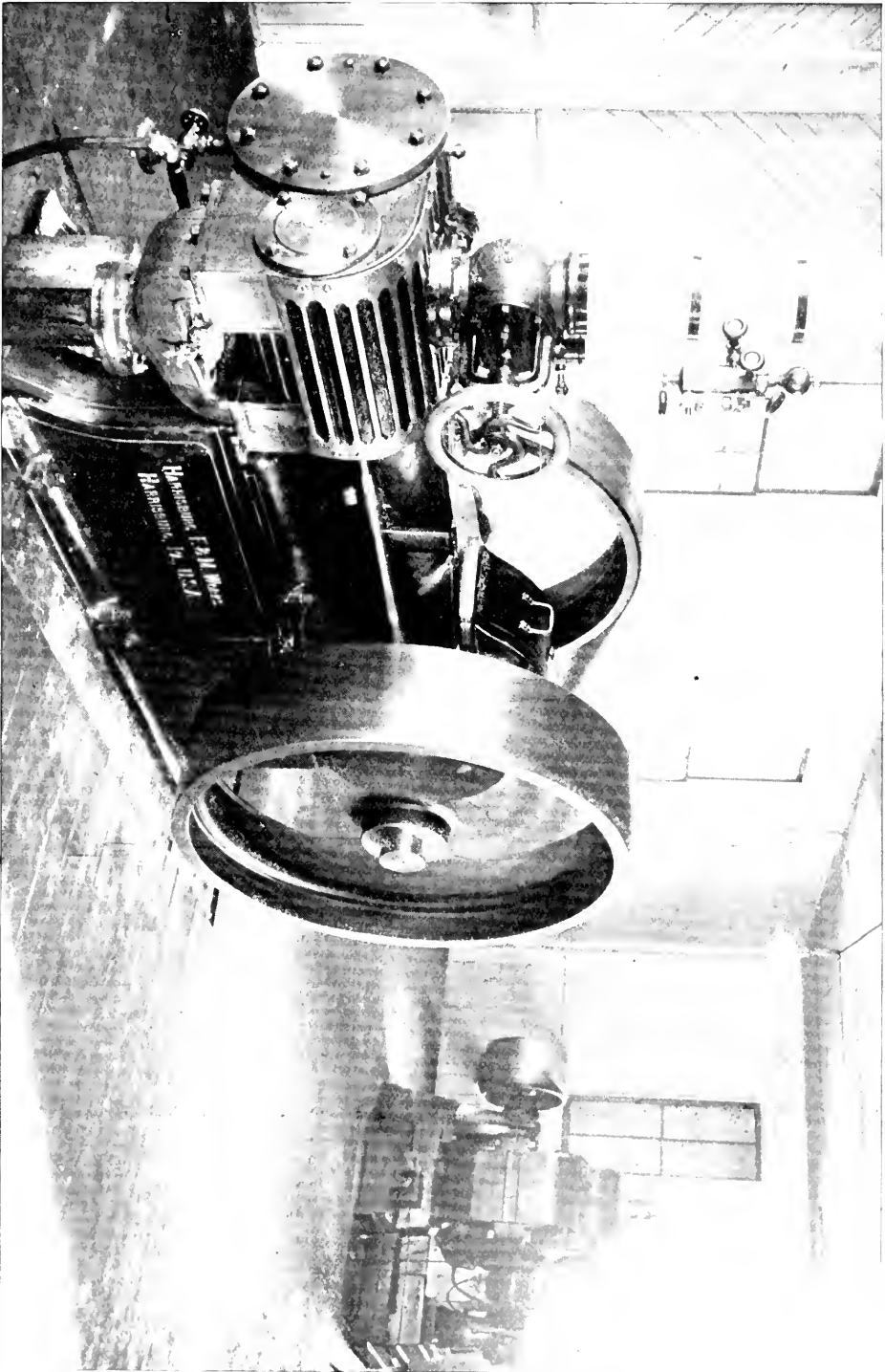

POWER HOUSE.





POWER HOUSE.



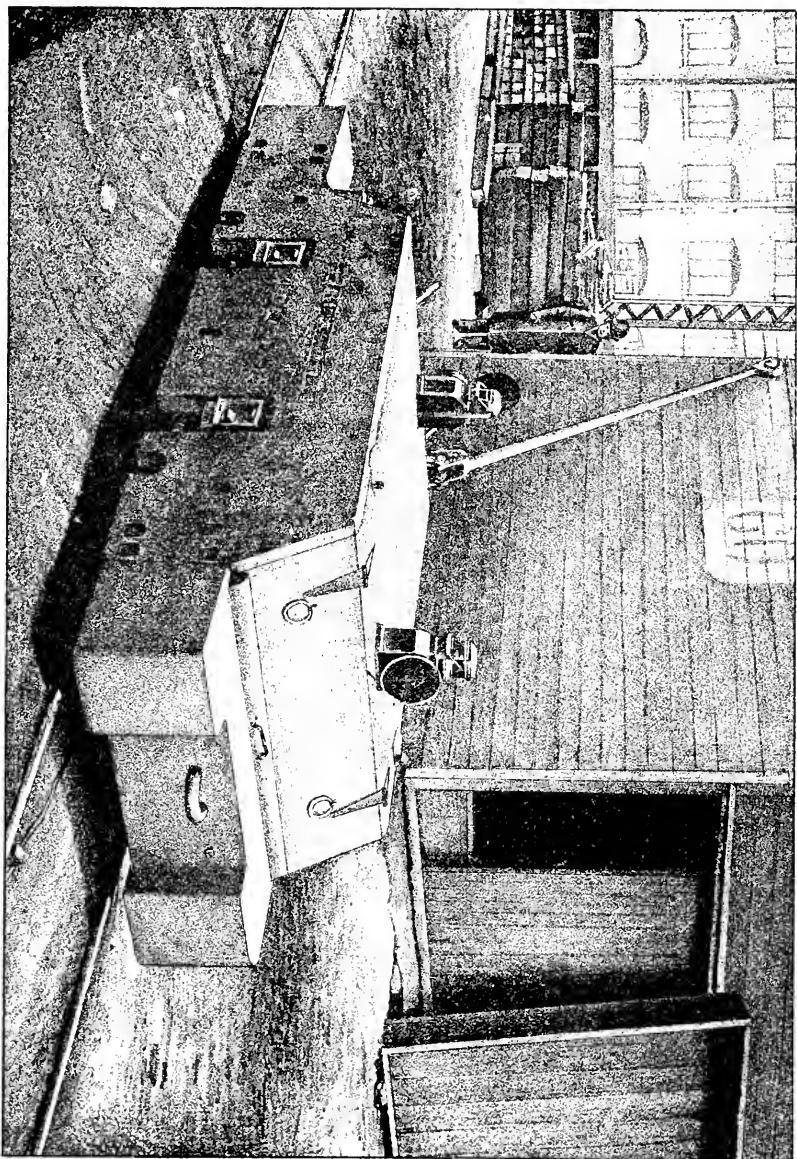

Electric Locomotive, 50-H. P.

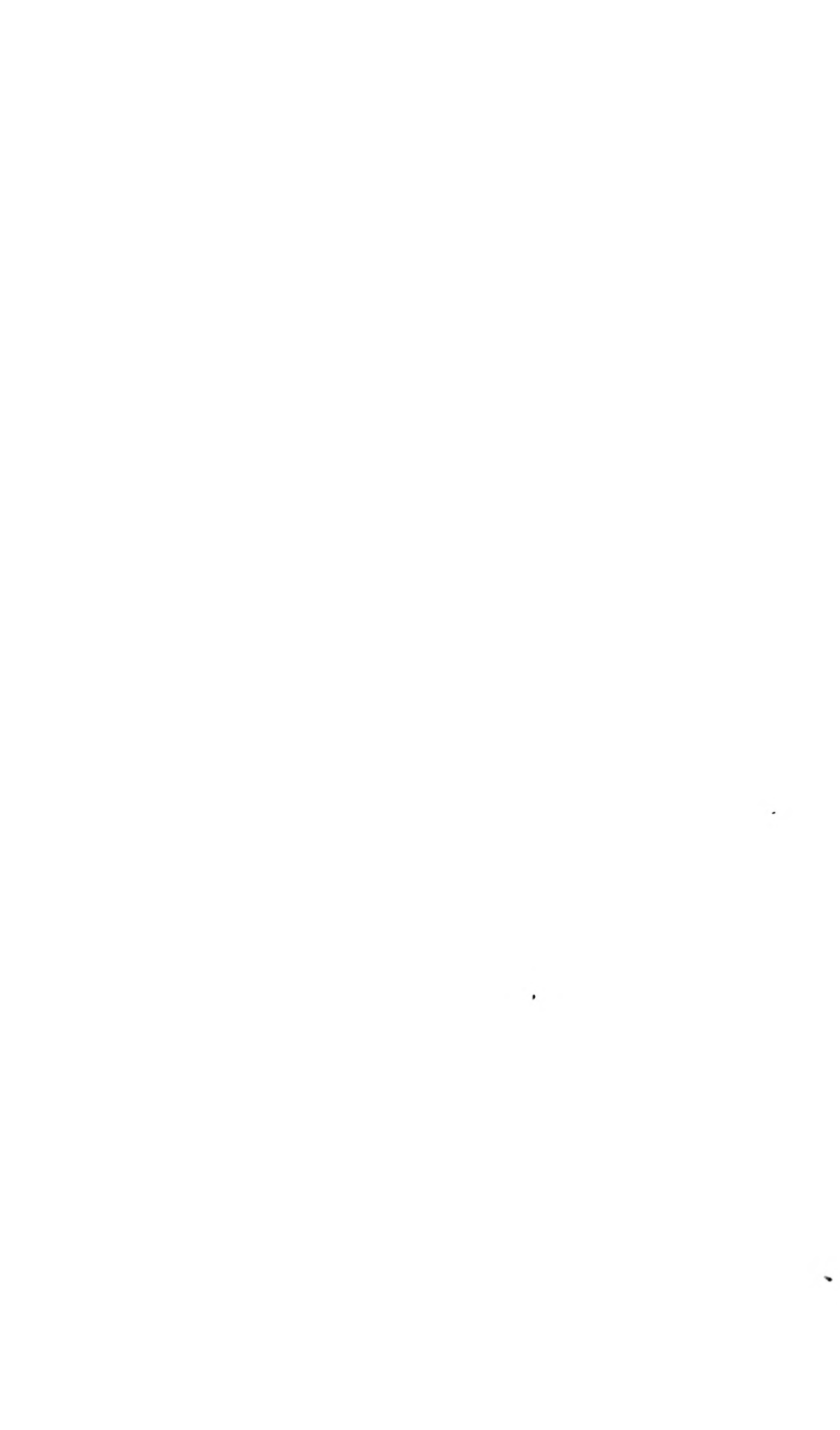

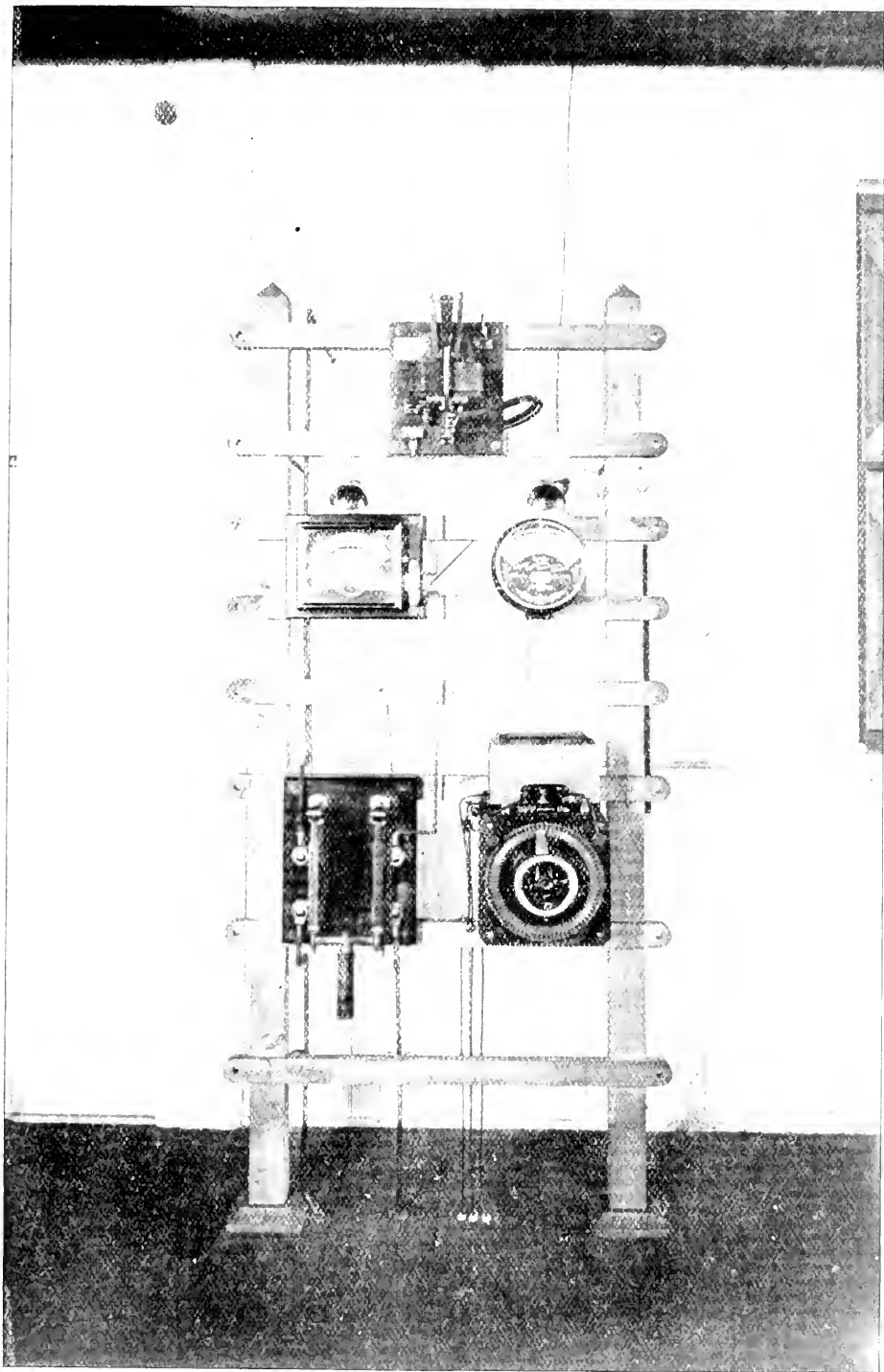

SWITCH BOARD.





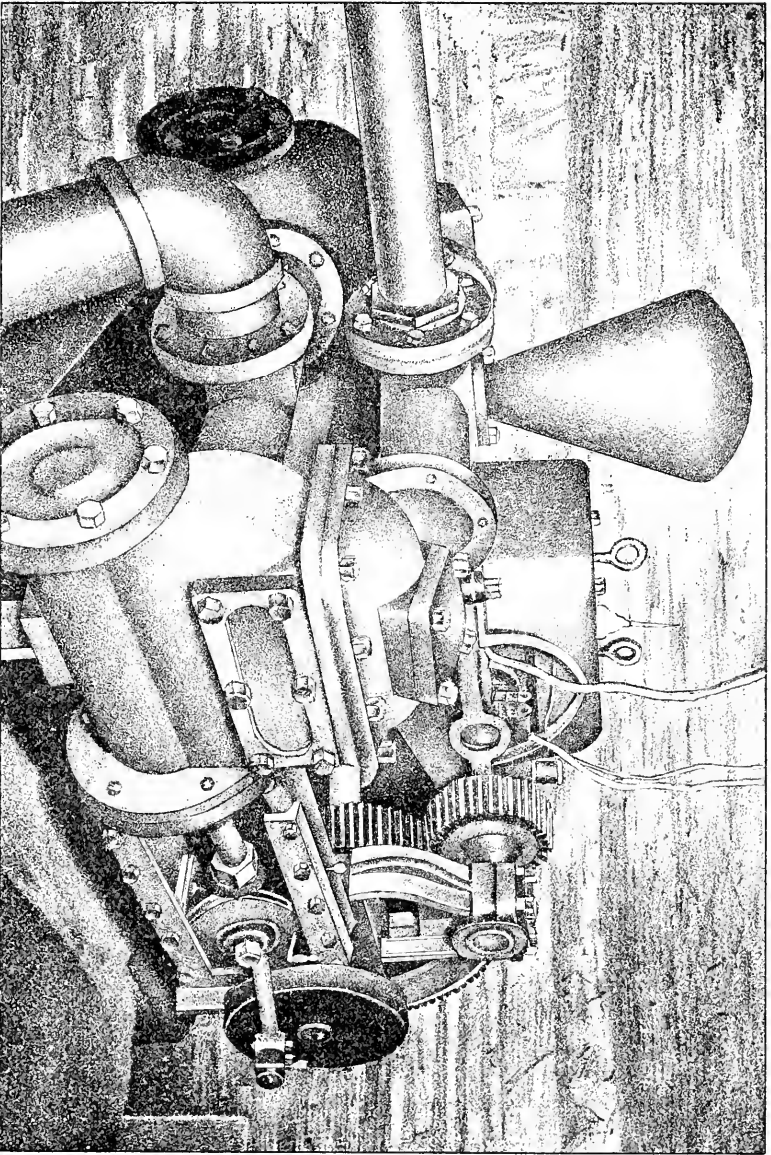

Electric Station Pump, Capacity 300 Gals. per Min.



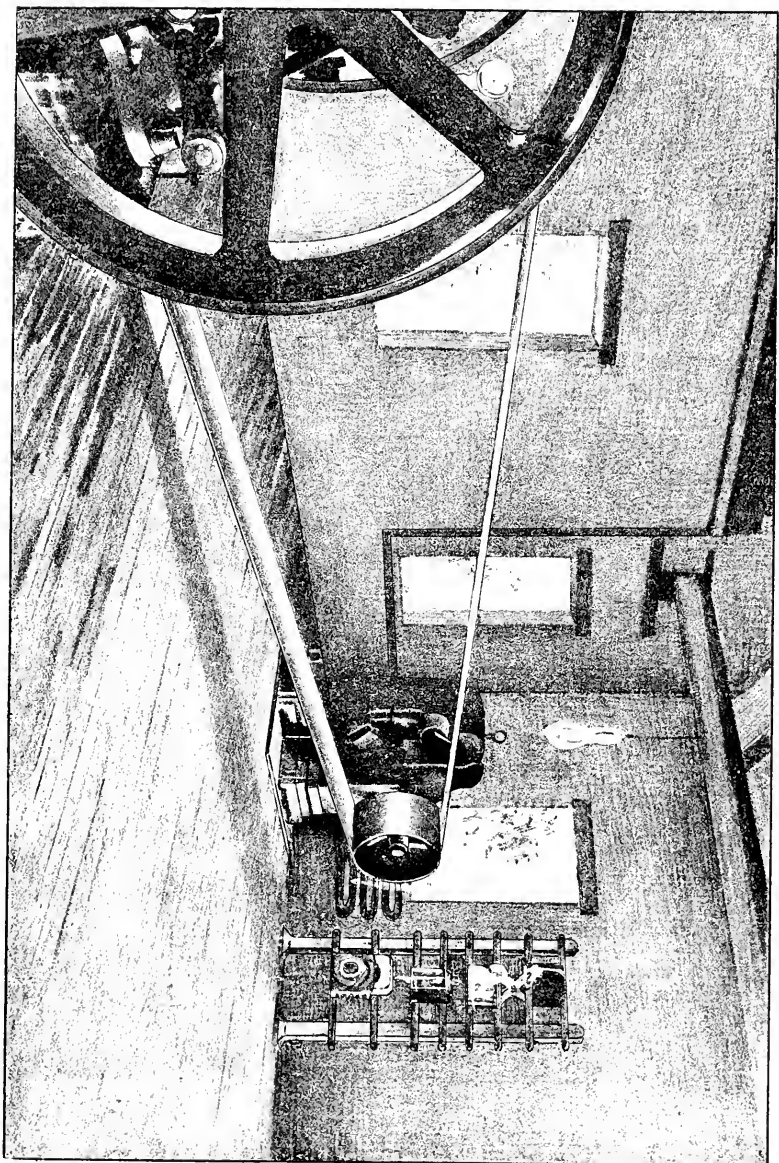

Electric Power Station, 135-H. P.



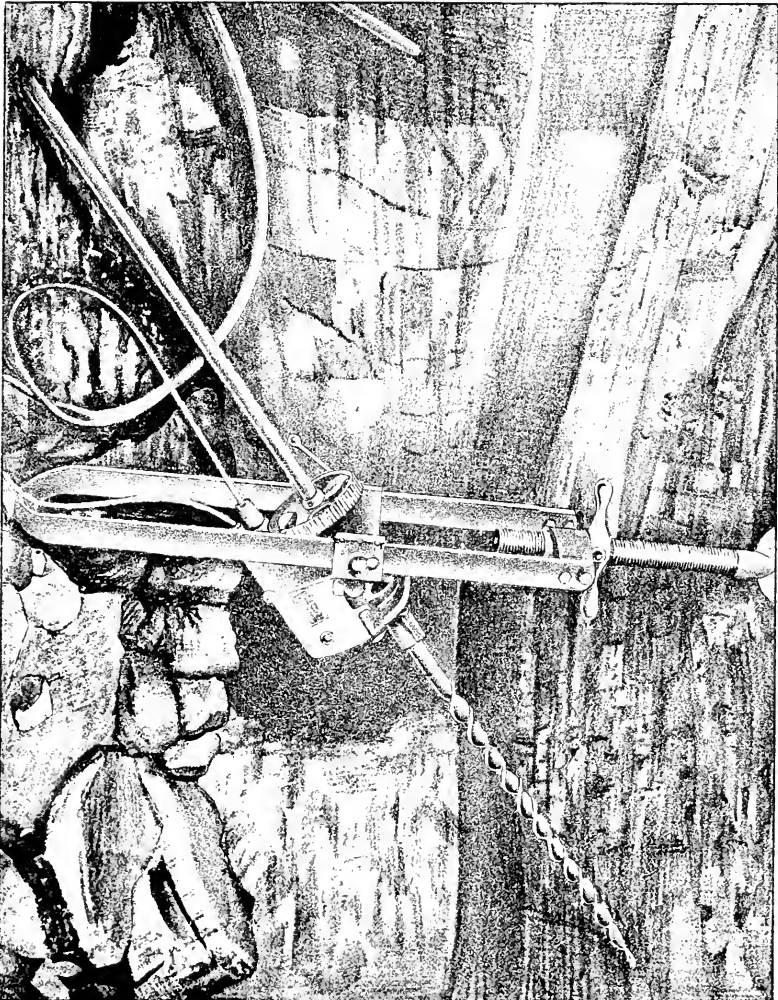

Rotary Electric Coal Drill.



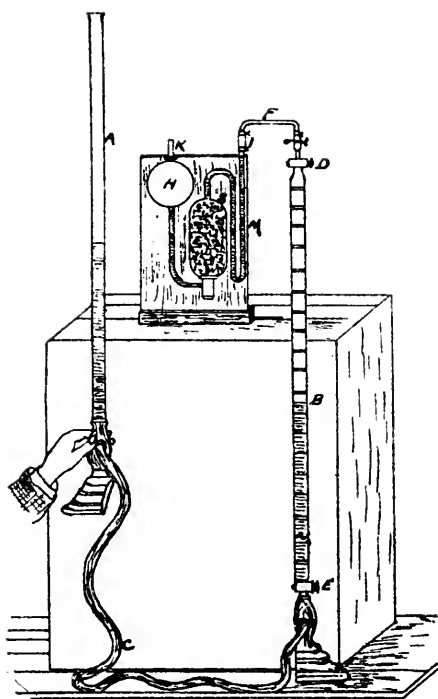

Fig. 1.—CO<sup>2</sup> BURETTE.

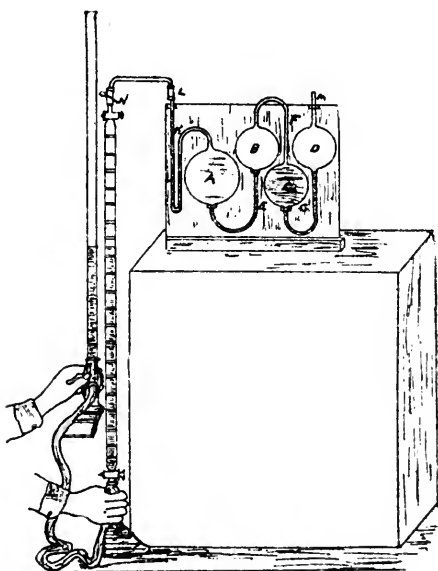

Fig. 2.—CO BURETTE.





Description of Injuries.

|  |             |
|--|-------------|
| Fractured limbs, .....                   | 23          |
| Injuries necessitating amputation, ..... | 4           |
| Fractures of skull, .....                | 5           |
| Powder burns, .....                      | 5           |
| Miscellaneous injuries, .....            | 52          |
|  | <hr/>       |
| Total, .....                             | 89          |
|  | <hr/> <hr/> |

This hospital is of inestimable value to the miners and to the injured generally. But to miners it is of especial benefit, as the admissions of men in that industry number 62½ per cent. of the total cases treated. Miss M. D. Fisher, the matron, is a perfect nurse and she is qualified for the position in every sense of the word, and merits all the approbation that the patients under her care and the general public bestow upon her.

**JOSEPH KNAPPER,\***  
Inspector.

---

\*Mr. Knapper is the present Inspector of this district.

TABLE No. 1.—Showing location, etc., of collieries in the Eighth Bituminous Mine District.

| Name of Colliery.            | Name of operator.                   | Location—county.  | Name of superintendent.   | Postoffice address.       |
|------------------------------|-------------------------------------|-------------------|---------------------------|---------------------------|
| Acme, .....                  | O. Perry Jones, .....               | Clearfield, ..... | J. R. Fleming, .....      | Phillipsburg,             |
| Atlantic No. 1, .....        | Berwind-White Coal Company, .....   | do, .....         | A. S. R. Richards, .....  | Osceola Mills,            |
| Atlantic No. 2, .....        | do, .....                           | do, .....         | do, .....                 | do,                       |
| Alexander, .....             | Thomas Blyth, .....                 | Centre, .....     | Thomas Blyth, .....       | Madeira,                  |
| Black Diamond, .....         | Robert A. Jackson, .....            | Centre, .....     | R. Jackson, .....         | Powellton, Centre county, |
| Bessemer, .....              | Morris Liveright, .....             | Clearfield, ..... | Harry Liveright, .....    | Osceola Mills,            |
| Battle, .....                | Baltic Coal Company, .....          | do, .....         | H. K. Grant, .....        | Phillipsburg,             |
| Coalhale No. 3, .....        | O. Perry Jones, .....               | do, .....         | J. R. Fleming, .....      | do,                       |
| Coalhale No. 5, .....        | do, .....                           | do, .....         | do, .....                 | do,                       |
| Colorado Nos. 1 and 2, ..... | E. R. Jackman, .....                | do, .....         | E. R. Jackman, .....      | do,                       |
| Colorado No. 3, .....        | do, .....                           | do, .....         | do, .....                 | do,                       |
| Central, .....               | T. C. Helms & Co., .....            | Centre, .....     | T. C. Helms, .....        | Osceola Mills,            |
| Decatur, .....               | John Nuttall & Co., .....           | Clearfield, ..... | George W. McJaffey, ..... | Phillipsburg,             |
| Derby, .....                 | T. Barnes & Bro., .....             | do, .....         | Thomas Barnes, .....      | do,                       |
| Eureka No. 1, .....          | Berwind-White Coal Company, .....   | do, .....         | A. S. R. Richards, .....  | Osceola Mills,            |
| Eureka No. 5, .....          | do, .....                           | do, .....         | do, .....                 | do,                       |
| Eureka No. 7, .....          | do, .....                           | do, .....         | do, .....                 | do,                       |
| Eureka No. 8, .....          | do, .....                           | do, .....         | do, .....                 | do,                       |
| Eureka No. 9, .....          | do, .....                           | do, .....         | do, .....                 | do,                       |
| Eureka No. 10, .....         | do, .....                           | do, .....         | do, .....                 | do,                       |
| Eureka No. 11, .....         | do, .....                           | do, .....         | do, .....                 | do,                       |
| Eureka No. 12, .....         | do, .....                           | do, .....         | do, .....                 | do,                       |
| Eureka No. 13, .....         | do, .....                           | do, .....         | do, .....                 | do,                       |
| Eureka No. 14, .....         | do, .....                           | do, .....         | do, .....                 | do,                       |
| Eureka No. 15, .....         | do, .....                           | do, .....         | do, .....                 | do,                       |
| Eureka No. 16, .....         | do, .....                           | do, .....         | do, .....                 | do,                       |
| Eureka No. 17, .....         | do, .....                           | do, .....         | do, .....                 | do,                       |
| Eureka No. 18, .....         | do, .....                           | do, .....         | do, .....                 | do,                       |
| Eureka No. 19, .....         | do, .....                           | do, .....         | do, .....                 | do,                       |
| Eureka No. 20, .....         | do, .....                           | do, .....         | do, .....                 | do,                       |
| Eureka No. 21, .....         | do, .....                           | do, .....         | do, .....                 | do,                       |
| Eureka No. 22, .....         | do, .....                           | do, .....         | do, .....                 | do,                       |
| Eureka No. 23, .....         | do, .....                           | do, .....         | do, .....                 | do,                       |
| Eureka No. 24, .....         | do, .....                           | do, .....         | do, .....                 | do,                       |
| Eureka No. 25, .....         | do, .....                           | do, .....         | do, .....                 | do,                       |
| Eureka No. 26, .....         | do, .....                           | do, .....         | do, .....                 | do,                       |
| Eureka No. 28, .....         | do, .....                           | do, .....         | do, .....                 | do,                       |
| Excelsior No. 4, .....       | do, .....                           | do, .....         | do, .....                 | do,                       |
| Electric, .....              | T. C. Helms & Co., .....            | Centre, .....     | T. C. Helms, .....        | do,                       |
| Ferris, .....                | Rickard Bros. & Co., .....          | Clearfield, ..... | George Gould, .....       | Brishin P. O,             |
| Fairmount, .....             | Morris Liveright, .....             | do, .....         | Henry Liveright, .....    | Osceola Mills,            |
| Gearhart, .....              | Thomas J. Lee & Co., Limited, ..... | do, .....         | Thomas J. Lee, .....      | Phillipsburg,             |
| Gramelin No. 1, .....        | R. C. Fishburn & Co., .....         | do, .....         | R. C. Fishburn, .....     | Munson,                   |
| Grampton No. 2, .....        | do, .....                           | do, .....         | do, .....                 | do,                       |
| Ghem, .....                  | Ghem Coal Company, .....            | Centre, .....     | Samuel E. Pfouest, .....  | Osceola Mills,            |
| Glenwood No. 1, .....        | Williams, Morris & Co., .....       | Clearfield, ..... | John M. Campbell, .....   | Phillipsburg,             |
| Highland, .....              | Jno. Walton & Son, .....            | do, .....         | John Walton, .....        | do,                       |

|                           |                                     |             |       |                          |                   |
|---------------------------|-------------------------------------|-------------|-------|--------------------------|-------------------|
| Hughes, .....             | Richard Hughes, .....               | do.         | ..... | H. M. Hughes, .....      | Osceola Mills.    |
| Henderson, .....          | Delaney & Gould, .....              | do.         | ..... | W. A. Gould, .....       | Erisbin.          |
| Imperial No. 1, .....     | R. L. Scott & Co., .....            | do.         | ..... | J. R. Fleming, .....     | Philipsburg.      |
| Jefferson, .....          | Adams & Co., .....                  | do.         | ..... | George H. Friday, .....  | do.               |
| Lancashire No. 1, .....   | T. Barnes & Bro., .....             | do.         | ..... | Thomas Barnes, .....     | do.               |
| Lancashire No. 2, .....   | do.                                 | do.         | ..... | do.                      | do.               |
| Lorraine, .....           | Rickard, Bros. & Co., .....         | do.         | ..... | George Gould, .....      | Erisbin.          |
| Lane, .....               | Fred C. Todd & Co., .....           | do.         | ..... | Fred C. Todd, .....      | Philipsburg.      |
| Leland, .....             | Cambria Coal Mining Company, .....  | do.         | ..... | D. D. Lewis, .....       | Smoke Run.        |
| Morrisdale shaft, .....   | R. E. Wigton & Sons, .....          | do.         | ..... | J. E. Hedding, .....     | Morrisdale.       |
| Mapleton, .....           | Berwind-White Coal Company, .....   | do.         | ..... | A. S. R. Richards, ..... | Osceola Mills.    |
| Mt. Vernon No. 4, .....   | United Collieries Company, .....    | do.         | ..... | G. M. H. Good, .....     | do.               |
| Mt. Vernon No. 5, .....   | do.                                 | do.         | ..... | do.                      | do.               |
| Mt. Vernon No. 6, .....   | do.                                 | do.         | ..... | do.                      | do.               |
| Mt. Vernon No. 7, .....   | do.                                 | do.         | ..... | do.                      | do.               |
| Orient No. 1, .....       | Blair Bros., .....                  | Centre,     | ..... | L. B. Blair, .....       | Tyrone.           |
| Ocean No. 1, .....        | Berwind-White Coal Company, .....   | Clearfield, | ..... | A. S. R. Richards, ..... | Osceola Mills.    |
| Ophir, .....              | Hoyt & Ashman, .....                | Centre,     | ..... | A. V. Hoyt, .....        | Philipsburg.      |
| Pardee No. 1, .....       | Magee & Lingie, .....               | Clearfield, | ..... | W. C. Lingie, .....      | do.               |
| Pardee No. 2, .....       | do.                                 | do.         | ..... | do.                      | do.               |
| Pioneer, .....            | Morris Liveright, .....             | Centre,     | ..... | Henry Liveright, .....   | Osceola Mills.    |
| Phoenix, .....            | do.                                 | do.         | ..... | do.                      | do.               |
| Summit, .....             | Summit Coal and Coke Company, ..... | Jefferson,  | ..... | C. F. Frazer, .....      | Hastings.         |
| Staffordshire, .....      | T. Barnes & Co., .....              | Clearfield, | ..... | J. T. Slinger, .....     | Philipsburg.      |
| Sterling No. 2, .....     | M. F. Craig, .....                  | do.         | ..... | M. F. Craig, .....       | Erisbin.          |
| Troy, .....               | R. E. Wigton & Sons, .....          | do.         | ..... | J. E. Hedding, .....     | Morrisdale Mines. |
| Victor No. 1, .....       | Bloomington Mining Company, .....   | do.         | ..... | Alex. Dansmore, .....    | Philipsburg.      |
| Victor No. 2, .....       | Thomas Barnes, .....                | do.         | ..... | J. T. Slinger, .....     | do.               |
| West Eureka No. 1, .....  | Berwind-White Coal Company, .....   | Jefferson,  | ..... | A. J. Cook, .....        | Horatio.          |
| West Eureka No. 2, .....  | do.                                 | do.         | ..... | do.                      | do.               |
| West Eureka No. 3, .....  | do.                                 | do.         | ..... | do.                      | do.               |
| West Eureka No. 4, .....  | do.                                 | do.         | ..... | do.                      | do.               |
| West Eureka No. 5, .....  | do.                                 | do.         | ..... | do.                      | do.               |
| West Eureka No. 6, .....  | do.                                 | do.         | ..... | do.                      | do.               |
| West Eureka No. 7, .....  | do.                                 | do.         | ..... | do.                      | do.               |
| West Eureka No. 8, .....  | do.                                 | do.         | ..... | do.                      | do.               |
| West Eureka No. 9, .....  | do.                                 | do.         | ..... | do.                      | do.               |
| West Eureka No. 10, ..... | do.                                 | do.         | ..... | do.                      | do.               |
| West Eureka No. 11, ..... | do.                                 | do.         | ..... | do.                      | do.               |
| West Eureka No. 12, ..... | do.                                 | do.         | ..... | do.                      | do.               |
| Webster No. 4, .....      | Bulah Coal Company, Limited, .....  | Clearfield, | ..... | James H. Minds, .....    | Ramey.            |



|                               | 5,661     | 5,661     | 35    | 29    | 8   | 8  | 3      | 2   | 1   |
|-------------------------------|-----------|-----------|-------|-------|-----|----|--------|-----|-----|
| Eureka No. 24, Clearfield,    | 5,661     | 5,661     | 112   | 33    | 60  | 1  | 1      | 1   | 1   |
| Eureka No. 25, Clearfield,    | 13,188    | 13,188    | 112   | 33    | 60  | 1  | 1      | 1   | 1   |
| Eureka No. 26, Clearfield,*   | 16,379    | 16,379    | 80    | 63    | 12  | 1  | 1      | 1   | 1   |
| Excelsior No. 4, Centre,      | 14,550    | 14,550    | 68    | 70    | 70  | 3  | 3      | 3   | 3   |
| Electric, Clearfield,         | 5,350     | 5,350     | 111   | 15    | 15  | 3  | 3      | 3   | 3   |
| Ferdale, Clearfield,          | 12,841    | 12,841    | 112   | 47    | 60  | 2  | 2      | 2   | 2   |
| Farmount, Clearfield,         | 29,534    | 29,534    | 85    | 106   | 118 | 6  | 6      | 6   | 6   |
| Gearheart, Clearfield,        | 16,634    | 16,634    | 76    | 103   | 118 | 2  | 2      | 2   | 2   |
| Grampion No. 1, Clearfield,   | 14,957    | 14,957    | 108   | 127   | 106 | 2  | 2      | 2   | 2   |
| Grampion No. 2, Centre,       | 15,129    | 15,129    | 107   | 127   | 106 | 2  | 2      | 2   | 2   |
| Glenwood No. 1, Clearfield,   | 39,103    | 39,103    | 152   | 85    | 133 | 8  | 8      | 8   | 8   |
| HIGHLAND, Clearfield,         | 12,371    | 12,371    | 9     | 32    | 150 | 3  | 3      | 3   | 3   |
| Henderson, Clearfield,        | 25,358    | 25,358    | 160   | 32    | 150 | 7  | 7      | 7   | 7   |
| Huglers, Clearfield,          | 25,000    | 25,000    | 240   | 32    | 180 | 10 | 10     | 10  | 10  |
| Imperial No. 1, Clearfield,   | 29,200    | 29,200    | 73    | 50    | 125 | 9  | 9      | 9   | 9   |
| Jefferson, Clearfield,        | 29,200    | 29,200    | 73    | 50    | 125 | 9  | 9      | 9   | 9   |
| Jefferson, Clearfield,        | 62,026    | 62,026    | 122   | 50    | 160 | 4  | 4      | 4   | 4   |
| Jefferson, Clearfield,        | 62,026    | 62,026    | 122   | 50    | 160 | 4  | 4      | 4   | 4   |
| Lancashire No. 1, Clearfield, | 92,614    | 92,614    | 127   | 168   | 627 | 22 | 22     | 22  | 22  |
| Lancashire No. 2, Clearfield, | 92,614    | 92,614    | 127   | 168   | 627 | 22 | 22     | 22  | 22  |
| Lorraine, Clearfield,         | 15,821    | 15,821    | 163   | 48    | 220 | 8  | 8      | 8   | 8   |
| Lorraine, Clearfield,         | 15,821    | 15,821    | 163   | 48    | 220 | 8  | 8      | 8   | 8   |
| Lorraine, Clearfield,         | 26,657    | 26,657    | 87    | 54    | 145 | 3  | 3      | 3   | 3   |
| Lorraine, Clearfield,         | 26,657    | 26,657    | 87    | 54    | 145 | 3  | 3      | 3   | 3   |
| Lorraine, Clearfield,         | 62,000    | 62,000    | 160   | 72    | 280 | 6  | 6      | 6   | 6   |
| Lorraine, Clearfield,         | 62,000    | 62,000    | 160   | 72    | 280 | 6  | 6      | 6   | 6   |
| Morrisdale shaft, Clearfield, | 189,649   | 189,649   | 165   | 496   | 1   | 1  | 1      | 1   | 1   |
| Morrisdale shaft, Clearfield, | 189,649   | 189,649   | 165   | 496   | 1   | 1  | 1      | 1   | 1   |
| Mt. Vernon No. 4, Clearfield, | 12,275    | 12,275    | 117   | 39    | 85  | 2  | 2      | 2   | 2   |
| Mt. Vernon No. 5, Clearfield, | 48,410    | 48,410    | 115   | 123   | 1   | 1  | 1      | 1   | 1   |
| Mt. Vernon No. 6, Clearfield, | 26,239    | 26,239    | 85    | 142   | 1   | 1  | 1      | 1   | 1   |
| Mt. Vernon No. 7, Clearfield, | 26,239    | 26,239    | 85    | 142   | 1   | 1  | 1      | 1   | 1   |
| Mt. Vernon No. 7, Clearfield, | 34,971    | 34,971    | 175   | 61    | 350 | 9  | 9      | 9   | 9   |
| Orient No. 1, Clearfield,     | 117,209   | 117,209   | 177   | 242   | 1   | 1  | 1      | 1   | 1   |
| Ocean No. 2, Clearfield,      | 26,328    | 26,328    | 70    | 112   | 1   | 1  | 1      | 1   | 1   |
| Ophir, Clearfield,            | 48,284    | 48,284    | 158   | 76    | 200 | 5  | 5      | 5   | 5   |
| Parlee No. 1, Clearfield,     | 170,124   | 172,867   | 149   | 314   | 500 | 24 | 24     | 24  | 24  |
| Parlee No. 2, Clearfield,     | 3,822     | 3,822     | 49    | 27    | 10  | 4  | 4      | 4   | 4   |
| Parlee No. 2, Centre,         | 13,442    | 13,442    | 228   | 26    | 28  | 1  | 1      | 1   | 1   |
| Phoenix, Clearfield,          | 7,610     | 7,610     | 243   | 17    | 51  | 4  | 4      | 4   | 4   |
| Phoenix, Clearfield,          | 8,924     | 8,924     | 62    | 42    | 100 | 3  | 3      | 3   | 3   |
| Staffordshire, Clearfield,    | 13,194    | 13,194    | 89    | 37    | 80  | 5  | 5      | 5   | 5   |
| Staffordshire, Clearfield,    | 44,089    | 44,089    | 78    | 172   | 404 | 12 | 12     | 12  | 12  |
| Stearling No. 2, Clearfield,  | 54,000    | 54,000    | 152   | 83    | 255 | 9  | 9      | 9   | 9   |
| Tray, Clearfield,             | 14,367    | 14,367    | 131   | 26    | 3   | 3  | 3      | 3   | 3   |
| Victor No. 1, Clearfield,     | 68,122    | 68,122    | 153   | 128   | 2   | 2  | 2      | 2   | 2   |
| Victor No. 2, Clearfield,     | 21,280    | 21,280    | 43    | 81    | 6   | 6  | 6      | 6   | 6   |
| West Eureka No. 1, Jefferson, | 64,294    | 64,294    | 92    | 183   | 3   | 3  | 3      | 3   | 3   |
| West Eureka No. 2, Jefferson, | 29,387    | 29,387    | 62    | 97    | 1   | 1  | 1      | 1   | 1   |
| West Eureka No. 3, Jefferson, | 105,512   | 105,512   | 143   | 212   | 4   | 4  | 4      | 4   | 4   |
| West Eureka No. 4, Jefferson, | 53,968    | 53,968    | 104   | 151   | 3   | 3  | 3      | 3   | 3   |
| West Eureka No. 5, Jefferson, | 139,967   | 139,967   | 179   | 236   | 4   | 4  | 4      | 4   | 4   |
| West Eureka No. 6, Jefferson, | 121,552   | 121,552   | 182   | 177   | 1   | 1  | 1      | 1   | 1   |
| West Eureka No. 7, Jefferson, | 75,784    | 75,784    | 100   | 141   | 2   | 2  | 2      | 2   | 2   |
| Webster No. 4, Jefferson,     | 75,784    | 75,784    | 100   | 141   | 2   | 2  | 2      | 2   | 2   |
| Total,                        | 3,454,078 | 3,382,396 | 9,173 | 8,160 | 17  | 13 | 100    | 837 | 71  |
|                               |           |           |       |       |     |    | 12,423 |     | 276 |

[[Not working during 1894.

\*New mine.



|                    |    |       |     |     |     |       |    |    |    |     |     |       |
|--------------------|----|-------|-----|-----|-----|-------|----|----|----|-----|-----|-------|
| Eureka No. 24      | 1  | 23    | 1   | 1   | 2   | 27    | 1  | 1  | 1  | 2   | 29  |       |
| Eureka No. 25      | 1  | 21    | 1   | 1   | 2   | 32    | 1  | 1  | 1  | 1   | 33  |       |
| Eureka No. 26      | 1  | 47    | 3   | 4   | 2   | 57    | 1  | 1  | 3  | 6   | 63  |       |
| Excelsior No. 4    | 1  | 55    | 6   | 3   | 3   | 65    | 1  | 1  | 2  | 1   | 70  |       |
| Electric           | 1  | 13    | 1   | 1   | 1   | 15    | 1  | 1  | 1  | 1   | 15  |       |
| Fairbank           | 1  | 34    | 5   | 1   | 2   | 44    | 1  | 1  | 1  | 3   | 47  |       |
| Farmington         | 1  | 81    | 9   | 1   | 3   | 100   | 1  | 1  | 1  | 6   | 106 |       |
| Garhart            | 1  | 86    | 3   | 2   | 2   | 96    | 1  | 1  | 1  | 3   | 103 |       |
| Grampion No. 3     | 1  | 110   | 3   | 2   | 2   | 120   | 1  | 1  | 3  | 2   | 127 |       |
| Grampion No. 1     | 1  | 35    | 8   | 2   | 2   | 46    | 1  | 1  | 1  | 4   | 47  |       |
| Ghem               | 1  | 70    | 2   | 1   | 3   | 79    | 1  | 1  | 2  | 3   | 85  |       |
| Glennwood No. 1    | 1  | 7     | 1   | 3   | 2   | 9     | 1  | 1  | 1  | 1   | 9   |       |
| Highland           | 1  | 27    | 1   | 3   | 3   | 32    | 1  | 1  | 1  | 3   | 32  |       |
| Hughes             | 1  | 26    | 3   | 1   | 3   | 34    | 1  | 1  | 3  | 1   | 39  |       |
| Imperial No. 1     | 1  | 75    | 9   | 1   | 6   | 93    | 1  | 1  | 2  | 6   | 99  |       |
| Jeffers            | 1  | 37    | 4   | 1   | 2   | 45    | 1  | 1  | 1  | 1   | 50  |       |
| Jeffers No. 1      | 1  | 130   | 14  | 2   | 9   | 161   | 1  | 1  | 3  | 2   | 168 |       |
| Lancashire No. 1   | 1  | 35    | 4   | 1   | 3   | 46    | 1  | 1  | 1  | 2   | 51  |       |
| Lancashire No. 2   | 1  | 42    | 2   | 3   | 2   | 48    | 1  | 1  | 2  | 3   | 51  |       |
| Lorraine           | 1  | 66    | 2   | 3   | 3   | 72    | 1  | 1  | 2  | 1   | 76  |       |
| Lattie             | 1  | 62    | 4   | 1   | 3   | 72    | 1  | 1  | 1  | 4   | 72  |       |
| Leland             | 1  | 400   | 35  | 11  | 38  | 471   | 5  | 1  | 7  | 25  | 496 |       |
| Morrisdale shaft   | 1  | 18    | 6   | 1   | 3   | 29    | 1  | 1  | 1  | 1   | 30  |       |
| Mapleton           | 1  | 19    | 1   | 1   | 1   | 22    | 1  | 1  | 1  | 1   | 29  |       |
| Mt. Vernon No. 4   | 1  | 88    | 10  | 2   | 10  | 113   | 2  | 1  | 5  | 2   | 123 |       |
| Mt. Vernon No. 5   | 1  | 108   | 7   | 4   | 6   | 131   | 1  | 3  | 5  | 2   | 142 |       |
| Mt. Vernon No. 6   | 1  | 50    | 1   | 4   | 4   | 56    | 1  | 1  | 3  | 5   | 61  |       |
| Mt. Vernon No. 7   | 1  | 194   | 11  | 8   | 11  | 229   | 2  | 3  | 3  | 13  | 242 |       |
| Ocean No. 1        | 1  | 91    | 3   | 8   | 4   | 108   | 1  | 1  | 1  | 4   | 112 |       |
| Ocean No. 2        | 1  | 55    | 3   | 1   | 6   | 68    | 1  | 1  | 1  | 1   | 76  |       |
| Opbitt             | 1  | 257   | 14  | 10  | 16  | 308   | 2  | 1  | 2  | 6   | 314 |       |
| Parke No. 1        | 1  | 20    | 2   | 1   | 2   | 27    | 1  | 1  | 1  | 2   | 27  |       |
| Parke No. 2        | 1  | 15    | 6   | 1   | 2   | 25    | 1  | 1  | 1  | 1   | 26  |       |
| Phoenix            | 1  | 13    | 1   | 1   | 1   | 15    | 1  | 1  | 1  | 2   | 17  |       |
| Phoenix            | 1  | 33    | 4   | 1   | 3   | 39    | 1  | 1  | 2  | 3   | 42  |       |
| Summit             | 1  | 1     | 1   | 1   | 1   | 1     | 1  | 1  | 1  | 1   | 3   |       |
| Staffordshire      | 1  | 140   | 11  | 3   | 9   | 164   | 1  | 3  | 4  | 8   | 173 |       |
| Starling No. 2     | 1  | 18    | 3   | 1   | 2   | 25    | 1  | 2  | 3  | 2   | 37  |       |
| Troy               | 1  | 69    | 10  | 1   | 3   | 75    | 1  | 3  | 3  | 8   | 83  |       |
| Victor No. 1       | 1  | 82    | 20  | 3   | 9   | 118   | 2  | 1  | 8  | 10  | 128 |       |
| Victor No. 2       | 1  | 59    | 3   | 5   | 3   | 71    | 1  | 3  | 6  | 10  | 81  |       |
| West Eureka No. 1  | 1  | 122   | 26  | 5   | 6   | 173   | 3  | 1  | 5  | 10  | 183 |       |
| West Eureka No. 2  | 1  | 68    | 10  | 3   | 6   | 87    | 1  | 3  | 6  | 10  | 97  |       |
| West Eureka No. 4  | 1  | 150   | 23  | 5   | 10  | 197   | 2  | 3  | 10 | 15  | 212 |       |
| West Eureka No. 5  | 1  | 107   | 15  | 8   | 7   | 141   | 2  | 2  | 8  | 10  | 151 |       |
| West Eureka No. 6  | 1  | 191   | 10  | 5   | 9   | 222   | 2  | 2  | 12 | 14  | 236 |       |
| West Eureka No. 10 | 1  | 133   | 15  | 8   | 7   | 167   | 3  | 1  | 8  | 10  | 177 |       |
| West Eureka No. 11 | 1  | 100   | 10  | 2   | 11  | 128   | 2  | 1  | 8  | 2   | 141 |       |
| West Eureka No. 12 | 1  | 100   | 10  | 2   | 11  | 128   | 2  | 1  | 8  | 2   | 141 |       |
| Webster No. 1      | 1  | 100   | 10  | 2   | 11  | 128   | 2  | 1  | 8  | 2   | 141 |       |
| Totals             | 77 | 6,234 | 623 | 136 | 416 | 7,656 | 84 | 63 | 26 | 208 | 93  | 474   |
|                    |    |       |     |     |     |       |    |    |    |     |     | 8,160 |

\*New mine; no shipments employed 1894.

|| No work at this mine in 1894.

TABLE NO. 4.—List of fatal accidents that occurred in and about the mines of the Eighth Bituminous Mine District, for the year ending December 31, 1894.

| Date of accident. | Name of Person.         | Occupation.  | Age. | Widow. | Number of orphans. | Name of Colliery.         | Location—County.  | Nature and Cause of Accident.   |
|-------------------|-------------------------|--------------|------|--------|--------------------|---------------------------|-------------------|---|
| Jan 5.            | Mike Yohoda, .....      | Miner, ..... | 28   | Yes    | .....              | Eureka No. 8, .....       | Clearfield, ..... | Caused by fall of roof. Was drawing a pillar and the roof began to fall and he had two cars in and was trying to get them out with his partners. He got one out and in trying to get the other out the roof fell on him, killing him instantly. |
| 28.               | Mike Tillio, .....      | Miner, ..... | 17   | No     | .....              | Coalhale No. 5, .....     | Clearfield, ..... | Was burned by powder, caused by handling powder in a hard can holding five pounds, with his lamp on his head, a spark from which fell into the can, burning him so badly that he died in a few days.  |
| 30.               | John Dudash, .....      | Miner, ..... | 18   | No     | .....              | Morrisdale shaft, .....   | Clearfield, ..... | It was a pure accident; the danger could not have been foreseen.  |
| Feb. 6.           | Steven Brezanski, ..... | Miner, ..... | 52   | Yes    | 6                  | Webster No. 4, .....      | Clearfield, ..... | Killed by a fall of rock. He was drawing out a prop to let down a bad piece of rock, but instead of standing to knock out the prop he got on his knees, and it caught him, killing him instantly.   |
| March 8.          | Charley Abuquist, ..... | Miner, ..... | 36   | Yes    | 3                  | West Eureka No. 12, ..... | Clearfield, ..... | Killed by a fall of coal which crushed his temple. Accident caused by his own neglect in not spragging the coal.  |
| Sept. 7.          | John Demick, .....      | Miner, ..... | 33   | Yes    | 2                  | Eureka No. 19, .....      | Clearfield, ..... | Killed by a fall of rock which broke his back; purely accidental.   |
| 28.               | Vin Vinskey, .....      | Miner, ..... | 21   | .....  | .....              | Eureka No. 12, .....      | Clearfield, ..... | Killed by a fall of rock for want of propping up his place.   |



|          |                        |                 |          |                              |                   |       |  |
|----------|------------------------|-----------------|----------|------------------------------|-------------------|-------|--|
| Oct. 8.  | David Llewellyn, ..... | Driver, .....   | 23 ..... | West Eureka No. 5, .....     | Jefferson, .....  | ..... | Was in a hurry on the dinner trip and did not use his breaks, and at a turn in the road the front car left the track and his legs were between the cars, crushing his legs necessitating amputation, from the effects of which he died. Was descending on a cage man and shaft with several other men and other parties were coming up on the cage, which stopped at the first landing to let off the men coming up. When the engineer started again to drop the cage the breaks failed to work, and he reversed his engine, but the distance was too short, and when the cage struck the bottom all jumped off in safety but this man, and the cage started up again, as the engineer did not get time to stop his engine after he had reversed it, so he was caught and dragged up with the cage, and squeezed to death. |
| 9.       | James Bowen, .....     | Roadman, .....  | 35       | Yes 8<br>Eureka No. 7, ..... | Clearfield, ..... | ..... | Was riding between loaded cars, and when going around a curve he fell between the cars and got under the wheels and was killed.  |
| 12.      | Wm. Fitzgerald, .....  | Driver, ....    | 16       | .....<br>Mapleton, .....     | Clearfield, ..... | ..... |  |
| Dec. 24. | Howard Davis, .....    | Door tender,... | 14       | .....<br>Pardee No. 2, ..... | Clearfield, ..... | ..... |  |

TABLE No. 5.—List of non-fatal accidents that occurred in and about the Mines of the Eighth Bituminous Mine District for the year ending December 31, 1894.

| Date of accident. | Name of Person.    | Occupation.  | Age.  | Name of Colliery.  | Location—County. | Nature and Cause of Accident.  |
|-------------------|--------------------|--------------|-------|--------------------|------------------|--|
| Jan'y.            | James Walker,      | Driver,      | 28    | West Eureka,       | Jefferson,       | Injured by a trip of runaway cars.   |
| 3.                | John Linkoe,       | Miner,       | ..... | Coaldale No. 3,    | Clearfield,      | Injured badly on foot and leg by a fall of coal.   |
| 11.               | Anton Makasavitz,  | Miner,       | ..... | Ocean No. 2,       | Clearfield,      | Head injured by a fall of coal.  |
| 19.               | John Hayden,       | Miner,       | ..... | Ocean No. 2,       | Clearfield,      | Hip dislocated by a fall of coal.  |
| 24.               | Evan Evans,        | Miner,       | ..... | West Eureka No. 5, | Jefferson,       | Leg broken in two places and rib and shoulder dislocated, by being run over by empty cars. |
| Feb'y.            | Peter Roulgers,    | Miner,       | ..... | Eureka No. 2,      | Clearfield,      | Left side and shoulder injured, ribs broken by a fall of coal.                             |
| 21.               | George Martich,    | Miner,       | ..... | Eureka No. 9,      | Clearfield,      | Shoulder blade broken by a fall of coal.   |
| 25.               | John Siford,       | Miner,       | ..... | Eureka No. 19,     | Clearfield,      | Small bone in leg broken by being caught between mine cars.                                |
| Mar.              | Alfred Johnston,   | Miner,       | ..... | Eureka No. 5,      | Clearfield,      | Collar bone broken by a fall of coal.  |
| 1.                | Gust Neidrick,     | Miner,       | 32    | Colorado No. 3,    | Clearfield,      | Shoulder broken by fall of bone and slate.   |
| 11.               | Luther Shoff,      | Driver,      | ..... | Atlantic No. 2,    | Clearfield,      | Kicked in the face by a mule.  |
| 20.               | John T. Burton,    | Miner,       | 30    | Lancashire,        | Clearfield,      | Ankle broken by a fall of stone.   |
| 36.               | William Lewis,     | Prop loader, | 20    | Atlantic No. 2,    | Clearfield,      | Kicked in the jaw by a mule.   |
| April             | John Steel,        | Door boy,    | 13    | Eureka No. 18,     | Clearfield,      | Leg broken by running into an empty car.   |
| 18.               | .....              | .....        | 13    | .....              | .....            | Arm broken by a fall of coal; knocking out a prop which struck his arm, breaking it.       |
| July              | Dennis Smith,      | Miner,       | 45    | Sterling No. 2,    | Clearfield,      | Arm burned above the elbow by falling on a steam pipe.                                     |
| 12.               | Emil Fisher,       | Miner,       | 40    | West Eureka No. 6, | Jefferson,       | Thigh broken by a fall of roof.  |
| 27.               | Joseph Tanna,      | Miner,       | 23    | Webster No. 4,     | Clearfield,      | Leg bruised by being caught between mine car and prop.                                     |
| Aug. 3.           | Andrew Godofefski, | Miner,       | 24    | Eureka No. 7,      | Clearfield,      | Severely injured by being caught under descending cage.                                    |
| 13.               | Jno. Levarchowsky, | Miner,       | 30    | Eureka No. 7,      | Clearfield,      | Collar bone broken by a fall of fire clay from the roof.                                   |
| 22.               | Charles Manister,  | Miner,       | 36    | Eureka No. 7,      | Clearfield,      | Spine badly injured by a fall of roof.   |
| 22.               | John Barko,        | Miner,       | 30    | Webster No. 4,     | Clearfield,      | .....  |

|       |     |                 |          |       |                    |             |   |
|-------|-----|-----------------|----------|-------|--------------------|-------------|---|
| Sept. | 5,  | James Kellock,  | Miner,   | 16    | Decatur,           | Clearfield, | Leg broken by being run over by an empty car.   |
|       | 18, | Samuel Walker,  | Miner,   | 55    | Decatur,           | Clearfield, | Arm badly cut by a fall of coal.  |
|       | 19, | James Wagstaff, | Miner,   | 61    | Eureka No. 15,     | Clearfield, | Injured by a fall of coal.  |
|       | 22, | J. S. Crashaw,  | Miner,   | 61    | Colorado No. 2,    | Clearfield, | Hip broken by a fall of coal.   |
|       | 28, | Frank Butchko,  | Miner,   | 17    | West Eureka No. 6, | Jefferson,  | Leg broken by being struck by a haulage rope.   |
| Oct.  | 2,  | C. Gearhart,    | Driver,  | 27    | West Eureka No. 6, | Jefferson,  | Taken by mine car.  |
|       | 8,  | Jacob Wein,     | Miner,   | 56    | Fairmont,          | Clearfield, | Injured on the head by a fall of coal.  |
|       | 8,  | David Lewellyn, | Driver,  | 22    | West Eureka No. 5, | Jefferson,  | Leg crushed above the ankle by being caught between mine cars.  |
|       | 11, | William Cahill, | Miner,   | 50    | Black Diamond,     | Centre,     | Toes smashed by being run over by mine cars.  |
|       | 16, | Andy Capko,     | Miner,   | 33    | Morrisdale shaft,  | Clearfield, | Foot injured by fall of coal; necessitating amputation.   |
|       | 25, | John Simon,     | Miner,   | ..... | Webster No. 4,     | Clearfield, | Far hip broken by being caught between the top of car and the roof.                                       |
| Nov.  | 1,  | Thomas Jenkins, | Miner,   | 15    | West Eureka No. 4, | Jefferson,  | Leg broken by fall of rock.   |
|       | 2,  | Henry Gross,    | Miner,   | 45    | Black Diamond,     | Centre,     | Collar bone broken by a fall of coal.   |
|       | 14, | William Box,    | Miner,   | ..... | Atlantic No. 2,    | Clearfield, | Injured by a fall of coal.  |
|       | 28, | Benj. Swigert,  | Cager,   | 50    | Eureka No. 7,      | Clearfield, | Compound fracture of the left leg below the knee; was caught between the cars at the bottom of the shaft. |
| Dec.  | 1,  | H. McAlaney,    | Roadman, | ..... | Eureka No. 16,     | Clearfield, | Thigh dislocated by being caught between cars and the rib.  |
|       | 11, | John Swobeski,  | Miner,   | 30    | Eureka No. 7,      | Clearfield, | Right leg bruised by a fall of coal.  |
|       | 12, | John McMirney,  | Driver,  | 22    | Eureka No. 7,      | Clearfield, | Foot and shoulder crushed by being caught between a car and the rib.                                      |
|       | 24, | Frank Butler,   | Miner,   | ..... | Lane,              | Clearfield, | Toes injured by a fall of coal; necessitating amputation.   |
|       | 24, | Edward Miller,  | Miner,   | 13    | West Eureka No. 1, | Jefferson,  | Leg broken by a fall of bone coal.  |



# NINTH BITUMINOUS DISTRICT.

(FAYETTE, WESTMORELAND AND ALLEGHENY COUNTIES.)

Connellsville, March 4, 1895.

Hon. Isaac B. Brown,

Secretary of Internal Affairs:

Sir: In compliance with the Act of Assembly, approved May 15, 1893, I have the honor of herewith submitting to you my annual report as Inspector of Coal Mines of the Ninth Bituminous district, for the year 1894.

There have been produced in this district 4,690,911 tons of coal, and 1,473,982 tons of coke, a falling off in the production of coal of 123,267 tons, and an increase in the production of coke of 233,818 tons, as compared with 1893. The average number of days worked was 163, against 180 days in 1893. The number of persons employed inside this year is 281 in excess of those employed in 1893, but two more mines have been in operation. The number of fatal accidents was 11, and the number of non-fatal accidents 40, which is 4 fewer fatal, and 5 more non-fatal than were reported for 1893. From the reading of the report of the accident to the boy Norton, it will be observed that he was not employed in the mine, but was visiting his relatives and he was forbidden to ride on the trips. He stole in on the empty trip and was too far in for the driver to put him off, as he had no lamp. Then, jumping on the first loaded trip that he met going out, he lost his life. In commenting on these fatal accidents, it may be said that eight of them occurred from the assumption of unnecessary risks by the victims. The killing of Brown, Burtoff and Kreuter might be termed accidents, because these men were good practical miners and careful in their work, and they did not think that there was immediate danger at the time of the accidents. Although this is a gaseous district, there were few accidents from gas. The report shows that eight persons had been burned but their injuries were slight and were caused by their disobedience of orders. Some of these accidents occurred in the mines that do not generate gas, or at least not in large or dangerous quantities.

This may be accounted for by remarking that in all of the explosive gas generating mines only safety lamps are used. About 50 per cent. of the accidents happened from falls. These accidents can only be prevented by the miners themselves exercising more care. Ignorance and carelessness are the general causes, and by reading the names of the accident tables, it will be seen who these careless persons are. There were five accidents from the careless handling of powder, from blown out shots, etc. There was one instance of a colored man carrying matches in his powder bag when he bought it at the store. While he was taking it into the mine the bag burst and he carefully put the matches and the powder into the same can. When he made his cartridge, no doubt some of the matchheads went into it along with the powder. It so happened that the cartridge stuck before it went all the way back to the end of the hole, and while he was in the act of tamping it back with his tamping bar, the cartridge went off and burned him and a boy who was working with him.

I cannot complain much about the sanitary condition of the mines, as there are only three of them where the ventilation is not as good as it should be. These three have become too expensive for the furnace power which is employed to ventilate them. The erection of fans at these places is contemplated. If these are put in, the mines will be in as good condition as the other mines in the district.

I have described the circumstances under which each fatal accident occurred. The usual statistics will be found in their proper order as part of this report, all of which is respectfully submitted.

Yours respectfully,

BERNARD CALLAGHAN,

Inspector.

Causes of Accidents for 1894.

|                                   | Fatal. | Non-fatal. | Widows. | Orphans. |
|-----------------------------------|--------|------------|---------|----------|
| By falls of roof, etc., . . . . . | 7      | 18         |         | 10       |
| By falls of coal, . . . . .       | 2      | 2          |         | 7        |
| By mine wagons, . . . . .         | 2      | 7          |         | 5        |
| By explosive gas, . . . . .       |        | 8          |         |          |
| By powder, . . . . .              |        | 5          |         |          |
| Totals, . . . . .                 | 11     | 40         | 7       | 22       |

|  |       |
|--|-------|
| Number of mines in the district, . . . . .               | 68    |
| Number of mines operated during the year, . . . . .      | 64    |
| Number of miners (men) employed, . . . . .               | 5,922 |
| Number of miners (boys) under 16 years of age, . . . . . | 227   |

|  |           |
|--|-----------|
| Number of daymen, including mine foremen, drivers<br>and trappers, .....                     | 946       |
| Total number inside, .....   | 7,098     |
| Total number outside, .....  | 2,112     |
| Total number of kegs of powder reported used, .....  | 11,145    |
| Total number of horses and mules, .....  | 553       |
| Total number of coke ovens, .....  | 5,028     |
| Total number of tons (2,000 pounds each) mined, .....  | 4,690,811 |
| Total number of tons (2,000 pounds each) shipped,...   | 2,625,335 |
| Total number of tons (2,000 pounds each) coke made,.   | 1,473,982 |
| Number of tons produced per fatal accident,.....   | 426,437   |
| Number of tons produced per non-fatal accident,.....   | 117,270   |
| Total number of days the mines were in operation,...   | 10,452    |
| Average number of days for each mine in operation,..   | 163       |
| Average number of cubic feet of air in circulation<br>for each employe inside of mine, ..... | 251       |
| Number of wives left widows, .....   | 7         |
| Number of children left fatherless, .....  | 22        |

=====

#### Accident List.

At Port Royal mine John Steve, a Slav, was killed by a fall of coal in the following manner: While working with another man in room No. 3, No. 8 entry, they had undermined the coal six feet deep, partly across the room and had put a shot in the side next to the left rib, which knocked down five or six feet and left others standing, but undermined and in a loose condition. Steve then commenced to undermine the rest of the cut with the intention of putting a shot in the other side when it should be undermined. He neglected to put sprags under it and the coal fell while he was under it, and killed him instantly. The assistant mine foreman said that he was in to see the miner that morning and told him to sprag his coal.

Eureka Mine. Henry Burtoff, American, was fatally injured by a piece of slate falling upon him in a peculiar way, and it resulted in his death sixty hours afterwards. He had his place in first-class condition and was considered one of the most careful miners in his district. He had only one piece of slate in his room and had posted it with one post, which was sufficient, as it was only three feet eight inches by two feet seven inches by ten inches. He was waiting on a wagon and was spending this time in taking down the piece of slate and cleaning it up. He commenced to push the last car which he had loaded, out of the way, and he put his back against the post

and his feet against the car. Instead of pushing the car he pushed the post out from the slate, and the whole mass came down on him with the above result. The place from which this piece of slate fell showed a slip over the coal along the right side, which could not have been seen while the slate was up, as the coal at this place was eight feet thick.

At the Scottdale Iron and Steel Company's mine on August 1, William Norton, a boy of 17 years of age, was killed by a trip of loaded wagons in the following manner: The evidence showed that the boy had come to Scottdale that day with a base ball club, and as his grandfather lived there, he stayed over with him a couple of days. He was curious to see the inside of a mine, and was told that no one was allowed to ride on the driver's trips. After loitering about the outside some time, he stole in on an empty trip. He met another trip coming out loaded. He had no light and being a stranger in the mine, he attempted to jump on the last wagon and ride out. As the trip was passing, it is supposed that he thought he was jumping on the last car on the trip, but instead, he attempted to jump on the next to the last one. He was caught between the last wagon and the rib, a space of only six inches. He died as they were bringing him out on the same trip.

At Summit mine, on August 8th, James H. Martin, while taking back a rib, No. 20, butt No. 7, had set a break row of posts on the previous day, but the roof did not fall then. He had some time to wait for a wagon. He went back into the space where the posts had been drawn out the day before, and the roof fell on him, burying him completely. The drivers called to him shortly after, and not finding him, gave the alarm. A search was made for him, and in two or three hours afterwards they found him under the fall, dead. This was the first accident that had happened in this mine, although it has been in operation over twenty years.

At Darr mine, on August 13th, while John Mudrok and John Blasko were working in No. 7 entry, room No. 13. Blasko was killed by a piece of coal which weighed about a ton falling on him. From the evidence in this case it appeared that these men were undermining a cut in the face of the rib, it being open on one side. John Mudrok discovered that this piece was loose and told Blasko several times not to work under it. No persuasion would induce Blasko to go away from the piece of loose coal and it fell upon him and killed him instantly. It is difficult to prevent accidents when men are so headstrong as this.

At Ocean mine No. 2, September 5th, George Twigg, an Englishman, and an experienced miner, was killed in his room, No. 10, No. 6 entry. From what we could learn in this case, the victim had been



off for a few days on a spree, but concluded to go to work on that morning, and having a great lot of slate up, he commenced to take it down. The position in which he was found, showed that he had been drawing posts when the slate fell on him. The man who worked in the next room heard the fall and went to see if all was right. Not finding him as he entered the room, he began a search and found the unfortunate miner under the fall of slate, dead. He was a single man, about 34 years old, and had been in this country about eight years.

In Davidsen shaft, on the afternoon of October 3d, Jacob Adams, a German, was instantly killed by a fall of top rock in his working place, room No. 1, No. 36 entry. It appeared from the testimony in this case that Jacob and his partner, Jacob Blezner, were drawing out their posts to make a fall. They had a break row up, but commenced to take out some posts that were back, and having them all out except three, Blezner advised Adams to leave them stand. Adams then commenced to cut the posts in the middle with his ax, and the whole roof that was supported by them came down upon him. It required two hours work to get his body from under the fall. He left a wife and two children.

At the Valley mine on the 27th of October, John Brown, a Scotchman, and an experienced miner, was killed in following manner: He and the miner that worked in the next room, William Ryan, were accustomed to assist each other when drawing posts. Ryan, in this case, had set up his break row, when Brown came in to help him. Two of the posts were taken out. They concluded to leave one of them in altogether, and then Brown began to knock out one of the two posts, but the roof suddenly began to give way. Brown tried to flee, but the fall knocked the post out, and it struck him on the side. He died in a half hour afterward. He was 47 years old and left a wife and five children.

Jacob Matson, a Russian, was injured at the Port Royal mine on October 29th, by a piece of slate falling upon him while he was shoveling coal from under it. This man did not seem to realize the danger in which he labored, or he would have either put up a post to sustain the roof, or would have taken the roof down. He had only been working in his place three days and was not accustomed to this kind of work. He died the next morning.

Lewis Kreuter, a German, aged 31 years, and an experienced coal miner, was fatally injured on the 8th of December, at the Smithton mine No. 2. A piece of slate fell upon him while tamping a hole to fire a shot. Lewis and his partner, John Both, were driving headings and had taken all the slate except one little piece on the left side. After they had tried to knock down this piece, they found

that it was too hard, so they made another cut ready, and put a shot in it to shear it on the same side on which the piece of slate was left up. Then they paid no more attention to it, thinking that it was still in the same condition. They were tamping a hole on the other side, Kreuter throwing in the tamping while John rammed it back. The slate unexpectedly fell, breaking John's leg and injuring him internally. He died the same evening. He left a wife and three children.

Michael Mauroskie, a Slav, was killed instantly at the Painter mine on the 29th of December by the locomotive that hauls the coal from the second opening to the tippie. Michael was coming home from work along with his brother-in-law, and instead of coming over the hill, they walked through the first opening, which served as a tunnel through which to haul the coal from the second opening. They had met the locomotive going back and thought to get through before its return trip. But the locomotive was able to haul only half trips on account of the snow. It got back sooner than usual, overtaking them before they got through, and ran down Mauroskie within 200 feet of the outside. There were plenty of shelter holes in the tunnel and plenty of room between the rib and the engine to pass except at the place where he was caught. This was his first day to have a check in his own name, although he had worked at helping his brother-in-law for about three weeks.

Steve Lauri, a laborer at Darr mine, was killed by a railroad car at the tippie on the 8th of March. I do not know whether this case comes under the head of mine accidents or not.

---

#### Description of the Mines on the Pittsburgh and Lake Erie Railroad.

Adelaide. All the coal mined at this place is made into coke. The plant has a working capacity of 342 ovens, and 274 persons are employed inside and outside. A new air shaft with a fan has been put down. The fan ventilation has a current of 105,000 cubic feet of air. This can be maintained and is well distributed throughout the workings, and although this is considered a gaseous mine and is worked exclusively with safety lamps, I can scarcely ever detect any explosive gas in any part of the mine.

Thomas Harris, mine foreman.

Fort Hill and Moreland Slope. These mines are virtually one operation, being connected both inside and outside. All the coal mined is made into coke. There are 350 ovens. The only improvement made at this place during the year was a brick and iron engine house outside. The ventilation is maintained by a fan, which gives

33,000 cubic feet of air per minute, and the current is well distributed throughout the mine, 2,240 cubic feet having been measured at cut-throughs at the furthest point on the slope side. This side is all worked with safety lamps, it being gaseous. No standing gas found when visited.

William Sloan, mine foreman.

Rainbow. This mine was not worked very steadily during the year, owing to dull trade. Some improvements were made in the way of overhauling things in general. If coal was wanted the mine could supply it in good shape. Fan, 34,700; at the face of the main heading, 10,640. Explosive gas is given off pretty freely in some entries, and these are worked with locked safety lamps.

Dennis Worldly, mine foreman.

Wick Haven. This is a new mine, the coal being hoisted from a shaft about 65 feet from the surface. Then a slope has been driven through the measures for the second opening and for the miners and others inside to travel upon. A temporary fan supplies the air at present, which gave 22,400 cubic feet at my last visit, and 9,500 at the face of the heading at the far end. This was expected to be a gaseous mine when they get deeper under the hill. Very little has been encountered so far. They intend to build a large ventilating fan in the near future, which will cope with the gas. They have built a fine wash house, fitted up with hot and cold water, for the benefit of the workmen. The place is heated by steam, so that the men can change their clothes at all times of the year. It is the only place of its kind in the district. Eighty persons are employed at the mine.

William Goldsboro, mine foreman.

Banning. The coal measures at this mine dip from the opening at the railroad and are followed directly to the end of their boundary by a slope. The entries are then turned off right and left. Butt headings are then driven up hill for rooms to be turned on the face of the coal. This was the system at first adopted, but they have changed this to turning the rooms up-hill on the butt of the coal, this being considered the best method for this kind of grade, as it insures safe and easy hauling for the drivers and mules, and also insures dry rooms. The coal is of the thick coal basin and gives off considerable quantities of explosive gas. The ventilation is maintained by a fan, and although only seven feet in diameter, it passes about 40,000 cubic feet per minute. This fan has given great satisfaction, but is now too small for the capacity of the mine, and has been replaced by one 20 feet in diameter. This is one of the gaseous mines and may have to be worked all through with safety lamps before long, although there is no standing gas at present in the

wine. The mine worked only 182 days during the year on account of the strike. There are 257 persons employed, and the coal is all shipped to market just as it leaves the mine.

William Holsing, mine foreman.

Darr. The coal measures dip directly from the opening the same as the one previously mentioned, and the coal is hauled by the tail rope system. The workings at the bottom of the slope are very gaseous, being worked exclusively with safety lamps. The system of mining the rooms on the butt of the coal is maintained through the mine, and it is considered the best on the steep grades. The mules then do not need to face the hills. This shows for itself in the quantity of coal produced for the number of laboring men, drivers, etc. A new fan has been erected at this place, it is 25 feet in diameter and produces 100,000 cubic feet of air per minute at a speed of 60 revolutions. The maker says that it can be run with safety at 100 revolutions.

Charles Watson, mine foreman.

Port Royal. This mine has about recovered from the fire and is in pretty good shape again. They are preparing to put in a haulage on the No. 1 shaft side in order to get as much coal to the one shaft as to the other. When this is completed, they will be able to ship a large quantity of coal. The coal is principally mined with coal-cutting machines of the Jeffrey type. These do the work fairly well, but their system of leaving the ribs is not a commendable one. A great quantity of gas is given off, but a sweeping current of air is kept well up to the face, and no gas is allowed to accumulate.

R. Mellroy, mine foreman.

West Newton. Very little can be said for this mine. The big strike and the bad trade hindered it in such a way that it did not advance much during the year. The haulage was extended a little. The mine is kept in good condition as regards ventilation and drainage.

Robert Hall, mine foreman.

Ocean No. 5. There is nothing to add to the good report of last year. The mine has good ventilation and drainage. There were no improvements during the year.

Robert Watson, mine foreman.

Forest Hill. This is one of the steadiest going mines in this district. The coal is all mined in the rooms and headings with the coal-cutting machines of the Jeffrey type, and the ribs are worked by hand labor. The system of ventilation and drainage is good.

They have crossed the track of one of Ocean No. 5 at half coal, taking the remainder of the height out of the roof, Ocean No. 5 taking their height by cutting down on the bottom. This arrangement was made by an agreement between the two companies. Some improvements were made here by taking up the bottom rock and blasting down the top.

Arthur Crossland, mine foreman.

Pacific. The condition of this mine is not very good on account of the poor ventilation. The furnace is no longer sufficient for the required volume of good air. They are preparing to put in a fan at the far end, where a pumping shaft will be needed to properly drain the mine. When this is completed it will be in good condition.

John Thomas, mine foreman.

Sarah. This is only a small operation and has not done much during the year on account of the dull trade. The general condition of the mine is much improved and will soon be satisfactory to every person employed.

Thomas Hall, mine foreman.

Ocean No. 2. I can not say that this mine is in very good condition as to ventilation, because like the preceding one it has become too extensive for furnace power. I believe everything has been done to use what power they have, but it is not more than half sufficient. The management, knowing this, have ordered a Capell fan, and expect to have it running by spring. The furnace gave, at my last visit, 38,130 cubic feet of air per minute, while at the back entries, about 1,800 feet were all that could be obtained. This quantity was not half enough under the circumstances.

John Mathews, mine foreman.

Ocean No. 4. This mine did not work much during the year. The ventilation has been improved some by putting in a new furnace. There are other improvements needed which will be attended to when trade revives.

Thomas Suffolk, mine foreman.

Painter & Cornell's. This mine is in good condition all through, but like the others was affected by the big strike.

E. B. Davis, mine foreman.

Dravo. The general condition of this mine is much improved and everything points to a continuance of prosperity if trade will only

revive a little to encourage the operators to make the necessary improvements.

John Matheson, mine foreman.

Brown's Nos. 1 and 2. In giving description of these mines one will suffice for both, as when one is working the other is invariably idle. Both of these mines ship by the river. They have done very little during the year. There is nothing to complain of in regard to ventilation or drainage at either of the mines.

Frank Ransik and Alex. Cochrane, mine foremen.

---

#### List of Mines on the Belle Vernon Railroad.

Bell Bridge. Very little can be said of this mine, as they did not work much during the year, as can be seen from their tonnage, 41,741 tons. My last visit showed things to be satisfactory.

H. Henderson, mine foreman.

Lovedale. This mine was not in operation during the year. I did not make a visit to it on that account. There is some talk of starting up in the near future.

Horner & Roberts. This place only worked about two months during the year, and the firm is now in bankruptcy. There is some talk of a co-operative company leasing it and starting it up soon.

H. D. O'Neil. This mine has worked very steadily during the year. They have made some improvements by putting the haulage rope down through the old workings to the main body of the coal. They have also improved the ventilation. The coal is cut with electric coal cutting machines, which process seems to give good results. They open up 64 feet of coal with two roads leading into these, and by cutting about five feet deep, the coal is easily shot down and in very large lumps.

John Besenthiner, mine foreman.

---

#### List of Mines on the Baltimore and Ohio Railroad.

B. & O. This is a small mine employing only about twenty persons all told. The coal mined is all used by the railroad locomotives and is worked more steadily than any I know of. They worked 365 days during the year, besides sometimes employing an additional shift at night. Although the ventilation is only by natural means, there is nothing to complain of. From 6,000 to 10,000 feet of air passes at

present, but as they get farther in, this volume cannot be maintained, so they propose to put in a fan.

Laclair Stillwagon, mine foreman.

Davidson Shaft. It is enough to say that this mine is in good condition. About 70,000 cubic feet of air passes in and circulates freely through the workings. There are no open lights used in this mine, although there is very little explosive gas given off, and what there is, is in the solid workings.

John Stevenson, mine foreman.

Henry Clay. This mine is connected on the inside with the Davidson shaft, although there is a different system of ventilation used. The opening was made from one mine to the other so that in case of an accident, the men would have refuge in one or the other direction. Explosive gas was never found at this place, although the only lights used are the safety lamps. A current of air of about 40,000 cubic feet per minute passes through the mine. The air is well distributed to the working places.

John Keck, mine foreman.

Tyrone. The management of this mine has had a great deal of trouble in getting out coal that was reckoned as almost lost by bad mining heretofore. When they commenced to draw out ribs and pillars there was so little means of support left that a squeeze commenced and threatened to overrun several entries. By judicious and general cribbing and posting, this was pretty well overcome. The management at this place deserves the greatest credit for their attention and perseverance in combatting their difficulties. They are now in pretty good condition and can boast that during all of their troubles they never had a single accident. They are now working in another old mine adjoining and haul the coal through their own opening.

Thomas R. Kane, mine foreman.

Sterling No. 1. There is very little coal left in this mine to be worked. They worked about three months during the year. A couple of years steady work in this mine will finish all the coal. The ventilation and drainage were good and can easily be maintained until the end.

Jackson. This mine has worked very steadily during the year, and although it is one of the oldest mines in the district, it will last a long time yet. It has only a small number of ovens to supply with charges, and will be one of the coal producing mines in the coke region for several years to come. They are troubled with an old fire

which is smouldering in the front of the mine. The drainage and ventilation are good. No explosive gas has ever been encountered at this place and it is worked with open lights.

George Moore, mine foreman.

Eureka. This mine is situated in the coke region basin, but none of its coal is made into coke. The coal is of a good, strong nature. The mine is being worked pretty extensively, and is kept in good condition as regarding both ventilation and drainage.

James Bayley, mine foreman.

Smithton Nos. 1 and 2. This mine has been leased by a different firm. They are working only No. 2 at present, but they intend to work both mines if trade will warrant. They are developing this mine in good shape. They are driving to connect No. 1 mine. When that is completed, the men can go in and out of the mine without going up and down the shaft.

John Harris, mine foreman.

Euclid Shaft. This mine has a small opening and a large coal and in a large territory. The vein is about nine feet thick and is the first mine to enter the thick basin towards Connellsville. This is proven by the fact that the coal becomes thinner as it nears West Newton, and it also becomes harder to work. I have never had cause to complain of anything at this place. Although there is a little gas, it is generated in the clay veins and in the solid workings. The mine is well looked after.

William Goodfellow, mine foreman.

West Newton Shaft. This shaft is used for the sole purpose of pumping outlet and a place to hoist the men, slate, house coal, etc., for the convenience of the No. 2 shaft.

Yough Slope. I can only reiterate what I have said about this mine in my former report. It has a bad roof and a little explosive gas, but it is being well looked after and is kept in fairly good condition. The quantity of air for ventilation at the outlet and inlet is 22,500 cubic feet per minute, and 6,800 and 6,000 feet at the face of each heading.

James Latimore, mine foreman.

Amyville. There is not much to complain of at this place. Every butt entry is driven through to daylight, and fresh air is supplied from the outside, and although only 2,240 to 3,000 cubic feet of air per minute passes through, it is pure and sufficient for the number of men when blasting is done in the evening. There is 20,000 feet at the furnace. Drainage is all right.

Samuel Jones, mine foreman.



Ocean No. 1. This is an extensive mine and is well looked after both as to ventilation and drainage. But it has gone beyond the limit of the furnace power to give a sweeping current of air, and a fan is expected to take the place of the furnace before long.

Josiah Saffolk, mine foreman.

Dillworth I expect that this will be about the last report that will be made of this mine as it is about exhausted. I have always found it in pretty good condition.

Thomas Whiteman, mine foreman.

Shaners No. 2. This is one of the mines that gives off a little explosive gas and has a bad roof in some places. There were four Italians burned in this mine by going past a danger signal when the mine was idle. An air and pumping shaft is to be put down as soon as they get down to a certain point. This shaft will make a great improvement.

Reuben Street, mine foreman.

Guffey Mine. This mine is being pretty well looked after. The ventilation is maintained by a furnace which passes off about 40,000 cubic feet of air per minute. Sometimes a little explosive gas makes its appearance at the solid workings. The fire boss visits all these places every morning before the men enter, and all the precautions are taken for the safety of the miners.

Ed. Bell, mine foreman.

Big Chief. If the arrangements contemplated at this mine are carried out it will rank among the foremost in the way of ventilation. At present the furnace is too far out of the way to be of much service for ventilation. Besides there is a large territory of coal left for the passage of a road. This coal, or the most of it, will be lost, if it is left in this way much longer. In order to obviate this, they are about to sink a shaft for air at a more convenient place, which will bring the ventilation to the required location.

H. D. Thompson, mine foreman.

Osceola. The workings of the mine at this place are now in a new field, the old field being about worked out. They have extended the rope into the new hill and have made it practically a new mine. The entries are driven to make connection for ventilation. This mine promises to be in good condition for a long time to come.

Frank Ridley, mine foreman.

### Mines on the Mt. Pleasant Branch.

**Rist.** This mine is entered by a short slope and is quite a large operation. It is connected with the Henry Clay slope, which in case of an accident would be a means of egress from either mine. It is ventilated by a fan which passes about 60,000 cubic feet of air per minute, and this air is then divided into the different sections, pure and in generous quantities. No. 10 butt has 15,000, and the others have the air in proportion as it is required. I have never found anything at this mine to complain about.

Charles Winginwroth, mine foreman.

**Morgan.** This mine is nearly worked out. It has not worked for a long time, until this year. They have commenced to finish it up, and then the ovens that were originally charged from it will be supplied from Rist mine. The ventilation is produced by a small fan which keeps the mine in good condition.

Patrick Reynolds, mine foreman.

**White.** This mine extends a great distance back, and is entered by two openings. It is connected with Rist mine by a passage way for an outlet in case of emergency. The coal is very shallow, which makes trouble in wet weather by the water entering the mine through the falls. Apart from this, the mine is in good condition.

Terrence Donnelly, mine foreman.

**Summit and Eagle.** These are practically one mine, being connected inside and outside. They have the same system of ventilation, ovens and railroad. The ventilation and drainage are good and are well looked after. The fan sustains 35,000 cubic feet of air per minute. The ventilation sweeps through the rooms in quantities of 6,920 and 5,000 cubic feet per minute.

Edward Mooney, mine foreman.

**Franklin.** This is a small operation and is ventilated by a furnace, which produces plenty of ventilation for the requirements of the mine. There were only 20 persons employed. The inlet measurement was 6,000 cubic feet for each entry and about 17,160 cubic feet per minute for the main heading at the inlet. The drainage is good and is well looked after.

Jacob Dewalt, mine foreman.

**Valley.** There is no mine in the district that is better looked after than this. I never find a fault in any particular. The ventilation is produced by a fan, which furnishes 77,840 cubic feet per minute. The air is distributed in various splits as follows: No. 8 butt, 24,509;

Nos. 6 and 7, 12,160; No. 9, 9,520. Nearly the same quantity can be found in the cut-throughs of rooms and elsewhere. A connection is made through to White mine, and an underground passageway to Connellsville.

James Jackson, mine foreman.

Scottdale Iron and Steel Company. This is only a small operation, the coal being mined for the sole purpose of supplying the boilers at the rolling mill. The pit cars are run down an inclined plane and dumped at the required place. The ventilation is produced by a fan which gives 23,500 cubic feet of air per minute. The air is well distributed throughout the workings as follows: No. 4 entry, 18,760; No. A flat, 12,600 cubic feet per minute. There are only 20 persons employed in this mine.

A. S. Suttle, mine foreman.

Dexter. This is a small mine, only fourteen persons being employed. The ventilation is maintained by natural forces, which seem to be sufficient for the present; 6,720 cubic feet of air per minute were registered at my last visit; drainage is all right.

S. Fairchild, mine foreman.

West Overton. This is but a small mine, employing only 47 persons. The ventilation is by natural means, which is sufficient on account of the falls to daylight over the mine. The drainage is perfect.

John Boyle, mine foreman.

Painters. The roads in this mine are very good and dry. The ventilation, though not in great volume, has been sufficient to keep the mine in good, healthful condition so far, but it can be improved. A furnace produces a current of 3,200 cubic feet of air per minute in the far end of the mine. There are 90 persons employed here.

Andrew Beatty, mine foreman.

Bessemer. This plant is working for the first time since '91. An air shaft has been put down, which has greatly improved the ventilation, but it is still poor and will not be bettered until a fan is put in, which will likely be done this spring.

At my last visit the furnace gave 29,600 cubic feet of air per minute, but this will not be sufficient in the summer.

John Nairn, mine foreman.

Rising Sun. Both the drainage and the ventilation in this mine are good. A furnace produces a current of 24,400 cubic feet of air per

minute. No 8 entry has 8,690 cubic feet. The surface is thin and very often falls in, thus leaving holes for free ventilation.

Thomas Evans, mine foreman.

Buckeye. This mine was in very good condition at my last visit. The ventilation is produced by a fan, which makes 25,200 cubic feet of air per minute. No. 2 entry has 10,000 cubic feet; rooms and cut-throughs, 1,720; No. 1 entry, 11,760; slope heading, 11,200. The drainage of this mine is good.

George Burns, mine foreman.

Mullen. This mine was in good condition at the last time I visited it. It was operated very little during the year.

William Alexander, mine foreman.

Emma. I found nothing at this mine of which to complain. There are only fourteen persons employed. A new pump has been put in in order that some coal in the dip can be worked.

Adam Whitehead, mine foreman.

---

#### List of Mines on the Southwest Pennsylvania Railroad.

Grace. There is good drainage at this mine, also good ventilation. The current of air is produced by a fan which makes 44,000 cubic feet per minute. No. 7 flat has 21,280 cubic feet; No. 6 flat has 6,300 cubic feet; the rooms have in No. 7 flat, 2,400; No. 9 flat has 8,100 cubic feet.

John McDonald, mine foreman.

Pennsville. I have always found this place in good condition. The ventilation is produced by a fan which furnishes 18,000 cubic feet of air per minute. At the far end of the workings there are 15,000 cubic feet maintained. The drainage is good. There are only twenty-five persons employed at this mine.

William Kooser, mine foreman.

Donnelly. I have found nothing at this mine of which to complain. The fan makes 27,840 cubic feet of air per minute; No. 4 butt has 5,600 cubic feet; the inlet at the far end has 13,800 cubic feet. There are 60 persons employed at present.

Andrew Neish, mine foreman.

Mayfield. This mine adjoins and is connected with Donnelly on the inside. The furnace makes 10,080 cubic feet of air per minute. No.

5 butt has 8,600 cubic feet; No. 4 butt has 5,670 cubic feet; there are employed 24 persons. The drainage and ventilation are good.

P. S. Steven, mine foreman.

Union. This mine employs twenty-two persons. It has not worked for some time until this year. The furnace produces 6,240 cubic feet of air per minute. The one inlet has 1,960 cubic feet. The drainage and the ventilation are good.

J. S. Røggor, mine foreman.

---

### Report of the Cottage State Hospital of Connellsville.

From the annual report of the management, just completed, we gather that there were 198 patients treated during the year. Since the opening of the hospital there have been 541 treated. Of those treated this year, 108 were Americans, 38 Hungarians, 11 Irish, 11 Austrians, 9 Germans, 9 Italians, 5 English, 3 Poles, 1 Swede, 1 Scot and 2 of unknown nativity.

Out of the 198 patients, there were but 23 deaths, some of whom died immediately upon admission, and the majority within from 12 to 48 hours after being admitted. These were all necessarily fatal cases. Ten of the fatal cases were those of miners injured while at work. Seven were those of miners injured while off duty. Two were railroad employes. Two others were injured on the railroad, but were not employes. One was a suicide, and one a victim of a coke-yard riot.

Many of the patients admitted during the year were severely injured and required great attention. The nurses and surgeons were kept busy with the care of such patients. There were no less than 49 cases of fractured limbs. There were three cases of broken back, twelve cases of crushed legs, besides a number of gun-shot wounds which necessitated amputation.

The occupations of the patients were as follows:

|                            |     |
|----------------------------|-----|
| Coke workers, .....        | 101 |
| Laborers, .....            | 19  |
| Railroad brakemen, .....   | 17  |
| Railroad engineers, .....  | 8   |
| Railroad conductors, ..... | 1   |
| Railroad firemen, .....    | 1   |
| Railroad hostlers, .....   | 1   |
| Machinists, ... ..         | 2   |
| Carpenters, .....          | 2   |
| Clerks, .....              | 2   |

|                          |       |
|--------------------------|-------|
| Soldiers, .. .. .        | 1     |
| Car inspectors, ....     | 1     |
| Agents, . . . . .        | 2     |
| Drivers, .. . . .        | 2     |
| Farmers, .. . . .        | 5     |
| Foremen, . . . . .       | 1     |
| Glassblowers, .. . . .   | 1     |
| Housekeepers, . . . . .  | 1     |
| Lumber dealers, .. . . . | 1     |
| Printers, .. . . .       | 2     |
| Plasterers, .. . . .     | 1     |
| Waiters, . . . . .       | 2     |
| Children, .. . . .       | 16    |
|                          | ===== |

The average cost per week for each patient was, during 1894, \$7.49. Pay patients, other than those injured, are charged \$1.00 per day.

TABLE No. 1.—Showing location, etc., of collieries in the Ninth Bituminous Mine District.

| Name of Colliery.  | Name of Operator.                   | Location--County. | Name of Superintendent. | Postoffice Address.             |
|--------------------|-------------------------------------|-------------------|-------------------------|---------------------------------|
| Adelaide.          | H. C. Frick Coke Company.           | Fayette.          | R. O. Thomas.           | Adelaide, Fayette county.       |
| Amyville.          | Youghiogheny Gas Coal Company.      | Westmoreland.     | John W. Peters.         | Suterville, Westmoreland Co.    |
| Boston No. 1.      | W. H. Brown & Sons.                 | Allegheny.        | James A. Dewar.         | Boston, Allegheny county.       |
| Boston No. 2.      | W. H. Brown & Sons.                 | Allegheny.        | James A. Dewar.         | Boston, Allegheny county.       |
| B. and O.          | Clair, Stillwagon & Co.             | Fayette.          | Clair Stillwagon.       | Connellsville, Fayette county.  |
| Banning.           | Morgan Moore & Bane Co.             | Fayette.          | J. Baysinger.           | West Newton, Westmoreland Co.   |
| Belle Bridge.      | Belle Bridge Coal Company.          | Allegheny.        | W. M. Fellaborn.        | Belle Bridge, Allegheny county. |
| Big Chief.         | John Blyth & Co.                    | Westmoreland.     | James Dumphy.           | Stauffer's, Westmoreland Co.    |
| Buckeye.           | McClure Coke Company.               | Westmoreland.     | James Devlin.           | Mt. Pleasant, Westmoreland Co.  |
| Bessemer.          | McClure Coke Company.               | Westmoreland.     | M. F. Picard.           | Connellsville, Fayette county.  |
| Coal Brook.        | McClure Coke Company.               | Fayette.          | John I. Munson.         | Connellsville, Fayette county.  |
| Dixson shaft.      | H. C. Frick Coke Company.           | Fayette.          | S. R. Fairchild.        | Scottdale, Westmoreland county. |
| Dexter.            | Joseph T. Stouffer & Co.            | Fayette.          | N. A. Kerr.             | Alverton, Westmoreland Co.      |
| Donnelly.          | McClure Coke Company.               | Westmoreland.     | A. W. Osborne.          | West Newton, Westmoreland Co.   |
| Dart.              | Osborn, Stager & Co.                | Westmoreland.     | Thomas Whiteman.        | Frank, Allegheny county.        |
| Dillworth.         | Wm. P. Dillworth & Co.              | Westmoreland.     | C. H. Wisser.           | Robbins, Westmoreland county.   |
| Dravo.             | Lake Shore Gas Coal Company.        | Allegheny.        | William McCune.         | West Newton, Westmoreland Co.   |
| Eureka.            | Eureka Coal Company.                | Westmoreland.     | J. W. Overholt.         | Scottdale, Westmoreland Co.     |
| Emma.              | J. W. Overholt & Co.                | Westmoreland.     | James A. Watkins.       | Fitzhenry, Westmoreland Co.     |
| Euclid.            | Ohio and Pennsylvania Coal Company. | Westmoreland.     | J. P. Brennan.          | Scottdale, Westmoreland county. |
| Enterprise.        | McClure Coke Company.               | Westmoreland.     | James Lynch.            | Scottdale, Westmoreland county. |
| Fountainb.         | H. C. Frick Coke Company.           | Fayette.          | R. F. Keiser.           | Summit, Westmoreland county.    |
| Franklin.          | E. F. Keiser.                       | Fayette.          | Thomas J. Mitchell.     | Vanderbilt, Fayette county.     |
| Fort Hill.         | W. J. Rainey.                       | Fayette.          | John Simpson.           | Vanderbilt, Westmoreland Co.    |
| Forrest Hill.      | Jas. W. Ellsworth.                  | Allegheny.        | Thomas J. Mitchell.     | Vanderbilt, Fayette county.     |
| Grace.             | W. J. Rainey.                       | Fayette.          | J. P. Hosack.           | Scott Haven, Westmoreland Co.   |
| Guffey.            | Youghiogheny River Coal Company.    | Westmoreland.     | J. P. Brennan.          | Scottdale, Westmoreland county. |
| Hazlet.            | McClure Coke Company.               | Westmoreland.     | Willie Kullen.          | Brood Ford, Fayette county.     |
| Henry Clay.        | H. C. Frick Coke Company.           | Fayette.          | Wm. R. Kullen.          | Elizabeth, Allegheny county.    |
| Horne & Roberts.   | Horne & Roberts Coal Co.            | Allegheny.        | H. D. O'Neil.           | Elizabeth, Allegheny county.    |
| H. D. O'Neil.      | H. D. O'Neil.                       | Allegheny.        | H. D. O'Neil.           | Everson, Fayette county.        |
| Home.              | Stouffer & Wylie.                   | Fayette.          | P. J. Cochran.          | Dayson, Fayette county.         |
| Jackson.           | James Cochran.                      | Fayette.          | George Gray.            | Elizabeth, Allegheny county.    |
| Lovelsale.         | John A. Wood & Son.                 | Allegheny.        | Thomas J. Mitchell.     | Vanderbilt, Fayette county.     |
| Moredland slope.   | W. J. Rainey.                       | Fayette.          | Frank Pickard.          | Stouffer's, Westmoreland Co.    |
| Mullen.            | McClure Coke Company.               | Westmoreland.     | N. A. Kerr.             | Brood Ford, Fayette county.     |
| Mayfield.          | McClure Coke Company.               | Westmoreland.     | William Mullen.         | Scott Haven, Westmoreland Co.   |
| Morgan.            | H. C. Frick Coke Company.           | Fayette.          | J. F. Hosack.           | Scott Haven, Westmoreland Co.   |
| Ocean No. 1.       | Youghiogheny River Coal Company.    | Westmoreland.     | J. F. Hosack.           | Scott Haven, Westmoreland Co.   |
| Ocean No. 2.       | Youghiogheny River Coal Company.    | Allegheny.        | J. F. Hosack.           | Scott Haven, Westmoreland Co.   |
| Ocean No. 3.       | Youghiogheny River Coal Company.    | Allegheny.        | J. F. Hosack.           | Scott Haven, Westmoreland Co.   |
| Ocean No. 4.       | Youghiogheny River Coal Company.    | Allegheny.        | James W. Shields.       | Emblem, Allegheny county.       |
| Ocean No. 5.       | Oceola Coal Company.                | Allegheny.        | J. F. Hosack.           | Scott Haven, Westmoreland Co.   |
| Oceola.            | Youghiogheny River Coal Company.    | Allegheny.        | Frank Cornell.          | Buena Vista, Allegheny county.  |
| Pacific.           | Youghiogheny River Coal Company.    | Allegheny.        | Frank Cornell.          | Buena Vista, Allegheny county.  |
| Painter & Cornell. | J. W. Painter Coal Company.         | Allegheny.        | Frank Cornell.          | Buena Vista, Allegheny county.  |

TABLE No. 1.—Continued.

| Name of Colliery.         | Name of Operator.                 | Location--County. | Name of Superintendent. | Postoffice Address.            |
|---------------------------|-----------------------------------|-------------------|-------------------------|--------------------------------|
| Port Royal.               | Port Royal Coke and Coal Company. | Westmoreland.     | W. Shilling.            | Flitzheny, Westmoreland Co.    |
| Plumer.                   | H. C. Frick Coke Company.         | Fayette.          | John I. Munson.         | Connellsville, Fayette county. |
| Pennsville.               | L. D. Sherrick & Co.              | Fayette.          | John D. Sherrick.       | Pennsville, Fayette county.    |
| Painter.                  | McCure Coke Company.              | Fayette.          | H. C. Culler.           | Scottsde, Westmoreland county. |
| Rainbow.                  | Rainbow Coal Company.             | Fayette.          | A. W. Osborne.          | West Newton, Westmoreland Co.  |
| Rist.                     | H. C. Frick Coke Company.         | Fayette.          | Wm. Mullin.             | Broad Ford, Fayette county.    |
| Rising Sun.               | McCure Coke Company.              | Westmoreland.     | James Devlin.           | McCleasant, Westmoreland Co.   |
| South West.               | Youghiogheny River Coal Company.  | Allegheny.        | Thomas Hall.            | Scottsdeven, Westmoreland Co.  |
| Sarah.                    | Youghiogheny Coal Company.        | Allegheny.        | Thomas Hall.            | Sureville, Westmoreland Co.    |
| Shavers No. 1.            | Criterion Coal Company.           | Westmoreland.     | Reuben Street.          | Youghiogheny, Westmoreland Co. |
| Smithton No. 1.           |                                   |                   |                         |                                |
| Smithton No. 2.           |                                   |                   |                         |                                |
| Scottsde Iron & Steel Co. | A. S. Livengood.                  | Fayette.          | A. S. Livengood.        | Everson, Fayette county.       |
| Sterling No. 1.           | H. C. Frick Coke Company.         | Fayette.          | George Rosser.          | Dawson, Fayette county.        |
| Sterling No. 2.           | H. C. Frick Coke Company.         | Fayette.          | George Rosser.          | Dawson, Fayette county.        |
| Summit.                   | H. C. Frick Coke Company.         | Fayette.          | C. A. Warpeck.          | Summit Mines, Fayette county.  |
| Top Top.                  | H. C. Frick Coke Company.         | Fayette.          | James Lynch.            | Scottsde, Fayette county.      |
| Valley.                   | Laughlin & Co. Limited.           | Fayette.          | Clifton Wharton.        | Scottsde, Fayette Co.          |
| Valley.                   | H. C. Frick Coke Company.         | Fayette.          | James Lynch.            | Valley Mines, Fayette county.  |
| White.                    | H. C. Frick Coke Company.         | Fayette.          | William Mullen.         | Broad Ford, Fayette county.    |
| White Haven.              | Laughlin Mining Company.          | Fayette.          | Edith Morrison.         | Lanning, Fayette county.       |
| West Overton.             | H. C. Frick Coke Company.         | Westmoreland.     | E. P. Ombolt.           | West Overton, Westmoreland Co. |
| West Newton.              | Gilbourne Sawyer & Co.            | Westmoreland.     | W. T. Allison.          | West Newton, Westmoreland Co.  |
| Yough slope.              | Yough Slope Gas Coal Company.     | Westmoreland.     | Alex. Moreland.         | West Newton, Westmoreland Co.  |





TABLE No. 2—Continued.

| Names of Collieries. | Location.     | Total production in | Total production in | Total shipment in tons | Number days worked. | Number persons employed. | Number fatal accidents. | Number non-fatal accidents. | Number kegs powder used. | Number steam boilers. | Number horses and mules. | Number mine locomotives. | Number coke ovens. |
|----------------------|---------------|---------------------|---------------------|------------------------|---------------------|--------------------------|-------------------------|-----------------------------|--------------------------|-----------------------|--------------------------|--------------------------|--------------------|
|                      |               | tons of coal.       | tons of coke.       | of coal.               |                     |                          |                         |                             |                          |                       |                          |                          |                    |
| Mayfield.            | Westmoreland. | 25,131              | 16,754              | .....                  | 197                 | 49                       | .....                   | .....                       | 25                       | 1                     | 5                        | .....                    | 104                |
| Morgan.              | Fayette.      | 10,618              | 7,964               | .....                  | 74                  | 21                       | .....                   | .....                       | 145                      | .....                 | 17                       | .....                    | 26                 |
| Ocean No. 1.         | Westmoreland. | 106,877             | 106,877             | 106,877                | 147                 | 198                      | .....                   | .....                       | .....                    | .....                 | .....                    | .....                    | .....              |
| Ocean No. 2.         | Allegheny.    | 198,587             | .....               | 198,587                | 182                 | 358                      | 1                       | .....                       | .....                    | .....                 | .....                    | .....                    | .....              |
| Ocean No. 3.         | Allegheny.    | 60,224              | .....               | 60,224                 | 80                  | 263                      | .....                   | .....                       | 100                      | 2                     | 20                       | .....                    | .....              |
| Ocean No. 4.         | Allegheny.    | 109,283             | .....               | 109,283                | 169                 | 252                      | .....                   | .....                       | 225                      | .....                 | .....                    | .....                    | .....              |
| Ocean No. 5.         | Allegheny.    | 92,980              | .....               | 92,980                 | 135                 | 142                      | .....                   | .....                       | 100                      | 2                     | 11                       | .....                    | .....              |
| Ocean No. 6.         | Allegheny.    | 114,952             | .....               | 114,952                | 191                 | 228                      | .....                   | .....                       | 230                      | .....                 | .....                    | .....                    | .....              |
| Pacific.             | Allegheny.    | 59,820              | .....               | 59,820                 | 126                 | 132                      | .....                   | .....                       | 30                       | .....                 | .....                    | .....                    | .....              |
| Palmer & Cornell.    | Allegheny.    | 59,820              | .....               | 59,820                 | 126                 | 132                      | .....                   | .....                       | 30                       | .....                 | .....                    | .....                    | .....              |
| Port Royal.          | Westmoreland. | 138,200             | 5,931               | 130,269                | 206                 | 244                      | 2                       | 4                           | 822                      | 14                    | 13                       | 1                        | 60                 |
| Pumet.               | Fayette.      | 30,700              | 23,025              | .....                  | 167                 | 68                       | .....                   | .....                       | 87                       | .....                 | .....                    | .....                    | .....              |
| Pennsville.          | Fayette.      | 135,000             | 90,000              | .....                  | 287                 | 70                       | .....                   | .....                       | 150                      | 1                     | 12                       | .....                    | .....              |
| Rainier.             | Fayette.      | 42,864              | .....               | 42,864                 | 110                 | 126                      | .....                   | .....                       | 500                      | 2                     | 5                        | .....                    | .....              |
| Rainbow.             | Fayette.      | 160,148             | .....               | 160,148                | 233                 | 244                      | .....                   | .....                       | 365                      | 4                     | 17                       | .....                    | .....              |
| Risc.                | Fayette.      | .....               | .....               | .....                  | .....               | .....                    | .....                   | .....                       | .....                    | .....                 | .....                    | .....                    | .....              |
| Rising Sun.          | Westmoreland. | 7,584               | .....               | 7,584                  | 100                 | 40                       | .....                   | .....                       | 20                       | .....                 | .....                    | .....                    | .....              |
| Sarah.               | Allegheny.    | 24,867              | .....               | 24,867                 | 269                 | 30                       | .....                   | .....                       | 20                       | 1                     | 5                        | .....                    | .....              |
| Scottdale.           | Fayette.      | 71,205              | .....               | 71,205                 | 165                 | 178                      | .....                   | .....                       | 30                       | 2                     | 11                       | .....                    | .....              |
| Shaners No. 1.       | Westmoreland. | 6,100               | .....               | 6,100                  | 27                  | 151                      | .....                   | .....                       | 50                       | .....                 | .....                    | .....                    | .....              |
| Shaners No. 2.       | Westmoreland. | 11,594              | .....               | 11,594                 | 60                  | 111                      | .....                   | .....                       | .....                    | .....                 | .....                    | .....                    | .....              |
| Smithton No. 1.      | Fayette.      | 32,540              | .....               | 32,540                 | 127                 | 152                      | .....                   | .....                       | 150                      | 3                     | 19                       | .....                    | 294                |
| Smithton No. 2.      | Fayette.      | 129,600             | .....               | 129,600                | 256                 | 172                      | .....                   | .....                       | 50                       | 1                     | 12                       | .....                    | 222                |
| Sterling No. 1.      | Fayette.      | 111,100             | .....               | 111,100                | 202                 | 108                      | .....                   | .....                       | 300                      | 1                     | 8                        | .....                    | 141                |
| Sterling No. 2.      | Fayette.      | 16,865              | .....               | 16,865                 | 70                  | 92                       | .....                   | .....                       | .....                    | .....                 | .....                    | .....                    | .....              |
| Summit.              | Fayette.      | 10,000              | .....               | 10,000                 | .....               | .....                    | .....                   | .....                       | .....                    | .....                 | .....                    | .....                    | .....              |
| Tyone.               | Fayette.      | 18,721              | .....               | 18,721                 | 388                 | 47                       | .....                   | .....                       | 700                      | 1                     | 13                       | .....                    | 288                |
| Tulp Top.            | Westmoreland. | 192,287             | .....               | 192,287                | 288                 | 228                      | .....                   | .....                       | .....                    | .....                 | .....                    | .....                    | .....              |
| Union.               | Fayette.      | 65,414              | .....               | 65,414                 | 310                 | 78                       | .....                   | .....                       | .....                    | .....                 | .....                    | .....                    | .....              |
| Valley.              | Westmoreland. | 74,376              | .....               | 74,376                 | 103                 | 240                      | .....                   | .....                       | 60                       | 2                     | 9                        | .....                    | .....              |
| West Overton.        | Westmoreland. | 69,288              | .....               | 69,288                 | 223                 | 81                       | .....                   | .....                       | .....                    | .....                 | .....                    | .....                    | .....              |
| West Newton.         | Westmoreland. | 59,304              | .....               | 59,304                 | 148                 | 148                      | .....                   | .....                       | .....                    | .....                 | .....                    | .....                    | .....              |
| Wick Haven.          | Fayette.      | .....               | .....               | .....                  | .....               | .....                    | .....                   | .....                       | .....                    | .....                 | .....                    | .....                    | .....              |
| White.               | Fayette.      | 28,654              | .....               | 28,654                 | 129                 | 129                      | .....                   | .....                       | .....                    | .....                 | .....                    | .....                    | .....              |
| Yough slope.         | Westmoreland. | .....               | .....               | .....                  | .....               | .....                    | .....                   | .....                       | .....                    | .....                 | .....                    | .....                    | .....              |
| Totals.              | .....         | 4,690,811           | 1,473,982           | 2,625,335              | 10,452              | 9,270                    | 11                      | 40                          | 11,145                   | 132                   | 553                      | 20                       | 5,028              |



TABLE No. 3.—Continued.

| Names of Collieries.         | Location.            | Occupations of Persons Employed Inside. |         |                   |                  |                      |                       |               | Occupations of Persons Employed Outside. |                             |                        |                |                  |  |                | Grand totals—inside and outside. |
|------------------------------|----------------------|---|---------|-------------------|------------------|----------------------|-----------------------|---------------|--|-----------------------------|------------------------|----------------|------------------|--|----------------|----------------------------------|
|                              |                      | Inside foreman or mine boss.            | Miners. | Miners' laborers. | All company men. | Drivers and runners. | Doorboys and helpers. | Total inside. | Outside foreman.                         | Blacksmiths and carpenters. | Engineers and firemen. | State pickers. | All company men. | Superintendent, book-keepers and clerks. | Total Outside. |                                  |
| Mullen.                      | Westmoreland county. | 1                                       | 30      | .....             | 5                | 3                    | .....                 | 30            | .....                                    | 1                           | 1                      | 18             | 6                | 1  | 27             | 66                               |
| Mayfield.                    | Westmoreland county. | 1                                       | 21      | 1                 | 2                | 4                    | 1                     | 29            | .....                                    | .....                       | .....                  | 16             | 3                | 1  | 20             | 49                               |
| Morgan.                      | Fayette county.      | 1                                       | 12      | .....             | 2                | 2                    | .....                 | 17            | .....                                    | .....                       | .....                  | .....          | .....            | 2  | 4              | 21                               |
| Ocean No. 1.                 | Westmoreland county. | 1                                       | 150     | 12                | 18               | 18                   | 2                     | 186           | .....                                    | .....                       | .....                  | .....          | .....            | 2  | 12             | 198                              |
| Ocean No. 2.                 | Allegheny county.    | 1                                       | 283     | 23                | 32               | 18                   | 12                    | 339           | .....                                    | .....                       | .....                  | .....          | .....            | 1  | 19             | 358                              |
| Ocean No. 3.                 | Allegheny county.    | 1                                       | 296     | 12                | 30               | 12                   | 12                    | 350           | 1  | .....                       | .....                  | .....          | .....            | .....                                    | 13             | 263                              |
| Ocean No. 5.                 | Allegheny county.    | 1                                       | 296     | 12                | 6                | 12                   | 6                     | 328           | .....                                    | .....                       | .....                  | .....          | .....            | .....                                    | 1              | 252                              |
| Oscoda.                      | Allegheny county.    | 1                                       | 110     | 5                 | 10               | 10                   | .....                 | 128           | .....                                    | .....                       | .....                  | .....          | .....            | .....                                    | 1              | 142                              |
| Pacific.                     | Allegheny county.    | 1                                       | 175     | 15                | 11               | 12                   | 2                     | 216           | .....                                    | .....                       | .....                  | .....          | .....            | .....                                    | 1              | 228                              |
| Painter & Cornell.           | Allegheny county.    | 1                                       | 110     | 5                 | 11               | 12                   | 2                     | 141           | .....                                    | .....                       | .....                  | .....          | .....            | .....                                    | 1              | 132                              |
| Port Royal.                  | Westmoreland county. | 1                                       | 167     | 3                 | 18               | 7                    | 1                     | 208           | .....                                    | .....                       | .....                  | .....          | .....            | .....                                    | 1              | 244                              |
| Plumer.                      | Westmoreland county. | 1                                       | 54      | .....             | 2                | 1                    | .....                 | 64            | .....                                    | .....                       | .....                  | .....          | .....            | .....                                    | 2              | 68                               |
| Pennsylvania.                | Fayette county.      | 1                                       | 30      | .....             | 2                | 1                    | .....                 | 37            | .....                                    | .....                       | .....                  | .....          | .....            | .....                                    | 3              | 70                               |
| Painter.                     | Fayette county.      | 1                                       | 84      | 3                 | 1                | 12                   | .....                 | 102           | .....                                    | .....                       | .....                  | .....          | .....            | .....                                    | 3              | 89                               |
| Rainbow.                     | Fayette county.      | 1                                       | 160     | 2                 | 8                | 1                    | 2                     | 171           | .....                                    | .....                       | .....                  | .....          | .....            | .....                                    | 4              | 126                              |
| Rust.                        | Fayette county.      | 1                                       | 197     | .....             | 6                | 16                   | 1                     | 211           | .....                                    | .....                       | .....                  | .....          | .....            | .....                                    | 1              | 244                              |
| Rising Sun.                  | Westmoreland county. | 1                                       | 131     | .....             | 6                | 16                   | 1                     | 155           | .....                                    | .....                       | .....                  | .....          | .....            | .....                                    | 5              | 244                              |
| Sarah.                       | Westmoreland county. | 1                                       | 30      | 2                 | 2                | 1                    | .....                 | 35            | .....                                    | .....                       | .....                  | .....          | .....            | .....                                    | 3              | 40                               |
| Scottdale Iron and Steel Co. | Fayette county.      | 1                                       | 18      | 1                 | 4                | 1                    | .....                 | 24            | .....                                    | .....                       | .....                  | .....          | .....            | .....                                    | 2              | 30                               |
| Smithton No. 2.              | Westmoreland county. | 1                                       | 125     | 3                 | 7                | .....                | .....                 | 135           | .....                                    | .....                       | .....                  | .....          | .....            | .....                                    | 2              | 151                              |
| Shamers No. 2.               | Westmoreland county. | 1                                       | 144     | 3                 | 10               | 3                    | .....                 | 160           | .....                                    | .....                       | .....                  | .....          | .....            | .....                                    | 2              | 178                              |
| Sterling No. 1.              | Fayette county.      | 1                                       | 26      | .....             | 2                | 30                   | .....                 | 56            | .....                                    | .....                       | .....                  | .....          | .....            | .....                                    | 10             | 61                               |
| Sterling No. 2.              | Fayette county.      | 1                                       | 64      | .....             | 2                | 18                   | 3                     | 87            | .....                                    | .....                       | .....                  | .....          | .....            | .....                                    | 12             | 111                              |
| Summit.                      | Fayette county.      | 1                                       | 65      | .....             | 2                | 10                   | .....                 | 82            | .....                                    | .....                       | .....                  | .....          | .....            | .....                                    | 3              | 63                               |
| Tub Top.                     | Fayette county.      | 1                                       | 40      | .....             | 2                | 2                    | .....                 | 50            | .....                                    | .....                       | .....                  | .....          | .....            | .....                                    | 7              | 172                              |
| Tyrone.                      | Fayette county.      | 1                                       | 44      | 2                 | 10               | 7                    | 2                     | 67            | .....                                    | .....                       | .....                  | .....          | .....            | .....                                    | 6              | 92                               |
| Union.                       | Westmoreland county. | 1                                       | 22      | .....             | 1                | 4                    | .....                 | 27            | .....                                    | .....                       | .....                  | .....          | .....            | .....                                    | 2              | 41                               |
| Valley.                      | Fayette county.      | 1                                       | 94      | .....             | 7                | 12                   | 7                     | 121           | .....                                    | .....                       | .....                  | .....          | .....            | .....                                    | 3              | 118                              |
| White.                       | Fayette county.      | 1                                       | 60      | .....             | 3                | 10                   | .....                 | 74            | .....                                    | .....                       | .....                  | .....          | .....            | .....                                    | 18             | 148                              |
| Wick Haven.                  | Fayette county.      | 1                                       | 60      | .....             | 4                | 3                    | .....                 | 69            | .....                                    | .....                       | .....                  | .....          | .....            | .....                                    | 7              | 148                              |
| West Overton.                | Westmoreland county. | 1                                       | 38      | .....             | 4                | 4                    | .....                 | 45            | .....                                    | .....                       | .....                  | .....          | .....            | .....                                    | 6              | 81                               |
| West Newton.                 | Westmoreland county. | 1                                       | 200     | .....             | 8                | 8                    | .....                 | 216           | .....                                    | .....                       | .....                  | .....          | .....            | .....                                    | 3              | 240                              |
| Yough slope.                 | Westmoreland county. | 1                                       | 105     | .....             | 4                | 5                    | 2                     | 117           | .....                                    | .....                       | .....                  | .....          | .....            | .....                                    | 9              | 126                              |
| Totals.                      | .....                | 60                                      | 5,922   | 227               | 288              | 512                  | 89                    | 7,098         | 11                                       | 106                         | 111                    | 469            | 98               | 2,112                                    | 9,207          |                                  |

TABLE NO. 4.—List of fatal accidents that occurred in and about the mines of the Ninth Bituminous Mine District for the year ending December 31, 1894.

| Date of accident. | Name of Person.  | Occupation.     | Age. | Widow. | Number of orphans. | Name of Colliery.          | Location—County.        | Nature and Cause of Accident.  |
|-------------------|------------------|-----------------|------|--------|--------------------|----------------------------|-------------------------|--|
| Jan. 16,          | John Steve,      | Miner,          | 30   | S.     | ....               | Port Royal,                | Westmoreland,           | Instantly killed by a fall of coal while undermining it.   |
| Feb. 16,          | Henry Bartoff,   | Miner,          | 54   | M.     | 3                  | Eureka,                    | Westmoreland,           | Fatally injured by slate falling on him while pushing a post from under it.  |
| Aug. 1,           | William Norton,  | Boy not empl'd. | 17   | S.     | ....               | Scottdale Iron & Steel Co. | Fayette,                | Killed by being caught between rib and loaded trip of wagons.  |
| 8,                | James H. Martin, | Miner,          | 36   | M.     | ....               | Summit,                    | Fayette,                | Instantly killed by a fall of top rock.  |
| 14,               | John Blasko,     | Miner,          | 40   | M.     | 4                  | Darr,                      | Vanmeter, Westmorel'd,  | While undermining coal a piece of about one ton weight fell on him, killing him instantly.   |
| Sept. 5,          | George Twigg,    | Miner,          | 37   | S.     | ....               | Ocean No. 2,               | Scott Haven, Allegheny. | In taking out posts from under the slate it fell on him, killing him instantly.  |
| Oct. 3,           | Jacob Adams,     | Miner,          | 35   | M.     | 2                  | Davidson shaft,            | Connellsville, Fayette, | Killed by a fall of roof while drawing out posts in a rib.   |
| 27,               | John Brown,      | Miner,          | 47   | M.     | 5                  | Valley mine,               | Everson, Fayette,       | When in the act of drawing out a post the roof fell and knocked the post against him with such force that he died in a short time. |
| 29,               | Jacob Matson,    | Miner,          | 30   | S.     | ....               | Port Royal,                | Fitzhenry, Westmorel'd, | Was injured by a fall of slate in his room and died the following morning.   |
| Dec. 8,           | Lewis Krenter,   | Miner,          | 31   | M.     | 3                  | Smithton,                  | Smithton, Westmoreland  | Was injured by a piece of slate falling on him; died the same day.   |
| 29,               | Mike Mauraskie,  | Miner,          | 34   | M.     | 5                  | Painter,                   | McClures, Westmorel'd,  | Was caught by locomotive trip of loaded wagons while going through a tunnel homewards after his day's work.                        |

TABLE No. 5.—List of non-fatal accidents that occurred in and about the mines of the Ninth Bituminous Mine District for the year ending December 31, 1894.

| Date of accident. | Name of Person.        | Occupation.    | Age. | Married. | Number of children. | Name of Colliery.     | Location—County.                     | Nature and Cause of Accident.   |
|-------------------|------------------------|----------------|------|----------|---------------------|-----------------------|--------------------------------------|---|
|                   |                        |                |      |          |                     |                       |                                      |   |
| Jan. 5,           | Charles Verish, .....  | Miner, .....   | 30   |          |                     | Darr, .....           | Westmoreland county, .....           | Leg and arm broken by fall of coal and slate.   |
| 16,               | John Jones, .....      | Miner, .....   |      |          |                     | Forest Hill, .....    | Allegheny county, .....              | Hurt on back by slate falling on him.   |
| Feb. 9,           | Roy Duggan, .....      | Trapper, ..... | 17   |          |                     | Moreland slope, ..... | Fayette county, .....                | Hurt badly by trip of wagons.   |
| March 16,         | Thomas Ashton, ....    | Miner, .....   | 53   | M.       |                     | Belle Bridge, .....   | Allegheny county, .....              | Hurt on the body by a fall of slate in heading.   |
| 8,                | Evan Howells, .....    | Driver, .....  | 20   | S.       |                     | Ocean No. 2, .....    | Scott Haven, Allegheny county, ..... | Leg broken by being run into by another driver.   |
| April 4,          | George Coanas, .....   | Driver, .....  | 22   | S.       |                     | Adelaide, .....       | Fayette county, .....                | Arm broken by wagon jamming him against the ribs.   |
| 12,               | Andrew Gotheart, ....  | Miner, .....   | 33   | M.       |                     | Banning, .....        | Fayette county, .....                | Leg broken, necessitating amputation, by a fall of slate.                                 |
| 19,               | Frank Carlison, .....  | Miner, .....   | 22   | S.       |                     | Forest Hill, .....    | Allegheny county, .....              | Leg broken by fall of slate.  |
| May 2,            | Andy Conock, .....     | Miner, .....   | 46   | M.       |                     | Grace, .....          | Fayette county, .....                | Burned on face and hands by powder.   |
| 2,                | John Sturkovich, ..... | Miner, .....   | 45   | S.       |                     | Grace, .....          | Fayette county, .....                | Burned on hands and face by powder. These two men were tampering a shot when it exploded. |
| July 2,           | Louis Tomse, .....     | Miner, .....   | 28   | S.       |                     | Ocean No. 4, .....    | Ruena Vista, Allegheny county, ..... | Burned by explosive gas.  |
| 5,                | Fred Matze, .....      | Miner, .....   | 24   | S.       |                     | Ocean No. 2, .....    | Scott Haven, Allegheny county, ..... | Leg broken by a fall of slate.  |
| 6,                | John Falkner, .....    | Miner, .....   | 30   | S.       |                     | Ocean No. 4, .....    | Ruena Vista, Allegheny county, ..... | Burned on hands and face by gas.  |
| 10,               | John Hill, .....       | Miner, .....   | 33   | M.       | 3                   | Euclid, .....         | Smithton, Westmoreland county, ..... | Burned by powder cartridge exploding while he was ramming it in hole.                     |
| 23,               | Patrick Ryan, .....    | Driver, .....  | 26   | M.       |                     | Forest Hill, .....    | Saterville, Allegheny county, .....  | Was caught by a chain on mule, bruising his leg very badly.                               |
| Aug. 4,           | John Ribby, .....      | Miner, .....   | 33   | M.       |                     | Rainbow, .....        | Whittset, Fayette county, .....      | Leg broken by a fall of slate.  |
| 7,                | Vick Shamer, .....     | Miner, .....   | 28   | S.       |                     | Brown's No. 2, .....  | Boston, Allegheny county, .....      | Burned on face and hands by explosive gas in front past the danger signal                 |
| 14,               | Andy Tomlin, .....     | Miner, .....   | 27   |          |                     | Darr, .....           | Van-Meter, Westmoreland Co., .....   | Leg broken by a fall of slate.  |
| 26,               | Robert Acton, .....    | Miner, .....   | 30   | M.       |                     | Ocean No. 2, .....    | Scott Haven, Allegheny county, ..... | Three fingers badly bruised by coal fall-<br>ing on him.                                  |
| 27,               | Andy Kosloski, .....   | Miner, .....   | 29   | M.       |                     | Eureka, .....         | Eureka, Westmoreland county, .....   | Ankle broken by roof coal while driv-<br>ing out posts.                                   |

|      |                    |         |    |    |                 |                                |   |
|------|--------------------|---------|----|----|-----------------|--------------------------------|---|
| 23,  | Sol Green,         | Driver, | 21 | S. | Grace,          | Moyer, Fayette county,         | Crushed between loaded wagon and rib.   |
| 24,  | Steve Soallge,     | Miner,  | 35 | S. | Grace,          | Moyer, Fayette county,         | In running away from a shot he fell and before he could get away the shot went off, mashing his arm below the shoulder. |
| 24,  | Henry Lane,        | Driver, | 24 | S. | Forest Hill,    | Suterville, Allegheny county,  | Arm broken between empty wagon and rib side.  |
| 30,  | John Kover,        | Miner,  | 40 | S. | Forest Hill,    | Suterville, Allegheny county,  | Leg badly bruised by a fall of slate.   |
| 5,   | Mike Seager,       | Miner,  | 21 | S. | Darr,           | Van-Meter, Westmoreland Co.,   | A fall of roof coal, while driving out posts, bruised him on body.  |
| 5,   | Patrick Monaghan,  | Miner,  | 33 | M. | Port Royal,     | Fitzhenry, Westmoreland Co.,   | Collar bone broken by a fall of coal.   |
| 14,  | George Schrie,     | Miner,  | 33 | M. | Port Royal,     | Fitzhenry, Westmoreland Co.,   | Injured on the back by a shot going off while he was too close to it.   |
| 27,  | Joseph Dowden,     | Miner,  | 50 | M. | Euclid,         | Fitzhenry, Westmoreland Co.,   | Foot mashed badly by a fall of slate, necessitating amputation.   |
| 28,  | Charles Buckaskie, | Miner,  | 32 | M. | Port Royal,     | Fitzhenry, Westmoreland Co.,   | Hurt on the body by a fall of slate.  |
| 5,   | Steve Yardboskle,  | Miner,  | 23 | M. | Ocean No. 1,    | Scott Haven, Westmoreland Co., | Leg broken by slate falling on him.   |
| 15,  | William Davidson,  | Miner,  | 43 | M. | H. D. O'Neil,   | Elizabeth, Allegheny county,   | Both legs broken by slate falling and knocking a post on him.   |
| 15,  | Andrew Synbro,     | Miner,  | 24 | S. | Wick Haven,     | Banning, Fayette county,       | Thigh broken by slate falling on him, necessitating amputation.   |
| 17,  | Ertynol Abelde,    | Miner,  | 26 | S. | Shaners' No. 2, | Shaners', Westmoreland county, | Burned by explosive gas in No. 10 entry.  |
| 17,  | Ertynol Ovicha,    | Miner,  | 17 | S. | Shaners' No. 2, | Shaners', Westmoreland county, | Burned on face and hands by explosive gas.  |
| 17,  | Lawrence Ovicha,   | Miner,  | 22 | S. | Shaners' No. 2, | Shaners', Westmoreland county, | Burned on face and hands by explosive gas.  |
| 17,  | Luviga Zinka,      | Miner,  | 32 | S. | Shaners' No. 2, | Shaners', Westmoreland county, | Burned on face and hands by explosive gas.  |
| Nov. | Alex Deebeis,      | Miner,  | 30 | S. | Darr,           | Van-Meter, Westmoreland Co.,   | Burned on body, hands and face by explosive gas. Exposed himself to cold at hospital, took pneumonia and died.          |
| 5,   | John Pochermoska,  | Miner,  | 40 | M. | Eureka,         | Eureka, Westmoreland county,   | Slightly burned on top of the head by explosive gas.  |
| 12,  | Tony Budman,       | Driver, | 23 | S. | Moreland shaft, | Fayette county,                | Face and neck badly burned by a blown out shot in his room.   |
| Dec. | George Tuebert,    | Miner,  | 44 | M. | Eureka,         | Westmoreland county,           | Collar bone broken by being caught between wagon and a room post.<br>Hand badly bruised by slate sliding from the gob.  |





# TENTH BITUMINOUS DISTRICT.

(HUNTINGDON, BEDFORD, FULTON AND BLAIR COUNTIES, AND THOSE PARTS OF CLEARFIELD, CAMBRIA AND INDIANA COUNTIES LYING ADJACENT TO THE BELLS GAP RAILROAD AND THE PARTS OF CLEARFIELD, CENTRE AND CLINTON COUNTIES, LYING ADJACENT TO THE MAIN LINE OF THE BEECH CREEK RAILROAD.)

---

Altoona, March 18, 1895.

Hon. Isaac B. Brown,

Secretary of Internal Affairs:

Sir: In compliance with the requirements of section 2, article 10 of the Bituminous Mine Law approved May 15th, 1893, I have the honor to submit my annual report for this district for the year 1894.

It will be noted that there is a great falling off in the tonnage of this district as compared with last year, also in the number of persons employed during the year. The production of coal was 1,882,629 tons as against 2,773,116 tons in 1893, showing a decrease for this year of 890,487 tons. The production of coke this year was 47,786 tons as against 224,181 in 1893, a decrease of 176,395 tons. The number of mines in the district is 68, and the number operated was 61. The total number of persons employed this year was 5,247 as against 5,697 in 1893. The number of fatal accidents this year was 2 as against 4 in 1893. The number of non-fatal accidents was 37 as against 31 in 1893. The average number of days worked this year was 111 as against 164 in 1893.

The past year was a disastrous one for both operators and miners, owing to the great strike that prevailed all over this part of the State, and other states also. The strike commenced April 21st and lasted for a period of from three to four months, and some of the operators are doing very little business yet, owing to their having lost what contracts they had, and there is no knowing when they will get them back again, while the earnings of the miner have never been so low as during the past year, and how they managed to live is indeed a great mystery. We trust, however, that we have seen the darkest days of the depression in the coal business, and that a revival will gradually take place, and operators be enabled to

realize a reasonable profit from the sale of their coal, and that the miner will get a price that will enable him to live in some degree of comfort.

A detailed description of each mine, and of the improvements made, whether of fan or furnace, will follow. One new mine was opened and one abandoned during the year, and if there is a revival in the coal business, there are several new operations that will be started, as they are only waiting for better times to come.

The following summary of the statistics sent to this office will show the tonnage, etc., during the year.

Summary of Statistics.

|  |           |
|--|-----------|
| Number of mines in the district, .....               | 68        |
| Number of mines operated during the year, .....      | 61        |
| Number of tons of coal mined, .....                  | 1,882,530 |
| Number of tons of coal shipped, .....                | 1,800,817 |
| Number of tons of coke produced, .....               | 47,786    |
| Number of persons employed inside, .....             | 4,749     |
| Number of persons employed outside, .....            | 498       |
| Total number employed, .....                         | 5,247     |
| Number of fatal accidents, .....                     | 2         |
| Number of non-fatal accidents, .....                 | 17        |
| Number of tons of coal per fatal accident, .....     | 941,265   |
| Number of tons of coal per non-fatal accident, ..... | 110,737   |
| Number of kegs of powder used, .....                 | 10,125    |
| Number of days worked during the year, .....         | 6,816     |
| Average number of days worked by each mine, .....    | 111 2-3   |

The usual tables follow.

R. HAMPSON,  
Inspector.

Condition of Mines.

Gazzam Mines. These mines are owned and operated by the Clearfield Bituminous Coal Corporation, and at present Mines No. 1 and 4 only are working. The coal at this place is very thin, ranging from one and a half feet to three feet in thickness, with a good slate roof over the vein.

No. 1 mine is a very extensive one as owing to the vein being thin a great deal of ground is gone over in the course of a year, and so a great number of headings are being driven all the time. The ventilation of the mine is produced by a large furnace, and the exhaust steam from a large pump is also used to help ventilate a portion of the mine. During the year the ventilation was good, and everything was well attended to.

No. 4 mine has never been a large producer, owing to the fact that they have encountered many difficulties in the way of dips and low coal, but during the past year they seem to have got into a good body of coal which is over three feet in thickness and they are more encouraged thereby. During the strike of last summer they blasted down the roof and made a new haulage way, and it has dispensed with the pumping that heretofore had to be done, and now the mine is in far better condition as regards ventilation and drainage than it was before.

O'Shanter Mines. These mines are two in number and are operated by Weaver and Ettla, but during the year they have not worked very much.

No. 1 mine is quite a long distance in, and the ventilation had grown weak, so during the year a new furnace was built on top of the hill and close to the present face of the workings, and the condition of the mine was very good as regards ventilation.

No. 2 mine was reopened during the year, and the drift and main heading were re-timbered and the furnace shaft overhauled and put in good condition, but at the time of my visit all the improvements were not completed, but the mine was in good condition as regards ventilation and drainage. The coal in these mines is a little over three feet in thickness with a band of cannel coal running from six inches to a foot in thickness next the roof.

Bloomington Mines. Mines are owned and operated by the Bloomington Mining Company, and they are the most extensive mines on this railroad. They are working the same vein as the O'Shanter mines, and the vein runs about the same thickness, with the same general characteristics as regards cannel coal and roof. No. 1 mine is worked out, and in No. 2 a few miners are pulling out the heading pillars. No. 3 mine is the most extensive mine, and their production when running full is about seven hundred tons per day. One part of the mine is ventilated by furnace, and as the headings are getting a long distance in, the condition is not as good in regard to ventilation as the part of the mine to the dip, which is ventilated by a fan. The general condition, however, is good, and as they are driving toward and expect to cut into the Keystone mine adjoining, it will improve the condition of that part of the mine materially, as it will very considerably shorten the distance the air current now has to travel.

No. 4 mine is not as large as No. 3 and their production runs from four to five hundred tons per day when running full. The mine is well ventilated, the same fan that ventilates part of No. 3 mine ventilates this mine, and the current is carried up to the face of the headings and the requisite number of splits used, so that each portion gets the requisite amount of air needed.

During the year they commenced work on a new slope, but the condition of trade was so poor that they have for the present abandoned it.

**Royal Slope.** This is a new slope put down during the year, and operated by O. Perry Jones & Co. The mine is well equipped with hauling machinery, and a Brazil fan has been put up for ventilation. The condition of the mine was only fair, as they had not yet got things in proper order, but with care and attention this will make a first class mine, and the management hope to make it one of the most extensive mines on this line of road, and there is nothing to hinder them, for they have a large body of coal to work and the vein is very regular, and runs a little over three feet in thickness.

**Kyler Mine.** Operated by R. C. Fishburn has worked very little during the past year. A new furnace has been built during the year and the ventilation and drainage of the mine are good.

**Harts Mine.** This is a small operation at Munson Station, operated by Thomas Hart, and has worked very little during the year. Visited it once and found a few miners at work. Ventilation and drainage are good.

**Douglas Slope.** This was formerly known as Lueder slope, but is now operated by A. O. Somerville, and has only worked a few days during the year. I had no chance to examine the mine as I could not find them at work.

**Kecks Mine.** This is operated by the Keck Coal Company, and they are working a vein of White Ash cannel coal which is a little over four feet in thickness with a very good slate roof. As only a few miners are employed and no powder is used, the mine was in a good sanitary condition, and the drainage was also good.

**Forest Mines.** These mines are two in number, and are operated by Jones & Walton and the vein is a little over three feet in thickness.

The condition of these mines is not very good, as there is a great deal of shooting done, the mine is in a more or less smoky condition, and as there are faults in the vein, it makes it difficult to drain the mine properly. There is a furnace in each of the mines, but the workings in No. 1 mine are getting quite a distance from the furnace, so that the ventilation at the face of the workings is weak. No. 2 mine is not as extensive as No. 1, but in this case the furnace is not very efficient owing to the shallowness of the shaft and so at the face of the headings the ventilation is weak. A great deal of new heading has been driven during the year, and the mine is capable of a good production if the state of trade warranted it.

**Somerville Mines.** Operated by Somerville and Buchanan, and at present there are two openings being worked. On my first visit the No. 4 mine was in a poor condition for ventilation, but on my subsequent visits the condition was much improved as they had driven

an opening to the outcrop near the face of the work, and as this shortened the distance of the air current, it made a great change in the ventilation of that part of the mine. They are now driving toward the outcrop in another part of the mine that lies to the dip, and the management intend to put down a shaft and use it both for ventilation and pumping, and as a steam pump will be needed, they will also put in a fan at the same time.

No. 6 mine is mostly confined to working out the heading pillars and a small quantity of coal next the outcrop, and the condition of this mine was good both for ventilation and drainage.

Peale Mines. These mines are known as Grass Flat, Pleasant Hill, Moravian, and Knox Run, and are operated by the Clearfield Bituminous Coal Corporation. Grass Flat is the most extensive mine, and its capacity is in the neighborhood of seven hundred tons per day. The coal is hauled out of the mines by the tail-rope system, and the ventilation is by means of a large furnace. The vein worked is the B vein and is a little over three feet in thickness with a small bone coal on top, and overlaid with a good slate roof. The ventilation has been good during the year, and it has been much improved by cutting into the workings of the Pleasant mine and thus considerably shortening the distance the air current had to travel, and bringing it near the face of the workings. The drainage of the mine is also good, as they keep a good water level driven along with the rest of the workings.

Pleasant Hill Mine. This mine is working the same vein as the preceding, and the ventilation is by means of a furnace, and as the mine is comparatively a new one, it is in a very good condition both as regards ventilation and drainage, and everything is well looked after.

Moravian Mine. Considerable work has been done in this mine by driving new headings, and the air current has been much improved by shortening the distance it had to travel, and the ventilation and drainage have been good during the year.

Knox Run. This mine was found in a good condition during the year, and the drainage is also good. A new opening is being put in and this will shorten the haul considerably, and will also improve the ventilation as the air current will come in near the face of the present workings.

Snow Shoe Mines. These mines are respectively Sugar Camp Nos. 1, 2 and 3, and Careytown mine, and are operated by the Lehigh Valley Coal Company.

Sugar Camp Nos. 1 and 2 were worked during the year, No. 3 having been closed on account of the depression in the coal business. At my first visit the mines were in poor condition, but on the subse-

quent visits they were found in good condition, the ventilation being well attended to. In the upper vein the work is getting narrowed down very much, and in a short time it will be confined mostly to pillar work.

There is a fine large furnace at this mine, and if this is well looked after there is ample ventilation for the number of miners employed. In the lower vein, which is about three feet in thickness, they have had considerable difficulty with a large dip, but they have now managed to drive a water level heading and have dispensed with the pumping that heretofore was necessary. A good furnace is used in this mine, and as there is a great deal of shooting necessary to get down the coal, it is necessary that a brisk ventilation be kept up to keep the mine clear of smoke.

Careytown Mine. This is a small mine employing about twenty miners, and as the coal is easily worked and brushed down, instead of being blasted, and there is a small furnace used, the ventilation is good.

Kellys Mine. This is a small operation worked by Kelly Brothers, and they are working crop coal that was left years ago by the former coal companies. They have recently leased a body of coal adjoining, and are developing the same, and as there is quite a body of it, they will be able to make a better show than in their present workings. They will put up a furnace, as there already is a shaft down to the vein.

Cherry Run Mine. Operated by Holt & Buck, and located near Snow Shoe. This vein runs from three to four feet in thickness. The mine is ventilated by a small furnace that so far has been sufficient for the needs of the men employed, but as the mine is spreading out, it will soon need to be replaced by a larger and better one. A large dip has been met with, and a syphon is used for draining it. They also have passed through several faults which have retarded them somewhat, but at my last visit things were looking brighter, for they had struck a body of coal about four feet in thickness.

Cato Mine. This mine was idle until the latter part of the year, when Messrs Lucas and Swope leased it and put a few miners to work. Did not visit it during the year.

Kelly and Morgan Mine. This is another small operation working a small piece of coal that was left by a former company, and as they cut into the old mine at intervals, the condition of ventilation and drainage is fair.

All the above described mines are located on and ship their product, with the exception of Kellys, Cherry Run and Careytown, over the Beech Creek Railroad.

Glenwood Mines. These mines are three in number, and are operated by the Glenwood Coal Company. Mines 1 and 3 are connected

and are quite extensive and they have a vein of coal running from four to five feet in thickness and perfectly clean. The ventilation is by means of furnace, and is good, as is also the drainage. The lower part of No. 3 mine is confined to pillar work, and is being pulled back.

No. 2 mine is a slope, and during the year they got to the bottom of the basin, and are working in a fine body of coal which in places is nearly six feet in height. The ventilation is by means of a furnace, but as the mine is being rapidly developed a fan will soon be needed as the furnace is not very large. The ventilation and drainage of the mine are good.

Urey Ridge Mines. These mines are three in number and are operated by the Urey Ridge Coal Company. Mines 1 and 3 were the only ones worked during the year, and in No. 1 mine the condition as regards ventilation was very good, as they have built a new furnace on the top of the hill, and as it is close to the face of the work, the condition is all that can be desired. No. 3 is a new mine, and the ventilation and drainage are good, as they have a good furnace in operation.

Penn Mine. Operated by Reakirt Bros. & Co., and working same vein as Glenwood No. 1, with the same general characteristics. During the year they worked very little and they are now endeavoring to reach a small body of coal at the extreme end of the property. At the lower end they have driven out a waterway, and this gives them access to a body of coal that has long been under water. The mine is ventilated by a furnace, and its condition has been very good during the year.

Cush Creek Mine. This mine, which has been idle for the past two years, was started up with a few miners with the object of driving through a fault that had barred their way, and consequently not much work has been done.

They have a small temporary furnace sufficient for their present needs, but if they manage to get through the fault they will put the mine in proper condition.

The mines above mentioned, Glenwood, Urey, Penn and Cush Creek, are all located on the Glen Campbell branch of the Pennsylvania Railroad.

National Mines. These mines are operated by the Philadelphia Coal and Coke Company, and have worked very little during the year. I visited them only once, and found the drainage and ventilation of the mine very good.

Irvona Mines. Operated by the Irvona Coal Company. No. 1 mine is in a series of faults and as they have great trouble with water, the condition of the mine is not good. No. 2 mine was worked for a short time after the strike, and it was at this time I visited it, and

found the ventilation of the mine very fair. They have done nothing since that time. No. 3 is a new mine on top of the hill, but was worked only for a short time and then was shut down indefinitely.

Oakland Mine. This is a small mine owned and operated by Samuel Hegarty, and only worked for a short period during the strike, and on my first visit was in very poor condition. A small furnace was put up and on my next visit the ventilation was much improved.

Bear Ridge Mines. These mines are operated by the Bear Ridge Coal and Coke Company, and on my first visit, No. 1 mine was in very poor condition, as they were working a piece of coal that had been left by a former mine boss, and there was no proper return for air. On my subsequent visits they were pulling out the pillars, and it is now nearly cleaned out. No. 2 mine was found in only fair condition on my first visit, but afterwards I found the condition of the mine good. This vein is less than three feet thick and the coal is used for coking purposes.

Eldorado Mine. This mine is operated by the Eldorado Coal Company. They did not do much work during the year and only a few miners are employed. The condition of the mine was poor, as on the left of the mine they cut into the old Great Bend mine, and as a great deal of black damp is met with in these old workings, and the furnace is not of much account, they cannot at all times keep it clear. They are endeavoring to drive to the outcrop on the right, and put in a new opening, but so far they have not succeeded, and until this is done they will have more or less trouble with the black damp from the old workings.

Blands Mine. Operated by Fred Bland and the greater part of the coal produced is used in coaling the engines on the Bells Gap Railroad. About thirty miners are at work here and the ventilation and drainage were good during the year. They have now struck a body of coal averaging four feet in thickness, and the prospects for this mine are much brighter.

Max Frick Mine. Operated by Max Frick, and employing about forty miners. The roof in this mine is very poor and needs constant watching. During the year they had a very bad squeeze, and it overran the main hauling way, but now they have another hauling way to the dip of this one, and the greater quantity of the coal is brought out on the new road. The ventilation and drainage of the mine were good during the year. A new opening is now being put in, and it will be ready for shipping coal some time during the summer, and then this mine will be abandoned.

Great Bend Mine. Operated by the Bellwood Coal Company. Has done very little during the year. This mine is a very hard mine to



do anything with, as the roof is so very poor that it is impossible to work one part of the mine at all. They also have great difficulty with dips which makes the drainage poor. They have cut into the old Loydsville tunnel, and in this part of the mine they have difficulty with black damp, and as the furnace is of very little use, being only a small affair built up in a crude manner, the condition of the mine is poor. I have notified the management that they must put their mine in a proper condition and expect to soon be able to report a better condition of affairs.

**Delaney Mine.** This mine is operated by the Altoona Coal and Coke Company, and its production when running full is between six and seven hundred tons of coal per day. No. 1 mine is mostly confined to working out the pillars, with a small section of solid coal near the outcrop. The ventilation and drainage of the mine were good during the year.

In No. 2 mine, the condition on my first visit was not good, but on subsequent visits it was in good condition, as they had put down an air shaft more than ninety feet in depth, and this was at the face of the workings, so that there was a decided improvement in the ventilation. They have had great difficulty in this mine with rock faults, and are now getting into a better body of coal. They have also put in a new mine opening on the Miller seam, and expect to be able to ship coal early in the spring.

**Glen White Mine.** This mine is operated by the Glen White Coal Company. It is a slope mine, the coal being hauled out by tail rope, and the ventilation is by means of a Brazil fan. The condition of the mine, both for ventilation and drainage, was very good. A new Boyts pump has been put in during the year.

**East End Mine.** This is a slope mine, operated by the East End Coal Company, and they haul the coal out by the tail rope system. A new lift has been sunk on the slope during the year, and quite a great deal of heading work driven, and the mine is being rapidly developed. The rooms on the upper lift on the right hand side nearly all went into bad roof, and they had to be abandoned, and the new lift started, and this part of the mine is in better coal and not so much troubled by clay veins as the upper part. A Brazil fan is used for ventilating, and the condition of the mine was good during the year.

**Bennington Slope Mine.** This mine is operated by J. L. Mitchel & Co., and has not done much work during the year; the work being confined to a small section of solid coal at the extreme end of the mine. The mine had been flooded for a long time prior to their commencing work, and they could not get all the water out of the roadways, so they were in a very poor condition. The ventilation of the mine was poor, as the fan was not capable of producing an ap-

preciable current at the face of the work, as it is two miles at least from the fan to the face of the workings.

**Porter Shaft.** This is operated by C. H. Porter & Co., and is a very old mine and the headings are a long distance from the foot of the shaft. They did very little work during the year, and the condition of the ventilation was not good, and as the mine is worked on the single heading plan, it is impossible to get the small quantity of air passing through the mine to the face of the headings, as would be the case if they were working double heading system.

**Bradley's Mine.** This is a new mine which was opened during the year and operated by Bradley and Meagher, and adjoins the Porter mine on the east, and connections have been made between the two mines. The same system of working is practiced here as at the Porter, namely the single heading system.

The condition of the mine was very poor, as the management had crowded the mine to its fullest capacity, and had made no provision whatever in the way of doors and bratticing for conducting the air current around the face of the work. There was an ample volume of air passing, and orders were given to put up doors and brattice, so as to carry it around to the face of the rooms and headings. If those in charge would only exercise a little judgment, this could be made a model mine in every respect.

**Tipton Mine.** Operated by the Evans and Bell Mining Company. This mine had been lying idle until last May, when the above parties assumed control of it, and they have not done very much work so far, as they have only from twenty to thirty miners employed. The vein runs about three and a half feet thick, and the quality of the coal is good. The condition of the mine was very fair, as ventilation is produced by the exhaust steam and heat from the boilers that are used in generating steam for hoisting the coal from the slope. A new traveling way has been made during the year, and this comes out into an old drift that was first put in to open up the coal. They have also developed to a small extent, a small vein near the mouth of the tunnel and it has proved very good, so far as regards quality.

**Dougherty Mine.** Operated by the Richland Coal Company. They have done very little business as they supply only house coal, but are expecting to enlarge their mine and do a better business in the coming year.

**Cumberland Mine.** Operated by the H. & B. T. M. R. R. Co. They have not done very much work at this mine during the year, and on my first visit I found the ventilation very poor, and I suggested the air current be reversed, as they have a Brazil fan in use, and this

was done, and on my other visits the mine was in a better condition. They have reached the bottom of the basin and are now working on the other side, but so far they have had difficulty with a very bad roof, and the steep pitch of the vein. A great deal of water enters the mine and it needs constant pumping. They have a good system of tail rope haulage for taking the coal from the mine.

**Crescent Mine.** Operated by the Lambrith Coal Mining Company. This mine is getting a long distance in, and they are working along the bottom of a basin and up to the top of the anticlinal on the right and left. There are from one hundred to one hundred and fifty miners at work, and the production is about six hundred tons per day when running full.

The tail rope system is used for hauling the coal from the mine, and the ventilation is by means of a Brazil fan. The ventilation of the mine was good, as was also the drainage during the year.

**Chevington Mine.** This mine is adjoining the Crescent and operated by the same company, but the conditions of the mine are entirely different from the Crescent, for while in the Crescent there is a good roof, in this mine the roof is very poor, and needs a great deal of timber to make it secure. About thirty miners are employed in the mine, and the ventilation was very fair.

**Kearney Mine.** This mine is operated by Joseph Thropp, and the product is used in making coke for the Everett Iron Company.

Very little work has been done here, and the condition of the mine, both as to drainage and ventilation, was good. They have got the slope down one lift, and in the coming spring a fan will be erected to furnish ventilation for the slope and the upper drift.

**Cambria Mines.** These mines are operated by the United Collieries Company, and like the rest have worked very little during the year. No. 1 mine was run for a short time during the summer. No. 3, the shaft mine, was only worked part of the year, and I found the ventilation and drainage very good. They are making preparations here for an inclined plane inside the mine, and when this is completed it will save hauling the empties up a very steep hill, and do away with the present mode of running the loaded cars down the hill, which will be a decided improvement.

**Elmira Mine.** This is a small mine operated by the Fluke Mining Company, and on my last visit I found them working twelve miners with no certificated foreman, and called the attention of the company to this fact, and now they are working fewer than ten miners.

**Eureka Mine.** Operated by James Allen, and employing about twelve miners. Only a little business has been done, as they commenced work only in the latter part of the year. The ventilation

was fair, the exhaust steam from a pump serving for ventilation at present.

Finley and Coalville Mines. These are small mines and run very irregularly, and are operated by G. McIntyre, and employ from sixteen to twenty miners. Could never find them at work when I was in that neighborhood.

Cunard Shaft. Operated by the Cunard Coal Company. They have not done much work the past year. This is a very old and extensive mine, and they have several very steep roads to go up, and are building an incline plane so as to do away with pulling up these steep hills. The ventilation of the mine was good, but the main hauling road was in very poor condition as regards drainage. A Brazil fan is used for ventilating the mine, but it is not very effective, owing to the contracted space leading from the fan into the mine.

Harvey Slope Mine. Operated by the Harvey Mining Company. This mine was worked very irregularly during the year. They have reached the bottom of the basin and are now driving headings along the basin and developing the property. The mine was found in good condition both for ventilation and drainage.

Brown's Mine. This mine is operated by Sweet & Brown, and is a very extensive one, and when running full their production is about six hundred tons per day. They have, however, done very little business during the past year, owing to poor trade. The ventilation of the mine was good, as they cut into the old Riddlesburg workings at intervals, and this brings the air current to the face of the work. A Brazil fan is used for ventilation, and the tail rope system for hauling the coal out of the mine. They have had great difficulty with a very poor roof, but at the face of the workings they now seem to be getting into a better roof which is a source of much satisfaction to those in charge of the mine.

Mt. Equity Mine. This mine is operated by the Kemble Iron Company and is a very old and extensive one, and the present workings are about a mile from the drift mouth, and on the top of a steep hill, with a basin beyond. On my first visit I found the ventilation very poor, as it was impossible by means of their furnace to ventilate the workings in the basin, so I requested the manager to put in a fan, and he put in a 16-foot Brazil fan. On my last visit the condition of the mine was very good as regards ventilation, and I believe they will in future have no more trouble on that score.

€ Benedict Mine. Operated by W. W. Reed. This mine like the rest has worked only a part of the year, and is not a very large one. The old mine is mostly confined to pillar work, and is nearly worked out. The new mine has been developed considerably during the year, and a great many rooms opened up. A small furnace was

built, and the ventilation of the mine was very fair during the year. They are now putting an opening into the seam above, and the coal looks very promising.

Huntingdon Mine. Operated by W. H. Sweet. The old mine is a long distance in, with very low roads, and the ventilation was poor. A new mine has been put in which will cut off all the old work, and shorten the haul. The condition of the mine at the beginning of the year was very fair, but on subsequent visits it was very poor, and those in charge were endeavoring to drive to the outcrop on top of the hill. When this is done, and a shaft put down and furnace erected, there will be some chance to ventilate the mine, and this is expected to be done very early the coming year.

Ocean Mine. This mine is operated by W. H. Sweet, and is getting in a long distance. The coal is very low and hard, and a great deal of shooting has to be done. The mine, in the early part of the year was in a fair condition as regards ventilation. On my other visits the ventilation was poor, and they were trying to drive into and make a connection with the Fisher mine above, and if this can be done before spring and a furnace shaft put down and furnace built, there is no reason why they cannot have a good mine. One great drawback in the ventilation of the greater number of these mines on Shoups Run is that the coal is so thin and the rock to be blasted is so thick, that proper airways cannot be driven and the air confined as it can be in mines where no rock is to be blasted. The vein here is less than three feet thick, and the roads, both headings and rooms, are five feet high, and the roof is of very hard sandrock.

Fisher Mine. Operated by E. Eichelberger. This is a small mine and working the same vein as Ocean Mine, and the conditions here are a little better as the coal is easier worked, and the vein more regular. The ventilation and drainage of the mine were very fair, and they are driving to the outcrop. When this is accomplished it will make an improvement in its condition.

Hickes Mine. This is only a small operation, and has done very little work during the past year, as they only supply a few local orders.

Robertsdale Mine. This mine and Woodvale Shaft are owned and operated by the Rockhill Iron Company, and they have done very little business during the year. Robertsdale is a very extensive mine, and the production when running full is from six to seven hundred tons per day. The coal is hauled out by the tail rope system. The ventilation and drainage of the mine have been good during the year, and considerable work has been done in draining a part of the mine that had to be pumped heretofore. Now they are driving a heading with the idea of tapping a large body of water

lying in the old workings, and when this is accomplished, it will give them coal to work that has been for a long time under water.

Woodvale Shaft. The work at this mine has been very intermittent during the year. I had a chance to visit it only once and then I found the ventilation and drainage good. The workings here take in a large quantity of water, and large pumps are needed to keep it clear. A very large lodgment for water has been made, and the mine is now in good shape for a large production of coal. The ventilation of this mine and Robertsdale is effected by means of Brazil fans, and they both do good work, for the headings and air ways of both mines are of large area. Everything about these mines is well looked after.

TABLE No. 1.—Showing location, etc., of collieries in the Tenth Bituminous Mine District.

| Name of Colliery.                  | Name of operator.                             | Location—county.  | Name of superintendent. | Postoffice address.                |
|------------------------------------|---|-------------------|-------------------------|------------------------------------|
| Blands, .....                      | Fred. Bland, .....                            | Cambria, .....    | Fred. Bland, .....      | Figart, Cambria county.            |
| Bennington slope, .....            | J. L. Mitchell & Co., .....                   | Blair, .....      | William Smith, .....    | Gadlitzin, Cambria county.         |
| Bradley, .....                     | Bradley & Mcgaster, .....                     | do, .....         | Thomas Smith, .....     | do, .....                          |
| Bloomington Nos. 1, 2 and 3, ..... | Bloomington Mining Company, .....             | Clearfield, ..... | John Dunsmore, .....    | Glen Ritchey, Clearfield county.   |
| Brown No. 2, .....                 | Sweet & Brown, .....                          | Bedford, .....    | W. H. Sweet, .....      | Saxton, Bedford county.            |
| Bowditch, .....                    | W. S. Reed, .....                             | Huntingdon, ..... | W. W. Reed, .....       | Dudley, Huntingdon county.         |
| Cato, .....                        | Swope & Lucas, .....                          | Centre, .....     | J. H. Lucas, .....      | Cato, Centre county.               |
| Cambria Nos. 1, 2 and 3, .....     | United Collieries Company, .....              | Bedford, .....    | James Dentthorne, ..... | Huntingdon, Pa.                    |
| Cherrytown, .....                  | Lehigh Valley Coal Company, .....             | Centre, .....     | J. F. Marsteller, ..... | Snow Shoe, Centre county.          |
| Cherry Run, .....                  | Holt & Buck, .....                            | do, .....         | Samuel Mitchell, .....  | Clarence, Centre county.           |
| Cush Creek, .....                  | H. & B. T. M. R. Co., .....                   | Indiana, .....    | John Baird, .....       | Glen Campbell, Indiana county.     |
| Cumberland, .....                  | Lambrith Mining Company, .....                | Bedford, .....    | John Langdon, .....     | Hopewell, Bedford county.          |
| Crescent, .....                    | do, .....                                     | do, .....         | do, .....               | do, .....                          |
| Cunard, .....                      | Cunard Coal Company, .....                    | do, .....         | do, .....               | do, .....                          |
| Delaney, .....                     | Altoona Coal and Coke Company, .....          | Blair, .....      | R. Chamey, .....        | Six Mile Run, Bedford county.      |
| Donaglass slope, .....             | D. Somerville, .....                          | Blair, .....      | John Munro, .....       | Delaney, Cambria county.           |
| Dougherty, .....                   | Richland Coal Company, .....                  | Clearfield, ..... | D. Somerville, .....    | Winburne, Clearfield county.       |
| East End, .....                    | East End Coal Company, .....                  | do, .....         | John Dougherty, .....   | Altoona, Pa.                       |
| Eagle, .....                       | John Gwin & Son, .....                        | do, .....         | William Smith, .....    | Gadlitzin, Cambria county.         |
| Edorado, .....                     | J. S. McCartney, .....                        | Cambria, .....    | Luther Gwin, .....      | Mountandale, Cambria county.       |
| Elmhurst, .....                    | Fluke Mining Company, .....                   | do, .....         | J. S. McCartney, .....  | do, .....                          |
| Eureka, .....                      | James Allen, .....                            | Bedford, .....    | D. S. Fricke, .....     | do, .....                          |
| Forest Nos. 1 and 2, .....         | James & Walton, .....                         | do, .....         | James Allen, .....      | Six Mile Run, Bedford county.      |
| Fisher, .....                      | E. Eichelberger & Co., .....                  | Clearfield, ..... | John Walton, .....      | Ridlesburg, Bedford county.        |
| Finley, .....                      | G. McIntyre, .....                            | Huntingdon, ..... | John Griffith, .....    | Phillipsburg, Centre county.       |
| Frieks', .....                     | Max Fricke, .....                             | Bedford, .....    | G. McIntyre, .....      | Broad Top City, Pa.                |
| Grass Flat, .....                  | Clearfield Bituminous Coal Corporation, ..... | Cambria, .....    | Max Fricke, .....       | Six Mile Run, Bedford county.      |
| Gazam Nos. 1, 2 and 3, .....       | do, .....                                     | Clearfield, ..... | R. Shillingford, .....  | Figart, Cambria county.            |
| Glen White, .....                  | Glen White Coal Company, .....                | do, .....         | do, .....               | Peale, Pa.                         |
| Great Bend, .....                  | Bellwood Coal Company, .....                  | Blair, .....      | Val. Eichenlaub, .....  | Glen White, Blair county.          |
| Glenwood Nos. 1, 2 and 3, .....    | Glenwood Coal Company, .....                  | Cambria, .....    | Charles Ford, .....     | Bellwood, Pa.                      |
| Horse Shoe, .....                  | Altoona Coal and Coke Company, .....          | Indiana, .....    | Arthur Riddle, .....    | Glen Campbell, Indiana county.     |
| Harts' slope, .....                | Harvey Coal Mining Company, .....             | Blair, .....      | John Munro, .....       | Delaney, Cambria county.           |
| Huntingdon, .....                  | W. H. Sweet, .....                            | Bedford, .....    | W. D. Shaw, .....       | Six Mile Run, Bedford county.      |
| Hicks', .....                      | A. F. and G. H. Hicks, .....                  | Clearfield, ..... | Thomas Hart, .....      | Munson, Clearfield county.         |
| Irvona Nos. 1 and 2, .....         | Irvona Coal and Coke Company, .....           | Huntingdon, ..... | W. H. Sweet, .....      | Saxton, Bedford county.            |
| Keeks', .....                      | Keek Coal Company, .....                      | do, .....         | A. F. Hicks, .....      | Coalmont, Huntingdon county.       |
| Kearney, .....                     | Jessup Thropp, .....                          | Clearfield, ..... | John McNulty, .....     | Woodport, Clearfield county.       |
| Kelly's, .....                     | Kelly Bros., .....                            | Bedford, .....    | J. S. Overly, .....     | Woodland, Clearfield county.       |
| Knox Run, .....                    | Clearfield Bituminous Coal Corporation, ..... | Centre, .....     | Thomas A. Jones, .....  | Kearney, Bedford county.           |
| Kyle, .....                        | R. G. Fishburn, .....                         | Clearfield, ..... | M. D. Kelly, .....      | Snow Shoe, Centre county.          |
| Kings', .....                      | J. King, .....                                | do, .....         | R. Shillingford, .....  | Peale, Pa.                         |
| .....                              | .....   | do, .....         | R. G. Fishburn, .....   | Munson, Clearfield county.         |
| .....                              | .....   | do, .....         | J. King, .....          | Gorton Heights, Clearfield county. |

TABLE NO. 1—Continued.

| Name of Colliery.           | Name of operator.                       | Location—county. | Name of superintendent. | Postoffice address.             |
|-----------------------------|---|------------------|-------------------------|---------------------------------|
| Lemon.                      | J. L. Michel & Co.,                     | Blair,           | William Smith,          | Gallitzin, Cambria county.      |
| Mountandale,                | Bear Ridge Coal and Coke Company,       | Cambria,         | Joseph Smittle,         | Mountandale, Cambria county.    |
| Moravian,                   | Clearfield Bituminous Coal Corporation, | Clearfield,      | R. Shillingford,        | Peale, Pa.                      |
| Mt. Equity,                 | Kimble Iron Company,                    | Bedford,         | William Lander,         | Riddlesburg, Bedford county.    |
| N. Conrad,                  | Philadelphia Coal and Coke Company,     | Clearfield,      | W. H. Helman,           | Irvona, Clearfield county.      |
| O'Shanter Nos. 1 and 2,     | Weaver & Etzla,                         | do.              | W. H. McDowell,         | O'Shanter, Clearfield county.   |
| Oakland,                    | Samuel Haggerty,                        | do.              | Samuel Haggerty,        | Coalport, Clearfield county.    |
| Ocedu,                      | W. H. Sweet,                            | Huntingdon,      | W. H. Sweet,            | Saxton, Bedford county.         |
| Penn.                       | G. McIntyre,                            | Bedford,         | G. McIntyre,            | Six Mile Run, Bedford county.   |
| Penn.                       | Reahnt Bros. & Co.,                     | Indiana,         | W. J. Trevisick,        | Glen Campbell, Indiana county.  |
| Pleasant Hill,              | Clearfield Bituminous Coal Corporation, | Clearfield,      | R. Shillingford,        | Peale, Pa.                      |
| Porter shaft,               | C. H. Porter & Co.,                     | Blair,           | C. H. Porter,           | Hollydaysburg, Pa.              |
| Royal slope,                | O. P. Jones & Co.,                      | Clearfield,      | James Fleming,          | Phillipsburg, Centre county.    |
| Robertsdale,                | Rockhill Iron Company,                  | Huntingdon,      | Peter Connor,           | Robertsdale, Huntingdon county. |
| Somerville,                 | Somerville & Buchanan,                  | Clearfield,      | John Somerville,        | Winburne, Clearfield county.    |
| Sugar Camp Nos. 1, 2 and 3, | Lehigh Valley Coal Company,             | Centre,          | J. F. Marstellat,       | Snow Shoe, Centre county.       |
| Tipton,                     | Evans & Bell,                           | Blair,           | J. Evans,               | Altoona, Pa.                    |
| Trey Nos. 1, 2 and 3,       | Trey Ridge Coal Company,                | Indiana,         | James Passmore,         | Phillipsburg, Centre county.    |
| Woodvale shaft,             | Rockhill Iron Company,                  | Huntingdon,      | Peter Connor,           | Robertsdale, Huntingdon county. |



TABLE No. 2.—Gives the total number of tons of coal mined and tons of coke produced in each colliery, number of days worked, number of employes, number of persons killed and injured, number of kegs of powder used, etc., in the Tenth Bituminous Mine District, for the year ending December 31, 1894.

| Names of Collieries.         | Location.            | Total production in tons of coal. | Total production in tons of coke. | Total shipment in tons of coal. | Number of days worked. | Number of persons employed. | Number fatal accidents. | Number of non-fatal accidents. | Number kegs powder used. | Number steam boilers. | Number horses and mules. | Number coke ovens. |
|------------------------------|----------------------|-----------------------------------|-----------------------------------|---------------------------------|------------------------|-----------------------------|-------------------------|--------------------------------|--------------------------|-----------------------|--------------------------|--------------------|
| Bland.                       | Cambria county.      | 33,000                            |                                   | 23,000                          | 290                    | 44                          |                         |                                | 290                      |                       | 4                        |                    |
| Bennington slope.            | Blair county.        | 15,008                            |                                   | 14,658                          | 165                    | 37                          |                         |                                |                          |                       | 15                       | 100                |
| Bradley.                     | Blair county.        | 4,353                             |                                   | 4,353                           | 100                    | 49                          |                         |                                | 5                        |                       |                          |                    |
| Bloomington Nos. 1, 2 and 3. | Chesterfield county. | 155,292                           |                                   | 155,292                         | 108                    | 264                         |                         |                                | 973                      |                       | 1                        |                    |
| Browns No. 2.                | Bedford county.      | 48,403                            |                                   | 48,403                          | 140                    | 145                         |                         | 2                              | 500                      |                       | 14                       |                    |
| Benelet.                     | Huntingdon county.   | 22,490                            |                                   | 22,490                          | 160                    | 46                          |                         |                                | 25                       |                       |                          |                    |
| Calo.                        | Centre county.       | 1,300                             |                                   | 1,160                           | 52                     | 4                           |                         |                                |                          |                       |                          |                    |
| Cambria Nos. 1, 2 and 3.     | Bedford county.      | 36,000                            |                                   | 36,000                          | 100                    | 127                         |                         |                                | 55                       |                       | 30                       |                    |
| Caroytown.                   | Centre county.       | 12,824                            |                                   | 12,824                          | 108                    | 22                          |                         |                                |                          |                       |                          |                    |
| Cherry Run.                  | Centre county.       | 16,175                            |                                   | 16,175                          | 140                    | 58                          |                         |                                |                          |                       |                          |                    |
| Cash Creek.                  | Indiana county.      | 1,800                             |                                   | 1,800                           | 70                     | 16                          |                         |                                |                          |                       |                          |                    |
| Cumberland.                  | Bedford county.      | 37,601                            |                                   | 37,601                          | 144                    | 82                          |                         |                                | 50                       |                       | 9                        |                    |
| Chesterfield.                | Bedford county.      | 49,543                            |                                   | 49,543                          | 134                    | 136                         |                         |                                | 190                      |                       | 2                        | 14                 |
| Conard.                      | Bedford county.      | 20,480                            |                                   | 20,480                          | 125                    | 52                          |                         |                                | 50                       |                       |                          |                    |
| Conard.                      | Bedford county.      | 14,677                            |                                   | 14,677                          | 84                     | 62                          |                         |                                | 36                       |                       |                          | 18                 |
| Delany.                      | Blair county.        | 115,562                           |                                   | 112,982                         | 185                    | 224                         |                         |                                | 1,300                    |                       | 21                       | 96                 |
| Douglas slope.               | Chesterfield county. | 2,225                             |                                   | 2,225                           | 25                     | 46                          |                         |                                |                          |                       |                          |                    |
| Dougherty.                   | Blair county.        | 9,136                             |                                   | 9,136                           | 133                    | 21                          |                         |                                | 81                       |                       |                          |                    |
| East End.                    | Blair county.        | 60,102                            |                                   | 58,662                          | 180                    | 176                         |                         | 1                              | 750                      |                       | 6                        | 50                 |
| Eagle.                       | Cambria county.      | 3,018                             |                                   | 3,018                           | 200                    | 10                          |                         |                                | 84                       |                       |                          |                    |
| Florida.                     | Cambria county.      | 8,000                             |                                   | 8,000                           | 135                    | 22                          |                         |                                | 15                       |                       |                          |                    |
| Elmira.                      | Bedford county.      | 4,480                             |                                   | 4,480                           | 110                    | 25                          |                         |                                | 2                        |                       |                          |                    |
| Forest Nos. 1 and 2.         | Bedford county.      | 800                               |                                   | 800                             | 28                     | 15                          |                         |                                |                          |                       |                          |                    |
| Fureka.                      | Bedford county.      | 116,416                           |                                   | 116,416                         | 142                    | 250                         |                         | 2                              | 80                       |                       | 13                       |                    |
| Fisher.                      | Bedford county.      | 10,169                            |                                   | 10,169                          | 113                    | 42                          |                         |                                |                          |                       |                          |                    |
| Forest Nos. 1 and 2.         | Washington county.   | 4,200                             |                                   | 4,200                           | .....                  | 52                          |                         |                                |                          |                       |                          |                    |
| Finey.                       | Bedford county.      | 26,500                            |                                   | 26,500                          | 197                    | 54                          |                         |                                | 372                      |                       |                          |                    |
| Fricks.                      | Cambria county.      | 92,926                            |                                   | 92,926                          | 142                    | 243                         |                         | 2                              | 1,136                    |                       | 17                       |                    |
| Grass Flat.                  | Chesterfield county. | 13,997                            |                                   | 13,997                          | 148                    | 245                         |                         | 1                              | 1,200                    |                       | 8                        | 100                |
| Gazam Nos. 1, 2 and 3.       | Chesterfield county. | 91,257                            |                                   | 91,257                          | 148                    | 245                         |                         |                                |                          |                       |                          |                    |
| Glen White.                  | Blair county.        | 48,000                            |                                   | 48,000                          | 200                    | 130                         |                         |                                |                          |                       |                          |                    |
| Great Bend.                  | Cambria county.      | 3,700                             |                                   | 3,700                           | 59                     | 38                          |                         |                                |                          |                       |                          |                    |

TABLE No. 2.—Continued.

| Names of Collieries.         | Location.          | Total production in tons of coal. | Total production in tons of coke. | Total shipment in tons of coal. | Number of days worked. | Number of persons employed. | Number fatal accidents. | Number of non-fatal accidents. | Number kegs powder used. | Number steam boilers. | Number horses and mules. | Number coke ovens. |
|------------------------------|--------------------|-----------------------------------|-----------------------------------|---------------------------------|------------------------|-----------------------------|-------------------------|--------------------------------|--------------------------|-----------------------|--------------------------|--------------------|
| Glenwood.                    | Indiana county.    | 104,007                           |                                   | 104,007                         | 117                    | 299                         |                         |                                |                          | 1                     | 21                       |                    |
| Horse Shoef.                 | Blair county.      | 48,181                            |                                   | 48,181                          |                        | 43                          |                         |                                | 140                      |                       |                          |                    |
| Harvey slope.                | Clearfield county. | 3,755                             |                                   | 3,755                           | 40                     | 30                          |                         |                                | 35                       |                       |                          |                    |
| Harris.                      | Huntingdon county. | 30,298                            |                                   | 30,298                          | 120                    | 33                          |                         |                                | 156                      |                       |                          |                    |
| Huntingdon.                  | Huntingdon county. | 2,250                             |                                   | 2,250                           |                        | 4                           |                         |                                | 7                        |                       |                          |                    |
| Hicks.                       | Huntingdon county. | 7,488                             |                                   | 7,488                           | 75                     | 59                          |                         |                                | 77                       |                       |                          |                    |
| Irvona Nos. 1 and 2.         | Clearfield county. | 16,981                            |                                   | 16,368                          | 214                    | 25                          |                         |                                | 108                      | 3                     | 10                       |                    |
| Kecks.                       | Clearfield county. | 10,459                            | 6,016                             | 14,309                          | 165                    | 47                          |                         |                                | 48                       | 1                     | 4                        | 118                |
| Keary.                       | Bedford county.    | 31,467                            |                                   | 31,467                          | 126                    | 64                          |                         |                                |                          |                       |                          |                    |
| Kelly's.                     | Centre county.     | 25,443                            |                                   | 25,410                          | 124                    | 65                          |                         |                                | 14                       |                       |                          |                    |
| Knox Run.                    | Clearfield county. | 1,783                             |                                   | 1,583                           | 80                     | 19                          |                         |                                |                          |                       |                          |                    |
| Kings.                       | Clearfield county. | 15,664                            | 419                               | 13,244                          | 70                     | 51                          |                         |                                | 250                      | 1                     | 12                       | 50                 |
| Kyster.                      | Blair county.      |                                   |                                   |                                 |                        |                             |                         |                                |                          |                       |                          |                    |
| Lemon.                       | Blair county.      | 18,755                            | 6,085                             | 10,671                          | 175                    | 62                          |                         |                                | 45                       | 1                     | 4                        | 50                 |
| Mountaineale.                | Cambria county.    | 44,678                            |                                   | 43,804                          | 192                    | 68                          |                         | 2                              |                          |                       |                          |                    |
| Moravian.                    | Clearfield county. | 45,801                            |                                   | 45,801                          | 227                    | 82                          |                         |                                |                          |                       |                          |                    |
| N. L. Equity.                | Bedford county.    | 11,340                            |                                   | 11,340                          | 36                     | 36                          |                         |                                | 40                       | 10                    | 100                      |                    |
| National.                    | Clearfield county. | 35,160                            |                                   | 35,160                          | 137                    | 113                         |                         |                                | 200                      |                       |                          |                    |
| O'Shauner Nos. 1 and 2.      | Clearfield county. | 1,568                             |                                   | 1,568                           | 40                     | 14                          |                         |                                | 18                       |                       |                          |                    |
| Oakland.                     | Bedford county.    |                                   |                                   |                                 |                        |                             |                         |                                |                          |                       |                          |                    |
| Oakdale.                     | Bedford county.    | 26,450                            |                                   | 26,450                          | 110                    | 81                          |                         |                                | 150                      |                       |                          |                    |
| Ocean.                       | Huntingdon county. | 33,500                            |                                   | 33,500                          | 150                    | 83                          |                         |                                | 238                      |                       | 9                        |                    |
| Penn.                        | Indiana county.    | 45,906                            |                                   | 45,906                          | 186                    | 66                          |                         |                                |                          |                       |                          |                    |
| Pearson Hill.                | Bedford county.    | 7,854                             |                                   | 7,854                           |                        | 56                          |                         |                                | 8                        |                       |                          |                    |
| Porter shaft.                | Blair county.      | 17,135                            |                                   | 17,025                          | 96                     | 43                          |                         |                                | 75                       |                       |                          |                    |
| Royal slope.                 | Blair county.      | 65,402                            |                                   | 65,503                          | 120                    | 183                         |                         |                                | 725                      | 10                    | 35                       | 122                |
| Robertson.                   | Clearfield county. | 50,908                            |                                   | 50,908                          | 50                     | 183                         | 1                       | 2                              | 625                      | 1                     | 25                       | 200                |
| Somersville Nos. 1, 2 and 3. | Huntingdon county. | 47,825                            | 13,969                            | 33,788                          | 63                     | 41                          |                         |                                | 90                       | 2                     | 5                        |                    |
| Sugar Camp Nos. 1, 2 and 3.  | Centre county.     |                                   |                                   |                                 | 7,443                  | 33                          |                         |                                |                          |                       |                          |                    |
| Troy.                        | Blair county.      | 56,149                            |                                   | 56,084                          | 101                    | 101                         |                         |                                | 465                      |                       | 7                        |                    |
| Upper Nos. 1, 2 and 3.       | Indiana county.    |                                   |                                   |                                 | 43                     | 122                         |                         | 1                              | 252                      | 6                     | 8                        |                    |
| Woodvale shaft.              | Huntingdon county. |                                   |                                   |                                 |                        |                             |                         |                                |                          |                       |                          |                    |
| Totals                       |                    | 1,882,530                         | 47,786                            | 1,800,817                       | 6,816                  | 5,247                       | 2                       | 17                             | 10,125                   | 55                    | 450                      | 690                |

TABLE No. 3.—Showing the number of each class of employes at each colliery in the Tenth Bituminous Mine District, during the year 1894.

| Names of Collieries.         | Location--County. | Occupations of Persons Employed Inside. |         |                   |                  |                      |                       |               |                             |                        |                | Occupations of Persons Employed Outside. |  |                |     |  | Grand totals--inside and outside. |
|------------------------------|-------------------|---|---------|-------------------|------------------|----------------------|-----------------------|---------------|-----------------------------|------------------------|----------------|--|--|----------------|-----|--|-----------------------------------|
|                              |                   | Inside foreman or mine boss.            | Miners. | Miners' laborers. | All company men. | Drivers and runners. | Doorboys and helpers. | Total inside. | Blacksmiths and carpenters. | Engineers and firemen. | Slate pickers. | All company men.                         | Superintendent, book-keepers and clerks. | Total outside. |     |  |                                   |
| Blands                       | Cambria           | 1                                       | 29      | 5                 | 1                | 2                    | 1                     | 1             | 1                           | 1                      | 40             | 1  | 3  | 1              | 44  |  |                                   |
| Bennington slope,            | Blair             | 1                                       | 19      | 4                 | 1                | 1                    | 1                     | 1             | 1                           | 1                      | 53             | 1  | 1  | 1              | 57  |  |                                   |
| Bradley                      | Blair             | 1                                       | 32      | 6                 | 1                | 1                    | 1                     | 1             | 1                           | 1                      | 45             | 1  | 1  | 1              | 49  |  |                                   |
| Bloomington Nos. 1, 2 and 3, | Clearfield        | 1                                       | 289     | 32                | 9                | 12                   | 5                     | 1             | 1                           | 1                      | 349            | 4  | 8  | 3              | 364 |  |                                   |
| Brown No. 2,                 | Bedford           | 1                                       | 100     | 20                | 3                | 10                   | 2                     | 1             | 1                           | 1                      | 135            | 2  | 6  | 10             | 145 |  |                                   |
| Benedict                     | Huntington        | 1                                       | 44      | 9                 | 1                | 4                    | 1                     | 1             | 1                           | 1                      | 58             | 1  | 4  | 3              | 66  |  |                                   |
| Cato,                        | Centre            | 1                                       | 30      | 2                 | 4                | 3                    | 1                     | 1             | 1                           | 1                      | 41             | 1  | 2  | 1              | 45  |  |                                   |
| Cambria Nos. 1, 2 and 3,     | Bedford           | 1                                       | 89      | 6                 | 4                | 9                    | 1                     | 1             | 1                           | 1                      | 114            | 3  | 8  | 1              | 127 |  |                                   |
| Caroytown,                   | Centre            | 1                                       | 17      | 3                 | 1                | 1                    | 1                     | 1             | 1                           | 1                      | 22             | 1  | 1  | 1              | 25  |  |                                   |
| Cherry Run,                  | Centre            | 1                                       | 49      | 1                 | 1                | 1                    | 1                     | 1             | 1                           | 1                      | 53             | 1  | 3  | 1              | 58  |  |                                   |
| Cush Creek,                  | Indiana           | 1                                       | 8       | 1                 | 2                | 1                    | 1                     | 1             | 1                           | 1                      | 13             | 1  | 1  | 1              | 15  |  |                                   |
| Cumberland,                  | Bedford           | 1                                       | 62      | 2                 | 3                | 5                    | 4                     | 1             | 1                           | 1                      | 77             | 2  | 5  | 2              | 86  |  |                                   |
| Crescent,                    | Bedford           | 1                                       | 103     | 5                 | 3                | 10                   | 4                     | 1             | 1                           | 1                      | 126            | 2  | 6  | 2              | 136 |  |                                   |
| Chevington,                  | Bedford           | 1                                       | 40      | 2                 | 1                | 4                    | 1                     | 1             | 1                           | 1                      | 49             | 1  | 3  | 1              | 52  |  |                                   |
| Cunard,                      | Bedford           | 1                                       | 40      | 4                 | 2                | 8                    | 3                     | 1             | 1                           | 1                      | 58             | 1  | 4  | 1              | 64  |  |                                   |
| Delaney,                     | Blair             | 1                                       | 179     | 15                | 6                | 15                   | 5                     | 1             | 1                           | 1                      | 221            | 3  | 8  | 1              | 234 |  |                                   |
| Douglas slope,               | Blair             | 1                                       | 28      | 5                 | 2                | 2                    | 1                     | 1             | 1                           | 1                      | 39             | 1  | 1  | 1              | 42  |  |                                   |
| Dougherty,                   | Blair             | 1                                       | 16      | 1                 | 1                | 1                    | 1                     | 1             | 1                           | 1                      | 19             | 1  | 1  | 1              | 21  |  |                                   |
| East End,                    | Blair             | 1                                       | 114     | 9                 | 2                | 6                    | 1                     | 1             | 1                           | 1                      | 132            | 2  | 3  | 1              | 139 |  |                                   |
| Eagle,                       | Cambria           | 1                                       | 9       | 1                 | 1                | 1                    | 1                     | 1             | 1                           | 1                      | 10             | 1  | 1  | 1              | 12  |  |                                   |
| Eldorado,                    | Cambria           | 1                                       | 19      | 1                 | 1                | 1                    | 1                     | 1             | 1                           | 1                      | 21             | 1  | 1  | 1              | 23  |  |                                   |
| Elmhurst,                    | Bedford           | 1                                       | 19      | 1                 | 2                | 1                    | 1                     | 1             | 1                           | 1                      | 23             | 1  | 1  | 1              | 25  |  |                                   |
| Europa,                      | Bedford           | 1                                       | 11      | 1                 | 1                | 1                    | 1                     | 1             | 1                           | 1                      | 13             | 1  | 1  | 1              | 15  |  |                                   |
| Forest Nos. 1 and 2,         | Bedford           | 1                                       | 211     | 8                 | 4                | 10                   | 3                     | 1             | 1                           | 1                      | 237            | 1  | 9  | 1              | 250 |  |                                   |
| Fisher,                      | Huntington        | 1                                       | 29      | 5                 | 1                | 3                    | 1                     | 1             | 1                           | 1                      | 39             | 1  | 1  | 1              | 42  |  |                                   |
| Finley,                      | Bedford           | 1                                       | 15      | 6                 | 4                | 1                    | 1                     | 1             | 1                           | 1                      | 24             | 1  | 1  | 1              | 25  |  |                                   |
| Fricks,                      | Cambria           | 1                                       | 42      | 1                 | 1                | 4                    | 1                     | 1             | 1                           | 1                      | 51             | 1  | 1  | 1              | 54  |  |                                   |



|                                   |    |       |     |     |     |    |       |    |     |    |     |    |     |       |
|-----------------------------------|----|-------|-----|-----|-----|----|-------|----|-----|----|-----|----|-----|-------|
| Royal slope, .....                | 1  | 24    | 5   | 1   | 3   | 1  | 55    | 1  | 2   | 1  | 2   | 2  | 8   | 43    |
| Robertdale, .....                 | 1  | 198   | 29  | 6   | 16  | 8  | 258   | 1  | 18  | 1  | 18  | 2  | 23  | 231   |
| Huntingdon, .....                 | 1  | 135   | 26  | 2   | 8   | 1  | 172   | 2  | 1   | 1  | 1   | 2  | 11  | 183   |
| Somerville Nos. 1, 2 and 3, ..... | 1  | 155   | 19  | 5   | 7   | 3  | 200   | 2  | 98  | 1  | 98  | 3  | 43  | 333   |
| Sugar Camp Nos. 1, 2 and 3, ..... | 1  | 19    | 8   | 5   | 3   | 1  | 36    | 1  | 1   | 1  | 1   | 2  | 5   | 41    |
| Tipton, .....                     | 1  | 78    | 7   | 1   | 6   | 2  | 96    | 1  | 1   | 1  | 1   | 2  | 5   | 109   |
| Urey Nos. 1, 2 and 3, .....       | 1  | 84    | 12  | 2   | 8   | 5  | 110   | 2  | 9   | 1  | 9   | 1  | 12  | 122   |
| Woodvale shaft, .....             | 1  | 84    | 12  | 2   | 8   | 5  | 110   | 2  | 9   | 1  | 9   | 1  | 12  | 122   |
| Totals, .....                     | 61 | 3,790 | 374 | 136 | 300 | 89 | 4,749 | 69 | 348 | 73 | 348 | 73 | 498 | 5,247 |

TABLE NO. 4.—*List of fatal accidents that occurred in and about the mines of the Tenth Bituminous Mine District, for the year ending December 31, 1894.*

| Date of accident. | Name of Person.       | Occupation.    | Age. | Widow. | Number of orphans. | Name of Colliery.   | Location--County. | Nature and Cause of Accident.  |
|-------------------|-----------------------|----------------|------|--------|--------------------|---------------------|-------------------|--|
| March 2,          | Benjamin Heath, ..... | Trapper, ..... | 12   | .....  | .....              | Robertsdale, .....  | Huntingdon, ..... | Jumped between the wagons of a loaded trip and fell, the cars running over him mashing his leg, necessitating amputation. He did not recover from the shock.               |
| April 5,          | Alex. McKaye, .....   | Miner, .....   | 34   | M.     | .....              | Gazzam No. 4, ..... | Clearfield, ..... | He had fired a shot in the solid coal alongside of the heading, the shot knocked out a prop, and when he went to load his car a rock fell upon him, killing him instantly. |

TABLE No. 5.—List of non-fatal accidents that occurred in and about the mines of the Tenth Bituminous Mine District, for the year ending December 31, 1894.

| Date of accident. | Name of Person.   | Occupation. | Age. | Widow. | Name of Colliery. | Location--County. | Nature and Cause of Accident.  |
|-------------------|-------------------|-------------|------|--------|-------------------|-------------------|--|
| Jan. 8,           | James Brett,      | Miner,      | 18   | S.     | Robertsdale,      | Huntingdon,       | Severely burned all over his body by a spark dropping into his cartridge as he was making it ready for a shot.               |
| 8,                | Thomas Brett,     | Miner,      | 21   | S.     | Robertsdale,      | Huntingdon,       | Burned fatally to his brother, but not severely, as he was falling away.   |
| 27,               | John Ammon,       | Miner,      | 35   | M.     | Browns,           | Bedford,          | Collar bone broken by a fall of ripping.   |
| 9,                | William Park,     | Miner,      | 13   |        | Forest,           | Clearfield,       | Leg broken and hip dislocated while trying to jump between rippings.   |
| March 5,          | Fred Abiquist,    | Miner,      |      | M.     | Grass Flat,       | Clearfield,       | Two fingers mashed, necessitating amputation. Was pushing car and it jumped the track and caught his fingers against a prop. |
| 8,                | Samuel Hetherill, | Driver,     |      |        | Grass Flat,       | Clearfield,       | Hand mashed by cars running over it.   |
| April 9,          | Aaron Lindley,    | Miner,      |      |        | Grass Flat,       | Clearfield,       | Hurt on back and hip dislocated by fall of coal.   |
| 13,               | Jas. Hetherill,   | Driver,     |      |        | Grass Flat,       | Clearfield,       | Foot mashed by car jumping the track on it.  |
| 16,               | Ducal Benedict,   | Miner,      | 40   | M.     | Woodvale,         | Huntingdon,       | Collar bone broken by a fall of coal.  |
| 16,               | George Damovitch, | Miner,      | 40   | S.     | East End,         | Blair,            | Arm broken by a fall of coal.  |
| 20,               | John N. Winters,  | Miner,      |      |        | Moravian,         | Clearfield,       | Injured by a fall of bone coal.  |
| Sept. 15,         | William Power,    | Miner,      |      | S.     | Fricks,           | Cambria,          | Leg badly bruised by rock rolling from the side of the heading on it.  |
| Oct. 31,          | George McMillan,  | Roadman,    | 35   | M.     | Browns,           | Bedford,          | Severely crushed by a fall of rock.  |
| Nov. 1,           | John Larson,      | Miner,      |      |        | Moravian,         | Clearfield,       | Collar bone broken by fall of bone coal.   |
| 22,               | Solomon Hathes,   | Trapper,    |      |        | Forest,           | Clearfield,       | Leg broken by being squeezed between mine cars.  |
| 24,               | William Hopkins,  | Trapper,    |      |        | Fricks,           | Cambria,          | Leg broken. Was riding between cars when car jumped the track breaking his leg.  |
| Dec. 10,          | A. M. Larson,     | Miner,      | 26   | S.     | Grass Flat,       | Clearfield,       | Shoulder blade broken, also cut on the head by a fall of bone coal.  |

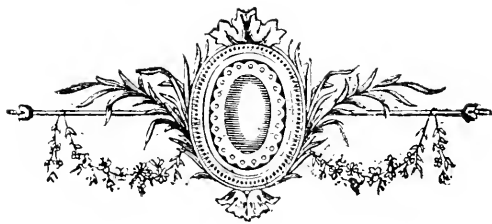



## INDEX.

|  | Page.       |
|--|-------------|
| MINING STATISTICS, .....   | v           |
| Aggregate production of Anthracite coal, .....   | v           |
| Aggregate production of Bituminous coal, .....   | v           |
| Average annual production of Anthracite coal per employe for five years, .....                           | v           |
| Aggregate production of Bituminous coal, .....   | v           |
| Average annual production of Bituminous coal per employe for five years, .....                           | vi          |
| Summary of fatal accidents for five years, .....   | vi          |
| Summary of non-fatal accidents for five years, .....   | vi          |
| Percentage of fatal and non-fatal accidents for the number employed, .....                               | vii         |
| Production of coal and coke by districts for five years, .....   | viii        |
| Number of employes by districts for five years, .....  | ix          |
| Production of Anthracite coal and number of employes by counties for five years, ...                     | x           |
| Production of Bituminous coal and number of employes by counties for five years, ..                      | xi          |
| Days in operation of Anthracite collieries for seven years, .....  | xii-xxvii   |
| Days in operation of Bituminous collieries for seven years, .....  | xxviii-liii |
| FIRST ANTHRACITE DISTRICT, .....   | 1           |
| Quantity of coal produced, .....   | 1           |
| Number of accidents fatal and non-fatal, .....   | 1           |
| Quantity of coal produced per life lost, .....   | 1           |
| Production of coal by each company, .....  | 2           |
| Number of fatal accidents amongst employes of each company, .....  | 3           |
| Classification of accidents, .....   | 4           |
| Occupations of persons killed and injured, .....   | 4           |
| Nationality of persons killed and injured, .....   | 4           |
| Mine improvements for 1894, .....  | 4-7         |
| Illustration of drum and fan, .....  | 6           |
| Pillar robbing, .....  | 7-11        |
| Lackawanna mine fire, .....  | 11-14       |
| Names of persons who were recommended for mine foremen's certificates, .....                             | 15          |
| Description of fatal accidents, .....  | 15-35       |
| Notes of testimony in coroners' inquest, .....   | 35-49       |
| Table No. 1--Showing location, etc., of collieries, .....  | 50-51       |
| Table No. 2--Giving total number of tons of coal mined, number days worked, number employes, etc., ..... | 52-54       |
| Table No. 3--Giving number of each class of employes at each colliery, etc., .....                       | 55-57       |
| Table No. 4--List of fatal accidents, .....  | 58-60       |
| Table No. 5--List of non fatal accidents, .....  | 61-64       |
| SECOND ANTHRACITE DISTRICT, .....  | 65          |
| Synopsis of report, .....  | 65          |
| Quantity of coal mined per fatal accident, .....   | 65          |
| Names of persons qualified to hold certificates as mine foremen, .....                                   | 65-66       |
| Table No. 1--List of fatal accidents, .....  | 67-69       |
| Table No. 2--List of non-fatal accidents, .....  | 70-74       |
| Table No. 3--Number of employes, .....   | 75-76       |
| Table No. 4--Number of tons of coal mined, number of employes at each colliery, etc.,                    | 77-82       |
| THIRD ANTHRACITE DISTRICT, .....   | 83          |
| Synopsis of report, .....  | 83          |
| Tons of coal mined by each company, .....  | 83-84       |
| Number of fatal accidents and tons of coal produced for each life lost, .....                            | 84          |
| Number of non-fatal accidents and tons of coal produced per accident, .....                              | 85          |
| Classification of accidents, .....   | 86          |

|   | Page.      |
|---|------------|
| Occupation and nationality of persons killed or injured .....   | 86         |
| Condition of mines, .....   | 86-89      |
| Description of accidents, .....   | 89-91      |
| Draining water out of mine shafts, .....  | 91-92      |
| Colliery improvements for 1891, .....   | 92-94      |
| Plan of electric haulage, etc., .....   | 94         |
| Description of same, .....  | 94-97      |
| Description of breaker fire, .....  | 97-98      |
| Table No. 1--Location, etc., of collieries, .....   | 99-100     |
| Table No. 2--Quantity of coal mined, number of days worked, number of employees, etc., .....                                    | 101-103    |
| Table No. 3--Number of each class of employes, etc., .....  | 104-106    |
| Table No. 4--List of fatal accidents, etc., .....   | 107-109    |
| Table No. 5--List of non-fatal accidents, .....   | 110-115    |
| <b>FOURTH ANTHRACITE DISTRICT, .....</b>  | <b>117</b> |
| Tons of coal mined by each company 1894, .....  | 117        |
| Number of fatal accidents and tons of coal mined per life lost, .....   | 118        |
| Number of non-fatal accidents and tons of coal mined per serious injury, .....  | 118        |
| Classification of causes of accidents, .....  | 119        |
| Description of collieries, .....  | 119-123    |
| Colliery improvements for 1894, .....   | 123-126    |
| Sketch of Buttonwood colliery, .....  | 126-128    |
| Continuation of improvements, .....   | 128-140    |
| Sketch of a breaker fire, .....   | 140-141    |
| A fortunate escape of a party of visitors to a colliery, .....  | 141-143    |
| Description of electricity from a surface trolley road being discovered in a mine, with tables showing experiments, etc., ..... | 143-148    |
| Description of a gas explosion probably due to a current from a trolley road, .....   | 149-151    |
| Examination of applicants for mine foremen's certificates, .....  | 151        |
| Names of successful applicants, .....   | 151        |
| Accidents during the year with illustration, .....  | 152-156    |
| Table No. 1--Location, etc., of collieries, .....   | 157        |
| Table No. 2--Number tons of coal mined, number days worked, number of accidents, etc., .....                                    | 158-160    |
| Table No. 3--Number of each class of employes, etc., .....  | 161-163    |
| Table No. 4--List of fatal accidents, .....   | 164-169    |
| Recapitulation of fatal accidents, .....  | 169        |
| Table No. 5--List of non-fatal accidents, .....   | 170-180    |
| Recapitulation of non-fatal accidents, .....  | 180        |
| <b>FIFTH ANTHRACITE DISTRICT, .....</b>   | <b>181</b> |
| Production of coal in tons for 1894, .....  | 181        |
| Number of lives lost during year, .....   | 181        |
| Number of non-fatal accidents, .....  | 181        |
| Number of tons of coal produced per each fatality, .....  | 181        |
| Tons of coal mined by each company, .....   | 182        |
| Number of fatalities and quantity of coal mined per life lost by each company, ...  | 182        |
| Number of non-fatal accidents and quantity of coal mined per non-fatality by each company, .....                                | 183-184    |
| Nationality of persons killed and injured, .....  | 185        |
| Classification of accidents, .....  | 185        |
| Comparative summary of accidents to number of employes for fifteen years, .....   | 186        |
| Improvements to collieries during year, .....   | 187-189    |
| Persons who received certificates as mine foremen and assistants, .....   | 189        |
| Fatal accidents and their causes for 1894, .....  | 190-194    |
| Description of fatal powder explosion, .....  | 195-196    |
| Table No. 1--Showing location, etc., of collieries, .....   | 197-198    |
| Table No. 2--Number tons of coal mined, number days worked, number employes, etc, .....   | 199-202    |
| Table No. 3--Number of each class of employes, etc., .....  | 203-207    |
| Table No. 4--List of fatal accidents, .....   | 208-214    |
| Table No. 5--List of non-fatal accidents, .....   | 215-222    |
| <b>SIXTH ANTHRACITE DISTRICT, .....</b>   | <b>223</b> |
| Synopsis of report, .....   | 223        |
| List of successful applicants for mine foremen's certificates, .....  | 223        |
| Fatal accidents and carelessness of workmen deplored as the primary cause, .....  | 223-225    |
| Classification of accidents, and nationalities of those killed or injured, .....  | 225        |

|   | Page.      |
|---|------------|
| Comparative statement of accidents for years 1893-1894, .....   | 225        |
| Number of fatal accidents and quantity of coal produced by each company per each life lost, .....                 | 226-227    |
| Comparative statement of fatal and non-fatal casualties and their causes for five years, .....                    | 228-229    |
| Number of persons employed inside and outside the mines and their occupations, .....                              | 230        |
| Description of an apparatus for detecting the presence of gas in mines, .....                                     | 231-233    |
| Description of a colliery fire with illustration, .....   | 233-242    |
| Table No. 1--Location, etc., of collieries, .....   | 243        |
| Table No. 2--Number of tons of coal mined, number days worked, etc., .....  | 244-245    |
| Table No. 3--Number of employes, etc., .....  | 246-247    |
| Table No. 4--List of fatal accidents, .....   | 248-253    |
| Table No. 5--List of non-fatal accidents, .....   | 254-259    |
| <b>SEVENTH ANTHRACITE DISTRICT, .....</b>   | <b>261</b> |
| Synopsis of report, .....   | 261        |
| Number tons of coal mined, number of fatal and non-fatal accidents, .....   | 261        |
| Examination of applicants for certificates as mine foremen, .....   | 261-262    |
| Condition of collieries, .....  | 262        |
| Description of a colliery fire with illustration, .....   | 262-263    |
| Description of a boiler explosion, .....  | 264        |
| Comparative statement of fatal and non-fatal casualties, .....  | 264-265    |
| Table No. 1--Location, etc., of collieries, .....   | 266        |
| Table No. 2--Number tons of coal mined, number of days worked, etc., .....  | 268-269    |
| Table No. 3--Number of employes, etc., .....  | 270-271    |
| Table No. 4--List of fatal accidents, .....   | 272-274    |
| Table No. 5--List of non-fatal accidents, .....   | 275-277    |
| <b>EIGHTH ANTHRACITE DISTRICT, .....</b>  | <b>279</b> |
| Synopsis of report showing production, number of fatal and non-fatal accidents, etc, .....                        | 279        |
| Condition of collieries, .....  | 279-280    |
| Description of a mine fire, .....   | 280-281    |
| Improvements to collieries during 1894, .....   | 281-287    |
| Persons recommended for mine foremen's certificates, .....  | 288        |
| Table showing production of coal by each company and number of fatal accidents for each company's employes, ..... | 288        |
| Summary for year, .....   | 289        |
| Classification of accidents for 1894, .....   | 289-290    |
| Table No. 1--Location, etc., of collieries, .....   | 291-292    |
| Table No. 2--Number of tons of coal mined, number of days worked, etc., .....                                     | 293-295    |
| Table No. 3--Number of employes, etc., .....  | 296-297    |
| Table No. 4--List of fatal accidents, .....   | 298-299    |
| Table No. 5--List of non-fatal accidents, .....   | 300-301    |
| <b>FIRST BITUMINOUS DISTRICT, .....</b>   | <b>305</b> |
| Synopsis of report, .....   | 305        |
| Monthly reports of accidents, .....   | 305        |
| Causes of accidents, .....  | 306        |
| Statistics of production, etc., .....   | 306-307    |
| Prosecutions for violations of mine laws, .....   | 307-309    |
| Summary of report, .....  | 309-310    |
| Description of mines, .....   | 310-323    |
| Description of accidents, .....   | 323-329    |
| Table No. 1--Location, etc., of collieries, .....   | 330-331    |
| Table No. 2--Number of tons of coal mined, number of days worked, etc., .....                                     | 332-333    |
| Table No. 3--Number of employes, etc., .....  | 334-335    |
| Table No. 4--List of fatal accidents, .....   | 336        |
| Table No. 5--List of non-fatal accidents, .....   | 337-339    |
| <b>SECOND BITUMINOUS DISTRICT, .....</b>  | <b>341</b> |
| Synopsis of report, .....   | 341        |
| Number and causes of accidents, .....   | 341-342    |
| Summary of report, .....  | 343-344    |
| Descriptions and improvements of mines, .....   | 344-357    |
| Table No. 1--Location, etc., of collieries, .....   | 358-359    |
| Table No. 2--Number of tons of coal mined, number of days worked, etc., .....                                     | 360-361    |
| Table No. 3--Number of employes, etc., .....  | 362-363    |
| Table No. 4--List of fatal accidents, .....   | 364-367    |
| Table No. 5--List of non-fatal accidents, .....   | 368-369    |

|   | Page.   |
|---|---------|
| <b>THIRD BITUMINOUS DISTRICT,</b> .....                                       | 371     |
| Synopsis of report, .....   | 371     |
| Brief description of fatal accidents, .....                                   | 371-373 |
| Causes of accidents for 1894, .....   | 373     |
| Table showing production of coal, etc., .....                                 | 373     |
| Remarks on the state of trade, .....  | 374-375 |
| Improvements at mines during year, .....                                      | 375-376 |
| Description of mines, .....   | 376-386 |
| Table No. 1--Location, etc., of collieries, .....                             | 387-388 |
| Table No. 2--Number of tons of coal mined, number of days worked, etc., ..... | 389-391 |
| Table No. 3--Number of employes, etc., .....                                  | 392-393 |
| Table No. 4--List of fatal accidents, .....                                   | 394-397 |
| Table No. 5--List of non-fatal accidents, .....                               | 398     |
| <b>FOURTH BITUMINOUS DISTRICT,</b> .....                                      | 399     |
| Synopsis of report, .....   | 399     |
| Statistics of production, etc., .....   | 400     |
| Classification of accidents, .....  | 400     |
| Description of mines, .....   | 400-406 |
| Report of Cottage State Hospital, .....                                       | 406     |
| Table No. 1--Location, etc., of collieries, .....                             | 407     |
| Table No. 2--Number of tons of coal mined, number of days worked, etc., ..... | 408-409 |
| Table No. 3--Number of employes, etc., .....                                  | 410-411 |
| Table No. 4--List of fatal accidents, .....                                   | 412     |
| Table No. 5--List of non-fatal accidents, .....                               | 413-414 |
| <b>FIFTH BITUMINOUS DISTRICT,</b> .....                                       | 415     |
| Synopsis of report, .....   | 415-417 |
| Comparative table of production, etc., between years 1893 and 1894, .....     | 418     |
| Attorney General's opinion as to the qualification of mine foremen, .....     | 419-421 |
| Description of a coal cutting machine, .....                                  | 421-423 |
| Description of mines, .....   | 426-439 |
| Table No. 1--Location, etc., of collieries, .....                             | 440-441 |
| Table No. 2--Number of tons of coal mined, number of days worked, etc., ..... | 442-443 |
| Table No. 3--Number of employes, etc., .....                                  | 444-445 |
| Table No. 4--List of fatal accidents, .....                                   | 446     |
| Table No. 5--List of non-fatal accidents, .....                               | 447-449 |
| <b>SIXTH BITUMINOUS DISTRICT,</b> .....                                       | 451     |
| Synopsis of report, .....   | 451     |
| Causes of accidents, .....  | 451-452 |
| Summary of production, etc., .....  | 452-453 |
| Improvements in mining, .....   | 453-455 |
| Condition of mines, .....   | 455-462 |
| Table No. 1--Location, etc., of collieries, .....                             | 463-464 |
| Table No. 2--Number of tons of coal mined, number of days worked, etc., ..... | 465-497 |
| Table No. 3--Number of employes, etc., .....                                  | 468-469 |
| Table No. 4--List of fatal accidents, .....                                   | 470-471 |
| Table No. 5--List of non-fatal accidents, .....                               | 472-473 |
| <b>SEVENTH BITUMINOUS DISTRICT,</b> .....                                     | 475     |
| Synopsis of report, .....   | 475-476 |
| Table of production, etc., .....  | 477     |
| Causes of accidents, .....  | 477     |
| Description of mines, .....   | 477-488 |
| Description of fatal accidents, .....   | 488-491 |
| Table No. 1--Location, etc., of collieries, .....                             | 492-493 |
| Table No. 2--Number of tons of coal mined, number of days worked, etc., ..... | 494-495 |
| Table No. 3--Number of employes, etc., .....                                  | 496-497 |
| Table No. 4--List of fatal accidents, .....                                   | 498     |
| Table No. 5--List of non-fatal accidents, .....                               | 499-500 |
| <b>EIGHTH BITUMINOUS DISTRICT,</b> .....                                      | 501     |
| Synopsis of report, .....   | 501     |
| Table of production, etc., .....  | 502     |
| Accidents and their causes, .....   | 502     |
| Report of Cottage State Hospital, Phillipsburg, Centre county, .....          | 502-503 |
| Plates illustrating an electric mining plant in use in Eighth district, ..... | 503     |
| Table No. 1--Location, etc., of collieries, .....                             | 504-505 |

|   | Page.      |
|---|------------|
| Table No. 2--Number of tons of coal mined, number of days worked, etc.....    | 506-507    |
| Table No. 3--Number of employes, etc., .....                                  | 508-509    |
| Table No. 4--List of fatal accidents, .....                                   | 510-511    |
| Table No. 5--List of non-fatal accidents, .....                               | 512-513    |
| <b>NINTH BITUMINOUS DISTRICT, .....</b>                                       | <b>515</b> |
| Synopsis of report, .....   | 515-516    |
| Causes of accidents, .....  | 516        |
| Table of production, etc., .....  | 516-517    |
| Accident list, .....  | 517-520    |
| Description of mines, .....   | 520-531    |
| Report of Cottage State Hospital, Connellsville, .....                        | 531-532    |
| Table No. 1--Location, etc., of collieries, .....                             | 533-534    |
| Table No. 2--Number of tons of coal mined, number of days worked, etc., ..... | 535-536    |
| Table No. 3--Number of employes, etc., .....                                  | 537-538    |
| Table No. 4--List of fatal accidents, .....                                   | 539        |
| Table No. 5--List of non-fatal accidents, .....                               | 540-541    |
| <b>TENTH BITUMINOUS DISTRICT, .....</b>                                       | <b>543</b> |
| Synopsis of report, .....   | 543-544    |
| Summary of statistics, .....  | 544        |
| Condition of mines, .....   | 544-556    |
| Table No. 1--Location, etc., of collieries, .....                             | 557-558    |
| Table No. 2--Number of tons of coal mined, number of days worked, etc., ..... | 559-560    |
| Table No. 3--Number of employes, etc., .....                                  | 561-563    |
| Table No. 4--List of fatal accidents, .....                                   | 564        |
| Table No. 5--List of non-fatal accidents, .....                               | 565        |





1882

# BARKER No 3 SHAFT

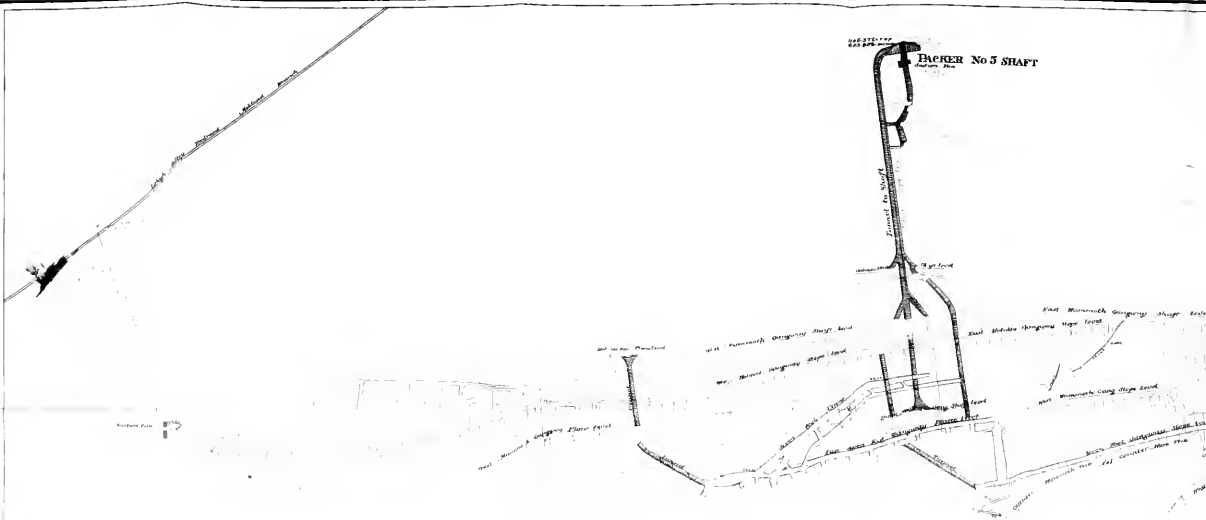

See Main Shaft for more details





MAP

SHOWING LOCATION OF

**FIRE-FANS-WATER-PIPE  
PACKER No 5 MINE WORKINGS**

LEHIGH VALLEY COAL COMPANY

Scale 1 inch = 100 feet

T. E. Lehigh Dec 1894

MAY 1894

H. A. Lothrop, Geol. Supr.

D. F. Bowen, Dra.

Drawn on the basis of the plan of the mine workings of the Packer No 5 Mine, Lehigh Valley Coal Company, Lehigh Valley, Pa.

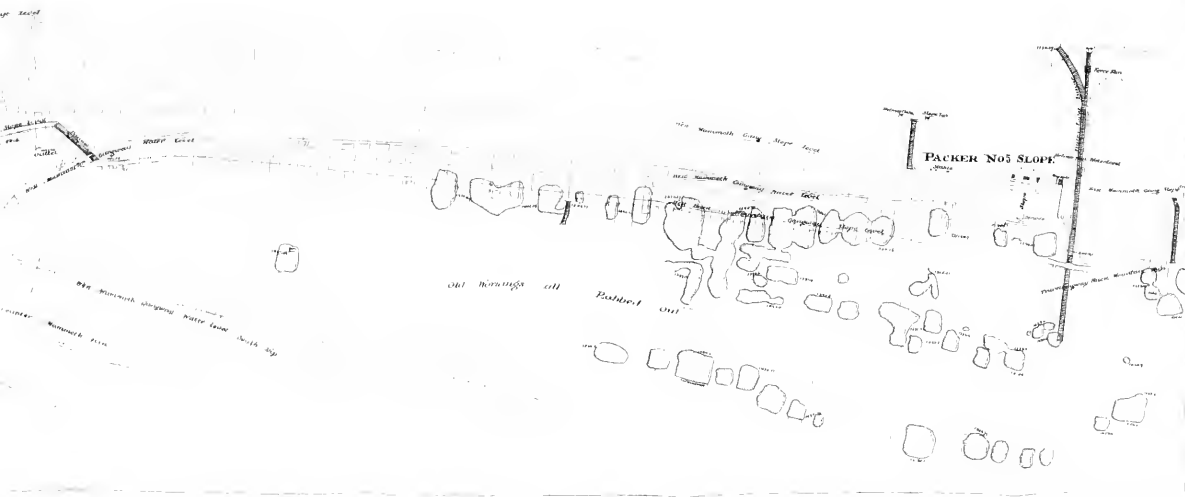



Blower

