

RESTRAINT  
OF  
DOMESTIC  
ANIMALS



Class SF911

Book W6

Copyright N<sup>o</sup> \_\_\_\_\_

**COPYRIGHT DEPOSIT.**

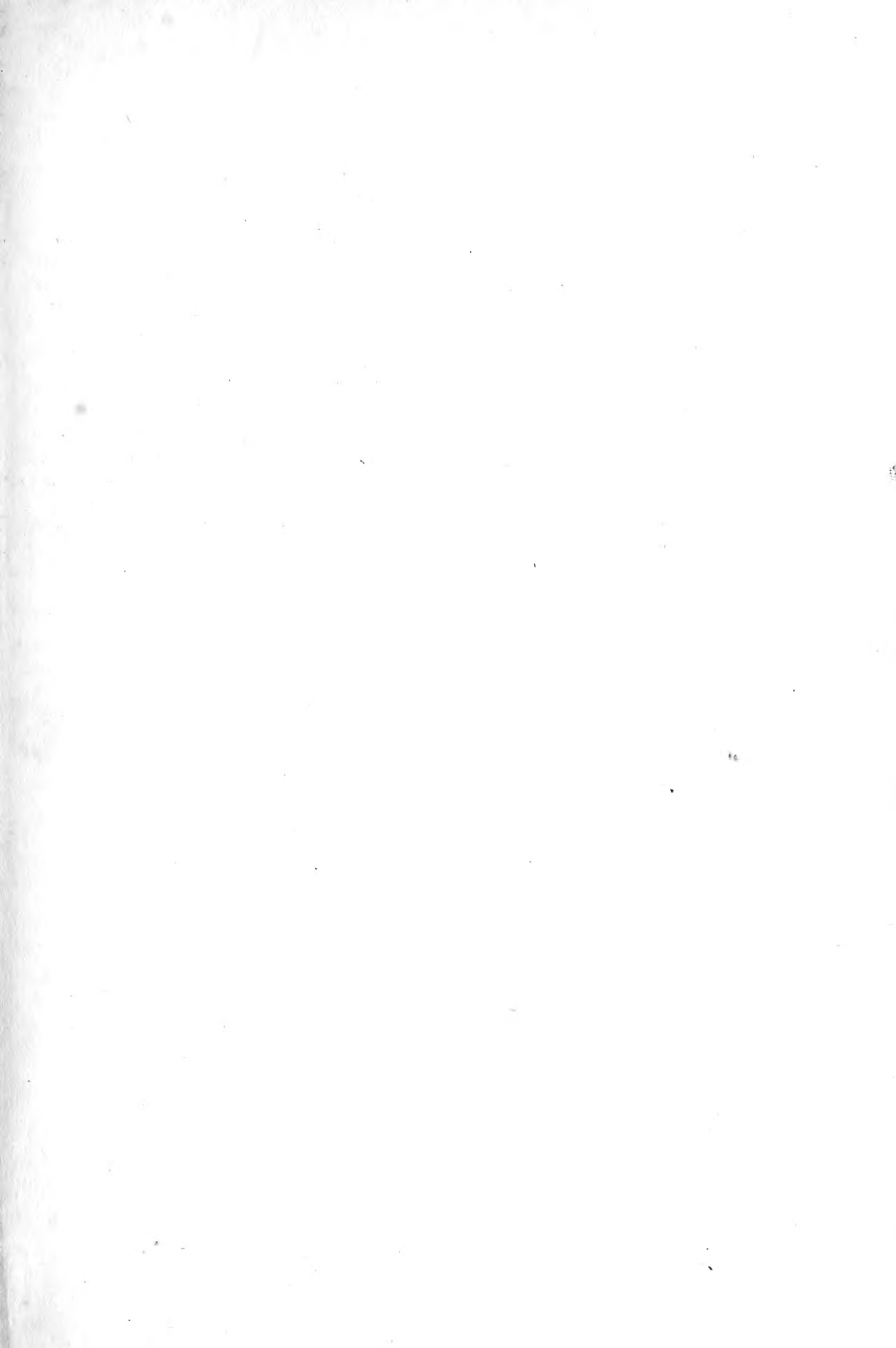

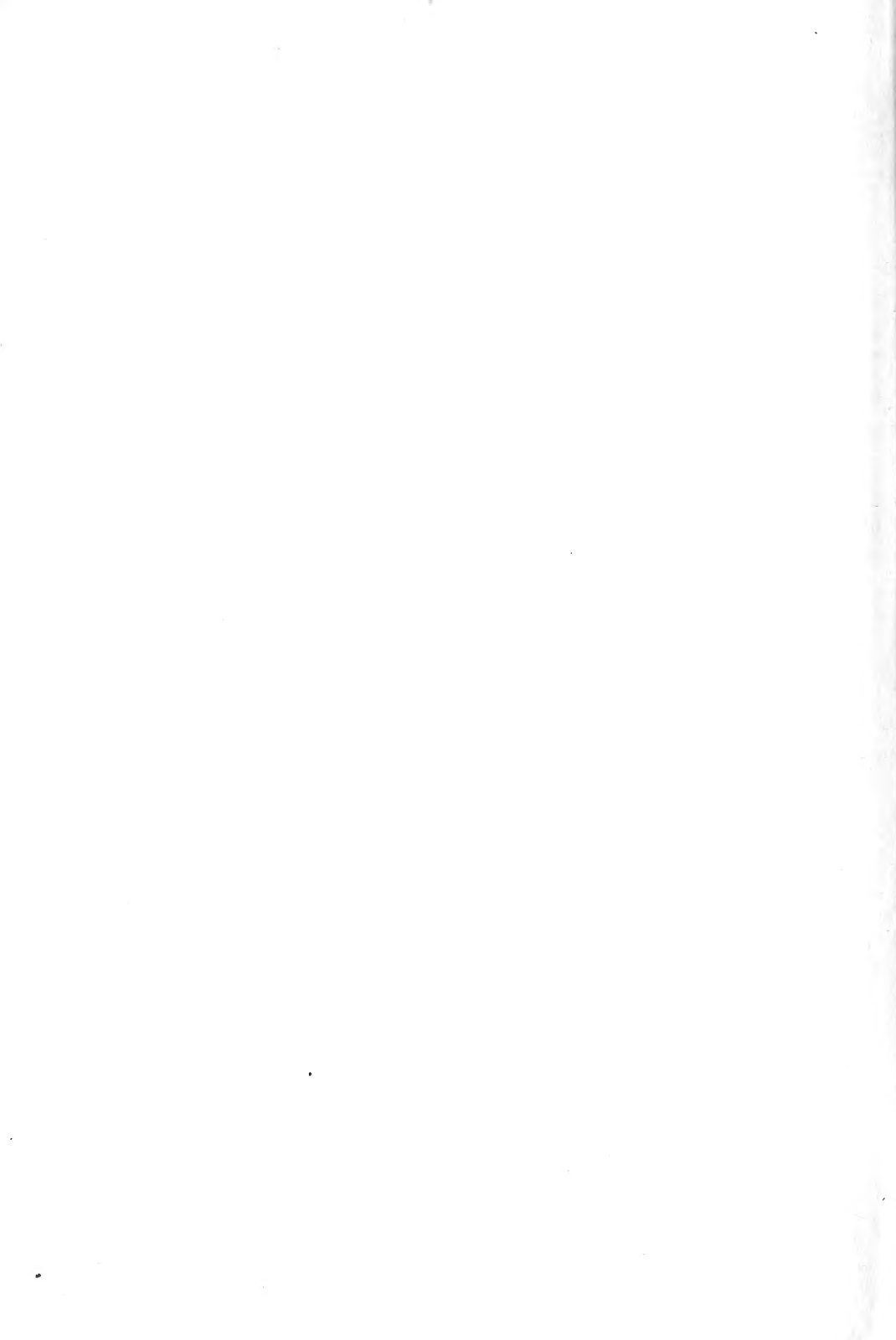







# Restraint

—OF—

# Domestic Animals

A BOOK FOR THE USE OF  
Students and Practitioners

*312 Illustrations from Pen Drawings and  
26 Half Tones from Original Photographs*

—BY—  
GEORGE R. WHITE, M. D., D. V. S.

*Graduate Columbia University (Veterinary Department), and University of Nashville (Medical Department)*

*Member  
American Veterinary Medical Association  
Tennessee State Veterinary Medical Association  
American Medical Association  
Tennessee State Medical Association  
Nashville Academy of Medicine  
and Davidson County Medical Society*



PUBLISHED BY THE AUTHOR

NASHVILLE, TENNESSEE

1909

SF911  
W6

RECEIVED  
1st Class Received  
MAR 15 1909  
Condition & Dry  
Feb. 19, 1909  
CLASS a XAC No  
231436  
COPY

**COPYRIGHTED 1909**

**BY**

**GEORGE R. WHITE**

---

**PRESS OF  
BAYLESS-PULLEN CO.  
NASHVILLE**

---

# Dedication

---

TO W. H. DALRYMPLE, M. R. C. V. S.

As a slight token of personal friendship, as well as for his untiring and continued efforts to advance the status of the Veterinary Profession in the South  
—especially for his pioneer work in the State of Louisiana,  
is this volume respectfully dedicated by

THE AUTHOR

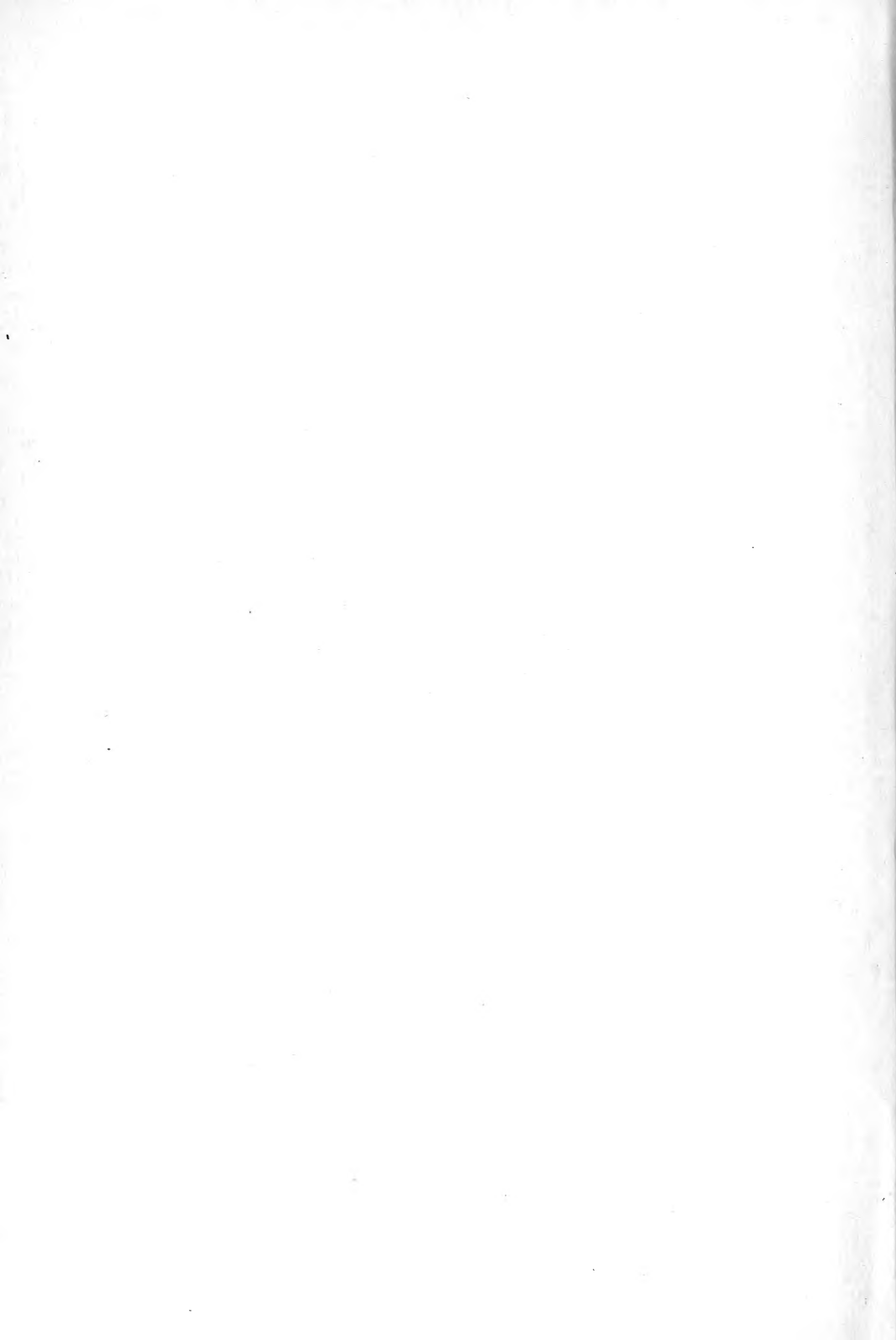

# TABLE OF CONTENTS

---

## PART I.

### *Restraint of the Horse in the Standing Posture.*

- CHAPTER I. Twitches, Gags and Barnacles.
- CHAPTER II. Restraint or "War Bridles" and Halters.
- CHAPTER III. Restraint Harness and Other Leather and Rope Appliances.
- CHAPTER IV. Stocks.
- CHAPTER V. Slings.

## PART II.

### *Restraint of the Horse in the Recumbent Posture.*

- CHAPTER I. Hobbles.
- CHAPTER II. Casting and Securing Harness and Ropes.
- CHAPTER III. Operating Tables.

## PART III.

### *Restraint of the Ox.*

- CHAPTER I. Restraint of the Ox in the Standing Posture.
- CHAPTER II. Restraint of the Ox in the Recumbent Posture.

## PART IV.

### *Restraint of the Dog.*

- CHAPTER I. Operating Tables.
- CHAPTER II. Muzzles, Tape and Other Methods.

## PART V.

### *Restraint of the Hog.*





## INTRODUCTION

---

Restraint of Domestic Animals, in the broadest acceptance of the term, means much to the average busy and active practitioner of Veterinary Surgery.

Each species of our domestic animals is endowed with one or more means of defense. These are oftentimes—in individuals of certain temperament—converted into weapons of offense. The horse will strike, kick and bite; the ox will gore and kick; the dog and hog will bite. It is with these weapons of offense that we are called upon to contend and overcome by restraint. These animals must be rendered harmless by the means of restraint which we have at hand. Of course the particular method employed depends largely upon the animal and the degree of restraint necessary.

While we constantly find it necessary to employ methods of restraint in order to confine the animal, we should always do so in as humane a manner as possible. Humanitarian treatment applies here as well as elsewhere in the practice of Veterinary science. We should never take advantage of an animal when confined in order to cause torture or to inflict unnecessary pain of any kind.

The surgeon is confronted with problems pertaining to restraint or some method of subjection almost every hour of each day of his professional career.

Not only does the restraint problem confront and concern the surgeon alone, but his client and patient are also directly interested to a well marked degree. The surgeon owes it to his client, his patient and himself to become proficient in properly and securely restraining animals for examination and operation. Without efficient means of restraint the surgeon is in constant danger of great bodily harm; the animal in danger of self-inflicted injuries as a result of its own efforts at resistance, thereby causing the owner financial loss which could and should have been avoided by proper methods of procedure.

In order to cast and secure an animal properly and successfully the operator should possess a level head associated with plenty of courage and confidence. He should retain his equilibrium in spite of any untoward accident or emergency which may chance to take place. Self-confidence and good judgment are both valuable assets in performing work of the character which this book undertakes to illustrate and describe. The surgeon should get control and remain in control from the time the twitch is placed on the animal preparatory to applying the hobbles or casting harness until the animal is again on its feet. Experience and dexterity are not to be underrated in the operator who is to undertake the task of securing and properly confining the larger of our domestic animals. Do not allow yourself to become excited or unduly alarmed or aggravated should everything not transpire as smoothly as you expect or desire, for in so doing the surgeon is not in possession of his mental faculties sufficiently to do justice either to himself, his patient or his client.

Perfect, or even good, surgery is impossible without perfect restraint. The surgeon is no better than the restraint method which he uses. It is rare to see a surgeon handle a knife any more skillfully than he handles his restraint technique. Imperfect restraint means an imperfect operation.

This book contains 338 illustrations; of this number 312 are zinc etchings made from pen drawings, and 26 are halftones from original photographs. In compiling and placing it before the profession of this country I have endeavored in so far as possible to avoid technicalities in order to make it valuable to the student and amateur horseman.

I do not care to be held responsible for the imperfections of many of the modes of restraint and subjection illustrated and described. I have endeavored to the best of my ability to illustrate and describe the good methods as well as those which are bad or even indifferent. Each operator should select his favorite method—the one or ones which most appeal to his fancy—and by practice become proficient in the skillful use of same.

My thanks are due and are hereby acknowledged to Professors A. Liataud, John A. W. Dollar, W. L. Williams, and L. A.

Merillat for their courteous assistance and advice; Mr. J. T. Jolley for his painstaking care in making the drawings, and all others who have in any way assisted me in my efforts to furnish the profession with a book on Restraint of Domestic Animals, which appeals to me as in a manner filling a long felt want in American veterinary literature.

GEORGE R. WHITE.



---

---

PART I.

---

Restraint of the Horse in the  
Standing Posture.

---

---



## CHAPTER I.

### TWITCHES, GAGS AND BARNACLES.

#### THE TWITCH.

If every practicing veterinarian in the civilized world was asked to name the first and most important factor in confining a horse in the standing posture, their unanimous answer would be "*a well made and properly applied twitch.*" The twitch as a means of subjection or restraint, is as ancient as the domesticated horse himself. Since its introduction it has been used with excellent and satisfactory results; although brutal in principle, it is the veterinary surgeon's most valuable asset against injury.

It is almost universally applied to the upper lip; however, in rare instances it is placed on the lower lip and ear. It is applied by grasping lip through loop of the twitch, and is tightened by rotating the handle. It acts by squeezing the lip until sufficient pain is produced to detract the animal's attention from the seat of operation. To use more force in this squeezing process than is necessary is inhuman, besides rough handling of the twitch or bearing on it too long will often cause labial paralysis.

The twitch diverts the animal's attention by compressing the sensory nerves of the lip. The ordinary *rope and stick* twitch, Figure 1, is one of the simplest and most inexpensive

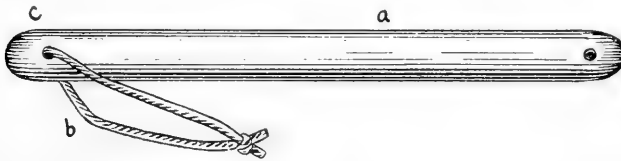

Fig. 1. Ordinary Rope and Stick Twitch.

forms. It is made by simply boring a round hole (c) in a stick (a), preferably hard wood, about one inch from the end.

When the hole is made, insert a piece of rope or sash cord (b); this may vary in diameter from  $\frac{1}{8}$  to  $\frac{1}{2}$  inch, and in length from 10 to 20 inches. Tie ends of rope or cord together and the twitch is completed.

Another *rope and stick* twitch, Figure 2, can be easily made by boring an oblong hole (e) in a piece of hard wood (a) similar to that used in Fig. 1. Use same diameter and length sash cord or rope (b) as is used in Figure 1. Instead of tying ends of rope together they are inserted through hole (e) on each side and are retained in place by a simple knot on each end (d) (c).



Fig. 2. Ordinary Rope and Stick Twitch.

### Ring Twitch.

The ring twitch, Figure 3, consists of a metal ring (b) and



Fig. 3. Ring Twitch.



Fig. 4. Triangle Twitch.



piece of rope (a). This ring may vary in diameter from 4 to 6 inches. Into the ring is tied the piece of rope or sash cord (a). This cord may vary in diameter from  $\frac{1}{8}$  to  $\frac{1}{2}$  inch, and in length from 8 to 18 inches. This makes a neat and light twitch, and one which can be folded up and carried conveniently in an ordinary instrument grip or satchel.

### *Triangular Twitch.*

The triangular twitch, Figure 4, is made similar to the ring twitch, Figure 3, except instead of a metal ring the piece of metal in shape of a triangle (b) is used into which the rope or cord (a) is tied.

### *Miles' Twitch.*

The Miles twitch, Figure 5, was designed and first used by "Farmer" Miles. It is made from a piece of hickory or other tough and hard wood 18 inches long,  $\frac{7}{8}$  inch thick, and 2 inches wide (a). A metal rivet (h) is inserted near the end. An oblong hole is bored to carry rope (e). Another hole (d) is bored about 3 inches from the small end of stick to carry strap or rope (b) (c). The rope (e) can vary in diameter from  $\frac{1}{8}$  to  $\frac{3}{8}$  inches, in length from 12 to 20 inches. Insert ends of rope through hole and retain in place by tying knots (f) (g).

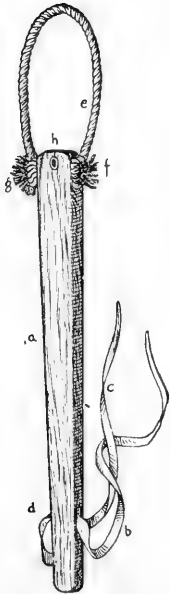

Fig. 5. Miles' Twitch.

The Miles twitch, Figure 6, is applied and used in the ordinary way, with the exception that the twitch stick (e) is fastened up to side of halter (a) by straps or ropes (c) (b), Figure 6. This dispenses with holding the twitch by hand. This is a convenient as well as an effectual method of using the twitch.

The rope and stick twitch with metal bound head, Figure 7, is more substantial than either of those described and illustrated above.

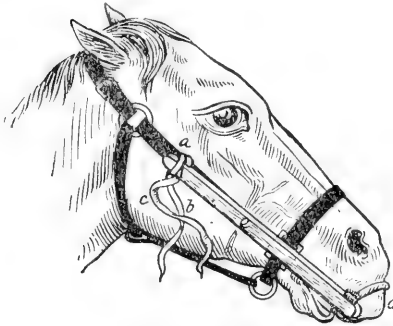

Fig. 6. Miles' Twitch Applied.

The stick (a) should be heavy and strong, size and shape to suit the operator. Spaces should be hollowed out of head under the metal band to accommodate rope or sash cord (f) (e). A metal band (g) (d) is shrunk around head of

twitch stick. A round hole is bored four inches from head (c) (b). The rope (f) (e) may vary in diameter from  $\frac{1}{8}$  to



Fig. 7. Rope and Stick Twitch Metal Bound Head.

$\frac{1}{2}$  inch, and in length from 18 to 22 inches, and are fastened together at side of head of twitch (c).

#### *Ball and Chain Twitch.*

Figure 8 consists of a piece of  $\frac{3}{8}$  to  $\frac{1}{2}$  inch twisted link chain 10 to 12 inches long attached to piece of iron at one end, and upon the other end is a ball, as shown in the illustration. This makes a good twitch, and one easy to apply. But on account of its rigidity it must be used with care and discretion.

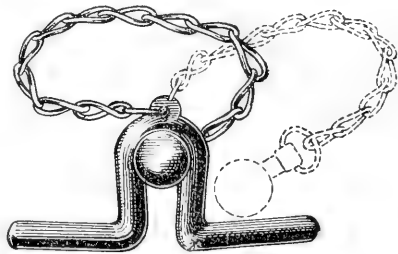

Fig. 8. Ball and Chain Twitch.

Another form of iron and chain twitch, Figure 9, is strong and durable. It is preferred by some operators, while by others it is condemned. The hand piece is simply a flat piece of iron hammered into proper shape. After shaping the metal two holes are drilled through it to accommodate the twisted link chain. The chain may be the same diameter and length as the one used in Figure 8. This same pattern of twitch may be made of wood for handle instead of metal, and horse-hair rope, sash cord, or common rope instead of chain.

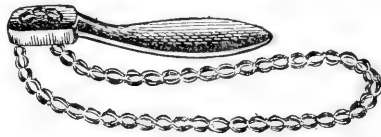

Fig. 9. Iron and Chain Twitch.

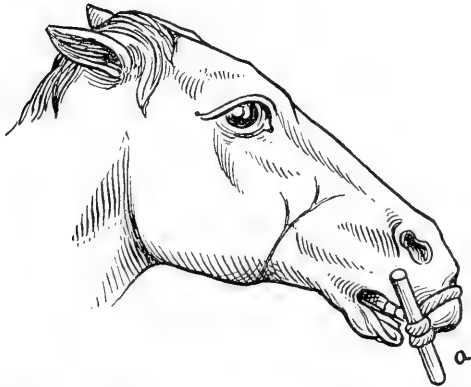

Fig. 10. Rope Loop and Short Stick Twitch.

The rope loop and short stick twitch, Figure 10, consists of a piece of rope or sash cord varying in diameter from  $\frac{1}{8}$  to  $\frac{1}{2}$  inch, and in length from 12 to 20 inches. The ends are tied together. A round stick (a) from 8 to 20 inches long is used to complete this twitch.

### THE GAG.

The "gag" has been used since time immemorial as a means of subjection and restraint. Although seldom used now by the

American veterinarian, its use is continued by many practitioners of central Europe. Unless used with extreme caution lacerations of the lips and contusions of the "poll" are liable to occur. The gag should always be used and removed as quickly as possible.

The *loop and rope gag*, Figure 11, consists of a rope or sash cord which may vary in diameter from  $\frac{1}{4}$  to  $\frac{1}{2}$  inch, and in length from 5 to 10 feet. To apply this form of gag it is only necessary to place rope in mouth (a), then pass looped end (d) over poll (c); now carry rope (b) through loop (d), and make the desired tension by pulling on free end of rope (b).

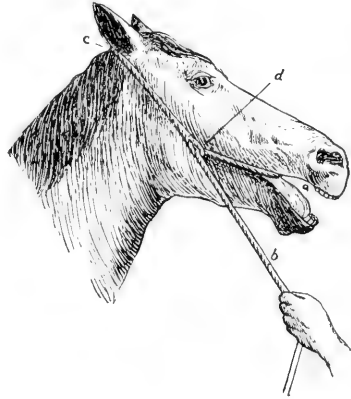

Fig. 11. Loop and Rope Gag.

*Rope and short stick gag*, Figure 12, is made by tying both ends of a rope together the proper size to fit a horse, somewhat similar to an ordinary bridle (a); then with a round piece of wood (c) 6 to 8 inches long, placed between rope and cheek, make traction by twisting at side of cheek (b) until the desired tension is obtained. The

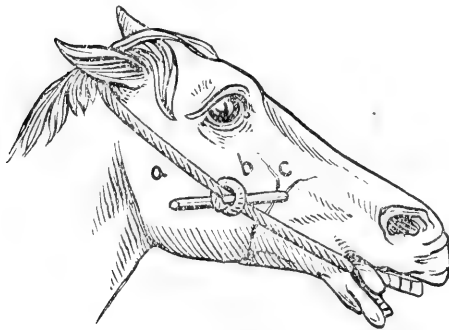

Fig. 12. Rope and Short Stick Gag.

diameter of the rope or sash cord used should be same as that described in Figure 11.

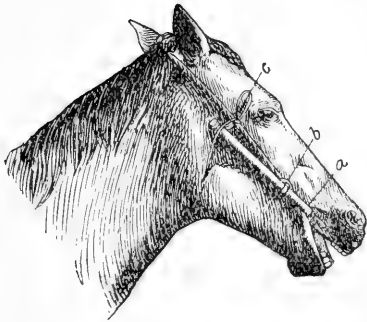

Fig. 13. Rope and Long Stick Gag.

The rope and long stick gag, Figure 13, is made similar to that of Figure 12 except the piece of wood (a) should be from 10 to 18 inches long. Insert the stick at side of cheek (b) and twist until desired tension is obtained. The free end of stick can then be tied to rope (c) at side of face.

#### BARNACLES.

*Barnacles* are made of either metal or wood. They consist of two pieces hinged together at one end and so shaped at the free ends as to make them easily and quickly brought together so that they can be "fixed" securely by cord or other means. The barnacle answers the same purpose as either the twitch or gag. It is more severe in its effects, and should always be used with discretion. The wooden barnacle, Figure 14, consists of two round pieces of hard wood  $1\frac{1}{2}$  inches

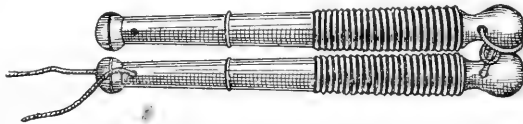

Fig. 14. Wooden Barnacle.

in diameter and 15 inches long, into which notches or circular ridges are cut to come in contact with the lip. These cause pain as well as prevent the appliance from slipping off the lip. They are hinged at one end by means of a piece of rope or cord. To apply this barnacle the lip is grasped and the free ends of the stick brought together until desired pressure on lip is obtained; then the free ends of sticks are tied together with cord.

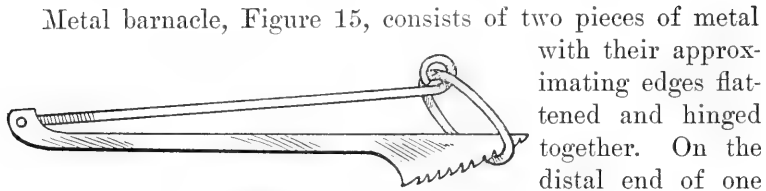

Fig. 15. Metal Barnacle.

Metal barnacle, Figure 15, consists of two pieces of metal with their approximating edges flattened and hinged together. On the distal end of one of these pieces of metal a ring is placed to fit into notches on the corresponding end of the other. To apply this barnacle, Figure 16, the nose

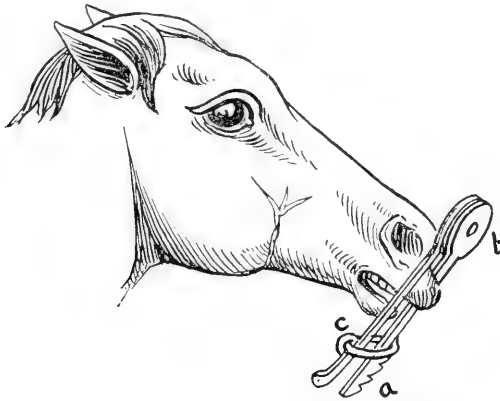

Fig. 16. Metal Barnacle Applied.

should be grasped and the metal pieces forced together until the desired tension is secured. The ring (c) is then locked in the appropriate notch (a).

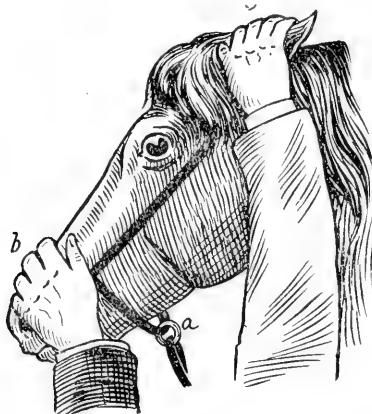

Fig. 17. Subjection by Grasping Nose and Twisting Ear.

## OTHER SIMPLE METHODS OF SUBJECTION.

To firmly grasp the nose (b) with the left hand, Figure 17, and simply twisting or compressing the ear (c) with the right hand will oftentimes prove to be sufficient restraint for examination and minor operation.

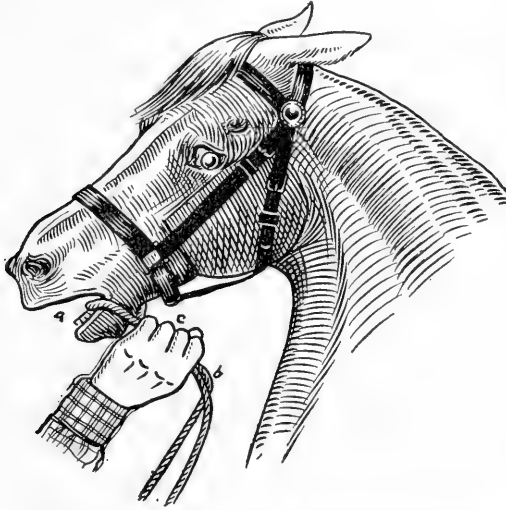

Fig. 18. Rope or Cord Held Tightly Around Lower Jaw.

Figure 18 represents a rope or cord (b) passed into the mouth (a) and held tightly around lower jaw (c). This will oftentimes enable the operator to examine and operate upon many animals without resorting to other methods of restraint.

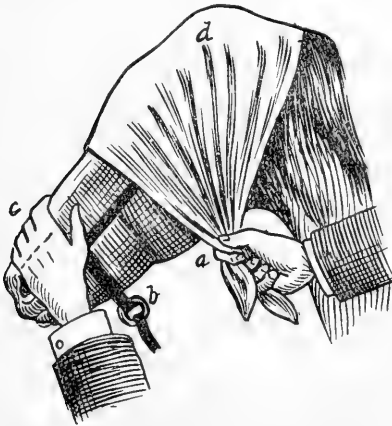

Fig. 19. Subjection by Blindfold.

To simply "blindfold" or cover the head, Figure 19, will cause many nervous and sometimes vicious animals to stand without resorting to other more complicated or painful methods.

## CHAPTER II.

### RESTRAINT OR "WAR BRIDLES" AND HALTERS.

---

#### THE RESTRAINT OR "WAR BRIDLE."

As a means of restraint and subjection of animals which are of a certain nervous or vicious temperament, the "war bridle" is far superior to the twitch or any other appliance. This device has been in successful use for many years by some of the world's most famous "horse tamers." It is oftentimes indispensable in handling certain animals. When properly applied, correctly adjusted and judiciously used there can come no bad results from its application. When the nervous and vicious character of some animals is taken into consideration, its use on them, even from a humanitarian viewpoint, is amply justified. The "war bridle" can be modified in a variety of ways to increase its power and efficiency. Experience, good judgment and extreme care are the three attributes necessary on the part of the operator to handle the "war bridle" successfully.

To make a good "war bridle" it is necessary to use rope or sash cord of first-class quality, varying in size from 5-16 to  $\frac{3}{8}$ -inch in diameter, and from 15 to 24 feet in length. The object of the "war bridle" is to cause pain by pressure on the spinal cord at its most exposed part, which is immediately over the axoatlloid articulation, at the same time tension is brought on cheeks at corners of mouth by traction on free end of cord. This also causes excruciating pain, thereby bringing the animal under immediate and thorough control. If properly used it is certainly a powerful and valuable method of restraint.



*Gleason's "War Bridle."*

The bridle of Gleason, Figure 20, is one of the simplest of war bridles. After securing sash cord or rope of proper diameter and length, the rope is passed around the neck (d) and tied securely (c). It is then passed into and through the mouth (a) to the

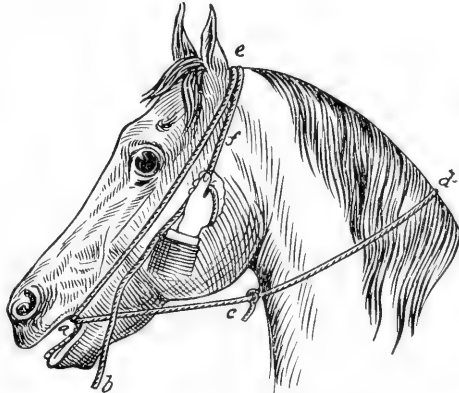

Fig. 20. Gleason's "War Bridle."

opposite side and over the poll (e) and back again (f), after which the pull or traction is made from end of rope (b).

*Eureka "War Bridle."*

Fig. 21. Eureka "War Bridle."

The Eureka "war bridle," Figure 21, is made and applied by tying the rope (g) (f) around the neck well posterior to the "poll." Next pass rope (c) to right side of face and through the mouth. Then pass rope (a) (b) back through loop around neck (d) and make traction on free end of rope (e).

*Bonaparte "War Bridle."*

Fig. 22. Bonapart "War Bridle."

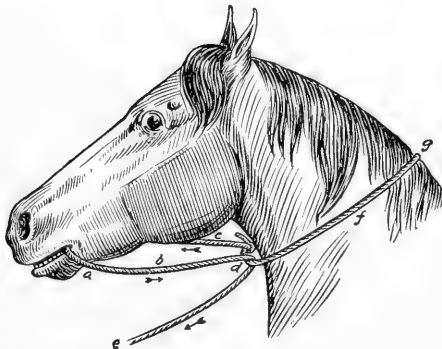
The Bonaparte "war bridle," Figure 22, is one of the most popular and widely used "war bridles" that has ever been designed. It is also known as the double draw-hitch bridle. It gives at least three times more power than any other form of "war bridle," and is especially useful in handling and controlling large, powerful and vicious animals.

To make this appliance the cord (d) is tied securely around neck (c). Then bring the cord from below upwards. Now pass it over poll (e) and back through mouth (a) thence through the loop (F) and make traction from free end of rope. If desired to secure still more power the cord may be placed under the upper lip instead of through the mouth.

*Magner's "War Bridle."*

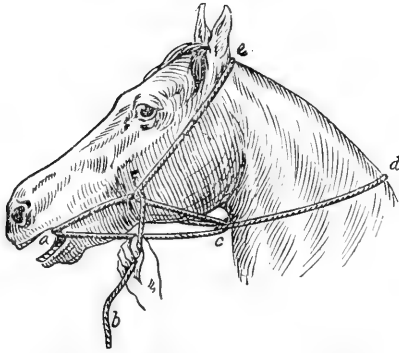
The Magner "war bridle," Figure 23, is made by simply making loop (a) around lower jaw and through mouth, after which pass free end of cord upward on off-side of head and over "poll" (b); then downward through loop (a) and make traction from free end of rope (c)

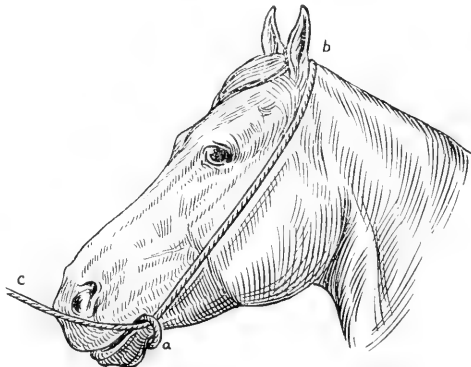

Fig. 23. Magner's "War Bridle."

*Magner's "War Bridle" Modified.*

Figure 24 represents Magner's "war bridle" modified. This bridle is applied by making a loop around lower jaw (a) with free end of rope on off-side; then over "poll" (d) downwards and through loop at lower jaw; thence under upper lip (e) back along side face on off side over poll again (d) down and through loop (b). Make traction from free end of rope (c).

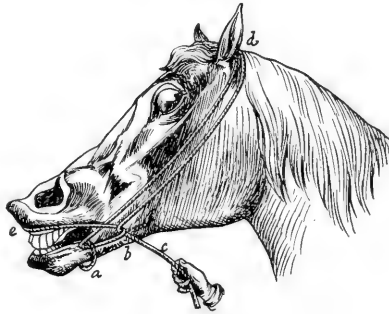

Fig. 24. Magner's "War Bridle" Modified

RESTRAINT AND DENTAL HALTERS.

Devices of this character are oftentimes useful in confining horses for minor surgical and dental operations. Inasmuch as the head does not require additional holding, these halters dispense with the services of at least one assistant. There are several good and substantial halters made for this purpose. The principal ones are as follows:

*Lucas' Dental Halter.*

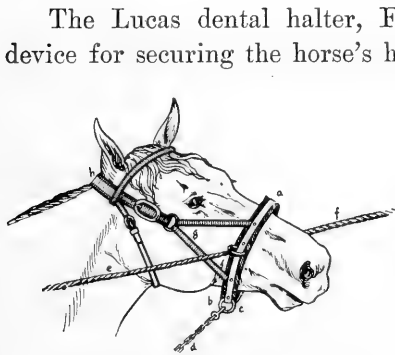

Fig. 25. Lucas' Dental Halter.

The Lucas dental halter, Figure 25, is a very desirable device for securing the horse's head in almost any position for minor surgical operations and dental work. It was designed by George H. Lucas, Veterinary Dentist, of Toronto, Canada, and consists of (a) metal nose band (a) hammered into proper shape. This nose band is well padded with felt or other soft material. The nose band is con-

nected with the heavy two-inch overhead or "poll strap" (h) by means of two 6-inch doubled and stitched straps (g). There are two side rings into which the two side ropes or straps (e) (f) are fastened. These side ropes or straps are fastened securely to a post on each side of the head to prevent movement of head from side to side. At bottom of nose band is a ring (c) into which is attached the chain martingale (d). This martingale is to fasten into a strong surcingle and prevent upward motion of the head. The Lucas dental halter, when properly adjusted, will effectually prevent the head from movement to either side or upwards.

*Fehr's Dental Halter.*

Fehr's dental halter, Figure 26, is an effectual device for holding the animal's head steady while performing minor surgical operations about the head, and dental work. It is simple and light, consisting of only four pieces.

The semi-circular metal nose band is covered with either rubber tubing or leather. The covering is held securely to the nose band by metal clamps to which are attached the suitable rings for attachment of the heavy over poll strap and the side ropes or

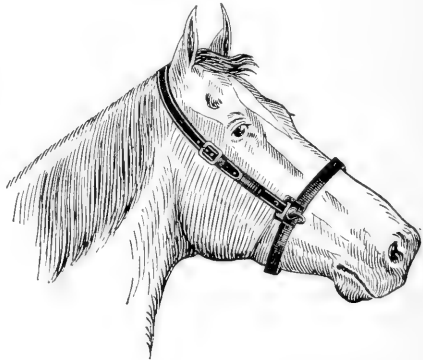

**Fig. 26. Fehr's Dental Halter.**

straps which are to secure the head on each side to post or sides of stall. All straps and ropes are adjustable. The apparatus is readily cleaned, and on account of its lightness and compactness may be easily transported.

*Ellis Combination Surgical and Dental Halter.*

The Ellis combination dental and surgical halter, Figure 27, is an appliance for fixing the head in certain positions for minor surgical operations and dental work. This halter possesses several original features which are valuable in restraining the head. The principal feature is the "lip strap" (b) to which the pillar or side reins (g) are attached. These suspend the head at the proper height and prevent side to side movement. The nose band (a) is metal, non-compressible and heavily padded. There are offsets in the nose band which hold the cheek pieces of the halter  $2\frac{1}{2}$  to 3 inches from the cheeks of the horse. The cheek pieces are doubled and very strong. The "lip strap" is covered with rubber. There is a piece of forged steel (c) into which a substantial martingale (e) is snapped (c). The side reins (g) are 7 feet long and can be of either sash cord, leather or chain. The halter is made of fine russet leather, rawhide, and metal with brass mountings.

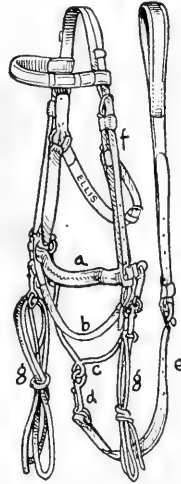

Fig. 27. Ellis Combination Halter.

*Directions for Its Application.*

After backing the horse into his stall in the usual manner for work upon the teeth, drop off the stable halter and apply the "combination" halter to the head, unbuckle the lip-strap on one side, pass it under the upper lip over the incisor teeth and buckle quite tight. Elevate the head by fixing the side or pillar reins to the stall-posts on each side as high up as you can reach; then tighten the strap leading to the surcingle which is provided with a buckle, thereby lowering the nose to a height convenient to the operator. If the stall chances to be excessively long, place a rope across it behind the horse before backing him in, for him to rest back against, and he positively cannot move, and you can operate upon the teeth and mouth with an ease and precision that is most satisfying.

## CHAPTER III.

### RESTRAINT HARNESS AND OTHER LEATHER AND ROPE APPLIANCES.

By the use of certain appliances made from leather and rope we are enabled to successfully confine or restrain one, two, or even all the legs of a horse in the standing posture. The particular pattern of apparatus varies according to the ideas or fancy of the individual surgeon in conjunction with the amount and character of restraint required. Of course, it is understood that the twitch is a necessary adjunct to all of the following methods of restraint.

#### RESTRAINT OF ONE FORELEG.

When it is desired to confine only one fore leg it can best be done by use of some form of knee strap. One of the best knee straps is represented by Figure 28. This pattern has been used by the author for a number of years. The straps are both two inches wide and made from first-class harness leather. To make them stronger they are doubled and stitched. The smaller strap (b) is applied between ankle and pastern. It is securely stitched into blank buckle (d) (e). A buckle (a) is inserted two inches below blank buckle (d). This strap is lined with soft leather or lamb skin to prevent chafing. When applied, the blank buckle (d) (e) takes all the strain off the main buckle (a). On the opposite side of the blank buckle (e) (d) is applied the main strap (g) (h), which fastens over the forearm when in use. This strap is adjustable and very satisfactory and convenient.

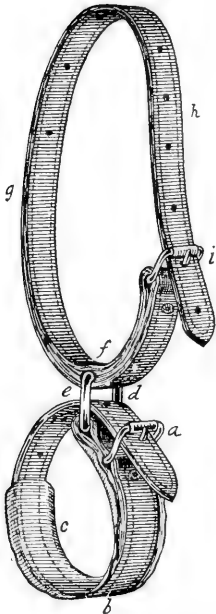

Fig. 28. Author's Knee Strap.

*Trasbot's Knee Strap.*

The knee strap designed and used by Trasbot, Figure 29, consists of a leather strap two inches wide and four feet long (d), pierced with a sufficient number of holes to render it adjustable to any size horse. At one end is a heavy blank buckle (c); on one side about ten inches from the blank buckle is a heavy and strong buckle (a). The strap (d) running through the buckle (c) forms a loop, which is applied around pastern and then wound around fore arm. It is then fastened in the buckle (a).

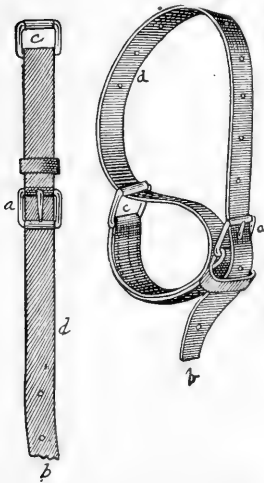

Fig. 29. Trasbot's Knee Strap.

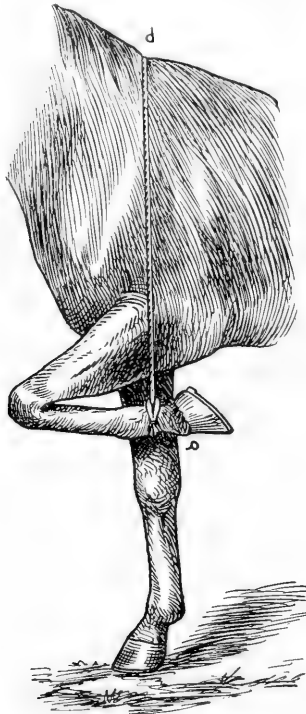

Fig. 30. Foot Held by Means of Rope.

Another method of holding one fore foot up, Figure 30, is to loop a rope around pastern and have it held over the withers (d) by an assistant. This is a safe method to the animal on account of the rapidity with which the leg can be released.

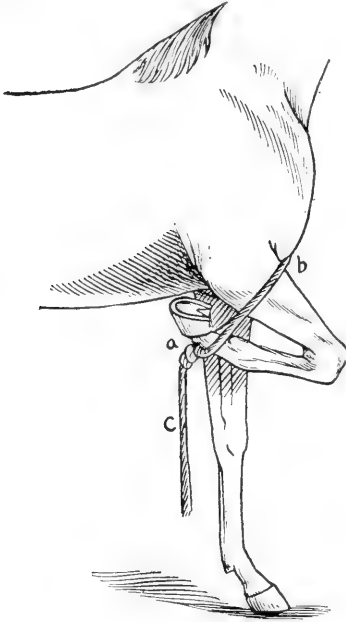

Fig. 31. Fixing Pastern to Forearm With Rope.



Fig. 32. Hess' Knee Strap.

Another method is to simply fix pastern (a) to the forearm (b) as shown in Figure 31. This is a simple as well as an inexpensive method of confining the fore leg.

#### *Hess' Knee Strap.*

The Hess knee strap, Figure 32, is made of a heavy leather strap  $2\frac{1}{2}$  to 3 inches wide. At one end is a strong buckle. About 8 inches below this end buckle a blank buckle is placed. The main strap is about 36 inches long, and is applied by looping bottom section of strap around pastern, then pass the strap between pastern and fore arm, thence around fore arm to buckle.



Surcingle and strap method, Figure 33, is simply a surcingle (d) applied tightly around chest. The strap is placed

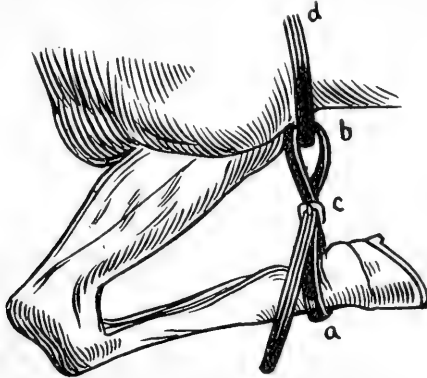

Fig. 33. Surcingle and Strap.

around pastern (a) by means of a loop, then it is passed through buckle (c), thence upward under surcingle (b), then down until it reaches buckle again.

#### RESTRAINT OF ONE HIND LEG.

The object of restraint or control of one hind leg is principally to prevent kicking. However, such restraint oftentimes has the effect of diverting the animal's attention and causing it to remain quiet while an examination is being made or a minor operation performed. The twitch must always be used in connection with any side line method. The hind leg may be controlled in a variety of ways. The principal ones are as follows:

##### *Hock Twitch.*

The hock twitch, Figure 34, is for the purpose of preventing the animal from flexing the hock. It is made from a heavy piece of rope 18 to 22 inches long, with a loop or opening in each end through which a stick of wood about 1½ inches in diameter and 12 inches long is thrust. This twitch is placed around leg from 4 to 6 inches above the hock and tightened by rotating the stick of wood.

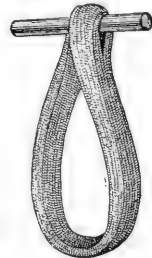

Fig. 34.  
Hock Twitch.

The tail can be utilized in connection with restraint of one hind leg, Figure 35. This is done by a special form of knot which will not slip when the weight is thrown on the tail,

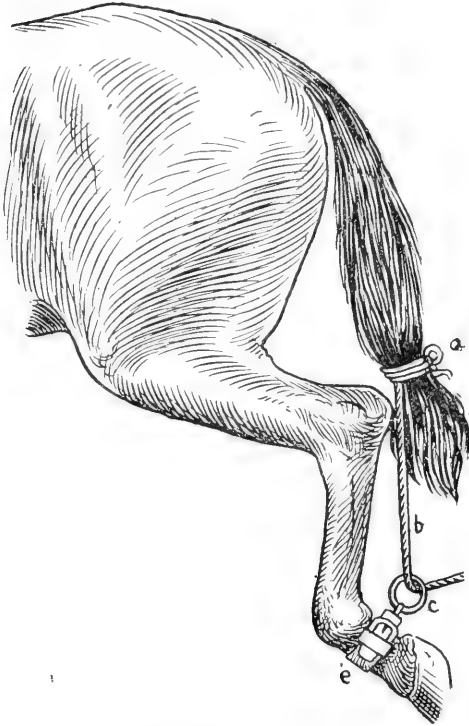

Fig. 35. Utilization of Tail in Restraint of Hind Leg.



Fig. 36. Tail Knot for Hind Leg Rope.

Figure 36. After securely fixing rope (b) to tail (a) it is then passed through the ring (c) of hobble strap. The foot can be raised in the backward position by making traction on free end of the rope.

Restraining the hind leg by sideline, Figure 37, is best done by using  $\frac{3}{4}$ -inch cotton rope; however, manilla, or sisal rope or webbing will answer the purpose. Loop rope around pastern (a), the free end is then carried under chest between fore legs; then upward and back of shoulder on opposite side; thence over back (c) and down behind elbow on the side of the

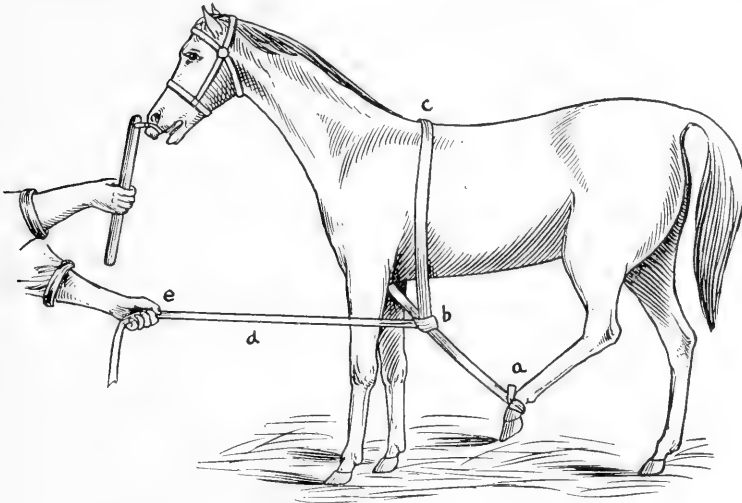

Fig. 37. Restraining One Hind Leg by Side Line.

leg which you desire to restrain. Draw hind leg up and make about two wraps around the rope (b). This will prevent the ropes from slipping. Hold free end of rope (d) with one or both hands (e).

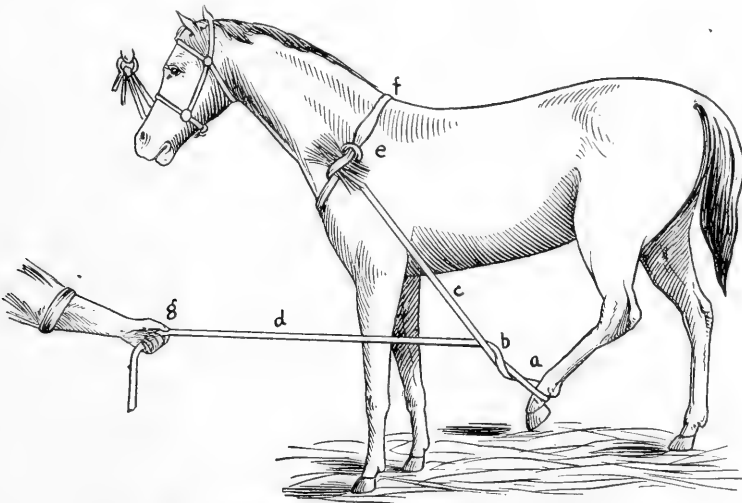

Fig. 38. Restraining One Hind Leg by Side Line.

Another method of restraining one hind leg by side line, Figure 38, is by tying the  $\frac{3}{4}$ -inch rope around the neck (f) (e), then pass rope (c) down to and around the pastern (a) which you desire to restrain. If you use a hobble strap the rope (c) is simply passed through the ring. Raise foot by making traction on free end of rope (d). Fix rope to prevent slipping by making one or two wraps (b).

Restraining one hind leg by means of surcingle and rope is done by (Figure 39) wrapping rope (b) (d) twice around fore legs below elbows, then fix by tying. Now bring rope upward

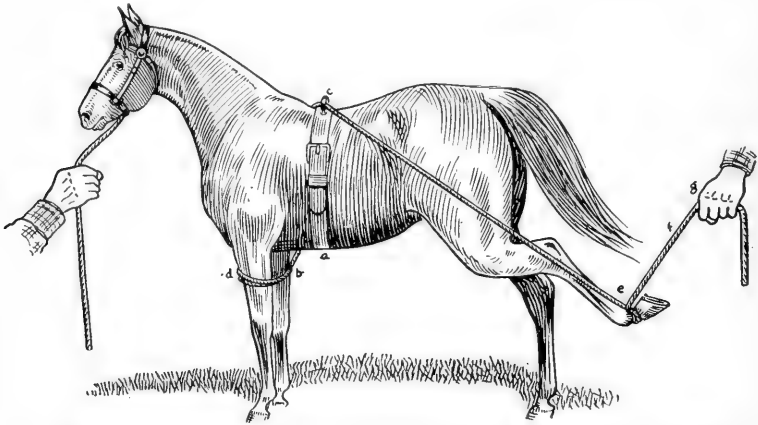

Fig. 39. Restraining One Hind Leg by Means of Surcingle and Rope.

through ring in surcingle (c); then pass rope downward and backward to pastern of leg which you desire to restrain. If hobble strap is used pass rope through ring. If no hobble strap is used simply wrap the rope around pastern (e), raise foot by making traction on rope (f).

Merillat's side line, Figure 40, consists of a hobble strap, a  $\frac{3}{4}$ -inch rope 20 feet long, and a special leather collar. The rope is attached to the bottom of collar (c). Collar is then put on horse, after which carry rope (d) down to and through

hobble ring (f), then upward (e) through hole in collar (a); by making traction on rope (g) the foot is lifted and held off the floor. The advantage of this method is that should the animal lunge or fall, the leg may be released instantaneously.

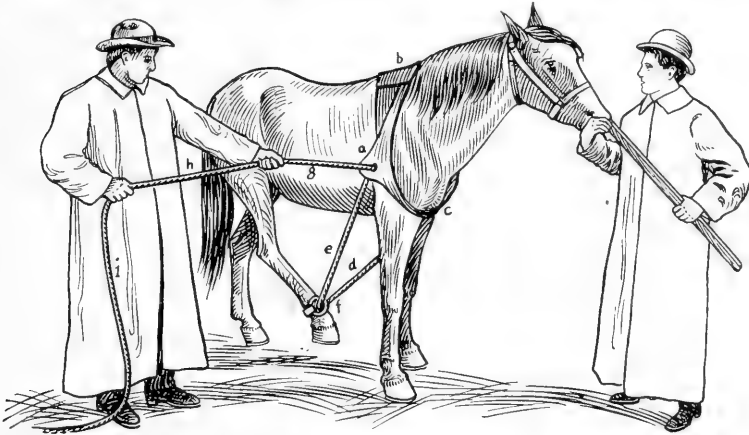

Fig. 40. Merillat's Single Side Line.

Another method of securing the hind leg, Figure 41, is by tying rope around neck with knot over withers; then carry

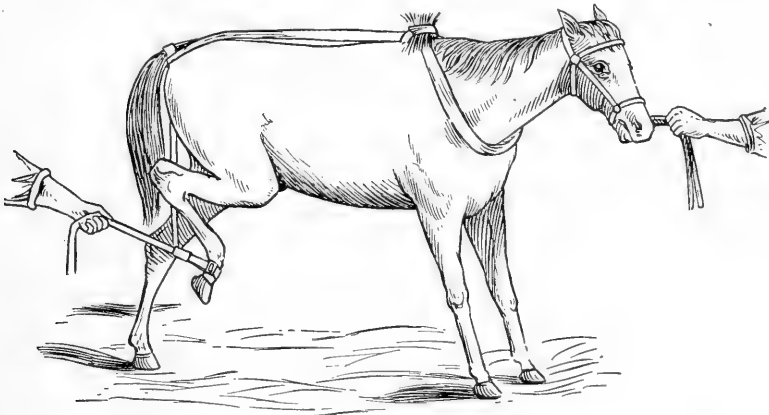

Fig. 41. Restraining One Hind Leg in Backward Position.

rope back to and around root of tail; thence downward to pastern; then back through hobble ring. Make traction on

free end of rope and the foot will be lifted from floor. By this method the weight is thrown almost entirely on the hips and back.

The German method of restraining one hind leg, Figure 42, is by first applying a heavy leather collar (h) (g). Then slip leather strap or rope loop (d) over tail. Now carry tail through loop in crupper strap (e) and fasten crupper strap

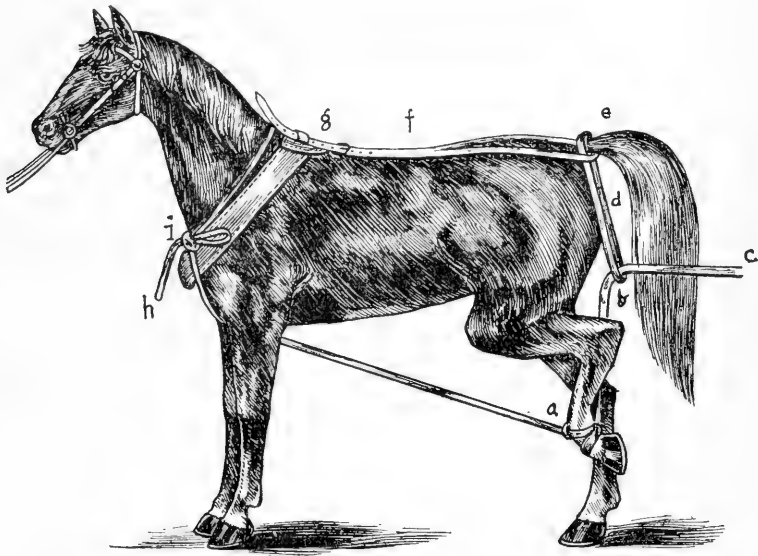

Fig. 42. German Method of Restraining One Hind Leg.

(f) to collar (g). Tie rope around neck with knot in front of chest (i); then carry rope between fore legs to and through ring (a) in hobble strap. Now carry rope up to and through loop (b) and make traction from free end of rope.

Another method of restraining one hind leg, Figure 43, is by looping rope or strap around leg above ankle (a); then carry rope or strap (b) upward to the opposite side and around chest

(e) (d). Then twist or wrap the rope around the other rope (b) behind elbow (c) and make traction on free end of rope (f).

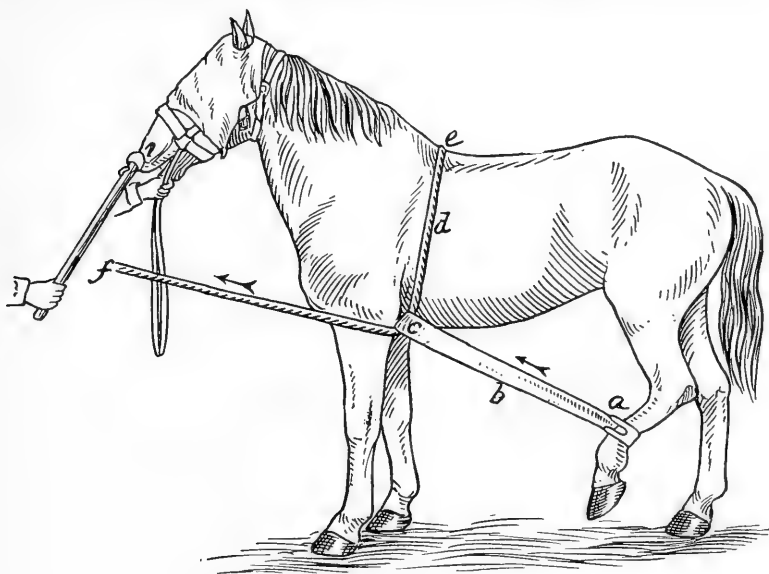

Fig. 43. Restraining One Hind Leg.

To restrain the leg in backward position, Figure 44, the rope is tied around neck (c) (d) with knot about middle of

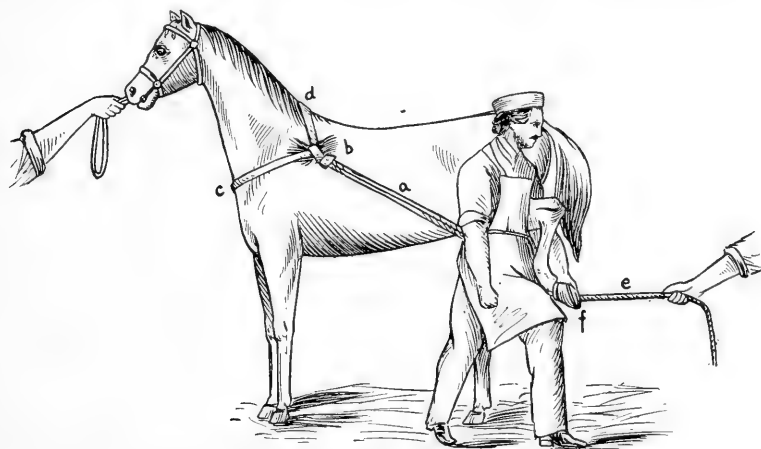

Fig. 44. Restraining Leg in Backward Position.

shoulder (b); then carry rope (a) downward to and through hobble ring (f). Instead of making traction forward the pull is made from behind. This raises foot and draws it backward. When using this method it is best to have an assistant to support the animal.

Another method of restraining the hind leg, Figure 45, is to buckle heavy surcingle (a) around horse; then loop rope around ankle (d) and fix it there in such a manner as to prevent the rope from slipping. Now pass one free end (c) through ring

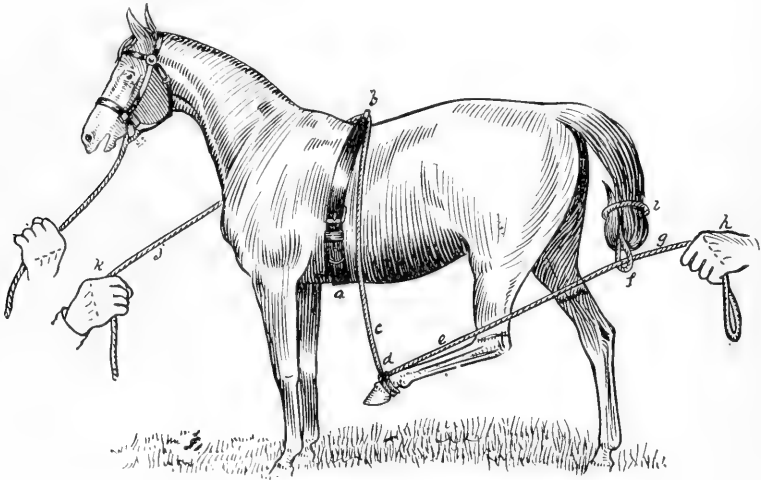

Fig. 45. Securing One Hind Leg Forward.

of surcingle (b) on top of back; then carry rope (e) backwards to and through tail loop (f). Make traction on front rope (j) to raise foot and draw it forward. Then make traction on back rope (g). In this position the animal is unable to move the leg either forward or backward.

#### RESTRAINT OF BOTH HIND LEGS.

The purpose of restraining both hind legs is to prevent the animal from kicking. This method of restraint is demanded



principally for breeding purposes. Restraint of this character will prevent a mare from injury to stallion during service, besides it is useful to the surgeon in making examinations and in performing operations upon the posterior parts of an animal.

The German apparatus, Figure 46, is for the purpose of preventing kicking by lifting or raising both hind legs off the floor. Two pieces of metal are made—one to fit over root of tail (e), the other to have loop near end of tail (d). Between these two metal parts are several strands of rope (f). A heavy strap is fastened around each hind leg, between the hock and stifle (d) (a). By means of a block and tackle (b) (c) the hind quarters are lifted sufficiently to get the hind feet clear of the floor.

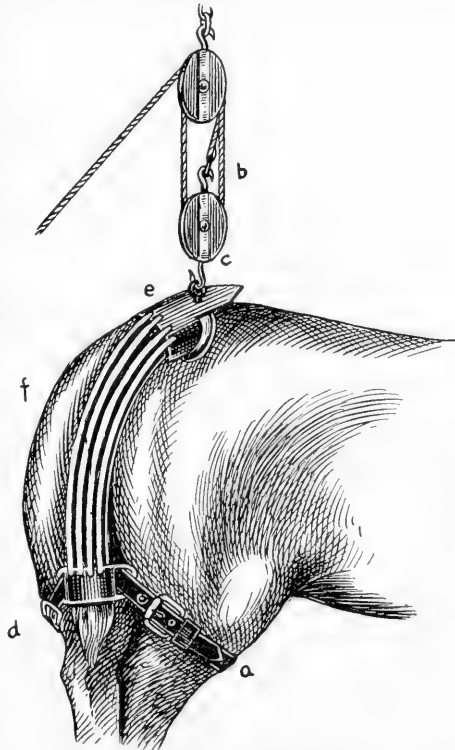

Fig. 46. German Apparatus for Lifting Hind Legs off the Floor.

#### *Wocher's Service Hobbles.*

These hobbles, Figure 47, will prevent kicking in every instance. They can be quickly applied and easily removed. They are made of good leather and rope and are strong, safe and durable. The parts are a heavy leather collar to the bottom of which is two doubled and stitched leather straps. These straps are punched with a sufficient number of buckle

tongue holes to render them thoroughly adjustable. To the two front straps are buckled the connecting rope from hobble rings.

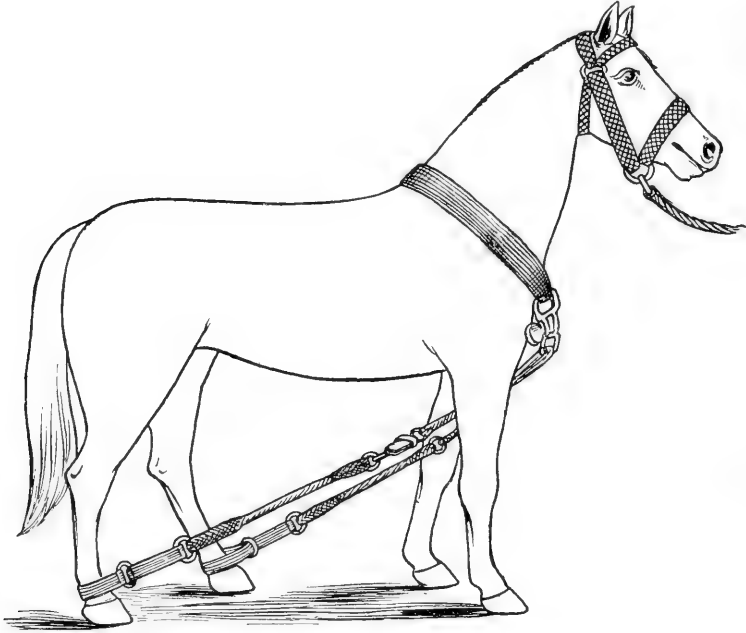

Fig. 47. Woche's Service Hobbles.

The Ewell Farm Service or Anti-Kicking Hobbles, Figure 48, are made by using a 4-inch leather collar (1) to which is securely fastened (k) the main strap. This strap passes between the fore legs to connect with the main buckle (i). The main strap is 2 inches wide and contains a sufficient number of buckle tongue holes to render it adjustable for any size animal. On each hock are two straps (c) (b) fastened at each end to a ring (a). These two rings are brought together and fastened into a heavy snap (e) (d). A 1-inch rope (f) running through a wooden pulley (g) connects the two heavy snaps which carry hock straps or hobbles. The main buckle (i) is fastened to the

pulley (g). By means of this arrangement the animal is enabled to walk or move in almost any direction; however, kicking is rendered impossible.

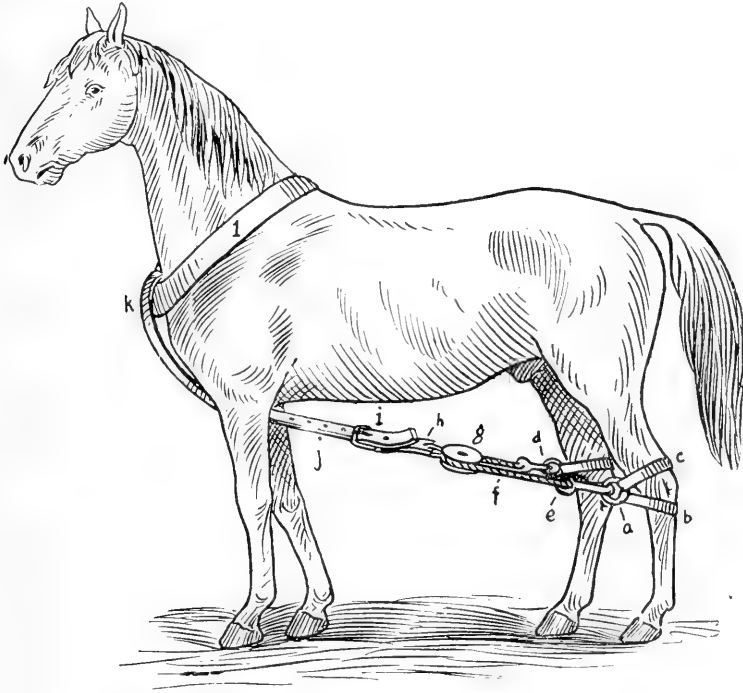

Fig. 48. Ewell Farm Service or Anti-Kicking Hobbles.

The rope and hobble method of restraining both hind legs, Figure 49, is easily and quickly applied. It is very effectual in prohibiting kicking. This device is made by applying a hobble strap to each hind pastern (a) (b). Connect the two hobble strap rings by means of a rope (c). This rope is then passed upward and forward between fore legs; thence upward on outside of shoulder on opposite side, and back over withers (f); then down and around rope (d) behind elbow. The free end of rope (g) is held by an assistant.

## RESTRAINT OF ALL FOUR LEGS.

We are called upon to restrain all four legs to prevent kicking as well as to prevent striking or pawing. This means of restraint oftentimes takes the place of stocks for restraint in the standing posture.

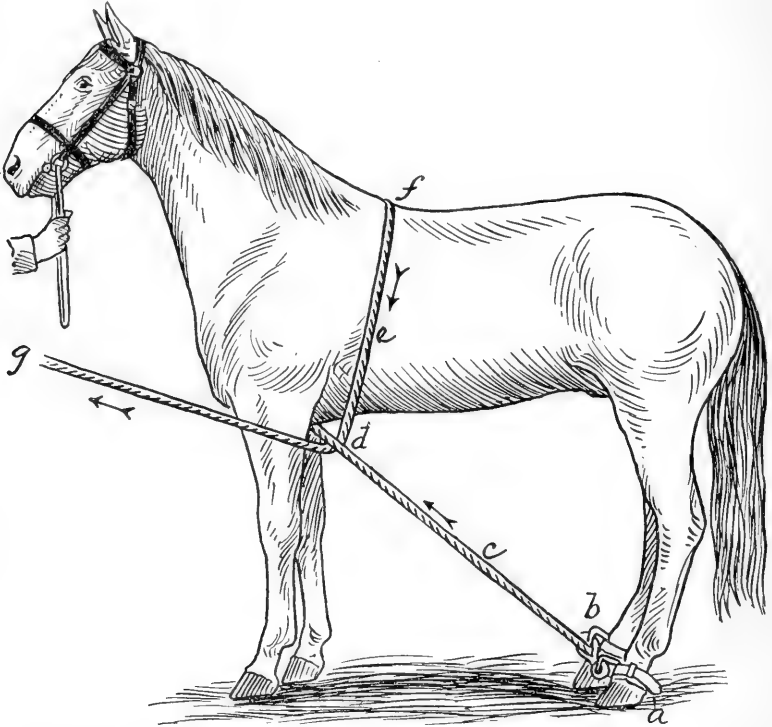

Fig. 49. Rope and Hobble Method of Restraining Both Hind Legs.

*Web and Rope Method.*

This appliance, Figure 50, when used properly, will effectually prevent an animal from using either of its four legs. The web rope should be made from either manila or sisal fiber. The total length should be from 22 to 25 feet. Begin with a heavy ring (c) and make the first 14 feet of web (d) 4 inches wide. The next 8 to 11 feet should be rope (a) (e)  $\frac{3}{4}$ -inch in

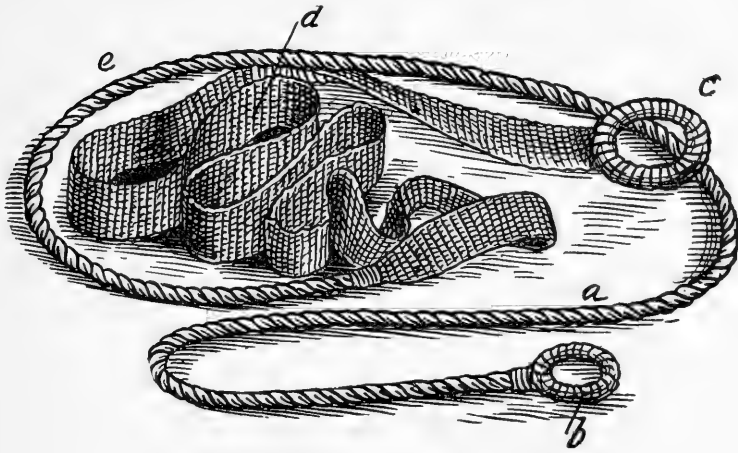

Fig. 50. Web and Rope Apparatus.

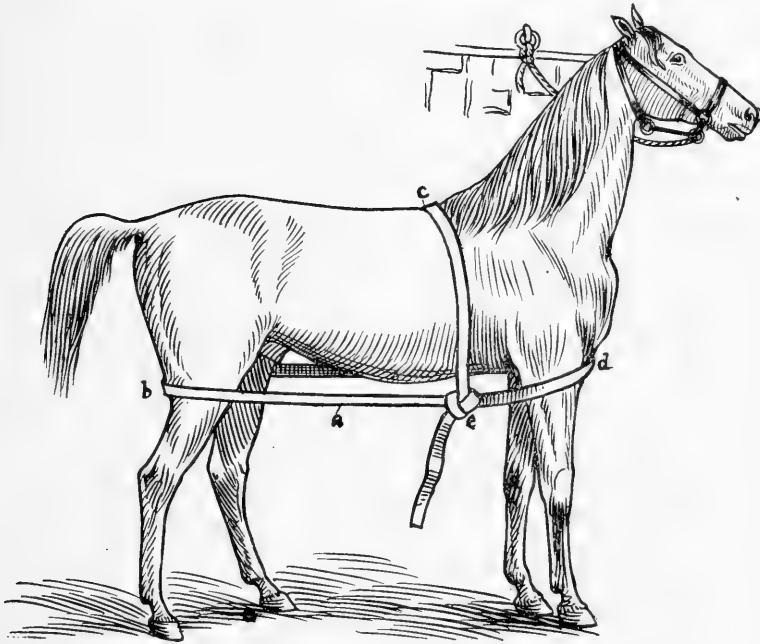

Fig. 51. Web and Rope—Plate Longe Applied to all Four Legs.

diameter; at the end of this rope is attached another heavy ring (b). This apparatus is applied by carrying the rope around the horse immediately above hocks and knees. After making it snug and tense against all four legs it is tied together at ring in the web end; the rope end is now carried over back and tied into web part on the opposite side; then carried under abdomen and tied in the ring or web end of rope.

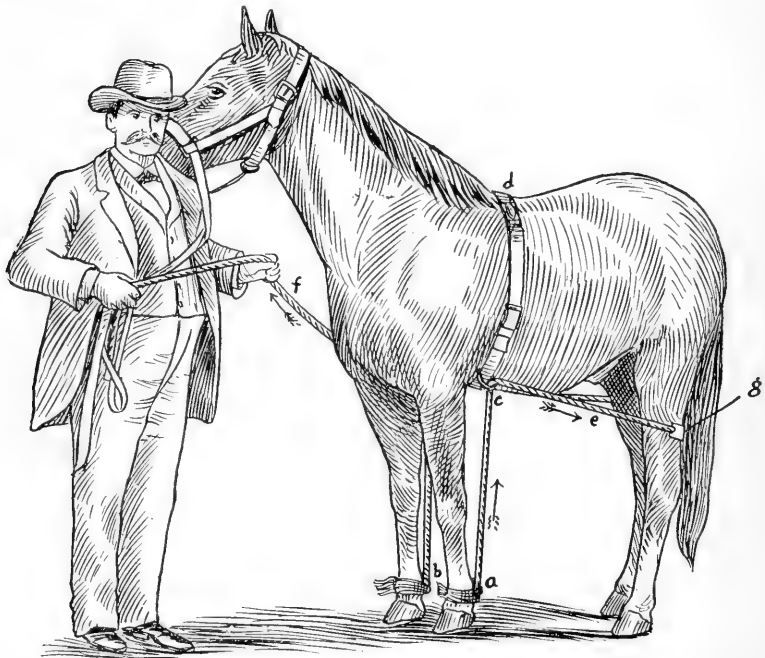

Fig. 52. Morgan's Method of Restraining All Four Legs.

Figure 51 will give a comprehensive idea of the proper way to apply and use the web and rope apparatus illustrated in Figure 50. This apparatus is applied by beginning with the rope on near side of horse about opposite the chest; pass it forward across the forearm of that side; then in front below breast (d) across forearm of off side; thence backward across thigh (b) well above hock; then pass it back of animal across other thigh to the starting point. It is here made secure. To

prevent it from slipping down the end of rope is thrown over back (c) and secured by a knot.

*Morgan's Method.*

The Morgan Method, Figure 52, is manipulated by means of surcingle, rope and two hobble straps. The rope should be  $\frac{1}{2}$ -inch in diameter and 20 to 25 feet long. Begin by attaching rope to hobble strap of near fore leg (a), pass upward to and through ring (c) in surcingle; then backward above hocks

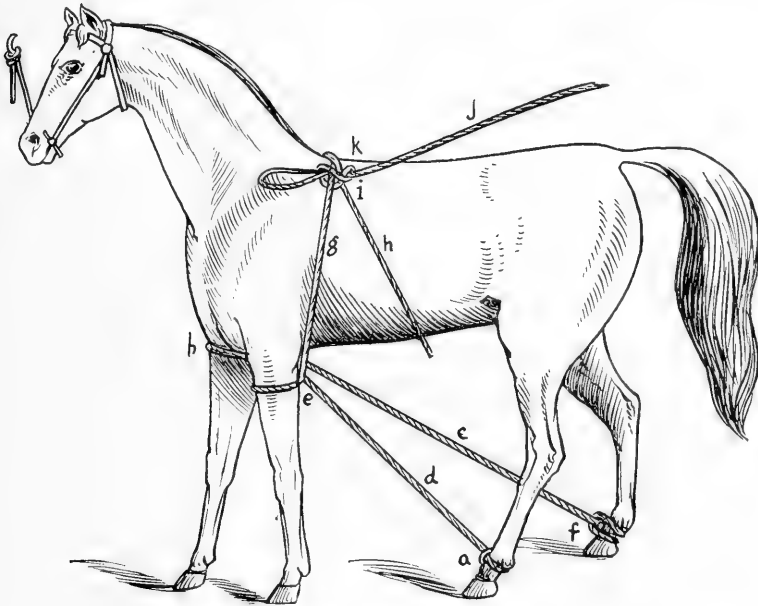

Fig. 53. Rope Method of Restraining All Four Legs.

(g) to and through ring in surcingle of opposite side; thence down to hobble ring of left fore (b) leg. The rope is now carried back to and through surcingle ring. Traction sufficient to prevent kicking is brought on free end of rope (f).

*Rope Method.*

To apply the rope method, Figure 53, two  $\frac{5}{8}$ -inch to  $\frac{3}{4}$ -inch cotton, manila or sisal ropes, each 15 feet long, are necessary.

Loop the ropes to each hind pastern (a) (f), or, if hobble straps are available, the ropes are fastened into the hobble rings. Then carry ropes (c) (d) upward, behind elbows (e) (h); thence from within outward under the preceding part of rope (e) and upward (g) over withers (k). The two ropes are then tied together (i), which completes the rigging.

*Galvayne Method.*

The Galvayne method of restraining all four legs of the horse, Figure 54, is by means of a single rope of the proper size and length. This rope is looped or wrapped around both

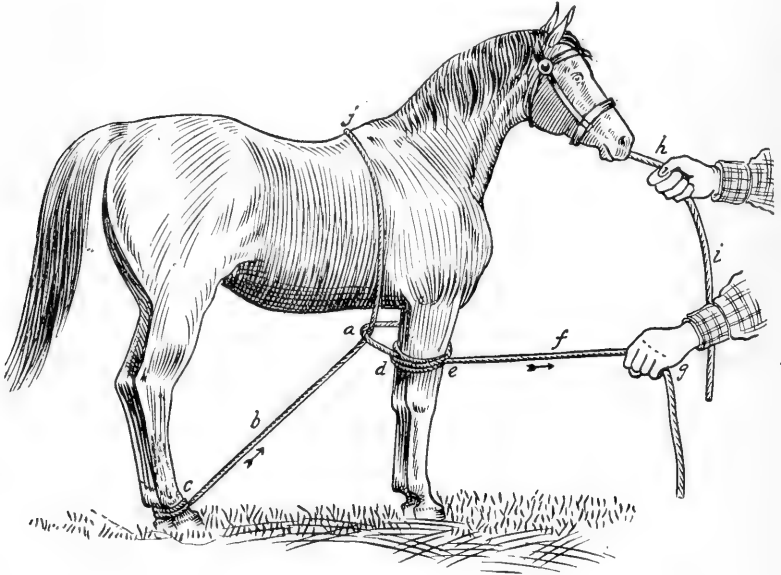

Fig. 54. Galvayne Method of Restraining All Four Legs.

hind pasterns (c); then pass rope (b) upward to and over withers (j); then down below elbow on opposite side; thence several times around both forelegs, at the same time taking in the main part of rope (b) immediately behind the elbow (a). This appliance will effectually prohibit kicking and striking.



*Hippo Lasso.*

By means of the Hippo Lasso, or Equine Straight Jacket, nervous and even vicious animals may in a short time be rendered docile and safe. There are several different designs of the Hippo Lasso; however, the result obtained by use of either one of them is the same. To prevent being kicked the hippo lasso is sometimes used preparatory to applying hobbles.

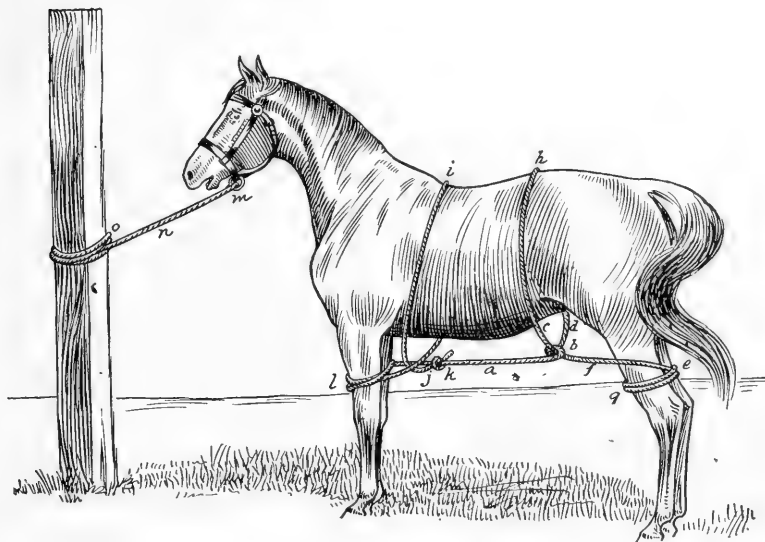

Fig. 55. Galvayne Method of Restraining All Four Legs.  
(The Galvayne "Straight Jacket.")

*Galvayne's Rope Hippo Lasso.*

The rope hippo lasso of Galvayne, Figure 55, will effectually confine all four legs of a horse, in the standing posture, with a single rope. It is possible to put this apparatus on vicious horses, even those which are wild and unbroken. It can be applied without injury to the animal or danger to the operator. As a means of subjection and restraint this equine straight jacket of Galvayne is second to none.

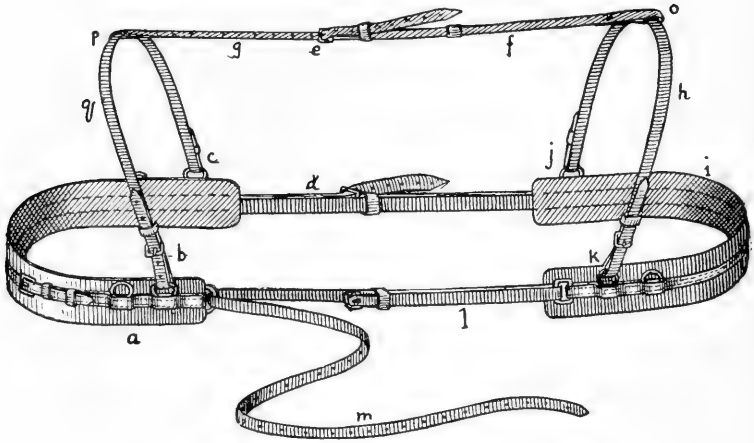

Fig. 56. Raabe's and Lunel's Hippo-Lasso.

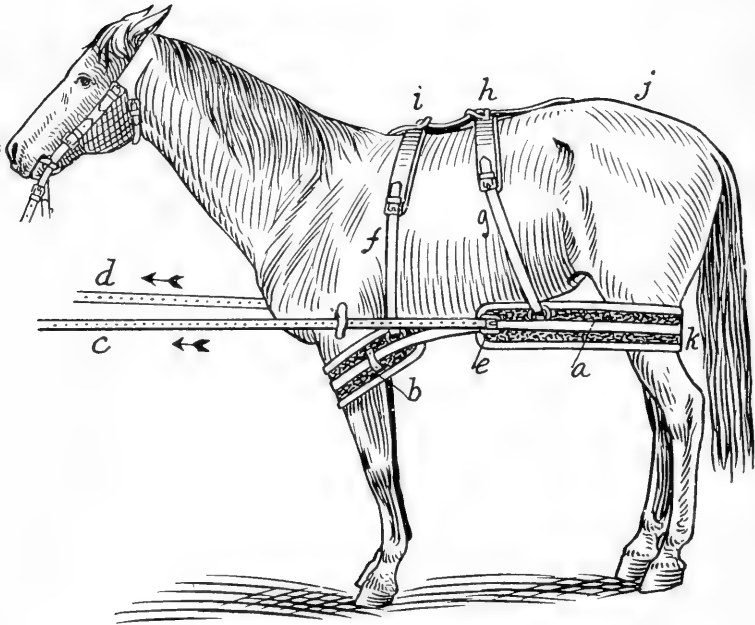

Fig. 57. Hippo-Lasso Applied.

*Raabe's and Lunel's Hippo Lasso.*

The hippo lasso of Raabe and Lunel, Figure 56, is composed of two principal parts, viz.: breast collar and breeching strap. These are joined together by two long side straps (e) (d). The breeching is suspended by a leather strap (g). This strap is buckled on each side to the breeching strap (b) (c). The breast collar (i) is also suspended by a similar strap (h) and is attached on each side by buckles (j) (k). The over-neck strap (h) and over-hip strap (g) are connected by an adjustable back strap (g) (f).

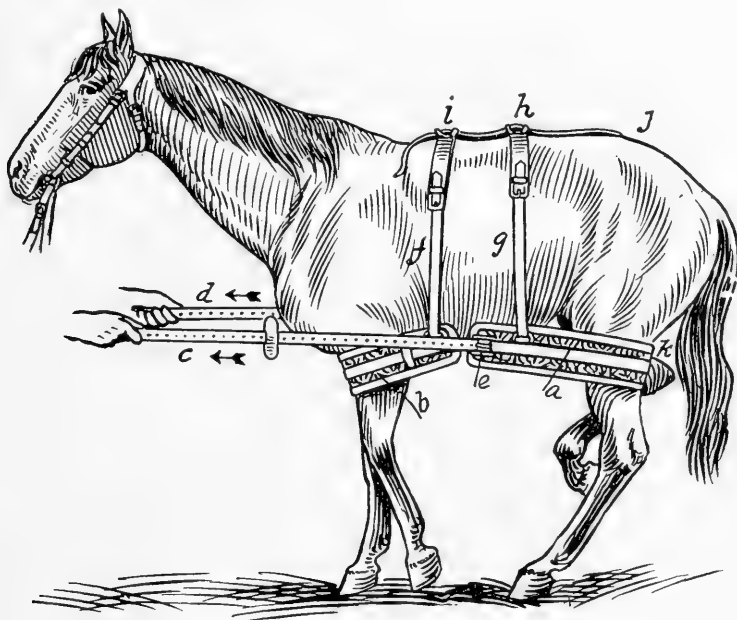

Fig. 58. Hippo-Lasso in Action.

Figure 57 represents the hippo lasso applied. The breast strap (b) is dropped down between knee and elbow. The breeching strap (a) (k) is dropped down between hock and stifle. The breeching and breast straps are suspended by over withers strap (i) and over back strap (h).

Figure 58 represents the hippo lasso in action. Tension

is being made on long side straps (c) (d) and the breeching band is being brought firmly against the hind legs of the horse.

*Belmont Rider Harness.*

The Belmont rider harness, Figure 59, is a heavy and strong hippo lasso. It is adjustable in all directions and affords a

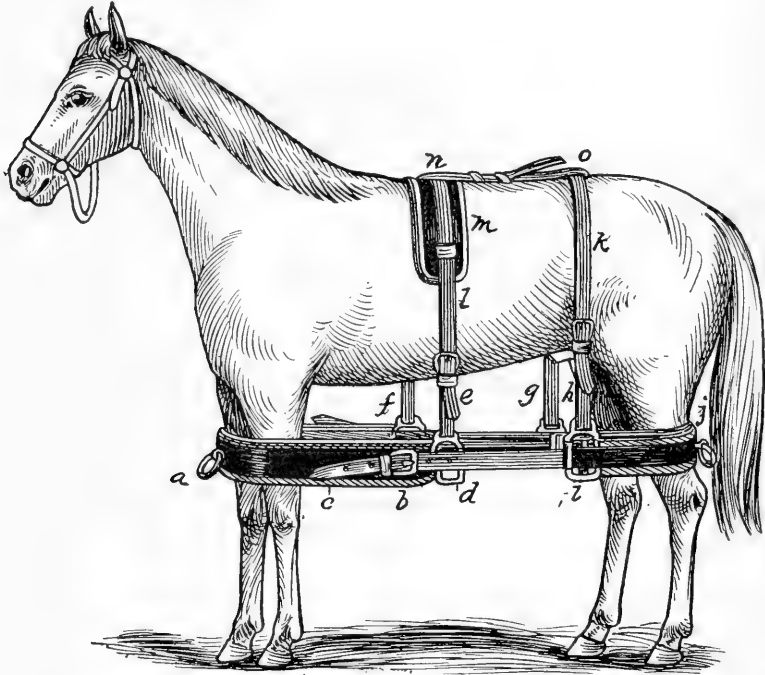

Fig. 59. Belmont Rider Harness.

convenient and safe method of restraining a horse in the standing posture.

*Gleason's Restraint Harness.*

The restraint harness, Figure 60, is a pattern of leather hippo lasso used by O. R. Gleason. The whole apparatus is made of leather without buckles. The breast collar (a) which drops down almost to knees is 8 inches wide. The breeching strap (b) is 6 inches wide and drops down almost to hocks. The

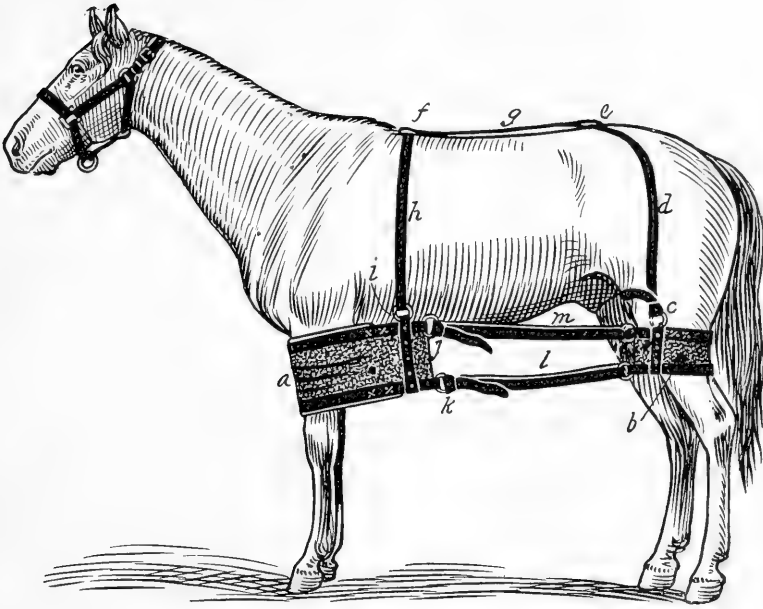

Fig. 60. Gleason's Restraint Harness or Hippo-Lasso.

withers strap (h) and hip strap (d) are connected by a back strap (g). These withers and hip straps support the breast and breeching straps. Two straps on each side run from breeching strap to rings in the breast strap and connect these two parts. The straps are all adjustable and are "fixed" by knots.

## CHAPTER IV.

### STOCKS.

With some operators the stocks are a favorite apparatus for restraint of the horse in the standing posture. Other operators, equally as competent and experienced, are severe in their condemnation of the stocks as a means of restraint. In my opinion there are good reasons for both of these conflicting opinions. Some animals cannot and should not be confined in the stocks; some operations cannot and should not be attempted with the stocks as the only means of restraint. Some forms of stocks are worse than worthless, while other models are very desirable. Properly constructed stocks are safe and sane adjuncts to any veterinary operating room. We must all admit that accidents to the operator and patient do sometimes occur whenever and wherever stocks are used; but on the other hand, we are forced to admit that accidents sometimes occur to the operator and the patient when any of the other methods of restraint are used. The knee strap, side line, hobbles, casting harness and operating table all have their objections. None of them afford us perfect means of restraint. Accidents sometimes occur when using all or any one of them. Admitting that the above in regard to other means of restraint is true, then how can any one be justified in severely condemning the stocks. The stocks afford a quick and easy means of restraint. Without hesitation an animal is placed in the stocks; they are labor savers, time savers, and by utilizing the stock one assistant can successfully confine or restrain a patient for many minor and even some major operations.

#### *The Barcus Stocks.*

The Barcus stocks, Figure 61, is the product of an unique and original idea of restraint in the standing posture. It is especially useful in shoeing and operations on the soles of the feet. The frame of this stock is triangular in shape, which renders it exceedingly strong. The two sides of the frame (f) (e)

are separate and hinged to the wall. When not in use they are open wide apart and swing back against the wall. The body girth (g) is made of heavy canvas or cotton belting, and when tightened by the ratchet it lifts the horse partly off the floor. This body girth is 32 inches wide. By means of the automatic self-adjusting foot clamp (a) the foot of any wild, vicious or nervous horse can be grasped, secured, and held in any position

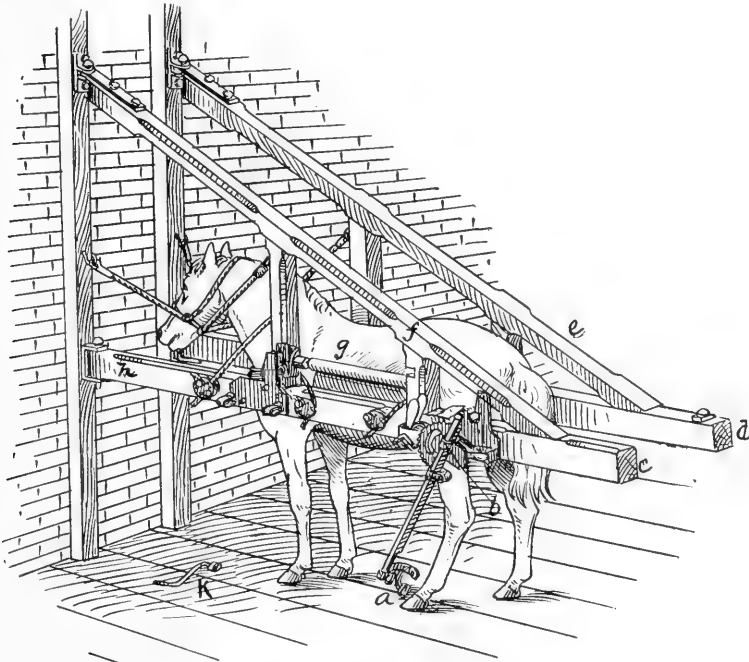

Fig. 61. Barcus Stocks.

with perfect safety to the operator. The castings are all malleable and are difficult to break. In placing a horse in this stock the head is tied to the wall, after which simply bring the two swinging sides of the stock together until they are against the horse. The forward movement of the animal is limited by a rope breast band which fastens by a cam. Lying down is prevented by the body girth which is tightened by a crank (k). The apparatus for controlling the foot consists of

a sliding or lifting bar, on the lower end of which is the automatic foot clamp. The sliding bar can be raised and locked at any desired height and then swung either forward or backward carrying the foot with it. On the side of the sliding or lifting bar is a rack, the cogs of which receive the locking bolt. It is constructed with an automatic self-locking, self-adjusting foot clamp, pivotly connected to the lower end of the sliding bar. With the automatic foot clamp the surgeon is in no danger of receiving a kick while fastening it to the foot. This clamp is self-adjusting and fits around any size pastern. The machine is provided with four supporting plates securely bolted to the frame immediately beside each leg of the horse, to these are locked, absolutely solid, the foot-handling device which is constructed in such a manner that the foot can be instantly released by simply raising the locking pall which unfastens

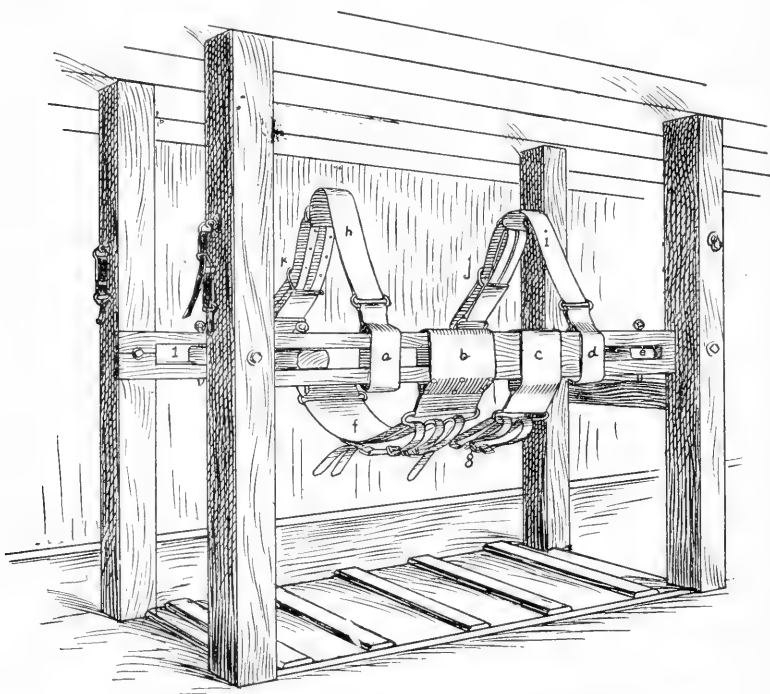

Fig. 62. McKillip Veterinary College Stocks.



the foot device and same can be as quickly adjusted and locked at either of the other supporting plates.

*McKillip Veterinary College Stocks.*

The stocks used at the McKillip Veterinary College, Figure 62, are strong and convenient. With them an animal can be

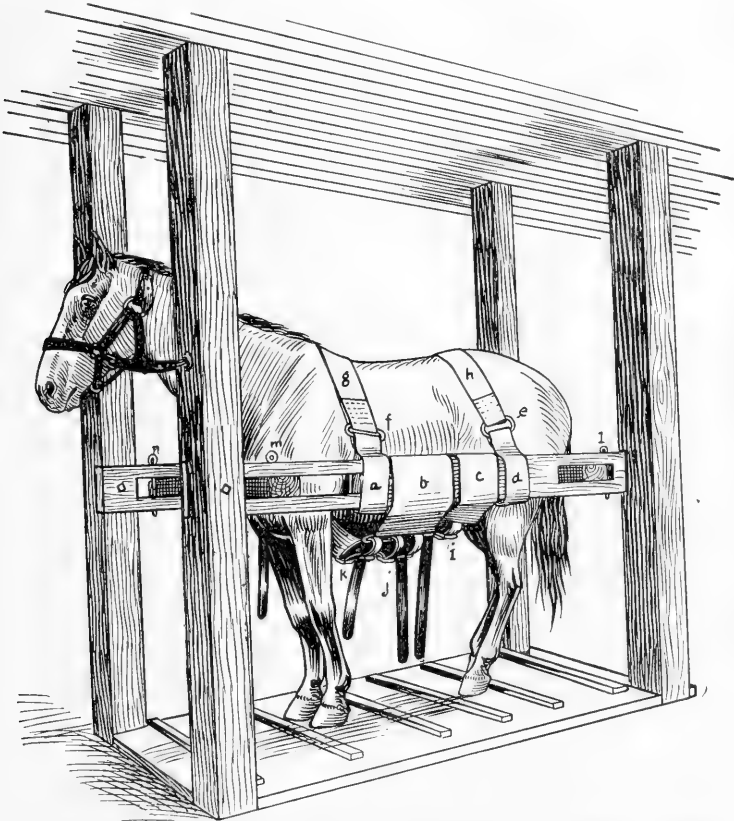

Fig. 63. McKillip Veterinary College Stocks with Horse Secured—Side View.

properly secured in the standing posture. They are made by securing four corner posts (6x8 inches) to both floor and ceiling. About 3½ feet from the floor these posts are sawed out to

accommodate the main (3x8-inch) side timbers. These side timbers are cut out, both in front (i) and behind (e), to accommodate the (3x8-inch) bars which are placed against the breast in front and hips behind. The girths (f) (g) are wide and made of heavy canvas or wide belting. The back straps (h)

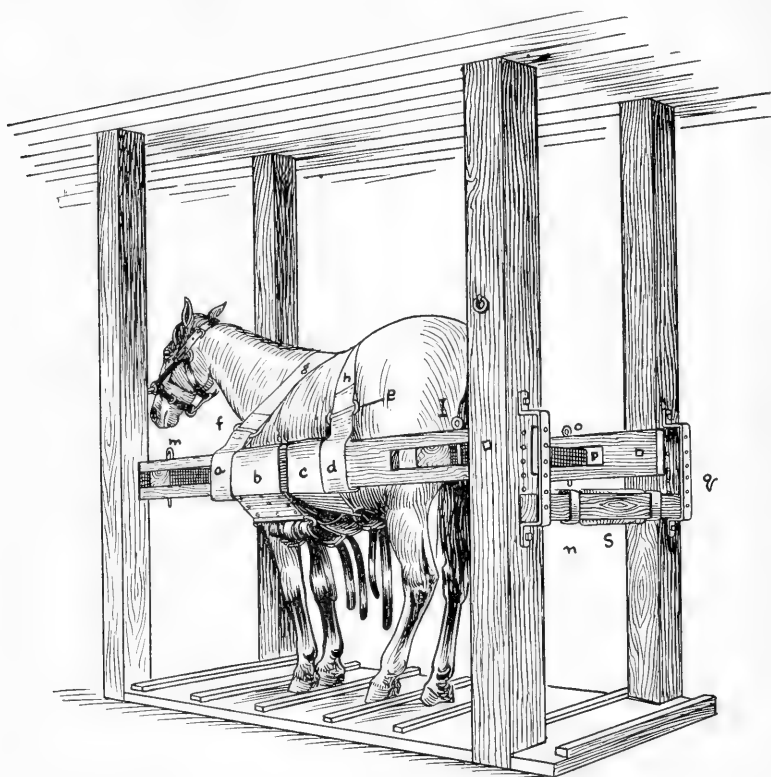

Fig. 64. McKillip Veterinary College Stocks—Side and Rear View.

(i) are also strong and made of the same material as that used in the girths. Figure 63 represents a side view of the stocks with a horse secured therein. It will be observed that the head is made fast on each side to the front corner posts of the stocks. The two girths (b) (c) are buckled under the abdomen. The two back straps are buckled on the opposite side. These prevent the animal from either lying down or rearing up, and

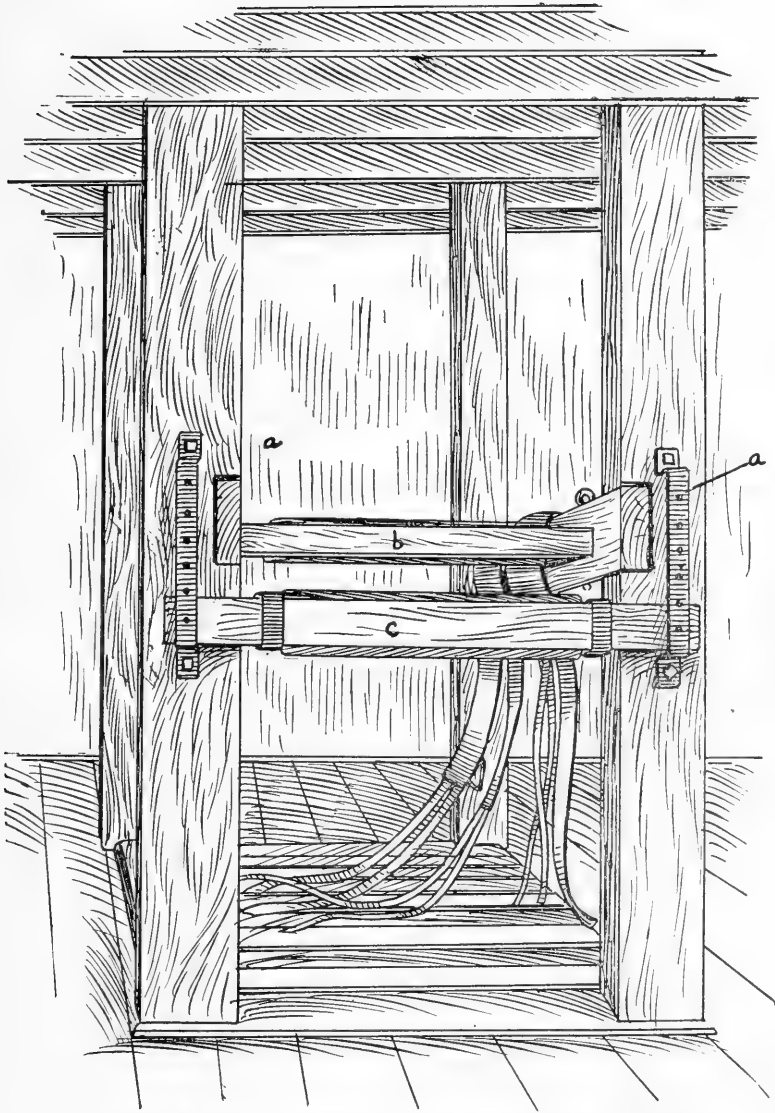

Fig. 65. McKillip Veterinary College Stocks—Rear View.

the cross bars prevent forward or backward movement. All parts are well padded on inside.

Figure 64 represents the rear and side view of the McKillip stocks. It will be observed that the cross bar behind the horse can be removed and the animal backed against the cross bar (s) on outside of rear corner posts. This places the posterior parts of the animal in an accessible position for examination and operation. The last mentioned position is especially convenient for all tail, rectal and vaginal operations.

Figure 65 represents rear view of the McKillip stocks and is self-explanatory. One advantage the McKillip stock has over many others is that by removing the three cross bars an animal may be led through the stock and back again, thereby dispensing with the troublesome practice of "backing them" in.

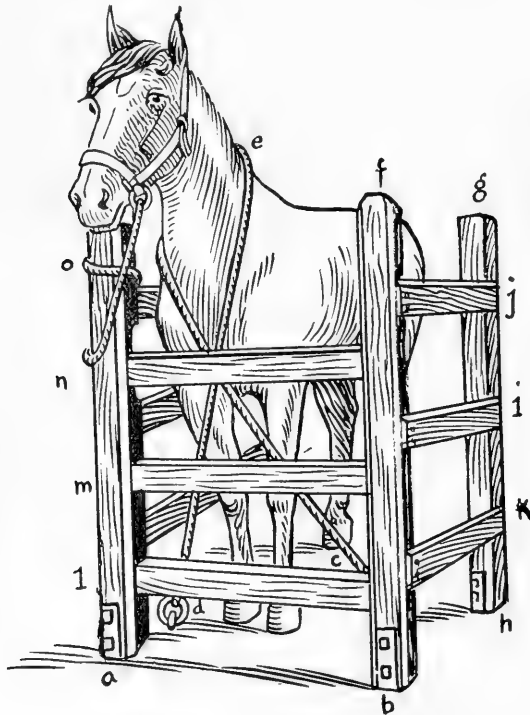

Fig. 66. Ordinary Wooden Stock.

Another advantage is that there is no obstruction between the operator and the legs and feet of the animal.

*Ordinary Wooden Stocks.*

Figure 66 represents an ordinary wooden stock. It is made by fastening four corner posts (6x6 inches) securely to the floor (a) (b) (h). The wooden timbers (i) (j) (k) (l) (m) (n) are firmly nailed or bolted to the corner posts. The horse is led into the stocks and the halter rein fastened to one of the four corner posts (o). A rope from the floor ring (d) is carried over withers (e) and back across to bottom of opposite post (c) and there secured.

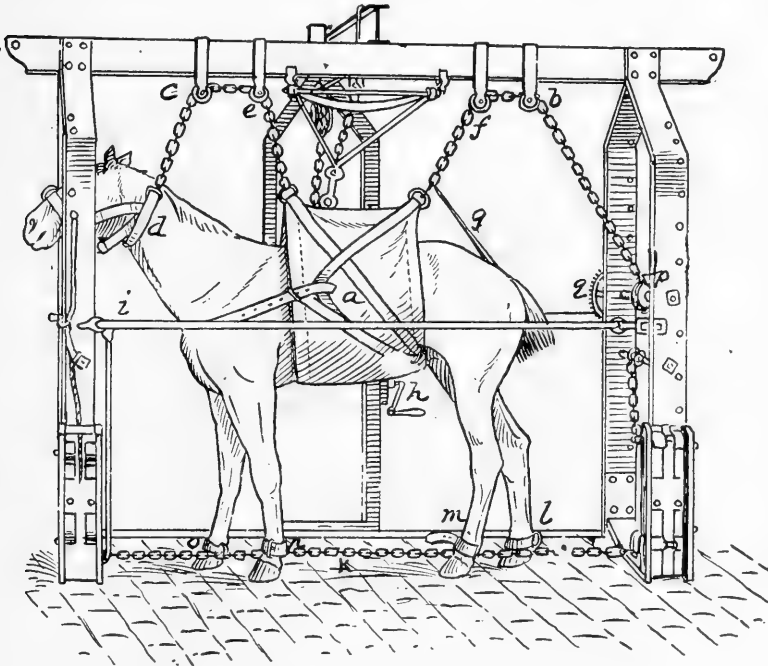

Fig. 67. Vinsot's Stocks.

*E. Vinsot's Stocks.*

The apparatus designed and used by E. Vinsot, Figure 67, is so arranged that the animal may, after being confined therein,

be operated upon either in the standing or recumbent posture. The corner posts on one side are hinged at their bottom. By this hinge arrangement the stocks are turned down to almost the horizontal position.

The frame of this stock is made of metal and equipped with a body girth (a) similar to that of the ordinary sling. This body girth is suspended by chains (c) (b), which are attached to the iron beam above. Traction on these chains is made by a ratchet windlass (q) which at the same time tightens the chain to which the hobble rings (e) (m) (n) (o) are attached. The horizontal bar (i) is removable in order to place the animal in the stock. The head is fixed on each side to the front upright corner posts. A leather strap (g) is attached to the body girth and passes between the hind legs and fastens into chain above to

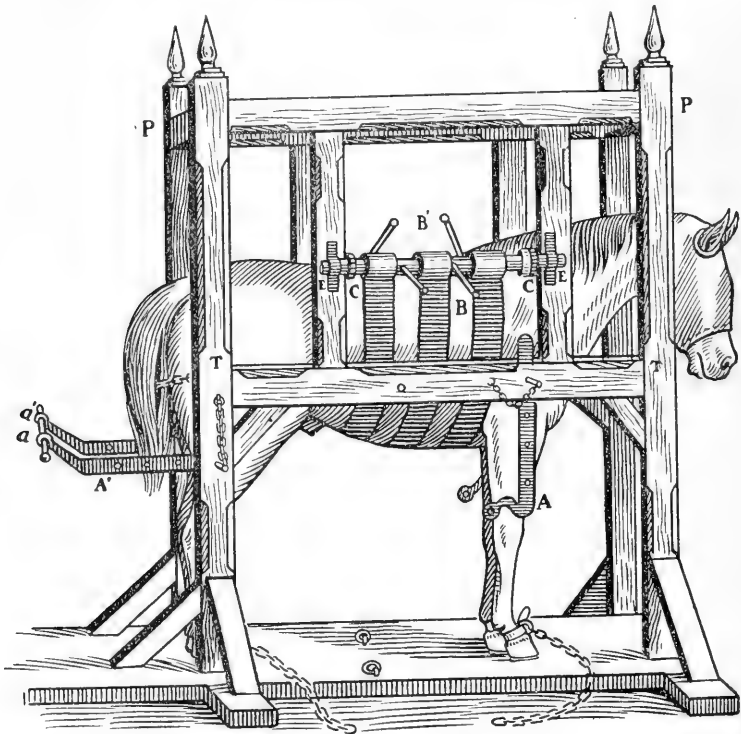

Fig. 68. Peuch and Toussaint's Stocks.

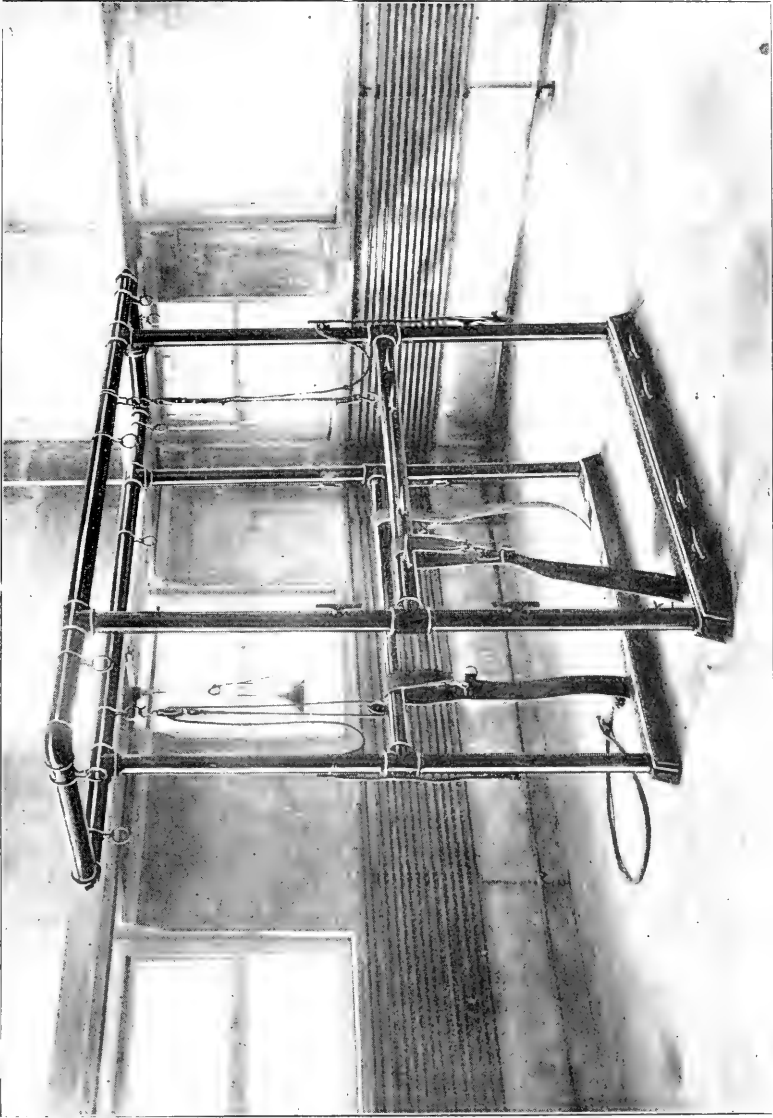

Fig. 69. New York State Veterinary College Metal Stocks.



Fig. 70. New York State Veterinary College Metal Stocks.



support the hind quarters. The Vinsot stock is the beginning of the John A. W. Dollar operating table. The Dollar table has during recent years been improved and perfected by the Bradwood Manufacturing Company, and is now known and sold in America as the Bradwood Humane Equine Operating Table. These tables are illustrated and described in Part II, Chapter III.

#### *Peuch and Toussaint's Stocks.*

The stocks described by Peuch and Toussaint, Figure 68, are satisfactory in many respects. The cut is self-explanatory. It will be observed that these stocks are built upon a strong wooden floor, which renders them portable. They are easily moved to any desired place in the hospital or operating room.

#### *New York State Veterinary College Metal Stocks.*

Figures 69 and 70 will give the surgeon a good general idea of the metal stocks now in use at the New York State Veterinary College. These stocks were designed and perfected by Prof. W. L. Williams and were manufactured and installed under his supervision. They are strong, neat, attractive and satisfactory. They are as near sanitary as it is possible for stocks to be made. By using this form of stocks almost every part of the animal is accessible. The unique and original method of applying the girths and back strap is especially attractive. These stocks are made almost entirely of tubular steel of a large and strong size. The steel tubing is joined together by elbows and threaded connections. These tight and strong joints make the apparatus rigid and substantial.

#### *Australian "Crush."*

The Australian "Crush," Figure 71, is simply a "pen" or "chute" into which wild and vicious horses are driven in order to catch them. It is made high enough to prevent the animal from jumping out, and narrow enough to make it impossible for him to turn around. An outfit of this kind is particularly convenient where a large number of unbroken "range horses" are to be caught and handled.

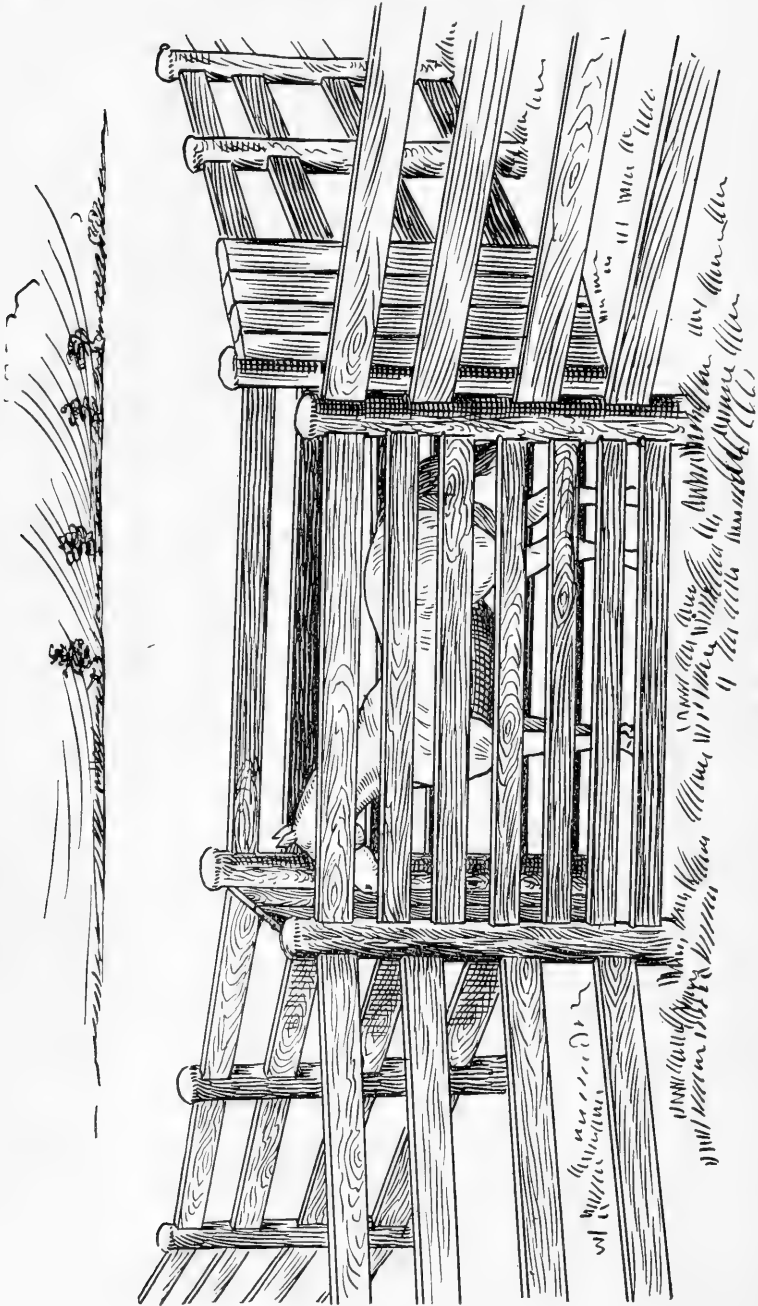

Fig. 71. The Australian "Crush."

## CHAPTER V.

### SLINGS.

Slings are useful appliances for restraint in the standing posture. The stock is often supplanted by a good strong sling in conjunction with some one of the several methods of restraining one or more legs. By means of the sling the animal's body is supported. If the head is held properly it is impossible for the animal to turn from side to side or to move either backward or forward.

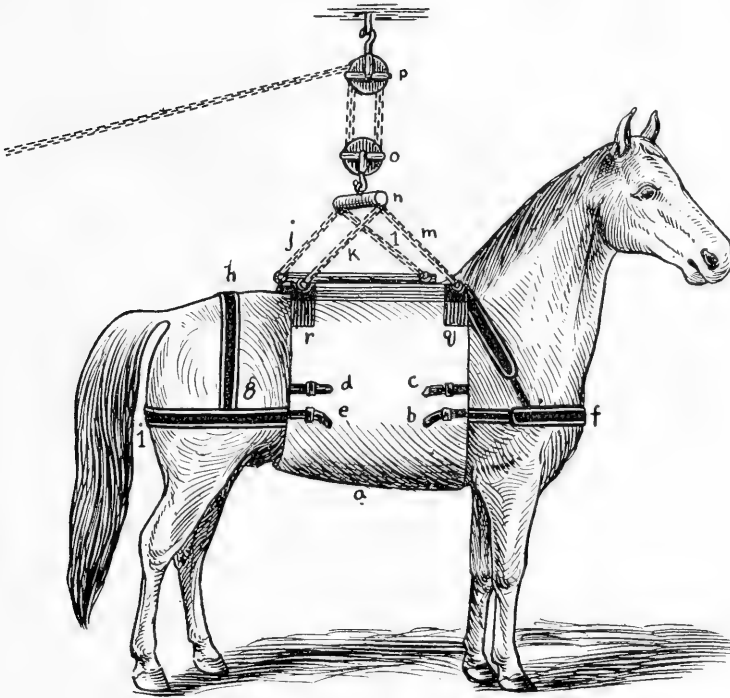

Fig. 72. H. & D. Sling.

*H. & D. Sling.*

The H. & D. sling represented in Figure 72 is made with a heavy sail canvas body girth (a) to which is attached the breeching straps (g) and breast harness (f). This canvas body girth is supported by and attached to a whiffletree (n). A block

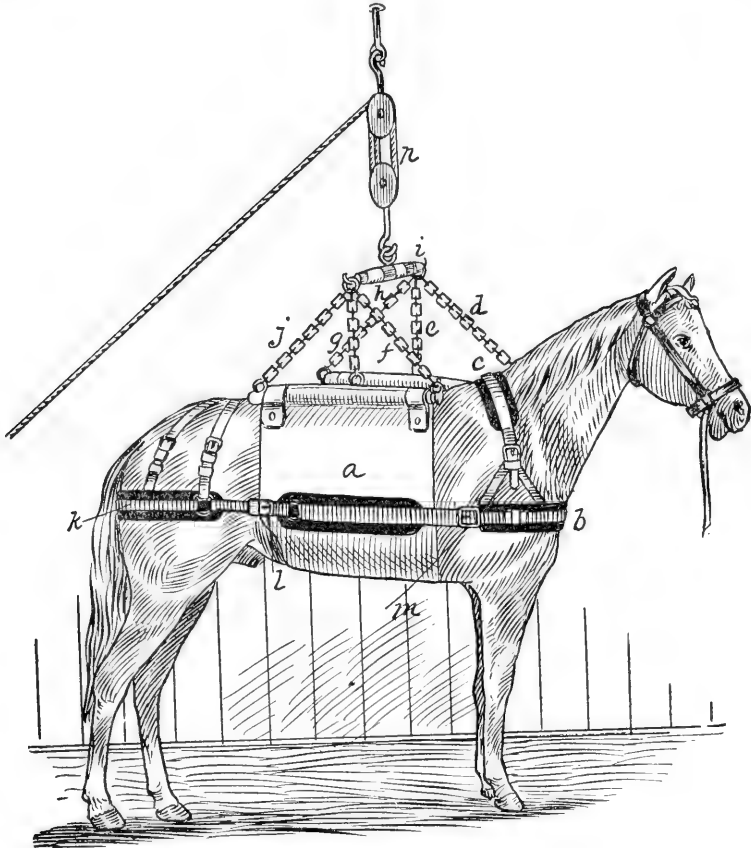

Fig. 73. An American Sling.

and tackle is attached to the whiffletree in its center by means of a hook. By this block and tackle (o) (p) sufficient tension can be made on the body girth to support the animal.

Figure 73 represents an American sling which is similar in

most respects to that shown in Figure 72. The main difference is that the breeching (k) and breast harness (b) are padded or lined with soft leather or canvas. This makes them wider and less liable to chafe the animal.

The sling represented in Figure 74 is made extra heavy with wide canvas body girth. The breeching and breast har-

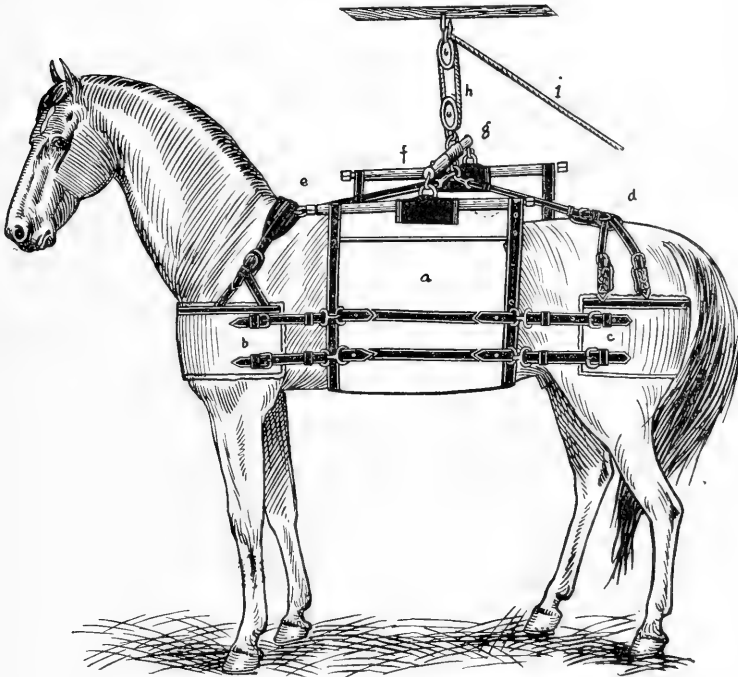

Fig. 74. Sling for Large Horses.

ness are wide canvas and are leather bound. It is made heavy and large throughout for use on large animals. The body girth (a) is three-ply canvas 3 feet long, bound and stitched, with 2-inch leather. Breeching (c) and breast collar (b) are 8 inches wide and made of leather, covered with canvas and lined throughout with lambskin. The straps are supplied with heavy snaps. The breeching and breast collar straps are connected

to center of whiffletree by means of  $1\frac{1}{2}$ -inch leather straps with snaps on each end.

The German sling, Figure 75, is in several respects similar to those of Figure 73 and Figure 74. The body belt (a) is

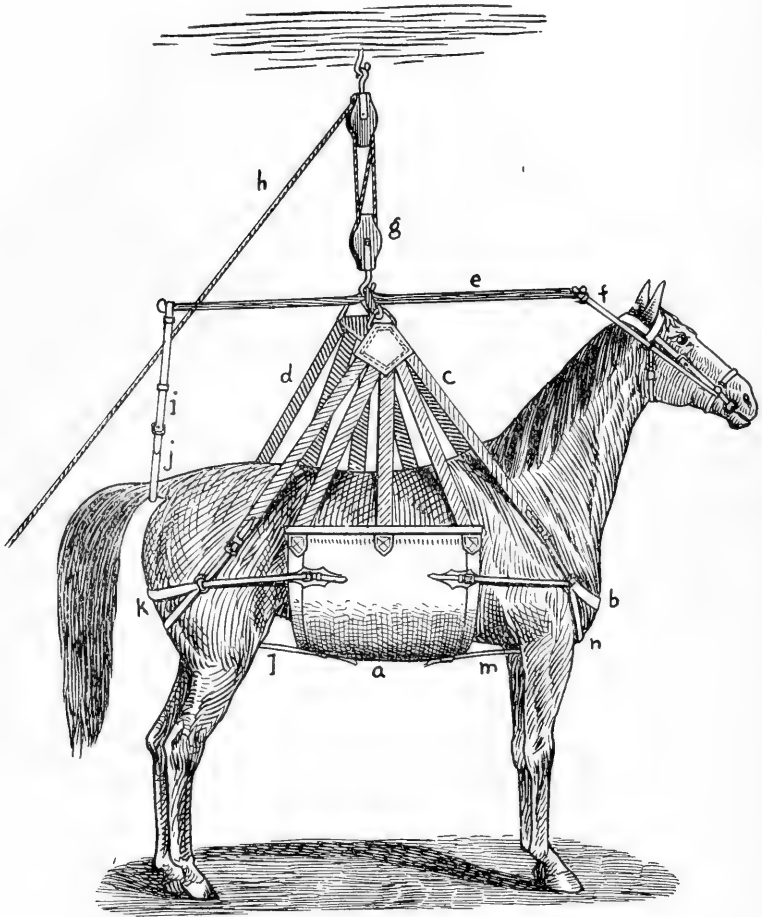

Fig. 75. German Sling.

made of heavy canvas. The breeching (k) and breast harness (b) are of  $1\frac{1}{2}$  and 2-inch leather straps. They are attached to the body belt, both anterior (l) and posterior (m). Five

heavy straps (d) (c) merge together at the whiffletree and connect the body with the whiffletree. An iron or wooden bar (e) runs lengthwise of the horse. By this bar the tail (j) and head (f) are supported.

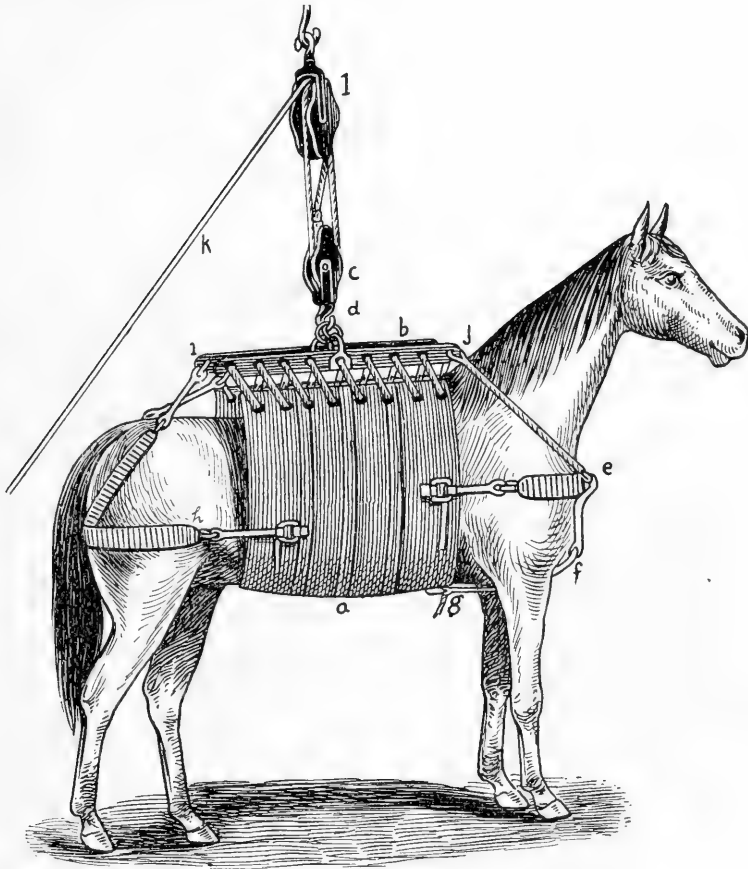

Fig. 76. Marsch's Sling.

Marsch's sling, Figure 76, is similar to those illustrated and described above, except that the body (a) is connected with the wooden or iron supporting piece (j) by means of a rope lace. This makes the sling body adjustable, which is an advantage in some instances.

The French sling, Figure 77, is neat and light. The body belt (a) is made of canvas. The breeching (n) (m) and breast harness (g) (j) (h) are web. Four iron rods (r) (s) (q) (p),

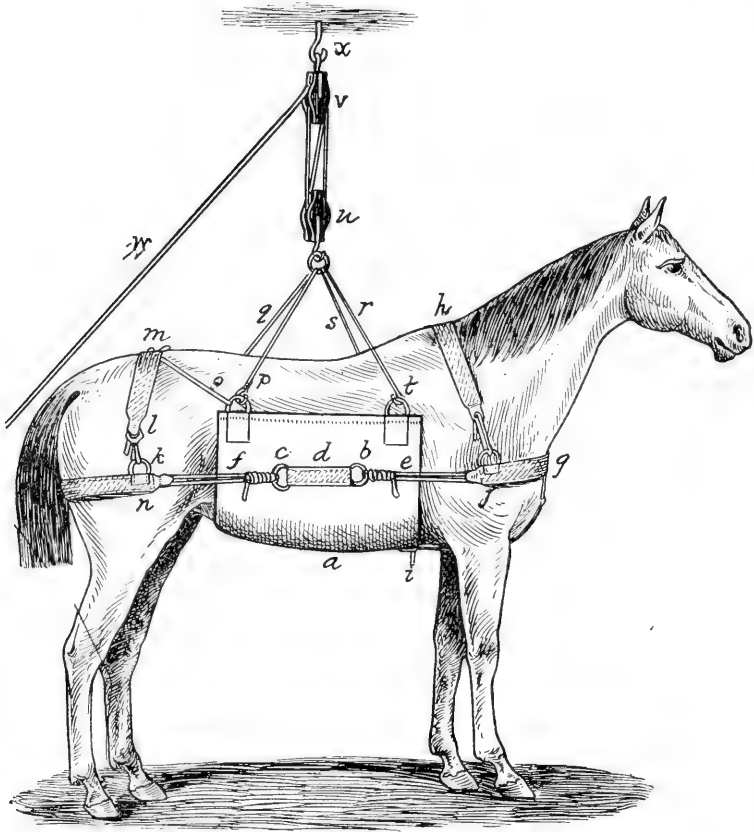

Fig. 77. French Sling.

one from each corner of body belt, merge together and fasten into a ring to which the block and tackle is attached. The sling body is attached in front (i) to a martingale strap. This strap prevents the sling from slipping backward.



---

---

PART II.

---

Restraint of the Horse in the  
Recumbent Posture

---

---

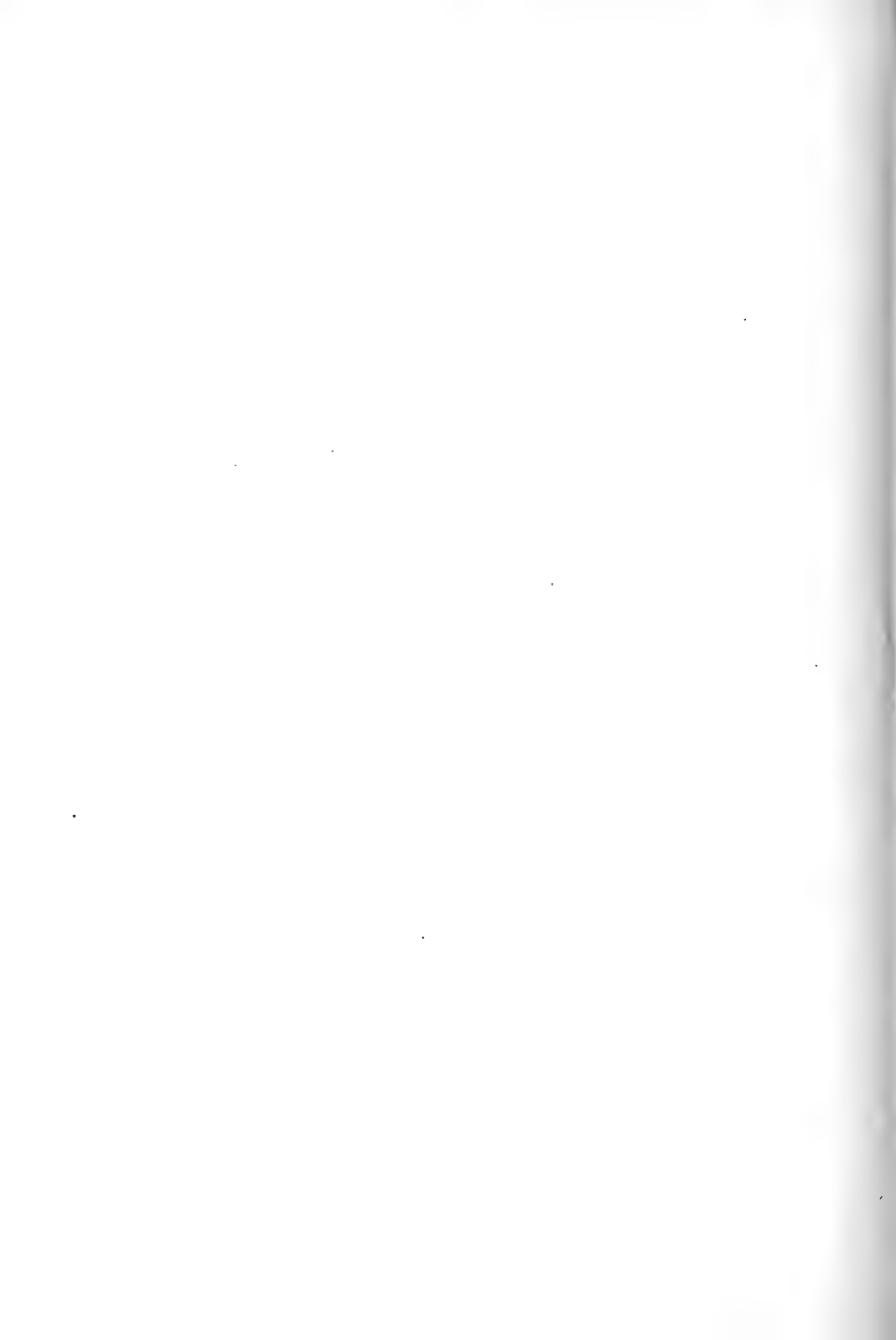

## PART II.

### RESTRAINT OF THE HORSE IN THE RECUMBENT POSTURE.

When deciding whether or not it is necessary to cast and secure a horse for operation or other purpose, the surgeon should carefully consider the temperament, the physical condition of the animal, the length of time restraint will be required, the painfulness and character of the operation, the part or organ to be invaded, and last, but by no means least, the physical ability and qualification of the operator. As a general proposition it is always advisable to cast and secure animals for painful or long continued major surgical operations. Nervous, highly bred and vicious animals should be cast and securely confined. When it has been decided to cast the animal we should, first of all, carefully survey the surroundings and select the most satisfactory location. Of course circumstances and existing conditions play an important role in making our selection. When the weather will permit the operation being performed out of doors, there is no place better adapted than an open field or lawn. It is here that we have ample room to manipulate our restraint technique without interruption. When we have selected the location the next problem which confronts us is the "casting bed." The ideal operating mat or mattress is a plot of green grass grown upon smooth ground. Always avoid the manure heap or the "rotten straw pile" whenever possible. They are both hotbeds of all forms of bacterial growth and are directly responsible for many cases of fatal septic infections. If we are forced to cast an animal inside of doors, then we must make the best of our misfortune and get busy in devising means and methods to best overcome that handicap. Select the place—be it hallway, stall or operating room—where the most room is available. Then a proper bed must be prepared. This may be done by the use of tanbark, soft wood shavings, straw, hay, excelsior, sawdust, etc., or a specially constructed mattress or pad may be used. The next proposition which confronts us is what particular form of hobble or casting harness it is advisable to

use in this particular case. We have the hobble, casting harness, and the equine operating table from which to make our selection. Each have their disadvantages as well as their advantages. The method selected or employed must depend largely upon the circumstances and surroundings encountered in each individual case. The temperament, size, strength, age and conformation of the animal must each receive due consideration. Then the location of the field of operation, the length of time required to operate, number and ability of assistants, value of the animal, and means of restraint available are all to be considered. To avoid rupture or dislocation of important internal abdominal organs it is best to prepare the patient before casting. This is done by withholding water and food for from twelve to twenty-four hours. When we once undertake the task of casting and confining the animal it should be completed with dispatch. Do it quickly, avoid accident unless same is unavoidable, and, above all things else for the personal safety and protection of the operator and the welfare of the animal, the restraint should be secure. The dangers encountered in performing work of this character are legion. The operator is often kicked, struck or bitten while applying and adjusting the casting apparatus. The animal may receive halter burns, lacerations and abrasions of different kinds. Rupture of muscles and tendons sometimes take place. Fractures of the vertebrae and other bones are by no means infrequent. Some patients present radial paralysis as a sequela of casting, while others become exhausted and never rise after being released.

There are three useful adjuncts to casting and securing animals which it is well to mention at this immediate juncture, viz., the operating hood, the apparatus of Bernardot and Buttell for preventing broken back, and the cross hobbles.

#### *The Operating Hood.*

The operating hood, Figure 78, is made of heavy canvas, doubled, stitched and padded, after which the hood (a) is bound around the edges with either leather or heavy cloth. Openings are made at top (d) to accommodate the ears. It is held on by buckles under chin and jaw (b) (c). This hood

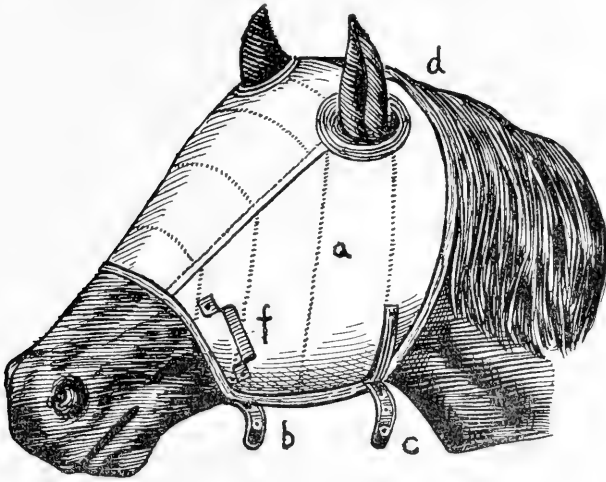

Fig. 78. Operating Hood.

protects the head from injury and at the same time it acts as a means of subjection by answering the purpose of a blindfold.

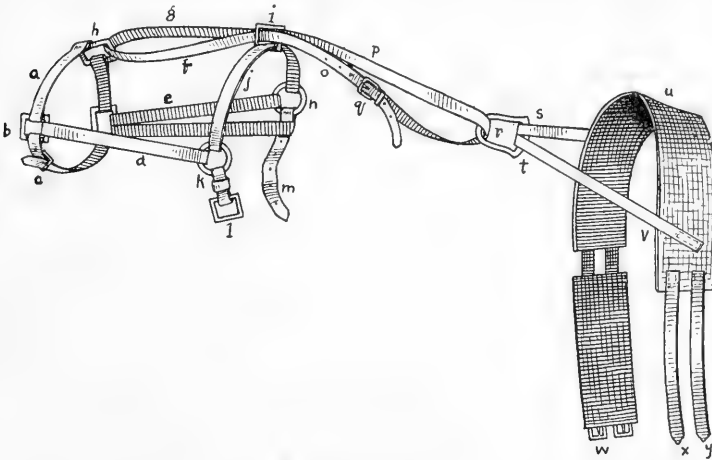

Fig. 79. Bernardot and Buttlet Apparatus for the Prevention of Broken Back.

*Bernardot and Buttlet Apparatus.*

The Bernardot and Buttlet apparatus, Figure 79, is for the purpose of protecting the spinal column from injury while

casting and confining an animal. This appliance was invented and used by E. Cooper Smith, M. R. C. V. S. By the use of this appliance "broken backs" can often be avoided. The main object of this apparatus is to hold the head in an extended position. This appliance consists of a wide and strong surcingle (u). On the end of this surcingle are two leather straps (x) (y) to fasten into the buckles (w). On each side of this surcingle are two straps (v) (s) which join together in front (s) (t). A strong halter is placed on the horse. This halter

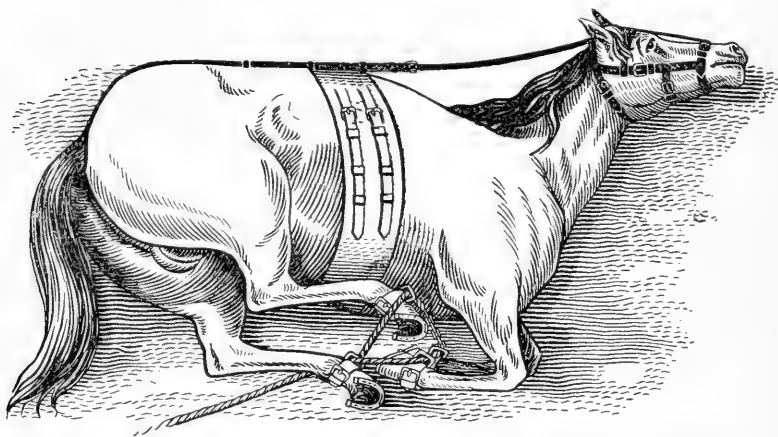

Fig. 80. Bernardot and Buttell Apparatus for Preventing Broken Back—Applied.

is supplied with a heavy over-check attached to the nose-band (h). This over-check passes in front of the face and forehead, between the ears, and attaches to a metal ring (y). To this metal ring has already been attached the two straps (s) (y) from the martingale. By lengthening or shortening the over-check strap (q) the head is placed in the desired position. The surcingle is prevented from slipping forward by a strong crupper and strap. The apparatus is applied loosely before the animal is cast, and tightened after it is on the ground.

Figure 80 shows the Bernardot and Buttell outfit applied. It will be observed that the head and neck are well extended, thereby lessening the liability to back injury.

*Cross Hobbles.*

In securing the animal in special positions we are called upon to use various appliances. Some of the arrangements for

this purpose are the cross hobbles and the side-bar hobbles. These hobbles are for use on the thigh and fore arm. The English cross hobbles,

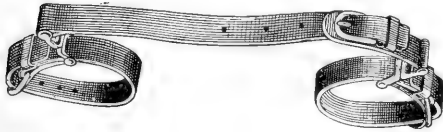

Fig. 81. English Cross Hobbles.

Figure 81, and those of James, Figure 82, can be used upon legs diametrically opposite, such as the near hind and off fore legs, and vice versa. While the side-bar hobbles, Figure 83,

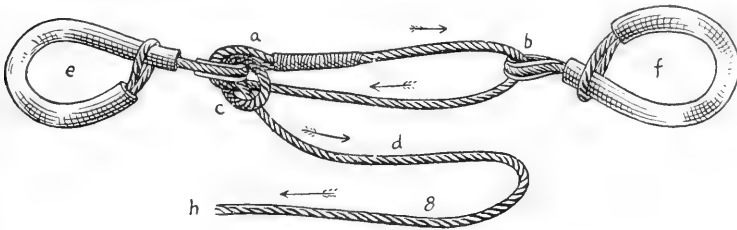

Fig. 82. James' Cross Hobbles.

are for use on opposite legs only. The illustrations, Figures 81, 82 and 83, are self-explanatory. Suffice it to say that these appliances are useful and valuable adjuncts to restraint in the

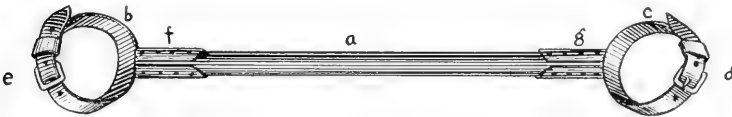

Fig. 83. Side-bar Hobbles.

recumbent posture. They should be used whenever the hobbles or casting harness fail in themselves to sufficiently immobilize the legs for operation.

## CHAPTER I.

### HOBBLER.

The advent of hobbles as a means of restraint in veterinary practice marked an epoch of beginning advancement in veterinary operative technique. The hobbles, as a means of restraint, have the advantage over any other method in so far as they are light, portable, strong and convenient. They can be quickly applied, the animal cast and secured, with few assistants and little ceremony. An animal can also be released promptly and allowed to regain its feet. The disadvantages of hobbles are the impossibility of securely restraining the patient, liability of accident to patient, and inability to fix the legs in special positions for operations where position plays an important role. There are numerous styles and kinds of hobbles; some are of course better and more satisfactory than others. In making a selection be sure and not make the mistake of sacrificing strength for appearance. Be sure the hobbles you use are well made and strong. The application of hobbles should always be preceded by the twitch. An operating hood or some other head protector should be applied before the hobbles are brought into action. There are numerous styles and kinds of hobble straps. They are made of leather, rope, metal, rawhide, webbing, etc.

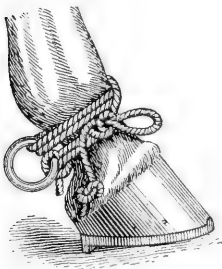

Fig. 84.

Improvised Rope Hobble of Denenbourg.

Figure 84 represents the improvised rope hobbles of Denenbourg. These are made by taking four heavy metal rings and four pieces of  $\frac{1}{2}$ -inch rope. Fix the rings with the rope by passing it several times around each pastern. For the forelegs the ring should be placed behind the pastern, and for the hind ones the rings should be in front of the pasterns. If metal rings cannot be procured, loops may be made on each end of the cord, through which the casting rope or chain can pass. By using



a casting rope or chain the animal is cast and secured in the ordinary manner.

Figure 85 represents Suykerbuyck's rope hobbles. Each hobble is made by braiding several cords together, or by a single rope or sash cord not less than  $\frac{3}{8}$  of an inch in diameter, folded upon itself. These are tied together in a simple knot

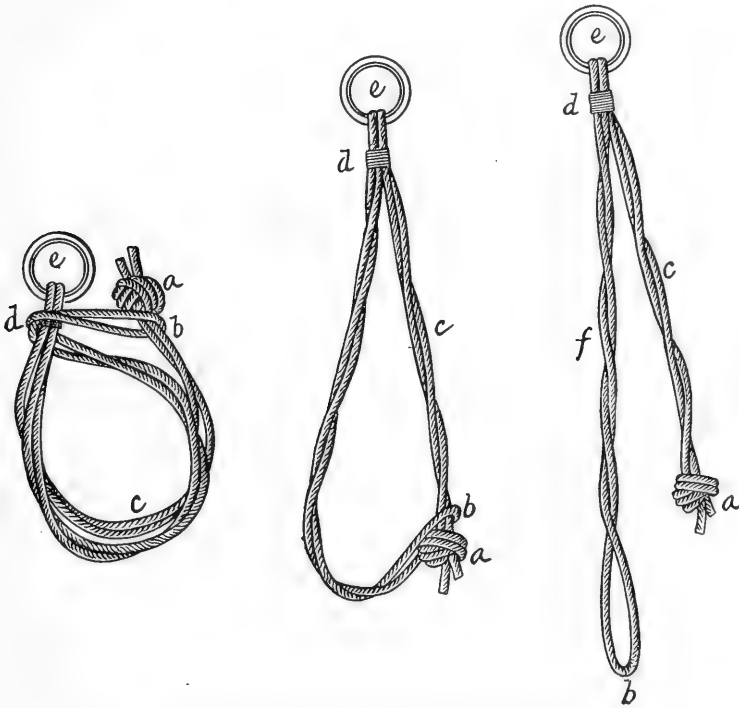

Fig. 85. Suykerbuyck's Rope Hobbles.

(a). A ring (e) is fastened in the loop formed by the folding of the ropes, and secured by wrapping or tying ropes together by means of a "waxed end," or strong string (d). The hobble is then placed around pastern as shown in the illustrations on the left. A casting rope or chain completes the outfit. To remove this hobble the tension on same must first be released; this is done by bringing the legs together.

Figure 86 represents the Miles rope hobble. It consists of a piece of  $1\frac{1}{2}$ -inch rope 35 inches long and a "D" metal ring (a). In the center of the rope (b) is looped the metal "D" ring. The ends of the rope (d) (e) are fastened together (c). These hobbles are applied by simply looping them around each pastern. It will be observed that when

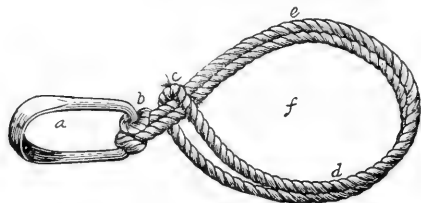

Fig. 86. Miles' Rope Loop Hobble.

the 34-inch rope is doubled it makes a hobble only 17 inches in length.

Figure 87 represents practically the same hobble strap as that shown in Figure 86. The "D" ring (a) is attached to the plaited rawhide rope (d) by means of a leather strap (e). A piece of leather (c) is applied to the rawhide hobble. This leather strap is to grasp with the hand in order to render its removal by unlooping more convenient.

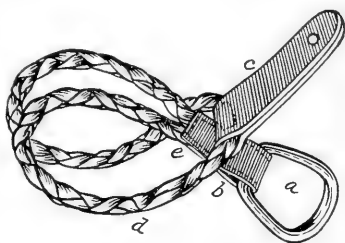

Fig. 87. Plaited Raw-hide Hobble Strap.

Figure 88 represents a heavy and strong leather loop hobble. The strap (e) is doubled and stitched. It is 17 inches long and 2 inches wide, fastened at each end by three rivets into a metal clasp (c) (d). These metal clasps also carry two blank buckles (a) (c). It will be observed that these blank buckles are so sized that one will pass conveniently through the other by turning it cornerwise, which prevents them from becoming unlooped and dropping off the pastern.

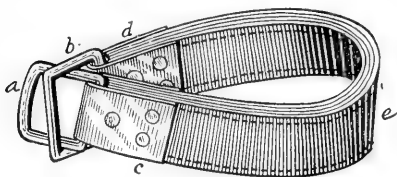

Fig. 88. Leather Loop Hobble.

It will be observed that these blank buckles are so sized that one will pass conveniently through the other by turning it cornerwise, which prevents them from becoming unlooped and dropping off the pastern.

Figure 89 represents Becker's hobble strap. The Becker hobble strap consists of a leather strap 3 inches wide, doubled and stitched. Near one end of this strap is the metal receptacle (A) for the spring lock pin (e) which holds the disengaging buckle (c). The hobble "D" (b) is attached near the above-mentioned receptacle. The free end of this hobble strap (d) is perforated with a number

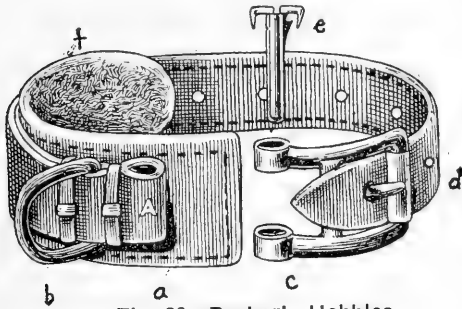

Fig. 89. Becker's Hobbles.

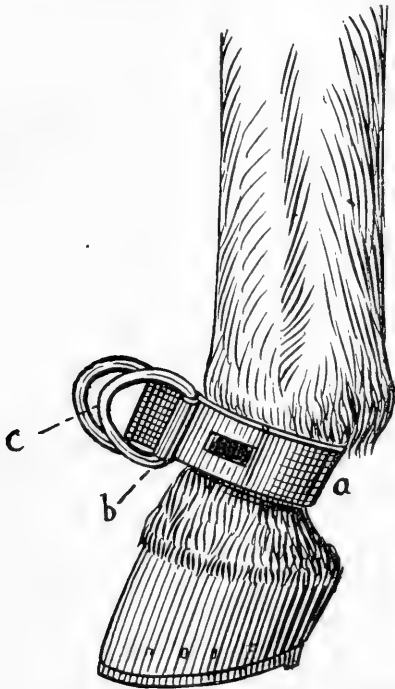

Fig. 90. Over's Spring Hobble.

of holes to accommodate the buckle (c). The inside of this hobble strap is lined or padded with felt or lamb's wool. The

buckle (c) of the hobble is disengaged by withdrawing the spring pin (e).

Figure 90 represents Over's spring hobble. It consists of a piece of flat spring steel (a)  $2\frac{1}{2}$  inches wide, and shaped to fit around the pastern. The hobble "D" or rings (c) (b) are attached to each end of the spring strap. The special advantage of this spring hobble of Over is that it can be readily slipped over the pastern, and when once applied the spring feature makes it self-retaining. There is no looping or buckling required, and the movements of the animal will not cause it to drop off.

#### DIRECTIONS FOR CASTING AND CONFINING A HORSE WITH HOBBLER.

*First.*—Select a suitable place and prepare a soft bed for casting.

*Second.*—Place the animal in proper position.

*Third.*—Apply the twitch.

*Fourth.*—Apply the operating hood.

*Fifth.*—Apply the hobbles.

*Sixth.*—Detail assistants to their proper positions and instruct them to obey orders.

*Seventh.*—Cast the animal.

*Eighth.*—Secure the animal.

There should be one assistant at the head; he should have charge of the twitch and halter rein. Two or more assistants should pull the main rope, strap or chain. The operator should stand directly behind the animal with a firm tail hold. As soon as everything is in readiness the command should be given, at which time sufficient traction is made on the main rope to draw the feet from under the animal. The success of the job depends largely upon the way the tail hold is manipulated. At the proper time the operator should, by pulling tail either to the right or left, unbalance the animal, and just before it comes in contact with the ground lift up on the tail. This will take much of the jar or concussion off the hind quarters and reduce chances of injury to a minimum.

DIRECTIONS FOR RELEASING AN ANIMAL FROM HOBBLER.

It requires some care and quite as much time to release an animal from the hobbles as is required in the casting and restraining process. If the horse is in the dorsal position it should be placed on its side. If the main hobble rope, strap or chain has been "fixed" while restraining, the same should now be "un-fixed" and withdrawn from the hobble rings. The

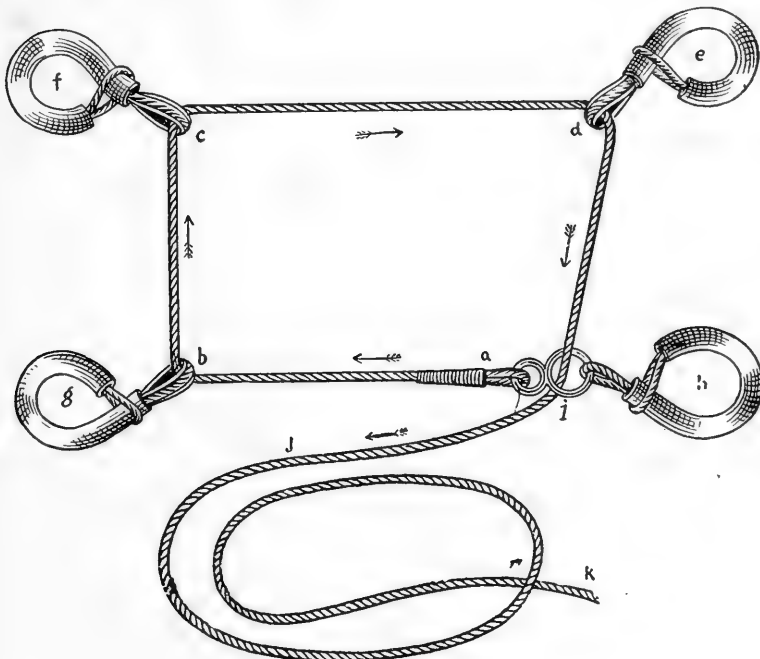

Fig. 91. James' Patent Hobbles.

operator should stand back well out of reach of the feet, however facing them, and carefully remove the hobble straps from each pastern and allow them to drop off. Now remove the hood, and lastly the twitch, after which allow the animal to rise.

*James' Patent Hobbles.*

Figure 91 represents the hobbles introduced by James. They are light and neat as well as sufficiently strong. They

consist of four pieces of  $\frac{5}{8}$ -inch rope double and fixed over a grooved piece of metal through which the main rope (j) glides. These hobble ropes (b) (e) (f) (g) are made in form of loops and are covered with leather or rubber hose to prevent chafing. They are each 17 inches long. The main rope (j) is fixed to one of the hobble rings (i) by means of wrapping with a "waxed end" or strong cord (a). This rope is passed through all the hobble rings (b) (c) (d) and back to the point of beginning (i). The main rope (j) is 18 feet long and  $\frac{3}{4}$  inches in diameter, preferably cotton.

*Barnick's Loop Hobbles.*

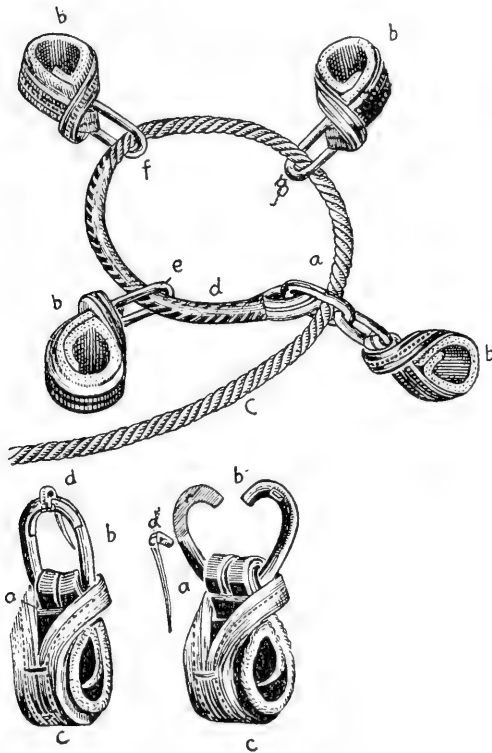

Fig. 92. Barnick's Hobbles.

Figure 92 represents the loop hobbles of Barnick. They consist of four hobble straps (b) made of leather in the form of a loop. Each of these are attached to a "D" metal ring (a) (e) (f) (g) of special design through which the main rope (c) passes. The leather straps are felt lined. These "D" rings open up and allow removal of main rope without removal of the hobble from pastern. They are locked on by means of a metal key. The

main rope is attached securely to an end ring (a); this ring is

also attached to ring of master hobble strap. That part of rope upon which the hobble strap rings glide is leather covered to prevent wear. This rope should be 18 feet long and  $\frac{3}{4}$  to  $\frac{7}{8}$  inches in diameter.

*Munich Hobbles.*

Figure 93 represents the Munich hobbles. They are similar in many respects to the improved English hobbles. They consist of four hobble straps (a) (b) (c) (d), which are applied by buckling around pasterns. These straps are felt or soft

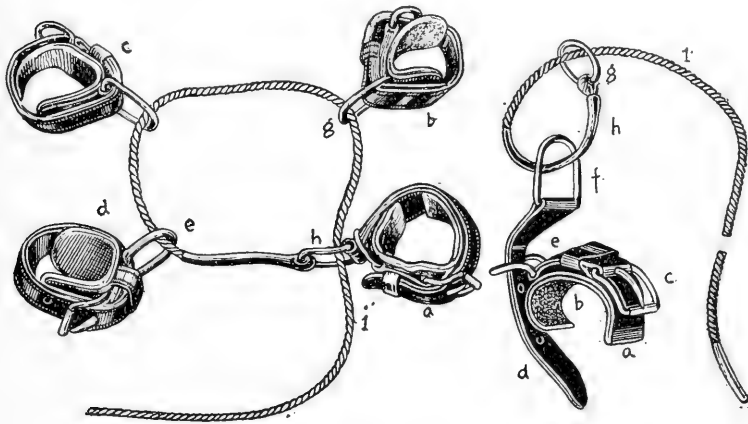

Fig. 93. Munich Hobbles.

leather lined, and each of them carry a "D" metal ring (h) (g) (e). The wearing end of the main rope is leather covered and attached to the "D" ring of master hobble (h). This rope may be attached by loop (g), as shown in the small illustration. Attachment to master hobble ring by the latter method makes the main rope (i) easy to remove.

*Matthias' Hobbles With Safety Lock.*

Figure 94 represents the hobbles of Matthias. These hobbles are supplied with safety lock (d). They consist of four heavy doubled and stitched hobble straps, felt or soft leather

lined, and are attached to hobble ring (c) by means of a loop (b). They attach to pastern by buckling. The hobble rings are metal and heavy, and of a special design. The ring (c)

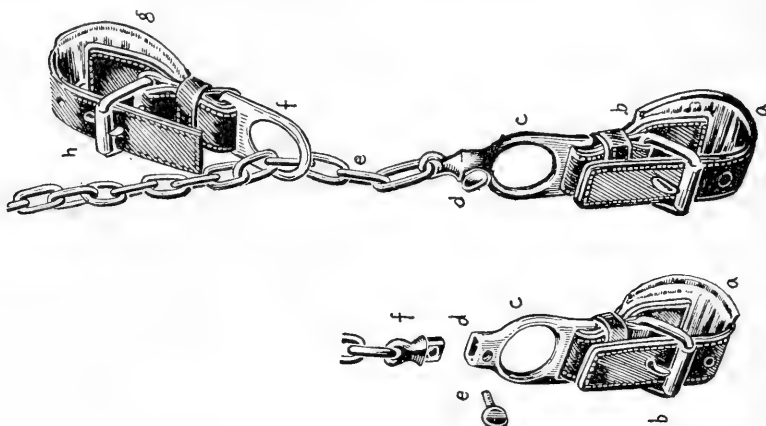

Fig. 94. Matthias' Hobbles with Safety Lock.

of the master hobble is attached to the main chain (e) by a safety lock (d). The safety lock makes their removal convenient.

#### *Conkey's Self-Locking Buckle Hobbles.*

Figure 95 represents the self-locking buckle hobbles of Conkey. These hobbles were designed by Professor L. L. Conkey and are now very extensively used by veterinarians throughout the world. The principle and most attractive feature of this hobble is the self-locking buckle device (e). These hobbles consist of four double and stitched hobble straps (a) (b) (c) (g). These hobble straps fasten around the pasterns by means of strong buckles. In three of these straps is a metal "D," which carries the main hobble chain (f). This chain itself is 4 feet long and is continued by 6 feet of  $\frac{5}{8}$ -inch rope. The object of this chain is to lock in the flat split spring-tongue of the buckle (e) which is attached to the master hobble strap (g). One end of the chain is also attached by means of a thumb screw (d) to this master hobble. To release the animal this thumb screw (d) is removed. The Conkey master hobble strap,





Fig. 95. Conkey's Self-Locking Buckle Hobbles.

lock buckle, and chain can be used with many designs of hobble straps. The following illustrated hobble straps can be used in conjunction with the Conkey lock-buckle: Figures 84, 85, 86, 87, 88, 89, 90, 91, 92, 93, 94; also the hobble straps from the English and Berlin hobbles.

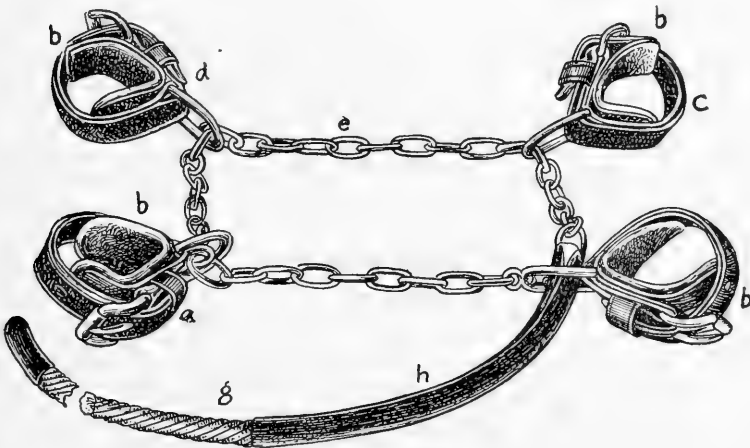

Fig. 96. Berlin Hobbles.

*Berlin Hobbles.*

The Berlin hobbles, Figure 96, consist of four leather hobble straps 2 inches wide, doubled and stitched. Each of these straps (b) carry a buckle and a metal "D," through which the main hobble rope (g) (h) passes. The hobble straps are lined with felt or soft leather and are attached around pasterns by buckling. To the master hobble is attached a strong chain (e).

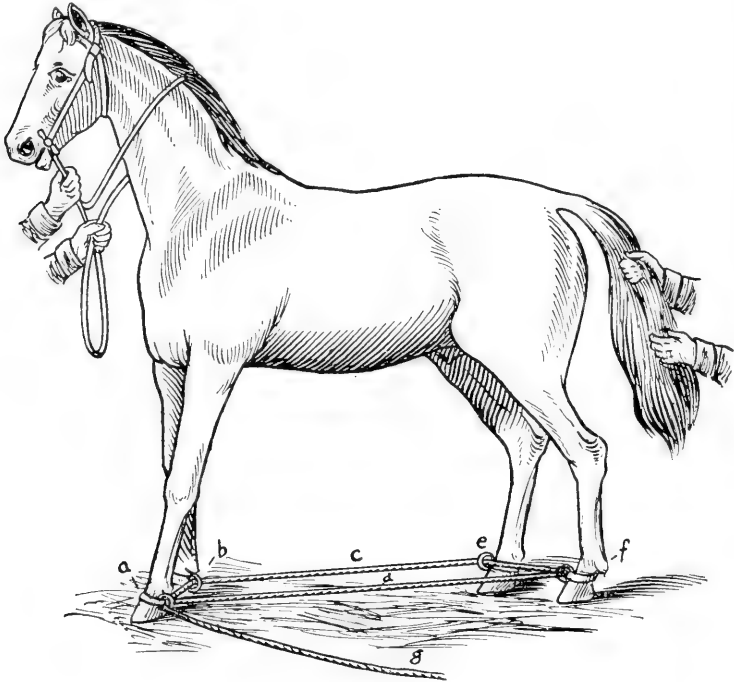

Fig. 97. Berlin Hobbles Applied.

This chain is 4 feet long. At its end a  $\frac{3}{4}$ -inch rope (g) is attached. The part of the rope which comes in contact with the "D" of the hobble strap is covered with leather. This leather covering prevents wear on rope. The Berlin hobbles applied is shown in Figure 97. A hobble strap is placed on each pastern. The king hobble strap is to be placed on near fore leg (a). The rope is carried from the near fore to the

near hind leg (f); then across to off hind leg (e); thence to off fore leg (b) and back through "D" ring of near fore (a). For further instructions, see directions for casting and securing a horse, with hobbles.

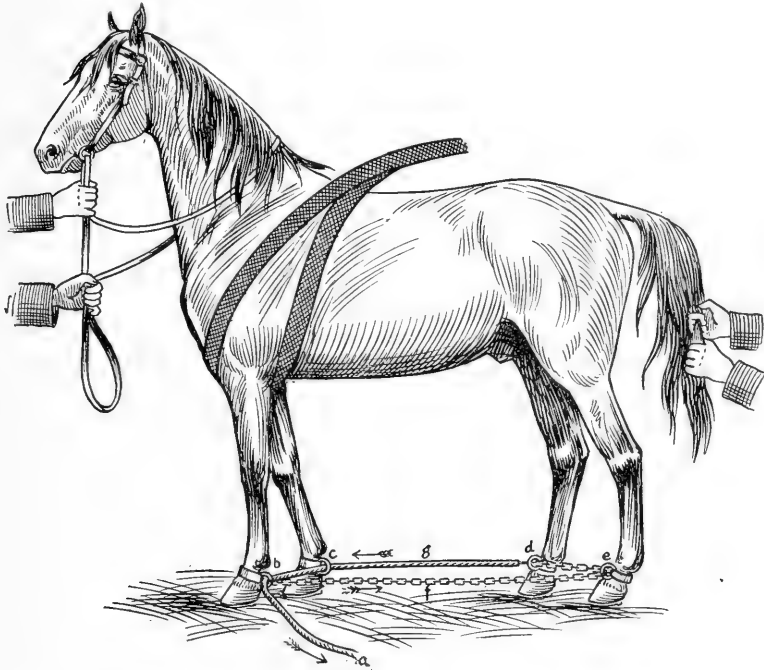

Fig. 98. Casting with Berlin Hobbles and Plate-longe.

Figure 98 illustrates the Berlin hobbles applied and used in connection with the plate-longe or "unbalancing strap," applied by a loop over the near elbow. By use of plate-longe the animal can be cast upon a mat or mattress.

*Stuttgart Method.*

In casting and restraining a horse by the Stuttgart method (old style), Figure 99, two ropes  $\frac{3}{4}$ -inch in diameter and 18 feet long are necessary. A loop is placed in one end of each rope. If it is desired to cast horse on near side one rope is

looped around near fore pastern (d); an ordinary hobble strap is placed around near hind pastern (b). On the off side the rope is looped around off hind pastern (c) and the hobble strap is placed on off fore pastern. The rope from the near side is then passed through the hobble ring on the off hind pastern. The end of the other rope is then passed through the hobble ring on the off fore pastern. The ropes are now crossed, the

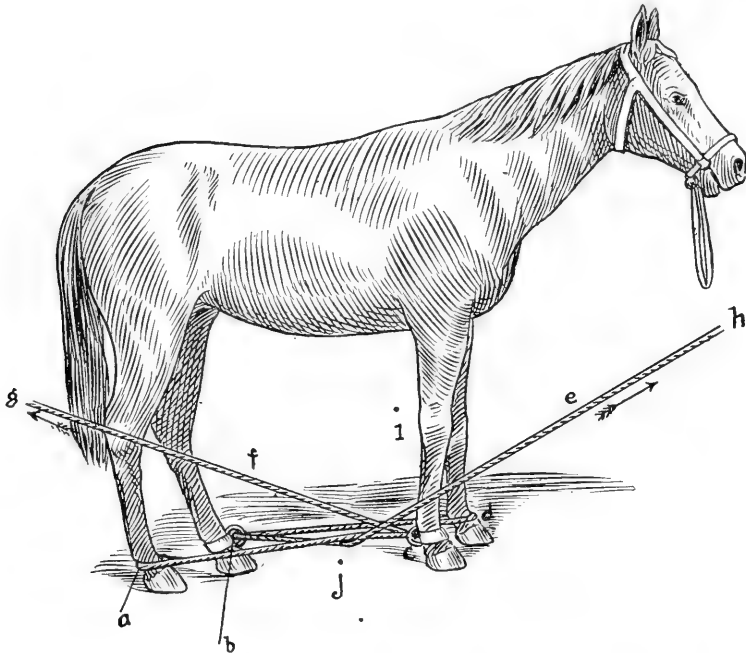

Fig. 99. Stuttgart Hobbles (old style).

one from the near leg to remain under the one from the off leg. Two men should pull on the same rope backwards and two pull on the other rope forwards. One assistant should be in charge of the head and another in charge of the tail. When the horse is cast it can be secured in the ordinary manner in several desirable positions.

Figure 100 represents the Stuttgart hobbles with surcingle (k) applied. The surcingle is for the purpose of aiding in

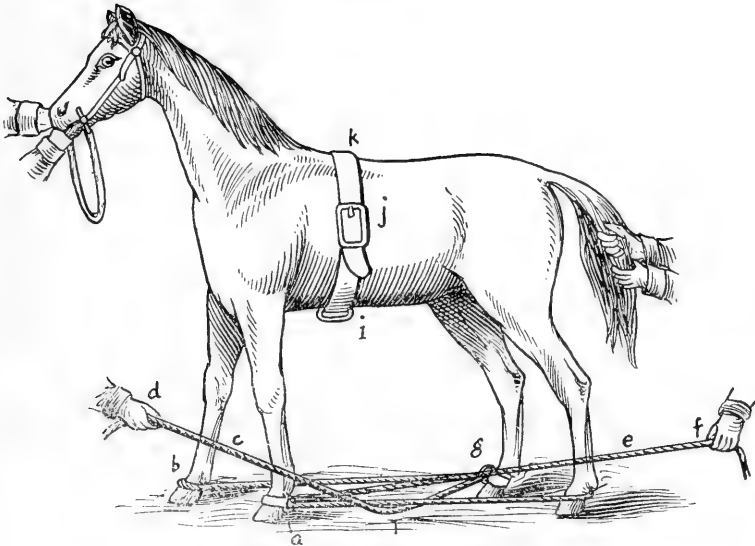

Fig. 100. Stuttgart Method of Casting a Horse.

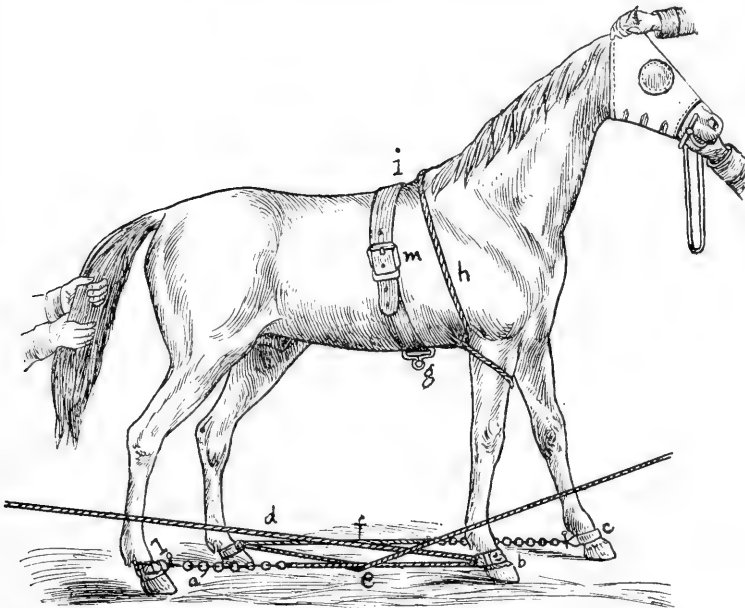

Fig. 101. Stuttgart Hobbles Showing Plate-longe or Unbalancing Rope in Use.

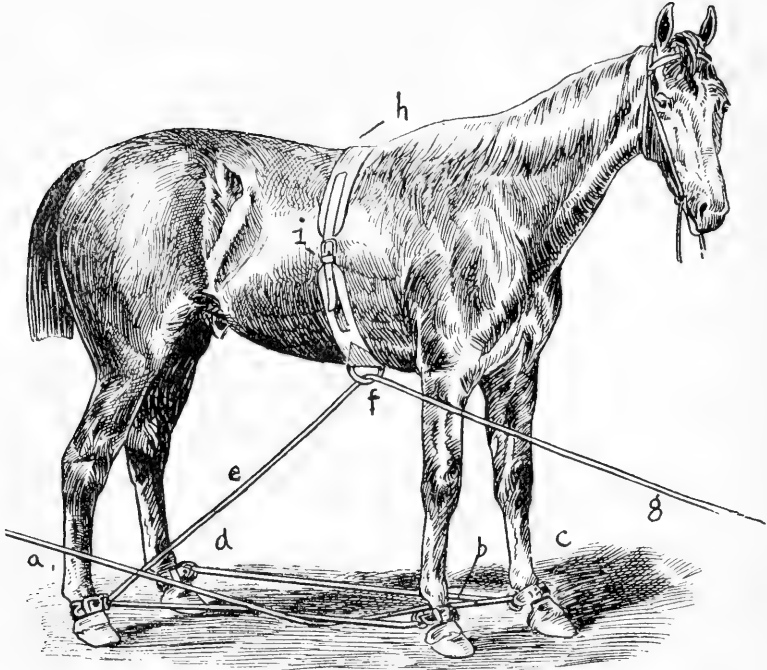

Fig. 102. Stuttgart Method of Casting a Horse as Modified by Von Chelchowski.

securing after horse is cast. Otherwise hobble arrangement is the same as that of Figure 99.

Figure 101 represents Stuttgart hobble, surcingle (i) and plate-longe or "unbalancing strap" (h) applied, ready for casting.

Figure 102 represents the Stuttgart hobbles as modified by Von Chelchowski. It will be observed that the hobble and rope arrangement here is the same as that of Figures 99, 100 and 101, with the exception of the free end of the off rope (e), which passes from off hind pastern to and through "D" ring (f) on surcingle. When the horse is cast the off hind and near forefoot are drawn near "D" ring of surcingle, as shown in Figure 103.

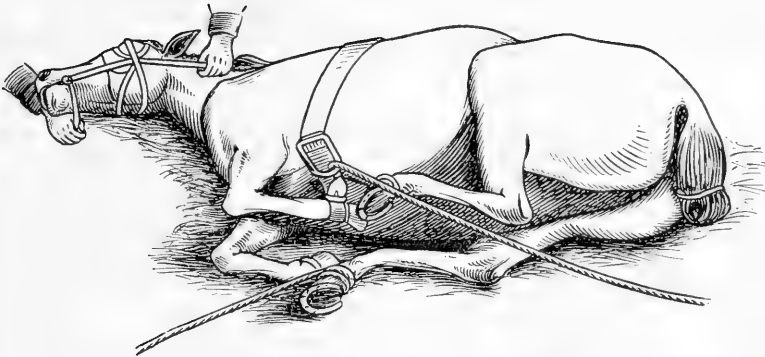

Fig. 103. Horse Cast and Secured with Stuttgart Hobbles.

*English Hobbles Improved.*

Figure 104 represents the improved English hobbles. These hobbles are probably more universally used than any yet devised. They consist of four hobble straps (h) (i) (f) (g), a chain, and a rope. The hobble straps are heavy and strong, being 3 inches wide and doubled and stitched. They are in two sections; one section carries a small metal "D" at one end and

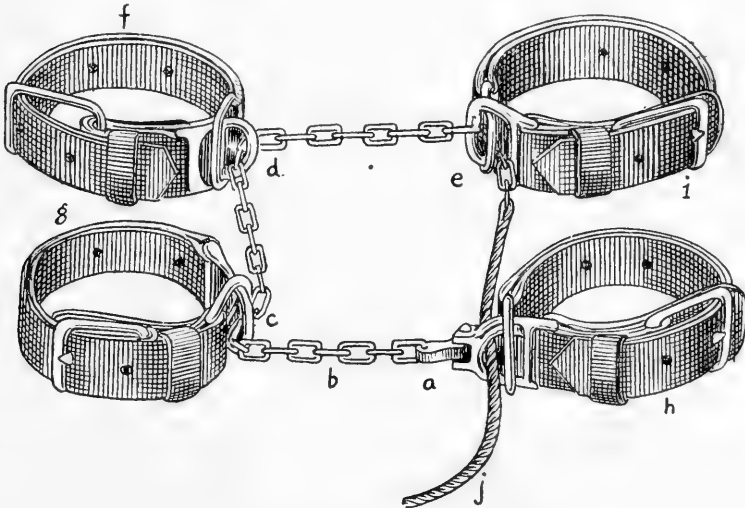

Fig. 104. Improved English Hobbles.

buckle tongue holes at the other end. The other section carries a large metal "D" at one end and a heavy buckle at the other end. The hobble strap is made smaller or larger by the buckle. This renders it adjustable to any size pastern. When once fitted to the pastern the hobble strap is applied by slipping the small "D" of one end through the large "D" of the other end. These smaller "D's" carry the main chain. The main chain is 4 feet

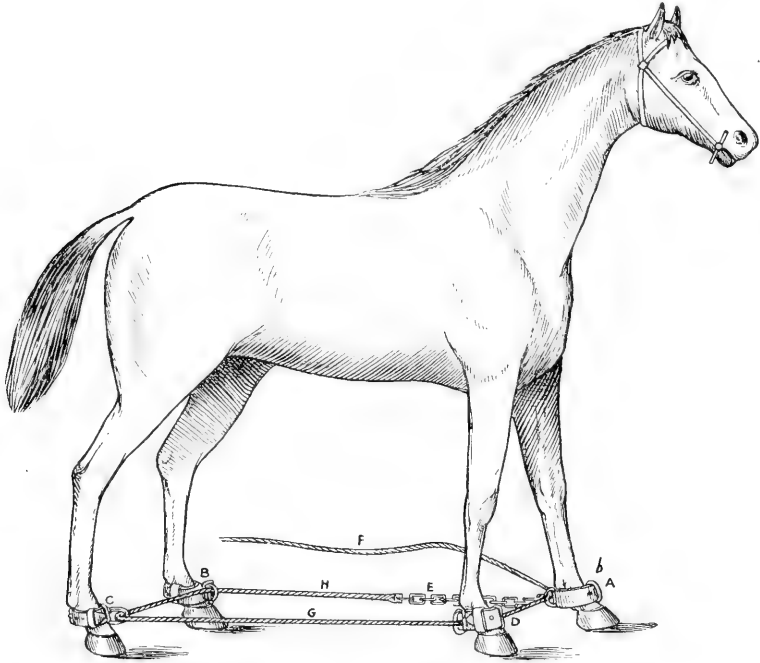

Fig. 105. Improved English Hobbles Applied.

long and attached to small "D" of the master hobble strap by means of a thumb screw. To the other end of chain a  $\frac{5}{8}$ -inch rope 20 feet long is attached.

Figure 105 shows the hobbles applied. It will be observed that if the horse is to be cast on the off side the master hobble is applied to pastern of near fore leg (a). Then pass chain (E) and rope (H) through "D" of near hind leg (B); then across to "D" of off hind leg (c); thence forward (G) to off fore



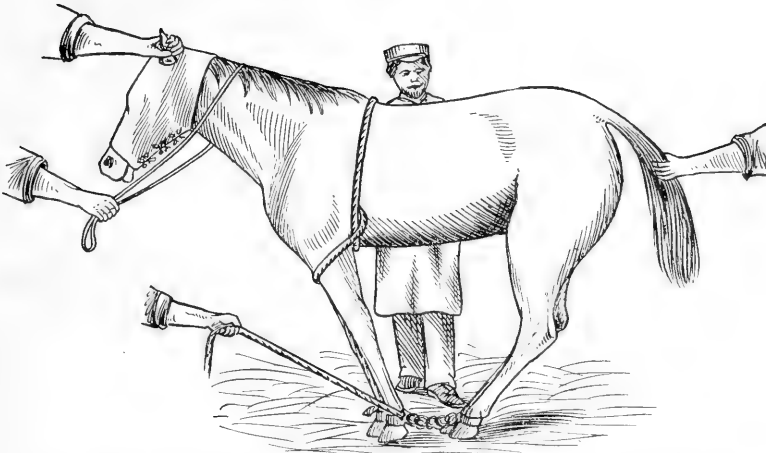

Fig. 106. Horse Ready to Cast with Improved English Hobbles and Plate-longe or "Unbalancing Strap" Around Forearm.

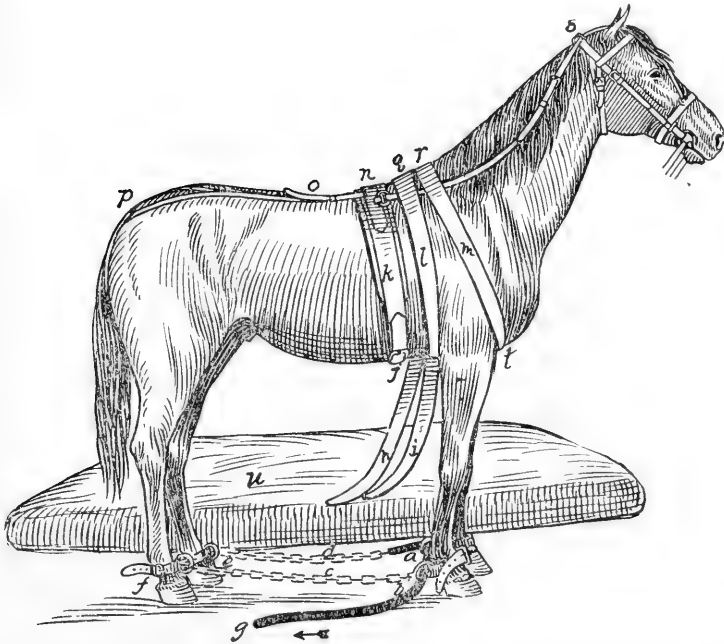

Fig. 107. The English Hobbles Applied, Together with Bernardot and Buttell's Apparatus; Also Plate-longe or Unbalancing Strap Around Fore Arm.

leg (D); then across to and through "D" of near fore leg. To cast the horse traction is made on free end of rope (F). See directions for casting a horse with hobbles.

Figure 106 represents a horse ready to be cast with improved English hobbles, and plate-longe or "unbalancing strap" applied to near fore arm.

Figure 107 represents a horse ready to be cast with the improved English hobbles, used in connection with Bernardot and

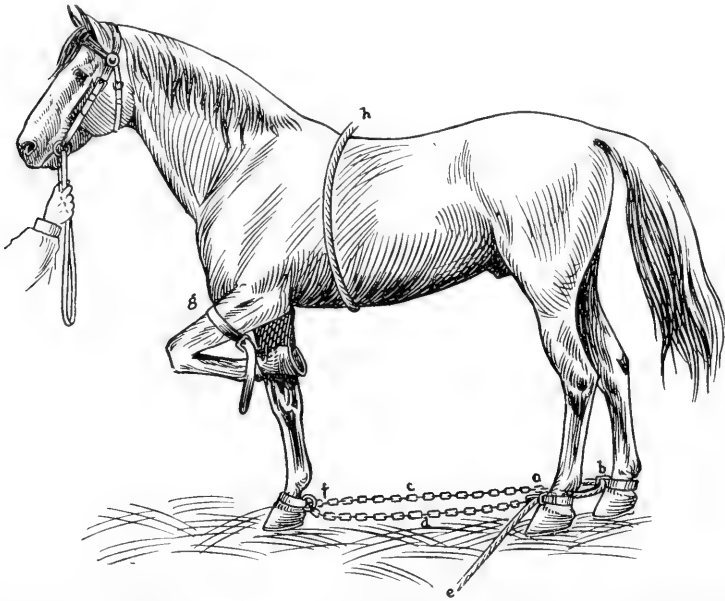

Fig. 108. Trasbot's Method of Casting with Three Hobble Straps and Knee Strap (English Hobble).

Buttel's apparatus for preventing broken back, and the plate-longe or "unbalancing strap" applied around off fore arm.

Figure 108 represents the method suggested by Trasbot for casting nervous or vicious animals with the English hobbles. It will be observed that the near forefoot is secured by Trasbot's knee strap (g). (See Knee Straps, Figure 29.) Only three hobble straps are used (g) (b) (f). The master hobble strap (c) is placed on near hind pastern; then pass chain (d) to off

fore (f); thence backward (c) to off hind; then across to and through "D" of the master hobble strap (g). The plate-longe is looped around the animal (h). Traction is made on free end of main rope (e). It is claimed by Trasbot that an animal thus cast struggles less than when cast by the ordinary method.

*"Farmer" Miles' Method of Casting a Colt.*

Figure 109 represents the Miles colt hobbles applied (first position). The hobbles of Miles consist of four hobble ropes.

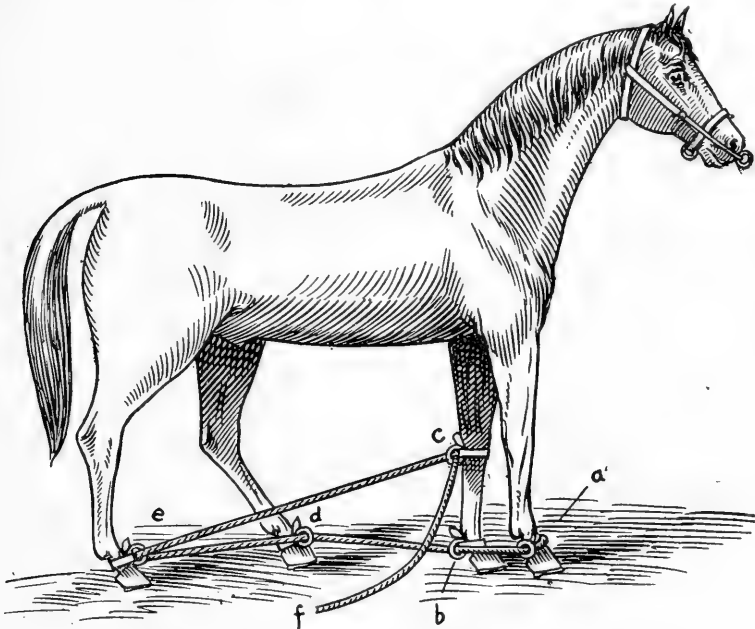

Fig. 109. Miles' Colt Hobbles Applied—First Position.

These are of the loop variety. The material used in making the loops may be either rawhide (plaited), Figure 87; leather, Figure 88, or rope, Figure 86. These hobbles are each from 15 to 18 inches long and are applied by looping. The main rope is  $\frac{3}{4}$ -inch, cotton, and 18 feet long. Upon one end is a 2-inch metal "D." This main rope is also used as the master hobble.

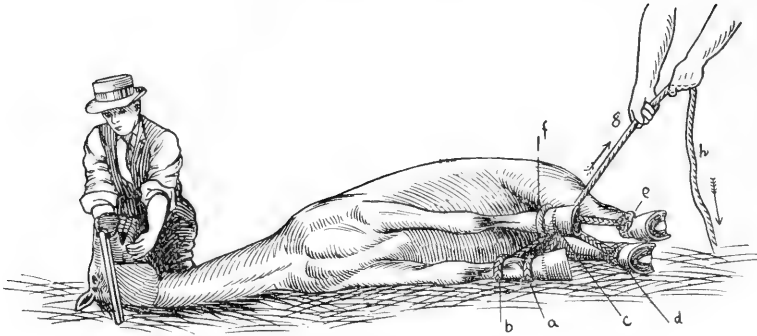

Fig. 110. Miles' Colt Hobbles (Second Position).

It will be observed that there is one hobble rope on each hind pastern, and two hobble ropes on off fore leg—one around pastern and the other below the knee. The main rope is applied around pastern of foreleg (a). It is now passed across through hobble ring on near fore pastern (b); then backward to near hind (d); thence across to off hind (e) and back to hobble ring (c) below near knee. The object of this arrangement of the ropes (two hobbles on near fore leg) is that when traction is made on free end of main rope (f) the near fore foot is raised or lifted off the ground. This in itself unbalances an animal and puts it to a decided disadvantage, besides by lifting the near fore foot the animal will go down on the shoulder of that side and will in all probability receive an easy fall. The animal

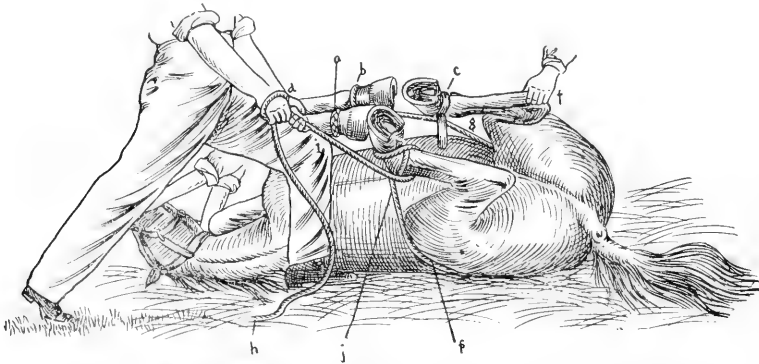

Fig. 111. Miles' Method of Securing a Colt (Third Position).

is cast as illustrated in Figure 110 (second position), and secured by taking two or more half hitches with the main rope around uppermost hind pastern. This is done by an assistant. The operator stands opposite the assistant and behind the animal and is handed the main rope (g) by the assistant (after it is fixed about upper hind pastern). The rope is carried over the loins and under the horse; thence to the lower hind pastern. Now by rolling horse on his back, Figure 111 (third position), and making downward pressure on the hind feet, at the same time drawing the rope tight by upward pull the hocks are flexed and all four feet brought down close to the abdomen.

The Miles method affords us a light, portable, strong, convenient, safe, and in every respect an efficient and satisfactory means of casting and securing the colt or even the horse. The colt is held balanced in the dorsal position by an assistant on each side.

#### SECURING THE HORSE IN SPECIAL POSITIONS WHEN CAST WITH HOBBLES.

Oftentimes after an animal is cast it becomes necessary to release one or more feet in order to re-secure them in some other or different position. By so doing, parts are rendered more accessible for operations of different kinds and in different locations, besides the restraint oftentimes is more perfect and secure. Upon the subject of "Special Positions," Moller, Liautard and Dollar have each contributed interesting as well as valuable descriptions. They are at the present time our best authorities on this important subject.

To restrain an animal in a special position after being cast with any of the ordinary hobbles, we may use either leather or rawhide straps, rope—preferably cotton rope on account of its softness and flexibility, or webbing. Moller's method of securing the legs to a board is useful in many instances. The board should be  $1\frac{1}{2}$  inches thick and 5 inches wide. It should be well padded and supplied with a curved iron handle. The cross hobbles, Figures 81 and 82, and cross bar hobbles, Figure 83, are very useful in retaining the legs in special positions.

Figure 112 represents the near fore arm (e) secured to the near thigh (j) by means of webbing. The off fore leg (a) is released from the hobble strap and fixed to the board (b) by wrapping with a web strap according to Moller's method. The near fore leg and both hind legs remain in the hobble straps (f).

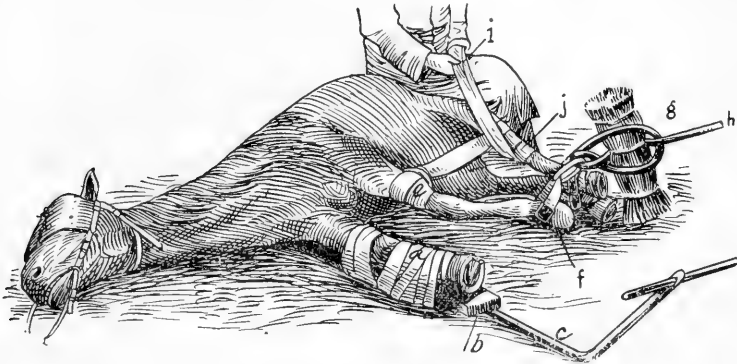

Fig. 112. Near Fore Arm Secured to Near Thigh and Off Fore Leg to Board (Moller).

Figure 113 represents the near hind leg secured to the near fore arm by means of the web strap. The off hind leg is released from the hobble strap and fixed to board (b) by means of another web strap (c).

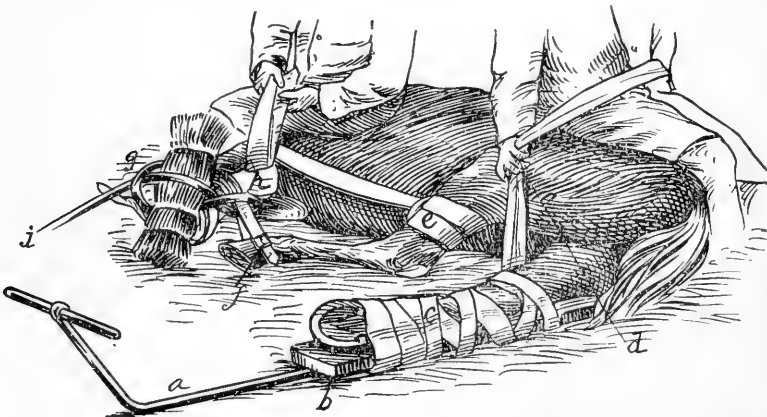

Fig. 113. Securing Off Hind Leg to Plank and Near Fore and Near Hind Legs to Each Other (Moller).

Figure 114 represents Dollar's method of fixing the hind leg by drawing it forward. The off hind leg is released from the hobble strap and the webbing applied by looping around pastern. The webbing (c) is carried over the withers, beneath the neck, over front of chest, over the fore arm (d), and thence back-

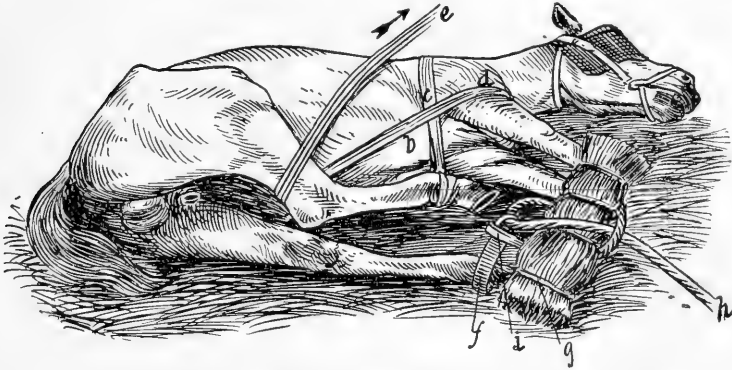

Fig. 114. Dollar's Method of Drawing the Hind Leg Forward.

ward (b) from below, upwards back of the tendon Achilles. Make sufficient traction on free end of web strap (e) to draw the leg in position shown in Figure 115. It will be observed that the off hind leg is well extended by tension above hock (a) and that the foot (c) is securely fixed behind the elbow.

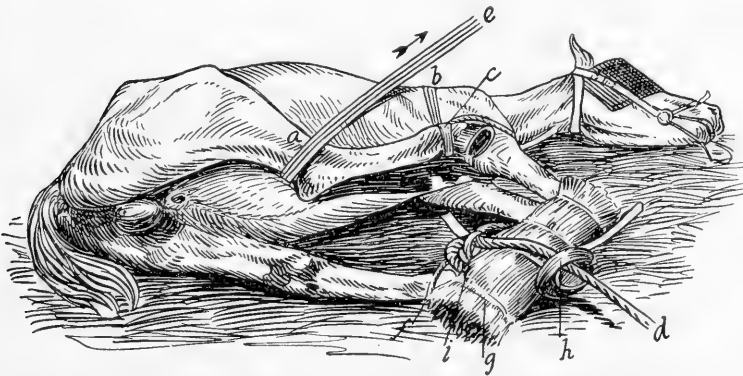

Fig. 115. Hind Leg Drawn Forward Ready for Operation (Dollar).

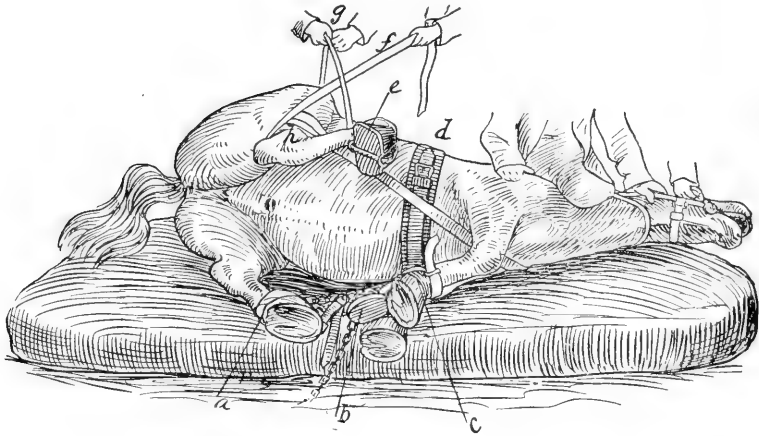

Fig. 116. Berlin Method of Drawing the Hind Leg Forward.

Another method of securing a horse in this position is by the Berlin method, shown in Figure 116.

Still another method of extending and drawing the hind leg forward is that of Liautard, Figure 117. The webbing is looped

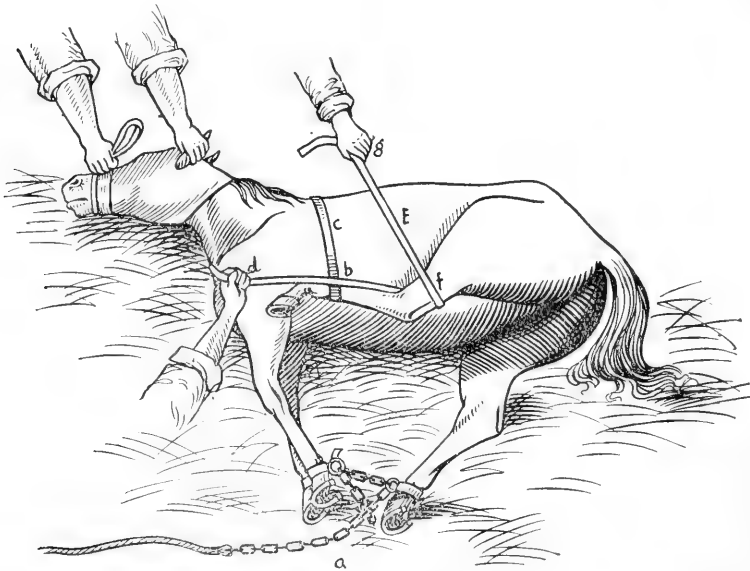

Fig. 117. Liautard's Method of Drawing the Hind Leg Forward.



above the ankle (b), then carried forward over the withers (c) under the neck, across the chest, over shoulder (d) and back to and under hind leg above hock (f). Extend the leg by making traction on free end of rope (g).

Dollar's method of securing the hind leg to the fore leg on the same side, Figure 118, is by releasing the hind leg from



Fig. 118. Dollar's Method of Securing the Hind Leg to the Fore Leg on the Same Side.

the hobble strap; then loop the webbing around leg above the hock (e); pass it forward between fore legs near the breast (d); thence under the shoulder to opposite side, where it is held by an assistant. The hind and fore legs are at this time crossed below the knee of one and below the hock of the other. They are to be held together in this position by another piece of webbing forming figure "8."

Liautard's method of securing the hind leg to the fore leg on the same side, Figure 119, is by allowing all four legs to remain in the hobble straps. Loop the plate-longe or web strap around the fore leg below the knee; from there it is carried

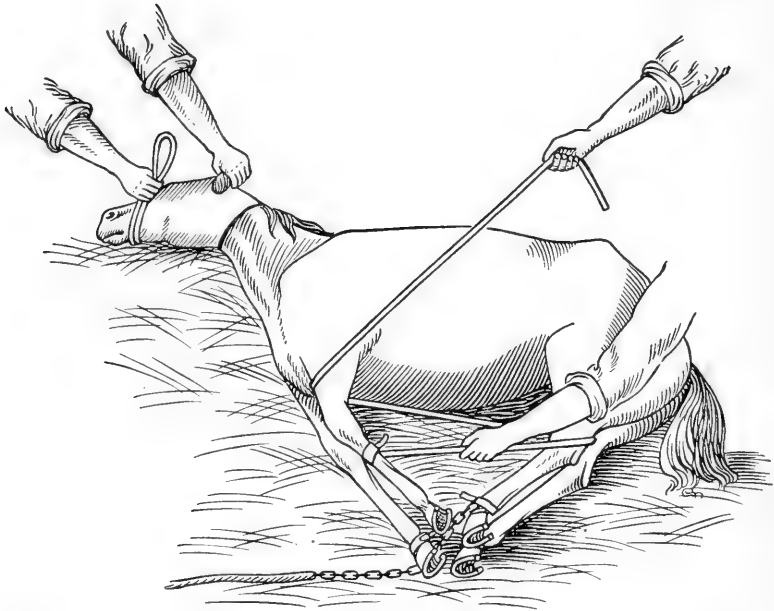

Fig. 119. Liautard's Method of Securing the Hind Leg to the Fore Leg on the Same Side.

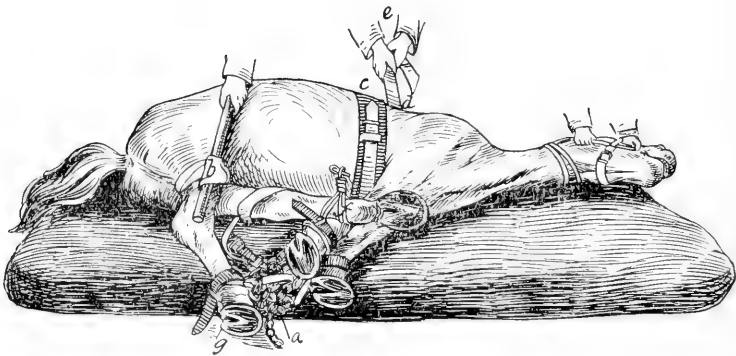

Fig. 120. Dollar's Method of Securing the Lower Hind to the Upper Fore Leg.

backward to, and from above, downward around hind leg above hock; thence forward to elbow; then around fore arm. Make traction from free end of the rope.

Figure 120 represents Dollar's method of securing the lower hind to the upper fore leg. The lower hind leg is released from the hobble strap. The plate-longe or webbing is looped around the leg above the hock. It is then carried forward between the fore legs, in front of the breast, under the neck and out on the opposite side, in which position it is held by an assistant. The legs are secured where they cross (f) by means of another strap. To make it more stationary and secure a hock twitch may be

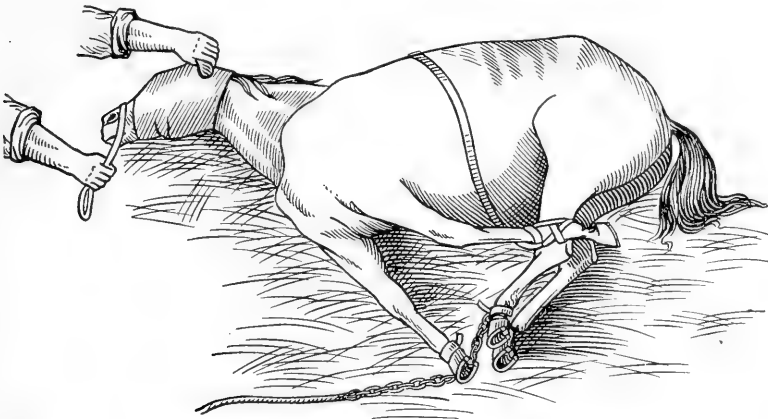

Fig. 121. Liatard Method of Securing Off Fore to Off Hind Leg.

applied around both hocks (b). To fix the near fore to near hind leg, Figure 121, it is necessary to loop the plate-longe or webbing around at the middle third of the metacarpal region. Then the leg is drawn up and placed across the hind leg above hock. They are secured here by tying in shape of figure "8."

Figure 122 represents the Berlin method of restraining a horse in the dorsal position after casting. The hind and fore leg of each side must be fixed together (b) (d), this is done with either webbing, rope or leather. With a running noose in the end of strap a loop is made around hind fetlock; then by two

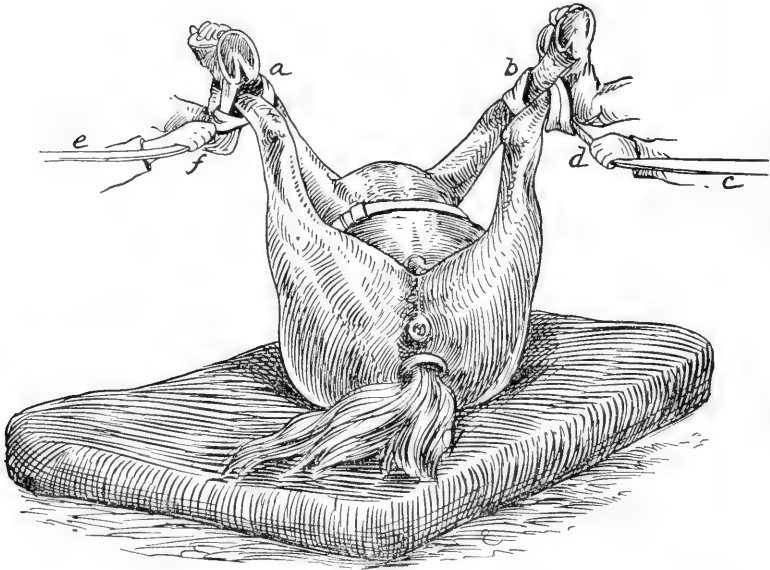

Fig. 122. Berlin Method of Restraining an Animal in the Dorsal Position.

or more half hitches the hind fetlock and fore fetlock are fastened together. The animal is now rolled on to its back. If more restraint is desired it may be readily obtained by looping a strap or rope just above the fetlock on near side; then carry it downward under the back thence upward to fetlock of off side.



Fig. 123. Vienna Method of Restraining a Horse in the Dorsal Position.

The legs and feet can now be drawn down close to the abdomen, which affords ample restraint.

Figure 123 represents the method used in Vienna for restraining a horse in the dorsal position. It is similar in all respects to the Berlin method, Figure 122, with the exception that

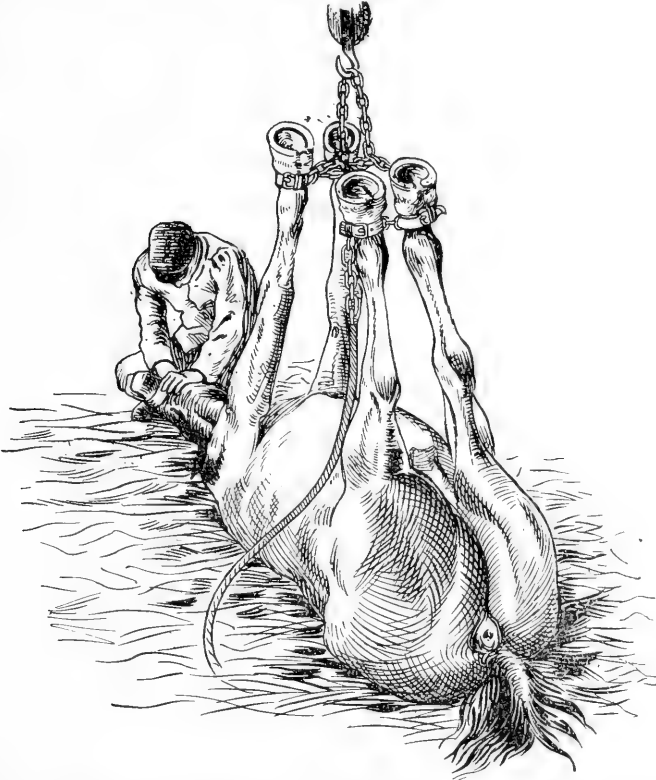

Fig. 124. Pulley and Short Chain for Holding Horses on the Back (English Hobbles).

a broad back strap (a) is used instead of the webbing or rope. This back strap (a) is 8 to 10 inches wide and made of leather. In each end is a large metal triangle. To apply this back strap (a) the horse is lifted by the tail until the back strap can be slipped under. Then by webbing or leather straps around and

above the fetlocks (b) and through the end triangles the legs can be drawn down against the abdomen to the desired position.

Figure 124 represents another method of restraint in the dorsal position. The animal is cast and secured with English hobbles, then by means of a short chain and pulley the animal is raised to and held in the dorsal position. It is possible for only two men to confine a large and strong animal by this method.

For another method of securing an animal in the dorsal position, see Figure 111.

## CHAPTER II.

### CASTING AND SECURING HARNESS AND ROPES.

Casting and restraining the horse by use of harness, ropes or other methods—aside from hobbles and operating tables—will surely test the skill and dexterity of the surgeon in the efficiency of his restraint technique. It is by means of the various designs of securing harness and ropes that most of the “special positions” of the animal are obtained. Special positions are necessary in order to perform certain surgical operations.

Restraint by use of casting harness and ropes means restraint in its broadest sense. With these special appliances we are enabled to render the animal absolutely motionless and at the same time harmless. When thus properly restrained the animal is entirely at our mercy, and we can with safety and confidence proceed with whatever operation we wish to undertake.

Casting and securing harness, and rope methods, vary much in their “make-up.” They not only vary in different countries but in different sections of the same country. The original designs are constantly being modified by different practitioners.

### KNOTS USED IN RESTRAINT FOR FIXING THE VARIOUS ROPES, CORDS AND STRAPS.

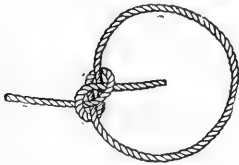

Fig 125. The Gramy Knot.

In order to properly fix or secure ropes, cords or straps, the surgeon should know the formation of the different varieties of knots used for this purpose.

Figure 125 represents the Gramy knot. The formation of this knot is somewhat tedious and complicated; however, when once formed or applied it will not slip.



Fig. 126. Double Hitch Knot.

Figure 126 illustrates the double hitch or "Clove hitch" knot. This knot is made by forming two loops and throwing them together. This is one of the principal knots used in recumbent restraint with casting harness and ropes. The *half hitch knot* so often mentioned and used is simply a part of this double hitch knot and is very simple in its formation.

Figure 127 represents the true lovers' knot. This is a knot which is simple in its formation; however, on account of its liability to slip or become untied, it is of doubtful value in restraint technique.



Fig. 127. True Lovers' Knot.

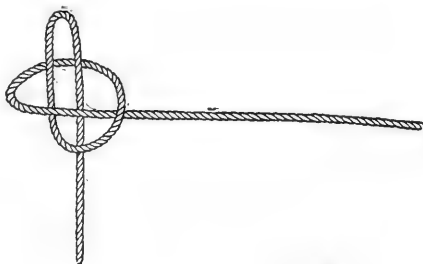

Fig. 128. Slip Bow Knot.

Figure 128 represents the slip bow knot. This knot is easily and quickly made and can be conveniently untied by making traction on one of its free ends.

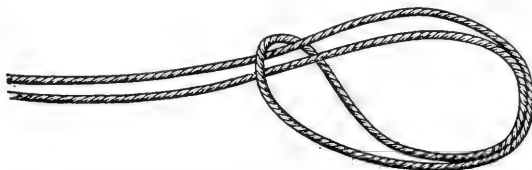

Fig. 129. Slip Knot or Loop.



Figure 129 represents the slip knot or loop. This loop is very extensively used in restraint work. So long as traction is made on the free end of this loop there is no liability of its slipping. Besides the above, there are ring knots, stopping knots, surgeon's knot, etc.

### *Hock Twitch.*

After the animal is cast and restrained by most of the casting harness and rope methods it oftentimes becomes necessary to supplement this restraint by applying the hock twitch, Figure 130. This twitch consists of a heavy rope with a loop in each end to carry the stick by which the twitch rope is tightened around the leg. This appliance limits the leg movement. The hock twitch is applied about 4 inches above the hock.

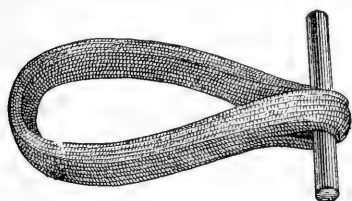

Fig. 130. Hock Twitch.

Figure 131 represents Petersen's hock joint flexing and fixing apparatus for bending and holding the hind leg in the flexed position. This apparatus consists of two heavy leather straps attached to a specially designed metal center piece. The metal is placed against and in the flexure of the hock. One of the straps is attached around the leg above the hock and the other below the hock.

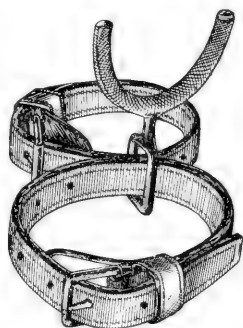

Fig. 131. Petersen's Hock Joint Flexing and Fixing Apparatus.

Figure 132 illustrates one of Dollar's modes of fixing the fore and hind legs together after an animal is cast.

### *Knee Straps.*

In order to properly throw an animal with casting harness it often becomes necessary to first restrain one fore leg by using some form of knee strap. Sometimes, or with some forms of casting apparatus, it becomes necessary after casting to apply

the knee strap in order to complete the restraint. These can be applied to one or both fore legs to a good advantage, thus

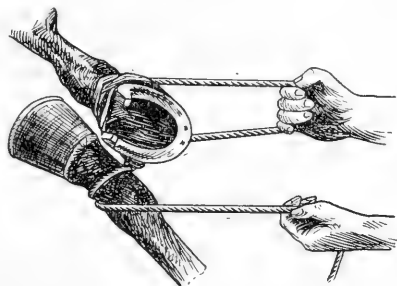

Fig. 132. Dollar's Method of Fixing the Fore and Hind Legs Together After Casting.

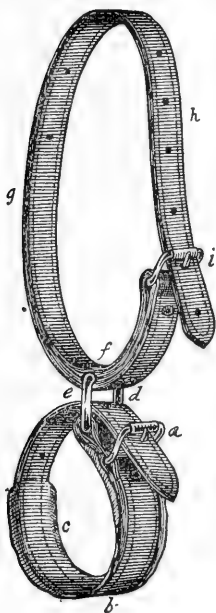

Fig. 133. Author's Knee Strap.



Fig. 134. Trasbot's Knee Strap.



Fig. 135. Hess' Knee Strap.

insuring most perfect restraint. The various forms of knee straps have already been described under head of "restraint of one fore leg," hence it is unnecessary to again describe them.

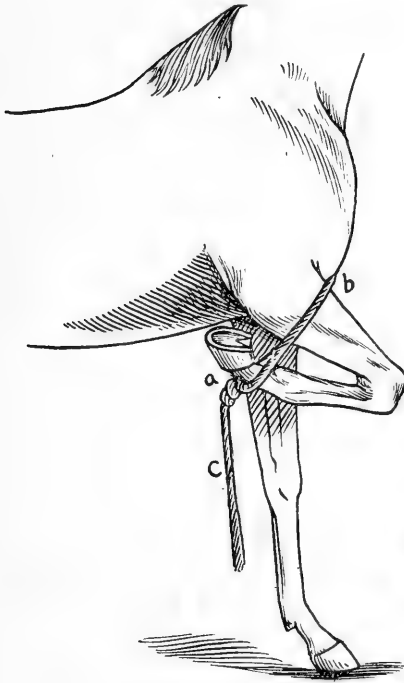

Fig. 136. Fixing Fore Leg Flexed With Rope.

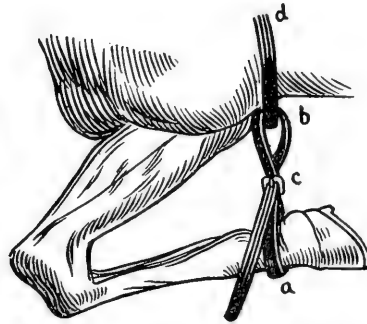

Fig. 137. Magner's Surcingle and Strap.

### *Conkey's Casting and Securing Harness.*

The Conkey casting and securing harness, Figure 138, affords us a safe and secure means of restraint. The strap parts are of rawhide, carrying heavy metal buckles and rings. The ropes are best grade sisal. All parts are adjustable. It will be observed that the animal is mostly cast with the hobbles, and secured after casting with the harness.

### *Directions for Casting and Restraining with Conkey's Harness.*

First apply the hood (A). This is done by laying it on the withers and gently drawing it up over the head until it comes in place, then instruct your assistant (1) to hold the head straight with the body and well up as shown in Figure

138; should the animal exhibit a restless disposition and continue to move about after applying the hood, you are to apply a twitch to the nose, which is to be held by assistant (1), who must not allow the animal to move *forward* under any circumstances. You will now proceed to adjust the harness by placing loin strap (B), back strap (C), belly girth (E) and breast strap (F) as shown in Figure 138. You will notice that breast strap (F) comes below the sternum and against the arm of front legs to prevent choking. Now buckle the short pastern

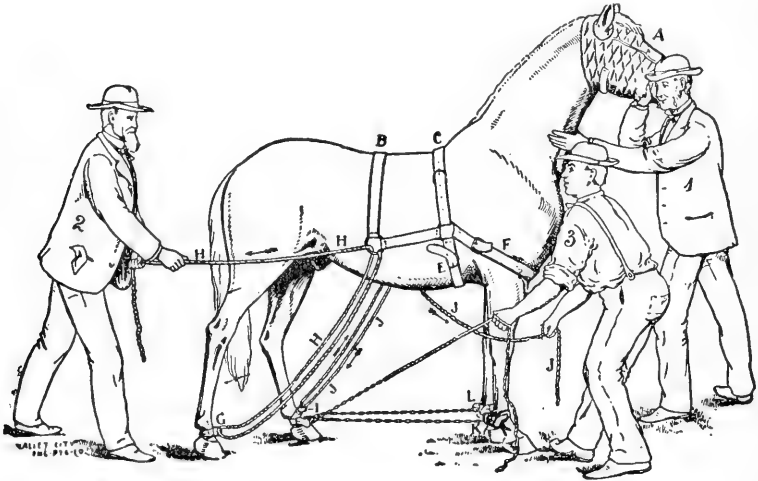

Fig. 138. Conkey's Casting and Securing Harness Applied.

strap (G) to the right hind pastern, *Dee* in front and buckle outside, then take side rope (H), pass it through the *Dee* (G) from right to left, carry it up to the side ring, passing it from left to right, and carry it back across the hips, handing it to assistant No. 2, who should stand close behind, facing the animal and a little to the left.

The operator (3) will now proceed to buckle the other pastern strap (I) to the left hind pastern, *Dee* in front and buckle inside, now pass the side rope (J) through the *Dee* (I) from right to left, then up to and through side ring from left to right, or outside in, then carry it through under the belly

dropping it in a convenient place, or you may give it into the hands of a bystander until you are ready for it.

The operator will now take three hobbles, the one having the chain buckle he will fasten to the near hind leg, buckle inside or to the right and just below the pastern strap (I), then buckle the other two hobbles (K) and (L) to the fore pastern, *Dees* behind and buckles to the right, now pass the chain rope from right to left through the right *Dee* (K) and the left *Dee* (L) carrying it back to the chain buckle and pass it from left to right through the chain buckle and carry it forward so that the operator will stand just in front and about 3 feet to the right of the animal as shown in the cut (138).

If a third assistant (J) is employed, which may be done with good results, he is to stand 3 feet behind and between No. 1 and the operator. He will at the word "*pull*," pull just enough to keep rope (J) tight until the horse drops, the operator managing the chain rope alone. As the horse drops, the operator will first see that the chain buckle has clasped the chain, then take rope (J) from his assistant (J) and proceed as if alone.

Do not pull a pound until the word "*pull*" is given, then you are to pull your rope across the hip until the horse drops on the left side, pulling hard enough to draw the foot up to, or near the side ring to which the rope is attached, and keep it there at all hazards.

The operator (3) will now take a firm hold of chain rope and a moderate hold of rope (J), he will now instruct assistant (1) to step the horse backward, and (above all do not allow the horse to take one step forward as he might trip and fall on his head, causing severe injury) push until he falls over on his left side. As the horse lifts his near hind foot the operator will give a quick pull on the chain rope, drawing the hind leg up to the front legs, where it is held by the self-locking chain buckle, at the same time shouting *pull*. Seeing that the chain buckle is secure, the operator turns his attention to the rope (1), holding it firm enough to prevent the harness from turning on the horse while assistant (2) draws the off foot up near the ring, giving his rope one turn around the foot, holding

it there until the operator unbuckles the chain buckle hobble from the hind leg, securing the leg by winding the rope around the foot, then back around the hock, describing a figure 8, as shown in Figure 139; give the rope several turns quite tight to prevent its slipping and make it fast; now proceed to secure the off hind leg in the same manner. Unbuckle the off front hobble (K), take knee strap (M), give it one turn around the pastern, then up around the arm, flexing the leg as shown in Figure 139; then unbuckle the near hobble (L), flex and bind the leg in

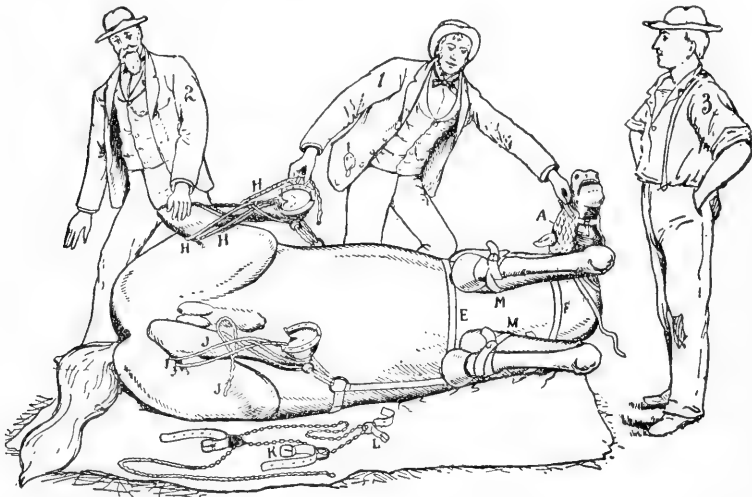

Fig. 139. Conkey's Casting and Securing Harness—Animal Cast and Secured.

the same manner; now instruct assistant (1) to hold the head as follows: Place your knee on the horse's shoulder, your right foot so that the leg comes against the horse's back; with your left hand grasp the halter or hood while the right hand is to grasp the rope at some convenient point near the hind foot, holding the animal in the position shown by the cut. Assistant (2) will grasp the hock, lifting the leg a little upward and you have the animal in the most desirable position that it is possible to gain.

In releasing the animal, remove the knee straps first; then

release the lower hind leg and then the upper one; unbuckle the belly girth (E), then breast strap (F), and lastly remove the operating hood and assist the animal to rise.

*W. F. Knowles' Casting and Securing Harness.*

The casting and securing harness illustrated in Figure 140 were designed by W. F. Knowles. These harness are made in

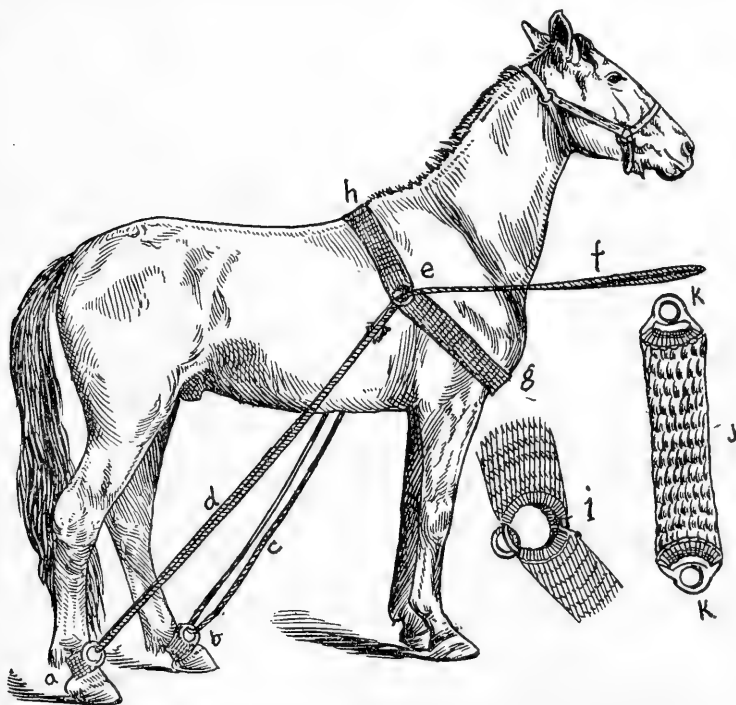

Fig. 140. W. F. Knowles' Casting and Securing Harness—Applied.

large and small sizes. The large size fits horses weighing 900 pounds or more, and small size harness fits those of smaller size.

This apparatus is light, compact, and convenient to carry. When properly used it affords ample restraint for all ordinary purposes. It consists of a flat webbing collar, two main ropes and two hobble straps. The collar is in two sections (h) (g); each section is connected on each side of the horse by heavy

double rings (e), one of which is of special design (i) to afford easy passage of the two main ropes (d) (c). The ropes (d) (c) are each  $\frac{5}{8}$ -inch in diameter and 20 feet long. One end is securely fastened into the inner ring (e) of the webbing breast collar. Around each pastern (a) (b) is placed a webbing hobble (j). In each end of this webbing hobble is fixed a specially constructed metal rounded "D" (K) (K) through which the ropes pass. To apply this harness the breast collar is placed over the head and adjusted to the shoulders. One section fits over the withers (h) and the other section is dropped down below point of shoulders (g). The free end of the ropes (d) (c) passes downward to and through each "D" of webbing hobble; then upward to and through "D" (e) of breast collar. If desired to cast horse on off side, the off fore foot is to be raised and secured by some form of knee strap. The free end of main rope on near side should be carried backward over back and held by two assistants. The free end of main rope (f) on off side should be carried forward, well in front of the animal and there held by two assistants. To cast the animal traction is made on each rope and at the same time the animal is forced backward a step by assistant in charge of the head. The head is pulled to the right, and the animal is cast on off side. After being cast the animal may be secured by two methods.

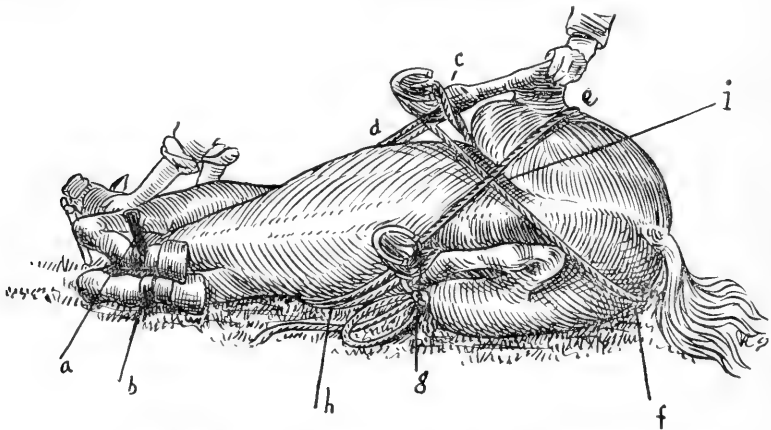

Fig. 141. Animal Cast and Secured with W. F. Knowles' Casting Harness by Crossed Rope Method.



Figure 141 represents animal secured by the crossed rope method. This tie is made by drawing the foot (c) forward; take a half hitch around pastern to fix rope; then pass rope down over back; then under horse and around hip (f); thence to pastern (c), where it is fixed by one or more half hitches. The knee strap is applied to near fore leg, after which turn animal over. The same procedure is gone through with on the opposite side, which secures the horse by crossing the ropes (i) in front, also on the back. A back rope may then be applied from crossed ropes behind to breast collar at withers. This prevents ropes from slipping off the hips.

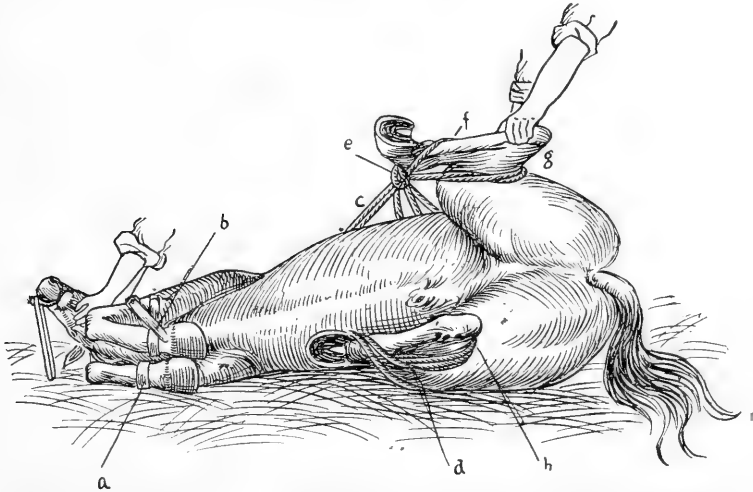

Fig. 142. Animal Cast and Secured with W. F. Knowles' Harness by Half Hitches Above and Behind Hock.

Figure 142 represents an animal cast and secured with W. F. Knowles' harness by half hitches above and behind hock (h) (g); these retain the hock in a flexed position which affords free access to the inguinal region. In securing by this method (Figure 142) no back rope is required.

#### *Whitwell's Casting and Securing Harness.*

The Whitwell casting and securing harness, Figure 143, are similar in many respects to those of W. F. Knowles (Figure

140); the principal variation is in the breast collar. It will be observed that the breast collar of Whitwell's harness consists of an over-withers strap (k) attached on each side to metal blank buckles (b); those carry the adjustable rope (d) which completes the breast collar. This harness is applied and the animal cast and secured same as by using W. F. Knowles' harness (Figures 140, 141 and 142.)

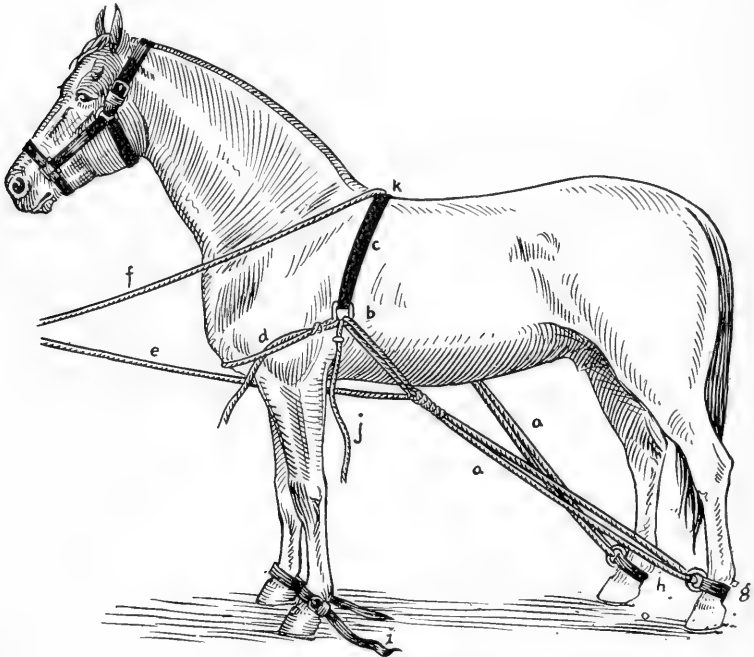

Fig. 143. Whitwell's Casting and Securing Harness.

*Hulburt's Casting and Securing Harness.*

The Hulburt casting and securing harness, Figure 144, consists of a very heavy and substantial body belt (f) made of leather. This body belt is applied so that the four heavy metal "D's" (e) hang down under the chest. The body belt is prevented from slipping forward by a crupper. A rope rein (h) is fastened around lower jaw (j) and to body belt (i). This

rein is used for controlling the head. A rope is looped around one hind pastern (a) and then carried forward (d) to and through one of the "D's" of body belt. One fore leg is fixed by means of a knee strap to one of the "D's" in the body belt; this puts the horse on three legs, which places him at a disadvantage while being cast by traction on free end of rope (c) at the same time head is drawn around to side. After casting, the other two legs are secured to "D" of body belt by means of hobbles and knee straps.

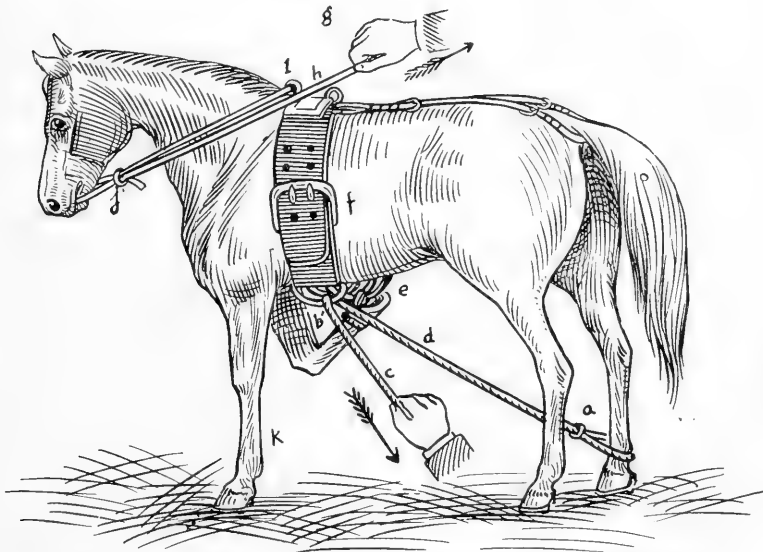

Fig. 144. Hulburt's Casting and Securing Harness—Applied.

#### *G. W. Ziegler's Casting Harness.*

The casting harness of G. W. Ziegler, Figure 145, consists of an over-withers strap which carries at each end a heavy metal ring (a); into this main ring another ring is fastened (b), also the girth rope, breast rope (j) and main casting rope (m). This casting rope is passed over the back, then downward (c) to and through hobble strap ring (d) of off hind pastern, thence upward and forward (f) to and through ring (b) on opposite side.

The same arrangement of ropes is made on the other side. One fore leg is flexed and fixed by using a knee strap. The animal is cast by making traction on free ends of main ropes (n).

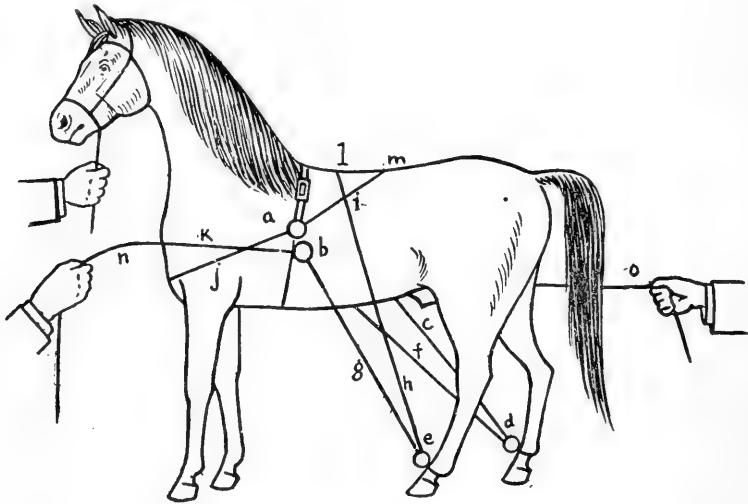

Fig. 145. G. W. Ziegler's Casting and Securing Harness.

#### *Danish Casting and Securing Harness.*

The original Danish method of casting has been modified in at least three instances. The authors of these three modifications are Abilgaard, Pfeiffer and Mathias. The original Danish casting harness, Figure 146, consists of a body girth, breast strap, four hobble straps, and two main casting ropes. The body girth is heavy and strong. It carries a heavy "D" at bottom (e) and one at the top (h). The breast strap (i) is adjustable and is attached to body girth on each side of horse to prevent girth from slipping backward. A hobble strap is applied to each pastern. If it is desired to cast horse on near side one of the main ropes is attached to hobble strap ring of off fore leg (d); the rope is then passed across to and through hobble ring (c) of near fore leg; thence backward to and through hobble ring of near hind (b); then upward through "D" (e) of body girth. Traction is made from free end of rope (j). The other

main rope begins at hobble ring of off hind; then carry rope (g) upward to and through "D" (h) on top of the body girth. As will be observed by the use of this process, the casting is done by forcing the animal to flex his legs, followed by its slowly falling on the bed. The legs being tied up to the body, their extension is impossible; muscular contraction is limited, and excessive flexion of the vertebral column prevented. Besides

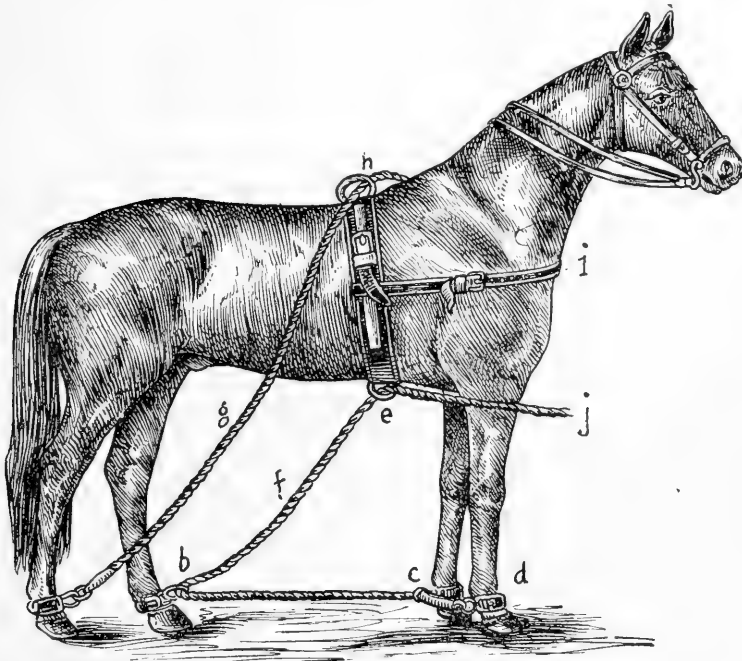

Fig. 146. The Original Danish Casting Harness.

this, the complete flexion of the extremities allows full view and easy access to all regions, especially the inguinal.

To cast the horse the head is held by an assistant; a pull made at the same time on the chain and on the rope bringing the legs together—the animal is cast. The chain is fixed in the usual way and the rope pulling near hind leg close to the body and towards the upper ring of the belt, is secured by half hitches around the coronet.

*Danish Casting Harness as Modified by Matthias.*

The casting harness, Figure 147, represents Matthias' modification of the Danish casting harness. It is similar in all respects to the original Danish casting harness (Figure 146) with the exception of the breast collar. In the harness, as modified by Matthias, a martingale breast collar is substituted for the plain strap breast collar of the original.

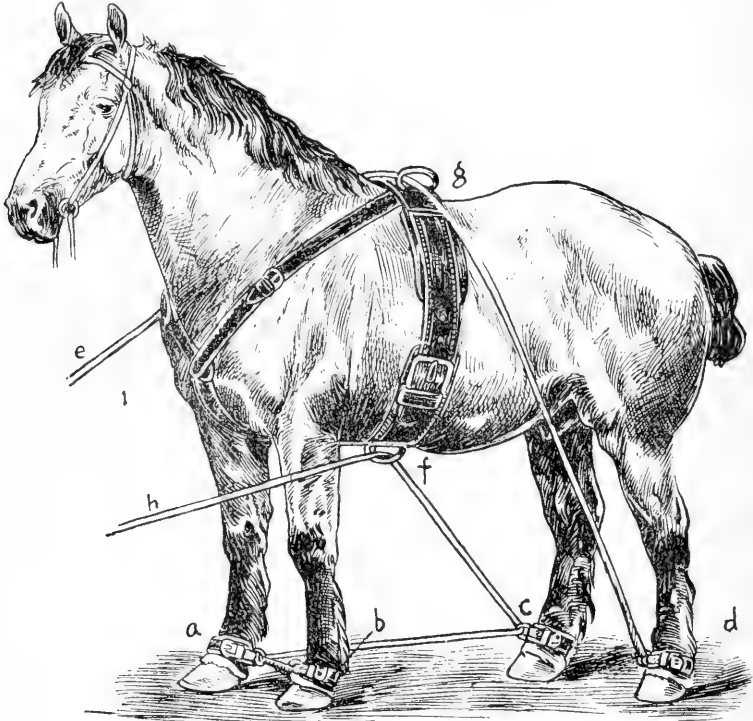

Fig. 147. Danish Casting Harness as Modified by Matthias.

*Danish Casting Harness as Modified by Pfeiffer.*

Figure 148 represents Pfeiffer's modification of the Danish casting harness. This again is the same outfit as the original, with the exception of the breast collar. The collar of Pfeiffer

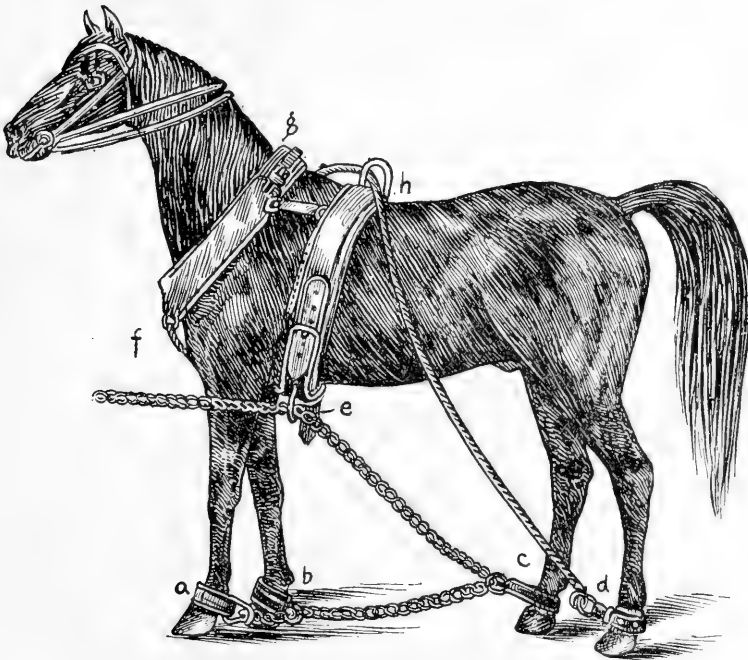

Fig. 148. Danish Harness as Modified by Pfeiffer.

is of leather and extra heavy. It is attached to the body girth by a strap (f) passing from lower margin of collar backward between the fore legs to lower margin of body girth (e). The rope and hobble strap arrangement is same as that of Figures 145 and 146.

*Danish Casting and Securing Harness as Modified by Abilgaard.*

Figure 149 represents Abilgaard's modification of the Danish casting harness, and consists of a heavy body girth which carries a strong metal "D" under the chest (f), three hobble straps and three ropes. The hobble straps are applied to both hind pasterns and near fore pastern in order to cast animal on the off side. One rope is attached to hobble ring of off hind; then it is passed forward to hobble ring of near fore;

thence upward to and through "D" of girth (f). Traction is made from free end of rope (C). Another rope starts from hobble ring (k) of near hind and passes upward (i) and forward over back (a). Traction is also made from free end of this rope (l). The third rope is used to flex and fix the off fore leg. This foot is raised and knee rope applied before casting.

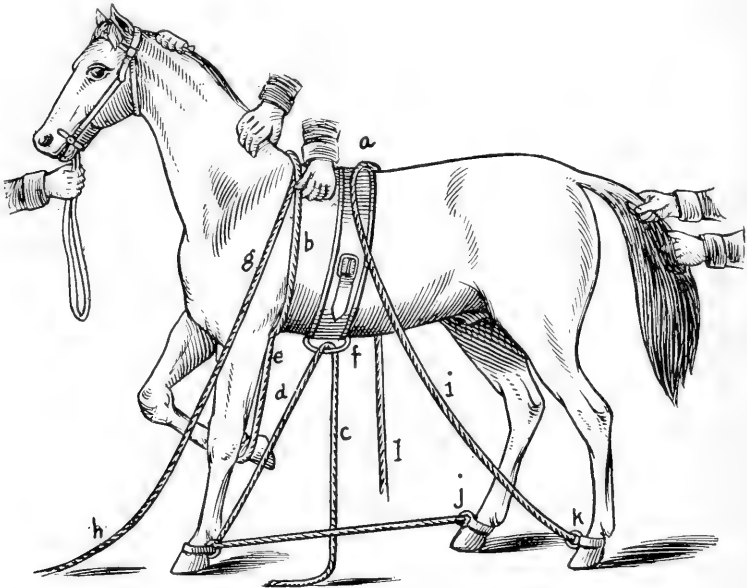

Fig. 149. Danish Casting and Securing Harness as Modified by Abilgaard.

*Rohard's Method of Casting and Restraining a Horse With Ropes.*

The rope method of Rohard, Figure 150, is simple in its construction and convenient in its application. It is intended to be used in casting and restraining wild, nervous or vicious animals on occasions where sufficient help for other methods is unavailable. A rope 25 feet long, furnished with a loop in end, is all that is necessary in making this appliance. To apply this rope and cast a horse an assistant holds the halter rein in



one hand and the animal's ear in the other. If the horse is to be cast on the off side the operator stands on the near side opposite the horse's shoulder. About 8 feet from the other end of the rope a ring knot (a) is made; this forms the loop (n) (i) which is then placed over the horse's head and around base of neck in form of a collar. Below this ring a check or lock knot is made; this latter knot holds the rope and prevents it

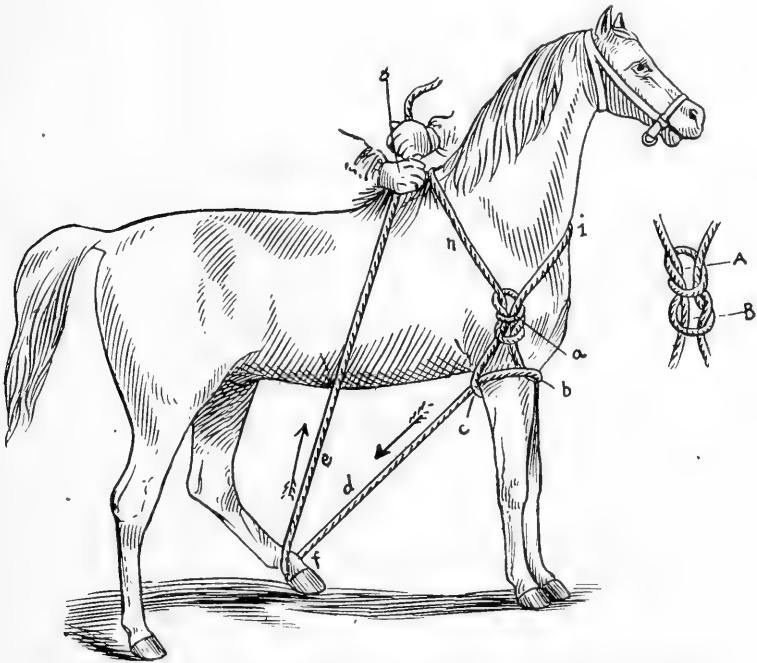

Fig. 150. Rohard's Method of Casting a Horse with Ropes.

from slipping. These knots reach near the point of shoulder. The other end of the rope is placed behind the fore arm below the elbow, then brought around the outer side of the near fore arm; thence in front of both fore arms (b) and lastly carried around the outer aspect of the off fore arm under the portion which has been passed around the back part. By the above arrangement we have the fore arms enclosed in the rope. This rope is then tightened by bringing the two fore legs closer

together. An assistant holds this rope arrangement in place while the operator passes the free end of the rope (d) under the body to and around the near hind pastern (f); then back to the withers (o) on the off side. The operator grasps free end of rope (o) by a firm hold, his body pressing at the same time against the horse's near shoulder. Then a gentle pull is made; at the same time lightly kick the horse's near hind foot to cause him to lift it; continue pulling slack out of rope until leg is completely flexed and animal will sink and fall lightly upon the ground. The legs are then secured in the following manner: On the near hind leg the free end of rope is passed around

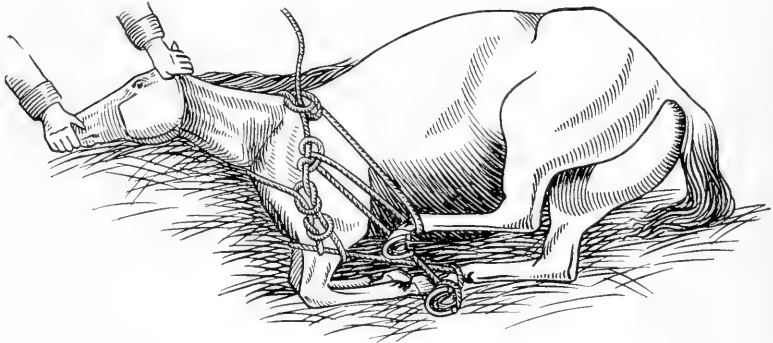

Fig. 151. Rohard's Method of Securing a Horse After Casting.

pastern but below the other part of rope proceeding from the fore leg, and there tied so that this pastern is secured by a double twitch knot. The remainder of the rope is carried up to the neck portion and hitched there. Then it is brought back to and around the off hind pastern and finally tied to the neck rope by a single knot. To effectually use this method much practice is required. The operator should constantly bear in mind the fact that the best results are obtained where the hind leg is pulled forward and completely flexed.

Figure 151 represents a horse cast and restrained by the rope method of Rohard. Only one assistant is necessary in casting and securing a horse by this method.

*Hayes' Improvised Casting Ropes.*

The collar loop, Figure 152, of Hayes' improvised casting ropes consists of a rope loop (d) large enough to slip over the head and small enough to fit snugly around base of neck. Into

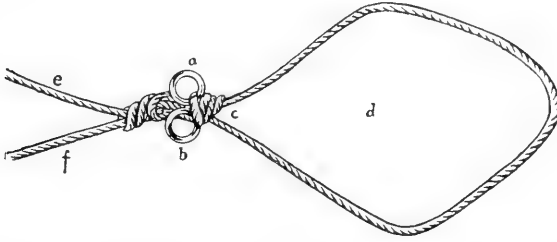

Fig. 152. Collar Loop of Hayes' Improvised Casting Ropes.

the knot (c) at base of this loop two  $2\frac{1}{2}$ -inch metal rings are fixed. To prevent these rings from slipping out of place another knot is made in rope behind them. This completes the collar loop of Hayes.

Figure 153 represents Hayes' casting ropes applied. It will be observed that the loop is placed around the neck (d) with

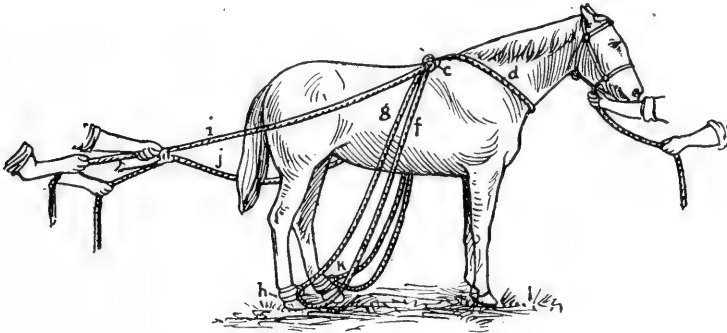

Fig. 153. Hayes' Improvised Casting Ropes Applied.

the knots and rings placed near the withers (c). There are two free ends of the ropes (i) (j); these are each 28 feet long. From the withers (c) these ropes are passed downward on each

side to and through rings of hobbles on each hind pastern (k) (h), thence upward (g) to and through the metal rings at withers (c). One fore foot is raised and fixed with a knee strap. The animal is then cast and secured in the ordinary manner.

*Dollar's Rope Method of Casting with Double Side Line.*

The double side line method of Dollar, Figure 154, consists of a  $\frac{3}{4}$ -inch rope 50 feet long. In the middle of this rope a loop

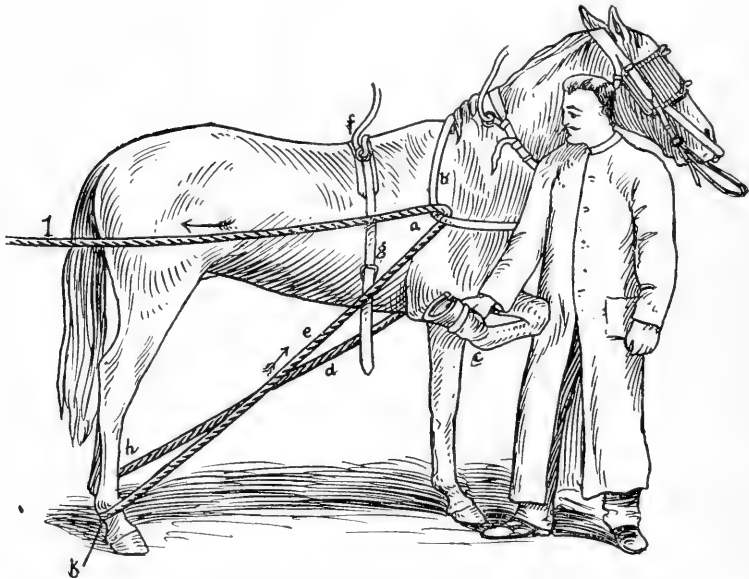

Fig. 154. Dollar's Rope Method of Casting with Double Side Line.

is made (h) large enough to fit around base of neck. The knot is placed against chest and each rope (d) (e) is passed downward to and around each hind pastern (k) (h); then upward through the neck loop (a). To cast the animal the free ends of the ropes are each held by two assistants. One of the fore feet (c) is lifted and held flexed by an assistant or secured by a knee strap. One of the main ropes is now pulled outward at

right angles to the shoulder and the other backward. When traction is made on the ropes with them in this position it causes the animal to drop upon its hocks and finally upon the ground. A plate-longe or webbing “unbalancing strap” may be attached to surcingle to aid in unbalancing the animal. As soon as the animal falls to the ground the ropes are tightened and animal rolled on its back—dorsal position. The hind feet should be drawn down close to the abdomen and secured by one or more half hitches around each hind pastern. “Halter burns” can be avoided by first applying bandages around hind pasterns. It is advisable to use cotton rope when possible in casting and restraining horses by this method.

*Lernberg Casting Ropes.*

Krolokowski's Lernberg casting and securing ropes, Figure 155, consist of 65 feet of  $\frac{5}{8}$ -inch rope, two hobble straps, and a

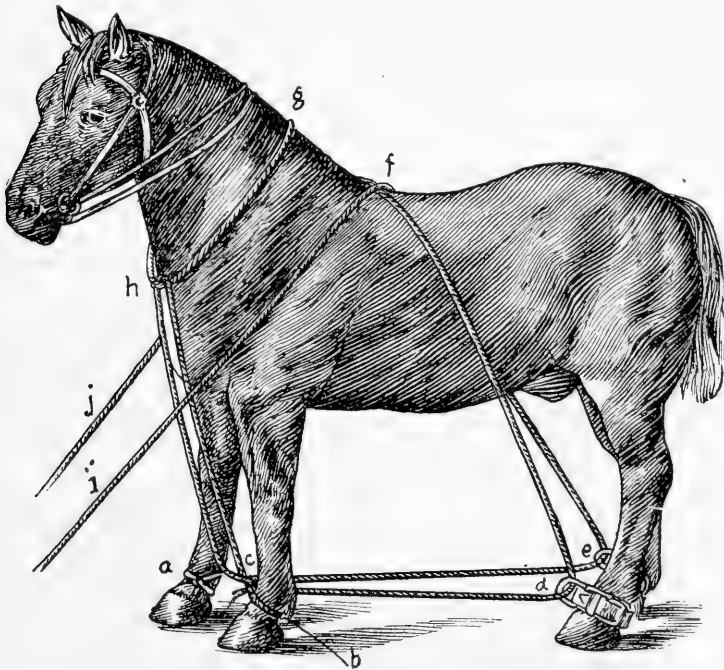

Fig. 155. Lernberg Casting Ropes Applied—Krolokowski's.

short rope with which to fix the fore legs together. In center of main rope a neck loop is made. This loop should be large enough to fit around base of neck (g) (h). The knot is placed in front of breast (h). The fore pasterns should now be fixed together by means of a short cross rope or strap (a) (b). The main ropes should be carried downward under cross rope (a) (b), then backward to and through hobble strap rings on each hind pastern (d) (e); thence upward on each side of horse; then over the back (f). The horse is cast by making traction on free ends of main ropes (i) (j). It is secured after casting by two or more half hitches around each hind pastern.

*McDonald's Casting Ropes.*

The casting ropes of McDonald, Figure 156, consist of 60 feet of  $\frac{5}{8}$ -inch rope. This rope is then doubled so that one free end will be 8 feet longer than its fellow on the opposite side. A neck loop (H) is made in this rope at its middle and placed over the head and around base of neck in the ordinary

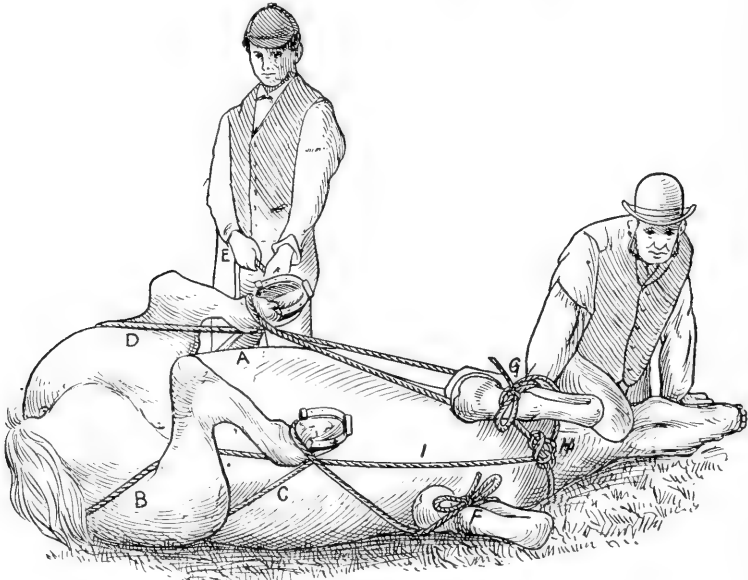

Fig. 156. McDonald's Casting Ropes—Horse Secured.

manner. The long end of the rope being placed on the side upon which we expect to cast the horse. Then cast him in the usual way. After being cast, the operator pulls the under rope backward under the withers and winds it two or three times around the upper fetlock. The rope is then passed down in front of the upper stifle (A), then backward and under the quarters, bringing it up on the outside of the opposite thigh (B) and around the front of the lower hind fetlock. The rope is now steadily and firmly pulled until the hind legs are well flexed; then it is wound twice around the lower hind fetlock, passed down in front of stifle (C), over the quarter to the opposite side; then upward on inside of the thigh (D). Now pull firm and wind rope twice around the upper hind fetlock and hand rope to an assistant to hold. The fore legs are flexed and secured by a knee rope or knee straps.

It will be observed that when an animal is cast and secured by the rope method of McDonald the hind legs are intensely flexed and the feet (hind feet) are firmly and securely fastened to the horse's own hind quarters.

#### *Over's Double Side Line Casting Ropes.*

The double side line casting ropes of Over, Figure 157, consist of two  $\frac{5}{8}$ -inch ropes. One rope is 20 feet long, the other one 25 feet long, and two hobble straps. Double the longer rope and at its middle make a loop to fit around base of neck, the knot being on the off side and loop near the withers (a). Pass the free end of the rope (e) through hobble strap ring on off hind, then upward (a) through the collar loop (b); then over the back where it is handed to an assistant (c). Attach the other rope by a loop around the near fore pastern (g); then pass its free end backward to and through hobble strap ring on near hind pastern (f). The rope should now be crossed over and brought outside the animal's off fore leg and there held by an assistant (h). This assistant should stand somewhat in front of the horse and to the off side. To cast the animal the assistant in front makes traction on rope (h); this lifts the near hind foot off the ground and draws it forward

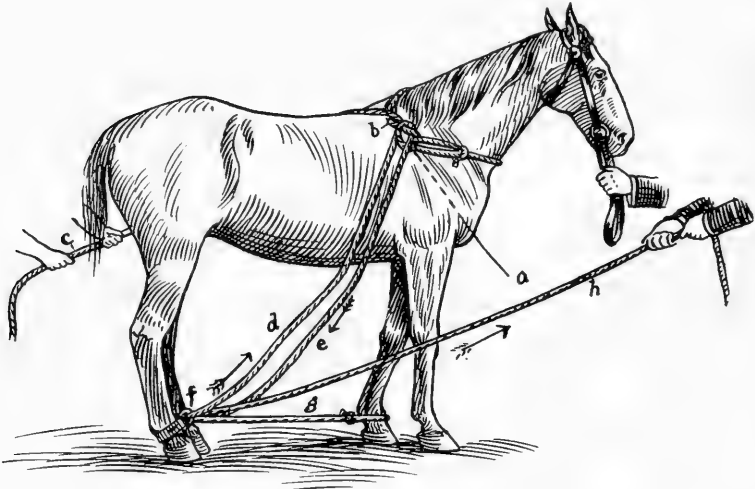

Fig. 157. Over's Double Side Line Casting Ropes Applied.

and causes the horse to drop down on his near hind quarter and finally to the ground. The horse is secured after casting by placing a hobble strap on off fore pastern. The rope which has already been passed from near fore to near hind is now passed through hobble strap ring on off fore. By tightening this rope the two fore feet and near hind foot are brought together. In this position they are secured by two or more half hitches around one of the pasterns. The other rope is tightened until the off hind foot is pulled down near the abdomen. It is then and there fixed by tying to collar.

#### *Russian Method of Casting with Ropes.*

The Russian method of casting with ropes, Figure 158, is similar in many respects to that of Rohard, Figure 150. It (Russian) consists of a  $\frac{5}{8}$ -inch rope 25 feet long; at one end is a heavy metal ring 3 inches in diameter. If the horse is to be cast on the off side, the collar is made by simply looping the ring end of rope (h) around base of neck (d) (e). The free end of the rope (b) is carried downward to and around off hind pastern (a); then forward and upward (c) to and through



ring (h). The operator now stands on the off side, the side upon which the animal is to fall, and makes traction on the halter rein (e) with one hand and free end of rope (g) with the other. This compels the horse to lie down.

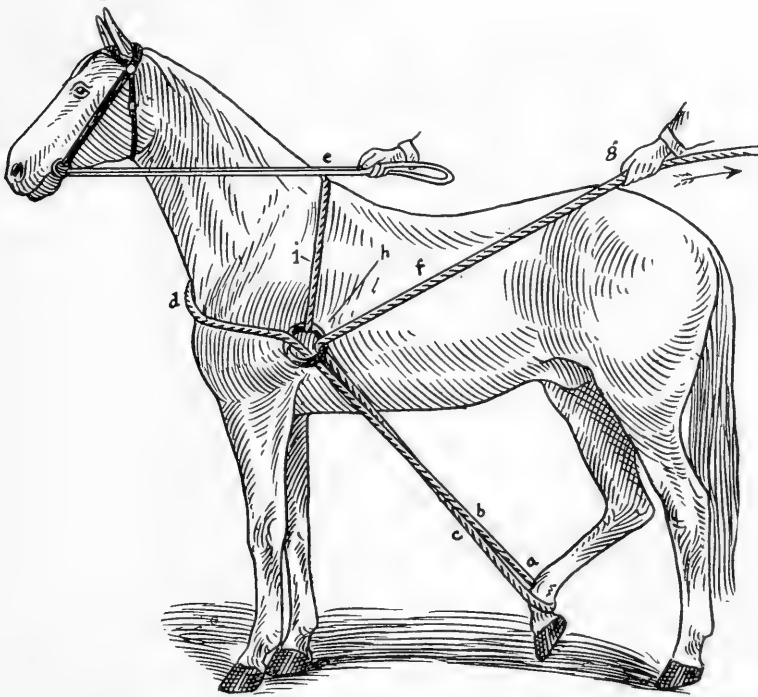

Fig. 158. Russian Method of Casting With Ropes.

*Ordinary Double Side Line Ropes.*

The rope used in casting and securing a horse by the ordinary double side line method, Figure 159, should be  $\frac{3}{4}$ -inch in diameter and 60 feet long. It is doubled and at its middle a collar or neck loop (k) (h) is made by tying a simple knot (h). This collar loop is placed around base of neck; the ropes are then passed downward between the fore legs, then backward (e) (f) to and around—from without inward—each hind pastern (a) (b); thence under the preceding rope in a crossed

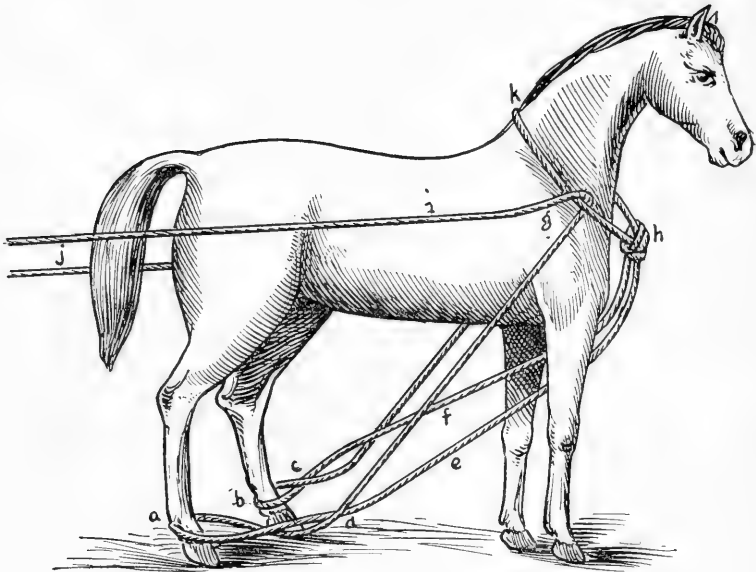

Fig. 159. Ordinary Double Side Line Ropes Applied.

position (c) (d) and back under collar loop (g). The horse is cast by making traction from behind on free ends of ropes (i) (j). If this method is used the hind pasterns should first be bandaged to prevent "halter or rope burns." It is better to use an ordinary hobble strap on the hind pasterns and allow the two ropes of the double side line to pass through the hobble strap

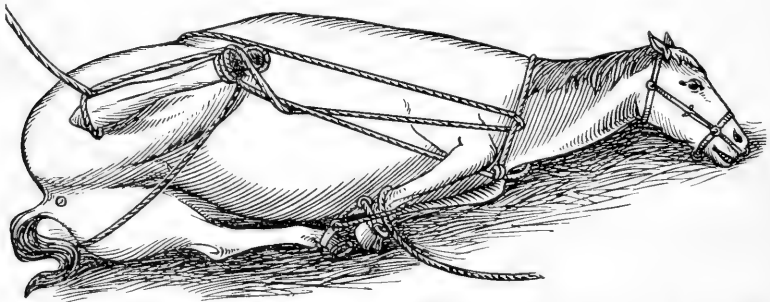

Fig. 160. Ordinary Double Side Line Ropes—Horse Cast and Secured.

rings. Cast in the ordinary manner. After casting the animal can be secured by tightening main ropes until hind feet are drawn well forward and down close to the abdomen, Figure 160. The ropes are now fixed by taking two or more half hitches around the hind pasterns; then pass ropes over loins and under back and fix by half hitches over hind pasterns.

*Miles' Rope Method of Casting and Securing "Ridglings"*  
(*Cryptorchids.*)

The rope method of casting and securing horses, as designed and used by "Farmer" Miles in his "Ridgling castration operations," Figure 161, consists of a cotton rope  $\frac{3}{4}$  inches in diameter and 66 feet long. The rope is doubled and at its middle a collar or neck loop is made by tying a knot in the rope. This rope plays no part in casting the horse; it is simply

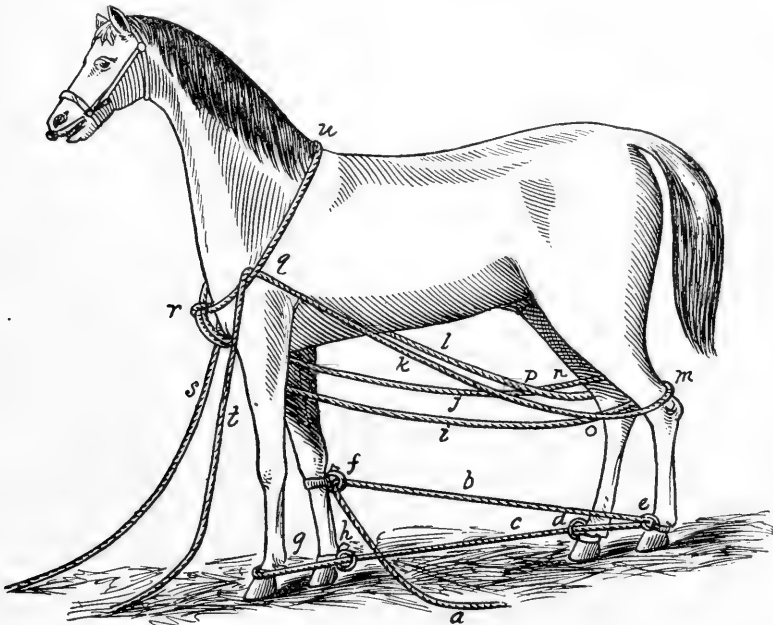

Fig. 161. Miles' Rope Method of Casting and Securing a "Ridgling."  
(First Position.)

for restraint after casting. The casting is done with Miles' rope hobbles, Figures 86 and 109. To cast and secure a horse by Miles' method a suitable place is selected. The Miles twitch, Figure 5, is applied and tied up to side of halter, Figure 6. The halter rein is held by an assistant. The loop of the Miles casting ropes is then placed over the horse's head and around base of neck (u) (r), with knot (r) in front of breast. Both ropes are passed between the fore legs and backward (i) (j)—from within outward, around the hind legs above the hocks (m); then forward and upward (k) (l) through the collar loop (q). The free ends of the ropes (s) (t) are now handed

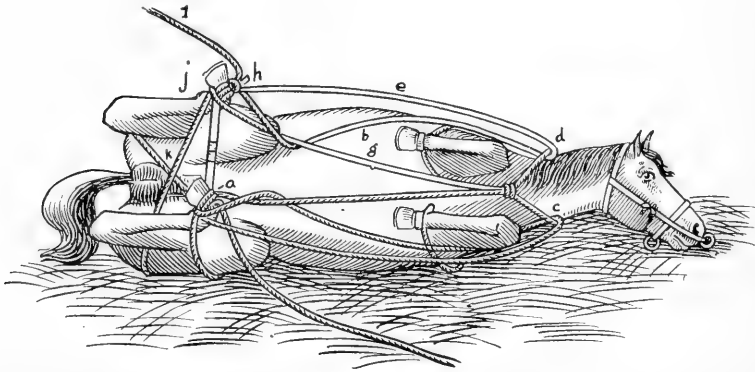

Fig. 162. Miles' Rope Method of Casting and Securing a "Ridgling."  
(Second Position.)

to two assistants who are instructed to keep all slack out of them, but not to pull a pound until after the horse is on the ground. The Miles rope hobbles are now applied. With the operator holding the tail the command is given and the horse is cast by two assistants making traction on free end of main hobble rope (a). After the horse is cast, Figure 162, the ropes are dropped from above the hocks (m) down to the hind pasterns. The hobbles are now removed and the fore legs flexed and fixed by means of knee ropes or straps. Sufficient traction is now made on free ends of the main ropes to draw the hind feet well forward. The rope is now fixed by taking two or more half hitches around the near hind pastern, then carry rope over

behind the horse in front of stifle (over the loins and under rump), and back behind the lower thigh; then across in front of scrotum (k). After drawing the rope tight and hind feet against abdomen, fix it around upper pastern (j) with two or three half hitches. The horse is now turned over and the same *modus operandi* proceeded with on the other side.

It will be observed that the ropes are crossed both in front and behind. To prevent them from slipping off the hips a back rope may be applied. This back rope is attached to the crossed ropes behind hips and to the collar loop on top of neck in front. If it is desired to have the legs stretched wider part the same can readily be done by inserting the Miles leg spreader between the hind feet.

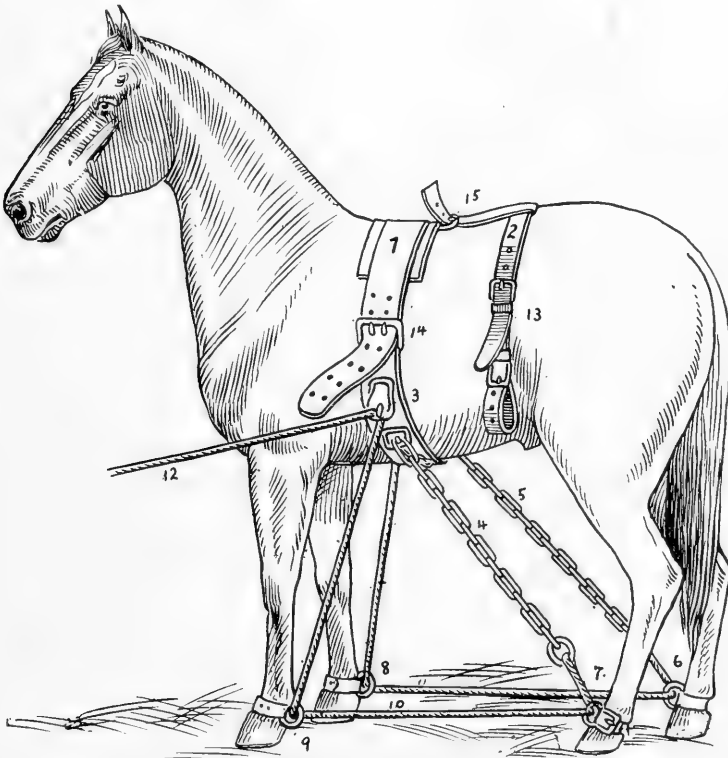

Fig. 163. Cowie's Casting and Securing Harness—Improved.

*Cowie's Casting and Securing Harness, Improved.*

The casting and securing harness of Cowie, Figure 163, is strong, safe and convenient. The chains (4) (5) prevent wear on the ropes, and the lock buckles (3) will not allow them to be drawn backward. It is therefore automatic in

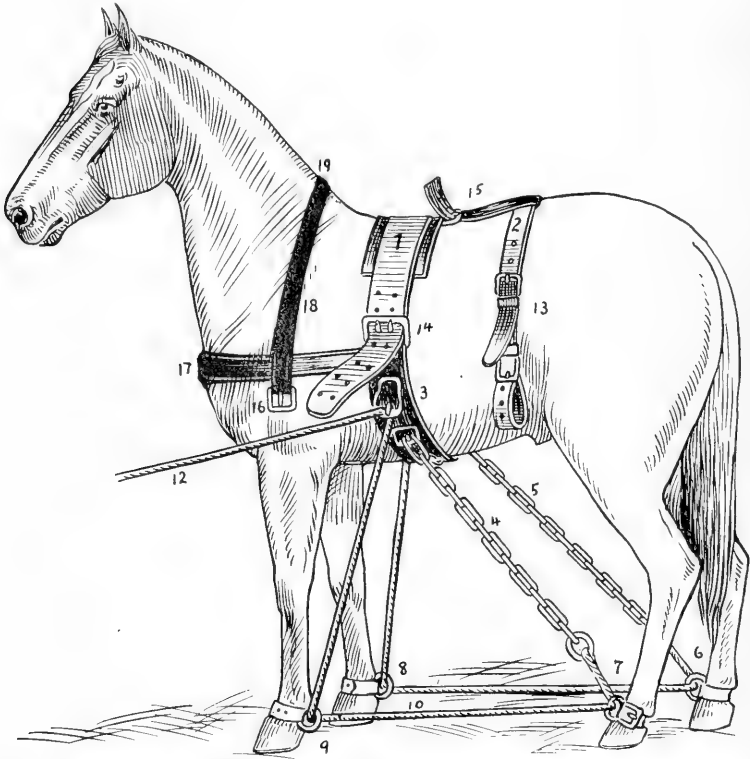

Fig. 164. Lewis' Modification of Cowie's Casting and Securing Harness.

locking. The body girth (1) is made of leather and strong. This girth carries a lock buckle (3) on each side, also two "D's," to which the chains are attached. Over the loins is a heavy leather strap (2) for the purpose of fixing the hind legs in a flexed position after casting. This strap is prevented from slipping backward by its attachment (15) to the body girth.

Four hobble straps (6) (7) (8) (9) are used on casting by this method. To the end of each chain a 12-foot rope is attached. In casting the horse these ropes are carried from their attachment to the body girth to and through hobble strap rings (6) (7) on each hind pastern. Then forward (10) (11) to and through hobble strap rings on fore pasterns; thence upward to and through the lock buckles (3). To cast the animal traction is made on free end of main ropes (12). This draws all the feet together and against the body girth and they are retained there by the action of the self-locking buckles on each side. After the horse is cast the loin strap (2) is buckled at each end around each hind leg above the ankle. This holds the hind legs flexed and secure.

Figure 164 represents Cowie's improved casting and securing harness as modified by Lewis. The modification consists of a breast collar attached to body girth on each side of horse. This breast collar carries two buckles (16) into which the knee straps (not shown in the illustration) buckle. The knee straps are buckled around the leg above the ankles and answer the same purpose in front as the loin strap (2) do behind. The breast strap (17) prevents the body girth from slipping backward.

#### "ONE MAN" METHODS OF CASTING AND SECURING A HORSE.

There are at least five good and reliable methods whereby one man is enabled to cast and secure a full grown horse with ease and safety. The methods referred to are the Russian, Galvayne, Gleason, Magner and Rarey.

##### *Russian Method.*

The Russian method, Figure 165 (first position), is not intended to be used by a "tenderfoot." It requires courage, strength, alertness and practice. To cast by this method a 12-foot rope carrying a loop at one end is necessary. If the horse is to be cast on the near side the operator stands close to the horse on that side. Be sure and do not fall before the horse does. A loop is passed around the base of the neck. The free

end of the rope is passed downward and around near hind pastern (d), then back to and through loop (a) in main rope. This rope is now held in the operator's right hand (c). The operator at this time is standing on the near side of the horse;

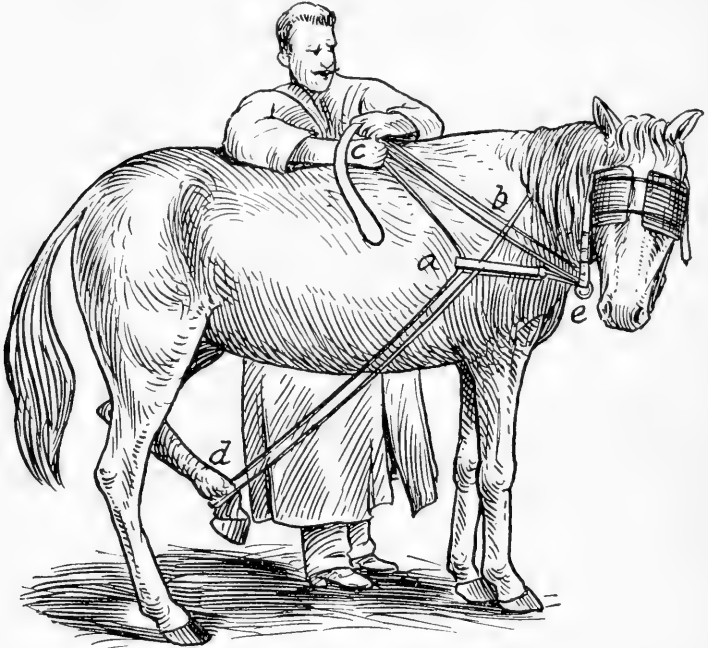

Fig. 165. First Position Russian One Man Method of Casting and Securing a Horse.

his right elbow is supported by the horse's loins. The halter rein is grasped firmly and held in the left hand. By making traction on end of rope (c) the near hind foot is lifted off the ground and drawn somewhat to the off side, Figure 166. By traction on halter rein the head is drawn around to the shoulder; then by pressing down with elbow on loins the horse is caused to drop down on his haunches, and later to lie down on the near side, Figure 167. If it is desired to secure the animal, the same can easily and quickly be done by first drawing the near hind leg well forward and fixing it there by tying main rope to collar rope, then carry the rope (e) back to and around off hind pastern, draw it forward and fix by tying to collar rope.



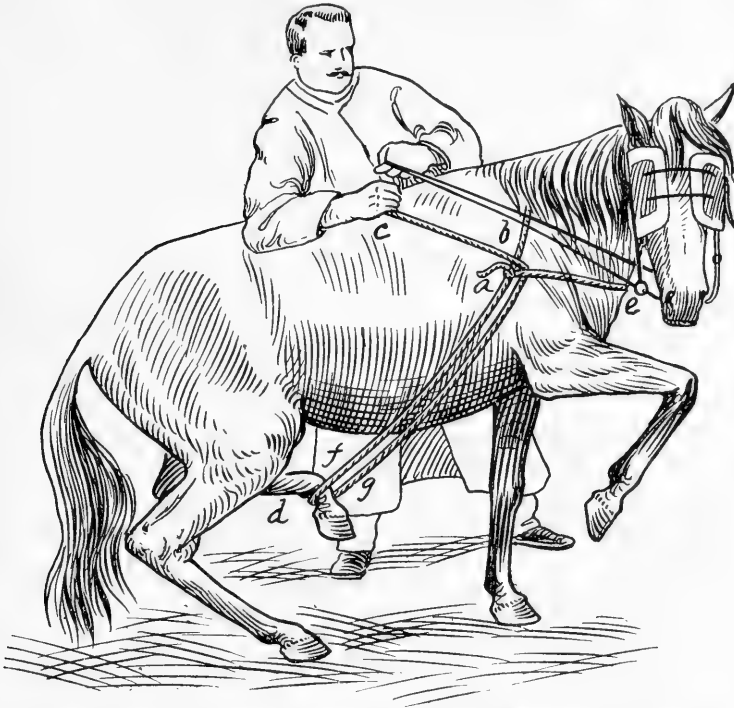

Fig. 166. Second Position Russian One Man Method of Casting and Securing a Horse.

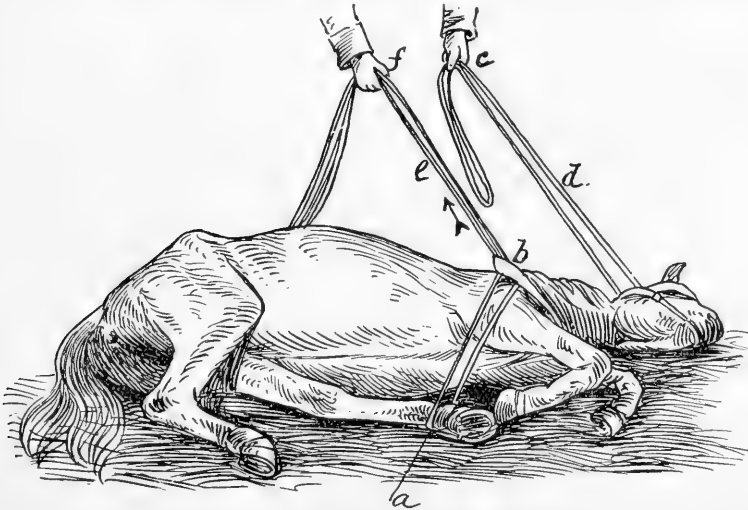

Fig. 167. Third Position Russian One Man Method of Casting and Securing a Horse.

*Galvayne's Method.*

First apply a heavy halter, surcingle and crupper, Figure 168; then pass a strap or rope through the side ring in the surcingle on the off side—that being the side upon which the horse is to fall; the strap or rope is then passed under the fore arm of the off fore leg. Tie by a simple bow slip knot and draw it around so as to bring the bowknot on inside of fore arm and close to elbow. The object of this strap is to prevent the sur-

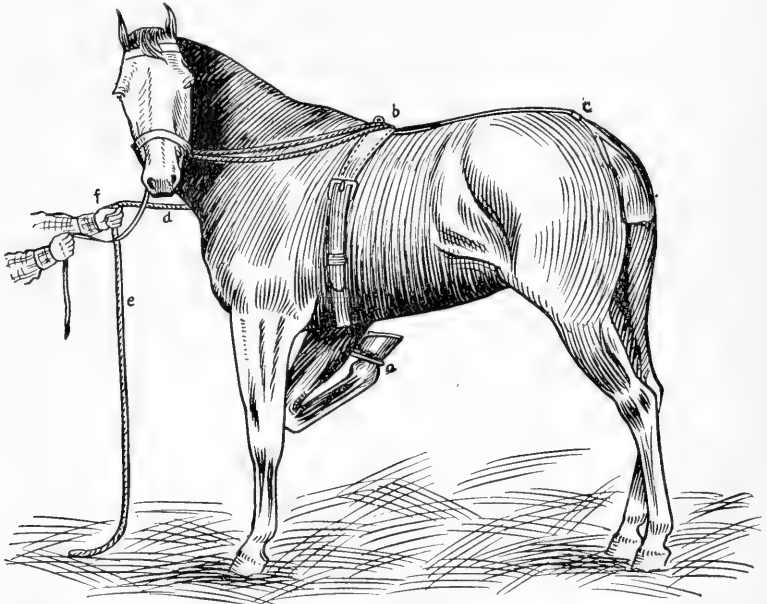

Fig. 168. Galvayne's One Man Method of Casting and Securing a Horse—First Position.

cingle from slipping around. Now fasten one end of the throwing rope to the second ring (b); from the front on the top of the surcingle pass the other end of rope through the near side cheek ring of halter; then back to and through the foremost top ring of surcingle. Tie up the off fore leg by means of knee strap or rope until the heel touches the elbow (a). Now you are ready to cast the animal. This is done by taking the halter

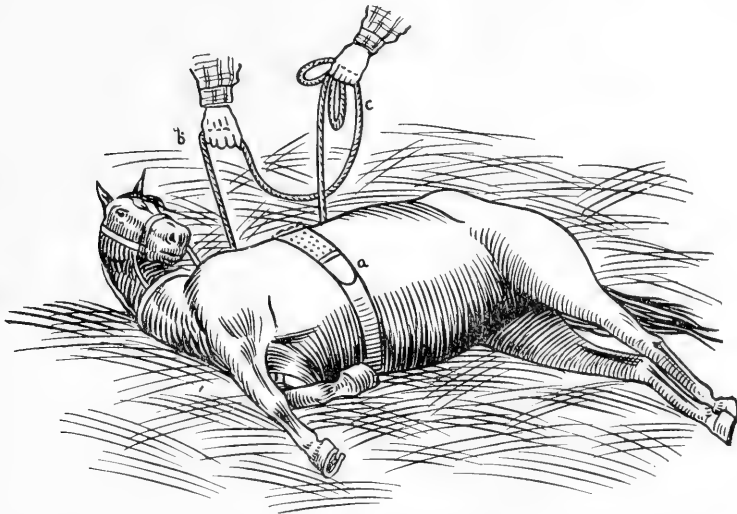

Fig. 169. Galvayne's One Man Method of Casting and Securing a Horse—Second Position.

rein in your right hand, pushing the animal's head away from you as far to his near side as possible, and at the same time take in the slack of the throwing rope (d); step back about 6 feet and steadily draw the horse's head around against the surcingle and the animal will gradually lie down. Should the

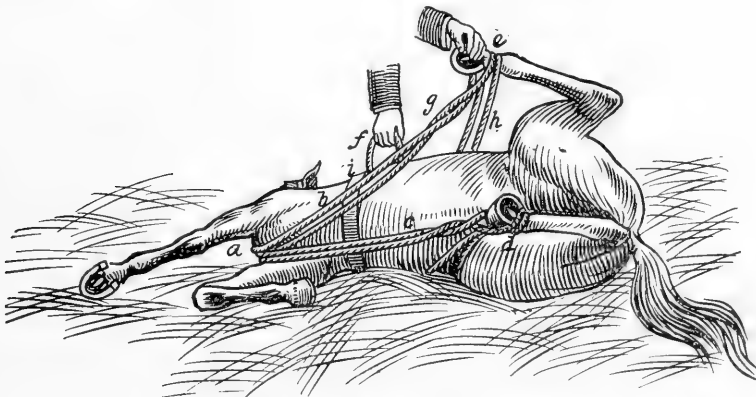

Fig. 170. Galvayne's One Man Method of Casting and Securing a Horse—Third Position.

animal attempt to rear, slacken the throwing rope by a jerk with the left hand and pull on halter rein with the right hand, Figure 168.

Figure 169 represents the horse cast ready to secure. To secure the horse, Figure 170, the double side-line ropes are used. Slip loop over head, down around base of neck; then carry ropes (a) between fore legs, back to and around hind pasterns (e) (d); fix by a half hitch, then carry the ropes around and under animal. Now fix to the hind pasterns. The rope from near hind should be fixed to off hind and vice versa.

*Gleason's Method.*

A horse can be cast and secured by the method of Gleason with a halter and rein, a knee strap and a piece of rope 15 feet long. Figure 171 represents the horse ready to be cast (first

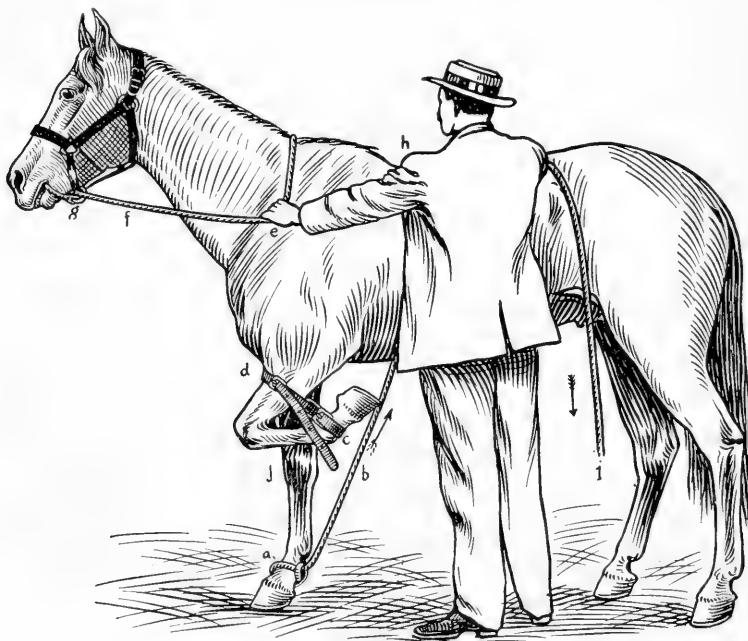

Fig. 171. Gleason's One Man Method of Casting and Securing a Horse—First Position.

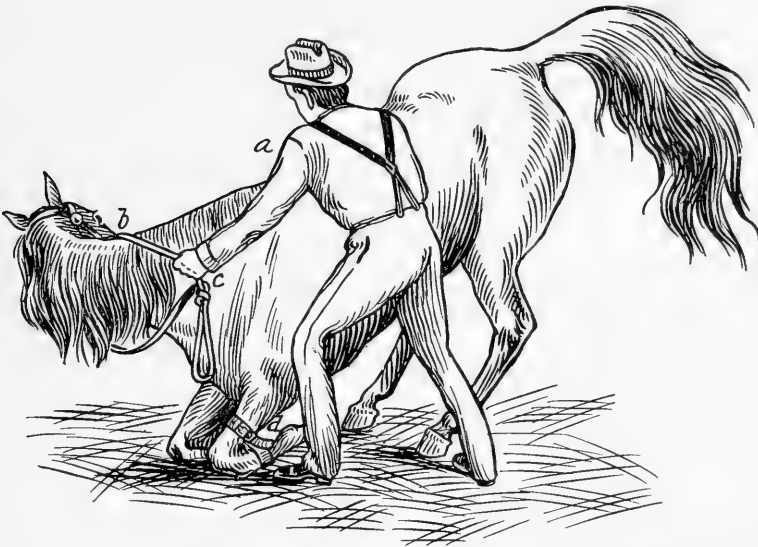

Fig. 172. Gleason's One Man Method of Casting and Securing a Horse—Second Position.

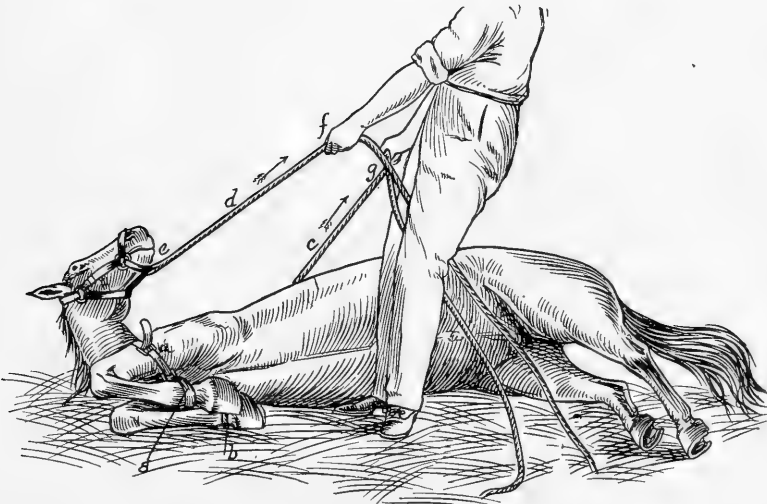

Fig. 173. Gleason's One Man Method of Casting and Securing a Horse—Third Position.

position). It will be observed that the operator stands on the near side with his breast pressing firmly against thorax of horse. The halter rein (f) is held in right hand (e). The near fore leg is flexed and fixed by means of knee strap (d) (c). A loop in end of main rope is placed around off fore pastern; then passed upward (b) and held in right hand (h). The horse is now caused to move and the rope is tightened, which prevents extension of off fore leg and puts animal down on its knees, Figure 172. The head is now drawn around to side and the horse topples over flat-sided, Figure 173. By holding head (e) off the ground, and rope (c) tight, the animal is prevented from regaining its feet. If more restraint is desired the hobbles or casting harness can be applied and used for that purpose.

*Magner's Method.*

In order for one man to cast and secure a horse by the method of Magner, a special harness or "rig" is necessary. For this purpose Magner has designed a leather "rig," Figure 174, and an improvised rope one, Figure 175. They are similar in design and their result is the same. The only difference is in the material used. The surcingle of the leather rig should be 3

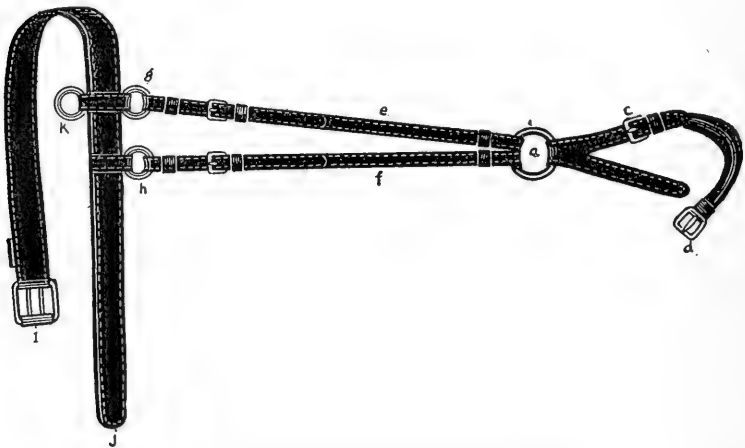

Fig. 174 Magner's Leather Casting Rig.

inches wide, double and stitched, and long enough to apply around the horse. It is best to have a double-tongue buckle (i) made of wrought iron. To this surcingle is attached the back straps (e) (f) by means of rings (g) (h). To these back straps the crupper (c) (d) is attached by a heavy ring (a). To make the rope rig, Figure 175, it is necessary to procure 18 or 20 feet of  $\frac{3}{4}$ -inch rope. Make a simple loop about 3 inches long at one end (e) and double the rope about 3 feet from the loop. Pass over this double part a heavy ring 3 inches in diameter (g). Measure the distance from the tail to where the saddle of the harness fits; to this place bring the ring (g)

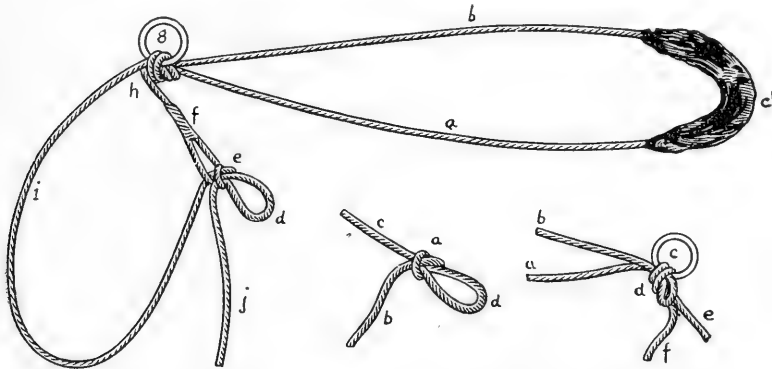

Fig. 175. Magner's Rope Casting Rig.

and fix it there by a simple knot with both ropes around it (h). Next put the doubled portion of rope (a) (b) under the tail (c). Now twist this rope two or three times and bring the ring to its place, about 8 inches to the right of back.

Figure 176 represents Magner's leather casting rig applied. Figure 177 represents the rope rig applied and in action. The near fore foot is raised and attached to body girth by Magner's knee strap, Figure 33. When using the rope crupper it is necessary to wrap same with some kind of soft cloth to prevent chafing. Next put on a strong halter with nose band well down on the nose and draw it up rather close, back of the jaw. Now take a strong cord or small rope 20 feet in length and fasten one

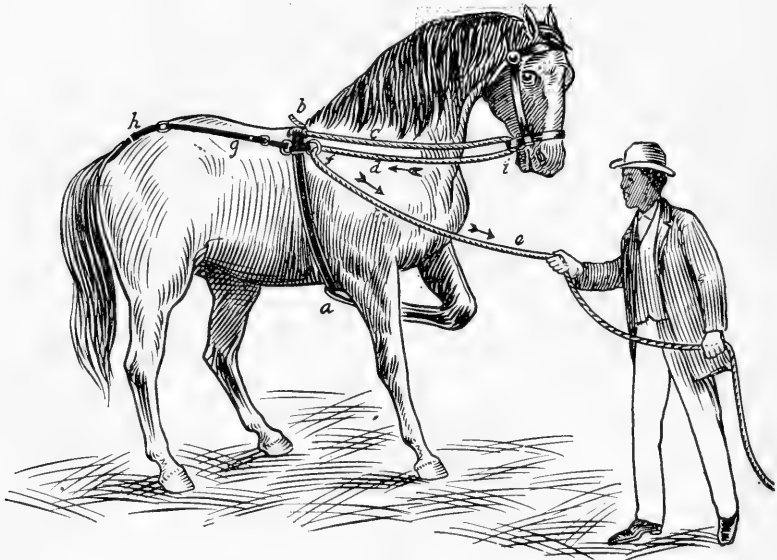

Fig. 176. Magner's Leather Casting Rig Applied.

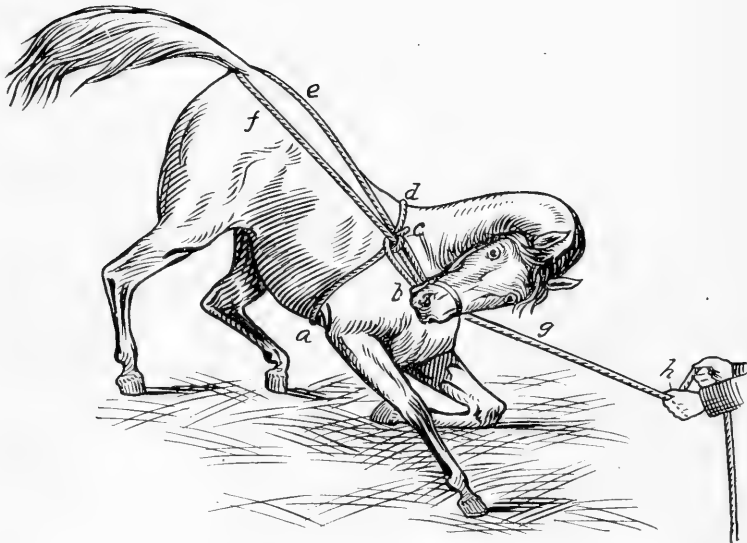

Fig. 177. Magner's Rope Casting Rig in Action.



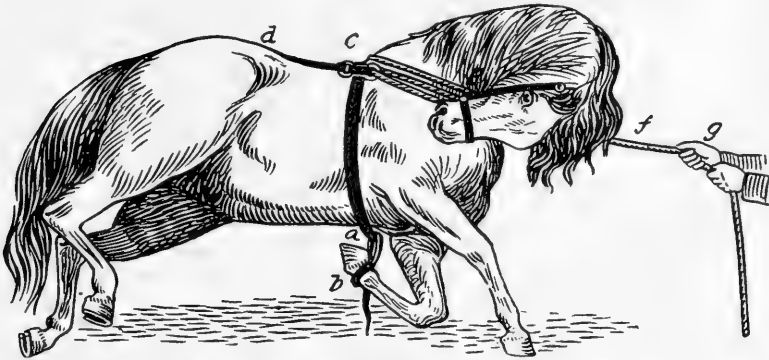

Fig. 178. Magner's Leather Casting Rig in Action—Horse About Ready to go Down.

end around the body girth just above the ring. Pass the other end from above down and over the halter strap behind the jaw, thence back to and through ring in body girth until all slack is taken up. The near fore foot is now tied up.

In casting animals by this method it is advisable to have them on soft ground free from stone. Now being ready to cast the horse, step a little to the right and almost in front of it, with a firm grasp on the cord or rope make gentle traction until the head is drawn down and backward almost against breast, Figures 177 and 178. This unbalances the animal and causes it to fall by rolling over on its side. Figure 179 represents the horse cast with the rope rig. The head is held around to the side to prevent rising.

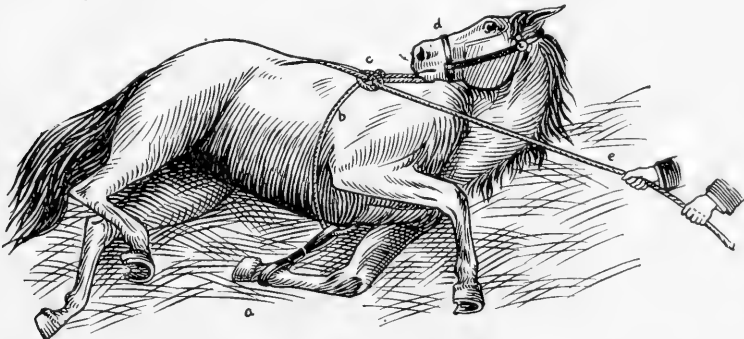

Fig. 179. Magner's Rope Casting Rig—Horse Down and Head Drawn Back to Prevent Rising.

*Rarey's Method.*

The method of Rarey, Figure 180, is similar in many respects to that of Gleason; the only difference is that Gleason applies the tripping rope to one fore foot and Rarey applies it to both the off fore and the off hind feet. In using Rarey's method a knee strap is applied to off fore leg and the foot raised against the elbow. A rope is then attached around near

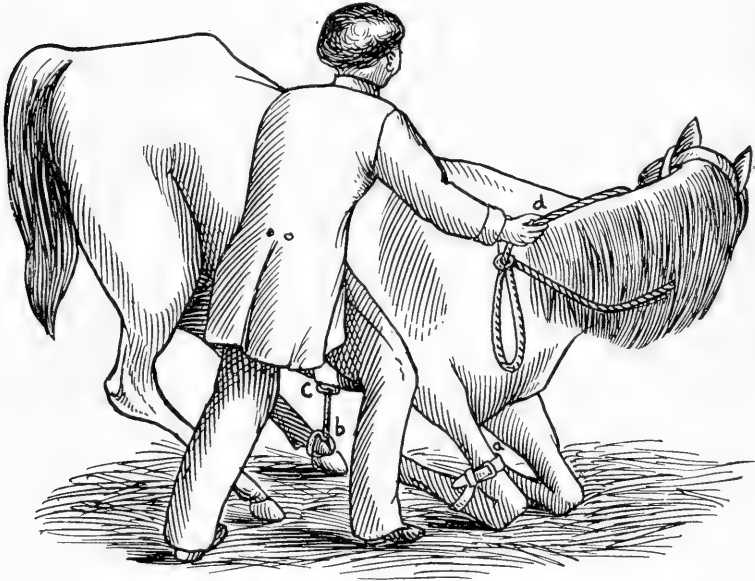
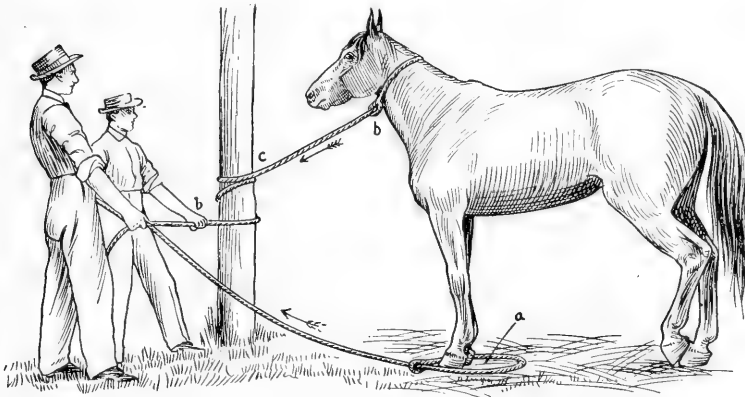

Fig. 180. Rarey's One Man Method of Casting a Horse.

fore pastern (a) and another rope around near hind pastern (b). A surcingle carrying a ring (c) is applied and the two leg ropes are carried through this ring (c) and then upward over back. The operator stands on the off side, against the horse. The head is drawn around to the opposite side by means of halter rein; at the same time traction is made upon both ropes. This puts three legs "out of commission" and the horse falls.

*Restraint of Wild and Vicious Horses.*

The practitioner of veterinary surgery oftentimes has occasion to subject and restrain wild and vicious horses—the kind that are often referred to as “bronchos.” These animals kick behind and strike viciously in front. They are dangerous to man, and to subject and restrain them without receiving bodily injury requires considerable tact and skill. These animals are often too wild and vicious to even allow the operator to put a halter, bridle, or twitch on them, to say nothing of adjustment of hobbles and casting harness around their legs and feet. They must be cast without going in striking or kicking distance of



**Fig. 181. Lasso and Loop Rope Method of Casting a “Broncho”—First Position.**

them. There are several methods of doing this; however, only three of them will here be illustrated and described.

Figure 181 represents the lasso and rope method (first position) of casting a broncho. The lasso is cast and the horse caught by a loop around its neck (b). The lasso rope is then carried one or more times around a post or tree (b) (c). Of course during this time the horse is busy in his struggling efforts to get away; however, no attention should be given to that part of the proposition. A loop (a) is made in the end of another rope and the horse allowed or forced to step into the loop with

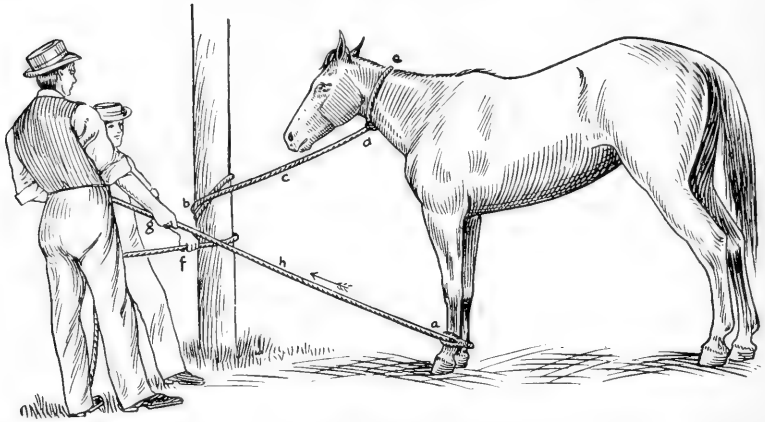

Fig. 182. Lasso and Loop Rope Method of Casting a "Broncho"—Second Position.

its fore feet, after which the loop is closed around the pasterns, Figure 182, by making quick and substantial traction on the free end (h) of rope. The horse will continue his efforts at resistance for a short while; however, it will finally become unbalanced and fall flat-sided to the ground, with its head extended by traction on neck rope, Figure 183. If suffocation is threatened the neck loop (d) may be relaxed. The hobbles are now applied and the animal secured in the usual manner.

Figure 184 represents the lasso method of casting a broncho. This method is used when a tree or post is not available. The

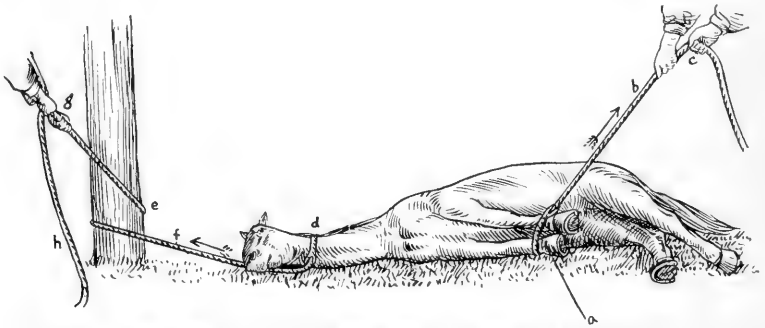

Fig. 183. Lasso and Loop Rope Method of Casting a "Broncho"—Third Position.

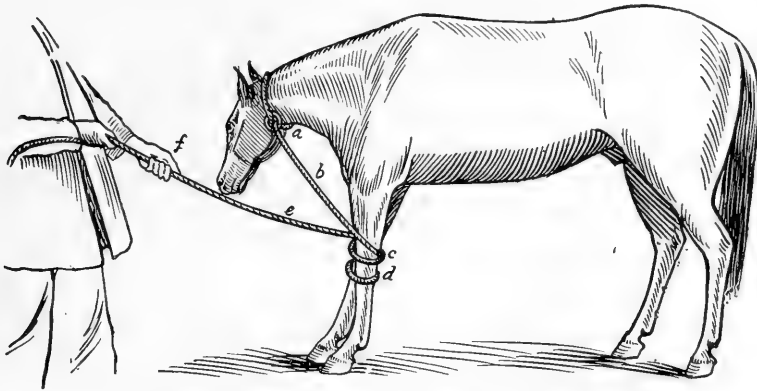

Fig. 184. Lasso Method of Casting a "Broncho."

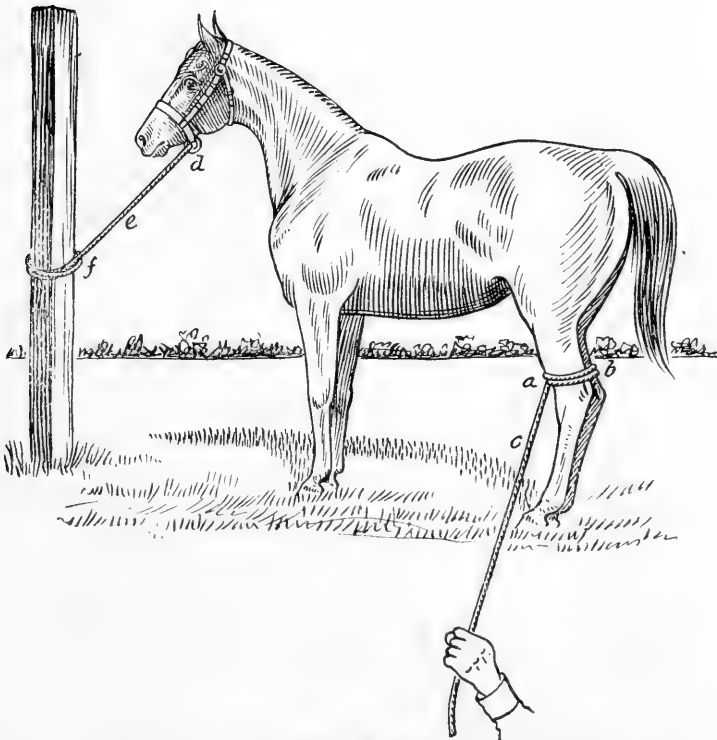

Fig. 185. Galvayne's One Man Method of Casting a "Broncho."

lasso is cast and the horse caught by a loop around the neck (a). The rope (b) is then wrapped two or more times around the fore legs below the knee (d). This pulls the legs together. By traction (f) on free end of rope (e) the horse is unbalanced and falls from the effects of its own efforts at resistance.

*Galvayne's "One Man" Method of Casting a "Broncho."*

Figure 185 represents the method of Galvayne for casting a broncho by one man. A strong halter is applied and the halter strap (e) secured to a post or tree with a double hitch knot (f) so that it cannot slip up or down. Now jerk the looped end of the casting rope under the animal towards the near side. Take the other end of the rope, walk quietly around the back of the animal with it, and pass it through the loop, thus making a slip loop. Then pull the end of the rope (c) until the noose is reduced to a suitable size and jerk it quickly upward, around both hind legs above the hocks; then draw the legs close together by making more traction on free end of rope (c). Stand on the near side, slightly to the rear, and continue to pull strongly. The horse will kick and otherwise resist at first, but will soon sit down upon its haunches and subsequently roll over on its side. The horse can now be secured with the casting rope, or hobbles may be applied for that purpose.

## CHAPTER III.

### OPERATING TABLES.

As a means of restraint in the recumbent posture, the Equine Operating Table occupies an important position; however, the operating table, as with the stocks, as a means of restraint, has its advocates as well as its adversaries. Some prominent surgeons of this and other countries are flattering in their praise of the table, while other practitioners of equal prominence and like experience are severe in their condemnation of the table as a means of restraint. Many have condemned all tables in general without subjecting even a single one of them to a fair and impartial trial. Others have condemned all tables because one table in their hands chanced to be defective in design, hence unsatisfactory. Some practitioners have even objected to the table because it is stationary and not sufficiently light or small to be carried with them from call to call. Another objection is the inconvenience or impossibility of putting some fractious or nervous animals on the table or because it cannot be used under all circumstances and conditions. They even dislike it because it occupies too much space in the operating room, and requires two or more assistants to successfully handle a large and strong horse on account of the equine operating table *not* yet being a "one man" affair.

The author being more or less acquainted and familiar with several different designs of operating tables, their advantages as well as their disadvantages, has no hesitancy in saying that the twentieth century practitioner of veterinary surgery cannot any longer afford to be influenced either by prejudice on the part of himself, or the adverse opinions of other people, to deprive himself of the advantages afforded by a properly constructed and modernly equipped equine operating table. Such tables are now manufactured and sold at reasonable prices, and their use and value to the surgeon should not be underestimated.

Professor Louis A. Merillat says: "The greatest advantage of the operating table in this connection is the leisurely manner

with which an operation may proceed without discomfort to the confined horse, and the decided freshness of the patient after the operation is over. The operating table does not often provoke exhausting struggles. With harness restraint the patient is uncomfortable throughout, and it is essential to hurry the operation in order to shorten the duration of the confinement. The patient always arises more or less exhausted, even from short operations, while with the table two or even three hours confinement will leave no exhaustive effect. In short, the horse is much safer on the operating table than upon the floor secured with casting harness. From the standpoint of thoroughness and exactness of the surgical technique, the table has both good and bad points. The operations are much cleaner. There are no flying particles from the litter and less dust in the operating place, and as the surgical field can be more securely tied there is much less danger of soiling the surgical wound and a much better opportunity of accurately executing the various steps of the operation. The dissection, the hæmorrhage, the suturing, and the dressing are greatly facilitated by the fixed state of the operating field."

Professor W. L. Williams says: "We could not consistently continue the use of the table in daily work for a period of nine years, side by side with the various kinds of casting harness, following the exclusive use of the latter during seventeen years' experience, except it had for us some points of superiority in cases of sufficiently wide range of character to warrant its installation and retention. Having made this use of the table and after a long study of its practical working, with so many radical changes that we have virtually operated four or five different machines and studied them carefully, besides temporarily operated upon or observed the actual working of an equal number of others and borrowed therefrom and applied to our own each feature commending itself to us, it is inevitable that we should favor the one with which we are most familiar."

Professor John A. W. Dollar says: "The advances of anti-septic surgery and the invention of the new operating machine have placed in the hands of veterinary surgeons a means of over-



coming obstacles hitherto regarded as insurmountable. Between these two factors, however, an important difference exists, inasmuch as while we all recognize with a fair degree of precision the requirements and capabilities of antiseptic surgery, it is impossible to accurately forecast the benefits to be obtained from a new means of controlling animals during operation. In important operations the disadvantages inherent to the old method not infrequently form a fatal bar to success, or even to experiment. While fully recognizing, therefore, the immense importance and possibilities of antiseptic surgery, I venture to predict for it an extended scope and greatly increased success in veterinary operations; since its application has been so greatly facilitated by the invention of this operating table.”\*

The first effort at devising an equine operating table was made by Hoerd. This apparatus was crude in design and cumbersome to handle, rendering it of doubtful value as a means of restraint. This machine or apparatus of Hoerd was soon modified and improved by Fromage de Feurgre, Kersting, Owen and others, until at the present time equine operating tables as a means of restraint are in great demand, and are used by most of the prominent surgeons throughout the world.

In selecting an operating table we should carefully consider the following important facts and accept that apparatus which possesses the most points of excellence:

1. *Strength*.—Any table to be satisfactory must be strong. The wood, ropes, chains and straps should all be double strength. One weak place in a single one of them subjects the operator and his assistants to liability of great bodily injury.

2. *Simplicity*.—The design and construction should be as simple as possible. However, never sacrifice efficiency, ease of operation, strength and safety for simplicity or appearance. Complicated mechanical construction was for many years the

---

\* Author's Note—Professor Dollar refers here to the table originated by Vinsot, later improved by Dollar. The “Dollar table” has, during recent years, been improved and perfected by the Bradwood Manufacturing Company, and is now known and sold in America as The Bradwood Equine Operating Table and Surgical Chair.

foundation of most of the objectionable features of the equine operating table, but these have to a large extent been eliminated in the successful table of today.

3. *Ease of Operation.*—A successful table never requires over three or four men to operate it—even when handling a large and strong horse. If more assistants are required, something is wrong, either with the table or the operator. However, as a general rule, we should beware of the tables that “can be lowered to the horizontal position by a small boy,” as it is liable to require the combined strength of two or more full grown men to put the table again in the upright position and the animal onto its feet. A table should possess speed as well as strength.

4. *Thoroughness of Restraint.*—A table should be so constructed and equipped that the restraint is thorough. This places the operator in perfect control of his patient, which is in itself a decided advantage.

5. *Safety to the Patient.*—A successful table should possess logical, safe and efficient means of placing the patient on the table as well as the same advantages for releasing it from the table. The best table is that one which reduces the danger in this respect to the smallest possible minimum.

6. *Accessibility of the Patient, Especially the Field of Operation.*—Tables should be so constructed that there is a minimum amount of obstruction between the surgeon and the operative field. The hinderance in this respect should be reduced as much as possible. This can be and is done by special table-top construction in the shape of “cut out” or removable center, removable head piece, cut out or indented sides, etc.

7. *Antisepsis and Asepsis.*—The table should be so constructed that its thorough cleansing and disinfection, when necessary, is possible. Sanitation is an important point of excellence in favor of any table.

8. *Special Positions.*—The time has come when special positions for special operations are necessary. A table should be so constructed that it affords the surgeon the widest possible range of means and methods of restraining the animal in special positions.

POSSIBLE ACCIDENTS TO PATIENT IN THE USE OF THE OPERATING TABLE AS A MEANS OF RESTRAINT.

Abrasions and contusions about the head and bony points of the body occur from insufficient padding or imperfect restraint. Or they may occur about coronets, pasterns and fetlocks from the hobble straps and chains. Fractures of one or more of the long bones sometimes take place. This is also liable to happen to some short bones, such as the phalanges and vertebræ; especially is this accident likely to occur in old horses or in those suffering from one or more of the various bone diseases, such as osteoporosis, rickets, etc.

Sprain or rupture of tendons and muscles is not an infrequent sequelæ of operating table restraint.

Dislocation of one or more of the important joints is another sequelæ of no rare occurrence.

DAVIAU'S OPERATING TABLE.

Daviau designed, made and used the first equine operating table of any practical value. The original apparatus of Daviau, Figures 186 and 187, was a large, hardwood, flat-top table, the top (a) being 6x8 feet.

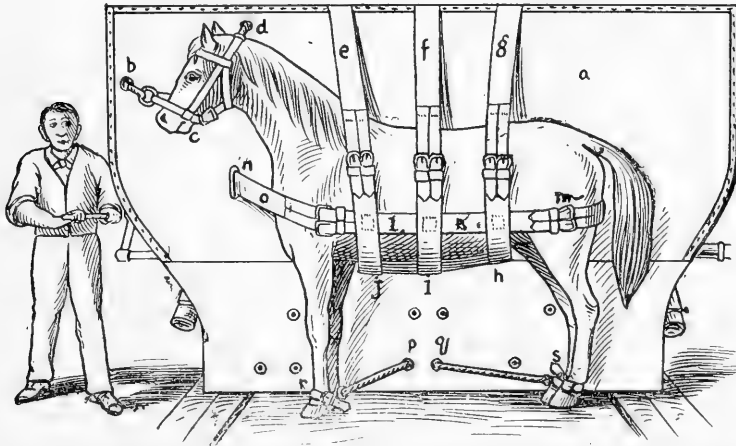

Fig. 186. Daviau's Operating Table, Upright Position, with Animal Secured.

The part coming in contact with the body and head of the horse was well padded, and the padding covered with heavy leather. Holes (b) (d) were made for passage of halter rein (b), neck strap (d), hobble ropes (p) (q), and body strap (n). The table top was equipped with body girths (e) (f) (g) and horizontal body breeching (m) and breast straps (o); also hobble straps (r) (s), and ropes by which the animal was secured. The supporting framework of this table was 2½ feet high and consists of four strong legs with substantial braces and cross braces between them. The frame work so arranged that

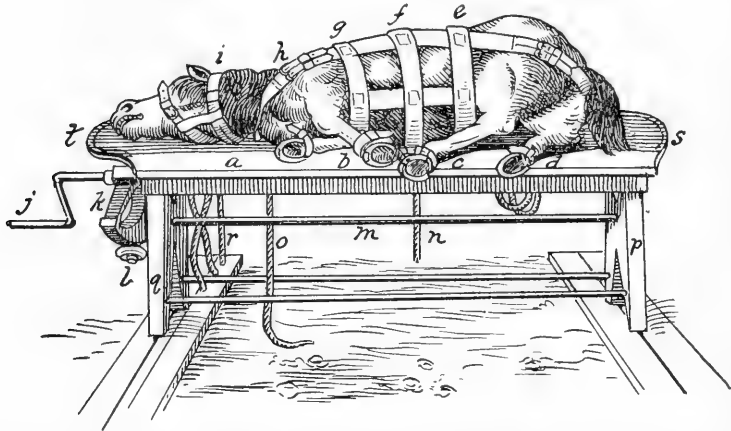

Fig. 187. Daviau's Operating Table, Horizontal Position, with Animal Secured Ready for Operation.

when the table is lowered by means of the cog gears and crank it acts as a support to the table top. Figure 187 represents the table top lowered to the horizontal position, with a patient ready for operation. This illustrates the body girth and hobble strap arrangement; also shows the legs and frame work of the supporting platform.

#### DAVIAU'S OPERATING TABLE IMPROVED.

Finding by experimentation and practice that the original table possessed several objectionable features, viz., difficulty of applying and tightening the straps and girths, the inaccessi-

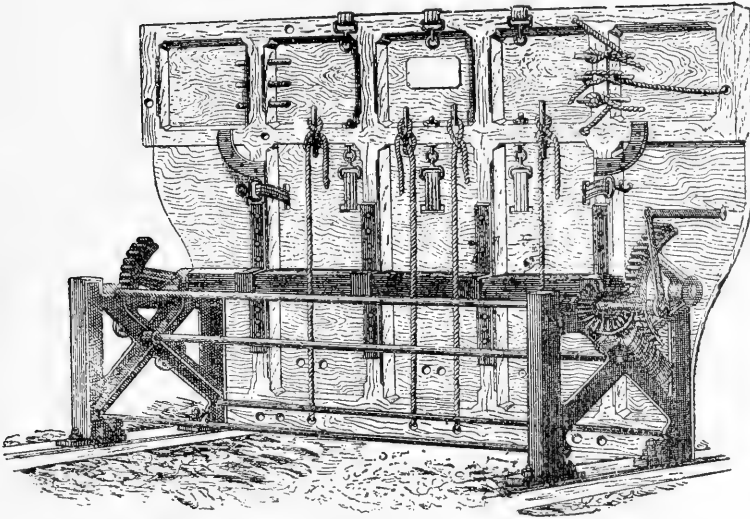

Fig. 188. Daviau's Table Improved, Upright Position, Back View.

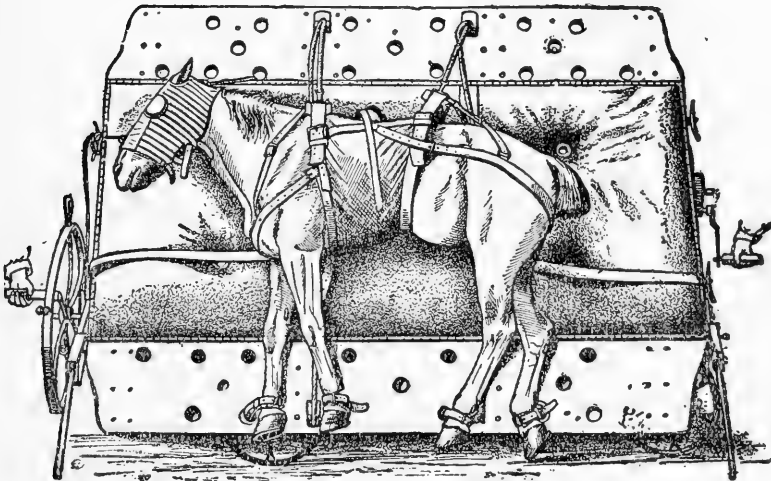

Fig. 189. Daviau's Table, Improved, Upright Position, Front View, Animal Secured Ready to Be Lowered.

bility of hobble ropes which were behind and underneath the table, etc., Daviau designed and made an improved table, Figures 188 and 189.

This latter table is quite satisfactory and is yet used in some parts of France and Germany. This improved table is much larger and more complicated than the original. Figure 188 represents upright position, back view. It shows the manner by which the ropes, straps and girths are fastened; also the mechanical construction of the raising and lowering device. Figure 189 represents the improved table, front view, upright position, with animal secured, ready to be lowered to the horizontal position. It will be observed that the body girths are considerably different from those of the original table.

#### COZIER'S IMPROVED EQUINE OPERATING TABLE.

The improved operating table of Cozier is simple in construction, neat in appearance, and said to be very satisfactory by those who have used it. Figure 190 represents front view of the table in upright position. This table is made from the best Puget Sound fir lumber. The top of the table (A) is about the usual size of veterinary operating tables, being seven feet wide by nine feet long. It is thoroughly padded and covered with canvas, paraffined and oiled, making it absolutely waterproof, and, as near as possible, aseptic.

The planks are 2x12 inches, doweled together and bolted to 4x6 inch cross pieces on which the table turns. That portion of the surface (S) on which the feet of the animal are secured is covered with No. 18 galvanized sheet iron, amply protecting it from the kicks and cuts of shoes. The sheet iron, canvas and bindings are all nailed on with galvanized nails, thus avoiding the action of rust, and adding much to the durability of the table.

The table is amply supplied with hooks, body girths (k) (q) (r), and hobbles (K) (L) (m) (n) for securing the patient. The adjustability of the straps makes it an essentially reversible table. The hobbles tighten automatically after buckling on the patient's feet. Long body girths and cams are furnished only

on request. Otherwise the table is fitted with short body girths (k) (q) (r) and ropes (e) (j) (g) running through rings (b) (c) (d) at the end as shown in cut. Dr. Cozier prefers this method. By it very much of the dirt and water that accumulates on or around a table is kept from coming in contact with the operator or patient by way of the body girths. The table is furnished with three body girths and rings, three lifting ropes, three

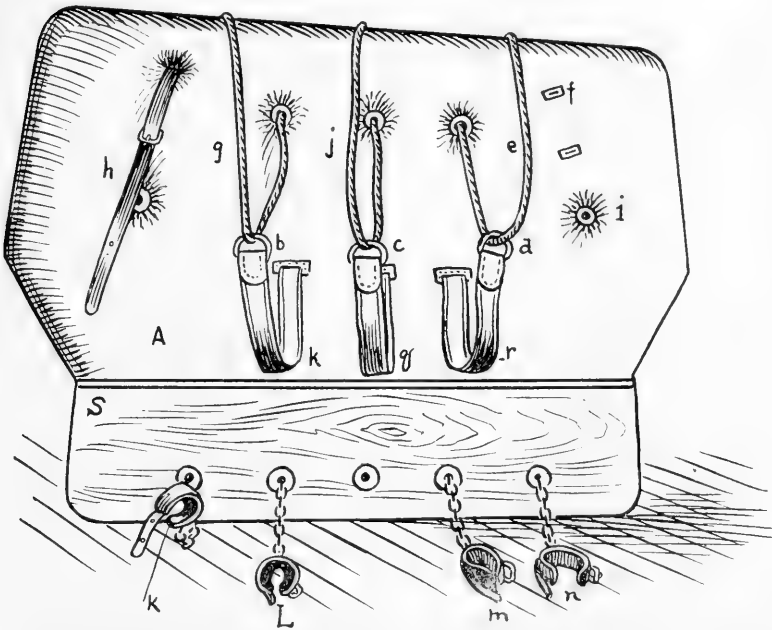

Fig. 190. Cozier's Improved Equine Operating Table, Front View.

one two-ply oil tanned neck strap (h), one twenty-foot side line rope, hobble straps and irons for securing the frame to floor.

Figure 191 represents rear view of the Cozier table. The frame (S) is built of 4x6 inch material fitted and bolted together with joint bolts, thus allowing all parts of it to be kept thoroughly tight. The special feature of importance is the gearing (h) (t) (m), which is Dr. Cozier's own designing. It is unique for its strength and simplicity. The power is applied to the table top at two points simultaneously, doing away with

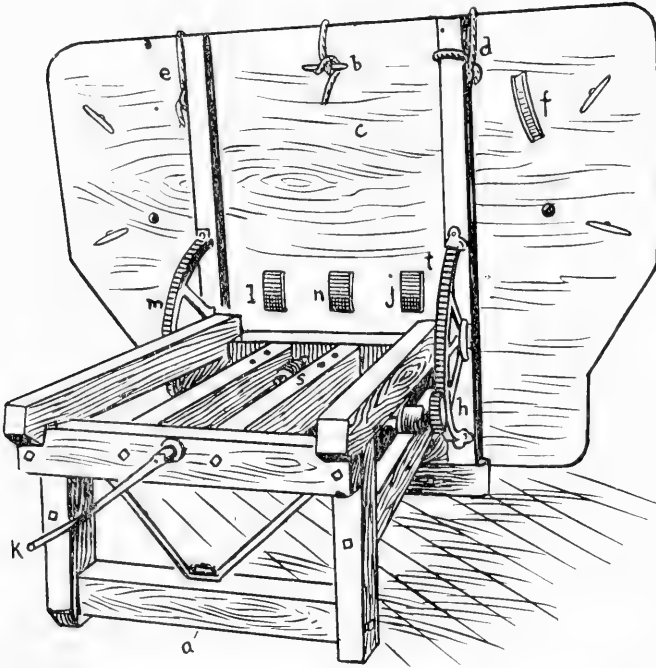

Fig. 191. Cozier's Improved Equine Operating Table, Rear View.

all lateral and racking motions, and is transmitted from the crank (K) to the lifting segments by means of a worm and worm wheel, thus forming a lock at all points of the arc through which the table turns. It is impossible, therefore, to move the table up or down without turning the crank.

#### *Hodgson and Magee's Equine Operating Table.*

The table, Figures 192, 193 and 194, was designed by Drs. Hodgson and Magee. It is simple in construction, with very little mechanism to get out of working order. The particular difference in this table and many others is the method of raising and lowering it by means of block and tackle, which is anchored in selected positions suitable to make traction at certain angles in order to handle the hinged table top which rests upon a strongly constructed wooden frame or base. Another important



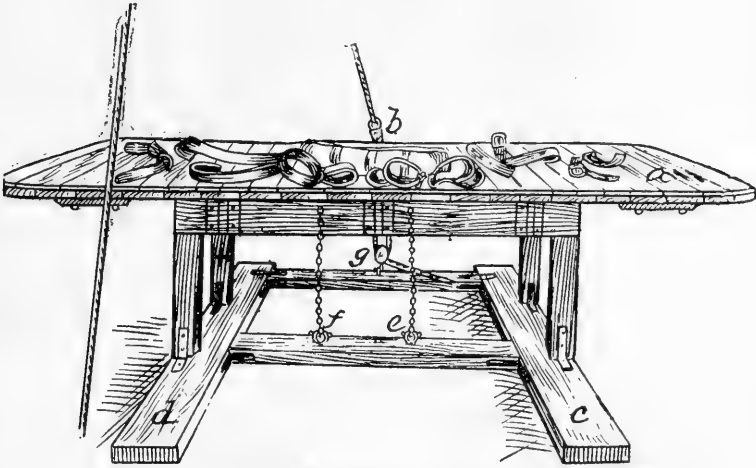

Fig. 192. Hodgson & Magee's Table, Horizontal Position.

difference between this and other tables, except the Kyle Bros. table, is the manner by which the hobble chains are tightened and rendered immovable. Figure 192 represents the table with its top (a) lowered to the horizontal position. It will be observed that the frame or base of the table is fixed securely to two

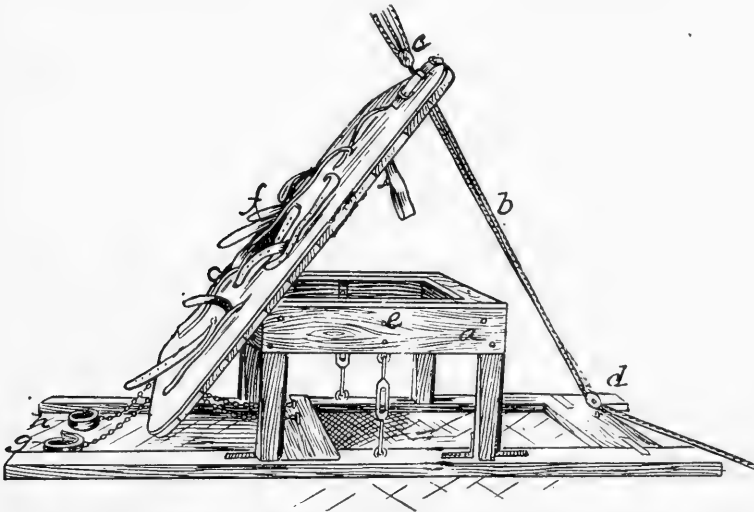

Fig. 193. Hodgson & Magee's Table, Oblique Position, Side View.

flat pieces of wood (c) (d) which rest upon the floor. Between these two flat pieces of wood are two braces; the front one carries two rings (f) (e) into which the hobble chains fasten, and the rear one carries one ring (g) into which the lowering pulley is fastened. The table top is made of hardwood boards substantially fastened together. Through this top are holes to accommodate the neck strap and hobble chains. A strong metal ring is

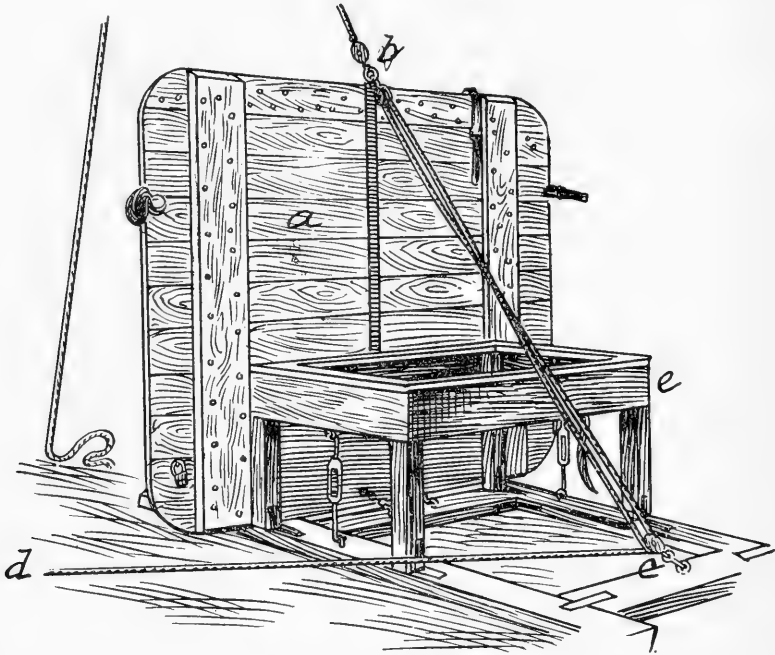

Fig. 194. Hodgson & Magee's Table, Upright Position, Back View.

attached on upper margin of table near its middle to accommodate pulley rope.

Figure 193 represents an end view of the Hodgson & Magee table raised to its oblique position. This position affords the reader a comprehensive view of the strong wooden base or frame (e), also the arrangement of the body girths (f) and neck strap.

Figure 194 represents a back view of the table top (a) raised to the upright position. It shows the legs and turn-buckles

applied on each side to render the table stationary and solid; also the rope and pulley arrangement which may be described as follows:

Directly below the middle of the superior border of the table on its posterior face are two heavy wrought iron rings (b). At the floor into the wooden cross brace or sill, another ring (c) is fixed. In the ceiling is another ring. This ceiling ring should be directly in line with the ring on table (b) and the one on the sill (c) at the floor. In handling this table two systems of pulleys and ropes are used. One pulley is attached into ring on ceiling and its rope to ring on the table top (b). Another pulley is attached to the ring on the sill (c) and its rope attached above to the lower ring on table top (b). These pulleys will allow the table to be raised and lowered with little difficulty. On account of the hobble chains being stationary to the cross brace at the bottom, the hobble straps are automatically tightened and loosened when the table is lowered or raised.

*The New York State Veterinary College Operating Table.*

The operating table which was recently installed by Dr. W. L. Williams, professor of surgery at the New York State Veterinary College, and known as "The New York State Veterinary College Operating Table," is the result of the expense of much time, thought and labor, to say nothing of the financial outlay. A similar outfit has recently been manufactured by William Sellers & Co., Philadelphia, Pa., and installed at the University of Pennsylvania (Veterinary Department) under the direction of Dr. John W. Adams, Professor of Surgery at that school.

This table, with that manufactured by the Bradwood Manufacturing Company (to be described later), represents the result of the latest and most up-to-date thought yet applied to equine operating table construction. With such machines as these in the reach of the veterinary profession, little can be said and proven derogatory to the equine operating table as a practical, useful and necessary apparatus. About the sole argument against them is the one of price, and when we stop to consider their cost of construction, perfection and usefulness, the price is to be considered a weak argument indeed against their installation.

The New York State Veterinary Operating Table is made of metal, except those portions upon which the body of the animal rests. The frame work is built of steel channels and I-beams securely connected, making a rigid support for the oak and plate steel platform. The wooden portion of the platform is made in three pieces; a main section and two smaller interchangeable square pieces. These may be entirely removed or placed in suitable positions for the head and tail; that intended for the head being slightly inclined.

Two heavy cast iron supports are provided, having their upper ends connected by hinged joints to the table, and upon these the table rocks from vertical to horizontal positions. The movement of the table from one plane to another is accomplished by a hydraulic cylinder, bolted to the foundation through a rocking joint, having its piston rod attached to the under side of the table frame; by admitting water to either end of the cylinder the piston rod can be moved in or out and the table rocked to the desired position. When the table is horizontal it rests on two metal posts of suitable height, which, together with the two main standards, give four points of support whereby all tendency to vibration is eliminated.

Figure 195 shows the table in an upright position ready for use. The animal stands close beside it. The halter strap is passed through a convenient aperture in the detachable head piece of the table and the head pulled against the surface, after which the strap is tied to cleats provided for the purpose. When this is done the girth-straps and foot nooses are tightened, the latter being accomplished by suitable ratchet windlasses on the under side of the platform. If required, the tail may be lashed to the detachable tail piece.

When the animal is thoroughly secured, the table may be tilted over by the hydraulic cylinder until it lies horizontally, or, if desired, to any intermediate angle, where it may be sustained indefinitely.

The cylinder is double acting, and so controlled by a valve as to be positively located in every position. Its action is smooth and free from all undesirable vibration. A small triplex pump driven by an electric motor provides the water supply. A

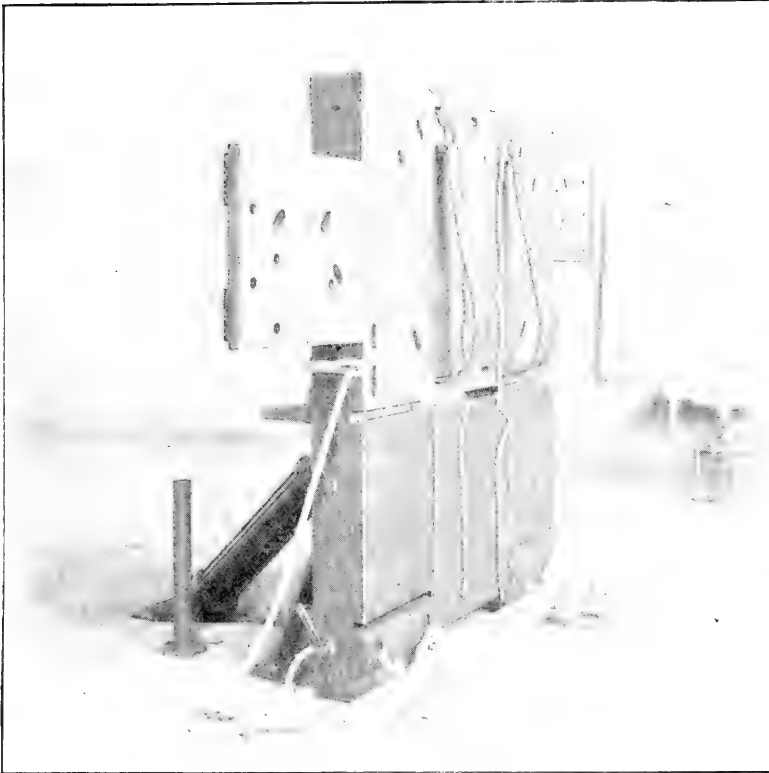

Fig. 195. New York State Veterinary College Table, Upright Position, Ready for Use.

This illustration shows adjustability of the head rests, the arrangement of body girths and ropes, the iron post which supports the table when in horizontal position, also heavy metal foot pieces at bottom of table. The head and tail rests are removable and interchangeable.



Fig. 196. New York State Veterinary College Table in Horizontal Position, with Horse Secured to Table Ready for Operation.

Observe the position of the body girths and rope, also the table resting firmly on the two metal posts.



Fig. 197. New York State Veterinary College Table, Upright Position, with Horse Secured to It After Operation Prior to Being Released.

To release the horse the hobble ropes are first removed from the feet. The neck strap is removed and halter rein slightly loosened, after which induce the animal to stand on its feet, and lastly release body rope and girths.

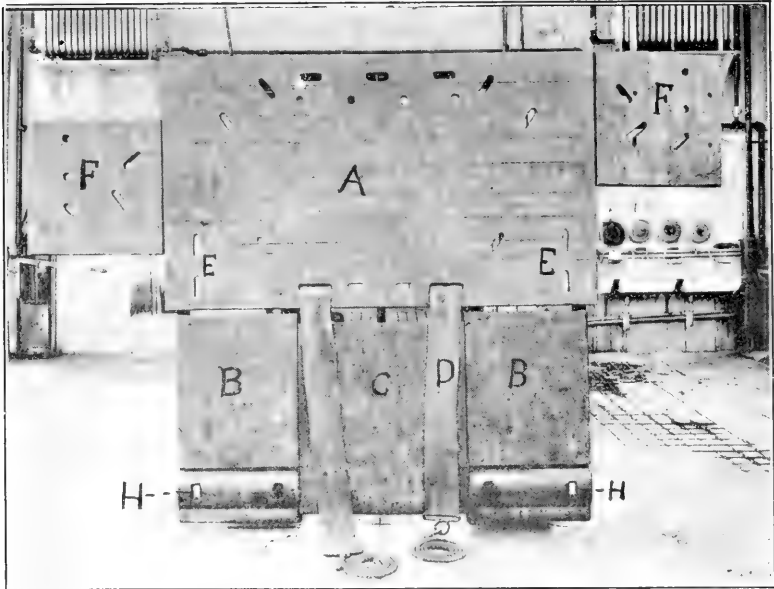

Fig. 198. The New York State Veterinary College Table, Front View, With Table in Upright Position.

(A) Table surface of polished hard wood.

(BB) Lower section of the table of heavy boiler plate iron.

(C) Detachable central section composed of heavy boiler plate iron.

(D) Securing straps or bands which act as a sling beneath the horse.

(EE) Openings in the table through which the side line or longitudinal strap passes in confining the animal.

(FF) Adjustable head pieces. The one on the right is placed at the highest point, while that on the left is attached lower to accommodate smaller sized animals. One of these is depressed as is shown in Figures 201, 202 and 203, while the other is direct.

(H) The foot pieces of heavy cast iron in each segment of which are two holes for the passage of the foot ropes as shown in Figure 201. These foot pieces are rounded and project above the general surface of the table sufficiently to have a space between the lower part of the limb and the table surface.





Fig. 199. New York State Veterinary College Table, Upright Position, Front View, Hydraulic Pump Against Wall to the Left.



Fig. 200. New York State Veterinary College Table, Rear View.

(I) The hydraulic jack by which the table is operated. The pump from which the jack is worked is located along the wall of the room and connected by concealed pipes.

(J) One of the pedestals upon which the table pivots.

(L) One of two supports upon which the upper portion of the table rests when horizontal. The second support is not shown in the photograph.

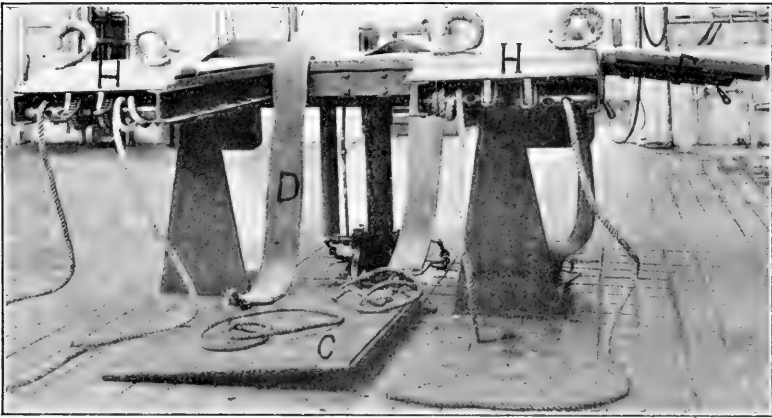

Fig. 201. New York State Veterinary College Table.

Turned down to a horizontal position with the center piece removed and dropped upon the floor, and the four looped foot ropes in position in the foot pieces (HH). The lettering is identical with Figure 198. Each foot rope is shown passing through a ratchet cylinder beneath the table. This cylinder is operated by means of a ratchet lever.



Fig. 202. New York State Veterinary College Table.

In horizontal position with an animal secured in position for operating for roaring. The depressed head piece is used and on either side of the head is placed a flange-like support (K), forming a sort of groove or trough in which the patient's head rests securely. The dorsal position of the animal is maintained by means of four over-head pulleys acting upon the feet. It is shown that three assistants are in an available position for aiding on one side of the head and neck and an equal number may as readily approach the part from the opposite side, thus showing that it is freely approachable from any direction.

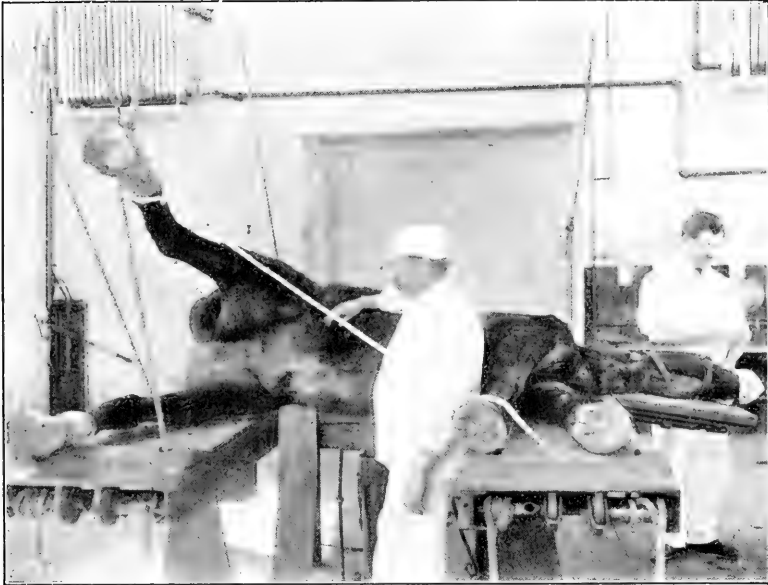

Fig. 203. New York State Veterinary College Table.

In the same position as Figure 201, with a horse confined in position for cryptorchid castration. The depressed head piece is used so that the animal's nose is lower down than the poll, rendering chloroform anaesthesia more safe. The central piece is removed and the operator stands against the ventral surface of the body of the animal between the anterior and posterior limbs. The right hind limb is drawn upward by means of two overhead pulleys and the right inguinal region is thoroughly opened. The posterior confining strap or girth marked (D), in Figure 198, has been released and dropped out of the way and the position of the patient made secure by fixing the tail to the upper border of the table. It will be seen that the ventral surface of the body is at a convenient height for operating, with operator in standing position.



Fig. 204. New York State Veterinary College Table in Horizontal Position. Hydraulic Pump Against Wall to Left. Metal Platform by Which Animals Under Anaesthesia are Removed to the Padded Recovery Stall.

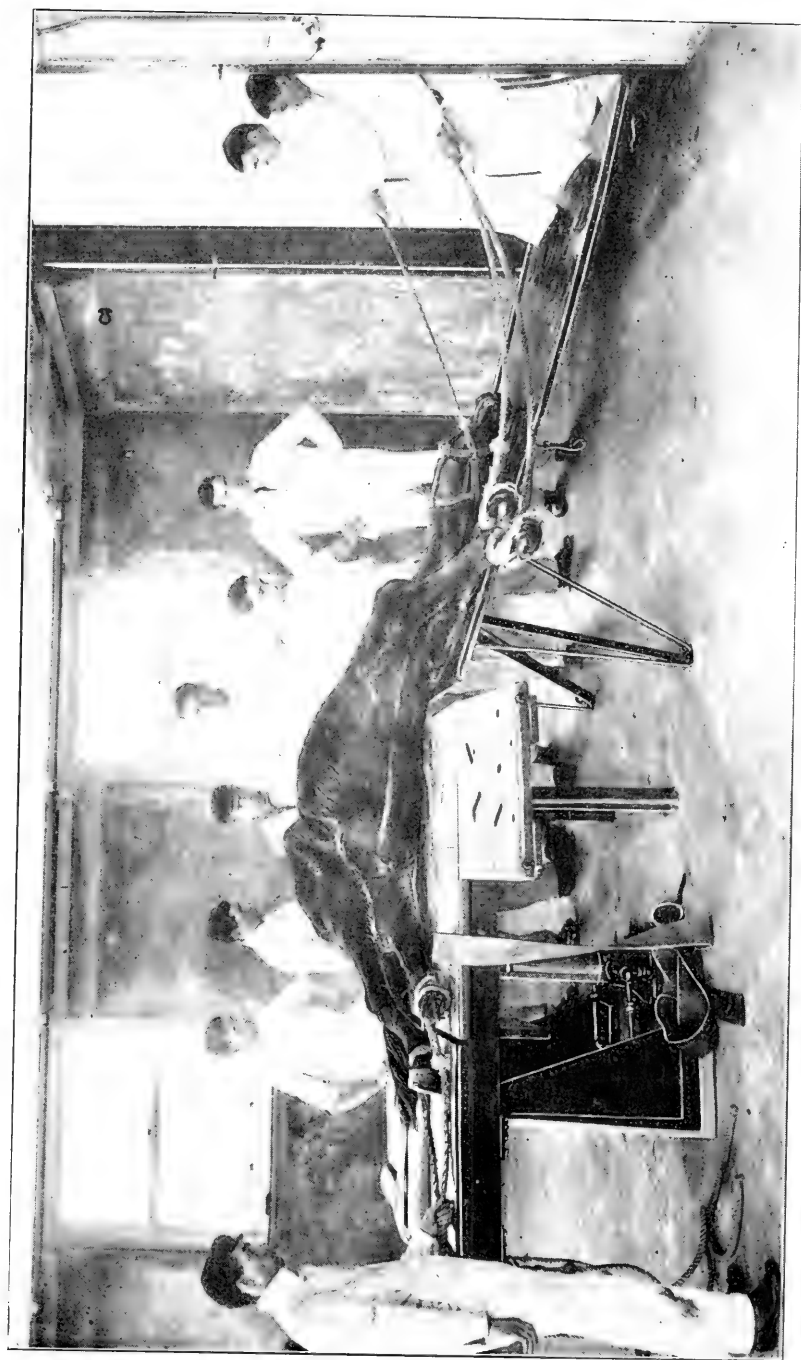

Fig. 205. New York State Veterinary College Table in Horizontal Position Showing the Metal Platform and an Animal Under Chloroform Anaesthesia in the Act of Sliding From the Table Into the Padded Recovery Stall.





by-pass valve is provided so that when water is not being delivered to the cylinder, and the pump still running, it passes back into the supply tank.

Figure 196 shows the table in an horizontal position, with horse secured to table ready for operation. The middle section of the lower half of the table may be easily removed, permitting the operator to stand between the legs of the animal.

Figure 197 shows the table in the vertical position, with a horse secured to it after the operation, prior to being released. The center section previously referred to is shown removed.

As the head and tail extensions are removable and interchangeable, the animal may be placed upon the table facing either way.

The manipulation of the operating table may readily be accomplished by the surgeon and a reasonably competent assistant.

Figure 198 represents the table in upright position—front view. To place an animal on this table the head is supplied with a strong halter to which is attached a 15 or 20-foot rein (rope). This rein is passed through the eye in the head piece of the table (F). The groom handling the rein can step entirely beyond reach of the animal and yet hold the head firmly fixed against the table. The fixation may be increased by carrying the halter rope back along the side of the patient and passing it through the table at "E," instead of the side strap for which this opening is made; by traction on this rope the animal's body is pressed firmly against the table. The horse is now in position where the operator can affix a hobble strap or rope to off fore pastern. This is passed through the opening "H," and tied by an assistant to prevent the animal from rearing. The body girths can now be applied without danger to the operator.

The table with the patient upon it can now be promptly brought to the horizontal position by means of the hydraulic pump, with the operator and assistants entirely out of reach of the animal in its struggles; and once down the restraint can be completed without coming in striking reach of the horse.

Figure 199 represents the table in upright position, front

view, ready for reception of patient—hydraulic pump against wall to the left.

Figure 200 represents the table, rear view. The hydraulic cylinder, or Jack *I*, supplies the power by which the table is raised and lowered. This is a strong and powerful apparatus and works automatically. The largest horse can be handled without any effort whatsoever upon the part of operator or his assistants.

Figure 201 represents the table turned down in the horizontal position, with the center piece removed and dropped upon the floor, also the four looped hobble ropes in the metal foot pieces, H. H. These ropes each pass through a ratchet cylinder beneath the table. They are tightened by means of the ratchet lever.

### *Special Positions.*

Animals are readily placed in special positions for certain operations on the New York State Veterinary College Table. Figure 202 represents the table in the horizontal position with the animal placed in the extended dorsal position by use of overhead pulleys. It will be observed that in this instance the animal is under chloroform anaesthesia; the depressed head piece is used, and on either side of the head there are flange-like supports (K). These hold the head stationary. This illustration also gives a comprehensive idea of the absence of obstruction between the animal and the surgeon and his assistants, or we might say the accessibility of the head and neck from the front and from either side.

Figure 203 represents animal in position to afford free access to the scrotal and inguinal regions. On account of the central portion of the table being removed almost every part of the animal may be easily and readily approached by the surgeon.

### *Special Metal Platform and Padded Recovery Stall.*

No doubt every surgeon has experienced the worry and vexation of attending an anaesthetized patient after operation upon the table. To prevent them from producing self-inflicted

injuries or doing damage to the operating room and its equipment requires constant attention for a length of time varying from fifteen to forty-five minutes. To obviate this difficulty, Prof. W. L. Williams has constructed a specially padded recovery stall adjoining his operating room. The animal is simply slid from the table to the padded recovery stall by using a metal platform shown in Figures 204 and 205. When once the animal is in this stall it may be left alone to recover without injury to itself or trouble to the surgeon or his assistants.

*The Chicago Veterinary College Operating Table.*

The operating table which is used at the Chicago Veterinary College is a flat top table. This table possesses several decided

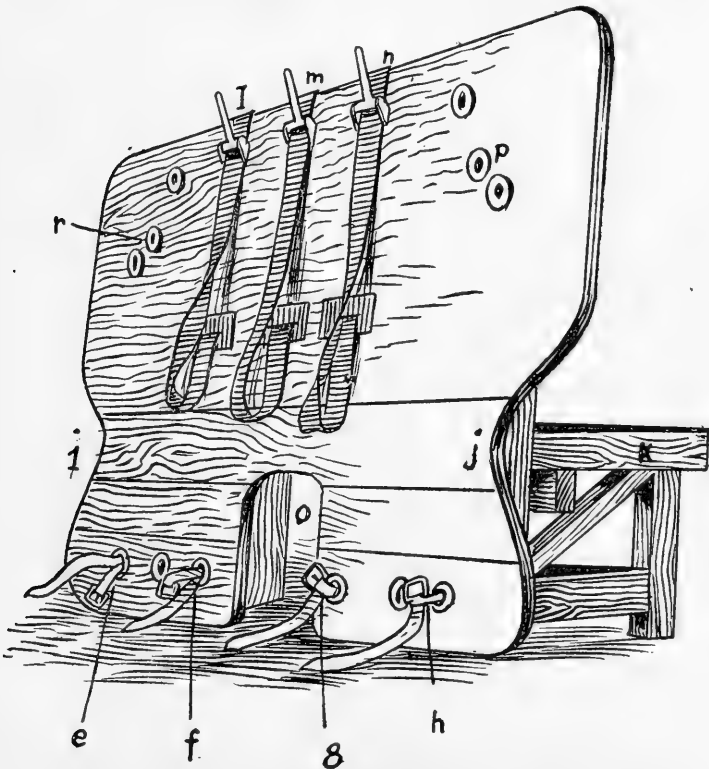

Fig. 206. Chicago Veterinary College Table, Upright Position, Front View.

advantages over some other tables of the same type. The Chicago Veterinary College table is a modification of the original Dyson table, the principal modification consisting in changing the gears from eight to sixteen turns of the crank to elevate or lower the table. This change increases the power by decreasing the speed; however, with the present gears the table possesses ample speed, and one man can easily turn the crank even when a heavy horse is being handled.

Figure 206 represents front view of Chicago Veterinary College table in the upright position, ready for reception of patient. The top of the table is made heavy and strong of hard wood. There are openings to accommodate hobble straps (e)

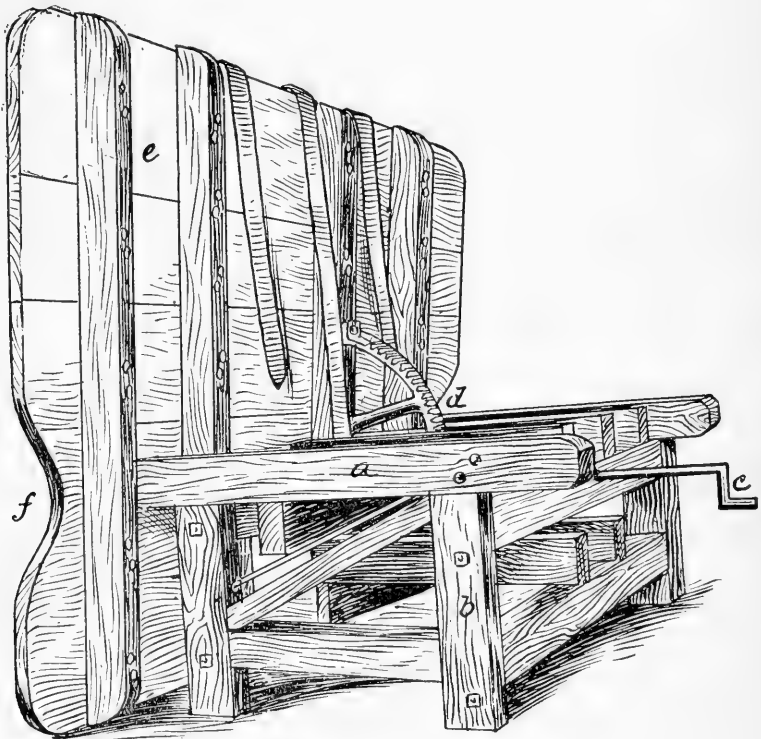

Fig. 207. Chicago Veterinary College Table, Upright Position, Rear View.

(f) (g) (h) and neck strap (r) (p). The center (o) and sides (i) (j) are cut out to allow free access to the patient. The top is padded with oakum and covered with painted canvas. The body belts (l) (m) (n) are of 5-inch 5-ply cloth belting, and fasten by means of cam buckles near top of table. The four hobble straps (e) (f) (g) (h) are 3-ply harness leather of a good quality. These are connected to chains which are fixed stationary to the frame of table. This table is elevated and lowered by sixteen turns of the crank. All gearings are substantial and extremely simple.

Figure 207 represents the table in upright position, rear view. The frame (a) (b) is built heavy and strong, being supported at each corner by a 4x6-inch post well braced in all directions. On the end of the crank (c) is a worm-gearing by which the power is transmitted to the main cog gear (d).

Figure 208 represents the table in horizontal position.

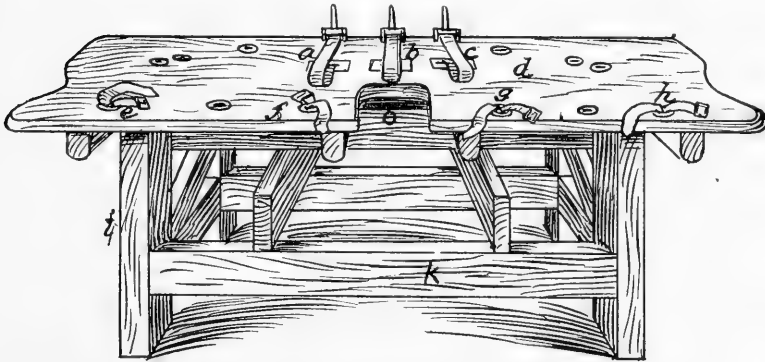

Fig. 208. Chicago Veterinary College Table, Horizontal Position.

*Directions for Placing Patient on the Chicago Veterinary College Table.*

Raise table to upright position, then induce the horse to stand alongside table and near enough to strap body to it by means of body girths and hobble straps. To accomplish this the horse should be blindfolded. Now, the halter rein should be passed through opening in the table and held by an assistant. The

foremost body girth should be brought around the animal and fastened. Then fasten the neck strap and the remaining two body girths. The hobble straps may now be placed around all four pasterns, after which re-tighten the halter rein, neck strap and body girths until horse is firmly against the table. The hindermost hobble straps—both fore and hind—must be buckled to pasterns of the outer legs. The coronet pastern and fetlock of outer hind leg should be protected from injury in struggling by wrapping with a bandage or heavy cloth.

Now turn the table down to the horizontal position as rapidly as possible.

To release the horse the hobble straps are removed first, then the twitch is removed, after which the neck strap and halter rein are loosened. The body girths are at this time loosened several inches. The table is then raised to the upright position. The head is still held with halter rein firmly against table. The blindfold should be removed as soon as animal is standing on its feet; so are all other girths and straps released at this time.

#### *The Conkey Equine Operating Table.*

The table designed and used by Professor L. L. Conkey, Figure 209, is of the flat top variety. The top is of hard wood, padded and covered with painted canvas. Openings are made through the top to accommodate the halter and neck straps, also hobble chains. This table has the center and sides cut out to afford free access to the patient. It is equipped with two

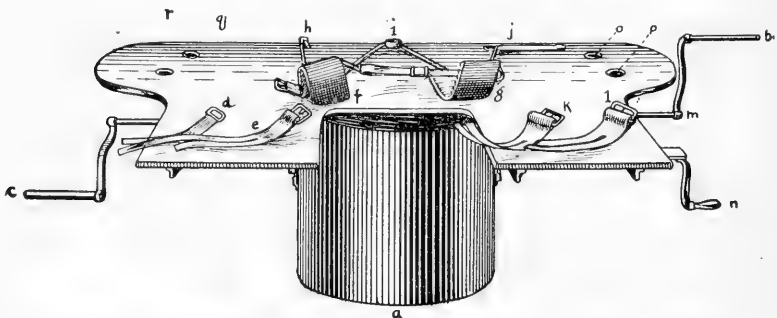

Fig. 209. Conkey's Equine Operating Table, Horizontal Position.

strong body girths (f) (g). These are made of heavy cloth belting, four strong leather hobble straps (d) (e) (k) (l) attached to chains from the ratchet by which they are tightened by turning the crank (n). On either side of the table are two heavy iron cranks (b) (c); by turning one of these cranks to the left the table top is raised to upright position, and by turning the same crank to the right the table top is lowered to the horizontal position. By turning the other crank to the right the table top is reversed (turned upside down), placing the patient in the dorsal position; and by turning the same crank to the left the table top is again brought to the horizontal position. The wide range of positions is an attractive feature of the Conkey table. Moreover, the table top rests upon a heavy metal base (a). This base is equipped with turn-table castings which enables the operator to turn the table with the patient on it in any direction, with perfect ease. All the mechanical parts are enclosed in the metal base, which protects them from dust and dirt.

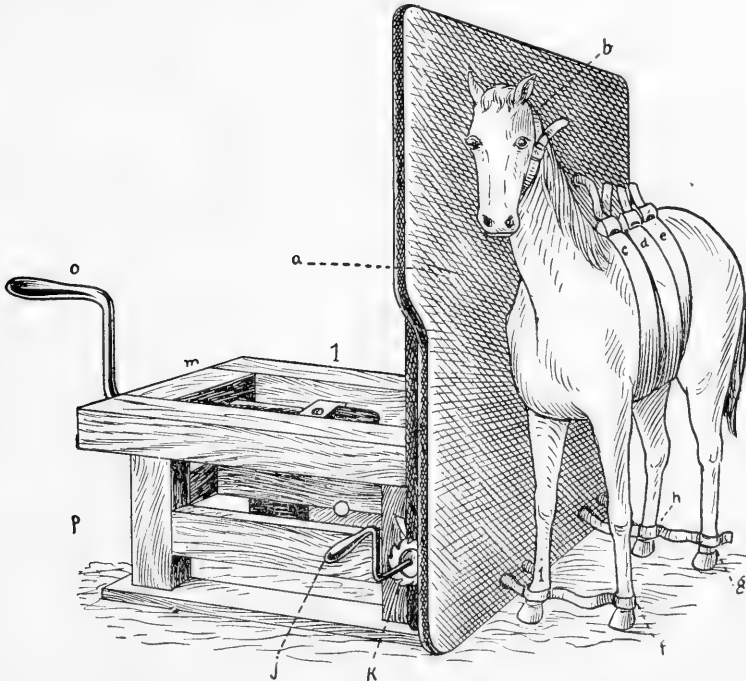

Fig. 210. Price's Equine Operating Table.

*Price's Equine Operating Table.*

The Price table, Figure 210, represents one of the earlier American designs of operating tables. The table top (a) is 9x6½ feet, heavily padded, and covered with painted canvas. This top is made of hardwood planks two inches thick, tongued and grooved to match. The table top is equipped with three heavy canvas body girths (c) (d) (e) supplied with cam buckles, also four hobble straps (h) (g) (i) (f), with their accompanying cams and two neck straps. The chains are attached under the table to a ratchet and are tightened by turning the self-locking crank (j). The top is supported by a heavy stationary wooden frame (l). This frame is braced in all directions, and on that account is very substantial. The table top is lowered and raised by turning the crank (o) in the rear.

Price's table is somewhat antiquated and very little used at the present time.

*Kyle Bros.' Combination Equine Operating Table and Stocks.*

The table top of Kyle Bros. is made of 2-inch plank, covered with heavy canvas and upholstered. The table frame is made of 4x6-inch lumber and put together in a bracing manner and will never rack.

Figure 211 represents the table in upright position, front and end view.

Figure 212 represents the table, upright position, rear view.

At the rear of the frame is situated a large master gear-wheel (f) 30 inches in diameter, with 3-inch face and 140 cogs, which is always in engagement with a small 3-inch gear-wheel on a winding shaft, which extends the full length of table so that cranks (a) (f) can be used at either or both ends of the table, operator always in position to watch the animal while tilting the table. On the rim of this master gear-wheel, at diametrically opposite points, are two cranks. To one of these is pivoted the lower end of a lever, and the upper end of this lever is pivoted into a pair of lugs, located at the rear edge of the tilting table. In the center of this lever are disc-like enlargements forming a hinge (c) provided at its front side with



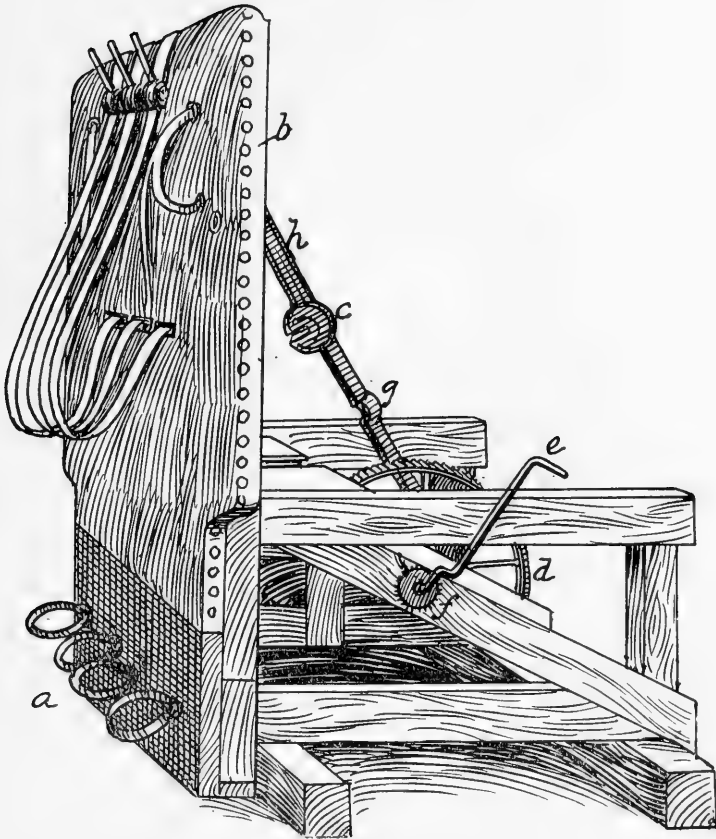

Fig. 211. Kyle Bros. Operating Table, Upright Position, Front and End View.

a radical slot, which lies in the path of the opposite free crank on master gear-wheel, and as this wheel turns around the free crank enters this slot in hinge and springs the hinge, which is so arranged as to grasp the crank, making it perfectly safe and a direct, quick and easy lift from the edge of the table. The platform is of 2-inch plank, 9 feet long and  $2\frac{1}{2}$  feet wide, well braced underneath with strong iron bars swung with large 30-inch rods to a hinge shaft, and by long rods to each end of the table; then by unhooking these chains the platform can be swung to its lower position while operating on the feet. Horse is lifted

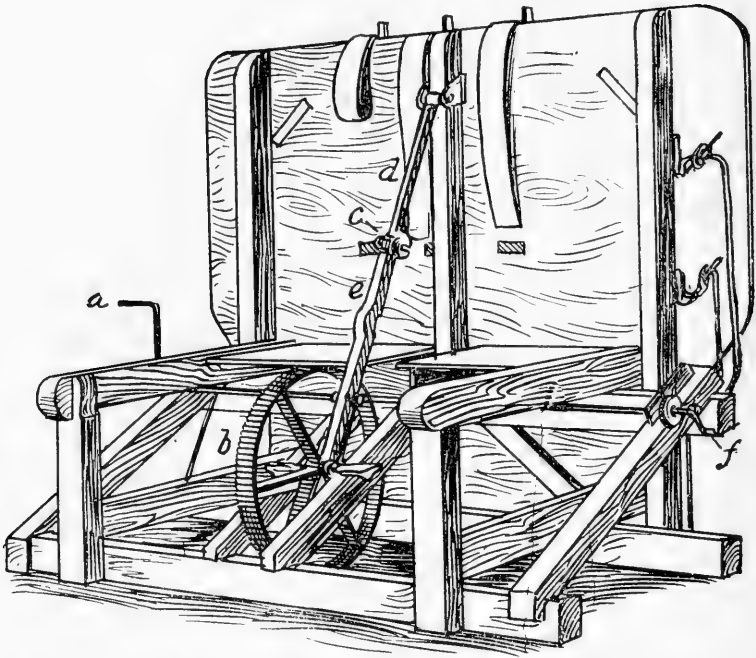

Fig. 212. Kyle Bros. Operating Table, Upright Position, Rear View.

by the feet instead of the girths, making it much easier on the animal.

Figure 213 represents the table in upright position, with horse attached ready to be lowered to horizontal position. The stocks are not illustrated in cut; however, they are made of 4x6 lumber and are located in front of the table, the padded table raised perpendicularly answering as one side. The sills of stocks are attached to the ends of the sills of the table frame and extend forward to outer edge of platform where the posts are attached, which are 7 feet high, well braced from one to the other by a beam and at corners by strong bolts.

Animals are forced into the stocks by a swinging (wooden) bar. This bar swings from either end and is operated by a rope attached to one end of the ratchet shaft. The girths and ratchet ropes are then applied, which prevents lying down or shifting about while making examinations of the mouth, drenching,

dressing teeth, or performing minor operations where it is unnecessary to cast an animal; also convenient in holding animals while applying girths and hobbles.

When the stocks are added to table it is not necessary for the table to be bolted to the floor, and if mounted on castors it can be shifted to the light or to any part of the barn by the ratchet ropes and shafts.

Located at each end of the table frame are two ratchet shafts, used in drawing stubborn horses up to table by the halter strap, and in forcing horse around against the table by passing a rope around it and onto one of the ratchet shafts, which is turned by a crank. This table is supplied with neck straps, girths, fastening for halter strap, and ropes; has four hobbles attached to heavy chains which work automatically, and is so arranged that the slack in the chains can be taken up to prevent them from being caught by the feet.

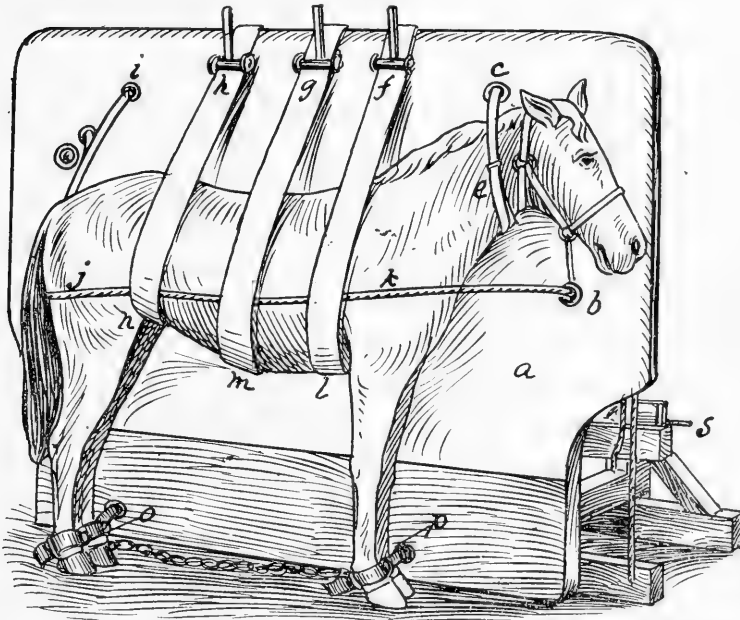

Fig. 213. Kyle Bros. Table, Upright Position, Horse Secured Ready to Be Lowered to the Horizontal Position.

The stocks are 8 feet high, but can be easily made lower if necessary. A table can be operated in a 10x12 stall, though 12x12 is better.

This table is also arranged for shoeing. A 5-inch plank can be easily removed at the bottom of the table, giving shoer access to the feet, while feet are held steady by ropes and the ratchet shafts.

*Directions for Operating the Table.*

If a kind, gentle horse, lead him up close to the padded side of the table, and if a stubborn horse, pull him up by means of the rope ratchet shaft and force him around to the table by

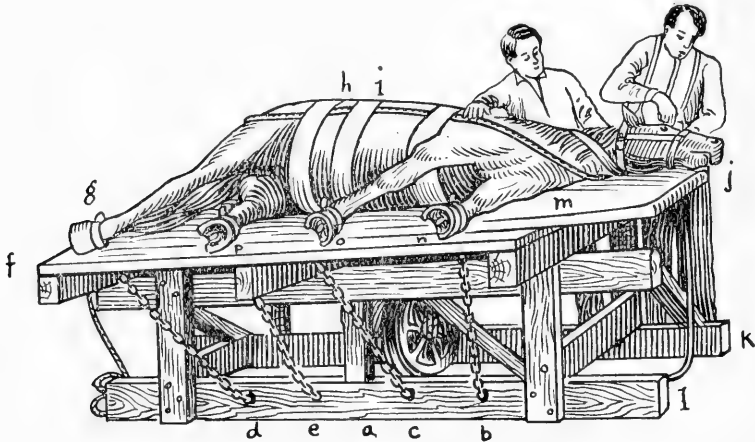

Fig. 214. Kyle Bros. Operating Table, Horizontal Position, with Horse Confined Ready for Operation.

the swinging bar of the stocks, or by the rope and ratchet shaft, then apply the girths and hobbles. Take up the slack in the hobble chains, then proceed to tilt the table.

Figure 214 represents the table in horizontal position, with horse secured ready for operation. Observe the arrangement of the lash rope, body girths and hobble strap chains.

The most attractive feature of the Kyle Bros. operating table is that it is possible for one man to confine and place a full grown horse in position for operation.



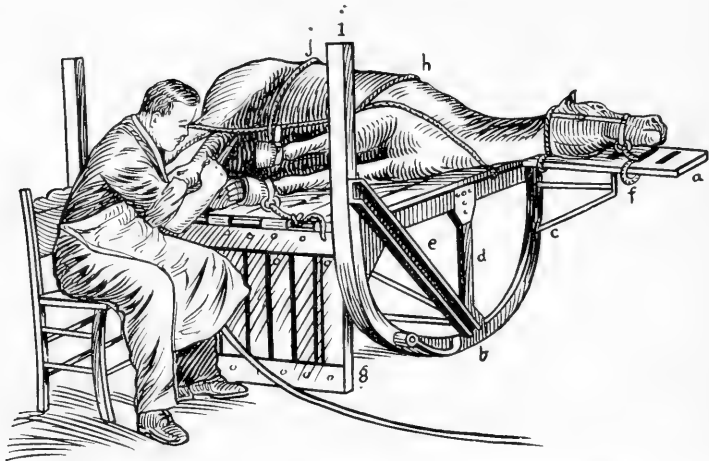

Fig. 216. German Equine Operating Table, with Horse Secured Ready for Operation.

platform (a) alongside the table. The head is fixed to head-board by means of a rope or strong halter strap. The body is then fixed securely to table with lash ropes. The table is then rocked over to the horizontal position, Figure 216; then the feet are secured, after which the horse is ready for operation.

Figure 217 represents the table in horizontal position. The platform or foot board is hinged to bottom of table. The head

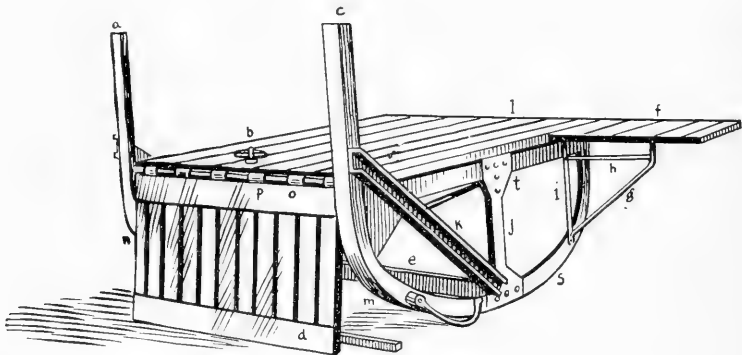

Fig. 217. German Equine Operating Table, Horizontal Position.

piece is removable and interchangeable and can be placed on either side, depending upon whether the horse is to be placed on the table on its near or off side.

This table is strong, well braced in all directions, light, cheap, and to a certain extent portable.

*Kansas City Veterinary College Rocker Operating Table.*

The "Rocker Table," Figure 218, used at the Kansas City Veterinary College, is one of the flat-top variety. The top is made by wood pieces 2x6 inches, these being placed crosswise in slat fashion. These pieces are each padded and covered separately with painted canvas. The head piece is made in the same

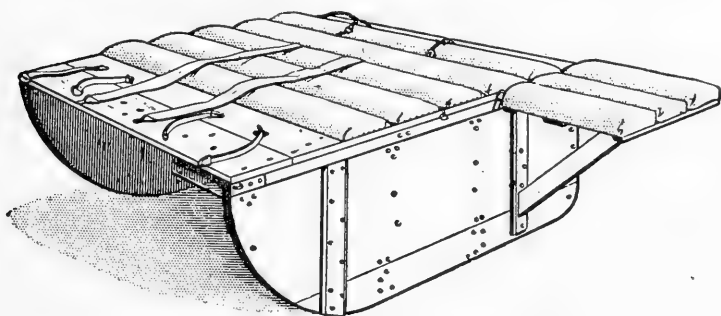

Fig. 218. Kansas City Veterinary College "Rocker Table."

manner and is interchangeable from side to side to accommodate each side of the horse. The top is equipped with eight hobble straps of special design; also hobble strap chains and two canvas body girths. The hobble chains are tightened and fixed by means of a crank at the end of table. Two hobble straps are applied to each leg—one around pastern and the other above ankle. The body girths are tightened by means of ropes which attach behind the table when in upright position. The rockers are of solid wood and strong. The table is also supplied with a foot board which drops off as soon as table is lowered to horizontal position.

To place a horse on this table the table itself is first raised

to upright position. The animal's head is fixed to head piece by using the halter rein. The horse is now placed alongside the table, standing on the foot board or platform. The body girths are now placed around the body and fastened. The table, with horse attached to it, is now rocked or turned over to the horizontal position. The feet are then made fast by the hobble straps and the body girths are reinforced by a lash rope extending alongside the horse and fastened at each end. The horse is now secured, ready for operation. To release the animal, first remove hobble straps, then the lash rope, after which raise table by means of a pulley and rope to the upright position. As soon as the animal's feet come in contact with the floor the trip is thrown, which releases the body girths instantly and allows the animal to regain its feet without difficulty.

*The Bradwood Humane Equine Revolving Operating Table and Chair.*

The fundamental principle of this invention belongs to M. Vinsot, of Chartres, in the form of Vinsot's Stocks, Figure 67. This apparatus of Vinsot, in the form of stocks, was later redesigned and shaped into an operating table by John A. W. Dollar, of London, and has long been known, manufactured and sold in England as the "Dollar table." Several years ago the apparatus of Dollar was brought to this country by Frank G. Atwood, who applied for and was granted a United States patent on same. Since that time the apparatus has been changed in several important mechanical respects under the direction of H. L. Bradley, and as now manufactured and sold by the Bradwood Manufacturing Company—from a surgical restraint viewpoint—it is probably the most perfect and desirable horse-handling machine manufactured in the civilized world. The table of today weighs only one-half as much, but is twice as strong, as the table of five years ago. Instead of large and heavy castings, strong steel forgings are substituted. It can readily be converted into a surgical chair or stocks. The table itself is 9 feet high, 12 feet long, 3½ feet wide. It requires 9 feet to turn in. There should, of course, be an allowance of at least 2 feet on all



sides to make the operating of it easy and convenient. This calls for a room 14x16 feet and 10 feet high.

Some of the most attractive features of this table are the ease and convenience with which the surgeon may approach the patient by entering the table from the back side. This allows him a space of 10 feet long by 5 feet high to enter the table, whereas in all other tables it is necessary to enter from the side the feet are attached to.

Another advantage is that of the table being used for a surgical chair after operations, as previously mentioned; and, lastly, the labor which it saves the veterinarian is a large item with the advantage of being able to turn it to the right or left or upside down. Its range of movement is far greater than that of other operating tables. If necessary the surgeon and one assistant can successfully secure a large horse for operation in this machine.

#### *Directions for Operating the Bradwood Table.*

When it is desired to secure an animal therein, one or more of the bars is freed from engagement with the ears of either of the end frames, and the horse or other animal is then led into the frame, after which the bars are secured into position. The sling is then properly disposed about the animal and the breast and breeching straps tightened. The hobbles are then secured around the ankles and the winding shaft is actuated to tighten the chain and thus securely hold the legs of the animal against movement. The winding shaft is next actuated through the mechanism explained to elevate the sling and lift the animal sufficiently to remove the feet from the ground. The animal being now in proper position to be thrown, the hand wheel is operated, and the table carrying the animal is swung either to the right or to the left and gradually lifts the feet of the animal from the ground, and at the same time the body will be caused to recline upon the cushion previously adjusted and positioned together with its auxiliary attachment, if necessary in the operation to be performed. The stay chain will obstruct the movement of the cushion, and any tendency of the

cushion to turn will be positively obstructed so that all danger of variation in the position of the animal will be obviated.

Means will also be provided in connection with one or both of the end frames for attaching halter straps or other head harness and great care will be exercised in the formation of the several parts as to distances apart to overcome any tendency to injury of the animal during his retention within the table. It will also be understood that the animal may be either led or backed into the table, and after the operation has been performed the release of the animal is pursued reversely to the steps just described in securing him.

One of the most essential features of the present invention is the mechanism for tilting the table to any position and holding it locked after the desired adjustment has been obtained. As before indicated this table, together with the attachments therein, is adjustable either to the right or left and fully through a circular path. It is obvious that under the control of certain actuating mechanisms the table, especially after an animal has been placed and secured therein, would require considerable manual strength to throw or position the animal at the angle desired. Consequently it is imperative from a standpoint of facility of operation that the necessary concomitants of the mechanism for adjusting or operating a table of this class are that they shall combine great strength, ease of operation, freedom from damage in use, and positiveness in holding the table at any required adjustment. Mechanism having the foregoing requirements in the present instance consists of a worm wheel secured to the pintle and held in constant mesh with a worm carried by a shaft having bearings in opposite brackets on the adjacent standard. The shaft is journalled in suitable ball bearings to reduce the friction in the operation of such shaft. When a horse is reclining upon either of the cushions, the lateral thrust against the threads of the worm will be excessive, and the provision of these ball-bearings reduces the resistance to movement of the shaft to a minimum.

This invention relates to veterinary operating tables wherein a frame or holding means is movably disposed and fulcrumed between uprights or standard devices anchored to a base rest.

The present form of table is equipped with attachments to facilitate the arrangement of the animal in any desired position for performing surgical and shoeing operations. In positioning the table carrying the animal, the labor incident to such operation is reduced to a minimum, and after the required adjustment has been obtained the possible movement of the table as well as injury to or bodily movement of the animal is prevented. Furthermore, the table is of such open construction that an operator or surgeon may enter any part thereof from either side or end close to the body of the animal, to easily and conveniently perform the necessary operation. The improved table is movable in a complete circle and has readily operated mechanism for throwing a horse over on either side, downwardly at an angle with the hoofs up, or fully over with the back down and the legs and hoofs in a vertical position. The table in the present instance is also supplied with readily adjustable auxiliary supporting attachments which in part are specially cushioned and padded to serve as rests for different portions of the body of the animal, and easily movable from one position to another with respect to the opposite ends and sides of the table to accommodate the position of the animal and assist in the performance of surgical operations. One of these attachments is specially useful in holding the head and neck of an animal during the administration of an anaesthetic, or one limb for special treatment or operation. A part or all of the attachments may be used in the table, and in addition to a sling of ordinary form included in the complement of attachments and having a freely movable securing means, other supporting harness or straps may be introduced, particularly when the table is so arranged that the legs and hoofs of the animal are turned up in vertical position. These additional supporting straps will be used in this instance to remove the weight strain from the legs of the animal, which under ordinary conditions are secured and firmly held against movement by hobbles attached to a part of the table. The possibility of introducing different kinds of harness or straps within the table is an important advantage, and is due to the open structure of the several parts of the table and the adjustability and removability of other auxiliaries.

It will be observed that the operator has free access to any or all parts of the animal without removing the patient from the table. This is of the greatest importance, on account of the danger to the operator, his attendants, and patient.

The following half-tone illustrations from original photographs will give the reader a comprehensive idea of the range of usefulness of this machine:

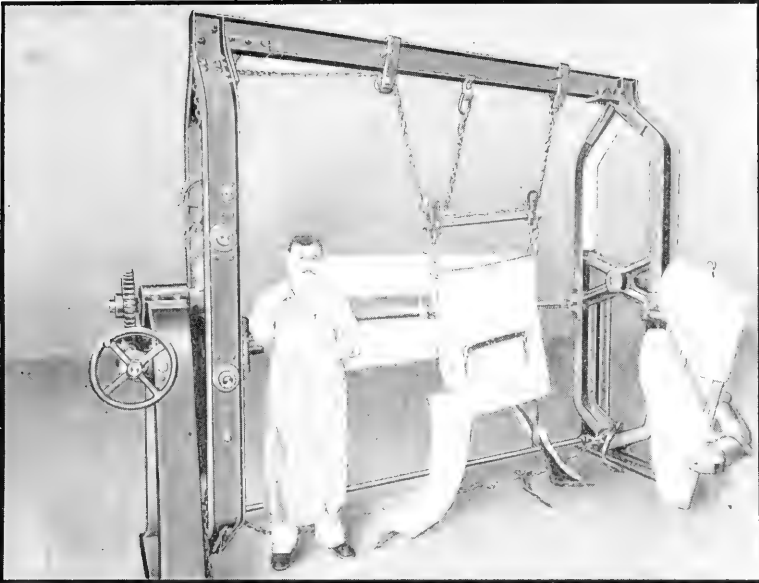

Fig. 219. Bradwood Operating Table in Upright Position Ready for Reception of the Patient.

It will be observed that this apparatus can be used for stocks. For operations in the standing posture the horse can be placed either forward or backward by shifting the iron loops on the overhead lengthwise beam. By this arrangement operations on posterior parts of animal can be performed with ease and safety.

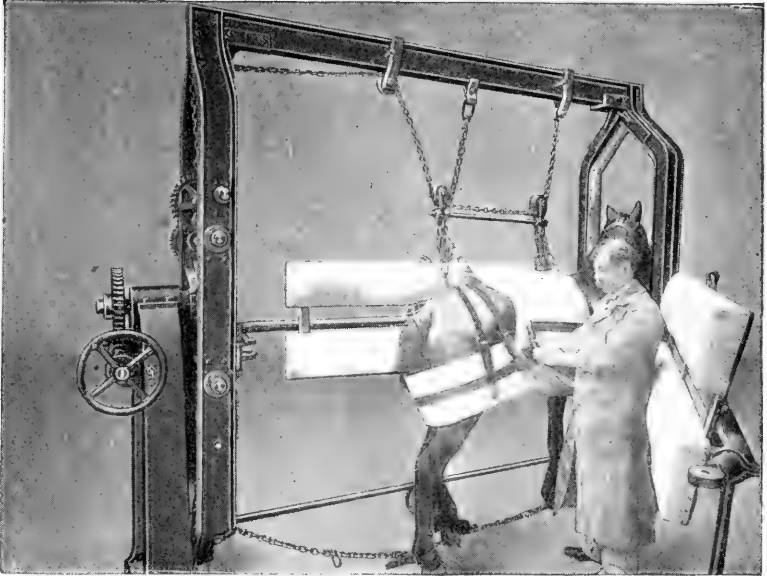

Fig. 220. Bradwood Operating Table Open for Reception of Patient, Illustrating Manner in Which the Slings Are Applied, also Both Side Pads on Table for Double Operation.

By this arrangement the operator is enabled to operate upon one fore or hind leg, or one side of the body, and immediately turn the other side in position for examination or operation without releasing the patient.

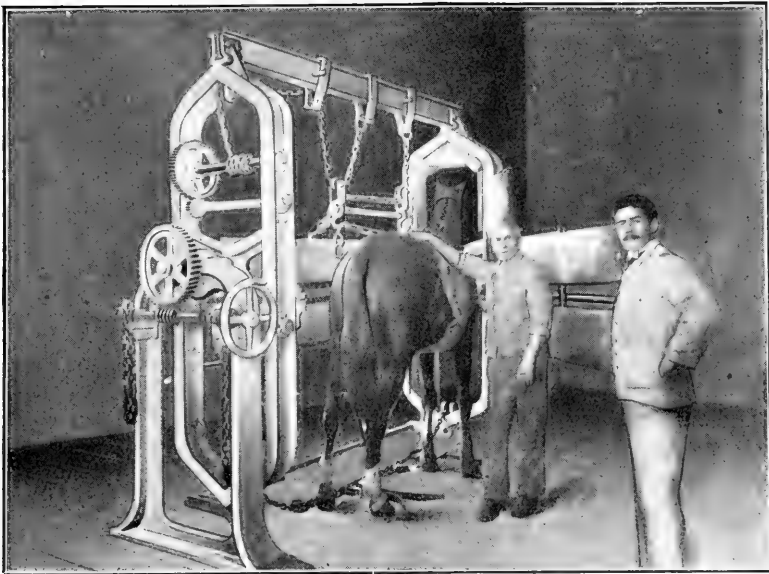

Fig. 221. Bradwood Operating Table, Side View, Illustrating Method of Removing Patient from Apparatus After Operation.

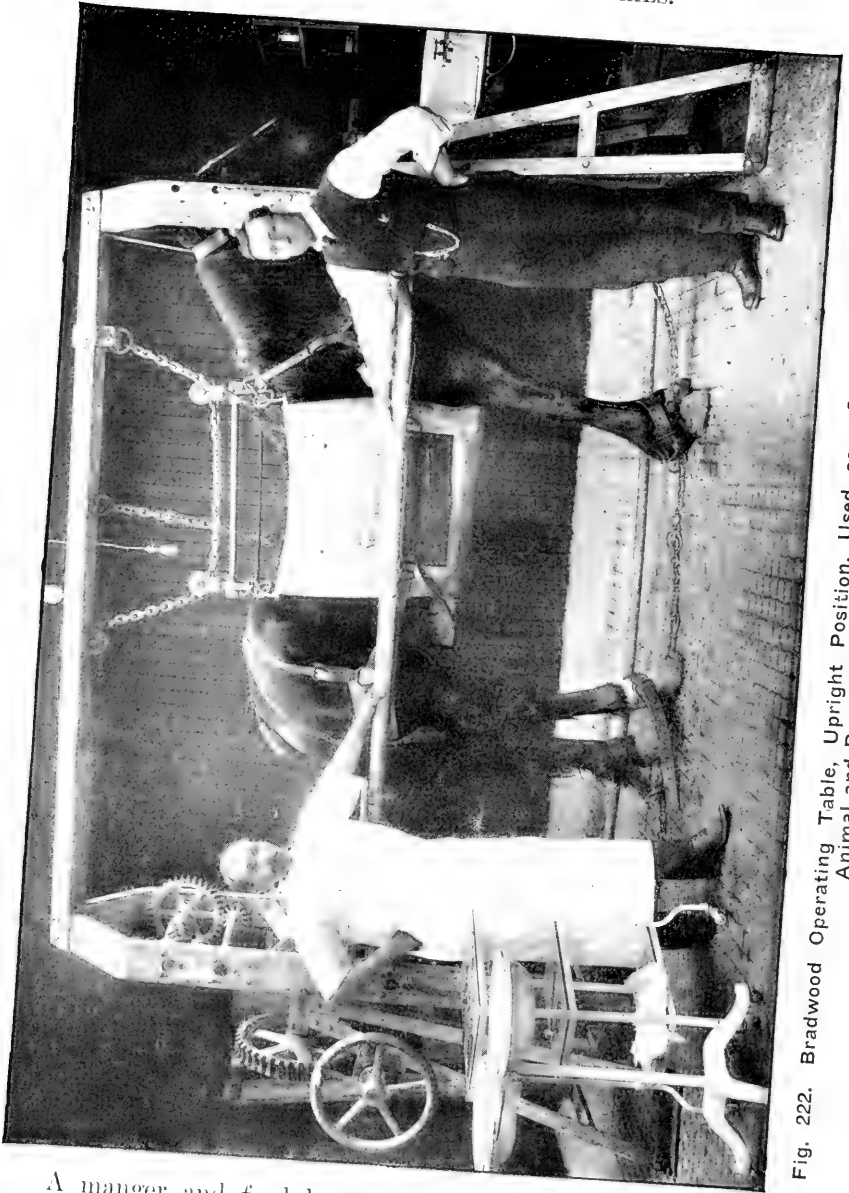

Fig. 222. Bradwood Operating Table, Upright Position, Used as a Surgical Chair by Supporting the Animal and Preventing Unnecessary Movement.

A manger and feed box can be supplied and the animal allowed to remain in this position for weeks, if necessary. In this position the table also answers well as either a stock or sling.



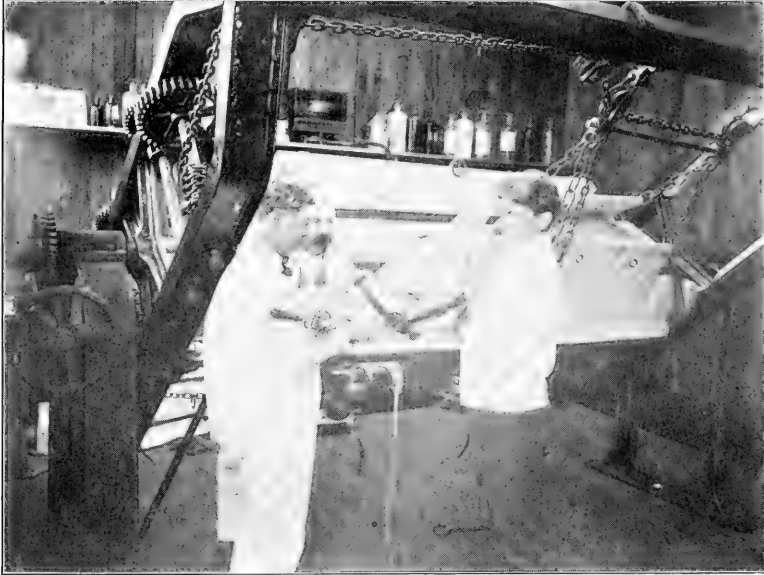

Fig. 223. Bradwood Operating Table.

The horse is backed into the table and secured in the usual manner. The table is then tilted slightly to the right, thus placing the animal in proper position for eye, head, mouth and poll operations. It demonstrates how easily the surgeon can pass out from the back side and back again when necessary. The amount of space for passage depends upon the angle of elevation of the table.

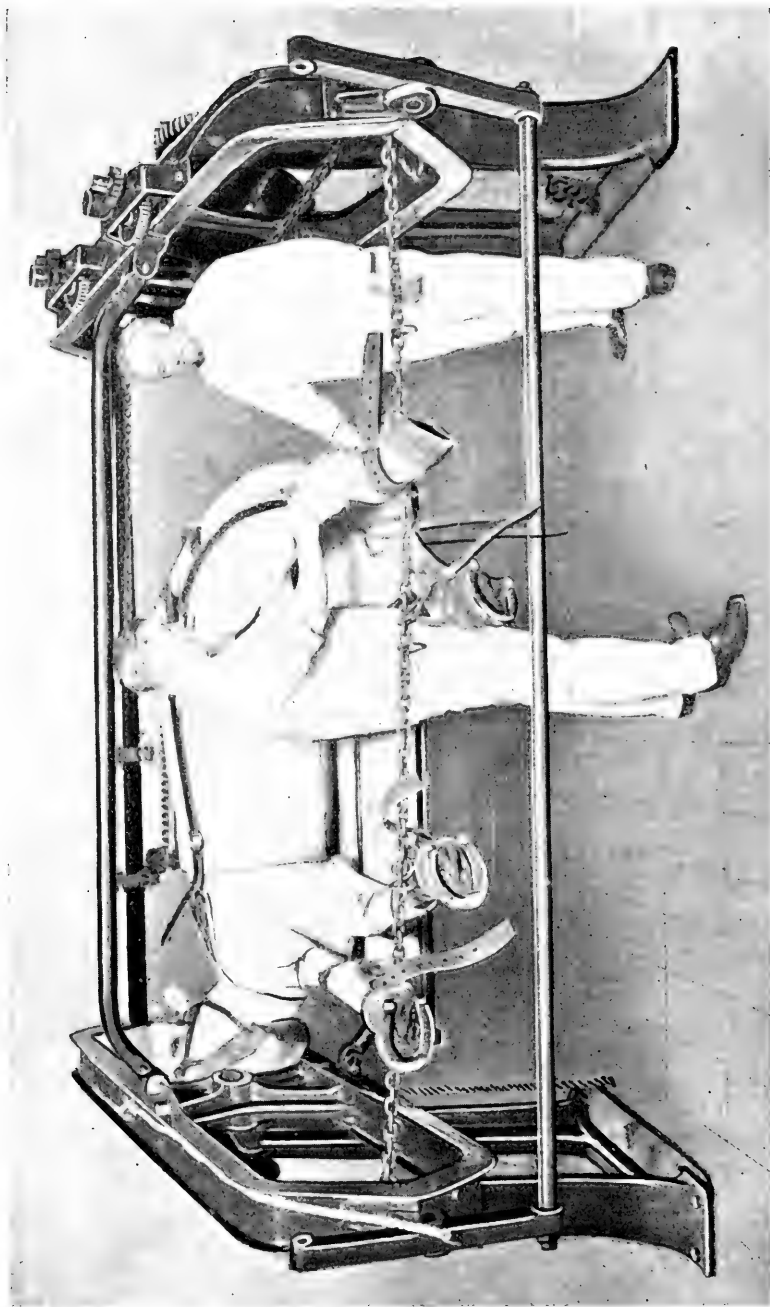

Fig. 224. Bradwood Operating Table, Horizontal Position, Heavy Horse in Position for Operation on External Lateral Aspect Off Hind Leg.



Fig. 225. Bradwood Operating Table, Horse in Dorsal Position for Roaring Operation, and Others Where the Dorsal Position is Desirable.

To place a horse in this position it is necessary to set the overhead iron loops back one or two notches. This places the horse entirely inside the machine, so that it can be turned completely over.

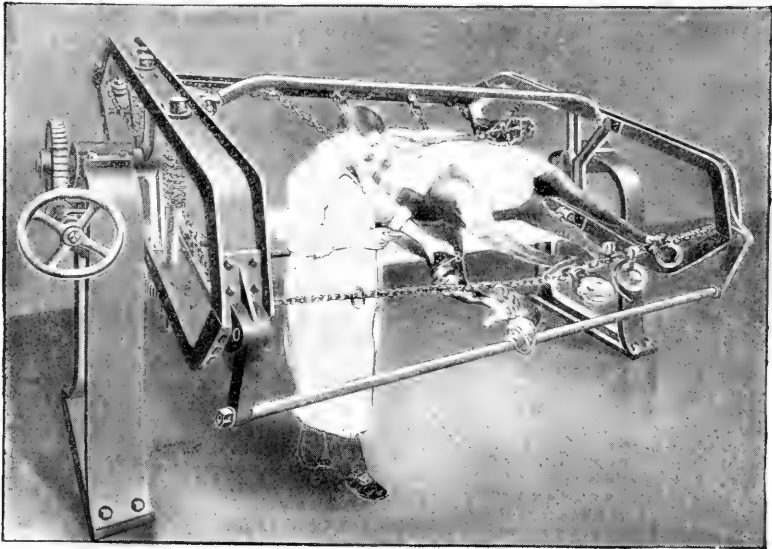

Fig. 226. Bradwood Operating Table, Horizontal Position, Legs Fixed in Position for Operation on Near Hind.

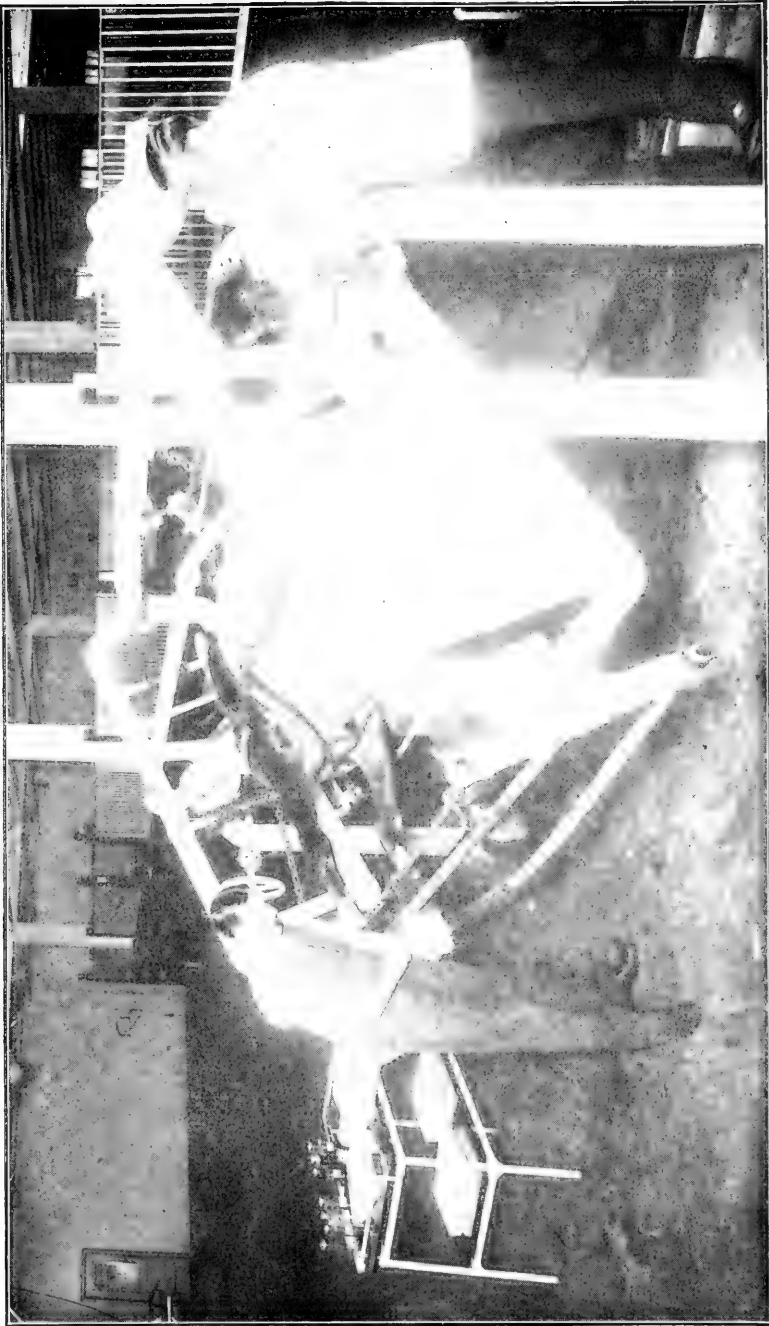

Fig. 227. Bradwood Operating Table, Horizontal Position, Foot Operation. Patient Under Chloroform Anaesthesia.

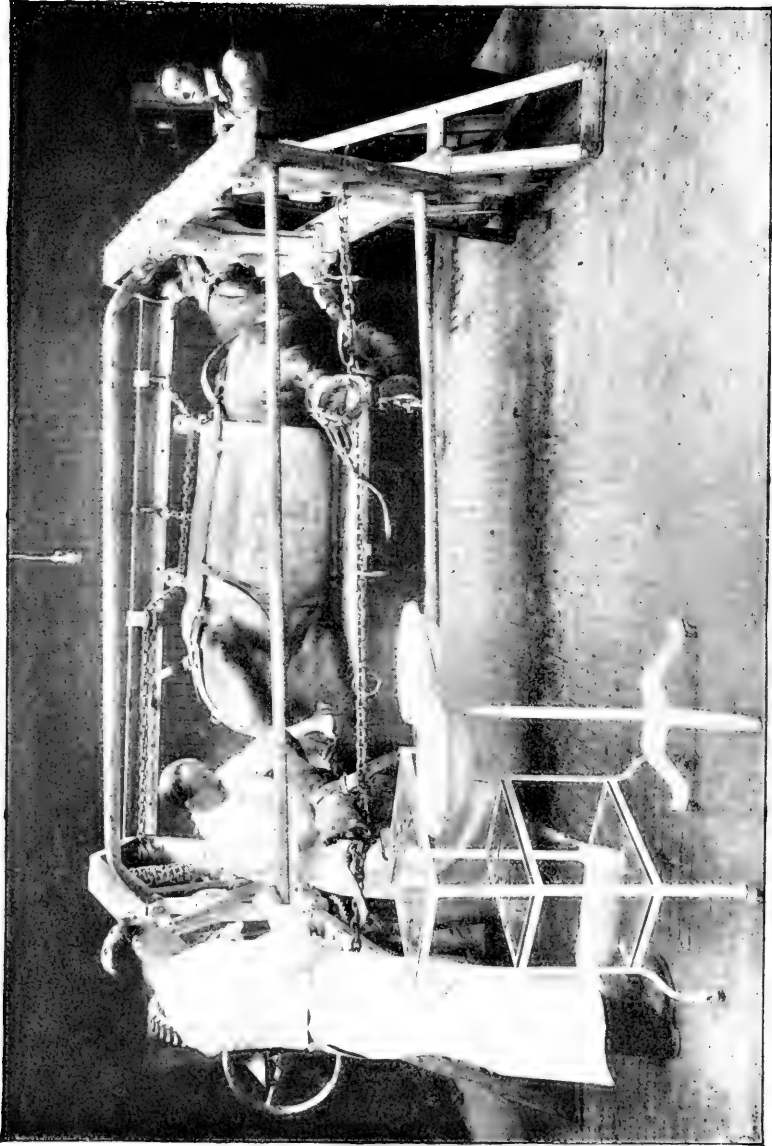

Fig. 228. Bradwood Operating Table, Horizontal Position. Table Turned to Left. Horse in Position for Operation on Internal Lateral Aspect of Near Hind Leg.

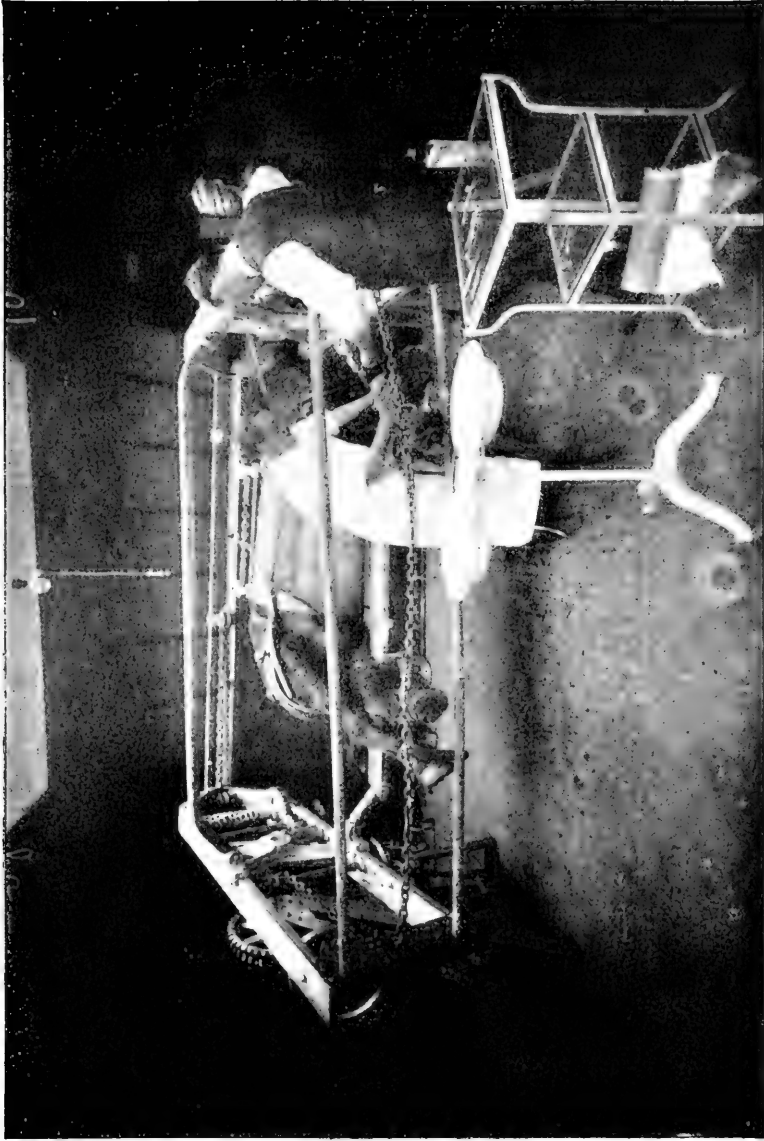

Fig. 229. Bradwood Operating Table, Horizontal Position. Table Turned to Left. Horse in Position for Operation on Near Fore Leg.

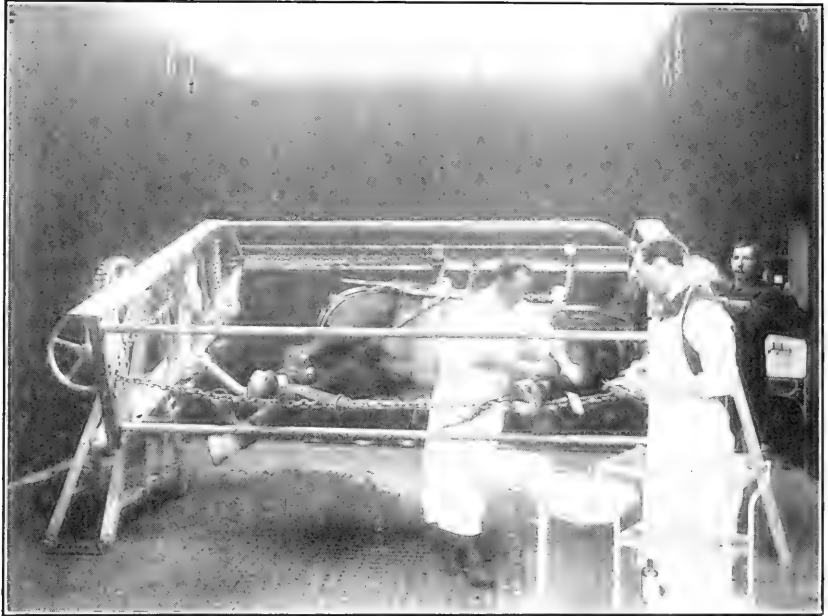

Fig. 230. Bradwood Operating Table, Horizontal Position.

This shows position which the surgeon can take in performing foot and leg operations. In entering the table for such an operation the surgeon enters from the back side and not from the side on which the feet are attached to the chain. This allows a space for the surgeon to enter 10 feet long by  $4\frac{3}{4}$  feet high.



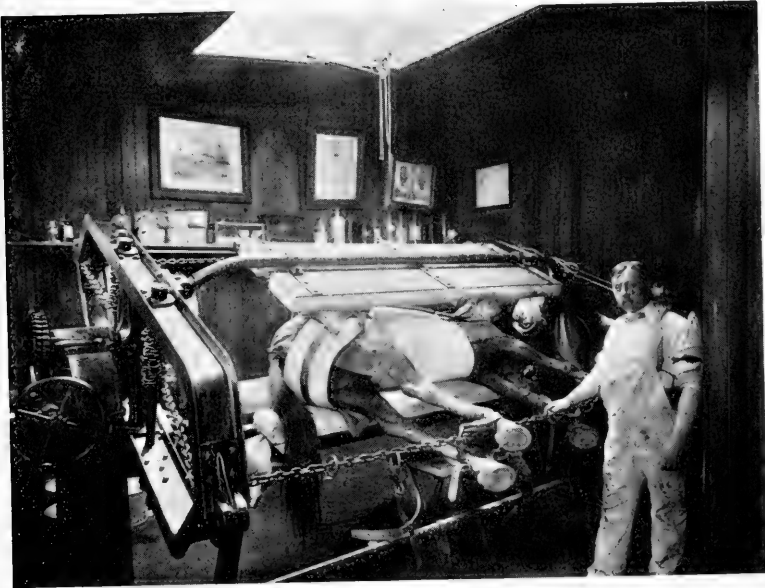

Fig. 231. Bradwood Operating Table, Horizontal Position.

The animal placed for operation on the feet. The hobbles can readily be removed and the leg to be operated on attached to chain bracket, which holds the same firmly in the position required, as the bracket is adjustable and allow the surgeon to stand outside the table with the leg held backward or forward as the case demands.



---

---

PART III.

---

Restraint of the Ox.

---

---



## PART III.

### RESTRAINT OF THE OX.

The object of restraint of the ox is to protect the operator against personal injuries as a result of kicking as well as goring. We also apply means of restraint for the purpose of immobilizing the animal sufficiently for examination and operation. The character and thoroughness of the restraint depends entirely upon the location, magnitude and painfulness of the operation to be undertaken. It also depends to a certain extent upon the size, strength, and physical condition of the individual animal and the number and ability of the surgeon's assistants. In many instances, partial restraint in the standing posture will suffice, while at other times complete restraint in the recumbent posture becomes imperative. As a rule, little can be accomplished by gentleness and kindness in controlling animals of the bovine species. Time may be saved and much vexation avoided by proceeding at once with whatever restraint method it has been decided to use. The ox is extremely susceptible to pain, and has a tendency to actively resist as soon as a pain of any character is inflicted, hence the necessity of prompt and efficient restraint.

## CHAPTER I.

### RESTRAINT OF THE OX IN THE STANDING POSTURE.

On account of the anatomical conformation and temperament of the ox, the modes of restraint in the standing posture vary greatly from those made use of in restraint of the horse in the standing position.

#### *Restraint of the Head.*

The simplest method of restraining or controlling the head is to firmly grasp the lower extremity of the *septum nasi* (a) between the thumb and index finger of one hand, and the horn (b) with the other hand, Figure 232. By a tight grasp in the nose most cattle are subdued sufficiently for examination and minor operation. Grasping the nose of the ox causes pain and

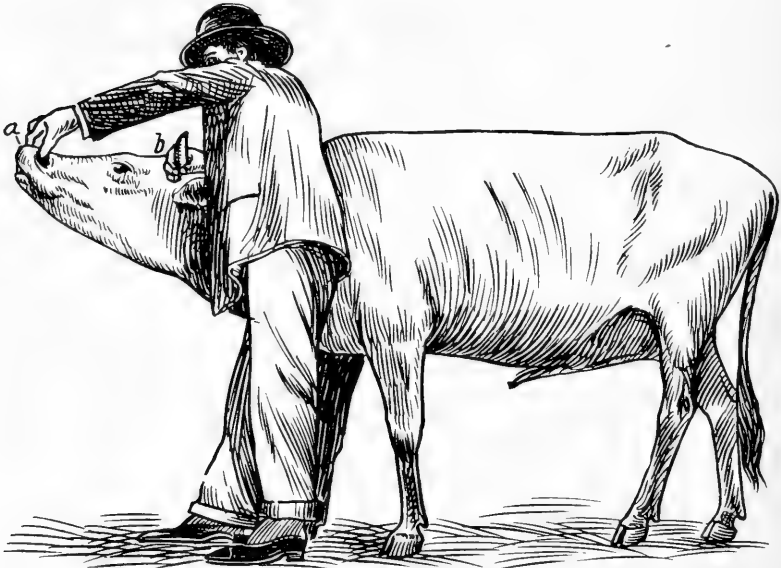

Fig. 232. Restraint by Grasping Septum Nasi with One Hand and Horn with the Other Hand.

detracts to a certain degree the animal's attention from the seat of operation. The nose grip, either by hand or by the nose clamp, has the same effect, from a restraint viewpoint, on the ox as the twitch does on the horse.

*Nose Clamp.*

There are several designs of nose clamps; all of them are made of metal, and when applied, all produce the same effect. They are useful implements of subjection and restraint, and should be applied whenever the ox is to be secured either for the purpose of examination or operation. The nose clamp is useful in the recumbent as well as in the standing posture. The following illustrations will afford the reader a comprehensive idea of the different designs of nose clamps now in universal use:

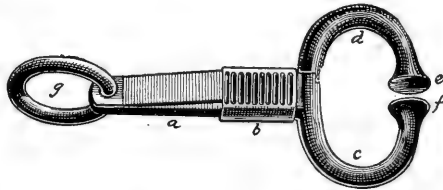

Fig. 233. American Nose Clamp with Sliding Metal Keeper.

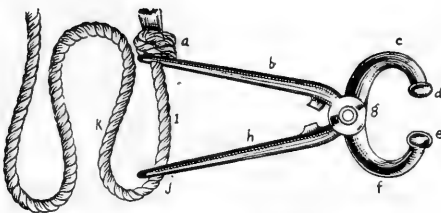

Fig. 234. American Nose Clamp With Rope.

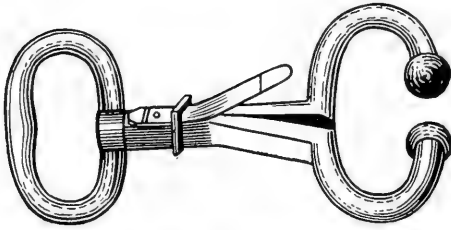

Fig. 235. Nose Clamp with Spring and Keeper.

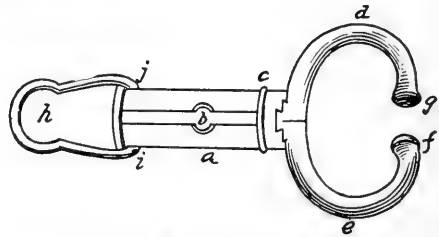

Fig. 236. Modified English Nose Clamp with Keeper.

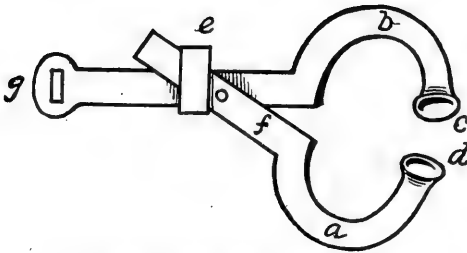

Fig. 237. Modified English Nose Clamp with Sliding Metal Keeper.

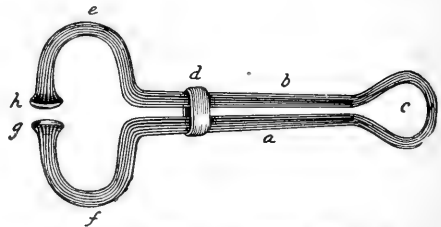

Fig. 238. German Nose Clamp with Sliding Ring Keeper.



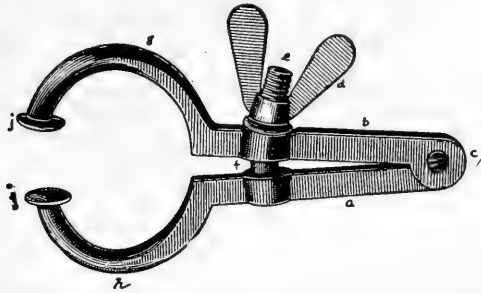

Fig. 239. Italian Nose Clamp with Set Screw Keeper.

*Vigan's Controlling Apparatus.*

The controlling apparatus of Vigan, Figure 240, affords us an efficient and safe method of immobilizing the head. It consists of a pole of sufficient length to reach from the withers to a point about twelve inches beyond the muzzle. At one end of this pole is an iron staple (d) through which passes a strong surcingle (e). The pole is then fixed between the horns by means of a rope or strap (c). The distal end of the pole carries an iron prolongation, about twelve inches from the end of which is a hook (b). This hook is to be inserted into the

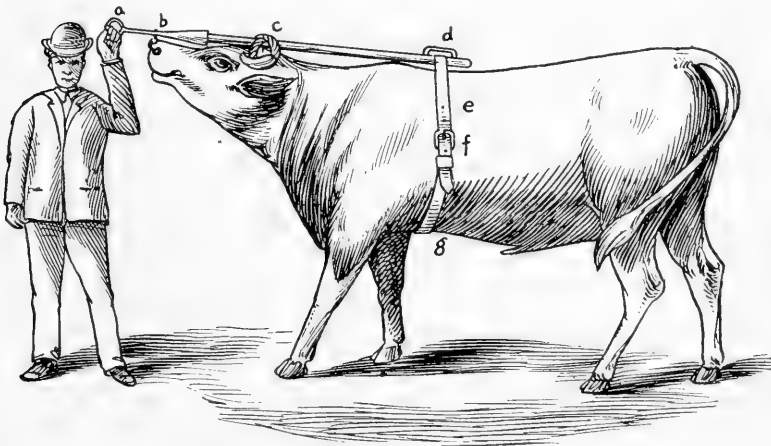

Fig. 240. Vigan's Controlling Apparatus.

nose ring. On the end of this iron prolongation is a large ring by which the head is controlled by one hand (a). This apparatus is positive and severe in its action, and the most vicious animals are quickly subdued and controlled by its application.

*Securing the Head to a Post or Tree.*

Another simple method of securing the head, Figure 241, is by looping or tying a rope around base of horns (a), after which

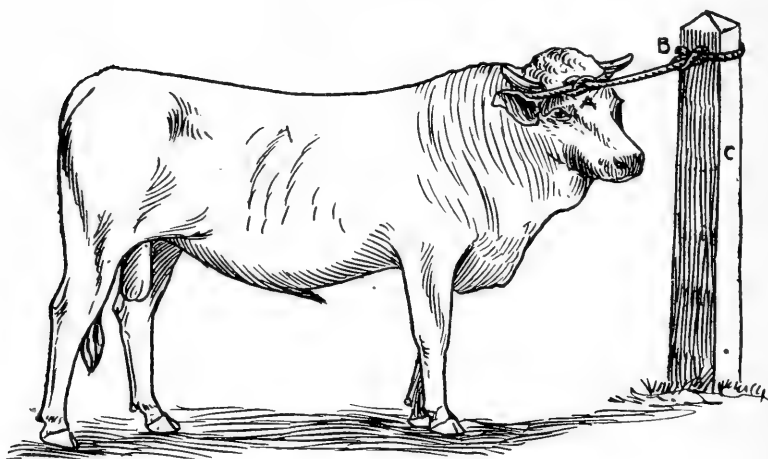

Fig. 241. Head Secured to Post.

the animal is forced in close proximity to a strong post (C) or tree around which the free end of the rope is fixed (B) by a simple knot.

Figure 242 illustrates a desirable method of restraining the head by means of a rope looped around base of horns (a), after which it is carried around the ear (e) (c) in a half-hitch fashion. Restraint is secured by tightening the rope by traction on its free end (b); this causes severe pain, and the animal quickly responds.

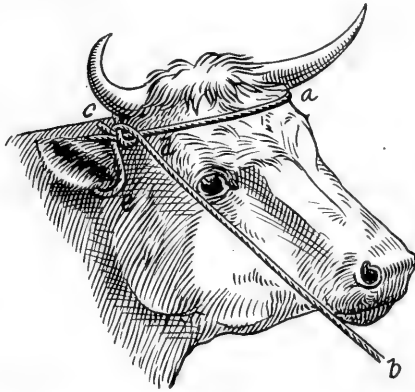

Fig. 242. Restraining the Head by Rope Around Base of Horns and Ear.

*Leavitt's Head Holder.*

The head holder of H. W. Leavitt, Figure 243, is intended to be used in connection with a chute or stocks which were designed by the same inventor. The head is thrust through the opening; the lever is then drawn over against the side of the neck and secured there by means of an iron pin thrust through a hole behind it. The rope is then dropped down over top of neck and tightened by means of a self-locking ratchet and windlass.

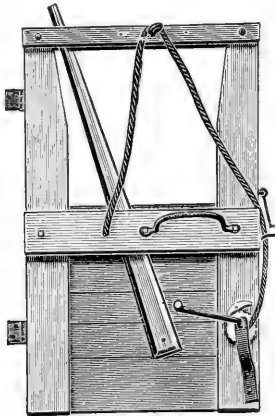
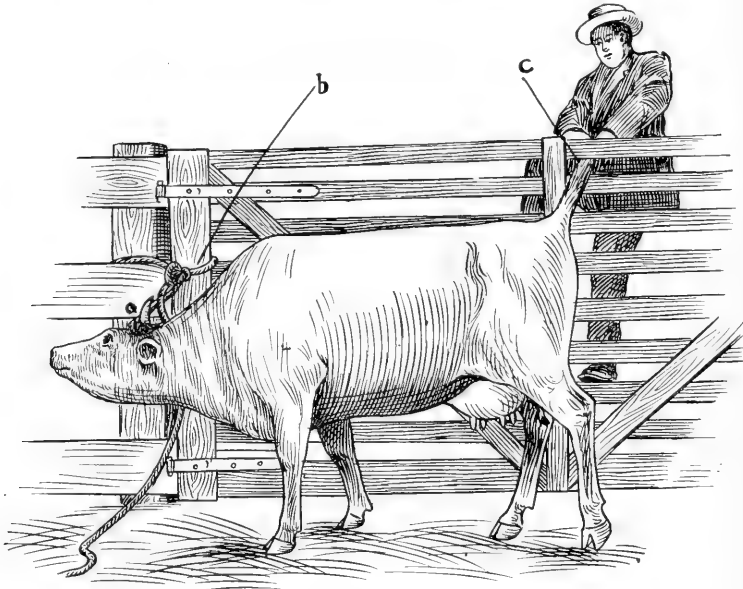

Fig. 243. Leavitt's Head Holder.

*Head Tied to Post, and Tail Through Opening Between Slats of Gate.*

Figure 244 represents a simple, quick and effectual method of securing cattle in the standing posture for "spaying" and other surgical operations. A rope is looped around base of horns (a); the head is then drawn near the gate post, around



**Fig. 244. Animal Secured by Head Tied to Post and Tail Held Through Opening Between Slats of Gate.**

which the rope is fixed by tying (b). The tail is then passed through opening between the gate slats above the animal (c) and there firmly held by an assistant. This "tail hold" prevents the animal from either turning around or lying down.

*Restraining the Fore Legs.*

The fore legs of the ox are restrained in many instances by means of knee straps of the same designs as those used in restraining the horse. Figures 245, 246 and 247 illustrate knee straps of satisfactory design:

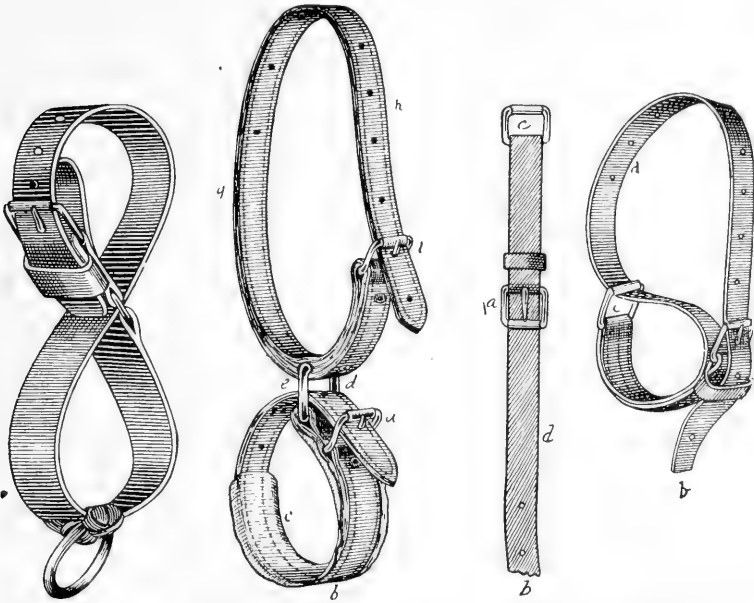

Fig. 245. Hess' Knee Strap.

Fig. 246. Author's Knee Strap.

Fig. 247. Trasbot's Knee Strap.

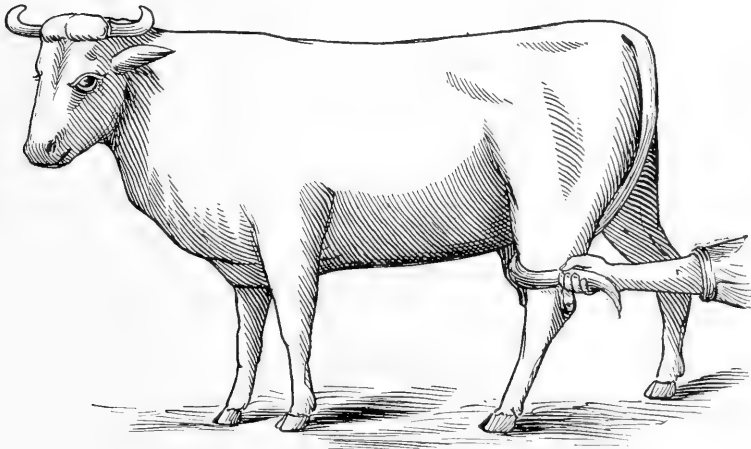

Fig. 248. Restraint of One Hind Leg.

*Restraining One Hind Leg.*

The simplest method of restraining one hind leg is by means of passing the tail between the legs, then forward and around in front of hind leg above the hock, in which position it is held firmly by a backward pull, Figure 248. If the animal attempts to kick or move, traction on the tail will cause pain and prevent such movement.

*Hock Twitch.*

The hock twitch, Figure 249, is an excellent appliance by which one hind leg may be restrained to prevent kicking. The rope of this twitch is placed around the leg above the hock; a

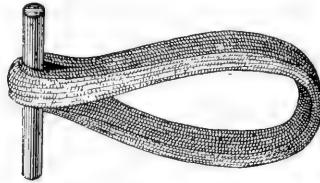

Fig. 249. Hock Twitch.

stick is then thrust through the loops in each end of the rope. The rope is then twisted until the tendo-Achilles is pressed down in contact with the posterior face of the leg. This prohibits the animal from kicking or raising the leg.

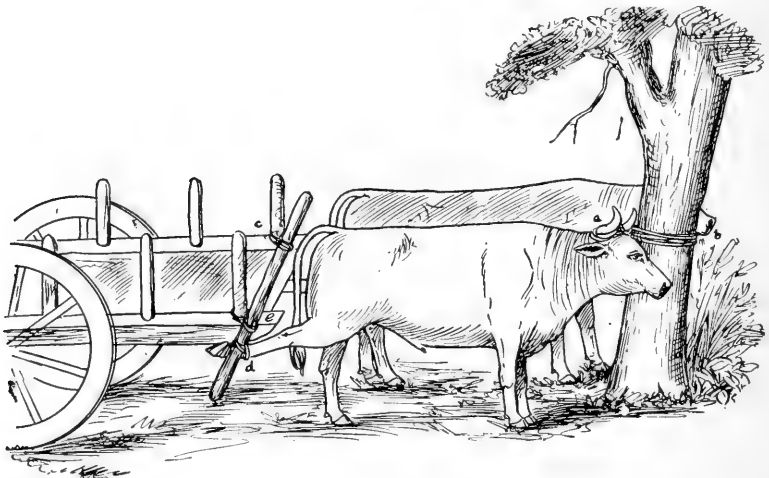
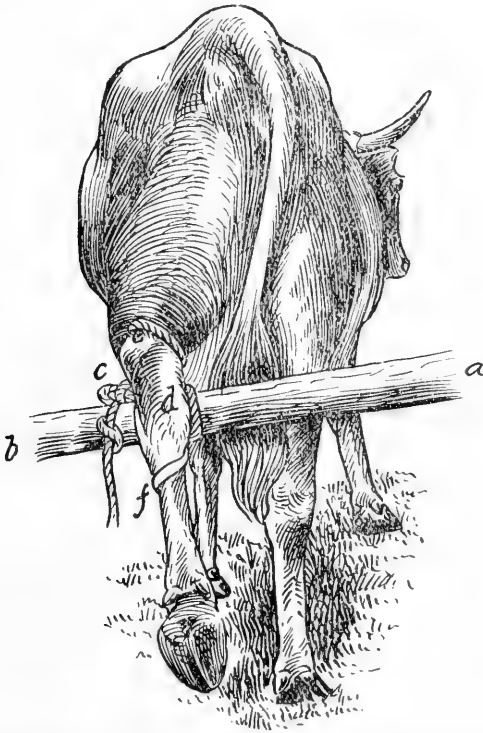

Fig. 250. Hess' Method of Restraining One Hind Leg.

*Hess' Method of Restraining One Hind Leg.*

Hess' method of restraining one hind leg, Figure 250, consists of securing the head to a tree or post by means of a rope looped around base of horns (a). The hind leg is then drawn back and fixed to the cart standard (d). This same method may



**Fig. 251. Hess' Method of Restraining One Hind Leg by Fixing to Pole.**

be used with the same degree of efficiency by substituting a tree or post for the cart standard.

Figure 251 represents another one of Hess' methods of restraining one hind leg by means of fixing the leg (d) to a pole (a) (b) which is placed in front of the hock (d). The leg is fixed to the pole by means of a rope, strap or cord.

*Restraining Both Hind Legs with a Rope Tie.*

Figure 252 represents Moussu's method of restraining both hind legs with a rope tie. The rope is simply looped (d) around one hind leg above the hock and passed backward and forward around the legs (b) (c) above the hocks, forming a figure "8," after which fix by a knot (a) between the legs.

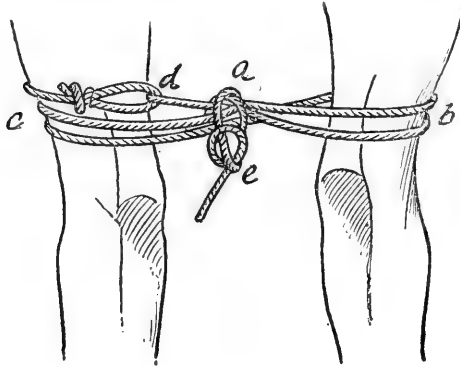

Fig. 252. Restraining Both Hind Legs with a Rope Tie.

*Smith's Anti-Kicker.*

Fig. 253. Smith's Anti-Kicker.

The anti-kicker, Figure 253, is made entirely of metal. It consists of two flat spring clamps (a) (d) so shaped as to fit firmly over the Achilles tendon. To one of these spring clamps one end of the chain (b) is securely fixed. The other spring clamp carries a locking ring (c) to receive and lock the chain.

Figure 254 represents the anti-kicker applied. This makes a convenient and safe hobble for the hind legs, and will effectually prevent kicking.



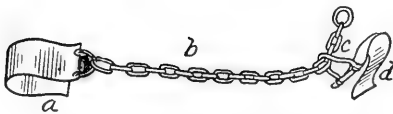
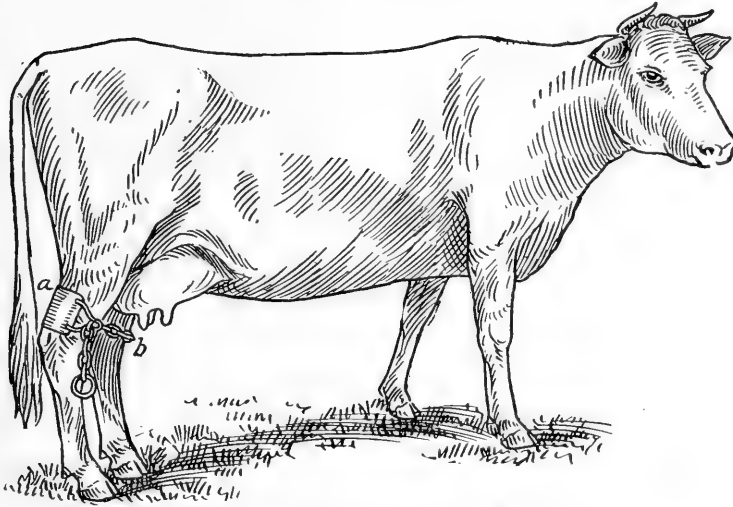

Fig. 254. Smith's Anti-Kicker Applied.

*Hess' Method of Restraining Both Hind Legs.*

The method of Hess, Figure 255, for restraining both hind legs consists of doubling a rope, webbing or strap, and placing it around one hind leg above the hock (b) (c). Pass one free end up between the hind legs and through the loop, and the other free end is passed in front and around the other hind leg (a) and through the loop. Traction is made on both free ends (d); this draws the legs together and prevents backward, forward and sidewise movement.

*Restraint of Both Hind Legs with a Sack or Cloth.*

Figure 256 represents restraint of both hind legs by means of a sack or cloth folded and placed in front of the hocks (a) and held on each side (b) (c) by an assistant.

*Restraint of Both Hind Legs by Pole in Front of Hocks.*

Figure 257 represents both hind legs restrained by placing a pole in front of the hocks (A). Each end (C) (B) of this pole is held by an assistant.

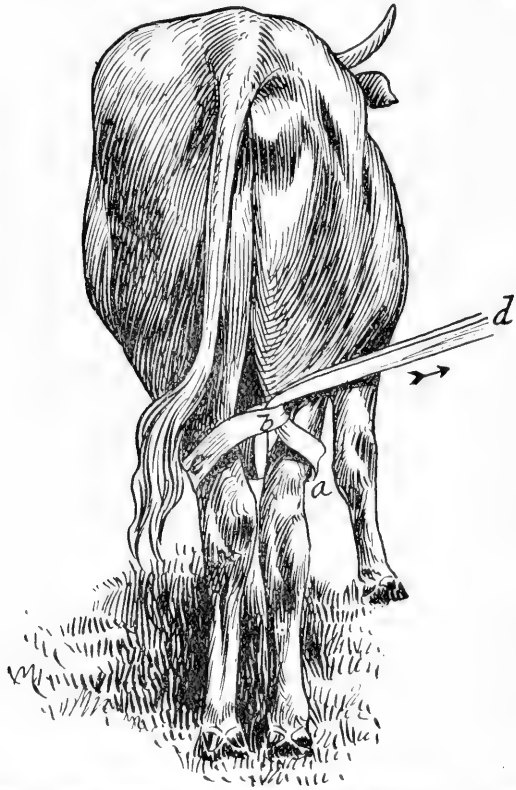

Fig. 255. Hess' Method of Restraining Both Hind Legs.

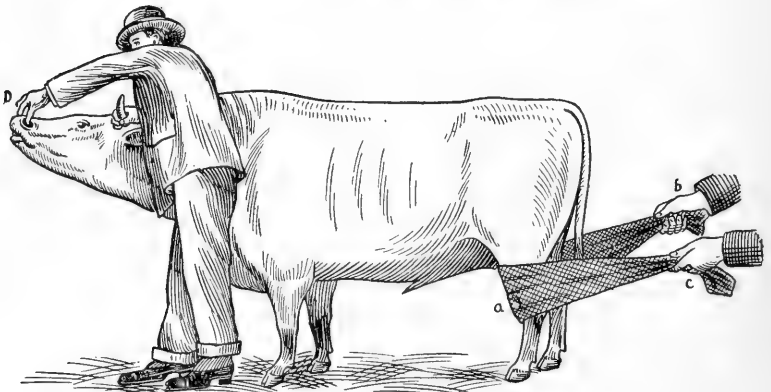

Fig. 256. Restraint of Both Hind Legs with a Sack or Cloth.

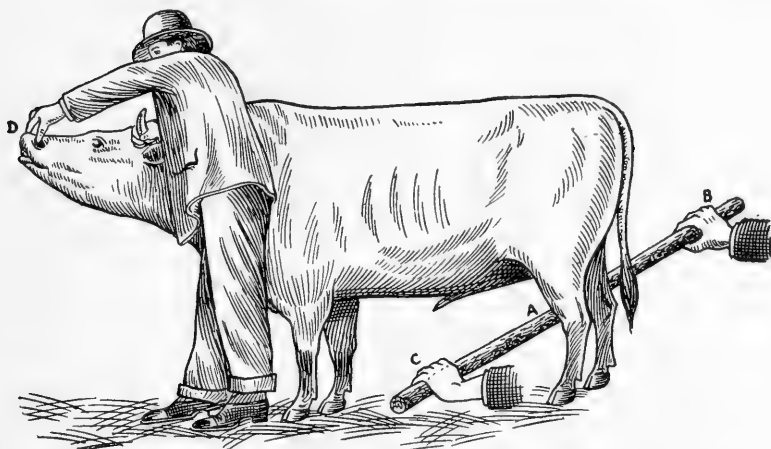

Fig. 257. Restraint of Both Hind Legs by Pole in Front of Hocks.

*Restraint of Both Hind Legs with a Plank Held by an Assistant.*

Figure 258 represents both hind legs restrained by placing a plank in front of the hocks (A) with one end down against the wall (C) and the other end held by an assistant (B). By means of a plank held in this manner the animal is forced and held against the wall and kicking is prevented by the plank being held in contact with the hocks.

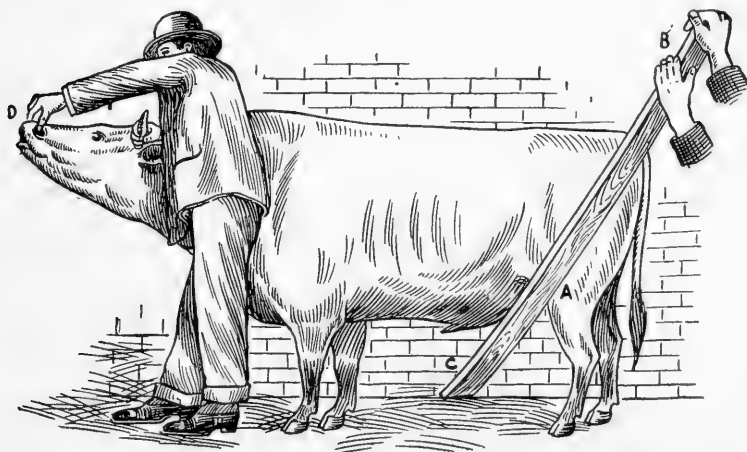

Fig. 258. Restraint of Both Hind Legs with Plank Held by One Assistant.

*Restraint of One Hind Leg and One Fore Leg.*

Fig. 259 represents the hind and fore legs fixed together with a rope. The rope is looped around the hind leg above the hock (a), then passed forward (b) to and around the fore leg (c) (d) above the knee and there fixed by a knot.

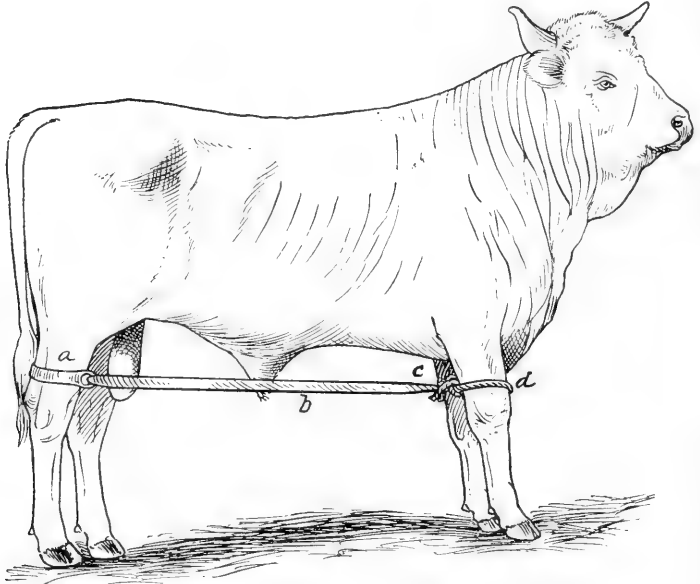

Fig. 259. Hind and Fore Legs Fixed Together with a Rope.

*Hess' Method of Restraining One Fore Leg and One Hind Leg.*

The method of Hess, Figure 260, of securing the animal to a wagon, consists of fixing the head to frame. Then lift one fore foot (a) with rope (b). The rope is then passed over frame (c) and its free end held by an assistant (d). The hind leg is fixed (f) to a pole (g) which has been thrust between the spokes of wheel.

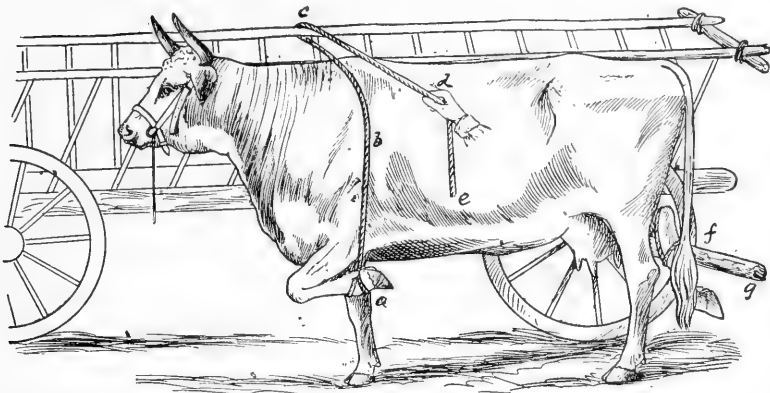

Fig. 260. Hess' Method of Restraining One Fore and One Hind Leg.

*Restraint of All Four Legs.*

Figure 261 represents one of the simplest methods of restraint of all four legs. It consists of two strong rings securely fixed in the wall—one in front (A) and the other behind the animal (C). To one of these rings a strong rope is fixed. The rope is then passed alongside the animal (B) to and through the other ring (C). Traction is made on the free end of the rope (D); this forces and holds the animal against the wall.

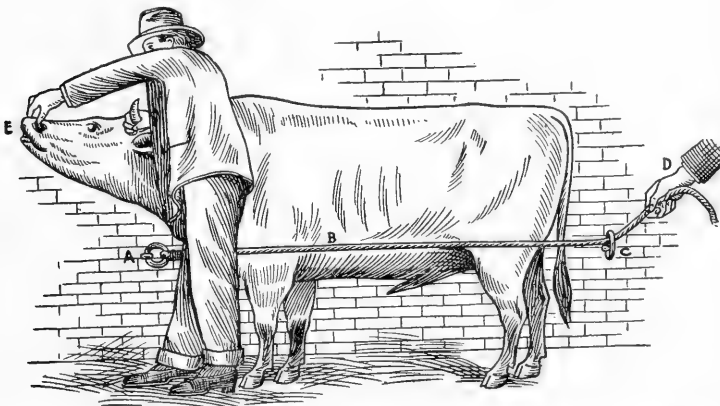

Fig. 261. Restraint of All Four Legs by Forcing Animal Against Wall with Rope.

*Travis or Stocks.*

Figure 262 represents a form of stocks now in general use on the Continent of Europe for controlling oxen. The four upright side posts are beveled and curved to fit the body of the animal. They are attached at their bottom by a hinged bolt to posts firmly fixed into the ground. They are united at the top by keyed pins (c) (a) (b) (d). A post (e) is placed in front of the animal, to which the head is fixed by means of a rope around base of horns. The hind legs may be fixed to the rear post (f); the fore legs are fixed to support (g) on front post.

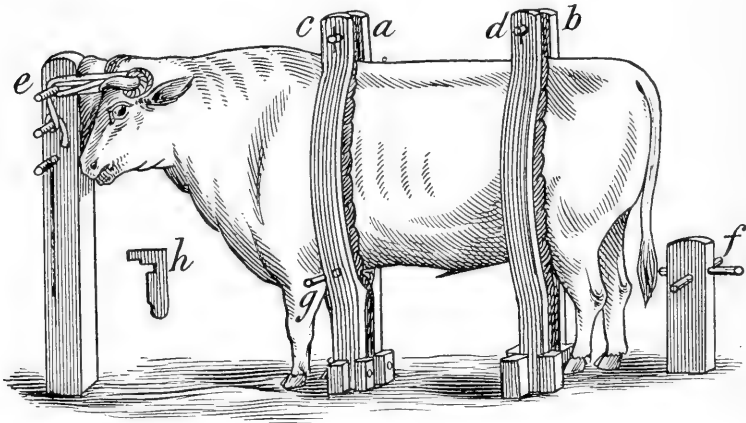

Fig. 262. Travis or Stocks.

*Cattle "Chute."*

Figure 263 represents a design of cattle "chute" which is used very extensively in the West and Northwest for confining wild and range cattle for spaying and other surgical operations. This "chute" is simply a wedge-shaped stockade. The sides of the "chute" are six feet high and the "chute" itself is only two and one-half feet wide. The gate (A) is eight feet high and two and one-half feet wide. The sliding bars or rails (B) are to be placed behind the animal to prevent backward movement and to wedge it in the "chute." The head is thrust through the

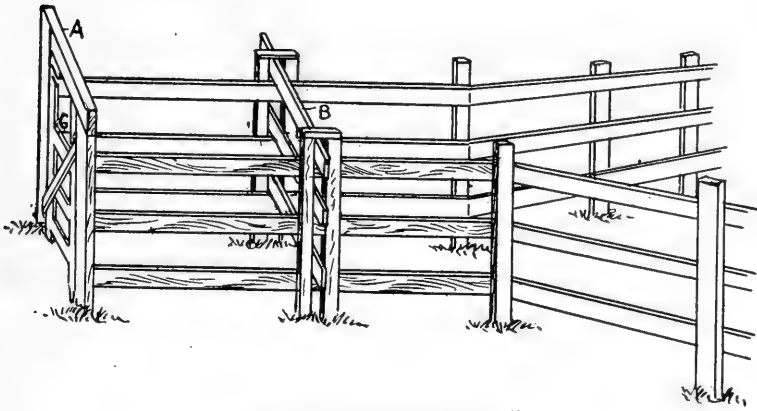

Fig. 263. Cattle "Chute."

opening in the gate (G). After the operation, the animal is released by simply opening the gate. This "chute" affords us a quick, safe and convenient method of restraining wild and vicious animals.

## CHAPTER II.

### RESTRAINT OF THE OX IN RECUMBENT POSTURE.

The ox is easily cast and secured for operation. This may be done with most any of the ordinary hobbles, ropes and casting harness which are used in casting and restraining the horse. These have already been illustrated and described in Part II.

The ox may also be secured on most of the equine operating tables which were also illustrated and described in Part II. However, there are a few special methods that are used exclusively in ox surgery. To make this volume complete, it will be necessary at this point to briefly consider the special appliances for subjection and restraint of the ox. In casting and securing this animal precautions must be taken against fracturing the horns and rupturing the rumen. It is always advisable to have the animal empty by fasting several hours before casting, and to cast upon a thick bed of straw or other soft material. In all cases the head should be supplied with a halter, or the nose clamp may be used.

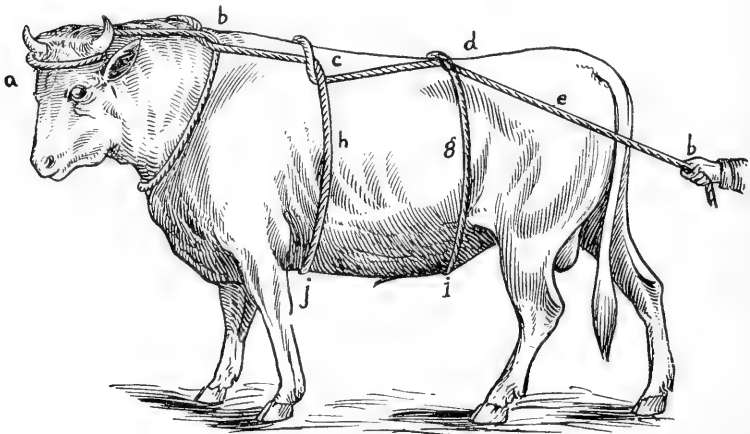

Fig. 264. Rueff's Method of Casting the Ox—First Position.



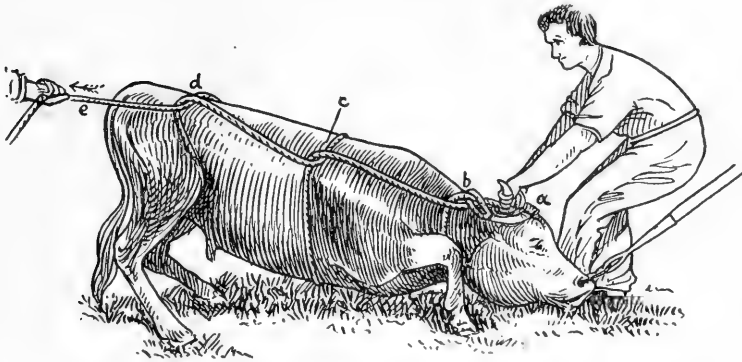

Fig. 265. Rueff's Method of Casting the Ox—Second Position.

*Rueff's Method of Casting.*

The method used in Germany by Rueff, Figure 264, consists of looping a rope thirty-six feet long around base of horns (a). This rope is then passed along on top of neck and half hitches taken around base of neck (b), chest (c), and flank (d). The free end is then carried backward over the hip (e) and with one assistant controlling the head, traction is made on free end of rope sufficient to compress the body, and in a few seconds the animal will lie down, at which time the restraint may be completed by application of hobbles.

Figure 265 represents the animal about ready to go down. Figure 266 represents the animal cast, ready to be secured.

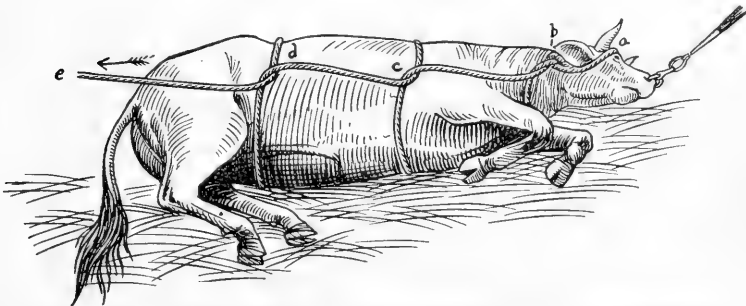

Fig. 266. Rueff's Method of Casting the Ox—Third Position.

Figure 267 represents a quick and convenient method of casting calves for "spaying operation." Two ropes are simply looped around the hind and fore legs (a) (b) above the ankles, and the calf is stretched broadsided on the ground by making traction on the free ends of the ropes (c) (d).

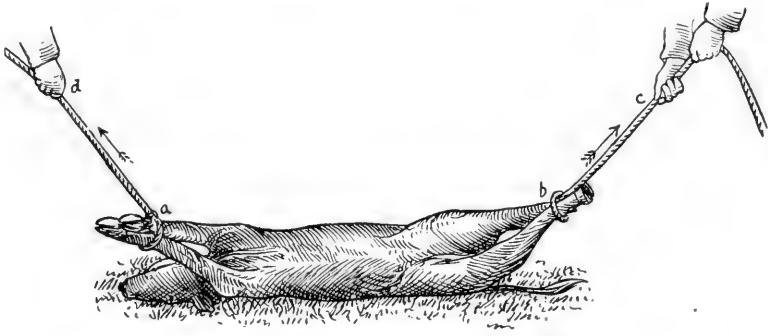

Fig. 267. Casting Calves for "Spaying Operation."

*Soffner's Method of Casting.*

The method of Soffner, Figure 268, consists of a forked rope, both ends of which are passed under the chin strap of the halter, then carried between the fore legs (f), thence to and through the ring (b) in surcingle (g), then the two ends are looped around each fore leg above ankles (a) (c). The animal is cast by making traction on free end of rope (e).

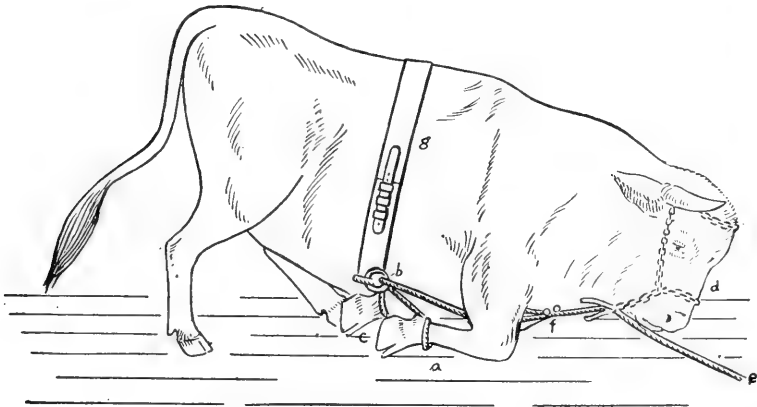

Fig. 268. Soffner's Method of Casting.

*“Draw Back” or “Pulley Harness.”*

The “draw back” or “pulley harness,” Figure 269, were originally designed for preventing cattle from “running away.” However, it later developed that they are also desirable for casting purposes. A rope surcingle carrying two pulleys is fastened firmly around the chest (d). Hobble straps are ap-

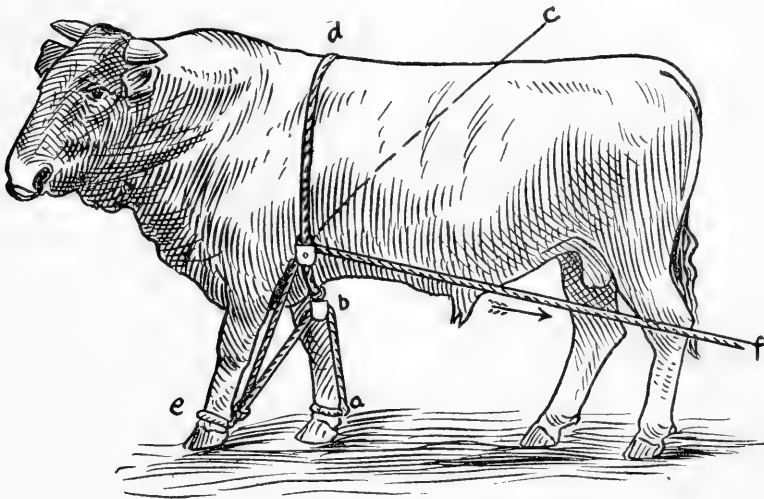

Fig. 269. “Draw Back” or Pulley Harness.

plied around both fore pasterns. The main rope is fixed to hobble strap ring (a) of off pastern. The rope is then carried upward to and through the pulley (b), thence downward to and through the hobble strap ring on near fore leg (e); then upward to and through the remaining pulley (c). Traction is made on free end of rope (f).

*Conkey’s Lock Buckle Hobbles.*

The lock buckle hobbles of Conkey, Figure 270, are very convenient for casting and securing the ox. The hobble straps are buckled around the legs above ankles. The master hobble (a) is applied to near fore leg when it is desired to cast animal

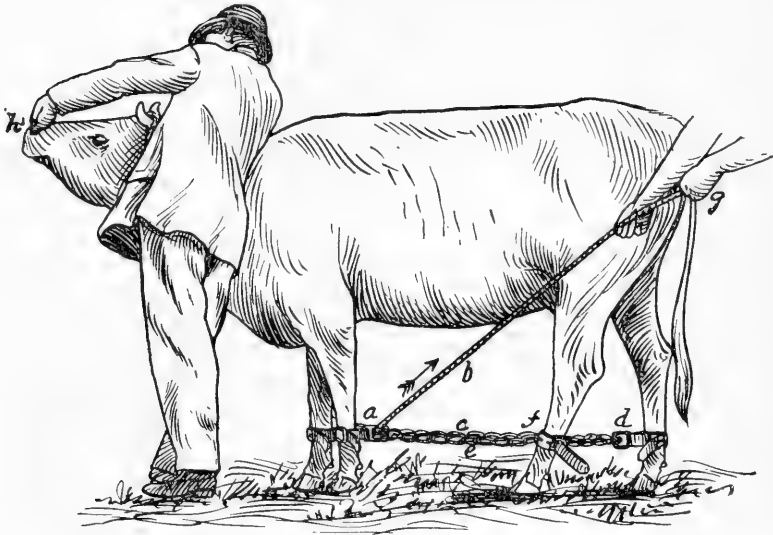

Fig. 270. Conkey's Lock Buckle Hobbles Applied.

on off side. The rope carrying the chain is passed from near fore to and through hobble strap ring of near hind; then across to off hind; thence forward to off fore, and back through lock buckle. The animal is cast and secured, Figure 271, by making traction on free end of main rope.



Fig. 271. Animal Cast and Secured with Conkey's Lock Buckle Hobbles.

*Casting with Rope on Three Legs.*

Figure 272 represents a mode of casting with rope on only three legs. The rope has a running noose or loop at one end which is placed around the near fore pastern (a) then carried around off fore pastern (b), thence around off hind pastern (c) and back around the part of the rope connecting the fore legs. The free end of the rope (e) is passed backward, and the animal is cast by two or more assistants making traction on rope.

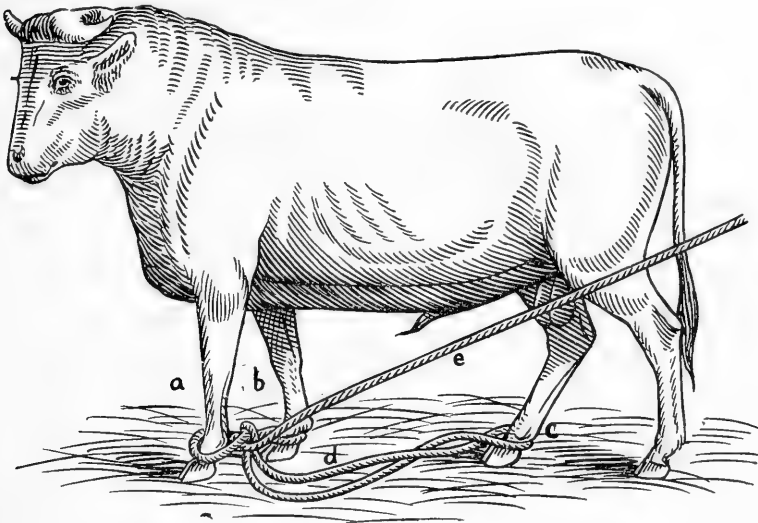

Fig. 272. Casting with Rope on Three Legs.

*Casting Ropes Fixed to Horns.*

Figure 273 represents the manner of casting an animal with main casting ropes fixed around base of horns. Take a  $\frac{5}{8}$  or  $\frac{3}{4}$ -inch rope fifty feet long; double the rope and loop its middle around base of horns (a). The free ends are brought down on either side between the fore legs behind elbows (b); then backward (c) (d) to and around each hind pastern (h) (i); thence forward (e) (f), and the animal is cast by traction on free ends of the ropes (j) (k). If available, it is advisable to use hobble straps on hind legs above the ankles.

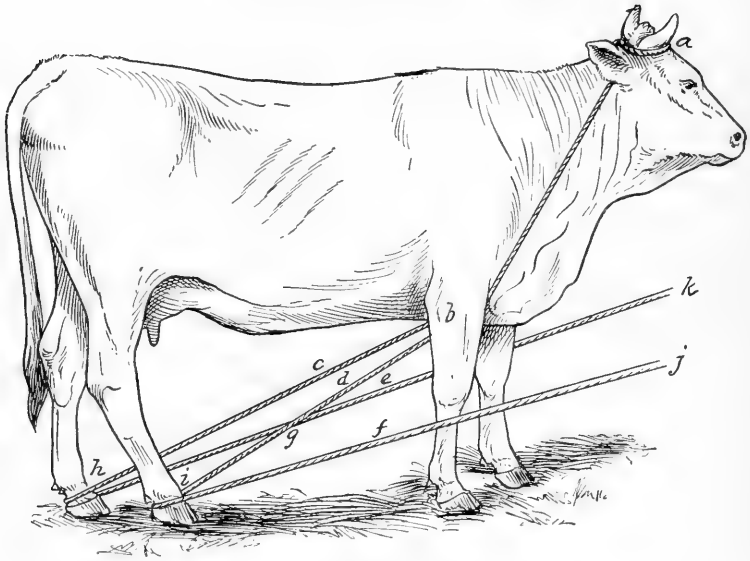

Fig. 273. Casting Rope Fixed to Horns.

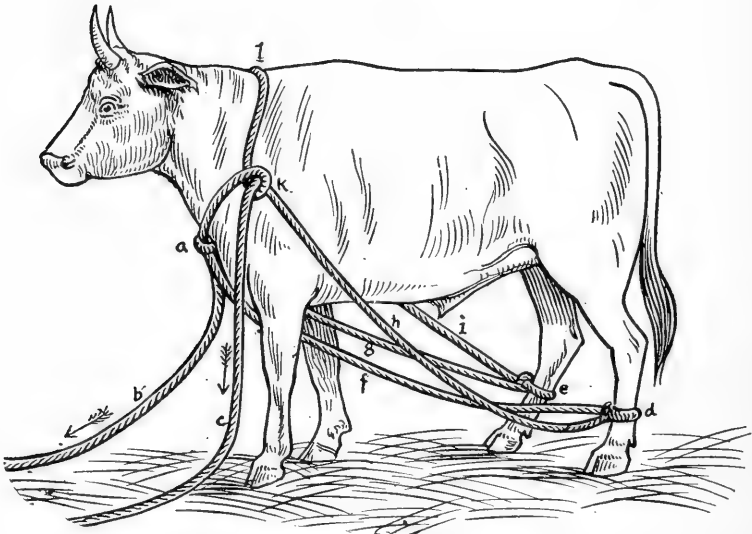

Fig. 274. Casting by Double Side Line.

*Casting by Double Side Line.*

Figure 274 represents the ox being cast by means of the double side line. The rope used should be  $\frac{3}{4}$ -inch in diameter and fifty feet long. A loop is made in middle of main rope sufficiently large to fit around base of neck (a), side loops (k) are made in this collar loop for passage of free ends of main rope. From the breast each main rope is passed between the fore legs and backward (f) (g) to and around each hind leg above ankles (d) (e); thence forward (h) (i) to and through side loops (k) in collar. The animal is cast by traction on free ends (b) (c) of the two main ropes.

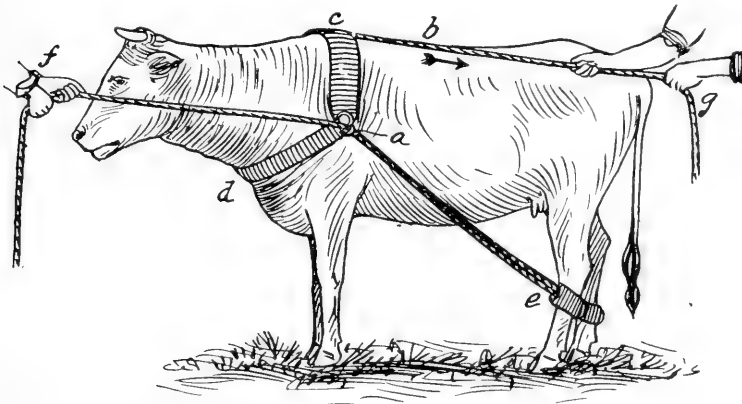

Fig. 275. Knowles' Web Casting Harness Applied.

*Knowles' Web Casting Harness.*

The web casting harness of Knowles, Figure 275, is an excellent appliance for casting the ox. This harness has already been fully described in Part II, hence it is unnecessary to re-describe it here. It will be observed that the webbing hobbles are applied above ankles in casting the ox, otherwise the harness is applied and used as in casting and securing the horse.

Figure 276 represents an ox cast and secured with the Knowles web casting harness.

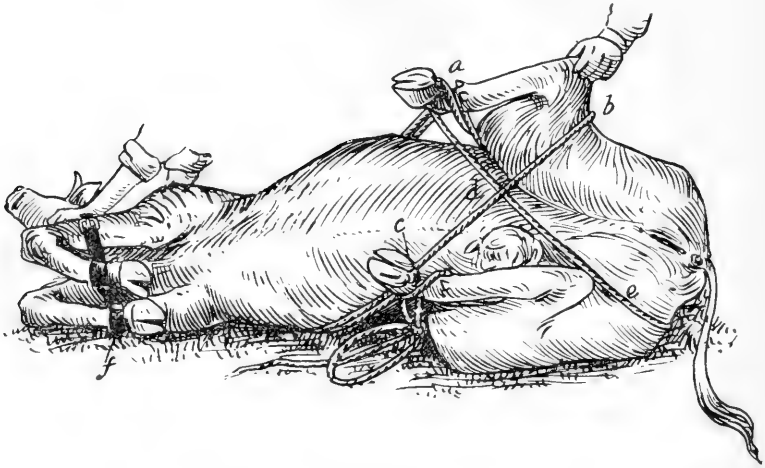

Fig. 276. Animal Cast and Secured with Knowles' Web Casting Harness.

*Fixing the Legs to Pole After Casting.*

Figure 277 will afford the reader a comprehensive idea of one method of fixing the legs to a pole after casting. With the animal thus secured, it can be placed in the dorsal position with little difficulty.

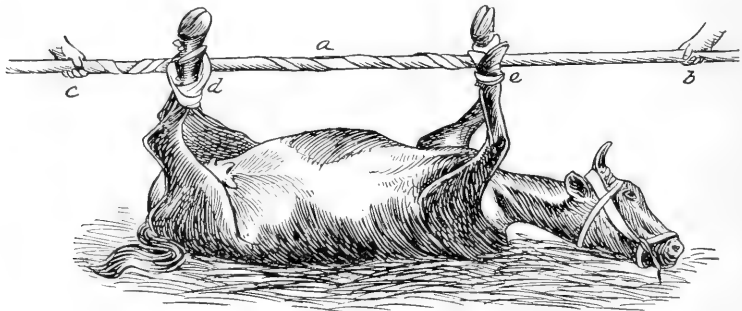

Fig. 277. Fixing the Legs to Pole After Casting.



---

---

PART IV.

---

Restraint of the Dog.

---

---

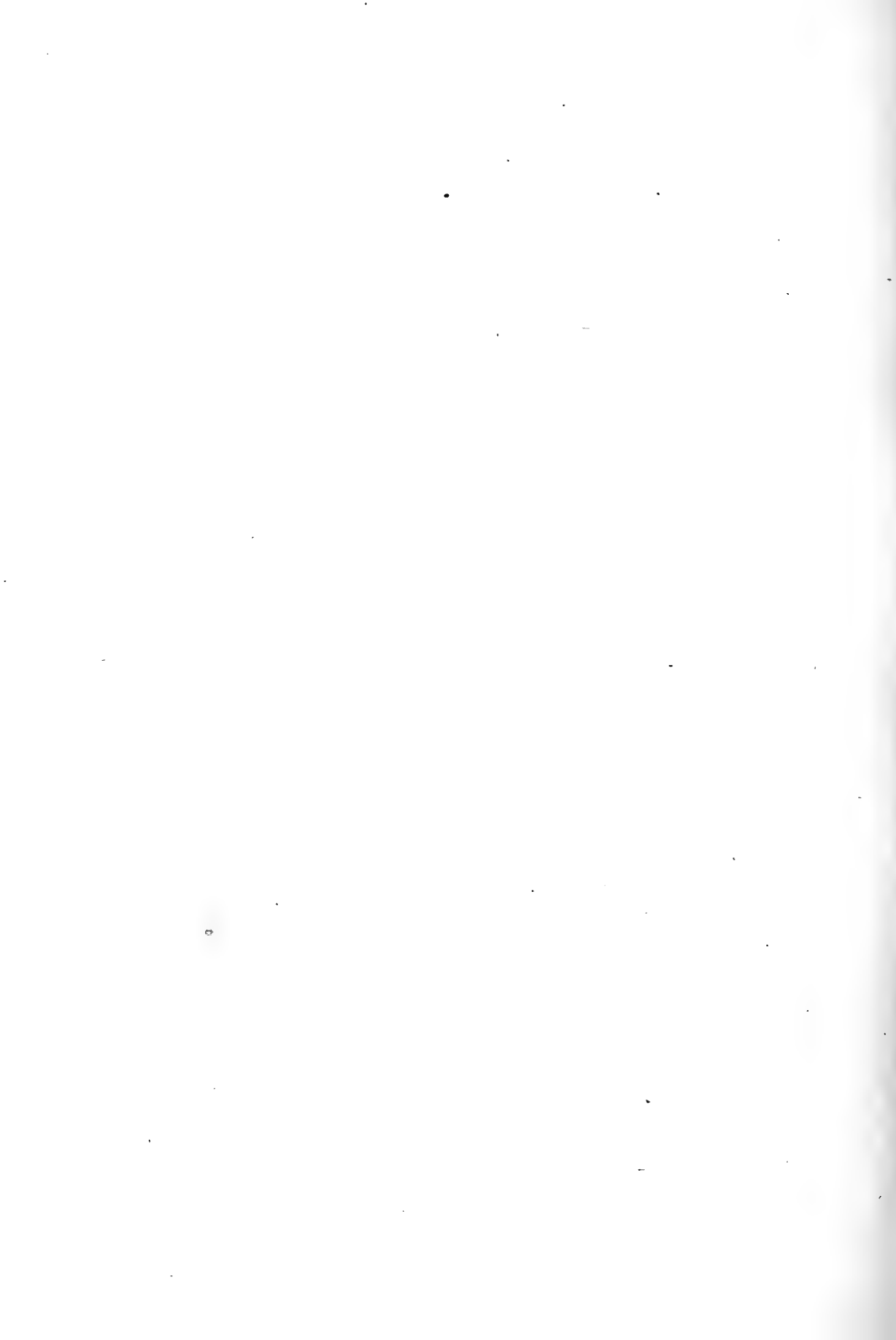

## PART IV.

### RESTRAINT OF THE DOG.

In restraining the dog for either examination or operation, care must be exercised to avoid injury. By rough handling, the animal is liable to receive both external and internal injuries; by improper or imperfect restraint the operator is liable to receive personal injuries as a result of bites from the animal.

Some animals are very active in their efforts at resistance, while others are docile and easy to manage. It is always advisable to apply some form of muzzle before proceeding far with any examination or operation. It only requires a few moments' time to apply a muzzle, and it will oftentimes relieve the surgeon of the embarrassment of caring for and treating severe punctured and lacerated wounds, or in many instances resorting to Pasteur treatment. Especial care must be exercised in handling nervous, fat and aged animals, also those of the smaller breeds, on account of their susceptibility to injury.

The quickest, as well as the safest, method of handling a dog is to promptly and firmly grasp the skin of the nape of the neck. But in very large, savage and dangerous dogs the risk of personal injury to the operator can be greatly minimized by seizing them with a long pair of collar nippers or tongs. In the absence of nippers or tongs an improvised "catcher" may be quickly made by procuring a stick four or five feet in length, through the end of which two holes are bored. Through these holes a piece of wire or cord is carried, forming a running noose at the end of the stick. Standing at a distance from the animal this noose is placed over the head and the wire or cord tightened. An appliance of this kind holds the dog at a safe distance until more secure restraint can be applied.

## CHAPTER I.

### OPERATING TABLES.

In order to intelligently and humanely manipulate the operative technique of canine surgery, the surgeon's operating room must of necessity be equipped with some form of operating table. This particular form of operating room equipment does not present itself as a question of choice, but confronts us as one of absolute necessity. To make most tables complete, there are two important adjuncts with which they must be equipped, viz., hobbles and operating trough. There are many different designs of hobbles; however, the Dawson-French hobbles and those of Hobday have proven themselves in actual practice to be far superior to all others.

#### *Dawson-French Hobbles.*

These hobbles, Figure 278, were designed and perfected by Doctors Charles F. Dawson and Cecil French. The Dawson-French hobbles are admirably adapted to canine use. The main feature of the hobbles is their self-locking action. A swinging ratchet arrangement is suspended in a frame through which the control rope passes. The frame is supplied with a screw clamp by means of which it is attachable to and removable from any operating table at will. One set of

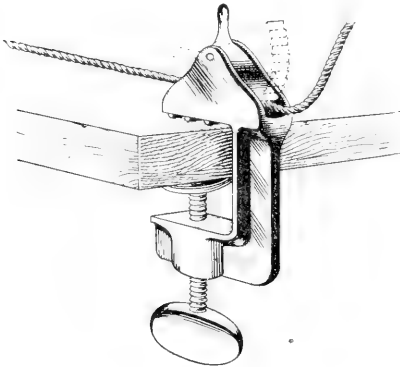

Fig. 278. Dawson-French Portable Hobble.

four large and one set of four small running-noose leg bands are provided. These will fit any sized animal, and are connected to the control ropes by steel snaps. Should the operator

wish to tighten the control rope he does so by merely pulling on it, and the moment he lets go it is firmly clinched by the ratchet. The animal can be quickly released from the control position at any moment by simply holding back the handle bars by which the ratchet is prevented from clinching, this allows free passage for the rope.

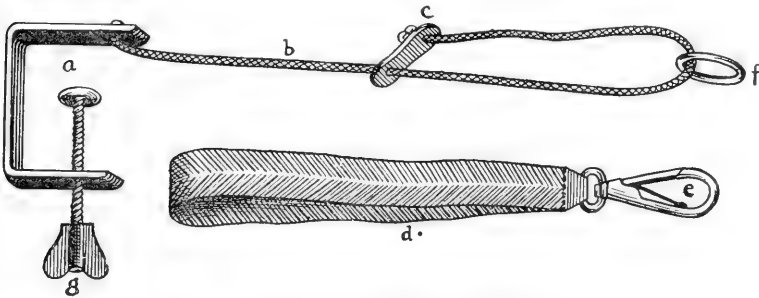

Fig. 279. Hobday's Hobbles.

*Hobday's Hobbles.*

The hobbles of Hobday, Figure 279, consist of a clamp (a) carrying a set screw (g) by which it is securely fixed to the corners of any operating table. The top of this metal clamp carries a small rope or cord (b), upon the free end of which is a specially-constructed, self-locking loop (e), carrying a metal ring (f) to which the webbing hobble strap (d) is attached by means of a snap (e). These hobbles are portable, and can be quickly and easily applied to and removed from any operating table. They are applied by looping the webbing hobble (d)

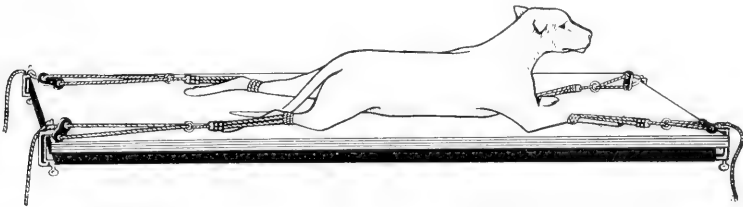

Fig. 280. Ordinary Table Equipped with Hobday's Hobbles—Dog Secured.

above the elbows and hocks of the patient. The slack is taken up by the sliding self-locking device (c).

Figure 280 represents an ordinary flat-top table equipped with Hobday's hobbles. The patient is secured in the extended abdominal position. Observe the position of the clamps at

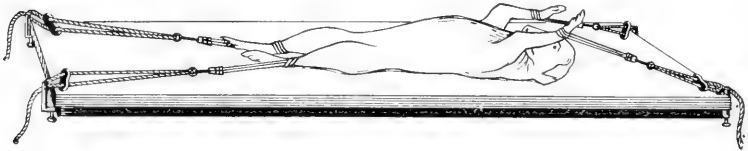

Fig. 281. Ordinary Table Equipped with Hobday's Hobbles—  
Dog Secured.

corners of table, the hobble straps applied and the self-locking device on each hobble rope. Figure 281 represents the same patient placed in the extended dorsal position. (The author much prefers to place the hobble loops on the fore legs above the elbows and hocks.)

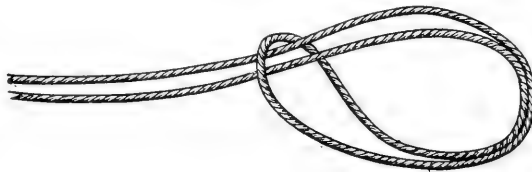

Fig. 282. Improvised Cord Hobble Loop.

*Improvised Cord Hobble Loop.*

The improvised hobble loop, Figure 282, is made by doubling a piece of cord, tape or webbing so as to make a slip noose or loop in the center. The hobble ropes may be fixed at each corner to the legs of any ordinary table.

*Key Hobbler.*

Figure 283 represents the key hobbler. The keys for this hobbler are made of brass or other metal having a shoulder or rim just underneath the head (B) of the keys to prevent them from pressing too far into the wooden top of the table. The hobbler consists of a piece of tape, leather or webbing passed through the ring (B) on the key, the two ends being stitched together. In order to use this key hobbler it becomes necessary to have key holes cut into

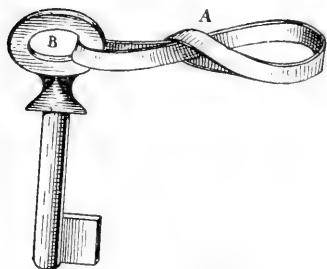
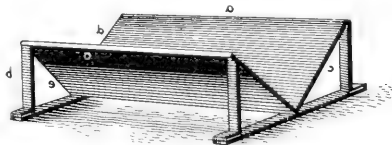

**Fig. 283. Key Hobbler Looped Ready for Application.**

the table top at intervals of about three inches. (See Hobday's table, Figure 289.)

*Young's Operating Trough.*

The operating trough of Young, Figure 284, is a valuable adjunct to most operating tables. It is useful in draining off the fluids as well as holding the patient in a stationary position. This trough sets flat on the table and is made of enamelled iron. It can be readily rendered sterile by boiling or by cleansing with any of the ordinary disinfectants.



**Fig. 284. Young's Operating Trough.**

Figure 285 represents the extension grate which is used for the same purpose as the operating trough. This appliance is depressed in its center and provided with a slat floor (a). It readily fits the top of any operating table.

*Bernard's Operating Table.*

The table of Bernard, Figure 286, is an ordinary flat-top table (a) provided with an operating trough (b) and a head-

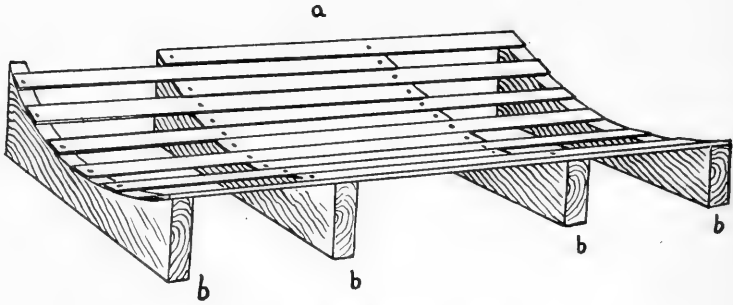

Fig. 285. Extension Grate.

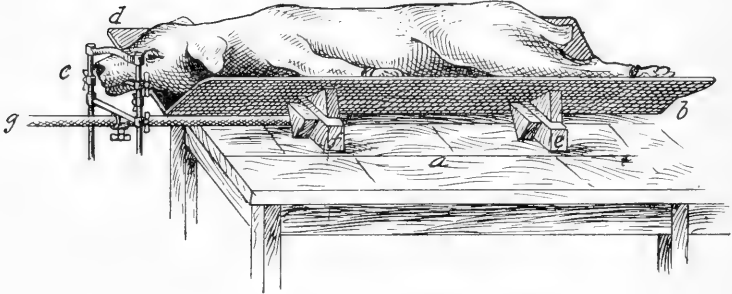

Fig. 286. Bernard's Operating Table.

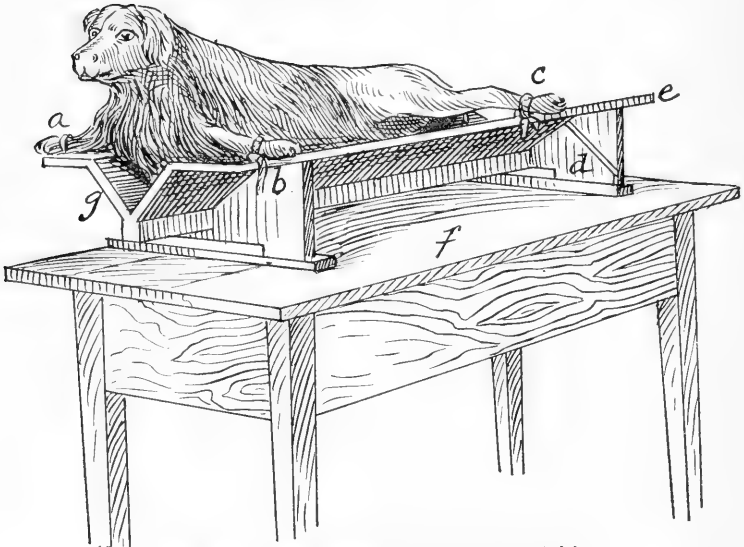

Fig. 287. MacQueen's Operating Table.



holding device (c) (g). Bernard's table is used very extensively in France and Germany, and is quite satisfactory.

*MacQueen's Operating Table.*

The table of MacQueen, Figure 287, is similar in many respects to that of Bernard, Figure 286. In fact, this is a modification of the Bernard apparatus. It is made of wood, consisting of four parallel leaves connected by hinges. The two outer leaves may be inclined at any angle toward one another, forming a trough to receive the animal's body. When folded it is readily portable.

*Ordinary Metal Flat-Top Table.*

The table, Figure 288, is an ordinary metal table of the flat-top stationary variety. This table is finished in enamel,

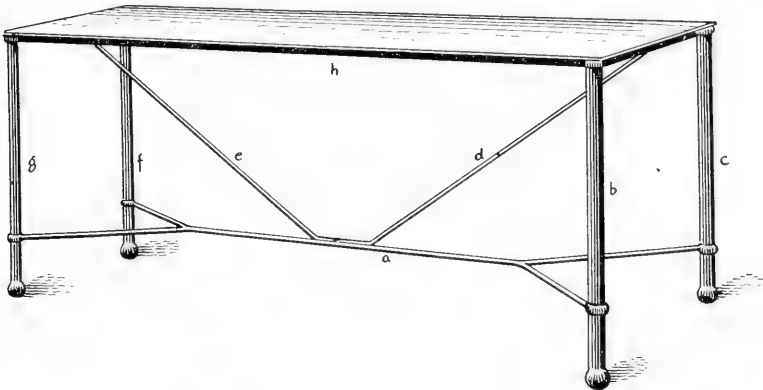

Fig. 288. Metal Table with Enamel Finish.

which makes it extremely easy to cleanse and render sterile. When equipped with hobbles it makes a very desirable table for ordinary purposes.

*Hobday's Operating Table.*

The table of Hobday, Figure 289, is made of wood. It is provided with a strong wooden base (i) of the cross-leg variety.

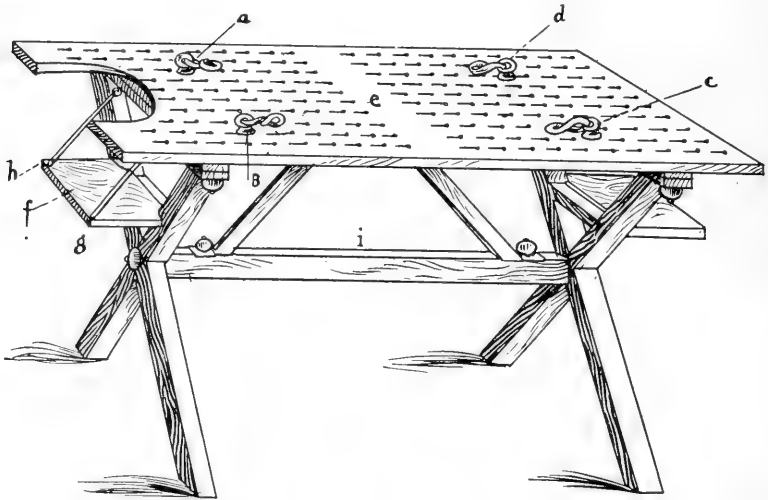

Fig. 289. Hobday's Operating Table.

At each end is a receptacle (f) (g) (h) for instruments and solutions. The top (e) is perforated with key holes and is supplied with key hobbles (a) (B) (c) (d), which are adjustable to any-sized animal.

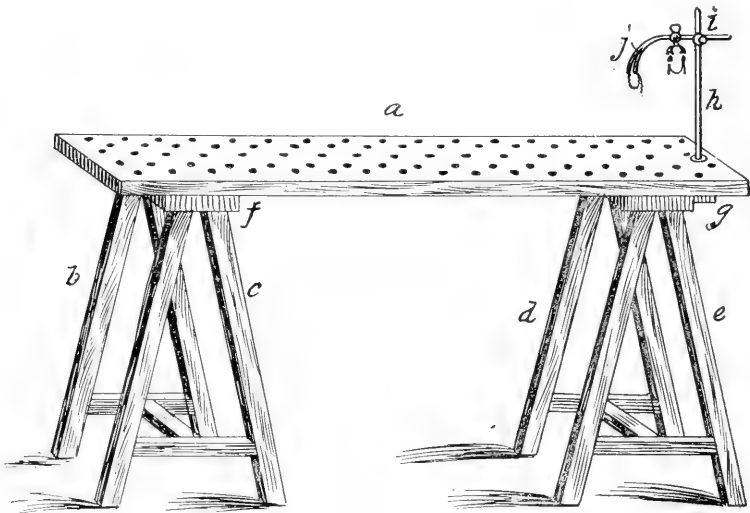

Fig. 290. Livon's Operating Table.

*Livon's Operating Table.*

The table of Livon, Figure 290, is made of wood, and is of the stationary flat-top variety. The top (a) is perforated to allow escape of fluids, and is attached to a substantial base consisting of eight legs (b) (c) (d) (e) placed cross-wise under the table.

*C. A. White's Operating Table.*

The table designed and used by C. A. White, Figure 291, is made entirely of metal, with white enamel finish. The top

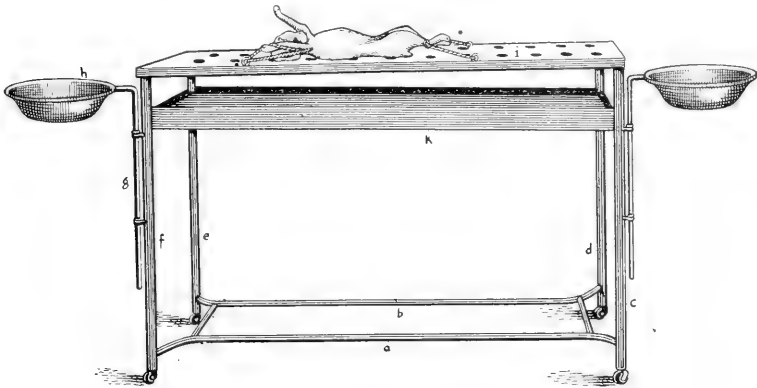

Fig. 291. C. A. White's Operating Table.

(i) and drain shelf (k) are made of sheet steel. The legs (c) (d) (e) (f) are of tubular iron. The basin holders (g) are of round steel rods and may be attached to either corner of the table. This table is mounted on heavy castors, and is five feet long, two feet wide, and three and one-half feet high.

*German Operating Table.*

The German operating table, Figure 292, is made with a wrought-iron frame and heavy plate glass top (a). The frame is white enamel finished, which makes the table as aseptic as it

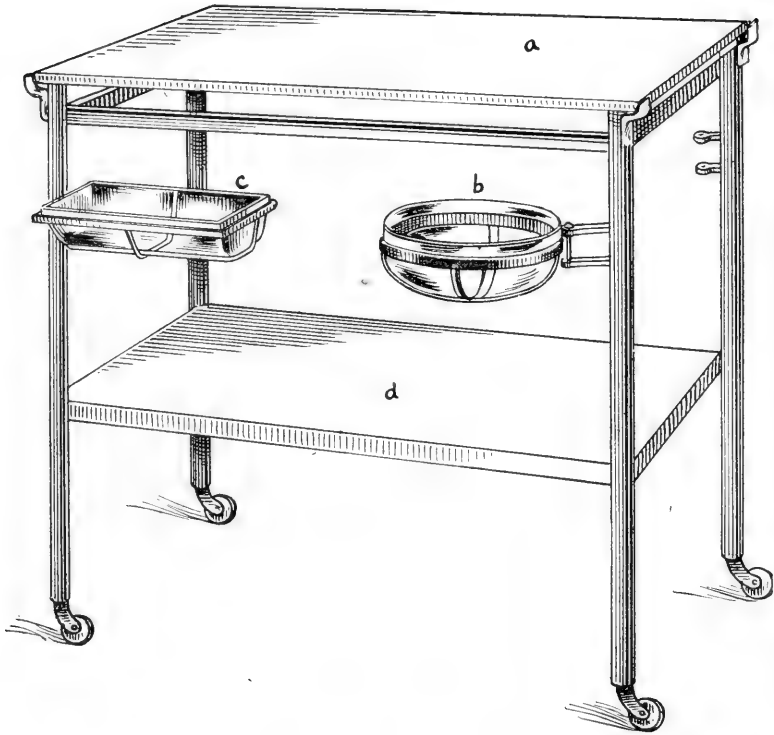

Fig. 292. German Operating Table.

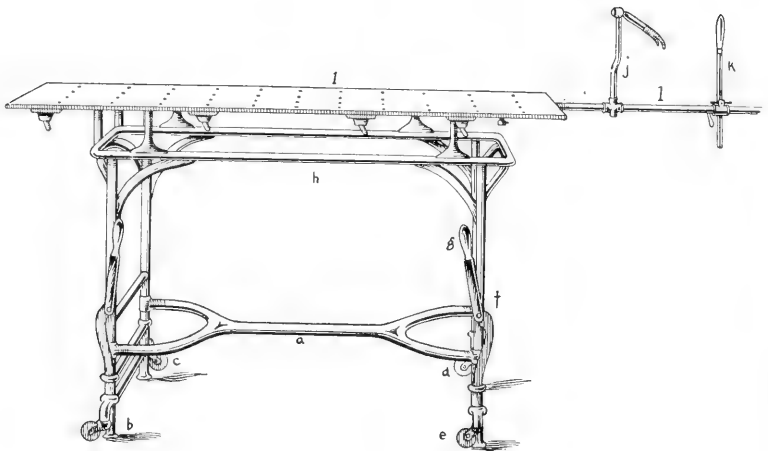

Fig. 293. Italian Operating Table.

is possible for it to be. The table is supplied with an instrument basin (c) and a solution basin (b), and is mounted on castors.

*Italian Operating Table.*

The Italian operating table, Figure 293, is made entirely of metal, the frame being tubular and the top of sheet steel. This table is equipped with castors (b) (c) (d) (e). When in the desired position the lever (g) is thrown, which displaces the castors and allows the table legs to come in direct contact with the floor this renders the table more solid and stationary.

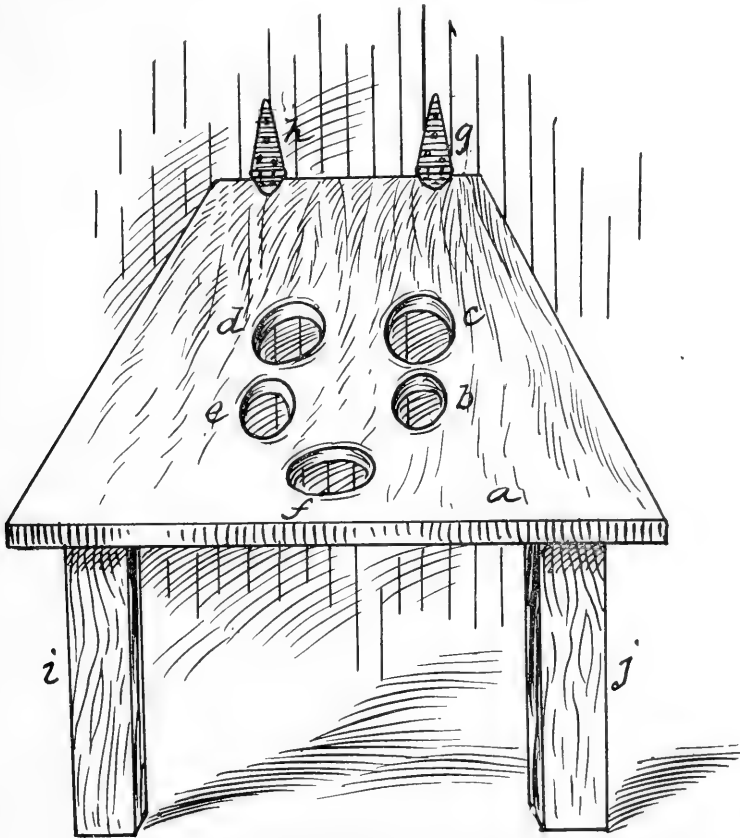

Fig. 294. Delahanty's Folding Table—Horizontal Position.

*Delahanty's Folding Operating Table.*

The folding table of Delahanty, Figure 294, is very convenient where the operating room space is limited. This table consists of a single wide board top (a) attached at one end by two hinges (g) (h) to the wall (g) (h). The other end is supplied at each corner with two hinged legs (i) (j). Five oblong openings are made through the top (b) (c) (d) (e) (f). These are to receive the four legs and nose of the dog. This table is especially convenient for "ear trimming," as it holds the dog perfectly motionless. The legs are thrust through the holes (b) (c) (d) (e) and tied together underneath the table. The

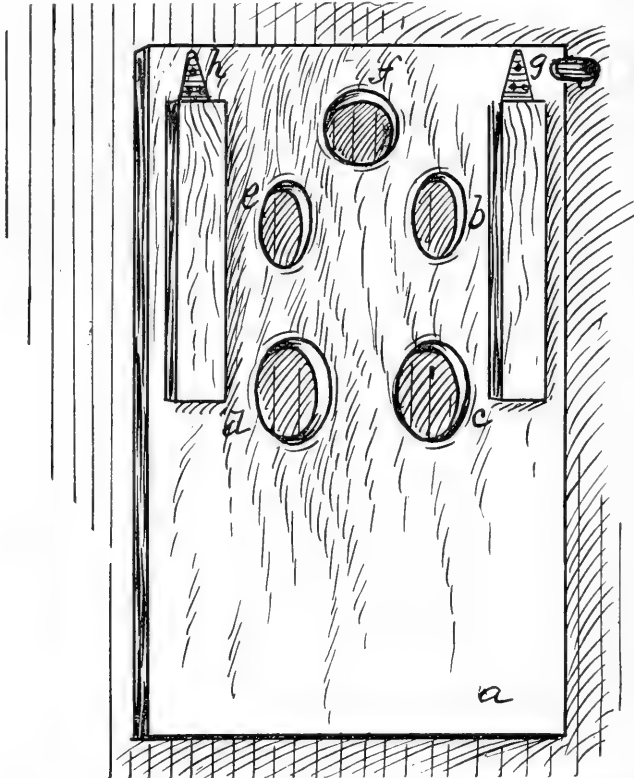

Fig. 295. Delahanty's Folding Table Secured Against the Wall.

nose is thrust through the front hole (f) and secured underneath the table with the muzzle tape.

Figure 295 shows the table from the underside and represents it folded back and fastened against the wall. Observe the hinged legs folded down against the table top and the button fastening (g) on wall, which holds the table up. When thus folded, the table is entirely out of the way.

*German All-Metal Revolving Table.*

The German table, Figure 296, is made entirely of metal, and is adjustable in most all particulars. The frame consists of four legs (b) (c) (d) (l), braced at the bottom (a). These braces merge together at the top against the center post (h). This post



Fig. 296. German All-Metal Revolving Table.

carries the mechanical parts of the table. These parts consist of a cog (s) and lever (f) device by which the table is lowered or raised to any desired height, a ball and socket device (f) which allows the table to revolve or be turned in any direction or elevated to any angle. The top consists of three short metal leaves (m) (n) (o). These are perforated with numerous holes to allow fluids to escape. The ones on either side are hinged to that of the middle, and are easily raised, lowered, and locked at any angle by the self-locking ratchets on each end of the table. They can even be dropped down to the sides and animal placed on the table in the astride position.

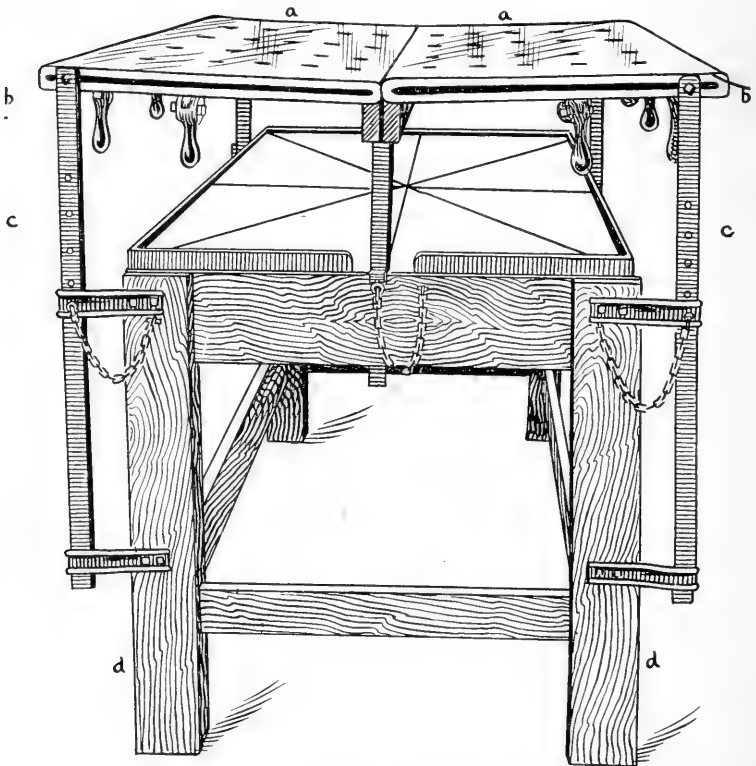

Fig. 297. Stuttgart Operating Table.



*Stuttgart Operating Table.*

The Stuttgart table, Figure 297, consists of an ordinary wooden table with metal top to which is attached by suitable fastenings the four metal legs of the Stuttgart apparatus. These legs support the two leaves (a) (a) of the hollow metal top. By a special arrangement the top can be lowered either at sides or in the center, which makes it in many particulars an adjustable table.

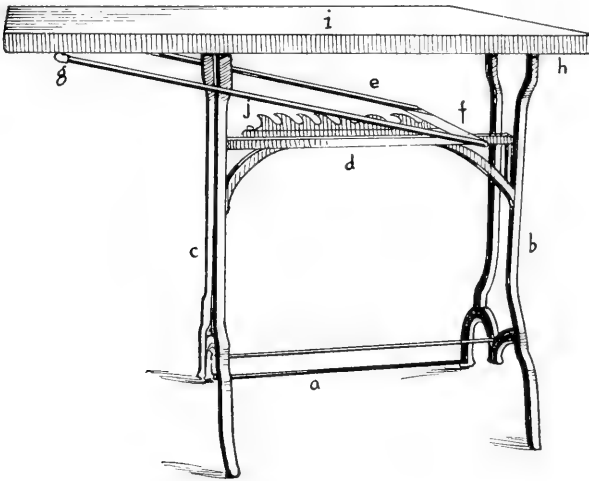

Fig. 298. Improvised Operating Table—Horizontal Position.

*Improvised Operating Table.*

The improvised operating table, Figure 298, is made from an ordinary sewing machine stand. The metal parts are painted with aluminum paint. The top (i) is of solid wood painted with white enamel paint. The top is hinged at one end (h) and the other end is supplied with hinged brace rods (g) which fit into ratchet notches (j) on the metal frame (d). By means of this arrangement the top can be elevated, Figure 299, to any desired angle. This table is cheap, neat, clean and efficient.

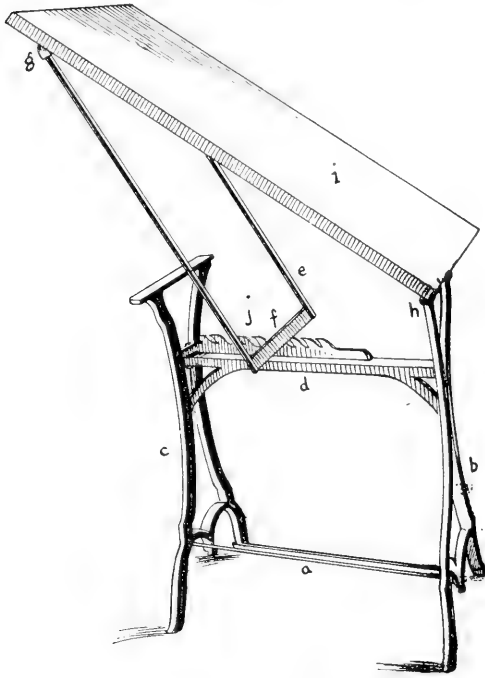

Fig. 299. Improved Operating Table—Upright Position.

## CHAPTER II.

### MUZZLES, TAPE AND OTHER METHODS.

#### MUZZLES.

To avoid being bitten the surgeon should take the wise precaution of applying some means of restraint to the mouth before



Fig. 300. Clove Hitch Muzzle.

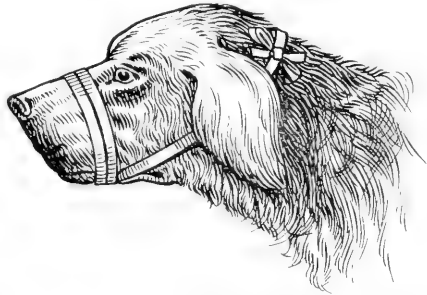

Fig. 301. Tape Muzzle Properly Applied.

an examination is made or an operation performed. The best and safest mouth restraint is some form of muzzle. The ordinary clove hitch, Figure 300, made of either cord, tape or



Fig. 302. Tape Muzzle Held by an Assistant.



Fig. 303. Leather Strap Muzzle Held by an Assistant.

leather, and applied around the jaws in such manner as to close the mouth and keep it closed with bow tie back of the poll, makes an excellent muzzling device. Figure 301 represents the tape muzzle properly applied.

As a simple, temporary precaution in making a hurried examination the muzzle may be applied and the ends of the tape held by an assistant as shown in Figures 302 and 303. All short-nosed animals, in which the capacity of the nasal passages is limited, must be secured by this method with extreme caution to avoid suffocation. To remove the muzzle and release the jaws, simply untie the knot by grasping end of tape. There are several desirable muzzles manufactured and sold, some of them better than others. A comprehensive idea of them may be obtained by referring to the following illustrations:

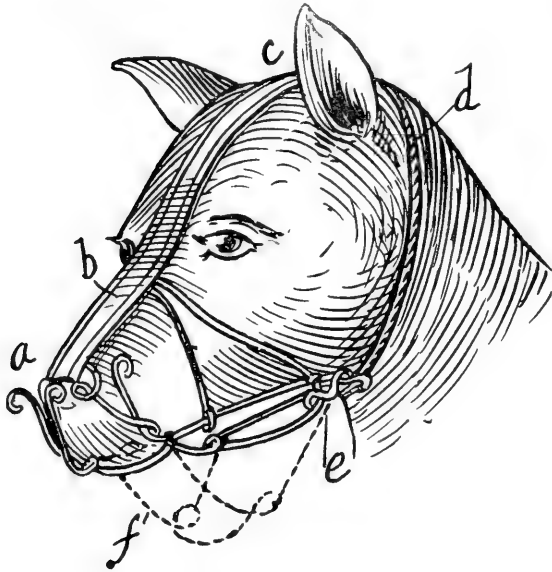

Fig. 304. Automatic Muzzle Applied.

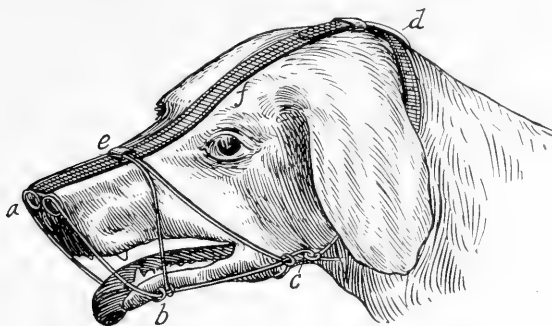

Fig. 305. Safety Muzzle Applied.

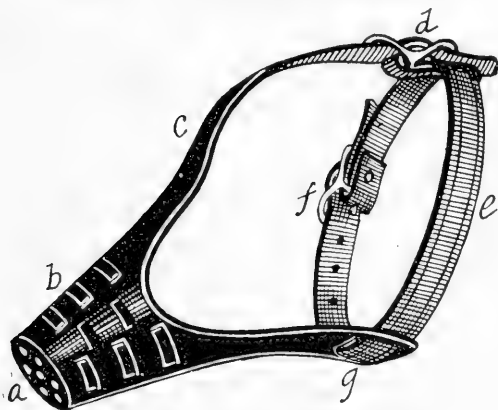

Fig. 306. Leather Box Muzzle.

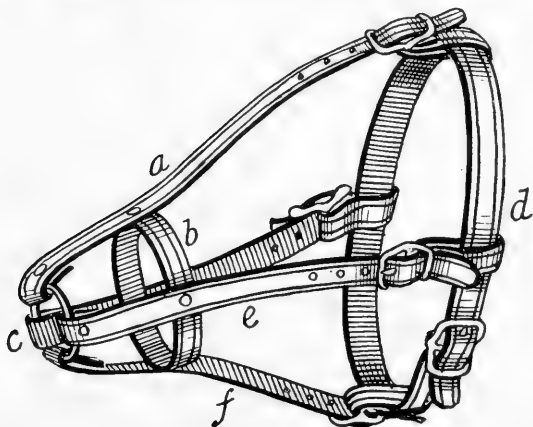

Fig. 307. Protection Muzzle.

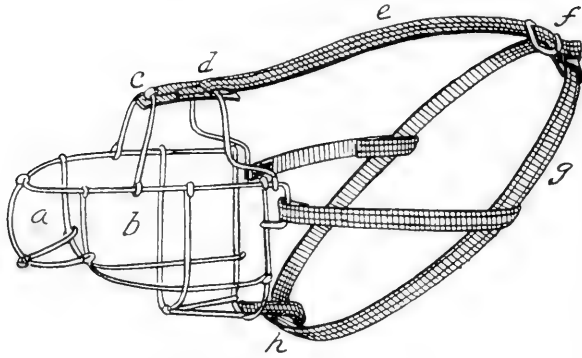

Fig. 308. Hungarian Muzzle.

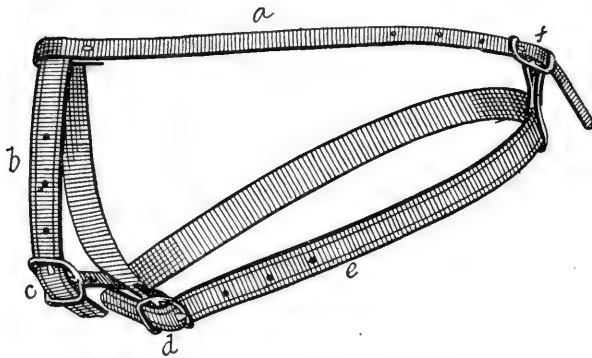

Fig. 309. Adjustable Leather Muzzle.



Fig. 310. Collar Nippers.

The collar nippers, Figure 310, are useful for grasping wild and vicious dogs by the neck preparatory to restraining them.

Figure 311 represents a dog held safe for examination by a firm grasp with one hand by the nape of the neck and the



Fig. 311. Hobday's Method of Holding a Dog Safe for Examination.



Fig. 312. Safe Method of Holding a Dog for Examination or Operation.

other hand held firmly against the lower jaw. A hold of this kind prevents opening of the jaws.

Another safe method of holding a dog, Figure 312, is by grasping the fore and hind legs and bringing them up to the side of the jaws, in which position they are held by tight grasping and firm pressure on each side of the face. In this position the dog is absolutely helpless.



Fig. 313. Holding Jaws Apart with Tapes.

Figure 313 represents the jaws being held apart with a tape or cord looped around both the lower and upper jaw.

*Miles' Method of Restraining the Bitch.*

The method of Miles, Figure 314, of restraining the bitch for "spaying" operation consists of first applying a tape muzzle



(i). A piece of small rope or cord (c) (b) is then tied by a running noose knot above each hock (e) (d). The bitch is then hung up to nail or hook (a). Another similar rope is fixed



Fig. 314. Miles' Method of Restraining the Bitch.

around both fore legs, above the elbows (f) (h). The operator now places his foot through loop (g) on fore legs, which allows him to make sufficient traction to hold the animal in an extended position without the aid of an assistant.



---

---

PART V.

---

Restraint of the Hog.

---

---



## PART V.

### RESTRAINT OF THE HOG.

Little or no difficulty is experienced in casting and securing young pigs or small hogs, either in the standing or recumbent positions; but aged and large animals are more difficult and dangerous to control, and by their tusks sometimes inflict severe lacerated wounds.

Some large hogs are tedious and difficult to catch, and when caught most of them are extremely difficult and unhandy to hold. This is largely due to the few and inaccessibility of projecting parts by which a firm hand hold may be taken. In restraining or securing the hog we have only two objects in view, viz., protecting the operator and assistants from bites and wounds from the tusks, and sufficient immobilization of the animal for examination and operation.

### CATCHING THE HOG.

Many methods have been suggested whereby the hog may be conveniently caught preparatory to securing for operation. The animal may be seized above the ankle of one or both hind legs, or by the ears, or both, and thrown on its side. Food may be placed in a deep vessel and while engaged in eating, it may be captured. Or a stiff piece of cord with a loop or running noose upon one end of it may be tied to end of a stick and a piece of bread or other solid food placed in the loop; when the hog opens its mouth to take the food the loop is passed over its snout and tightened. Or a loop may be placed on the ground and tightened as soon as the animal has placed one of its feet into it.

The mechanical hog catcher, Figure 315, is an excellent device for catching hogs. It consists of a pair of metal jaws (c) (d) fastened to the end of a long pole (h). These jaws are hinged (j) and are closed (a) (b) around the leg of the

animal by making firm and continued traction on the rope (e) (g). The hog can now be approached and further restraint applied.

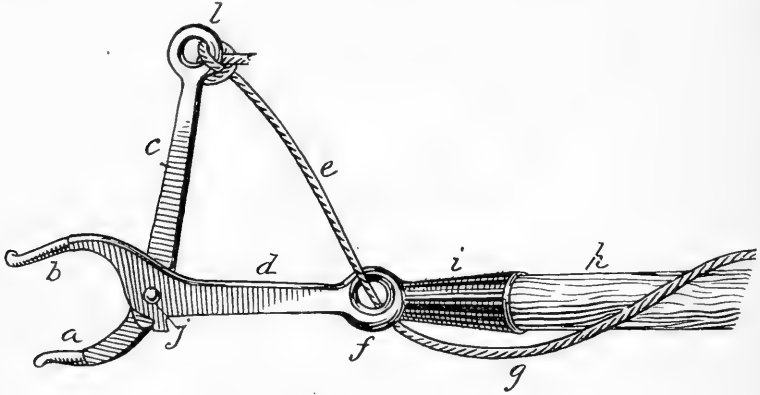

Fig. 315. Mechanical Hog Catcher.

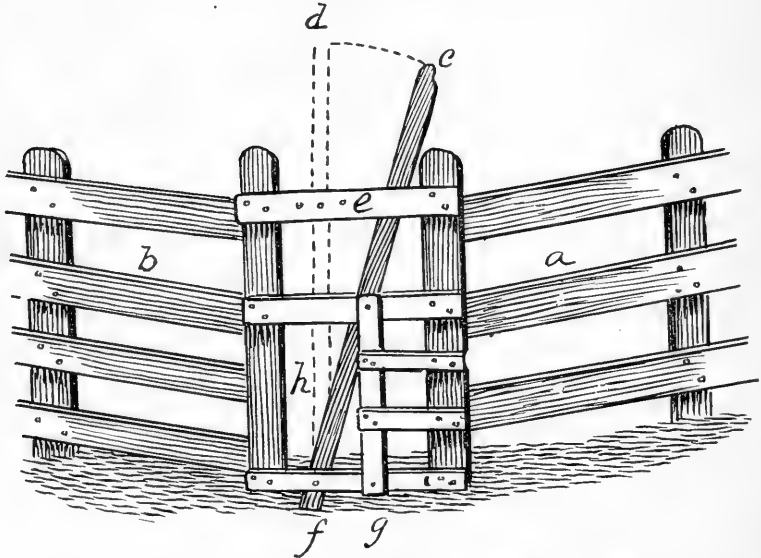

Fig. 316. Hog Catcher Open Ready for Reception of Animal.

Figure 316 represents a hog catcher placed in the gateway of a fence (a) (b). The lever (e) is attached in pivot fashion

at bottom by a strong nail or iron pin. The hog thrusts its head through opening (h) at which time the lever is forced over (d) against side of animal's neck and locked by pins through holes (e) in top support.

Figure 317 represents hog trap made in box or crate fashion. The frame is made of 2x4 inch lumber strongly bolted at corners. The front end has a door (A) made of two strong thick oak boards with cross cleats on the inside at top and bot-

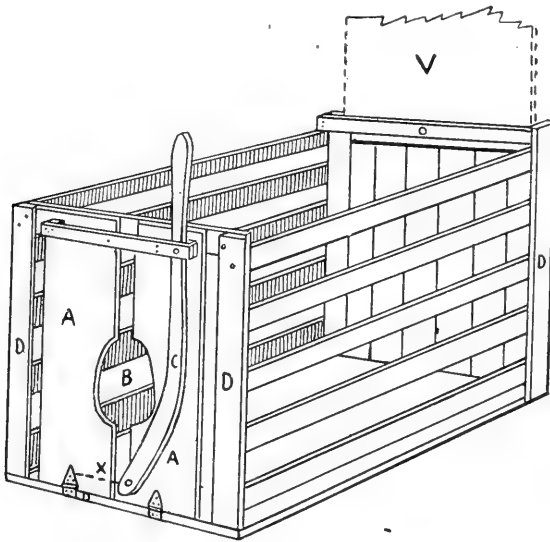

Fig. 317. Hog Trap.

tom. This is held to the frame by two strong hinges, and when in use is held up by the strong iron clamp (F). The lever is so arranged that the trap can be set for small or large hogs. The crate is four feet two inches long, two feet four inches high, and one foot six inches wide, inside measure. Place the trap with rear end close to the hog pen with the lever thrown back. When the hog enters he will thrust his head through the hole and you can then pull the lever and hold him. With two strong handles attached to the sides of the crate it makes an excellent loading device.

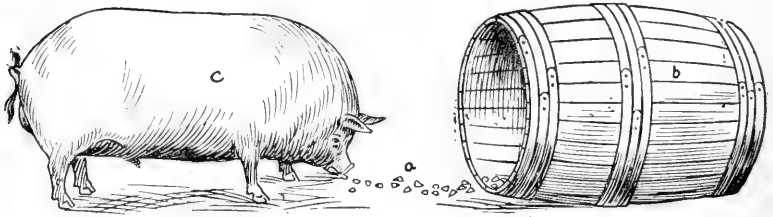

Fig. 318. Catching Hog by Corn and Barrel Method—First Position.

Figure 318 represents first position of catching a hog by the corn and barrel method. An ordinary barrel (b) is placed on the ground in the horizontal position, with open end facing the hog. Corn or other food (a) is scattered on the ground, and some of it thrown into the barrel. The hog (c) will eat up to

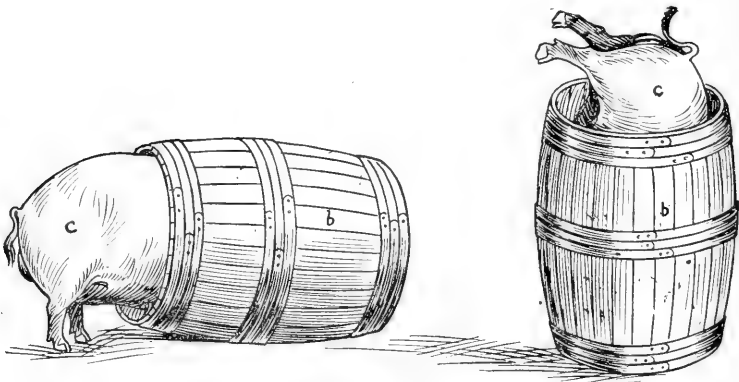

Fig. 319. Catching Hog by Corn and Barrel Method, Second Position.

Fig. 320. Catching Hog by Corn and Barrel Method, Third Position.

and into the barrel, Figure 319, at which time the barrel is quickly raised to upright position, Figure 320, and the animal is caught and in a way secured with head down and hind feet up. It is impossible for it to emerge from the barrel by its own efforts alone.



One of the first things to be done after catching a hog is to apply the twitch, Figure 321. This twitch consists of a piece of wood 18 inches in length, flattened at one end. The flattened

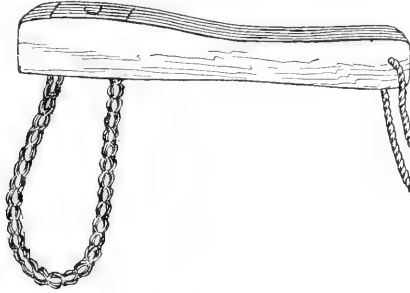

Fig. 321. Hog Twitch.

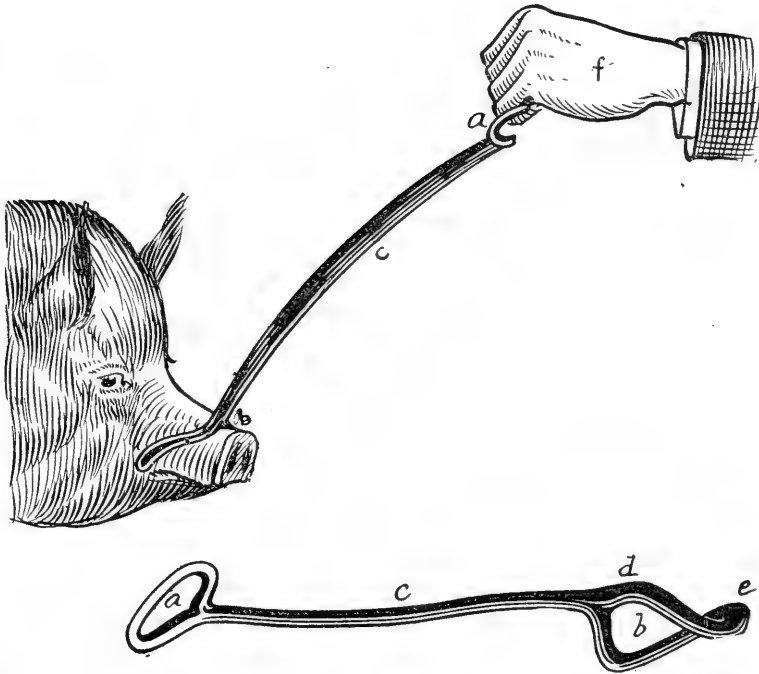

Fig. 322. Champion Hog Holder Applied.

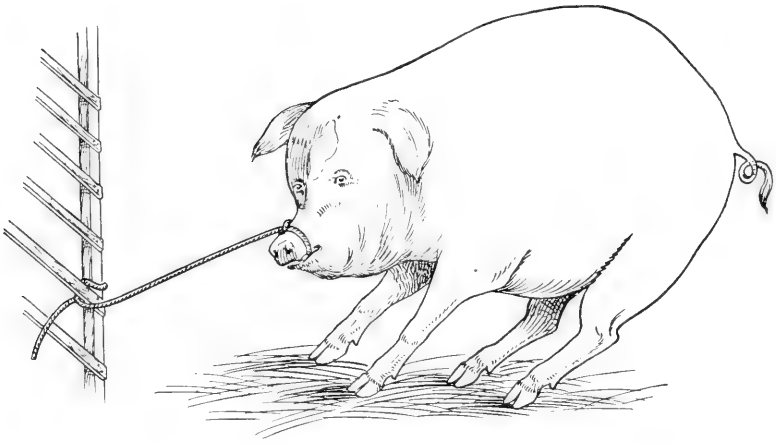

Fig. 323. Practical Method of Securing a Hog.

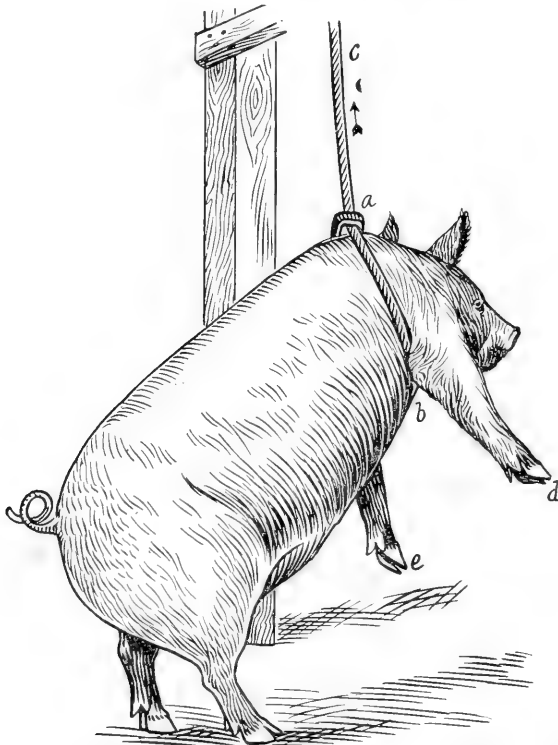

Fig. 324. Practical Method of Securing a Large Hog with only One Assistant.

end carries two holes for passage of the cord or chain for the loop. This loop is passed around either the upper or lower jaw, or around both jaws. Instead of the twitch, the Champion Hog Holder, Figure 322, may be applied to the upper jaw (b). This holder is made entirely of metal and by slight traction by one man, with one hand (f) the largest hog can be held perfectly secure without assistance.



Fig. 325. Pig Held Between the Knees.

Figure 323 represents a practical method of securing a hog by placing a loop around the upper jaw back of the canine teeth, and fixing the free end of rope or cord around a post or tree.

Figure 324 represents a practical method of securing a large hog when only one assistant is available. A heavy rope with a loop on one end is placed over the head, neck and one leg (a)

(b). The free end of the rope is thrown over a beam above the hog. Traction on this rope will raise fore feet of the hog off the ground and place it in a helpless position.



Fig. 326. Pig Held Between the Knees.



Fig. 327. Pig Held Between the Knees in Proper Position for Administration of Medicine.

Figures 325, 326, and 327 represent proper methods of holding a pig or light hog between the knees for either examination or operation.

To secure a large hog in the recumbent position an assistant grasps one of its hind legs. He rapidly slides his right knee toward the front of the left side of the chest, passes his left hand over the withers, and by the combined use of his knees and arms, throws the animal on its left side. The animal is then further secured by passing a cord, rope or strap in figure "8" fashion around the legs above the ankles, Figure 328. If necessary, all four legs may be secured, after which apply the twitch or Cham-

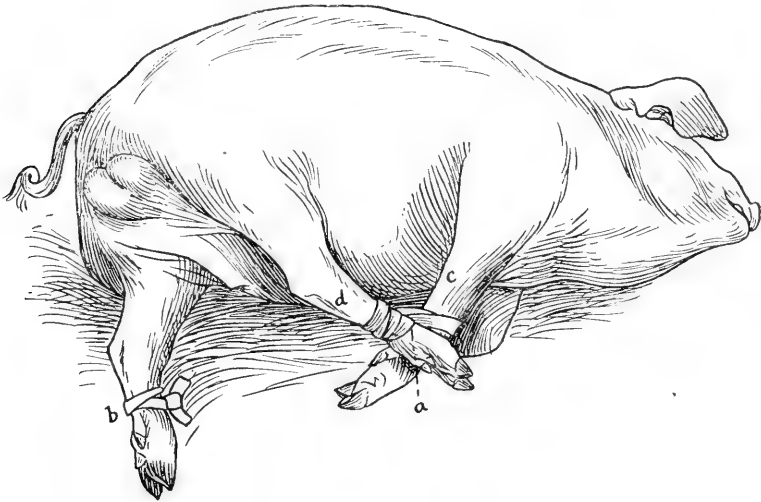

Fig. 328. Hog Secured Ready for Operation.

pion Hog Holder, and the restraint is complete. Or, instead of fixing the legs together, the animal may be secured as in Figure 329, with a pole or rail over the neck and shoulders. This pole (c) is simply thrust through an opening (b) between the rails of a fence, and is held down firmly against the hog by pressure downward (d) on its free end. If two assistants are available to seize, cast and secure a hog of ordinary size, it should be done as follows: One assistant seizes a hind leg above the hock, the other assistant seizes the two ears, then by their

combined efforts the animal is cast on its side and kept in that position by placing the knee on its neck.

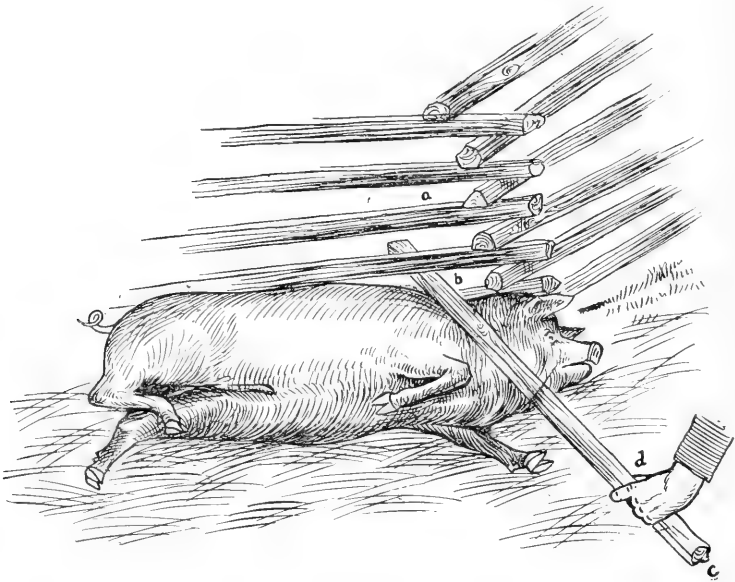

Fig. 329. Hog Secured by a Pole or Rail Over Neck and Shoulders.

*Conkey's Method of Restraining the Sow for "Spaying Operations."*

Procure a piece of 3-8 inch rope (soft) about six feet long, tie the free ends together forming a loop, as shown in Figure 330. Next you will procure a 2x14-inch plank about 12 feet long; place it on the floor or ground as the case may be, either spike the upper end fast or drive a stake in the ground below, or in some manner make the plank secure (D). Now make your rope fast to the upper end of the plank with a spike (B), or by boring a hole through the plank large enough to allow the rope to be drawn up through, when it will be secured by a large knot in its ends. This should be so arranged that when the hog is fastened to the plank she will be about waist high, as indicated in the following illustrations:

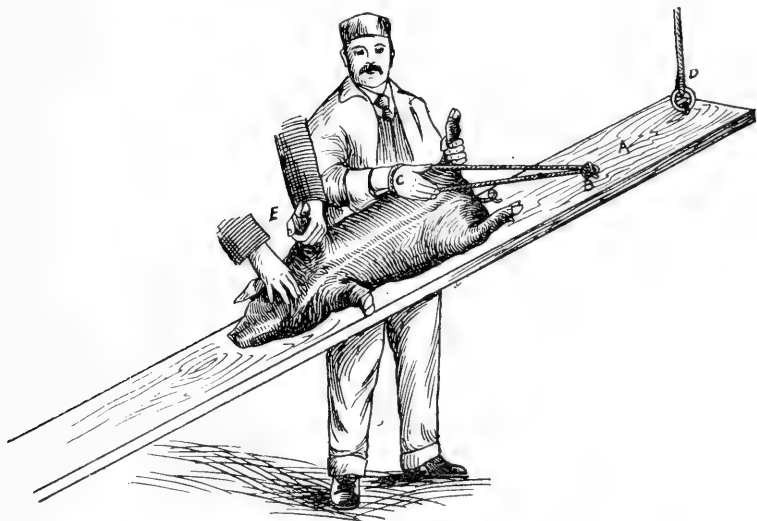

Fig. 330. Conkey's Method of Restraining the Sow for "Spaying Operation"—First Step.



Fig. 331. Conkey's Method of Restraining the Sow for "Spaying Operation"—Second Step.

The operator will stand facing the plank, with his right hand toward the low end of the plank; pass your *right* hand (a) through the looped rope, and instruct your assistant to grasp both *right* legs of the hog and bring it to you, placing it on the board. As he approaches pass your *left* hand under your *right* hand and the rope, grasping the *left* hind leg, while your *right* hand grasps the *right* hind leg; now guide the *left* leg to your



Fig. 332. Conkey's Method of Restraining a Sow for "Spaying Operation"—Animal Secured.

*right* hand, which grasps it. The right hand now retains both hind legs, Figure 331, while your left hand grasps the loop from over your wrist and carries it back, dropping it posterior to the hind feet. As you drop the rope back of the feet you are to say "pull"—meaning that your assistant is to pull the hog downward on the plank, making the rope taut, as is shown in Figure 332.

With a little practice a sow can be secured, by this method, in less than five seconds.



---

---

# INDEX

---

---



# INDEX

## A

	PAGE
Abilgaard's Modification of Danish Casting and Securing Harness .....	125, 126
Accidents to Horse in Use of Operating Table .....	161
Adjustable Dog Muzzle .....	268
American Nose Clamp .....	221
American Nose Clamp, with Rope .....	221
American Sling .....	66
Anti-Kicker—Smith's .....	230
Australian "Crush" .....	63, 64
Author's Knee-Strap .....	28, 112, 227
Automatic Dog Muzzle .....	266

## B

Barcus' Stocks .....	52, 55
Barnacles .....	19, 20
Metal .....	20
Wooden .....	19
Barnick's Loop Hobbles .....	84
Becker's Hobbles .....	81
Belmont Rider Hippo-Lasso .....	50
Berlin Hobbles .....	88, 89
Bernardot and Buttel Apparatus .....	75, 76, 95
Bernard's Operating Table .....	253
Blindfold .....	21
Bradwood Operating Table and Chair .....	198-215
Broken Back, Apparatus for Prevention of .....	75, 76, 95
"Broncho," Restraint of .....	153, 154

## C

Casting and Securing Harness and Ropes .....	109-256
Casting and Securing Harness, Conkey's .....	113-116
Cowie's .....	139, 140
Cowie's as modified by Lewis .....	140

	PAGE
Casting and Securing Harness—Continued.	
Danish .....	122-126
Dollar's Double Side .....	130, 131
Double Side Line .....	135, 136
Hayes' .....	129
Hulburt's .....	120, 121
Knowles' .....	117, 118, 119, 245, 246
Lernberg .....	131, 132
McDonald's .....	132, 133
Miles' (Ridgling) .....	137-139
Over's .....	133, 134
Rohard's .....	126-128
Russian .....	134, 135
Whitwell's .....	119, 120
Ziegler's .....	121, 122
Casting and Securing the Horse, One Man Method of.....	
Galvayne's .....	141-146
Gleason's .....	146-148
Magner's .....	148-151
Rarey's .....	152
Russian .....	141-143
Casting and Securing Horse with Hobbles, Directions for.....	
82	
Casting and Securing the Ox.....	
238-246	
With Conkey's Self-Locking Buckle Hobbles .....	241
With Double Side Line .....	245
With Knowles' Web Casting Harness .....	245, 246
With Rope Fixed to Horns .....	243
With Rope on Three Legs .....	243
Rueff's Method of .....	239
Soffner's Method .....	240
Calves, Casting and Securing for "Spaying" .....	
240	
Catching the Dog with Collar Nippers .....	
268	
Catching the Hog .....	
275-278	
With Corn and Barrel .....	278
With Mechanical Catcher .....	276
With Trap .....	277
Champion Hog Holder .....	
279	
Chicago Veterinary College Operating Table.....	
185-188	
"Chute" for Cattle .....	
237	
Clove Hitch—Dog Muzzle Made by.....	
265	
Collar Nippers .....	
268	
Conkey's Operating Table .....	
188, 189	
Conkey's Method of Securing the Sow .....	
285, 286	
Conkey's Self-Locking Buckle Hobbles .....	
86, 87, 241	

	PAGE
Controlling Apparatus for Ox, Vigan's .....	223
Cowie's Casting and Securing Harness .....	139, 140
Cozier's Operating Table .....	164-166
Cross Hobbles .....	77
Crush, The Australian .....	63, 64

**D**

Danish Casting and Securing Harness .....	122-126
Daviau's Operating Table .....	161
Improved .....	162, 163
Dawson-French Dog Hobbles .....	250
Delahanty's Operating Table .....	259, 260
Denenbourg's Improvised Rope Hobbles .....	78
Dental Halters .....	25-27
Ellis' .....	27
Fehr's .....	27
Lucas' .....	25
Directions for Casting and Securing Horse with Hobbles.....	82
Releasing Horse from Hobbles .....	83
Dog Hobbles .....	250-253
Dawson-French .....	250
Hobday's .....	251
Improvised Cord Loop .....	252
Key .....	253
Dog, Holding Safe for Examination and Operation .....	269
Dog Muzzles .....	265-268
Adjustable .....	268
Automatic .....	266
Clove Hitch .....	265
Hungarian .....	268
Leather Box .....	267
Leather Strap .....	265
Protection .....	267
Safety .....	267
Tape .....	265
Dog Operating Tables .....	250-264
Bernard's .....	253
Delahanty's .....	259, 260
German .....	257, 258
German, All Metal .....	261, 262
Hobday's .....	255, 256
Improvised .....	263, 264
Italian .....	258, 259

	PAGE
Dog Operating Tables—Continued.	
Livon's .....	256, 257
MacQueen's .....	254, 255
Metal, with Enamel Finish .....	255
Stuttgart .....	262, 263
White's .....	257
Dog, Restraint of the .....	249-271
By Holding .....	269
By Holding Jaws Apart with Tape .....	270
Miles' Method .....	270, 271
Operating Tables .....	250-264
Dollar's Method of Casting and Securing with Double Side Line.	130, 131
Drawing Hind Leg Forward .....	101
Securing Fore and Hind Legs Together .....	112
Securing Hind Leg to Fore Leg on Same Side .....	103
Securing Lower Hind to Upper Fore Leg .....	104, 105
Double Side Line, Casting by .....	135, 136
Drawback or Pulley Harness .....	241

## E

Ellis' Combination Dental and Surgical Halter .....	27
English Cross Hobbles .....	93, 96, 107
Hobbles .....	77
Nose Clamp Modified .....	222
Nose Clamp Modified with Metal Keeper .....	222
Ewell Farm Service Hobbles .....	41
Extension Grate .....	253, 254

## F

Fehr's Dental Halter .....	26
French Sling .....	70

## G

Gags .....	17-19
Loop and Rope .....	18
Rope and Long Stick .....	19
Rope and Short Stick .....	18
Galvayne's One Man Method of Casting and Securing a Horse.	144-146
Galvayne's One Man Method of Casting and Securing Wild and Vicious Horses .....	155-156

	PAGE
Galvayne's Method of Restraining All Four Legs.....	46
Straight Jacket .....	47
German Apparatus for Restraining All Four Legs .....	39
Metal Operating Table .....	261, 262
Method of Restraining One Hind Leg .....	36
Nose Clamp .....	222
Operating Table for Dog .....	257, 258
Operating Table for Horse .....	195-197
Sling .....	68
Gleason's Hippo-Lasso .....	51
One Man Method of Casting and Securing a Horse .....	146-148
War Bridle .....	23
Grate—Extension for Dogs .....	253, 254

## H

H. & D. Sling .....	66
Halters, Restraint and Dental .....	25-27
Hayes' Improvised Casting Ropes .....	129
Head, Restraint of Ox .....	220-225
To Post .....	224
With Leavitt's Holder .....	225
With Rope .....	225
Hess' Knee Strap .....	30, 112, 227
Method of Restraining Both Hind Legs of Ox.....	231
Method of Restraining One Fore and One Hind Leg of Ox.	234
Method of Restraining One Hind Leg of Ox.....	228, 229
Hippo-Lasso .....	47-51
Belmont Rider .....	50
Galvayne's .....	47
Gleason's .....	51
Raabe's and Lunel's .....	48
Hobbles for Dog .....	250-253
Dawson-French .....	250
Hobday's .....	251
Improvised Loop .....	252
Key .....	253
Hobbles for Horse .....	78-108
Barnick's Loop .....	84
Becker's .....	81
Berlin .....	88
Conkey's Lock Buckle .....	86, 87
Cross .....	77

	PAGE
Hobbles for Horse—Continued.	
English .....	93-98
James' .....	83
Leather Loop .....	80
Matthias .....	85
Miles' Rope .....	80
Munich .....	85
Over's Spring .....	81
Plaited Raw-Hide Loop .....	80
Rope, Improvised .....	78
Service or Anti-Kicking .....	39-41
Side Bar .....	77
Stuttgart .....	89-92
Suykerbuyck's Rope .....	79
Hobday's Hobbles .....	251
Method of Holding Dog .....	269
Operating Table .....	255, 256
Hock Joint Fixing Apparatus .....	111
Twitch .....	31, 111, 228
Hodgson & Magee's Operating Table .....	166-169
Hog, Catching the .....	275-278
By Corn and Barrel .....	278
By Trap .....	276, 277
By Mechanical Catcher .....	276
Hog, Champion Holder for the .....	279
Hog, Restraint of the .....	275-286
By Conkey's Method .....	285, 286
By Holding Between Knees .....	281, 282
By a Practical Method .....	280
By Pole or Rail Over Neck .....	284
Hog Trap .....	277
Hog Twitch .....	279
Hood, Operating .....	74
Horse, Casting with Hobbles .....	78-108
With Ropes and Harness .....	109-156
Directions for Casting with Hobbles .....	82
Directions for Releasing Horse from Hobbles .....	83
Operating Tables for the .....	157-215
Special Positions when Cast .....	99-108
Restraint of in Recumbent Posture .....	78-215
Restraint of in Standing Posture .....	13-70
Restraint of Wild and Vicious .....	153-156
Hulburt's Casting and Securing Harness .....	120, 121
Hungarian Dog Muzzle .....	268



**I**

	PAGE
Improvised Casting Ropes (Hayes) .....	129
Cord Loop Hobbles .....	252
Operating Table .....	263, 264
Italian Nose Clamp .....	223
Operating Table .....	258, 259
Improved English Hobbles .....	93-96

**J**

James' Cross Hobbles .....	77
Patent Hobbles .....	83

**K**

Kansas City Veterinary College Operating Table.....	197, 198
Key Hobbles .....	253
Knee Straps .....	28, 31, 111-113, 227
Author's .....	28, 112, 227
Hess' .....	30, 112, 227
Magner's .....	31, 113
Trasbot's .....	29, 112, 227
Knots Used in Restraint Technique .....	109, 110
Knowles' Web Casting and Securing Harness .....	117-119, 245, 246
Krolokowski's Lernberg Casting Ropes .....	131, 132
Kyle Brother's Operating Table .....	190-194

**L**

Leather Box Dog Muzzle .....	267
Strap Dog Muzzle .....	267
Loop Hobbles .....	80
Leavitt's Head Holder .....	225
Lernberg Casting Ropes .....	131, 132
Lewis' Modification of Cowie's Casting Harness .....	140
Liautard's Method of Drawing Hind Leg Forward .....	102
Method of Securing Hind Leg to Fore Leg on Same Side..	104
Securing Off Fore to Off Hind Leg .....	105
Livon's Operating Table .....	256, 257
Lucas' Dental Halter .....	25

## M

	PAGE
MacQueen's Operating Table .....	254, 255
Magner's Knee Strap .....	31, 113
Leather Casting Rig .....	148
Rope Casting Rig .....	149
One Man Method of Casting and Securing a Horse.....	148-151
War Bridle .....	24
War Bridle Modified .....	25
Marsch's Sling .....	69
Matthias' Hobbles with Safety Lock .....	85
Modification of Danish Casting Harness .....	124
McDonald's Casting Ropes .....	132, 133
McKillip Veterinary College Stocks .....	55-59
Merillat's Single Side Line .....	35
Miles' Method of Securing the Dog .....	270
Method of Securing "Ridglings" .....	137-139
Rope Hobbles .....	80, 97-99
Mohler's Method of Securing All Four Legs .....	45
Method of Securing Near Fore Arm to Near Thigh.....	100
Method of Securing Off Hind to Plank and Near Fore and Near Hind Legs to Each Other .....	100
Munich Hobbles .....	85
Muzzles, Dog .....	265-268
Adjustable .....	268
Automatic .....	266
Clove Hitch .....	265
Hungarian .....	268
Leather Box .....	267
Leather Strap .....	265
Protection .....	267
Safety .....	267
Tape .....	265

## N

New York State Veterinary College Operating Table.....	169-185
Stocks .....	61-63
Nippers—Collar .....	268
Nose Clamps .....	221-223
American .....	221
American, with Rope .....	221
English, Modified .....	222
English, Modified, with Metal Keeper .....	222

	PAGE
Nose Clamps—Continued.	
German .....	222
Italian .....	223
With Spring and Keeper .....	222

## O

One Man Method of Casting and Securing the Horse .....	141-152
Galvayne's .....	144-146
Gleason's .....	146-148
Magner's .....	148-151
Rarey's .....	152
Russian .....	141-143
Operating Hood .....	74
Operating Table for Dog .....	250-264
Bernard's .....	253
Delahanty's .....	259, 260
German .....	257, 258
German, All Metal .....	261, 262
Hobday's .....	255, 256
Improvised .....	263, 264
Italian .....	258, 259
Livon's .....	256, 257
MacQueen's .....	254, 255
Metal, Enamel Finish .....	255
Stuttgart .....	262, 263
White's .....	257
Operating Tables for Horse .....	157-215
Bradwood .....	198-215
Chicago Veterinary College .....	185-188
Conkey's .....	188, 189
Cozier's .....	164-166
Daviau's .....	161
Daviau's Improved .....	162, 163
German .....	195-197
Hodgson and Magee's .....	166-169
Kansas City Veterinary College .....	197, 198
Kyle Bros. ....	190-194
New York State Veterinary College .....	169-185
Price's .....	190
Operating Trough—Young's .....	253
Over's Double Side Line Casting Ropes .....	133, 134
Spring Hobbles .....	81

	PAGE
Ox—Restraint of the .....	219-246
In Recumbent Posture .....	238-246
By Conkey's Hobbles .....	241
By Double Side Line .....	245
By "Pulley Harness" .....	241
By Knowles' Harness .....	245, 246
By Rope Fixed to Horns .....	243
By Rope on Three Legs .....	243
By Rueff's Method .....	239
By Soffner's Method .....	240
Ox—Restraint of, in Standing Posture.....	220-237
All Four Legs .....	235-237
All Four Legs by "Chute" .....	237
All Four Legs by Stocks .....	236
Head .....	220-225
With Leavitt's Holder .....	225
With Hold in Nose .....	220
With Nose Clamps .....	221-223
With Rope .....	225
With Rope to Post .....	224
With Vigan's Apparatus .....	223
Both Fore Legs .....	226, 227
Both Fore Legs by Knee Straps .....	227
Both Hind Legs .....	230-233
Both Hind Legs by Hess' Method .....	231
Both Hind Legs by Pole .....	231-233
Both Hind Legs by Plank .....	233
Both Hind Legs by Rope .....	230
Both Hind Legs by Sack or Cloth .....	231, 232
Both Hind Legs by Smith's Anti-Kicker .....	230
One Fore and One Hind Leg .....	234, 235
One Fore and One Hind Leg by Hess' Method.....	235
One Hind Leg .....	227-229
One Hind Leg by Hess' Method .....	228, 229
Hock Twitch .....	228

## P

Patent Hobbles—James' .....	83
Peterson's Hock Joint Flexing and Fixing Apparatus.....	111
Peuch & Toussaint's Stocks .....	63
Pfeiffer's Modification of Danish Casting Harness.....	124, 125
Plaited Rawhide Loop Hobbles .....	80

	PAGE
Plate Longe .....	43, 89, 91, 95
Practical Method of Restraining Hog .....	280
Price's Operating Table .....	190
Protection Dog Muzzle .....	267

## R

Raabe & Lunel's Hippo-Lasso .....	48
Rarey's One Man Method of Casting a Horse .....	152
Recumbent Posture—Horse in .....	78-215
Ox in .....	238-246
Releasing a Horse from Hobbles—Directions for .....	83
Restraint of "Broncho" .....	153-156
Restraint and Dental Halters .....	25-27
Restraint of Dog .....	249-271
By Hobbles .....	250-253
By Holding .....	269
By Miles' Method .....	270-271
By Muzzles .....	265-268
By Operating Tables .....	250-264
Restraint of Hog .....	275-286
By Conkey's Method .....	285, 286
By Holding Between Knees .....	281, 282
By Pole or Rail Over Neck and Shoulders .....	284
By Practical Method .....	280
For Operation .....	283
Restraint of Horse .....	13-215
In Recumbent Posture .....	78-215
Casting and Securing Harness and Ropes .....	109-256
Cross Hobbles .....	77
Hobbles .....	78-108
One Man Method of .....	141-152
Operating Tables .....	157-215
Restraint of Horse in Standing Posture .....	13-70
All Four Legs by Galvayne's Method .....	46
All Four Legs by Hippo-Lasso .....	47-51
By Morgan's Method .....	45
By Rope .....	45
By Stocks .....	52-63
By Web and Rope .....	42
Both Hind Legs .....	38-41
Both Hind Legs by Ewell Farm Service Hobbles .....	41
Both Hind Legs by German Apparatus .....	39

	PAGE
Restraint of Horse in Standing Posture—Continued.	
By Ropes .....	42
By Woche's Service Hobbles .....	40
One Fore Leg by Knee Straps .....	28-31
One Hind Leg .....	31-38
One Hind Leg by German Method .....	36
One Hind Leg Merillat's Single Side Line .....	35
One Hind Leg by Rope to Tail .....	32
One Hind Leg by Side Line .....	33
One Hind Leg by Surcingle and Rope .....	34
Restraint—Knots Used in .....	109, 110
Restraint of Ox .....	229-246
In Recumbent Posture .....	238-246
By Conkey's Hobbles .....	241
With Drawback or "Pulley Harness" .....	241
With Double Side Line .....	245
With Knowles' Web Casting Harness .....	245, 246
With Rope Fixed to Three Legs .....	243
With Rope Fixed to Horns .....	243
Reuff's Method .....	239
Soffner's Method .....	240
Restraint of Ox in Standing Posture .....	220-237
"Cattle Chute" .....	237
By Hand Held on Nose .....	220
By Hess' Method .....	228-231
By Hock Twitch .....	228
By Nose Clamps .....	221-223
By Plank .....	233
By Pole .....	231, 233
By Rope Tie .....	230
By Sack or Cloth .....	231, 232
By Smith's Anti-Kicker .....	230
By Stocks .....	236
Rope Method of Restraining All Four Legs .....	45
Both Hind Legs .....	42
One Fore Leg .....	29, 30
One Hind Leg .....	32-37
Rope Hobbles, Denenbourg's .....	78
Miles' .....	80, 97, 98, 99
Suykerbuyek's .....	79
Rohard's Method of Casting With Ropes .....	126-128
Russian Method of Casting With Ropes .....	134, 135
One Man Method of Casting a Horse .....	141-143

## S

	PAGE
Safety Lock Hobbles, Matthias' .....	85
Self-Locking Buckle Hobbles—Conkey's .....	87
Service Hobbles—Ewell Farm .....	41
Wocher's .....	39
Side Bar Hobbles .....	77
Slings .....	65-70
American .....	66
French .....	70
German .....	68
H. & D. ....	65
Marsch's .....	69
Smith's Anti-Kicker .....	230
Soffner's Method of Casting the Ox .....	240
Special Positions of Horse when Cast with Hobbles.....	99-108
Standing Posture—Restraint of Horse in.....	13-70
Restraint of Ox in.....	220-237
Stocks .....	52-63, 236
Barcus' .....	52-55
McKillip Veterinary College .....	55-59
New York State Veterinary College .....	61-63
Peuch's & Toussaint's .....	63
Vinsot's .....	59, 60
Wooden .....	59
Stuttgart Method of Casting .....	89-93
Subjection of Horse by Barnacles .....	19, 20
By Blindfold.....	21
By Gags .....	17-19
By Galvayne's "Straight Jacket" .....	47
By Operating Hood .....	74
By Twitch .....	13-17
By War Bridle .....	22-25
Subjection of Ox by Hand Hold .....	220
By Nose Clamps .....	221-223
By Vigan's Apparatus .....	223
Surcingle and Strap .....	29, 30
Suykerbuyck's Rope Hobbles .....	79

## T

Tables—Operating, for Dog .....	250-264
For Horse .....	157-215
Tail Knot for Restraining Hind Leg .....	32

	PAGE
Tape—Dog Muzzle .....	265
Method of Holding Jaws Apart .....	270
Trasbot's Knee Strap .....	29, 112, 227
Trap for Hog .....	277
Trough—Young's Operating .....	253
Twitch—Ball and Chain .....	16
Hock .....	31
Hog .....	279
Iron and Chain .....	17
Miles' .....	15, 16
Ring .....	14
Rope and Stick .....	14
Rope and Stick with Metal-bound Head .....	16
Rope Loop and Short Stick .....	17
Triangular .....	14, 15
Wooden .....	13
Twitches, Gags and Barnacles .....	13-20

## V

Vienna Method of Restraint in Dorsal Position .....	106, 107
Vigan's Apparatus .....	223
Vinsot's Stocks .....	59, 60
Von Chelchowski's Method of Casting.....	92

## W

War Bridles .....	22-25
Web and Rope Apparatus .....	43
Web—Knowles' Harness .....	117-119, 245, 246
White's Operating Table .....	257
Whitwell's Casting and Securing Harness.....	119, 120
Wocher's Service Hobbles .....	40
Wild and Vicious Horses—Restraint of .....	153-156
Wooden Stocks .....	59

## Y

Young's Operating Trough .....	253
--------------------------------	-----

## Z

Ziegler's Casting and Securing Harness.....	221, 222
---	----------



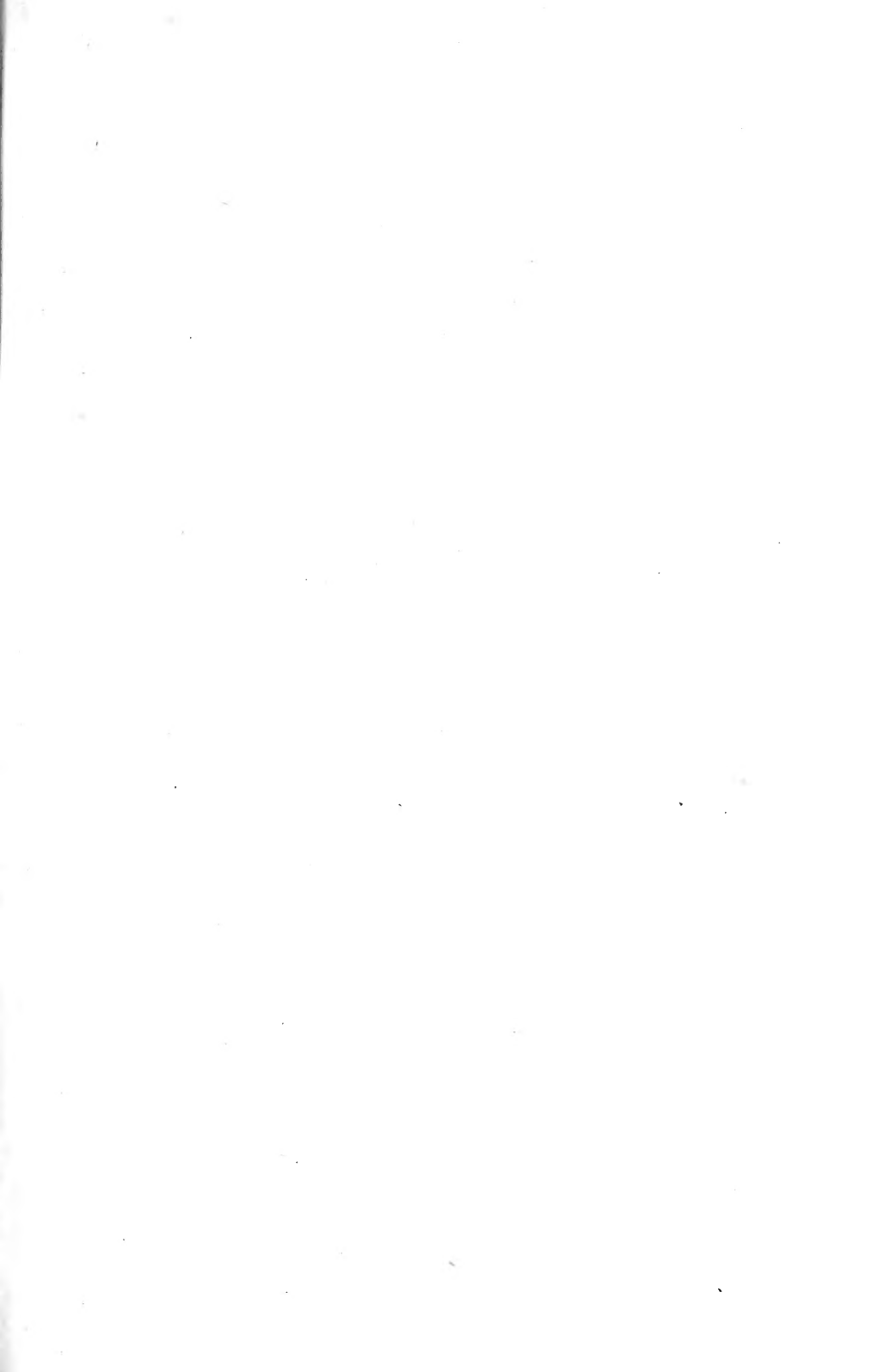

LIBRARY OF CONGRESS



0 002 993 872 6

