

NYU IFA LIBRARY

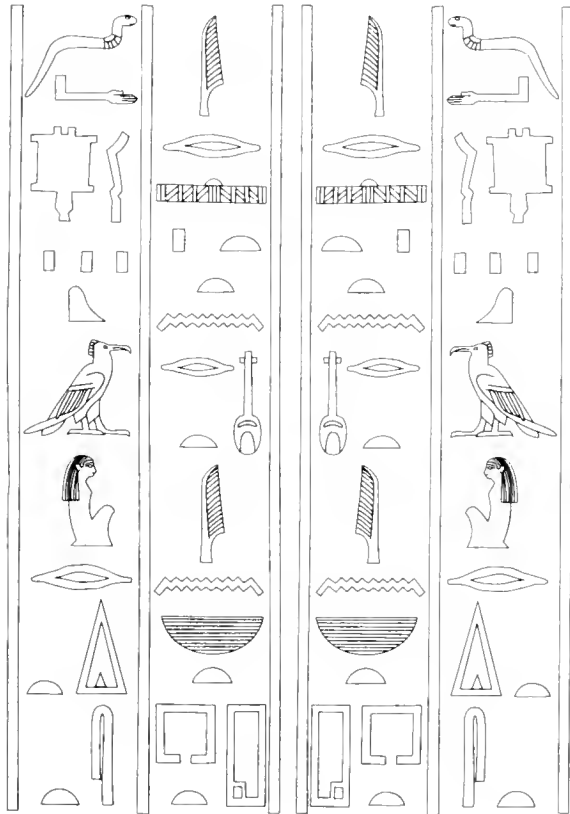

31162028585892

IT









ARCHAEOLOGICAL SURVEY OF EGYPT

EDITED BY F. LL. GRIFFITH

*FOURTEENTH MEMOIR*

THE ROCK TOMBS

OF

E L A M A R N A

PART II.—THE TOMBS OF PANEHESY AND MERYRA II.

BY

N. DE G. DAVIES

FORTY-SEVEN PLATES

LONDON

SOLD AT

THE OFFICES OF THE EGYPT EXPLORATION FUND, 37, GREAT RUSSELL STREET, W.C.

AND PIERCE BUILDING, COPLEY SQUARE, BOSTON, MASS., U.S.A.

AND BY KEGAN PAUL, TRENCH, TRÜBNER & CO., DRYDEN HOUSE, 43, GERRARD STREET, SOHO, W.

B. QUARITCH, 15, PICCADILLY, W.; ASHER & Co., 13, BEDFORD STREET, COVENT GARDEN, W.C.

AND HENRY FROWDE, AMEN CORNER, E.C.

1905

11-100-51

LONDON:

PRINTED BY GILBERT AND RIVINGTON LIMITED,

~~10, JOHN'S HOUSE, CLEVERWELL.~~

# EGYPT EXPLORATION FUND.

## President.

SIR JOHN EVANS, K.C.B., D.C.L., LL.D., F.R.S., V.P.S.A.

## Vice-Presidents.

THE RT. HON. THE EARL OF CROMER, G.C.B., G.C.M.G., K.C.S.I. (Egypt).	
GENERAL LORD GRENFELL, G.C.B., G.C.M.G.	THE HON. CHAS. L. HUTCHINSON (U.S.A.).
SIR E. MAUNDE-THOMPSON, K.C.B., D.C.L., LL.D.	PROF. G. MASPERO, D.C.L. (France).
	PROF. AD. ERMAN, Ph.D. (Germany).
THE REV. PROF. A. H. SAYCE, M.A., LL.D.	JOSIAH MCLENS, Esq. (Australia).

## Hon. Treasurers.

H. A. GRUEBER, Esq., F.S.A.      GARDNER M. LANE, Esq. (U.S.A.).

## Hon. Secretaries.

J. S. COTTON, Esq., M.A.      ALBERT M. LYTHGOL, Esq. (U.S.A.).

## Members of Committee.

T. H. BAYLIS, Esq., M.A., K.C., V.D.	THE REV. W. MACGREGOR, M.A.
C. F. MOBERLY BELL, Esq.	C. McILVAINE, Esq. (U.S.A.).
J. R. CARTER, Esq. (U.S.A.).	THE MARQUESS OF NORTHAMPTON.
SOMERS CLARKE, Esq., F.S.A.	FRANCIS WM. PERCIVAL, Esq., M.A., F.S.A.
W. E. CRUM, Esq., M.A.	F. G. HILTON PRICE, Esq., Dir.S.A.
LOUIS DYER, Esq., M.A. (for U.S.A. Com <sup>tee</sup> ).	SIR HERBERT THOMPSON, BART.
ARTHUR JOHN EVANS, Esq., M.A., F.R.S.	MRS. TIRARD.
PROF. ERNEST A. GARDNER, M.A.	EMANUEL M. UNDERDOWN, Esq., K.C.
F. LL. GRIFFITH, Esq., M.A., F.S.A.	JOHN WARD, Esq., F.S.A.
F. G. KENYON, Esq., M.A., Litt.D.	E. TOWRY WHYTE, Esq., M.A., F.S.A.
PROF. ALEXANDER MACALISTER, M.D.	MAJOR-GENERAL SIR CHARLES W. WILSON,
Mrs. McCLURE.	K.C.B., K.C.M.G., F.R.S.



# CONTENTS



	PAGE
LIST OF PLATES . . . . .	vii
 CHAPTER I. THE SITE OF THE NORTHERN TOMBS.	
1. The Site . . . . .	1
2. The smaller tombs . . . . .	1
3. The stone dwellings . . . . .	4
4. Quarries, surface burials, &c. . . . .	1
5. The roads . . . . .	5
6. The chronology of the tombs . . . . .	6
 CHAPTER II. THE TOMB OF PANEHESY.	
A. Architectural Features.	
1. The Exterior . . . . .	9
2. The Hall . . . . .	9
3. The Inner Chamber . . . . .	11
4. The Shrine . . . . .	11
5. The Sculpture . . . . .	11
6. Coptic remains . . . . .	11
B. The Sculptured Scenes.	
1. The Entrance Portal . . . . .	13
2. The Thickness of the outer wall . . . . .	13
3. The Hall. Architraves and abaci . . . . .	15
4.     „     South portal . . . . .	16
5.     „     S. wall, W. side . . . . .	16
6.     „     „     E. side . . . . .	17
7.     „     E. wall . . . . .	17
8.     „     N. wall . . . . .	19
9.     „     N. portal . . . . .	19
10.    „     W. wall . . . . .	20
11. The Thickness of the partition wall . . . . .	28
12. The Shrine, E. wall . . . . .	28
C. The Religious Texts.	
1. The longer prayers . . . . .	29
2. The shorter prayers. . . . .	30
3. Burial petitions . . . . .	31

## CHAPTER III. THE TOMB OF MERYRA (II.)

	PAGE
A. Architectural Features	
1. The exterior . . . . .	33
2. The Hall . . . . .	33
3. The Inner Chambers . . . . .	33
4. The Sculpture . . . . .	34
B. The Sculptured Scenes.	
1. The thickness of the outer wall . . . . .	34
2. The Hall, S. wall, W. side . . . . .	34
3. „ „ E. side . . . . .	36
4. „ E. wall . . . . .	38
5. „ N. wall . . . . .	43
C. The Religious Texts.	
1. The longer prayers . . . . .	44
2. A shorter prayer . . . . .	45
3. Prayers on the architraves . . . . .	45
INDEX . . . . .	46

# LIST OF PLATES

WITH REFERENCES TO THE PAGES ON WHICH THEY ARE DESCRIBED

PLATE	PAGE
I. General survey . . . . .	1—6
II. Tomb of Panchesy. Plan . . . . .	9, 10, 11
III. Sections, &c. . . . .	9, 10, 11, 19
IV. Fragments . . . . .	10, 12, 15, 16, 29, 30
V. Fragments (lintels, &c.) . . . . .	13, 15, 17, 20, 30
VI. Jambs of entrance door . . . . .	12, 13
VII. West thickness . . . . .	13, 14, 15, 29, 30
VIII. East thickness . . . . .	14, 15, 29, 30
IX. S. door and ceiling patterns . . . . .	11, 16, 26, 29, 31
X. S. wall. W. side. Panchesy decorated . . . . .	16
XI. „ Lower registers . . . . .	16, 17
XII. „ E. side. The royal family offering . . . . .	17
XIII. E. wall. Key plate . . . . .	17, 18, 19
XIV. „ The palace . . . . .	18
XV. „ Princess and train . . . . .	18
XVI. „ The King and Queen . . . . .	18
XVII. „ The escort . . . . .	18, 19
XVIII. W. wall. The temple (front half) . . . . .	20—23, 28
XIX. „ „ (back half) . . . . .	23—26, 28
XX. N. wall. King and Queen worshipping . . . . .	12, 19, 26
XXI. N. door and ceiling inscriptions . . . . .	11, 19, 26, 30, 31, 32
XXII. Inner thickness. Panchesy . . . . .	28
XXIII. Shrine. Panchesy and family . . . . .	28, 29
XXIV. *Exteriors . . . . .	1, 2, 3, 5, 9
XXV. *Smaller tombs . . . . .	1, 2, 9
XXVI. *Tomb of Panchesy. N. wall . . . . .	9, 10, 11, 12, 19
XXVII. * „ Sculptures . . . . .	11, 13, 14, 15, 28
XXVIII. Tomb of Meryra ii. Plans. . . . .	33, 34
XXIX. Fragments . . . . .	33, 38, 45
XXX. E. thickness. Hymn . . . . .	34, 44, 45
XXXI. W. thickness. Hymn . . . . .	34, 45

\* Photographic plates.

## LIST OF PLATES.

PLATE			PAGE
XXXII.	S. wall.	W. side. The King drinking . . . . .	34—36
XXXIII.	„	E. side. Key plate . . . . .	36—38
XXXIV.	„	„ On the balcony . . . . .	36, 37
XXXV.	„	„ The bystanders . . . . .	37, 39
XXXVI.	„	„ Meryra welcomed home . . . . .	33, 37, 38, 45
XXXVII.	E. wall.	Key plate . . . . .	38—43
XXXVIII.	„	Tribute of the South . . . . .	38—40
XXXIX.	„	Tribute of the East . . . . .	40, 41
XL.	„	Lower registers . . . . .	33, 41, 42
XLI.	N. Wall.	Meryra rewarded . . . . .	43, 44
XLII.	Tombs 1A, 1B, &c.	Plans . . . . .	3, 4, 7
XLIII.	„	3A, 3C, 3D. Plans . . . . .	2, 3, 7
XLIV.	„	3B, 3E, 6C. Plans . . . . .	1, 2, 3, 7
XLV.	„	3F, 6B. Plans . . . . .	2, 7
XLVI.	*Tomb of Meryra ii.	The hall . . . . .	33—36
XLVII.	* „	Sculptures . . . . .	37, 40, 41

\* Photographic plates.

NOTE—The plans of the tomb of Meryra (Plate xxviii.) and of the smaller tombs (Plates xlii., xliii., xliv.) are published, with a few alterations and additions, from plans drawn in 1892 by Mr. John Newberry (see Part I., p. 5).

The plates, with the exception of Plates xxxv. and xxxvii. to xli., which are from tracings, are nearly all reproduced from drawings made on a scale of one quarter and checked by continual measurements from fixed horizontal and vertical lines.



# THE ROCK TOMBS OF EL AMARNA.

## PART II.

### CHAPTER I.

#### THE SITE OF THE NORTHERN TOMBS.

##### THE SITE.

As has been said in the former volume, the northern group of tombs at El Amarna lies on the N.E. side of the desert plain (Plate i.). The hills here are cleft by a ravine which brings down the waters of the occasional torrential rains, formerly of enormously greater volume than now. The range at this point is not lofty, only reaching an elevation of about 280 feet above the level of the plain, and dipping somewhat on both sides to the *wady*. It affords, as usual, a more or less abrupt face for the upper half of its height, and for the lower a steep foot-slope of looser rock (see photograph, Plate xxiv.). The rock-hewn tombs naturally lie at the meeting of the two, a little more than half-way up (approximately 150 feet for No. 5). The limestone is of bad quality, and contains enormous flint-like boulders, which, freed from the rocks by denudation, cover the level heights above, like fallen fruit. It is in most places very subject to weathering, and many of the rock stelae have almost disappeared under this process. The stratification of the range has a dip approaching the vertical, and the weakness thus given to the surface of the tomb walls has caused much injury to the sculptures.

##### THE SMALLER TOMBS.

Tomb 6c. The earlier tombs of the group are those furthest to the east. We shall begin, therefore, with No. 6, the tomb of Panchesy (No. 1 of Lepsius), leaving this and other large tombs for separate notice. The cliff at this point tends to a sheer face or even overhangs. Near No. 6 it presents a curious appearance (Plate xxv.), for well above and a little to the left of that tomb a small rock-chamber, provided with both doorway and window, has been hewn in the unscalable rock. As the sill is 24 feet even from the mounds below, it was necessary to lash two ladders together to effect an entrance. A small irregular chamber some six feet high was found, devoid of inscriptions or graffiti (Plate xlv.). There is nothing to prove that the excavation was made for purposes of burial, but this is probable, even if it be of late date. Those who afterwards made a dwelling-place of it cut a very neat and serviceable window with converging sides and top. The need for it may have been due to a partition of the room, of which there are some traces. Brick houses beneath perhaps rendered this retreat more accessible than now, but it is unlikely that they reached to the full height, and holes which pierce the

corners of the door-check indicate that the ascent was by a rope-ladder or some such means. In any case the place must have been singularly secure. The excavation seems to have been effected by cutting broad vertical grooves and then breaking away the intervening mass.

6D. Another small and very similar chamber is found on the ground level a little to the right of No. 6. It also has a window and affords no proof of use as a tomb.

6B, 6A. A short distance westward are two other excavations, one in the cliff-face and one in the slope below it. The latter (6A) has been so much altered in later times that its original size and shape are quite lost. The former has a promising doorway, but the interior is unfinished. A recess in the left hand wall is a relic of later occupation, as also are the exceptionally solid and regularly built walls of piled stone outside. These must have formed an excellent abode, as homes go in the Orient, with several rooms, of which the original chamber was the inmost and most secure. A part of the dwelling was on an upper level of rock, in which a rude stairway has been cut. (See Plates xxv. and xlv.).

A considerable distance separates these from the next tombs to the west, Nos. 5, 4 and 3 (of Pentu, Meryra, and Ahmes), which follow one another at some interval and without any dependent tombs of smaller size. Beyond them, where the cliff is much reduced in height, a series of small tombs was cut in the slope below it.

3F (No. 5 of Lepsius). The first of these (Plate xlv.) was not wholly uninscribed. The decoration of the portal may even have been completed, but the weathering of the rock has left us little of it. The type of façade, representing a portal set in a wall, is repeated in all the succeeding tombs. The projecting cornice, as sometimes also the roll below it, was often formed of stones cemented into a groove instead of being cut in the living rock.

The lintel shows the cartouches of Aten, flanked by those of the king and queen, and apparently also by the figure and prayer of the deceased. On the upper part of the right jamb can still be read,—“Life to the father—god and king—the living Ra, ruler of the two horizons . . . . .!” “I give praise to the living Aten . . . . .” The open side of the forecourt has been built up with walls of piled stone to form a house.

The interior shows hurried preparation, directed primarily to the provision of a burial vault. The transverse gallery of which it was to consist has not been given its full height or finished at the N. end. The mouth of the burial shaft is cut in a mastaba of rock, and at the depth of only a few feet admits to a little chamber on the east. Two little niches for lamps in the W. wall are relics of the domestic use to which this and all the other tombs were put in later days.

3E (Plate xlv.) is the first of a series of neighbouring tombs cut in a low ledge of rock and facing a little west of south. It is of irregular shape, just allowing standing room, and contains no provision for burial. A lamp-niche in the wall outside dates from the time when the court was made a dwelling-place.

3D (Plate xliii.). This tomb is of much the same shape as the last and shows similar signs of incompleteness. Later occupants have fashioned a shelved recess 39 inches high in the south wall.

3C (Plate xliii.). A tomb of the corridor type with an inner chamber set transversely. Only the outer hall has been finished. The walls outside are rough, and, like those of its neighbours, have no trace of inscription. The walls inside are well laid out and finished to a good surface. The ceiling is highly vaulted near the doorway, but becomes almost flat at the N. end. There is a rough trench in the floor, parallel to the W. wall and deepening towards the ends, which seems designed (cf. Part

i. pp. 12, 13). A rough recess has been cut in the W. wall. The doorway to the inner chamber has not been completely excavated, and the inner room is not more than begun, the upper part, as usual, having been first attacked. Drill holes are noticeable at intervals in the floor down the axis of the hall.

3B (Plate xlv.). This, the finest of the uninscribed tombs, is of the same type as the last, but of much larger proportions. The façade has suffered much, but apparently had never been inscribed. Again we have the arch of the ceiling flattening towards the N. end and a trench near the W. wall. In this case there is also a corresponding groove in the ceiling for about the same distance, but not exactly above it. I do not doubt that it is a constructional error, utilized or concealed in the finished tomb. There are recesses on the W. side, probably due to the removal of patching stones. As in 3c, the inner room has not been begun. Evidence of the mode of removing the stone is afforded by a circular trench in the floor. It is about six inches wide and narrows to the bottom. As the chamber was still extremely low on this side, no machine of any size could be used, while the rough character of the groove indicates hand-work.

3A (Plate xliii.) is now nothing more than a tiny cave (uncleared). Only a minimum of work can have been spent on it.

The four remaining tombs are on the W. side of the gap in the hills. The two inscribed tombs are hewn in the first available slope; and some distance beyond these will be found two smaller chambers, excavated in a low ledge of rock, which is cut back deeply in each case for a width just sufficient to receive the portal.

1B (Plate xlii.). The excavation of the interior is still unfinished above and below. It seems to have been the intention to furnish it with architraves, though without supporting columns. Evidence of subsequent occupation is given on the one hand by two recesses, one

of which has two cups to hold water-jars: and on the other by two pits excavated in the floor to the shape of sarcophagi. The dimensions of these pseudo-collins only just allow them to contain human bodies. A tethering staple has been formed in the wall at the head of each. This seems accidental, this corner having been the stable of the inhabitants. The burial, no doubt, was of much later date than the tomb.

1A. TOMB OF RUDU (Plates xlii., xxiv.).—This small chamber was never completed, the front and upper parts being well finished, while the lower part of the walls and the back of the room are left in the rough. But although this tomb was abandoned by the owner without having been furnished with a place of interment, the smoothed lintel outside enabled either him or some usurper to scratch a faint memorial of his name and hopes. With difficulty one deciphered “. . . . . in the presence of the Lord of the Two Lands, and a good burial by the gift (?) [of the king?]¹ on the great cliff of Akhetaten like any favourite of Ua-en-ra (?). For (?) the *ka* of Rudu.”²

SCATTERED TOMBS.—Besides this series of tombs along the hill-side there are a few of unknown date in the vicinity, within the hills. On passing through the gap, a *wady* will be seen directly opposite and two others to the right and left. Between that on the left and the central ravine is a track ascending the hills. Slightly to the right of this path is a tomb with a tiny doorway. It consists of a chamber some 16 feet by 5, containing an oblong pit, 8 feet deep. From the E. and W. ends of the pit two good-sized burial chambers are entered. Another tomb will be found at the first bend of the central *wady*, high up the cliff and facing the gap. A third and fourth will be found back to back in a low ridge of rock to the right of the

¹ Perhaps .

² Cf. *L. D.*, *Text*, ii. p. 141.

gap. That facing the gap is large but excessively rough, perhaps a natural cave enlarged; the other consists of a chamber 7 feet square, but only 2 feet high.

#### THE STONE DWELLINGS.

In front of all the tombs just described, walls of piled stone will be found marking out the rooms of what were once tolerable dwellings (Plate xlii.) They are generally considered to have been built for the convenience of the workmen engaged on the tombs, but this is obviously not so. They would in that case have been cleared away as soon as the tomb was completed; and while it is true that every tomb has ruined huts attached to it, any shelter afforded by a fallen boulder, a natural cave, or an overhanging ledge was also seized upon for a wind-tight retreat, while roomier chambers were built on to it to suit the occupants' fancy and need. Such constructions are found from end to end of this hill-side, and form colonies far from any tomb. Some are even placed on the summit, notably a group above Tomb 6. They are by no means of the rudest kind, but occasionally represent a considerable expenditure of labour, massive retaining walls having been built up to make a level platform, and recesses formed in the walls for domestic uses. In some cases substantial cement pavements were laid down in slabs; and in all the doorways in the groups 3A to 3F a step of smoothly plastered bricks or stones was set, perhaps as a deterrent to wandering snakes and scorpions. Where the owner was fortunate enough to have secured a tomb for his inmost chamber and a rock-hewn court in which to shelter his outer rooms, he cut holes in its façade to receive roof-beams, recesses for water-jars<sup>1</sup> and lamps, and staples for tethering his animals. All this is

clear proof that this hill-side was for some time the abode of a population numbering several hundreds. Security seems to have been a matter of consideration, for some of the little colonies are built like birds' nests on ledges of rock at the summit of the cliff, in spite of great inconvenience and danger. Even at the very end of the range, an hour's walk from the river, I found a large cave reached by a stairway cut in the rock, which staples for pendant lamps and the remains of coarse pottery showed plainly to have been the lonely home of some anchorite or refugee. A good example of the solid character of these constructions is found on the opposite side of the hill from No. 5. Here, at great labour, a large platform has been raised on retaining walls of natural boulders and rough blocks of limestone, and covered with a solid pavement of slabs of cement.<sup>2</sup> A rough chamber hewn in the hill-side serves for an inner room, and a neat stairway, cut in the wall of rock, gives access to the summit just above. The whole is now much broken up. Although I have not found a single Coptic graffiti in these houses, I do not doubt that the builders were Copts; and if any one questions the probability of a number of people living so far from water and in such eyries, he has only to visit the village of Deir Rifeh, near Assiout, where the spectacle may still be seen, even in the security and civilization of these days. So sundered from the life of Egypt were these mountain-dwellers that the use of mud bricks is limited to some buildings outside Tomb 6, which was then their place of worship. The pottery, according to Prof. Petrie, is late Roman.<sup>3</sup>

#### QUARRIES, SURFACE BURIALS, ETC.

The one stela (V.) on this site is so completely weathered away that only a few hieroglyphs remain. There is a small quarry of coarse

<sup>1</sup> Cf. p. 3. There is a specially neat recess hewn in the rock-face between Tombs 6 and 6B. It forms a little rock-cut sideboard, having cups to hold six jars.

<sup>2</sup> Cf. *Sheikh Saïd*, p. 4.

<sup>3</sup> PETRIE, *T. A.*, p. 6.

afabaster in the *wady* behind No. 5, and surface quarries are numerous between Tomb 1 and the river. In one above No. 6 several loose blocks about  $24 \times 14 \times 10$  ins. remain on the spot. In the quarry in which Queen Tyi's cartouche is cut there is also sculptured, high up on a pillar of rock, a doorway and a figure, both of the type characteristic of the period.

Other interesting antiquities of the site are some occurrences of burials on the summit of the cliff. At several points on both sides of the gap are large round cairns built of the globular boulders which strew the hill, sometimes with buttress walls or appended heaps of smaller size. Most are wrecked, and one on the western hill I found open and filled with a mass of burial *débris*, including cloth, leather, and fragments of wooden stools and bowls (?). They seem built on the solid rock, and certainly merit further examination. Behind No. 3 is an open shaft, but the large amount of boulders round it seem to have been removed from the interior and do not presuppose a cairn.

Still more interesting is a cist-tomb, above No. 6, like a diminutive cromlech, built of boulders and roofed with pieces of weathered rock (Plate xxiv.). It measures only 93 ins. by 69 ins. outside, and about 24 ins. in height, and as the interior breadth is only about 18 ins. it could scarcely contain a full-sized body. It is built on the rock, and its axis is due east and west, the opening being to the east. I do not venture to claim an early date for it, but it is in any case an interesting instance of recourse to a primitive mode of burial when implements for any reason fail and only loose stones are to hand.

A finely-ground limestone axe-head was picked up at the foot of the hills near Hawâta.

#### THE ROADS.

The roads which Akhenaten caused to be laid out in the desert of El Amarna have been the object of most commendable labour

by Professor Petrie.<sup>1</sup> Unfortunately accident prevented its completion. My own work on those roads which fall within the limits of Plate i., has not the exactness I could wish: for, though plainly traceable from above and in certain lights, they become so indistinguishable near at hand that they are difficult to plan without help. It is to be hoped that the Government will include these roads in their Survey, and note the points at which they strike the ruins or the river.

The roads are formed simply by the removal of the loose pebbles to one side; but, slight as this preparation was, millenniums have done little to efface it. In some cases they waver or change their direction, but often, and for long stretches, they are ruled as with a pen on paper, and this is even true of some which have only the breadth of a narrow track. Very few can be the result merely of continual traffic between two fixed points. Such a path would be very far from straight, as I had occasion to notice. The track which my water-donkey left on the plain, and which threatens to be the most permanent memorial of my three winters' stay, meanders in a way worthy of the animal and yet was always followed by the natives.

The larger roads may have been used for chariots ("wheel roads" the natives still call them), some only by pedestrians, palanquin bearers or patrols. Nearly all lead to obvious goals such as tombs or stelae. Some seem to make for the stone-built hamlets, and therefore may be of Christian times, though one would not have expected carefully laid-out paths from them. The roads cannot be traced close to the tombs, as they have there been disturbed or replaced by tourist paths.

The laying-out of the roads is in good accord with the priority which will be claimed for Tombs 3, 5, and 6. Apparently the road N

<sup>1</sup> PETRIE, *T. A.*, plate xxxv. and pp. 4, 5. See also *L. D.*, *Text*, ii., pp. 136, 137.

leading to No. 6 was first made, showing that that site was one of the first to be appropriated. At a point opposite Tomb 3 two short roads were led off from N to Tombs 3 and 5. When Meryra made his tomb, however, he laid out the great avenue K, thirty-one feet in breadth and stretching from the foot of the hills to a great clearing in the plain mid-way to the river. In this square Professor Petrie found three mounds, two of them approached by ramps on all four sides.<sup>1</sup> The northernmost has a square brick foundation, and its eastern side faces down the avenue. Only the central one is shaped like an altar, and I am tempted to see in that mound to which the avenue leads the site of a great rostrum where Akhenaten's public appearances were made. This is figured in the tomb of Huyra with four ascents, and as having a raised shrine opposite it and an altar between—the exact relation of these remains.

The rest of these roads from the tombs are far from converging to one point, but make directly for the river to the north of the city, perhaps in order to avoid the loose sand of the watercourses to right and left.<sup>2</sup>

The roads may be briefly described as follows:—

A. Road to 1A, 1B from K or C, only traceable a short distance. Direction  $12\frac{1}{2}^{\circ}$ .

B. Road to Tombs 1 and 2 from the avenue (?), 12 ft. broad. Direction  $27^{\circ}$ .

C. Road along the foot of the hills (?).

D. Road to the *wady* from far across the plain. Not very straight, but well cleared, 16 ft. broad. Direction  $23^{\circ}$ .

E. Road to the *wady* from the S. tombs (?), 12 ft. broad. Direction  $2^{\circ}$ .

F. Road to stela V. Scarcely visible.

G. Narrow and ill-defined path aiming at Tomb 3, but bending off to the tombs round 3c. Direction  $92^{\circ}$ .

H. Narrow path aiming at Tomb 4, but bending off towards Tomb 3. Direction  $93\frac{1}{2}^{\circ}$ .

K. Avenue above described. Direction  $104^{\circ}$ .

L. Broad road to Tomb 4, from the junction with N.

M. A similar road to Tomb 5.

N. Road to Tomb 6, 14 ft. broad. Direction  $102^{\circ}$ . It is nearly parallel with K, but makes a sudden bend away from it, the original direction being continued by a faint track.

O. Road to Tomb 6 from a different point; faint and irregular. Direction  $93^{\circ}$ .

P. Road to Tomb 6 (?). Fairly broad. Direction  $87^{\circ}$ .

Q, R. Two narrow paths, diverging from a common track. Q leads towards a collection of stone huts; R seems intended to ascend to the top of the hills.

#### THE CHRONOLOGY OF THE TOMBS.

As dates are specified only in Tombs 1 and 2, the clearest evidence of sequence is the number of daughters who accompany the King and Queen in the various tombs. Although this is open to error, since even a precise artist might well ignore infants at any rate, the regularly increasing family of Akhenaten seems to have been faithfully noted. The case of failure in the tomb of Huyra, which I cited in Part i, p. 42, is much ameliorated by my subsequent discovery of scenes in which four daughters appear; but the royal tomb seems to ignore two children.

The sequence of the tombs on this basis, so far as my information goes, is as follows:—

(N=North group; S=South group of tombs).

One daughter. S 9 (Mahu); S 11 (Rames).  
Stelæ of 4th and 6th years.

Two. S 23 (Any); stelæ of 6th and 8th years.

Three. S 10 (Apy); S 25 (Ay. Nezemet-mut shown); S 8 (Tutu); N 3 (Ahmes); N 5 (Pentu).

<sup>1</sup> PETRIE, *T. A.*, plate xlii.

<sup>2</sup> The line which runs parallel to the river from a bay in the hills, just outside the "North Town" in Petrie's map, is not a road but the remains of an outer dyke or wall of the town.

Three and four. S 7; N 6 (Panchesy. Nezet-met-mut shown in both).

Four. N 4 (Meryra); N 1 (Huya. Baketaten shown).

Five and six. N 2 (Meryra ii.).

Seven. (Four?) Royal Tomb.<sup>1</sup>

Three daughters seem to have been born in the latter part of the 4th, 6th and 8th years; and if we suppose this regularity to have continued, the youngest and seventh (?) daughter of Nefertiti, who was in arms at the funeral of Meketaten, would be born in the 16th year of the reign. Hence we may assign the tombs of Ahmes and Pentu to the 9th year, Panchesy to the 10th, Meryra to the 11th, Huya to the 12th and 13th (since an event of the mid-twelfth is recorded in it; probably the fifth daughter was just born, but is not depicted), and Meryra ii. to the 14th and 15th, with a later addition.

This order coincides well with three other lines of evidence: (1) the position of the tombs, (2) their character, (3) the form of the cartouches of Aten. We find that the tombs of the S. group belong to the three-children period; one, at most, may be a little later. The burial-place, then, was shifted at this period to the opposite side of the desert, where the bold cliffs afforded better sites. The steepest faces of rock would naturally be first appropriated, and this consideration marks out Pentu, Ahmes, and Panchesy as the earliest. These three were perhaps begun simultaneously, though that of Panchesy took much longer to construct. But we cannot see the reason for abandoning the good sites near Panchesy; and still less for removing the latest tombs far to the west.

(2) The forms of tomb in vogue in the south

were: (a) the small tomb with narrow transverse chamber, (b) the tomb in which this was placed at the end of a long corridor, (c) the tomb with a more spacious hall crowded with columns. The first type was retained in the N. groups only for smaller tombs; the third was found too elaborate, till the columns were reduced to two or four, when it became the model type. The economical corridor tomb alone was taken over, with its mode of decoration, from the S. groups, and employed for the burial of Ahmes and Pentu.

The tomb of Panchesy, which modified the form of the columned hall, has elsewhere the closest affinities with the southern tombs, among them being the decoration of the entrance with figures of the worshipping King and Queen as well as the deceased, the provision of a winding stairway to the burial vault, and the naos-like shrines in the hall.

(3) One of the features that distinguishes the latter half of Akhenaten's reign is the changed form of the cartouches of the god.<sup>2</sup> The earlier form is almost invariable in the S. tombs,<sup>3</sup> and on the stela. It appears in the N. group also, but it is precisely to the tombs of Ahmes, Pentu, and Panchesy<sup>4</sup> that it is confined. It fell into complete disuse then, with the 10th year of Akhenaten's reign.

The uninscribed tombs 3A—3F, are of the small T-shaped and corridor types common in the earlier tombs, but the form of the cartouche in 3F puts this tomb later than the three just mentioned. The two tombs 1A, 1B, belong no doubt to the same period as Nos. 1 and 2.

It will be seen that the 9th year of Akhenaten is one of exceptional activity and inventive-

<sup>1</sup> The eldest four children are shown in the royal tomb, and a suckling whose name ended in *t*. It must therefore either be the fourth daughter, who elsewhere is seen walking with Meketaten or weeping at her bier, or a seventh. I do not think the lacuna can possibly admit Neferneferuat-en-ta-she-rat.

<sup>2</sup> Part i., pp. 9, 45.

<sup>3</sup> The only exceptions I know are in the tombs of Mahu (early?), and on the columns of Tutu.

<sup>4</sup> This tomb perhaps shows the transition, like that of Tutu, but the cartouches that seem of the later form are scarcely legible.

ness, and no doubt represents the high-water mark of prosperity in Akhetaten. The public buildings had been completed, and the officials having been provided with suitable buildings in the city, could plan ambitious "houses of eternity" in the desert. But the craftsmen of Akhetaten could not keep pace with the lavish projects of the King or his courtiers. Not one of these splendid tombs was quite finished. The walls were prepared and the hard-driven artist pacified all his employers by making a brave beginning in paint where he could not spare a chisel. Meanwhile, when hopes were high, Meryra, who as high-priest of Aten had the post of power and favour at court, usurped all the talent for his splendid tomb and left Pentu, Almes, and many more lamenting their half-executed decorations, or halls which had only half emerged from the rock. The days of prosperity and leisured luxury were never to return, either to them or to new favourites in Akhetaten, and the tombs have come down to our day as the downfall of Aten-worship left them, a few years after its inception.



## CHAPTER II.

THE TOMB OF PANEHESY  (or .

## A. ARCHITECTURAL FEATURES.

## THE EXTERIOR (Plates ii., v., vi.).

Previous plans are :—

HAY, MSS. 29,817, foll. 12, 13 (complete).

L'HÔTE, *Papiers*, iii. 279 (unplotted).

THE tomb is excavated at the foot of the boldest of the rock-faces hereabout, though the full effect is lost by the base being buried under several feet of débris (photograph, Plate xxv.). As the tomb was at some period a place of Christian worship, there has been a considerable amount of Coptic building round its door. The wall of rock has been dressed to a fairly smooth surface for some distance to right and left of the doorway, a bank of rock being left along the foot. The entrance is adorned by a portal of the type already familiar. Both lintel and jambs are sculptured, but the latter are half cut away, and on the right an apse-shaped niche has been cut out by the Copts.

## THE HALL (Plates ii., iii., iv.).

The exterior wall is of the customary solidity, and the thickness has been used for decorative purposes. The interior fulfils the Egyptian ideal by affording a suite of three chambers, the outer hall as a place of public gathering and worship, an inner chamber containing the place of interment, and a smaller shrine as a place of privacy for the deceased. If the plans be compared with those of Meryra it will be seen that, but for the addition of an ante-chamber to that tomb and the unfinished state of its inner rooms, the two are closely alike, the

tomb of Panchesy having evidently been taken as a general model.

The first hall was a room whose breadth little exceeded the depth, but a rough enlargement of the lower part at the hands of the Copts has greatly altered the dimensions of the ground plan. Other disfigurements too have greatly changed the appearance of the hall, the chief being the removal of the two western columns and the substitution of an ecclesiastical apse for the false door which once balanced its fellow on the east side. This violence, combined with minor injuries and the wash of grey plaster with which the Copts obliterated the sculptures, has given a very sorry aspect to a hall which the bats, that pest of Egyptian tombs, have, on their part, not spared.

When fresh from the hands of the designers the hall was divided by two rows of two columns each, leaving about half the area of the hall between them. The walls were free for sculpture on all but the north side, where two false doors occupy half the space. This latter feature does not recur in any other of these tombs, unless the uncut doors in Meryra's ante-chamber and the false doors in the inner room of Ahmes represent it. Such doorways are found, however, in the large halls of the S. group and contain sitting statues of the deceased, intended apparently to mark his presence in the reception room as well as in his private retreat. Whether the portal now destroyed contained such a figure cannot be determined. Its fellow had been only partially

excavated when it was found that a natural fissure interfered with the work, and in disgust at this mischance the designer abandoned the whole corner, including the sculpture on the adjacent walls, so that it remains a monument only to his ill-temper. Dissatisfaction with this part of the hall led, then or later, to a further disfigurement, by the construction of a flight of steps descending to a rough burial chamber just below floor level.

The columns differ little essentially, though a good deal in appearance, from those in Tomb 4 (I. ii.), for in the latter that detail was probably shown in paint which is here marked by the chisel. They are much more squat in appearance, being greater in girth though less in height. Here, too, each of the eight bundles of papyri which the column represents is again broken up above the sheathing leaves (not sculptured here) into four stems. About half-way between the foot and the bands under the capital there is a break, the thirty-two stems of which the column is now built up seeming to be shifted round by half a stem's breadth (see drawing of east side). This, however, is due in reality to the customary insertion of shorter papyrus stems, three to each of the eight bundles. Each of these inserted stalks lies between the original stems and covers them. One out of the four stems in each of the eight bundles, however, is left visible and differentiated by being coloured yellow, while the inserted stems are painted conventionally, blue, red, blue. Thus there are thirty-two divisions, above as below, twenty-four of them representing the overlaid stems and eight those underlying. The representation, however, is not congruous with the conditions; for it is a *division* between two stems, and not the surface of one stem, which forms the centre of a bundle of four and would be left uncovered by the inserted stems. This error appears plainly on the upper part of the capital, where the thirty-two original stems again become visible; for

that stem which was left uncovered is seen not to coincide with any of the thirty-two, but with a division between them. As the swelling capital represents the heads of the papyrus, the leaves of the calyx are represented like sheathing (red lines on yellow) on the eight underlying stems which are visible just above the bands. That the inserted stems consist of eight bundles of three is plain from the four bands which unite them (coloured conventionally blue, red, green, blue, whereas the band of the column itself is a natural yellow). The colouring of these overlaid stems and their bands suggests that the architect was ignorant of their *raison d'être*.

The details of the columns on the W. face are interrupted by a blank space representing an affixed placard. The device on these tablets is similar to that on the lintels of the doorways, except that here a space below the cartouches is occupied by a design representing the union of the Southern and Northern kingdoms, under the symbol of their representative plants. The sign for "union" occupies the centre. The whole device on the N. column is shown on Plate iv. and the ends of that on the S. column. (See p. 30 for the translations of the prayers.)

It may be well to compare at this point the picture of a papyrus column from the temple on the W. wall (Plate iv. *h*).<sup>1</sup> It will be seen that the typical column of the artist was of very different proportions from those in the tomb. In reality the columns when *built*, not excavated, may have approached this pattern.

As will be seen from the photograph (Plate xxvi.), even the remaining columns have been greatly mutilated. A number of cups have been cut in the base of the S. column, to hold porous water-jars, with ducts for draining off

<sup>1</sup> The Plate is inexact. The colouring below the tablet is correct in the right hand column, thus showing the apparent twist of the bands noted above, but is lost in its fellow.

the overflow into a basin in the floor. Of the destroyed columns only the abaci remain. The floor of the W. half of the hall is very rough.

The gloom of the hall was once relieved by the brilliant colouring of the walls, the columns, the frieze of cartouches, the pediment and the ceiling. Of this but little now remains, but the ceiling designs have been recovered as far as possible (cf. L'HÔTE, *Papiers* iii. 281). The scheme can be gathered from Plate iii., and the patterns identified from Plate ix. Pattern B seems to be identical with pattern B of l. xxxix., the blue centre, perhaps, excepted.<sup>1</sup> What remains of the columns of hieroglyphs between the patterns will be found on Plate xxi., and an attempted translation of these on pp. 30-31.

INNER CHAMBER.—This is of the same shape and almost the same size as the outer hall. The ceiling feigns to be supported by four columns, carrying architraves. These columns are of the papyrus-bud type like those of the hall, but no detail at all is shown, and even the contracting foot is not represented. A small pit in the centre of the room is obviously a subsequent addition.

The place of burial is reached by a stairway of forty-three steps, which descends along the E. wall of the room. After reaching a landing some distance below, it turns at a sharp angle to the left, and descends as a curving stairway with a sharp return upon itself at the end. The chamber is merely a level length of passage. The depth below floor-level is shown on Plate iii. The winding stairway is borrowed from the earlier tombs, and is not repeated in this necropolis.

THE SHRINE.—The third room, conformably to practice, is inscribed, while the second hall (theoretically only a passage to the burial chamber) is not. The little chamber contained,

according to custom, a sitting statue of Panehesy, but it has been completely removed.

THE SCULPTURE.—The work in the tomb, it must be confessed, was not good, and was, therefore, less able to bear injury. The figures have been executed for the most part in the stone itself, so that, despite the falling away of the thin coating of plaster, the sculpture still retains the general outline and, in places, almost the full measure of the original outline. Scarcely any plaster is left on the thickness of the outer walls, for instance, yet the scenes there are the best in the tomb. The plaster must have been a mere overlay, giving smoothness to the whole and filling up irregularities, as well as enabling details to be elaborated or supplied in colour. The stiff treatment of the designs also detracts from the value of the scenes, but this unattractiveness has been their salvation, the injury shown in Plate vii. being the only modern mutilation.

As the architecture, so the scheme of subjects also was taken over for the hall of Meryra (with an exchange between the E. and W. walls), but carried out there with much individuality and greatly superior technique. The two efforts show how varied was the skill of the artists, or the success of their methods of working in plaster.

COPTIC REMAINS.—When the Copts sought a place of assembly, the W. false door, which they saw could be adapted to their needs with but little labour, seems to have drawn them to this tomb. Retaining the cornice of the original construction, they fashioned an apse having a moulded arch resting on pilasters with decorated capitals (photograph on Plate xxvi.). The apse seems to have been designed with a view to baptismal immersion, for a font five feet deep occupies nearly the whole space. Two rough steps would enable a person to scramble from the edge into the inner room through a narrow aperture which has been cut in the back wall. But it is not easy to see how any one could be immersed in, or himself emerge from, the font

<sup>1</sup> In the plates *dr.* signifies drab, *b.* = blue, *bk.* = black; *r.l.* or *r.p.* indicates that the line is not cut, but only in red paint.

with any dignity. There is a shallow niche in the walls of the apse on each side.

The apse having been made, it was impossible to leave the pagan sculptures close by it in naked assertiveness. Yet the earliest worshippers seem to have thought it enough to daub the sacred cross and an Alpha and Omega in red paint over the figure of the Queen. A later generation, however, was more particular, and, having covered the whole wall with plaster, (now largely fallen away again), decorated the surface with the picture of a saint<sup>1</sup> and floral designs. The decorations in the apse, too, are not original, but have been renewed on a second

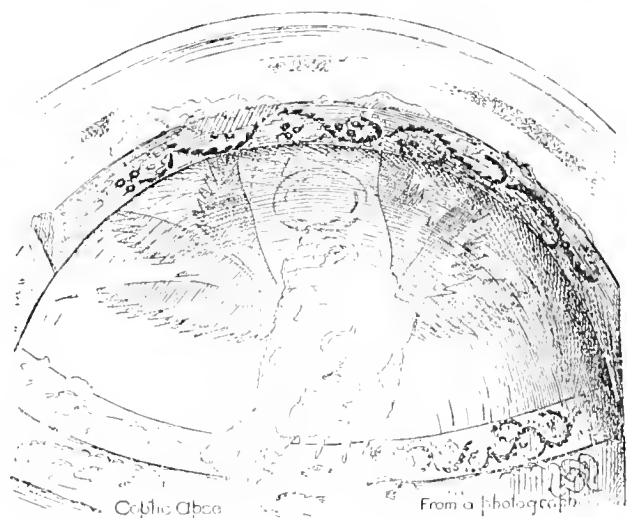

coating of plaster from very similar designs. All the walls on this side of the hall have been covered in like manner with a thin wash of plaster, which on the W. wall has adhered with deplorable tenacity. Above the cornice there seems to have been a bird with outspread wings, not, perhaps, without reminiscences of the winged scarab, disc, or vulture. On each side of the apse are decorated staves (?).

The wall of the apse is painted gray, with darker marbling. Separating it from the dome are two borders, the lower showing two inter-twisted bands (Plate vi. *c*), the upper a branching

spray of leaf and fruit (*d*). The latter design is also applied to the soffit of the arch (*a, b*). The moulding of the arch is coloured yellow with a band of white splotches on a black background. The dome is occupied by the figure of a soaring eagle (?) sketched in browns of various shades. Its outstretched wings are tripartite (in allusion to the seraph of Isaiah's vision?), and on its head is a halo or disc (perhaps also a reminiscence of the solar hawk). It is much broken, and none of the graffiti here can be read. The lower of the two borders is continued on the wall to the left of the apse. Below this a singular decoration, viz. a disc of deep blue glass about five inches across, was added, set in a bedding of mud-plaster, but at a later time was covered over again.<sup>2</sup> A cupboard has been cut out in the wall hard by.

Having made their apse in the extreme corner of the hall, the unsuitability of such a position became evident, and to make it central to the congregation the tomb was considerably enlarged on this side for half its height, and the two columns broken away to admit light. Several grooves in the wall and floor suggest that a partition was erected outside the line of the architrave. Other relics of this occupation are the arched recess in the S. wall near the entrance and a similar one outside. To judge by the putlog holes and a deep recess in the E. wall, the stairway was bridged over and the space behind the columns put to some special use. It may be added that the spectacle of a Christian church thus quartered in a heathen tomb may still be seen under very similar conditions at Deir Rifeh.

On the S. wall of the inner room are painted two crosses with the Alpha and Omega in the

<sup>1</sup> Plate xx. The name (or merely *apa*?) seems to have been very short (Plate iv. *a*).

<sup>2</sup> It is now gone. When it was perceived under the plaster, the guard was specially charged with its preservation, but it disappeared before my return. It can be guessed what measure of safety antiquities enjoy which are *not* under lock and key!

corners, and one or two indecipherable words or symbols. To the Copts is probably also due a strange squaring out of the W. side of the S. wall, and a still more irregular marking out of the W. wall. All this is in black paint.

## B. THE SCULPTURED SCENES.

### 1. THE ENTRANCE PORTAL (Plates v., vi.).

Cf. L'HÔTE, *Papiers*, xi. 36.

The decoration here is somewhat out of the common. Instead of columns of prayers and the divine and royal cartouches, scenes of worship by the royal family are exclusively portrayed. On each of the broken jambs are two pictures of the royal family worshipping the sun, with a border below of the symbolical *rekhyt* birds (cf. L. D. iii. 109). The upper panels exhibit the King with the crown of the North (on the left, i.e., more northerly jamb), and of the South (on the right). In the lower panels he wears the *khepersu* helmet. The royal pair lift up offerings of food to the deity from the tables or stands of provisions which are before them. They seem to have been accompanied in these scenes by Merytaten alone.

The lintel shows the same subject in a design which for purposes of symmetry is repeated with slight variation on both sides of a central table of offerings, on which the rays of the Aten stream down. The King and Queen stand beside the table, the materials for the ceremony being laid on stands near them. On the left they are engaged in burning incense to the god, throwing aromatics with the right hand into the flaming bowl of the censuring-spoon, which is held in the left. On the right the censers have been laid aside, and libations are being poured from the spouted vases taken from the stands. The titularies of Aten and of the royal pair are inscribed above them. The long laudation of the Queen (most of the phrases of which may be restored from Plate vii.) shows the position which was accorded to her as the royal heiress. The three

eldest princesses shake sistra behind the Queen under the care of their nurses. A younger, but here unnamed sister of the Queen is also in the train, attended by two shade-bearers and two female fan-bearers. Two misshapen female dwarfs who are of the party seem also among her attendants (Plates vii., viii.; and twice in the tomb of Ay). Their names, which in this tomb are greatly damaged, can fortunately be recovered from the tomb of Ay; for no little satirical humour has been shown in the nick-names given to these ill-favoured favourites. One is the "The Queen's Vizier (?), 'For ever,'" and the other "His mother's Vizier (?) 'The Day' (or 'The Sun')!"<sup>1</sup>

"His mother" would seem to mean the King's mother Tyi, and "the Queen" may also designate Tyi or some other Queen of Amenhotep III.; for as the sister of Nefertiti is only mentioned in tombs of this period, and the dwarfs only shown in her company, it is likely that she was at this time on a lengthened visit to Akhetaten, and had brought these attendants from the Theban court of Tyi.

### 2. THE THICKNESS OF THE OUTER WALL.

Plates vii., viii., xxvii.

Previous copies are:—

BURTON, *Excursions*, plate vi. (upper part of W. side).

L'HÔTE, *Papiers*, xi. 35 (the E. side is reproduced in AMÉLINEAU, *Sépulture*, plate lxxxiv., p. 610).

LEPSIUS, *D.* iii. 91 (E. side, upper part).

WEST SIDE (Plates vii., xxvii.).—The wall surfaces in the entrance to the tomb are fittingly reserved for representations of the worship of the sun. As naturally as the dweller in the town or village comes to his doorway at dawn and evening to see the sun rise in fresh brightness or set in splendour, the occupant of the

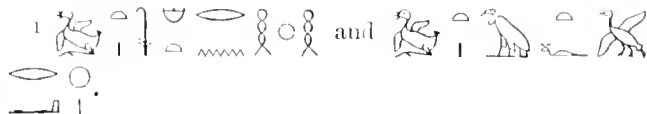

tomb leaves its dark recesses and greets the appearing or departing deity at the entrance. But here, as often in the earlier tombs, the King and his household also are seen engaged in worship. This may be due, not only to the impulse of the Egyptian King to self-commemoration, but also to the need to create traditions for the new form of faith by giving prominence to the example of the Court. Therefore the figure of Panehesy and his prayer are relegated here to the lower part of the walls (for a translation of both texts, see pp. 29, 30), while the upper part shows the royal family offering to the radiant Disc. The King and Queen are extending their sceptres towards the god as if in acknowledgment of their delegated power (cf. I., xxvii.). Before them is a loaded table, having little figures holding offering-bowls at the two front corners. The table having first been spread with jars, flat round loaves have been placed on their mouths, and the rest of the offerings laid on top and crowned with flowers and bowls of burning spices. The King's person is adorned, as often, with the cartouches of the god. These were probably inserted in light jewellery or fastened on ribbons; for they always occupy the place of armlets and pectorals, though the attachments are rarely shown.

The elaborate titulary of the Queen written over her head reads:—

“The heiress, great of favour, mistress of the district of the South and North, fair of face and gay with the two feathers, soothing the heart of the King at home (?),<sup>1</sup> pleased at all that is said, the great and beloved wife of the King, Lady of the Two Lands [Nefertiti].”

The three eldest princesses shake the sistrum behind their parents.<sup>2</sup>

EAST SIDE (Plates viii., xxvii.).—The change in the royal attire on this wall may have been prescribed by the ritual: for the King is here

burning spices in the hawk-headed censuring-spoon towards the sun, while the Queen presents a bouquet of flowers.<sup>3</sup> Both wear an elaborate variety of the *Atef* crown, into which, as in a coat of arms, forgotten history and symbolism are crowded. Two or three shocks, somewhat resembling those familiar to us in the *kheker* ornament, and each flanked by two plumes, occupy the centre, standing upright on the combined horns of the bull and the ram. In the King's head-dress each is also crowned by the solar hawk, identified with the god of the Aten cult by the double cartouche. Erect on either side, and pendant also from the horns, are figures of the crowned uraeus. The whole is attached to the head by a broad base, adorned with uraei. The King has thrown a flowing mantle over his shoulders, and his tunic shows a flap adorned with uraei and the attachment of the bull's tail behind (not often assumed by him). The Queen is again distinguished by an encomium:—

“The heiress, great of favour, mistress of all women—when she saith anything it is done<sup>4</sup>—the great wife of the King whom he loveth [Nefertiti], living for ever and ever.”

The register beneath this scene is practically in duplicate on the two walls. The point of interest is a female figure in the centre, attended by two dwarfs of her sex, and identified by this as the sister of Queen Nefertiti, already seen on the lintel outside. This interpretation is supported by the broken inscription which evidently ran, “the sister of the great wife of the King, Nefertiti, who lives for ever and ever, Nezemut-mut.”<sup>5</sup> She is attended by two shade-

<sup>3</sup> The drawing of the figures in the *Denkmäler* utterly misrepresents the original.

<sup>4</sup> This phrase is applied to a queen in the very earliest times (PETRIE, *Royal Tombs* ii., pl. xxiv., seal 210), and again to Queen Hatshepsut (NAVILLE, *D. el Bahari* ii., p. 16).

<sup>5</sup> Restore  Cf. I. *D.* iii. 109. She appears also twice in the tomb of Ay, and apparently in that of Tutu (I. *D.* iii. 106*b*).

<sup>1</sup> If  is intended.

<sup>2</sup> The (injured) sistrum of Merytaten has been omitted by error in Plate viii.

bearers, four fan-bearers, three nurses, and a detachment of police, and is being received by one or two officials, including, no doubt, Panehesy himself. On closer inspection, however, the impression of deference to the royal sister is seen to be mistaken. The row of figures really forms part of the scene above, so that the homage of the officials and the train of servants belong to the royal party as a whole, the nurses being attached to the three daughters of Nefertiti. Both here and on the lintel Nezemut-mut stands aloof from the act of worship, and thus seems to belong to the adherents of the old polytheism, as her name, "the pleasant one of Mut" probably implied. She appears to be older than her nieces, as might be expected, and even if she had been resident at the court of her sister in Akhetaten, her disappearance henceforth would be naturally accounted for by marriage. It is a pity that the accompanying inscription does not anywhere show her parentage, and so decide that of her sister Nefertiti. There is no strong ground for supposing it to have been foreign. The Queen's rights as heiress rather imply a royal Egyptian descent on both sides. She is more likely to have been a daughter of Amenhotep III. by an Egyptian heiress whom the King's strong preference for Tyi kept quite in the background. The marriages with Syrian princesses were purely political alliances, and possibly were not always consummated (cf. WINCKLER, *Tell El Amarna Letters*, No. i.); so that even if Nefertiti is not the princess of Mitani whom Akhenaten seems to have married, she may after all have had no real rival in the harem.

### 3.—THE HALL. ARCHITRAVES AND ABACI.

(Plates iv., v.). Previous copies are :—

HAY, MSS. 29,847, fol. 63. L'HÔTE, *Papiers*, iii. 280. LEPSIUS, *D.* iii. 91 i.

The same inscription in large blue hieroglyphs runs along both architraves, with but

slight differences of spelling. It enumerates the revered powers in heaven and on earth thus :—

"Life to the good god having pleasure in Truth, Lord of the Solar Circuit, Lord of the Disc, Lord of Heaven, Lord of Earth, the great living Aten who illumines the two Lands!<sup>1</sup> Life to the Father—God and King<sup>2</sup>—

(Ra-Horakhti, rejoicing on the horizon) (in the name of the Brilliance which is in the Aten), who gives life for ever and ever, the great living Aten, abiding in the *sed*-festivals,<sup>3</sup> Lord of Heaven, Lord of Earth, within the temple of Aten in Akhetaten; (and to) the King, &c., Akhenaten, great in his duration; (and to) the great wife of the King, &c., Nefertiti, living for ever and ever!"

The faces of the four abaci towards the nave are engraved with the name and offices of

<sup>1</sup> A pleonastic introduction to fill out the space.

<sup>2</sup> Further experience shows that the translation in Part i., p. 8, cannot be sustained, and that this is to be taken as a double determinative, explanatory of the word "father" in this connection. The strange group must be due to the unfamiliar application of the double royal cartouche to the title of the god. We must recognize in the double cartouche a conscious dualism in the religion of Akhenaten (cf. *seten dy hetep* prayers to Aten and to Ra, ruler of the two horizons, on Stela 324 of the British Museum). The need of explaining the relation of the new to the old faith, and of the Aten to the well-known god Ra, was the practical necessity out of which the use grew. The cartouches which showed the double nature of the King as divine son and earthly regent, were used to prove that the new religion was still the worship of Ra, but in his visible form, "The Brilliance from the Sun-disc (Aten)." The cult, therefore, was that of the visible Aten. The two determinatives apply to the two cartouches; the sign of the god to the first, that of the ruler to the second (cf. Pl. iv. *g*; more clearly differentiated in III. xxvii., L. *D.* iii. 100*b*, 105*b*, and SHARPE, *Eg. Inscriptions*, ii. 48). Naturally this fine distinction was apt to be lost, and in later tombs (I. xxv., III. xxi.) the word is determined by two kingly figures. It may be observed that this recurring laudation of the two natures of the Father-god, along with the divine-human son, and not omitting the highest female power, is a strange anticipation of Christian Trinitarian worship in its most popular form, and suggests that the faith of Akhenaten was much more than a personal eccentricity or a freak in religious thought.

<sup>3</sup> Variant .

Panehesy, and the same treatment also was proposed for the N. and S. faces also, as traces of writing in blue paint are observable. With great difficulty parts of three of these were deciphered (Plate iv., *c*, *d*, *e*, with enlargements *b* and *f*), *c* and *d* being from the N. side of the S. and N. columns respectively, and *e* from the S. side of the N. column. These are of interest as giving two fresh titles to Panehesy: "Superintendent of the oxen () of the Aten" (*d*), and "superintendent of the granary of the Aten in Akhetaten" (*c*). The other four abaci have "The [great] favourite of the good god, the chief Servitor of Aten in the temple of Aten in Akhetaten, Panehesy, *maakheru*."

#### 4.—SOUTH PORTAL.

Plates v. (lintel) and ix. (jambs). Earlier copies are:—

HAY, MSS. 29,847, fol. 63 (lintel). L'Hôte, *Papiers*, xi. 36.

The door-framing has no cornice, but reaches to the ceiling. The lintel is adorned in the way made familiar by Part I., the central part being occupied by symmetrically-arranged cartouches, and the ends by prayers and praying figures of the deceased. Each jamb is occupied by four prayers in as many columns, addressed to the Aten, the King under both names, and the Queen. (See pp. 30, 31 for translations of all the prayers.)

#### 5.—PANEHESY REWARDED BY THE KING.

South Wall. West side. Plates x., xi.  
Cf. L'Hôte, *Papiers*, xi. 31.

The reward of the faithful official by the King (a scene which is seldom or never omitted from a fully inscribed tomb at El Amarna) is set forth on this wall. It differs in no essential from other representations of the kind (regarding the building, etc., see Part I., pp. 20-22). Four princesses are present, the youngest, Neferu-

neferu-aten, being depicted as very small; and as she does not appear with the other three in Plates v., vii., viii., xviii., she may have been born while the tomb was in process of decoration. The three youngest children are lovingly linked together. Merytaten, the eldest, has the privilege of being taken by her parents into the window, over the cushion of which she just manages to reach.<sup>1</sup> With that frank naïveté which is so characteristic of the scenes at El Amarna, the Queen encircles her husband's waist with one arm and passes the other round the daughter's shoulders.

Panehesy, happy under a weight of golden necklaces, stands outside the porch with arms uplifted in homage. The servants are still in the act of receiving further favours for him from the King, while a whole chest-full of other presents are set out on stands behind him, or are in the hands of his retinue. This largesse of collars, necklaces, bracelets, pectorals, and of other personal ornaments is being duly inventoried by the scribes. In the upper registers Syrians and negroes (possibly ambassadors or hostages) wait along with the sunshade-bearers. The inscription over Panehesy is obliterated.

The pictorial narrative is continued in the subsidiary registers below (Plate xi.). In the centre is shown a further array of royal gifts, amongst which tables loaded with provisions for a banquet are to be noted. On the right is another group of Panehesy's friends and retainers, and on the left his chariot waits to conduct him home. Having left the presence of the King and gained the public streets or his own home, Panehesy descends from his chariot and is hailed by the populace, or by his household, with

<sup>1</sup> The signature "Nestor L'Hôte, Janv. 1839," is written in pencil on this cushion; and though modern graffiti are to be discountenanced, we can more than pardon this modest memorial of one who alone of the old copyists had the thoroughness to copy this dull tomb *in extenso*.



unrestrained acclamations. The men wave branches and make demonstrations of joy and devotion; the women have formed themselves into a choir, or have engaged professional performers to represent them. (cf. Part I., pp. 22, 29). A little escort of soldiers marches behind Panehesy in double file. The further rank, which is naturally hidden by the nearer, is rendered visible in the picture by the simple device of raising the men head and shoulders above their fellows. Two military standards are borne by the squad.

In a short inscription attached to the scene, Panehesy is designated as usual "the great favourite of the Lord of the Two Lands and the chief Servitor of the Aten." What seems to be the cry of the crowd is almost illegible ". . . . . health, life, prosperity (?) to Pharaoh! O Aten! grant it for ever."<sup>1</sup> The wall has been made unsightly by the Copts, who cut an arched recess near the doorway and two long upright grooves in the wall. They were perhaps contemplating a doorway or window at this point.<sup>2</sup>

#### 6.—THE ROYAL FAMILY MAKING OFFERINGS TO THE ATEN.

South Wall. East side. Plates xi., xii.

Previous copies are :—

L'HÔTE, *Papiers*, xi. 2 (reproduced by AMÉLINEAU, *Sépulture*, pl. lxxxiii., p. 608). LEPSIUS, *D.* iii. 91*n* (head of servant at top of Plate xii.).

The treatment of this familiar subject offers no features of exceptional interest. In face of these altar-stands loaded with meat offerings, one feels that Akhenaten had scarcely succeeded in finding a ritual in harmony with the severely simple and natural conception of deity which he had introduced. But if this massing of food and drink offerings is felt to be an inheritance

of old traditions and crass anthropomorphism, it is redeemed by the preference given to flowers and fruits as objects acceptable to the god. The presentation of those products of the soil whose grace and colour is their chief attraction, and which are so obviously called into being and beauty by the sunlight, bears witness to a finer sentiment, which even Christianity approves. Its prominence here is obvious. Not only are the meat-offerings covered with flowers and grapes, and the stands set about with bouquets and lotus-blooms, but the offerings of the King (?) and Queen consist of such. The princesses too are provided with these fit emblems of "the beauty of the Aten," whose fragrance Ankhesen-pa-aten would have her little sister enjoy once more before parting with them to the god. Nor is the King content to devote one bouquet only. Panehesy (indicated by his name and familiar titles) and his attendants bring yet others for the King to dedicate. As "Chief Servitor of the Aten" he assists the King in the rites, and it may be in commemoration of such occasions that the scene is portrayed in his tomb. The faces of two of the shade-bearers high up on the wall have escaped injury, and present very characteristic El Amarna profiles. (Consult the large reproduction in *L. D.* iii. 91*n*).

The subjoined register (Pl. xi.) only contains the usual figures of attendants, and a repetition of the figures of Panehesy (?) and his fellow-priests (?) The royal chariot is distinguished by size and decoration from the private car of Panehesy.

#### 7.—THE ROYAL FAMILY DRIVING OUT.

East Wall. Plates xiii. to xvii.

Cf. L'HÔTE, *Papiers*, xi. 6, 28.

The scene on this wall remains unfinished on the left hand, and, as there is no inscription, the object of the public appearance which it depicts is uncertain. But it seems to be the original

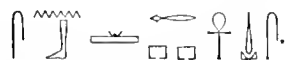
<sup>1</sup> Conjecturing  Cf. I. xxx. and the tombs of Mahu and Pentu.

<sup>2</sup> For the mode of decorating the top part of the S. wall, see Plate v.

of the design on the W. wall of Meryra's tomb (l. x., x.A). Probably a representation of the temple set vertically, as there, should have filled the blank space. The subject, therefore, seems to be a State visit to the temple. The palace is seen in the top right-hand corner (Plate xiv.). The interesting variations from other pictures of the building which it offers have been discussed in detail in Part I., pp. 23 to 25. The ostensible reason for its inclusion in the picture is as the point of departure of the cortège, but the repeated representation of the buildings of Akhetaten wherever any pretext offered itself betrays that it was to the order of the royal builder of the city that these tombs and sculptures were executed.

Akhenaten himself standing in his chariot, under the guardianship of the ever-solicitous sun, and guiding in person his bounding horses, makes a worthy centre-piece to the picture, in spite of the mutilations of the sculpture. There is little to add to the comments made upon the design on its occurrence in Part I. The animals in these larger examples create a vivid impression of motion and of the grace of strength, and if this stereotyped design is far from affording a correct study of the horse, it exhibits all the Egyptian power of proving triumphant, in spite and even by means of glaring inaccuracies. The artist is very much less happy when he shows the animal in slower movement. The disproportion given to the neck there becomes glaring (Plates xv. and xvii.).<sup>1</sup>

The details of the harness are made specially clear here. The guiding rein is seen to pass through the loop of a leather thong attached to the pad, and also apparently through the ornamental ring of the yoke, which fixes over the stud of the pad. The curved end of the yoke terminates prettily in a lotus-bloom and buds. The

<sup>1</sup> There is a considerable amount of correction by the sculptor on this wall. The false lines have not always been indicated in the plates.

stay, which extends from the front rim of the car to the pole, is adorned with a row of uraei in what seems a dangerously slender design. (The block at the King's knee represents the uraei which are sewn on the hem of his tunic; they have been left uncarved).

The saïses who run before the horses have been placed beneath them in order to make the picture more compact.

The Queen also (in representation at least) drives her own chariot and pair, which are in every way the counterpart of the King's on a smaller scale.

Six chariots follow. The foremost of these, which contains only a driver or an official, is being urged at a gallop like those of the King and Queen; the rest follow more leisurely. Two of these (underneath and behind the Queen's chariot) contain the four princesses, who, like her, for dignity's sake, are feigned capable of driving themselves. The three remaining cars carry six fan-bearers, one for each of the party.<sup>2</sup> Three of the police bring up the rear.

In front of the King and in the register below are shown the military escort and the retinue. (The wall here is in a very bad condition.) The advanced guard consists of a detachment of five Egyptian spearmen in charge of a sergeant, and preceded by a Syrian and a Lybian as types of the army. One of the number is attached to the three standard-bearers as a guard. Below on the left is another armed escort led by a negro (?) bowman and a Syrian spearman (l. xv., III. xxxiv.) and four bearers of military standards. The soldiers are very variously armed but the state of the wall leaves the weapons very uncertain in some cases.

Those who carry shields for defence are probably also in every case armed with the spear. They are meant to meet spearmen, and

<sup>2</sup> I am in error in not placing fans in the left hand of the attendants in the lowest row of chariots in Plate xv.

carry a falchion in addition, so that they may not be defenceless when their spears have been hurled. Others have as arms the square-headed axe and the club. The position of the escort implies that it is attached to the royal chariot. The same may be said of the three foremost chariots, whose speed conforms to that set by the King and Queen. The anxiety in face and attitude of the official in the first car is comical, and perfectly justified, one would think, by the over-horsing of so light a vehicle. The official on the second chariot seems to be the secretary in attendance, for he carries on his shoulder a little box, such as would hold a scribe's materials. The succeeding chariots, containing an official and body-servants, move at the slower pace of the princesses to whose train they belong. The posture of the six men of the police who run alongside is intended to show the action of running, and not the stealthy scouting which to our eye it suggests.

As has been said, the objective of the ride has not been sculptured. Fragments, however, of the greeting crowd are seen at the top of the wall and in face of the advanced troop, and justify us in supposing that the lost design would have closely resembled that of Meryra.

#### 8.—THE KING AND QUEEN WORSHIPPING THE ATEN.

North Wall. West Side. Plates xx., xxvi.  
Cf. L'HOTE, *Papiers*, xi. 31.

This, the only sculptured scene on the N. wall, now presents a strange appearance, though one not infrequent in Egypt. Christianity has often thought to easily efface the pagan decorations by covering them with plaster and substituting its own emblems. But the tenacious life of the painstaking work of antiquity has reasserted itself with time; and where the reappearance is only partial an incongruous medley of pagan and Christian symbols and portraiture results, which is often highly

ludicrous, and is itself symbolic of the very imperfect victory of the higher creed in this early mission-field of the faith.

The original scene showed the King and Queen making offerings to the sun. Akhenaten stands before two altar-stands, and uplifts an oblation arranged on a platter. It is a varied gift of bread, meat, fowl, and vegetables, topped by a flaming bowl. The latter would seem to be a lamp rather than a censer; for it appears to contain wicks or tubes from which the flame is fed.<sup>1</sup>

The Queen appears to be presenting a bouquet. The titulary of the Aten was written to the left of the disc, and there followed a series of cartouches, divine and royal, which filled the space between the sky and the cornice of the shrine (Plate iii.).

The space under the main scene is occupied by figures of Panehesy, who holds a jar of milk (?), and of two attendants. The inscription commences with the usual panegyric of the deceased, "The royal acquaintance (?) beloved of his lord, the great favourite of the Lord of the two Lands, etc., Panehesy . . . . . possessor of love . . . . ." (or ". . . Ua-en-ra, thy child").

The decorations on the Coptic plaster, which in places still clings to the walls and lends to the scene its bizarre aspect, have already been commented upon (p. 12).

#### 9.—NORTH PORTAL.

Plates xxi., xxvi.

The form and decoration of the doorway to the inner chamber is of the kind already familiar. The cartouches on the lintel are arranged between a sky above and a mat below. (For translations of the prayers on the jambs and lintel see pp. 30, 31, 32.)

<sup>1</sup> I do not understand the graffito on the loaf.

### 10.—A ROYAL VISIT TO THE TEMPLE OF THE ATEN.

West Wall. Plates xviii., xix.

Cf. L'Hôte, *Papiers*, xi. 30. (A sketch; the altar is shown in *Lettres Écrites*, p. 63.)

We have here a subject which may be the same as that on the opposite (East) wall, but treated in a wholly different way. There the royal figures and their train were made so prominent that the temple to which they were bound was altogether omitted. Here, on the contrary, that building occupies the whole available space, and what was all-important there becomes here a mere accessory. Obviously economy has come into play, the subject being spread over the two walls with as little repetition as possible. Meryra, however, as we have seen, did not hesitate at the laborious duplication of the royal train, the palace and the temple.

Here the escort of the royal party is reduced to a few soldiers and policemen, a charioteer or two, and a few groups of shade-bearers and attendants. The two troupes of female musicians are familiar to us already from I. xiii. The royal family, accompanied by a few attendants, have entered the Court of the Great Altar, and are seen engaged in worship there. The three elder children assist in suitable ways: the King and Queen, standing side by side at the top of the steps of the altar, scatter fragrant spices on to the flaming lamp-bowls, which crown the pile of offerings. A number of the priesthood assist; the two who are prominent being perhaps Meryra and Panehesy, the High Priest and the Chief Servitor. The radiant sun which blesses the sacred building is three times repeated, perhaps with significance (see p. 27). The following description of the temple is drawn from the two pictures in the tomb of Meryra, equally with that now before us.

The south group of tombs contains no representation of the temple whatever. Though the

building was in an advanced state, drawings of it may not yet have reached the portfolios of the decorators. Besides the three complete pictures in the northern tombs, the smaller of the two sanctuaries of which the temple was composed is shown in Tombs 3 and 5 and twice in the Royal Tomb, and an abbreviated copy of it seems given in Tomb 1.<sup>1</sup> The three principal views of the temple present it in as many aspects; in bird's eye view from the front

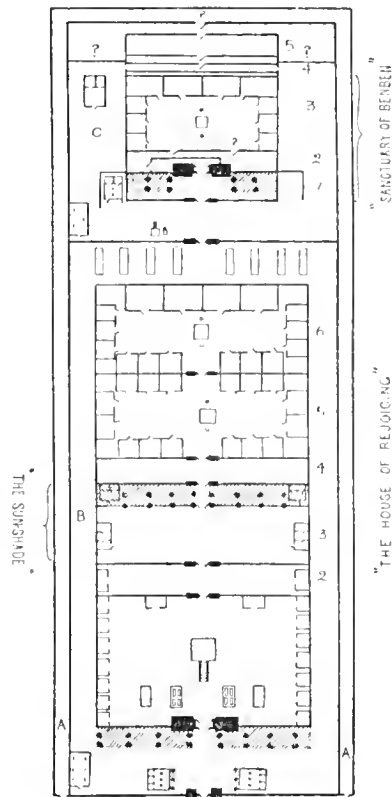

THE TEMPLE OF THE ATEN.

(I. x.A), from the left (I. xxv.), and from the right hand (II. xviii., xix.). If the tombs are supposed to be oriented east and west (which, though far from being the case, is still the impression of the natives), the temple is represented on the walls in six out of the eight occurrences in its actual orientation. The

<sup>1</sup> This fuller enumeration must replace that in Part I., p. 29. The picture in Tomb 1 (Huya) will be referred to under III. ix.-xi. (*L. D.* iii. 101, 102); that in Tomb 3 (Ahmes) under III. xxx.; that in Tomb 5 as Pentu.

remarkable correspondence in detail, which all the laxity exhibited by the artists does not invalidate, makes it plain that these are studied views of the great building. Though it cannot be claimed for them that they satisfy the requirements of architectural plans, in the main they present us with a clear and complete knowledge of the building.

To facilitate references to the temple, it may be divided as follows. As there is no proof that any section of the building was roofed, its divisions have been merely termed courts. Roofed colonnades are shaded in the adjoining plan.

A. Ambulatory.

B. Outer Court with Greater Sanctuary, containing—

1. Court of the Great Altar.
2. Forecourt to the Colonnaded Court.
3. Colonnaded Court.
4. Forecourt to 5 and 6.
5. Fifth Court.
6. Sixth Court.

C. Inner Court with Lesser Sanctuary—

1. Portico of the Royal Statues.
2. Corridor.
3. Court of the Altar.
4. Corridor.
5. Adjoining Chapel (?).

THE AMBULATORY.—The temple enclosure appears to have been surrounded, except on its frontage, by two high enclosing walls, parallel to one another and leaving only a narrow ambulatory or ward between them. To this ward there was admittance from without only at the two ends, where it met the frontage. The outer wall is drawn in the two sectional plans with a cornice (II. xviii., xix., and I. xxv., where the gaps are only to admit the hieroglyphs, etc.). This must signify a high corniced wall, not a roofed building. In I. x.a this cornice is not marked, as it should have been, at the back of the building, but instead there is a building extending beyond the wall

and affording a through passage from the outside to the interior. The other plans, however, show plainly that this building lay within the enclosing wall. Similarly, the door shown on the extreme left in I. xxv. can only indicate an entrance to the inner court from the ambulatory, not from the exterior; for, apart from other testimony, it is unlikely that the security of the building would be weakened in this way. The narrow ward is represented in I. x.a as absolutely clear of encumbrance, and forming a passage round three sides of the building. From a side view such a passage would be plainly visible on the near side but almost invisible on the other. This natural aspect is reflected in both cases. In I. xxv. the corridor on the near side is faithfully shown at the bottom of the picture as a narrow blank space, to which a little door on the right admits. Its existence on the other side is only indicated by a similar doorway above (i.e. beyond) the great entrance-gates. In II. xix. it is not indicated at all. The inner wall apparently was not corniced, but it stood quite free, being separated by an open court from the walls of the sanctuaries within.

THE ENTRANCE.—The area enclosed within the double wall was divided into two unequal parts by a partition wall which stretched across from one side to the other, the space nearest the entrance being by far the larger. Each of these two courts contained a sacred edifice: the outer being occupied by the temple proper, while the smaller space behind was reserved for a temple of the Royal Spirits, which I think may be identified with the "temple of the Benben."

The front wall of the sacred enclosure was single. It was pierced at the extreme ends by two tiny doorways which admitted to the ambulatory and to this alone, and in the centre by the great gateway. "Pylon" it can scarcely be called, for, whether with correctness or not the ruins unfortunately do not show, this and all succeeding gateways are represented with vertical sides. All the gateways in the building

are constructed after one pattern, differing only in size and the possession of a single or double set of gates.<sup>1</sup> They consist of two solid corniced towers with jambs projecting from the inner face, between which double-leaved doors swing, their upper pivots secured by the heavy overhanging cap.

THE OUTER COURT.—The entrance admitted immediately to an open court, in the midst of which the greater sanctuary lay, leaving a free space all round it. This was devoted to various purposes. Just within the gates to right and left (I. x.A) were two villas, the residences, no doubt, of officials of the temple. The plans, though inexact, show what were considered the essentials of such a dwelling. There is a large reception room, extending across the breadth of the house, its ceiling carried on several columns. Three inner rooms were accessible from it on the one side. The other and outer wall contained the entrance, and was shaded by a columned portico. According to I. xxv. it had also at one end the large balcony window with which we have been made familiar. On the left-hand side of the great gateway was the slaughter-house. Its purpose is unmistakable, for the artist has shown the carcase of the ox, the severed head, the flayed skin, the trussed birds, and the tethering stones. Along the whole length of the temple on both sides, the court is shown crowded with altar-tables, each accompanied by a lamp-stand. The tables are set out with loaves, a joint or two of meat, and a bowl of burning incense. Presumably they are offerings of private persons, which the priests were under contract to serve. At the back of the temple are seen eight oblong lavers or bathing tanks, and all the material for a

ceremonial offering, a rite prescribed perhaps before entering the second sanctuary. Such an offering we see being made by the King before the gate of the greater temple (I. xxv.).

THE GREATER SANCTUARY. THE FAÇADE.—The entrance to this building was by a gateway immediately opposite the outer gate. It was an imposing structure, finding room on each broad face for five masts, from the high tops of which red pennants gaily fluttered.<sup>2</sup> These masts were firmly secured to the towers by being passed through two rows of pierced stones projecting from the masonry, and by having their feet stepped in heavy pedestals. The passage was barred by two double-leaved gates. The inner one being high and unwieldy, a similar but smaller gate was set within its jambs, contracting the passage.<sup>3</sup>

Meryra's artist indicates the open door by a free passage merely, but the other artists both by line and colour (deep ochre) show the leaves flung back against the wall, in a way which, in the case of double gates at least, is quite impossible.

A feature of the pylon has been left unnoticed, viz. the eight columns, which in I. xxv. are seen between the flagstaffs on both sides, arranged in two tiers of four. This, however, is a mere architectural convention, signifying that a portico of such columns, two deep and four broad, ran along the frontage on both sides. This interpretation is furnished by the entrance pylon to the second temple. Elsewhere it is shown as a pylon of this form, with two tiers of two columns; but in I. xxxiii. a side-view in perspective reveals that this signified to the initiated a portico of four

<sup>2</sup> The evidence of the foundations, suggesting greater depth than breadth for this pylon, does not seem compatible with the pictures and is in itself surprising. Can they be foundations for colossal statues? (PETRIE, *T. A.* § 35.)

<sup>3</sup> *L. D.* iii. 243 shows such an arrangement for a doorway between pylons.

<sup>1</sup> The artists by no means agree which entrances had additional gates. Meryra assigns them only to the doorway of the greater sanctuary, Panchesy to those of both sanctuaries, others to all the chief gateways. No further notice will be taken of this variation.

columns two deep extending along the façade. Unfortunately the device could also represent a colonnade on the *inside* of the wall. But in face of the above unmistakable explanation<sup>1</sup> we are obliged to apply it to the greater sanctuary also and imagine its frontage formed by a portico of columns, eight in line and two deep, broken by the entrance, and with the towers and masts reaching high above it in the centre. Such a unique façade we find actually portrayed in the building shown in I. xxxii.,<sup>2</sup> which, indeed, may be a minor sanctuary built in general on the model of the great temple, but comprising only its first three courts, throwing these into one, and substituting an elaborate platform for the great altar of the Aten.

THE COURT OF THE GREAT ALTAR.—The temple, though extensive, was very simple in arrangement, consisting of a succession of seven courts, each entered by a gateway in the axis of the temple. The first court seems to have been bare of adornment, three of its sides being occupied by a series of little chapels or magazines, each separate and of the same pattern. Shown in elevation as little pylon-like erections but in plan as mere cells, they must represent side-chapels or store-chambers open to the sky. The contents of the room are seen, not only through the open doorway, but, by fictionary drawing, through the front walls.<sup>3</sup> A stand, piled with joints of meat and accompanied by a large water-jar or two, forms the unit of provision, and five or six such occupy each of

the little magazines. The centre of the court is occupied by the great altar, probably four-square, like its earlier model at Deir el Bahari. It is set on a wider base, has panelled sides, a cavetto-cornice surmounted by a parapet sculptured with open lotus flowers, and finally a series of rounded castellations which serve to retain the offerings. To this altar a flight of nine (?) steps<sup>4</sup> ascends, guarded by a ramp. It ends, according to II. xviii., in a little platform, but this is probably only introduced as a convenient base for the figures of the King and Queen. The altar is piled high with joints of meat, fowl, bouquets, and bowls of incense. In I. xxv. it seems as if the space within the altar and under the steps was used for storage of meat-offerings, but more probably these are only sculptured on the sides. Near the altar are four erections, two of which appear to be lavers, divided into four basins each, corresponding to those at the gate of the smaller temple. The other two appear to be empty tables or slabs. Numerous subsidiary places of offering are also shown in this court.

THE COLONNADED COURT.—The second court appears to have only been a forecourt to the third. It is occupied by small tables of offering and magazines of the type just described, each artist depicting as many as his space admitted. The third court was colonnaded, but it is hard to realize the arrangement from the very diverse representations. The earliest picture (II. xix.) gives a clear and natural disposition, the back of the court being occupied by a colonnade of eight columns<sup>5</sup> two deep (as on the façade). As the central passage is closed, not only by the gate of the court but also by a small gate flush with the outer row of columns,

<sup>1</sup> Yet III. xi. (L. D. iii. 102) perversely puts this colonnade of the second temple inside. II. xviii. also leaves the great pylon blank, suggesting that the portico, if there, was within. I. x.A shows an alignment of four columns only, perhaps by confusion with the second temple.

<sup>2</sup> In the illustration in Part I., p. 40, I set the first colonnade inside, but I now think that the elevation given in I. xxxii. must be taken as an exact picture of the façade.

<sup>3</sup> II. xviii. again refrains from adopting such a convention.

<sup>4</sup> In I. xii. the altar is in plan, but the steps are shown by the colouring to be at once in plan and elevation. Seventeen steps are improbable besides.

<sup>5</sup> It is evident that the space below the apparent base of the temple does not show the court outside it, but continues the representation of the interior.

it seems that this row was linked by a dwarf wall (corniced), and it must be this that is shown like a pillar between the last column and the end (top) wall. A little three-roomed building is placed under the colonnade at this end, and another close by it in the open court.

The two pictures in Meryra's tomb, however, show arrangements which differ considerably from this and partially from one another, but agree in the number of columns. Huya's colonnaded court (III. x.; *L. D.* iii. 101), if identical with it, shows a greater divergence. While the first two pictures represent a colonnaded space which does not occupy the whole of the court, Huya's court is completely colonnaded, the little door and the dividing wall having disappeared. The plans in Pane-

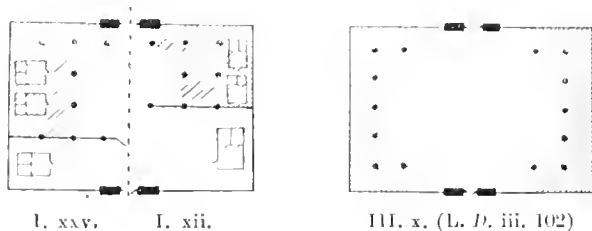

COLONNADED COURT.

hesy and Huya (earliest and latest), though divergent, are both simple and in accordance with Egyptian architecture. Those of Meryra are themselves divergent and difficult to reconstruct intelligently. The simplest explanation is to suppose a complete change of this court during the interval, and that I. x.a and I. xxv. reflect either the progress of the change (or changes), or a compromise between the final form and the original plans. I suggest then, that after the court had been built with a simple colonnade of sixteen columns on one side, it was decided to turn it into a place of adoration of royal statues, with a colonnade round all four sides. If the plan in Huya's tomb does not represent the court in question, we should still have to suppose a change in construction from the 8 by 2 colonnade of II. xix. to one 6 by 4 (I. xxv.),

or 6 by 3 (I. xii.), with gaps in the inner rows, forming an irregular hypostyle hall within this court.

**THE REMAINING COURTS.**—The fourth court only contains a few offering-tables and seems to be a mere forecourt to the succeeding two, which are furnished in an almost exactly similar way. A great altar (ascended by steps in II. xix.?) occupies the centre of each court and is piled high with varied meat and drink offerings, &c. Round the walls are sixteen little magazines,<sup>1</sup> each having its table and lamp-stand. The vacant spaces of the court are set out with small altars, and with stands containing the materials, vessels, and vestments used in the various ceremonies.

With this court the end of this sanctuary is reached. In order to enter the building which lies behind, the suite of courts must be re-traversed to the gates and one of the side avenues taken.

**B. THE LESSER SANCTUARY. THE COURT.**—The gateway to the smaller sanctuary lies at the back of the larger building, but in the same axis. In front of it are the offerings and lavers already mentioned. It admitted, like that of the first temple, to an open court, in the midst of which the building stood. The uses to which this space was devoted are manifest from the various drawings, which differ but little, and evidently follow a common exemplar. On the left hand of the gateway was a great stela set on a high pedestal and reached by a flight of steps or a ramp. Of this stela, which may have been the "Benben" (I. xxx.), we perhaps possess fragments found on the site, and showing figures of the King, Queen, and princesses.<sup>2</sup> By the side of the pedestal was a sitting statue of the King (coloured black in II. xix.; omitted in I. x.a; possibly accompanied by others in III. xxx.).

By the side of the temple here were set, as in

<sup>1</sup> The number eight seems to be favoured.

<sup>2</sup> PETRIE, *T. A.* § 33.



the case of the other sanctuary, a slaughter-house and a three-roomed villa (with two columns on III. xxx. ; with an official emerging in II. xix.). On the other side are shown several sets of offerings, each consisting of a table of beer-jars, a stool with a stand of offerings and a lotus-shaped drinking cup (?). The space on the right of the gateway is generally occupied by a choir led by a harpist. (I. x.a, I. xxv., III. xxx., and the Royal Tomb: perhaps destroyed in II. xix.). A second band, led by a player on the guitar, is shown in III. xxx. Both player and singers are invariably depicted with shut eyes, indicating blindness. The menials of the temple are also shown in this courtyard, busy at their tasks; one sprinkling the yard with water, and another sweeping and gathering up the refuse, a third replenishing the offerings, others bringing animals for sacrifice.

THE PORTICO OF THE ROYAL STATUES.—The entrance to the temple was by a great pylon, adorned like the first by a portico on the exterior, which is realistically shown in I. xxxiii., but elsewhere by the strained convention already noticed. The temple being less broad than the other has only four columns in alignment instead of eight. In front of each pillar were placed standing statues of the King, holding the crook and fly-flap, and wearing the crowns of the South and of the North in the two rows respectively. Small female statues are shown accompanying his own (I. x.a, III. xxx.); from their size they might be ascribed to his eldest daughter Merytaten, who we know had a shrine in this temple,<sup>1</sup> but more probably they are the Queen's (cf. III. xi., xxx.). The statues of the King are sometimes shown of the stiff Osirian form; at other times as natural figures of a living King. It is a

<sup>1</sup> SHARPE, *Egyptian Inscriptions*, ii. 48. The inscription on this block suggests, too, that it is the base of a statuary group of the King and his daughter.

testimony to the fidelity of the picture that pieces of colossal statues of the King carrying these insignia were found on the spot by Professor Petrie.<sup>2</sup>

For the protection of these statues, no doubt, there was a walled forecourt, entered by a little gate, in front of and enclosing the pylon. Several tables of offerings are shown in it. The same protective purpose apparently was served by a flanking wall, which we find built out from the main edifice on both sides of the forecourt, so as to enclose a small space on all sides but the front. This addition is shown in all copies

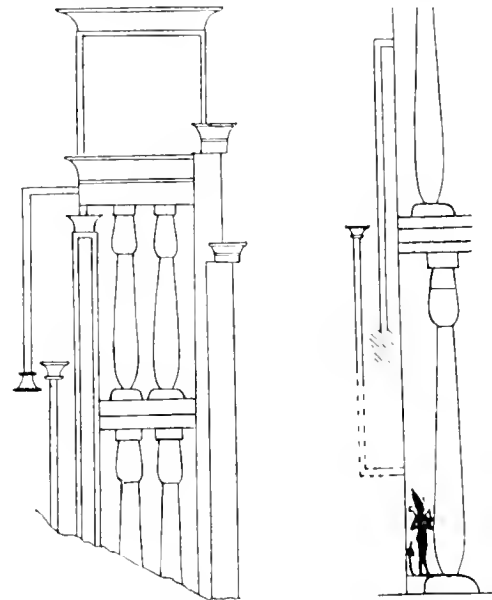

ROYAL TOMB.

III. xxx.

(with the cornice of the wall curiously indicated in II. xix., and perhaps also in III. xxx.). The little villa before-mentioned is set within the court so formed in III. xxx.; II. xix. also shows it occupied.<sup>3</sup>

A similar feature is shown in I. x.a, behind the pylon, and in I. xxxiii. assumes a mysterious form. The construction becomes plain in III. xxx. (supplemented by a less injured representation in the Royal Tomb), and again gives evidence of anxiety for the safety of this sanctuary.

<sup>2</sup> PETRIE, *T. A.* § 34.

<sup>3</sup> It must be due to injury that the pile on the altar here resembles a cow!

It indicates two covering walls like those just noticed, the ends of which, instead of merely approaching and leaving a passage, overlap considerably, and so form a tortuous approach, by means of which the entrance could be easily defended or concealed. The drawing in I. xxxiii. harmonizes with this explanation, if the single covering wall there shown, furnished with a gate, falls within the corridor behind the pylon. That corridor then forms the second turn of the path. The visitor to the sanctuary, after passing the forecourt and pylon, was obliged to turn sharply to one hand down a narrow passage, and as this itself lay within a corridor, he had to double back before he could find an entrance to the inner rooms. The copy in II. xix. also shows a very devious instead of a direct ingress, but omits the protecting wall.

COURT OF THE ALTAR.—This presents much the same appearance as the 5th and 6th courts of the outer temple, chapels or magazines being ranged round three sides, and the open space in the centre occupied by a great altar of offerings and by smaller articles of furniture connected with the oblations. All the copies agree in allowing no entrance to the temple from the rear.<sup>1</sup>

THE ADJOINING SHRINE.—There remained, however, another building, outside the boundary wall according to I. x.a, but within and joined to the back of the temple in all other plans; yet marked by all as independent of it.<sup>2</sup> To safeguard the sanctuary from violation under cover of this building, its rooms were separated from the temple by an empty passage (double or treble according to II. xix.), which was only

entered by doors in both sides of the temple, and so could be easily patrolled. The true entrance to this subsidiary building was by a door at the rear. In the tombs of Panehesy and Meryra it is furnished only with the smaller paraphernalia of worship. In III. xxx. the interior is left a complete blank.

The question as to the identity of the elaborate building shown in Huya's tomb must be reserved for the next volume. There remain for discussion the terms under which the temple or temples of the Aten are referred to in the texts.<sup>3</sup>

The references to the temple, other than as "the temple (*per*) of Aten" are as follows:—

(1) "The splendid places which Pharaoh made in the Sanctuary of the Benben in the temple of Aten." I., p. 36, Pl. xxx.

(2) "The singers and musicians in the court of the Sanctuary of the Benben, and (in) every Shade of Ra in Akhetaten (?)" [var., "every sanctuary in Akhetaten"]. I., p. 51, Pl. xxxvii. (where the rendering should be as above).

(3) "May she (the Queen) grant . . . water and offerings in the Sanctuary of the Benben" [var. "in the temple of Aten"]. Pl. xxi., p. 32.

(4) "May he (the King) grant . . . an offering at every festival of the living Aten in the Sanctuary of the Benben." Pl. ix., p. 31.

(5) "The elect who hear thy sweet voice (the King's) in the Sanctuary of the Benben." *Recueil*, xv., p. 47.

(6) "Conducting Queen Tyi, to let her see her 'Shade of Ra.'" L. D. iii. 101.

(7) "The Aten . . . in the 'Shade of Ra' of the Queen mother . . . Tyi." L. D. iii. 102.

(8) "The Aten . . . in the 'Shade of Ra' of the Princess . . . Merytaten . . . in the 'House of Rejoicing' of the Aten in the temple of Aten in Akhetaten." SHARPE, *Egyptian Inscriptions*, ii. 48. (Brit. Mus. 1000.)

(9) "The Aten . . . in the midst of the 'House of Rejoicing' of the [Aten] . . . PETRIE, *T. A.*, pl. xii.

Further, in the stelae K and X, by the decay of which a complete story of the doings of Akhenaten at Akhetaten seems to have been

<sup>1</sup> Owing to injury the exact arrangement of the buildings at the rear in I. xxxiii. and II. xix. is open to question.

<sup>2</sup> The earlier plans of the temple ruins by ERBKAM not only show the smaller sanctuary as a distinct edifice, but also this dependent building jutting out at the rear of it (cf. L. D. i. 64).

<sup>3</sup> The interesting article of Prof. BREASTED on this subject (*A. Z.* xl., pp. 106-113) only came into my hands when this chapter was already in print.

lost to us, the King enumerates seven buildings which he has made for the Aten:—

1. "The Temple of Aten."
2. "The [Sanctuary?] of Aten" (a very short name).
3. "The Shade of Ra" (of the Queen?).
4. "The 'House of Rejoicing' of Aten . . . in the island (?) 'Aten, eminent in *sed*-festivals' in Akhetaten."
5. "The 'House of Rejoicing'" (in the same locality).
- 6 and 7. (Possibly not buildings, but dues, &c.)

This is an imposing list for the few years<sup>1</sup> at Akhetaten, but let us consider how many of these represent separate buildings.

It is to be observed that both the Sanctuary of the Benben and the House of Rejoicing are "in the temple of Aten," and the "Shade of Ra of Merytaten" is within the House of Rejoicing. The "Shade of Ra" of Tyi was also in the same place, if Huya's building is taken as an abbreviated picture of the temple. The finding of pieces of about seventeen royal statues at one side of the temple site, when that picture shows sixteen such statues on each side of the court, is a remarkable coincidence.<sup>2</sup> Moreover, one fragment from the same spot bears the record, "the Aten . . . in the House of Rejoicing."<sup>3</sup>

What is "the Shade (or Shadow) of Ra"? The meaning "spirit of Ra," or "image of Ra," is here inapplicable. In a religion which recognizes only the beneficent Sun a grateful shade could not be regarded as a conquest of the hostile action of the Sun, but must be attributed, however illogically, to the action of the Sun itself. The "sun-shade" then may have its natural meaning of a shelter from the sun's heat and light, and as it is evidently applied here to a building, it must be a covered building. Probably the only screened buildings in the temple of the Aten were the porticoes under which the royal statues were placed; and as we see Queen

Tyi being led towards such a portico containing her statues among others, it is almost certain that "her sun-shade" is equivalent to "her colonnade." Perhaps Merytaten also at a later date had a portico in this colonnaded court, but this cannot be asserted, and the "House of Rejoicing" remains unidentified.

Since it is evident from the pictures that "singers and musicians" had very special duties in the courts of the second temple, the quotation (2) above affords a strong proof that that is the "sanctuary of the Benben"; to say nothing of the presence in that court of the only monument to which the word Benben can apply. This smaller temple must have been the chief centre of worship. Here are the singers and the servants. It is to this alone that the King pays most of his visits. On the other hand, the offerings which are besought for the dead, and which seem to be granted from amongst those made to the King and to the Aten, are expected to come from the sanctuary of the Benben. There also the King's voice is most often heard and the festivals held, we are told.

The "House of Rejoicing" signifies probably no more than a place of worship; for the cult of the Aten seems to have been specially marked by demonstrations of joy. "The House of the propitiation (*shelep*) of Aten," of which one May is steward,<sup>4</sup> is more likely to refer to some storehouse of the temple than to a sanctuary. (Cf. I. xxx.)

The representation of the smaller sanctuary so often by itself shows that this was a perfectly independent part of the temple and of great importance. The addition to this of the colonnaded court of the temple in the tomb of Huya suggests that this also had a certain separateness, and it may not be fanciful to see a real significance in the three suns whose out-

<sup>1</sup> The date of the stelae is doubtful; probably the fourth year (post-dated).

<sup>2</sup> PETRIE, *T. A.* § 34.

<sup>3</sup> *Ibid.* and pl. xii.

<sup>4</sup> DARESSY, *Recueil*, xv. 41; cf. PETRIE, *T. A.* p. 33, pl. xxii.

stretched arms mark off the house of the Aten, as it seems, into three parts (II. xviii, xix; less decisively in Pentu). Certainly the three divisions so made might well correspond with the three definite sanctuaries:—

(1) "The Temple of the Aten" proper, viz., the *enceinte* and the court of the great altar.

(2) "The House of Rejoicing," containing the "Sun-Shade" of Tyi and comprising courts 3 to 6 of the greater Sanctuary.

(3) "The Sanctuary of the Benben," coinciding with the smaller Sanctuary.

#### PANEHESY.

11. THICKNESS OF PARTITION WALL. Plates xxii., xxvii.

Cf. L'HÔTE, *Papiers*, xi. 29 (reproduced in AMÉLINEAU, *Sépulture*, pl. xcix., p. 644).

Only the left side of the passage to the inner chamber is sculptured. Here a large figure of Panehesy (unnamed) is given, which by its marked difference from the conventional figure which has elsewhere stood for him, seems to be a real attempt at portraiture. The shape of the head shows us how consciously conventional the typical El Amarna head is, and how far from being founded on racial peculiarities or realism. It shows also that if Panehesy's name has any racial significance it must be taken in its more general meaning "Southerner," not "Negro"; for both he and his sister (Plate xxiii.) show the utmost contrast to the negro type. In front of Panehesy is a little female figure, in whom we may recognize his daughter, though she is unaccompanied by any inscription. It is the only tomb at El Amarna where a recognition of the deceased's descendants is permitted.

#### PANEHESY'S HOUSEHOLD.

SHRINE. EAST WALL. Plate xxiii.

Previous copies are:—

HAY, MSS. 29,817, fol. 63. (inscription). L'HÔTE, *Papiers*, xi. 29. LEPSIUS, *D.* iii. 91k, m, and *Text*, ii, p. 132 (inscription).

With the exception of the tomb of Huya, this is the only case in which the walls of the shrine are decorated; and here the sculpture is confined to the East wall, where Panehesy and his household are shown sitting at table, conformably to the use which this little apartment was hoped to serve for those buried in the tomb.

We may gather from the scene that Panehesy was a widower with one little girl, and allowed his house to be managed by his sister, who had been left a widow with two daughters. These all appear with him therefore in this banqueting scene, sitting together before a low table, which is spread with a blue table-cloth and various viands. Panehesy is seated on a slender leather-bottomed stool and his little daughter on a joint-stool at his side. "His beloved sister, the house-mistress Abneba (Abka?), *maatkheru*," sits behind her brother on a chair, her two daughters standing by her side. They appear from their dress and headgear to be older than their cousin. Akhenaten's attraction to women, and the chance that made him father of a large family of daughters, may, not improbably, have strengthened the importance attached to the female line at his court, which flattered him by giving prominence to its women also. It may even have gone so far that on the monuments they ignored the existence of sons, as daughters were neglected in earlier times.

A male figure in front of Panehesy offers a bouquet, that he may inhale its perfume. No name or description is appended; for the writing above him seems only to contain his pious wish, "His reward from the Aten (?). May he grant thee a good old age as to a favourite." Over the head of Panehesy is written "Unto<sup>1</sup> the great favourite of Ua-en-ra, the Chief Servitor, etc., etc., Panehesy, *maatkheru*." The figure is apparently set there

<sup>1</sup> Correcting to .

merely to suggest that ministration and intercession which Panehesy hoped to receive often within this shrine from friends and visitors. An enormous bouquet is painted on the wall behind this figure, more for decoration of a blank space than as part of the picture. It is repeated also on the door-check close by, and a border of similiar kind is traceable on the back wall, where scarcely a vestige remains of the seated statue of Panehesy, which once, no doubt, occupied the room.

It need hardly be said that we know nothing more of Panehesy than may be gained from his titles in this tomb, and his possession of one of the few spacious tombs presented to the favourites of Akhenaten. His offices may fitly be collected here:—

(1) Chief Servitor of Aten in the temple of Aten in Akhetaten (*passim*).

(2) Servitor of the Lord of the Two Lands, Nefer-kheperu-ra, in the temple of Aten (Plates iv.e, xxi.).

(3) Second priest of the Lord of the Two Lands, N., who giveth life (Plate ix.).

(4) Intimate of the King (Plates viii., xx.).

(5) Superintendent of the Granary of the Aten in Akhetaten (Plate iv.e).

(6) Superintendent of the oxen of the Aten (Plate iv.d).

(7) Chancellor of the King of the North (Plate xxi.).

Panehesy seems, then, to have taken only second rank to Meryra in Akhetaten, and in view of the titles 5 and 6 we are probably not making a great assumption if we suppose that the lower half of the W. wall contained much the same scene as that which fills the space under the picture of the temple on the E. wall of Meryra, viz. his reward for the excellent administration of these two departments. Meryra, indeed, is there probably sharing the credit and reward of his subordinate's successes; a share, however, which may have been due to him.

## C.—THE RELIGIOUS TEXTS.

### I. THE LONGER PRAYERS.

#### 1. (Outer thickness. W. side. Plate vii.)

“An adoration of [Ra-Horakhti, &c.], who giveth life for ever and ever, at his dawning on the Eastern horizon [and] a propitiation of him at his setting on the Western horizon. Homage to thee! Thou dawnest in the sky and shinest in the morning<sup>1</sup> on the horizon of heaven, coming in peace, the Lord of Peace. All mankind lives at sight of thee, the whole land assembles at thy rising; their hands salute thy dawning.”

(Said) by the Chief Servitor of Aten in Akhetaten, Panehesy, *maakheru*. He says:—

“Praise to thee, my god who has formed me and dispensed good to me; he who fostered me and gave food to me and provided my goods by his *ku*:<sup>2</sup> the ruler who made me among mankind, who caused me to associate with his favourites, and caused<sup>3</sup> every eye to know me.<sup>4</sup>

“Thou didst bring me to the front from the rear,<sup>5</sup> making me powerful when I was of no account. All my neighbours<sup>6</sup> (rejoiced?) because I became the favourite of him who did it (?). My city came (?) to me. I was supplicated (?) and grew great thereby (?), by a decree of the Lord of Truth.<sup>7</sup>

“I give praise to the height of heaven, I adore the Lord of the Two Lands, Akhenaten, the Fate who gives life, and is Lord of ordinances<sup>8</sup>, the Light of every land in whose time there is life, the Nile-god of the land of men by whose spirit one is fed, the god who maketh

<sup>1</sup> Reading . For the whole salutation, cf. III. ii. and *L'Hôte, Papiers*, iii. 294 (Pentu).

<sup>2</sup> The ascription of beneficent activity to the *ku* of the King is frequent in these tombs. A striking analogy in the Proverbs of Ptahhetep is noted in *PETRIE, Religion and Conscience*, p. 179.

<sup>3</sup> Reading .

<sup>4</sup> The Plate is completed from *L'HÔTE* (v. *AMÉLINEAU, Sépulture*, pl. lxxxiv.)

<sup>5</sup> Reading .

<sup>6</sup> Reading .

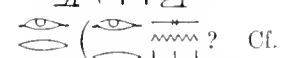
<sup>7</sup> Reading . Cf. *L'HÔTE*'s copy)

<sup>8</sup> Reading .

<sup>8</sup> See Plate viii. col. 12.

princes and formeth the humble, the Breath of all nostrils,<sup>1</sup> by whom men breathe!

“For the *ka* of the Chief Servitor of Aten in the temple of Aten, Panehesy.”

2. (Outer thickness. E. side. Plate viii.)

“[An adoration of the living Aten] and of the King of the South and North (here follow the two titularies of the King and that of the Queen). Praise to thee, O Ua-en-ra . . . . . the whole [land] . . . . . [they live at seeing thee] . . . . . (column 7) . . . him thy favourite.”

“(Said) by the great favourite [of the good god]<sup>2</sup> the Chief Servitor . . . . . of Aten in the temple of Aten in Akhetaten, Panehesy. He says—

“Hail [each one in] Akhetaten who desires good fortune<sup>3</sup> (?). Relate to one another the benefits which my ruler did to me. He caused me to associate with princes and companions. I was promoted to praises (?). When I knew not the companionship of princes I was found to be an intimate of the King. His Majesty is Ra, who formeth the humble at his pleasure, and creates princes by his *ka*. (He is) the Fate who confers life, the Lord of wholesome ordinances. When he is appeased every land has joy, when (?) . . . . . is provided in the house of the King, power arises in the palace . . . . . reward. The silent man becomes loud of voice<sup>4</sup> by his teaching (?), the possessor of daily favours. His body thrives at sight of thy goodness . . . . . then others after me shall say ‘How is the intimate of the King, the Chief Servitor of the Aten, Panehesy, prospered!’”

2. THE SHORTER PRAYERS.

1. (Plate v. Lintel of S. Door. Left side.)

“Praises . . . . . mankind [gives] praises (?) . . . . . mankind. They live because of thy dawning. Thriving and firm of countenance is he who seeth thee; he increases wealth (?)<sup>5</sup> in the palace.

“Said by the Chief Servitor, &c., Panehesy.”

<sup>1</sup> Reading 

<sup>2</sup> Reading .  should have been printed in the plate.

<sup>3</sup> Conjecturing  (?). Cf. ceiling inscription, No. 3, Pl. xxi.

<sup>4</sup> Reading 

<sup>5</sup> Emending to  as the first  is doubtful.

2. (*Ibid.* Right side.)

“Praise to thee, the living Aten, who illumines heaven and earth by his dawning, Lord of Eternity, Maker of Everlastingness. When he rises all the land is in joy. His rays produce eyes for all that he has created. Men say ‘It is life to see him; there is death in not seeing him.’

“The Chief Servitor, &c., Panehesy *maakheru*.”

3. (Plate xxi. Lintel of N. Door. Left side.)

“Praise to thee, the living Aten, Lord of that which is, Creator of that which exists. When thou dawnest all mankind live, their hands giving praise to thee; the whole land gathers together at thy rising. Health<sup>6</sup> to Ua-en-ra thy fair child. Give to him millions of<sup>7</sup> *sed*-festivals.”

“(Said) by the Chief Servitor, &c. [Panehesy].”

4. (*Ibid.* Right side.)

“Praise to thee, the Aten, [Lord] of Eternity, Maker of everlastingness, and (to) the *ka* of the King, who lives on Truth, Lord of the Two Lands, Nefer-kheperu-ra, who giveth life, my Lord who formed me, fostered me, gave me a happy life in the service of his *ka*.”

“(Said) by the Chancellor of Lower Egypt, the beloved of the Lord of the Two Lands, praised daily by his Lord, the Chief Servitor of Aten, &c., Panehesy.”

5. (Plate iv. Tablet of N. Column. Left side.)

“Praise to thee, the living Aten, Lord of Eternity, Maker of everlastingness. I give praise to Ua-en-ra. I propitiate the good ruler.”

“(Said by) the Chief Servitor, &c., Panehesy.”

6. (*Ibid.* Right side.)

“Praise to thee, the living Aten, who illumines the Two Lands with his beauty (and to) the *ka* of the King. Thou art Ua-en-ra, the son of the Aten. Life, prosperity, and health in the daily affairs of every day!”

“(Said) by the Chief Servitor, &c., Panehesy.”

The two prayers in the S. column are too broken to be of use.

7. (Plate xxi. Ceiling Inscription, 2.)

“Praise to Thy *ka* [my] Ruler, Light (?)<sup>8</sup> clothed in love like the Aten, producing eyes for the land (so that)

<sup>6</sup> Reading 

<sup>7</sup> Reading 

<sup>8</sup> Conjectural reading . Cf. Plate vii. and I. xxxviii. The three inscriptions are so defaced that the whole text is more or less conjectural.

they (the people) see by means of it<sup>1</sup>; their Nile-god who makes them live (?), the Breath of life who hears the desire (?) . . . . . Nefer-kheperu-ra. Grant that my two eyes may see thee daily, my lord, and that I may not fail (but) be firm (?) . . . . . There is life in the service of the lord; life is not in possessions.

“For the *ka* of the Chief Servitor, &c., Panehesy.”

S. (*Ibid.* Inscription No. 3.)

“The great favourite of the good god, the Chief Servitor, &c., Panehesy, *maakheru*, says—

“Ho! one and all who are in Akhetaten, desiring . . . . . [Relate] to one another the benefits which the ruler, my lord, did to me<sup>2</sup>; namely, that he gave to me gold from the daily bounty (?) . . . . . whom his lord advanced (?) in rank,<sup>3</sup> whom the King of the South made, and the King of the North fostered,<sup>4</sup> whom the Lord of the Two Lands made by his *ka*.”

BURIAL PETITIONS.

(To be recited by visitors on behalf of the dead.)

1—4. (Plate ix. South Door. Left jamb.)

A *seten dy hetep* of—

(1) Ra-Horakhti.

“May he (the god?) grant<sup>5</sup> entrance with the right (conferred by) the Lord of the two Lands, advancement (?) in rank by his Lord,<sup>6</sup> and the accomplishment of his designs.”

(2) Nefer-kheperu-ra.

“May he grant a term of old age, and vigour of body, and that old age be decreed for thy relatives (?) ”

(3) Akhenaten.

“May he grant [a reception of the loaves]<sup>7</sup> that are offered in the Presence, and purity of his hands at the prostration in the court.”

(4) Nefertiti.

“May she grant a laudation (?)<sup>8</sup> of the King in his house, my lord who forms, makes, fosters.”

*Close*: “For the *ka* of (the favourite of the Lord of the Two Lands) the Chief Servitor of Aten in the temple of Aten in Akhetaten, Panehesy.”

5—8. Right jamb.

*Introduction.* As before.

(5) Ra-Horakhti.

“May he (the god?)<sup>9</sup> grant entrance and exit from the King’s house. May he (the deceased) be established, and his turn not fail (?), until he becomes *amakh* (the state of the rewarded dead) in the peace which the favourites of the Lord of the Two Lands enjoy.”

(6) Nefer-kheperu-ra.

“May he grant a sight of the living Aten<sup>10</sup> at his rising and an adoration of him, and that he may listen to what thou sayest as (he listens to) his favourites.”

(7) Akhenaten.

“May he grant a reception of loaves, presented at every festival of the living Aten in the hall of the Benben.”

(8) Nefertiti.

“May she grant the entrance of favour and the exit of love,<sup>11</sup> and a happy recollection in the presence of the King, and that thy name be welcome in the mouth of the Companions.”<sup>12</sup>

*Close*: “For the *ka* of the Chief Servitor of Aten in the temple of Aten in Akhetaten (or, in cols. 2 and 1, “the second priest of the Lord of the Two Lands, Nefer-kheperu-ra, who gives life”), Panehesy, *maakheru*.”

9—12. (Plate xxi. North Door. Left jamb.<sup>13</sup>)

*Introduction.* “Praises to thy *ka*, Nefer-kheperu-ra (9 and 11), Akhenaten (10), Nefertiti” (12), with the proper titularies.

(9) “May he grant a happy old age and a journey with favours to the hill of Akhetaten, thine everlasting seat.”

(10) “May he grant a long life, seeing thy beauty: may the sight of thee not fail any day.”

<sup>1</sup> Reading

<sup>2</sup> Cf. prayer 2, p. 30.

<sup>3</sup> Cf. petition 1, below.

<sup>4</sup> Cf. Part I., p. 49.

<sup>5</sup> The *t* inserted into the word in these four columns must be a blunder. Yet see ceiling inscription 3. Pl. xxi.

<sup>6</sup> *Ibid.*

<sup>7</sup> Cf. petition 1, Part i., p. 53. The space is blank, the hieroglyphs not having been cut.

<sup>8</sup> Supply (?).

<sup>9</sup> Or the King of the *seten dy hetep*, for on both jambs the requests are for court favours.

<sup>10</sup> Note the rare determinative of Aten, a figure of the god Ra; but whether with the head of a hawk or a man is not clear.

<sup>11</sup> I.e. the *entrée* of an established favourite who never falls into disgrace.

<sup>12</sup> It will be noticed that these court favours, though in the gift of the King, would largely depend on the goodwill of the Queen.

<sup>13</sup> Consult the duplicate copies from both jambs in Part I., pp. 52, 53.

(11) "May he grant that thy offerings be abundant in thy tomb-chamber; may thy name<sup>1</sup> be celebrated for ever and ever."

(12) "May she<sup>2</sup> grant a reception of loaves, that which has been offered in the Presence, a drink-offering and meat-offering in the sanctuary of the Benben."

*Close:* "For the *ka* of the great favourite of the Lord of the Two Lands (2 and 4 'his lord'; 3 'the good ruler'), the Chief Servitor of Aten in Akhetaten" (2 and 4, "the Servitor of the Lord of the Two Lands, Neferkheperu-ra, in the temple of Aten").

<sup>1</sup> The sculptor has only half erased an error.

<sup>2</sup> The later copy in Tomb 4 changes this to "he." If this has been done because the address there is to the Aten as well as Nefertiti, it shows that the petition is to the god.

13—16. (*Ibid.* Right jamb.)

*Introduction* (as on the other jamb).

(13) "May he grant entrance of favour and exit of love, and a reception of the favours of the Lord of the Two Lands, the daily dues."

(14) "May he grant thy tomb of everlasting, thy seat of eternity: may thy name not be forgotten for ever."

(15) "May he grant a good burial after [old age] and interment in the favoured burial-ground."

(16) "May she grant a pleasant recollection before the King, and his favour . . . every day, and that the children of the house pour out libations for thee at the entrance to thy tomb-chamber."

*Close:* (as on the other jamb).



## CHAPTER III.

THE TOMB OF MERYRA II. ( or .

## A.—ARCHITECTURAL FEATURES.

EXTERIOR (Plates xxviii., xxix.).—The position of the tomb has already been described (p. 3). No great labour was expended on the exterior. The bank of rock in which the tomb was excavated was low; and as it was cut back for a very short distance, the portal had to be correspondingly low, and unprotected by a cornice of rock. It has suffered severely in consequence, the surface being in most parts quite weathered away. It can just be seen that the jambs were inscribed in three columns. On the left the titulary of the Aten can be recognized, and on the right familiar phrases of prayer, such as “grant him a duration like (Aten).” On the left these were terminated by the figure of the deceased and his prayer. (Plate xxix. For a translation see p. 45.)

THE HALL (photograph, Plate xlvi.).—This is the only tomb of the north group which has kept its columns intact, and the outer hall presents in consequence a very pleasing aspect architecturally. The walls, too, owing to their unfinished and unpainted condition, present a cleaner surface and reflect the light freely. The columns which, conformably to the small size of the wall, are only two in number, support architraves parallel to the axis of the tomb, and decorated with a running inscription on the

outer side (Plate xxxvi., translation on p. 45). The ceiling between them is higher than at the sides, and slightly arched. The columns are of the type elsewhere used, and in appearance most nearly resemble those in the tomb of the other Meryra (I. ii.). In this case, however, the sheathing is not marked, the tablet is placed lower down and so as to face the incomer, and the heads of the inserted bundles of three stems each are shown in sculpture above the bands. Neither abacus nor tablet has received inscriptions. The entrance from outside has no framing, but that to the second chamber is decorated with the usual portal, and the pediment above is adorned in paint with the usual series of cartouches and figures of the deceased at prayer (a short inscription lost?). The top of the doorway has been broken away in order to admit more light to the inner rooms. This was done, no doubt, by later occupants, who have also cut a neat recess in the wall close by, and drawn two rough sailing-boats in ink. The west wall of the tomb is quite blank of sculpture or design. The north wall is also bare, except for the sculpture and sketch given in Plate xli. The pit found in this room is probably not contemporary, and is sure to have been violated. I therefore left it uncleared.

THE INNER CHAMBERS.—These are of the narrow transverse pattern adopted for the corridor type of tombs. Two rock-cut architraves cross the ceiling. A mastaba was left at the east end to receive the mouth of the burial shaft, but of this there is only the merest commencement.

<sup>1</sup> So called here in order to distinguish him from the chief priest of this name (Part I.). The tomb is No. 2 (No. 6 of Lepsius). Cf. *L. D. Text*, ii., pp. 137, 138.

The shrine also is only partially hewn out, but it gives sign of the intended statue of the deceased. The doorway to the shrine was to have been furnished with a decorated door of the type shown in tombs 1 and 3 (III. xix., xxvi.); but it was only begun, even the jambs being only marked out in paint. Here also a recess has been made in the wall close to the door.

THE SCULPTURE.—If the sculptures in many places betray haste, the best parts show considerable powers of drawing the human figure, though those of animals are failures. The arms and hands and Akhenaten's lolling attitude in Plate xxxii. are skilfully rendered, and even the rough execution of the crowded scenes on the east wall does not destroy this power (notably the groups of wrestlers and the leaping children in Plate xxxviii.). The technique is very poor, the final coating of plaster being allowed to fill up the outlines, so that only the larger figures are successful. Wilful injury has robbed us of many important fragments that Lepsius and others copied; and the upper parts of the walls, where the bats congregate, are almost destroyed by their agency.

## B. THE SCULPTURED SCENES.

### 1. THE PRAYERS OF MERYRA.

The thickness of the outer wall. Plates xxx., xxxi.

Previous copies are:—

HAY, MSS. 29117, fol. 63 (name and titles only).

L'HÔTE, *Papiers*, iii., 290, 291 (from which the plates are restored).

LEPSIUS, *D. Text*, ii., p. 137 (name and titles).

The walls are greatly damaged both by time and violence, but, thanks to Nestor L'Hôte, the modern thefts are partially recoverable. It will be seen that the walls were already patched with better stone in ancient time. The figures show nothing distinctive. For translations see pp. 44, 45.

### 2. THE KING AT HOME.

South wall. West side. Plates xxxii., xlvi. (photograph).

Previous copies are:—

L'HÔTE, *Papiers*, xi. 9 (published in AMÉLINEAU, *Sculpture*, pl. xcv., and partially in *Lettres Écrites*, p. 66).

LEPSIUS, *D.* iii. 98b.

PRISSE, *L'Art Égyptien*, ii., pl. xvi.<sup>1</sup>

The scene engraved on this wall has no very obvious connection with the life of Meryra. Its presence here is due to the curious practice of Akhenaten of dispersing the scenes which should have occupied the walls of his own tomb throughout those of his courtiers. As a result, instead of seeing the deceased and his family enjoying the burial provisions, or those earthly banquets which were to be the standard and pattern for *post-mortem* delights, it is the royal family whom we find at the richly furnished tables; while the deceased, as in life, serves his royal master. If his own repast is remembered at all, it is relegated to the walls of his private chamber, the narrow inner shrine.

The King's repast is not an infrequent subject in these tombs, but the scene here shown forms an especially charming picture of royal recreation. Akhenaten sits in one of the kiosks, which were an indispensable part of an Egyptian garden. The light roof is borne on columns, the sides being left open. It was a pleasant custom to hang the ceiling of these garden pavilions with flowers and foliage, and this habit passed into a decorative device. Here we see nature and convention united; for while sprays hang from the roof-beam in all the irregularity of nature, the alternating bud and flower of the lotus form part of the carved design. The stiffly arranged bouquets which are mixed with

<sup>1</sup> I wish to modify my description of Prisse's drawings at El Amarna as reproductions of the plates of Lepsius (I., p. 4). They seem to have been originally independent drawings, often superior to Weidenbach's in detail, but Prisse, or his editor, has added to the plates every additional feature found in the *Denkmäler*, and so has reproduced every inaccuracy of that edition.

the sprays show the transition from nature to art.

The columns of the kiosk show one of those elaborate patterns which are known to us only in picture, no examples having survived. This is natural; for the open-work design of the capitals, often representing, as here, the open flower, could not be executed in stone, and was not, so far as we know, in metal. It must then have been of wood, and very fragile at the best. That shown here is a papyrus column of very peculiar shape. The shaft is solid, and has the peculiar contraction at the foot, where the sheaths of the papyrus are seen. But similarity to the ordinary type ends at the neck, where the shaft is abruptly cut off and furnished with a kind of abacus. On this rests an open-work design representing three open papyrus-heads on slender stems, which gain the needed support by being attached to the interior rim of a ring. (This we must suppose to lie in a horizontal plane, not as in the picture, where the two very different forms given to it show how subjective the representation is.) To the outer rim (?) of this ring or disc are fastened three pendant ducks and as many bunches of lotus, which, while appearing to hang from it, form a clever means of support.<sup>1</sup>

The motive seems to be taken from the sportsman's shelters, hastily constructed in the marshes from the abundant material found there, and to the pillars of which (made also of papyrus), the birds which had been secured were naturally hung; hence the strange combination. The attempts of Akhenaten's artists to escape from current conventions, or their imperfect training

in them, often resulted in forms still more false to nature and devoid of grace. This is one of their least happy innovations. Equally regrettable are the substitution of three loose sashes in place of the tight bands under the capital, and the attachment of ribbons to the ring of the capital. This feminine impulse to beribbon everything without regard to fitness is very noticeable under Akhenaten, and may easily be paralleled in our own times as the distorted echo of a real movement towards naturalistic art.

Akhenaten sits under the shelter of this light pavilion, or rather he lolls in that attitude of slack repose which his artists seem to have judged to be characteristic of him, in a cushioned chair (again with irritating drapery round the carved legs), his feet resting on a soft footstool. The Queen, "living and healthy for ever and ever," and her little daughter, no less than the officials of the household, are assiduous in ministering to all his pleasures. He has already in one hand a few flowers from the plentiful supply which little Ankh-es-en-pa-aten has brought. The other hand holds out a shallow patera, which the Queen fills with some choice beverage from a little jar, filtering the liquid through a strainer as she pours. His eldest daughter, Merytaten, stands at his knee, offering some additional gratification,<sup>2</sup> and Meketaten (?) brings the cap of ointment (?) for the head (frilled, like everything else).

It may easily have been that at such entertainments Meryra performed the office of chamberlain, receiving the viands from the servants and tasting them before presenting them to the monarch. At any rate, in the unfinished scene which is appended predella-wise to the main group, an officer appears to be discharging this function. Two vessels are before him on pedestals near a high lamp-stand (?), and he is taking a large goblet from the hands of

<sup>1</sup> The rough execution of the scene has led Weidenbach and L'Hôte to a curious misrepresentation of the capital. Prisse gives it correctly, but elaborates it in plate xviii. of his first volume, as is his wont. I may add here that I found Max Weidenbach's signature on the east wall of this tomb under the scene which he copied there, dated "d. 14 Juni 1845."

<sup>2</sup> Not from a bag: this is the end of her father's sash.

a servant. Here, too, are shown the musicians of the harem, who divert the King with music. These female performers, six in number, are all furnished with stringed instruments, two playing the harp of seven strings, two the lyre, and two the lute (or the viol with the bow?).

The picture is framed in the familiar border, the blue sky stretches above, and the free space under the ceiling is filled in with coloured bands.

### 3. MERYRA REWARDED BY AKHENATEN.

South wall. East side. Plate xxxiii. (comprising Plates xxxiv. to xxxvi.) and xlvii. (photograph).

Previous copies :—

L'Hôte, *Papiers*, xi. 15 (published in AMÉLINEAU, *Sépulture*, pl. xciv., p. 634); iii. 130, 131, and *Lettres Écrites*, p. 70 (captives only).

LEPSIUS, *D. Text*, ii., p. 138 (Princesses' names).

The scene on this wall is that repeated on almost every tomb of El Amarna that offers scope for it. The bestowal of golden necklaces and other costly articles of dress or plate (dishes, goblets, cups, gloves, signet-rings, bracelets, fillets, &c., in *L. D.* iii. 103, and perhaps even gold itself in *L. D.* iii. 106) was the traditional proof of royal favour. Except in special cases the scene of this presentation is the verandah of the palace. The building may be altered by omissions and rearrangement, but the essential features are always the same, and point unmistakably to a single impression on the memory of the artist (see Part I., pp. 23-25, 41). Generally only the verandah or only the façade of the palace is shown, but wherever there is space some part of the interior is added behind. In the tombs of Ay, Tutu and No. 7 the whole complex of the royal establishment is depicted; even, in the case of the two first, in duplicate.<sup>1</sup> Here the space was desired for the princesses; yet the artist has managed to place one of the

store chambers at the top of the picture, and so indicate the palace interior by sample. Above the serpent-crowned framing of the balcony are seen the four columns which support the roof, and, to the right, the two columns of the porch. The two doors underneath seem to be the side-doors of the façade, placed there for convenience.<sup>2</sup> The ascent to the balcony is not shown, though the doors are some distance from the ground.

The decorations on the framework of the window correspond, in the main, to that shown in I. vi. Divine and royal cartouches and titularies within variegated borders make the surface rich with fine detail and bright colours. The panel of the front, which is usually filled by a geometric design (I., vi.; III., xvii.), is here filled with a characteristic Egyptian design, the faint ink of which is only partially recoverable.<sup>3</sup> In the centre is the *sam* sign of union. On the right of it is a clump of the plant of the South, growing in the fields (or on trellis-work?) while on the left, a group of papyrus stems, the plant of the North, springs from the clods. Some of the stems grow up straight, others bend over and meet them flower to flower, and yet others fetter the necks of captives; of whom there are three on each side. The captives bound by the plant of the North represent races of the North (three different types?). Similarly those on the right belong to the negro races of the South (cf. Plate iii.). The design thus combines two ideas; the union of the two Egypts and the subjection to each of its neighbour races. The captives walk on tiptoe, whether in indication of their half-throttled state, or whether, like Agag, they walk delicately in apprehension of the worst.

The interest of the royal family in the reward given to one, who as superintendent of the

<sup>2</sup> The space between has been cut away in ancient times, as if on account of something objectionable.

<sup>3</sup> Cf. *L. D.* iii. 109.

<sup>1</sup> Partially in *L. D.* iii. 106*a* (one-half was never cut) and 109.

Queen's household was so well known to them, is made evident. The King, who from the balcony hands down the necklaces one by one to Meryra, receives them from the hands of the Queen; she, in her turn, having been supplied with them by the princesses Merytaten and Meketaten. Their younger sisters, Ankhes-en-pa-aten, Nefer-neferu-aten the younger, and Nefer-neferu-ra are also present.<sup>1</sup> Very little exaggeration has been shown in the drawing of these childish figures; far from being flaccid, they are notably thickset and sturdy (Plate xlvii.). The King's sash is richly worked, as in l. xvii. The ties at his breast seem to indicate some upper garment too thin or close-fitting to be represented. The triple sets of armlets which Ankhes-en-pa-aten wears are only uncommon because this painted detail has so often perished. The thick cushion of the balustrade is upholstered in red, with diamonds of blue and another colour.

In the courtyard of the palace (Plate xxxv.), one of the outer gates of which is seen in the right-hand top corner, are assembled the King's train, two royal chariots, and the indispensable scribes and attendants of Meryra. This official himself stands in the porch close under the balcony, and receives a great double necklace from the hands of the King to add to the two which are already upon his neck. Three scribes are busy making entries of the gifts.<sup>2</sup> It will be noticed that the ancient Egyptian servant, like the modern fellah, was wont to save his precious shoes from wear as much as possible, carrying them with him merely for use when his foot-soles gave out.

The group of foreigners (ambassadors?) is interesting for the variety of dress and head-gear which they exhibit. Unfortunately, the painted detail is imperfectly preserved. The

picture of the bearded Semite with a heavily-fringed garment wound round and round his body in graceful folds, and secured round the waist by a broad girdle into which a handkerchief (:) is tucked, is unmistakable. The negro tribesmen wear the white *jibbeh* with red sashes and belts, or else tunics from which one or more real or imitated tails dangle. It is impossible to say if the men in the topmost register carry weapons or only wands of office.<sup>3</sup>

The dado (Plate xxxvi.) shows, as usual, the by-incidents of the scene; in this case, the return of Meryra to his home, and his acclamation by the household there. The lowest register shows Meryra arriving at the gates in his chariot, his neck laden with the king's bounty. Men and women have come out to meet him. The former raise their arms and applaud the new fortunes of their master; the latter, forming into a choir, dance, beat cymbals and wave branches.

Above this is shown the next movement in the little drama. Meryra has passed through the gates and, on descending from the chariot, is again saluted with exuberance by his servants. Unable to contain themselves, they dance and shout, and one falls on the ground to kiss his master's feet. Even the charioteer joins in the acclaim: the grooms show a more practical devotion, and are already busy rubbing down and feeding their charges.

Meanwhile the servants bring the whole bounty of the king, set out on tables, that Meryra may see its full extent. It includes a grand repast, sent from the royal kitchen. The picture which we gain here of the villa of an official of Akhetaten is interesting. It is shut in from the outside world by enclosing walls and a high gateway, in front of which two trees have been planted. The space immediately

<sup>1</sup> The names are now destroyed: they are completed in the plate from *L. D. Text*, ii. p. 138.

<sup>2</sup> For details of the chariots and trappings see Part I., pp. 26, 27.

<sup>3</sup> Red hair is observable here and in other tombs, but I am inclined to think that it is due everywhere to the disappearance of the black pigment, which generally fades first and leaves the red of the preparatory sketch.

within the gates is pleasantly laid out, date-palms, alternated with shade-giving trees, being set in rows on both sides of a T-shaped tank. A gateway in a cross-wall (shown in section) admits to another courtyard, at the back of which is a small building. The walls carry no roof, and the gateway also implies an open enclosure: yet the porch and the contents within suggest a ceiled room. Behind this again is seen a fragment of the harem; whose occupants, not being permitted to share in the demonstration outside, are giving themselves to dancing and mirth within the walls. The building above represents the main building, containing the dining-hall. The staff of servants is cleverly suggested by the house-boy, who leisurely sprinkles the floor with water from a jar, and the *barwib* (doorkeeper), who has nothing to do but lean idly against the door-check and gossip.

#### 4. THE TRIBUTE OF THE NATIONS.

East Wall. Plates xxxvii. (comprising Plates xxxviii.-xl.) and xlvii.

Previous copies are:—

HAY, MSS. 29,814, foll. 47, 48; 29,817, fol. 64 (inscriptions).

L'HÔTE, *Papiers*, xi. 3 (published in AMÉLINEAU, *Sépulture*, pl. xevi., p. 638).

LEPSIUS, *D.* iii. 99b (pavilion only).

The scene on this wall not only is new in kind and manifestly records an historical event, but a descriptive note and a date are appended to it. The one, it is true, is brief and very bald, and the other too broken to be reliable; but fortunately there is in the adjoining tomb a second, though very differently treated version of the same or a similar occurrence, the dating of which is clear, and agrees with what remains of the numbers here. The inscription is as follows:—<sup>1</sup>

“Year [twelve, second month of the winter season, eighth day] of the King of Upper and

Lower Egypt, living on Truth, Lord of the Two Lands, Nefer-kheperu-ra, Son of the Sun, living on Truth, Lord of [Diadems], Akhenaten, great in his duration, and the great wife of the King, his beloved, Nefertiti, living for ever and ever. His Majesty appeared<sup>2</sup> on the throne of the Divine and Sovereign Father, the Aten, who lives on Truth; and the chiefs of all lands brought the tribute<sup>3</sup> . . . . . praying favour at his hand (?) in order to inhale the breath of life. The inscription in the tomb of Huya records the event as the bringing of tribute from Kharu and Kush (Syria and Ethiopia), the East and West, and the islands of the sea; a description probably more rhetorical than exact.

The scene is cleverly set out. The King, drawn to a large scale, sits enthroned in the middle of the picture, accompanied by his family. On the right the tribes of the South (Plate xxxviii.), on the left the nations of the North (Plate xxxix.), approach the platform humbly. The dado (Plate xl.), shows the foreground—the crowd on this side of the pavilion. The canopied platform on which the King sits to receive the gifts is similar to several shown on these tombs, and yet cannot be identified with any of them (Pl. xxxii.; I. xxxi.; III. xiv.); for the light columns here are as unique as those on the south wall (Pl. xxxii.). They carry a triple capital, formed by the papyrus, the lotus (?), and the lily, superimposed one upon the other in an ungraceful combination.<sup>4</sup> The royal pair sit on cushioned

<sup>2</sup> Conjectural reading .

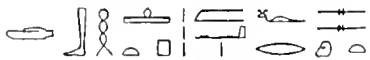
<sup>3</sup> Reading  (?). . . . . . The word might mean “gift” merely, but, in view of the scenes, forced gifts must be meant.

<sup>1</sup> Reversed by accident in the revised copy on Plate xxix.

<sup>4</sup> The capitals are very roughly cut, and their shape is somewhat indeterminate.

chairs side by side, with their feet resting on double hassocks. Even at this public appearance before men of foreign nations their attitude to one another is still most amatory. The Queen has her right arm thrown round her husband's waist, and her left hand reposes in his. So much is perceptible: but the bodies of both have been almost erased from the hips upwards in ancient time. As usual, all but the bare outline of the farther figure was covered by the nearer.

Six princesses are shown, a number greater than is found elsewhere. The new comers are Nefer-neferu-ra, whom we have already seen on the south wall, and Setep-en-ra. The pretty groups have been injured by time and ruined by thieves, but the names and attitudes are preserved in several earlier copies and squeezes.<sup>1</sup> Meketaten turns her head to her sister, and so shows us the side without the hanging lock. Attracted by the smell of a pomegranate (?) which Ankh-es-en-pa-aten is holding to her nose, she is stretching out her hand for another which is in her sister's right hand. Nefer-neferu-aten seems to be holding up a tiny gazelle, and her sister behind has a similar pet on her right arm, which Setep-en-ra is tickling. Both hold flowers in the other hand. The different ages of the children is not indicated by their height or demeanour. As Setep-en-ra does not appear on the south wall, it may be that she was born during the decoration of the tomb, about the fourteenth year of the reign. Three nurses of the children stand by the side of the platform.

The titulary of the sun above contains some indecipherable additions to what is usual (perhaps "in the great desert of Akhetaten" on the left).

In front is depicted, in six registers, the bringing of gifts by negro tribes of the South, and though the picture does not convey the

idea of a spontaneous and unforced payment of tribute, this may be a mistaken impression. In the topmost register are specimens of the gifts. On native initiative and artistic impulse, apparently, the tribute of the South was wont to be made more presentable by the inclusion of set pieces, which were sometimes very complex and even, in a barbaric way, picturesque (cf. *L. D.* iii. 118). One of the commonest and simplest methods was to decorate a yoke with skins and tails of animals, and with rings of gold suspended in long chains or sewn on a foundation of skin or cloth. These hung from the yoke, while a row of ostrich feathers adorned the upper side. One such pole is seen resting on a stand, and two others are being borne by negroes.

A second trophy, of which an example is seen here, takes the form of a representation of the *dôm* palm, presumably in precious metal. In *L. D.* iii. 118, also, it is set in a basket, but here the blocks (ingots of silver?) instead of being built into an elegant pyramid are merely placed in two rough piles. Behind these trophies are seen trays holding ingots (?), bags of gold dust, and rings of gold; also shields, bows, and arrows, &c. Below, similar gifts are being presented by negro chiefs, from Wawat or Mam in Ethiopia, to judge by their dress (cf. Plate xxxv. and *L. D.* iii. 118). Ivory, and the eggs and feathers of the ostrich, form part of the tribute, and the Egyptian love of animals is gratified by the inclusion of tame leopards, a wild ox (?), and an antelope (?).

In the third and fourth registers we see prisoners taken in a raid, or perhaps slaves as a natural item of the tribute. About a dozen male negroes are being dragged forward by ropes tied round their necks and fettering the wrists also. Half that number of women are being led in the same way, except that their hands are left free. Each is accompanied by three or four children, the elder ones led by the hand, the youngest one or two carried in a

<sup>1</sup> The additions to the plate are from *L. D.* iii. 99b.

pannier which rests on the back, but is supported by a band passing round the forehead. This seems to have been a custom general among several tribes (cf. NEWBERRY, *Beni Hasan*, ii., plate xlv.; WILKINSON, *Manners and Customs*, i., p. 272).

The next register exhibits a war-like scene, but as weapons are absent, it is to be interpreted as a series of athletic exercises by the troops, who show their prowess in this more pacific form. The sports are of three kinds, wrestling, singlestick, and boxing. In the first competition, two out of the eight combatants have thrown their men, who lie helpless on their backs as dead. Two of the contests are still being stubbornly disputed, though the victors can be easily foretold. The execution of these scenes is very rough, but their vigour is unmistakable. There are only two rivals in the fencing, and one of them has already received a decisive blow on the head. Of the three sets of boxers, one pair is still struggling for the victory, but the victors of the other rounds are already jumping for joy and loudly proclaiming themselves.

Meanwhile Meryra (?) and four other officials are humbly ascending the platform to present themselves to the King. They are followed by their shade- and fan-bearers, and by others who may be a select body of the troops which took part in the expedition, or formed the escort to the mission. In the midst the street boys give unrestrained expression, after the manner of their kind, to their delight at the whole proceedings (cf. III. xiv.; L. D. iii. 104). A little group also shows proleptically the intended decoration of Meryra with the double necklace. Honours appear to be reserved for his companions also; for as many necklaces are displayed on stools, and the closed coffer may also contain something more in the way of reward.

On the left of the platform (Plates xxxix. and xlvi.) the peoples of the North (our East) are seen. Those in the six registers immediately

behind are evidently Syrians, to whom the Egyptians applied the loose term *Retnu*. Nearly all have the bushy hair and full beard, and the robe wound in several turns round the body from ankles to neck. Some, however, have the head shaven, though the beard is long; —a type which Professor Petrie classes as Amorite.

At the top of the picture we see a large part of the gifts grouped, consisting of those weapons of war which their Syrian campaigns had taught the Egyptians to prize and use. There are bows and quivers (?), falchions and daggers (?), spears, shields, coats of mail (?), and a chariot, with its two horses. Beneath, we see other presents in the hands of men of the *Retnu*. Three young girls who form part of the tribute are pushed forward in front, as likely to win favour for the rest. The kneeling figures in this and succeeding rows show, no doubt, the leaders of the embassy.<sup>1</sup> Among the gifts here are a metal vase, a casket, an elephant's tusk, a bow and arrows, and three animals, an antelope,<sup>2</sup> an oryx, and a lion. In the next row nine captives or slaves are led forward by Egyptians: their hands are fettered by handcuffs. The two vases shown here may have had ornamental covers (Hay credits the shorter with a panther's head), but the state of the wall prevents the exact forms of the vessels on it being ascertained with accuracy.

The next register seems to show a separate deputation, perhaps from the land of the Amorites. Their gift comprises two maidens, a chariot and pair, and various vases of fine workmanship, including a mounted trophy with the head of a lioness on the lid. The lower two registers may show still another tribe of the

<sup>1</sup> These figures often seem to have had their hands amputated, and though this would be quite credible in prisoners of war, it is rather to be set down to clumsy drawing and decay. The wall seems to have suffered since the early copies were made.

<sup>2</sup> A stag, according to L'Hôte.



Retnu, but there are no means of distinguishing it. Their gift consists chiefly of vases in fine metal work. Besides these, there are two antelopes, and a file of slaves, including women and children.

The enumeration of the tribes of the north who presented tribute at this time is continued in the long registers below, perhaps with this difference, that there is no longer any show of force, but a much greater likeness to embassies of peace.

In the topmost of these three rows (Pl. xl.) a small deputation of seven men is seen, who are clothed simply, and much after the Egyptian fashion. Their offerings are of an equally simple nature, and clearly from a fertile, but not a manufacturing land. There are calves (or calf-shaped metal weights), piles of grain or incense shoulder-high, which two men are measuring up, and precious metal (?) formed into a flattering imitation of the two characteristic Egyptian structures, the pyramid and the obelisk. It seems certain from these offerings that they are sent from the land of Punt,<sup>1</sup> its people being grouped here with the northerners as a non-negro race.

The next embassy is as plainly that of a desert population. The eggs and feathers of the ostrich are all they have to offer. Their flowing, open mantle, and the side-lock, and the feather in the hair proclaim them to be Temehu or Lybians.

While the dress of the remaining nation marks it out as Syrian, the queue into which the hair is drawn behind indicates the formidable Kheta (Hittites?) of the distant north. So far, however, from appearing as members of an invading horde, the elaborate and tasteful metal-work which they have to offer, as rich no doubt in material as in form, betokens the highest civilization.

When we seek a more definite origin for

these vessels by a comparative study of the metal-work of Syria we find it a difficult task, though vessels of similar types are often seen on Egyptian monuments.<sup>2</sup> They are generally attributed there to the Retnu, a term which at its loosest could cover all Syria; for to the Egyptians, as to us, these racial names were largely only rough geographical distinctions. The vase, adorned by a bounding bull, as well as that in which the full-faced head of a bull with a disc between the horns forms the cover, is seen in the tribute of Rameses III. at Karnak, where they are attributed to the Retnu. Hittites, however, are seen to be included there under this name. In the tomb of Reklmara, where a more careful classification is to be looked for, the finely-chased vases with richly ornamented rims are put in the hands both of the Keftiu (Cretans?) and of the Retnu; but the use of animals, or animals' heads, as ornaments, and the more elaborate creations, are assigned to the Keftiu. Amongst them are pieces which are almost duplicates of the heads of the ox and the lioness found in our picture. The long-necked lipped jug here brought by the Kheta is carried both by Keftiu and Retnu elsewhere.

Where, then, was the centre of this cultured manufacture? The answer may be supplied by a scene in a Theban tomb,<sup>3</sup> where the chiefs of the Kheta, the Keftiu, Kedesh and Thenpu (probably Tunip, a city which in Akhenaten's time was in the hands of the Kheta), are presenting vases very similar to those shown here. "A sculptor" follows the chief of Tunip, carrying a piece of plate. He wears the dress of the Keftiu, and most of the men who follow, bearing vases, are of the same nationality. A few

<sup>2</sup> See I. xxxi.; PETRIE, *History*, ii., pp. 109-123, &c.; PRISSE, *Histoire de L'Art Égyptien*, ii. plates 73-78; ROSELLINI, *Mon. Civ.*, plates lvii., lviii., lxii.; L. D. iii. 115, 116; *Mission Française*, v., plate iv.

<sup>3</sup> VIREY, *Mission Française*, pp. 202-205. The semi-publication of these tombs is to be deplored.

<sup>1</sup> Cf. VIREY, *Reklmara*, pl. iv.

resemble in face and dress "the chief of the Kheta" there shown; but he does not show the peculiar Hittite face or garb. From this and other evidence we might gather that the country of the Keftiu was the home of the craft, and that the neighbouring nations, the Hittites, Retnu, and others imported these splendid products, and perhaps even learned to imitate the less elaborate forms; so that it was as much by their agency as by direct trade with the Keftiu that they were introduced into Egypt.<sup>1</sup> The recent discoveries in Crete render this hypothesis extremely likely by pointing to that island as the home of the Keftiu.

There is no reason, then, why such vases should not be found in the hands of the Kheta, though it is just possible that our artist has erroneously drawn Hittites for Keftiu; for the Hittites, by reason of distance, are less likely to have sent tribute, and while they are not named or seen in the tomb of Huya, the people of "the islands of the sea" there named are not depicted.

The remaining groups on the wall do not form part of the embassies, but are Egyptian. Below, i.e. on this side of the royal pavilion, is ranged a large body of troops. The six men drawn up in line in front show, perhaps, the number of files, but of these only two are actually depicted. They are curiously armed. Some men of the first file are dressed in the short tunic of the Egyptians, and carry a long staff curved at the upper end, and a battle-axe. Two feathers are worn in the hair. Others wear a longer tunic and carry only a javelin or curved staff. The hair is worn short and a ribbon attached to the back of the head. The men of the second file carry a spear and a hooked staff alternately.<sup>2</sup> As the curved staff is a

Bedawi weapon, according to Wilkinson,<sup>3</sup> we probably have here the troops who have escorted the embassies into Egypt.

The two palanquins of the King and Queen rest beside the platform. They take the form of state-chairs, each of them carried by two strong poles. Sphinxes bearing the head and crowns of the King of the two Egypts, serve as arm-rests, and the chair is guarded on each side by the carved figure of a walking lion. The floor on which the creature stands is attached to the poles before and behind by a *naz* column, and, in the King's larger chair, by the figure of a kneeling captive also.

Here we meet also the personal attendants of the King, his censuring priest, his servants, whose backs are loaded and hands full of all that he may call for, and the police. The two royal chariots wait in front of the platform, gaped at by a little crowd. Here also is the military escort, and several servants who bring forward, for sacrifice or feasting, bouquets, fowl, and three stabled oxen, whose misshapen hoofs show their fat condition.

It has been made a severe reproach against Akhenaten that by sheer indolence or incapacity he let slip all the conquests that his ancestors had won in Syria. But his policy might be given a very different aspect; for it is clear that a firm hold on Syria, and the compulsion of a heavy tribute, could only be obtained at the cost of repeated military expeditions on the largest scale and in face of enormous risks. That the priesthood at Thebes had reaped the largest advantage from such a policy was little likely to recommend it to Akhenaten, who well knew that there was a method of diplomacy also, which, by preventing a confederation of the Syrian peoples against Egypt, secured to her a supremacy of a less vainglorious sort, and a tribute which, though moderate in amount, was still of considerable value and much less provo-

<sup>1</sup> In the interesting fresco shown by DARESSY, *Revue Arch.* 1895, p. 286, a ship bringing vases of these shapes, including a dish with a walking bull on the cover, is manned by men in the dress of the Retnu.

<sup>2</sup> Cf. VIREY, *Tombeau de Pehsuker*, p. 295.

<sup>3</sup> *Manners and Customs*, iii, p. 218.

cative. The Tell el Amarna letters may not give us a high idea of the skill or spirit with which this policy was carried out by Akhenaten; yet it seems to have been fairly successful till towards the end of the reign. The nations may have "saved their face" by paying tribute in the form of gifts for which they pretended to expect a full exchange, and their rulers adopted an attitude which to us seems intolerable in vassals. Nevertheless, so long as the gifts were sent, Egypt prudently took her revenge in the same cheap form, and with an exaggerated assumption of overlordship, spared her dependent States no humiliation in her chronicles. We should probably then be equally wrong in taking this pictorial record as a faithful mirror of Egypt's foreign relations at this date, or as an elaborate falsehood without any real basis in fact.

There is no sufficient ground for refusing to believe that at this time the nations here represented made a formal acknowledgment of Egypt's suzerainty by valuable gifts,<sup>1</sup> or even that the Kheta, who were already feeling their strength, veiled their hostile intentions under a guise of humility. We may be even more sure, however, that the most has been made of it here, and should be chary of accepting to the full the construction put upon it.

Although it is given the aspect of a payment of tribute in due course, the depiction of the scene in these tombs alone shows that it was extraordinary, and that its presence here is

<sup>1</sup> Dr. BUDGE's assertion in his *History* iv. p. 204, that the embassy from Dushratta, King of Mitani, arrived with presents "in the first month of winter in the twelfth year of the reign," would be of great interest in this connection, were it authoritative. But the date on the tablet in question is broken. The fractured number, the statement that "the court was in the Southern Capital" (Thebes), and the contents of the letter, all speak for the year 2, not 12. This early date in Akhenaten's reign is itself important. I am obliged to Dr. Schaefer, of the Berlin Museum, for a copy of the fragment.

much less due to any part Meryra or Huya had in it than to the stir which it caused. It may have been that missions from such widely separated regions as Coele-Syria, Ethiopia and Punt met by chance in Egypt, and that the opportunity was taken for a parade of Egypt's greatness. Or, late as it was, it may have been the first time that Akhenaten was able to convince the nations that he was firmly seated on the throne of his fathers, and to arrange an exhibition of loyalty. Or, not unlikely, it was the result of timely military demonstrations on the N. and S. frontiers. The promptitude and the liberality with which the tribute was paid by many tribes probably always depended on such significant hints. Even if we regard the prisoners in these scenes as slaves, not captives of war, the military sports suggest that there had been some such expedition on the S. frontier at least. But whether the inducement to bring tribute was more warlike or diplomatic, Meryra seems to have taken a leading part in it. Some unnamed official at any rate is being rewarded, and we may hope that Akhenaten had this excuse for making a political event so prominent in the eternal house of his servant.

#### 5. MERYRA REWARDED BY KING SE-AA-KA-RA.

North Wall: East side. Plate xli.

Previous copies are:—

HAY, MSS. 29847, foll. 63, 61.

L'HÔTE, *Papiers*, xi. 14 (partial).

LEPSIUS, *D.* iii. 99, a (partial).

PRASSE, *Monuments Égyptiens*, p. 3 (cartouches).

The unfinished picture on this wall seems to reflect the troubles which gathered round the new capital in the later years of the reign or upon the death of Akhenaten. Hastily executed, or left in the rough ink-sketch, the figures of the King and Queen, with the familiar cartouches of Akhenaten and Nefertiti replaced by those of Merytaten their daughter

and her husband, Ankh-kheperu-ra,<sup>1</sup> the interrupted project speaks of events, actual or menacing, in which leisured art could have no place. It is somewhat difficult to decide whether the design as well as the cartouches belong to Se-aa-ka-ra's reign, and whether, therefore, these figures represent Akhenaten and his wife or their successors on the throne. In the absence of sufficient grounds of suspicion, we must assume that the whole belongs to the reign, or at least to a co-regency of the new King. Yet it is not obvious why not even one small design should be completed by him, or why the sun and the royal pair should be left untouched. The cartouches seem somewhat large and clumsy in comparison with the rest of the inscription, but the execution of the whole also is very different from that of the other walls. (We cannot object to there being two scenes of the rewarding of Meryra; because that occurs in the neighbouring tomb, and there is, therefore, even a presumption in favour of it.) It might be put forward as a plausible theory that the King's sculptors were called away to work in the tomb of Meketaten, and returned later to complete the scenes. But the execution of the work coincided with an illness of the King, which threatened to prove fatal, and under the circumstances the royal cartouches and figures were not proceeded with: then,

<sup>1</sup> These cartouches have been removed by thieves, only the Queen's cartouche surviving. For the King's we must have recourse to the four copies, which unfortunately give as many readings for the personal name. There is little doubt, however, that the reading of Lepsius, Se-aa-ka-ra—zeser-kheperu (*D. Tert.*, ii., p. 138), must be adopted, as the others are only imperfect readings of this. A squeeze exists among the papers of L'Hôte (*Papiers*, xviii. 1), and though the third sign is broken, *aa* is much the most satisfactory reading. It appears that the state of the cartouche was due to time and rough cutting, not to mutilation, and that it was fairly legible to a practised eye. The two rings of this King (*Petrie*, *T. A.* pl. xv.) cannot shake this evidence, since each suggests a different hieroglyph. The cartouche of the Queen is set a little too high up in the Plate.

when the apprehension concerning the King was justified, the cartouches of his successor were hastily inserted as a date; though events, or the disinclination of the new King, stopped any further progress with the tomb. The burial shafts were never made, and Meryra's hopes of a splendid interment here shared the general ruin. The roughly sketched figures of the King and Queen, the ink of which is now almost invisible,<sup>2</sup> stand under the radiating sun in the centre of the picture. Behind them is the palace and before them their faithful palace official, with his friends and attendants. A part of the group has been removed by the formation of a recess here at a later date. Meryra is standing on a stool, or upborne by his friends with officious care, to receive the guerdon of golden necklaces from the king. His breast is already covered with these marks of royal favour; and it was no doubt a wise proceeding on the part of the new monarch to make sure of the devotion of an official so influential in the royal harem.

#### D.—THE RELIGIOUS TEXTS.

##### THE LONGER PRAYERS.

1. (Thickness of Outer Wall. East side. Plate xxx.)

“When thou settest alive<sup>3</sup> [the Earth]<sup>4</sup> worships thee, West and East give praise to thee, Ra-Aten, who givest life for ever and ever. Thy setting, O Thou that livest upon Truth, is . . . . . They raise shouts to the height of heaven at seeing Akhetaten which Ra made for his son, ‘He who lives on Truth.’ He gives him rule over all countries on which the sun shines. He transmits to him all the circuit<sup>5</sup> that he may gladden his heart therewith<sup>6</sup> . . . . . They are

<sup>2</sup> All existing lines were traced and included in the plate, though many of them must be false lines and the figure restored on them somewhat of a travesty.

<sup>3</sup> In contrast to the idea of a sun that dies at setting.

<sup>4</sup> Conjecturing .

<sup>5</sup> I.e. the land traversed by the sun. Read *shenent* (from a squeeze, L'Hôte, *Papiers*, xviii. 1.).

<sup>6</sup> Cf. Plate xxxvi. and I. xli.

under the feet of Ua-en-ra, beloved like the Aten, who shall live (?) until the ocean goes on foot, and until the mountains rise up to travel by land and water,<sup>1</sup> the good ruler of the Aten. Thou art . . . . the Aten.<sup>2</sup> He appoints as thy boundaries, the Southern . . . . . the breezes, thy Northern (boundaries?) as far as Aten shines. It is thy strong arm that protects the Two Lands, thy valour that makes the *rekhyt* to live; Ua-en-ra, beloved like Aten, great (in his duration?) . . . . .

"The royal Scribe and Superintendent of the royal harem, the Steward Meryra, *maakheru*."

2. (West side of same. Plate xxxi.)

". . . . . [Aten] lord of love, who bare him . . . . . do thou grant . . . . . his duration like thy duration in . . . . . of the giving of the Lord of (?) Eternity and Everlastingness in . . . . . all herds and flocks that go upon four feet, led to the temple of Aten, the Aten has ordained them for 'Him who is great in his duration,' the great and good Nile-god of [the people] . . . . . grant his duration among the living [until] my<sup>3</sup> coming [with] reward in peace. Ordain for him his mansion of [eternity] in the great cliff of Akhetaten, as (for) a favourite of the King.

For the *ka* of the Steward, the Superintendent of the Treasury, the Superintendent of the royal harem of the great wife of the King [mistress of the Two Lands] Nefertiti, who lives for ever and ever, the royal Scribe, Meryra, *maakheru*."

<sup>1</sup>Cf. III. xxix. (L'Hôte, *Papiers*, iii. 287; BURTON, *Excerpta*, plate vii.)

<sup>2</sup>From this point cf. III. xxix.

<sup>3</sup>It should be "his," but the scribe has followed the formula of the E. architrave (Plate xxxvi).

A SHORTER PRAYER.

(Outer jamb. W. side. Plate xxix).

"I give praises to the Ruler (?). He sets on the Western horizon of heaven. May he give pleasant airs to the *ka* of the royal Scribe, the Superintendent of the royal harem of the great wife of the King, Nefertiti, living for ever and ever."

ARCHITRAVE INSCRIPTIONS.

1. (West Architrave. Plate xxxvi).

"A *Seten dy hetep* of the living Aten who illumines the Two Lands with his beauty. He dawns to give life to all the circuit, Aten, fair of forms, radiant with colour. Eyes have life at sight of his beauty; hearts have health when he shines for them. May he give the pleasant airs of the north wind, the milk which appears on the altar, all kind of offerings, all kind of vegetables, bread (?), beer (?), and food at (?) all thy shrines, everything good and sweet, for the *ka* of the Superintendent of the harem of the King, the royal scribe and steward Meryra, *maakheru* in Akhetaten."

2. East Architrave.

"Praise to thy *ka*, O Nefer-kheperu-ra, the good ruler beloved of Aten, the great Nile-god of the whole land, at sight of whom they (i.e. the people) have life, Ua-en-ra beloved like Aten. Every day Ra giveth unto thee, whenever he dawneth, hundreds of thousands of *sed*-festivals. Aten protects his offspring. Thou art his son, 'He who lives upon Truth.' He delegates to thee all his circuit to gladden thy heart therewith. Grant that my life may be with happiness, and that I may see thy beauty until my arrival at the mansion which I have made in the great cliff of Akhetaten for the *ka* of the royal Scribe Meryra."

## INDEX.

Abneba . . . . .	28	Bats . . . . .	9, 34
Ahmes, tomb of . . . . .	2, 6, 7, 8, 9, 20	Benben, the . . . . .	20, 24, 26, 27, 28, 31, 32
Akhenaten (see also Royal) . . . . .	5, 6, 26, 34, 43, 44	Birds in Coptic designs . . . . .	12
„ daughters of . . . . .	6, 7, 28	„ pendant from capitals . . . . .	35
„ foreign policy of . . . . .	42, 43	Blind choir . . . . .	25
„ foreign marriage of . . . . .	15	Bouquets . . . . .	14, 17, 19, 23, 28, 29, 34
„ his prominence in the scenes . . . . .	18, 31, 43	Brickwork . . . . .	1, 4
„ prayers to . . . . .	16, 26, 30, 31, 32, 45	Budge, Dr. . . . .	43
„ statues of . . . . .	21, 25, 27	Bull's tail as ornament . . . . .	14
Akhetaten, ruins of . . . . .	5, 6, 22, 26, 27	Burial pits . . . . .	3, 11, 33
Altars . . . . .	6, 20, 23, 24, 26, 28	„ on surface . . . . .	5
Ambassadors . . . . .	16, 38, 41	„ shafts . . . . .	2, 5, 33, 45
Ambulatory of temple . . . . .	21	„ vaults . . . . .	2, 7, 10, 11
Amélineau, M. . . . .	13, 17, 28, 34, 36, 38	Burton . . . . .	13
Amenhetep III. . . . .	13, 15	Cairns . . . . .	5
Amorites . . . . .	41	Captives depicted . . . . .	37, 40, 41
Animals . . . . .	18, 31, 39, 40, 41, 42	Cartouches of Ra-Aten, form of . . . . .	7
Ankh-es-en-pa-aten, Princess . . . . .	20, 36, 37, 39	„ as ornaments . . . . .	13
Ankh-Kheperu-ra, King . . . . .	44	Ceiling vaulted . . . . .	2, 3, 38
Any, tomb of . . . . .	6	„ designs . . . . .	11
Apse, Coptic . . . . .	9, 11, 12	Cement pavements . . . . .	4
Apy, tomb of . . . . .	6	Censing . . . . .	13, 14, 19, 43
Artists . . . . .	6, 8, 11, 35, 36, 37, 42	Chamberlain, office of . . . . .	36
Atef crown . . . . .	14	“Chancellor of the North” . . . . .	29, 30
Aten, cartouches of . . . . .	7, 15	Chariots . . . . .	16-20, 37, 38, 43
„ Chief Servitor of . . . . .	16, 17, 20, 28, 29, 30, 31, 32	“Chief Servitor of Aten” . . . . .	16, 17, 20, 28, 29, 31
„ determinative of . . . . .	31	Christianity, relations with . . . . .	15, 17, 19
„ dualism in worship of . . . . .	15	Chronology of the tombs . . . . .	5, 6, 7, 45
„ high-priest of . . . . .	8, 20	Cist-tomb . . . . .	5
„ offerings to 13, 14, 17, 19, 20, 22-27, 31, 32, 42, 45		Colonnaded court, plan of . . . . .	23, 24
„ prayers to 2, 15, 16, 17, 19, 28, 29, 30, 31, 33, 44,	45	Columns . . . . .	7-12, 33
„ styled “Father” . . . . .	2, 15, 38	„ representation of . . . . .	10, 22, 23, 24, 35, 38
„ temple of . . . . .	15, 18, 20-28	Coptic emblems . . . . .	12, 13
„ worship of . . . . .	8, 13, 14, 17, 19, 20	„ designs . . . . .	12, 19
Avenue in desert . . . . .	6	„ place of worship . . . . .	4, 9, 11, 12
Axe-head . . . . .	5	„ saint . . . . .	12
Ay, tomb of . . . . .	6, 13, 14, 36	Copts, mutilations by . . . . .	9, 17
Baketaten . . . . .	7	Corniced walls represented . . . . .	21, 22, 24, 25
Balcony . . . . .	16, 22, 36, 37	Corrections of scenes . . . . .	18
		Corridor-type of tombs . . . . .	2, 7, 33

- Crete, evidence from . . . . . 42  
 Cups for holding jars . . . . . 3, 4, 10
- Date, record of . . . . . 38, 41  
 Deir Rifeh . . . . . 1, 12  
 Dress . . . 13, 14, 16, 18, 28, 36, 37, 38, 39, 41, 42  
 Dushratta, King . . . . . 43  
 Dwarfs . . . . . 13, 11  
*Dy hehety seten* formula . . . . . 15, 31, 46
- Ethiopia . . . . . 39, 40, 11  
 Excavation, methods of . . . . . 2, 3
- False doors . . . . . 9, 11  
 Females, importance given to . . . . . 28  
 Flagstaffs of temple . . . . . 22  
 Flowers as offerings . . . . . 11, 17, 19, 23  
 „ as decorations. . . . . 15, 23, 29, 31, 38  
 Foreign relations of Egypt . . . . . 15, 42, 43, 41
- Gateways, construction of . . . . . 22  
 Glass as decoration . . . . . 12  
 Graffiti . . . . . 4, 12, 16, 19, 33, 35
- Harness . . . . . 18, 37  
 Hatshepsut, Queen . . . . . 11  
 Hawata . . . . . 5  
 Hawk, the solar . . . . . 12, 11  
 Hay, Robert . . . . . 9, 15, 16, 28, 31, 38, 41, 44  
 Hittites . . . . . 42  
 Horses, drawing of . . . . . 18, 31  
 Hostages . . . . . 16  
 "House of Rejoicing" . . . . . 26, 27, 28  
 "House of the Propitiation of Aten" . . . . . 27  
 Houses on the hillside . . . . . 1, 2, 4  
 Huy, tomb of . . . 6, 7, 20, 21, 26, 27, 28, 39, 42, 44
- Ink sketches . . . . . 16, 33, 36, 37, 43  
 Intimate of the King . . . . . 19, 29
- Ka* of the King . . . . . 29, 30, 31, 46  
 Keftiu . . . . . 42  
 Kharu . . . . . 39  
 Kheta . . . . . 42, 43  
 Kush . . . . . 39
- Lamps . . . . . 2, 4, 19, 20, 36  
 Lepsius, R. . . . . 1, 2, 13, 15, 17, 28, 31, 36, 38, 41  
 Letters, Tell el Amarna . . . . . 15, 43  
 L'Hôte, Nestor . . . 9, 11, 13, 15-20, 28, 31, 35, 36, 38, 41  
 Lybians . . . . . 18, 12
- Mahu, tomb of . . . . . 6, 7, 17  
 May, the scribe . . . . . 27  
 Mekelaten, Princess . . . . . 7, 8, 35, 36, 37, 45  
 Meryra ii. . . . . 8, 20, 29  
 „ tomb of . . . 2, 6, 7, 9, 11, 18, 19, 20, 21, 24, 26, 29, 33, 31  
 Merytaten, Princess . . . . . 13, 16, 25, 26, 36, 37, 44  
 Mitani . . . . . 15, 11  
 Musicians . . . . . 17, 20, 21, 25, 36, 38  
 Mut . . . . . 15  
 Mutilations, ancient . . . 2, 3, 4, 9, 10, 11, 12, 17, 18, 36, 39, 41  
 „ modern . . . . . 11, 12, 33, 34
- Nefer-neferu-aten, Princess . . . . . 7, 16, 37, 39  
 Nefer-neferu-ra, Princess . . . . . 37, 39  
 Nefertiti, Queen (see also Royal) . . . . . 25, 30, 45  
 „ „ family relations of . . . . . 13, 14, 15  
 „ „ laudation of . . . . . 13, 14  
 „ „ prayers to . . . . . 16, 26, 31, 32  
 Negroes . . . . . 16, 18, 28, 37, 38, 40  
 Newberry, Mr. J. . . . . viii  
 Nezemut-mut, Princess . . . . . 6, 7, 13, 14, 15
- Paint, use of . . . . . 8, 10, 11, 12, 13, 28, 31, 37  
 Palace, the . . . . . 18, 20, 36, 37, 38, 45  
 Palanquin . . . . . 13  
 Pavilions depicted . . . . . 6, 35, 39, 42  
 Pentu, tomb of . . . . . 2, 6, 7, 8, 17, 20, 28, 29  
 Petrie, Professor . . . . . 4, 5, 6, 25, 41  
 Pilasters . . . . . 11  
 Plaster, use of . . . . . 11, 12, 19, 31  
 Police . . . . . 15, 18, 19, 20, 42  
 Portico, mode of showing . . . . . 22, 23, 25  
 Portraiture . . . . . 17, 28  
 Pottery . . . . . 1  
 Prayers . . . . . 2, 3, 13, 14, 16, 19, 29-32, 33, 31, 45  
 Priest, High . . . . . 8, 29  
 „ "Second" . . . . . 29
- Princesses (see Royal Family and names)  
 Prisse d'Avennes . . . . . 34, 35, 44  
 Proverbs of Ptahhotep . . . . . 29  
 Punt, land of . . . . . 41, 41  
 Pylons, entrance . . . . . 24, 22, 25, 26
- Quarries . . . . . 4, 5
- Ra (see also Aten) . . . . . 15, 30, 41  
 Rames, tomb of . . . . . 6  
 Recesses in walls . . . . . 2, 3, 4, 12, 17, 33, 34, 41  
 Rekhmara, tomb of . . . . . 42  
*Rekhyt*, the . . . . . 13, 45

Relations of deceased pictured . . . . .	28	Stone, walls of piled . . . . .	2, 4
Retnu, the . . . . .	41, 42	“ Superintendent of the granary of Aten ” . . . . .	16, 29
Reward of officials, the . . . . .	16, 36, 38, 41, 45	“ Superintendent of the oxen of Aten ” . . . . .	16, 29
Ribbons, use of . . . . .	35, 36	“ Superintendent of the royal harem ” . . . . .	45, 46
Roads in desert . . . . .	5	“ Superintendent of the treasury ” . . . . .	45
Roman remains . . . . .	1	Syria, policy regarding . . . . .	43
“ Royal acquaintance ” . . . . .	19, 29	Syrians depicted . . . . .	16, 18, 37, 41, 42, 44
Royal Family at home . . . . .	31, 35		
“ „ receiving tribute . . . . .	38	T-shaped tombs . . . . .	2, 3, 7
“ „ rewarding officials . . . . .	16, 36, 37, 40, 41	Tanks . . . . .	22, 23, 24, 38
“ „ visits the temple . . . . .	18, 20	Technique . . . . .	11, 34
“ „ worships Aten . . . . .	13, 14, 17, 19	Temple (see Aten)	
“ “ Scribe ” . . . . .	45	“ „ divisions of . . . . .	21, 26, 27
“ statues . . . . .	22, 24, 25, 26	Temples of Akhetaten . . . . .	26, 27, 28
“ tomb . . . . .	6, 7, 20, 25	Tomb No. 7 . . . . .	7, 36
Rudu, tomb of . . . . .	3	Tombs 1A, 1B . . . . .	3, 6, 7
Ruins of Akhetaten . . . . .	5, 6, 22, 26, 27	“ „ 3A-F . . . . .	2, 7
		“ „ 6A-C . . . . .	1, 2
		“ „ scattered . . . . .	3, 4
		“ „ as dwellings . . . . .	1, 2, 3, 4, 33
		“ „ southern group of . . . . .	6, 7, 9, 11, 20
Scenes, lack of variety of . . . . .	20, 36	Trenches in floor . . . . .	2, 3
“ „ re-use of . . . . .	11, 18, 20, 38	Tribute, articles of . . . . .	40, 41, 42
Schaefer, Dr. . . . .	43	“ „ of Ramesses III. . . . .	42
Sculpture, character of . . . . .	11, 34, 40	Tutu, tomb of . . . . .	6, 7, 14, 26
Se-aa-ka-ra, King . . . . .	41	Tyi, Queen . . . . .	5, 15, 26, 27, 28
“ Servitor of the Lord of the two Lands . . . . .	29		
<i>Seten dy hetep</i> prayer . . . . .	15, 31, 46	Ua-en-ra . . . . .	3, 19, 28, 30, 45, 46
Setep-en-ra, Princess . . . . .	39	Union, symbol of . . . . .	10, 37
“ Shade of Ra ” . . . . .	26, 27		
Site of tombs . . . . .	1-5, 9, 38	Vases depicted . . . . .	41, 42
Slaves depicted . . . . .	40, 41	Villas pictured . . . . .	21, 25, 38
Soldiers . . . . .	17, 18, 20, 40, 43		
Sports, military . . . . .	40	Weapons . . . . .	18, 19, 41, 43
Stairways . . . . .	2, 4, 7, 10, 11, 12, 23, 36, 40	Weidenbach . . . . .	34, 35
Staples . . . . .	3, 4	Wilkinson . . . . .	40, 43
Statues . . . . .	9, 11, 22, 24, 25, 27, 31	Windows . . . . .	1, 2, 16, 17, 22, 37
Stelae . . . . .	1, 4, 5, 6, 24, 26, 27		
“ Steward ” . . . . .	45, 46		
Stone, condition of . . . . .	1, 10, 33		



PLATES.

## NOTE.

An index to the passages in the text which are explanatory of the several plates will be found on page vii.



EL AMARNA II.



Scale  $\frac{1}{5500}$

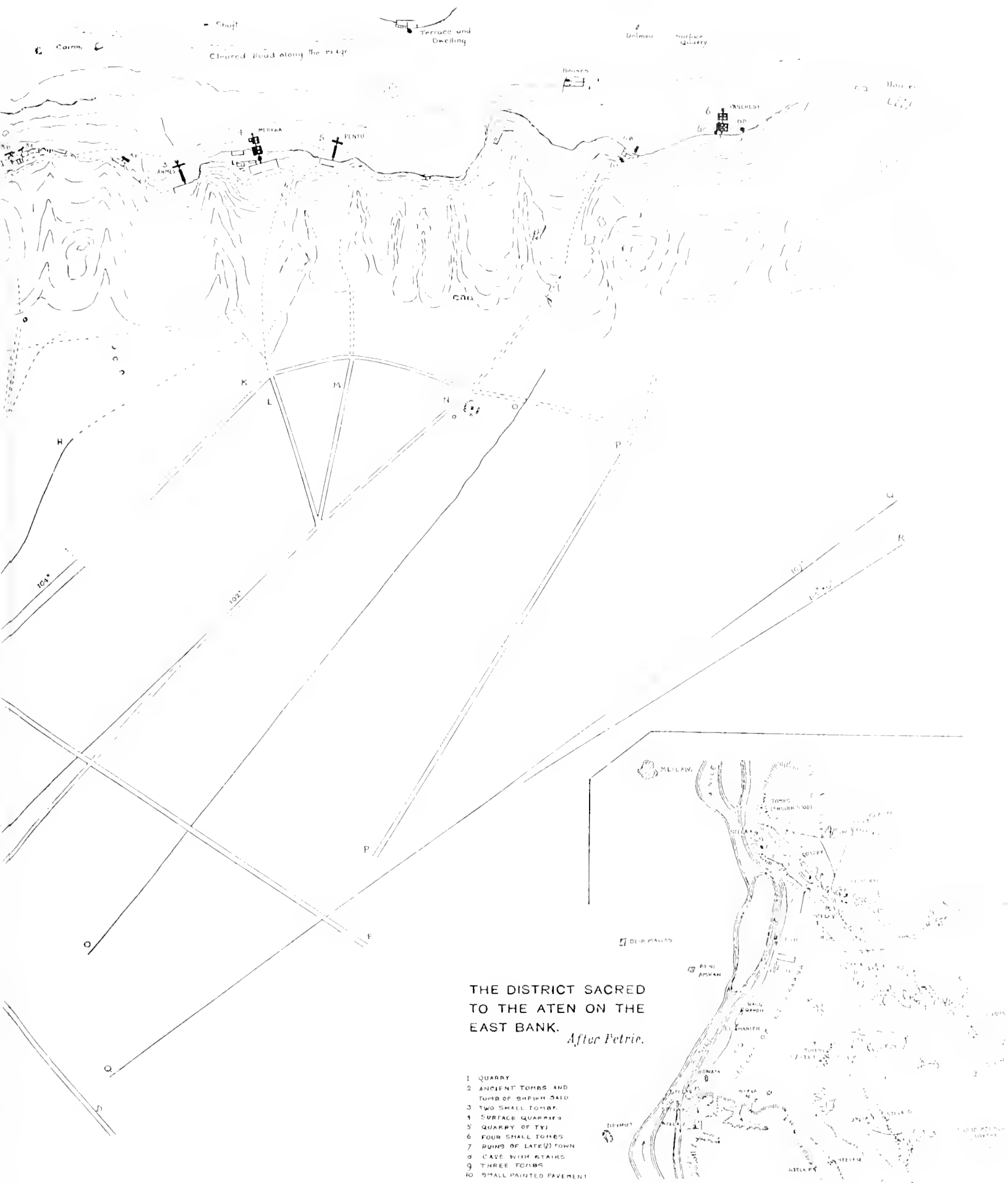

THE DISTRICT SACRED TO THE ATEN ON THE EAST BANK. *After Petrie.*

- 1 QUARRY
- 2 ANCIENT TOMBS AND TOMB OF SHESHA DALE
- 3 TWO SMALL TOMBS
- 4 SURFACE QUARRIES
- 5 QUARRY OF TYPH
- 6 FOUR SMALL TOMBS
- 7 RUINS OF LATE(?) TOWN
- 8 CAVE WITH STAIRS
- 9 THREE TOMBS
- 10 SMALL PAINTED PAVEMENT



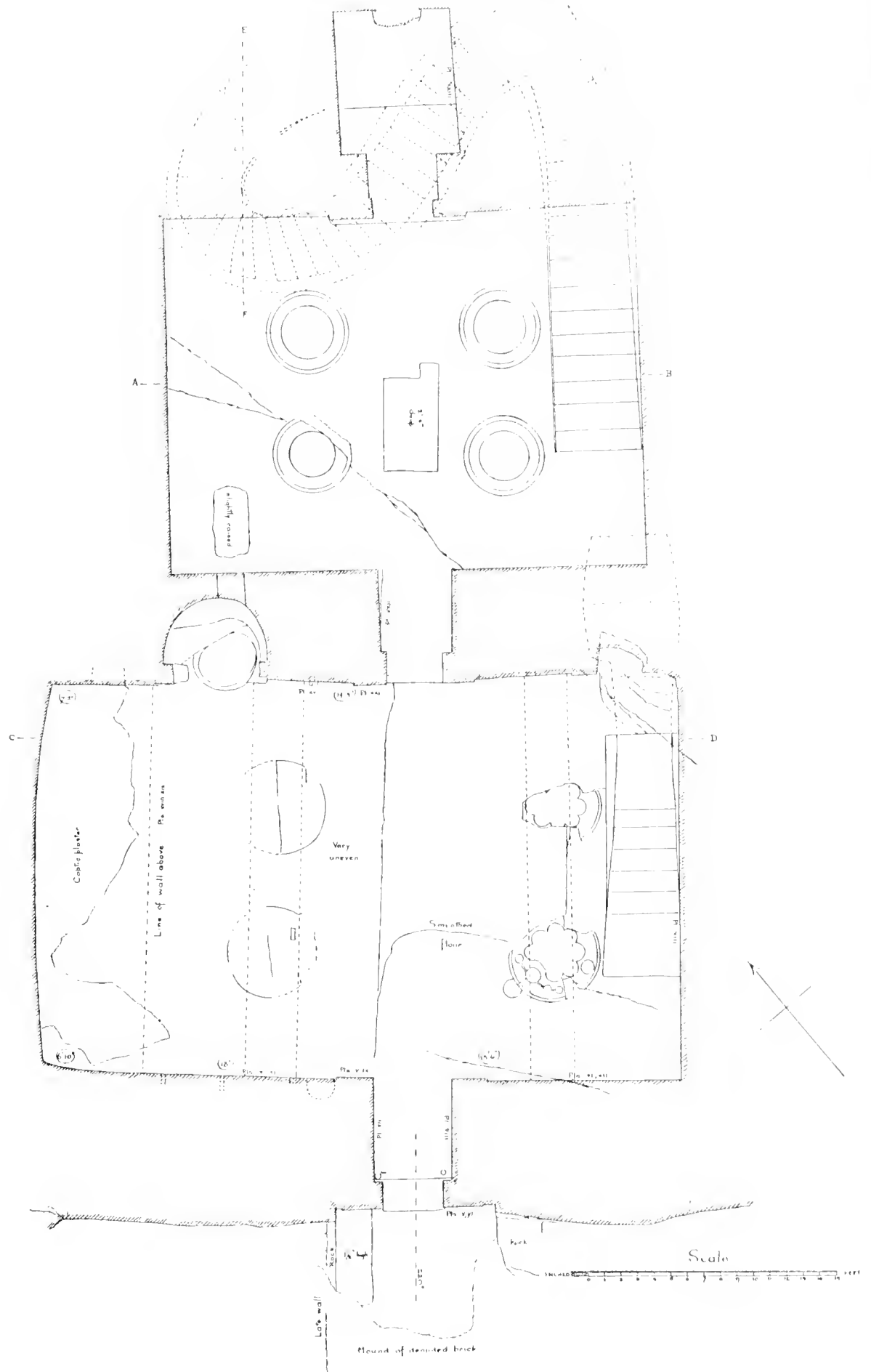

Scale  $\frac{1}{100}$





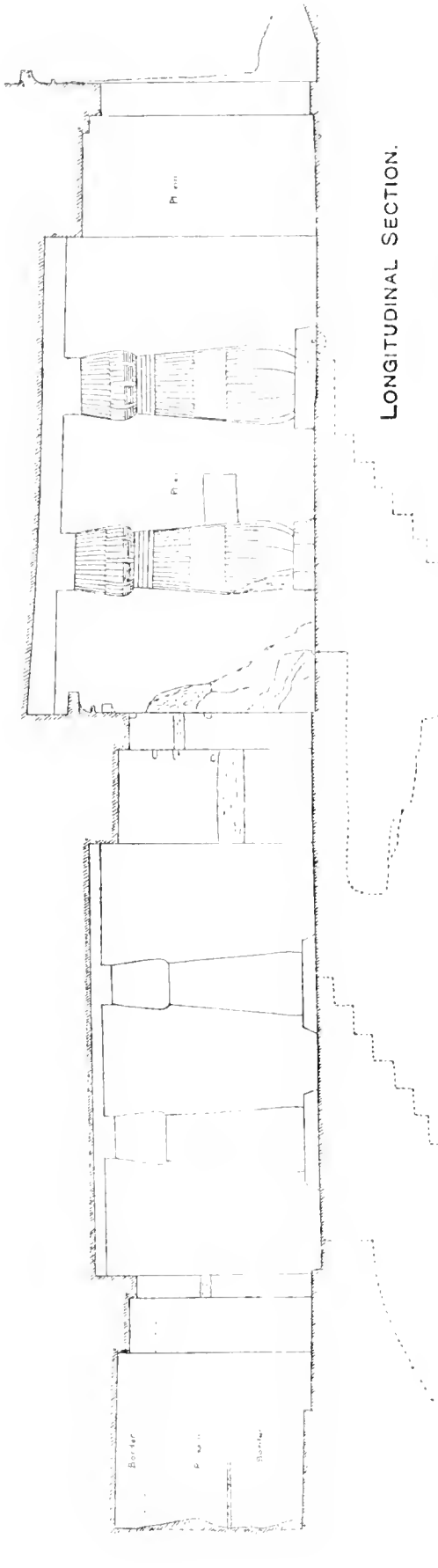

LONGITUDINAL SECTION.

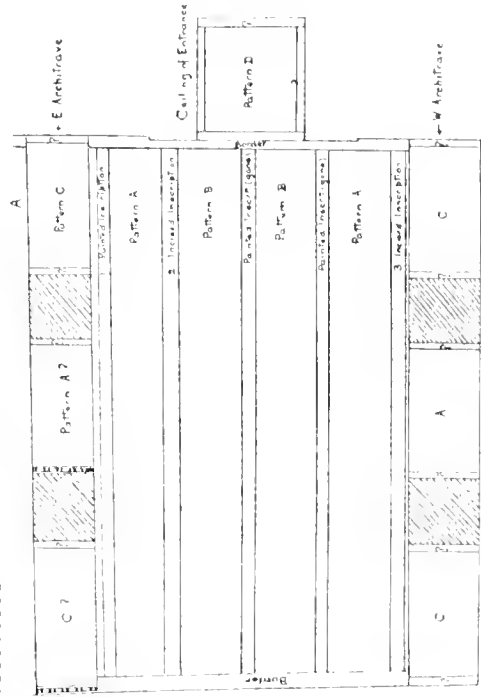

SCHEME OF CEILING DECORATION

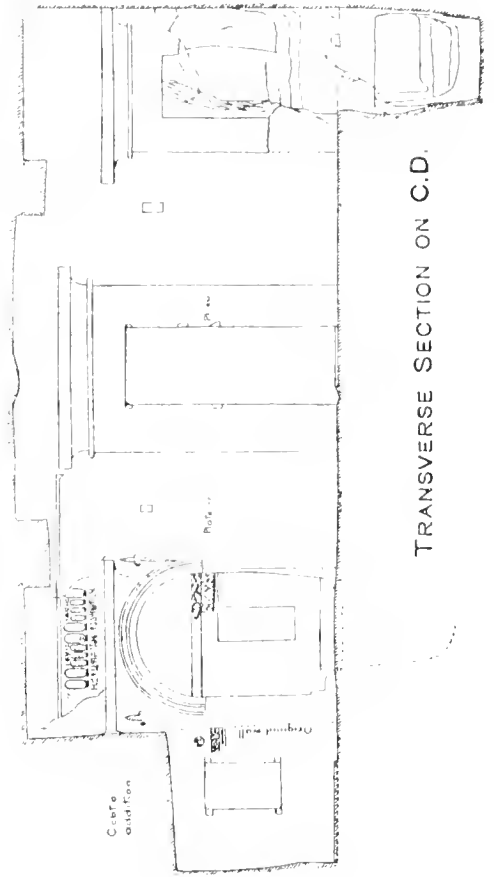
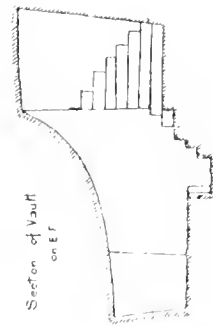

TRANSVERSE SECTION ON C.D.

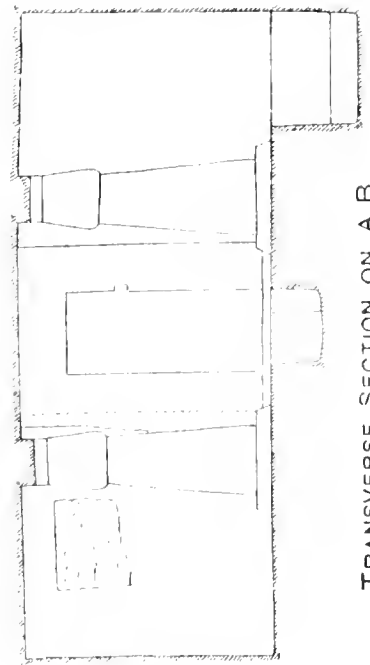

TRANSVERSE SECTION ON A.B.



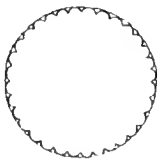

Section on A B

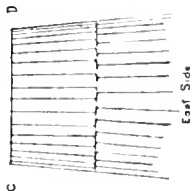

East Side

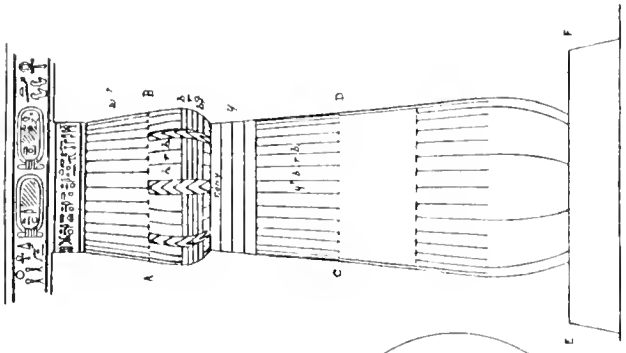

SOUTH COLUMN, W. SIDE.

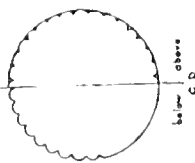

below above C D

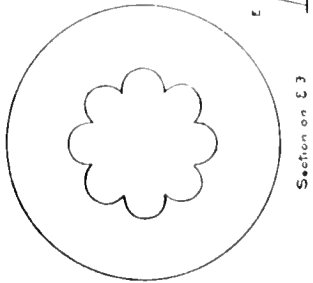

Section on E F

Scale 1/50

ABACI OF COLUMNS.



HIEROGLYPHS.

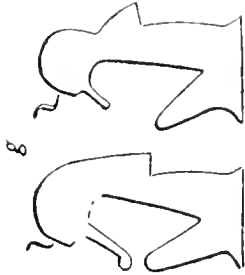

Scale 1/3

COLUMNS, W. WALL.

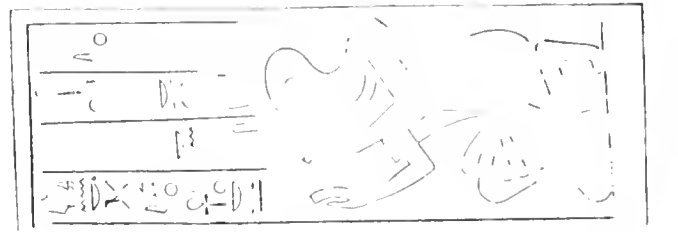
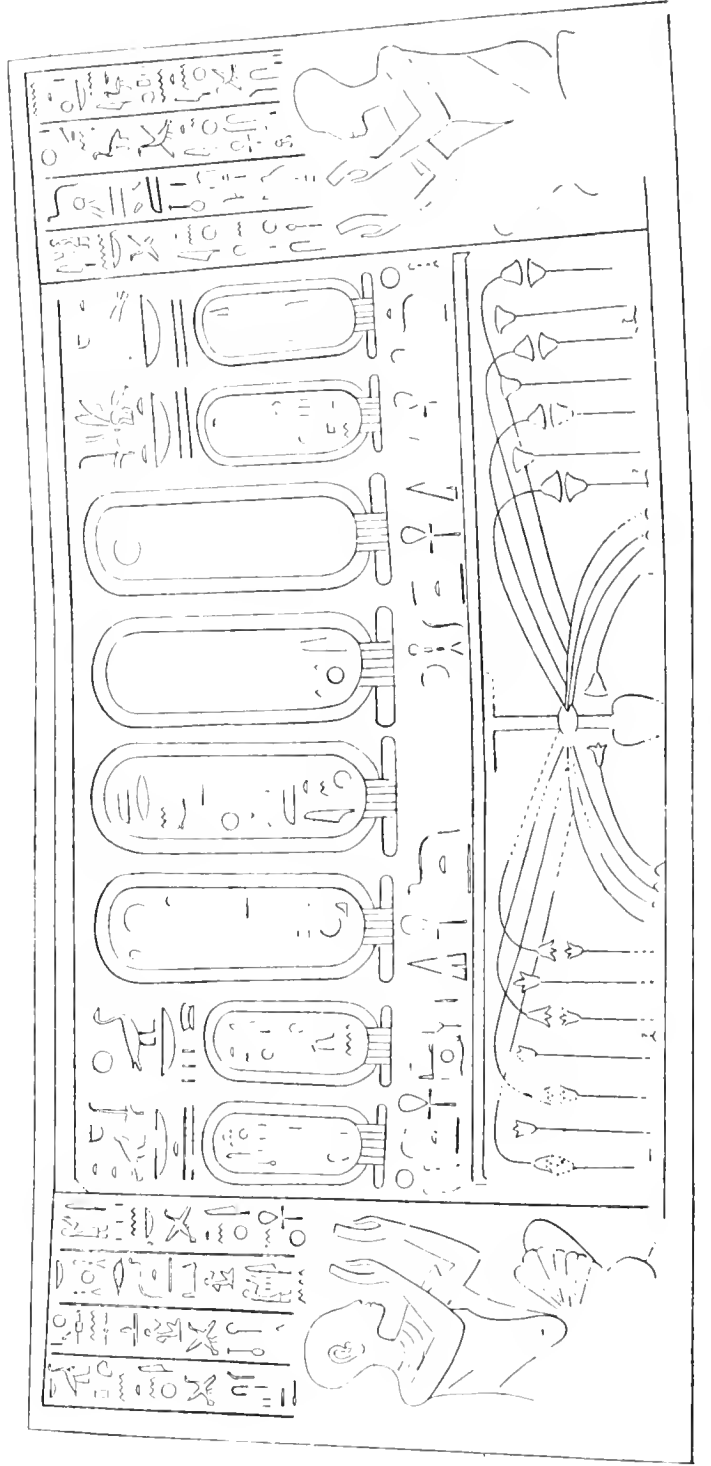
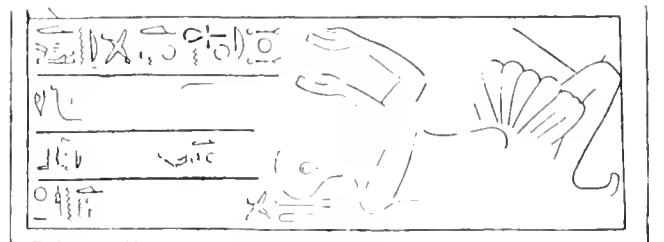
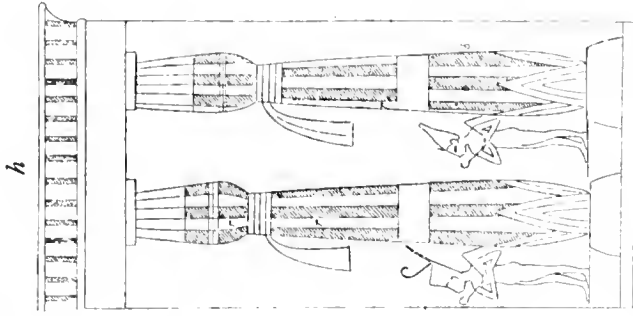

INSCRIPTIONS FROM N. AND S. COLUMNS.

Scale 1/6





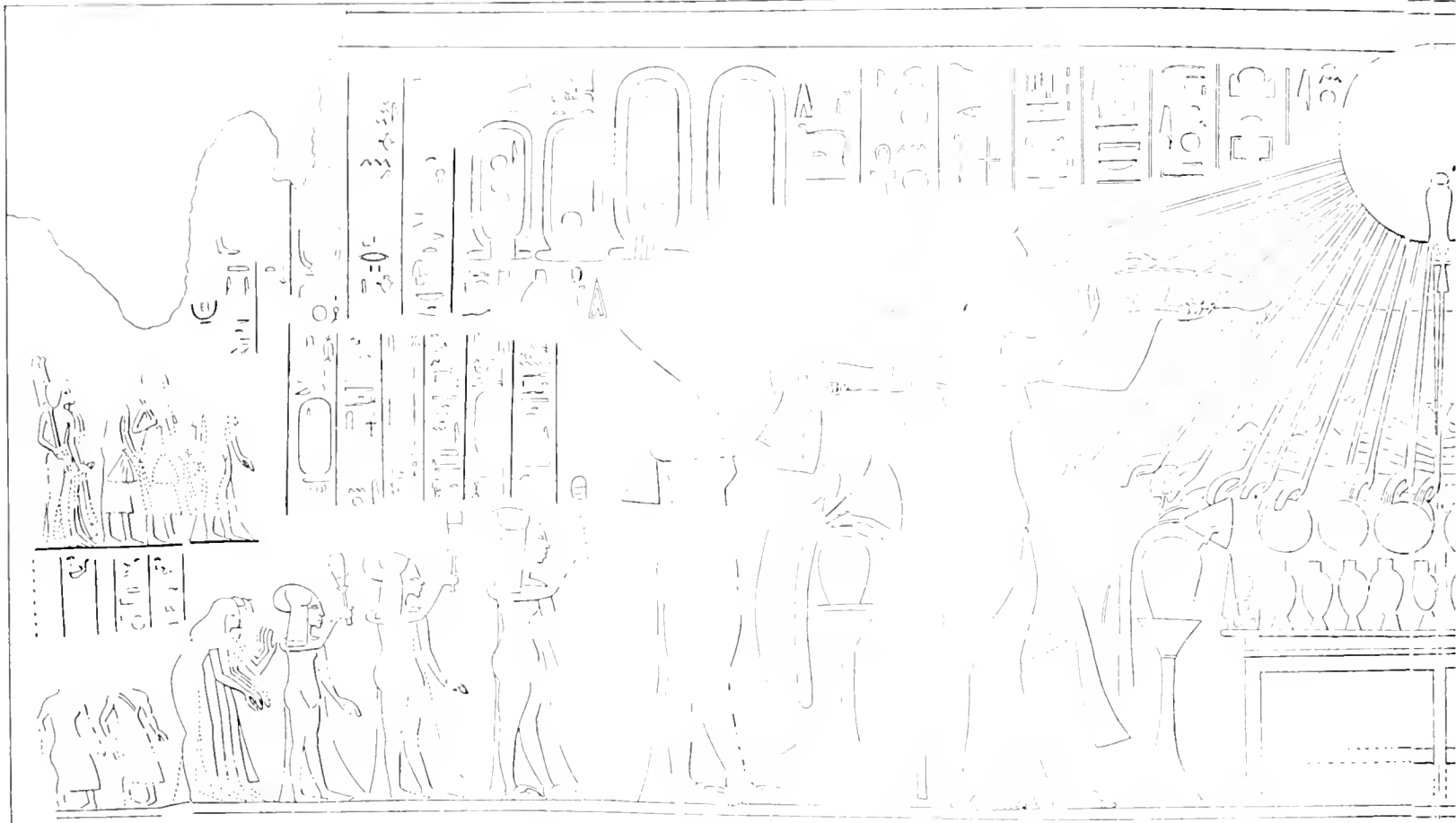

Scale 1/8

LINTEL OF QU

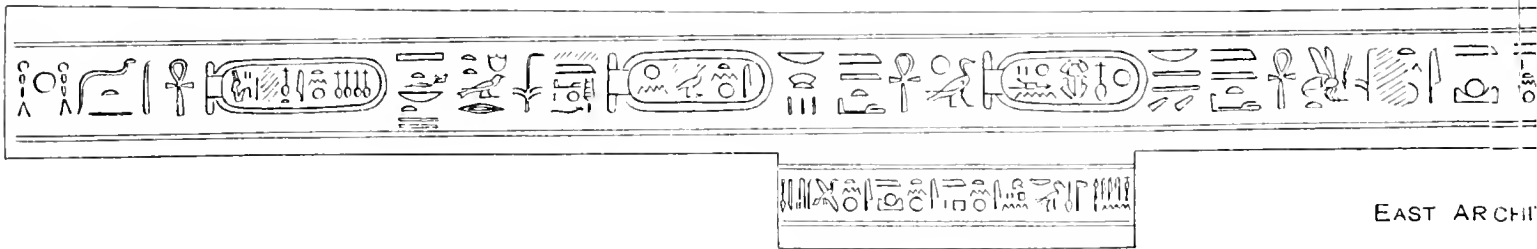

Scale 1/18

EAST ARCHIT

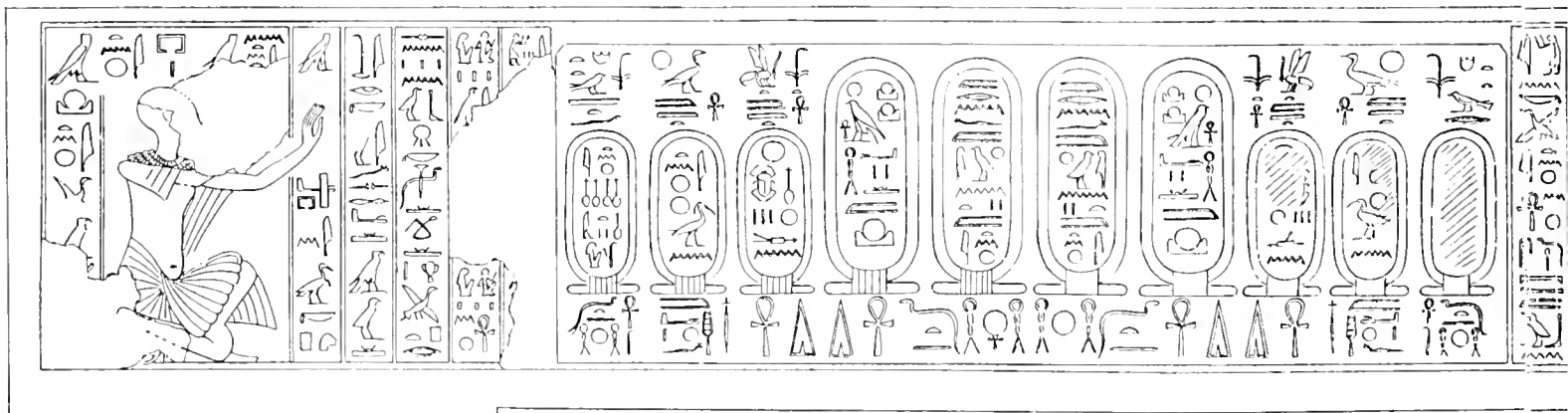

Scale 1/10

LINTEL OF S. DOOR.

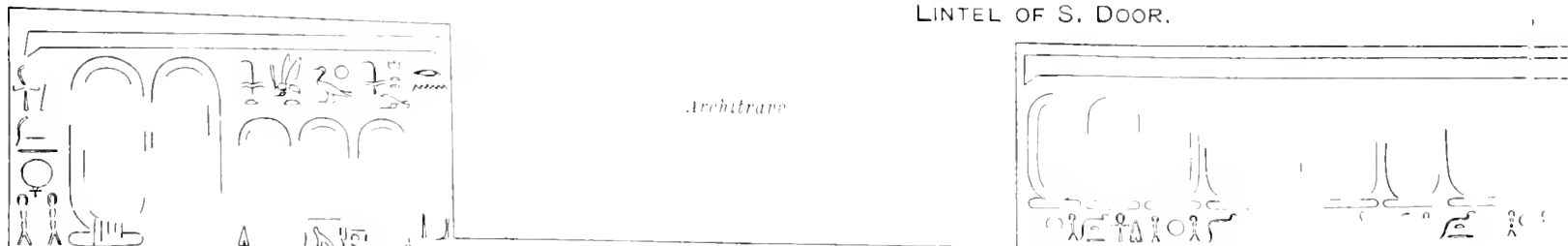

Scale 1/12

FRIEZE OF SOUTH WALL, W SIDE.

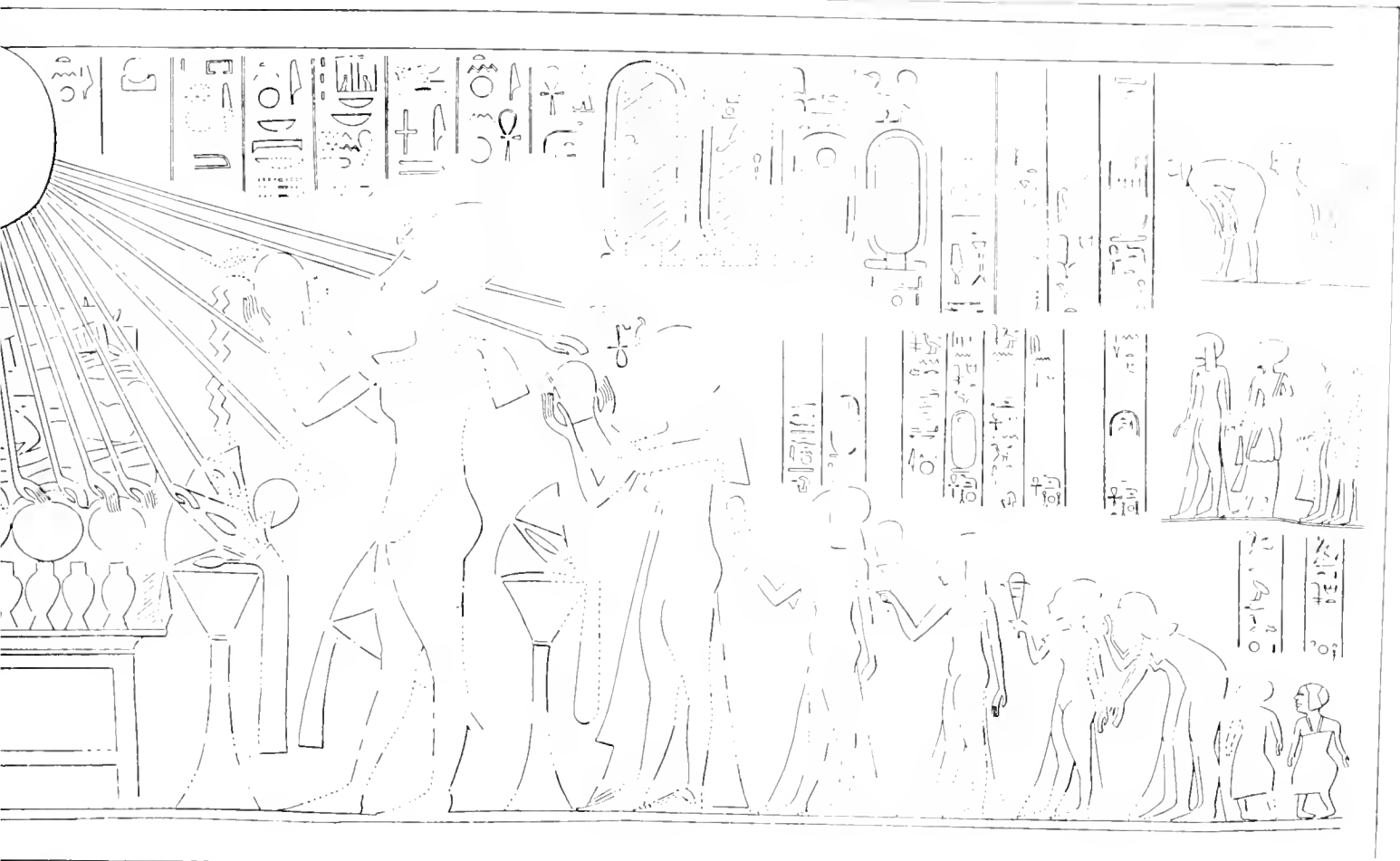

DOOR.

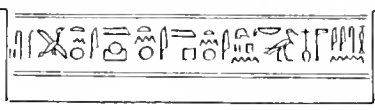
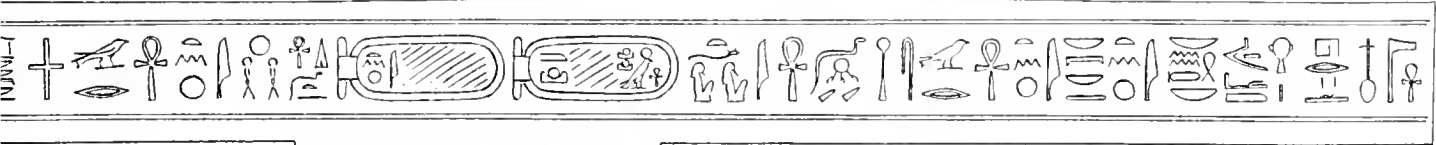

VE.

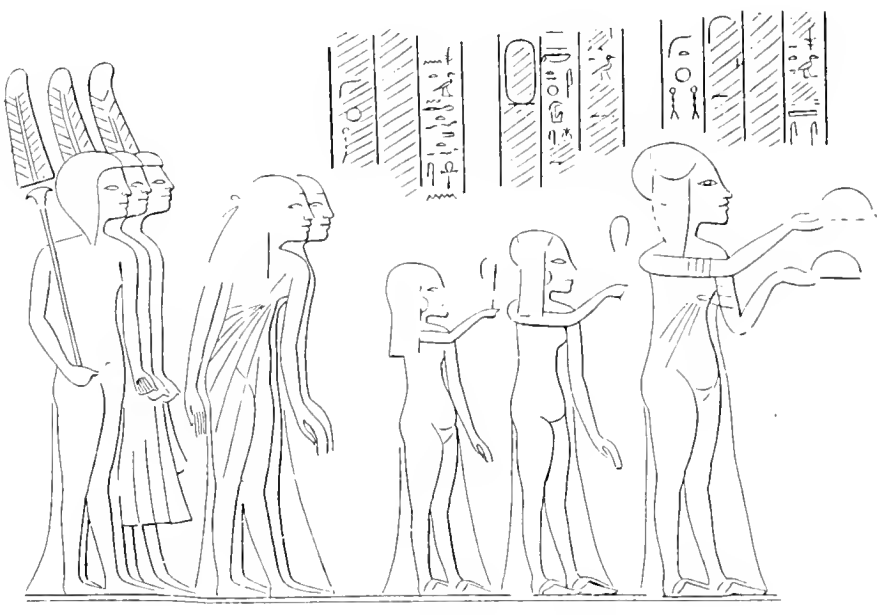
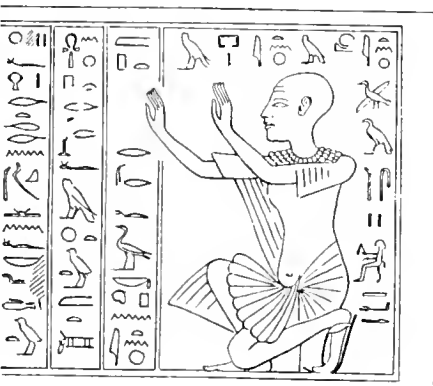

☉

Scale 1/2

THE THREE PRINCESSES (W WALL).





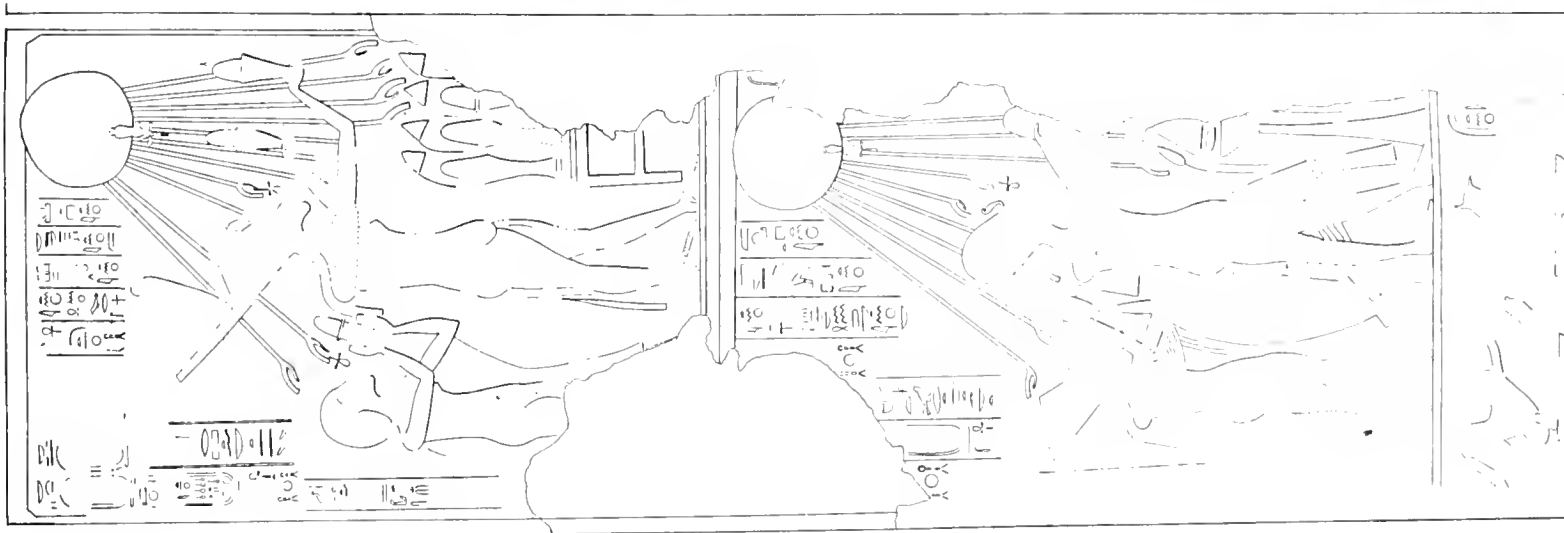
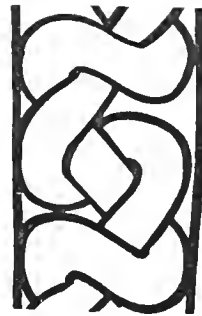
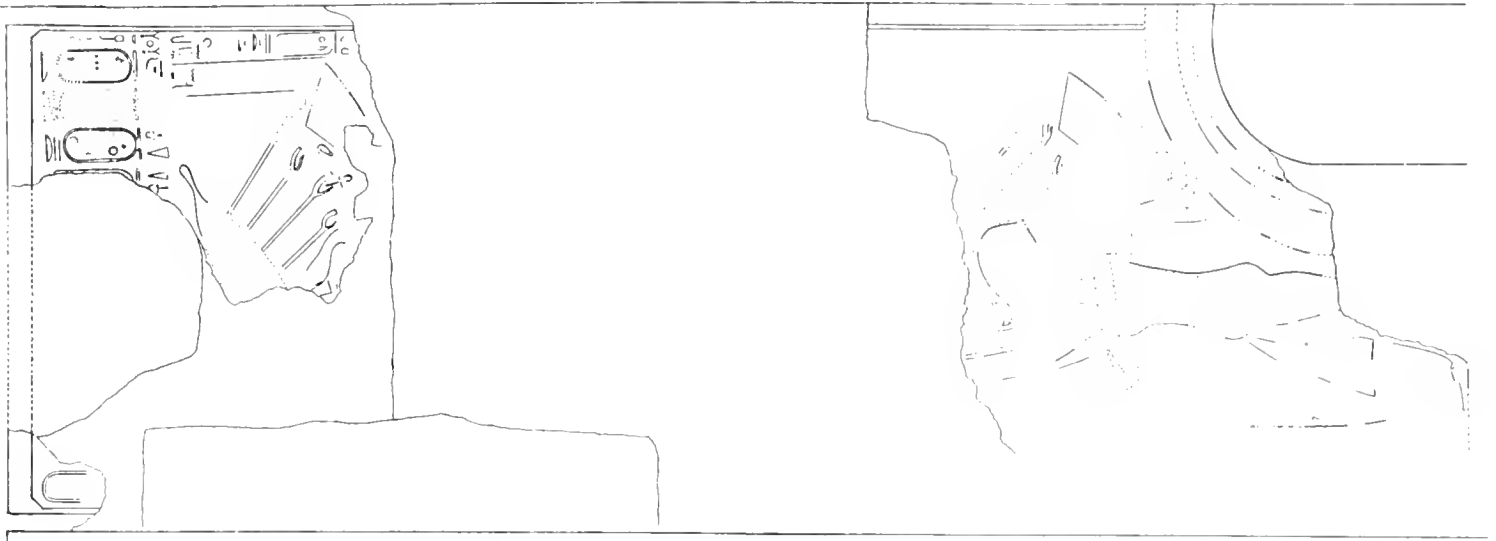





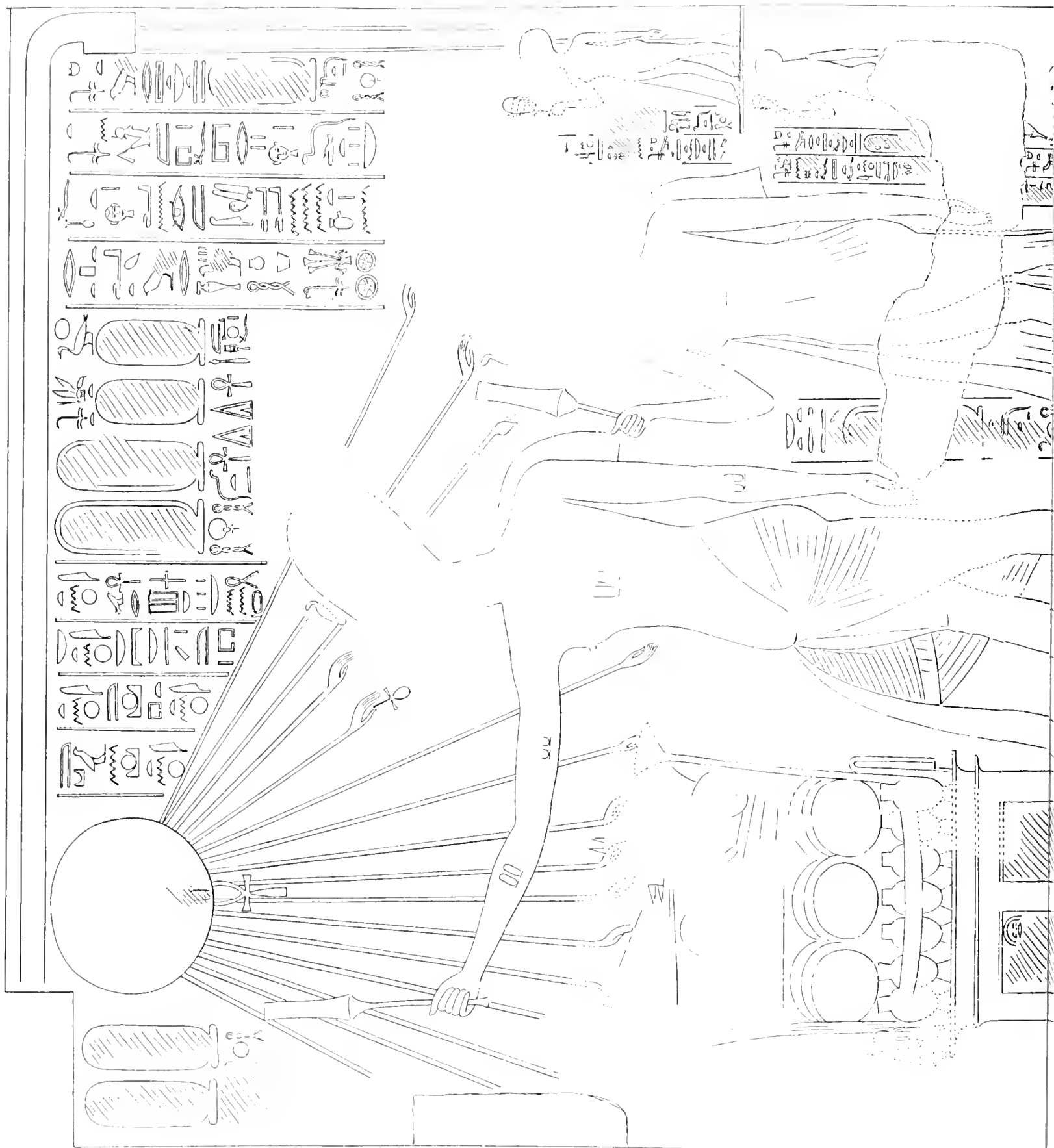

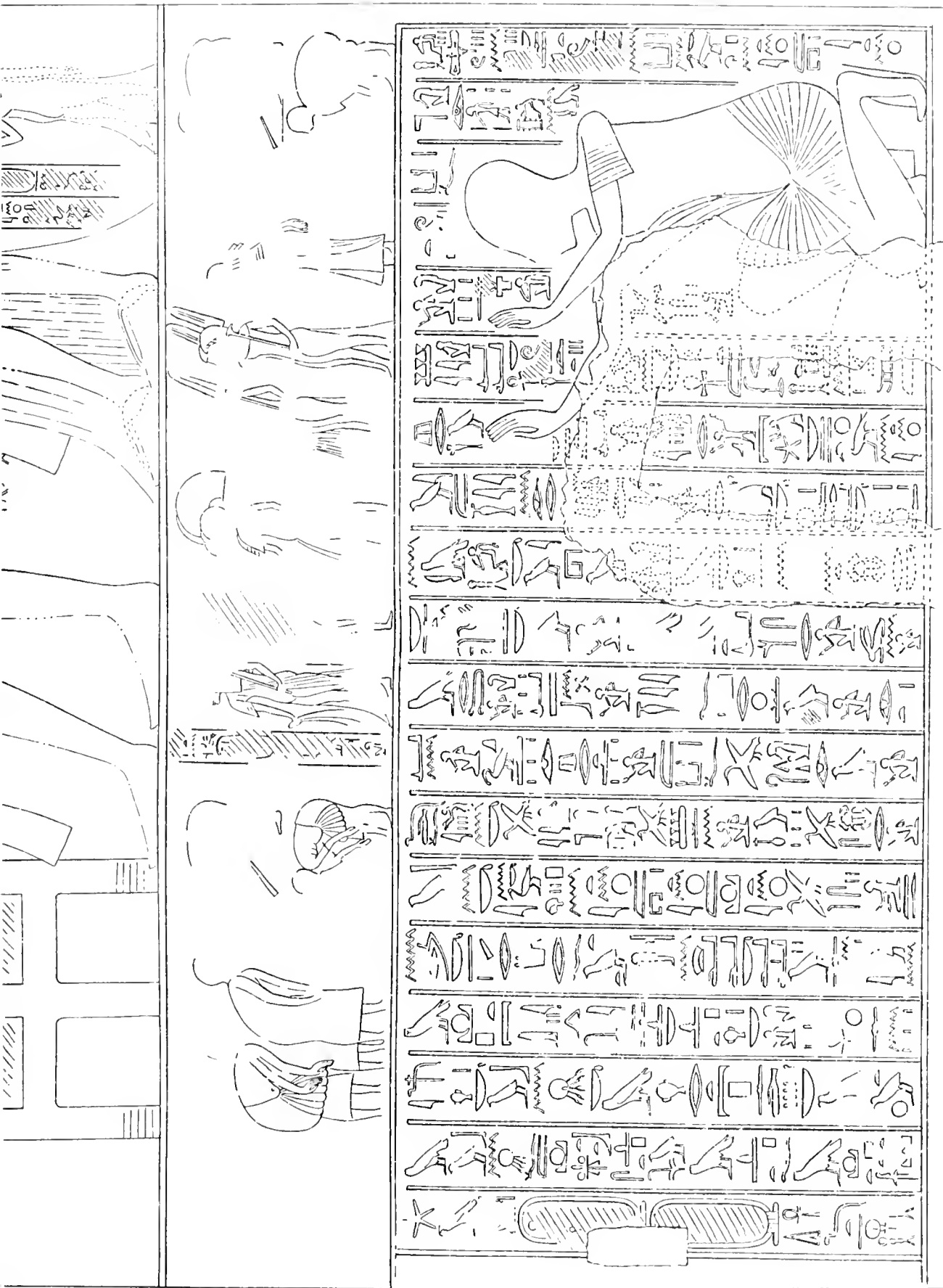

GIVING HOMAGE TO THE SUN





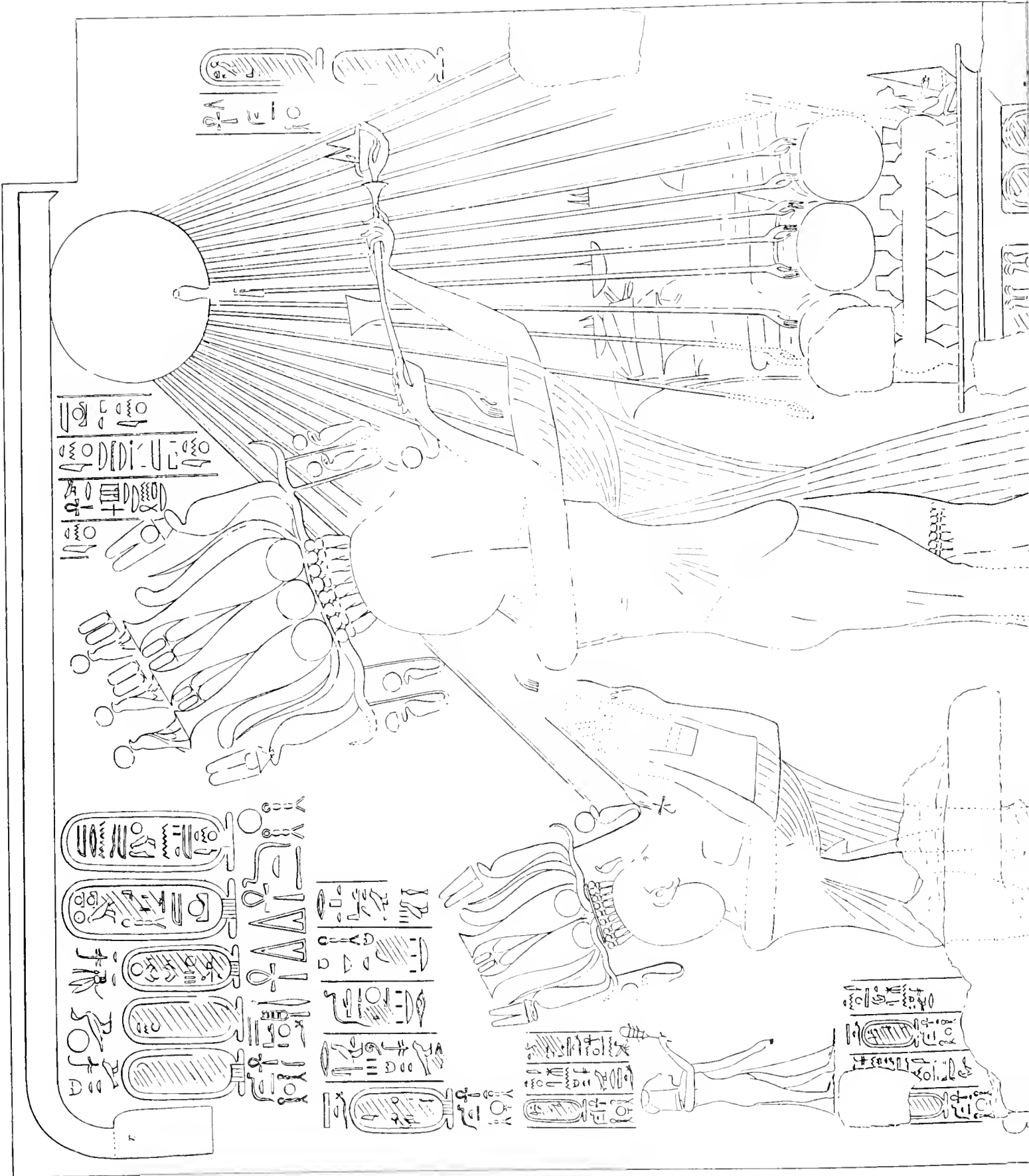





ADORATION OF THE SUN.



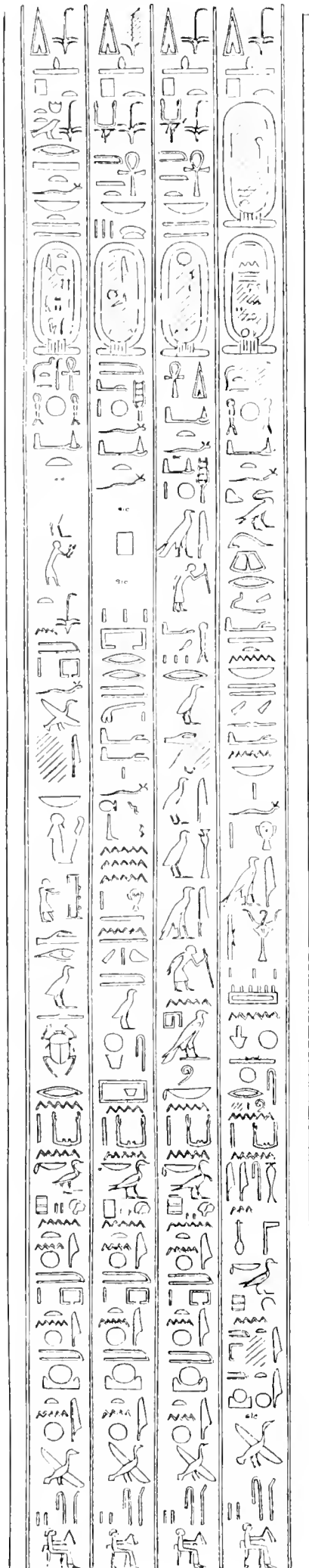

Scale 1/12

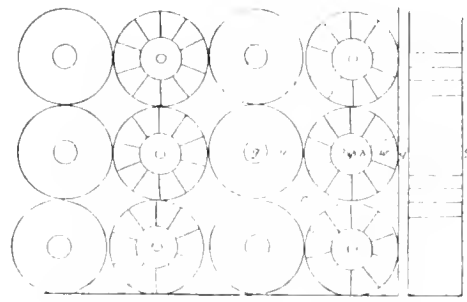

Pattern C (Soffit of Architrave)

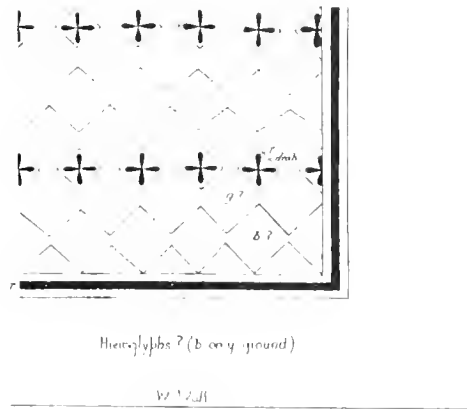

Pattern D (Ceiling of Entrance)

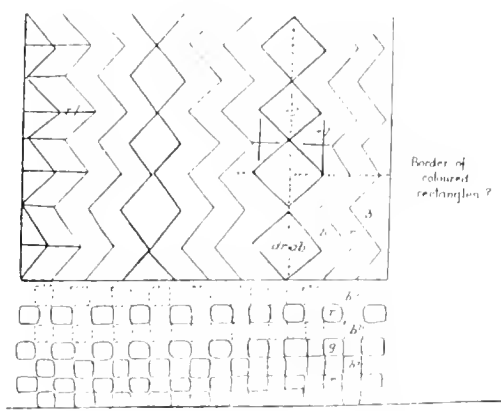

Pattern A (Soffit of Architrave)

CEILING DESIGNS. Scale 1/2

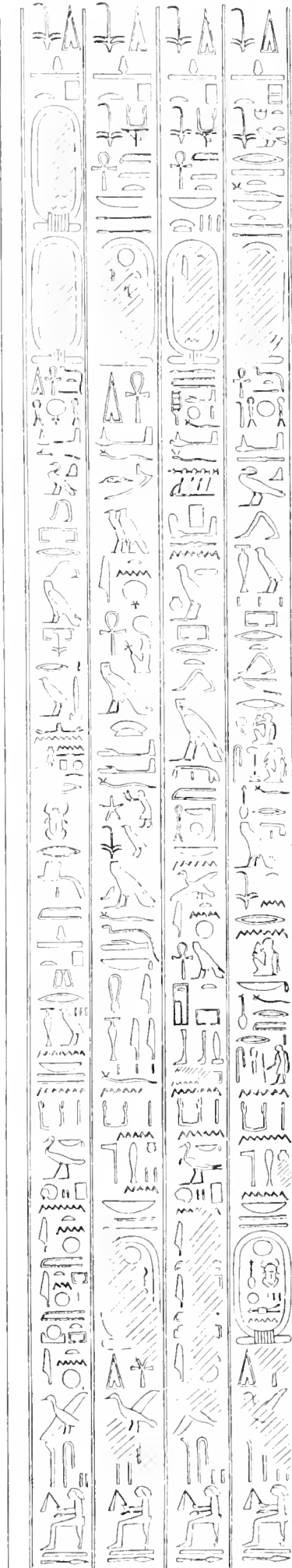





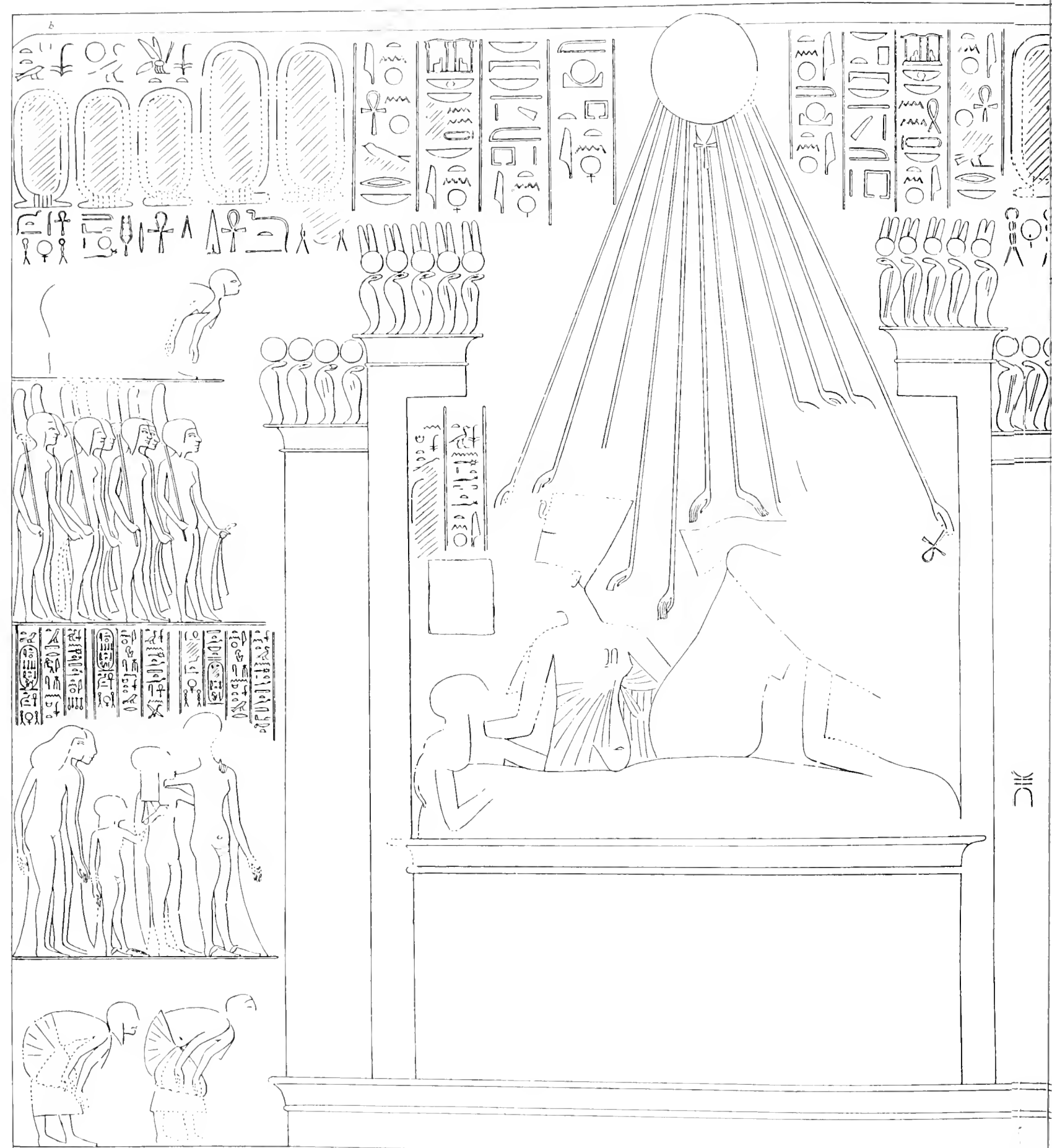

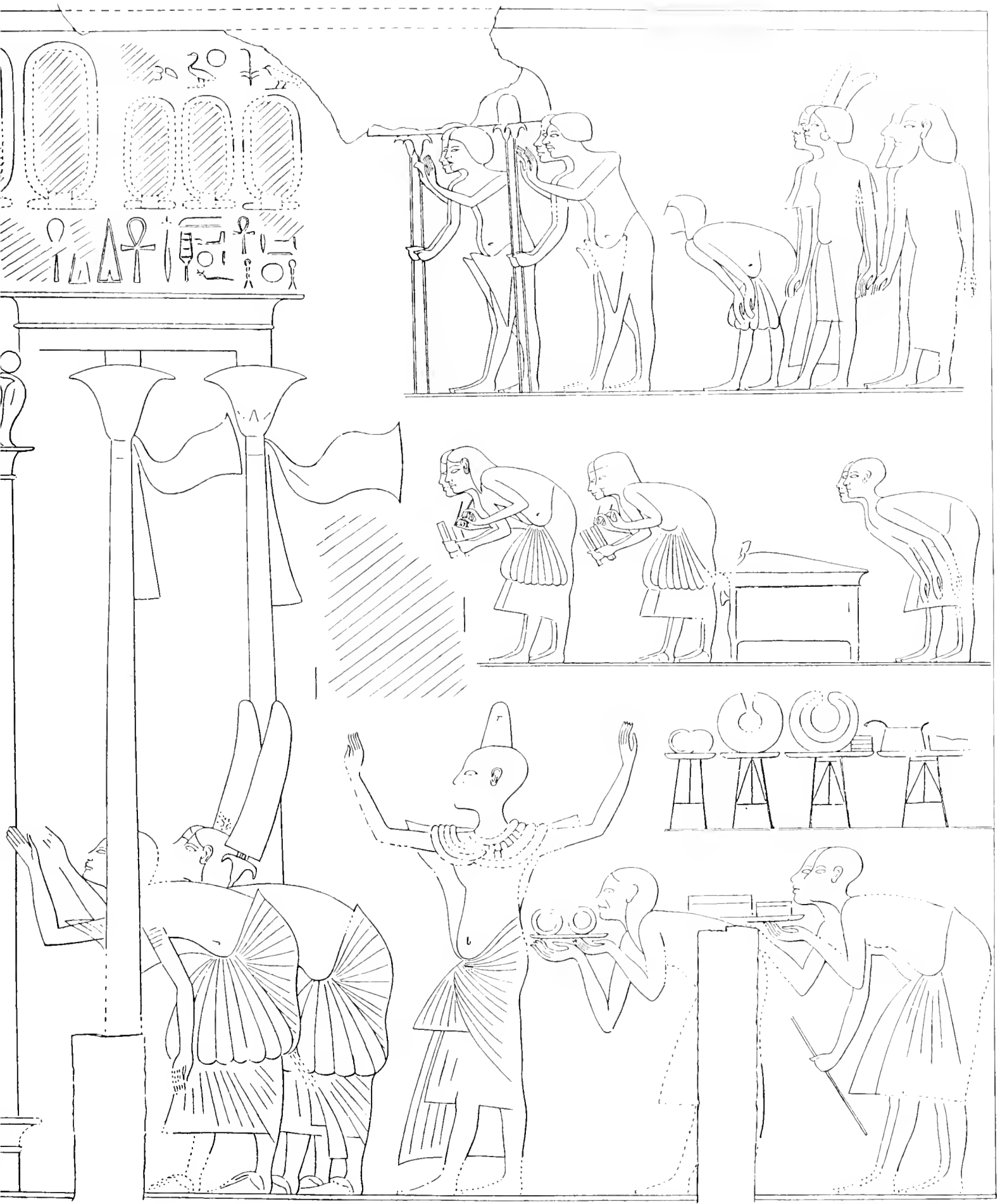









WEST

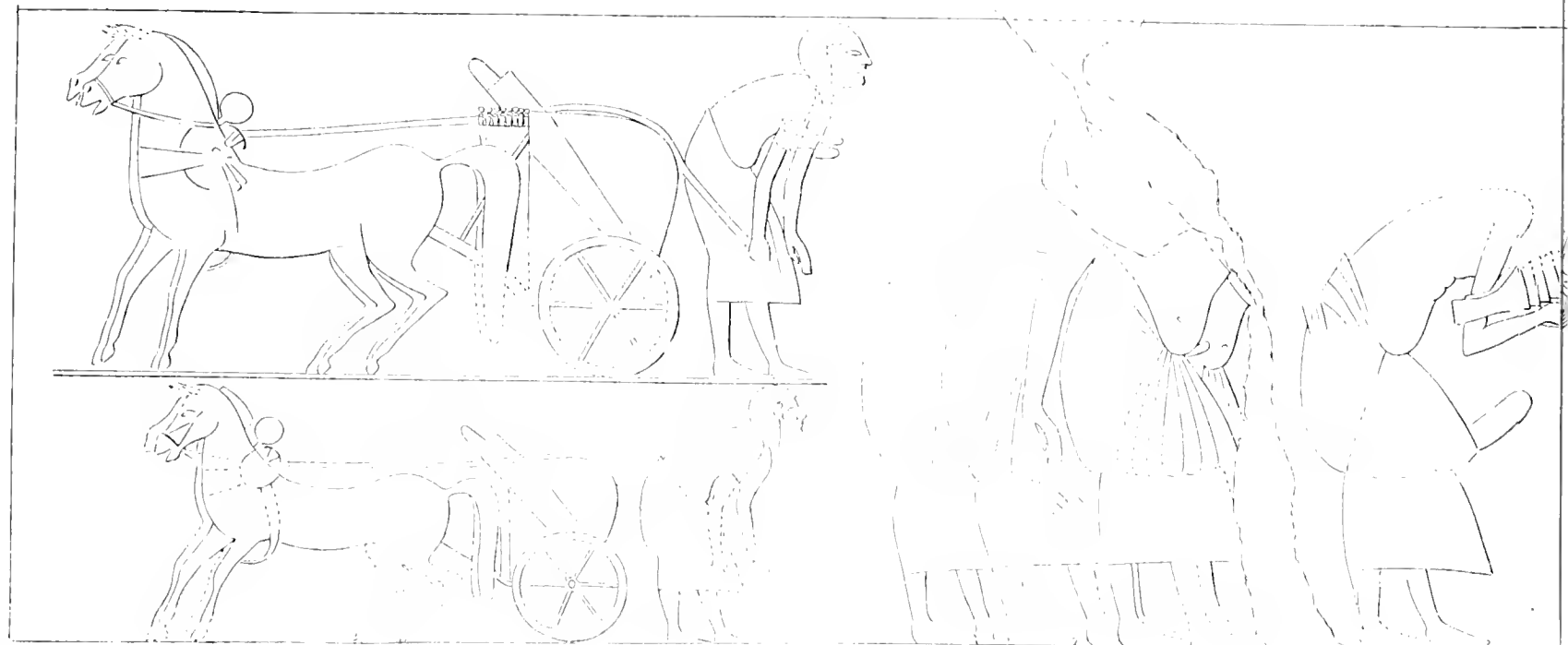

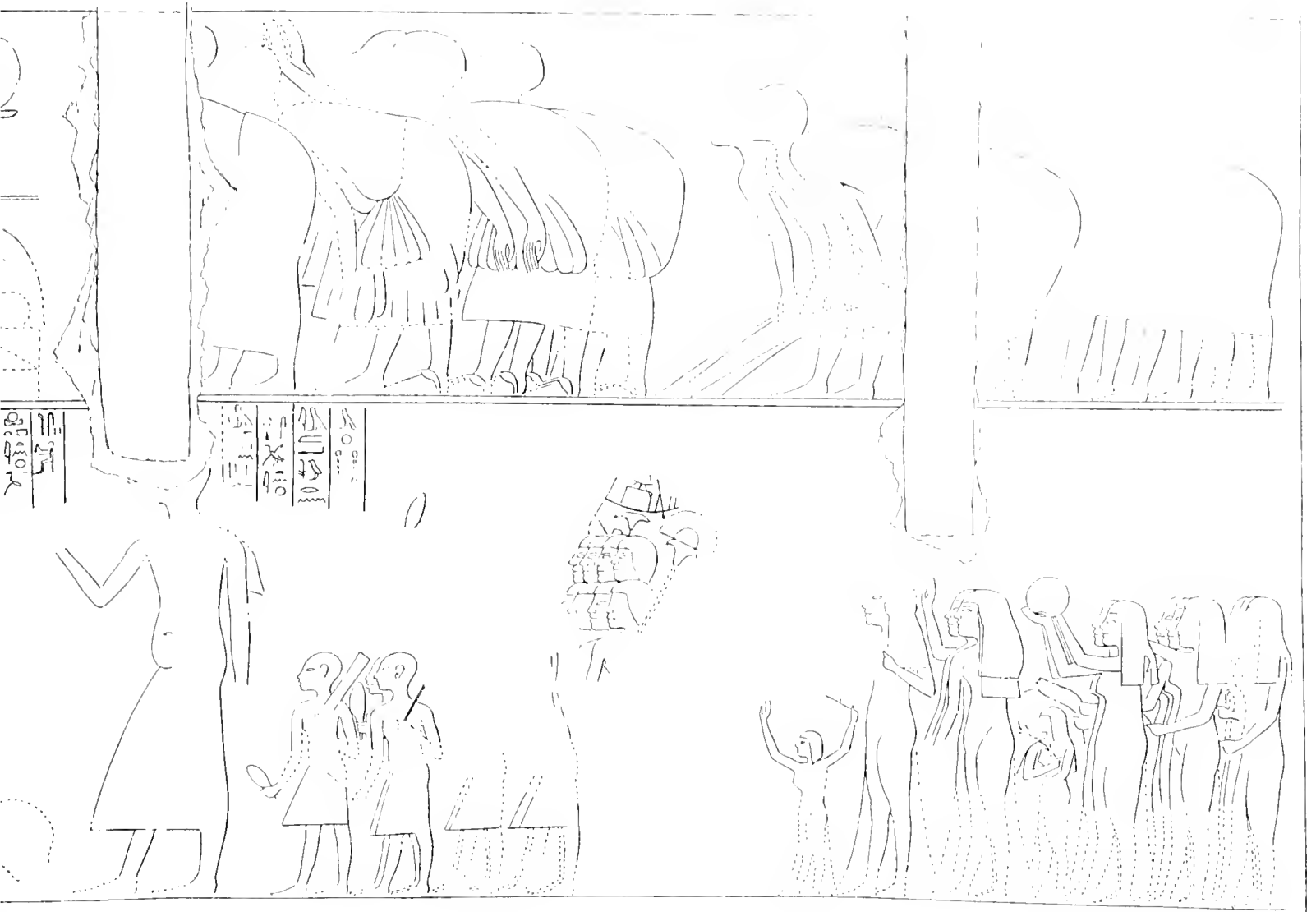

DE.

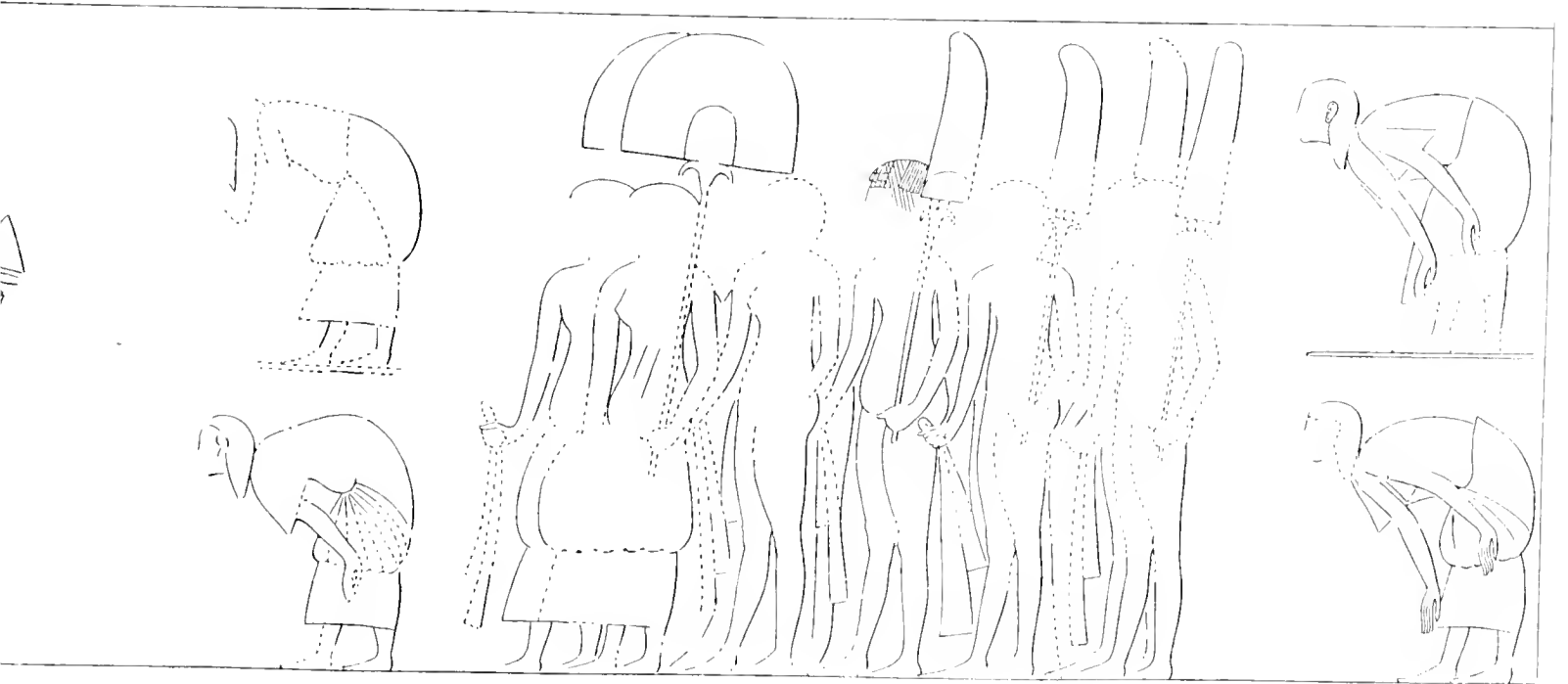

E.





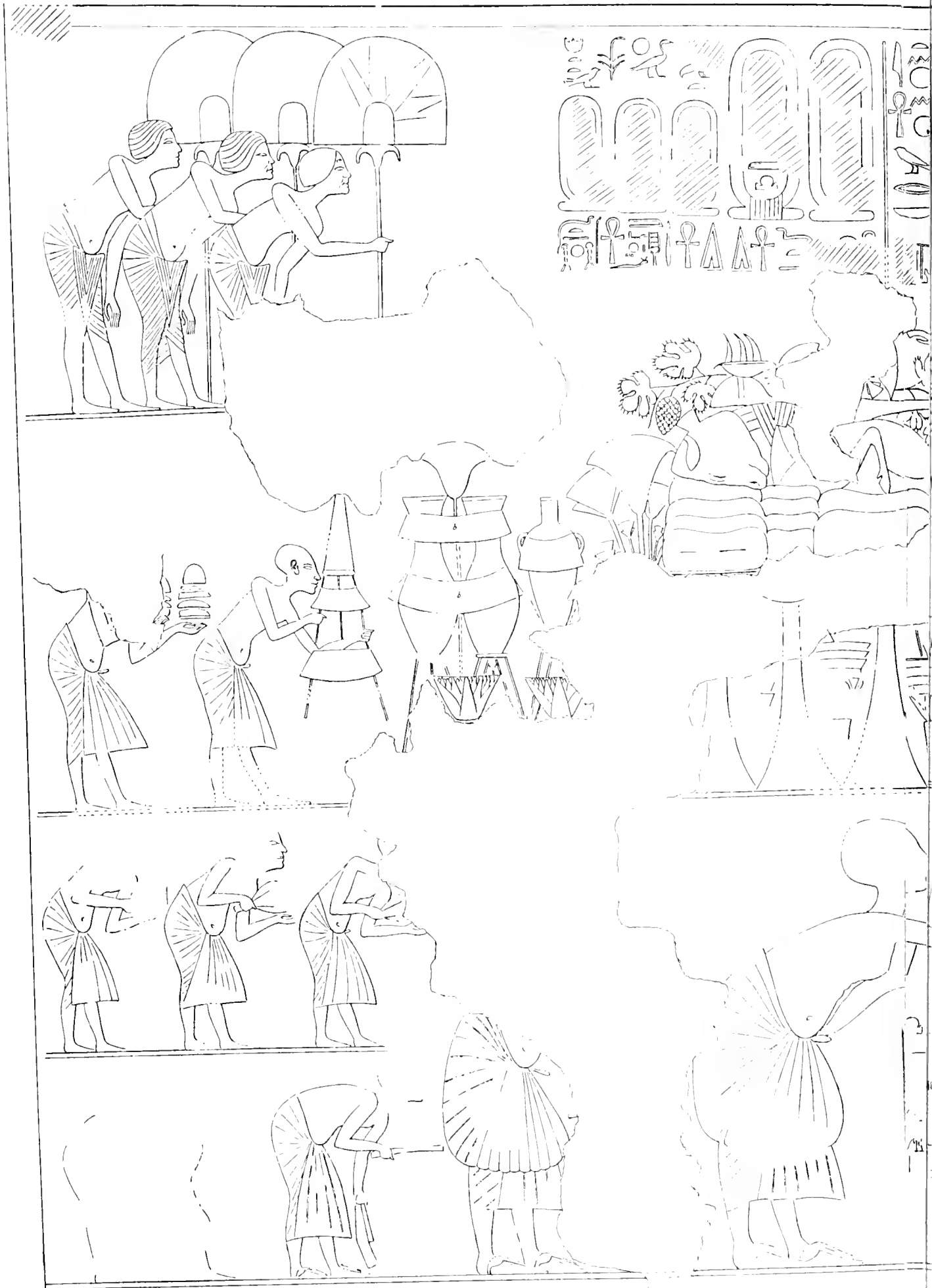

THE ROYAL FAMILY FR













DRIVING OUT.



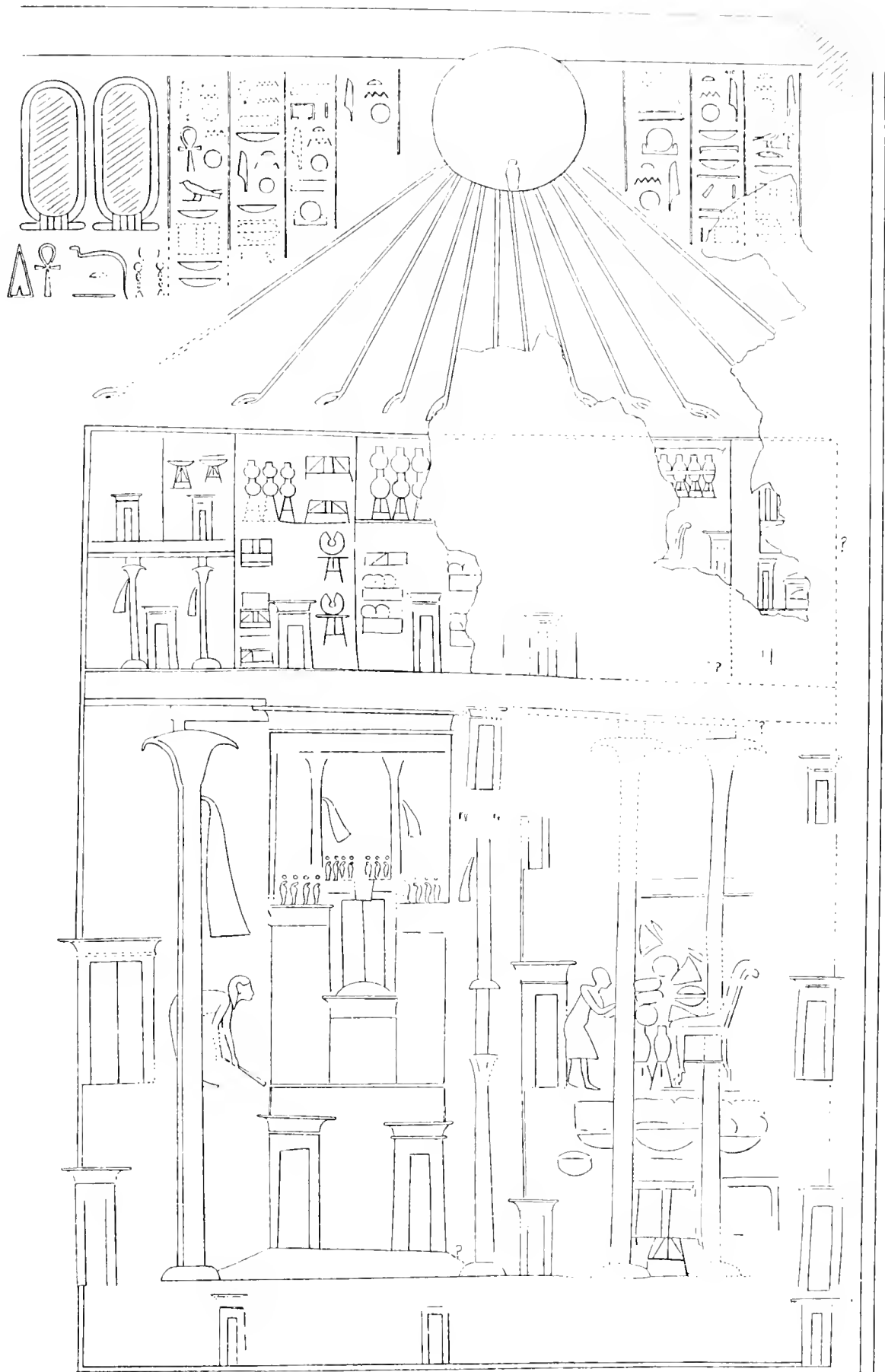

Scale  $\frac{1}{6}$

THE PALACE.





A PRINCESS AND HER TRAIN







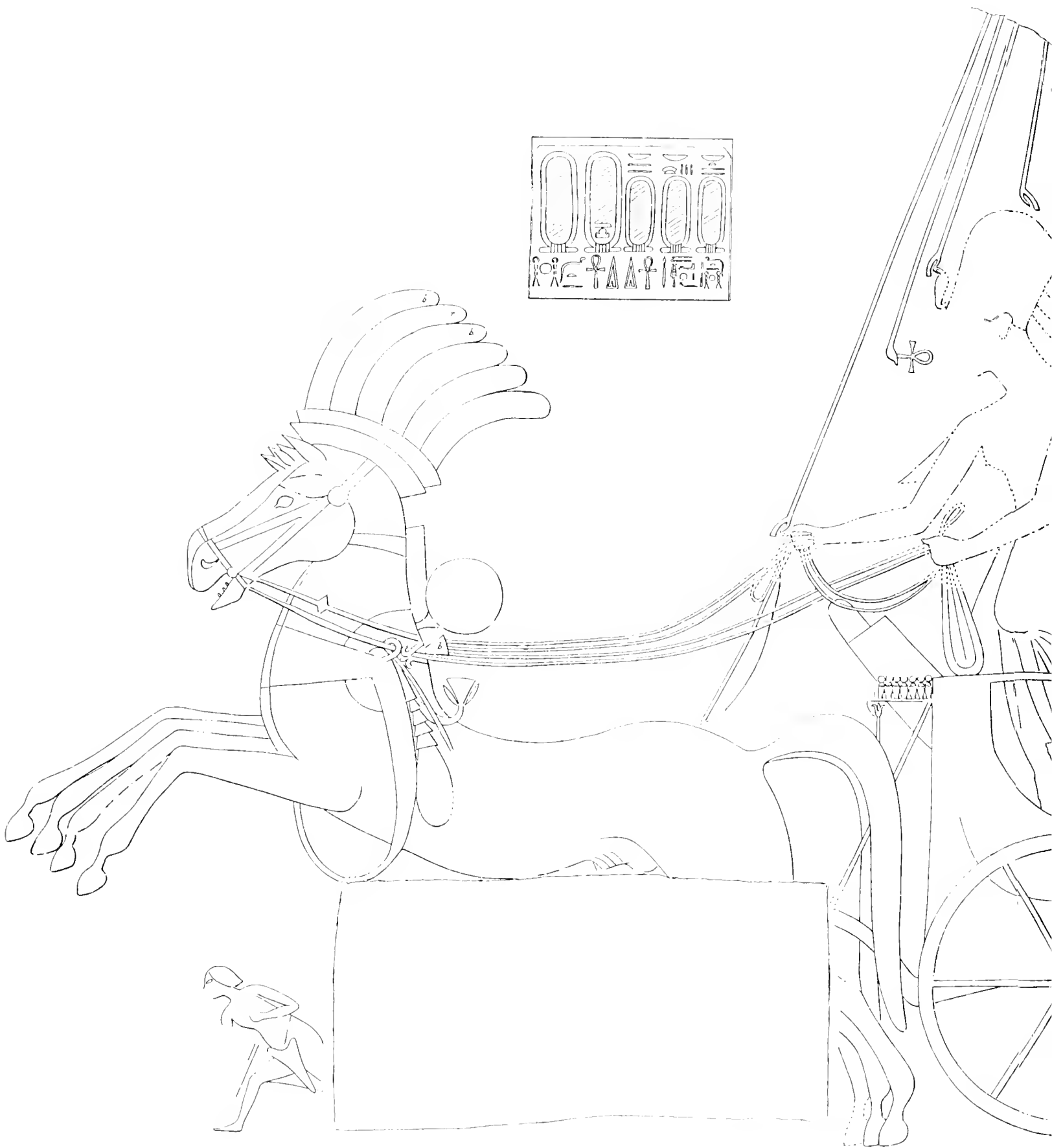

Scale  $\frac{1}{2}$

THE KING AND QUEEN





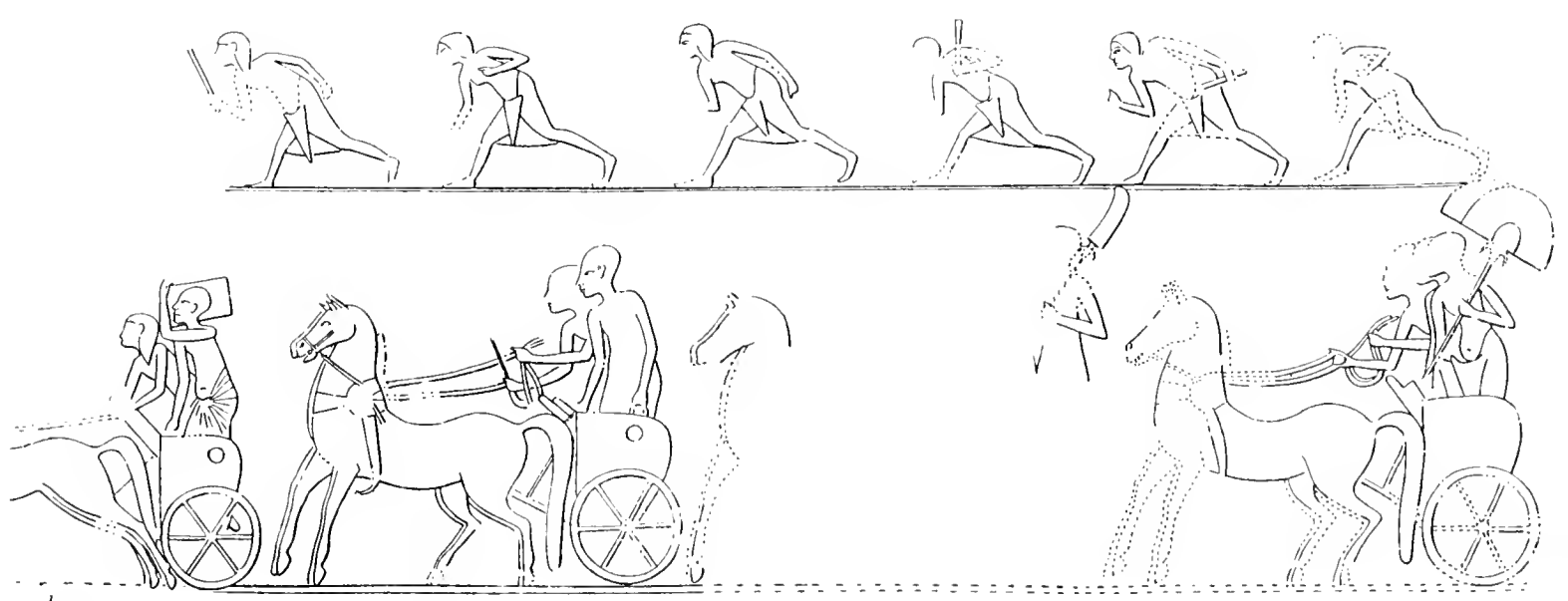
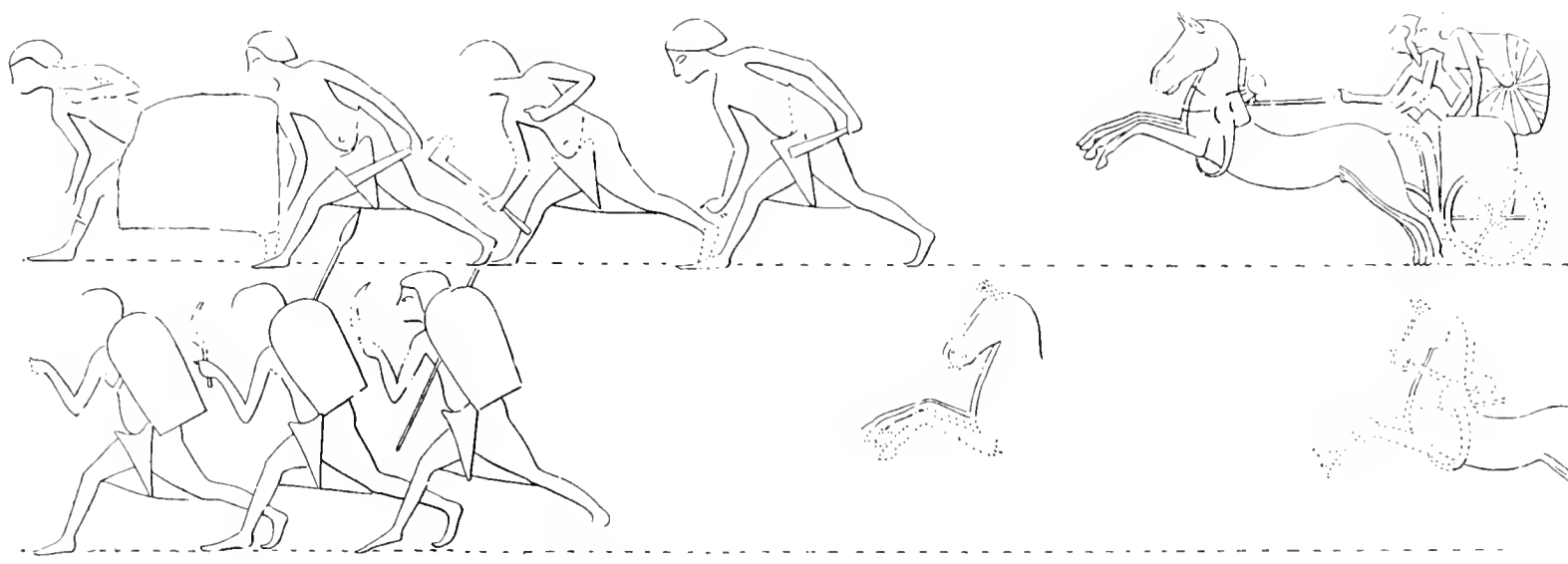

Scale  $\frac{1}{10}$

THE ESCORT.





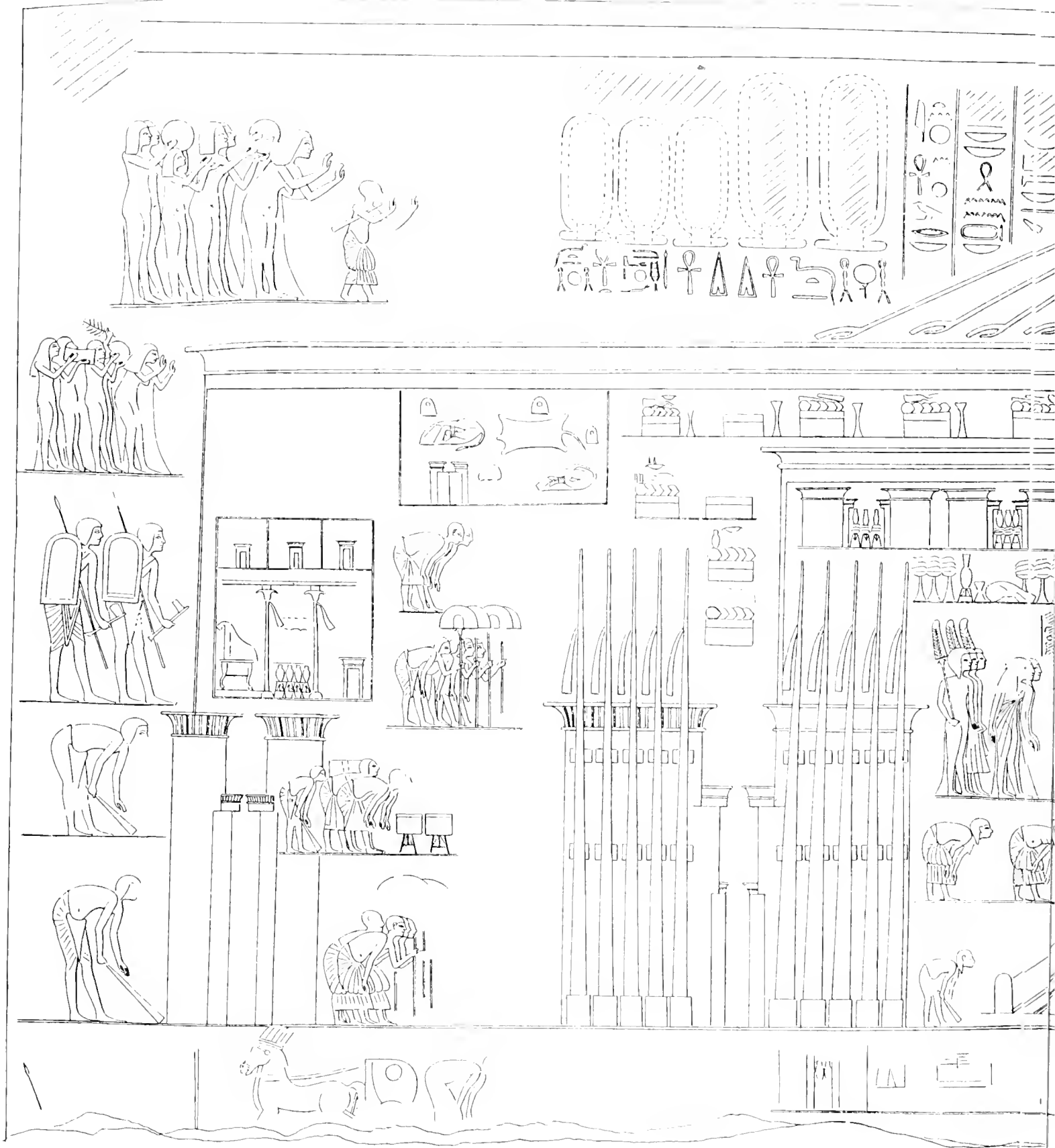



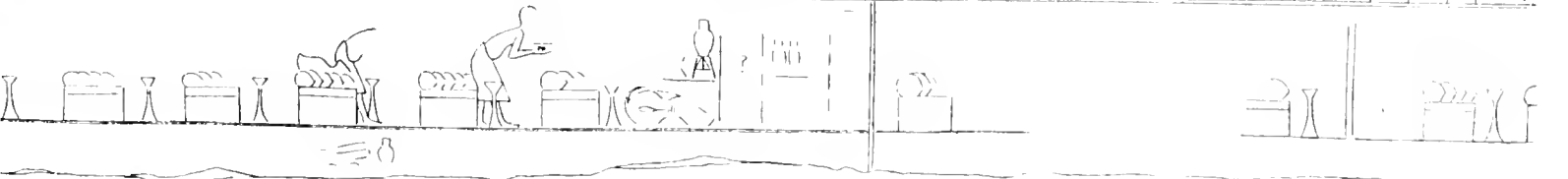
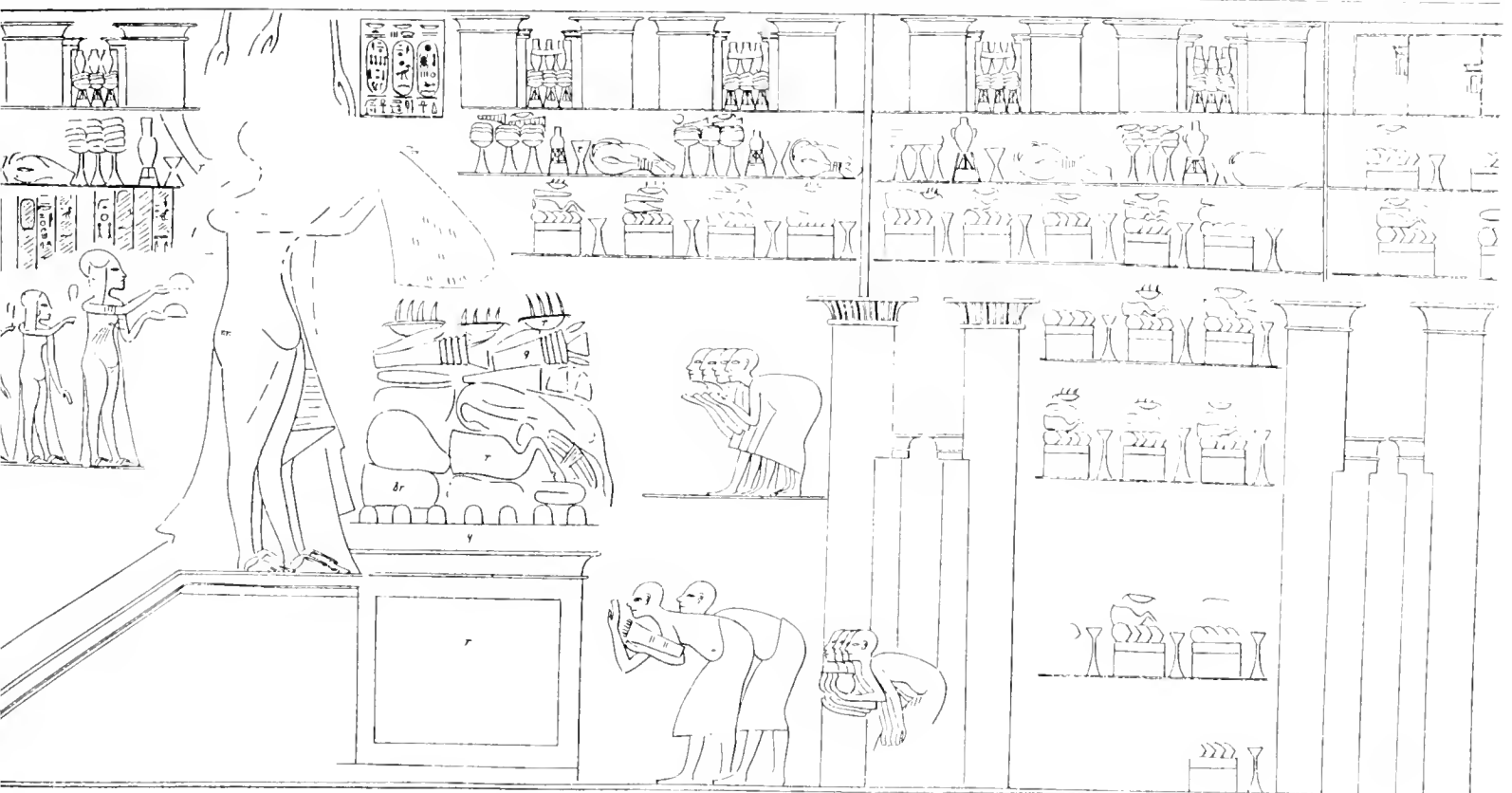
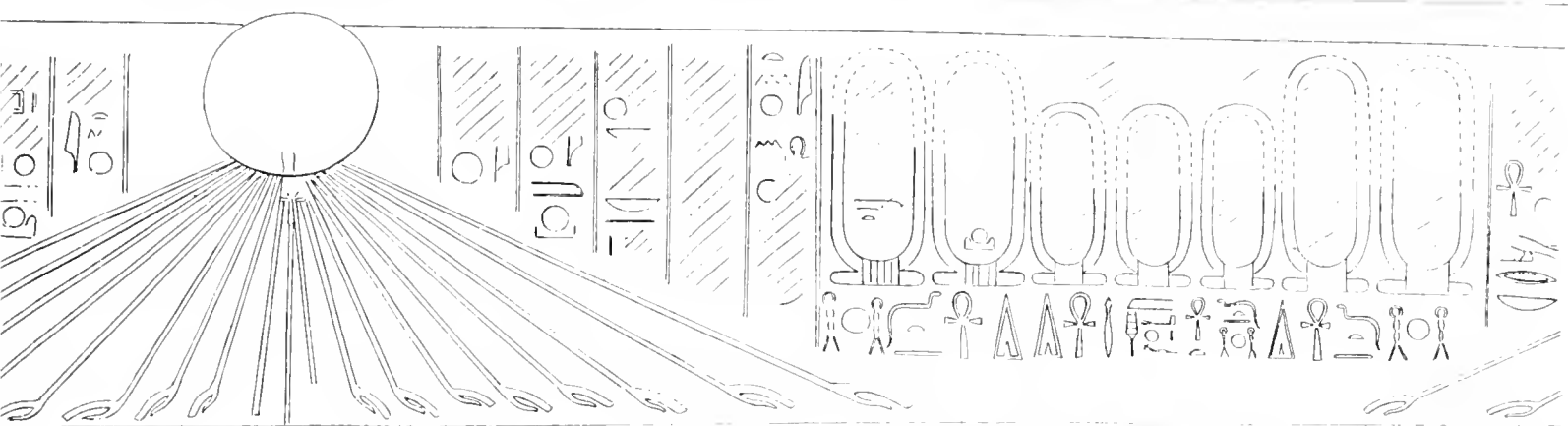

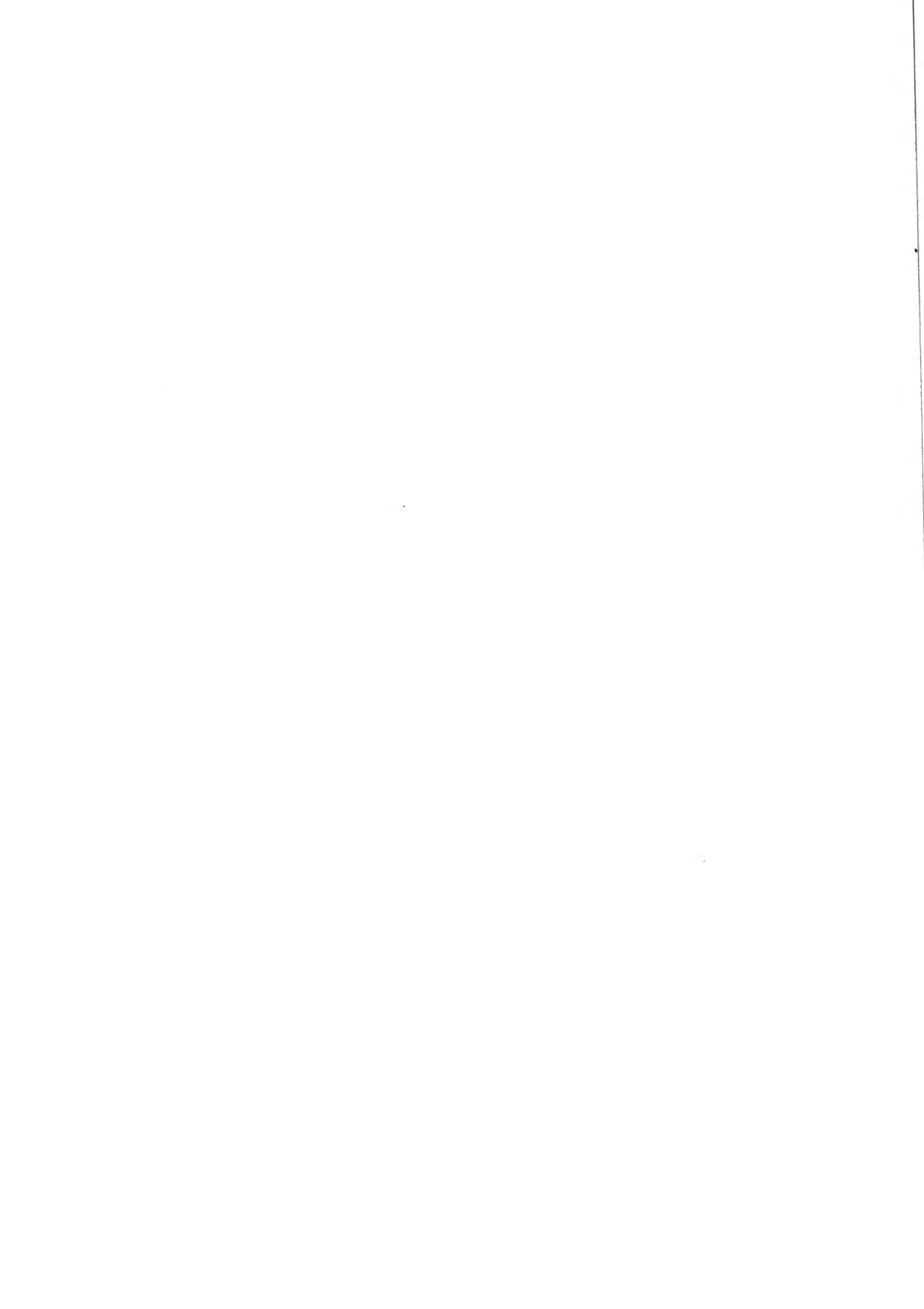



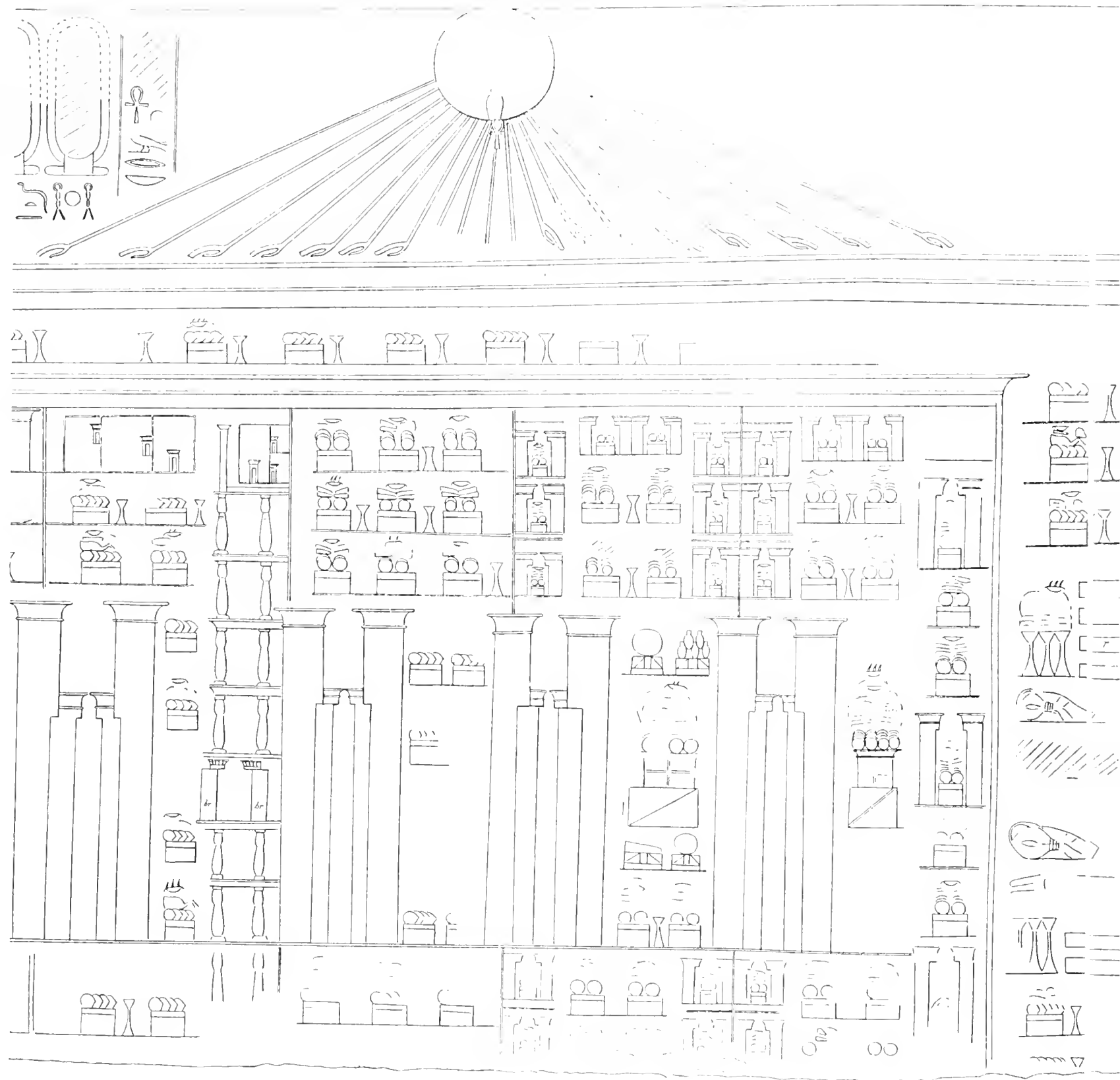

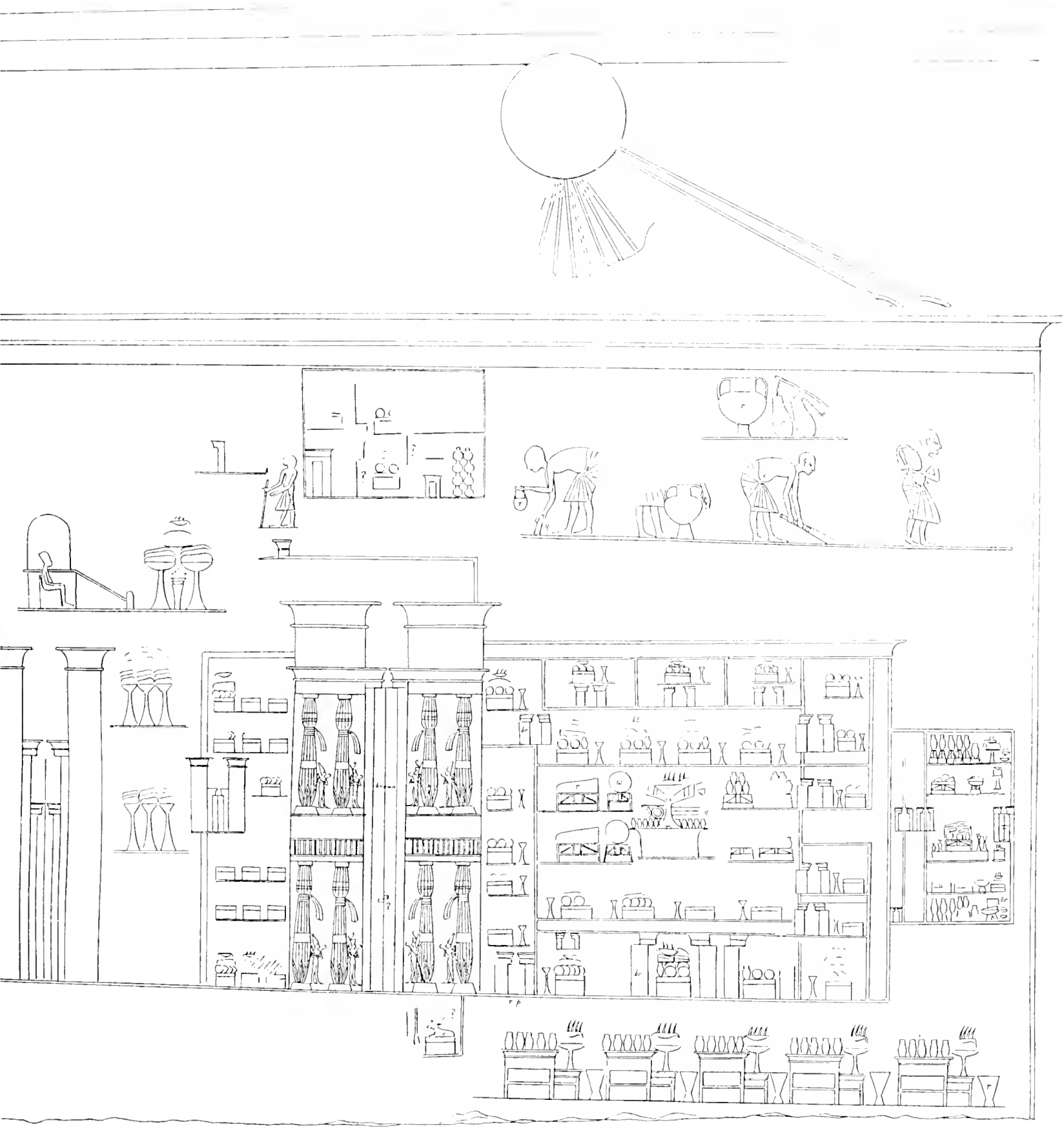



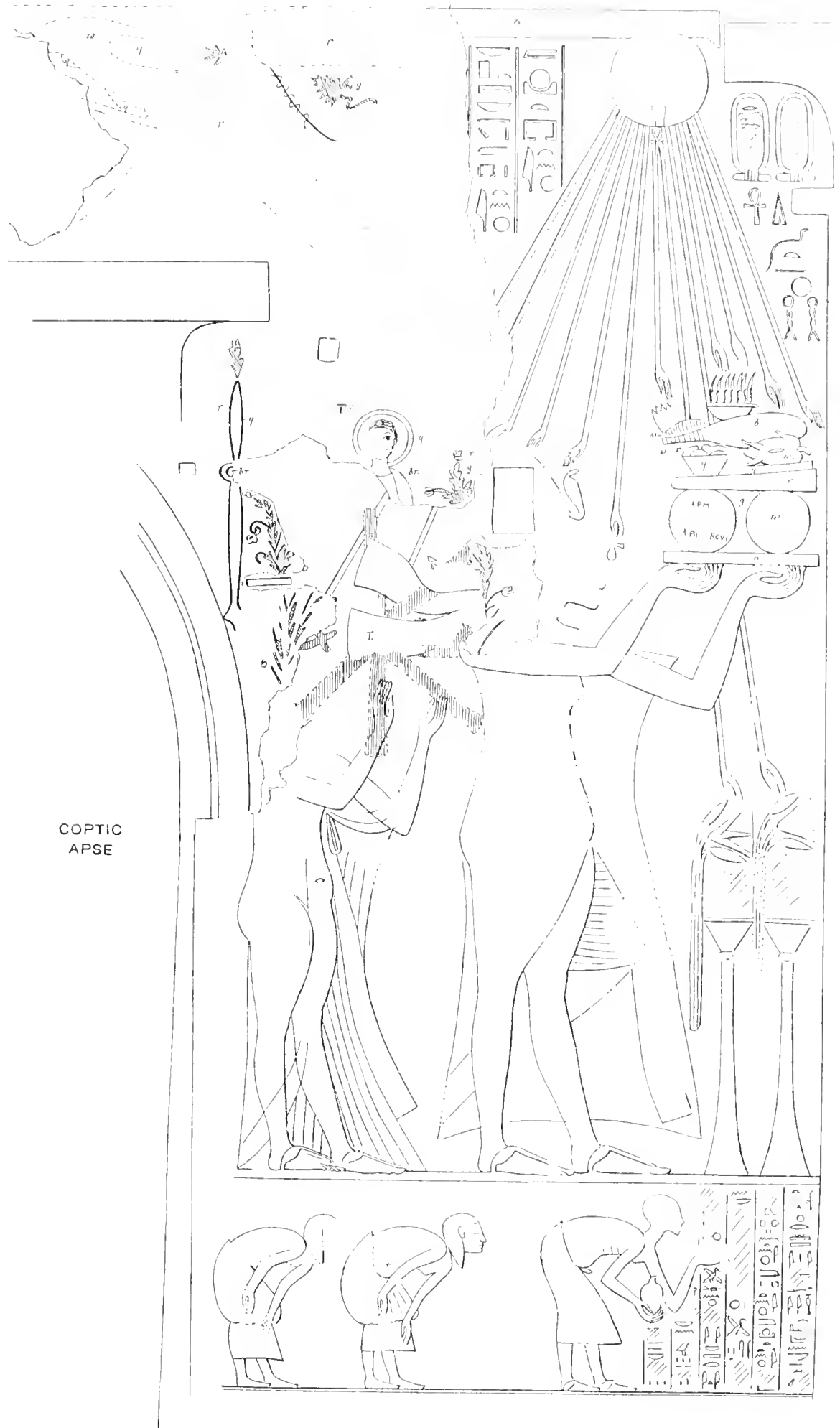

COPTIC  
APSE

THE KING AND QUEEN WORSHIPPING (Coptic overlay).





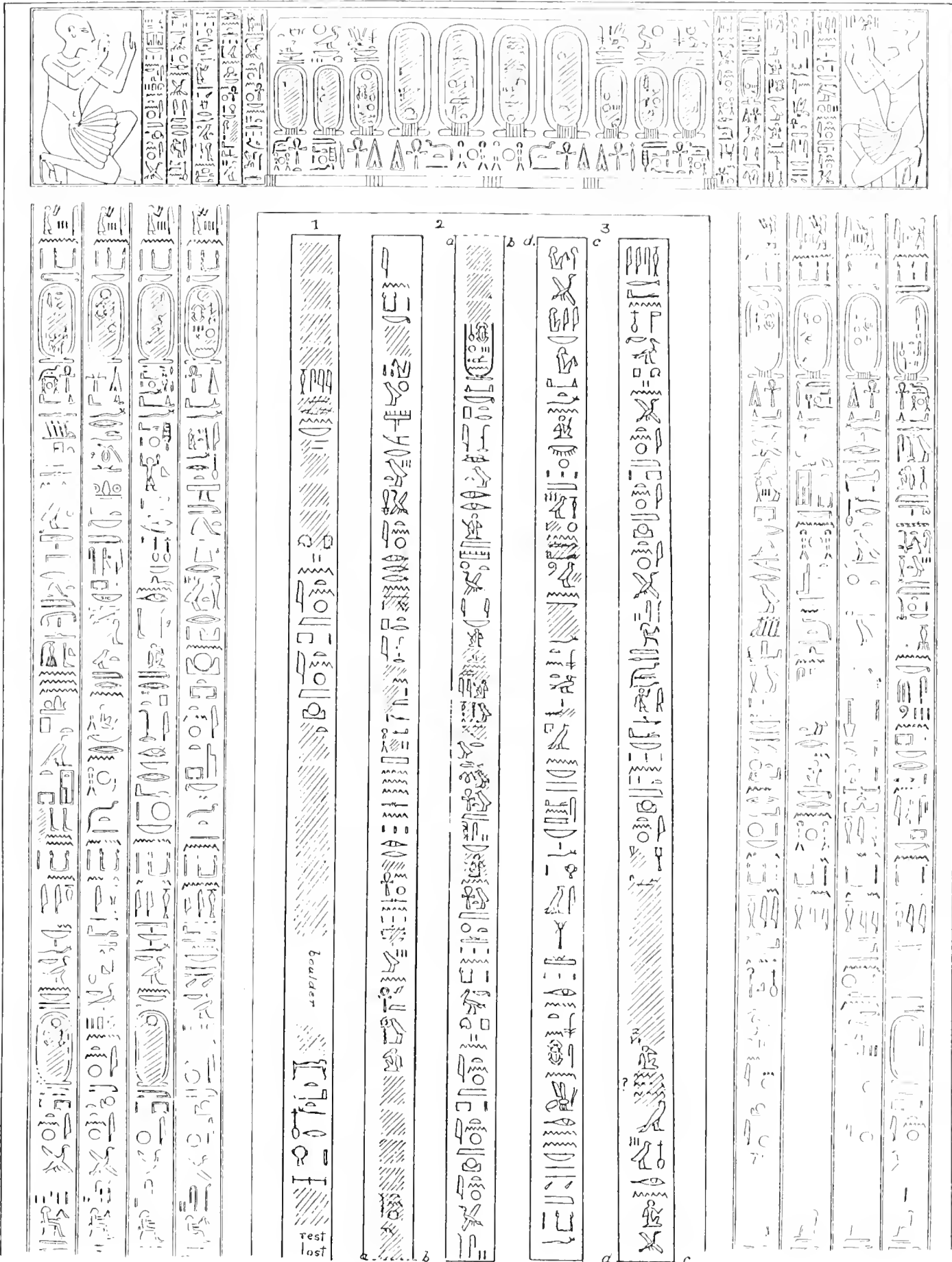

CEILING INSCRIPTIONS.



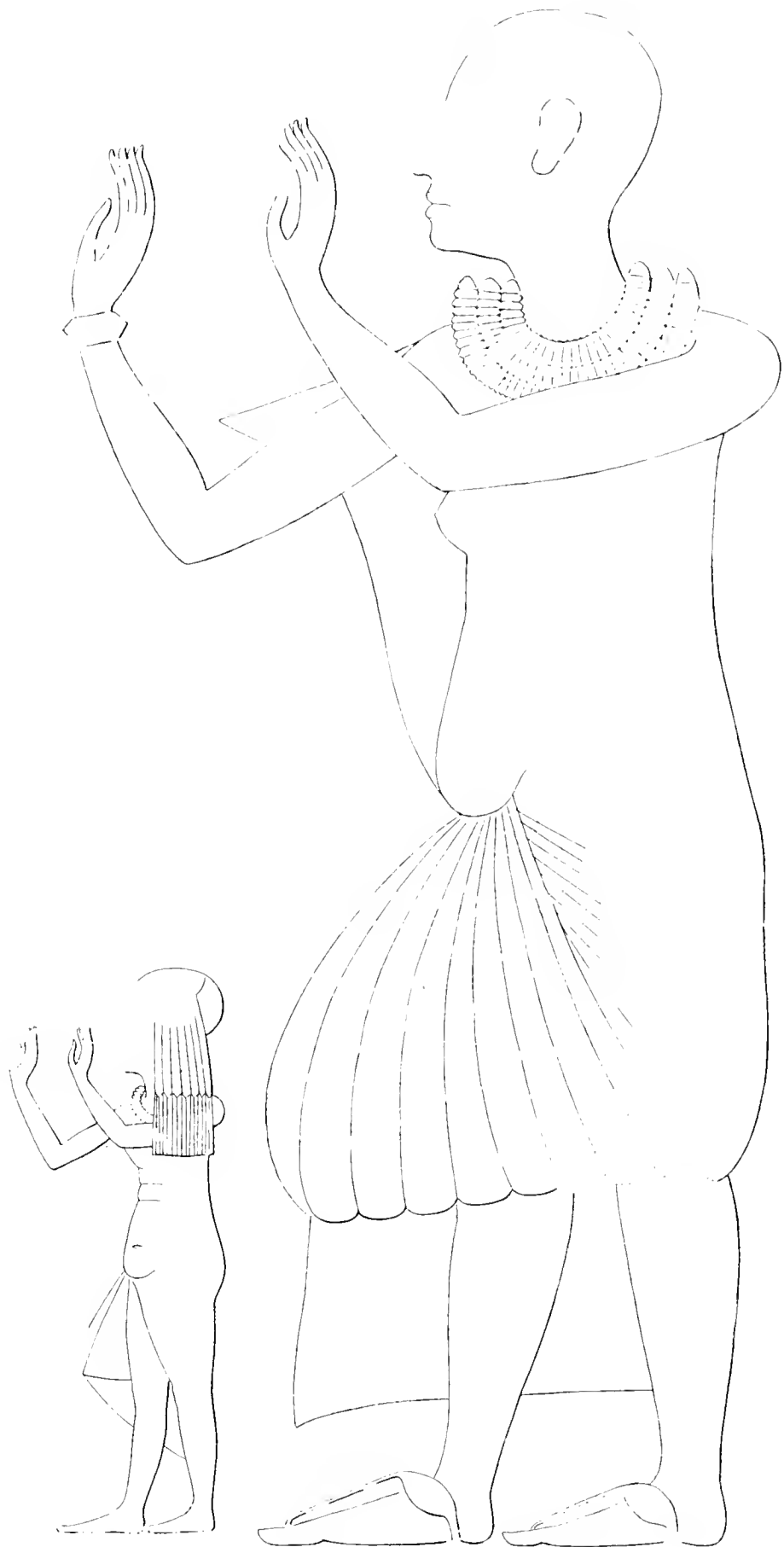

Scale 1/2

PANEHESY.







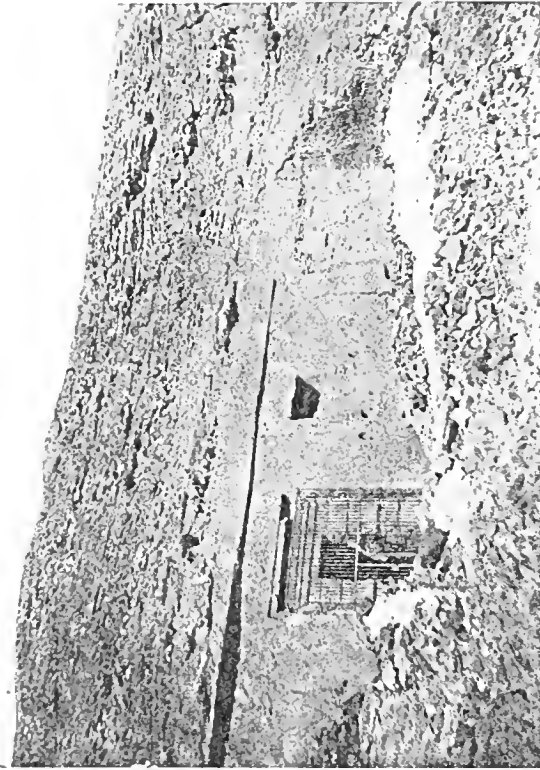

TOMB 3 (MERYRA).



TOMB 3 (MERYRA).

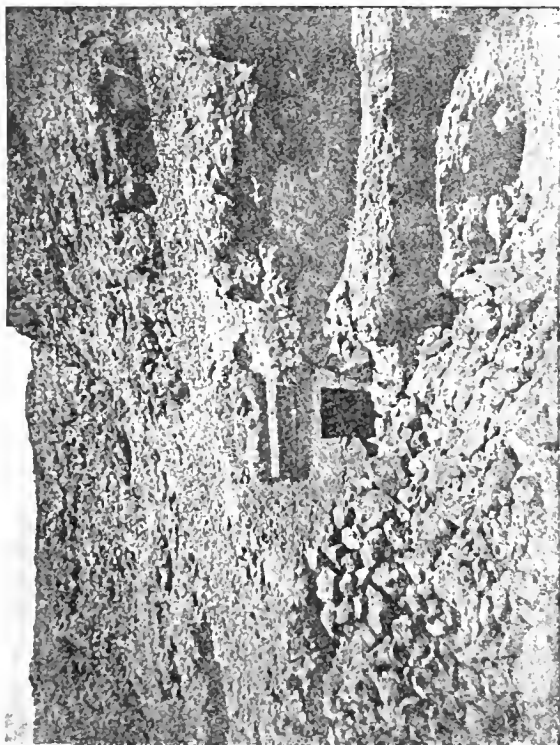

TOMB 1A (RUDU).

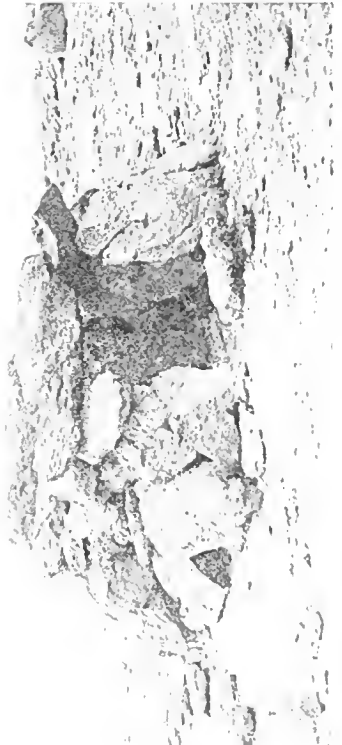

TOMB 1A (RUDU).







TOMB 6 B.

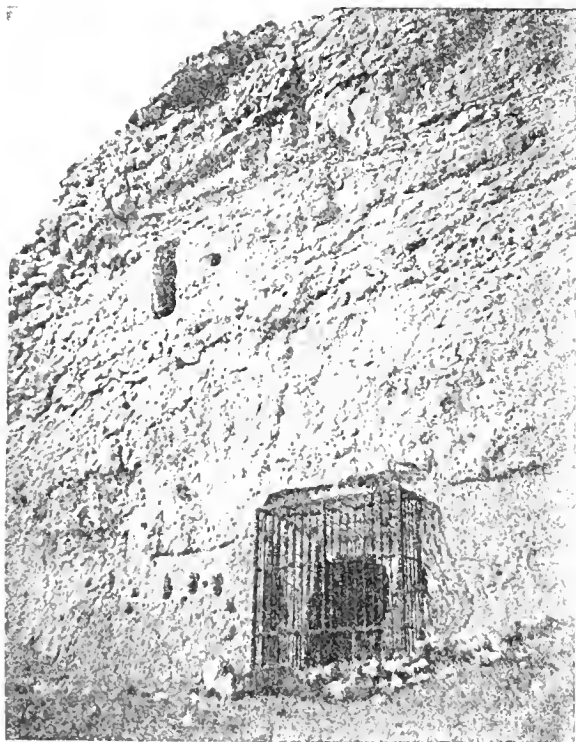

TOMBS 6. 6 C.



STELA J.



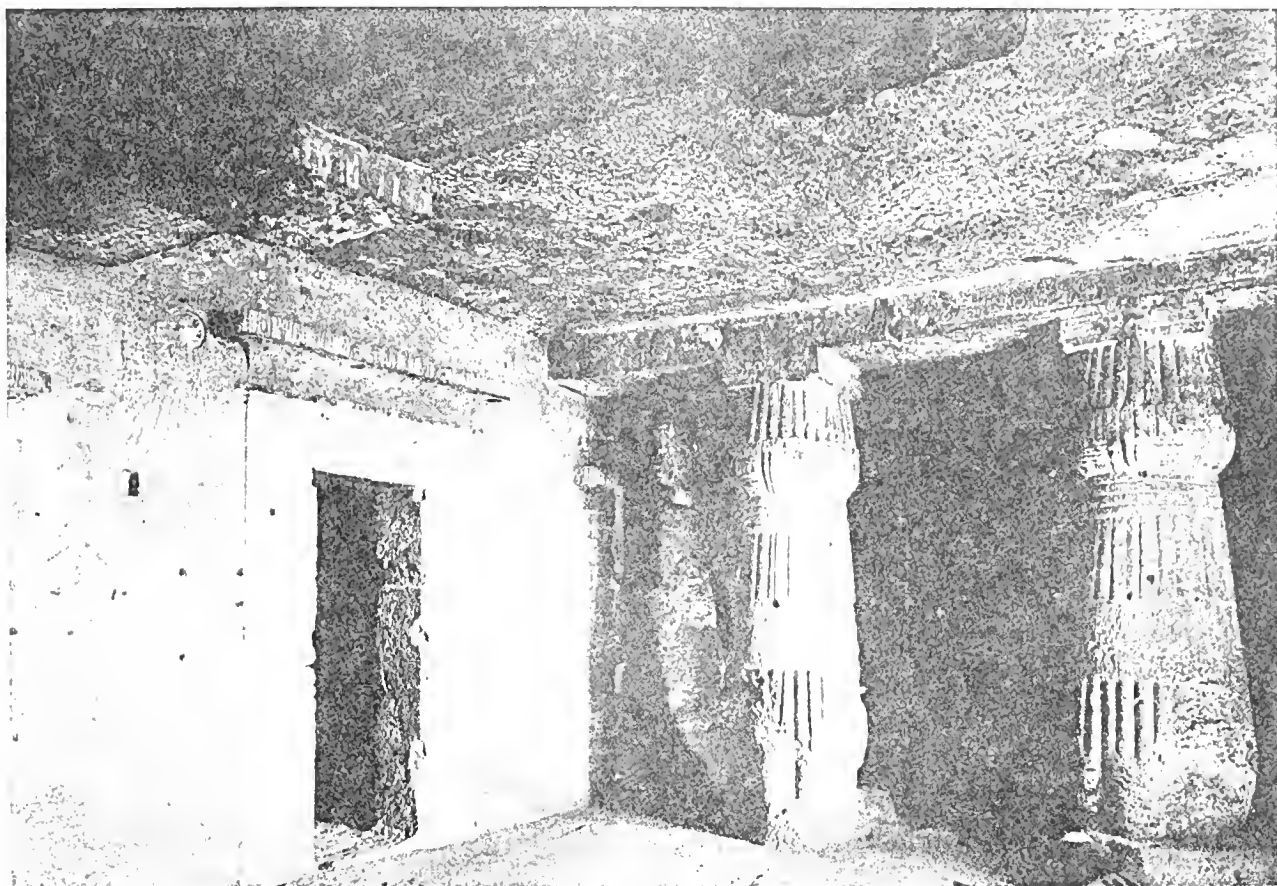

NORTH WALL AND COLUMNS.



NORTH WALL.



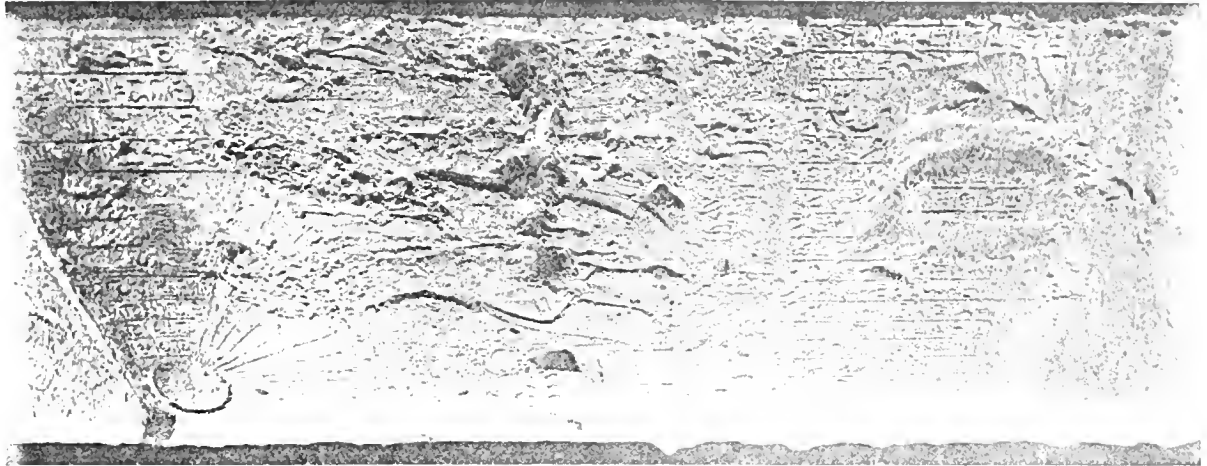

W. THICKNESS.  
(PLATE 7).

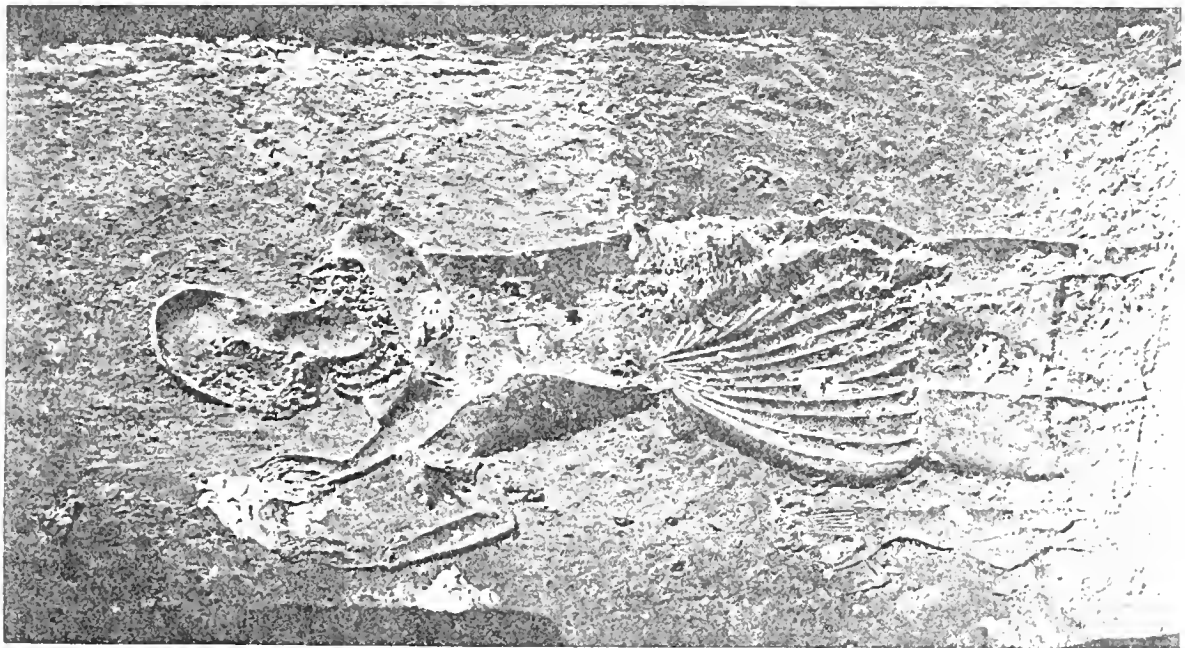

INNER THICKNESS.  
(PLATE 22).

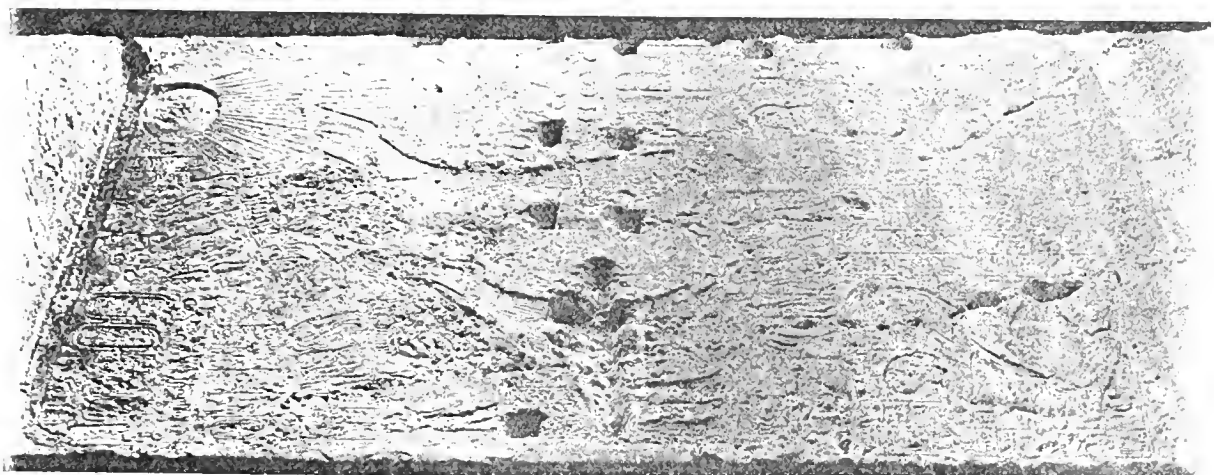

E. THICKNESS.  
(PLATE 8).



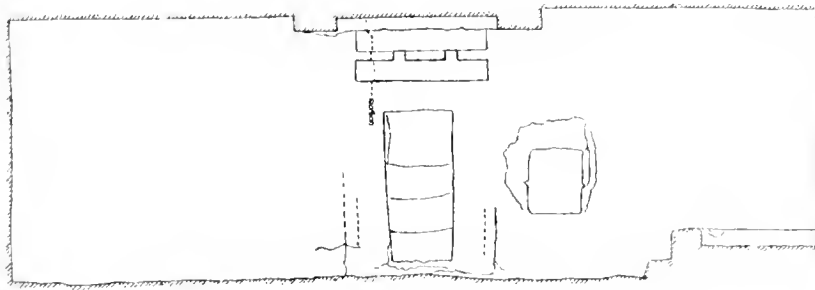

TRANSVERSE SECTION ON A.B.

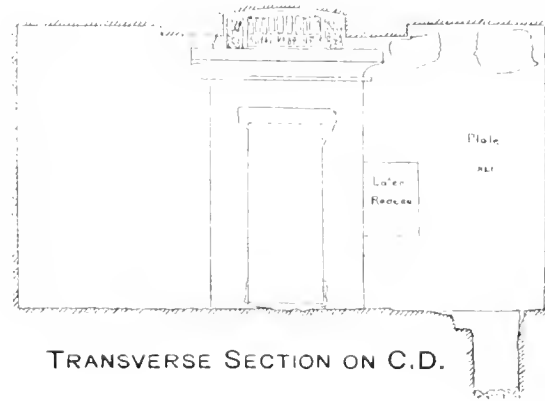

TRANSVERSE SECTION ON C.D.

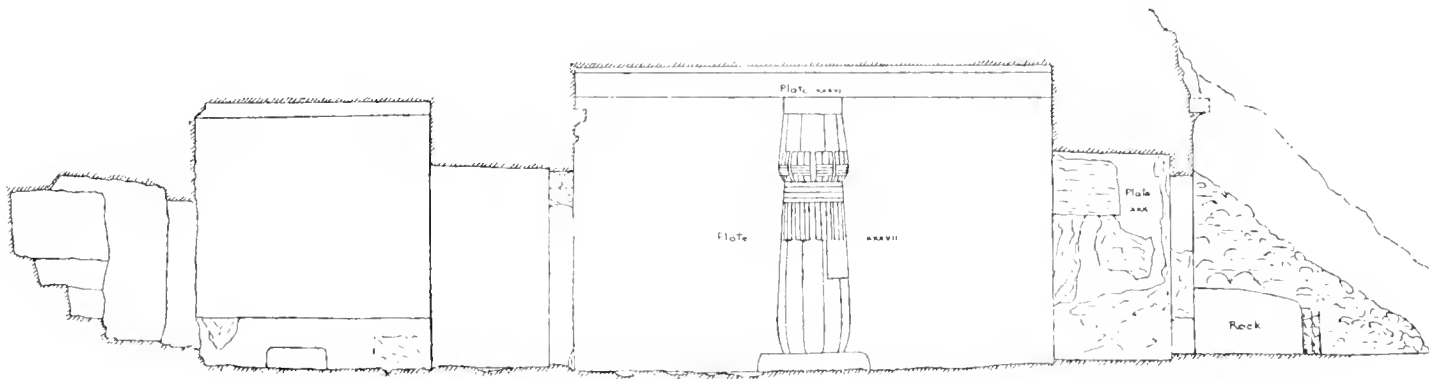

LONGITUDINAL SECTION.

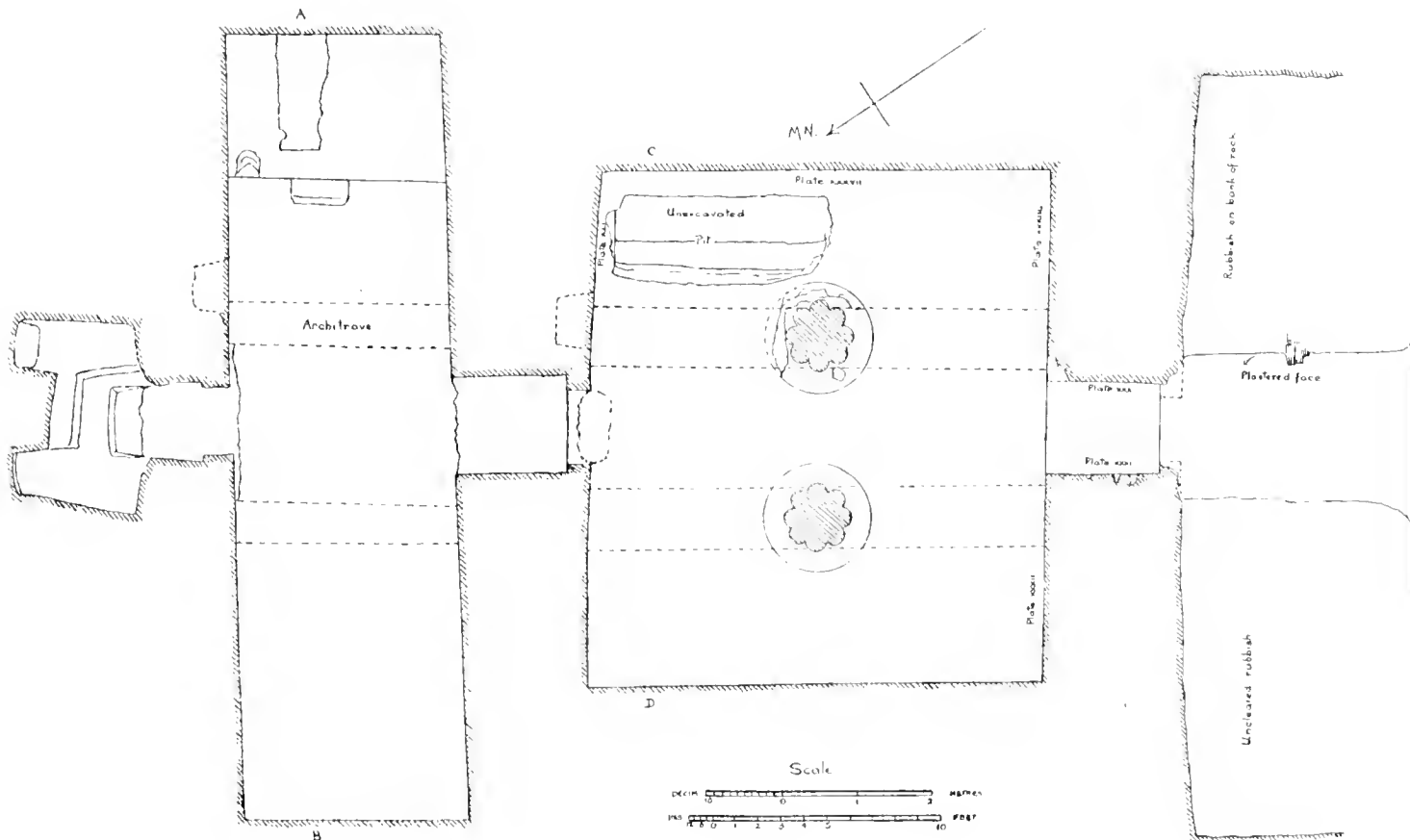

Scale



PLAN.

Scale  $\frac{1}{96}$





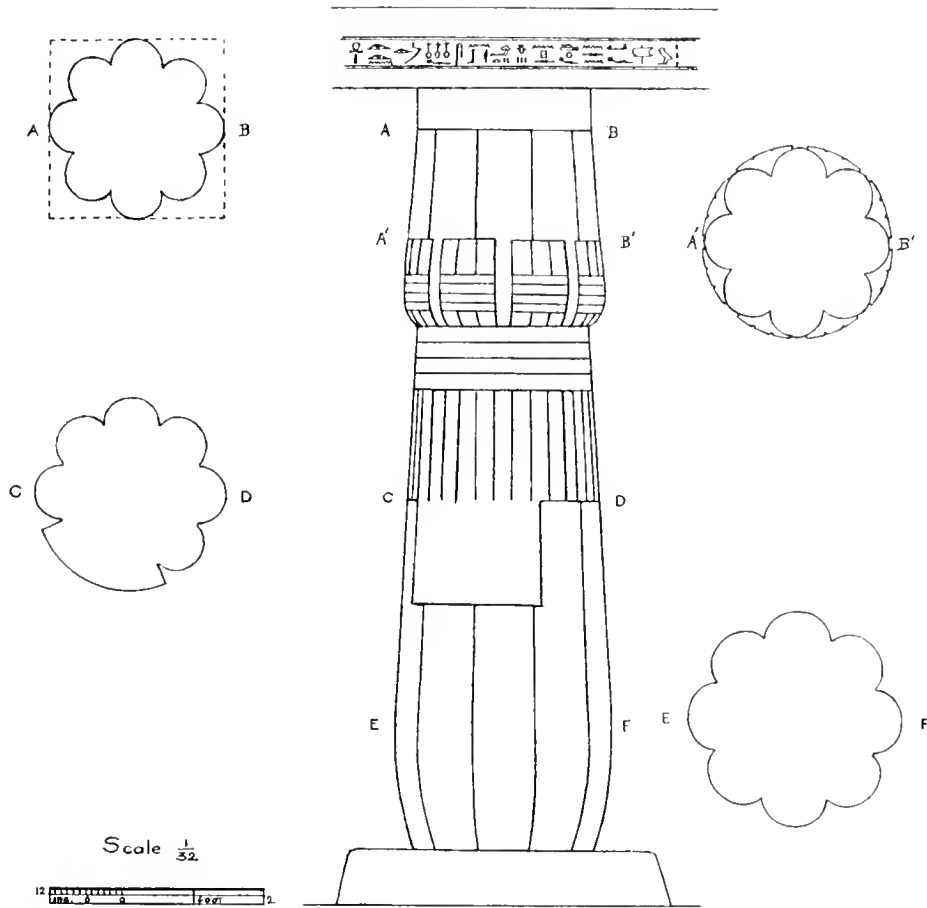

WEST COLUMN—EAST FACE.

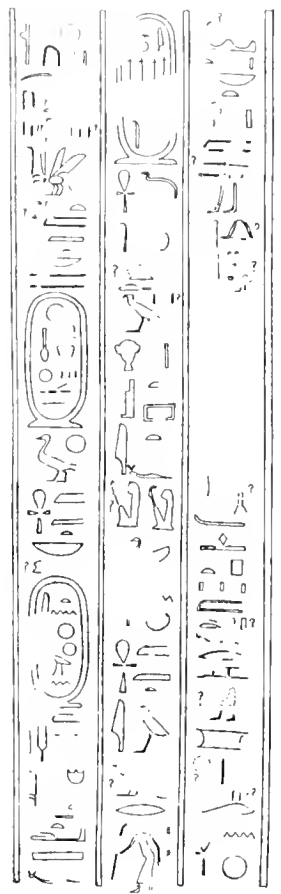

INSCRIPTION—E. WALL.

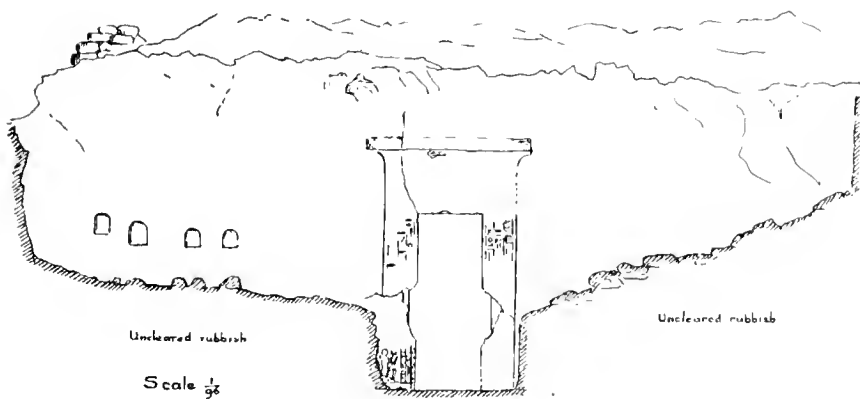

FAÇADE—ELEVATION.



FRAGMENT—OUTER JAMB.



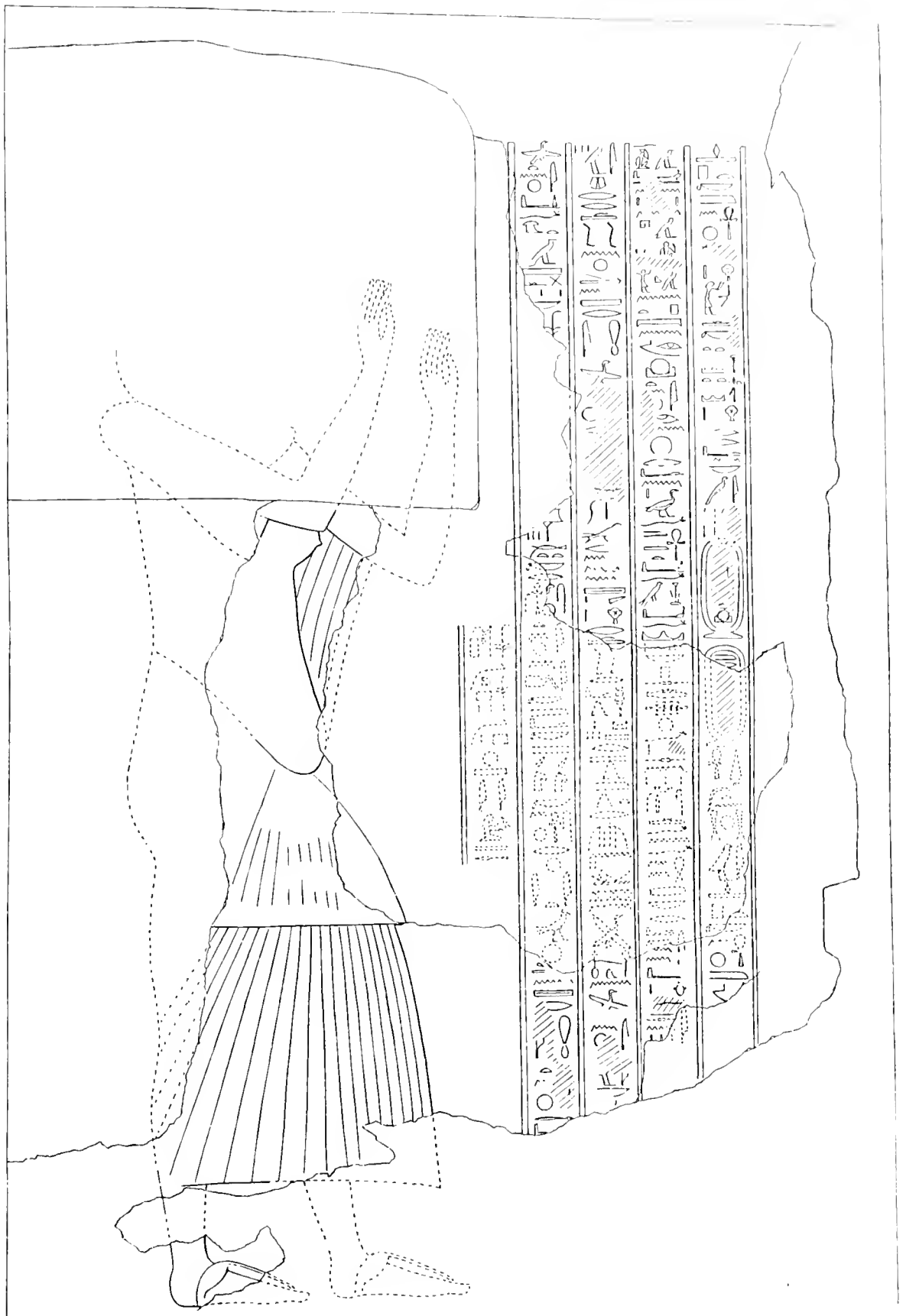

Scale  $\frac{1}{10}$

HYMN TO THE SETTING SUN.



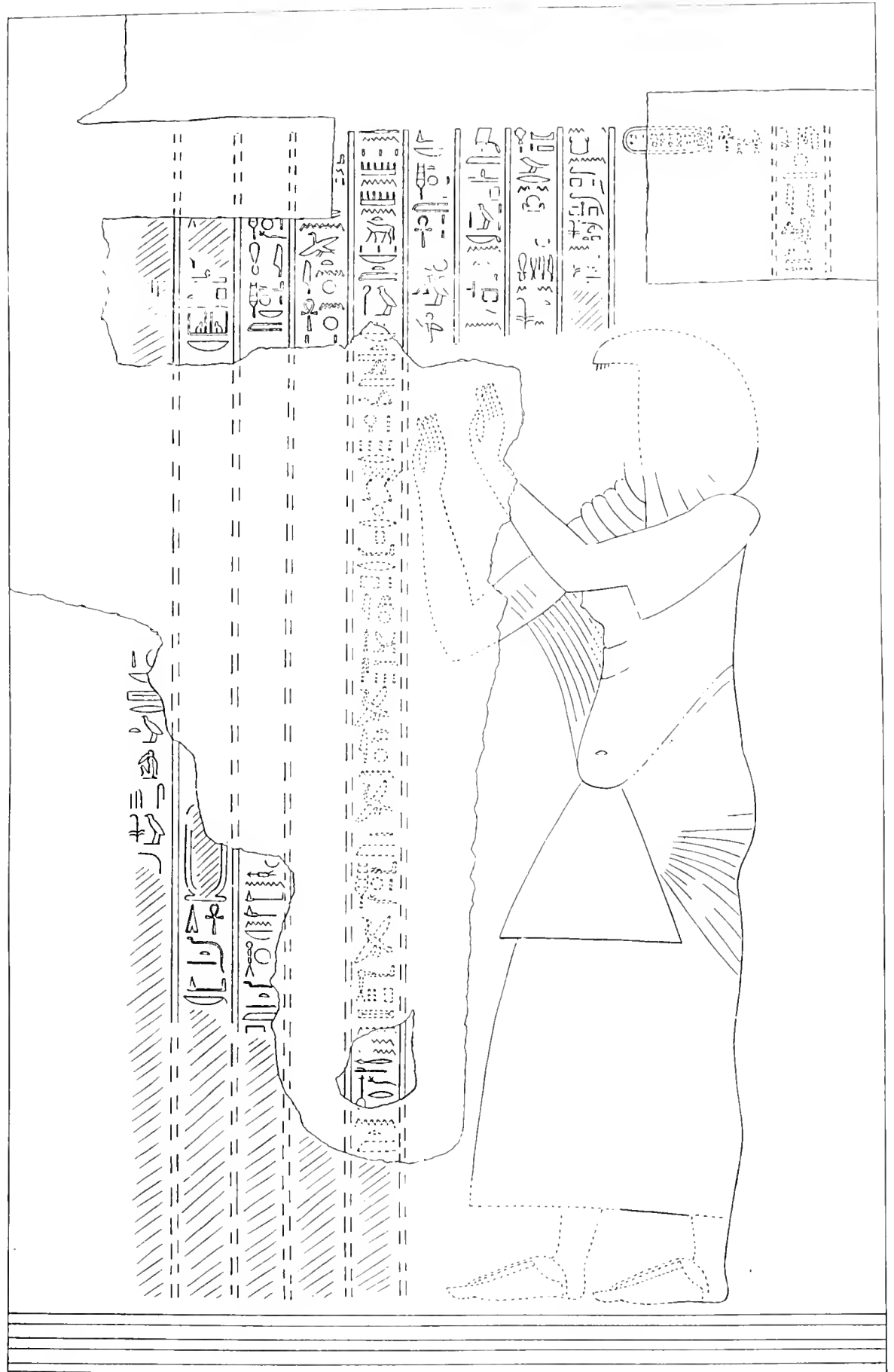

Scale  $\frac{1}{10}$

MERYRA ADORING THE SUN.





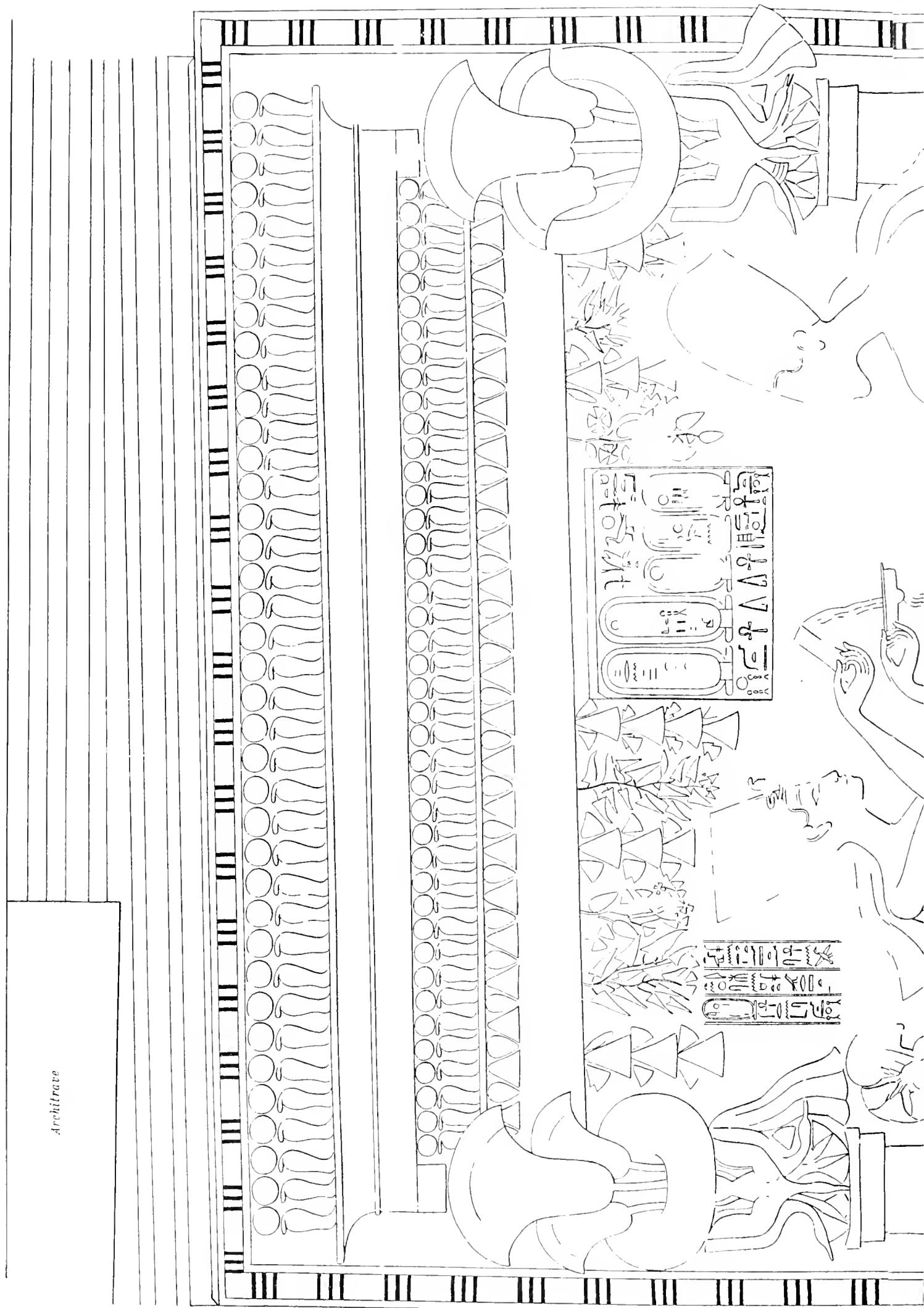

Architrave





THE QUEEN FILLING THE KING'S CUP.

Scale :



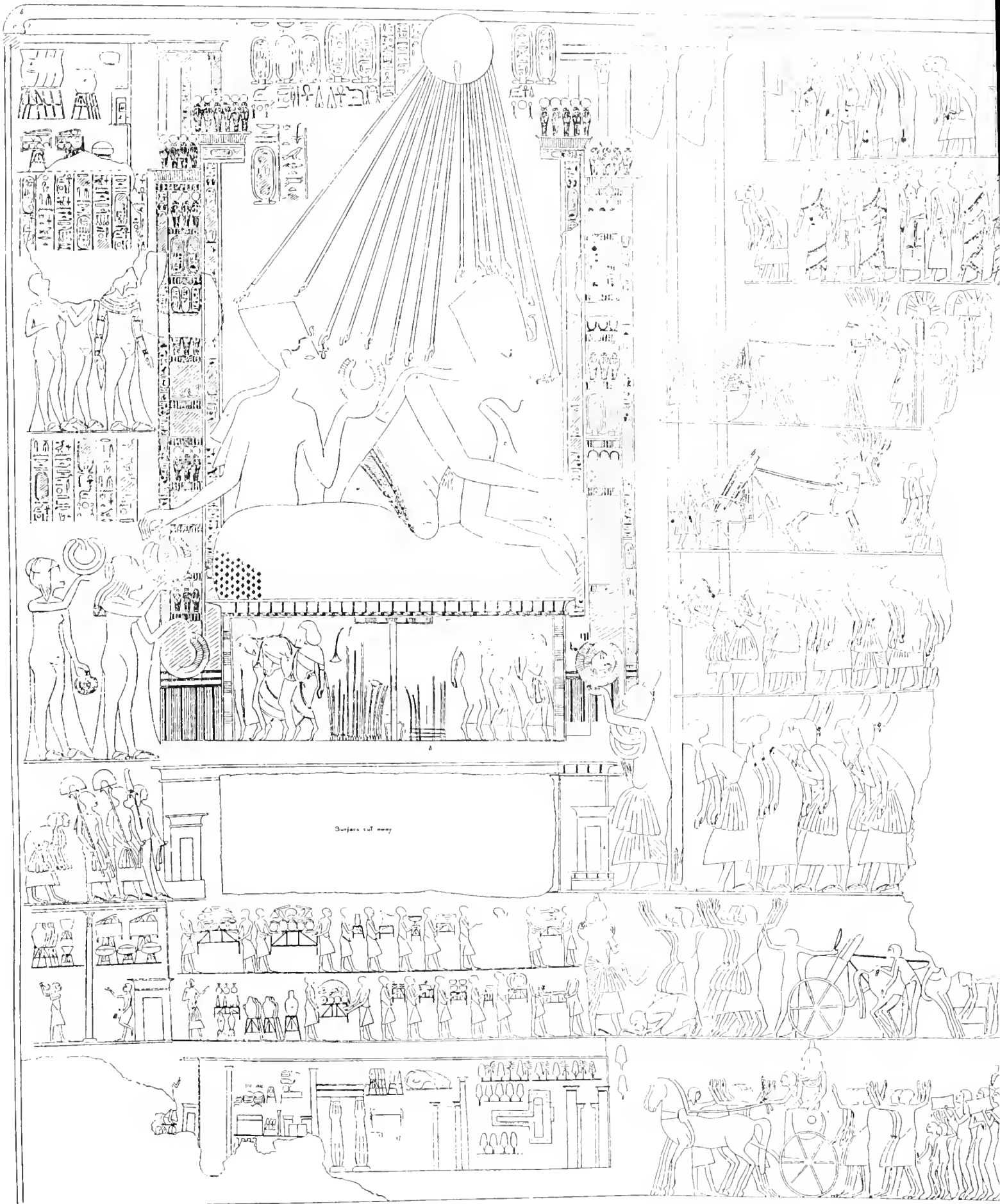

Surfaces cut away





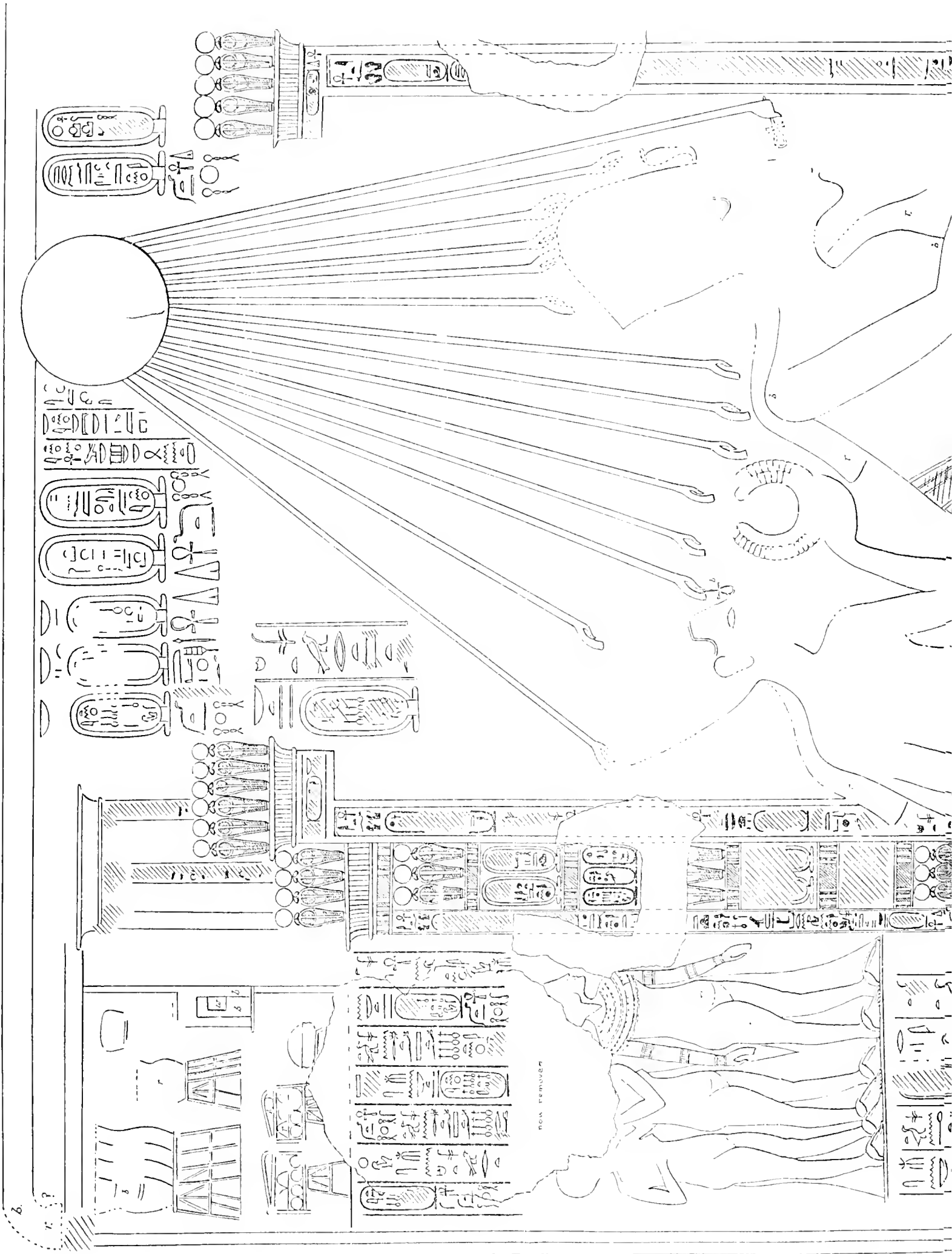



THE ROYAL FAMILY ON THE BALCONY.







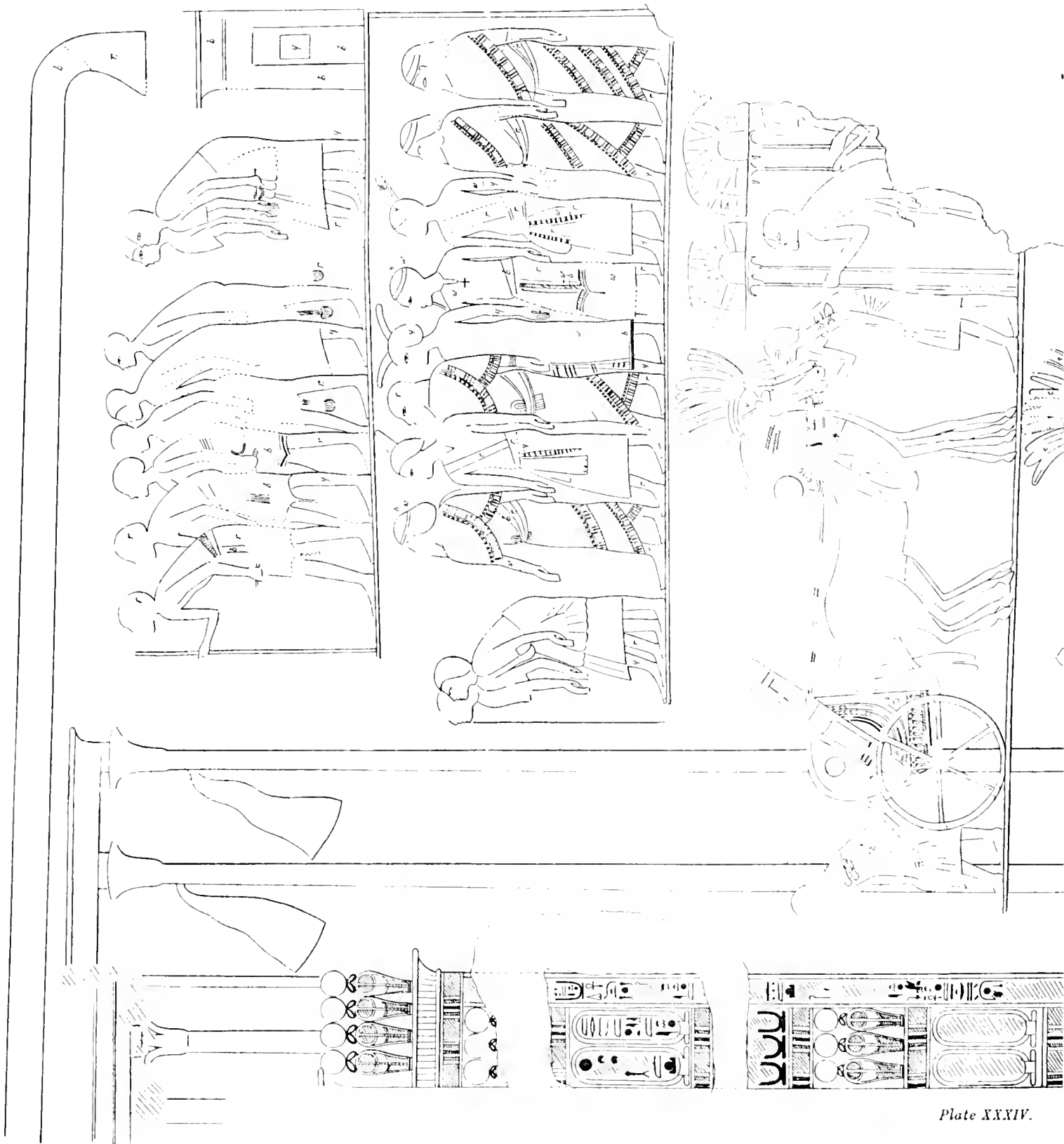
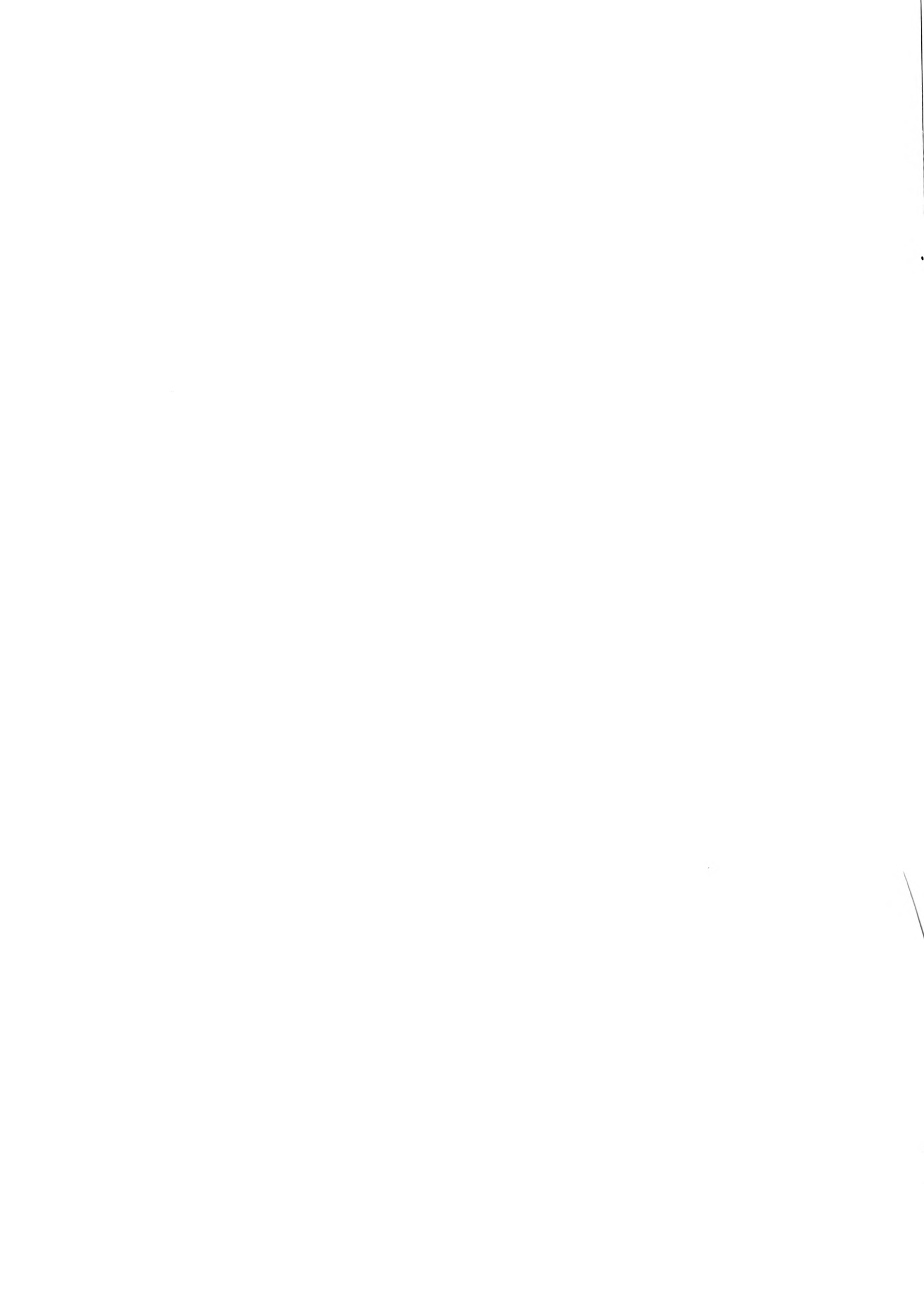

Plate XXXIV.



MERYRA AND THE BYSTANDERS.





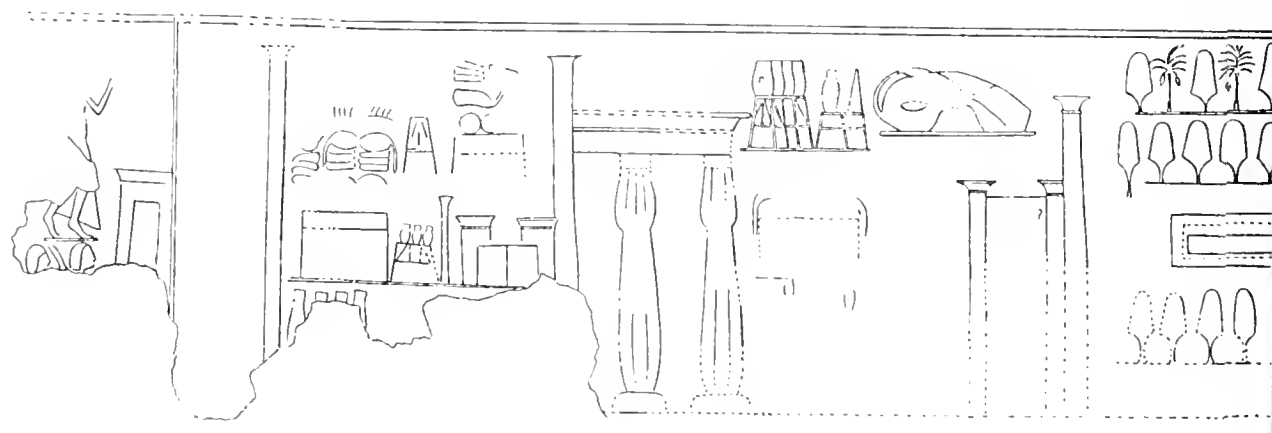
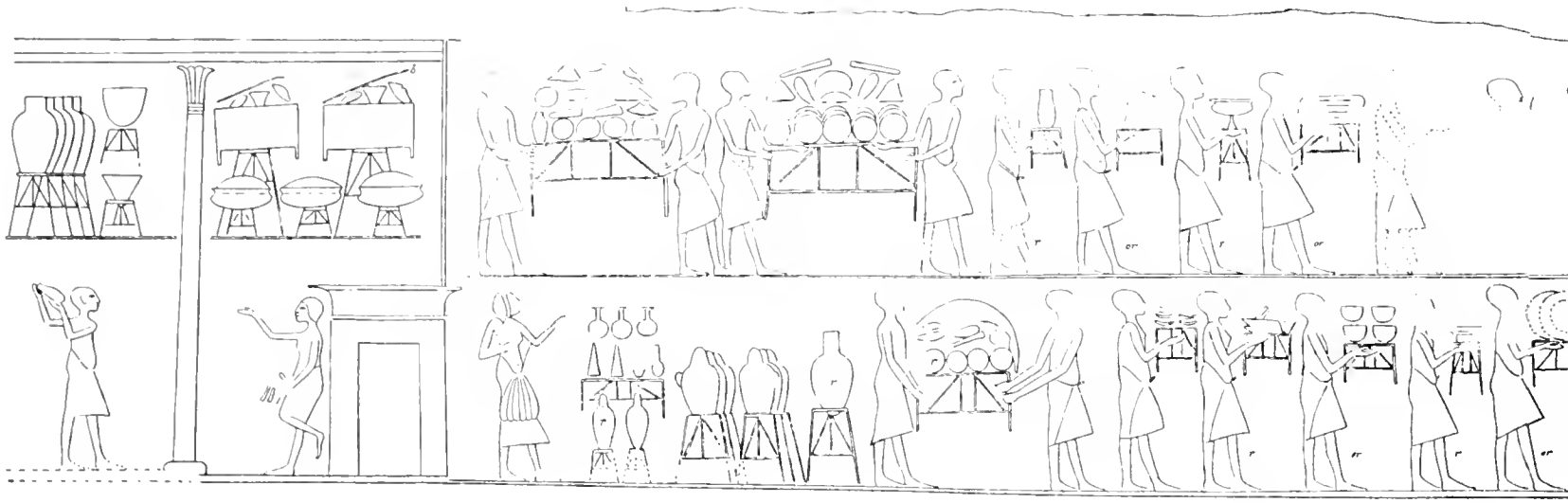

Scale  $\frac{1}{6}$

MERYRA

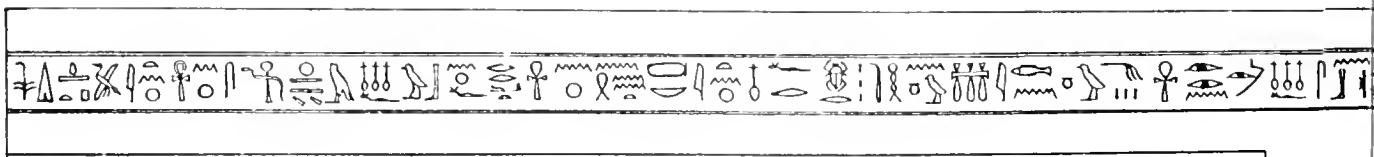

WEST

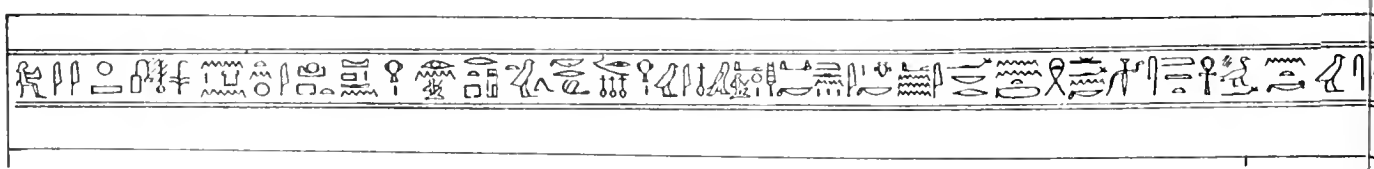

EAST

Scale  $\frac{1}{10}$

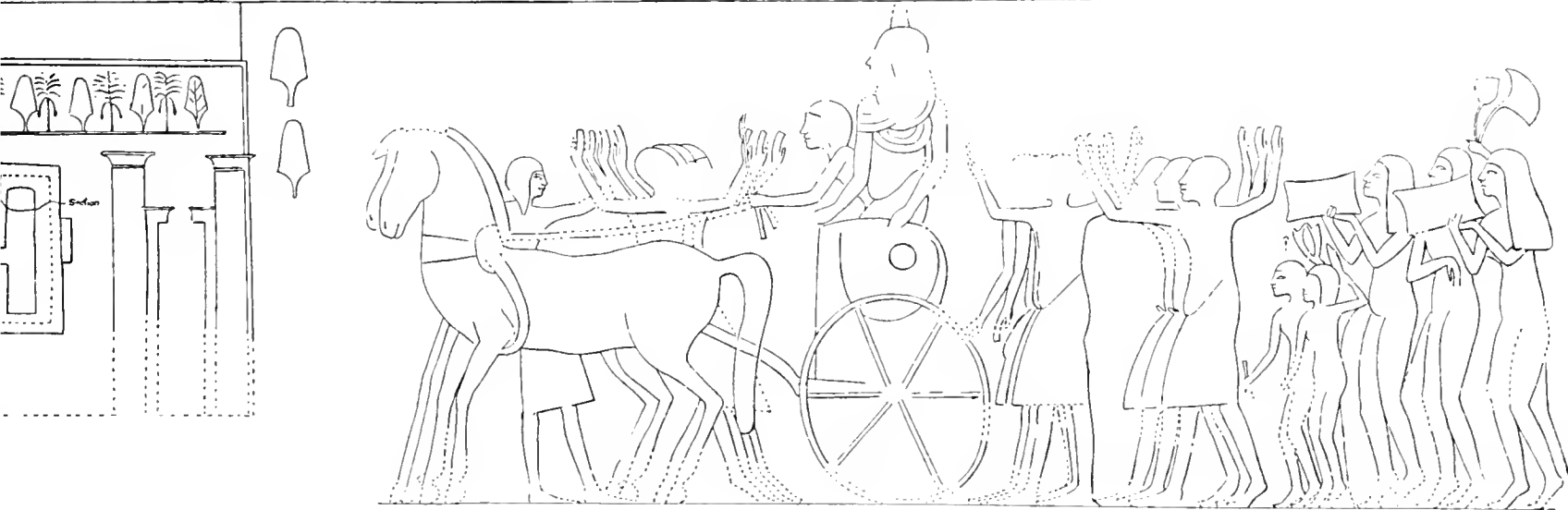
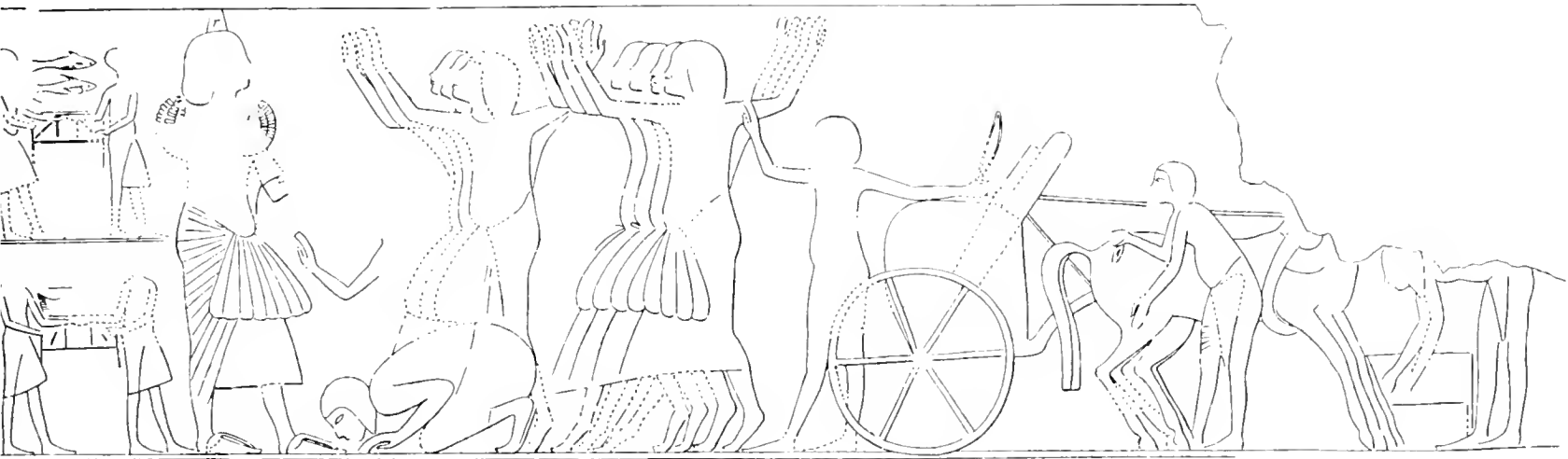

WELCOMED HOME.

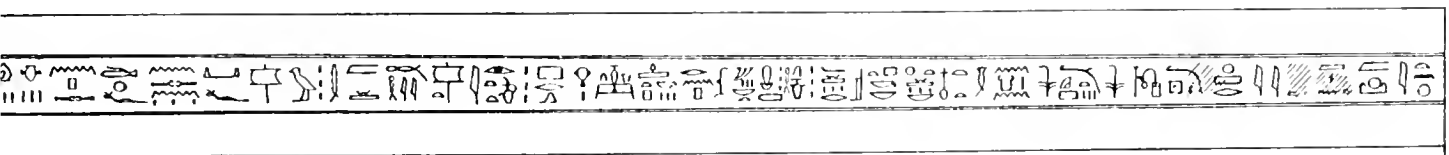

ARCHITRAVE.

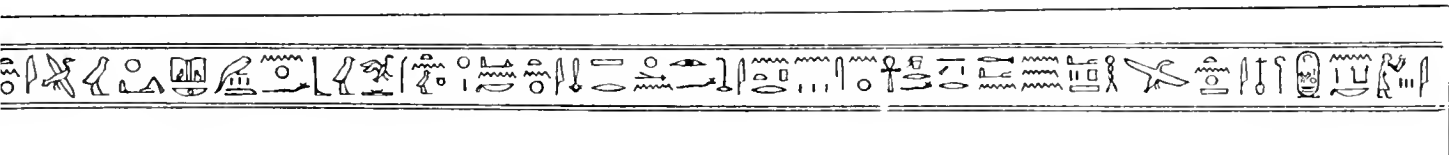

ARCHITRAVE.







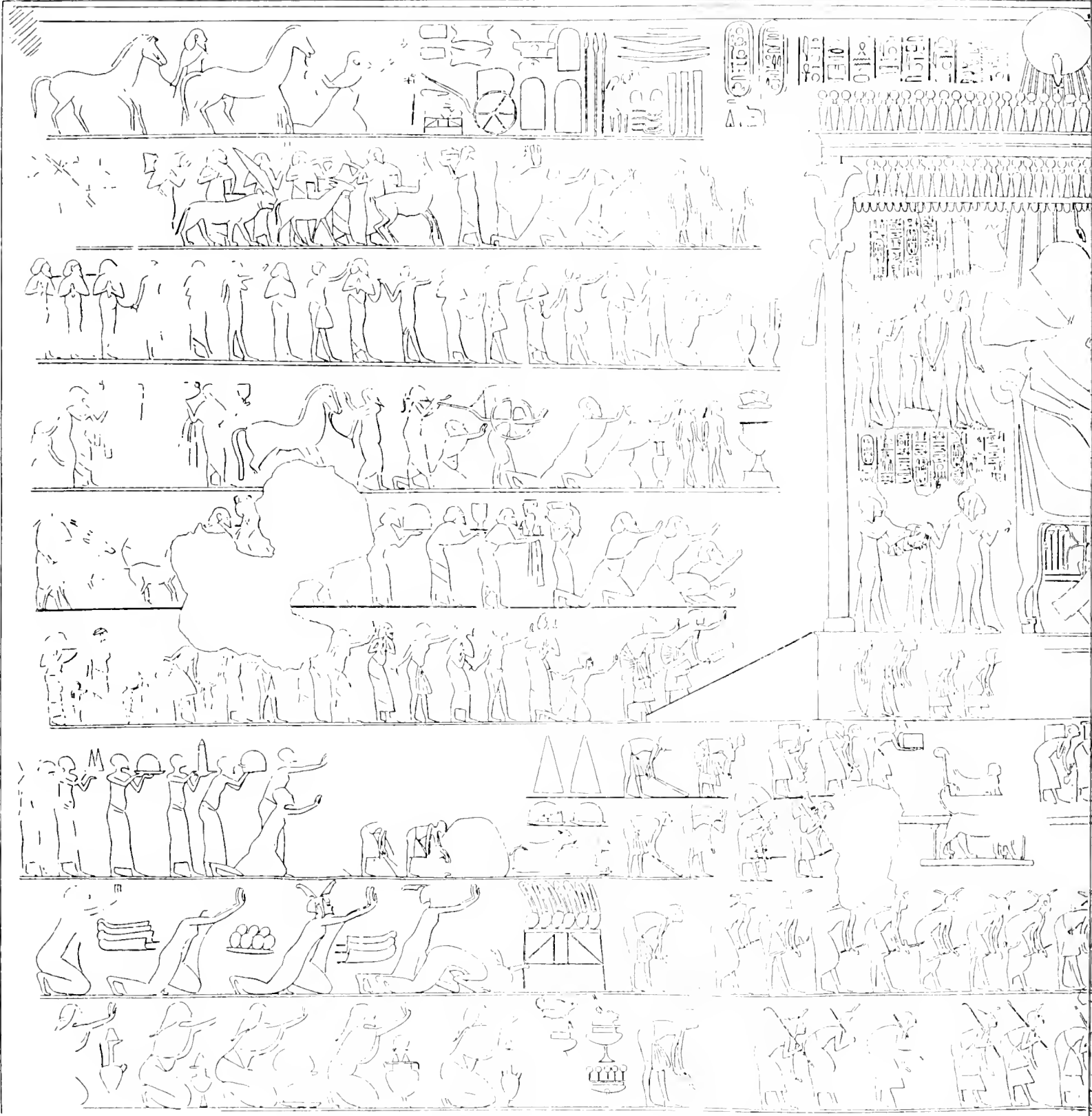

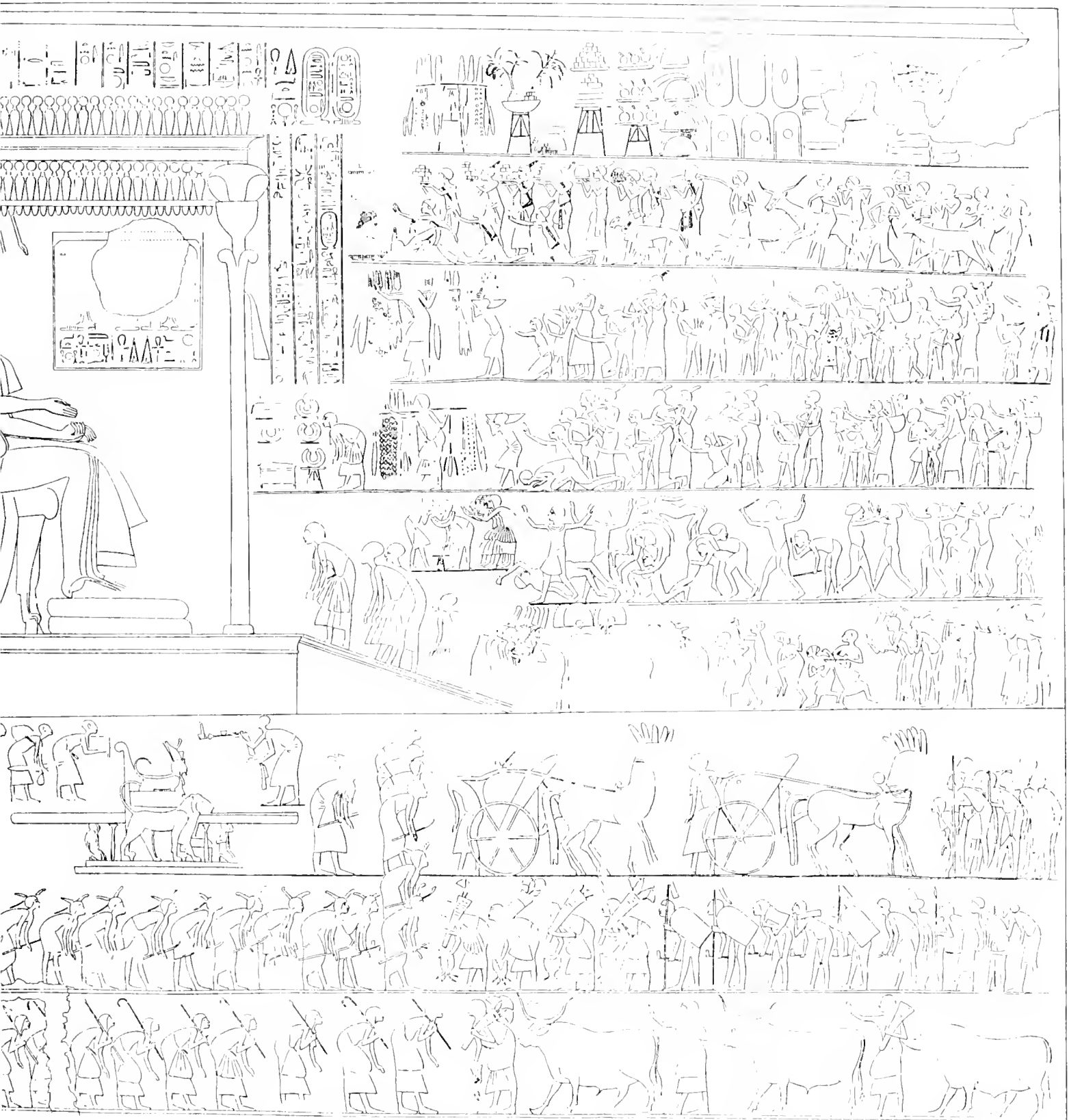





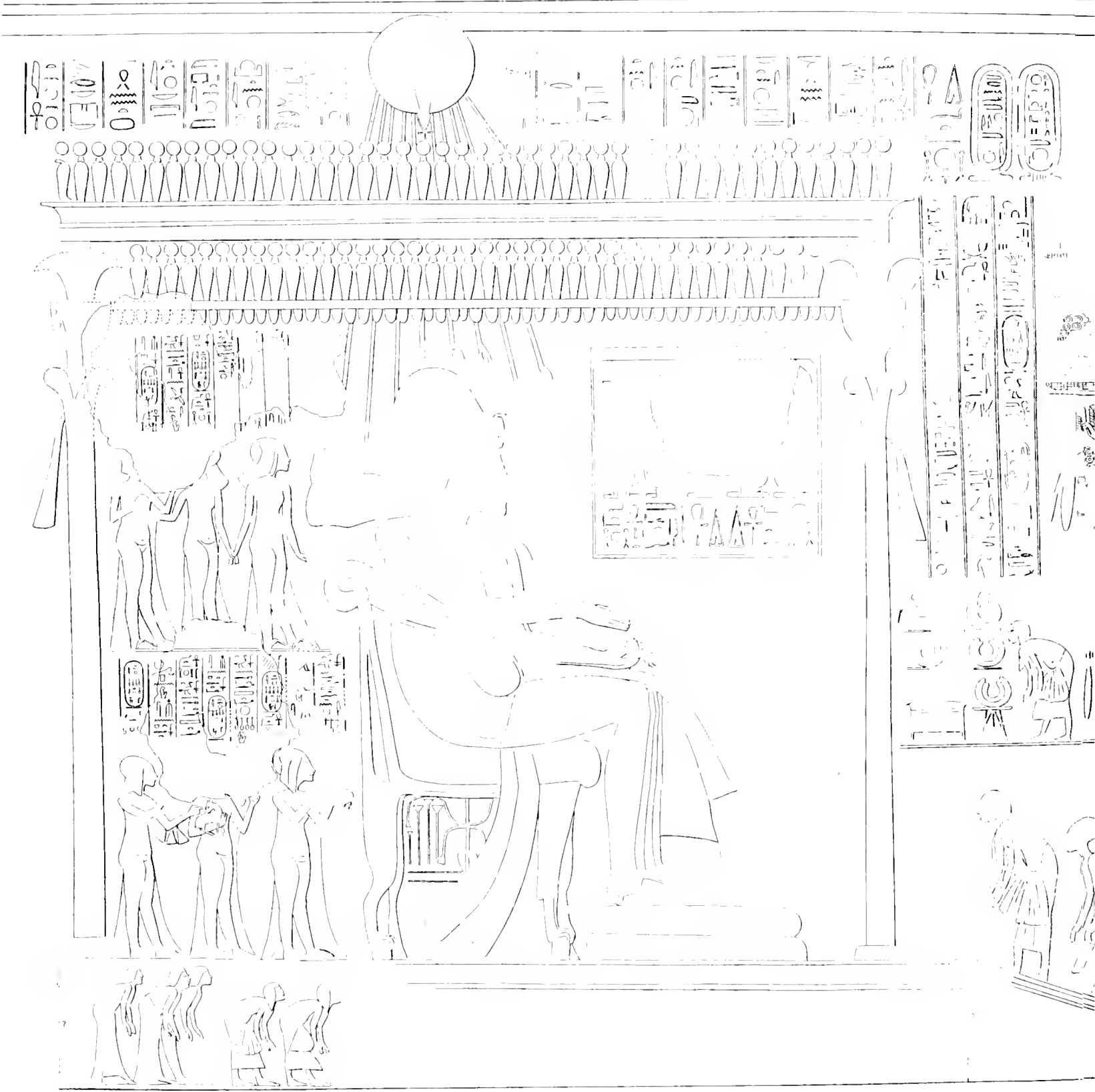

THE TRIBUTE OF THE SC

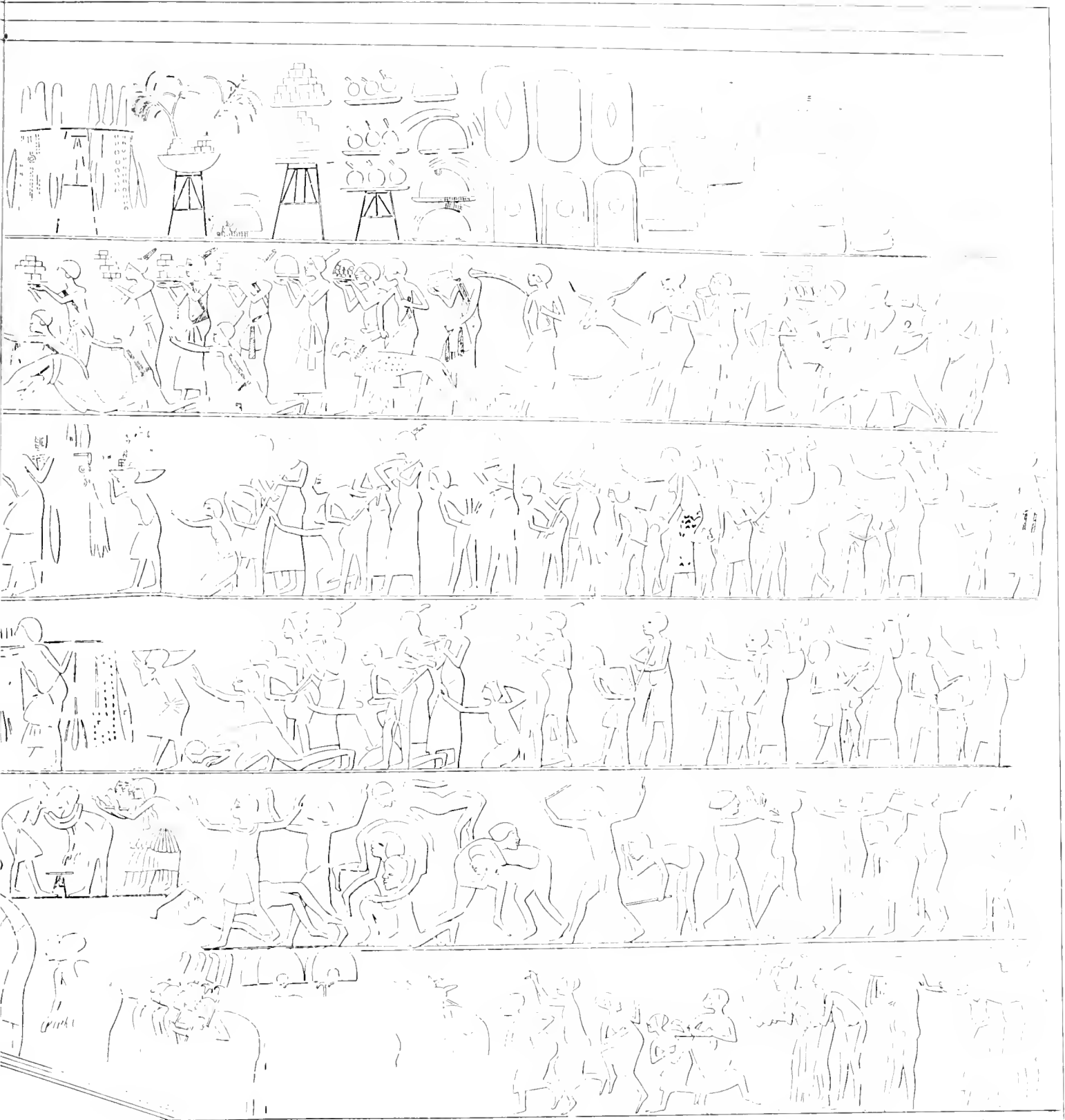











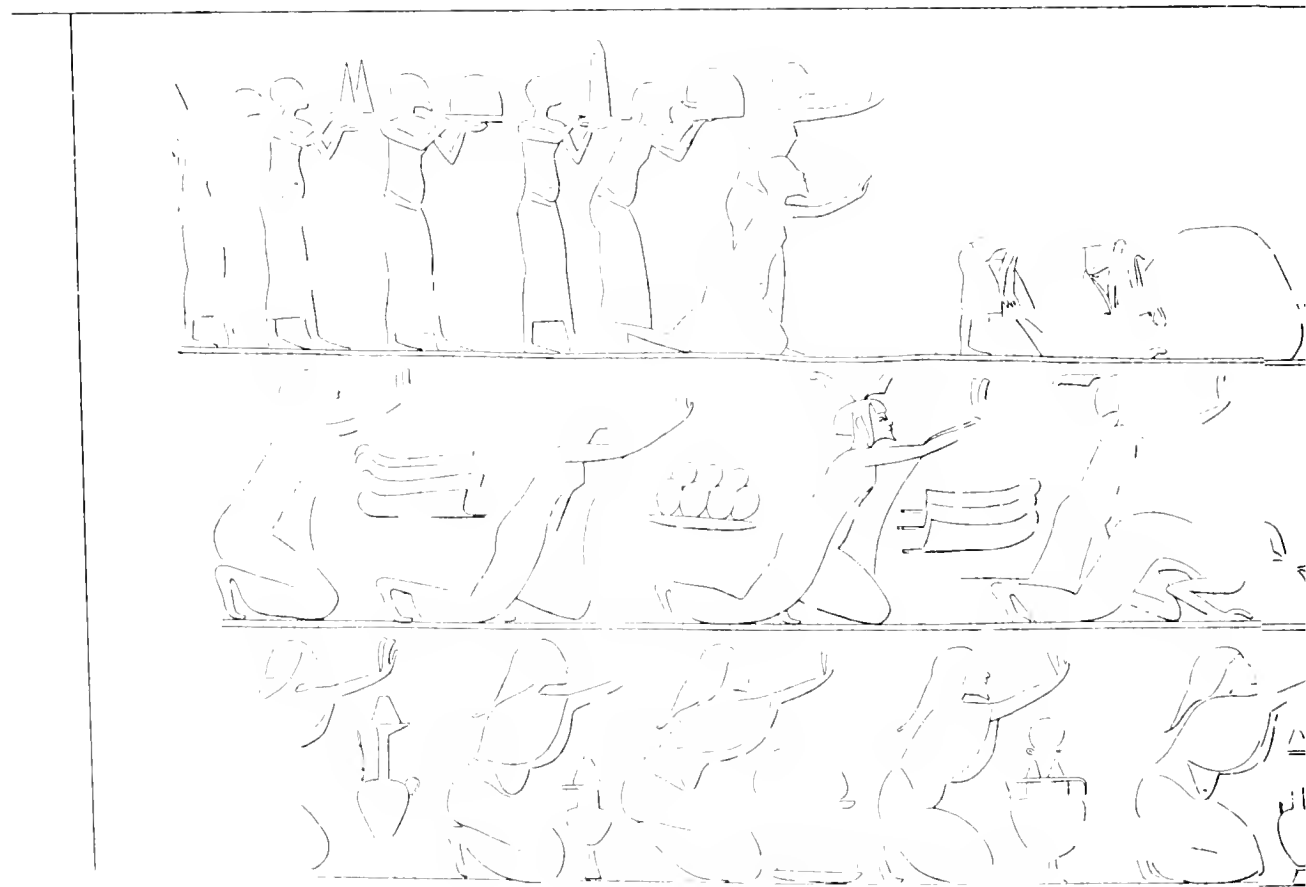

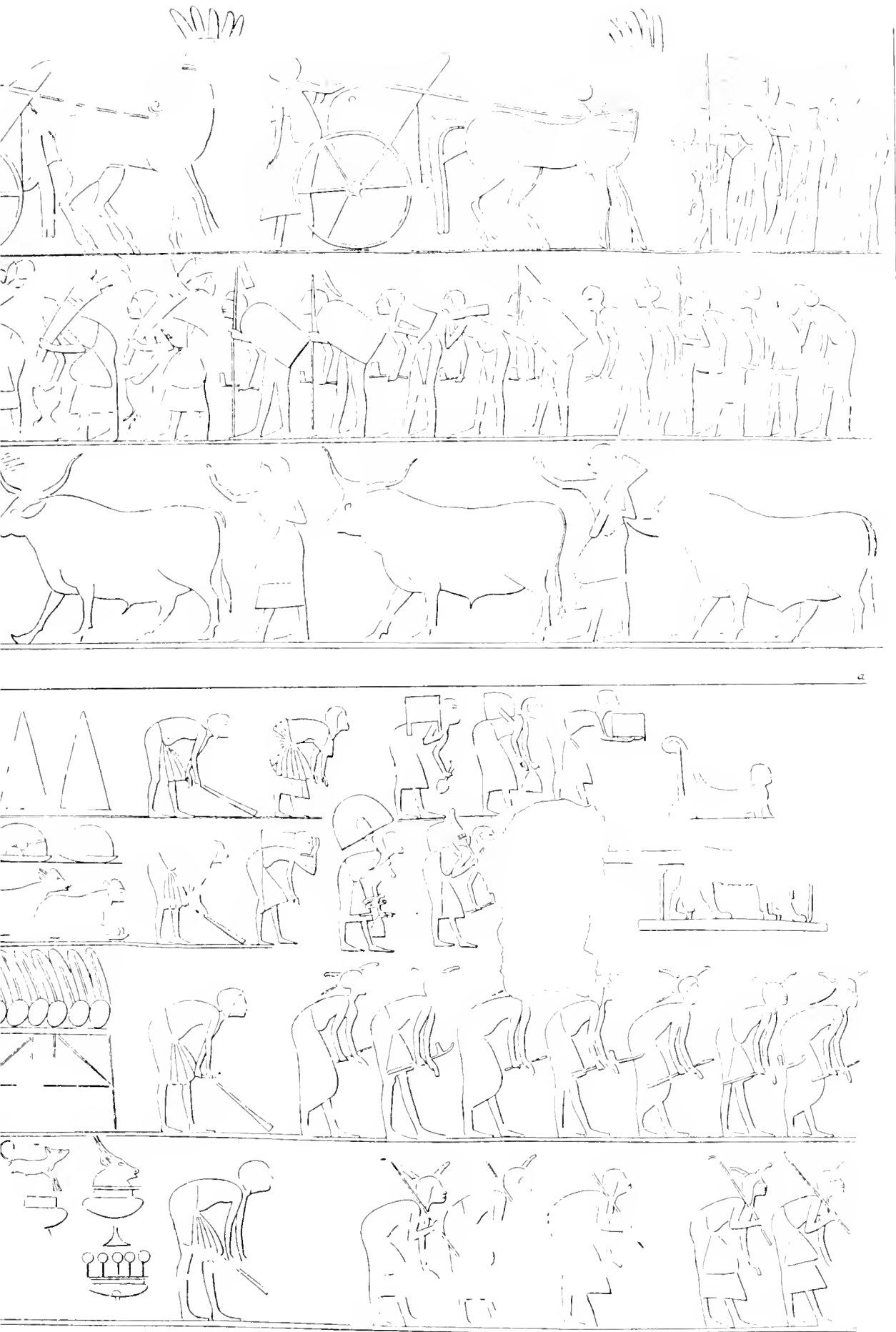

a

b











SECTION.

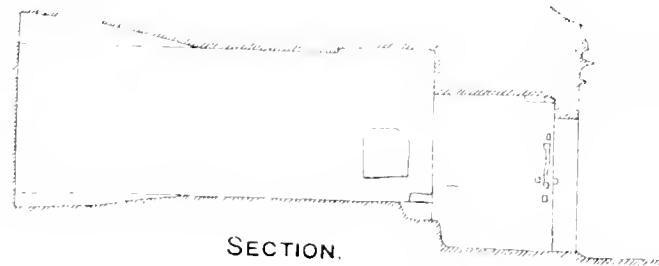

SECTION.

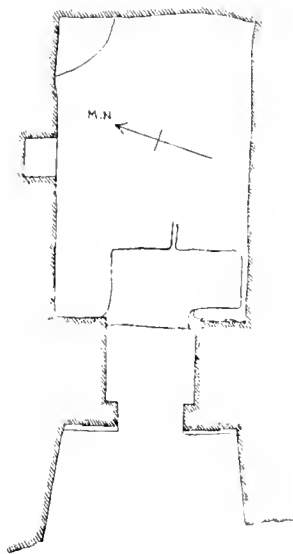

PLAN.



INSCRIPTION ON FAÇADE.

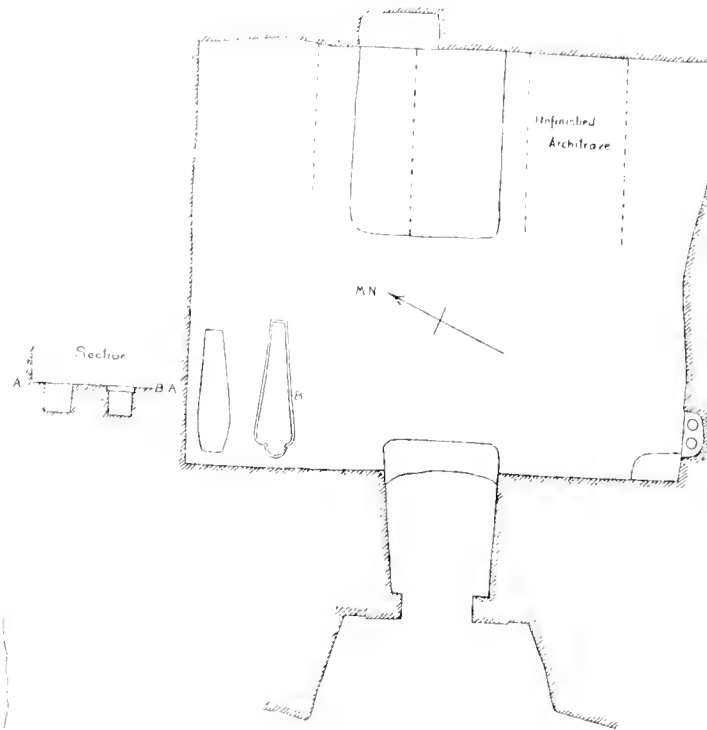

PLAN

TOMB 1B.

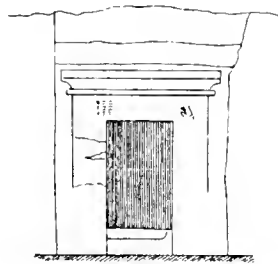

ELEVATION

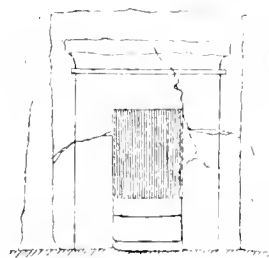

ELEVATION

TOMB 1A.

Scale  $\frac{1}{16}$

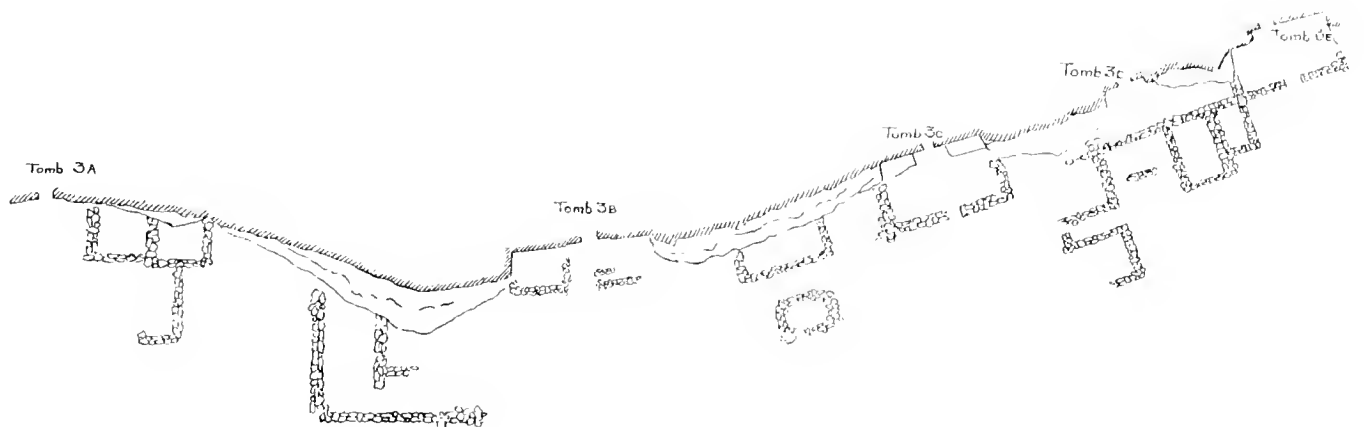

Scale  $\frac{1}{180}$

RUBBLE WALLS OUTSIDE TOMBS 3A-E.



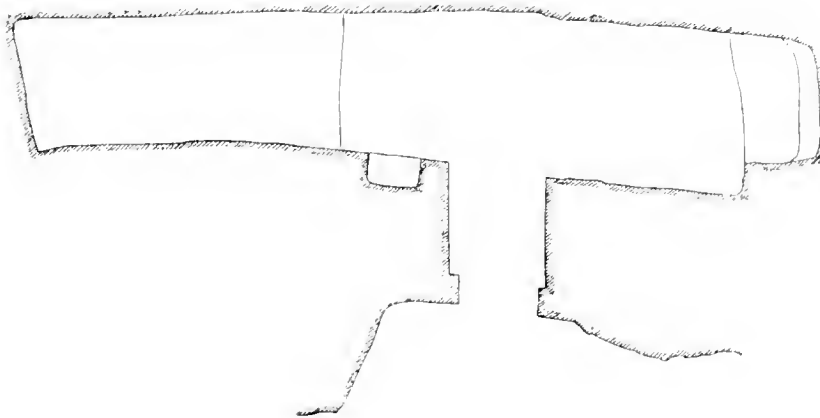

PLAN.

ELEVATION

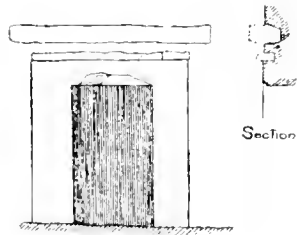

Section

TOMB 3D.



Uncleared

TOMB 3A.

PLAN.

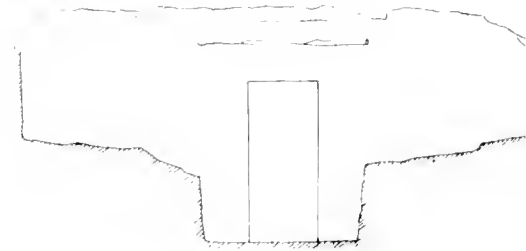

ELEVATION

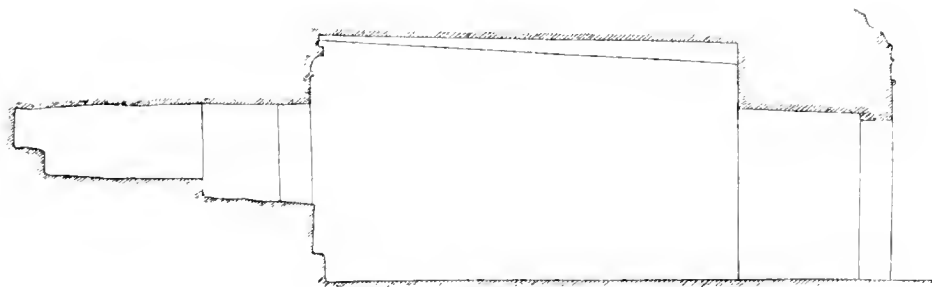

LONGITUDINAL SECTION

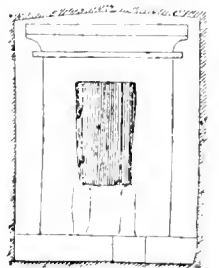

SECTION ON A.B.

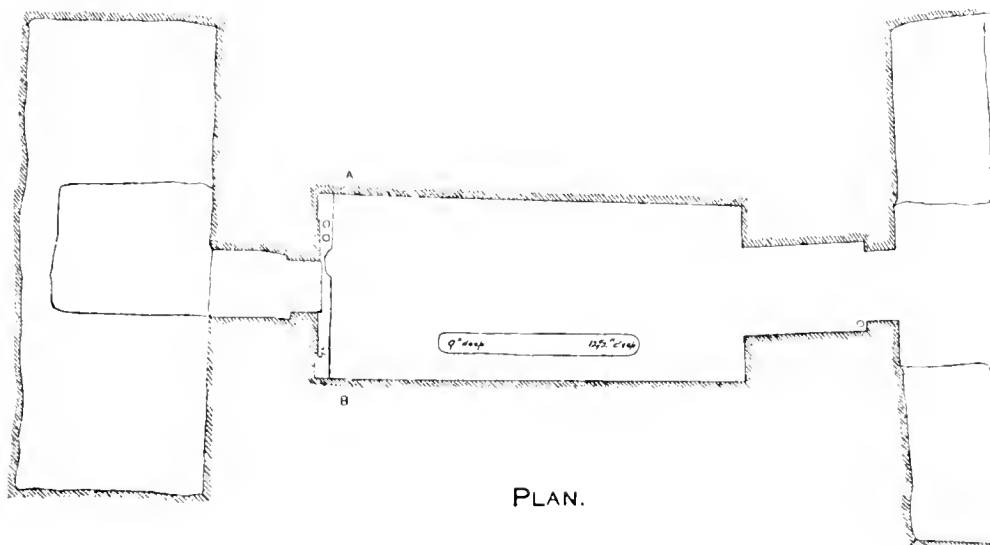

PLAN.

TOMB 3C.



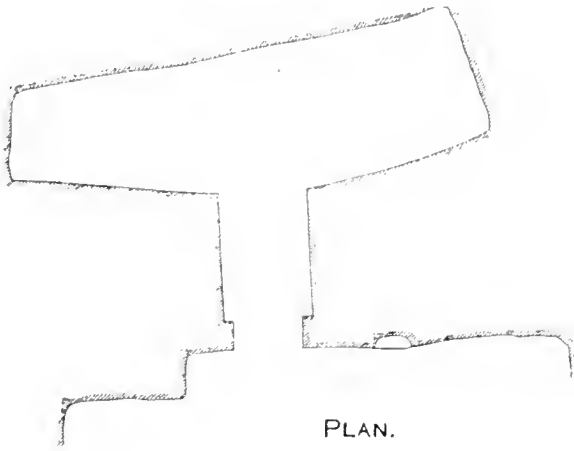

PLAN.

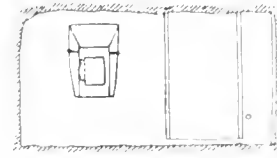

SECTION ON A.B.

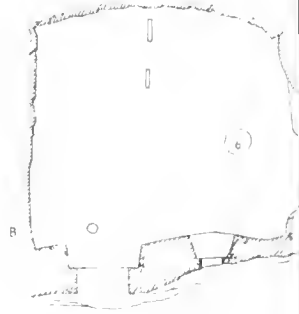

TOMB 6C.

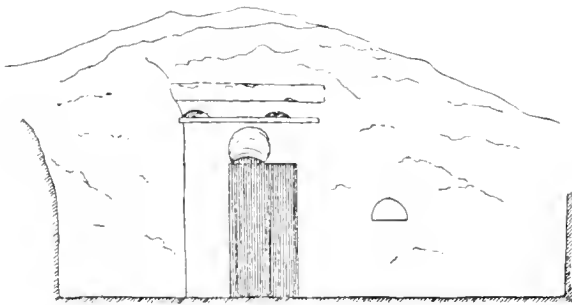

TOMB 3E. ELEVATION.



Cornice

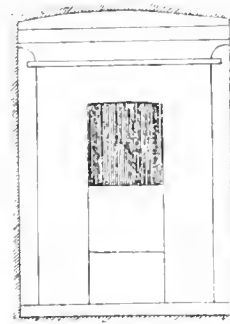

ELEVATION, TOMB 3B.

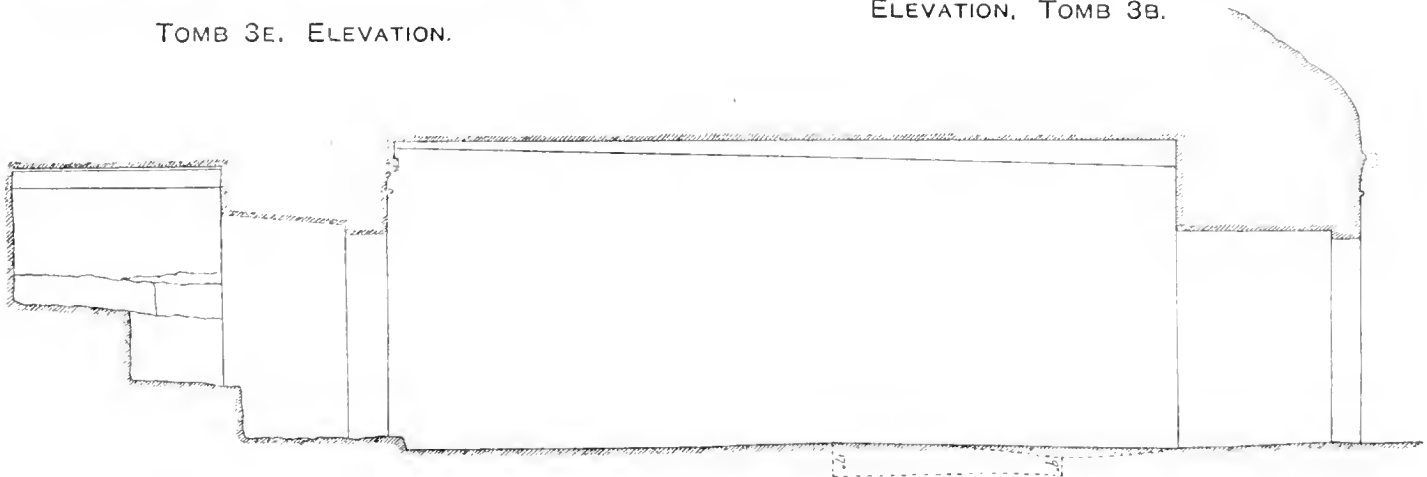

LONGITUDINAL SECTION

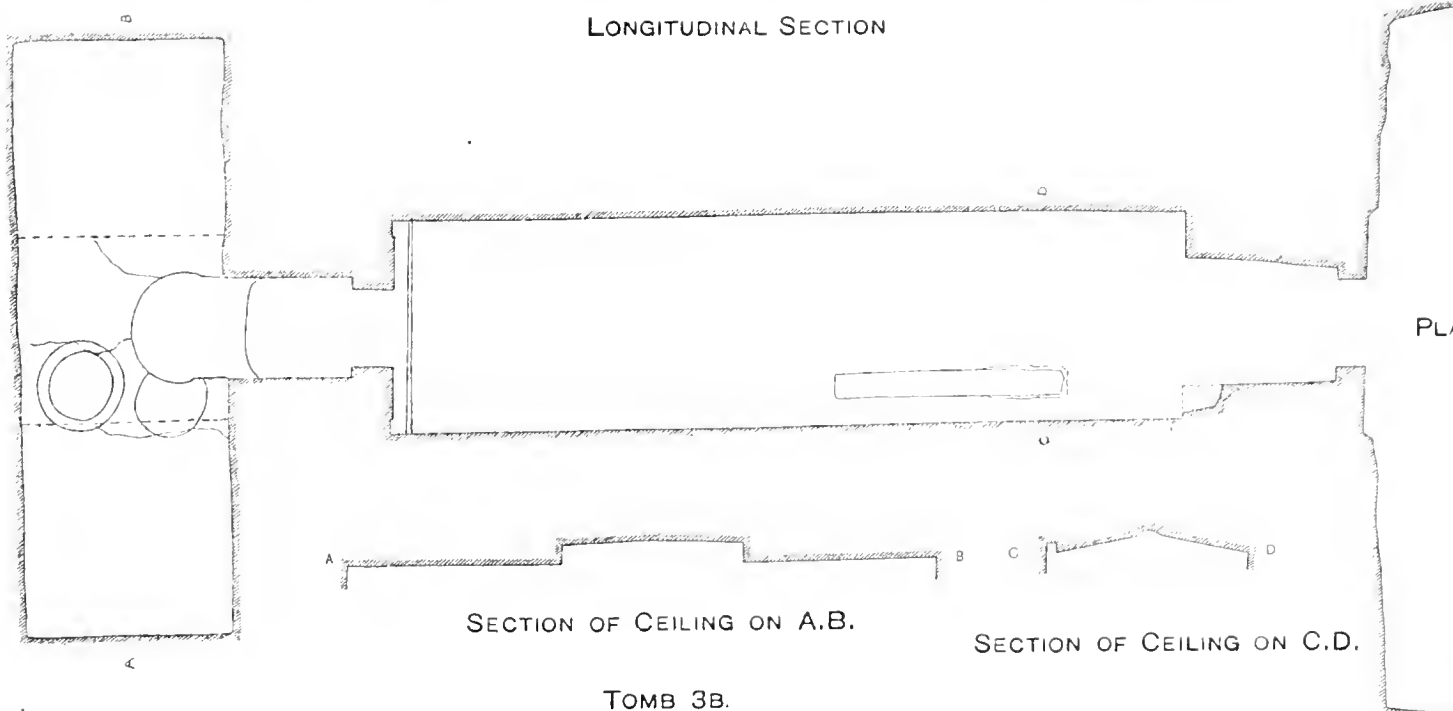

SECTION OF CEILING ON A.B.

SECTION OF CEILING ON C.D.

TOMB 3B.





SECTION.

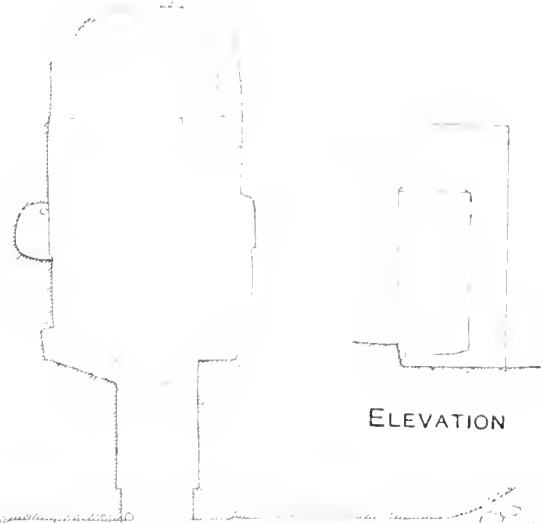

ELEVATION



TOMB 6B. PLAN.

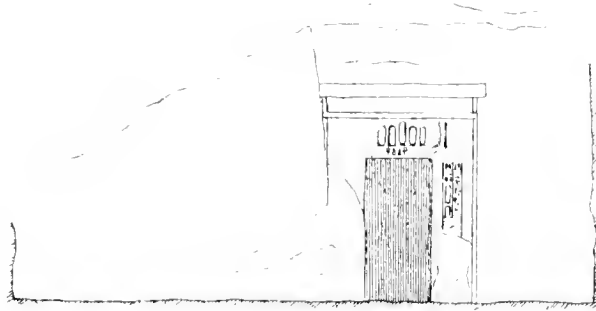

ELEVATION

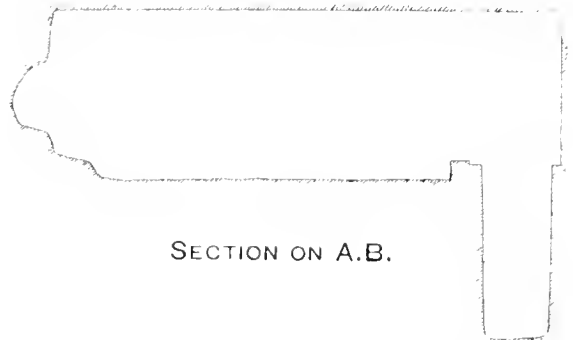

SECTION ON A.B.

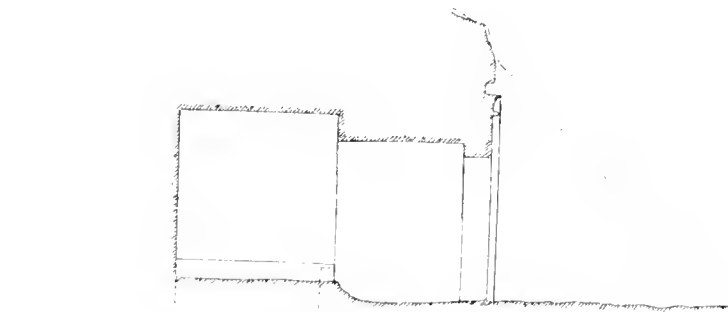

SECTION ON C.D.

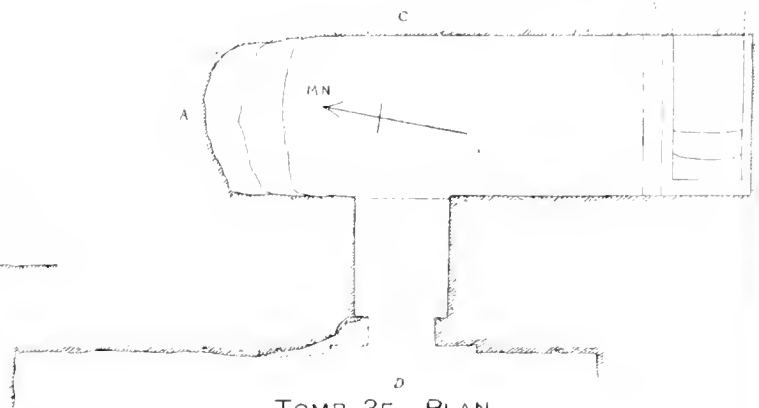

TOMB 3F. PLAN.







THE ROYAL FAMILY.  
(PLATE 32).

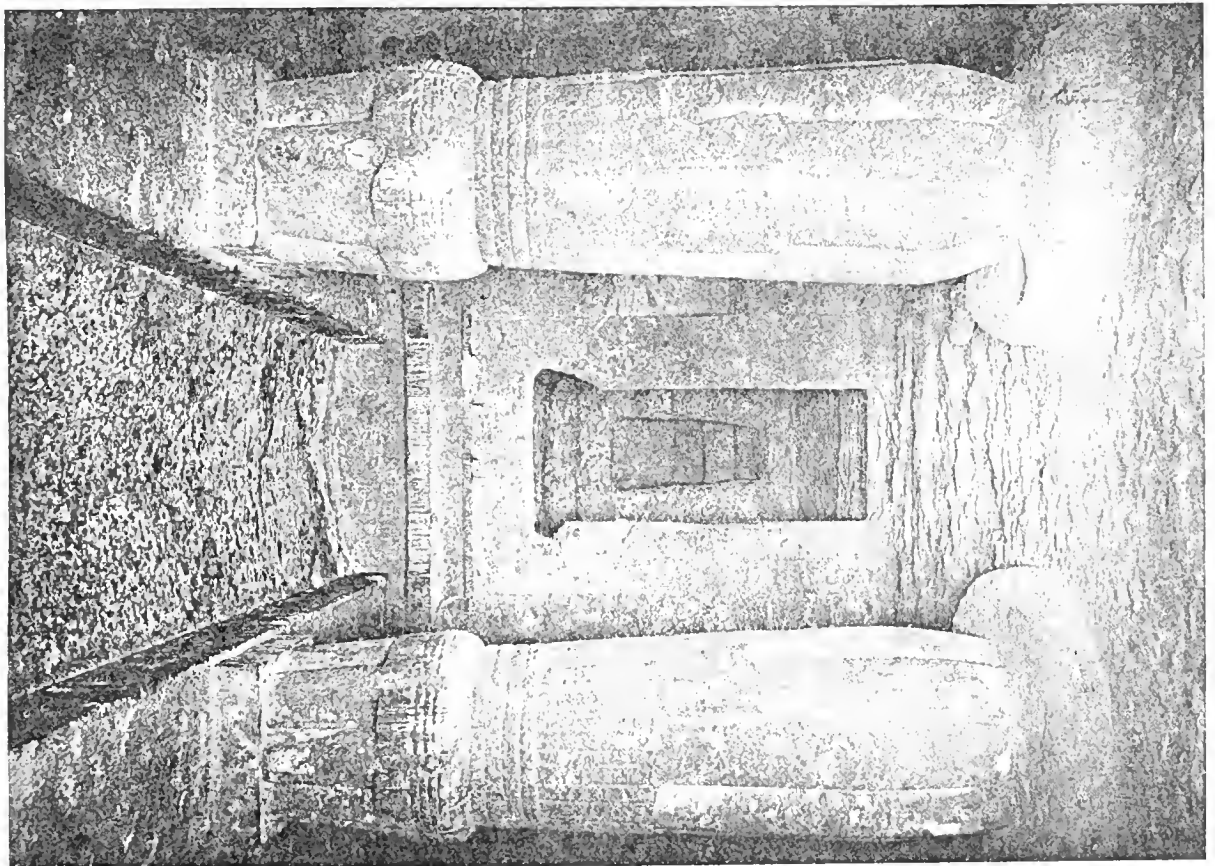

THE HALL.





THE PRINCESSES  
(PLATE 34).



THE TRIBUTE  
(PLATE 37).













INSTITUTE OF FINE ARTS LIBRARY



3 1162 02858 5892

LI