

TS

547

K5

**Rules and Practice
for
Adjusting Watches**



Class — SF47

Book — 15

Copyright N^o —

COPYRIGHT DEPOSIT.





RULES AND PRACTICE

FOR

Adjusting Watches

BY

WALTER J. KLEINLEIN

AUTHOR OF "THE WATCH ADJUSTER AND HIS WORK"

Copyright, 1920, by Walter J. Kleinlein

All rights reserved

TS547
.K5



DEC 13 1929

©CLAC01967

nl 1

PREFACE

IN THE early days of horology the apprentice was taught the art of making a complete watch. Production was slow, very few duplicate watches were constructed, and it was necessary that extra material be made individually by hand in the same way that the original part was produced. As time passed the value of the repairer was indicated by his ability to make new parts and to replace them so that the watch would again be in running condition. This was the prevailing situation for many years and the repairer was judged according to his skill in making and finishing the various parts.

A similar method of judging ability is still in force among some employers, although the development of the industry into machine and specialized work has made many changes in regard to the most important duties of the repairer.

It is no longer necessary for him to know how to make a complete watch and only on occasional instances is it necessary for him to make a part. Genuine material for modern watches is supplied by the manufacturer at less expense than it can be produced by the individual and in this particular branch of the work the repairer's requirements have been very considerably curtailed.

A more exacting and a higher standard of time-keeping has developed, however, and in this field the requirements of the watchmaker have increased to the extent that it is no longer sufficient to merely restore a good watch to running condition. It must keep time. This development has grown gradually and surely and the past twenty-five years may be assumed as the period of greatest advance.

It has been made possible by scientific and practical refinements which permit the adjustment of watches so that they will keep time within closely defined allowances under varying conditions.

The larger problem of the successful repairer of

PREFACE

today, therefore, is that of understanding the principles governing close time and of knowing how and where to look for the causes of variation, so that the higher standard of timekeeping may be restored in case of damage since the original adjustment.

It is naturally essential to know when material is correct, how to make it fit in its proper place, and how to make and finish some of the individual parts. It is also commendable to be skilful in all classes of lathe work, as this at times gains prestige for the workman through restoring old model watches to running condition.

It is, however, a disadvantage to develop one's ability in making parts for watches of a bygone age and neglecting the training that happens to be most essential and of daily advantage in repairing modern watches so that they will keep time as consistently after repairs have been made as they did when new.

The object of this book is to present the essential points of watch adjusting in an elementary and non-technical way that will interest the average watchmaker and to enable him to have a convenient source of information, covering the necessary refinements that are fundamental in repairing, regulating and adjusting the better class of watches.

The author trusts that the experienced successful watchmaker will read the book with interest and also with profit and that the novice will be enabled to foresee that there is something more to the art of watchmaking and repairing than that of merely assembling a watch and making it "tick."

It so happens that the author has had many years of experience in both factories and repair shops and that a considerable part of his duties have been devoted to instruction.

He has for a long time felt the need of a book that would, above all else, be practical in its description of the rules that an adjuster follows and which would prove its value in actual experience by being per-

PREFACE

sonal as far as permissible in the same sense that detailed shop instruction would be.

Since writing the article entitled "The Watch Adjuster and His Work" several years ago numerous inquiries have been received for this class of information and the present book is an effort to meet this demand in a manner that can be followed without highly technical or theoretical education.

To promote advancement and interest in everyday practical results is the foremost consideration, and to this end definite means are presented for personal development and for obtaining better results from high grade watches than can possibly be obtained without a fair knowledge of the final details which go so far toward assuring close time.

WALTER J. KLEINLEIN,

July 21, 1920

Waltham, Mass.

CONTENTS

PART I.—THE ADJUSTMENT TO TEMPERATURE

CHAPTER I

	Page
The Compensation Balance, Controlling Factor	3
1. General Method of Obtaining Results	
2. How to Place Screws When the Rate is Either Slow or Fast in Heat Compared to Cold.	
3. Composition of and Distortions of Compensation Balances.	
4. Tests and Experiments.	
5. Effect of Shifting Screws to Different Locations.	
6. Permanency of the Temperature Adjustment.	

CHAPTER II

Equipment for Temperature Adjusting.	9
7. Various Methods Available.	
8. Electrically Equipped Oven, Description and Dimensions.	
9. The Lower Temperature Box.	

CHAPTER III

Difference in Observatory and Commercial Systems	13
10. Observatory System.	
11. Commercial System.	
12. Rating Card and Method of Calculating Variation	
13. Value of the Normal Period Rate.	
14. Definition of the Characters Used on Rate Cards for Gain or Loss in Time.	
15. Increasing or Decreasing the Extremes of Temperature.	

CHAPTER IV

Some Practical Methods of Correction	19
16. Example of Maintaining a Pleasing Appearance of the Balance.	
17. Correction Varies When Screws are Above or Below Normal Size and Weight	
18. Over or Under Compensation.	
19. Special Corrections for Over or Under Compensation.	
20. Example Illustrating that Temperature Variation is Not Always Due to the Balance and Spring.	

CONTENTS — *Continued*

CHAPTER V

	Page
The Middle Temperature Error.	26
21. Why this Error Exists and What it Consists of.	
22. How Nickel Steel Balances Overcome this Error.	

PART II.—THE ADJUSTMENTS TO ISOCHRONISM AND POSITIONS

CHAPTER VI

General Consideration.	31
23. Optional Allowances for Variation.	
24. Some Necessary Requirements for Learning Adjusting.	
25. Train and Escapement Freedom.	

CHAPTER VII

Theory and Practice	39
26. Theory of Frictional Errors and the Isochronal Hairspring.	
27. How Theory Works Out in Practice and what Isochronism Consists of.	
28. Common Causes of Extreme Isochronal Variation.	

CHAPTER VIII

Relative Pinning Points of the Hairspring.....	43
29. Original Springing of Watches.	
30. How Pinning Point Alterations are Made.	
31. Even Coil Hairsprings Very Incorrect for Some Watches.	
32. How to Find the Correct Collet Pinning Point for Any Watch.	
33. Results in Vertical Position Rates due to Changing the Pinning Point.	
34. The Natural Position Error and Why it Cannot be Eliminated.	
35. Principle of Pinning Point Alterations.	
36. Same Principles Apply in Case of American Hunting Models.	

CONTENTS — *Continued*

CHAPTER IX

Page

Manipulation of the Regulator Pins.....	51
37. Altering the Length of Spring by Regulator Pins	
38. Method of Examining Vibration of Over Coil Between the Pins.	
39. Position Corrections Obtained by Spreading or Clos- ing the Regulator Pins.	

CHAPTER X

Factory and Repair Shop Adjusting.....	53
40. Routine Varies According to Circumstances.	
41. Considering the Watchmaker in the Small Shop of One or Two Workmen.	
42. Advantages of Understanding Adjusting Even Though Watches are Not Tested in Positions or Isochronism.	
43. Concerning Watchmakers of Limited Experience.	

CHAPTER XI

Preliminary Notes and Practice for Beginners	56
44. Practical Suggestions.	
45. The First Point of Consideration in Learning to Adjust.	
46. Causes of Variation Between Dial Up and Dial Down.	
47. Short Motion Generally Indicates Where to Find Trouble.	
48. Short Motion Sometimes Caused by Burr on Oppo- site Pivot.	
49. Examining the Hairspring.	
50. Exceptions in Regard to Gaining Rate and Short Motion.	
51. Detailed Practice.	
52. Which Rate to Use as the Unit for Comparison.	
53. Damaged Pivots, Pitted End Stones and Methods of Correction.	

CHAPTER XII

Preliminary Notes and Practice on Vertical Corrections....	64
54. Five Principal Causes and Corrections for Pendant Up Variation.	
55. Poor Motion, Cause and Effect.	
56. Regulator Pin Practice for Pendant Up Variation.	
57. Pendant Up Corrections Through Poise of Balance	
58. Concentricity of the Hairspring.	
59. Correcting Pendant Up Variation Through Pinning Point Alterations.	
60. Percentage of Watches Requiring Correction of Position Rates	

CONTENTS — *Continued*

CHAPTER XIII

	Page
Concrete Examples Showing Definite Three Position Alterations and Labor Utilized.....	70
61. Order of Position Timing and Method of Calculating the Variation.	
62. Example No. 1, Three Positions, Columbus.	
63. Example No. 2, Three Positions, Ball.	
64. Example No. 3, Three Positions, Elgin.	
65. Example No. 4, Three Positions, Hampden.	

CHAPTER XIV

Concrete Examples Showing Definite Five Position Alterations and Labor Utilized.....	77
66. What Five Position Adjusting Consists of — Detailed Allowances.	
67. Example No. 5, Five Positions, Hamilton.	
68. Example No. 6, Five Positions, Elgin, B. W. R.	
69. Example No. 7, Five Positions, Waltham, Vang.	
70. Example No. 8, Five Positions, Vacheron and Constantin.	
71. Example No. 9, Five Positions, E. Howard	
72. Example No. 10, Five Positions, Illinois, B. S.	
73. Causes of Extremely Fast Vertical Rates.	
74. How to Locate Defective Gearings.	

CHAPTER XV

Timing and Final Regulation	91
75. Mean Time Screws and Timing Washers.	
76. Importance of Properly Fitted Regulator.	
77. Effect of the Middle Temperature Error.	
78. Some Practical Reasons for Slow Rates.	

PART III.—SPECIAL NOTES

CHAPTER XVI

Special Notes.....	99
79. Efficiency of Execution Analyzed (Two Examples)	
80. Truing the Balance.	
81. Poising the Balance.	
82. Truing Hairsprings.	
83. Treating a Rusty Hairspring.	
84. Stopping by Escapement Locking when Hands are set Backward or When Watch Receives a Jar.	
85. Essentials and Non-Essentials in Cleaning Watches.	



RULES AND PRACTICE

FOR

Adjusting Watches

PART I

THE ADJUSTMENT TO TEMPERATURE

CHAPTER I

THE COMPENSATION BALANCE CONTROLLING FACTOR

1. General Method of Obtaining Results.

ONLY since the introduction of the compensation balance which received its most substantial early experiments as recently as the year 1859, has it been possible to control the variation in pocket timepieces which is caused by changes in temperature. Previous to this introduction it was not uncommon for the best watches to vary as much as two or three minutes with changes of forty or fifty degrees Fahr. Through experiment and improvement in the quality and application of balance materials, such advancement has been made, that this variation has been reduced to seconds and temperature adjusting is now quite universal in the production of medium and high grade watches.

In the large factories, girls and young men of very little previous experience are frequently taught to make the alterations and to do the testing, while men of experience in watchmaking handle only the more intricate cases such as "stoppers" and radical rates that may require investigation of the inner workings of the movement. The simplicity of the adjustment naturally becomes more apparent with experience and the general alterations consist merely of transferring the balance screws in opposite pairs, either forward or backward one or more holes, according to the extent of the correction desired.

As these alterations are quite positive the adjustment can be undertaken with considerable certainty of obtaining results in every instance.

The repairer will not find as much daily necessity for understanding temperature adjusting as he will for being thorough in Position adjusting. The subject is covered, however, for the benefit of those who may desire practical experience in this branch of adjusting and also for those who desire a general knowledge of the details.

2. How to Place Screws When the Rate is Either Slow or Fast in Heat Compared to Cold.

If a watch rates slow in heat compared to cold it is necessary to shift screws in opposite pairs out toward the cut or free end of the rims; because when the metals expand the hairspring becomes weaker and produces a loss in time. During this period the free ends of the balance rims, carrying the transferred weight are forced toward the center and produce a gaining rate which compensates for the loss caused by the weakened spring.

As the metals contract in cold the free ends of the balance are drawn outward from their true form and the concentrated weight of these screws near the ends reduces the fast rate in cold and in principle works both ways in its action on the rate.

Should the circumstances be just opposite, or the rate be fast in heat compared to the rate in cold, it will be necessary to move the screws away from the free end of the rims. In doing this, less weight will be carried toward the center as the free ends curl inward and as a result, the rate in heat will become slower and the slow rate in cold will be reduced.

3. Composition of and Distortions of Compensation Balances.

Compensation balances are generally made of one layer of brass and one of steel, with the brass on the outside consisting of about three-fifths of

The Compensation Balance Controlling Factor

the total thickness and the steel on the inside consisting of about two-fifths. These metals are firmly soldered together and the distortions in changes of temperature are as follows. In heat both metals expand, which infers that the rims become longer as well as wider and thicker. Brass expands more than steel and because of its attachment to the steel it cannot continue to lengthen in its true circular form, due to the fact that the steel does not become enough longer to maintain the true curve, and the result is that the free ends of the rims are forced inward.

In cold the brass, contracting more than the steel, pulls the rim outward at the free end which is just in reverse of the operations in heat.

The end of the rim which is attached to the balance arm always moves in the opposite direction from the free end, or outward from the center of balance, when the free end moves in, and inward when the free end moves out. In comparison, however, this movement is negligible as will be noted later in the results obtained in moving screws in that direction.

4. Tests and Experiments.

It is generally understood that the purpose of the compensation balance is to act in opposition to the error caused principally by the hairspring. The steel hairspring having no compensating qualities, either grows stronger or weaker with changes in temperature. When it becomes longer, wider and thicker in heat, experiments seem to prove that the increased width and thickness are not in proportion to the increased length, for if they were, the spring would actually be stronger; while timing proves that it is weaker because of the loss in time. In cold the shortening factor seems to dominate because of a gain in time.

In a series of tests with steel springs on uncut steel brass balances, the temperature error in the

extremes of 40 degrees and 90 degrees Fahrenheit was found to be from eighty to one hundred and sixty seconds. With the same balances cut the error was reduced from seventy to one hundred and thirty seconds in each instance, without any correction of the balance screws.

A former test with palladium springs on the same balances, previous to having been cut, showed a considerably reduced error, indicating that the steel springs were mainly responsible for the temperature variations.

The above tests were in actual practice and results are given as noted, regardless of scientific or established formula relating to the cubic measurement of metals in changes of temperature.

5. Effect of Shifting Screws to Different Locations.

As a rule compensation balances generally have five or six pairs of balance screws in addition to two pairs of mean time screws. High grade Swiss and some American models do not have mean time screws and are therefore generally supplied with seven or eight pairs of balance screws. The mean time screws are never disturbed in making alterations for temperature, such alterations being confined to the balance screws only and the mean time screws are reserved for timing.

For appearance sake the balance screws should be evenly distributed, although it is necessary at times to closely assemble them to obtain temperature results and they should not be disturbed in making ordinary repairs, as the adjustment may be destroyed in so doing. With the larger balances the moving of one pair of screws for a distance of one hole, generally makes a difference of four or five seconds in the temperature rate. In the case of smaller balances this alteration does not make as much difference, although the weight and location of the screws has considerable influence on the result.

A pair of screws shifted from the second holes from

the cuts, to the holes adjoining the cuts, will generally make a correction four or five times as great as would be obtained by shifting a pair of screws from the third to the fourth holes from the arms. The same proportional difference is obtained in moving a pair of screws from the center of the rims out to the cut, compared to moving a pair of screws from the holes nearest the arms out to the center of the rims. This principle also obtains in moving the screws in the opposite direction and is due to the fact that while the metals composing the balance follow the common laws of expansion and contraction, the balance actually becomes smaller in area during expansion and larger during contraction. This condition is made possible entirely through joining the metals in proper proportion and then cutting the rims.

In the factories where large quantities of a particular model having a standard style balance are handled, tests are usually made to determine as to just what degree of correction will be obtained by shifting various pairs of screws certain distances. This information is then used in making alterations with considerable certainty. The expert temperature adjuster becomes fully informed as to the peculiarities of various models and is capable of getting larger percentages of watches within the limits of allowance, after making alterations, than he could obtain otherwise.

Through understanding the various models individually, he is also enabled to furnish information that will cause intelligent arrangement of the balance screws, for each model, when they are originally fitted. The production thereby showing a greater yield of good watches that do not require alterations after the first test.

6. Permanency of the Temperature Adjustment.

When the original temperature adjustment has been carefully executed it is quite permanent and

The Adjustment to Temperature

unless the screws have been mutilated or changed in location there will seldom be an occasion for readjusting. The balance may be retrued and re-poised many times and the spring may be retrued, altered, or even changed, without seriously interfering with the temperature rating, as long as the screws are not shifted. In changing the spring, however, it is necessary that the same number of coils and the same size of spring be used, as otherwise readjusting would be required.

CHAPTER II

EQUIPMENT FOR TEMPERATURE ADJUSTING

7. Various Methods Available.

TWO boxes are necessary for temperature testing. One fitted up to maintain a temperature of about 90° Fahr. and the other maintaining a temperature of about 40° Fahr.

The method employed in obtaining the high temperature varies in different styles of boxes, while the low temperature is always obtained through the use of ice. When only an occasional test is made, any simple method whereby approximately close results in the two extremes can be obtained, may be used. For instance, the watch may be enclosed in a tin box and placed in sand that is kept at a temperature of 90 or 95 degrees F. A thermometer placed in the sand indicates when the temperature rises too high or falls too low. The ordinary household refrigerator may be used for testing the cold. Tests by this method are advisable only for short periods and for an approximate idea as to the extent of error.

If frequent tests are made and accurate results are expected, it is quite important that the special boxes be used. Such boxes are often constructed with a capacity of four or five hundred watches, or they may be constructed to receive only half a dozen watches. Some are made with a zinc or copper tank in which warm water is placed and which surrounds the chamber in which the watches are deposited. The water is kept at the desired temperature by means of a small adjustable flame. In other instances electrical arrangements are used, in which case no water is required.

The Adjustment to Temperature

In either instance a thermostat controls the source of heat.

8. Electrically Equipped Oven, Description and Dimensions.

A very practical arrangement for testing a few watches at a time in the higher temperature is shown in Fig. 1. This is electrically equipped and will maintain an even temperature at all times.

The outside of the box is constructed of about one-half inch lumber and the inside is lined with asbestos. It is about fourteen inches high by ten inches wide and eight inches deep.

"A". Is an incandescent lamp set in a porcelain base.

"B". Is a porcelain plug through which the wires "C" enter the box.

"D" and "E". Are metal uprights with a thumbscrew on the top, under each of which a wire terminates.

"F". Is the compensating bar, one end of which is fastened solidly to "D" with rivets.

The opposite end is free and rests against the end of a thumbscrew which passes through "E."

The thumbscrew is to be adjusted so that the free end of "F" will rest against it in a temperature of 70° Fahr. or any lower temperature. As the temperature rises the free end of the bar moves away from the end of thumbscrew, breaking the circuit and extinguishing the light, which cuts off the source of heat. As the temperature decreases the bar again comes into contact and creates the circuit.

This bar can be made of various compensating metals, one combination of which is a strip of zinc about six inches long by three eighths of an inch wide and one thirty-second of an inch thick. On the outside of this soft solder a strip of tin six inches or a trifle less in length, by one fourth inch wide and one thirty-second of an inch thick. Both

metals should be bent to a curved form before they are soldered together as shown in the cut.

It is generally preferable to have the bar taper to a slightly narrower width at its free end, and near this free end it is necessary to solder a small strip of platinum at the point where the end of thumbscrew comes in contact.

"G", "H", "I" and "J" are ventilating holes one inch in diameter and covered by a swinging slide so that the holes can be opened or closed as desired for regulating the ventilation. "K".

Is a shelf of brass screen located about five inches

from the top and on which the watches and a thermometer are placed in testing.

"L". Is a handle for the purpose of convenience in carrying the box. The front is to be enclosed by a door made in two parts, the upper section of which is glass which will admit of observing the thermometer. Proper adjustment of the thumbscrew and bar makes the box ready for use.

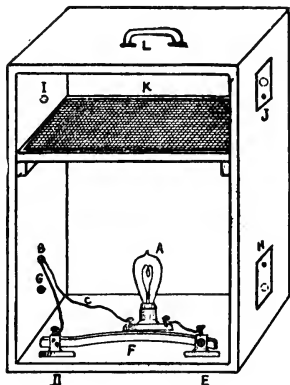

9. The Lower Temperature Box.

Fig. 2 shows a box specially made for testing watches in cold. It is constructed of wood and stands about twenty-four inches high without the legs and about eighteen inches square.

A double partition packed with about one inch of sawdust will be most reliable.

The upper half of the box should contain a water-tight zinc tank for holding cracked ice and about an inch of space should be left above for circulation of the air,

The Adjustment to Temperature

The chamber for receiving the watches may be about six inches square and supported by a cross-piece and attachment to the front. It should be covered above to prevent particles of ice from falling on the watches which are to be placed on the floor or on a shelf of the chamber, but the sides may be left partly open to improve the circulation of cold air. The door may also be filled with sawdust but does not require glass as the moisture would prevent observation of the thermometer

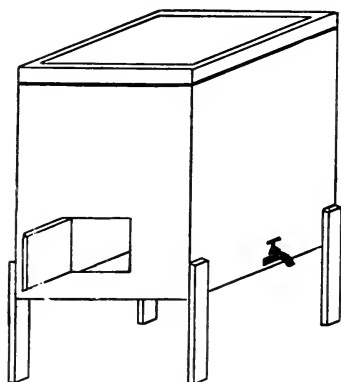

which should be inside for checking up the temperature when the door is opened.

The bottom of the tanks should be slightly higher on one side than on the other, with a one-half inch drain pipe fitted to the low side. The inlet end of the pipe should be covered with a fine screen to prevent dirt from accumulating in the pipe and the outlet may be either at the extreme bottom or on one of the sides as shown in the cut. The upper part or cover of box should be made so that it can be easily removed for filling and cleaning the tank.

CHAPTER III

DIFFERENCE IN OBSERVATORY AND COMMERCIAL SYSTEMS

10. *Observatory System.*

IN THE foreign observatories where watches are generally tested for competition prize, or certificate purposes, they are subjected to either three or five day tests in each temperature, preceded by one intermediate day at normal temperature which is not considered in making the deductions. The purpose of this is to allow the metals to assume the natural condition before being placed in, or changed from, one degree of temperature to another. After the three or five day test, according to the grade of the watch, the average of the daily rates in each temperature is considered in making the comparison and arriving at the total variation. The total error is then considered in the summary, as a fraction of a second variation per each degree of temperature. As an example we will consider that the total error between the two averages is five seconds and that the difference in the two extremes of temperature was fifty degrees F. The variation would be given as one-tenth of a second per each degree of temperature.

11. *Commercial System.*

In manufacturing watches for commercial purposes, both foreign and domestic, the tests are generally made for twenty-four hours in each temperature and the difference in the rates is considered as the total error.

Sometimes preliminary tests of four or six hours in each temperature are made to obtain an estimate

as to the extent of error, then alterations are made, after which the watch is subjected to the regular twenty-four hour test. There is nothing to be gained by this in regular work, although for a special rush job a day's time may be saved. Watches are always expected to be in first-class condition and such features as close fitting pivots or dirty oil will prevent any dependable timing. It is also advisable to time them closely before the test is made, as too great mean time variation may confuse in estimating the error, especially if the time is not taken in each temperature exactly at the end of twenty-four hours.

The testing should preferably be done in the dial up position to eliminate poise errors as much as possible. The first test is made in heat at 90° Fahr., then in normal temperature of sixty-five or seventy degrees and finally in the lower extreme of 40° Fahr.

When the watch is removed from the cold box it will be covered with moisture which will immediately begin to condense. The time should therefore be quickly noted and the watch replaced in the higher temperature box for four or five hours to become thoroughly dry and prevent against rusting of the steel parts.

12. Rating Card and Method of Calculating Variation.

A card ruled similar to the cut shown in Fig. 3, may be used for entering the rates and the watch need only be set at the beginning of each test, as deductions can be made from the entries on the card and the variation accurately ascertained without resetting or disturbing the time.

Details as to the methods to be followed would be about as follows: Wind and set the watch to correct time, place it in the heat box and at the end of twenty-four hours enter the variation from correct time in the upper left hand square of the card.

Assuming that the time is four seconds fast, enter

this as shown in the first column Fig. 3, then wind but do not set the watch and place it in normal temperature and at the end of twenty-four hours enter the total variation noted in the second square of first column. Assuming the time to be just cor-

Fig. 3

No.		Make					
HEAT	+4	+4	+2	+2			
NORMAL	0	-4	+6	+4			
COLD	+16	+16	+8	+2			
		12	0				

rect, place a zero as shown. Next wind the watch and place it in the cold box, and assuming that the variation is sixteen seconds fast at the end of twenty-four hours, enter this in the lower square of the first column as shown in Fig. 3. The watch is next placed in the heat box to dry and the variation shown in the three sets of figures in first column are carried out as follows.

In the upper square we find +4, enter this in upper square of second column at its full value as shown.

Next we find a "0" in the second square of first column, and as this is a loss of four seconds from the entry shown in the square above we carry it out in second column as -4. In the lower square of first column we find +16 and as this is a gain of sixteen seconds over the square above, it is necessary to carry this to second column at its full value as per illustration.

To determine the extent of variation between heat and cold, simply ignore the normal rate of -4 in the second column and subtract +4, from +16, which indicates an error of twelve seconds slow in heat compared to cold.

Or it may be determined as twelve seconds fast in cold compared to heat. For convenience sake it is advisable to form the habit of using one of the

temperatures as a unit for comparison and wherever large quantities of watches are adjusted, it is generally the custom to use the higher temperature for this purpose and the rate is stated as either slow or fast in heat. In this instance the rate is slow in heat and it will be necessary to shift one or more pairs of screws toward the cut as explained in Chapter 1, No. 2.

13. Value of the Normal Period Rate.

The rate in the normal period cannot be considered as of any value, its importance consisting only of allowing the metals to return to the natural form and tension before being placed in the cold box.

This is quite important in obtaining a true estimate of the error, because of the fact that in transferring the watch immediately from the extreme of heat to the extreme of cold, there will be a period of time during which the metals are readjusting themselves to the natural form, and the variation in time during this period will not be accounted for, as the real comparative rate will not begin to develop until after the natural form and tension is reached.

If the limit of time devoted to testing is no object and if a very fine rate is desired the observatory method is of course to be preferred. However, by allowing an intermediate day at normal temperature we have the assurance that the hairspring is at the same tension and that the balance has the same form concentrically when the test begins in cold that it had when the test began in heat.

As the object is to find the variation between the two temperature extremes the estimate will be quite close enough and allows the saving of many days' time. Some authorities advocate in addition to the five days required for observatory testing in each temperature that the watch be subjected to an intermediate day in each, instead of in normal, before considering the daily rate. This seems very logical, as the time noted each day would be taken

at the actual extremes in both instances and any outside factor in the timing would be eliminated.

14. *Definition of the Characters Used on Rate Cards for Gain or Loss in Time.*

In making entries on the rate cards and in figuring the variations the sign + is used as denoting that the watch is running faster than the standard time and the sign — is used as denoting that it is running slower than standard time.

This is stated for the reason that in some instances, generally foreign, the signs are used in reverse, or as indicating that the watch requires a correction of + or — the number of seconds indicated, to attain the correct standard of time. When the signs are identical in a column it is necessary to subtract the lesser from the greater and the result is the variation. There are often instances however, when one rate will be + and the other — as shown in second column of Fig. 4, and in these instances it is necessary to add the figures to obtain the variation.

The first column is always the progressive rate and the second column shows the variation carried out. This example shows +8 in heat, the normal rate in the second square is not considered, for the reason previously explained and the rate in cold is shown as —1. The total variation between the extremes is therefore arrived at by adding +8 and —1, which in this instance gives us a total of nine seconds fast in heat.

Fig. 4

No.		Make					
HEAT	+8	+8					
NORMAL	+20	+12					
COLD	+19	-1					
		9					

The Adjustment to Temperature

15. *Increasing or Decreasing the Extremes of Temperature.*

The extremes of 40° and 90° Fahr. have been used for the reason that they are best suited for general purposes. When it is known, however, that a watch is to be used in a warm climate the extremes may be raised five or ten degrees to advantage. If the watch is to be used in a cold climate, the extremes may be lowered this amount. The metals, however, can only stand the strain of expansion and contraction to a certain degree, and still maintain the positive qualities. Therefore it is quite important that the extremes be not raised or lowered very much beyond these figures.

CHAPTER IV

SOME PRACTICAL METHODS OF CORRECTION

16. *Example of Maintaining a Pleasing Appearance of the Balance.*

IN ALTERING the location of screws during the temperature adjustment it is often possible to either mar or improve the appearance of the balance. As a demonstration of this point the correction made in regard to Fig. 3 is analyzed. The balance had twelve screw holes in each rim, with the space between the first and second holes from the arms equal to double the space between any other two holes. There were seven screws in each rim, equally divided as per cut Fig. 5, which indicates screws in the first, second, fourth, sixth, eighth, tenth and twelfth holes.

A correction of the rate could have been obtained by shifting the screws in either the sixth or eighth holes forward three holes. Or those in either the first or second holes could have been shifted to the ninth holes and those in the fourth holes might have been shifted to the ninth holes with good results possible in either instance.

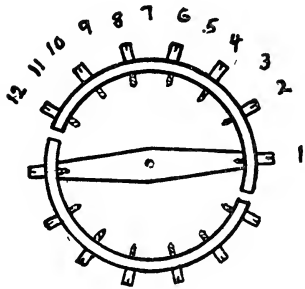

Fig. 5

Moving one pair of screws under any circumstances however would have caused a massing of three pairs of screws at some point and a vacant space of three holes at another point which would

not present a very good appearance for high grade work. Therefore the alteration made was to move the screws from the second to the third holes, fourth to seventh, and from the eighth to the ninth holes as indicated by the positions shown in Fig. 6.

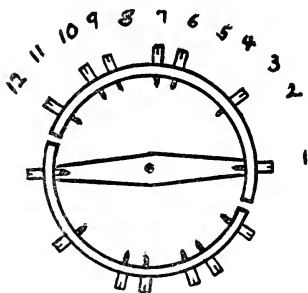

Fig. 6

Examination of the fourth column Fig. 3, which gives the result of the second test will show that the desired correction was obtained with a better appearance of the balance than would have been possible if only one pair of screws had been shifted.

In following the logic of the alterations made we must consider that the screws moved from the second to third holes made no correction, due to the fact that the balance rims remain almost stationary at this point, the alteration being for appearance only, those moved from the fourth to the seventh holes were estimated for a correction of seven or eight seconds only, for the reason that the alteration did not carry them beyond the center of the rims where the greatest curvature takes place. The screws moved from the eighth to the ninth holes however were estimated for the full correction of four or five seconds which is to be expected through shifting a normal pair of screws from one hole to another beyond the center of the rim on sixteen or eighteen size balances. In moving a pair of screws one hole between the first quarter and the center of the rims, a correction of from two to three seconds can be expected and from the center to the cut the difference for one hole is generally four or five seconds, while an alteration between the arm and the first quarter seldom yields any correction.

The matter of appearance should at all times be respected, for it is just as easy to obtain results in most instances and also have a well-appearing balance. There is also less disturbance of the poise usually in moving several pairs of screws a short distance than there is in moving one pair a longer distance.

17. Correction Varies When Screws are Above or Below Normal Size and Weight.

Normal corrections can only be realized when normal screws are shifted. Some balances have one half, or quarter head screws which of course will not produce a correction as great as will be obtained by shifting regular screws. Sometimes platinum, or other extra heavy screws will be found in balances and these will produce a correction almost double that of ordinary screws of the same size.

18. Over or Under Compensation.

On some occasions it will be found impossible to maintain a pleasing arrangement of the screws because the temperature variation will make it necessary to mass all of the screws either in the holes nearest the cuts or in those nearest the arms.

This is due to either over or under compensation of the balance. Over compensation is caused by too large a proportion of brass in the rims, which causes them to curve inward too far at the free ends in heat and outward too far in cold. When the extent of this error is so great that the rate is still fast in heat, with the screws massed in the holes nearest the arm, a correction can be obtained by fitting heavier screws in the holes adjacent to the arms and lighter screws in the holes nearer the free ends.

When the rate in heat is slow with the screws massed at the free ends of rims the balance is

under compensated, which is caused by too large a proportion of steel compared to the proportion of brass in the rims. This prevents the free ends of rims from curving inward far enough to carry the weight the proper distance toward the center of balance. A correction for this can be obtained by fitting heavier screws in the holes adjacent to the cuts and lighter screws in the holes toward the center of rims.

In changing the weight of screws as stated above it should be remembered that the gross weight of all screws must remain the same or the timing will be seriously affected. It is also important that the poise be tested whenever a considerable degree of alteration is made, as this will assist in obtaining an accurate rate.

19. Special Corrections for Over or Under Compensation.

Balances having the extreme degree of over or under compensation will seldom be found in high grade watches. In any instance, however, it is possible to obtain a better distribution of the screws by fitting either a larger or a smaller hairspring. For instance, we will assume a case of under compensation in which the screws have all been massed at the holes nearest the cuts. If the spring has seventeen coils, a correction of from five to ten seconds can be obtained by selecting and fitting a spring of the same make that will have eighteen coils, and the correction obtained will permit of shifting one or two pairs of screws back toward the arms.

In case of over compensation a spring of the same make, one coil smaller, will permit of shifting one or two pairs of screws toward the free ends of rims.

In a series of tests it was demonstrated that by duplicating or changing springs of the same make and size, on balances that had previously been compensated, there was very slight difference in

the temperature variation of the watch. Also by changing pinning points or breaking out one-fourth to one-half of the coil around collet and adding weight to the balances to correct the mean time the difference in the variation was almost negligible.

On the other hand it was found that by replacing the springs with others of larger or smaller size, variations of from three to ten seconds were noted in all instances.

In selecting and fitting a spring that will be one coil larger or smaller, it should be noted that the inner coil of the original spring and that of the new spring are approximately the same distance from the collet. For if there was considerable space between the collet and inner coil of the original spring, and the new spring was colleted quite close, there might be the addition of an extra coil in the inside only. This was found to produce only a very slight correction, compared to that obtained by the addition of a complete outer coil. These tests indicate that the proportion of strength of the spring in the temperatures varies with any appreciable change in length while slight changes make practically no difference.

20. *Example Demonstrating that Temperature Variation is not Always Due to the Balance and Spring.*

The following example is submitted to show that temperature variation is not always due to the

Fig. 7

No.	Make						
HEAT	-10	-10	+4	+4	+1	+1	
NORMAL	-6	+4	+5	+1	+4	+3	
COLD	+12	+18	+1	-4	+7	+3	
	28		8		2		

balance and spring, and that the general condition of the watch may be responsible. The second column of Fig. 7, indicates an error of twenty-

The Adjustment to Temperature

eight seconds slow in heat with all screws assembled in the holes nearest the free ends of the rims.

Examination proved that the motion of the balance in cold was reduced to about one-fourth of a turn. In heat the arc of motion was at least one full turn. This difference in motion was sufficient to prove that there was some binding in the train.

A very close fitting of the escape pivots was found and this undoubtedly caused binding of the pivots in heat due to slight expansion. Expansion of the stone would also tend to close the hole, and while the degree of temperature would hardly have any bearing on this point it is sufficient to show in what direction the tendency would be. The fourth wheel end shake was very close and probably caused binding of the wheel in cold, due to greater contraction of the bridge than of the fourth pinion. Furthermore the mainspring was only 0.02 of a millimeter narrower than the space in the barrel box. This no doubt also caused binding through greater contraction of the barrel than occurred in the mainspring.

The above defects were remedied and the rate was found to be eight seconds plus in heat as per third and fourth columns Fig. 7.

This made it necessary to shift several of the screws away from the cut, in almost the same position in which they were before the alteration which caused the close assembling of the screws was made. The final rate was two seconds slow in heat as shown in fifth and sixth columns.

The variation of thirty-six seconds between the second and fourth columns was entirely erroneous, and was due to condition of the watch irrespective of the balance and hairspring. Should the variation with the screws assembled have been by chance within the limits of allowance the watch would undoubtedly have been a very unreliable timepiece. The errors in the watch would no doubt have been corrected during the position adjustment later, but the large error in temperature

which would have been introduced by wrongly moving the screws, would have prevented reliable timing until possibly at some future period a test in temperature would have been made and the screws replaced in the proper positions.

CHAPTER V

THE MIDDLE TEMPERATURE ERROR

21. *Why This Error Exists and What it Consists Of.*

IN ADJUSTING watches to temperature it is not always possible nor expected to obtain a perfect rate between the two extremes, manufacturers generally allowing from two to ten seconds variation according to the grade.

Even when the rate obtained is perfect it will only be so at the two extremes and there will always be a few seconds variation in the middle or normal temperature.

This variation will always be a gain of from two to four seconds in the higher grades of steel brass balances and usually more in cheaper balances.

As there is no possible correction for this irregularity in ordinary balances it has long been known as the middle temperature error and for many years was one of the most perplexing problems that the manufacturer of specially fine timepieces had to deal with.

Various devices were originated from time to time for the purpose of counteracting the error but they were always too infinitely complicated to be of commercial or scientific value, and none of them were ever adopted as a solution of the problem.

In chapter I, No. 3, will be found a description of the distortions of compensation balances in the extremes of temperature and the cause of the middle error is due entirely to the fact that these distortions are not exactly equal in both directions. The free ends of the rims are drawn outward from the concentric form to a slightly greater proportional degree as the temperature decreases from normal and they are not forced inward at an even proportional degree with increase of temperature.

22. How Nickel Steel Balances Overcome the Middle Temperature Error.

Through extensive experiment in the foreign laboratories balances containing nickel steel have been found to almost eliminate the middle error, which is reduced to one second or less, making it possible to obtain perfect adjustment in various temperatures.

All highest prize watches passing through the Geneva Observatory are equipped with these balances and they have been adopted for commercial use to a large extent by the manufacturers of the finer grades of watches.

From the same source success has recently been attained in applying this metal to hairsprings and using them in connection with uncut balances, but owing to the necessary high cost of production, their general use may be delayed for some years to come. Their general use however would revolutionize the present-day methods of adjusting to temperature as there would be practically no expansion or contraction to deal with.

Nickel steel balances will always be found to have the cuts about one eighth of the circle distant from the arms instead of close to the arms. This is made necessary by the fact that the coefficient of nickel steel is about ten times less than that of ordinary steel, and if the cuts were made close to the arms the brass in expansion would force the free end of the rims to curve inward to such an extent that it would cause an abnormally fast rate in heat.

By making the cuts more central the length of the segments are reduced, thereby causing less curvature of the extreme ends and more nearly equalizing the extent of curvature both ways from the concentric form. This equalization is what causes the reduction in the middle error and its absence in ordinary balances is what causes the larger error,

The Adjustment to Temperature

Non-magnetic or palladium balances are also credited with a smaller middle temperature error than the ordinary steel brass balance, but owing to the unstable nature of the metal they have not proved to be as reliable in other respects and are not used to any large extent.

The middle temperature error is of course a small factor in the larger sense of obtaining time from commercial watches but its influence is apparent in timing and it will therefore be considered further in the section devoted to Final Regulation, Chapter XV, No. 77.

PART II

THE ADJUSTMENT TO ISOCHRONISM
AND POSITIONS

CHAPTER VI

GENERAL CONSIDERATION

23. *Optional Allowances for Variation.*

THE phrase "Adjusted to Isochronism and Positions" does not always indicate the same high quality or the expense assumed in obtaining close rating in different kinds of watches.

One particular model may be stamped "Adjusted to Five Positions" and this may indicate that the manufacturer of this model has tested all watches of this grade for twenty-four hours in each of five positions and that the extreme extent of variation from one position to any other, among any of these watches, did not exceed six seconds. Another model may be stamped in exactly the same way and it may indicate that all watches of that particular grade have been tested in exactly the same way and that the extreme extent of variation from one position to any other, did not exceed twenty-five seconds.

The statement regarding the number of positions to which the watch has been adjusted is just as legitimate in the latter instance as it is in the former, for the watches are really tested in five positions and required to perform within specified allowances.

The important difference is in the established limits of requirement, one demanding an extreme of only six seconds variation and the other allowing twenty-five seconds. Both watches may have the same number of jewels and there is no way to discern the actual variation except through a test in positions.

Technically it would be just as legitimate to stamp and advertise watches as above and have an allowance of fifty or more seconds, providing that

The Adjustment to Isochronism and Positions

they were actually tested and not allowed to pass with a variation greater than this limit.

Close limits of allowance require adjusters of greater skill and material of a finer degree of accuracy, however, than do greater allowances, but the dealer and consumer are generally not informed in regard to this particular point. Some watch-makers also do not understand this feature clearly and the limits of variation to which watches have been adjusted are seldom considered.

Should the difference in allowances and identical advertising be interpreted as an injustice to the manufacturer who maintains close limits for his various grades of watches, it must be remembered that they speak for themselves after passing over the counter and into the hands of satisfied customers. His reputation after a period of years will be more firmly established than will that of his less particular competitor in the high grade field. A similar situation prevails in the repair shop, and the fact that many of the leading dealers and railroad watch inspectors require at least a three position adjustment in the repairing of high grade watches, is convincing evidence that position rating demonstrates its importance in actual service when applied to repair work, as surely as it does when applied to new watches.

In placing limits of allowance for variation in various grades it is not intended that all watches of a particular grade will have the extreme variation. It is possible that an individual watch in the twenty-five seconds allowance class may have an even better rate than another watch that is in the six seconds class. It is also possible for a watch in either class to have a perfect rate, although these would be rather exceptional instances.

24. Some Necessary Requirements for Learning Adjusting.

The adjustments to isochronism and positions are not permanent to the same extent that the

temperature adjustment is, and they can be damaged or destroyed entirely by the average workman in making ordinary repairs unless he is familiar with the common principles governing their production and maintenance.

Experienced workmen who are familiar with these principles avoid unconsciously doing any damage and make practical repairs in a manner that will maintain or improve the original adjustment and time-keeping qualities of the watch.

To know and to make use of these principles does not make a "putterer" of the workman, in fact the consequence is just the reverse, because the training acquired tends to eliminate guess work and enables him to determine more readily as to just what the trouble may be, how to correct it, and as to just what degree of perfection is required in a particular instance.

Certain practical requirements are necessary in reaching this standard of workmanship and it would not be profitable to attempt to do adjusting unless one has first had a reasonable degree of training as a watchmaker or repairer, especially in such branches of the work as truing and poising balances; truing, leveling and centering hairsprings; matching the escapement; finishing pivots, and properly cleaning and assembling watches.

These mechanical requirements and experiences alone are not sufficient, however, and a certain amount of study must be consolidated with them in order to become proficient. This study should not deal so much with the problems of manufacture of the watch, or its various parts, as it does with the problems pertaining to the finished results that are to be obtained through refinement and intelligent assembly of these parts. The workman's willingness to indulge in such study is a very large asset among the requirements, and it only remains for him to obtain the proper class of instruction and then to conscientiously follow correct methods in his practice and to make personal experiments,

conforming to the instruction, so that his confidence will become more enduring.

It is further required that he be capable of realizing the difference between genuine and imitation materials, especially such essentials as balance staffs, hole jewels, mainsprings and roller jewels, which are the most frequently changed and most frequently substituted parts of watches. Imitation materials may be less expensive as a matter of first cost but staffs may have pivots and shoulders out of line, or out of true; hole jewels may be rough, out of round or extremely thick; mainsprings soft, or of improper proportion, and roller jewels may have sharp edges which cause rubbing in the fork and "hanging up" when the second hand is reversed. It is most satisfactory to depend upon the materials supplied by the manufacturer of the watch, as imitation goods are seldom any better.

25. Train and Escapement Freedom.

Beyond a general insight of high class watchwork this book is not intended to meet the requirements of beginners. It is designed principally for watchmakers of some experience, and cannot presume to cover details that would be essential for those in early apprenticeship. It is thought essential, however, to consider some matters in a general way and among these are the subjects of side shakes and end shakes, and the escapement, as far as they pertain to general inspection of the watch without consideration of details that refer to correction of irregularities which are presumed to have been acquired in earlier training.

Thoroughness of mechanical ability always demands a system of inspection and of making corrections and it is quite necessary to follow some method that will reveal any point or points that may not be up to standard.

As a rule it is best to begin at either end of the watch, and if it is to be taken down the best place

to begin is usually with the balance and examine each part as it is removed until the barrel has been reached. If it is not to be taken down, just as good results will be obtained by beginning the examination at the barrel and finishing with the balance. Sometimes watchmakers of considerable ability will demand as a basic consideration that pivots be fitted with very little side shake and that end shakes also be quite close if close time is to be expected.

These presumed to be, wide side shakes and long end shakes, very often have nothing whatever to do with the absence of a close position rate and frequently are absolutely necessary for good performance of the watch and proper space for oil.

The importance of reasonable limits is of course granted, but it is very detrimental to have pivots too close fitting and more stoppage and irregular time keeping can be traced to lack of freedom than can be traced to excessive shakes.

If the repairer is not familiar with accepted standards of side and end shakes, he can improve his judgment by examining watches of the higher grades and comparing the results with those found in cheaper makes of watches.

Such examination will invariably disclose the fact that fine watches receive very careful consideration in this respect. The center, third and fourth wheels generally having from 0.03 mm. to 0.05 mm. freedom for end shake and 0.015 mm. to 0.02 mm. for side shake. The escape wheel, pallet and balance will be found to run quite uniform at from 0.02 mm. to 0.03 mm. freedom for end shake and from 0.0075 mm. to 0.0125 mm. for side shake. The smaller and thinner watches generally favoring the lesser figures and the larger and thicker watches favoring the higher.

This uniformity of freedom will be found absent in cheaper watches; for instance, a center wheel may have 0.02 mm. end shake and 0.01 mm. side shake which would be very close fitting for large pivots. The fourth wheel may have as much as 0.08 mm.

end shake and 0.03 mm. side shake which would be too great. The pallet may have 0.05 mm. end shake and the balance 0.01 mm. and in this instance the short end shake of the balance would be more detrimental in most instances than would the longer end shake of the pallet. The variation will even be found to exceed these figures and when they are found in connection with thick, straight hole jewels they often interfere with a close position rate and with regularity of time in service. The interference in timekeeping is considerably aggravated in cases where one pivot has excessive side shake and the opposite pivot is close fitting, as this tends to cause almost certain binding of the close fitting pivot as soon as the power of the mainspring is applied.

The end shake and side shake allowance for the barrel depends considerably upon its style of construction. Safety barrels constructed so that the arbor revolves with the main wheel, when the watch is running, may have about the same end shake and side shake as applied to the center, third and fourth wheels, and if the pivots of the arbor are quite large they may have a trifle more side shake.

As a rule larger pivots will stand more side shake than smaller pivots; this, however, does not apply in the case of large bearings, such as safety main wheels that revolve around a stationary arbor, or going barrels where the entire barrel revolves around the stationary arbor when the watch is running.

In such instances the main wheel or barrel should have from 0.03 mm. to 0.05 mm. end shake on the arbor and should be just free for side shake.

The arbor which turns only when the watch is wound requires merely freedom for end shake between the plates, as well as for side shake where the pivots pass through the plates.

With reference to the escapement, good watch-makers often have different methods of examining the various points and of making corrections and it is not of so much importance as to just how correct

conditions are obtained, as it is that they actually be obtained.

Whatever the method may be it is certain that each escape wheel tooth must have positive locking on each pallet stone and that there must be positive space for drop between the back of each stone and the pointed end of each escape wheel tooth. There must also be sufficient draw when each tooth and stone are locked to hold the fork against the bankings.

When the lock, drop and draw are correct it is next necessary to see that the fork length and guard pin freedom are correct.

There is only one positive method of determining as to when the fork length is correct, and this is through closing the bankings to drop.

This can be done either before or after placing the balance in the watch and merely requires turning the banking screws so that the excentric pins will close in on the fork until the fork arrives at the pins, at the same instant that the tooth drops on the pallet stone. This eliminates any slide of the stone on the tooth beyond the actual locking and in this condition it is required that the roller jewel pass through the fork slot and out of the fork horn entirely on both sides with perfect freedom.

Should it touch on both sides of the fork, then the fork is either too long or the roller jewel is too far forward, and if it touches on one side only it may require simply equalization of the freedom. The guard pin length also must be obtained with the bankings closed to drop and should be just free from the safety roller on both sides.

When the inspection proves that these conditions have been properly provided for, it is necessary to slightly open the bankings so that there will be just a trifle of slide of each stone, on each tooth, after the locking takes place.

Extremely wide side shakes of the escape, pallet or balance pivots will sometimes cause striking of

The Adjustment to Isochronism and Positions

the roller jewel when conditions are otherwise correct, and these side shakes should not be very much beyond the extreme limits mentioned in this number. The fact of this feature, however, should not be construed as a recommendation that these pivots be closely fitted, for reasonable freedom is to be desired because it is positively necessary.

CHAPTER VII

THEORY AND PRACTICE

26. *Theory of Frictional Errors and the Isochronal Hairspring.*

THEORY teaches us in brief, that the position adjustment is made necessary principally because of frictional errors. It would therefore seem that if the watch was mechanically correct there would be little or no requirement for position alterations.

We are also advised that an isochronal hairspring is one which will cause the long and short arcs of the balance to be made in equal time and that to attain this, the center of gravity of the spring must coincide with the center of gravity of the balance and that a certain pinning point is necessary in producing this result.

Now if we have a watch of correct mechanical construction and fitted with an isochronal spring it would seem that a close rating timepiece would be assured.

27. *How Theory Works Out in Practice and What Isochronism Consists of.*

Practical adjusting, however, proves that such is not the case, for even when the construction and alterations produce watches as nearly correct as scientific methods can determine, there is often considerable variation in the position rates. A twenty-four hour test in any position may prove that the long and short arcs are made in equal time showing the spring to be isochronous and yet the position variations have not been accounted for. In this connection experience proves that a

spring showing a perfect isochronal rate may have its collet pinning point changed, in relation to the pinning point at the stud and that through such an alteration, a correction in positions can be obtained, without in the least disturbing the perfect isochronal rate.

This indicates that the separation of the two adjustments which is possible in theory, does not hold good in practice, because a spring showing a perfect isochronal rate has been altered for the purpose of counteracting some position error and thereby producing a practical center of gravity of the balance and spring combined, instead of separately.

This may be further explained as creating an error in a spring which is supposed to be theoretically isochronous, with the idea of making it act in opposition to the position error and the combination thus obtained produces practical isochronism as well as a corrected position rate.

It is not suggested that these relative pinning points be altered for the purpose of overcoming position variation such as may be caused by dirt and gummy oil, damaged pivots, or balances that are out of poise. The watch should be in first-class condition and have a good motion in every position and then the alterations may be safely undertaken in accordance with the principles.

Adjusted to isochronism indicates that the watch functions uniformly during the entire twenty-four hours running. It is immaterial as to whether the rate be perfect or whether it be a gain or a loss, so long as it is uniform.

The watch is not isochronous if there is both a gain and a loss in the rate, even though the time be perfect at the expiration of twenty-four hours.

Experiment will demonstrate that watches carefully adjusted to positions will also have a very close isochronal rate. These isochronal experiments can be made by timing watches for twenty-four-hours in any one of the vertical positions and

noting the variation in periods of from four to twelve hours and by comparing the variation in the first period, during which time the arc of motion is long, with the variation in the latter period when the mainspring power is weaker and the arc of motion is short.

28. *Common Causes of Extreme Isochronal Variation.*

The most common causes of isochronal variation with which the repairer has to deal and which are often very destructive to position rates, as well as to general time keeping, may be found in the factor of, out of poise and uneven motive force, which is one of the elementary principles of adjusting. This feature should be thoroughly understood by all watchmakers, so that as good results as possible may be obtained from all watches above low grade, even though no test for adjustment is to be made.

When the balance is slightly out of poise and the motion is exactly one and one-fourth turn during the twenty-four hours, this out of poise will not affect the isochronism. When the motion varies and reaches approximately one and one-half turn during the first few hours after winding and then drops to one and one-quarter turn and finally to one turn or less during the latter part of the twenty-four hours, the poise error will have considerable effect. This factor is not perceptible in the flat positions, but shows up to the full extent in the vertical positions and the variation differs according to the location of the point that is heavy. For example, if the balance is heavy on the lower side when at rest, the watch will lose during the hours that the arc of motion is over one and one-fourth turn and will gain when the motion drops to one turn or less.

Should the heavy point be on the top side of balance the result will be reversed and the watch will gain when the motion is over one and one-fourth turn and will lose when it drops to one turn or less.

The Adjustment to Isochronism and Positions

The total variation may be either seconds or minutes, depending upon the extent of the poise error and experiments will prove that serious isochronal variations can be traced to the simple cause of lack of poise and irregular motion in more instances than to any other cause.

The arc of one and one-fourth turn is the ideal motion, as slight poise errors are neutralized at this point, but very few watches will maintain this motion for twenty-four hours, therefore the poise must be as nearly perfect as possible. The nearest approach to even motion of modern watches is found in the fine Swiss grades equipped with stop work, which causes only the best part of the mainspring to be utilized.

Such watches also receive the most expert attention as to gearings of wheels and pinions and the train wheels are specially rounded up on their respective staffs. This latter feature has been adopted by at least two of the American manufacturers of fine watches during the past few years with considerable benefit in producing even motion and the use of lighter mainsprings. It should be definitely understood that these tests refer to the vertical positions of the watch only and that the horizontal positions are not affected in the same way by lack of poise.

CHAPTER VIII

RELATIVE PINNING POINTS OF THE HAIRSPRING

29. *Original Springing of Watches.*

THEORY and practice agree that different models of watches have important relative points of attachment of the spring to collet and stud. In the original springing and adjusting of high grade watches, these points receive careful consideration, and only a very small percentage ever require future alterations.

There are instances, however, where the original allowance of position variation has been considerable, also medium grades where no attention has been directed to pinning points and in which an occasional alteration may be required before a close position rate can be obtained.

30. *How Pinning Point Alterations are Made.*

These alterations are generally made by breaking off or letting out a small section of the inner coil at the collet. In making such alterations a quarter of a coil broken away at the collet will have the same effect as will a quarter of a coil broken off at the outer end and will require less weighting of the balance to correct the mean time. It will also avoid breaking and remaking the over coil and the possible necessity of readjustment to temperature. Letting out the spring can be accomplished by unpinning and repinning the spring at collet with less of the coil entered in the pinhole. This is not a positive alteration, however, because very often the segment in the pinhole is as short as it can be with safety.

A more substantial correction is that of reforming

the over coil in a manner that will cause the end holding the stud to be shifted further forward.

The method of obtaining this correction is illustrated in Fig. 8. The broken line shows the original formation of the over coil with the stud on the line "B". The solid lines show the corrections with the stud shifted to the line A.

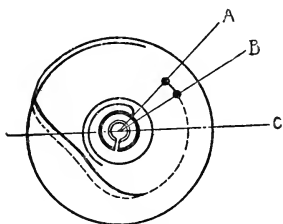

Fig. 8

When the collet is turned to replace the spring in beat, the stud will be in its original location on the line "B."

This will cause the pinning point at collet to be shifted from "A" to "B" and bring it that much nearer to the horizontal line "C."

This alteration has the same effect as that of letting out the spring at the collet or of moving the stud forward on the over coil, with the advantage of eliminating any change in the mean time.

It should be definitely understood that the objective in making the above alterations and as illustrated with the aid of the following cuts, is the relation of the pinning point at collet to the pinning point at stud, and that the change in length of the spring has no bearing on the matter whatever as far as the position rate is concerned.

31. Even Coil Hairsprings Very Incorrect for Some Models.

It is often supposed that hairsprings having exactly even coils are correct for close position and isochronal rating. Such springs do approximate the nearest correct relation in more instances than any other relation. They are precisely correct for very few models, however, and are very incorrect for many models, as will be seen through study of the follow-

Relative Pinning Points of the Hairspring

ing cuts showing the various points of attachment and the different results obtainable in each.

32. *How to Find the Correct Collet Pinning Point for Any Watch.*

A very simple method of locating the proper point of attachment of the spring to collet is to face the train side of the movement and hold the balance stationary with a small twig, and with the pallet fork just midway between the two bankings.

Presume the existence of a vertical line through the center of hairspring and collet as shown at "A B" Fig. 9. Then presume a horizontal line as

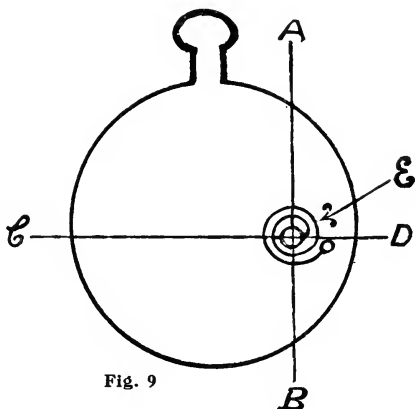

Fig. 9

shown at "C D" on the same cut.

The proper pinning point is at the intersection of the collet and horizontal line; the spring may be either over or under even coils, depending entirely up-

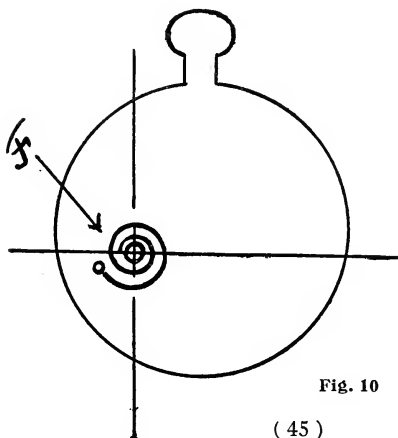

Fig. 10

on the location of the stud hole in the balance bridge as demonstrated by Figures 9, 10, 14, 15.

When the spring develops to the right from collet as shown in Fig. 9, for example, the proper point of attachment is on the right side of collet as shown at "E" Fig. 9. and also at "J" Fig. 14.

If it develops to the left as the springs of all fine Swiss watches do, the proper point of attachment is on the left side of collet as shown at "F" Fig. 10.

33. Results in Vertical Position Rates Due to Changing the Pinning Point.

In either of the above instances the spring will develop upward as it leaves the collet. These points of attachment always produce a fast pendant up rate when compared to the opposite, or pendant down rate, and all high grade watches are originally fitted with springs conforming to this principle.

If these points of attachment were changed to the opposite side of collet so that the spring would develop downward as shown at "G" Fig. 11, and "H" Fig. 12, the results would be reversed and the pendant up rate would be slow in comparison to the pendant down rate.

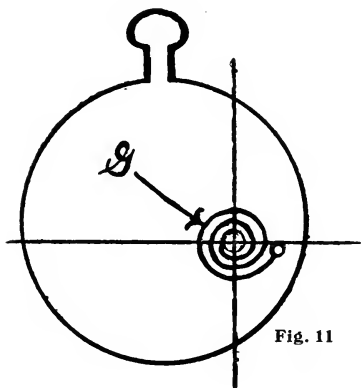

Fig. 11

This point of attachment in which the spring develops downward from the collet is generally known as the slow point among adjusters, and when a spring is pinned at either the slow or fast point the pendant right and left positions generally compare quite closely to each other in

Relative Pinning Points of the Hairspring

timing, provided that the poise and other conditions of the watch are correct.

If the pinning point was changed to the intersection of the collet and vertical line as shown in "I" Fig. 13, the pendant up and down rates would compare nearly equal to each other and the pendant right position would be slow compared to the pendant left position.

If it were pinned at the intersection of the collet and vertical line just opposite to that shown in Fig. 13, the pendant left position would be slow compared to the pendant right position.

The vertical points of attachment are seldom

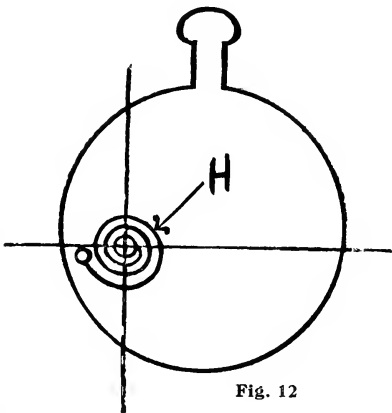

Fig. 12

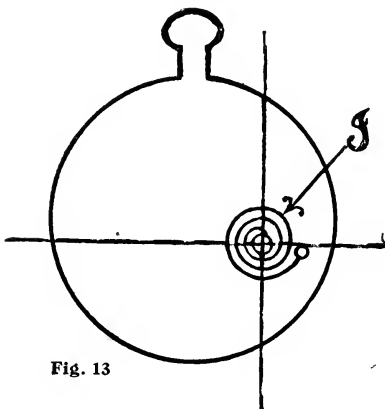

Fig. 13

used, for the reason that the variation between the pendant right and left positions would be very difficult to control within close limits, due to the existence of the natural error. As these positions, together with the pendant up position are the most

important of the four vertical positions, they are given preference, and the natural error is placed in

the pendant down position where it will be the least detrimental to the performance of the watch.

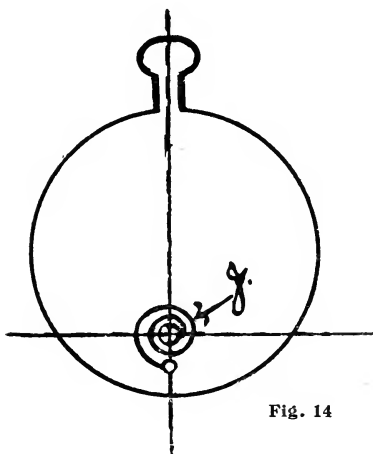

Fig. 14

34. *The Natural Position Error and Why it Cannot be Eliminated.*

The natural error generally consists of from twelve to fifteen seconds in finely constructed watches, and exists because of the fact that it is impossible to perfectly poise a spiral spring. The

location of the heavy point, however, may be shifted by changing the point of attachment at collet as described in No. 33, this Chapter. The nearest approximation of a poised spiral spring is probably attained through L. Lossier's inner terminal curve. Results are not positive, however, and any deviation from the required precision makes the curve valueless. It is possible to obtain perfect adjustment between three vertical quarter positions and the two horizontal positions, but all four quarter positions cannot be perfectly adjusted because the natural error will show up in one of them. Manufacturers of fine watches do not of course presume to supply perfect adjustment in the five positions. Some however, have considerably closer limits of allowance for variation than do others and it is logical to presume that a line of high grade watches having a five position allowance of six seconds from one position to any other would show better results than another line which had even a six position ad-

justment and an allowance of fifteen seconds from one position to any other.

35. *Principle of Pinning Point Alterations.*

When an alteration of any pinning point is necessary, the extent and direction of the alteration are determined by the rate of the watch. For instance, if a spring is pinned at the fast point and if a slightly slower pendant up rate is desired, the spring can be broken off at the collet and pinned one-eighth above the horizontal line.

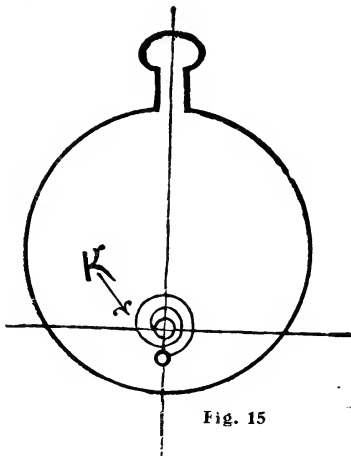

Fig. 15

If the rate is to be made slightly faster, the spring can be let out a trifle at the collet, the over coil reformed or the stud moved forward on the over coil so that the collet point of attachment will come slightly below the horizontal line when the spring is placed in beat. The former alteration causes an approach toward the slow point and in making the latter alteration we assume that the fast point is a trifle below the horizontal line on that particular watch. When altering springs from the extreme fast point to the extreme slow point, it is advisable to remove a trifle less of the inner coil than the extreme calculation. This will cause the point of attachment to be slightly above the horizontal line on the slow side and will most always produce the result desired and if it does not, there is still a possibility of further alteration. The same principle applies in making an alteration from the extreme slow to the extreme fast point and in this

case the point of attachment to collet may be just a trifle below the horizontal line.

The theory of this is that all shortening of the coil from the fast to the slow point produces a slower rate pendant up, until the extreme slow point is reached. After passing this extreme slow point the pendant up rate begins to grow faster until the extreme fast point is reached.

*The designations "right" and "left" in regard to pinning points are used with the explicit understanding that the individual is facing the train side of the movement. The same designations used as referring to position rates, or results to be expected in positions should be interpreted to mean with the individual facing the dial side of the watch.

*(Important Note.)

36. Same Principles Apply in Case of American Hunting Models.

The points shown in Figures 14 and 15 refer generally to American hunting models. In all other high grade watches the location of the balance and spring will be found either to the right or left of the center of the watch.

In American hunting models the balance and spring are located in the lower center of the watch.

This is due to the fact that American manufacturers do not construct separate models for hunting watches as is done by foreign manufacturers.

Instead of producing an entirely separate model, the method simply calls for a change in the construction of the barrel bridge by reversing the position of the barrel and winding wheels. This places the winding sleeve at figure three on the dial, which is customary on hunting watches and causes the entire movement to be shifted by ninety degrees with the balance just about opposite the pendant.

CHAPTER IX

MANIPULATION OF THE REGULATOR PINS

37. *Altering the Length of Spring by Regulator Pins.*

ON some occasions when the pinning points seem to be comparatively close and the watch is in good condition with the balance in poise, it is possible to obtain corrections by closing or opening the regulator pins.

This, however, can only be resorted to, to a limited extent, as otherwise the value of the regulator may be impaired.

The pins should not be closed tight enough to cause "kinking" of the over coil and they should not be spread apart any more than enough to make the mean rate about 2 seconds per hour slower.

Some models of watches consistently require that the pins be closed, while other models require that they be slightly spread, and it is therefore advisable not to disturb the pins when cleaning watches unless they have been bent by incompetent hands.

It is better to reserve the majority of pin alterations for such time as the position rate determines the necessity of an alteration. When the pins are open, however, it is necessary to adjust the coil so that its vibration will be equal.

Correct execution in spreading or closing the pins will very often make it possible to obtain a correction of six or eight seconds between the vertical and horizontal positions.

38. *Method of Examining Vibration of Over Coil Between the Pins.*

The proper method of examining this vibration is to stop the balance and observe the movement of the coil between the pins.

The vibration should be equal at the slightest oscillation of the balance as well as during the longer arcs. The coil should not rest against one or the other of the pins at any time unless they are both closed. Emphasis is placed upon equal vibration of the coil when the pins are open because of its importance, and if results are not obtained (as expected) the examination should be repeated to see if correct conditions have been attained. Examination of this vibration should be made from both sides of the pins and usually the best estimate can be obtained by looking between the pins from the stud side.

39. Position Corrections Obtained by Spreading or Closing the Regulator Pins.

When the regulator pins are tightly closed and the watch has a fast pendant up position rate, it will be possible to obtain a slower rate by slightly spreading the pins.

When the pins are spread and vibration of the coil between them can be discerned, and the pendant up rate is slow, a faster rate can be obtained by closing them.

In spreading the pins they should be drawn away from the coil equally, as otherwise the coil will strike one pin with more force than the other, which will not produce results as expected and will cause uncertain regulation. In closing the pins they should be drawn together one at a time until both are in equal contact. They should not be merely squeezed together, as this causes distortion of the coil at the point of contact.

CHAPTER X

FACTORY AND REPAIR SHOP ADJUSTING

40. *Routine Varies According to Circumstances.*

THE principles covering the adjustment of watches are the same in the repair shop as they are in the factory and they are equally the same in the various lines of high grade watches regardless as to whether they are of American or foreign extraction.

The routine covering the work to be done, however, may vary, depending upon the quantity of watches that are turned out. In the factories where large numbers of watches are adjusted the adjuster is trained in the various branches of watch work and eventually devotes his entire time to adjusting. The watches are generally turned over to him after they are all assembled and ready for the final balance and spring work, or after they have been finished and rated, in which instance he receives only those that are not within the requirements and he then makes the necessary alterations, after which they are again tested for results.

In some repair shops where large numbers of fine watches are handled, a similar system is used and one competent adjuster devotes his time principally to the work of timing and adjusting.

41. *Considering the Watchmaker in the Small Shop of One or Two Workmen.*

By far the greater number of watchmakers are employed in stores having only one or two workmen who are required to do the cleaning and to make all repairs. For this reason an adjuster of equal skill could not do as much actual adjusting as could be

done in either of the two previous instances, but for the same reason he would not be expected to do as much.

He can, however, adjust the high grade watches that he repairs just as closely, and he should not permit himself to feel that time and the nature of his position prohibits him from doing so. Whether it does, or does not prevent him from obtaining close rates depends entirely upon his training and understanding of the necessary details. If he is skilful and accurate, his output of work in the long run will not be reduced, his work will give better satisfaction and he will have less "comebacks" to take up his valuable time.

42. Advantage of Understanding Adjusting Even Though Watches are Not Tested in Positions or Isochronism.

To understand position adjusting thoroughly is of the greatest advantage in obtaining satisfactory time from any medium or high grade watches even though they are not to be tested in positions because vital points will receive intelligent observation where they would otherwise be overlooked.

43. Concerning Watchmakers of Limited Experience.

The previous notes and rules covering pinning points of the hairspring as detailed by the cuts and descriptions, together with the concrete adjusting examples to follow would no doubt be of sufficient note for watchmakers of considerable experience.

There are, however, many ambitious workmen who have not devoted any time whatever to the study or practice of adjusting and to whom some elementary study and practice may be quite indispensable.

To be of service to this class of workmen chapters XI and XII are devoted to preliminary notes and practice lessons.

The contents of these chapters can be worked out in practice by almost any workman who is capable of holding a position as watchmaker and it is substantially necessary that they be mastered before finished results are to be expected.

CHAPTER XI

PRELIMINARY NOTES AND PRACTICE FOR BEGINNERS

44. *Practical Suggestions.*

EXPERIENCE will eventually prove that most of the variations in positions are caused by apparently insignificant details. The mistake made by the average repairer is generally that of failing to detect these details and to make slight corrections where necessary, as he proceeds with the ordinary cleaning and repairing of the watch.

This oversight often prevents what would otherwise be excellent results in timekeeping and makes it necessary to utilize extra time and labor in the effort to obtain more consistent timekeeping.

45. *The First Point of Consideration in Learning to Adjust.*

The first consideration in position adjusting should be directed toward equalizing the time in the two horizontal positions. This equalization should be accomplished entirely by attention to details that can be plainly seen before arriving at the point of actual timing of the watch. The principal requirement for equal time between dial up and dial down is equal arc of motion of the balance in each of the two positions, and the adjuster should become capable of obtaining this equal arc of motion before attempting to obtain close rating in the other positions.

46. *Causes of Variation Between Dial Up and Dial Down.*

Variations between dial up and dial down may be due to one or more of the following causes which

have been arranged in two groups, the first group consisting of the most frequent and common causes, while the second group consists of causes equally detrimental but less common.

Group No. 1

1. Dirt or thick oil in one or both balance jewels.
2. Burred or marred balance pivots.
3. End of one balance pivot flat or rough and opposite pivot polished.
4. Ends of both balance pivots polished but not same form.
5. Balance pivot bent.
6. Hairspring rubbing balance arm or stud.
7. Hairspring concave or convex in form instead of perfectly level.
8. Over coil rubbing under balance cock.
9. Over coil rubbing center wheel. (Some watches).

Group No. 2

10. Balance pivots fitted too close in jewels.
11. One pivot having excessive side shake and the opposite close fitting.
12. Escape or pallet pivots bent or damaged.
13. Balance end stone pitted or badly out of flat.
14. Over coil rubbing outside coil, at point where it curves over spring.
15. Balance arm or screw touching pallet bridge.
16. Balance screw out too far, touching bridge or train wheel.
17. Safety roller rubbing dial plate or jewel setting.
18. Fork rubbing impulse roller.
19. Guard pin rubbing edge of safety roller.
20. Roller jewel long and rubs guard pin.

47. *Short Motion Generally Indicates Where to Find Trouble.*

Any of the above irregularities will cause a variation in motion between dial up and dial down and

invariably the trouble will be found on the side which has the shorter motion. For instance, a pivot that is flat or rough on the end will cause a shorter motion, when it is down, than will the opposite pivot when it is down, provided that its end is slightly rounded and highly polished. The same is true when the oil is gummy or dirty in one jewel and the opposite jewel is clean and freshly oiled.

Capped escape or pallet pivots when flat or rough on one end have the same effect to a lesser degree.

It is never proper to make the end of a pivot flat or rough and thereby shorten and equalize the motion. Neither should the ends of both balance pivots be flattened at any time. On the contrary, the ends of pivots should always be slightly rounded and highly polished: there is no logical reason for having them otherwise.

48. Short Motion Sometimes Caused by Burr on Opposite Pivot.

There are occasionally instances where a poor motion on one pivot is caused by a slight burr on the opposite pivot. This is usually due to the fact that while the burred pivot is running on its own end stone, there is space enough between the end stone and jewel to give the burr clearance, but when the position of the watch is reversed, the balance end shake allowance causes the burr to rub on the top of jewel hole and prevents perfect freedom of motion when the good pivot is downward.

49. Examining the Hairspring.

The hairspring may be true and level but it should be carefully examined to see that there is no possibility of touching at any point. The observation should take place during the full arc of motion of the balance, for there are some instances in which no rubbing takes place until the motion accelerates. The watch should be held at different angles and

the space between the balance arm and spring, and the stud and spring, closely scrutinized for possible contact. The space between the spring and over coil at the point where the over coil rises and curves over the spring should be at least equal to the width of the coils and care should be taken to see that the over coil just before the point of rising has the usual space between it and the next coil. Either position in which the hairspring may rub will have a shorter motion and a gain in time compared to the opposite position in which there is no interference.

50. *Exceptions in Regard to Gaining Rate and Short Motion.*

Invariably the arc of motion which is the shortest will gain time compared to the opposite position which has a longer motion. There are, however, some few instances in which there are exceptions to this rule, and knowledge of these exceptions is quite valuable in preventing confusion and doubtfulness in the certainty of making specific alterations. As an example in the horizontal positions; if both end stones are perfect and the freedom of one pivot in the jewel is correct while the opposite pivot has entirely too much freedom, the motion may be somewhat shorter with the proper fitting pivot downward while the rate may be slower compared to the opposite position. This is caused by the balance describing a larger circle when the large hole jewel is upward, as the pivot is allowed to travel a greater distance from the center of the hole as it wavers from side to side during the oscillations.

When the watch is reversed the weight of the balance prevents the pivot from wobbling in the large hole and eliminates the possibility of compensating for the larger circle described by the balance in the opposite position.

The same results are possible when the freedom of both pivots is correct and when one end stone is pitted, as the pit in the stone causes a short motion

when downward and prevents the pivot from having any side play whatever, while the opposite pivot^t enjoys full play to whatever freedom there may be and through this causing a somewhat larger circle to be described by the balance and a slower rate in time.

It should be understood that this does not refer to instances where the end stone surface is merely slightly worn, but to pittings in which the surface of the stone has been actually pierced. In most instances of slight wear the motion will be shorter and the rate fast which conforms to the general rule covering rate and motion.

51. *Detailed Practice.*

For preliminary practice in position adjusting, select a watch of about 17 jewels which has just been cleaned and put in order to the best of one's ability.

Regulate it so that it will time within ten seconds in twenty-four hours. Then run it dial up for twenty-four hours and make a notation as to the number of seconds either fast or slow. Next run it dial down for twenty-four hours and make note of the number of seconds fast or slow in this position. If there is a variation in time between the two positions it will be found that the position having the faster rate of the two will also have a shorter arc of motion.

*(Note Exceptions in No. 50).

The exact arc of motion in each position can be known by observing the arms of the balance and comparing the extent of the arc with some point on the pallet bridge.

A variation of one-eighth of an inch in motion will generally make a difference of four or five seconds in the rate and greater variations will make corresponding increases in the difference.

When a watch is in good order a correct motion for the horizontal positions is generally considered to be that of one and one-half turn, which consists

of three-quarters of a revolution of the balance in each direction.

Should the motion be very much below this, in both positions, there may be something wrong with the general condition of the watch or possibly there may be a weak mainspring at fault, or an imitation spring that is too long and thick may take up too much room in the barrel and cause poor motion as surely as will one that is two weak.

Assuming, however, that the motion is good in one position and drops off in the other, it is quite probable that only an ordinary position correction will be required and the immediate problem to be considered is that of causing the short arc of motion to accelerate enough to equal the longer arc. The precise correction required will most probably be found among the causes listed in No. 46, this Chapter.

52. Which Rate to Use as the Unit for Comparison.

The horizontal position which has the slower rate of the two should be considered as the unit which is correct and it will always have the longer motion of the two, barring the occasional exception as described in No. 50.

This longer arc of motion is universally due to a better condition, while the shorter motion indicates that something is wrong, and it should always be the aim of the adjuster to improve some condition that is below standard, rather than to make some good condition a little worse in order to equalize the rates.

It may be possible to equalize horizontal rates by flattening the ends of pivots, but it does not require much more time to improve the motion in one position than it does to make it a little worse in another. The advantage is all one way and results either good or bad depend entirely upon the viewpoint of the worker and how he applies himself to the situation.

53. *Damaged Pivots, Pitted End Stones and Methods of Correction.*

In the examination of pivots, end stones and jewels, it is necessary to use a stronger glass than the one used for ordinary work.

Damaged pivots can often be detected by looking through the end stone with a strong glass while the balance is moving. If imperfect they will appear dark or display a slight waver or flash and if they are in good condition they will appear bright and seem to stand still. They can also be examined in the lathe and a good true enclosed balance chuck is of immense value in detecting burrs, chipped edges, rings on the sides, slight bends and poorly shaped ends. The complete balance and spring can be inserted and the pivots can be refinished without disturbing the roller or hairspring. The chuck should be revolving very slowly when making the examination and moving the belt with the hand will enable one to see more than can be seen when the lathe is running at regular speed. Some watchmakers use small bow lathes for examining and finishing pivots, or the Jacot lathe, which is excellent for this kind of work. An end stone that has been deeply pitted should always be discarded and a new one supplied. If the hole is very slight, however, it can be removed entirely and the surface of the stone repolished on a lap charged with No. 5 diamond powder, but the stone and setting should be thoroughly cleansed by brushing and pithing before replacement.

Should a slight particle of diamond or any other hard stone powder possibly remain on the stone or in the bezel it might eventually enter the end of pivot and again cause pitting. In case that the end stone is of the type that is flat and highly polished on both sides, such as is usually found on detachable dome foreign watches, it can be punched out with a piece of brass wire or peg wood and replaced in reverse position, after which the bezel can be closed

and the stone will be just as serviceable as a new one.

Pivots that have been running on pitted end stones are generally rough on the end which is charged with some hard substance. They require special treatment to remove the cause of the pitting and the following method of refinishing is very good. Place the balance in the lathe and draw a soft Arkansas oil stone over the end of pivot with pressure enough to remove a bit of the metal. This will drag out any hard particles that may be lodged in the end and after this has been done the pivot should be pithed clean and polished with a smooth hard steel burnisher covered with oil.

A hard stone such as sapphire or jasper, or a steel burnisher should not be used on the pivot until the Arkansas stone has first done its work, because a hard instrument of this description will force the small particles that cause the pitting further into the end of the pivot instead of removing them entirely.

A pivot that has been treated in this way will not pit the end stone a second time unless carelessness in the use of hard powder permits additional particles to come in contact with the pivot or end stone.

There are some instances in which the steel is highly carbonized but manufacturers generally use the best steel obtainable for balance staffs and excessive carbon can generally be detected with a magnifying glass. Free use of diamond powder and emery wheel dust are more often responsible. The holes of jewels should never be enlarged or polished with diamond powder after the jewels have once been placed in their permanent settings, as this allows the powder to lodge between the jewel and the setting where it cannot be removed by cleaning but where it will be drawn out by the oil and charge any pivot that may be run in the jewel. The grey powder in such instances may be seen through the top of jewel with a strong glass.

CHAPTER XII

PRELIMINARY NOTES AND PRACTICE ON VERTICAL CORRECTIONS

54. *Five Principal Causes and Corrections for Pendant Up Variation.*

THE first of the vertical positions to be considered is that of Pendant Up and to understand the causes of and corrections for variations in this position completes what is known as three position adjusting.

The usual causes of variation in the pendant up position as compared to the horizontal positions are as follows.

Poor Motion Pendant Up.

Regulator Pins not properly adjusted.

Balance not in poise.

Hairspring not in circle.

Hairspring not pinned at proper point.

55. *Poor Motion, Cause and Effect.*

Among these causes that of Poor Motion covers a number of troubles such as roller jewel rubbing in fork, guard pin rubbing roller, strong lock on the escapement, or no lock on some teeth.

Such causes may not prevent close rating between the horizontal positions because of non-interference until the position of the watch is changed.

The pendant up motion should therefore be the first vertical point of investigation and if at fault the cause should be eliminated. In this connection it should not be expected that the arc of motion in the pendant up or any other vertical position will be as long as it will be in the horizontal positions,

for when a watch is in excellent condition in every particular the vertical arcs are always approximately one-fourth of a turn shorter than the horizontal.

This is due to frictions and is impossible of correction and therefore should not be confused with a poor motion of greater extent which has removable causes that are practical of execution.

A good motion is to be considered as one of the results to be expected in overhauling and putting a watch in good order and it should not be understood that it is particularly to be associated with adjusting only, nor should any watch be slighted in cleaning and assembling with the idea that adjusting will correct it in a few minutes' time. On the other hand it should be understood as fundamental that no watch can be a close time keeper unless it has a good motion and no good adjuster will attempt to obtain close time in one position or a close rate in different positions until the motion is first what it should be. If it is what it should be, about ninety per cent of the necessary work required for obtaining close position rates will have been completed.

56. Regulator Pin Practice for Pendant Up Variation.

When the watch is in reasonably satisfactory condition and a three position test proves that the pendant up position has a variation of from ten to twenty seconds either fast or slow compared to the horizontal positions, the regulator pins may be the first point of examination. If there is considerable vibration of the coil between them, and the pendant rate is slow, it will be necessary to close the pins and if the rate is fast and the pins are found to be closed so that there is no vibration of the coil, it will be necessary to spread them slightly. Closing the pins will of course make the general timing of the watch faster and spreading them will make it slower and therefore it will be necessary to regulate the watch for one or two seconds per hour before

again testing it in positions. The result of either operation, however, will be to cause the rate in the pendant up position to conform more closely to the horizontal rates.

Preliminary and profitable two position experiments can be made between dial up and pendant up, by having the pins closed on most any watch that is in good order and timing it within five or ten seconds in twenty-four hours, then rating it in these two positions. Next spread the pins slightly, re-time the watch and rate it in the same two positions and compare the variations. A few experiments of this description will soon demonstrate as to the extent of correction that can be obtained in this way. *The rule of equal vibration of the coil between the pins after they have been spread must be rigidly enforced.

Note (See Chapter IX, on Regulator Pin Alterations.)

57. Pendant Up Corrections Through Poise of Balance.

Assuming that the motion and regulator pins seem to be satisfactory, the next point of investigation should be the poise of balance. The hair-spring should be removed and the pivots known to be straight and polished before testing. The rollers are of course a part of the balance and are not to be removed. A perfectly poised balance can be stopped at any point on the tool and it should at least remain stationary at each of the four quarters of its circumference. No. 28, Chapter VII, should be consulted for details on poise corrections.

58. Concentricity of the Hairspring.

The next point of consideration may be the concentricity of the hairspring, and it is quite important that the spring be centered as nearly perfect as the trained eye can determine. Any unusual pressure

of the spring in one direction will cause undue friction and a fast rate compared to the opposite direction.

There are several easy tests for determining as to how nearly the spring may be centered. One of these is to look straight down upon the spring and examine the space between the coils that extend beyond the circumference of the dome. This test may be made in three ways, one with the balance at rest, one with the coils of the spring wound up and the third with the coils unwound. With the balance at rest and the spring centered there will be the same space between the coils all around as though the spring were out of the watch entirely and laying on the bench.

If it is not properly centered there will be more space between the coils on one side than there will be on the opposite. The same conditions will be apparent when the spring is wound up, although the coils will all be nearer to each other than they were with the balance at rest, and when they are unwound the coils will all be farther apart with the same apparent difference on opposite sides when the centering is not correct.

The winding and unwinding of the spring is alternating and almost instantaneous, as the balance oscillates from one extreme to the other. For observation of the spring when it is wound or unwound it is necessary to stop the balance with the finger or camel's hair brush as it reaches its extreme arc of motion, then hold it stationary for a few seconds while the space between the coils is being examined. The balance should then be allowed to swing to the opposite extreme, when it should again be held for examination of the coils. In one of these extremes the coils will be wound and in the other they will be unwound and after a few experiments in stopping and starting the balance it will be found that the entire examination will not require over ten seconds' time.

When the spring is not properly centered the

reason is of course found in some curve of the over coil and the most usual point at fault is the section or curve on which the regulator pins act. If the coils open too wide on the side where the regulator pins are located this section of the coil will be too near the center and should be moved outward, possibly equal to one-half or one full space of the coils. If the coils are too close on the side where the pins are it will probably be found that the section requires shifting toward the center slightly. The balance should be removed from the watch in either instance and the coil circled with the over-coiling tweezer, although experienced workmen can frequently make excellent corrections with a fine pointed tweezer without removing the balance.

Finely adjusted watches will always be found to have springs as nearly perfectly centered as it is possible for expert workmen to get them and it is quite interesting and instructive to observe the vibration of a perfect spring by any one interested in the work.

Some watchmakers center the spring on the balance cock before it is staked on the balance and very good results can be obtained in this way. The balance cock is placed on the bench in the inverted position which makes it easy to locate the point or curve requiring alteration.

59. Correcting Pendant Up Variation Through Pinning Point Alterations.

Should most careful investigation of the condition of the watch indicate that the Motion, Regulator Pins, Poise of Balance and Centering of the Hairspring as well as the general condition of the watch are satisfactory and the rating show that there is still considerable variation between the horizontal positions and the pendant up position there is still one source through which positive correction may be obtained.

This refers to the relative positions of the collet

and stud pinning points which is defined with explanatory cuts and formula in Chapter VIII.

60. *Percentage of Watches Requiring Correction of Position Rates.*

In constructing this chapter and the preceding one it has been preferred to go into detail for the purpose of defining the possible corrections and alterations, together with the results to be expected. Not every watch demanding position correction would require the extent of investigation and possible alteration that is pointed out and in most instances the direct cause will be disclosed with very little investigation. In fact, the experienced adjuster can tell almost immediately where to look for trouble by merely observing the position rate as entered on the card.

It should also be clearly understood by the student that when the repairing and cleaning of high grade watches is done by one who understands the details of adjusting, there will be only a very small proportion of the watches requiring position corrections. As a rule among experienced adjusters there will be about seventy per cent of the watches that will have very close rates. If, therefore, one hundred watches are put in order and tested in positions there should be seventy that do not require any correction, while about thirty will require either minor or major alteration. The time required for making alterations on this thirty per cent of the watches will be offset by a smaller percentage of unsatisfactory returns and a better reputation for doing good work.

CHAPTER XIII

CONCRETE EXAMPLES SHOWING DEFINITE THREE POSITION ALTERATIONS AND LABOR UTILIZED

61. *Order of Position Timing and Method of Calculating the Variation.*

IN submitting the previous chapters it is assumed that the average ambitious watchmaker will gain enough knowledge from the various details to enable him to understand the meaning of the adjustment of watches, the causes of variations and the principal alterations for obtaining corrections.

There are many features covered that will enable him to develop in practice and to experiment in individual points of importance, without running up against mathematical deductions that halt and discourage further interest in the subject.

To understand the principles constitutes a large percentage of the qualifications required and to be able to execute the practical alterations and corrections required in different kinds of variations completes the general qualifications. It would hardly be sufficient, however, to conclude the work at his point without giving more definite examples for comparison, together with some indication as to the approximate time that may ordinarily be utilized in doing the work and also showing some instances of a possible choice of several alterations and why a particular alteration is advisable. For this reason the following examples will be found to have an important part in fulfilling the mission of this book.

In selecting these examples the fineness of results has not been the principal consideration. The deciding factor was the differences in variation and

Definite Three Position Alterations

alterations, and the fact that they cover the widest field for general instruction that could be selected from hundreds of equally good rates among various models of watches which, with three exceptions, were put in order for railroad service.

The method of computing the variation from one position to any other is similar to that used in temperature adjusting as described in Chapter 3, No. 13. The watch should first be timed closely and then rated for twenty-four hours in each position. It should be wound before being started in each position but should be set only on the first day so that the time is never disturbed.

The first position to be rated is universally Dial Up, then in succession Dial Down, Pendant Up, Pendant Right and Pendant Left. The daily total number of seconds fast or slow should be entered in the first column of the rate card after each twenty-four hours run. This column then constitutes the progressive rate from which the actual variation between the different positions is ascertained.

The figure in the upper square is first carried out to the adjoining column at its full value and then the difference between this figure and that of the second square is entered in the second square of second column, and so on until the difference between each of the succeeding squares of first column is registered in the second column.

If the figure in a square of first column is greater than that in the preceding square the carried out figure would be entered in second column as +. If the figure is less than the preceding square it would be carried out as —.

The total variation in positions is obtained from the figures entered in second column. If these figures are all entered as either plus or minus it is necessary to merely subtract the lesser figure from the greater. If, however, some figures are entered as plus and others as minus it will be necessary to

The Adjustment to Isochronism and Positions

add the greater figure of each of the two denominations.

62. Example No. 1, Three Positions.

Columbus, No. 358846, Open Face, 17 Jewels.

Repairs Made. New balance staff, two balance screws changed, hairspring trued and cleaned.

After timing the watch closely it was tested in three positions and found to have a variation of eleven seconds fast pendant up as per second column, Fig. 16.

No. 358846... Make Columbus

DU	+1	+1	+4	+4			P
DD	0	-1	+7	+3			
PU	+10	+10	+14	+7			
			11	4			

Fig. 16

Investigation showed the hairspring to be pinned nearly correct, true level and in circle; balance true; regulator pins closed and motion satisfactory. A correction could have been made in one of several ways; either by making a slight alteration of the pinning point at the collet; correcting a possible slight error in poise or by slightly spreading the regulator pins.

As the extent of variation did not indicate any serious error at any particular point for a watch of this description the possible poise error and the slight variation in the pinning point were waived and the regulator pins were spread just enough so that slight equal vibration of the coil could be seen with a double eyeglass. After this alteration the mean time was found to be one second per hour

Definite Three Position Alterations

slow which was corrected on the mean time screws and the next test showed that the variation had been reduced to four second as per fourth column, Fig. 16. The time consumed in making the alteration aside from the repairing was less than ten minutes.

63. *Example No. 2, Three Positions.*

Ball No. B060816, Open Face, 17 Jewels.

Repairs made. Refinished balance pivots and cleaned. The first test in positions disclosed a variation of thirty-five seconds as per second column Fig. 17.

Investigation found the balance true; hairspring true, level and circle; regulator pins very nearly closed and the motion one and one-eighth turn. This rate like example No. 1, was also fast in the pendant up position, but the greater extent of the error indicated that there must be some serious poise error, and upon investigation this was found to be the case. A screw on the roller jewel side or at the bottom when the balance was at rest was found to be heavy. This was corrected and the next test showed a much improved rate although there was still a variation of eight seconds fast pendant up as per fourth column Fig. 17.

No. B060816..... Make... Ball.....							
DU	+2	+2	+7	+7	+7	+7	P
DD	+2	0	+14	+7	+14	+7	
PU	+37	+35	+29	+15	+24	+10	
		35	8	3			

Fig. 17

A better rate than this was desired and further examination proved that the locking of the pallet

stones and escape teeth was quite strong and caused the pendant up motion to have a shorter arc than would have been entirely desirable. An alteration was made by pushing the receiving stone further back into the slot and rebanking the escapement. The third position test showed an improved motion and a variation of three seconds as per sixth column. The total time required for making the alterations was about three quarters of an hour.

64. Example No. 3, Three Positions.

Elgin No. 7457488. Open Face, 21 Jewels.

Repairs made. Cleaned; polished pivots and new mainspring fitted. The first position test showed a variation of nineteen seconds as per second column, Fig. 18.

It will be noted that this example differs from Nos. 1 and 2, in that the rate is slow in the pendant up position. Examination showed all points satisfactory except that the regulator pins were spread considerably and allowed too much freedom of vibration for the coil.

Had this vibration been slight it would have been advisable to examine the poise. As it was considerable, however, the alteration made was to close the pins so that only slight vibration was visible with a strong glass.

No. <u>7457488</u> ... Make <u>Elgin</u> ...						
DU	-9	-9	+5	+5		P
DD	-18	-9	+8	+3		
PU	-46	-28	+9	+1		
		19		4		

Fig. 18

This watch was not equipped with mean time screws and it was therefore necessary to fit a pair

Definite Three-Position Alterations

of thin timing washers because closing the pins caused a gaining rate of two seconds per hour in the mean time. The next position test showed a variation of four seconds as per fourth column Fig. 18.

The time consumed in making the alteration and fitting the washers was about ten minutes.

65. Example No. 4, Three Positions.

Hampden No. 1438676, Open Face, 21 Jewels.

Repairs made. New balance staff and hole jewel fitted and cleaned.

The first position test showed a variation of twelve seconds slow pendant up as per second column Fig. 19.

No. 1438676... Make Hampden						
DU	+2	+2	+2	+2		P
DD	+4	+2	+6	+4		
PU	-6	-10	+9	+3		
		12		2		

Fig. 19

Investigation found all points such as balance true, hairspring true, level and circle and the regulator pins reasonably satisfactory. The motion, however, was not as good as it should have been when the spring was nearly wound up. It was let down to where it would ordinarily be after about twenty-hours run and found to have barely one turn pendant up and a trifle over one turn in the flat positions. This proved that the motion was not satisfactory for a watch that had just been put in order and all pivots were examined for close end or side shake; they were found to be satisfactory and the mainspring was removed for examination and found to be somewhat set and about 0.01 mm. thinner than those generally used for

this grade watch. A new mainspring was fitted and the motion was improved by about one-fourth of a turn and the next position test showed a variation of two seconds as per fourth column Fig. 19. The time consumed in examination and changing the mainspring was about twenty-five minutes.

The three position limit of variation allowed by most manufacturers and railroad inspectors is seven seconds from one position to any other. Records of thousands of watches on which the work has been carefully done in putting the watches in order, show that about seventy per cent of the watches will rate within five seconds in the three positions without making alterations and that only ten per cent will be close to the limit of seven seconds, while about twenty per cent will require alterations such as shown in the four examples above. (See Chapter XII, No. 60.)

One or two more examples might be introduced to show variations and corrections between dial up and dial down; this feature has been pretty well covered however in Chapter XI, and five position example No. 9 also shows a variation of the horizontal rates with correction.

CHAPTER XIV

CONCRETE EXAMPLES SHOWING DEFINITE FIVE POSITION ALTERATIONS AND LABOR UTILIZED

66. *What Five Position Adjusting Consists of—Detailed Allowances.*

FIVE position adjusting consists of a further refinement of the condition of the watch. The fact that a very close rate is shown in the first three positions is not an indication that the watch will be an excellent timepiece under all conditions.

In fact there are instances where there may be an excellent three position rate and a further test in the pendant right and left positions may disclose some error that would positively prevent close timing in service. Even under the five position test the limit of allowance must be reasonably close or unfavorable conditions may exist and cause irregularity in timing.

A popular allowance for very fine watches among Swiss and some American manufacturers is six seconds variation for the five positions as an extreme limit, and for medium high grades ten seconds extreme variation is considered a fair allowance. These allowances are graduated, however, and a six seconds extreme allowance watch would have an allowance not exceeding three seconds in the horizontal positions, with two seconds additional in the pendant up position and one second additional in either the pendant right or pendant left positions.

Watches having an extreme allowance of ten seconds may be permitted to have not more than five seconds variation between the two horizontal positions, with two seconds additional for the pen-

dant up position and still three seconds additional in either the pendant right or left positions.

It will be noted that there is considerable difference between six or ten second allowances of this description and straight limits of six or ten seconds.

Some manufacturers have greater limits of allowance, sometimes as great as twenty-five seconds for the five positions, but as a rule the first three positions are required to rate within seven seconds and the difference of eighteen seconds is divided between the right and left positions.

Under limits of this description a watch that would not be tolerated under the six or ten seconds class would be considered as good. Watches having such large allowances, however, and rating close to the limit are hardly justified in being considered as adjusted to five positions. The fact that they are so considered however, is the reason why watchmakers will sometimes fine wide variation in new watches before they have been damaged or mishandled. The following five position examples were selected with the same care as were the three position specimens and will be found to cover a wide field of variation for comparison with rates that the adjuster may desire to correct.

67. Example No. 5.

Hamilton, No. 248027; Open Face, 21 Jewels.

Repairs made. New balance staff and cleaned. The first test in five positions showed a variation of twenty seconds as per second column Fig. 20. It will be noted that in four of the positions the rate was quite close and that the pendant right position had an extremely fast rate.

A casual investigation indicated that all points relating to the spring, regulator pins and balance were reasonably satisfactory but that there was a slight falling off in motion in the pendant right position. Further investigation of this feature disclosed

Definite Five Position Alterations

a slight striking sound when the watch was held to the ear in this position. The dial was removed and the bankings were closed to drop whereupon it was discovered that the fork was long on the inside, or when the receiving stone was locked on the escape teeth. This prevented the roller jewel from passing through the fork freely as it did on the opposite side.

The balance pivots had the limit of allowance for side shake which aided the cause of the roller jewel in striking.

No. 248027... Make Hamilton							
DU	+1	+1	+3	+3			P
DD	+2	+1	+7	+4			
PU	+4	+2	+8	+1			
PR	+22	+18	+12	+4			
PL	+20	-2	+8	-4			
	20		8				

Fig. 20

After correcting the roller jewel shake and re-adjusting the slide and guard pin freedom the next test showed a variation of eight seconds in the five positions as per fourth column Fig. 20. The side shake of the balance pivots was not detrimental after the real cause of the variation had been removed and therefore no correction was required in this respect.

If the error in the escapement had not existed and if the watch had shown the same rate with all points appearing to be satisfactory, the trouble would most likely have been found in the poise of balance with the upper side heavy in the pendant right position.

The time consumed in making the correction was about one half hour.

68. *Example No. 6.*

Elgin. B. W. Raymond. No. 4, 109,543, Open Face, 15 Jewels.

Repairs made. New fourth pinion; new end stone; mainspring; refinished balance pivots and cleaned. Note that this was only a 15-Jewel watch.

It belonged to a railroad engineer, however, who wanted it placed in first class condition, as it had not been satisfactory. The first five position test showed an error of twenty-four seconds as per second column Fig. 21.

Examination of the motion, pivots, regulator pins, escapement and poise proved them to be satisfactory.

The hairspring however, was found to be pinned at the slow pendant up point as per illustration in Fig. 22.

No. 4. 109.543. Make Elgin.....							
DU	+8	+8	+2	+2			P
DD	+16	+8	+3	+1			
PU	0	-16	+2	-1			
PR	+4	+4	-1	-3			
PL	-1	-5	-6	-5			
		24		7			

Fig. 21

The alteration made was to break out one-half of the inner coil at collet so that it was pinned at the fast point as illustrated in Fig. 23.

A pair of balance screws were removed and a heavier pair fitted to correct the mean time, which would have been about ten minutes fast in twenty-four hours because of shortening the spring.

Definite Five Position Alterations

The balance was reposed and the next test in positions showed a variation of seven seconds as per fourth column Fig. 21.

The time required for making the alteration was about one half hour.

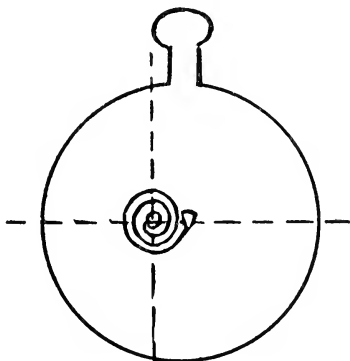

Fig. 22

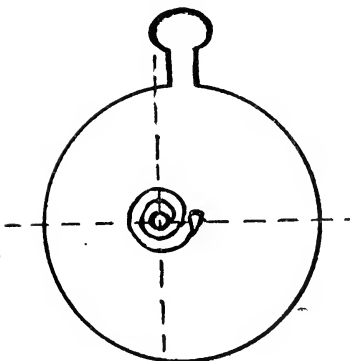

Fig. 23

This watch was a full plate model with the train developing to the left from the center and illustra-

The Adjustment to Isochronism and Positions

tions No. 22 and 23 are given to show that, while the train follows the Swiss development, the spring follows the American method and develops to the right from the collet even though it is located to the left of the watch center. The principle remains the same as that illustrated by Figs. 9 and 11 and explained in Chapter VIII.

69. Example No. 7.

Waltham. No. 10504112. Open Face, Vanguard model; 23 Jewels.

Repairs made. Cleaned and new hole jewel.

First five position test showed a very erratic rate as per second column Fig. 24.

Investigation proved that the motion dropped off considerably after a few hours run and that the mainspring was too weak for this grade of watch. A proper mainspring was fitted which in turn corrected the motion, but the next test in positions proved that there was still a variation of eighteen seconds as per fourth column Fig. 24.

No. 10504112 - Make <u>Waltham</u>							
DU	0	0	-2	-2	-1	-1	P
DD	0	0	-5	-3	-1	0	
PU	+14	+17	-21	-16	-4	-3	
PR	+4	-10	-19	+2	-5	-1	
PL	+16	+12	-25	-6	-3	+2	

Fig. 24

24 • 18 5

The balance and spring were removed and considerable poise trouble was discovered. The trouble was at different points of the balance and no one location seemed to be heavy at all times. The balance pivots were carefully gauged with a metric

micrometer and found to be out of round, or to be exact, more oval in form than cylindrical. A new staff with round pivots was fitted, after which the balance was easily poised and the next test showed a variation of five seconds as per sixth column Fig. 24. The total time required for making the examination and alterations was about one hour.

70. Example No. 8.

Vacheron and Constantin. No. 272,854, Open Face, 21 Jewels.

Repairs made. New balance staff, hole jewel, cap jewel, glass, and cleaned.

The first test after making the repairs showed a variation of twelve seconds as per second column Fig. 25.

It will be observed that the rates in the horizontal positions are on the fast side and those in the vertical positions are on the slow side. In this instance the hairspring developed to the left from the collet similar to the illustration shown in Fig. 10, page 45.

Investigation found the escapement, regulator pins and pinning point satisfactory; the motion was one and one-fourth turn in the vertical positions when fully wound and only a trifle less when partially let down. In the flat positions, however, the motion was very little better than in the vertical, which

No. 272,854 - Make V. & C.							
DU	+2	+2	-4	-4			P
DO	+5	+3	-8	-4			
PU	-1	-6	-14	-6			
PR	-8	-7	-21	-7			
PL	-17	-9	-25	-4			
		12		3			

Fig. 25

indicated either pivot or end stone trouble as under normal conditions the flat motion would be about one-fourth turn greater than that of the vertical.

Inspection of the end stones proved that they were satisfactory but the ends of the balance pivots were found to be somewhat flat and not perfectly polished.

The ends of the pivots were slightly rounded and highly polished, the jewels and end stones cleaned and reoiled and the balance replaced, after which the motion in the flat positions was one and one-half turn with the mainspring fully wound and only slightly less when partially let down.

The motion in the vertical positions was also slightly improved and the next test in position showed a variation of three seconds as per fourth column Fig. 25.

Time required for making the above alteration was about one-half hour.

In the study of this example it should be clearly understood that when the ends of balance pivots are flat, burred or not well polished, or when the end stones are dry or dirty the motion in the horizontal positions will be shorter than normal and this will always cause the rate to be faster than it should be. Acceleration of the motion in such instances by means of refinishing the pivot ends or by cleaning and reoiling the jewels and end stones will always produce a slower rate through causing a longer arc of motion.

This point is covered in Chapter XI, No. 47.

71. *Example No. 9.*

E. Howard. No. 1,116,735. Open Face; 23 Jewels.

Repairs made. New balance staff; hole jewel; mainspring and cleaned.

The first test in positions showed a variation of eleven seconds. The rate in all positions was fast

Definite Five Position Alterations

with the exception of the dial down rate, which was slow. See Fig. 26.

At first glance it might appear that by causing a faster rate of six or seven seconds in the dial down position the watch would have a very good rate. This, however, would not be consistent unless the rate was due to the exception referred to in Chapter XI, No. 50.

Examination of the motion in the horizontal positions proved that it was about one fourth turn better in the dial down position than it was in the dial up position which rate compared very closely with the vertical positions. It was therefore evident that the dial up rate was not true and investigation found the oil in the upper jewel had become thickened by the entrance of dirt which caused the short motion and fast rate when the balance was running on this end stone.

No. 1116.735... Make E Howard							
DU	+2	+2	-5	-5	+2	+2	P
DL	-3	-5	-10	-5	+4	+2	
PU	+1	+4	-6	+4	+9	+5	
PR	+7	+6	0	+6	+10	+1	
PL	+9	+2	+2	+2	+14	+4	
			//	//		4	

Fig. 26

After thoroughly cleaning the jewel, end stone and pivot, the motion in the dial up position was improved and equaled that of the dial down position.

The next position test showed the horizontal rates to be equal but the variation of eleven seconds in the five positions still existed as per fourth column Fig. 26. The vertical rates were all fast compared to the horizontal; the regulator pins were found to be slightly open which prevented a correction at this point. The locking of the escapement was ex-

amined and found to be satisfactory, so the balance was again removed and tested for poise which was also found satisfactory.

The hairspring was pinned at the usual fast point as per illustration in Fig. 9, Chapter VIII. The most positive alteration to be made under the circumstances was to break off the spring at the collet and repin it at about 45° above the horizontal line. This would be slightly approaching the slow point as explained in detail in Chapter VIII, No. 35.

The mean rate of the watch would necessarily be faster after shortening the spring; the mean time screws were found to be turned in close to the rim and were each turned out about one full turn to compensate for the gain. The poise was tested and found to remain correct and the next position test showed a variation of four seconds as per sixth column Fig. 26.

The total time required for the alterations was about one hour.

72. *Example No. 10.*

Illinois. No. 1,483,023, Open Face, 21 Jewels.

Repairs made. Trued and poised balance, new balance jewel and cleaned.

This example has been selected for the purpose of illustrating a test in the sixth or pendant down position and to give a practical demonstration showing that the rates in the pendant down and pendant up positions can be reversed, with positive results, through reversing the collet pinning point of the spring, as covered in "Relative Pinning Points" Chapter VIII.

This alteration can be undertaken with assurance of results even though there may be serious errors of construction in the watch.

The first five position test proved that the rate pendant up was extremely fast compared to all other rates as per second column Fig. 27.

Definite Five Position Alterations

Investigation proved that the hairspring was properly centered and pinned at the fast pendant point and that the regulator pins were slightly spread with equal vibration of the coil between them. The motion was about one and one-fourth turn pendant up and over one and one-half turn in the horizontal positions when the mainspring was nearly full wound. The ends of balance pivots were found to be perfectly flat, which was no doubt due to an effort to produce a faster rate in the flat positions to cause them to compare more favorably with the pendant up rate. This, however, was unsuccessful as indicated by the rate.

It is quite possible that if the watch ever was closely rated it was due to counterpoise of the balance as with the present rate the poise, escapement and regulator pins were satisfactory and did not admit of further corrections that would be of advantage.

By examining the P. U. rate in second column Fig. 27, it will be found to be twelve seconds fast and then by referring to the separate P. D. (Pendant Down) rate at the bottom, it will be found to be four seconds slow. Adding these figures gives a total variation of sixteen seconds between these two positions.

No. <i>1483023</i> ... Make <i>Illinois</i>							
DU	-3	-3	-1	-1			P.
DD	-8	-5	-2	-1			
PU	+4	+12	-6	-4			
PR	0	-4	-4	+2			
PL	-6	-6	-7	-3			
P.D.		-4		+11			

Fig. 27

Now if these rates were reversed and the P. D. rate was in the place of the P. U. rate the watch

would have shown a very good position rate in the first five positions and the greater part of the sixteen seconds variation would have been in the pendant down position where it would be of the least disadvantage. In order to obtain this condition the collet pinning point was changed from the fast to the slow point, or from "E", Fig. 9, to "G", Fig. 11, Chapter VIII.

A pair of heavier screws were fitted to the balance to compensate for the difference in time caused by shortening the spring and the next five position test showed a variation of six seconds. A separate pendant down test proved that the pendant up and pendant down rates had been practically reversed as shown in the fourth column.

73. Causes of Extremely Fast Vertical Rates.

Extremely fast pendant up rates are not particularly unusual, although the causes and corrections may be widely different.

For instance, the poise and motion feature, No. 28, Chapter VII, may be responsible, or the balance may be in poise and the collet having a wide slot may cause out of poise and be responsible if the slot is located at the proper point. A defective escapement or regulator pins tightly closed may also be responsible. Should these points be found satisfactory, however, the rate is generally due to one of three causes.

1. Excessive side friction of pivots because of being too large in diameter.

2. Train wheels and pinions being of incorrect proportion and causing irregular motion and affecting the vertical positions mostly.

3. Centrifugal force, which would cause the balance rims to spring outward in the longer arcs of vibration and thereby produce an abnormal slow rate in the horizontal positions where the arc

Definite Five Position Alterations

of motion is always longest. This is due to the balance rims being too heavy in proportion to the arms or center bar.

When either of these three conditions are found there will be others among the same lot of watches, but as a rule they are only found on older watches made before correct proportions were firmly established.

Train depthings can often be improved if the workman is equipped with a rounding up machine and knows how to use it. Otherwise the watch can be sent to the factory for correction and the only alternative of the repairer is to cut the spring to the slow point, or counterpoise, with the intention of eliminating expense and getting as good results as can be expected for the financial returns that are to be received.

74. How to Locate Defective Gearings.

Defective gear or depthing of wheels can be detected in two ways, one by observing the engaging surfaces of the wheel teeth and another by testing the engagement of wheel and pinion.

If the gearing is correct, observation will show that the engaging surfaces of the wheel teeth are smooth and either dark or possibly polished from wearing away of the plating. If the gearings are not correct the engaging surfaces will have cuts or ridges crosswise which have been produced by the pinion leaves.

The cause of this cutting is due to either a faulty construction of the teeth or to the fact that the pitch circle of the wheel is too small while that of the pinion is too large.

Testing the gearing in the watch is accomplished by placing the engaging wheel and pinion in the watch so that they are free to turn without engaging with any other wheel. A piece of ivory or celluloid several inches long and about the diameter of a

piece of peg wood should be pointed at one end and this end should be held between the upper pivot and oil cup of the jewel, with enough pressure of the left hand to cause friction in turning the pinion. The larger wheel should then be turned in the direction in which it revolves when running; this is accomplished with a piece of peg wood held in the right hand.

If the gearing is perfect there will be smoothness as the wheel and pinion turn and if it is imperfect there will be a butting effect in the action. Should there be a slight intermittent stepping action due to drop of the wheel teeth on the pinion leaves it should not be mistaken for butting as this is not detrimental and will not cause cutting of the teeth.

Watches that have below standard train gearings require considerably stronger mainsprings than do those which have correct gearing and they will seldom take a reasonably good motion without a strong spring.

A safe way to judge gearings if in doubt is by the motion and the engaging surfaces of the wheel teeth. If the motion is steady and the teeth are not cut by the pinion leaves they may be considered as satisfactory. If the motion is steady for a time and then suddenly drops off there is generally something wrong in the gearing. The wheel and pinion in error can be determined by noting at what particular intervals the motion decreases. In nearly all instances this condition will cause a gaining rate in the vertical positions because of the fact that the vertical arcs are shorter and comparatively more easily affected than the horizontal arcs.

CHAPTER XV

TIMING AND FINAL REGULATION

75. *Mean Time Screws and Timing Washers.*

IN the general overhauling of watches, changing staffs, retrueing and repositing of balances it is often necessary to make corrections of several minutes per day in the mean time.

For this reason and for the convenience of the future some manufacturers have provided from two to four mean time screws in the balances. A complete revolution of these screws either in or out, generally corrects any variation that may be required and frequently considerably less is all that is required in bringing the watch to time.

It is of course necessary that these screws be turned in opposite pairs as well as equal distances and that they be fitted with enough friction to prevent looseness and not too tight to cause bending of the pivots when they are turned.

If properly used for the purpose for which they were intended they are of inestimable value to the repairing fraternity in producing results.

The manufacturers of some watches do not supply mean time screws with the balances and the repairer is obliged to depend entirely upon timing washers for fast corrections, for it is, of course, not to be expected that repair shops will carry an assortment of all different kinds of screws such as the factories are able to maintain.

Occasionally a jeweler or watchmaker will be found who has strenuous objections to the use of timing washers in any sense, but unless they are supplied with a large assortment of the various makes and weights of screws and are willing to use

the extra time required for properly changing the screws it is difficult to see just what legitimate alternative they can adopt. Investigation of this point disclosed the fact that the method employed by some watchmakers was to spread the regulator pins, which would of course make the mean time slower but would certainly destroy the adjustment to positions and make it practically impossible to obtain results from the regulator.

It is admittedly poor workmanship to use ill-fitting washers and poor taste to use brass washers on high grade gold screw balances, but the fact should not be overlooked that the manufacturers of many fine watches use washers to a limited extent, even when an abundance of balance screws are available and very fine Swiss models are often supplied with a pair of thin platinum washers which are not easily detected. The regulator should not be moved from the center of the index in correcting the mean time but should be used for minor final regulation only. The length of the hairspring should also not be disturbed in correcting the mean time of an adjusted watch and while a slow rate can be corrected by reducing the weight of a pair of balance screws it is necessary to use either heavier screws or washers for correcting a fast rate.

76. Importance of Properly Fitted Regulator.

Final regulation of watches is necessary after making repairs regardless as to whether they have been adjusted to positions or not. Position rating does not necessarily suggest that the timing has been completed as the object is only to limit the variations from one position to any other and a test of three or four days should always be made in one position after the position rating has been completed. This additional timing has for its purpose the close regulation of the watch either in the pendant up position or in the position it is carried. The last column on the rate card is reserved for this purpose.

In this respect the repairer who comes in contact with the customer may gain considerable advantage by noting in which pocket the watch is usually carried and then being guided in the final regulation by this knowledge. The method of doing this regulating consists generally of moving the regulator which requires certain attention to be effective when it is moved.

The regulator should be carefully fitted around the dome and all attachments in connection should be tightly fitted to the plate or bridge so that they will remain rigid when regulation takes place.

The tension around the dome should be even and if a tension spring is used in connection it should be strong enough to keep the regulator against the screw constantly without sticking at any point as the screw is moved forward and backward.

It should also be closely examined to see that there is no shake. This can be determined by lightly taking hold of the segment holding the regulator pins and moving it up and down and side ways before the tension spring is fitted. This should be examined with a glass and a correction made if any looseness is noted.

77. Effect of the Middle Temperature Error.

In the final regulation of watches it is important that the middle temperature error receive due consideration. This error is always a few seconds fast as explained in temperature adjusting Chapter V, No. 21, and is of some consequence in the larger number of complaints regarding losing rates in the pocket, compared to complaints of gaining rates.

The position rating as well as the final regulation is generally done in normal temperature which produces a rate from two to four seconds faster than the heat extreme and it is to be expected that the pocket rate will be slower because the temperature will be higher than normal. This loss may not be

the full amount of the middle error as it would depend upon the actual temperature encountered for the entire twenty-four hours and the watch may only be subjected to the pocket temperature for a part of this period. This works in exactly the same way in a lower temperature, as the variation is a loss in either direction from the middle or normal temperature and in case that the watch should be subjected to a freezing temperature at night the result will be a loss during that period.

As an example we will assume the regulation of a watch in which the temperature rate at the extremes of 40° and 90° Fahr. is perfect, while at the temperature of 70° it will time four seconds fast.

Now if this watch is regulated to no variation in the normal temperature it will be plainly seen that there will be a loss of four seconds per day if the watch is placed in service at either of the temperature extremes. If it had been regulated to run four seconds fast in the middle or normal temperature it would time more nearly correct in the pocket.

It is safe to assume that the watch will lose its proportional rate with a lesser change in temperature and for this reason it is of advantage to finally regulate all watches from two to four seconds fast in the rack rather than to time them just correct.

78. Some Practical Reasons for Slow Rates.

There are additional reasons for the suggestion of timing watches a few seconds fast rather than just correct. Among them may be mentioned the fact that many watches are carried in the left vest pocket, and that in this instance they very often assume the pendant right position which is generally a trifle slow compared to pendant up in most watches of close adjustment. Magnetism to any extent whatever always causes a slow rate and this will have its effect whenever the balance, hairspring, regulator, regulator spring or pallet are slightly effected or

when the mainspring, large winding wheels or case springs are considerably charged and experiments have shown that in no instance has a fast rate been produced from this cause.

The gradual weakening or loss of elastic force of the hairspring is also a factor to be considered.

There are some influences which cause a gaining rate that to some extent may offset these losses, although in the absence of necessity for cleaning or other repairs these influences are slight in comparison to the natural and possible causes for a slow rate.

PART III
SPECIAL NOTES

CHAPTER XVI

SPECIAL NOTES

79. *Efficiency of Execution Analyzed (Two Examples).*

IN performance of the various alterations and corrections that have been touched upon in the chapters devoted to position adjusting there are some points that deserve special note. This refers to positive execution of the correction which the watchmaker sets out to make.

As an example we may analyze the simple feature of polishing a pivot and cleaning and reoiling a jewel to improve the motion in one of the horizontal positions. Ordinarily this would seem to be a very simple proceeding requiring no additional remarks.

It is, however, quite possible to go through all of the operations of removing, cleaning and reoiling the jewel and polishing the pivot and then find that no improvement has been made in the motion.

Invariably the workman of moderate experience will say that he has just cleaned and reoiled the jewel and polished the pivot and that it must be all right.

Investigation, however, will sometimes show that the pivot has again been marred or that a particle of dirt has found its way into the jewel hole during replacement either through dust in the oil or through clinging to the end of the pivot when the balance was laying on the bench.

This experience is one that comes occasionally to the best and most careful adjusters and if it is found that results have not been obtained the first time it will be necessary to go over the operations a second time.

It is possible to almost entirely eliminate this duplication of work if proper care is exercised in examining the pivot and jewel with a good glass before replacing and in using oil from a closed receptacle in which it has not been possible for dust to collect.

The point raised in this instance is that the improvement desired is not assured because of merely going through the operations of doing the work.

It is necessary to actually remove the cause and then keep it removed. The proof is found in the improved motion and it would hardly be worth while to retest in positions until this improvement was obtained.

Proper curvature of the over coil within the range of the regulator pins is another feature that may be corrected and the correction unconsciously destroyed in replacing the balance or in centering the spring.

A slight kink in the coil close to the regulator pins may cause the spring to be forced out of center when the regulator is moved, or it may cause the coil to lay against one pin and cease vibrating between the pins. This would cause a gain of some seconds per day when the regulator had actually been moved to cause a slower rate.

These two examples are introduced to convey the idea that it is necessary to actually produce the corrections or alterations in any instance and that close timing and close position rates depend more upon this practical execution and understanding as displayed by the watch repairer than they do upon a high degree of technical knowledge.

Personal instruction of watchmakers in adjusting has demonstrated in most instances that the refinements are not considered seriously enough at first, but that consistent practice and reference to the rules soon make the proper impression, after which results are attained in less time than was at first required for faulty execution.

80. *Truing the Balance.*

The balance should invariably be true in the round and flat and always in poise before it is placed in the watch.

It is at times pardonable to pass a balance that is not perfectly true in the round, especially when the watch has been repaired on several occasions and it is noted that the rims have a tendency to become set slightly inward or outward after having been perfectly trued. This shows a natural tendency of the metals to find a permanent position which may be slightly away from the true concentric form. A balance of this description may be poised as it is and often will produce better timing results than would be gained by perfect truing and subsequent regulation during readjustment of the metals.

It is advisable to always have the flat true as by doing so any slightly bent pivots will be detected through wavering of the balance and the flat is not very frequently affected by setting of the metals.

Balances should generally be trued and poised in normal or slightly above normal temperature. If they are trued in a low temperature they will be out of true and possibly out of poise in the temperature to which they are mostly subjected. Compensation balances are not presumed to be true in the round under variations of temperature and therefore inspection for true is necessary in somewhere near the same temperature in which they are trued.

81. *Poising the Balance.*

In poising balances it is necessary to consider the mean rate of the watch and several details in connection therewith.

If the rate is known to be fast, weight should be added to the light side, and if it is known to be slow weight may be removed from the heavy side.

If the rims of the balance have been trued outward it is a safe rule to remove weight from the heavy side in poising and if they have been bent inward to get the balance true, weight should be added to the light side in poising.

A balance that is in perfect poise can be brought to a perfect stop on a fine jeweled poising tool at any point of its circumference. For ordinary work it is generally considered as satisfactory if it can be brought to a perfect stop at each of the four quarters. When the heavy point seems to be first at one place and then just opposite it is proof that either a pivot is bent or oval in form instead of round.

In some instances balances will be found to swing slightly and stop at several different places. This is usually an indication that there are several flat places on one or both pivots and if the watch is a fine one the staff will require changing or the pivots may be rounded up on a Jacot Lathe. A fine edge jeweled poising tool is best for fine work as defects in pivots and variations in poise can be more easily discovered than with calipers.

82. Truing Hairsprings.

Original truing of the hairspring is made necessary by the fact of attaching the collet to its center. When springs are turned out by the manufacturer they are perfectly true, that is, the coils are level and perfectly spiral in form and the deviation from this spiral form, made necessary in attaching the collet, is what demands certain forming of the inner terminal so that it will blend with the other coils of the spring which have not been disturbed.

In attaching the collet it is first necessary to have the spring level before the pin is forced tightly in place. This can be fairly well determined by sighting across the flat of the spring and focusing upon the inner coil to see that it is level for at least one half of its length from the point of exit. After

this operation has been completed and the pin has been set up tight, with the surplus ends cut off flush with the collet it will be necessary to slightly pull the coil up or down, providing it is not perfectly level. The next operation will be that of truing the round and all work and bending of the spring for this operation is concentrated within the first quarter of the coil from its point of attachment and it is seldom ever necessary to make any bends beyond the first eighth of the coil from the attached point.

Figure 28 may be of some value in gaining an idea as to just how this inner coil should appear when it has been trued.

The broken lines illustrate a condition after colleting and before truing. The heavy lines illustrate two positions into either of which the coil may be formed in getting the spring true.

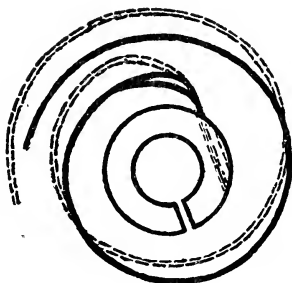

Fig. 28

The outer black line shows the most adaptable form for most instances. The inner black line shows the most practical form for use in instances where there is unusual space between the collet and the inner coil. It will be noted that these two forms blend into the true spiral form of the spring at about one-eighth of the coil distant from the collet. These forms may be used as a basis for

truing the spring in any instance in which it has been bent or mishandled around the collet after its original truing.

Experts always true springs after they have been staked to the balance and a light weight calipers tapered on one end to a smaller diameter than the collet is used for spinning the balance, making observations, and corrections.

Considerable progress can be made by some watchmakers in removing the spring from the balance and placing it on a colleting tool or tapered broach and then truing the flat and round as good as possible, after which it should be perfected in the calipers. When the balance is spinning in the calipers and the spring is true in the flat there will be no jumping or quivering of the coils as observation is made across the top of the inner four or five coils.

When it is perfectly true in the round and the balance is spinning in one direction the coils will seem to be whirling into a hole of which the collet is the center. When spinning the balance in the opposite direction the effect of the coils will be similar to the waves produced by dropping a small stone in still water and they will appear to be whirling away from the center. This effect in both instances is caused by the eye following the spiral form of the coils as the spring revolves.

83. Treating a Rusty Hairspring.

When rust begins its attack upon any point of a hairspring there will be a constant loss in time until its advance is stopped.

Should considerable headway have been made by the rust before the watchmaker's attention is enlisted for an examination it may be necessary to change the spring entirely before good results can again be obtained.

There are many instances, however, in which proper care at the right time will produce as good results as will a new spring.

The first appearance of rust is generally indicated by one or more spots of a light brown shade and in such instances it has hardly attacked the metal to any serious extent, although usually enough to cause a slightly losing rate. At this stage the spots may be scraped with a piece of peg wood after which the spring can be placed in a small copper pan containing lard oil to a depth of about one-fourth inch.

This pan should then be held over an alcohol lamp until the oil becomes hot enough to smoke, after which the spring should be removed, immersed in benzine for about thirty seconds and then dried in sawdust. This treatment will stop further rust and the only indication of previous rust may be a removal of the color from the spot which had been affected.

In case that the rust has reached a stage far enough advanced to seriously pit the metal, good results cannot be expected from the spring even though further rusting may be prevented.

84. *Stopping by Escapement Locking When Hands are Set Backward, or When Watch Receives a Jar.*

This is sometimes a very annoying trouble and while it should not occur on high grade watches at all, it does show up just often enough to cause a certain degree of unpleasantness for the owner of the watch as well as for the watchmaker.

There are two principal causes for the difficulty. One is due to the back of discharging pallet stone having a very sharp corner combined with a slightly rough edge on the back of the escape wheel teeth and when the two factors meet with some slight force, such as is caused by reversal of the train wheels the sharp corner of the stone wedges itself into the rough surface of the tooth and holds until pulled away by some small instrument. This can be remedied by removing the sharp edge of the stone on a diamond charged polishing lap and a very slight correction is sufficient.

The second principal cause is due to sharp edges on the roller jewel. First quality roller jewels always have these edges rounded, as otherwise they may wedge into the horn of the fork and often will not release through ordinary shaking of the watch.

A short guard pin can also cause the trouble by allowing the roller jewel to catch on the end of the fork horn before it enters, or the guard pin may catch on the edge of the crescent on the safety roller, but the two causes mentioned above will allow "hanging up" even when the guard pin, roller jewel and all other shakes are correct.

When the above conditions are correct and all setting connections are properly fitted, the hands may be set either forward or backward without in any way disturbing the time. There are instances, however, where the watch will stop when the hands are reversed and at times the second hand will actually turn backward although the watch will immediately begin to run as soon as the backward pressure on the hands is discontinued.

This is caused by the cannon pinion being so tightly fitted that turning it backward will require more force than that which is supplied by the mainspring. A condition of this description is more pronounced when the mainspring is nearly run down and sometimes it will happen at such times and will not occur when the spring is fully wound.

85. Essentials and Non-Essentials in Cleaning Watches.

It would be difficult to suggest a best method for general cleaning of watches. Different watchmakers have different methods and good results are attained in more than one way. Whatever the method, however, there are certain definite requirements that are fundamental.

Among these are the thorough cleansing of pivots, jewels, pinion leaves, wheel teeth, mainspring and winding parts.

It is not sufficient to depend upon routine and simply dip the parts in various solutions, brush and reassemble the watch. There are many instances in which the oil becomes gummy and sticks to the jewels and pivots to such an extent that peg wood and pith must be applied with considerable energy to obtain perfectly clean surfaces and holes.

The essential feature is that of actually removing every particle of dirt from the contact surface.

It is not essential that the plate and bridges should have a high lustre, as this does not facilitate the running. If it is desired and if facilities are available, the plates and bridges may be dipped in benzine and dried in sawdust, then washed and brushed in a solution of hot water, borax and castile soap, then rinsed in fresh water, dipped in alcohol and dried in sawdust. This produces a lustre to the plate bridges and wheels. When it is not convenient to use hot water the parts may be dipped and brushed in benzine for at least one minute and dried in sawdust, then dipped in alcohol and again dried in sawdust. In either event thorough pegging and pithing of the jewels, pivot holes and pivots is necessary as well as brushing and examining all wheel teeth and pinion leaves. The steel parts should be examined and gummy oil eliminated. Fresh oil should be applied in proper quantities in the proper places. This requires some study, as either too much or too little oil is detrimental.

When a watch is cleaned annually by the same workman it is not necessary that the mainspring be removed and reoiled each time, for a mainspring properly oiled will last for two or three years before requiring cleaning and reoiling.

It is well known that mainsprings frequently break shortly after being removed and cleaned and

this annoyance may be avoided in many instances by intelligent use of this rule.

Balances should not be dipped in acid solutions, as the liquid gathers under the screws and will often cause them to discolor in a short time. It is better to polish them with fine rouge and cotton thread arranged on a wire bow as the lustre will be more lasting.

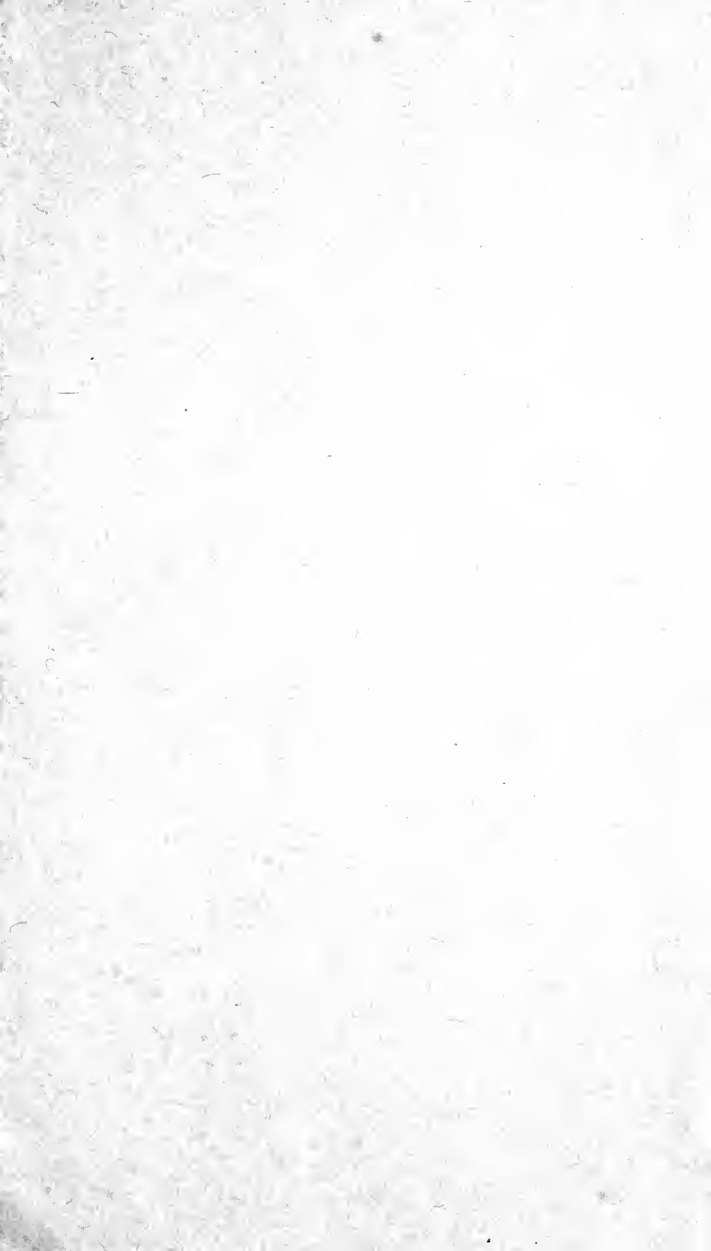



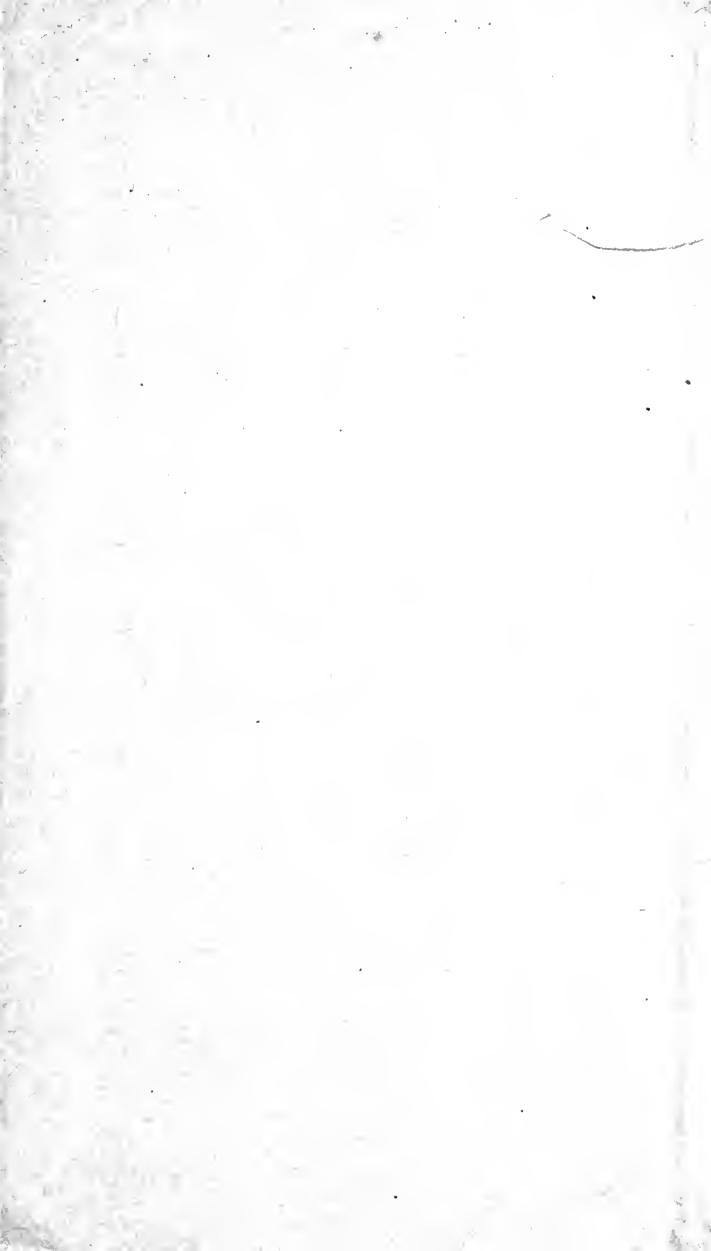

LIBRARY OF CONGRESS



0 017 107 585 3