

TJ  
7  
M3  
v.140

UC-NRLF



B 3 018 855

5 CENTS

# SAFEGUARDS

FOR

MACHINE TOOLS AND POWER PRESSES

SUGGESTIONS FOR PREVENTING ACCIDENTS

DEVICES FOR SAFEGUARDING OPERATION

RULES FOR AVOIDING INJURIES

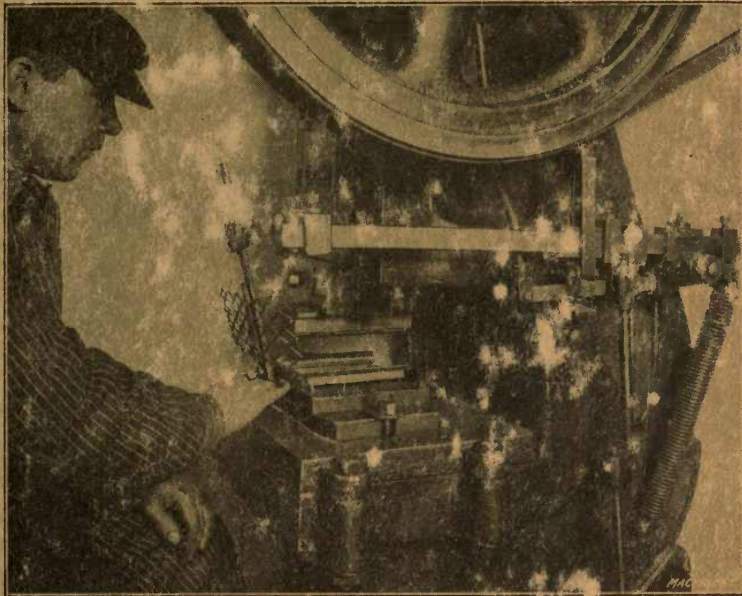

MACHINERY'S REFERENCE BOOK NO. 140  
PUBLISHED BY MACHINERY, NEW YORK

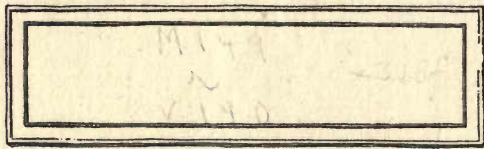
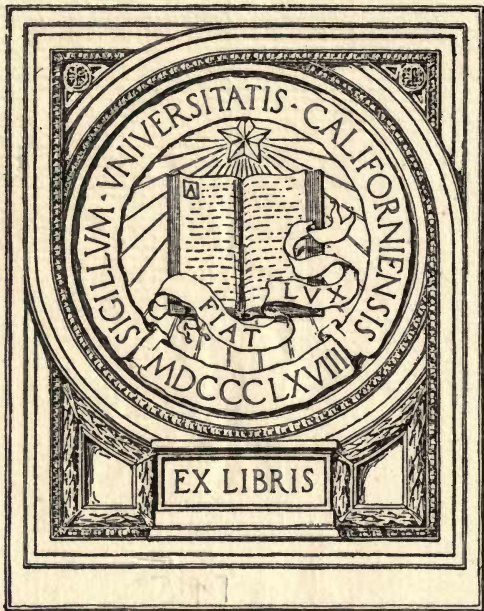





# MACHINERY'S REFERENCE SERIES

EACH NUMBER IS A UNIT IN A SERIES ON ELECTRICAL AND  
STEAM ENGINEERING DRAWING AND MACHINE  
DESIGN AND SHOP PRACTICE

NUMBER 140

## SAFEGUARDS FOR MACHINE TOOLS AND POWER PRESSES

### CONTENTS

Industrial Accidents and Their Causes - - - - -	3
Safety Devices for Machine Tools - - - - -	7
Safety Guards for Grinding Wheels - - - - -	16
Safeguards for Power Presses - - - - -	24
Rules for the Prevention of Accidents - - - - -	44

Other books in this series of interest to mechanical men generally are as follows:

- No. 36—IRON AND STEEL
- No. 125—AUTOGENOUS WELDING
- No. 127—ELECTRIC WELDING
- No. 134—PATENTS
- No. 139—SHOP SYSTEMS

TJ7  
M3  
v. 170

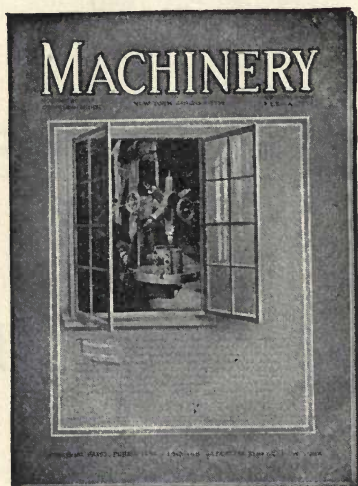

NO. 170  
MACHINERY

## MACHINERY

The Leading  
Mechanical Journal

MACHINE DESIGN  
CONSTRUCTION  
SHOP PRACTICE

THE INDUSTRIAL PRESS

140-148 Lafayette St.  
New York City

51-52 Chancery Lane, London

## CHAPTER I

### INDUSTRIAL ACCIDENTS AND THEIR CAUSES

The prevention of accidents in the industries—in machine shops and factories—is a subject which of late has been given more and more attention by prominent engineers, leading corporations and engineering societies. While there are no official statistics in the United States giving exact information as to the number of industrial accidents, there is ample evidence from official sources that the number of accidents in industrial work is much greater than one would ordinarily expect. A great many of these accidents could be prevented. As an example may be mentioned one plant where the yearly average was 200 accidents, and where, as the result of greater attention given to preventive measures, the number of accidents during one year was reduced to sixty-four; of these accidents only thirty-eight were of a character to be considered as wholly non-preventable or accidental in the most literal sense of the word. Compared with the previous yearly average of 200 accidents, this would indicate that in the average American shop only about twenty per cent of the accidents belong in the non-preventable class, while possibly about eighty per cent and certainly seventy per cent could be eliminated if greater attention were paid to safeguarding the machinery, instructing the employes, and in other ways removing the possibilities of accidents. The estimate above is based on actual results obtained in one plant in the United States as stated by Mr. John Calder in a paper read before the American Society of Mechanical Engineers.

#### Causes of Accidents

The first thing necessary in order to prevent accidents as far as possible is to analyze the causes of accidents. Mr. Calder, in the paper previously referred to, states that in analyzing thousands of accidents with a view of devising remedies, he has found the following to be the chief causes: ignorance; carelessness; unsuitable clothing; inefficient lighting; dirty and obstructive work places; defects of machinery and structures; and the absence of safeguards.

#### Ignorance

In spite of ample facilities for the acquisition of some knowledge of mechanical principles, says Mr. Calder, he has found some superintendents, a number of foremen, many operators and not a few managing owners of smaller plants grossly ignorant of the possibilities for preventing accidents to themselves and others. Nothing but administrative vigilance in selecting employes and instructing them regarding their own special risks will prevent accidents due to ignorance.

### Carelessness

Carelessness, sometimes combined with ignorance, sometimes due to sheer thoughtlessness or folly, stands highest as a cause of industrial accidents. Little can be done to shield the worker and those whom he sometimes involves from the results of his own carelessness. Many a man takes foolish and wholly unnecessary chances with his life and limbs—chances which in no way add to his efficiency or his earnings. The maintenance of strict discipline in the shops and the elimination of the dangerous employe is all that can be done in addition to a campaign of education throughout the shop.

### Unsuitable Clothing

Accidents are sometimes caused by many machine parts which are necessarily exposed near the operator and with which he would never come into dangerous contact except for the use of unsuitable clothing. Ragged sleeve ends, loose ties, and open jackets have, again and again, been wound upon seemingly small parts in motion and inflicted frightful and sometimes fatal injuries. Not a few survivors have to thank the inferior strength of the usual overall for their escape.

### Inefficient Lighting

Inefficient lighting is the cause of numerous accidents. The maximum of accidents occur toward the close and beginning of each year, during the months of minimum daylight.

In shops, the intensity of artificial lighting at the cutting point of tools and over a limited area at the machine tool or bench is frequently far above actual requirements, while all around the operator a semi-darkness prevails which has a blinding effect, and is a source of danger. It has been found that the concentrated illumination, by means of shades, of ordinary 16-candlepower incandescent lamps at cutting tools in machines is often several times as intense as the ordinary daylight on the same parts. From the point of safety, the elimination of this excessive light on spots is required, and a more generally diffused light of less unit intensity should be substituted by the use of fewer but larger lamps, located to suit varying shop requirements, and reflecting from white walls and ceilings.

### Dirty and Obstructed Work Places

Dirty and obstructed work places are closely allied to defective illumination. It is the duty of the management of every shop to see that the cleaning of floors and passages and the removal of waste are systematically provided for. Sometimes this condition is due to the employe himself; sometimes it is due to attempts to save floor space, thereby crowding machines and workers together without due regard to their safety. Almost all mechanical operations can be conducted under pleasanter and safer conditions than at present, as far as light and cleanliness are concerned. Ample space should be provided around each machine for the movement of the operator and for the work. Economy of floor space can be carried too far.



## Defects of Machinery and Structures

Apart from the question of specific safeguarding provisions, machines or processes which are essentially dangerous because of defective design or arrangement, or from lack of repairs, are comparatively rare. It does not pay any employer to keep a defective tool in operation, nor is it in the interest of the employe to use imperfect apparatus. While defects of machinery contribute to some serious and a number of minor casualties, they do not do so to the extent commonly alleged.

## Absence of Safeguards

Absence of safeguards, although it is not the most prolific cause of accidents, closely concerns the mechanical engineer. In many cases of injuries to operators caused by the absence of a suitable safeguard, it will be found that it has been removed or rendered ineffective by the employe. In many cases some machines will be safeguarded in one part of the plant and not in another, due to the operation of the principle that what is permitted to be everybody's business is nobody's business. The provisions for safeguarding should, therefore, never be left to the initiative of a number of individuals in any one plant.

The machine tool builders have already accomplished a great deal in the way of useful safeguarding, particularly in guarding against the dangers of gears in metal-working machinery. Sometimes, however, so-called "guards" are encountered which are not guards at all but rather delusions, indicating that the designer had appearance rather than utility in mind. This is illustrated by such cases where gears are covered on the top, which may be the out-running and safe side, by semi-circular flanged hoods, whereas the intaking and dangerous parts of the gears are unprotected and likely to grip the clothes and fingers of unsuspecting operators.

Many designers seem to believe that anything which looks like a cover for a part of a machine constitutes an efficient safeguard, but this is not true if no regard is paid to the actual direction of rotation or to reversal of motion, or to the likelihood of the guard being left off permanently. The real points of danger in daily practice must be studied before a satisfactory protection can be provided. Shafts and spindles, low pulleys, belts, gears, narrow clearances between fixed and moving parts, couplings, projecting screws, nuts and pins, etc., are all best protected by the machine tool builder when designing the machine. It is important that the guards for machines are so designed and applied that there be no temptation for the workman to throw them aside as cumbersome. To educate the employe to use caution and foresight about dangerous machines is difficult enough, and it should not be rendered more so by making him work with an impractical safeguard. A careful inquiry into the conditions under which an employe has to work should be made and the safety devices should enable him to work with the same efficiency as without the safeguard. This point is often overlooked by designers and others responsible for the safeguarding of machinery.

When guarding equipment built in position, the manner of installation and the precise nature of the workman's duty around it must be taken into consideration. Protection against accident in power-generating machinery, for instance, is not secured, as is sometimes supposed, by merely guarding the dangerous moving parts. In power houses, for example, the edges of all stairs, platforms, ladders and gratings should have low fenders of metal on all sides so as to prevent nuts, bolts, tools and other small parts from rolling off into the machinery or striking the employes. In addition, a double metal railing not less than three feet high and not nearer than twelve inches to any moving part, should be provided at all dangerous places, such as crank and flywheel pits, and at the edges of all stairs and elevated platforms.

#### Interlocking Safety Devices

It will be apparent, however, that, even when safety devices are used, it is entirely possible for industrial accidents to occur if the workman is careless or uninterested. The highest principle in safety devices is that which in other departments of engineering is called the "interlocking" principle; that is, it may be made mechanically impossible for the operator, for example, to have his fingers in the danger zone and have the tool set in motion while his fingers are there. This principle is introduced by having the engaging device require a concurrent action of both hands, in order that the machine may function. In a press, for example, it may be arranged so that the belt has a tendency to pass to the loose pulley unless a counterweight attached to the shifter is held in a certain position by the right hand. When the right hand has gripped this one lever, it still requires that the left hand shall throw the clutch lever to make the machine operate. Obviously, the workman has no hand free to put in the path of the plunger of the press. The engagement may also be pneumatic, and require that two valves be opened, one with each hand.

#### Conclusion

In all industries the executive should reckon closely with the varying degree of responsibility which can be expected of young persons, men and women, respectively; no person under 16 years of age should be employed at or near machinery, and no one should be allowed to clean machinery while it is in motion. The installation of machinery in relation to walls, passages and adjacent tools and equipment should be given careful consideration. In any confined space through which any person is likely to pass and toward which the carriage of any self-acting, reciprocating machine runs out, there should be left a clear passageway of 18 inches between the extreme outward position of the carriage and the wall.

In conclusion, it should be said that safeguards should be constructed of metal to secure durability. Reinforced steel mesh work is preferable for all but the heaviest machinery, because it permits of easy inspection without detaching the safeguard. Warning and caution notices should be sparingly used and as brief as possible.

## CHAPTER II

### SAFETY DEVICES FOR MACHINE TOOLS

In the following chapter a number of simple guards and safety devices which can be applied to machine tools without incurring any great expense are illustrated. Most of these require but little description, and are intended merely to aid the designer by giving him an idea of the type of guard or device to be used. Obviously, the suggestions given may not apply directly to any specific case, but the principle involved can easily be adapted to the different requirements in individual shops. Figs. 1 to 5 show types of covers ordinarily

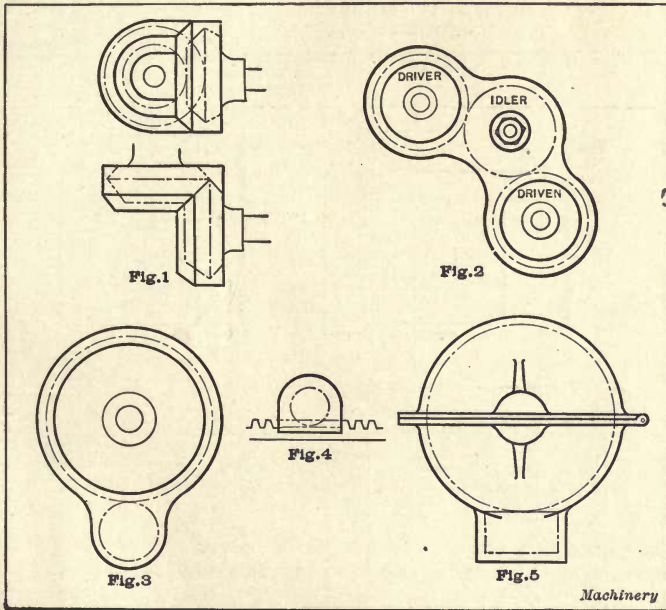
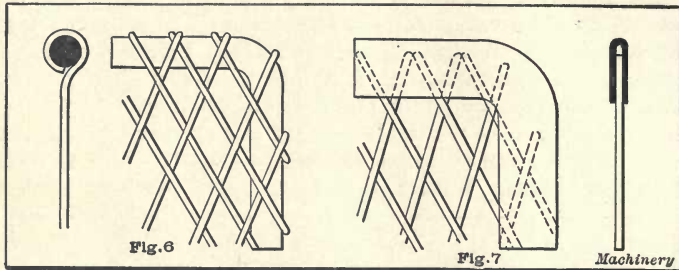

Fig. 1. Cover for Bevel Gears. Fig. 2. Cover for Train of Spur Gears.  
Fig. 3. Cover for Spur Gear and Pinion. Fig. 4. Cover for  
Rack and Pinion. Fig. 5. Cover for Worm-drive

applied to gearing. In general, the shape of the cover takes, as nearly as possible, the form of the outline of the gear. The method of supporting the cover will depend entirely on the circumstances. In Fig. 2, for example, the cover for the three gears shown is supported by the stud of the idler gear, as indicated.

The covers for gearing present the neatest appearance, and are undoubtedly strongest, when made of cast iron. In some cases, however, they would be too costly and massive if made of this material,

and then sheet-iron or wire-mesh guards can be used. Types of guards of this kind are shown in Figs. 6 to 11, inclusive. In the guard shown in Fig. 6, a strong wire frame is used for supporting the wire mesh. In Fig. 7 a sheet-iron frame is used as the support, being bent over the ends of the wires. In Fig. 8 a sheet-iron guard is used, reinforced by a strong wire frame. In Fig. 9 the reinforcement or stiffening of the sheet-iron plate is obtained by pressing a rib into the sheet iron. In Fig. 10 the reinforcement or stiffening of the sheet-iron plate is obtained by pressing a rib into the sheet iron. In



Figs. 6 and 7. Methods of Attaching Wire-mesh Guards to Frames

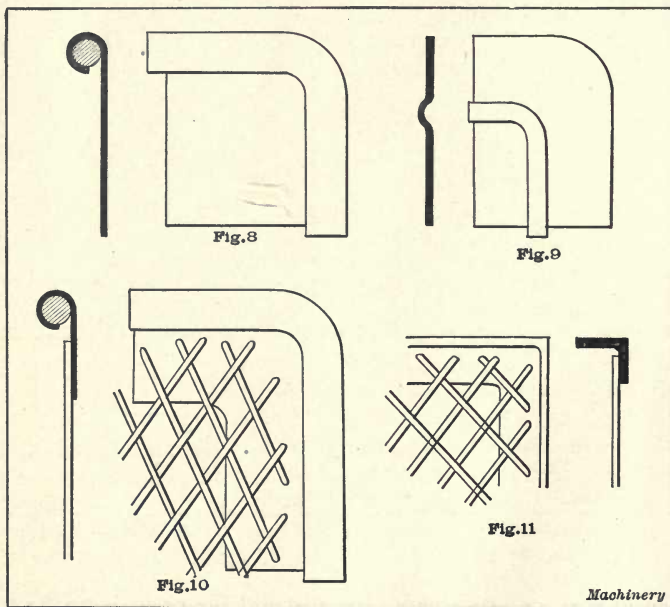

Figs. 8 to 11. Types of Sheet-steel and Wire-mesh Guards

Fig. 10 a sheet-steel frame is employed to which the wire mesh is attached, and this frame, in turn, is strengthened by a wire about which the sheet steel is coiled. In Fig. 11 is shown an angle-iron frame supporting the wire mesh.

Whenever it is possible to provide a door in covers over parts to which it is necessary to have access, this should be done. There are

various methods for applying doors to machine frames and covers. The simplest method of arranging a door is shown in Fig. 12. This door is opened by raising it by the handle sufficiently to permit it to open. The required amount of play is left at the hinges to compensate for this movement. In Fig. 13 is indicated a type of hinge cast in a spiral shape. This is known as the "rising hinge," and it always returns the door automatically to a closed position, thus preventing accidents which might occur by the door being left open.

As far as possible there should be no projections on the surface of covers, frames, etc. In the case of doors and covers, these should be as level and flush with the surrounding surface as possible. Safety

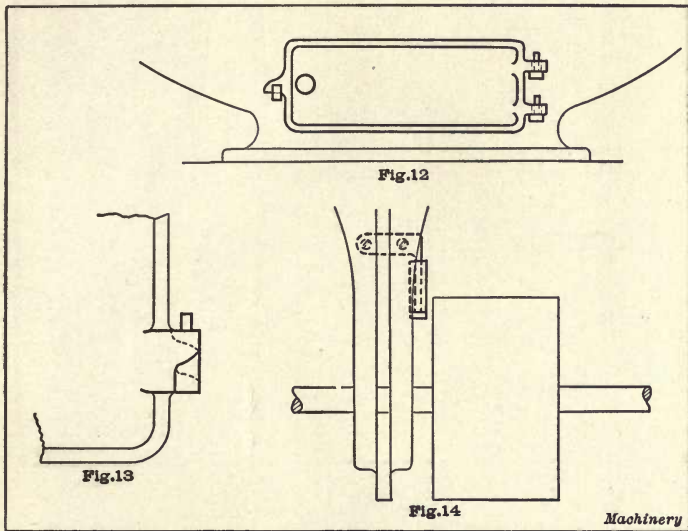

Fig. 12. Ordinary Type of Door used on Covers or Machinery Frames.

Fig. 13. "Rising Hinge" used for automatically closing Door.

Fig. 14. Guard for Preventing Belt from Slipping in between Pulley and Hanger

set-screws should be used wherever feasible. Rotating parts, such as chucks, that cannot conveniently be covered with a guard, should always be fitted with safety set-screws.

When tapping castings, the tap is likely to stick in the casting and force it to rotate, sometimes causing injury to the hands. An arrangement for preventing this is shown in Fig. 16. The device shown is an adjustable support. The two standards *A* support two arms *B* which are adjustable on the standards. The clamping device is made of two strips *C* and *D*, holding the casting while it is being tapped. These strips slide back and forth on arms *B*.

The device shown in Fig. 14 prevents the belt from slipping into the narrow space between the pulley and the hanger. This device consists simply of a bracket screwed to the hanger and carrying a guard which regulates the position of the belt. Wide belts running

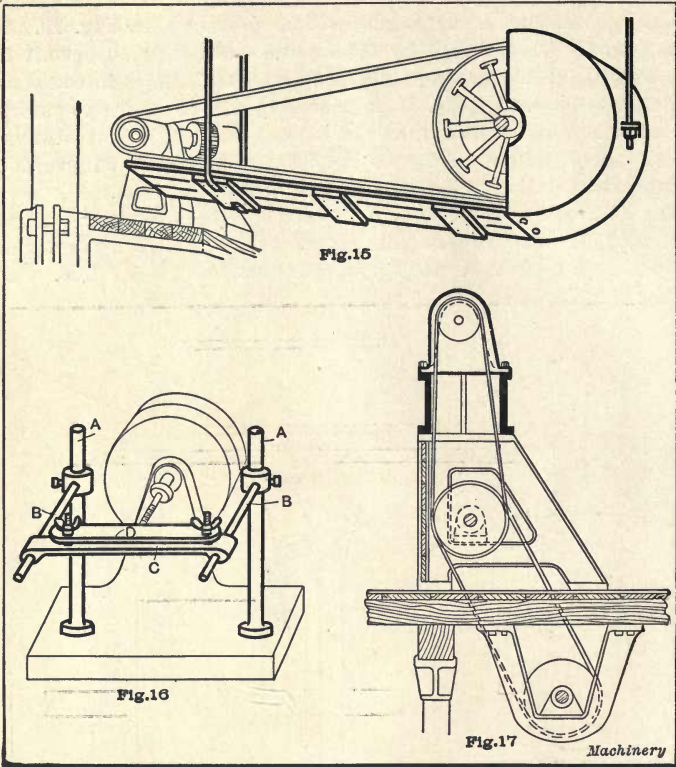

Fig. 15. Guard for Overhead Drive. Fig. 16. Preventing Rotation of Castings when Tapping. Fig. 17. Safe Method of Driving Polishing Heads

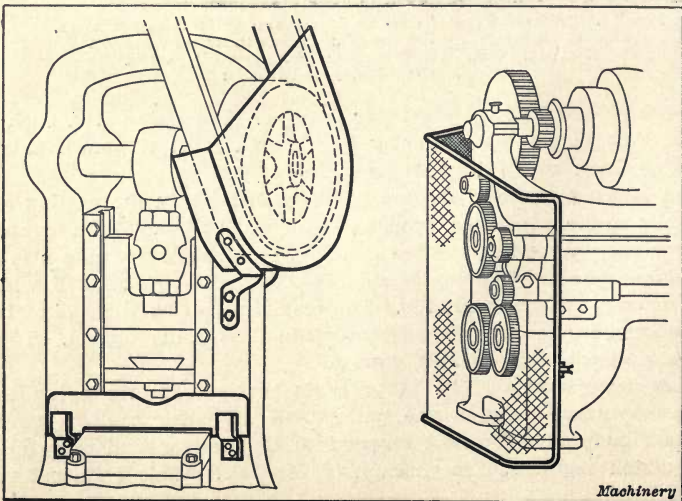

Fig. 18. Guards for Punch Press. Fig. 19. Guards for Change Gears

over machines are very dangerous. A cheap and effective guard is shown in Fig. 15. Here a sheet-steel cover is supported from the ceiling and encases the pulley, while a board guards the remainder of the drive as indicated. A safe and satisfactory system of driving polishing wheels from below is shown in Fig. 17. This is especially suitable where boys are employed. This drive obviates all belt risks, and at the same time permits the belts to be inspected much better than when the drive is overhead.

The following illustrations show some special machine-tool guards. The punch press undoubtedly is one of the most dangerous tools around the machine shop. It is very seldom efficiently guarded, al-

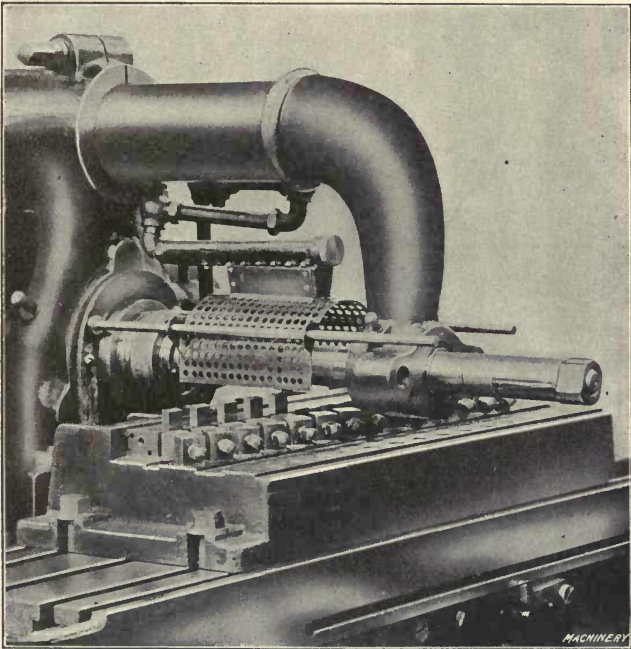

Fig. 20. Milling Cutter Guard

though many simple methods can be adopted. The guarding of the space between the punch and die is, of course, of prime importance. A couple of brackets screwed to the frame and supporting a sheet-iron plate with an aperture on the under side, large enough to push the stock through, is simple and yet very effective. A guard of this type is indicated in Fig. 18. Movable guards, such as plates with a horizontal reciprocating motion, timed to push the fingers away, or guards provided with a vertical motion and descending upon the hand previous to the cutting action, are also used. The flywheel and driving belt should also be guarded, as they have caused many accidents. A simple method of providing a cover for them is also indicated in Fig. 18.

In the case of change gearing on a lathe, cast-iron covers cannot always be used to advantage, but a guard made of wire mesh, as shown in Fig. 19, is very useful. The milling cutter guard shown in Fig. 20 was originally patented by Messrs. Alfred Herbert, Ltd., Coventry, England. It has been found quite satisfactory and has

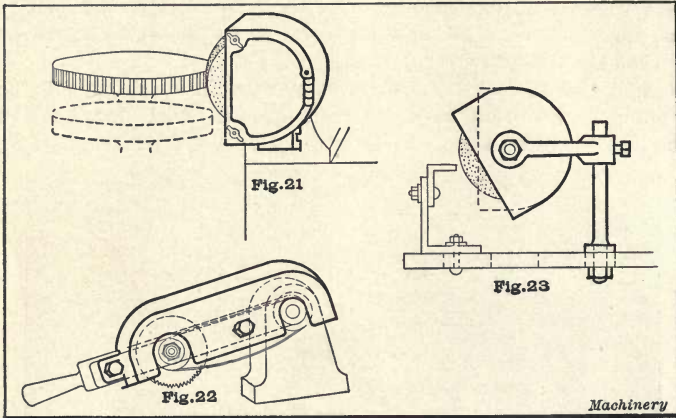
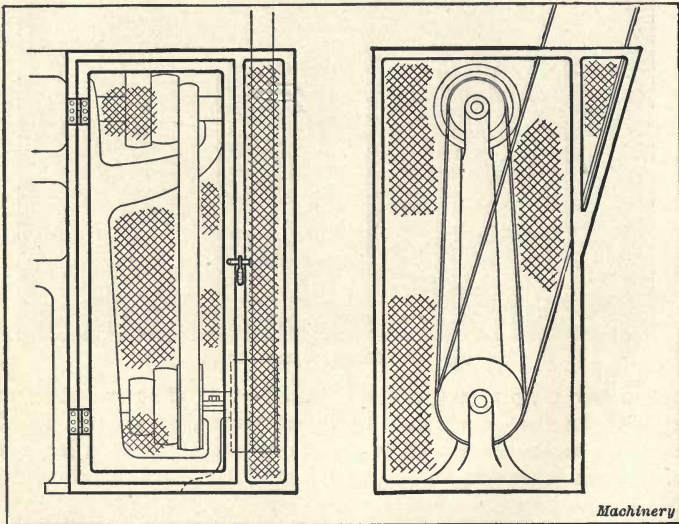

Fig. 21. Cover for Emery Wheel. Fig. 22. Cover for Cold Saw and Chain. Fig. 23. Adjustable Emery-wheel Cover



• Fig. 24. Guard for the Driving Pulleys of a Vertical Drilling Machine

been approved by the official inspectors of factories in Great Britain. The firm owning the patent has, however, withdrawn its rights, so that this guard can be freely used by the public. In Fig. 21 is shown an emery-wheel gear-tooth grinder provided with a cover. This cover has a loose side or door fastened by thumb-screws and hinges. In



this way the removal of old wheels and the mounting of new ones can be done without removing the guard proper.

A cover for a cold saw is shown in Fig. 22. The cover is screwed onto the handle which supports the saw, and thus prevents the handle from coming in contact with the saw or getting trapped in the chain. Covers for ordinary emery grinders are very numerous. One of the simplest types is shown in Fig. 23. This cover has the advantage of

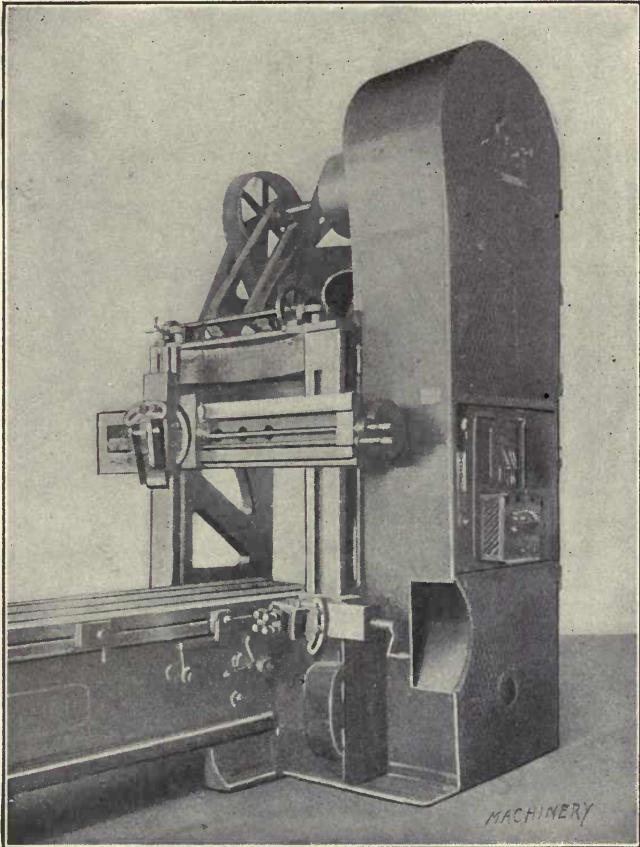

Fig. 25. Guard over Belting and Gears

being adjustable as regards its height and position. It is made of a steel stamping with a nut and bolt support.

Exposed driving pulleys and speed cones of a drilling machine are extremely dangerous, especially when a man has to work behind them or when they face toward a passage. In Fig. 24 is shown a method of encasing them with a cage having an angle-iron framing. A door is provided to facilitate the changing of speeds.

In Fig. 25 is illustrated a form of safeguarding against belt accidents, and, of course, the same principle can be extended to gears.

This guard is somewhat expensive, but very effective. A slippery floor or a loose end of a garment may be the cause of throwing a man into the path of the belt, and he may be seriously injured before the motion can be stopped.

The wood-working or pattern shop is a place where dangerous cutting edges are moving at high speed. These conditions make the circular saw, the jointer or buzz-planer, the molder or sticker, and the

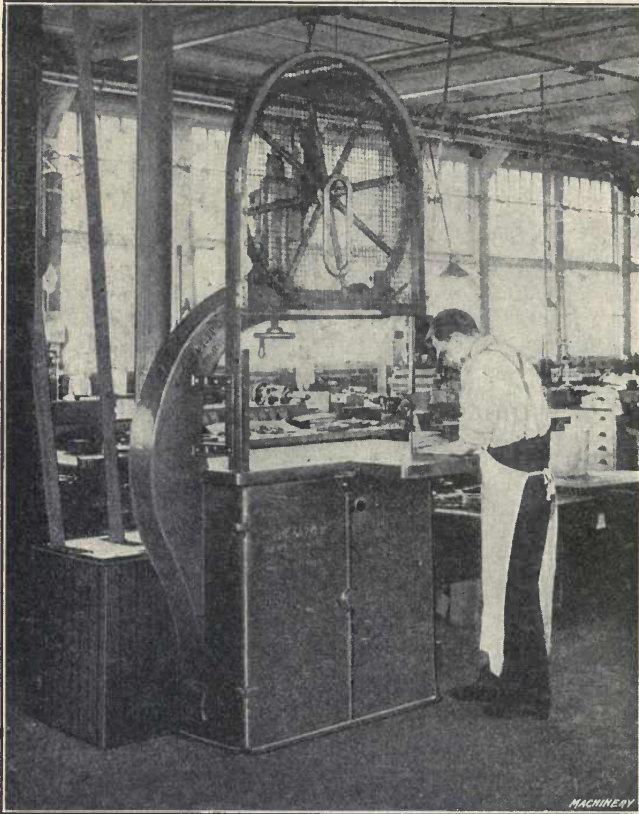

Fig. 26. Guards for a Band-saw

band-saw, sources of most distressing accidents, which seem almost worse by reason of their suddenness of attack without warning. Fig. 26 illustrates the trend of modern prevention of accidents of this kind. The lower part of the band-saw is completely encased, and the upper wheel covered with a guard. The accident from the breakage of the saw, and the danger to the forehead of the workman are practically eliminated. He can still, however, lose a finger in the danger zone of the tool. Improved designs of cutter-heads for planers have greatly reduced the dangerous character of the accidents which happen about it, and many forms of guards for the circular saw have been applied.

The lathe, working on small diameters, or with work in its chuck or on its faceplate, is particularly liable to entangle the sleeve of the workman and break or lacerate his arm. In Figs. 27 and 28 are shown two suggestions for safeguarding the man. The drum A in Fig. 27 should keep his clothing from the projecting points of the chuck or faceplate, while Fig. 28 shows how the common dog can be prevented from his vicious biting.

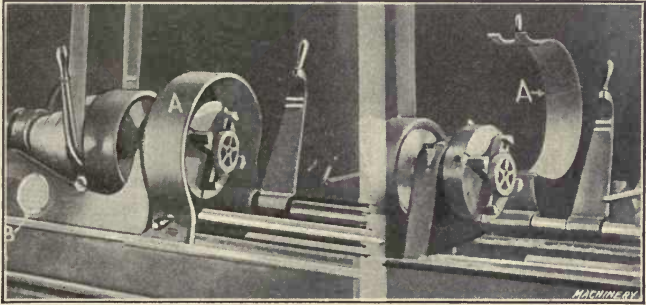

Fig. 27. Guard for the Lathe over Faceplate or Chucks

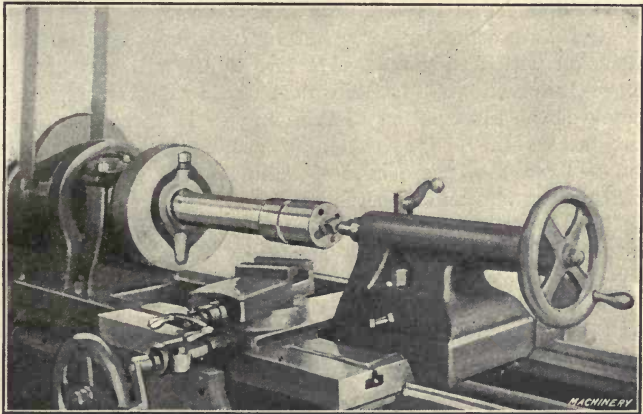

Fig. 28. Lathe Dog Guard

Accidents in the shop do not originate alone in the danger zone of a power driven tool. The process of chipping often sends a flying particle with considerable force over quite a distance, and the delicate tissues of the eye can easily be pierced by such a barbed missile. A simple form of safeguard should be provided; a screen of burlap is stretched upon a light frame in the path of such steel particles. The fibrous character of the screen catches what is thrust against it, and the particles drop harmlessly to the ground.

## CHAPTER III

### SAFETY GUARDS FOR GRINDING WHEELS

All rapidly moving machine members present possibilities for the occurrence of serious accidents, and in view of the fact that it is necessary to operate grinding wheels at such speeds that the cutting surface travels at about a mile a minute, more than usual precautions must be observed in their operation in order to provide for the safety of the operators. These precautions may be sub-divided under two headings; first, to eliminate as far as possible, all causes which are known to have been responsible for grinding wheel breakages; second, to provide adequate means of protection for men and property in event of a wheel breaking. Reputable manufacturers of grinding wheels test each wheel before it is shipped. This is done by rotating the wheel at a speed which subjects it to between three and four times the centrifugal force that would be exerted when operating under average conditions. The wheel is then marked by the inspector to show that he has found its condition satisfactory.

The design and condition of grinding machines as well as the foundations on which they rest, says Mr. R. G. Williams in a paper read before the National Machine Tool Builders' Association, from which much of the information in this chapter is abstracted, are very important factors in the prevention of accidents, as such accidents can often be traced to these causes. The modern grinding machine with its heavy spindle and massive base, and its long closely adjusted bearings, is responsible for the elimination of many accidents which would otherwise occur. Grinding machines should be kept in good condition and they should be mounted on a rigid foundation. Machines used for rough work, such as snagging castings, are frequently subjected to severe abuse and it is significant that statistics show that the majority of grinding accidents occur in foundries, where such conditions exist.

A somewhat unusual cause of breakage of grinding wheels is that resulting from undue heating of the wheel. In such cases this is usually due to the wheel becoming glazed so that excessive pressure is necessary to maintain the desired rate of production. Where this condition exists, the wheel is unduly heated at its periphery and this leads to uneven expansion, resulting in rupture. This danger is eliminated by keeping the wheel properly dressed at all times. Another source of danger arises from the possibility of damaging wheels used in snagging castings. Where the casting is suspended by a chain hoist, the operator may allow the casting to strike the side of the wheel with sufficient force to either break it directly or weaken it so that it will break later on. In the following are given the main causes of grinding wheel accidents.

## Causes of Grinding Wheel Accidents

1. The wheel receives a blow from the side.
2. The work-rest is improperly adjusted.
3. The wheel is unduly heated by forcing the work excessively.
4. The operator is careless in handling heavy work, thus causing the wheel to be damaged.
5. The wheel is mounted between flanges of unequal size.
6. The flanges have an uneven bearing against the wheel.
7. The wheel is running out of truth.
8. The inside flange is loose on the spindle.
9. The spindle is too tight a fit in the hole in the wheel.
10. The flanges are not provided with the necessary relief to assure an even bearing.
11. The nut on the spindle is tightened excessively.
12. The washers are either too small or omitted.
13. The spindle and spindle bearings become overheated.
14. The wheel is run at too high a speed.
15. The wheel is mounted in such a way that the nut on the spindle works loose.

## Methods of Avoiding Grinding Wheel Accidents

1. The use of protection hoods or safety flanges to provide for the safety of the operator in the event of the wheel breaking.
2. The use of wheels which have been subjected to a speed test by the grinding wheel manufacturer to discover any defects which may exist.
3. Testing each wheel before it is mounted on the grinding machine ready for use.
4. The use of machines of the necessary rigidity and the mounting of such machines on rigid foundations.
5. The exercise of the necessary supervision on the part of the superintendent or foreman to be sure that none but wheels of the proper size are used on each machine, and that these wheels are driven at suitable speeds.
6. The use of goggles and spark shields to protect the eyes of the operators from injury.

## Hoods or Guards for Emery Wheels

The danger from emery wheels is from the bursting of the wheel, either by the pressure of the work at the periphery of the wheel, or, more rarely, simply from the action of the centrifugal force. A safeguard against these accidents can be secured by the use of large disks or washers which grip the wheel at a considerable distance from the revolving axis. If, further, the wheel is thicker at the center than where the washers bear, the danger from flying parts of a broken wheel is materially lessened. Furthermore, the wheel can be covered, except just at the working sector, by a steel or cast-iron guard strong enough to keep in any fragments of the wheel if it should burst.

Figs. 1 to 5 show various forms of guards or armors, successfully used for retaining fractured wheels on grinders. The guard in Fig. 2

has hinged sides of plate steel and a strong cast-steel front guard, also hinged. The guard as a whole can slide parallel to the plane of the wheel for taking care of reduced wheel diameters. The hinged front guard can be dropped to meet the same condition. Wheels have been tested to destruction with all of the guards shown, without wheel fragments being thrown around.

Fig. 6 shows a safeguarded emery wheel with the belt protected within a steel shield, and the eyes of the workman shielded by screens either of glass or of fine wire mesh. If exhaust currents of sufficient strength to overcome the centrifugal tendency of abraded particles are led away from the wheel, the respiratory tract of the workman

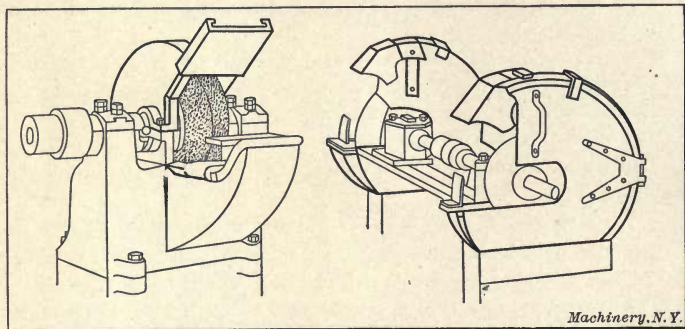

Figs. 1 and 2. Effective Guards for Grinding Wheels

is saved from the slow deterioration which it would otherwise suffer. No one should ever be required to work at a dry polishing lathe or emery grinder which is not provided with dusthoods and efficient suction for preventing the dust from filling the room. The dangers due to breathing the impure air in a grinding room not provided with an efficient suction system are greater, in many respects, than those due to smaller accidents from which the victim may soon recover. A man may never recover from the injuries caused by the grinding dust constantly entering his lungs.

#### Mounting Emery Wheels

The observation of suitable precautions in mounting the wheels is a most important factor in preventing them from breaking. Fig. 7 illustrates an example of dangerous mounting. The outside flange was lost and the operator substituted a small washer in its place. This produces such a severe strain on the wheel that it either breaks immediately upon attaining the operating speed or soon after it is put to use. Fig. 8 shows how an accident was caused in a factory in the Middle West. The operator had a piece to grind that was of such a shape that the outside flange on the wheel interfered with the work. Without obtaining permission from anyone, he removed the nut and the outside flange, and then obtained a rough forged washer into which—for some unknown reason—he was very careful to hammer a lead bushing from an old grinding wheel. He then

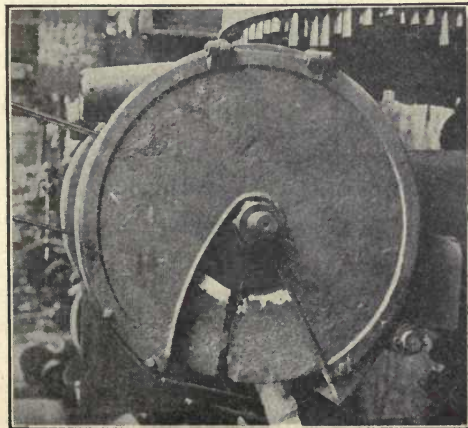

Fig. 3. An Efficient Type of Protection Hood used by the International Harvester Co.

mounted the wheel as shown. The man lost his life from the breakage which resulted when he attempted to work with the wheel in this condition.

In order to avoid accidents resulting from broken wheels, be sure that the flanges used are of equal size and that their diameter equals at least one-half of the diameter of the wheel. It is also highly important for the flanges to have an even bearing on the wheel. Where the bearing is uneven, it is usually caused by the flanges being damaged

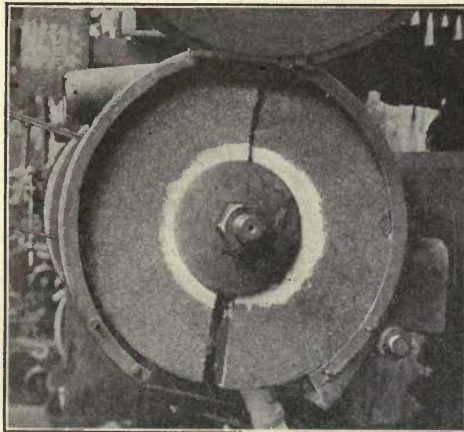

Fig. 4. Same Type of Hood shown in Fig. 3, with End Cover swung back

to such an extent that they lose their original shape. In rare instances, flanges have been used which were not machined, but were taken right from the casting in the sand. Such practice brings unequal stresses to bear on the wheel and a breakage is the logical result. The wheel must also run true, in order to avoid subjecting it to uneven strains. When it does not run true, it may be due to the hole in the wheel being much too large for the size of spindle, or to the fact that the flanges do not hold the wheel properly. This,

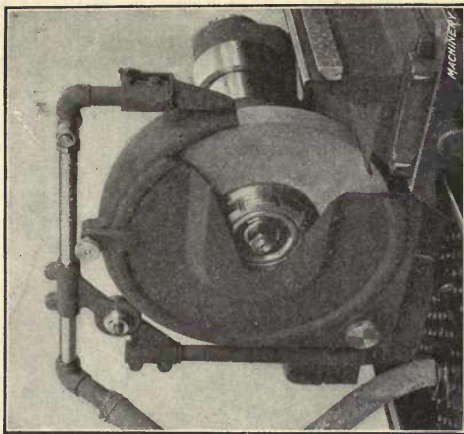

Fig. 5. Type of Protection Hood applied to Norton Grinding Machines

in turn, may be caused by the nut becoming wedged on the spindle before it has been drawn up to the flanges, due either to dirt in the thread of the spindle or in the thread of the nut. The man mounting the wheel gets the impression that he has properly drawn up the flanges against the wheel, when such is not the case. Another cause for wheels running out of true is directly traceable to failure to give proper attention to the machine bearings. The bearings become highly heated, the bearing metal flows, a heavy brake action is produced on the spindle, and when the machine is stopped the momentum of the grinding wheel is sufficient to loosen the mounting. When the

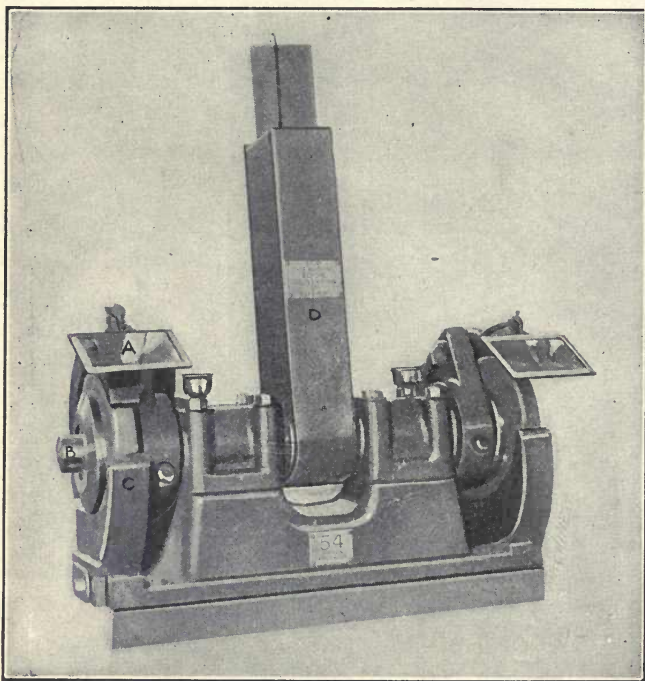

Fig. 6. Emery-wheel Head Effectively Guarded

wheel is started again the nut will not automatically tighten.

Wheels should not be allowed to remain partly submerged in water, because they will be badly out of balance when started. Some people seem to believe that water has a detrimental effect on grinding wheels. This is not true of modern grinding wheels; even those bonded by means of silicate bonds are made waterproof. Another noteworthy precaution is to have the inside flange either keyed or pressed on the spindle. Accidents have been known to result from the work being rubbed against a loose inside flange, thus exerting a brake action on the flange, which, in turn, caused the nut on the spindle to crawl. In this way, enough pressure was exerted on the wheel by the flanges to crush it.



An accident may result by having the wheel screwed on the spindle when the hole is too tight a fit. The illustration Fig. 9 shows the result when the hole is too small for the spindle. The lead bushing becomes deformed by the wheel being screwed on over the spindle, with the result that each flange only bears on the wheel for a short distance. The remedy for this is to make sure that the hole is of such size that the wheel will slide on the spindle easily. Fig. 10 shows a possible result from the use of unrelieved flanges. As an illustration, consider an instance where the operator exerts excessive pressure on the nut when mounting the wheel. This causes straight flanges to become slightly convex, as shown in the illustration, and con-

TABLE OF SMALLEST SPINDLES FOR VARIOUS SIZES OF GRINDING WHEELS

Diameter of Wheel	Maximum Thickness of Grinding Wheels in Inches													
	1	1 $\frac{1}{4}$	1 $\frac{1}{2}$	1 $\frac{3}{4}$	2	2 $\frac{1}{4}$	2 $\frac{1}{2}$	3	3 $\frac{1}{2}$	4	4 $\frac{1}{4}$	5	5 $\frac{1}{2}$	6
8	$\frac{3}{4}$	$\frac{3}{4}$	$\frac{3}{4}$	$\frac{3}{4}$	$\frac{3}{4}$	$\frac{3}{4}$	1	1	1	1	1 $\frac{1}{4}$	1 $\frac{1}{4}$	1 $\frac{1}{4}$	1 $\frac{1}{4}$
9	$\frac{3}{4}$	$\frac{3}{4}$	$\frac{3}{4}$	$\frac{3}{4}$	1	1	1	1	1	1 $\frac{1}{4}$	1 $\frac{1}{4}$	1 $\frac{1}{4}$	1 $\frac{1}{4}$	1 $\frac{1}{4}$
10	$\frac{3}{4}$	$\frac{3}{4}$	$\frac{3}{4}$	1	1	1	1	1	1 $\frac{1}{4}$	1 $\frac{1}{4}$	1 $\frac{1}{4}$	1 $\frac{1}{4}$	1 $\frac{1}{4}$	1 $\frac{1}{4}$
12	1	1	1	1	1	1 $\frac{1}{4}$	1 $\frac{1}{4}$	1 $\frac{1}{4}$	1 $\frac{1}{4}$	1 $\frac{1}{4}$	1 $\frac{1}{4}$	1 $\frac{1}{4}$	1 $\frac{1}{4}$	1 $\frac{1}{4}$
14	1	1	1	1 $\frac{1}{4}$	1 $\frac{1}{4}$	1 $\frac{1}{4}$	1 $\frac{1}{4}$	1 $\frac{1}{4}$	1 $\frac{1}{4}$	1 $\frac{1}{4}$	1 $\frac{1}{4}$	1 $\frac{1}{4}$	1 $\frac{1}{4}$	1 $\frac{1}{4}$
16	1	1 $\frac{1}{4}$	1 $\frac{1}{4}$	1 $\frac{1}{4}$	1 $\frac{1}{4}$	1 $\frac{1}{4}$	1 $\frac{1}{4}$	1 $\frac{1}{4}$	1 $\frac{1}{4}$	1 $\frac{1}{4}$	1 $\frac{1}{4}$	1 $\frac{1}{4}$	1 $\frac{1}{4}$	1 $\frac{1}{4}$
18	1 $\frac{1}{4}$	1 $\frac{1}{4}$	1 $\frac{1}{4}$	1 $\frac{1}{4}$	1 $\frac{1}{4}$	1 $\frac{1}{4}$	1 $\frac{1}{4}$	1 $\frac{1}{4}$	1 $\frac{1}{4}$	1 $\frac{1}{4}$	1 $\frac{1}{4}$	1 $\frac{1}{4}$	1 $\frac{1}{4}$	1 $\frac{1}{4}$
20	1 $\frac{1}{4}$	1 $\frac{1}{4}$	1 $\frac{1}{4}$	1 $\frac{1}{4}$	1 $\frac{1}{4}$	1 $\frac{1}{4}$	1 $\frac{1}{4}$	1 $\frac{1}{4}$	1 $\frac{1}{4}$	1 $\frac{1}{4}$	1 $\frac{1}{4}$	1 $\frac{1}{4}$	1 $\frac{1}{4}$	1 $\frac{1}{4}$
22	1 $\frac{1}{4}$	1 $\frac{1}{4}$	1 $\frac{1}{4}$	1 $\frac{1}{4}$	1 $\frac{1}{4}$	1 $\frac{1}{4}$	1 $\frac{1}{4}$	1 $\frac{1}{4}$	1 $\frac{1}{4}$	1 $\frac{1}{4}$	1 $\frac{1}{4}$	1 $\frac{1}{4}$	1 $\frac{1}{4}$	1 $\frac{1}{4}$
24	1 $\frac{1}{4}$	1 $\frac{1}{4}$	1 $\frac{1}{4}$	1 $\frac{1}{4}$	1 $\frac{1}{4}$	1 $\frac{1}{4}$	1 $\frac{1}{4}$	1 $\frac{1}{4}$	1 $\frac{1}{4}$	1 $\frac{1}{4}$	1 $\frac{1}{4}$	1 $\frac{1}{4}$	1 $\frac{1}{4}$	1 $\frac{1}{4}$
26	..	..	1 $\frac{1}{4}$	1 $\frac{1}{4}$	1 $\frac{1}{4}$	1 $\frac{1}{4}$	1 $\frac{1}{4}$	1 $\frac{1}{4}$	1 $\frac{1}{4}$	1 $\frac{1}{4}$	1 $\frac{1}{4}$	1 $\frac{1}{4}$	1 $\frac{1}{4}$	1 $\frac{1}{4}$
28	..	..	1 $\frac{1}{4}$	1 $\frac{1}{4}$	1 $\frac{1}{4}$	1 $\frac{1}{4}$	1 $\frac{1}{4}$	1 $\frac{1}{4}$	1 $\frac{1}{4}$	1 $\frac{1}{4}$	1 $\frac{1}{4}$	1 $\frac{1}{4}$	1 $\frac{1}{4}$	1 $\frac{1}{4}$
30	..	..	1 $\frac{1}{4}$	1 $\frac{1}{4}$	1 $\frac{1}{4}$	1 $\frac{1}{4}$	1 $\frac{1}{4}$	1 $\frac{1}{4}$	1 $\frac{1}{4}$	1 $\frac{1}{4}$	1 $\frac{1}{4}$	1 $\frac{1}{4}$	1 $\frac{1}{4}$	1 $\frac{1}{4}$
32	..	..	1 $\frac{1}{4}$	1 $\frac{1}{4}$	1 $\frac{1}{4}$	1 $\frac{1}{4}$	1 $\frac{1}{4}$	1 $\frac{1}{4}$	1 $\frac{1}{4}$	1 $\frac{1}{4}$	1 $\frac{1}{4}$	1 $\frac{1}{4}$	1 $\frac{1}{4}$	1 $\frac{1}{4}$
34	..	..	1 $\frac{1}{4}$	1 $\frac{1}{4}$	1 $\frac{1}{4}$	1 $\frac{1}{4}$	1 $\frac{1}{4}$	1 $\frac{1}{4}$	1 $\frac{1}{4}$	1 $\frac{1}{4}$	1 $\frac{1}{4}$	1 $\frac{1}{4}$	1 $\frac{1}{4}$	1 $\frac{1}{4}$
36	..	..	1 $\frac{1}{4}$	1 $\frac{1}{4}$	1 $\frac{1}{4}$	1 $\frac{1}{4}$	1 $\frac{1}{4}$	1 $\frac{1}{4}$	1 $\frac{1}{4}$	1 $\frac{1}{4}$	1 $\frac{1}{4}$	1 $\frac{1}{4}$	1 $\frac{1}{4}$	1 $\frac{1}{4}$

centrates the retaining pressure near the center of the wheel instead of distributing it uniformly throughout the area of the flanges. The remedy for such a situation is to have the flanges—either straight or beveled—relieved to such an extent that a bearing surface approximately 1/16 of the diameter of the flanges is left near the rim. By the excessive tightening of the nut, sufficient pressure can be set up between the wheel and the flanges to crush the structure of the wheel. It has been calculated that where the size of the spindle is 1 $\frac{1}{2}$  inch in diameter, a man with a four-foot wrench can exert a pressure between the wheel and the flanges of over a ton and a half. The nut should not be tightened more than enough to hold the wheel firmly.

Washers of blotting paper or some other compressible material should be used between the wheel and the flanges. These tend to distribute the stresses set up when the flanges are tightened against the sides of the wheel. The washers should be somewhat larger than the flanges. It is possible for a small piece of metal to become caught in some way between the wheel and the flanges, which, if no com-

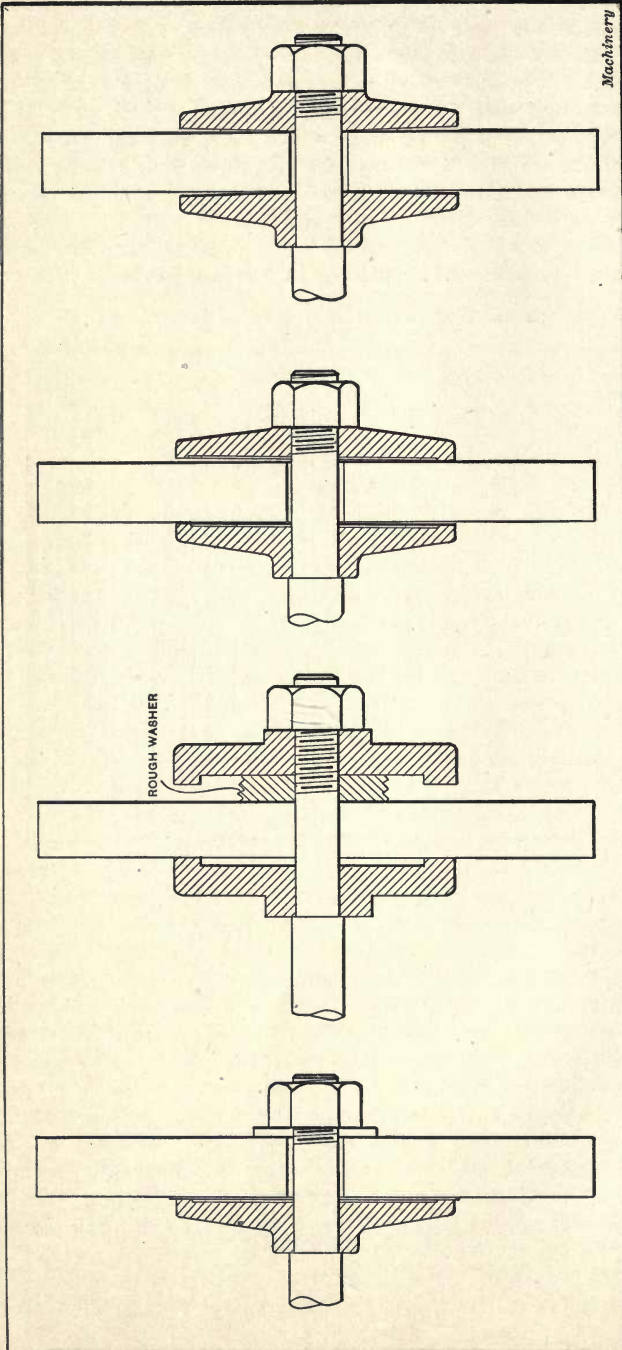

Fig. 7

pressible washer is used, will cause an excessive strain to be set up at this particular point when the flanges are tightened. The use of compressible washers in such an in-

Fig. 8

stance tends to distribute the unequal stresses. When the spindle becomes overheated, the heat is conducted to the lead bushing of the wheel, which may expand to a

Fig. 9

Fig. 10

point where it causes the wheel to break. This danger can be readily overcome by proper attention to the bearings of the machine. Another possibility of accidents is due to the fact that a careless workman may so equip the machine that the revolutions per minute of the spindle are far too great for the particular size of wheel in use; or it may possibly be that through a foreman's desire to increase production, he speeds up the wheels so that they will cut faster. Again, where a machine is equipped with cone pulleys and the belt is loose, it is possible for the belt to automatically shift to a smaller step and thus greatly increase the speed of the grinding wheel. Sometimes ignorant workmen will mount large wheels on a machine which is equipped and intended for very much smaller ones, thus creating a dangerous condition.

Polishing stands are sometimes used for rough snagging work, with wheels which are much too heavy for this type of machine. Bench and floor types of grinding machines are usually designated by the size of the spindle on which the wheel is mounted. It is, therefore, a common practice to designate the maximum size wheel to be used on any machine by tabulating spindle sizes and wheel sizes, as presented in the table, page 21. Accidents may be caused by mounting a wheel so that the nut works loose, which will cause the wheel to run badly out of true. This can happen in three ways: 1. A machine is taken apart for repair and when set up the spindle is turned end for end from its original position. 2. The motor or shafting which drives the machine is changed so that it will revolve in the opposite direction from which it should. 3. When putting on a new belt, an unreliable workman may use a twisted instead of a straight belt. All of these conditions can be very easily remedied by a little care on the part of some responsible person. In addition, belt locking devices may be used, and so set in the base of the machine as to make it impossible to mount too large a wheel. To further guard against such mistakes it is good practice to have a special notice attached to each machine giving information as to the size of the wheel to be used, the number of revolutions per minute at which the wheel should be run and the class of work for which it should be used.

Laws in almost every country require the removal of dust from grinding. This necessitates the use of a hood, and if a hood must be used, it might just as well be strong enough to offer protection in case of the wheel breaking. A proper hood affords complete protection, which flanges cannot give; but in instances where a hood would interfere with the proper use of the wheel, flanges offer the next best method of protection. There are many satisfactory types of protection hoods on the market, the reason for more than one type being found in the variety of grinding operations.

#### The Use of Goggles

There are several satisfactory designs of goggles for grinding, and every operator doing snagging work should be required to wear them.

Since the particles cut off by grinding wheels are comparatively small, a heavy type of goggle is not necessary. Goggles should have side guards of wire or leather, as particles coming from the side have been known to enter the eye. A glass spark shield which can be attached to the top of a protection hood is found very satisfactory where wheels are used intermittently, as in the case of a general purpose wheel in a machine shop. It is recommended that wire glass be used. Glass spark shields have not been found entirely satisfactory where wheels are used continuously, however, due to the fact that the glass soon becomes pitted from the heated chips of metal. Another form of protection from grinding wheel sparks is a device consisting of a piece of leather attached to the top end of a protection hood and extending down over the face of the wheel, a slot being cut in the leather of the approximate width of the grinding wheel.

#### Dressers

Grinding wheel dressers are sometimes the cause of accidents. If the work-rest is not properly adjusted there is a possibility of the dresser being caught between it and the wheel, and the revolving cutters sometimes break into pieces large enough to cause serious damage. A type of dresser is recommended which has a hood as an integral part of the handle, the hood serving to protect the user in case the cutters break. The ordinary type of dresser can be made more safe by attaching a thick guard of sheet iron over the cutters.

## CHAPTER IV

### SAFEGUARDS FOR POWER PRESSES

In discussing the subjects of safeguards for power presses all machines will be considered on which punching, embossing and stamping is done, both in the large and small sizes. There are two classes of power presses: first, those in which the piece is fed mechanically, by automatic feeding devices, under the descending ram; and second, those which must have the metal placed in position by hand. Very few accidents happen to employes operating presses of the former class; but in the case of the latter, a large number of operators have had their fingers crushed or sheared off by the descending ram.

There are two means of throwing the clutch into mesh to cause the ram to descend: first, by the operator pressing his foot on a treadle; second, by the operator moving a lever with one or both of his hands. To prevent power press accidents, the hands of the operator should be kept from under the ram when it descends by means of safeguards put on the machines for this purpose. There are four methods by which this can be done. First: by having a guard which pushes the hand away before the ram descends. Second: by

having a device which prevents the clutch being thrown, locking the ram in its upper position while the operator's hands are under the ram but releasing it when the hands are removed. Third: by having a guard entirely surrounding the danger zone. Fourth: by requiring both hands to be used to operate the machine. The machines which are operated by the foot will require guards of the first, second or third classes, as the hands will be free to get in the way of the descending ram. A machine so designed as to require the use of both hands to operate it is a safety device in itself; but if only one hand is required, then it would be advisable to adopt one of the other three methods.

#### Foot Operated Machines

To prevent the occurrence of accidents, it is essential that the persons who operate power presses should not have their minds diverted from the work in hand. The continual working of the foot treadle by the operators and the feeding of pieces with the hands soon becomes second nature. The result is that they acquire a certain automatic movement which is likely to prove disastrous, should a mental disturbance be caused by a sudden noise or movement in the vicinity of the operators, or a desire on their part to look around at something happening near them. It might be safely said that practically all power press accidents occurring on this type of machines, in which the operator has one or more fingers crushed, are due to his mind being diverted for the instant, causing him to forget to take the fingers away from the point of danger before the treadle is depressed and the ram descends.

In operating these machines, the ram should be allowed to come to a full stop in its upper position before the treadle is depressed again. In piece work it often happens that the operators do not take time to allow this to be done; and to remedy this condition, several of the press makers have a device by which the clutch lever detaches itself from the treadle action each time the latter is depressed, by means of a cam upon the main shaft which, itself, performs the stopping action of the clutch. Accidents are sometimes caused by the clutch getting out of order or by the flywheel seizing, due to improper lubrication, thus causing the ram to descend when it is least expected. Where small objects are required to be formed or repunched, necessitating placing them between the dies, they should be inserted and removed with a stick of pine wood instead of with the fingers.

It sometimes happens that an operator places a piece in the die in the wrong position, and then at the moment of depressing the treadle with the foot he discovers his mistake. An accident will occur if he attempts to remedy the mistake with his hands at the moment of discovery. This is not an unusual thing to occur in a machine shop. If the fingers are required to be under the ram while doing repair work or in changing the dies on the machine, a block of wood or metal should be placed in such a manner that the ram will be unable to descend if the treadle is depressed accidentally. The same

thing should be done in case the clutch gets out of order or the flywheel seizes. The gears on the front of the presses should be enclosed with metal guards and the belting should also be covered. These guards are especially needed on machines which are operated by women, in which case there is a possibility of their hair being caught.

#### Push Guards

The guards in this class push the hand of the operator away from the danger zone before the clutch engages the flywheel and causes

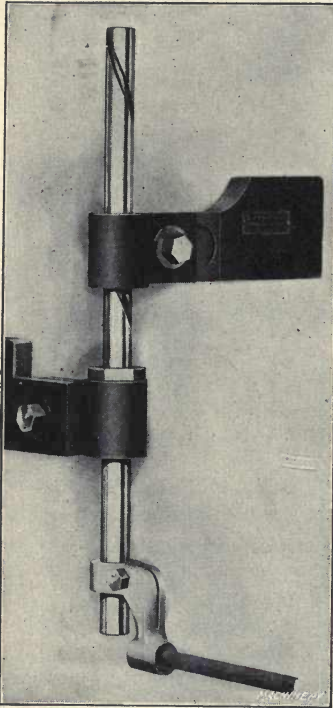

Fig. 1. Hemphill "Push Guard"

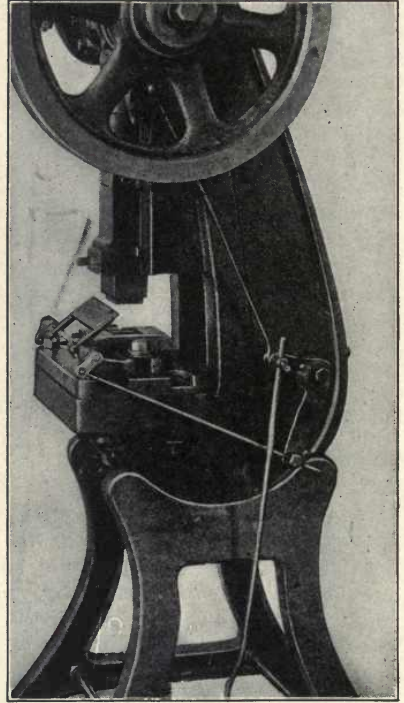

Fig. 2. H. & A. Lock "Push Guard"

the ram to descend. One of the first of this type of guards to be put on the market is that shown in Fig. 1, which is made by A. J. Hemphill & Co., 11 Broadway, New York City. From the illustration it will be seen that the hands of the operator are forced away from the danger zone by a radial arm, which swings across the face of the lower die as the ram is descending. This arm is actuated by means of a nut which fits in a helical groove in the upright at the left-hand side of the machine (see also Figs. 13 and 14). Another guard which belongs to this class but which works on a somewhat different principle is that illustrated in Fig. 2. This guard is made by the H. & A. Lock Co., 156 Fifty-third St., Brooklyn, N. Y. It consists of a metal plate which lies flat on the bed plate of the press

when the ram is in its upper position, but which swings outward and upward toward the operator by means of a bell-crank operated by the treadle, throwing his hand away from danger before the clutch becomes engaged.

#### Lock Guards

In this class belong those guards which so lock the clutch that the treadle will not operate the machine until the fingers are removed from the danger zone. In Fig. 3 is illustrated a safeguard which is in use in a large number of factories in the United States. It is a product of the Lockhart Hodge Co., 12 Waverly St., Buffalo, N. Y. As the foot of the operator depresses the treadle of a machine equipped

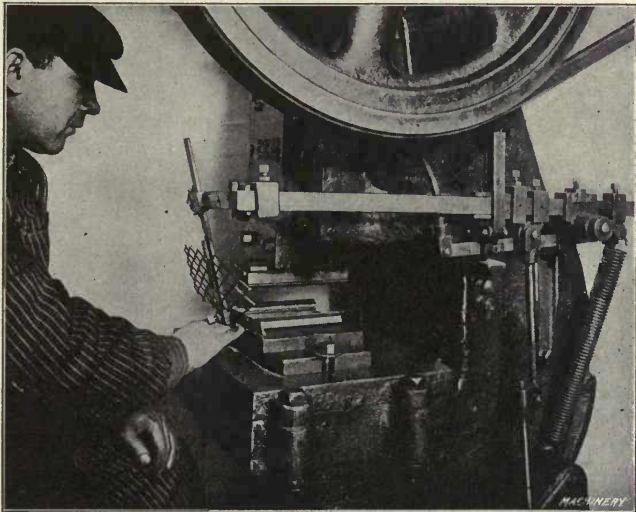

Fig. 3. A Safeguard of the "Lock" Type

with this guard, a long lever swinging on a pivot is drawn down and carries with it the gate that descends in front of the dies. This gate drops almost to its lowest point before it reaches the bottom of the yoke, and it is only when the bottom of this yoke has been reached that a downward movement is communicated to the rod leading to the latch which sets the press in motion. From this it will be seen that the gate must be flush with the bed plate before the latch will operate to set the machine in motion. Therefore, should a person's fingers be under the gate at the time he depresses the treadle, the machine will not operate until such time as he withdraws them. Means are provided in connection with this guard to prevent the gate from rising until the press is again at rest. Other guards of a similar type are shown in Figs. 7, 8 and 9, and will be described later.

One of the simplest and at the same time a very effective guard of the lock type is illustrated in Fig. 4. It consists of a free swinging rod of wood or other light material which is suspended across the

front of the machine. In the operating position it hangs straight, but should the employe put his hand in the danger zone the rod will be swung forward by contact with his arms, causing a second rod attached to it to lock the trip. The wooden rod is attached to a bracket on the machine and can be removed or replaced at will. The Corbin Cabinet Lock Co., New Britain, Conn., is the manufacturer.

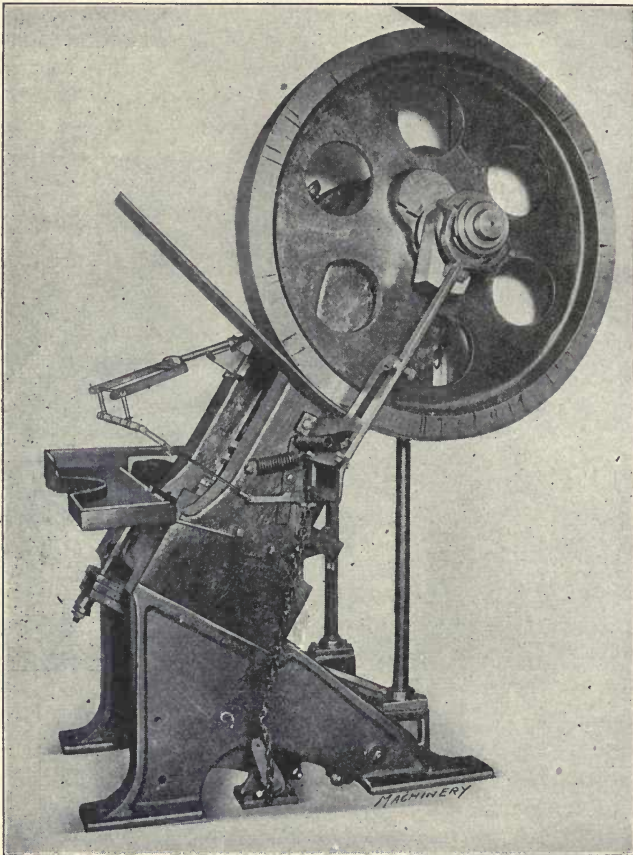

Fig. 4. Corbin "Lock" Type of Power-press Safeguard

#### Fender Guards

In this class belong those guards which completely surround the danger zone. There are very few guards of this kind, since they can, by the nature of their construction, be used in only a limited number of cases. In Figs. 5 and 6 is illustrated a safeguard of this type which is in use in Germany. The construction closely resembles that of a collapsible cup fitted to the under side of the ram, bottom side up; and the moving ram oscillates, as it were, within the cup. The cup is so adjusted for height that the fingers of the operator cannot



pass between the edge of the cup and the bottom die. The sheet metal, however, can be fed through the space that is left. It will be seen, therefore, that the work can be fed to the danger zone but the fingers are not allowed to get through. As the ram descends upon the stock the cup collapses, as the rings of which the cup is formed slide within each other. On the up stroke the cup extends itself again, leaving room for the strip of stock to pass beneath its lower edge. If any variation in the thickness of the strip occurs, the cup collapses accordingly. This guard, which was developed by the Allge-

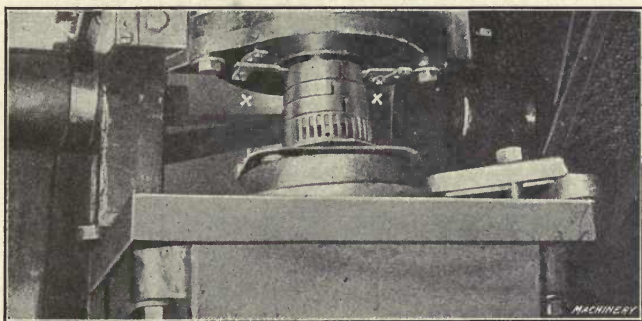

Fig. 5. Punch Press with Telescoping Guard

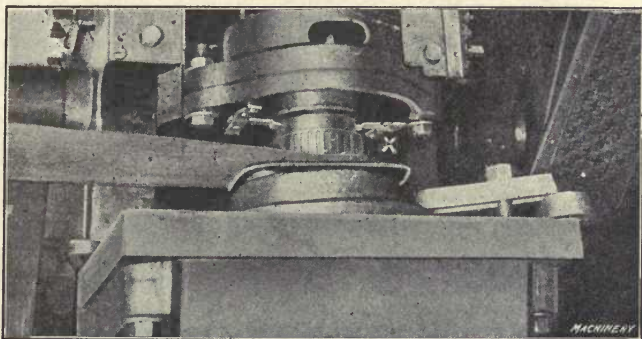

Fig. 6. Punch Press Guard in Fig. 5 with the Ram in its Lower Position

meine Elektrizitäts Gesellschaft, Berlin, Germany, can be used in many cases on large machines.

#### Hand Operated Machines

In the machines previously discussed, the clutch which actuates the ram is operated by the workman's depressing a treadle with his foot. He does not need his hands to operate the machine, only using them to place or feed the stock in the dies. In the class now to be considered, both the feeding—if there is no automatic feed—and the operating are done by either one or both hands. Nothing would be gained as regards safety by having only one hand do the engaging; therefore, practically no machines are in existence which depend on

this operating method. Should a machine requiring a lever movement by both hands to make it operative be automatically fed, then the workman would not have to take his hands off the operating mechanism and he would be able to work faster, at the same time keeping his hands away from the danger zone. But should there be no automatic feed attached to the machine, the workman would not be able to work as fast as in the case of a machine having a treadle engagement and fitted with one of the guards previously mentioned. However, the two-handed engagement principle is by far the best safeguard.

Figs. 20 and 21 show a machine equipped with a safeguard made by the Benjamin Electric Mfg. Co., Chicago, Ill. It has two levers placed one on each side of the machine, which are required to be pressed down by the hands of the operator before the clutch is engaged with the flywheel. The pressing of one lever will not start the machine. This safeguard will be described in detail later.

#### General Requirements in Safeguards

A guard should be made so that it will protect the worker against the possibility of his putting his hands in the danger zone from either side of the machine, as well as from the front, if it is to meet all the requirements of a guard. The guard shown in Figs. 5 and 6 meets this requirement, while those illustrated in Figs. 1, 2, 3 and 4 do not show that this condition has been met. A guard must not hamper the workman by preventing him from turning out the maximum number of pieces per day, and it should be so attached to the machine that it cannot readily be removed and not used. It should also consist of as few parts as possible. The guard shown in Fig. 3 is composed of a number of parts and is almost impossible for the operator to remove without spending considerable time, while Fig. 4 shows a guard which has very few parts and can easily be removed.

It cannot be said that any one of the preceding guards would meet all conditions under which a press may be used. It is a fact that with this class of machines very few of the guards are used continuously in the manufacture of one form or finished piece. It is more than likely that one machine will be used on different classes of work during a period of one year, and it has been found that each class of work would need its own special type of guard. On this account it is very difficult to determine what make of guard to install. The numerous examples of guards described in the following pages will indicate the possibilities for the use of safeguards, and show their application. The different forms shown have found successful application in well-known manufacturing plants. An important advantage in favor of their application lies in the fact that they can be used on the presses which a shop already has in operation, thus providing for the safety of the operator at a relatively small expense. Among the different types, one can almost always be found which will meet the requirements of any one class of power-press work.

## The Cream City Accident Preventer

The safeguard illustrated in Fig. 7 is manufactured by the Geuder, Paeschke & Frey Co., Milwaukee, Wis. In the manufacture of tinware and sheet steel ware, this company experienced great trouble from the injury of power press operators, and as the result of study given to the subject, the guard shown was developed. The original idea was merely to avoid power press accidents in the company's shops, but the guard was found to give such satisfaction that it was decided to place it upon the market. It is known as the "Cream City Accident Preventer," the first two words corresponding with the names of this company's other products.

The guard consists of an expanding gate, of the pantograph type, which opens before each down-stroke of the ram, thus blocking the approach to the die. It is attached to the press by means of two brackets *A*, which are secured to the press by means of the regular gib screws. The method of operation is entirely automatic. A lever *B* is fulcrumed to the side of the press where the driving clutch is located, and is connected with the treadle by means of rod *C*. When the treadle is tripped, this rod pulls down the lever, which, in its turn, expands the gate in advance of the descent of the ram. The guard is arranged in such a manner that the gate must be all the way down before the clutch can be engaged. This makes it necessary for the operator to remove his hands from the work before the press can be tripped, and should he attempt to adjust the position of a blank at the last moment—which has been one of the most frequent causes of accidents on unguarded presses—the descent of the gate is checked, thus preventing the engagement of the clutch and the down-stroke of the ram. When the treadle is released, the tension of spring *D* causes the gate to return instantly to the folded position, so that it is out of the way for the next operation.

At the place where lever *B* is pivoted to the frame of the press, a screw *E* is provided, which enables the point to which the gate must descend before the clutch is engaged to be adjusted. For most classes of work, this screw is set to bring the gate to within at least  $\frac{1}{8}$  inch of the table before the clutch is engaged. Such a setting, however, would interfere with sheets that extend out in front of the press, and for such classes of work the gate is set to descend to a point just above the level of the die before the engagement of the clutch can be effected. In such cases, the bottom of the gate is practically in contact with the face of the work; consequently, the same degree of protection for the operator is secured.

The application of this guard does not require the construction of the press to be altered in any way, the only work necessary being that of drilling and tapping holes for the bolts which secure the operating lever *B* to the frame of the machine. The openings in the guard gate enable the operator to have his work in plain view at all times.

A somewhat similar, although less efficient guard than the one just described, is shown in Figs. 8 and 9. In this case the pantograph

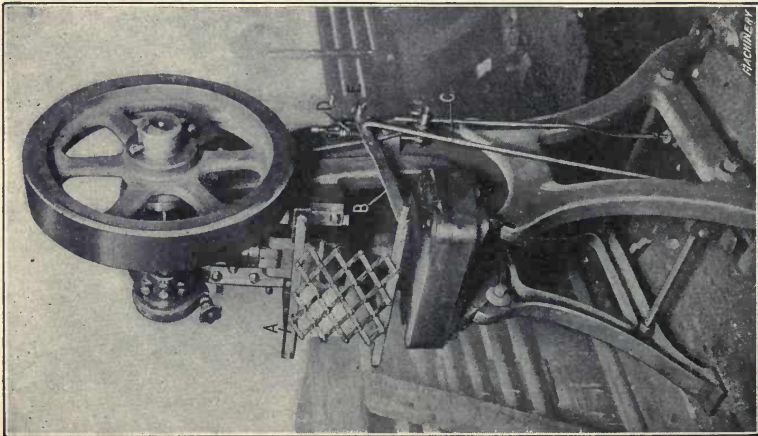

Fig. 7. The Cream City Accident Preventer made by Geuder, Paeschke & Frey Co.

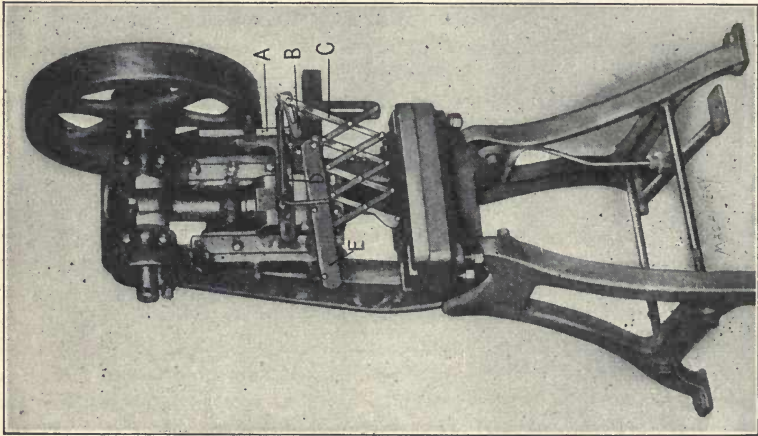

Fig. 8. Safeguard with Pantograph Gate which expands from Side

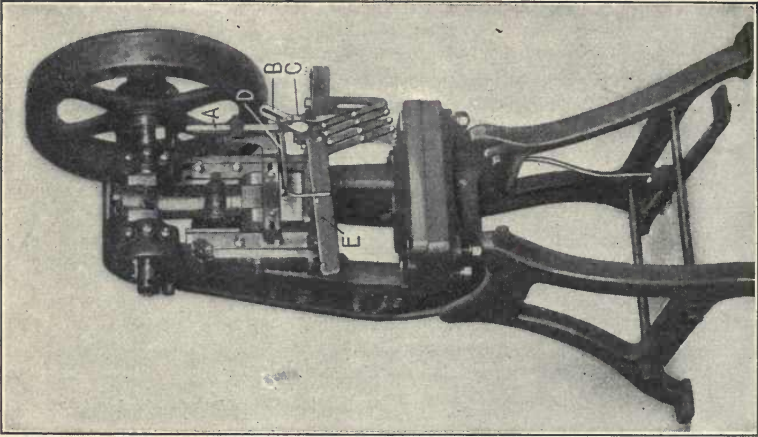

Fig. 9. Same Press as in Fig. 8, with Guard folded to One Side

gate expands from the side, its movement being controlled by the bar *A*. As the slide descends, this bar, which is attached to it, engages a cam carried by the pivot on which lever *B* is mounted. This swings lever *B* down into a nearly horizontal position, as shown in Fig. 8, and expands the pantograph gate across the front of the die, through the leverage exerted by the extended arm *C* of the gate. The action of the mechanism is so timed that the gate shuts off access to the die before the punch has descended upon it. When the ram rises, bar *A* is carried up with it. This releases the mechanism, and the gate is closed by the tension of spring *D*; *E* is simply a guide in which the gate travels.

#### The Jones Stamping Press Guard

The press illustrated in Figs. 10 and 11 is equipped with a safety device known as the Jones stamping press guard, which is manufactured by the Jones Safety Device Co., Chicago, Ill. When in operation, the wire-mesh gate drops somewhat ahead of the down-stroke of the ram, thus barring the operator's access to the die during the working stroke. The design is such that the gate must reach the bottom of its stroke, which brings it into contact with the table, before the clutch can be engaged.

The operation of the guard is controlled by lever *A*, which is pivoted to the frame of the press. Connection is made between the treadle and the clutch by means of two rods which are secured to this lever by adjustable clips. When the guard is to be applied to an inclinable press, the treadle rod is in two sections, which are threaded at their ends to carry an adjusting clip, so that the length of the rod can be varied as required.

When the treadle is pushed down to trip the press, lever *A* carries the gate down to the table. If the operator fails to remove his hand from the die, the descent of the gate is blocked and this prevents the press from operating, because the clutch cannot be engaged until the gate has reached the bottom of its stroke. After the ram has completed its working stroke and started to rise, the gate is immediately lifted by the action of a spring which connects the rear end of lever *A* and the frame of the press. If it is more convenient, this spring can be attached between the treadle and the frame of the machine. The instantaneous action of this spring prevents the output from being reduced, as the guard is out of the way as soon as the ram has risen sufficiently to enable the operator to begin preparing for another operation.

Clip *B*, which secures the gate bar to lever *A*, enables the position of the guard to be adjusted to meet the requirements of different classes of work and dies. The gate should always be set to a point where it touches the table before the clutch can be engaged. This guard is easily attached to the press on which it is to be used. The only work entailed consists of drilling and tapping holes in the frame to secure the operating mechanism in place. In some cases, the wire mesh gate has been replaced by a flat rod, covered with leather, some-

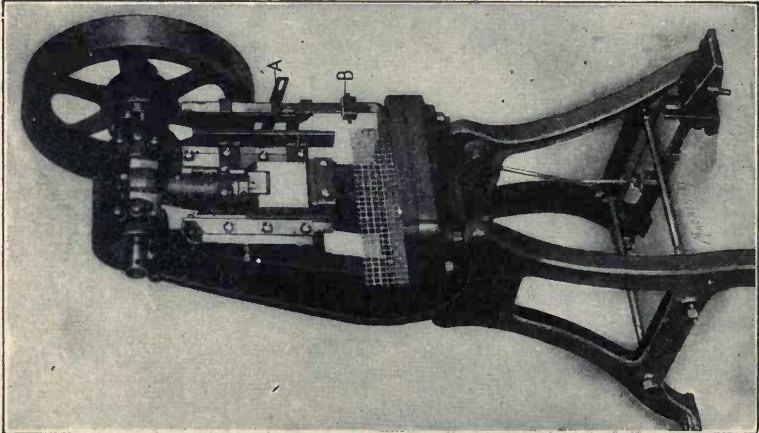

Fig. 10. The Jones Stamping Press Guard; Ram Descending

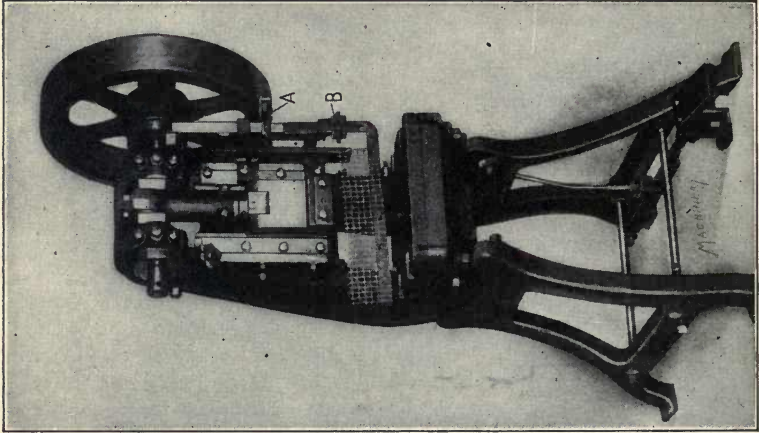

Fig. 11. The Jones Press Guard in Position before Treadle is tripped

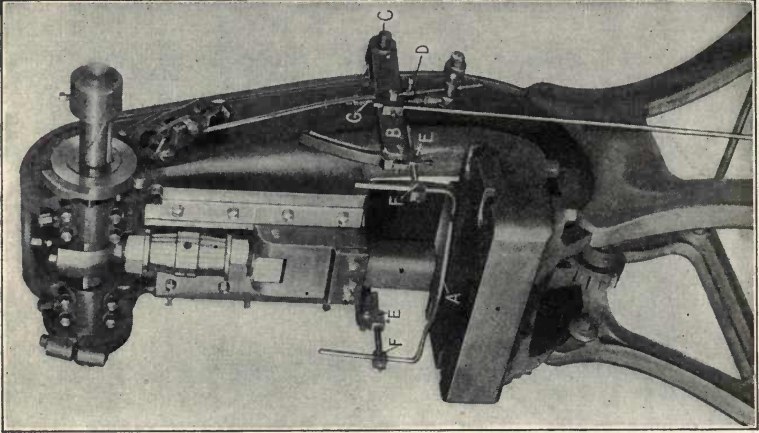

Fig. 12. Safeguard using a Bar instead of Gates of Gates

what similar in shape to the one upon which the wire netting is mounted. The object of this modification is to allow the operator an unobstructed view of his work during the entire working period of the press.

#### Safeguard using Bar instead of Gates

In Fig. 12 a power press guard is illustrated which works on much the same principle that governs the operation of the ones shown in Figs. 7, 10 and 11. In this case, the guard bar *A* has been adopted in place of the gates used in the two other devices referred to. When an operator is working at a press equipped with one of these guards, his hands are beneath the bar *A* and this bar must drop to the die bed before the clutch can be engaged. This makes it impossible for the operator to trip the press and forget to remove his hands from the die, because, under these conditions bar *A* cannot fall far enough to allow the clutch to be engaged.

The operation of this guard is controlled by lever *B* which is pivoted to the frame of the press at *C*. When the treadle is depressed, this lever carries the guard bar down with it. After the guard has practically reached the die bed, lever *B* engages the stop *D* on the clutch rod and pushes it down sufficiently to throw the clutch into action.

It will be seen from the illustration that the position of the guard rod can be adjusted horizontally at *E* and vertically at *F*, and that the stop *D* on the clutch rod may be adjusted to correspond with different settings at *F*. This enables the guard to be adapted to different classes of work. The stop *D* should, in all cases, be set so that the clutch cannot be engaged until the guard rod is almost in contact with the die bed.

After the press has been tripped, spring *G* throws the guard up as soon as the ram has begun its return stroke, so that the operator is not delayed in any way. This type of guard can be applied to any type of press without altering its construction, by simply drilling and tapping the holes in the frame of the machine necessary for securing the guard in place.

The two guards shown in Figs. 13 and 14 work on essentially the same principle. When the ram of the machine shown in Fig. 13 begins its down-stroke, the vertical rod *A* is rotated by means of the twisted section which runs through a bearing in *B*. This causes bar *C* to swing over the die, and in case the operator has neglected to remove his hands, they are struck by this bar, thus warning him of his danger. Bar *C* moves considerably before the ram has reached the bottom of its stroke, so that the operator is given plenty of time to get his hands out of danger if he has neglected to do so at the time of tripping the press.

The action of the guard shown in Fig. 14 is similar to that of the one just described, but in this case the round rod *A*, with a spiral groove cut in it, has been substituted for the twisted square rod shown in the preceding illustration. The groove in this rod is engaged by a pin in bearing *B*, thus swinging the guard bar *C* as previously described.

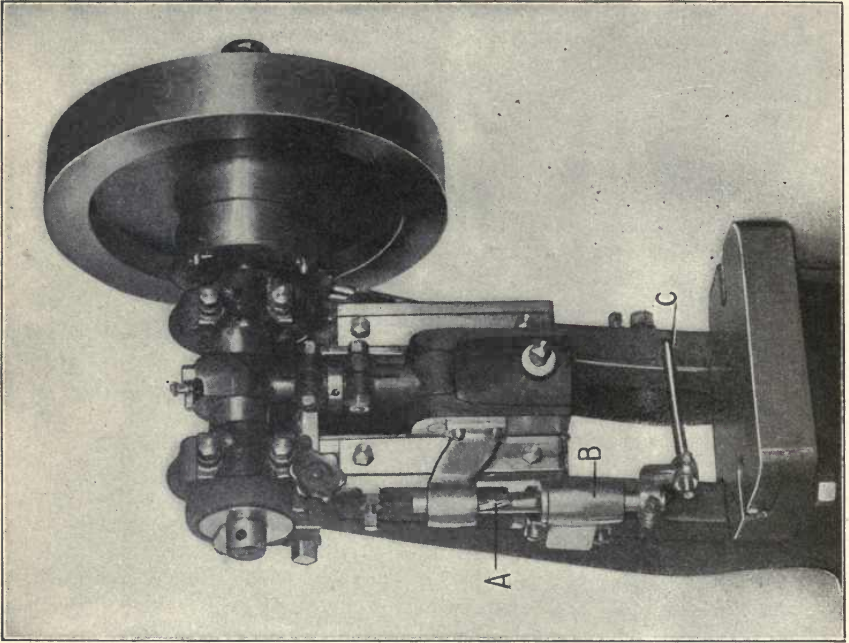

Fig. 14. Guard Bar swung over Die by Pin in Spiral Groove

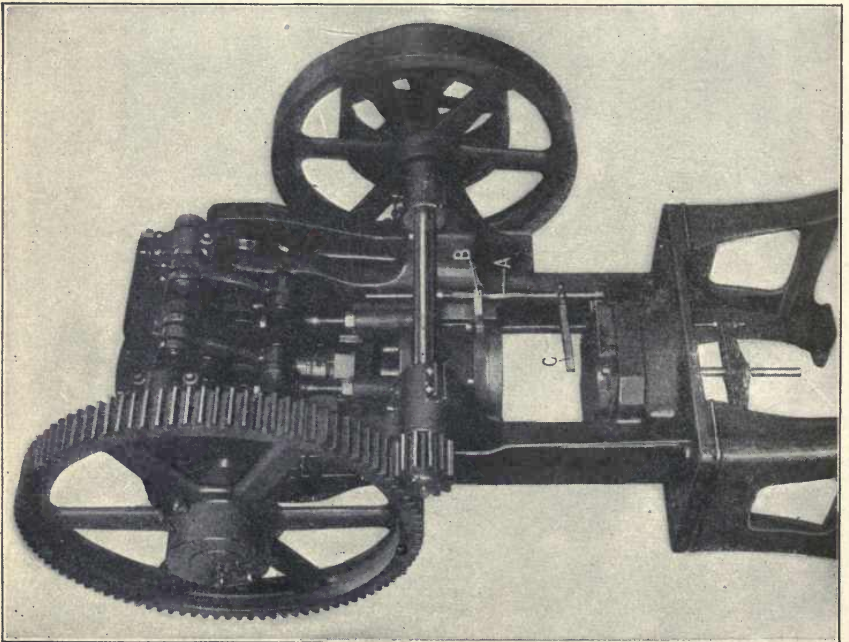

Fig. 13. Guard Bar swung over Die by a Twisted Rod



## Guards Used in General Electric Co.'s Shops

The guard illustrated in Fig. 15 was developed by the General Electric Co., for use in its power-press shops. When the operator sets the press in motion, the pin which runs in slot *A* swings lever *B* about pivot *C*. The shape of slot *A* is such that lever *B* carries the gate to the right a little ahead of the down-stroke of the ram. This shuts off access to the die during the working stroke of the press; should the operator fail to remove his hands from the work at the time of tripping the slide, he is warned of his danger by the movement of the guard. The gate runs on a guide on the die bed. The guard is secured to the press by bracket *D*, which carries the pivot *C*. This bracket is secured by one of the gib screws and a couple of small pins which prevent it from rotating.

Fig. 16 illustrates another form of power-press guard which has been used in the shops of the General Electric Co. In this case, the guard plate *A* comes forward, ahead of the down-stroke of the ram, and pushes the operator's hands away from the die. The movement of the guard plate is controlled by a cam attached to the rear of the slide. When the working stroke has been completed and the slide commences its upward travel, this cam releases the guard and allows it to be returned to the rear of the die by the tension of a spring.

The guard illustrated in Figs. 17 and 18 has been adopted by the General Electric Co. as a modification of the equipment shown in the preceding illustration. In this case, guard plate *A* swings on rod *B*, passing over the die far enough ahead of the ram to give the operator ample time to get his hands out of danger if he has neglected to do so at the proper time. The guard is attached to the press by means of bracket *C*, which is held in place by means of the regular gib screws. Rod *B* is a loose fit in this bracket, so that it is easily rotated by the action of *D* upon the twisted section of the rod.

When a press is engaged in stamping out parts from thin sheets, a guard of the type shown in Fig. 19 can be used to good advantage. In using a press equipped in this way, the operator slips the stock under guard *A*. The space between the bottom of this guard and the die is just sufficient to admit the stock, but will not permit the operator's fingers to get within reach of danger. The General Electric Co. uses guards of this type on presses for stamping mica insulations; they would prove equally serviceable on other classes of work where thin stock is being handled.

## The Benjamin Stamping Press Guard

The stamping presses illustrated in Figs. 20 and 21 are equipped with a safeguard which has been designed and placed upon the market by the Benjamin Electric Mfg. Co., Chicago, Ill. This device was first developed to meet the requirements of the Benjamin shops, but proved to be so satisfactory that it has recently been placed upon the market. It is not intended for presses used for blanking from strips or ribbon stock, and when presses are used alternately for such operations and for stamping, the guard may be easily disconnected, and the regular

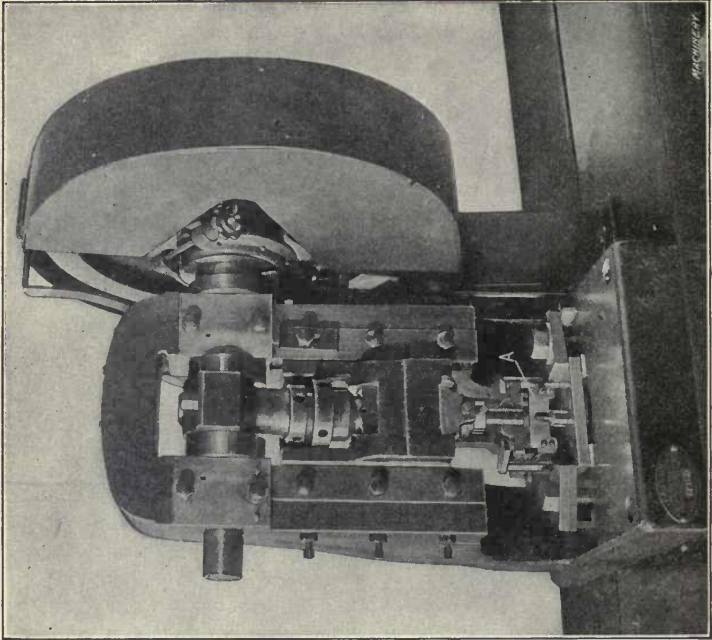

Fig. 16. Guard with a Plate operated by Cam attached to the Ram

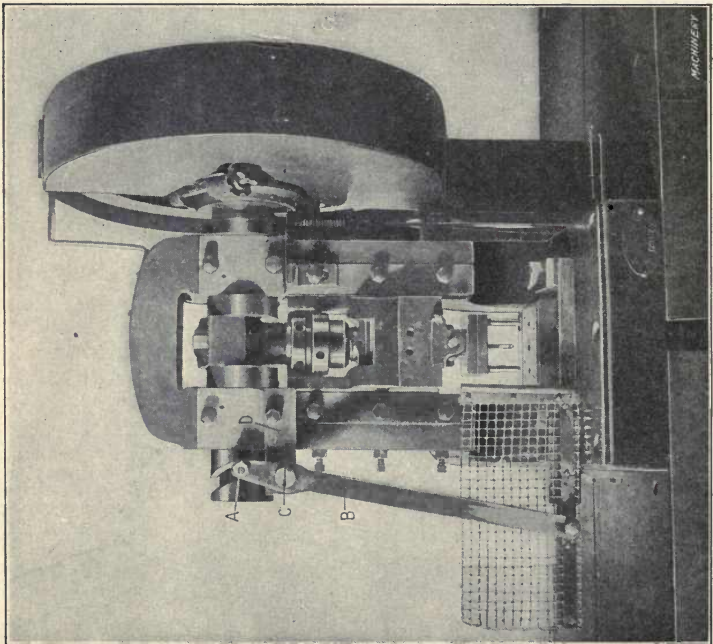

Fig. 15. Safeguard with Gate which swings from the Side

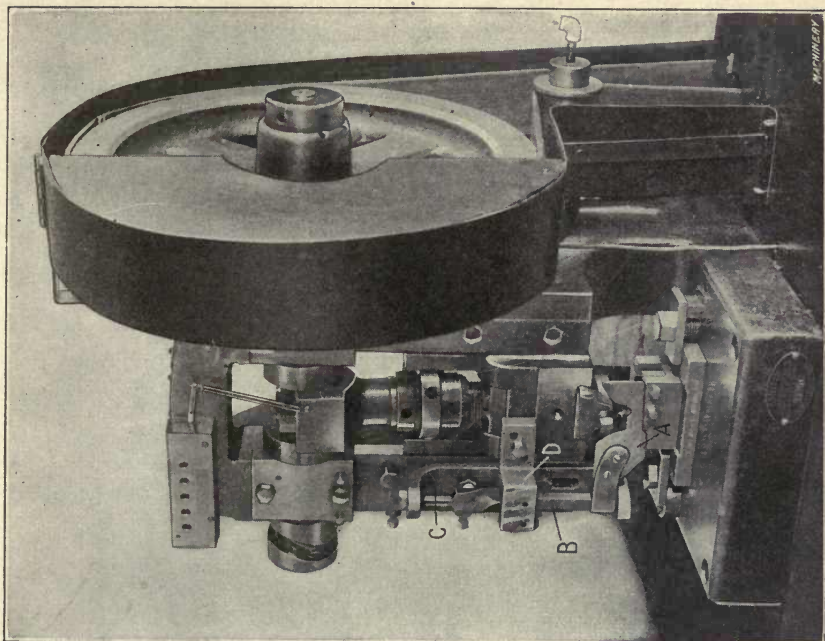

Fig. 17. Guard which sweeps over Die before Ram descends

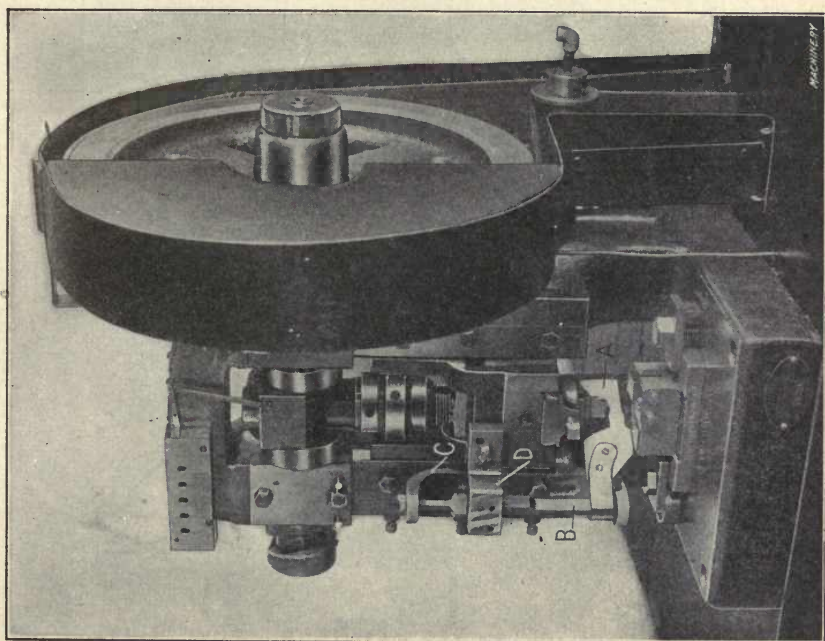

Fig. 18. Same Guard as in Fig. 17, in Position in Front of Die

treadle used. This change does not involve any particular risk, as blanking operations on ribbon stock do not require the operator to work with his fingers under the ram.

As shown in the illustration, the guard consists of two hand levers *A*, one at each side of the press. These levers connect with the equalizer *B* which is mounted on the clutch rod. This equalizer swings about a pivot at its center, so that pushing down only one of the hand levers does not have any effect upon the clutch. Both levers must be pushed down to trip the press, and as both hands are required for this purpose, the operator cannot get his fingers caught. The release of either lever allows the latch to return to its normal position, thus making it impossible for the press to repeat unless both levers are kept down until the second stroke has been started. In this case,

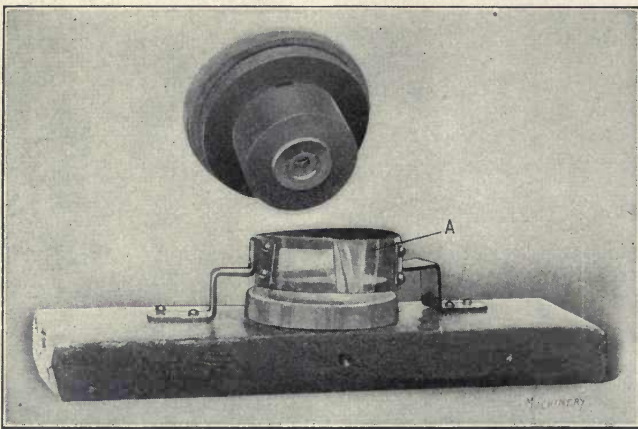

Fig. 19. Guard used for Operations on Thin Stock

the operator would not have time to get his hand under the ram before its downward travel was completed. Different arrangements of this guard have been worked out to adapt it for use on all standard forms of presses, two such arrangements being shown in the illustrations.

Experience has shown that it is poor policy to depend upon the tension of a spring to control the operation of any mechanism, the failure of which may inflict a serious injury upon the operator. The tension of a spring weakens with age, and may become inadequate for the service which is required of it.

#### The Bliss Safety Clutch

A large majority of power-press accidents are caused by the failure of the operator to remove his foot from the treadle after completing an operation. In such cases, the wheel is kept locked to the shaft and causes the ram to descend a second time when the operator is not expecting it. To avoid such accidents, the E. W. Bliss Co., Brooklyn, N. Y., and several other well-known builders of power presses, have designed clutches which require the treadle to first be released

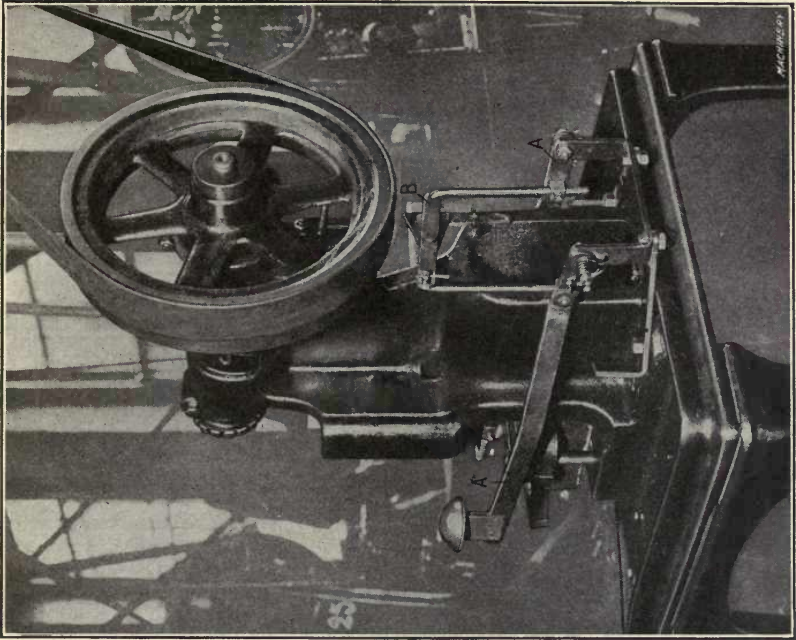

Fig. 21. Another Arrangement of the Benjamin Guard

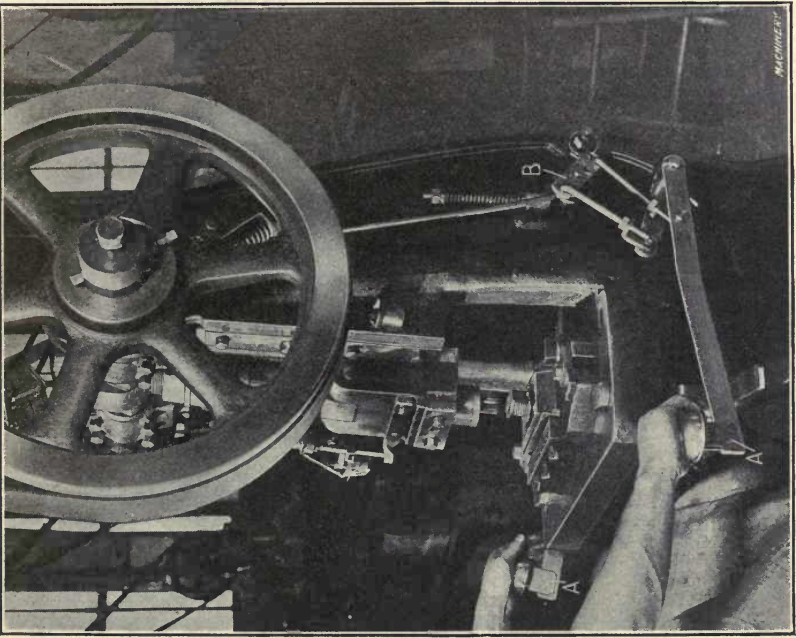

Fig. 20. Arrangement of the Benjamin Stamping Press Guard

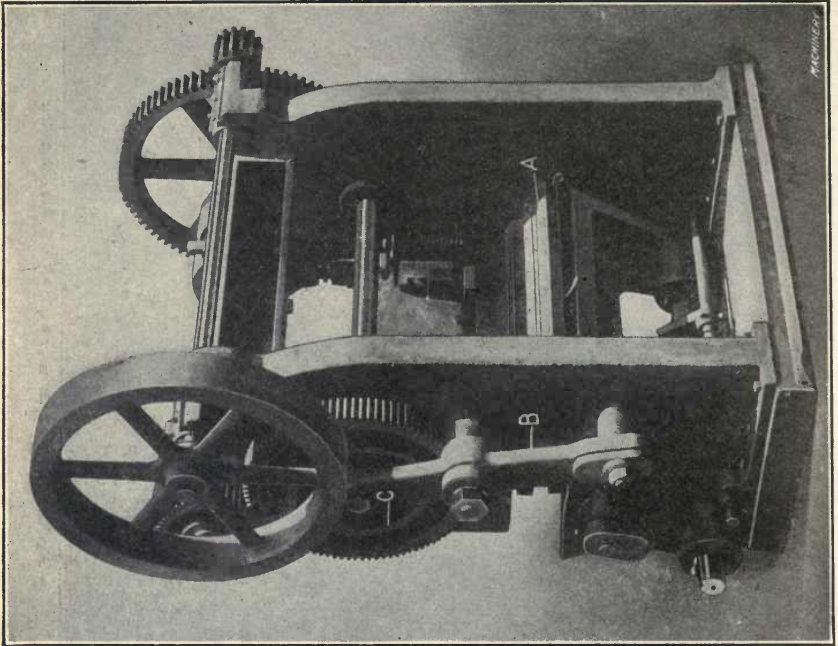

Fig. 23. The Improved Queen City Safety Press

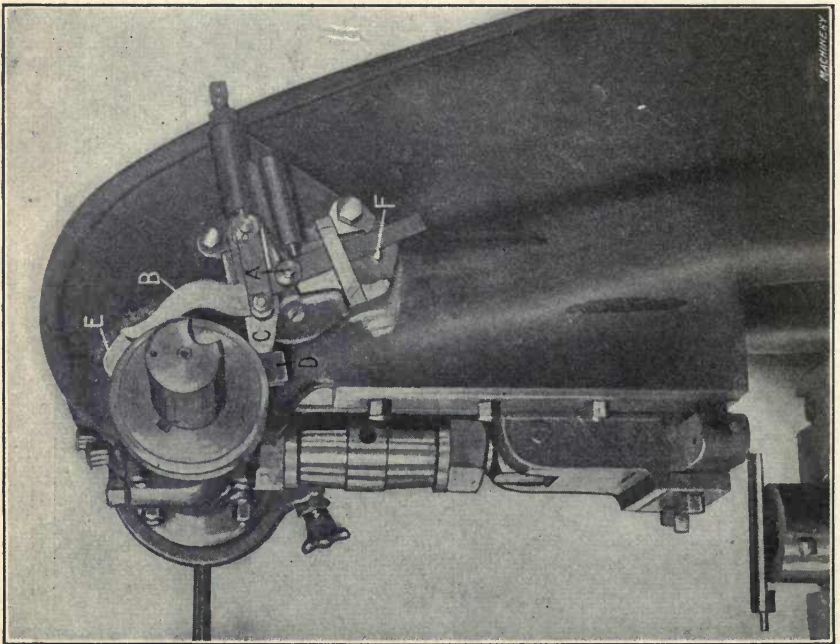

Fig. 22. Mechanism of the Bliss Automatic Safety Clutch

and then pushed down again in order to cause the ram to descend for the next operation.

Fig. 22 shows the Bliss safety clutch, which operates in accordance with this principle. When the treadle is pushed down, latch *C* is lowered by means of trip-hook *B*, thus allowing the end of the clutch-key *D* to spring out and throw the clutch proper into position to engage with the flywheel. The shaft now revolves, bringing trip-dog *E* against trip-hook *B*, disengaging it and breaking the connection between *C* and the treadle rod that connects at *A*. This allows the latch to spring up and throw the clutch out of action.

When the foot is removed from the treadle, trip-hook *B* re-engages with latch *C*, and the mechanism is ready to be tripped for the next operation. The press may be run continuously by sliding the trip-hook *B* ahead of the spring-pin *F*. In this position, the trip-dog does not strike against the hook, and no break is made between the treadle and the clutch. Consequently, the slide continues to operate as long as the treadle is kept down. The E. W. Bliss Co. is now putting these clutches on all of its presses.

#### The Improved Queen City Safety Press

The press illustrated in Fig. 23 is built by the Queen City Punch & Shear Co., Cincinnati, O., and has been designed along lines which provide for the operators' safety. The oscillating table *A* swings out from under the ram to permit the removal of finished work and the substitution of new blanks. Hence the operator does not need to put his hands under the ram. The oscillation of the table is controlled by means of rocker arm *B* and cam *C*. The machine shown in the illustration is equipped with a double set of dies and requires two men to operate it, one standing at the front and the other at the rear. After the working stroke, the die bed in which the work has been formed or pressed remains stationary until the ram is partly raised. It then moves forward to the operator and remains at rest long enough to give him ample time to remove the finished work from the dies and replace it with new blanks. During this time, the other die bed is under the ram, a working stroke of the press being made. The die beds thus receive alternate strokes of the press, allowing plenty of time for the operators to perform their work, while the dies are swung out away from the danger zone beneath the ram. Machines of this type are also built with a single die bed and only require one operator to run them.

## CHAPTER V

### RULES FOR THE PREVENTION OF ACCIDENTS

The rules for the prevention of accidents in machine shops naturally divide themselves into two main classes—those which primarily concern the employer, and those which must be observed by the machine operator in his effort to guard himself against injury. The employer must provide the required safeguards; the employe must use care in operating his machines without taking unnecessary chances. In the following, the rules and suggestions—collected from various sources—are classified, in the first place, with regard to these two main classes. It must be remembered, however, that there can be no hard and fast line drawn between the duties of the employer and those of the employe in the prevention of industrial accidents; a spirit of co-operation should always be present.

#### I. SUGGESTIONS AND RULES FOR THE SHOP MANAGEMENT

The first thing to do in the prevention of accidents is to get a clear idea of the particular dangers that need to be guarded against. The arrangement and erection of machine tools comes first in order, as it determines the conditions under which the operator works and has much to do with his safety. The particular dangers met with must then be taken care of; these include the risks arising from projecting keys and set-screws, unguarded gears and belts, dangerous position of machines, as for instance, a planer placed so that at full stroke it might crush anyone who passed between it and a wall or bench. Bearings must be so placed that to oil them does not involve a risk, etc.

#### Instructing Employes

A very important consideration is that of the instruction of employes in regard to the dangers against which they must be on their guard. Apprentices in machine shops should be given better supervision than is now the case, and they should be systematically and thoroughly instructed as regards the dangers of machinery. But in addition, all employes, especially new employes, must be carefully instructed in a *language they understand*, regarding the work they are to do, and particularly regarding possible dangers of the employment. The dangerous parts of the machinery about which they must work must be pointed out to them, and they must be cautioned about the same.

When printed rules are used, each foreman must make it his business to know that every employe has read the rules, and *understands* them, and is familiar with the danger of his work. If an employe is changed to other employment, the same care with regard to instruction must be used. No employe must be allowed to remain in a department who cannot be made to fully understand the instructions.



In many cases, an important part of the instruction given is to show the men how to place themselves so that they can move out of danger if anything should slip or break.

#### Arrangement of Shop and Machinery

In many shops the men have to spend much of their time looking out for their own safety. If the management, therefore, wishes to increase the efficiency of such shops, it must arrange the machines and place the equipment in such shape that the workmen can work in safety, and not have to waste their time in self-protection.

Plenty of light, natural or artificial, should be provided around each machine, and in all stairways and passageways. Statistics show that light has a very important place in protection. The light in a shop may be greatly increased by keeping the electric globes clean and the windows washed. If workmen cannot see, they must feel, and it is this that costs so many fingers and sometimes lives. Clean windows and floors and whitewashed ceilings and walls (and even machines painted white) would prevent many accidents.

Economy of floor space, while important, can be carried too far. Ample room should be provided around each machine for the free movement of the operator and his work.

The traversing carriage or table of any machine should not be allowed to run out within a distance of less than eighteen inches from any fixed structure not being a part of the machine, if the space over which it runs is a space over which any person is liable to pass, whether in the course of his employment or otherwise. A planer, for example, should never be placed so that the platen, under any circumstances, could crush a man between it and a wall, post or other fixed object. Nor should a planer be so set that the platen will need to travel over a gangway, especially if the gangway is used for moving trucks or heavy castings or forgings along it. Someone may be easily crushed between the platen and the object moved along the gangway.

When drop hammers are located near an aisle where persons pass along to the rear of the hammer, a shield must be provided to stop flying scales.

Where necessary, there should be sufficient room for the operator to pass right round his machine without endangering his person by coming into contact with belts, gears, etc.

All benches in the shop should be so arranged that there will be no danger of the workman being jammed between his work or the bench and moving parts of machinery, cranes, shop cars, or trucks.

All passageways and gangways should be kept smooth and in good repair, and free from all obstructions over which the men may stumble and fall. The foreman should constantly watch the passageways and see that they do not become crowded. All passageways where men must pass in the regular course of their work must be sufficiently wide to insure safety.

Cleanliness, fresh air and proper heating are of first importance.

Turnings and metal chips should not be allowed to accumulate in any part of a machine shop, especially not in the vicinity of machines.

The floor of the shop should not be littered up with defective and discarded castings. Finished work and jigs not in use should be removed promptly.

The floors of the shops should be kept in good condition. Tracks for shop truck or railway tracks should not project above the surface of the floor.

#### Oiling of Shafting and Shafting Guards

All machines and shafting (line and counter) should be periodically and systematically oiled, the frequency of oiling depending upon the extent to which the machine and shafting are used and their duty. The oiling of shafting must be done by special men, who must be required to wear tight-fitting clothing, and use long-stemmed oil-cans where possible. Where practicable, oiling should be done when the power is off. The ladders used by oilers must be equipped with steel points at the bottom. A ladder must not be allowed to lean against shafting which is in motion if it is possible to avoid so doing. Where a lineshaft is close to a wall, a workman must never place a ladder against the wall and thus put himself between the shafting and the wall. Working in a cramped space like this, close to a rapidly revolving shaft, is always dangerous.

Shafting within twelve inches of the floor should be encased. Shafting higher than twelve inches and not more than seven feet from the floor should be railed off or otherwise guarded. The ends of shafting, where exposed to contact, should be protected.

Countershafts should not be placed directly over the operator, but should be placed back of the machine. All overhead hanger-bolts should be inspected frequently.

All pulleys, collars, etc., should be examined periodically for security of holding, while the former should also be examined for truth of running. Any defects should be remedied at the time of discovery.

#### Stairs and Railings, etc.

Stairs should not be built at a sharper angle than 50 degrees. When an angle over 50 degrees is required, ladders should be used instead. The sum of the riser and tread should equal about  $17\frac{1}{2}$  inches. All stairways must be equipped with hand-rails, and the rails must be kept smooth and free from nails and splinters.

Railings should be at least three feet six inches high. Pipe railing should be made of not less than  $1\frac{1}{4}$ -inch pipe. Angle railing should be made of not less than  $2 \times 2 \times \frac{1}{4}$ -inch angle iron. All railings ten feet above the floor should be made of metal, and should have a toe-board at their base. Angle-posts should be chamfered.

Counterweights on doors or machines should be so situated or guarded that they cannot fall on anyone should something break.

Where a machine is located so that the operator must stand near a swinging door, a stop must be so placed as to prevent the door from striking him.

All swinging doors should be equipped with windows, properly guarded, and of sufficient size to make it easy to see a man approaching from the opposite side. A size of window which has been found adequate is  $8 \times 24$  inches, with one window provided for each of the two swinging doors. Both sides of the door must be provided with light, either natural or artificial. The windows must be kept clean.

Avoid hinged skylight windows, as the danger due to falling glass has often been demonstrated.

All portable ladders, where practicable, should be equipped with metal points or spurs at the bottom, and with hooks at the top.

#### Safeguards for Machines

All moving machine parts, where dangerous and where exposed to contact, must be properly guarded, and all projections of any nature on moving parts, where exposed to contact, must be properly protected.

Collars used on shafting should have safety flanges high enough so that the head of the set-screws will not project above the flange. All set-screws should be placed in safety collars, countersunk, or covered by a guard.

Set-screws with heads projecting from the moving parts of a machine should be replaced with headless or socket set-screws, when no other protection is provided.

Chucks or other revolving parts with projecting screw heads should be avoided wherever possible.

All screws and bolts on parts which have to be reversed frequently should have locking nuts placed on them to prevent their slacking back and falling out; or, in place of these, some other effective method of fixing and locking them in position should be resorted to.

Lead-screws placed in the front of the lathe should not have a spline-cut in them. Men standing close to the machine often have their overalls wound up on the lead-screws and are in danger of injury.

All gears should be either enclosed or guarded wherever possible. In cases where it is necessary to remove the gear guards for the purpose of changing the gears, the guards should be replaced immediately after the gear-changing operation and before the machine is set in motion.

Handles on the ends of feed-screws and shafts should, preferably, be of the loose type, connected to the screw or shaft by means of a claw clutch or similar means, so that the handle can, when not in action, be slid off the screw or shaft. This prevents any accidental movement of the handle by the operator.

Shapers and boring mills should be provided with a brake in addition to the ordinary shifter, so as to make it possible to stop them quickly.

Drilling machines, especially where girls are the operators, should be well protected from revolving spindle parts, as there is a possibility of entangling the hair when the operator leans over toward the work.

Guideways should be provided for counterweights.

Emery or abrasive wheels over five inches in diameter should be provided with metal guards.

Emery wheels over eight inches in diameter should have a safety taper of three-fourths inch to the foot, should be equipped with safety collars, and with substantial tool rests.

All cup wheels should be guarded.

Emery wheels which are used almost continually should have a guard over the wheel connected to suction pipes, for the removal of dust. The dust is more dangerous than the more remote possibility of breakage.

For the shop print (mounted or unmounted), a hook or fixture should be placed in such a position that the operator can readily see it without leaning over the machine.

When repairing machine tools, changing dies, gears, etc., all power to the machines should be shut off and the belt thrown off, if possible.

When making overhead repairs, a sign which can be clearly seen from all sides should be placed on a stand about six feet high or suspended by wires at the same height. A good sign which can be clearly seen from all sides can be made of tin, triangular in shape, painted red and having the word "danger" in large letters.

Lights at machines should not be suspended by wires from the ceiling, but should be held in adjustable brackets or stands.

Where incandescent electric lamps are used, metallic reflectors, guards, and means for quickly adjusting the light to suit the work should always be provided. No makeshifts should be permitted.

The switch box of every motor driving a machine or group of machines should contain at least one extra fuse, for an emergency.

Where a group of machines is driven by an electric motor, the switch should be placed within easy reach of each machine. Before starting or stopping the motor timely notice should always be given.

Where electricity is used, all switches, transformers, fuses, motors, rheostats and controlling apparatus should be marked plainly with the voltage and amperage of the current passing through them when in operation. In addition, the word "danger" in large letters should be placed on any parts carrying over 200 volts, for while a shock of 200 volts may not be dangerous, it is generally quite disagreeable.

#### Belts and Pulleys

Belts and pulleys should be so located, wherever possible, as not to be dangerous to employes, or should be properly enclosed, fenced, or otherwise guarded. Belt and gear guards, covering belts and gears, are now being made extensively of sheet-metal, bent to suit conditions, made in box forms, and oxy-acetylene-welded at the angles. These, when painted, make very neat appearing guards. In place of the above, wire mesh or expanded metal is sometimes used, held at the edges or corners, by small rolled metal angles.

Bare pipe railing, used as a belt guard, is to be used only where the location of the belt is isolated—where there is but little traffic, and the probability of catching anything in the belt is remote. Wire

netting should be made of wire not less than No. 12 gage, and not more than 1½-inch mesh. Steel casings should be made of not less than No. 10 gage plate.

In the lacing of belts the joints should be made close and smooth, and the laces or hooks should not be placed too near the edge of the belt. With high-speed machines it is best to make the belts endless. All hand-operated belts should be laced with rawhide. Where practical, special men should be given the work of making, repairing, lacing and putting on all belts.

Whenever possible, belts should be placed overhead and as far away from working places as possible. Belts running in opposite directions should not be arranged in close proximity to each other.

All belts running through floors, or low, should be encased or guarded. All heavy, high-speed belts should be guarded.

Belts near female workers, where the hair is in danger of being caught by static electricity, should be guarded.

All loose pulleys must be furnished with a permanent belt shifter, so located as to be within easy reach of the operator. The loose pulley and the shifter must be so constructed as to make it impossible for the belt to creep from the loose pulley back onto the tight pulley. The belt shifter should not be placed where it can come in contact with the driving belt in any position. Sometimes the driving belt will touch the shifting lever when it is in the "off" position, and the lacing or joint will jerk the shifter and start the machine.

When two pulleys must be close together, or when a pulley is nearer to a hanger than the width of its belt, a hook should be so placed as to catch the belt, if it should run off, and prevent it dropping to the shaft or becoming wedged.

A good many countershafts are so arranged that they cannot be oiled without throwing the belt off, and this causes the oiling to be shirked. All loose pulleys should be designed so that they can be oiled without disturbing the belt.

Shifters on belt-driven tools, and controllers on motor-driven ones, should be within easy reach of the operator, if possible. See that there is plenty of clearance near the controller handle.

#### Cranes and Hoists

No person except the duly appointed operator should be allowed to operate a crane.

All cranes should have, in plain view, signs showing their capacity.

A substantial foot walk of steel construction throughout, provided with rough surface and located not less than 6 feet 6 inches below the roof truss, should extend the entire length of one or both bridge girders. Where the walk is on one girder only it should be on the driving side. This foot walk should have a railing at least 3 feet 6 inches high, and a guard or toe-board at least 6 inches high along the exposed edge of it, to prevent tools and other objects from falling off. There should be at least 18 inches clearance between the railing and the nearest part of the trolley, and on the driving side there should

be at least 18 inches clearance between the railing and the shaft. The inside of this walk should be brought up against the bridge girder to prevent material falling between the walk and the girder. Where there is a foot walk on one bridge girder only, there should be a platform provided at one end of the bridge and opposite the foot walk, for use in inspecting and repairing the trolley. Where practicable, there should be a platform on the ends of the trolleys. The foot walk, where practicable, should be carried around instead of over the bridge motor.

The operator's cage should be made of steel and should be absolutely fireproof. A safe, convenient arrangement should be made for passing from the cage to the foot walk. Wherever possible, this should be within the cage proper, but if it is necessary to place a ladder for this purpose on the outside of the cage, an auxiliary platform—with railing and toe-board—should be provided to prevent anyone falling from the ladder to the ground. Where the cage is open, a toe-board at least six inches high should be provided around the floor of the cage.

Stairs and ladders on the buildings for the purpose of getting into the crane should, where practicable, terminate in a platform with regulation railing and toe-board.

All crane cables should be six strands, 37 wires, with hemp core for ordinary service, and iron core for cranes handling hot metal. Sheaves and drums should be not less than thirty times the diameter of the cable.

All chains should be made of wrought iron. In replacing links only those made of wrought iron should be used.

Only fully guaranteed, long fiber, manila rope should be used.

All slings used on hoists should, where practicable, be made of wire cable instead of chain, as cable gives warning of weakening by broken strands.

All hoists should be equipped with the best and especially approved wire rope. No chain ought to be used.

The drums should have flanges on each end not less than 1 inch thick, and should project at least  $2\frac{3}{4}$  inches from the drum body.

#### Elevators

All elevator doors should be of the automatic drop type, that is, they should close as soon as the platform leaves the floor.

The platform of an elevator should be entirely enclosed with wire panels, as should also the shaft.

The top of the shaft should be roofed with only a hole cut in it for the lifting rope, so that in case any parts should fall from the running gear, they cannot fall down the shaft.

#### II. RULES FOR EMPLOYEES

By far the greater proportion of accidents are caused by momentary thoughtlessness or carelessness. To avoid accidents, it is necessary that the workman concentrate his attention solely on his work.

Many unnecessary risky things are done by many men simply because they have formed a careless habit. When lifting heavy pieces with crane, hoists or jacks, or in other ways, some workmen subject themselves to unnecessary risks by placing the hands or feet, and sometimes their whole body, where injury is sure to result if one of the parts bearing the load should slip or break. In cases where it is necessary for men to work under parts suspended, blocking should be used for protection.

It is inadvisable to scuffle, fool, or play practical jokes in the shop. Many serious injuries have been caused by this practice.

Where there is not plenty of room between machines, one should not try to pass. To avoid danger, go where there is sufficient space to pass.

Operators of machine tools should, as far as it is possible and practicable, wear closely-fitting clothing, so that the risk of any revolving projection catching in any part of the operator's clothing and thus causing injury is reduced to a minimum. In particular, do not wear overalls with ragged sleeves, nor flowing neckties.

#### Rules for Lathe Operators

Do not try to hold a drill and dog by hand, between centers, when the drill is over  $\frac{1}{4}$  inch in diameter.

Do not put any other than a light-weight chuck, faceplate or special fixture on the lathe spindle, with the belt or controller "full on."

Keep clear of a fast-running lead-screw, if it has a keyway running along its length.

Be careful of heavy projecting arms on any piece of work, especially when polishing.

Chuck wrenches should not be left in chucks, when not in use.

Do not forget that the thread-tool and carriage will rapidly reach the tailstock after reversing. You may hurt yourself trying to stop the damage you see being done.

In the lathe, always file left-handed near the dog or lathe chuck. Never use a file without a handle. When filing, always have the sleeve of the left arm rolled up far enough to avoid all danger of catching in the revolving parts.

Do not start a chuck on the spindle with the machine running; do it by hand. It is also better to start the chuck, when removing it from the spindle, by hand rather than by power.

Do not touch a running gear with your fingers under any circumstances.

Do not rest your hand idly on the compound rest; it may be squeezed between the rest and the chuck jaws.

Lathes, used for turning off the surfaces of electric motor commutators, for example, requiring a high speed, should be fitted with a mica shield placed on the tool-holder and bent over in an arc, so as to cover the point of the tool on the work, thus preventing chips from flying into the workman's face.

Keep the countershaft well oiled to prevent the lathe from starting up when the belt is on the idle pulley.

### Rules for Milling Machine Operators

Do not put on or take off the milling machine arbor nut by applying the power of the machine.

Do not wipe chips from revolving cutters with the finger or with a measuring scale, and use a brush only on the "off" side of the cutter. In general, do not clear chips away from the work or cutter while the machine is running. Even if a brush is used it is very easy to injure the fingers.

Do not leave a wrench resting on the vertical drive-pulley of a vertical miller. This is a thing that is often done. When the machine is started the wrench is hurled past (at best) the operator's head.

Do not reach across the table while the cutter is running, to regulate the oil-feed; step around to the proper side.

Using a dull, thin cutter, especially on very hard material, is dangerous.

### Rules for Drill Press Operators

In drilling large holes, the work should always be clamped or strapped to the table of the machine or held securely in some other way. Bolt down all work that cannot easily be controlled by hand.

Oil or chips should not be wiped from the drill or work when the machine is running.

Drill operators, both male and female, should wear a cap to prevent the hair from catching in the spindle. Grave accidents have happened to women in this way.

If the drill gets "caught" in a piece of work on the drill-press table and the work is whirled around the table, do not try to stop it with the hands, but shut off the power of the machine immediately.

If a drill slips in a chuck while drilling, do not try to tighten the chuck by clasping it in the hand while it is in motion. Stop the machine and tighten the chuck properly with a spanner wrench.

Do not insert the drill drift for removing the drill until the machine comes to a full stop.

Make sure that circular tables are tightened, before beginning to drill.

Using waste, a file or any piece of metal, to pull chips from a fast running drill, should be avoided. Use a pine stick.

Do not remove parts of a broken drill with a center-punch and hammer. It is dangerous for the eyes.

### Rules for Planer and Shaper Operators

Place safety dogs at each end of the planer table to prevent its running off.

When shifting a planer dog be sure that you have plenty of time to do it.

Do not reach under the cross-rail, when the bed is in motion.

Keep your fingers away from the rack feed, if it happens to exist.

When the stroke allows the work to project above the cross-rail, be careful with the planer dogs and yourself, when the bed is in motion.



Do not put the hand between the table and the lower framework of the machine when it is in motion.

On shapers, never take a chance on wiping a chip from the tool when the machine is in operation.

Be sure that the shaper vise is clamped securely to the table to prevent it from being brushed onto the floor.

Be sure that a vise, capable of turning or swiveling, is tightened, before you begin to cut.

Do not try to hold a piece, say 18 inches high, in a vise whose jaws have a depth of 2 inches, and then try to take a heavy cut.

Have plenty of room between the ram, at its maximum rear stroke, and any immovable object.

Be sure that the last man using the shaper tightened the head. You may injure yourself, trying to prevent damages.

When a shaper head has been set over, on a short stroke, outside the housing, do not shift to a long stroke before satisfying yourself of clearance between the head and the housing.

#### Rules for Slotter Operators

Not frequent, but serious accidents occur, due to forgetfulness, when the ram nearly touches the work on the down-stroke.

When the ram is up and you are about to start the machine, be sure the tool clears the work. Better lower the ram before putting in a tool.

If you have left a tool in the air for a time on the up-stroke, and then return to the machine, do not start it until you are sure that no movement of the table has occurred.

On the slotter, use a long-handled brush for cleaning away dust or oil from the lines on the work.

#### Rules for Boring Mill Operators

Tools or metal pieces of any sort should not be left in the T-slots of boring mill tables. They might fly out.

Do not reach under the cross-rail while the table is in motion.

Pulling up chuck jaws while the table revolves is dangerous unless the table runs very slowly.

When the work nearly reaches the limit of the swing, accidents sometimes occur between the work and the housing.

#### Rules for Grinding Machine Operators

Heavy spectacles should be worn by emery-wheel operators for protection of the eyes.

Before using an emery wheel, test the soundness of it by tapping it. If there should be a crack in it, it will sound "dead" for a short distance about the crack.

Do not use a grindstone that is badly out of true. Be sure that the tool rest is as near to the stone as possible.

A piece of leather should be attached to the top of the opening of the hood of each emery wheel and so adjusted as to extend down close

to the surface of the wheel. This serves to confine the sparks and dust to the hood and to protect the eyes of the operator.

On emery wheels sixteen inches or more in diameter, the rest should not be set more than two inches below the center of the wheel. On wheels less than sixteen inches in diameter the rest should be placed less than two inches below the center. In all cases the rest should be high enough to make it certain that the work will not get caught in such a way as to break the wheel.

In putting a wheel on an arbor, care should be taken to see that the wheel does not bind; it should never be forced on, but should be an easy fit.

Mounting wheels between flanges that bear unevenly when the nut is tightened is dangerous.

Screwing nuts against wheels not having flanges is not allowable.

Do not allow the arbor to become loose, due to wear.

Keep the wheel true with an efficient wheel dresser.

#### General Rules for Machine Operators

Do not wear jewelry on your hands in the shop.

Before starting, the operator should look carefully over the machine each morning to see if everything is in good working order.

In general, never wipe on or near the running parts of a machine when it is in motion. Shift all belts with a rod rather than by hand. On motor-driven machines take care where the hand is put when throwing the switch.

Do not try to feel the edge of your tool during the reversing stroke on a slotter, planer or shaper; rather stop the machine.

Do not measure or caliper work while the machine is in motion.

Do not start the machine until you are sure that the work is securely clamped in place.

Do not try to tighten the clamps or set-screws while the machine is in motion.

Do not attempt to set the cutting tools while the machine is in motion.

To prevent injury from the end of a rod extending from a screw machine, cut out a piece of light colored cardboard not less than four inches square, make a small hole in the center, and force it onto the end of the stock. This will attract attention.

If waste is caught on a nut, tap or screw, do not attempt to withdraw it while the machine is running.

Pieces of steel which may get into the eye should be removed at once to avoid serious injury.

#### General Rules for the Machine Shop

See that the handles on such tools as files, chisels, hammers, etc., are kept tight and in good repair.

When doing special work above other workmen, notify those underneath; and when doing special work underneath other workmen, notify those above.

When erecting large pieces of machinery, do not throw nuts, bolts or tools from man to man; hand them back and forth.

Do not drop articles from the top of large machines, as they may injure a workman beneath.

When stripping or erecting machinery, before removing one part see that all other parts are held safely.

Avoid the use of nearly stripped bolts and nuts.

When chipping, provide yourself with a mask and eye shield, and see that the tools are not battered, thereby preventing chips from injuring you.

When the head of a cold chisel or punch begins to overlap, grind off the edges, as they may otherwise cause injury to the hand. Do not make a center punch by grinding a round file down to a point. Owing to the brittleness of the file it is liable to break off when struck with a hammer. Do not use an old file as a cold chisel.

When it is necessary to cut off the heads of rivets or to chip brittle substances like cast iron, place a shield to protect other workmen from the flying pieces.

See that the path of your hammer is clear before starting to swing a sledge.

When you complete a job, do not leave tools or material lying overhead. Tear down all temporary scaffolds as soon as you are through with them. Do not allow boards with nails sticking up to lie around anywhere. Many men have been injured by a piece of board lying on the floor with one or more nails in it with the point upward; usually such pieces can be put in a safe place with but little trouble, if the habit is formed.

After repairing machinery, always replace safeguards before leaving the job.

Do not pile any material so high that it is liable to fall.

In storing long bars or poles or pipes, they must never be stood in a perpendicular position, but always given slant enough to make it certain that they will not fall over.

If it can be avoided never stand with your face in line with swiftly moving revolving parts.

Do not use defective machinery and tools until repaired.

Do not use weak or defective ladders, or those that have been spliced to increase their length.

#### Belting

Never throw a belt that you are not familiar with over by hand. Examine it carefully first.

Do not attempt to stop a machine by grabbing the belt.

When belts are laced with wire lacings, or any lacings containing metal, take care that no projecting ends are left. Inspect the lacings occasionally to see that the metal lacings have not worn so that they leave a projecting end on either the inner or outer edge of the belt.

When it is necessary to put on a belt, stop the machinery or reduce the speed one-half.

When an overhead belt is caught and begins to wind around the shaft, do not try to release it, but get away from it and have the power shut off immediately. If the belt on an overhead pulley is thrown on by the hand, always pull the belt towards you.

When putting on a belt connecting the countershaft to the main line, put the belt on the countershaft pulley first and then throw it onto the main line pulley.

When throwing off belts, never allow two belts to occupy the same space between two pulleys on the driving shaft.

In replacing an overhead belt upon a pulley while it is in motion, a pole should be used, and the length of the pole should be nearly equal to the distance of the pulley from the floor, thus forcing the man to hold the pole at his side instead of in front of him. A short pole held in front is dangerous. If the belt is too high to be handled with a pole, and it is necessary to use a ladder, the ladder should be placed on the side of the pulley opposite the belt.

Do not lean the end of the ladder against a moving shaft, but rest the end on a stringer or beam.

Do not place a ladder between two shafts to adjust a belt; place it on the outer sides.

After having tightened the clutch fingers, or other parts of a countershaft, do not leave any tools on the stringers overhead as the vibration will cause them to fall down.

#### Cranes and Hoists

When transferring a chain hoist about the shop, extreme care should be taken not to collide with the moving parts of some machine or with some workman who may not be aware of its approach.

Do not exceed the safe load given by the maker for cranes or jacks.

Do not work underneath loaded cranes unless absolutely necessary.

Do not carry a load on the crane directly over the heads of other workmen.

Do not place the hands on top of the parallel blocks when the crane is lowering a piece onto the machine table. If it is necessary to move a block, do it either with a hook or by placing the hands at the sides in such a way that if the load is lowered suddenly or anything slips, the hands are clear.

Subject cables, chains and slings to frequent inspection.





YC 53944

TJ7.  
M3  
K140

347604

machinery's

UNIVERSITY OF CALIFORNIA LIBRARY



# MACHINERY'S HANDBOOK

For MACHINE SHOP  
AND DRAFTING-ROOM

---

A REFERENCE BOOK ON MACHINE  
DESIGN AND SHOP PRACTICE FOR  
THE MECHANICAL ENGINEER,  
DRAFTSMAN, TOOLMAKER AND  
MACHINIST.

---

MACHINERY'S Handbook comprises nearly 1400 pages of carefully edited and condensed data relating to the theory and practice of the machine-building industries. It is the first and only complete handbook devoted exclusively to the metal-working field, and contains in compact and condensed form the information and data collected by MACHINERY during the past twenty years. It is the one essential book in a library of mechanical literature, because it contains all that is of importance in the text-books and treatises on mechanical engineering practice. Price \$5.00. (£1).

## GENERAL CONTENTS

Mathematical tables—Principal methods and formulas in arithmetic and algebra—Logarithms and logarithmic tables—Areas and volumes—Solution of triangles and trigonometrical tables—Geometrical propositions and problems—Mechanics—Strength of materials—Riveting and riveted joints—Strength and properties of steel wire—Strength and properties of wire rope—Formulas and tables for spring design—Torsional strength—Shafting—Friction—Plain, roller and ball bearings—Keys and keyways—Clutches and couplings—Friction brakes—Cams, cam design and cam milling—Spur gearing—Bevel gear—Spiral gearing—Herringbone gearing—Worm gearing—Epicyclic gearing—Belting and rope drives—Transmission chain and chain drives—Cane chain—Dimensions of small machine details—Speeds and feeds of machine tools—Shrinkage and force fit allowance—Measuring tools and gaging methods—Change gears for spiral milling—Milling machine indexing—Jigs and fixtures—Grinding and grinding wheels—Screw thread systems and thread gages—Taps and threading dies—Milling cutters—Reamers, counterbores and twist drills—Heat-treatment of steel—Hardening, casehardening, annealing—Testing the hardness of metals—Foundry and pattern shop information—The welding of metals—Autogeneous welding—Thermit welding—Machine welding—Blacksmith shop information—Die casting—Extrusion process—Soldering and brazing—Etching and etching fluids—Coloring metals—Machinery foundations—Application of motors to machine tools—Dynamo and motor troubles—Weights and measures—Metric system—Conversion tables—Specific gravity—Weights of materials—Heat—Pneumatics—Water pressure and flow of water—Pipes and piping—Lutes and cements—Patents.

---

---

MACHINERY, the leading journal in the machine-building field, the originator of the 25-cent Reference and Data Books. Published monthly. Subscription, \$2.00 yearly. Foreign subscription, \$3.00.

THE INDUSTRIAL PRESS, Publishers of MACHINERY

140-148 LAFAYETTE STREET

NEW YORK CITY, U. S. A.