

SAN FRANCISCO OAKLAND BAY BRIDGE

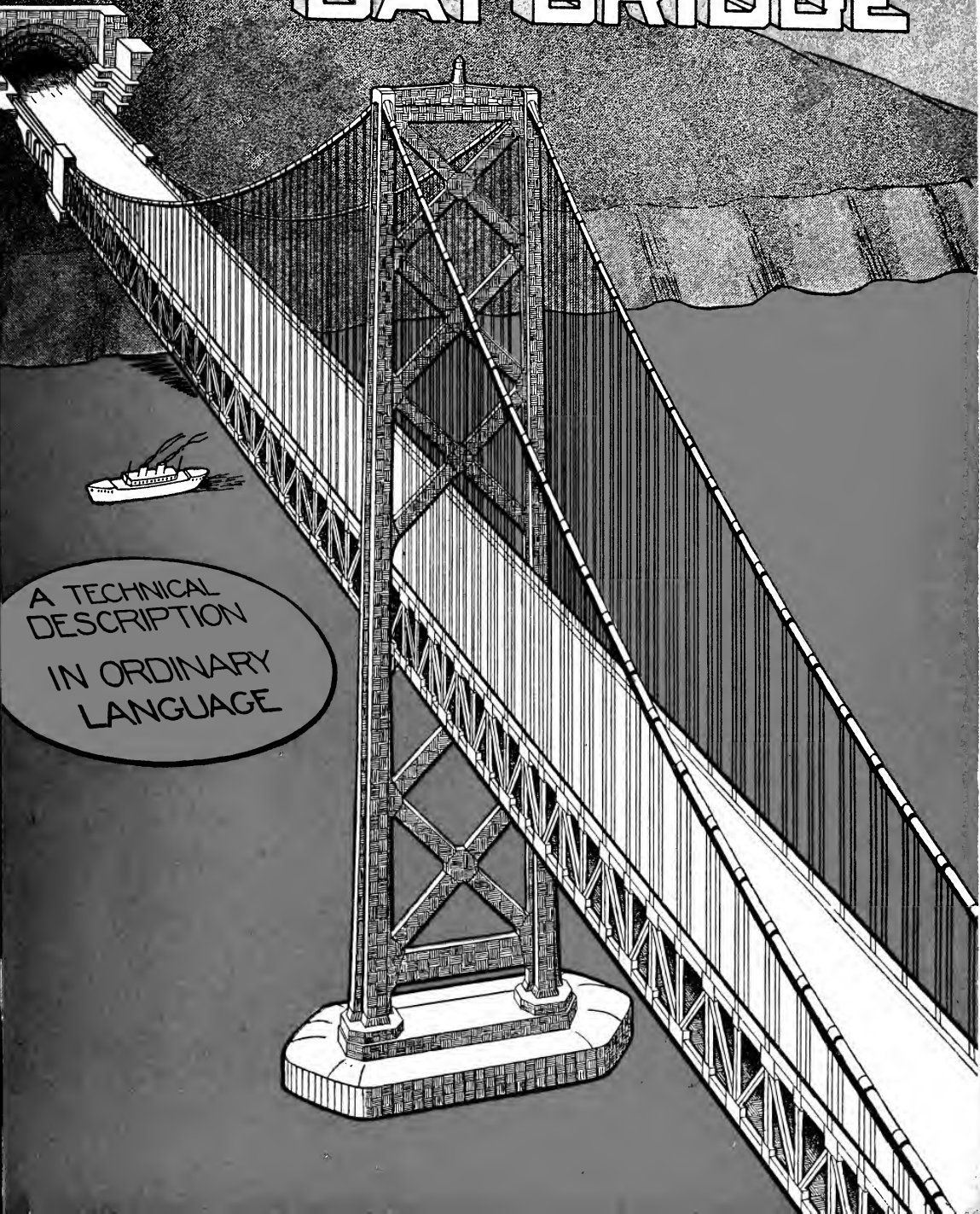

A TECHNICAL
DESCRIPTION
IN ORDINARY
LANGUAGE

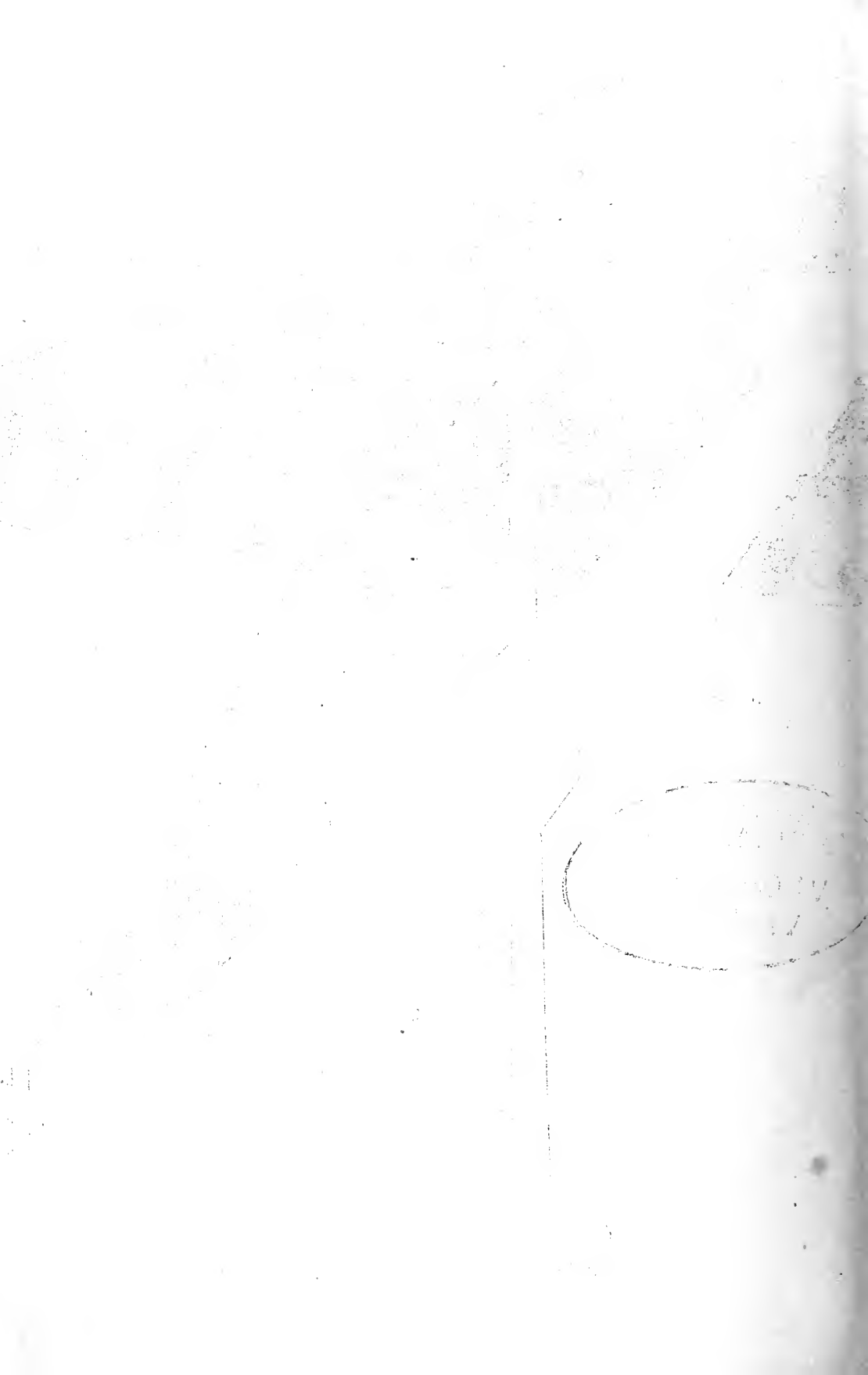

THE SAN FRANCISCO OAKLAND BAY BRIDGE

A Technical Description in Ordinary Language

In ancient times, history informs us, there were seven wonders of the world. In more recent times, various lists of the "seven modern wonders" of the world have been compiled. Seven times seven would not suffice to enumerate the modern wonders that are to be found in almost every part of the activities of every day life as we know it today. However, the San Francisco Oakland Bay Bridge is one of the more spectacular wonders of the modern world, and for that reason has attracted widespread interest. Its size, being the largest in the world, has attracted the attention, not only of the local residents, but that of people from all over the world.

This widespread interest has thrown the spotlight of publicity on a branch of the engineering profession that ordinarily is buried in obscurity, since the largest percentage of bridges built are located anywhere but in the heart of a city. Of all the various types of bridge construction possible, the building of a cable suspension bridge probably impresses the layman the most. Likewise, the principles involved in its construction are probably the most difficult for him to grasp.

This book is therefore offered to those members of the general public who desire to know something about the construction of this great bridge, and yet are unfamiliar with the principles made use of by the engineer as he pursues his labors. Engineering is a highly specialized profession, and since it is one of precision, higher mathematics and technical phrases are constantly made use of in expressing the principles involved.

In writing this book, the intent was to present the subject in a simple, clear manner that would be easily understood by the average layman. The illustrations, which are the essence of the book, were drawn by the author from sketches made at the bridge site, and have never before been released for publication. The only acknowledgment of assistance proffered and with thanks, is to those readers who purchased the author's first book on this bridge, as well as his Golden Gate Bridge book. There is no intent that this book shall be issued or accepted as an "official" publication. The author hopes that it will be accepted on its own merits.

Copyright 1936, by
E. CROMWELL MENSCH
San Francisco, California.

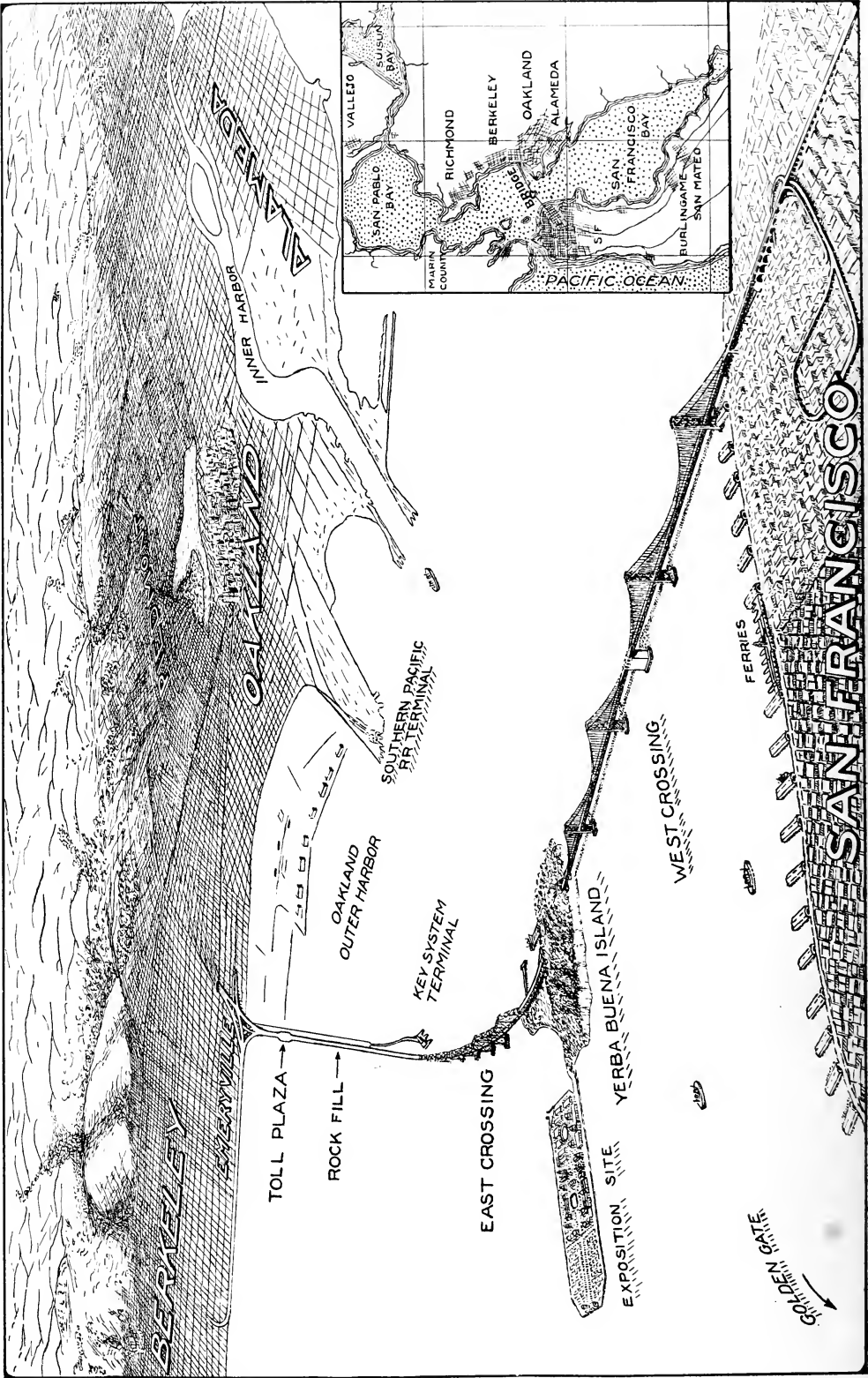

I—THE PROJECT

The building of the San Francisco Oakland Bay Bridge is an engineering project of the first magnitude. Just how far back men thought of building such a structure is problematical, but the records disclose that such a project was proposed some sixty six years ago. Then, as now, the first step necessary was to transform the thought into a set of plans that would form the basis on which to get the project under way. These original plans are known to the engineer as preliminary studies, are used to make preliminary estimates of its cost, to present the project to the financial agencies, and, later, as a basis on which to make more complete and detailed plans.

ITS PRESENTATION

These preliminary studies are in the form of blueprints and reports, which, to an engineer, convey a complete story of just what the undertaking is all about. That the public may get the same conception of a project, it is the usual custom to have an artist prepare a perspective drawing from the blueprints in advance of the actual construction. Such a drawing is shown opposite, and approximates a camera study of the project as it will appear when finished. For those who are not familiar with San Francisco and the "Bay" area, a little map has been inserted at the right hand margin of the drawing. It will be seen that San Francisco lies at the northern tip of a peninsula, and is separated from the "East Bay" cities of Oakland, Berkeley and Alameda by a large body of water, known as San Francisco Bay. Prior to the building of the bridge, the traffic between San Francisco and the east bay cities has been carried on ferry boats, landing at either the Key System or the Southern Pacific R. R. terminals. Interurban trains, running to various parts of the east bay cities, carried the passengers to their destination. Upon completion of the bridge, these interurban trains will be run direct over the bridge into the city of San Francisco.

THE GENERAL LAYOUT

Approximately in the center of the bay is located the Island of Yerba Buena (good pasture), over which the bridge structure passes. Part of this island crossing consists of a tunnel. That part of the bridge that lies between San Francisco and the island, is known as the West Crossing, and consists of two complete suspension bridges, placed end to end. They are joined at the center of the crossing by a center anchorage, which is common to both suspension bridges. That part of the bridge that lies between the island and the east bay cities, is known as the East Crossing. The main feature of this east crossing is a 1400 foot cantilever span, followed by a steel structure that terminates at a causeway, or rock fill, as it is called. Located on this rock fill is the toll plaza, and, beyond, an overpass system that distributes the traffic to various arterials leading away from the bridge head. The population of the bay area, which the bridge is designed to serve, is estimated at 1,500,000. The amount of travel passing across the bay on ferry boats, in round figures, was placed at 4,000,000 vehicles and 50,000,000 passengers, per year. The estimated capacity of the bridge is placed at 25,000,000 vehicles and 50,000,000 passengers per year. Depending on their destination, the ships passing under the bridge, may use either the channel under the West Crossing, or under the East Crossing where it is spanned by the cantilever structure. The City of Oakland, through the enterprise of its civic organizations, has developed both an inner harbor and an outer harbor, as shown in the drawing. The location of the exposition site is also shown.

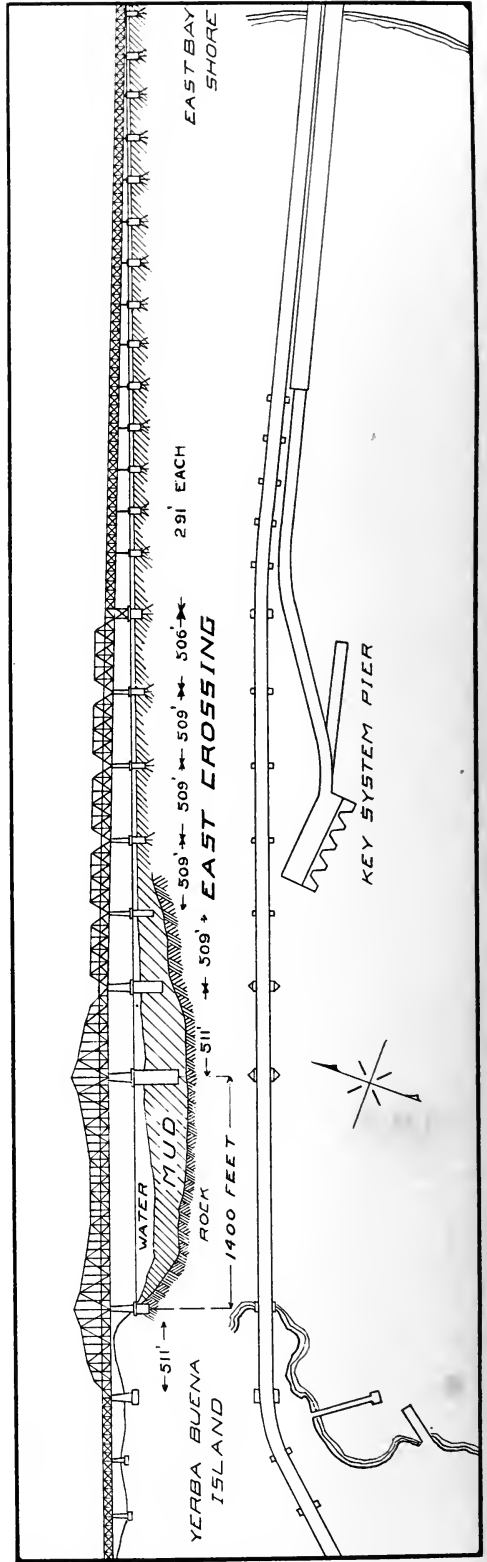
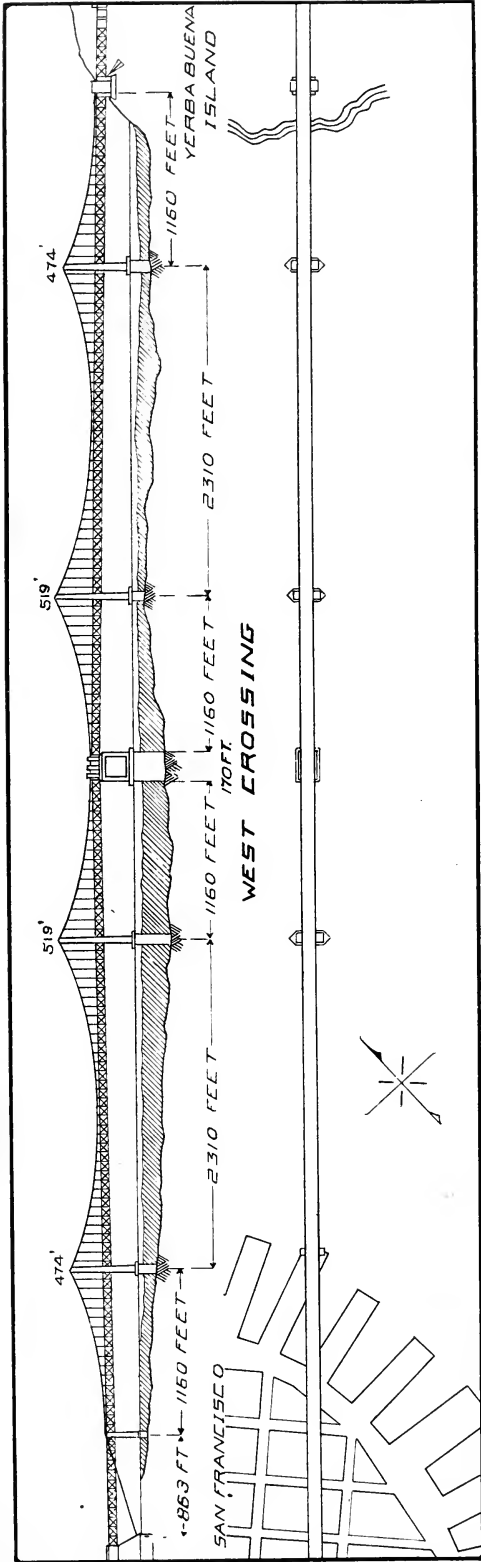

II—THE PLAN OF THE BRIDGE

The upper half of this plate shows the West Crossing of the bridge; the upper portion being a side elevation, or, as it would appear to an observer looking north. Just below this is a plan view of this crossing, looking down from above. The lower half of the plate shows the East Crossing, likewise in elevation and plan. If the two halves of this plate were placed end to end, Yerba Buena Island would be interposed in between the two. In designing the bridge, a great many factors had to be taken into consideration, such as the length of the crossing, the clearance, or space to be allowed for ship channels, depth of foundations, etc. Alternate plans were submitted for this West Crossing, and this plate shows the final plan as accepted. It consists of two separate suspension bridges, joined end to end. As its name implies, a cable suspension bridge is one where the bridge, or roadway of the structure, is suspended from cables by means of ropes. The cables in turn are strung across the tops of two or more towers. The weight of the roadway exerts a pull, vertically downwards, on the ropes from which it hangs. These ropes, called suspender ropes, in turn, exert a downward pull on the cables. Since the cables are strung out in a more or less horizontal direction, this downward pull from the suspender ropes is transformed in the cables to a horizontal pull, or, more properly, a pull that is parallel to the axis of the cables. The ends of the cables are secured to enormous blocks of concrete, known as anchorages, that resist this pull of the cables. Where the cables pass over the tops of the towers, the weight sustained by the cables is transformed into a vertical, downward, pressure on the towers. Since this design called for two such suspension bridges, there were two sets of towers, and two sets of anchorages. The anchorage placed at the point where the two bridges are joined is called the center anchorage, and is common to both bridges.

EAST CROSSING DESIGN

There were several alternate plans also prepared for the East Crossing, among which was a cable suspension design. However, the design finally adopted is the one shown in this plate. Unlike the suspender ropes and cables of a suspension bridge, which are quite flexible, the East Crossing structure is composed entirely of rigid steel members. This East Crossing is made up of three separate types of bridges. Immediately to the east of the island, and over the ship channel, it consists of a structure known as a cantilever span, which is more fully described in Plate XXIV. To the right of the cantilever are five smaller truss spans, of the railroad type; and to the right of these the bridge consists of flat, steel, truss spans. As will be noted in the plan view of this East Crossing, the bridge makes a slight turn to clear the Key System pier, and on the island, it makes another turn in order to line up with the general direction of the West Crossing, beyond the tunnel.

WEST CROSSING DESIGN

In selecting the type of structure for the West Crossing, the ship channel clearances were of prime importance. When a bridge of the suspension type was decided upon, a design for a single span, with a clear space between towers of 4,100 feet, was submitted. In that design the ship channel next to the San Francisco shore would have been located west of the first tower, and would have been only 1900 feet wide. In the design adopted, as shown here, the width of the ship channel adjacent to the San Francisco shore is 2310 feet wide. Had the other design been adopted, it would have

been necessary to demolish two steamship docks to accommodate the anchorage. The bridge as built, takes up but a comparatively small space on the end of only one dock. The cost of this single span suspension bridge would have increased the cost by \$3,000,000. The design that was adopted had the least number of objections, and the only unusual feature that called for a departure from ordinary design, is the center anchorage. The roadway capacity of a bridge depends on its width, the wider the bridge, the more lanes of traffic it can accommodate. However, for extra width, it is required that the floor beams, supporting the roadway, be made stronger and heavier. An economy in weight was effected in the design adopted by making use of two decks, one above the other. Since a bridge over a harbor must have enough vertical clearance to permit ships to pass under it, the ends of the bridge, or approaches as they are called, must be built on a grade in order to bring the deck over the ship channel to the proper height. By placing the trucks and electric trains on the lower deck, obviously they do not have to climb to as great a height as they would on the upper deck. In addition, automobiles, being lighter, are better adapted to climbing a steeper ramp, such as is provided at the San Francisco end. It is hoped that no one suggests that the upper deck affords a better view, for there are enough jay drivers as it is. As is shown in Plate XXVI, there are three truck lanes, one for each direction of travel, and the third for passing. Had the two train tracks been placed in the center of the lower deck, this passing lane for trucks could have been utilized for only one direction of travel. Had the truck lanes been placed in the center, the tracks would have been split, and any switch-backs the trains might have had to make on the bridge would have blocked the truck traffic.

TWIN SUSPENSION SPANS

Referring to the drawing, it will be seen that the bridge between the center anchorage and the island consists of two towers, over which the cables have been strung. The structure between the two towers is known as the Center Span; and, between the tower and anchorage, at either end, is known as the Side Span. The center span is 2310 feet long, while each side span measures 1160 feet. Between the center anchorage and San Francisco, the bridge also consists of a 2310 foot center span, and two 1160 foot side spans. The San Francisco anchorage, however, is not located at the end of the west side span, but sets back some 863 feet. A third tower, but much smaller, was therefore placed at the end of that side span, and its function is explained in Plate XX. The vertical clearance, or distance above the surface of the water, at the two 474 foot towers, is 185 feet; while adjacent to the center anchorage this clearance reaches a maximum of 227 feet. All ordinary ships will pass under a 185 foot clearance. Should bigger ships be built, or should the few existing ships with a greater height find occasion to pass under this bridge, they could do so at the center anchorage. To elevate the bridge to this clearance at the center anchorage, the two adjacent towers are 519 feet tall. These tower heights include the "gingerbread," or ornamental treatment at the top, as well as the beacon lights installed on the top thereof.

THE CURVES OF THE BRIDGE ARE PLEASING

By holding a straight edge under the roadway in this drawing, this elevation at the center anchorage is shown very clearly. To obtain it, the roadway is built on a 3% grade from the approaches to a point about $\frac{1}{3}$ out into the center spans; from these points to the center anchorage, the decks

assume an upward curve somewhere between a parabola and a catenary. In ordinary bridges, this upward curve, known as the camber of the bridge, is designed to place the longitudinal members of the deck above the horizontal. When the deck is loaded, these members support the load in compression. Were they permitted to fall below a horizontal position, these longitudinal members of the deck structure would be placed in tension, which they are not always designed to withstand. In a suspension bridge, however, this distortion from loading is distributed lengthwise in the stiffening truss, as it is called, and indicated in this drawing by small crosses at the bottoms of the suspender ropes. Owing to the length of the spans in this bridge, this distortion is mostly absorbed into the cables and stiffening trusses before reaching the ends of the span. This subject is more fully treated of in Plates XIX and XX. Although the subject is controversial, some engineers maintain that the upward curve placed in a suspension bridge is for the sake of appearances only. The cables sag down 231 feet at the mid-span point in the center spans, the function of this sag being explained in Plate XII.

AN OPTICAL ILLUSION

To the eye, the $2\frac{1}{4}$ inch suspender ropes seem altogether too small in proportion to the size of the $28\frac{3}{4}$ inch main cables. These suspender ropes are spaced approximately 30 feet apart, and correspond to the length of the stiffening truss panels. The roadway being 58 feet wide, a rectangular length of roadway, 30 x 58 feet would contain 1740 square feet. The number of vehicles that could be placed in a space 58 x 30 is rather limited, and it is only the weight of the vehicles in a space of this size, on both decks, that each group of suspender ropes is called upon to support. There are 77 of these 30 foot spaces, or panels, in 2310 feet of length. If the number of wires in each cable, 17,464, is divided by 77, the quotient is 227. If there were only one 30 foot length of roadway suspended between the towers by two cables, each containing 227 wires, the optical illusion that the suspender ropes are too small would disappear. It is customary to measure the load coming upon a bridge in pounds per lineal foot. The trusses in this bridge are designed for a live load of 7,000 lbs. per lin. ft. There are several factors used in fixing the load for which the bridge is designed, but they are rather technical. The greatest concentrated loads will be the interurban cars of 70 tons weight, on the lower deck. The upper deck will be restricted to passenger vehicles, but it is designed to support a 10 ton truck at any one point, with the other lanes also loaded. The wind load is calculated at 30 lbs. per sq. ft. on the structure, with an additional 500 lbs. per lineal ft. on the vehicles, or live load. Under extreme conditions, this wind loading is calculated to deflect the mid-span point 10 feet out of normal. The dead weight of the cables is 1750 pounds per lineal foot, each. The dead weight of the suspended structure is calculated at 10,000 lbs. to the lineal foot.

CONSTRUCTION ACTUALLY COMMENCED IN 1933

After the final design and plans had been approved, bids were called for, and in April 1933, contracts were awarded, covering the six major parts of the bridge. Actual work was started in July 1933, the intervening period being required by the contractors to assemble material and equipment. A great deal of preliminary work was done prior to the awarding of the contracts, and this work dates from 1929, when the state legislature passed an enabling act. This enabling act gave the engineers authority to proceed with the preliminary studies, and to undertake the necessary work that would pave the way for actual commencement of the project.

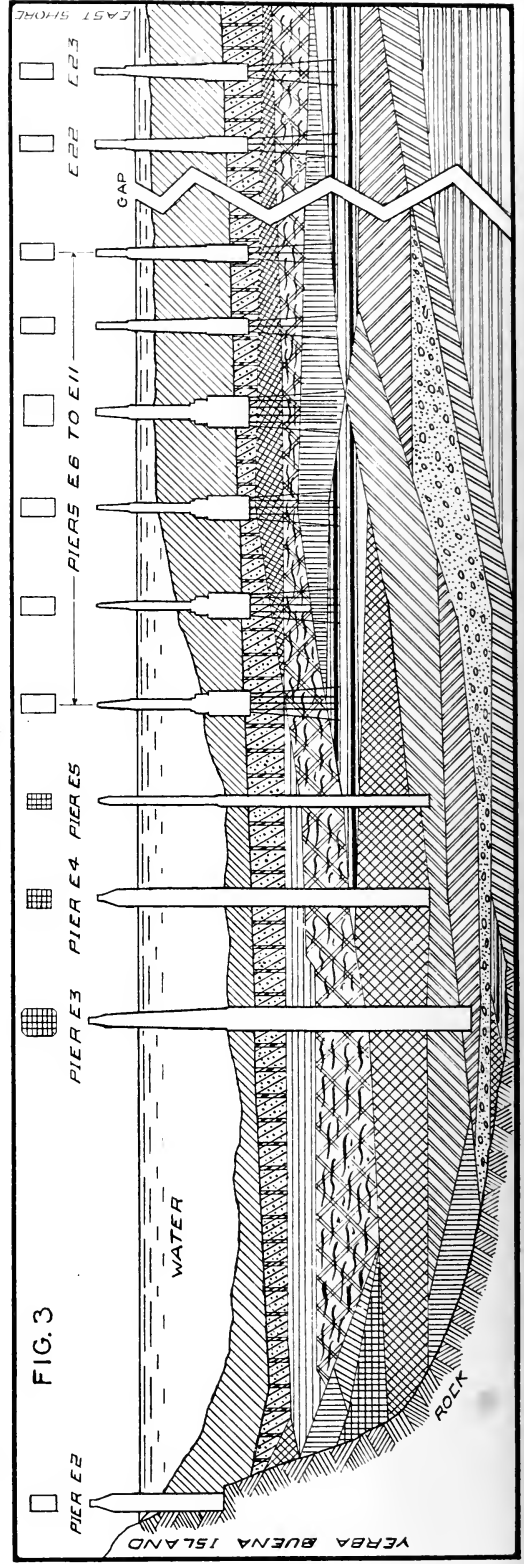
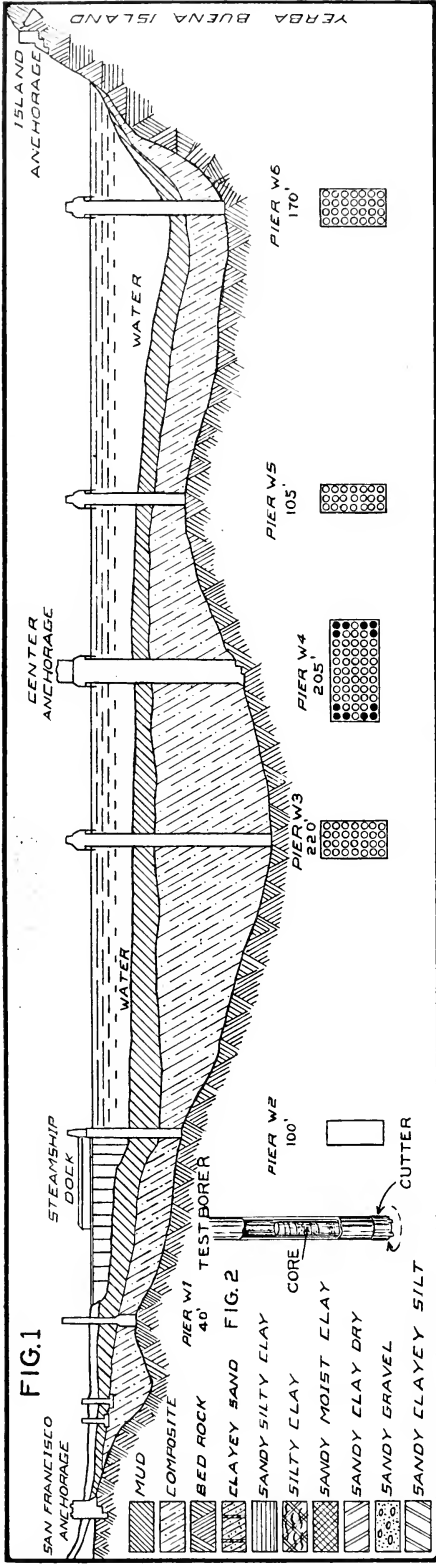

III—FOUNDATION STRUCTURES

Fig. 1 of this plate is a profile drawing of the west crossing, and Fig. 3, a profile drawing of the east crossing. By profile drawing is meant a cross section, showing the underlying strata. It is not unlike the cutting through of a loaf of bread, in order to expose the composition of the interior of the loaf. A profile drawing of this nature was made up prior to the drawing up of the final plans for the bridge. These profiles are an index to the character of the underlying strata on which the foundations are placed. Had such a profile indicated unfavorable conditions, a new location would have been selected. Such a new location might have made it necessary to draft an entirely new set of bridge plans. For, if the foundation conditions at some other location had not permitted of the towers being placed at the same distance apart, it would have been necessary to change the character of the bridge design in order to accommodate the new spacing.

TEST BORINGS

These profile drawings are made up from the logs of test borings, made at the site of the intended location of the foundation structures. Fig. 2 illustrates the manner in which these test borings were made. A barge, loaded with the necessary equipment, was towed out to the tentative location. From this barge a casing, or large pipe, was lowered down into the water until its lower end sank into the mud. Inside of this casing a smaller pipe was lowered, equipped at its lower end with a cutting head. The business end of this cutter was studded with diamonds. As this inner pipe was rotated by suitable machinery on the barge, the cutter in turn was rotated. As it cut its way down into the rock and other strata, a core was left inside of the pipe. At stated intervals this cutter, with its core inside was hoisted up to the deck of the barge. The depth to which the cutter sank was carefully entered in a book called the "log," and the cores carefully labeled and preserved. The profile drawings were then made up from the data contained in the log, and the cores enabled the engineers to plot the true character of the strata on these profile drawings.

WEST CROSSING PIERS REST ON BEDROCK

To the left of Fig. 2 is the key to the various strata that are shown in Figs. 1 and 3. The foundation structures of a bridge are called piers. Since all of the piers in the west crossing were carried down to bedrock, the nature of the intervening strata is simply indicated as "composite." To reach bedrock it was necessary to sink these piers to a depth never before reached in a structure of this kind. In fact, a previous report had declared that it was not feasible to sink foundations to such depths as these, and recommended that a different site be selected. Of the several methods used in sinking foundation piers, the two general types most commonly employed are known as "open cofferdams" and "caissons." A description of an open cofferdam will be found in Plate VI, and that of a caisson in Plates IV, V and VI. In this west crossing, four of the foundation piers were sunk by means of caissons, four by means of an open cofferdam, and the excavation for the San Francisco Anchorage effected by means of the open pit method. That is, in excavating the site for the anchorage, steam shovels were used without the use of any substructure. Owing to the number of foundation piers constructed in the building of this bridge, 51 in all, each pier was designated by a number. In the west crossing, the prefix "W" was used, and in the east crossing, the prefix "E" was used. To more clearly illustrate the substructures, the scales used in these drawings are somewhat distorted.

WEST CROSSING PIERS

Pier W-1 of Fig. 1 is located just east of Spear Street in San Francisco, and was sunk 40 feet to bedrock by means of an open cofferdam. As the waterfront used to come up this far, several piles that were part of an old steamship dock were encountered in sinking this pier. They had to be removed by sawing off small lengths during the sinking operation. Pier W-2, at the end of a steamship dock on the Embarcadero, San Francisco's waterfront, was sunk by means of an open cofferdam. A timber frame, measuring 56 x 112 feet, was first sunk at this site. Sheet steel piling was then driven all around this frame so as to form a rectangular "box," open at the top. The interior of this cofferdam was then excavated by means of clam-shell buckets, removing all mud and sand above bedrock. The total depth here was 100 feet. After the interior was cleansed of all mud, the cofferdam was filled with concrete in a solid mass to a level of 9 feet below the surface of the water. The cofferdam was then pumped dry, and the balance of the pier built in the "dry," to a height of 40 feet above the surface.

AN OLD PATENT REVIVED

Piers W-3, W-4, W-5 and W-6 were all sunk by means of a caisson. Although a patent had been issued as early as 1873, covering the essential features of the caissons used here, it is the first time that a caisson embodying these features was used on a major structure of this size. These caissons, which are more fully described in the succeeding plates, consisted of a number of tubes, or wells, each 15 feet in diameter. The ones used in sinking Piers W-3 and W-6 each contained 28 of these wells, as shown in the sectional drawings just beneath the profile shown in Fig. 1. The one used in sinking Pier W-5 only contained 21 wells, as under its location, bedrock was reached at a depth of only 105 feet. Pier W-4 contained 55 of these wells. The other piers support the towers, but W-4 is called upon to support the center anchorage, and consequently had to be made large enough to withstand the pull of the cables that will come upon it. As explained in Plate XIX, the pull on the cables is transferred to a vertical pull in this anchorage at its outer edges. Therefore, the 3 wells on each corner of this caisson were filled solid with concrete to offer more resistance to this pull. The balance of the wells were not filled with concrete. They are, however, connected to the tide water of the bay and will always have water in them to the height of the tide. As a matter of design, the amount of concrete around the outside of the wells is sufficient for the proper functioning of the piers. This same amount of concrete, without the wells, would serve the same purpose. However, the wells increase their lateral dimensions and lateral stability. The weight of the water trapped in the interior of the wells is also a factor in their stability.

RECORD BREAKING DEPTHS

The greatest depth of water in the west crossing is adjacent to Yerba Buena Island, and the caisson for Pier W-6 was sunk in 105 feet of water before reaching the mud line. The depth to bedrock was 170 feet. Although the water at Pier W-3 was only 70 feet deep, the 220 foot depth to bedrock made this the deepest pier of the west crossing. Pier W-4 was sunk to a depth of 205 feet before landing on bedrock. The rock line is of course not on a level, being similar to the rock surface on a hillside. Hence, as one corner of the caisson contacted a high spot in the rock, it sank no further. To bring the concrete to a bearing on the rock under the entire surface of the caisson, further excavations were made after the caissons had stopped sinking. This concrete bonded the caisson to the rock and was known as a seal.

EAST CROSSING PIERS

With the exception of Pier E-2, as shown in Fig. 3, the east crossing piers were not sunk to bedrock. Bedrock to the east of the island slopes sharply downwards, and reaches a depth of 290 feet below the surface of the water under Pier E-3. Were the vertical scale of this drawing not distorted, the rock line would fall considerably below where it is here shown. The depth to which caissons may be sunk are not limited by their mechanical structure, but by the human element. In order to bond the caisson to the rock once it is landed there, it must be sealed to the rock with concrete. If this rock contained pockets of mud, the bond would be ineffective. It would be similar to trying to make paint adhere to a floor from which the dirt had not first been removed. The removal of these mud pockets at the bottom of a caisson is accomplished by directing jets of water under high pressure against the rock; the dislodged mud being brought to the surface by means of pumps. As this is an underwater operation, the discharge from the pump is watched until muddy water ceases to flow. Before pouring the concrete, it is necessary that a diver descend to the bottom of the caisson wells, and examine the bottom for further mud pockets by running his hand over the rock surface. At the depths attained in these caissons, the diver worked in total darkness.

PIERS THAT SERVE AS ANCHORS

Since a diver could not descend to a depth of 290 feet, the sinking of these east crossing piers to bedrock would have been fraught with uncertainty as to whether they would have been properly bonded to the rock. Nor would there have been any guarantee as to their stability, since an actual examination of the surface was impossible. However, at a depth of 235 feet a stratum was found that was capable of supporting the weight these piers would impose, and although even that depth was extreme for a diver, the diving operations were carried out successfully. Piers E-2 and E-3 support the weight of the 1400 foot cantilever that spans the ship channel immediately east of the island. Pier E-2 was carried to bedrock at the 45 foot level. Pier E-3, supporting the east tower of the cantilever, was carried to the 235 foot level, as explained above. Ordinarily Pier E-4, which supports one end of the 511 foot span between it and E-3, could have been much smaller in size. However, as is shown in Plate XXIV, Pier E-4 forms the counterweight, or anchor for the east end of the cantilever, and it was therefore built to the proportions as shown here in Fig. 3. Pier E-1, not shown here, forms the anchor for the west end of the cantilever, and is a land pier.

SMALLER PIERS TO SUPPORT SHORTER SPANS

Progressing towards the east bay shore, the water becomes more shallow, and strata capable of supporting the weight of the bridge and piers is found at lesser depths. The spans between piers from E-3 to E-9 are slightly over 500 feet in length, while the balance of the spans to the east are slightly under 300 feet in length, as shown in Plate II. These conditions naturally do not call for piers capable of supporting as much weight as the piers supporting spans of 1160 feet, 1400 feet, or 2310 feet in length, do. Therefore, the piers from E-6 to E-23 were of a different design, and were sunk by means of an open cofferdam, described in Plate VI. East of E-23, the roadway is brought down to a rock fill. Pier E-5, however, is the exception. At its location, it was necessary to sink it to a greater depth than the piers to the east of it, in order to reach a suitable bearing stratum. Owing to the limits of its size, a gap was left in the drawing between Piers E-11 and E-22; the intervening piers being of the same design and type as those shown.

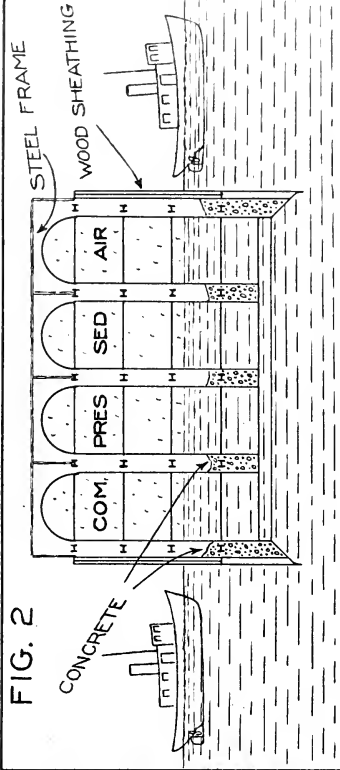

FIG. 2

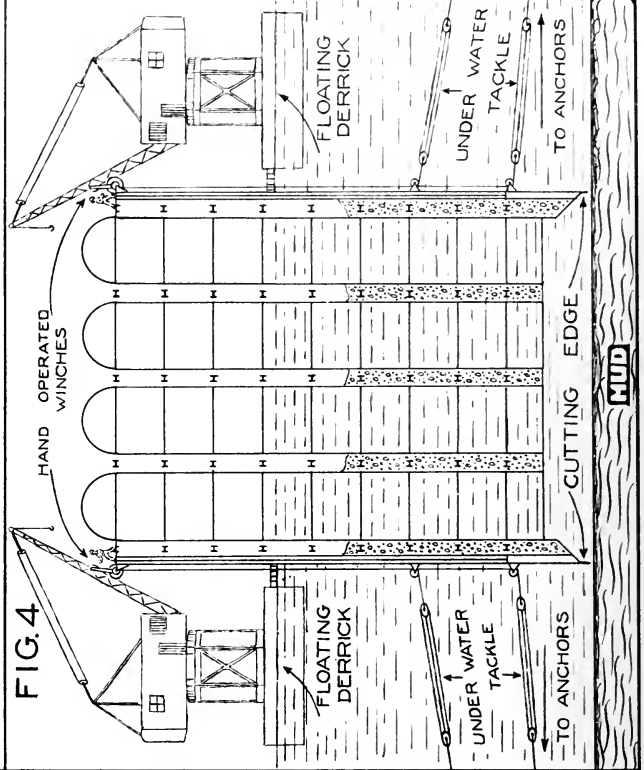

FIG. 4

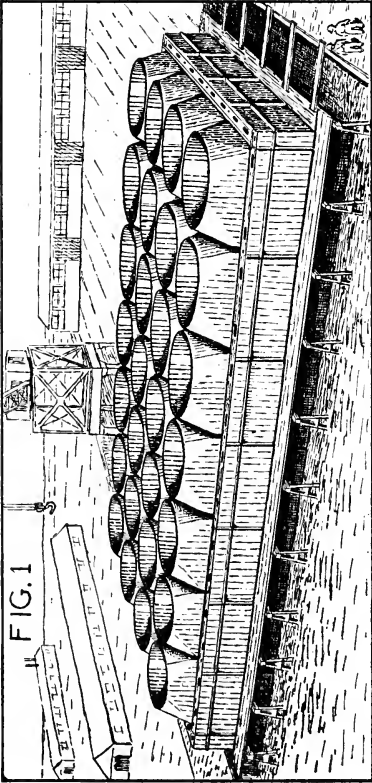

FIG. 1

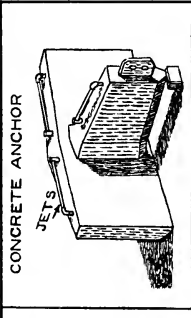
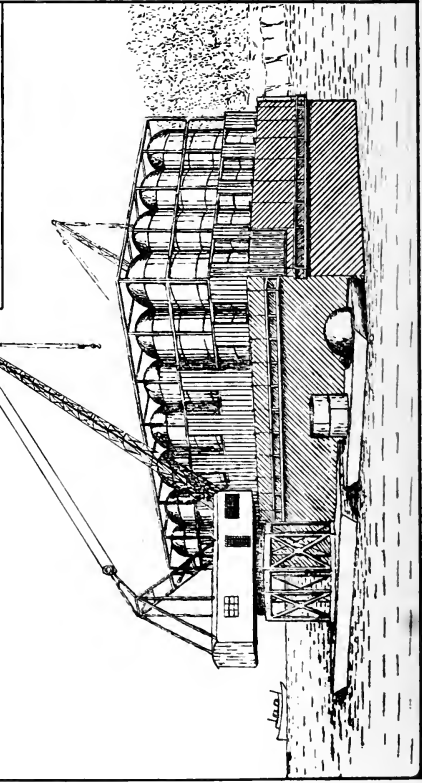

FIG. 3



Hand

IV—WEST CROSSING CAISSONS

A caisson is a structure used for sinking foundation piers. A surface foundation is built, whereas an underwater pier is sunk. Unlike a cofferdam, which is built in place, a caisson is usually built at some distance from the pier site. It is floated, and then towed to the pier site. It is a structure that permits of the excavation of waste material within its confines, and at the same time, serves as a form for the concrete that the pier is composed of. It is capable of being sunk downwards as these operations are performed, and is primarily an underwater device. Fig. 1 shows the base of one of the caissons, used in the west crossing, on the ship ways before launching. It consists of a rectangular steel box, 17 feet high, inside of which are 28 adapters. These adapters are square at the bottom for structural strength, and adapt themselves at the top to the circular cross section of the 15 foot diameter wells that are attached to them. The 17 foot steel sides form what is known as the cutting edge. This base was launched into the water, and then built up to a height of 60 feet by welding sections of the vertical cylinders to the adapters, as shown in Fig. 2. A steel frame work was built up around the outside of the cylinders, and to the outer edge of this frame that was attached to the cutting edge, wood sheathing was bolted. This wood sheathing was made water tight by caulking, and formed the "hull" of the caisson.

SEAGOING BUILDING OPERATIONS

Before towing it to the pier site, its draft, or the distance it sank into the water, was increased by pouring concrete in between the cylinders, as shown. The interior of the cylinders were open at the bottom, which permitted the water to rise within. Domes were welded to the tops of the cylinders, and compressed air forced into the space between the domes and the water. The buoyancy of the caisson could be regulated by the pressure of the air, a higher pressure would increase its buoyancy, and a lesser, reduce it. By increasing the pressure in the cylinders on one side of the caisson or the other, the entire structure could be kept on an "even keel," or in a vertical position. Fig. 3 illustrates the caisson at W-6, where it was anchored by means of concrete anchors, shown in the inset. There were 16 of these anchors attached to the sides and corners of the caisson, the largest weighing 25 tons, measuring 8 feet 10 inches high, and was 9 feet 5 inches long. They were lowered from a barge at a distance from the caisson and caused to sink into the mud by water jets attached to a hose from the barge. The caisson was caused to sink into the water by releasing some of the air pressure, and pouring in additional quantities of concrete. Additional sections of cylinders were then added by first removing the domes, a few at a time. The steel frame was extended upwards, and additional wood sheathing bolted to it, as shown in Fig. 3. Two layers of sheathing were used for strength, the outer layer being laid diagonal.

SUNK TO THE MUD LINE

When a new height had been completed, the caisson was again sunk, and this cycle repeated until it reached the mud, as shown in Fig. 4. As the caisson sank into the mud, its position was maintained by working a set of hand winches at the top, thus pulling the caisson in one direction or the other by means of the underwater tackle attached to the concrete anchors. On account of the depth of the water at Pier W-6, floating derricks were used to place the material, and later for the dredging operations. The caissons sunk at Piers W-6 and W-3 each measured 127 x 75 feet; the one at Pier W-5, 127x57; and the one at Pier W-4, 197 x 92 feet. These dimensions coincide with the size of the finished piers.

FIG. 1

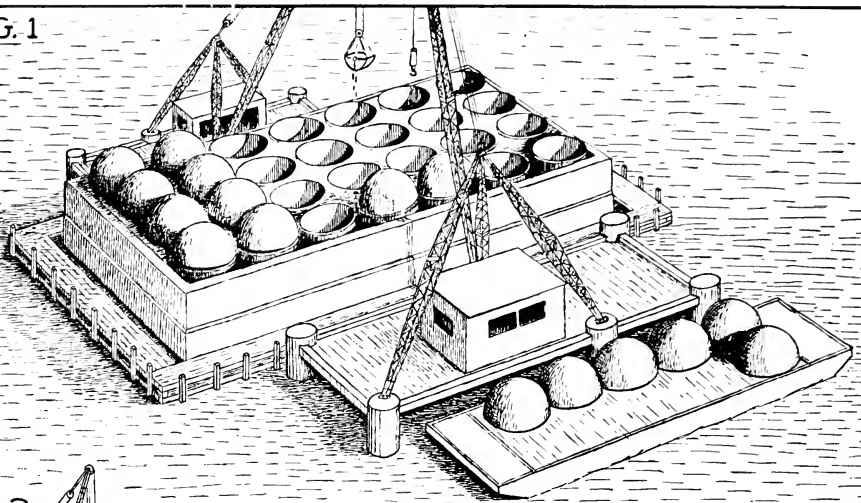

FIG. 2

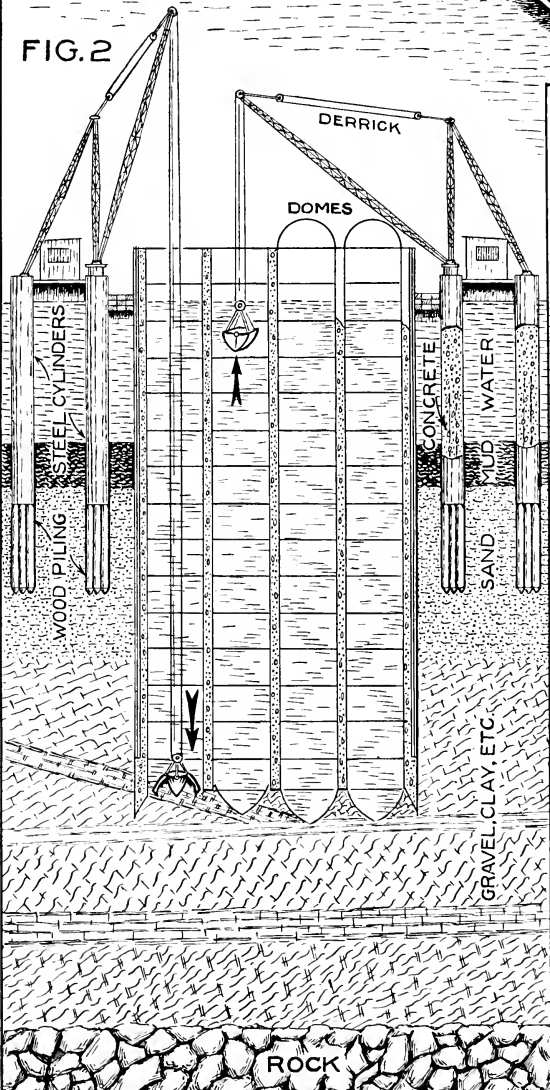
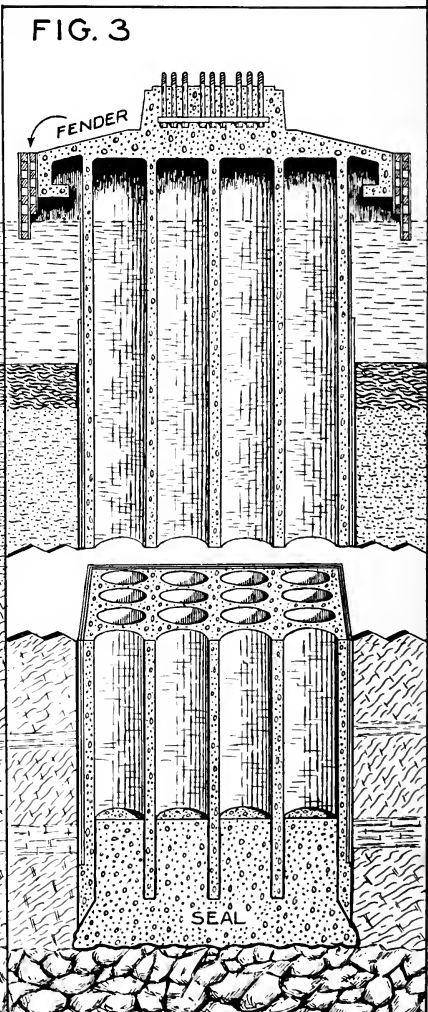

FIG. 3



V—DREDGING OPERATIONS

After the caisson had sunk into the mud, the domes were removed, and dredging operations commenced by dropping clamshell buckets down into the wells. Only a few domes were removed at a time, until the caisson had been sunk to a depth where they were no longer required to control its buoyancy. Fig. 1 is a perspective drawing, showing the general appearance of the top of the caisson, with some of the domes removed. In place of floating derricks, working docks were used for sinking the caissons at W-3 and W-4. The sectional view in Fig. 2 shows the manner in which these working docks were supported on steel cylinders, filled with concrete. They were afterwards removed. This Fig. 2 is a continuation of the sinking operations shown in the preceding plate. The cycle here was the same, except that dredging operations were carried out between the building on of additional sections at the top, and the sinking of the caisson. The derricks were swung outboard and the material dumped overboard, permission having been granted to do this from the harbor authorities.

ENGINEERING SKILL AVERTS DISASTER

In designing these caissons with cylinders in which air could be used to control its buoyancy, and for the purpose of maintaining it in a vertical position, the engineers were prompted by previous experiences where caissons had tipped over and sunk on their sides. At Pier W-6 the wisdom of their judgment was justified. Although floating derricks were actually used at W-6, Fig. 2 shows the reason why that caisson listed over, which seemed at the time to be in danger of tipping over. Under the left hand corner is shown a layer of underlying stratum inclined from the horizontal. It only passed under one side, and consequently left the other side resting on comparatively soft material. This layer of stratum was very tough and sticky, and adhered to the bottom of the "legs" between the wells. It could not be made to flow into the wells where the clamshell buckets could reach it. As a result, the caisson "hung up" on that side, and sank on the other, which caused it to list over at an angle from the vertical. Before this angle had increased to the danger point, this movement was stopped by increasing the air pressure in the wells on the opposite side, and which had their domes still in place. A diver was then sent down, and this tough material washed out from under the "legs" by means of jets. Further dredging on this side slowly brought the caisson again to an "even keel."

FROM CAISSON TO PIER

These dredging and sinking operations were carried out until the caissons had been sunk to the underlying bedrock. Fig. 3 is a vertical section of the finished caisson, or pier, as it has now become. When it had landed on bedrock, divers descended to the bottom of each well. After their inspection had determined that the rock was clean, concrete was placed inside of the wells to a height of 30 feet, by lowering it down in hopper buckets. This formed a seal, bonding the pier to the rock. This Fig. 3 is broken away at the center in order to show a horizontal section. The concrete bulk is equal to half the pier area, and is thoroughly interlaced with reinforcing steel, no little part of which is the steel framework of the caisson. Pipes admit water to the wells, which rises and falls with the tide. The steel cylinders were left in place. As they support neither weight nor concrete, any rusting they may be subject to is immaterial. The tops of the wells were capped over, and this concrete mat at the top forms the base on which the steel of the towers rest. Anchor bolts project above the top surface, and were used to bolt the steel work firmly to the pier. The fender is described in Plate VII

FIG. 1

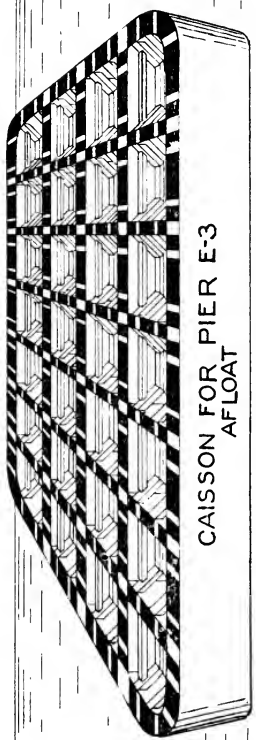

FIG. 3

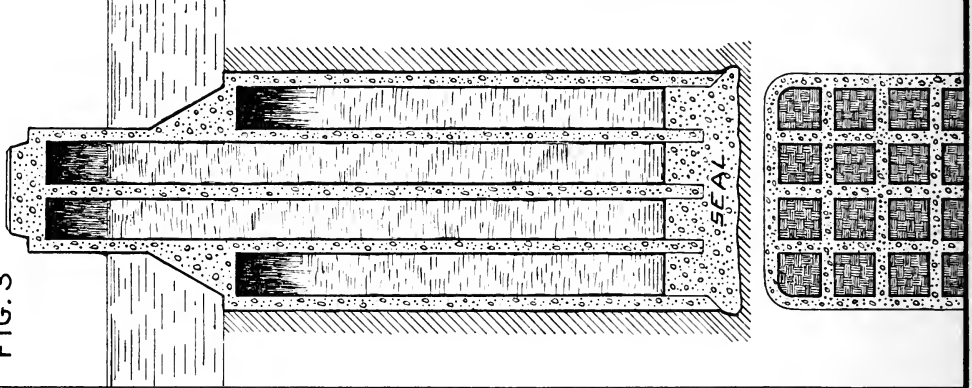

FIG. 4

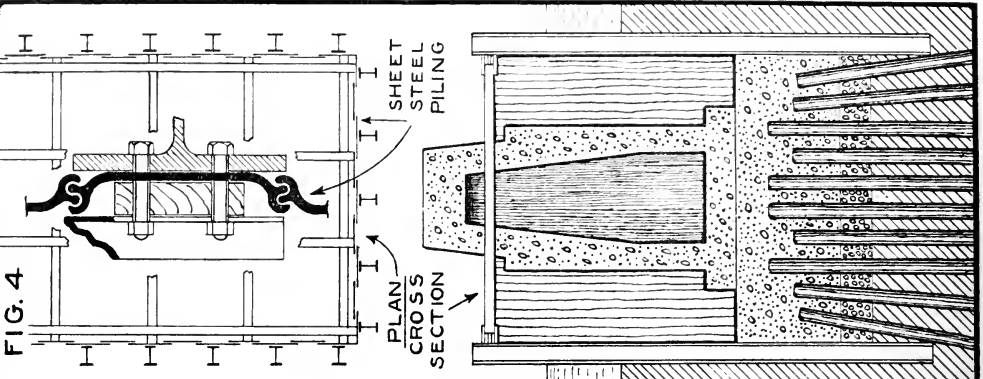
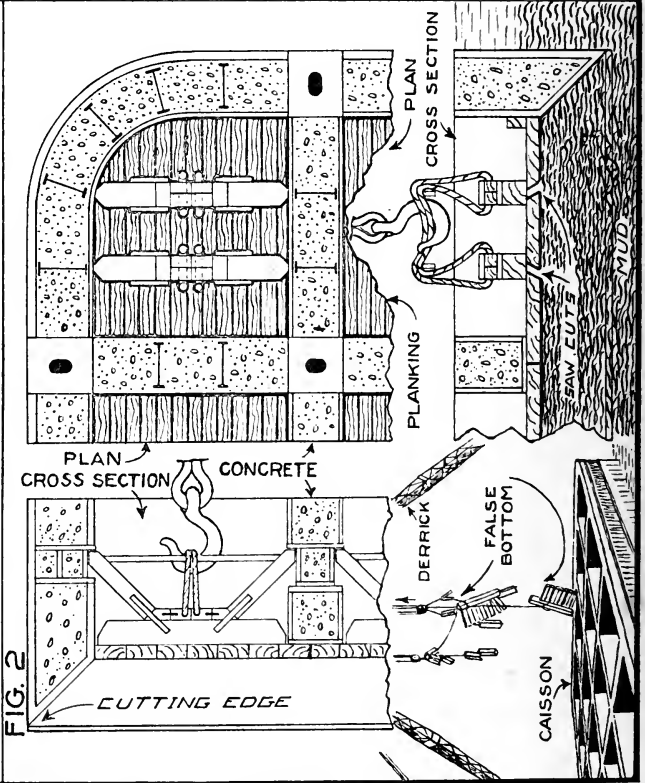

FIG. 2



VI—EAST CROSSING FOUNDATIONS

As will be noted from Fig. 3 of Plate III, the foundation piers in the east crossing were not carried down to bed rock; bed rock being located at such a depth that an entirely different problem was presented than was the case in the west crossing. The caissons for the west crossing were all sunk to bed rock, and their weight was an advantage. In the east crossing, however, the weight which was to be supported by the underlying strata was a limiting factor in both the design of the bridge and the foundation piers on which it rested. The design of the caissons used in sinking Piers E-3, E-4 and E-5 called for a structure much lighter in weight than was the case of the west crossing caissons. Fig. 3 is a vertical cross section of Pier E-3, except that the vertical scale is foreshortened to allow room for a horizontal cross section underneath. The caisson used to sink it contained 28 dredging wells, square in section, and measured $80 \times 134\frac{1}{2}$ feet. The caissons used for sinking Piers E-4 and E-5 were similar in design to that used for E-3, except that they were smaller. They measured $60 \times 90\frac{1}{2}$ feet, were sunk to a depth of 180 feet, and contained only 15 dredging wells each.

CAISSON COMPARISON

The buoyancy of the west crossing caissons was controlled by compressed air, trapped under domes placed over the tops of the dredging wells. The east crossing caissons were of an entirely different design. No domes were used, and consequently no compressed air could be employed. To reduce the amount of concrete in the walls between the wells, and consequently the weight of the caisson, the wells were designed square in cross section. To give the caisson buoyancy while being towed out to the pier site, these wells were closed in by false bottoms. Fig. 1 shows the caisson for Pier E-3 afloat. It is companionate with the base of the west crossing caissons, shown in Fig. 1 of Plate IV. This caisson was towed out to the pier site and sunk in a manner similar to that described for the west crossing caissons. The black portions in Fig. 1 indicate the spaces in between the dredging wells that were filled with concrete. These walls were built up by the use of flat steel forms, which were later removed. Wood planking was used for the exterior walls of the caisson, which was not removed. As this caisson was sunk into the water, and prior to reaching the mud line, its buoyancy was controlled by the relationship between the amount of concrete placed in it, and the height of the forms that enclosed the interior spaces. It was anchored in the same manner as the west crossing caissons, except that metal anchors were used, much smaller in size than the concrete ones. To give them the proper purchase, they were driven down into the mud by a pile, extended down from a pile driver at the surface.

FALSE BOTTOMS

Details of the false bottoms, placed in each of the 28 dredging wells, are shown in Fig. 2. The plan view, looking down, shows how the entire bottom was covered with planking. This planking was fastened to the under side of cross beams. The cross section to the left shows how these cross beams were held in position by small blocks and diagonal braces. These blocks were attached to a steel wire rope that was led up to two cross members, so that the rope formed a loop that could be engaged by a hook lowered down from the derricks. The cross section underneath the plan shows how the planking was provided with saw cuts, so that when the blocks, diagonal braces, and cross timbers were pulled loose, the planking would come clear also. All members of this false bottom, including the planking, were also attached to

the wire rope, so that all of the false work could be pulled clear by the derricks. When the caisson had sunk into the mud a short distance, as shown, the hooks were lowered from the derricks and engaged the loop of wire rope. There was enough slack in the rope between the various members, so that they came loose progressively, one after the other. The little sketch in the lower left hand corner shows how the false work appeared as it was being hoisted clear of the caisson.

A LARGE EXTRACTING JOB

The pulling of these false bottoms was effected shortly after the caisson had sunk into the mud a short distance, i. e., after the caisson had settled into the mud as far as it would go from its own weight. The order in which the false bottoms were pulled from the 28 wells was so scheduled as to keep the caisson level, or technically, on an "even keel." As soon as a false bottom was pulled, the mud would flow up into that well a short distance, and the caisson would settle on that side a corresponding amount. In spite of the extreme care exercised, the caisson did lean over to one side. This was due to the fact that the mud proved to be extra soft under one corner. To right the caisson, dredging was resorted to on the opposite corner, and when the resistance to sinking had been equalized, the caisson was slowly righted.

FURTHER SINKING OPERATIONS

After all the false bottoms had been pulled, dredging operations were commenced in the interior of the wells in the same manner as was shown in Plate V. The excavated material was removed by means of scows, as the depth of the water in the channel to the east of the island was not sufficient to permit of dumping it overboard. The comparative light weight of this caisson, and the extreme depth to which it was sunk, caused considerable skin friction to develop at the lower depths. By skin friction is meant the friction, or gripping power, that the surrounding mud and other material effects on the outside, or skin, of the caisson. This was anticipated, and pipes had been provided in the outer wall of the caisson near the cutting edge. When the skin friction retarded its sinking progress, water under pressure was pumped through these pipes, and jetted outwards. This washed the material away from the exterior of the caisson, reduced the skin friction, and thus permitted of further sinking.

DEEPEST PIER

These sinking operations were continued until the caisson had landed on the stratum, which was to be its final resting place, 235 feet below the surface of the water. The center wells were then dredged to an additional depth of 15 feet, and cleaned of all mud by means of underwater jets and pumps. These center wells were then sealed to the stratum with concrete. The extension of this plug-like seal below the bottom of the caisson not only keyed it to the stratum, but enabled the balance of the area under the caisson to be cleaned with greater ease. As the remaining area was jetted, the force of the jetted water backed up against this central plug and washed the mud out away from under the caisson.

OPEN COFFERDAM CONSTRUCTION

The east crossing piers east of Pier E-5, 17 in number, and beginning with Pier E-6, were sunk by means of an open cofferdam. Unlike a caisson, these open cofferdams were constructed at the pier site itself. The pier site was first dredged to a depth of about 25 feet, and around this excavation

temporary piling was driven, that served as false work. The cofferdam itself, shown in Fig. 4, consisted of a box-like structure, open at the top. It was formed by driving sheet steel piling into the mud in the form of a rectangle. To drive this sheet piling, a vertical frame was fastened to the false work piling, and the sheet piling was slid down vertically on this frame. This sheet piling is composed of flat pieces of steel, with grooves in their edges that interlock with one another, as shown in section in the plan view. Each pile is interlocked with the preceding one by hoisting it, and then sliding the grooves into one another as it is lowered away.

SOMETHING NEW

Cofferdams constructed of sheet piling are quite common, but the unusual feature of these cofferdams consisted of the fact that they were clear of any false work in their interiors. A structure of this nature is naturally subject to considerable pressure on its exterior from the surrounding water and mud. To overcome this, the ordinary cofferdam is constructed with cross braces in its interior, or shores as they are called. These cofferdams, however, were so constructed that no shoring was used or needed. Every fourth sheet pile had a heavy "I" beam bolted to it in the manner shown in the sectional plan of Fig. 4. The piles with these "I" beams bolted to them were tied across the top of the cofferdam to the one on the other side by means of angle irons, as shown in the cross section at the bottom of Fig. 4. The "I" beams stiffened the walls formed by the sheet piling, and these cross ties at the top braced the walls against one another. When this rectangular "box" of sheet piling had been completed, the mud was excavated from its interior. A series of fir piles were then driven down into the mud inside of the cofferdam to a depth of from 70 to 100 feet. A blanket of gravel was then placed in the bottom of the cofferdam, and around the wood piling. The purpose of this gravel was to form a clean base for the concrete which was to follow.

UNDERWATER OPERATIONS IN THE "DRY"

On top of this blanket of gravel, and completely encasing the tops of the wood piling, a mat of concrete was poured, as shown in the lower part of Fig. 4. Concrete will set under water if it is confined, and not allowed to disperse. In construction jobs of this nature, this is accomplished by the use of a device called a tremie pipe. In this case, a pipe was plugged up at its lower end, and then lowered vertically into the water until it just rested on the gravel blanket. It was then filled with concrete from a hopper located on top of the cofferdam. By suddenly hoisting the pipe a short distance, the plug was dislodged and the concrete flowed out at the bottom, lying directly on the gravel. This was repeated over and over, and the hopper was mounted on the top framework in such a way that it could be moved to all parts of the cofferdam. Up to this point all of the operations had been carried out under water. As soon as this concrete mat had set, the interior of the cofferdam was pumped out, and after a few minor leaks had been stopped, it was made fairly dry. A crew of carpenters then went to work in this cofferdam, constructing the forms for the concrete of the foundation pier proper. It was made hollow to reduce the weight, but the walls of the pier were of ample proportions to transfer the weight of the bridge to the underlying concrete mat and supporting wood piles. Where shoring is used in the interior of a cofferdam, it is necessary to continually shift these cross braces, as they pass through the space to be occupied by the pier. As no shores were used in this cofferdam, a considerable amount of time and labor was saved.

FIG. 1

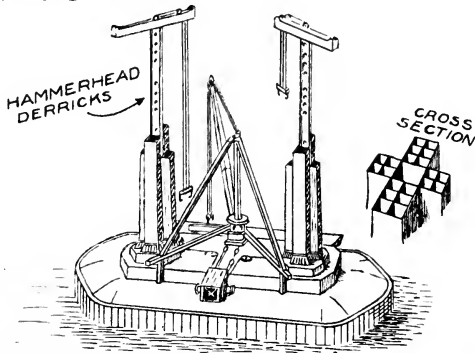

FIG. 2

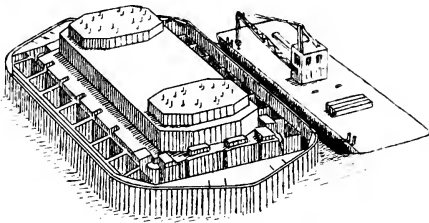

FIG. 3

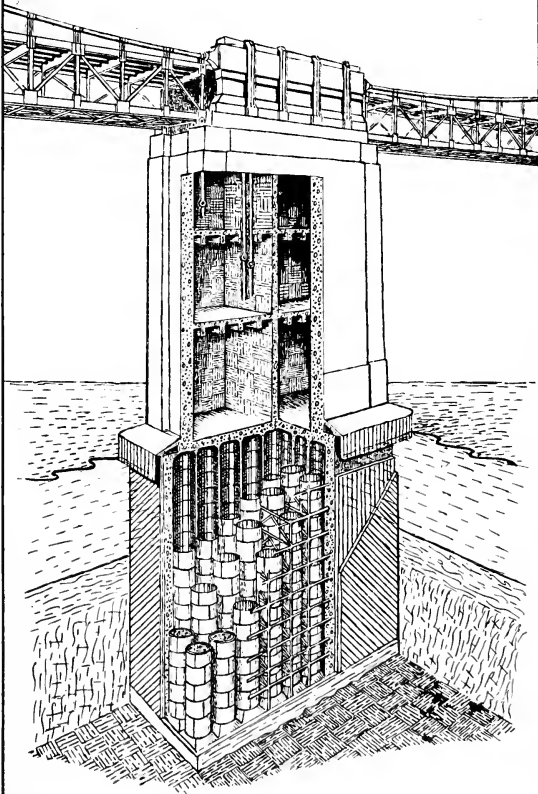
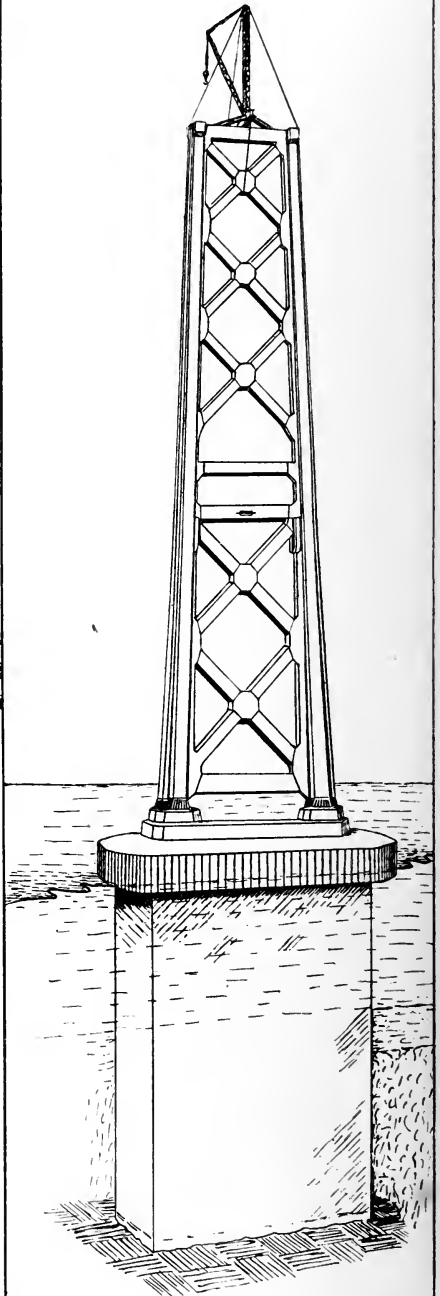

FIG. 4



VII—STEEL TOWERS

This plate continues on from Fig. 3 of Plate V, where the completed foundation piers of the west crossing were shown. Fig. 2, here, shows the top of the pier during the construction of the fender that encircles the pier at the water line. Since the size of the pier precludes any possibility of damage to it by a colliding ship, the fenders were designed so as to inflict a minimum of damage on the ship. The timber work on the outside would ward off any ordinary blow. Should the ship crash through this and strike the concrete with enough force to puncture its hull, the hole would be above the water line and there would be less danger of its sinking. The small dots projecting above the two pedestals are the anchor bolts for the tower steel. A 4-inch steel slab was fitted over these bolts, on each pedestal, and the bases for the legs of the tower were set on these slabs. As shown in Fig. 1, a stiff-leg derrick was first erected on the pier between the pedestals, and it was used to set the bases and lower sections of the tower steel. The steel sections were composed of cells, and formed a cross with a hollow square in the center, as shown in the cross section.

HAMMERHEAD DERRICKS

Into each of these hollow squares was set a derrick, known as a hammerhead derrick. They consisted of a vertical column, with a horizontal cross girder mounted on a swivel on top of the column. On top of this cross girder was mounted a trolley, over which the hoisting ropes were passed. The trolley could be run in or out, and the cross girder could be swiveled, so that any part of the work within its range could be reached. The steel for the towers was fabricated in the east, and accurately fitted together in sections. Upon arrival at the pier site, these sections were hoisted and set in place, one at a time. The steel for the legs of the tower was made up in four sections, one section forming each side of the cross. When these sections had been built up to the neck of the hammerhead, a tackle was fastened to the top of the steel, and the other end dropped down inside the hollow square and fastened to the lower end of the hammerhead column. It was then hoisted to a new height, and held in that position by bolting lugs to the steel, and under the bottom of the column. These hammerheads had a lifting capacity of 80 tons, and a few of the lower sections of steel were within a couple of tons of this capacity. When the steel had been erected in this manner to the full height of the tower, as shown in Fig. 4, one of the hammerheads was given an extra lift, and used to erect the derrick shown on top of the tower. Unlike the hammerheads, which needed no lateral support, this derrick had to be held in place by guy ropes. This derrick was then used to dismantle the hammerheads, which were lowered away to a barge and taken to the next pier. This guy derrick was used for erecting the catwalks, during the spinning operation, etc., and remained in place until the bridge was completed.

FINISHED TOWER AND BASE

The finished tower measured over 500 feet above the water line, the extra 19 feet being taken up by the saddles, hoods, and beacon light placed at the very top. At the base slab, the tower legs measured 24 x 37 feet, and were spaced 85 feet apart, center to center. The tower tapers toward the top, giving a center to center distance between the cables of 66 feet. Fig. 3 is a cut away section of the center anchorage; the cellular type of construction in its base being the same as was used in the foundation pier under the steel tower. The forces at work in this center anchorage, from the pull of the cables, is treated of in a later chapter.

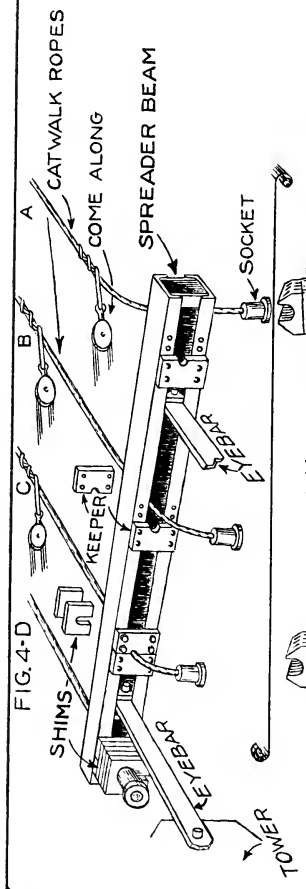

FIG. 5

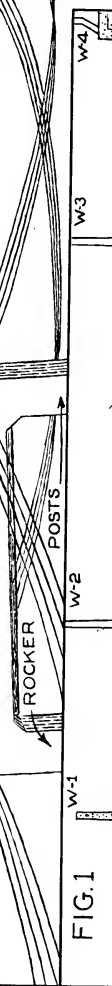

FIG. 1

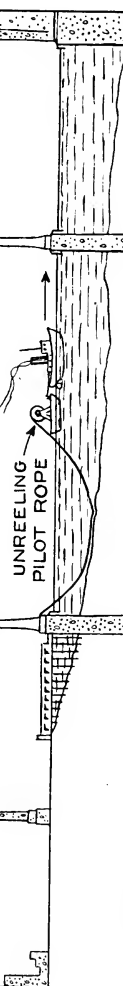

FIG. 2

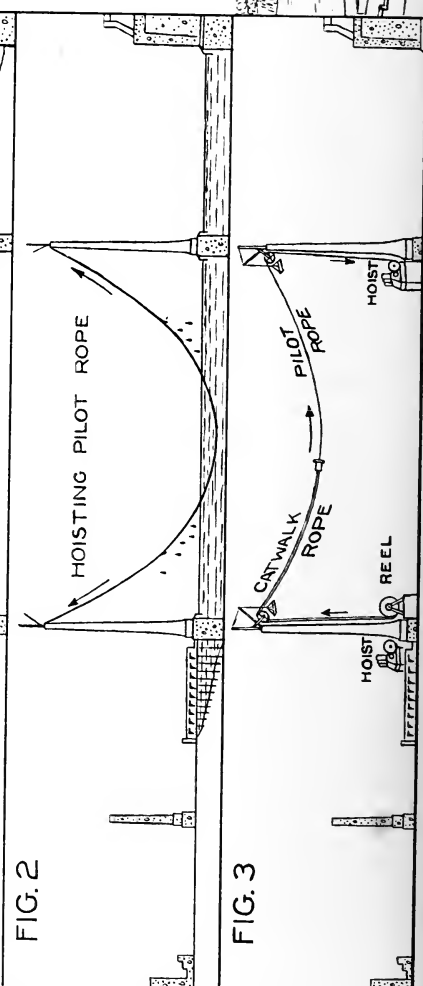
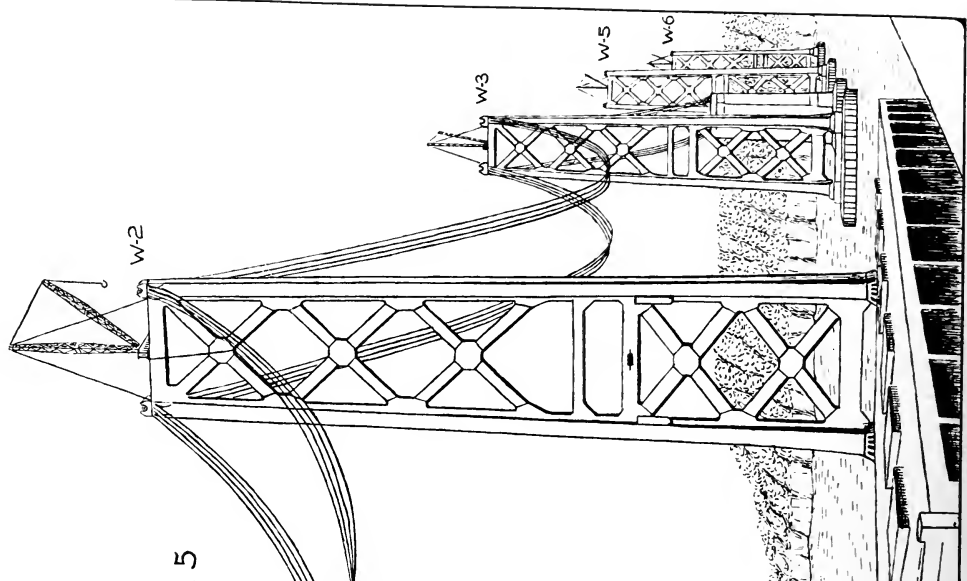

FIG. 3



VIII—CATWALK ROPES

Upon completion of the towers and the anchorages, the next step was the preparation for the spinning of the cables. Like in the construction of an ordinary building, it is necessary that a scaffolding be erected in order that the workmen might have access to all parts of the cable during the process of spinning it. This scaffolding is known as a catwalk, and Fig. 1 shows the first step in its erection. A reel of one-inch steel wire pilot rope was mounted on a barge, and as it was towed across from Pier W-2 to W-3, it was unreeled and dropped down to the bottom of the bay. Upon arrival at Pier W-3, the end was taken from the barge and hoisted to the top of the tower; at the same time, the other end at Pier W-2 was hoisted to the top of the tower, as shown in Fig. 2. When it was clear of the water, and in the approximate position shown in Fig. 3, the end at W-2 was attached to one end of the 2¼-inch catwalk rope. This catwalk rope was then pulled across in mid-air by the pilot rope. The motive power was supplied by a deisel engine hoist at the base of W-3. The hoist at W-2 was used principally to control the paying out of the catwalk rope, since it was quite heavy, and once started, would "run" out of its own weight.

MEN ON THE FLYING TRAPEZE

The next step was carried out by the workmen standing on platforms suspended from the derricks atop the towers, as shown in Fig. 3. There were four ropes placed for each catwalk, and these ropes were fastened at the tower tops to a spreader beam, as shown in Fig. 4. The spreader beam was fastened to the tower by means of eyebars, that were pinned to it. As the pilot rope brought the end of the catwalk rope to the tower, a tackle was fastened to it by means of a come-along, as shown at 4-A. The pilot rope was then released, and the end of the catwalk rope, fastened to which was a socket, was passed through the spreader beam, as shown at B. A keeper, half of which was previously riveted to the spreader beam, was then bolted on, as at C, encircling the rope, as shown. To adjust the length of the rope, shims were placed between the socket and the keeper, and as the come-along was released, the catwalk rope ran back through the keeper until it gripped the shims, as shown at 4-D.

MAN-MADE SPIDER WEB

This same operation was repeated for the ropes strung between W-3 and the center anchorage. Between W-1 and W-2, the ropes were first dragged out across the pier shed. Between W-1 and the San Francisco anchorage, the ropes were dragged out across the ground, and then hoisted into position. Spreader beams were used as fasteners at both W-1 and the anchorage. This same process was repeated when ropes were strung across between the center anchorage and Yerba Buena Island, except that this was carried out entirely over water. These ropes were so placed, as shown in Fig. 5, that their position was about three feet below the cable position, or so that the cable would come about breast high to the workmen. After the cables were spun, the ropes supporting the catwalks were removed and cut up into lengths for use as suspender ropes. To those who witnessed the cable spinning, it was interesting to note that most of the cables were spun between San Francisco and the center anchorage, before operations were begun between Yerba Buena Island and the center anchorage, thus demonstrating the ability of the center anchorage to sustain a "one sided" load. The steamship pier immediately in front of Pier W-2 was turned over to the bridge authority for the use of the contractors, and as headquarters for field operations. Equipment and material was delivered here for storage prior to being barged out to the bridge site.

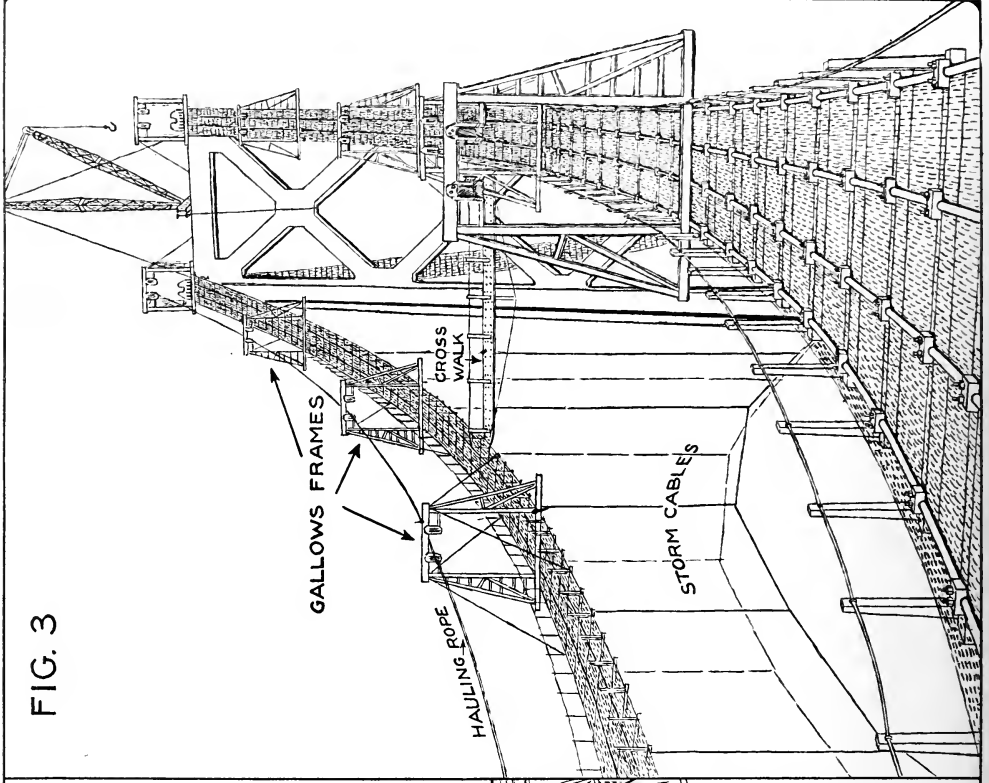
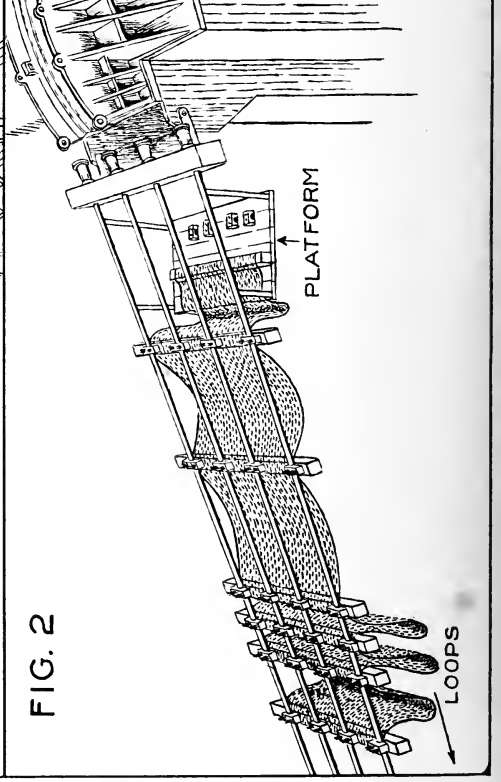
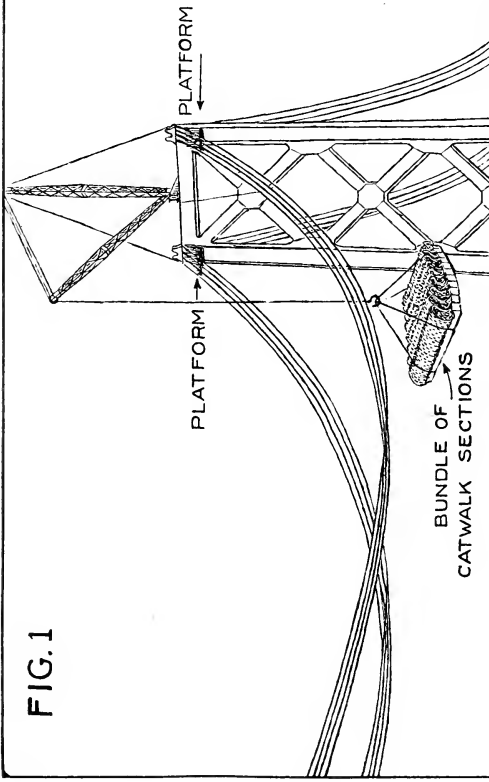

IX—CATWALKS

The catwalk itself was made up on the ground. Ten timbers were placed in a horizontal frame at 10-foot intervals, and a heavy wire mesh screen stretched over the tops of these timbers. Four sets of holes were drilled in each timber, to correspond to the four ropes on which the catwalk was to rest. Bolts were then placed in these holes, together with an oak block, that formed a clamp. The wire mesh was stapled to the timbers, and the entire section removed from the frame and the timbers pushed together. This formed a bundle, not unlike a carpet, and these bundles were taken out to the piers and hoisted to the top of the towers. Fig. 1 shows a bundle of catwalk sections being hoisted to a platform located near the top of the tower.

A STEEL CARPET

Fig. 2 shows the manner in which the catwalk was fastened to the ropes. The four oak blocks were removed, and the first timber was hoisted up to the underside of the ropes. The oak clamps were replaced on the upper side of the ropes, the bolts passed through the timber, and nuts and washers placed on the bolts. These oak clamps were only placed on loosely, which permitted the timber to be slid down the ropes. As several sections were pushed along the ropes, the wire mesh formed loops, as shown. The succeeding sections of wire mesh were secured to those ahead by wiring them together. After the entire lot of sections had been placed in position in this manner, a rope was fastened to the first timber, and the entire catwalk pulled down, or stretched out, into position. The workmen then went back over the catwalk, and tightened up the oak clamps.

FALSE WORK BRIDGE COMPLETED

Fig. 3 shows the completed catwalk, and also illustrates an important function of the catwalk: namely, the manner in which the gallows frames were placed on the catwalk. These gallows frames formed the tramway, or supports for the hauling ropes. These hauling ropes were used to haul, or pull, the spinning wheels across from anchorage to anchorage. These gallows frames were assembled on the ground, hoisted up to the top of the towers, and placed flat on a sled. The runners on this sled were deep enough so that it cleared the oak clamps, and permitted the frames to be slid down the wire mesh to their proper position. They were then upended, and clamped to the catwalk ropes, with guy ropes extending out from their tops to keep them in an upright position. Vertical posts were bolted to the ends of the cross timbers of the walk, and a small line strung along their tops to form a railing. A finer mesh screen was placed over the top of the first mesh, which prevented small tools from falling through the catwalk. This finer mesh was extended up the sides a few inches, forming a "kick board," i. e., kept things from being kicked overboard. Although the wind resistance offered by this wire mesh catwalk was very small, it swayed in the wind. To cut this sway down to a minimum, a system of storm cables, or ropes, were secured to its underside, and the ends of these ropes fastened to the towers. To stiffen the catwalks in a horizontal direction, they were tied together by means of cross walks, as shown. These also formed a means of passing from one catwalk to the other. Electric service was installed for the entire length of the walks, including lights for night work, telephone, and flasher light communication. Two hangers were fastened to each gallows frame, to which sheaves were fastened. When the hauling ropes had been reeved through these sheaves, the catwalks, 10 feet in width, were ready for the spinning operation.

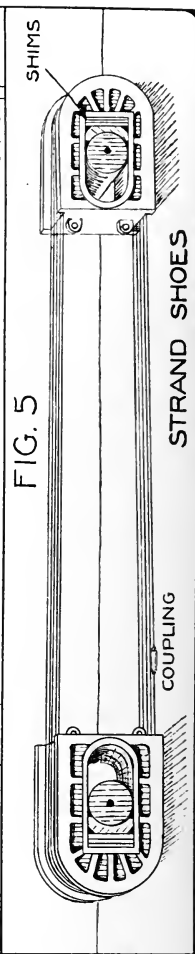
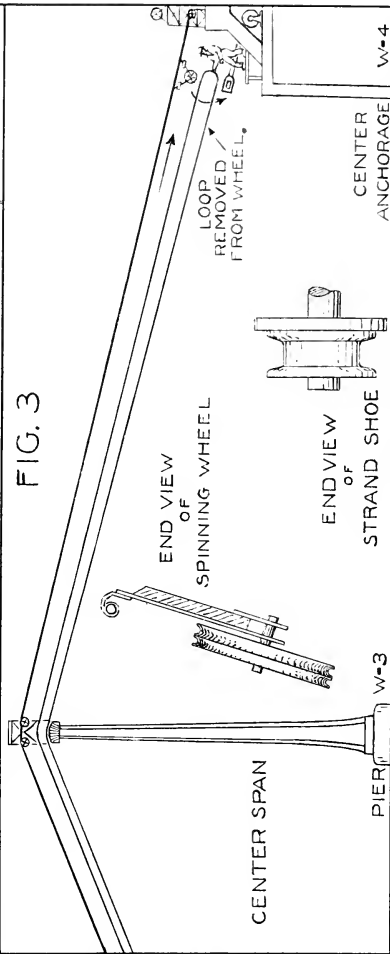
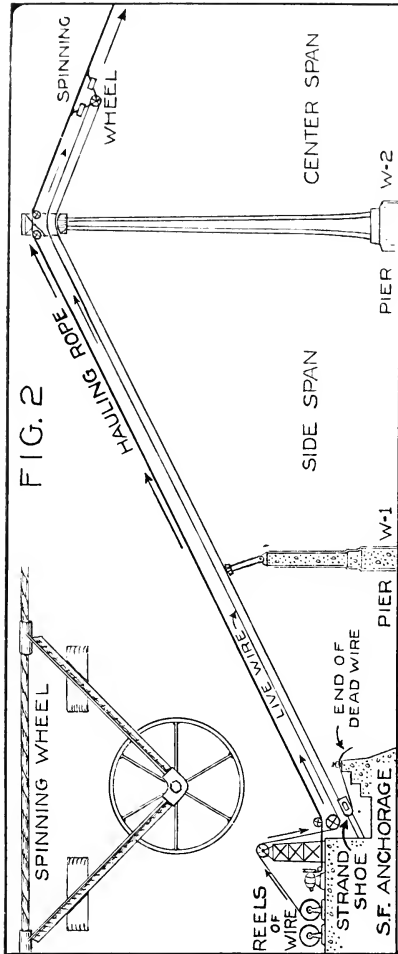
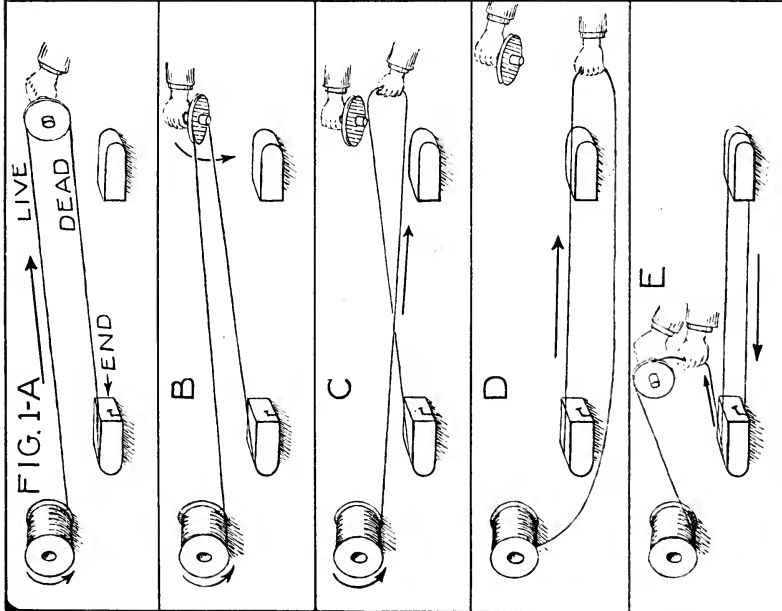

X—SPINNING OPERATION

Although the mechanical apparatus used in cable spinning may appear quite complicated, the principle involved is very simple. This principle is illustrated in Fig. 1, the apparatus consisting of a spool of thread, two book-shaped blocks, and a hand wheel. The end of the thread is tacked to the inside of the left-hand block, and a loop of thread pulled out until it is over the right-hand block, as in 1-A. By tipping the wheel, the loop is given a half turn as it is removed from the wheel and placed on the right-hand block, as shown, successively, in B, C and D. This half turn is given to the loop so that when the second loop is pulled out, as shown in E, there will be no crossed wires. In D the wire is being pulled to the right in order to stretch it tight over the blocks, and in E it is also being pulled in order to stretch the wire in the under side of the loop tight as well. Successive loops may be pulled out in this manner indefinitely, or until the required number of wires are placed on the two blocks.

STRAND SHOES AT THE FOOT OF THE CABLE

These blocks, about three feet tall, are known as strand shoes; a pair of which are illustrated in Fig. 5, with five loops of wire in place. When the fifth loop of wire was placed on these shoes, the wire was cut at the spool and joined to the beginning end (see 1-A) by means of a coupling. This coupling is shown in Fig. 4, and consists of a sleeve, cut away in the drawing, to show its construction. The two ends of the wire are threaded, one with a right-hand thread, and the other with a left-hand thread. As the sleeve is turned, in the same manner as a turn buckle, the two ends of the wire are drawn together until the beveled edges jam against each other at the center, and the coupling is securely locked. This drawing is made full size, and represents the actual size of the coupling and wire, which is 0.195 inches in diameter (about one-fifth inch). The wire is manufactured in lengths of about 3,000 feet, and is joined in this manner as it is placed on the spools, or reels. It is also joined in this manner when replacing an empty reel with a full one, so that the wire in the cable becomes endless. The wire has a tensile strength of approximately 235,000 pounds per square inch. Inspectors tested the wire by means of a machine, equipped with a dial not unlike a scales. This machine pulled a single wire apart, and when it broke, the dial registered the number of pounds pull required to break it. A single wire, with a coupling in it, pulled apart under a tension of around 6,900 pounds.

SPINNING A WEB OF STEEL

The actual spinning operation is illustrated in Figures 2 and 3, showing how the spinning wheel is pulled out from the San Francisco anchorage with its loop of wire in Fig. 2, and its arrival at the center anchorage in Fig. 3. Upon arrival there, the loop of wire is removed from the wheel, by hand, and given a half turn as it is placed on the strand shoe. The end view of the strand shoe shows how it is grooved to accommodate the 236 loops of wire that are placed on each pair of shoes (472 wires). The spinning wheel is firmly attached to a steel wire hauling rope, and as this rope is driven, or hauled, it pulls the wheel along with it. The wheel used was a double wheel, i. e., it had two grooves in it, and two loops of wire were pulled out at one time. Only a single loop of wire is shown in this plate for simplicity. The lower wire in the loop is securely fastened, and does not move. It is therefore known as the dead wire. The upper wire, called the live wire, must travel twice as fast as the spinning wheel, as it not only lays out its own length, but an equal length which goes to form the dead wire.

FIG. 1

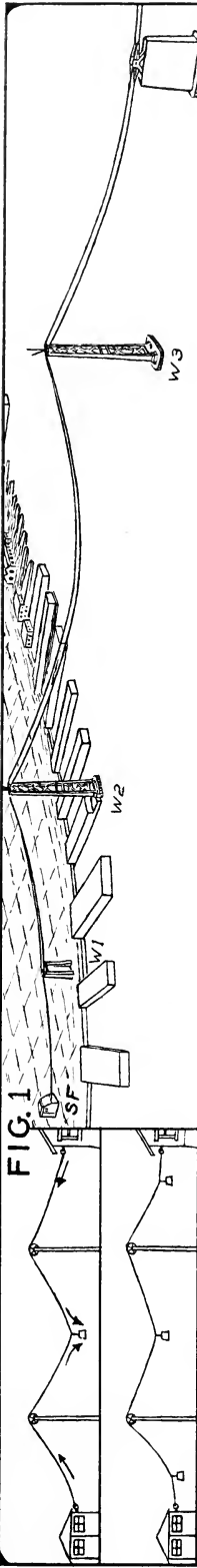

FIG. 2

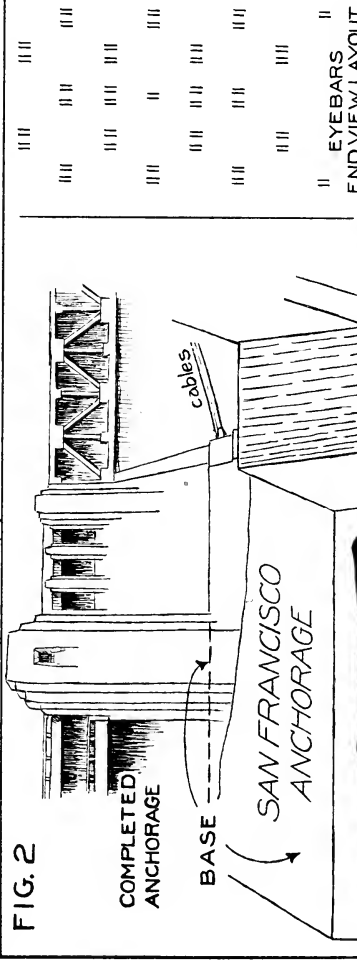

FIG. 4

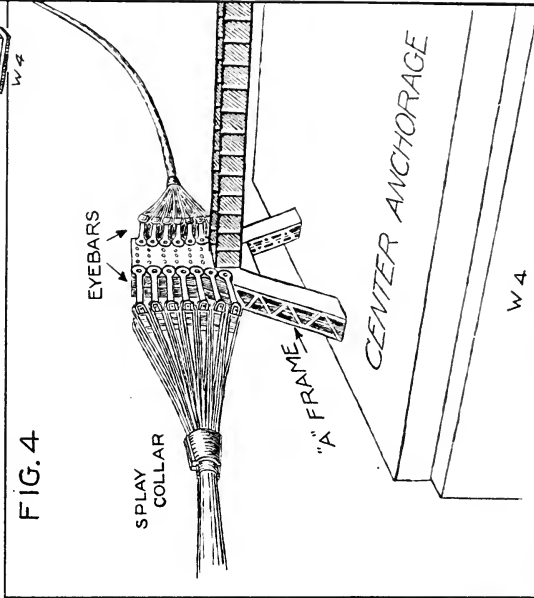
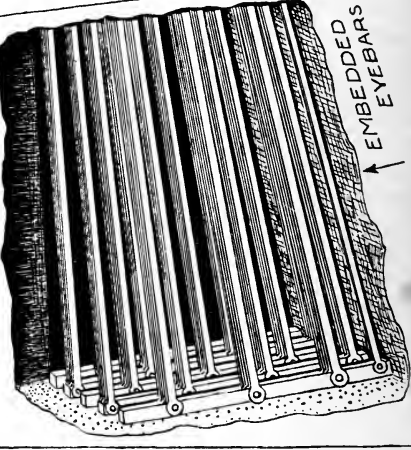
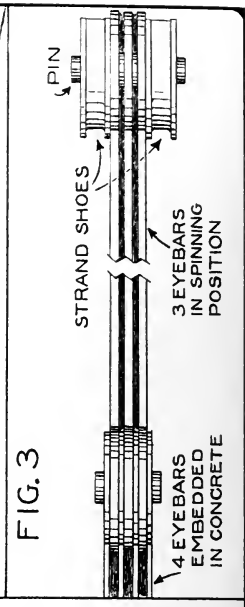

FIG. 3



SAN FRANCISCO ANCHORAGE

END VIEW LAYOUT
EYEBARS

STRAND SHOES
WIRE
CATWALK ROPE

COMPLETED ANCHORAGE

BASE

EYEBARS

SPLAY COLLAR

"A" FRAME

CENTER ANCHORAGE

W4

PIN

STRAND SHOES

3 EYEBARS IN SPINNING POSITION

4 EYEBARS EMBEDDED IN CONCRETE

EMBEDDED EYEBARS

XI—ANCHORAGES

Fig. 5, Plate X, illustrates the manner in which the wires were looped around a pair of strand shoes. The strand shoes, in turn, are pinned to flat bars of steel that are embedded in the concrete of the anchorages. These bars are called eyebars because they have a hole in their ends, the same as an ordinary sewing needle has an eye in one end of it. The right portion of Fig. 1 is a diagram showing the cables stretched between the San Francisco and center anchorages; passing over towers W-1, W-2 and W-3, respectively. The left hand portion illustrates the function of the anchorages. If a clothes line is stretched over two poles, between the house and the garage, and a weight hung in the center, it will be seen that the line exerts a pulling effect at both ends. This holds true if several weights are placed on the line, and also holds true if the house is taller than the garage.

A SOLID BLOCK OF ARTIFICIAL STONE

The upper portion of Fig. 2 shows the completed San Francisco anchorage, and the lower portion is a cut-away section, illustrating the manner in which the eyebars were embedded in the concrete. They extend to the rear of the anchorage, where they are pinned to inclined, vertical girders. This arrangement may be likened to a tree, for, in the same manner that the roots of a tree spread out where its trunk enters the ground, so are the eyebars spread out into the anchorage to form the roots of the cable. This spreading point is called the splay point, and the cable is encircled here with a collar (Fig. 4). This arrangement distributes the 37,000,000-pound pull of each cable throughout the entire base block. As shown in the end view, there are 37 pairs of eyebars embedded in the concrete, each pair accommodating one of the 37 strands, or bundles, of wire. To each four of these embedded eyebars, a group of three larger eyebars were pinned, as shown in Fig. 3, and two strand shoes were pinned to the outer ends of this latter group. A pit was left in the anchorage to accommodate these latter eyebars so as to provide room for the spinning operation. As the strands were spun in groups of four, four strand shoes, and their supporting eyebars, were placed in position at a time. After the spinning of the cables was completed, this pit was filled in solid with concrete, and the anchorage built up to a total height of 150 feet. However, neither the strand shoes nor the wire were embedded, but a tunnel was left, encircling the space occupied by them, so that access for inspection purposes might be had at all times. Below these main eyebars, two pairs of smaller eyebars were provided, to which the catwalk ropes were attached. This drawing shows the south cable pit; a duplicate pit being provided on the other side of the anchorage for the north cable. A total of some 68,000 cubic yards of concrete was used in the construction of this anchorage.

CENTER ANCHORAGE

Fig. 4 illustrates the method of fastening the cables to the center anchorage. Here, the eyebars were pinned to a steel "A" frame, and were not embedded in concrete. Although the pull exerted by the cables coming from Yerba Buena Island is opposed to the pull exerted by the cables coming from San Francisco, these forces are not always neutralized in these A frames, and any unbalanced pull is transferred through these A frames to the concrete in which they are embedded. An explanation of the forces at work in these A frames is given in Plate XIX. Some 165,000 cubic yards of concrete was used in constructing this center anchorage. The ensemble of this center anchorage is illustrated in Plate VII, and this Fig. 4 shows the A frame prior to its being enclosed in a hood.

FIG. 1-A

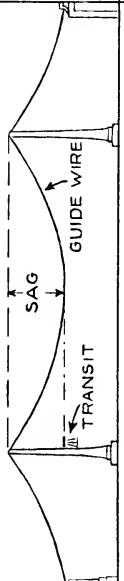

B



C

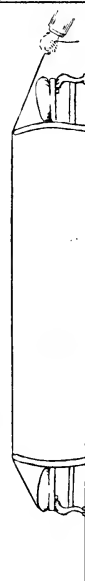

D



E



FIG. 2

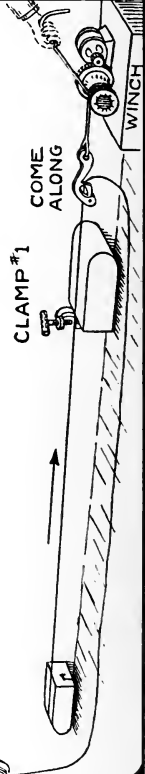
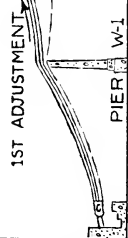
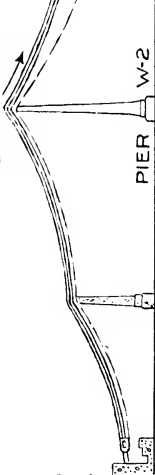

FIG. 3-A



B



C

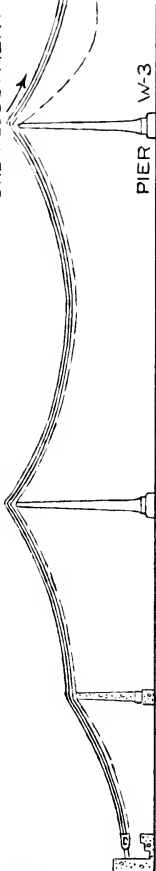

D

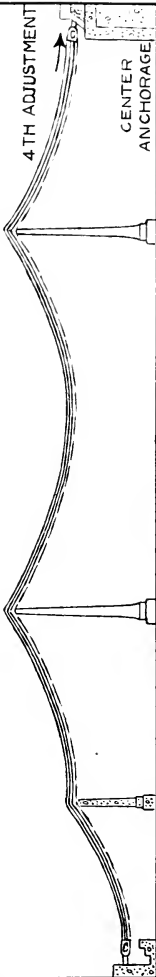
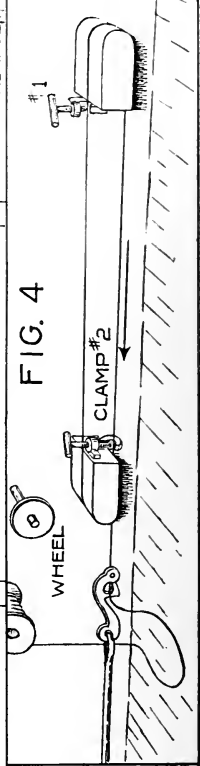

FIG. 4



XII—ADJUSTING THE WIRE

The cables each contain 17,464 wires, and each one of the individual wires was so adjusted that it took its proper share of the load coming upon the cable. This adjustment was made by measuring the "sag" of each wire immediately after it was pulled across by the spinning wheel. The sag is the vertical distance, measured at the mid-span point, below a horizontal line projected across the tower tops, as shown in Fig. 1-A. The first wire taken across from anchorage to anchorage is known as the guide wire. It is very accurately adjusted to this sag by means of surveyors' instruments. There is a direct relationship between the amount of sag and the amount of tension in a wire. This relationship is worked out according to a mathematical formula. To illustrate this principle without the use of mathematics, a string is stretched across two chair backs, as shown in 1-B, with a sag approximating that of the cables. If the string is pulled out to a horizontal position, as shown in C, it will be under a greater tension than it was in B. This is easily proved by applying a little more tension, as in D, and the string will break. Or, if the string is slacked off, as in E, until it lies on the floor, there will be no tension in it at all.

ADJUSTMENT BY "COME-ALONG"

The method of making this adjustment is illustrated in Fig. 2, which shows a loop of wire placed around two blocks. The wire is gripped by means of a device called a come-along, which acts somewhat on the same principle as a pair of pincers. This come-along is secured to a rope that is given a couple of turns around a small winch. When the wire is brought to its proper tension it is held in that position by means of clamp No. 1. Between San Francisco and the center anchorage, four of these adjustments were made, a come-along and winch being brought into use on top of each tower. Fig. 3 shows, progressively, these four adjustments. The solid lines represent wires that have already been adjusted, and the dotted line, the wire that is being adjusted. A man was stationed about half way between the San Francisco anchorage and Pier W-1. As the come-along on top of Pier W-1 pulled in on the wire and brought it to the level of the guide wire, this man signaled the man on top of Pier W-1. This man then stopped pulling on the wire, and set up on his clamp. If it was pulled too high, it then had to be slacked off. This operation was then repeated between Pier W-1 and W-2, between W-2 and W-3, and, finally, between W-3 and the center anchorage. This adjustment was on the dead wire, and was carried out immediately after the spinning wheel had passed over the succeeding tower.

SLACK RETURNED TO SAN FRANCISCO

When the fourth adjustment had been completed at the center anchorage, the wire in the other side of the loop was adjusted in the same manner, only in the opposite direction. Fig. 4 illustrates how this was done. No. 1 clamp, as shown, would be at the center anchorage. As the slack in the wire was worked around the strand shoe, the wire would be pulled by a come-along traveling in the opposite direction, or towards San Francisco. When the wire had reached its proper tension, it would be held in position by clamp No. 2, the come-along would be released, and the wire looped around the wheel ready for the second loop to be pulled out. For simplicity, only a single loop is shown in this plate; actually, each spinning wheel pulled out two loops and the adjustment was carried out simultaneously on both wires. Since the cables are $28\frac{3}{4}$ inches in diameter, an allowance was made for the strands whose position was higher up in the cable.

FIG. 1

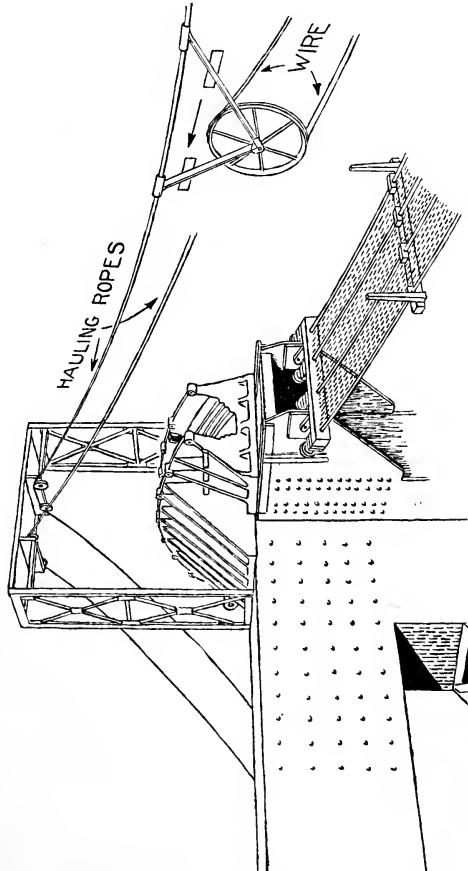

FIG. 3

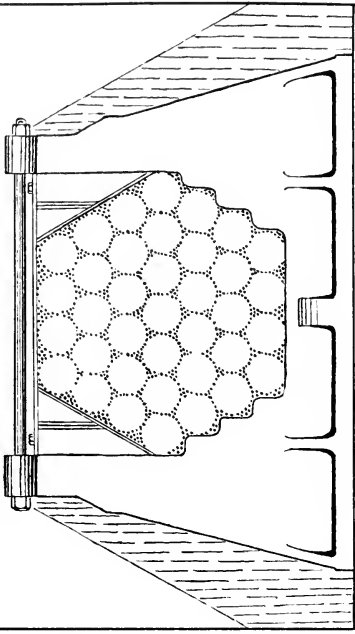
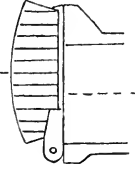

FIG. 4-A



B

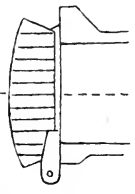
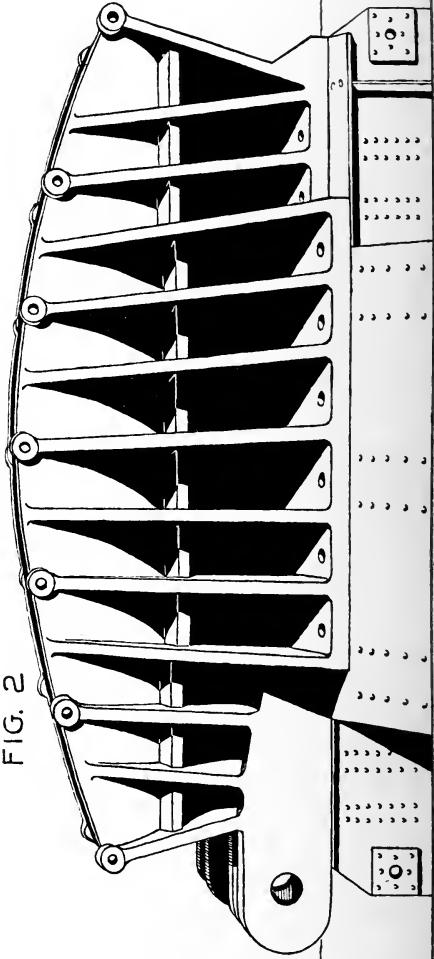

FIG. 2



XIII—MAIN SADDLES

Fig. 1 illustrates the spinning wheel as it is about to pass over one of the tower tops. It is traveling "up grade," and as it passes through the frame work supporting the hauling ropes on top of the tower, it will travel "down grade," depositing the dead wires in the saddle. Just as these individual wires will rest in the saddle, so will the completed cable rest in the saddle, and completely fill the cable groove in it. Putting it another way, the function of the saddles is to form a seat for the cables as they pass over the tower tops. The weight of the cables, together with their suspended load, will be transferred to the tower through the saddles. The cable coming up on a slope from either side of the tower, will form an angle at the saddle, and the groove in the saddle is designed so as to form an easy curve where the cable changes its direction. A portion of the catwalk is shown here, but the stairway that enabled the workmen to get from the catwalk up to the saddle, is omitted.

A SADDLE THAT RIDES 500 FEET IN THE AIR

Fig. 2 is a side view of the saddle. Due to the enormous weight coming upon it, the cable has a tendency to flatten out at this point, and ribs in the saddle resist this flattening effect, as well as serve to distribute the weight over a larger area of the tower top. The saddles are set directly on top of the towers, and given a "setback," as shown in Fig. 4-A. The curve in the cables changes as the weight of the roadway steel is suspended from them. Since the distance between the two towers is approximately twice that between one of the towers and the adjacent anchorage, there will be more resistance to this change in curve on the anchorage side of the tower. Hence, the saddles are set back from the center line of the tower, and towards the anchorages. As the weight of the roadway steel comes upon the cables, the saddles are pulled toward the mid-span point, and until their center lines coincide with that of the towers, as shown in Fig. 4-B. This set-back amounted to about 20 inches on Tower W-3, but owing to the fact that San Francisco anchorage is 865 feet beyond Pier W-1, the set-back on Tower W-2 was approximately 4 feet. To permit of this movement, a special lubricant was placed between the bottom of the saddles and the tower top, and the eyes shown to the left of the saddle in Fig. 2 afforded a means to attach powerful hydraulic jacks to it; the foot of the jacks resting against the tower. As soon as the saddles were jacked into position, they were permanently fastened to the tower tops by means of bolts and rivets. Due to the friction between the wires, and against the cable groove, at no time does the cable move, or slip in the saddle, the towers themselves bending back and forth as the strain comes upon them. Each saddle weighs 48 tons.

A CROSS SECTION OF THE CABLE

Fig. 3 is an end view of the saddle, with a cross section of the cable in it. The bottom of the saddle is flat, with steps in the lower portion of the sides, so that the cable in the saddle forms a hexagon. The upper part of the hexagon is formed by wedges fixed to the sides of the cable groove. The entire cable was shaped to a hexagon as it was spun, but was later squeezed to a circular cross section. However, it will always remain hexagon shaped in the saddles. A cover is bolted on to the top of the saddle to protect the cable from the elements, and above this is shown one of the cross bolts that tie the tops of the saddle together. The 37 strands are distinguished in this drawing by means of circles; actually, the wire, which was deposited directly into the saddle by the spinning wheel, formed a solid mass.

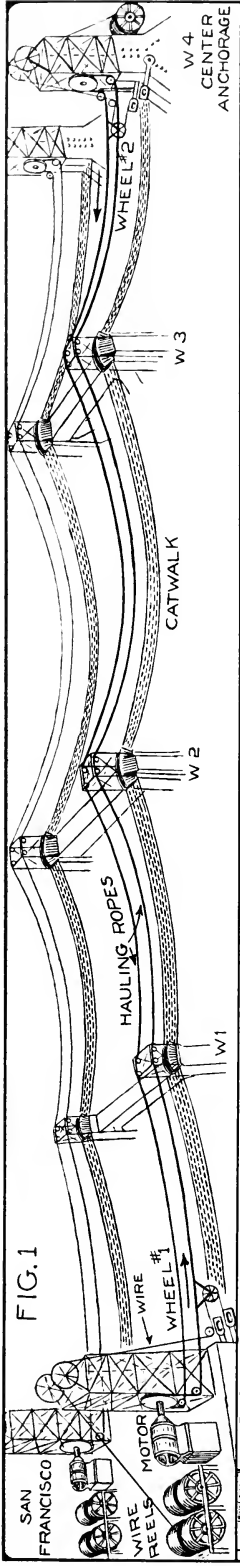

FIG. 1

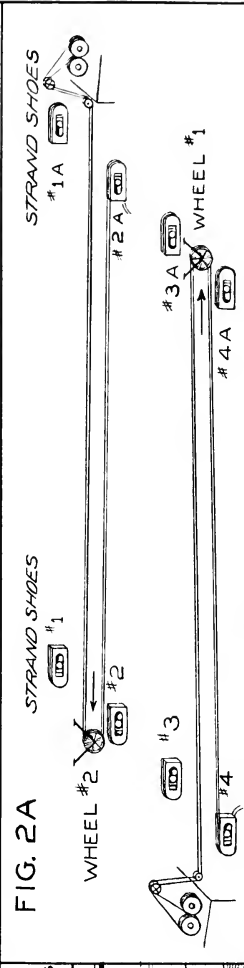
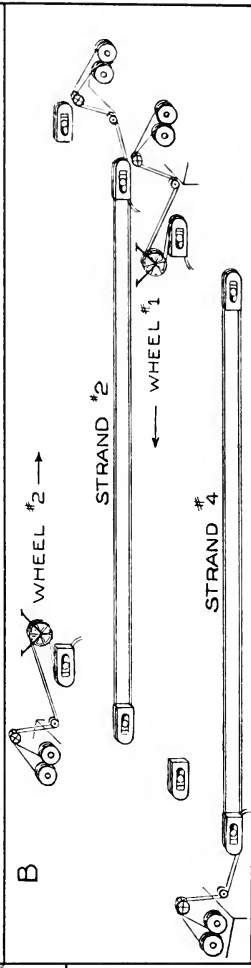
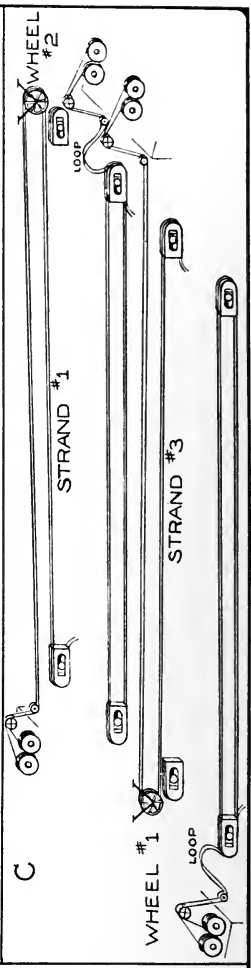

FIG. 2A



B



C

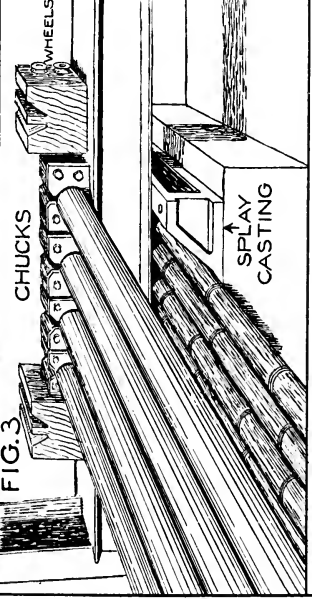

FIG. 3

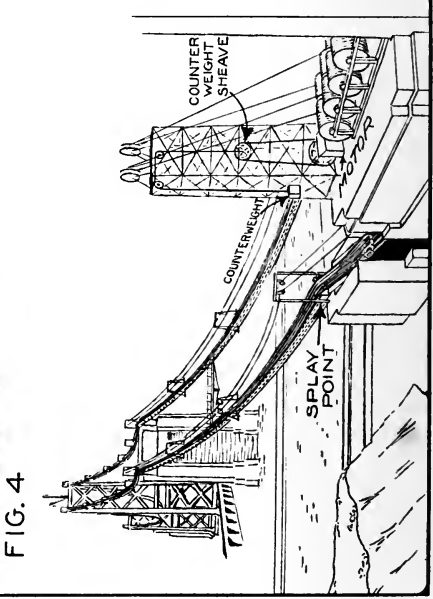

FIG. 4

XIV—SPINNING CONTINUITY

Fig. 1 shows the complete ensemble of the spinning apparatus between San Francisco and the center anchorage. These cables were spun first, and the same apparatus was then used to spin the cables from Yerba Buena Island to the center anchorage. The gallows frames are omitted, and the hauling ropes are shown suspended from the frames on top of the towers. There are two of these hauling ropes, one over each catwalk. They form an endless loop, passing out in one direction to the center anchorage, run around a wheel there, and return in the other direction on the opposite side of the same catwalk. Each is driven by a motor located at the San Francisco anchorage. Two spinning wheels are attached to each rope, and the spinning is carried out over both catwalks at the same time. Action on the near catwalk only is shown here. No. 1 wheel is shown at the S. F. Anchorage, and about to pull 2 loops of wire out to the center anchorage; at the same time, wheel No. 2 at the center anchorage is about to pull 2 loops of wire from the center anchorage to San Francisco.

WHEEL TRAVEL

Fig. 2-A shows these same two wheels at the opposite ends of the catwalk; No. 2 wheel having pulled out 2 loops of wire for No. 2 strand; and wheel No. 1, two loops of wire for No. 4 strand. These loops are then placed on strand shoes 2—2-A and 4—4-A, respectively; being the first wires for Strands No. 2 and No. 4, respectively, as shown in B. Loops are then placed on the wheels from another set of reels, and their directions reversed. On the return trip, shown in C, wheel No. 2 pulls out wire for strand No. 1, and wheel No. 1, wire for strand No. 3. These wires are placed on their respective strand shoes, and enough slack is pulled in the wire, by hand, from the reels serving strands No. 2 and No. 4, to place loops on the spinning wheels for their second outbound trip. This completes the cycle, and the operation is repeated over and over until 472 wires have been placed in each of the 4 strands that are spun at one time.

FURTHER DETAILS

Fig. 3 is a close up of the splay point, i.e., where the strands forming the cable, branch out to their respective eyebars and strand shoes. As the spinning wheel passed this point, the live wire was hooked under one of the small wheels shown to the right of the wooden block, and the dead wire was laid in the block. As soon as the wire was adjusted, it was taken from the block and placed in the chuck. These chucks shaped the strands. When a group of 4 strands was completed, they were hoisted clear of these chucks, the chucks and supporting beam was disassembled, and the strands were lowered into the splay casting, and were then made ready for the next group of 4 strands. At the saddles a similar arrangement of block and wheels, but extending the full length of the saddle, was employed. However, no chucks were used, as the wire was placed directly in the saddle without being formed into a strand. To keep the hauling ropes taught, they were passed over a "floating" counterweight sheave just before passing around the driving wheel connected to the motor, as shown in Fig. 4. Attached to this sheave by means of a rope passing over a set of small wheels, was a counterweight that hung outside of the frame work. As this counterweight moved up and down, it maintained the tension in the hauling rope uniform at all times. A similar arrangement was used for each wire as it passed over the top of the frame, but the sheaves and counterweights for the wire were located inside of the frame. Connected to the reels by gearing was an air driven motor, the slowing or speeding up of which controlled the tension in the wire, and was regulated according to the rise or fall of the counterweight sheaves.

FIG. 1

COMPACTED CABLE

FIG. 3A

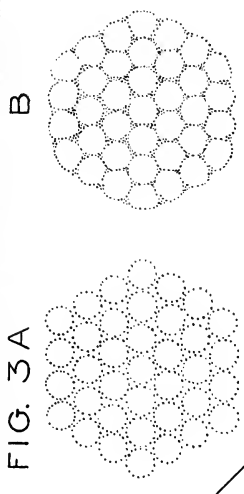

C

D

FIG. 2

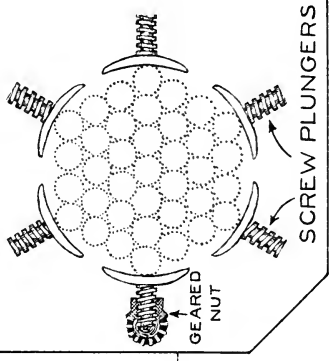

INDIVIDUAL STRANDS

BANDS

HAND WINCH

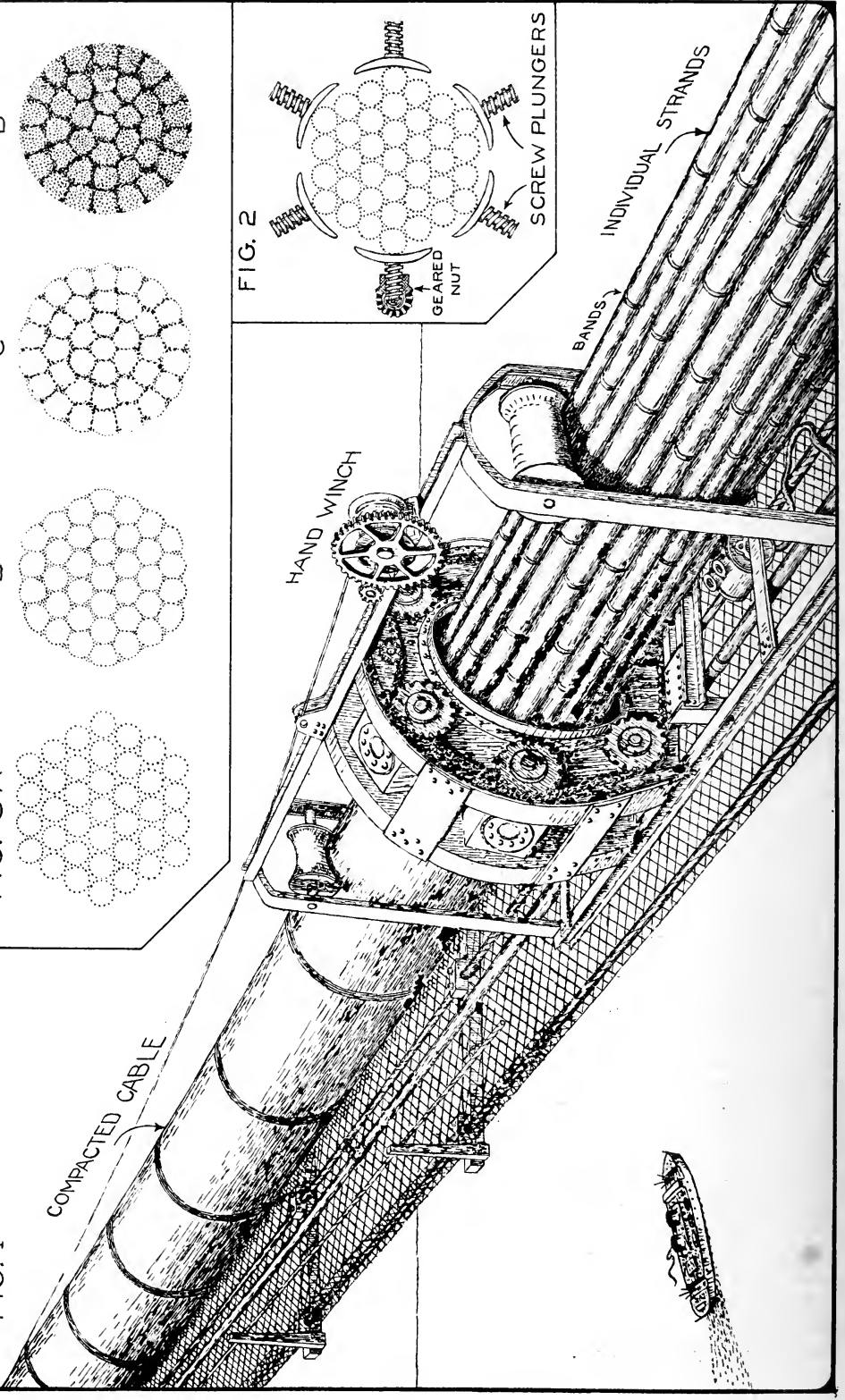

XV—SQUEEZING OPERATION

Continuing the operation from the preceding plate; as soon as a group of 4 strands had been completed, they were squeezed to a circular cross section, and held in that position by small flat bands of tin. When the strand had been squeezed and banded for its entire length, it was adjusted for its proper sag in somewhat the same manner as the individual wires were adjusted, i.e., by either pulling in on the ends, or slacking off. As the wires in the completed strand were endless loops, the strand shoes themselves took care of the differential in length, by having shims, or flat pieces of steel, interposed between them and the eyebar pin against which they bear. The position of these shims is shown in Fig. 5, Plate X. Fig. 1, here, shows how the 37 strands appeared when they had all been completed. As was explained in connection with the anchorages, it was necessary to break the cable down into smaller units in order to fasten it at those points. Also, how the strands were handled as units during the various spinning operations. Once the cable was completed, these strands as units had served their purpose, and the cable functions better as a single unit. To obtain this result, the cable was squeezed until all the wires were compacted to a more or less solid mass. The cable thereafter acted as a solid steel shaft, except that the thousands of individual wires of which it is composed give it more flexibility than would be the case were it a solid shaft.

THE MAIN SQUEEZE

Fig. 1 is a view of the squeezing apparatus used to compact the wires. It consisted of a steel frame work, having a set of six screw plungers, that pressed against the cable as the screws were operated. These screws are shown in Fig. 2. A geared nut was fitted to the top of each screw, and by means of bevel gears and shafting, these nuts were turned by a set of sprocket wheels. These sprocket wheels were connected to a driving sprocket by means of a chain, as shown. This driving sprocket was geared to an air driven motor located under the squeezer. Compressed air, generated by a compressor on the ground, was piped over the entire length of the catwalks, and convenient outlets provided to which an air hose from the motor could be connected. The weight of the squeezer was supported on the cable by means of a framework and large wooden spools. As the strands formed a hexagon prior to being squeezed, the leading spool was flat, and the follow-up spool concave. To move the squeezer along the cable, a hand winch was located on top of this frame. After the squeezer had brought the cable to a circular cross section, and before the pressure was released, a temporary wrapping of wire was placed around the cable immediately behind the squeezer. This prevented the wires from springing apart when the pressure was released. The bottom of the squeezer could be unbolted so that it could be placed on the cable, or removed at the saddles, to again be bolted on at the other side. The squeezes were made at approximately 3 foot intervals.

FROM 17,464 WIRES TO A SOLID MASS

Fig. 3-A is a cross section of the cable, showing the approximate position of the 37 strands prior to squeezing. At B the pressure is applied, and the strands are all brought together; and at C they are beginning to lose their circular shape as further pressure is brought to bear. D shows the cable as it was finally brought to a more or less solid mass in the form of a perfect circle, $28\frac{3}{4}$ inches in diameter. The tin bands were removed on the outside strands, but those in the interior remained. The amount of voids, or spaces between wires, averaged between 12 and 18% of the cable area.

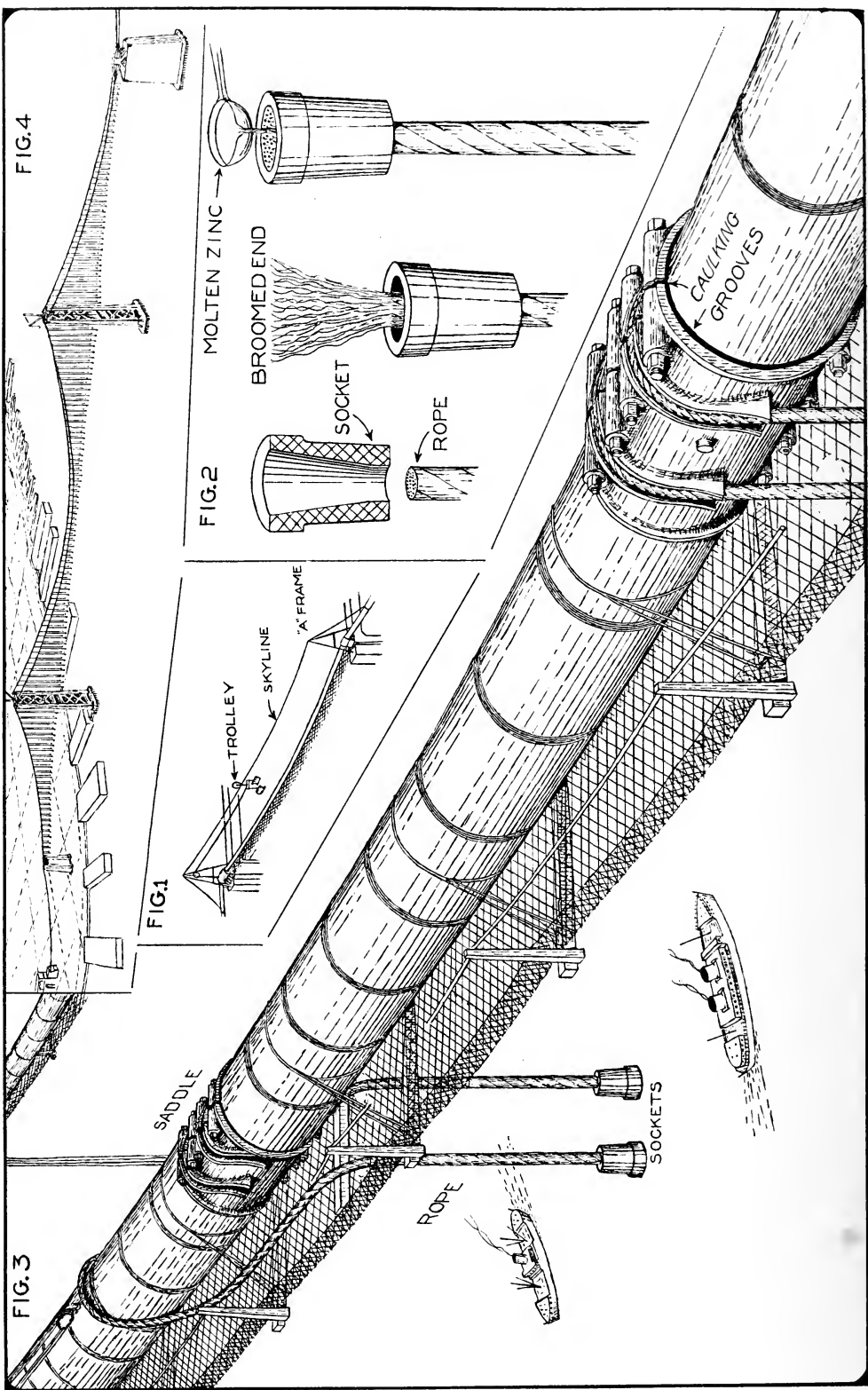

FIG. 4

FIG. 2

FIG. 1

FIG. 3

MOLTEN ZINC

BROOMED END

SOCKET

ROPE

TROLLEY

SKYLINE

'A' FRAME

SADDLE

ROPE

SOCKETS

CALLING GROOVES

XVI—SUSPENDER ROPE SADDLES

When the cables had been squeezed to a circular cross section, they were ready to receive the suspender ropes. The suspender ropes are so-called because the steel for the roadway structure is suspended from the cables by these ropes. The ropes are not placed directly on the cables, but are placed on saddles, sometimes called cable bands. These suspender rope saddles are circular in shape to conform to the shape of the cable, and are manufactured in two halves. The two halves are bolted together, and the interior machined out to a smooth finish. Two of these saddles are shown in Fig. 3. Fig. 1 illustrates the manner in which they were placed on the cable. Two "A" frames were erected, one on top of the tower W-2 and the other on top of W-1. A "skyline" was strung between the two frames, and a trolley fitted to this skyline. The suspender rope saddles were hoisted to the top of W-2 by the derrick, and from here the two halves were suspended from the trolley by means of chain falls. A hauling rope attached to the trolley controlled its trip down the skyline. When the two halves arrived at the proper point on the cable, workmen stationed there lowered away on the chain falls until the two halves encircled the cable. The 8 bolts were placed in position, and the nuts screwed up until the saddle was secure on the cable. The chain falls were then released and the trolley hauled back up to the tower for another saddle. These saddles were placed on the cables at approximately 30 foot intervals, which correspond to the length of the panels forming the roadway steel. The size of the bolts are such that they are capable of exerting an enormous pressure as the two halves of the saddle are clamped together around the cable, thus removing the possibility of any slippage.

SUSPENDER ROPES

The suspender ropes, up until this time, supported the catwalk. It will be noted in the drawing that the catwalk is now lashed directly to the cable by means of small wire ropes. After the entire catwalk had been lashed in this manner, the suspender ropes were released and cut up into various lengths. These lengths corresponded to twice the distance between the cable and the calculated height of the steel work. The ends of the ropes were then socketed. A cut away section of one of the sockets is shown in Fig. 2, with a rope end immediately below it. The socket was slid down the rope a short distance, and the rope above the socket was "broomed" out, as shown. The socket was then pulled back up the rope until the latter was flush with its end. Molten zinc was then poured into the broomed end of the rope, and upon cooling, permanently keeps the rope end spread out in a cone shape, conforming to the shape of the interior of the socket.

43 MILES OF ROPE

After the ropes had been socketed, they were hoisted to one of the tower tops and dragged along the catwalk to the proper position for installing. To hang them, one end was placed over the cable, and worked down to the saddle, as shown in Fig. 3. The longer ropes were handled with a block and tackle. Holes were cut in the catwalk to pass them through. Each saddle has two suspender rope grooves into which the ropes came to rest. The ropes are $2\frac{1}{4}$ inches in diameter, and there were some 43 miles of them used. To make the saddle weather proof, caulking grooves were provided around their edges and where the two halves were joined, and these grooves were caulked with a lead wool in the same manner that a plumber caulks a soil pipe. Fig. 4 indicates the manner in which the suspender ropes were dropped down from the cables between San Francisco and the center anchorage.

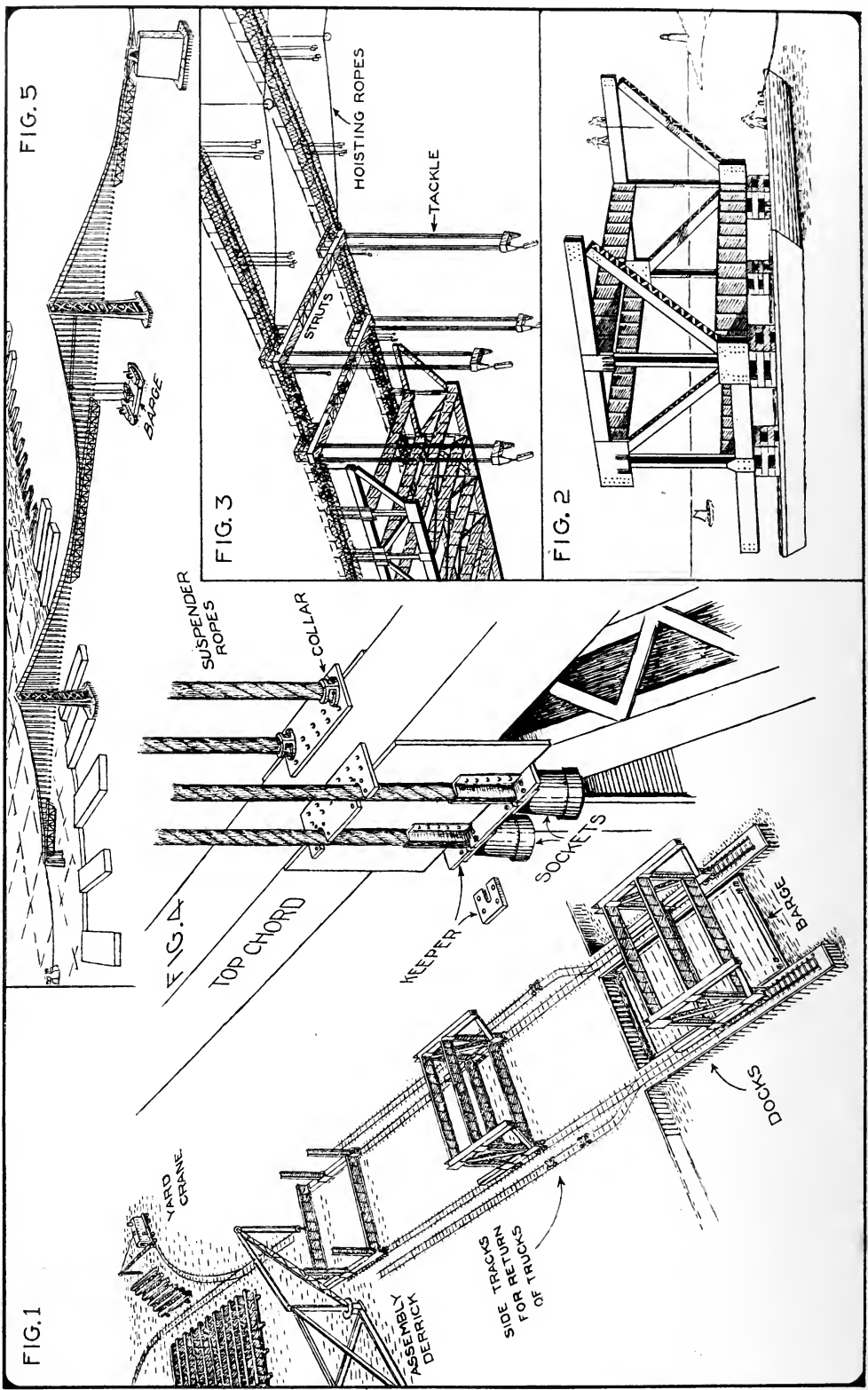

FIG. 1

FIG. 5

FIG. 3

FIG. 2

FIG. 4

TOP CHORD

SUSPENSER ROPES

COLLAR

KEEPER

SOCKETS

HOISTING ROPE

TACKLE

STRUTS

YARD CRANE

ASSEMBLY

SIDE TRUCKS FOR RETURN

DOCKS

BARGE

XVII—STEEL WORK IN MASS PRODUCTION

With the suspender ropes in place, the next step was to hang the roadway steel to these ropes. The steel was fabricated in the east and brought out to San Francisco by boat. It was unloaded at Islais Creek and stored in the open. There were several acres of it. The manner in which the steel was assembled and hoisted into place was an innovation in bridge building. As shown in Fig. 1, a yard crane brought the steel from the storage piles to an assembly derrick. In front of this derrick were two sets of standard railroad tracks, on which were mounted four railroad trucks. Two panels, or sections, of the bridge structure were assembled on these railroad trucks. Upon completion, this assembled section was pulled down the tracks, and another section assembled by the derrick. The ends of these tracks were built out onto two narrow docks, between which a barge was floated, after being partially filled with water. As the water was pumped from the barge, it rose, and lifted the steel work from the trucks. Fig. 2 shows a section, or two panels, of roadway structure loaded on the barge and ready for towing out to the bridge site. There were as many as 7 sections on the line at one time. If Henry Ford knew about this, the contractors would have to pay a royalty.

ANOTHER INNOVATION

Fig. 5 shows the barge in position under the bridge. Fig. 3 illustrates the novel method used in the actual hoisting of the steel into place. No derricks were used. Two sets of tackle were hung from the cables, and one line of each tackle was run over a set of sheaves to the adjacent tower, where the hoisting engines were located. Each set of tackle was connected across the two cables by light trusses, or struts. During the hoisting, this tackle was connected directly to the cable by means of a sling, a piece of brake lining being interposed to prevent the bruising of the wires. To enable the tackle to be moved to a new position, a jack knife frame extended out over the cable from the inside of the strut, thus clearing the catwalk. A large wooden pulley under the jack knife frame came to a bearing on the cable, and the strut was ready to be rolled up the cable. In the new position, the slings were replaced, the jack knife frames released, and the apparatus was ready for hoisting another section of steel. The hoisting was commenced at mid-span, or farthest away from the towers, and at each new hoist, a little more of the hoisting ropes were reeled in on the drums.

ROADWAY SUSPENSION

During the hoisting, the man in charge of operations stood on the strut, and communicated his signals to the hoisting engineer at the tower by means of a telephone. As the steel section came up to the proper level, the workmen steered the suspender ropes into their receptacles, as shown in Fig. 4. These consisted of a flat steel plate, riveted to the under side of the top chord, and provided with 4 slotted holes, one for each of the suspender ropes. A keeper, with a slot running the other way, was then placed on the rope and bolted to the plate. The hoisting ropes were slacked off, and the steel work came to a bearing on the top face of the sockets. To prevent chafing at the socket, the ropes were also secured to another plate on top of the chord, the keeper in this case being a split collar that was bolted to that plate. Over the Embarcadero, at the San Francisco end, the steel was brought up from the yard by rail, and assembled in the street. It was hoisted in the same manner as described above. Over the steamship docks it was necessary to make single hoists, as the sections could not be assembled first.

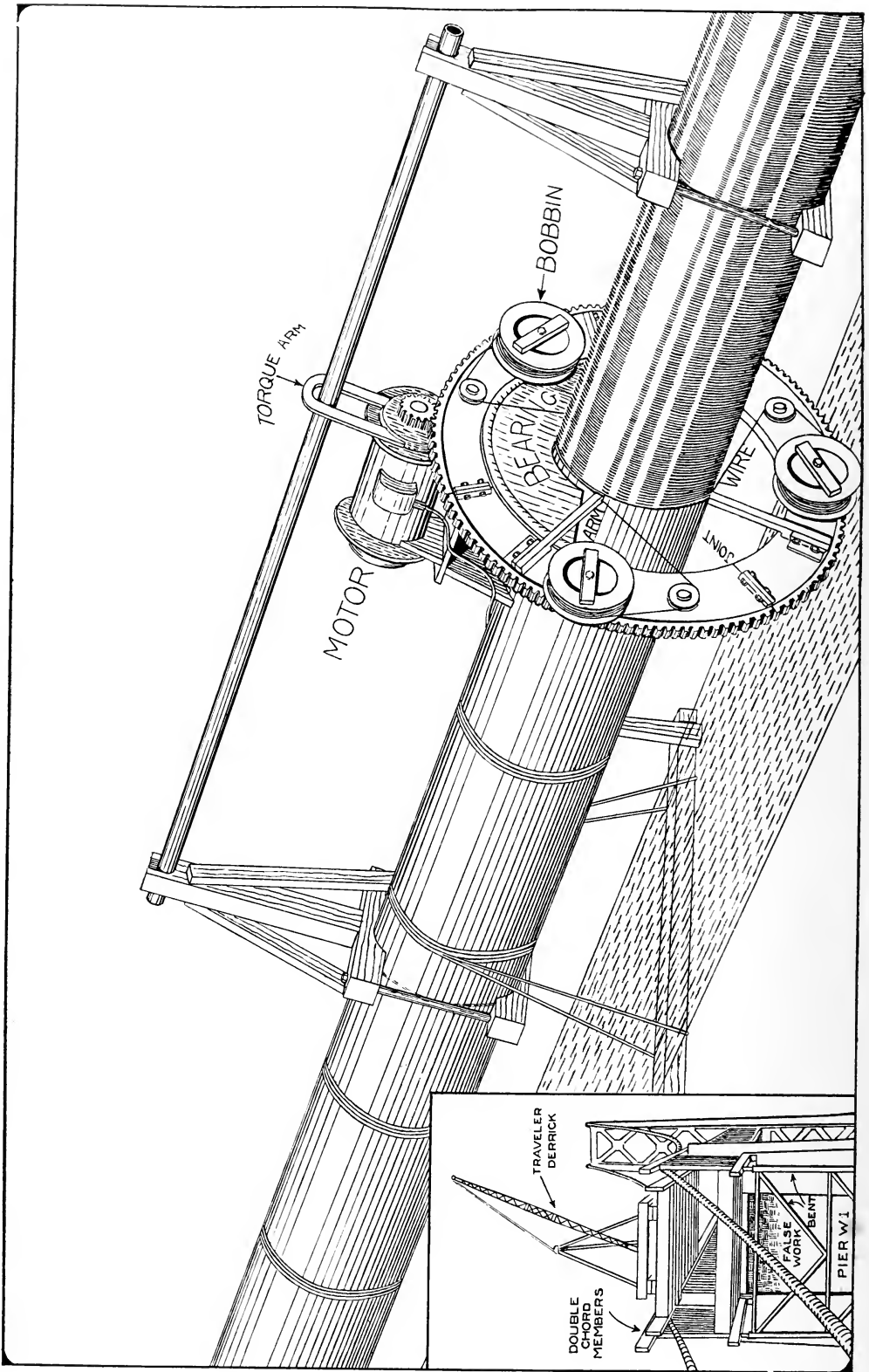

XVIII—WRAPPING OPERATION

Between Pier W-1 and the San Francisco anchorage the cables pass down below the level of the roadway steel, and the steel work is not supported by them in this span. The steel work here was erected by a traveler derrick, so called because it travels out over the newly erected steel. Double chord members, i.e., the horizontal members of the truss, were used here to permit the cables to pass down through the steel work, as shown in the small inset drawing. As this span is over land, the steel work was erected on false work, or bents, as the engineer calls them, which were removed after the span was completed. When this derrick had erected the steel work shown here up to the San Francisco anchorage, it was reversed, and traveled back over the steel on what is known as a "second pass." On this second pass it was used to erect the steel curbs for the roadway, hand rails, light braces, etc. Another set of travelers did the same thing between W-2 and W-3, and between W-3 and the center anchorage, although in that case it was their "first pass." A revision of nomenclature seems to be needed.

WRAPPING, THE LAST CABLE OPERATION

This plate illustrates the wrapping operation, or final operation on the cable. The purpose of wrapping the cable is two-fold; to maintain the cable in a circular cross section, and to give it a weather proof covering. To effect this latter it is necessary that the wrapping wires be placed absolutely tight against one another. Although the subject is controversial, it is maintained that the cables will stretch a minute amount as the load of the roadway steel is placed upon them. At any rate the weight of the steel does change the curve of the cables, and were the cables wrapped prior to hanging the steel, the wrapping wire would tend to open up in spots and buckle in others, thus defeating its function as a weather proof covering. The cables are therefore not wrapped until most of the load has been placed upon them. It will be seen from the drawing, however, that the wrapping machine requires a certain amount of clearance, and could not pass through the steel work shown in the small inset drawing. That portion of the cables passing through this steel work, therefore, was wrapped prior to the erection of the steel.

THE MACHINE GOES AROUND AND AROUND

The wrapping machine consists of a large flat ring, with gear teeth cut around its outer edge, that mesh with a driving gear on the end of the motor shaft. The inner edge of this ring sets in a flat, grooved bearing plate that rests on the cable. Another supporting rest is located under the back end of the motor, that also rests on the cable. Attached to the face of this ring are three bobbins, containing the wrapping wire. The wire from each bobbin is passed over a small wheel to an arm that just clears the cable. On the outer end of this arm is a finger that presses the wire being wrapped, tightly against that already wrapped. As the motor revolves the large gear, the wire is wrapped onto the cable 3-ply at a time. To keep the entire machine from turning, a "torque arm" is extended up to a pipe that is set in two posts, clamped to the cable. The cable wires are painted with red lead paste just before being wrapped. When the machine arrives at a suspender rope saddle, the large ring is unbolted, the machine lifted over the saddle, and again bolted together on the other side. The galvanized wrapping wire is slightly smaller than the cable wire. The weight of the machine furnishes the pressure against the wire, being free to slide along the cable. This was regulated by means of a block and tackle, fastened to the upper post.

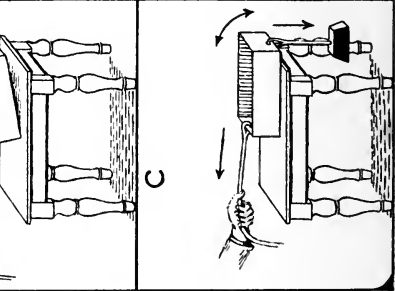
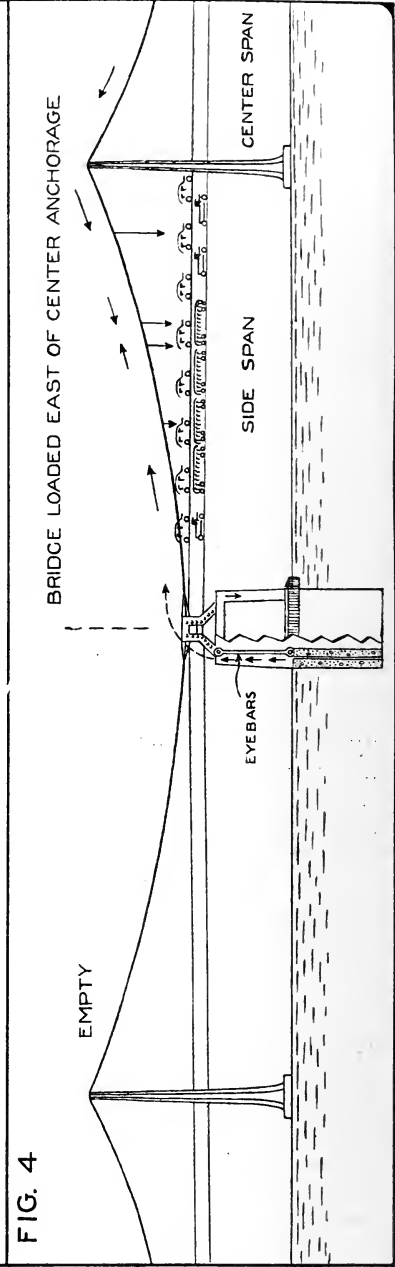
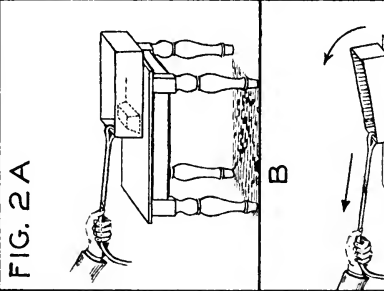
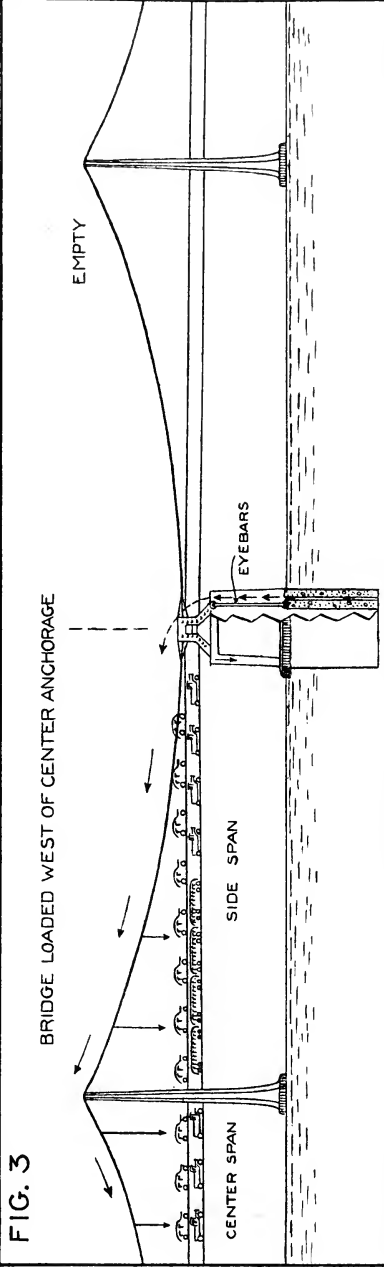
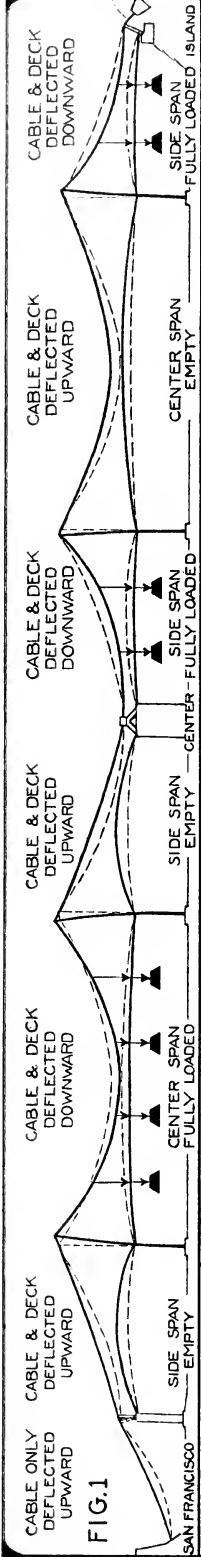

XIX—UNBALANCED LIVE LOADS

To those who have seen the bridge, it seems incredible that the massive steel towers are capable of bending, yet such is the case. Everything in nature expands and contracts, and steel is no exception. The bare towers, before the cables were spun, were deflected out of vertical an average of 9 inches from the action of the sun alone. As one side of the tower was in shadow, the other side was exposed to the rays of the sun, and the steel expanded more on the sunny side, causing it to lean over. The deck steel and cables are also subject to expansion and contraction, as the temperature rises and falls. On a hot day the steel will expand, and they will be longer than they are on a cold day. In addition to the movement caused by changes of temperature, the bridge is subject to movement from the live load that comes upon it. By live load is meant the automobiles, trucks, and electric trains that will cross the bridge.

17-FOOT VERTICAL MOVEMENT

Fig. 1 illustrates the effects on the bridge of unbalanced live loads, i.e., by live loads that are not symmetrically balanced from one end of the bridge to the other. It must be borne in mind that there are two separate suspension bridges between San Francisco and Yerba Buena Island. Also, when the term "fully loaded" is used, it means that every foot of space is occupied by the heaviest kind of traffic. The bridge to the left of the center anchorage is shown as being fully loaded in the center span, with the side spans empty. The dotted lines indicate the normal position. The center span will go down, the side spans up, and the towers will bend toward each other. On an extremely hot day, say 40° above normal, the mid-span point will be deflected downwards 115 inches from normal, and the towers 27 inches from normal. The bridge to the right of the center anchorage is shown as being fully loaded in the side spans, and empty in the center span. The side spans will go down, the center span up, and the towers will bend away from each other. On an extremely cold day, say 40° below normal, the mid-span point will be deflected upwards 85 inches from normal. This makes a vertical movement of 200 inches, or $16\frac{2}{3}$ feet, under these extreme loading conditions and temperature variations. These conditions will probably never be met with, but the bridge is designed to take care of them should they arise.

AN ANCHORAGE THAT IS DOUBLE OR SINGLE

In Fig. 2-A is shown a box resting on a table, with a rope tied to one end. If a lead weight is placed in the box to hold it fast to the table, and the rope is pulled, it will tip up, as shown in B. To overcome this tipping effect, a weight is hung from the other end of the box; this weight will counterbalance the pull, and the box will remain flat on the table. This, in effect, is the principle on which the center anchorage functions when taking care of a live load, unbalanced in respect to this anchorage. Fig. 3 shows the bridge fully loaded to the west and empty to the east, which throws more of a pull in the "A" frame on the loaded side than is opposed to it by the cable to the east. Such a load is transferred to the base of the anchorage through the vertical eyebars on the opposite side. Fig. 4 shows the bridge loaded to the east of the center anchorage and empty to the west. The same effect is obtained on the center anchorage, except in the opposite direction, even though in this case there is only a partial loading. When the bridge is equally loaded on both sides of this anchorage, or entirely empty, the pull in the cables neutralizes each other with respect to the vertical eyebars.

FIG.1A

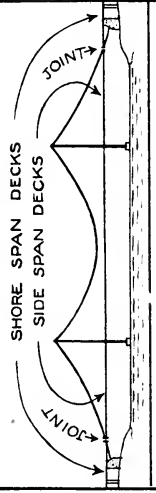

B

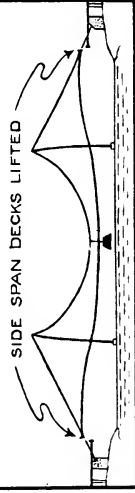

C

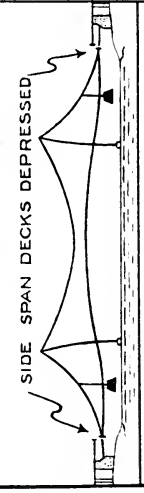

D

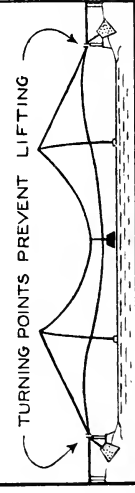

E

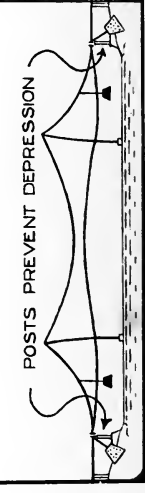

CENTER ANCHORAGE

COMPOUND CURVE

3% GRADE

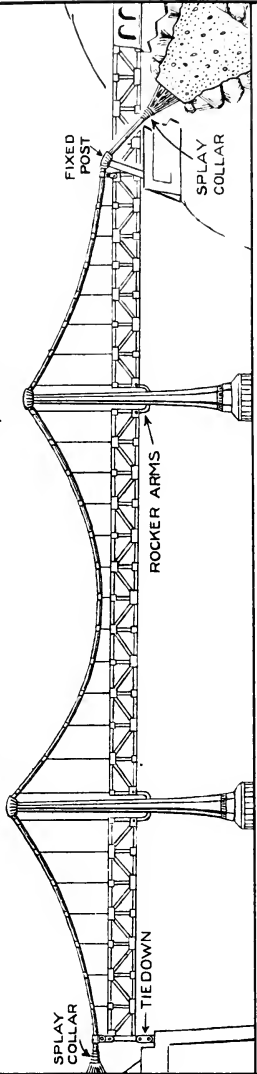
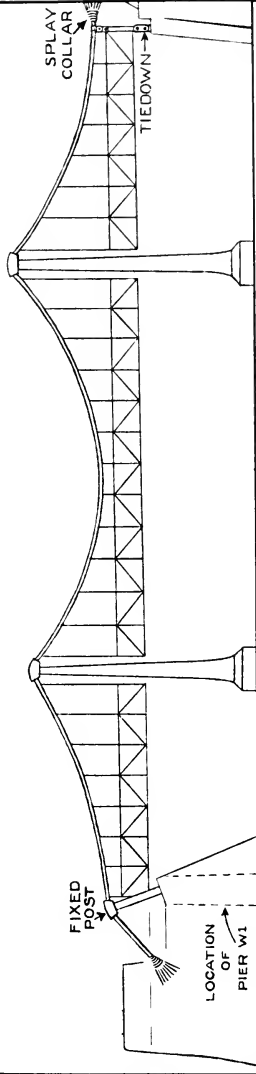

FIG.2

YERBA BUENA ANCHORAGE

SAN FRANCISCO ALTERNATE

FIG.3



SAN FRANCISCO ANCHORAGE AS CONSTRUCTED

FIG.4

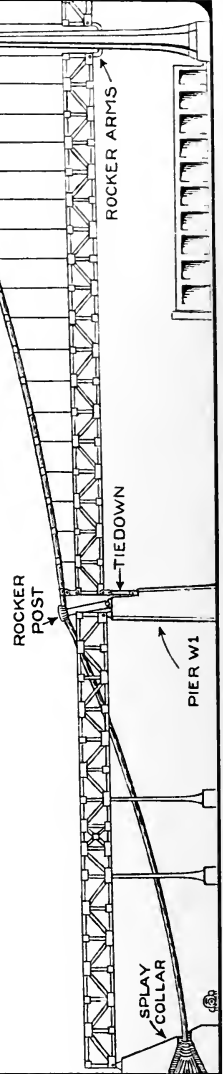

ROCKER ARMS

XX—FIXED POINTS

Fig. 1-A is a silhouette of a simple suspension bridge in a normal position. That part of the deck, or roadway, hung from the cables, is known as the suspended structure. Obviously, the deck cannot be suspended beyond the ends of the cables. From these end points to the ends of the approaches of the bridge, the roadway rests on piers built on the ground. These shore span decks, therefore, are not subject to vertical movement, such as occurs in the suspended structure when the cables are deflected. A joint is therefore provided where the suspended structure meets the shore span structure. B and C indicates how the suspended structure would be raised or lowered from the level of the shore span decks if the cables were unrestrained at these points. The cables are therefore given a "fixed point" at these junctures, by turning them downward over a post. As shown in D and E, these turning points cause the side span and shore span decks to remain in alignment regardless of any deflection in the cables. This same effect is obtained where the cable slopes upwards, by placing a "tie-down" at the fixed point.

ALTERNATE FOR EXPLANATION PURPOSES

In order to place the full length of the span within the limits of the drawing, Fig. 2 is greatly distorted in scale, as is Fig. 3. Fig. 4 more nearly approaches a true scale. In Fig. 2 the fixed point at the left occurs just to the right of the splay collar at the center anchorage. Vertical eyebars transfer the pull on the tie-down to the base of the anchorage in the same manner as was shown in the previous plate. At the island anchorage the cable is given a turning point down over a fixed post. The manner in which the "tunnel" anchorage grips the rock is also shown. Fig. 3, designated as an alternate plan, was not even contemplated, but is shown here to indicate the manner in which the bridge would have been designed had the San Francisco end been made symmetrical with the Yerba Buena Island end. In other words, the rocker post on top of Pier W-1 corresponds with the fixed post at the island.

EXTRA CABLE LENGTH VS. PROPERTY VALUES

The end of the suspended structure at the San Francisco end occurs at Pier W-1, and under certain conditions, the anchorage would have been located at this point. However, from Plate III it will be seen that the bed rock slopes sharply downwards here, and in the same direction as the cable pull. Therefore, to secure a firm anchorage at the W-1 site it would have been necessary to excavate to a considerable distance below the surface of the rock. Furthermore, the size of the anchorage would have taken up a considerable area of waterfront property. At the base of Rincon Hill, bed rock was found near the surface of the ground, and its surface was almost level. The San Francisco anchorage was therefore "set back" 865 feet from its "normal" position, as shown in Fig. 4. At the island anchorage, the short length and steep angle of the cable between the fixed post and splay collar prevents any deflection of the cable there. At the San Francisco end, where the cable in back of the post is 865 feet long and the angle not so steep, there is bound to be some deflection. Any change in deflection here would change the angle of the thrust in the post, were it fixed. But by mounting the post on a trunion, it is permitted to rock back and forth, and any change in deflection in the back part of the cable will be transferred to Pier W-1 through the trunion, and within the limits of the post movement, in a vertical downward direction. To obtain a maximum clearance of 227 feet at the center, the bridge slopes upwards from both ends towards the center.

FIG. 3

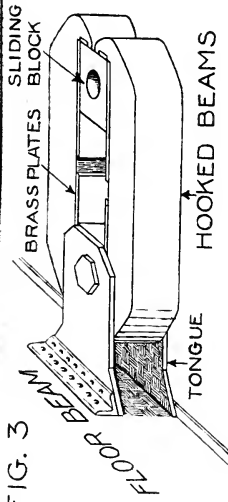

FIG. 4

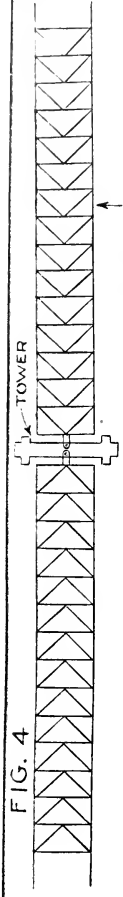

FIG. 2

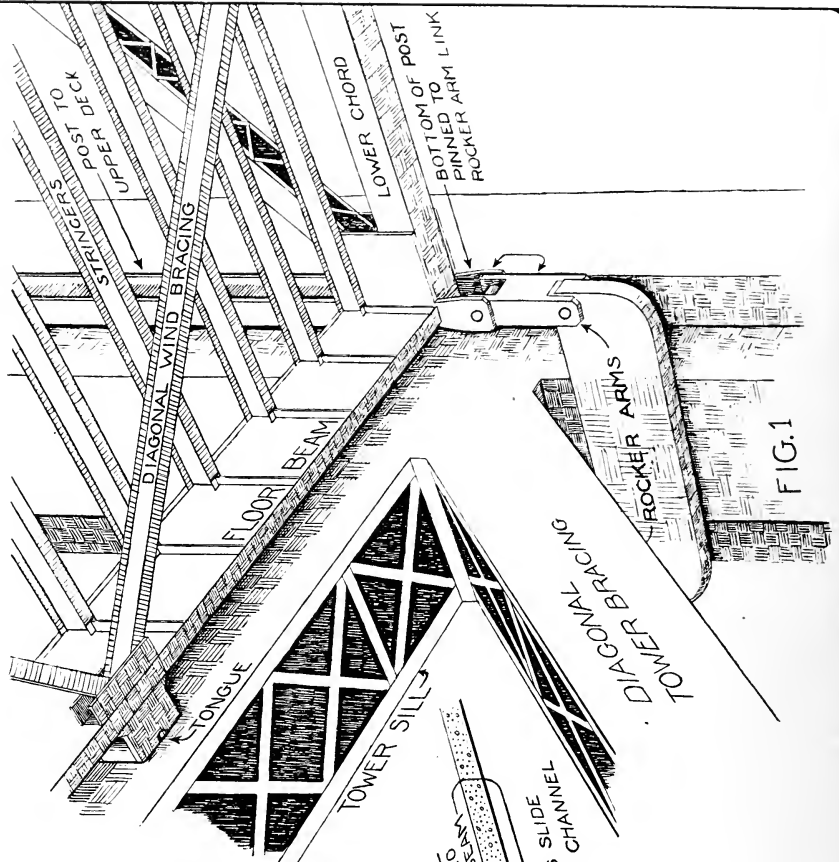
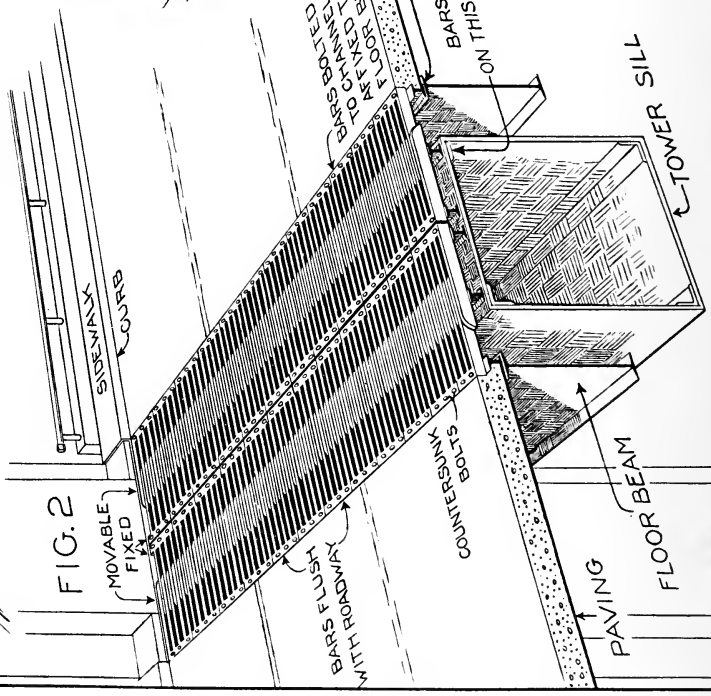

FIG. 1

XXI—EXPANSION JOINTS

The two preceding plates described the movement that the bridge is subject to from loading and temperature changes. In Fig. 3 of Plate XX, the center span is shown entirely suspended from the cables and not connected to the towers. Since the towers are fixed, and the suspended decks subject to movement, it is necessary to provide a flexible joint at the point where the decks connect with the towers. This is known as an Expansion Joint. Fig. 1 of this plate shows the details of this tower connection, as well as the structural details of the decks, and is a view looking up from below the lower deck. The end next to the tower, of the panel that is adjacent to it, is supported on rocker arms. These rocker arms tie the suspended structure to the tower, and, at the same time, permit movement of it due to expansion and contraction, loading deflections, and wind sway. To keep the deck in alignment with the tower, a tongue is extended out from the floor beam, which is permitted to slide in and out of a corresponding opening in the tower sill. The link in the rocker arm imparts a more or less horizontal direction to the movement of the decks, and prevents lifting, as would be the case were they pinned direct to the tower, for they would then describe an arc.

SLIDING FINGER JOINTS

Since the rocker arms permit of a more or less horizontal movement of the decks, it is necessary to provide a gap between their ends and the towers. This gap varies according to the movement of the decks. To permit of the smooth passage of vehicles across this gap, a series of "fingers," or bars, are fitted to the decks and tower sill, that telescope into one another. These are shown in Fig. 2, which is a view looking down from above the upper deck. The fixed ends of alternate bars are bolted to channels that are placed underneath them. The channels under the fixed ends of the movable bars are affixed to the floor beams of the decks, while the channels to which the fixed ends of the fixed bars are bolted are affixed to the tower sill. A third channel, in between these two, is affixed to the tower sill, and permits the movable bars to slide back and forth on it. The entire arrangement is like placing the fingers of both hands together, and sliding them back and forth. The bars are 4 feet long, and, in the neutral position, overlap each other approximately 2 feet. The narrow sidewalk shown, is a service sidewalk, for the use of workmen and inspectors only. Certain members of the traveling public, however, will no doubt be invited to pull over to the curb.

CONNECTING LINK

A similar expansion joint, of sliding bars, is provided on the north side of the lower deck for the passage of trucks. On the south side, the rails of the tracks only, telescope, as the deck moves. The tongue, rocker arms, and diagonal wind bracing are all fastened to the lower deck. Since the posts rigidly fasten the two decks together, they move simultaneously. However, the stringers, on which the roadways are laid, are designed for expansion in both decks. At one end these stringers are riveted to the floor beam, while at the other they slide back and forth on a shelf like angle iron. Provision is made for expansion of the stringers, in this manner, in all the panels, for the entire length of the structure. As shown in Fig. 4, the diagonal wind bracing comes to a focus at the tongues. These tongues are pinned to blocks that slide back and forth in between two hooked beams, fitted into a rectangular opening in the tower sill, as shown in Fig. 3. Brass plates act as a bearing surface, and the hooked ends prevent the tongues from pulling out.

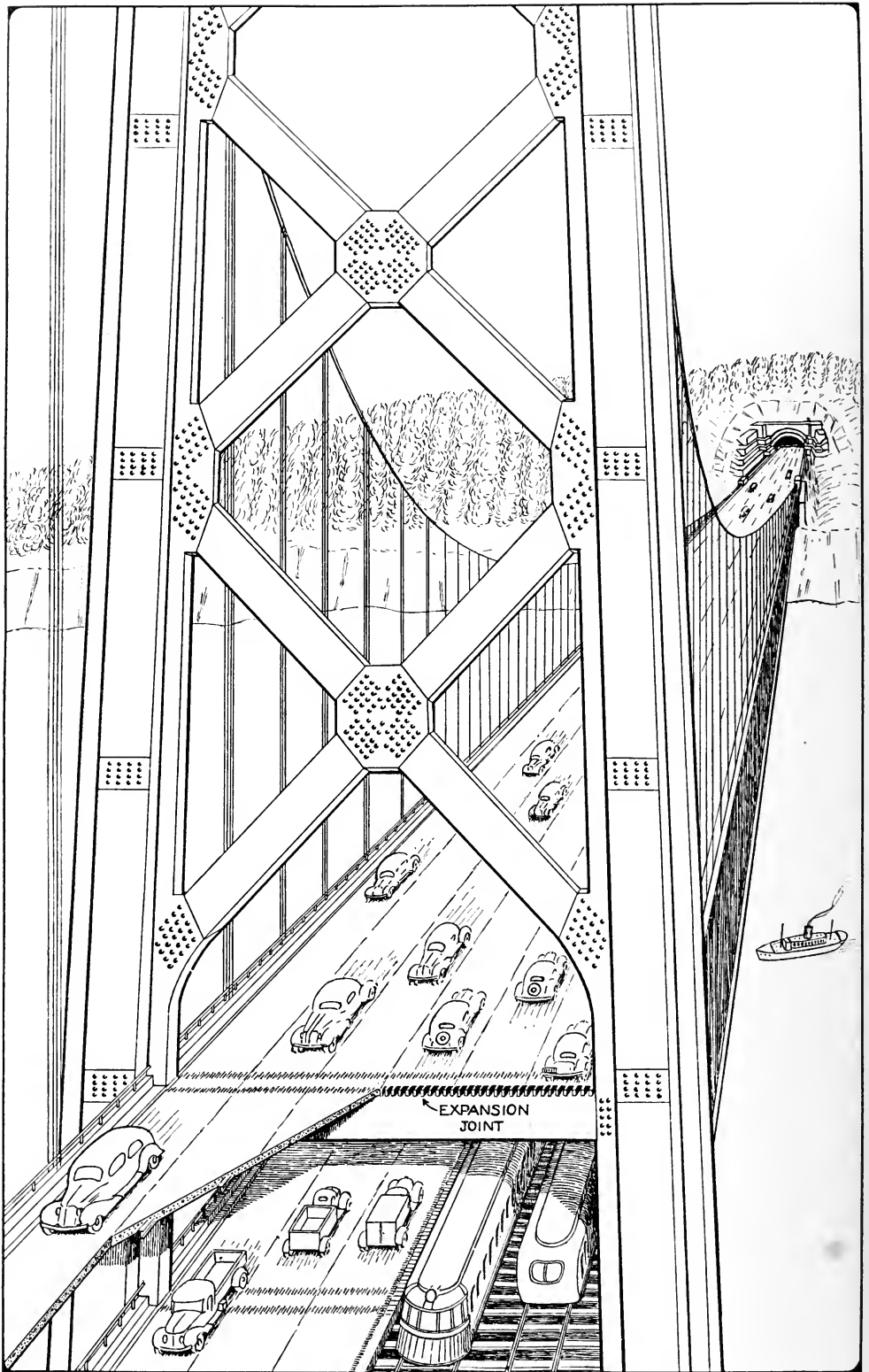

XXII—THE COMPLETED STRUCTURE

Cross bars, of the reinforcing type, were placed across the stringers, and the concrete for the roadway poured into collapsible forms, supported from below. To reduce the weight, the concrete was made up of a synthetic aggregate in place of the usual crushed rock. When steel is rolled in the mill, there is a hard brittle scale formed on its surface, which is known as mill scale. In the case of steel that is protected, or is exposed to ordinary conditions, paint is applied to it without first removing this scale. Under extreme exposure conditions, this scale will peel off in spots, exposing the steel to the direct action of the weather. On this bridge, however, the mill scale was removed first. The steel was shipped out from the east, and exposed out in the open for a period of months. This caused enough rust to set in, that the scale became loosened up somewhat. It was then removed by sandblasting, and the steel immediately given a coat of red lead paint. Another coat of red lead was applied after the steel had been erected, and, finally, an aluminum top coat applied. The original specifications, however, called for a black top coat.

SAN FRANCISCO INVITES YOU TO CROSS TO OAKLAND

An attempt was made to so arrange the continuity of the previous plates, that it corresponded to the order in which the various steps of the actual construction of the bridge was carried out. Following through from here, nothing now remains but to cross the bridge, the opening date having been set for November 7, 1936. This plate therefore, shows the completed bridge with traffic moving on both decks; six lanes for automobiles on the upper deck, 3 east, and 3 westbound; one lane in each direction for trucks, with a passing lane in the middle. The electric trains are of the author's own invention, and his conception of streamlining. The center to center distance between the cables is 66 feet. With the guard rails, sidewalks and curbs, this allows a clear roadway width of 58 feet between curbs for the upper deck. The distance between the upper and lower decks, or the vertical clearance, is 20 feet. The truck roadway, curb to curb, measures 31 feet, and the remaining 28 foot width accommodates the electric trains.

ELECTRIC SERVICE PROVIDED THROUGHOUT

The various steel members of the tower were joined together by means of splice plates, and although only 16 rivets are shown here in these splice plates, an attempt to count them would create the impression that there is closer to 1600. Beneath the lower deck, and running across the entire width of the bridge, is suspended a service deck, about 6 feet wide. At either end of the deck, or gangplank, are attached a set of wheels that run on a track riveted to the outer edge of the bottom chord. A hand winch permits this gangplank to be propelled along beneath the lower deck for the entire length of the span. As its name implies, it is for service use such as future paintings, inspections, etc. There is one of these between each pair of towers, and one in each of the four side spans. As an aid to navigation, there has been installed huge electrically operated sirens on Piers W-2, W-3, W-5, W-6, E-2 and E-3. These sirens are audible at a distance of 10 miles. Each siren is sounded according to a code, the intervals between blasts indicating to a ship's captain, during a fog, the pier from which the warning is coming. During the construction period, a two-way, short wave radio set was installed on each pier, so that communication could be had with headquarters on shore. This was of considerable assistance in scheduling the dispatch of material to the piers as needed.

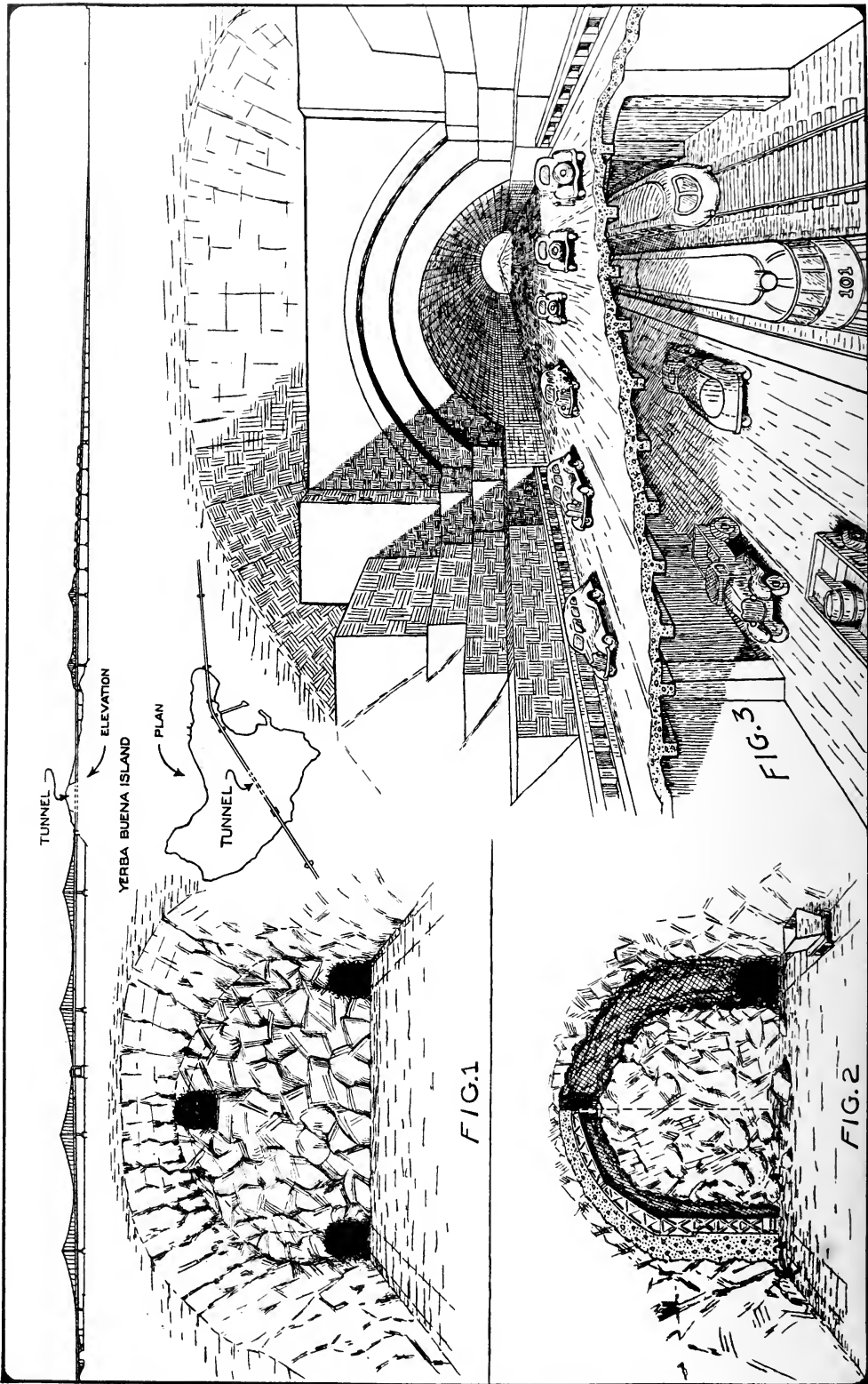

TUNNEL

ELEVATION

YERBA BUENA ISLAND

PLAN

TUNNEL

FIG. 1

FIG. 2

FIG. 3

101

XXIII—A BRIDGE WITH A TUNNEL AT ITS CENTER

The small silhouette at the top of this plate shows how the traffic, moving east, will pass from the suspension spans on to Goat Island, as Yerba Buena is commonly called. To provide a straight line passage across the island, a tunnel was bored through the hill on the west side. Upon emerging from the east portal, concrete and steel trestles carry the roadways over the old parade grounds of the U. S. Naval Training Station, since moved to San Diego. This tunnel is unique in that it is a double deck tunnel, and the largest bore tunnel in the world. It measures 76 feet across at its widest point, is 58 feet high, and 540 feet long. The total length of the island crossing is 2,950 feet. Ramps are provided on the island to divert traffic to the exposition, to be held in 1939, and which will commemorate the completion of the two bridges now being built.

PILOT TUNNELS

The method used in boring this tunnel was unusual, in that the tunnel was "built" first, and the hole excavated afterwards. Fig. 1 shows how a space for the portal was first excavated, and then three, 12 foot pilot tunnels driven through the rock. Fig. 2 shows how a channel was broken down through the rock from the upper pilot tunnel to the lower ones. The excavated material was removed from the lower tunnels by means of small cars. Steel forms were then slid along this channel, as shown at the left, and concrete poured between the forms and the roof of the channel. When the concrete walls forming the main tunnel had been completed for its entire length, the core was excavated by blasting, and the material removed by means of steam shovels. The advantages of this method are due to the fact that the entire roof of the tunnel did not have to be shored up by false work; nor was it necessary to remove the bulk of the excavated material by means of small cars. Since there was no false work to interfere, trucks could be backed right up to the steam shovel.

DOUBLE DECKS

As shown in Fig. 3, the double deck system of the bridge proper was carried right through the tunnel, the vehicles on either upper or lower deck passing through without change of grade or direction. As shown in Fig. 2 of Plate XX, there is a short distance between the turning point of the cables and the tunnel portal. Over the top of the anchorage the decks are supported on steel work, passing onto a concrete trestle as the portal is reached. This drawing illustrates the west portal; the east portal being practically a duplicate, except that the ramps for the take-off on the island are located a short distance beyond that portal. As will be seen from the plan view of the island, there is a small harbor on the southeast side where the Navy boats land. Just to the south of this, is located the supply depot of the U. S. Light House Service. The exposition site, shown in Plates I and XXVII, lies to the north of the island in shoal water. The U. S. Army dredgers are filling in this site, and upon the closing of the exposition, it is planned to convert this site into an air field.

Some of the quantities of the material used in building this bridge include 18,500 tons of cable wire, 30,000 tons of reinforcing steel, and 152,000 tons of structural steel. The wood used, principally for concrete forms and the caissons, totaled 30,000,000 board feet. The concrete placed, totaled 1,000,000 cubic yards, composed in part of 1,300,000 barrels of cement. The paint used will total 200,000 gallons.

FIG. 1 A

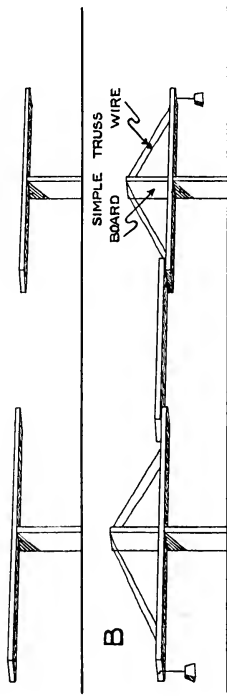

FIG. 2

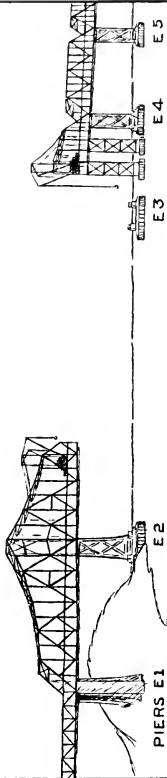

FIG. 3

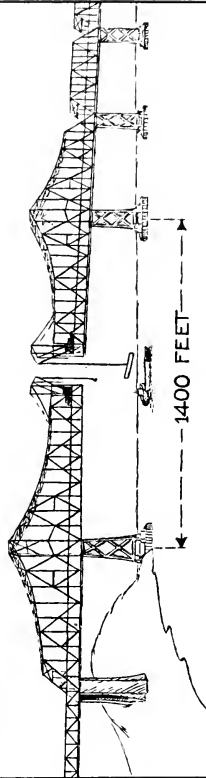
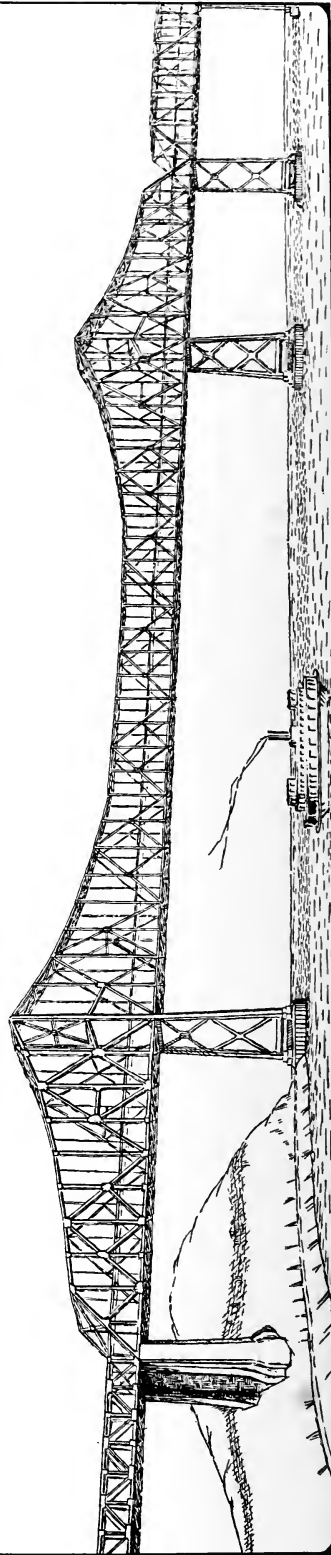

FIG. 4



XXIV—THE CANTILEVER PRINCIPLE

As explained in Plate III, the waters of San Francisco Bay are quite shallow near the east bay shore. However, just east of Yerba Buena Island there is a deep water ship channel. This ship channel is crossed by a cantilever span, so-called because its own weight is balanced, or "canted" out from the supporting towers on the lever principle. This principle is illustrated in Fig. 1, by showing how two one inch boards, placed horizontally, may be balanced over two vertical boards, as in 1-A. In B a third board has been placed on top of the first two, and across the intervening space. To keep the three boards in balance, or technically, to maintain their equilibrium, it is necessary to hang weights on the outer ends of the first two. A one inch board, several feet long, will bend, or deflect from a weight placed upon it. Hence, to keep it from deflecting, it is necessary to support it at the points where the weight is applied. This may be done as in B, by placing vertical blocks at the centers, and stretching wires from these blocks down to the points where the weight is applied. This forms a simple truss, as it is called in engineering practice.

1400 FEET IN THE CLEAR

Fig. 1-C shows this principle adapted to the mechanics of the cantilever span. The solid lines indicate the two sections of the span that are balanced over the supporting towers, with the piers on their outer ends serving as weights. Without these end piers the solid line sections would remain in balance over the towers, but it is necessary that they be built heavy enough to counterbalance the weight of the center section, drawn with dotted lines. It was shown in previous chapters, how these foundation piers were built heavy enough to perform this function. Quite a number of cantilever bridges are built by first assembling this center section, floating it out on a barge to the bridge site, and then hoisting it into position. This method is somewhat dangerous, for if there is any delay in securing the hoisting tackle to the steel, an outgoing tide may cause a shifting of weight, and the entire structure is liable to collapse into the water. This happened with the Quebec Bridge, with a loss of 11 lives. This cantilever span, however, was erected out from the towers, as shown in Figs. 2 and 3. The steel between Piers E-1 and E-2 was erected on false work supported on the ground. Between Piers E-4 and E-3, false work was also used, except that it was supported on temporary piers, as shown in Fig 2. Between Piers E-2 and E-3, the steel was erected by means of two traveler derricks, traveling towards each other, and the steel was unsupported by false work, as shown in Fig. 3. When the two travelers met at the center, the closing panel was brought into alignment by means of powerful hydraulic jacks, that caused the entire overhanging structure to move until the eyes of the eyebars forming the last panel lined up with those in the adjacent panels.

FERRY BOAT ENGINEERS

Fig. 4 illustrates the completed cantilever span, and to the right, the first of the 5 smaller truss spans that are part of the east crossing. The commuters who crossed daily on the ferry boats, had an opportunity to watch the progress of this part of the construction work, and their interest never lagged. In the discussions had regarding the details of the work, anyone who asserted himself was branded as a "Ferry Boat Engineer." The vertical clearance under this part of the bridge is 185 feet at high tide, or 50 feet greater than that of the Brooklyn Bridge. This amount of clearance made it unnecessary to provide a lift or draw span.



XXV—EAST BAY TERMINAL

The boosters club of Oakland would have liked it better had the bridge been named the "Oakland Bridge." However, when the title of the bridge was fixed, the placing of the word "Bay" therein made theirs a lost cause. Officially, it is the San Francisco Oakland Bay Bridge, but by common usage it has been called the "Bay Bridge" ever since the project got fairly under way. The boosters club, however, should not be worried about any rivalry with San Francisco. Their concern should be directed towards the competition that will arise from the development of Marin County, to the north, when the other bridge that will serve San Francisco is thrown open for traffic. The east bay cities are located at the base of a range of hills that form an "L," as shown in the left hand side of this plate. San Francisco is limited in area to some 43 square miles, as a result of which, a goodly percentage of the residential property was laid out in lots only 25 feet in width. The east bay cities, on the other hand, have a natural advantage in being able to offer unlimited areas of residential plots of a size that ought to satisfy even the most enthusiastic of gardeners. If the civic organizations of Oakland show as much enterprise as they did when promoting their splendid harbor facilities, they will bend every effort to promote sub-surface arterials leading to the bridge head.

THE CROSS ROADS

Just as the rivers drain the great central valleys of California, so do the highways lead down to the bay area from the north, south and east. San Pablo Avenue, shown on the map, is the main arterial leading north out of Oakland; East Fourteenth Street to the south; and, Foothill Boulevard to the east. The east bay terminal of the bridge intercepts these main arterials at the point shown on the map by a cross. The back country beyond the hills of Berkeley will be served by a new low level tunnel, at the end of Broadway. The commuters of Alameda have protested against this layout, and their stand that the bridge has lengthened their crossing time, rather than reduced it, is justly taken. However, the automobile traffic over the bridge is as much of a factor as the train borne traffic, and the locations as selected will no doubt stimulate through travel, as well as local commuter traffic.

A JIGSAW PUZZLE

The map, at the left, heads in a general northerly direction. At the terminal of the bridge causeway, indicated by the cross, is a structure that might well be called a traffic "separator." This structure is illustrated in the right hand side of this plate, and heads in a general easterly direction. As the traveler from San Francisco leaves the causeway, he may bear off to the right, clear both the electric train and Southern Pacific R. R. tracks on the overpass, and then either turn towards downtown Oakland, or take the crosstown route through the San Pablo underpass. In the other direction, the traveler may come from either of these last two named routes, drive onto the overpass, and then continue on to Berkeley, or turn left to the bridge. To and from Berkeley, the highway connects directly with the causeway, and without the necessity of driving onto the overpass. By driving onto the overpass, from Berkeley, either downtown Oakland or the crosstown route may be reached. From any one of the four points of this structure, to any of the others, and in either direction, the passage can be made without crossing any of the other routes at the same level. During its erection, this structure had the appearance of a genuine jigsaw puzzle.

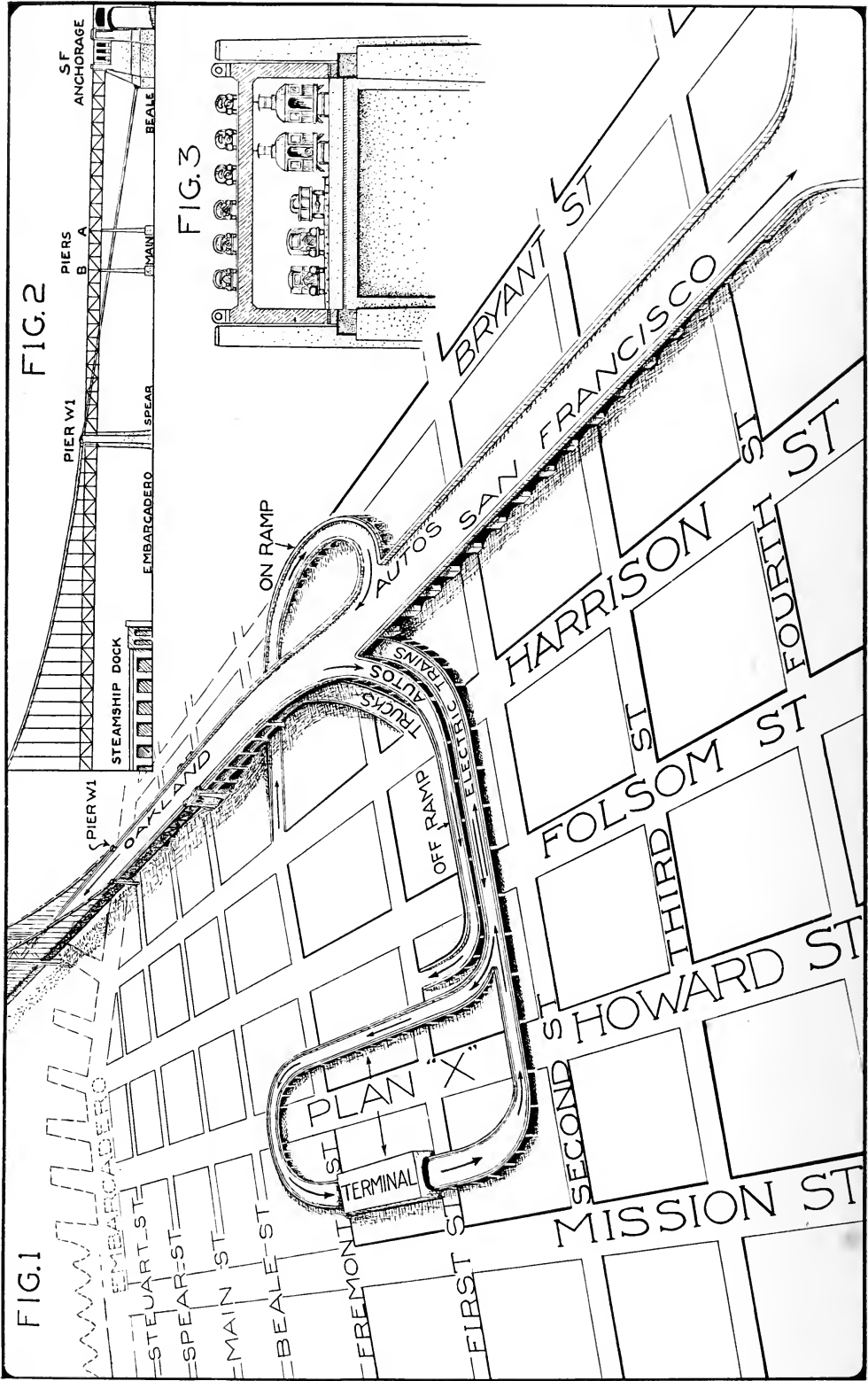

FIG. 1

FIG. 2

FIG. 3

EMBARCADERO
 STEUART-ST
 SPEAR-ST
 MAIN ST
 BEALE-ST
 FREMONT ST
 FIRST ST
 PIER W1
 STEAMSHIP DOCK
 EMBARGADERO
 SPEAR
 PIER W1
 PIER B
 PIER A
 SF ANCHORAGE

PLAN X
 TERMINAL

TRUCKS
 AUTOS
 ELECTRIC RAMP

OFF RAMP

ON RAMP

BRYANT ST
 AUTOS SAN FRANCISCO
 HARRISON ST
 FOLSOM ST
 THIRDS ST
 HOWARD ST
 MISSION ST
 SECOND ST
 FOURTH ST

XXVI—SAN FRANCISCO TERMINAL

The upper deck, or automobile causeway, at the San Francisco end of the bridge, comes to a western terminal at 5th Street, between Harrison and Bryant, as shown in Fig. 1. For motorists desiring to cross the bridge, and who are located below Second Street, an "On" ramp is provided at Fremont and Harrison Streets; it passes underneath both decks, swings around in a curve to the south of the bridge, and comes into the upper deck on the right hand side. In the other direction, motorists may take off at this same point on the "Off" ramp, which terminates on First Street, between Folsom and Howard Streets. Trucks, on both entering and leaving the bridge, will pass over a curved ramp on Harrison Street, between First and Second Streets. As will be seen from Fig. 3, the electric trains will use the south side of the lower deck. The ramp for these trains will take off just west of the automobile off ramp, will pass over an elevated structure alongside of this off ramp to where it turns into First Street; from here it will branch out and form a loop as shown in Fig 1.

PLAN "X"

This elevated loop, and terminal that is shown located just south of Mission Street, is known as Plan "X." It was the plan submitted by the engineers along with the final plans of the bridge structure proper. This plan was opposed by several groups, one of which proposed that the electric trains be turned off to the south of the bridge, swing around to the Embarcadero, and that the Ferry Building be utilized as a terminal. At any rate, this Plan "X" seems to have found more favor than any of the other terminal plans proposed. Prior to the building of the bridge, the trans-bay traffic was carried on ferry boats that connected with interurban systems of electric trains serving the east bay district. Since these were operated under the jurisdiction of the Railroad Commission, the question arose as to what disposition would be made of these operating properties should the bridge authority decide to operate its own trains on the bridge. Or, as an alternative, what arrangements could be made with these companies to consolidate the rail facilities on the bridge with the existing interurban systems. These, and other pertinent questions, were subject to negotiations and hearings, and consequently have consumed considerable time. Until a decision was reached, it obviously would have been poor policy to acquire the necessary properties for a terminal. Hence, it will take at least a year to erect a terminal and install the trackage and equipment for the electric train system, after the bridge has been thrown open to automobile traffic.

RINCON HILL A NATURAL TAKE-OFF POINT

The bridge passes over the crest of Rincon Hill at First Street, and between Second and Beale Streets this hill forms a barrier to any direct access to the level property south of Bryant Street. As shown in Fig. 2, Beale Street passes under the bridge at the east face of the San Francisco Anchorage, with ample clearance under the cables for automobiles, steam trains, etc. As previously explained, the roadways are not supported by the cables between here and Pier W-1, and this figure shows how the supporting piers A and B straddle Main Street. Spear Street passes under the bridge just west of Pier W-1. Fig. 3 shows how the traffic for the two decks will pass through Pier W-1, and the manner in which it will clear the two rocker posts, with their connecting cross beam. Expansion joints are provided here, as was described for the towers in Plate XXI. Market Street, San Francisco's main arterial, lies one block to the north of Mission Street.

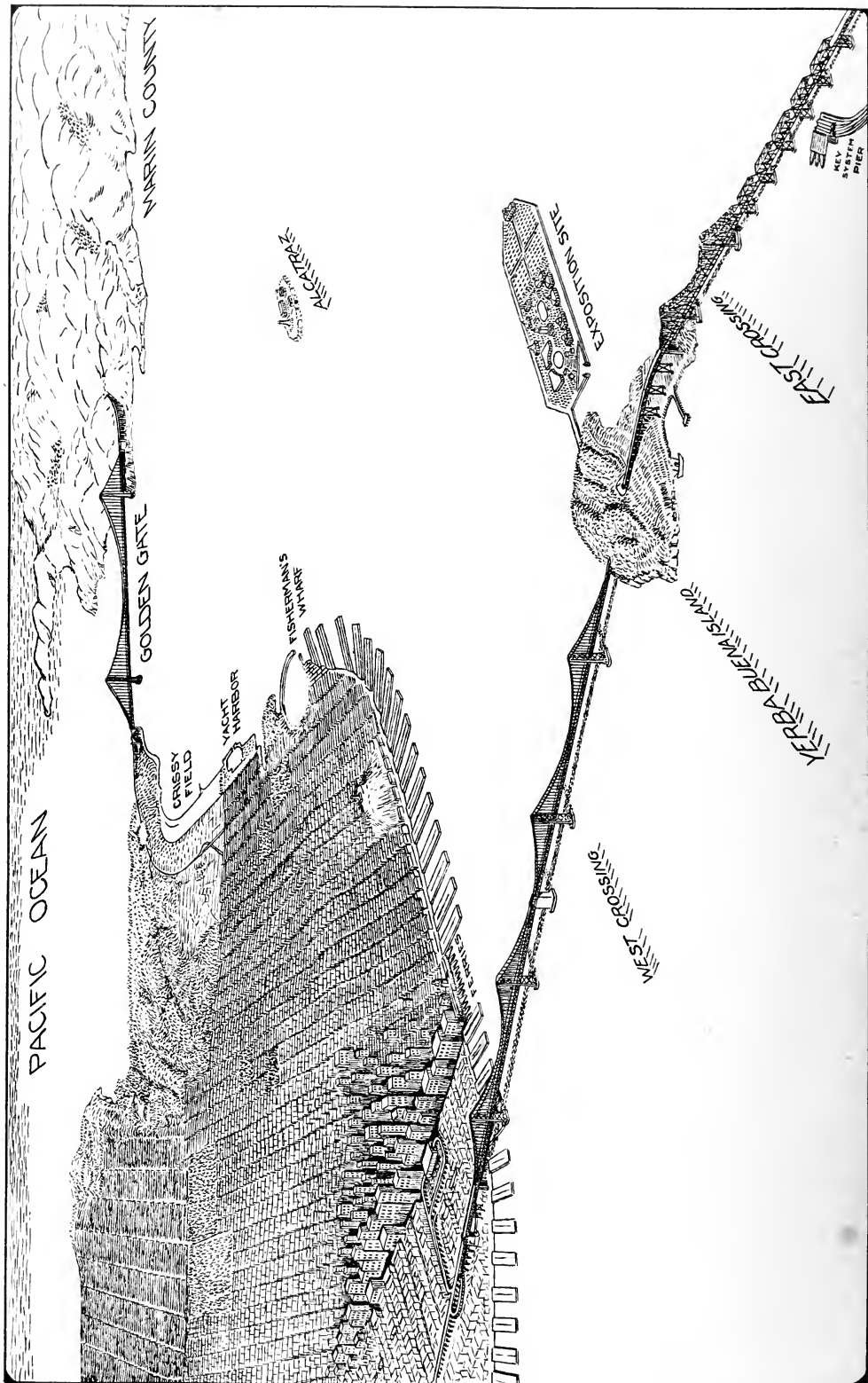

PACIFIC OCEAN

MARIANA COUNTY

GOLDEN GATE

CRISPY FIELD

YACHT HARBOR

FISHERMAN'S WHARF

EXPOSITION SITE

WEST CROSSING

KUREA BLENNISLAND

EAST CROSSING

KEY TO SYMBOLS

ARCHITECT
W. S. WATSON

XXVII—SAN FRANCISCO, THE CITY BY THE GOLDEN GATE

As will be noted from Plate XXV, the eastbay end of the bridge does not terminate in the downtown section of a city. The overpass system at that terminal distributes the traffic to various arterials. San Francisco, shown in this plate, presented an entirely different problem. With the exception of the newer residential sections in the southwest corner, its 43 square miles of area is built up rather compactly. Originally, the area just west of the Ferry Building lay under water, that formed an indentation where the early shipping found shelter. As the city grew, this area became the commercial center of the community. It lies between two hills; Rincon Hill on the left, where the bridge now lands; and, Telegraph Hill, at the water's edge to the north, indicated in this drawing about half way between the ferries and Fisherman's Wharf. With the Ferry Building at its foot, Market Street extends west from the waterfront, and is indicated in this drawing by the cluster of tall buildings. Market Street, San Francisco's main arterial, is 125 feet wide, and the streets to the south of it run parallel with it for most of its length. The streets to the north, bisect Market Street at an angle, and are not as wide as those are to the south. Although Telegraph Hill was recommended as a terminal in some of the earlier bridge projects, the street layout in its vicinity would have led to serious congestion of traffic to and from the approaches.

NEW TRAFFIC COMES WITH A NEW BRIDGE

During the course of its growth, it was natural for the commuter traffic to find a center of gravity in the district adjacent to lower Market Street. The layout of the interurban train terminal, designated as Plan "X," was made to coincide with this center of gravity as nearly as possible. What effect the Golden Gate Bridge traffic will have on this is problematical. That there will be a new center of gravity for traffic entering and leaving San Francisco, however, is certain. Traffic stimulates growth, and with the new highways leading down the peninsula to the south, there is bound to be a realignment, with both bridges exerting their influence. The Plan "X" terminal, however, is designed to take care of the ready-made commuter traffic from the east bay cities that is now using the ferry boats. Once this is put in operation, the tolls can be applied to bond interest and sinking funds.

UNDERPASS VS. SUBWAY

The landing of the automobile traffic of the Bay Bridge to the south of Market Street, not only affords a better city distribution of traffic, but creates a more direct routing to the peninsula highways. The disadvantage is that there is no direct routing, as yet, to the Golden Gate Bridge. A great many new traffic problems will arise in San Francisco from the placing of the Bay Bridge in service. Many of them could be solved by underpassing Market Street. It cannot be denied that the underpass adjacent to the Ferry Building has been a wonderful investment for the merchants operating fleets of trucks, or salesmen's cars, not to mention the reduced running time of the street cars. Had a second underpass been located further up Market Street at the time that one was built, it would probably have liquidated itself by this time. In such a case, its abandonment to make room for a subway, should one be built, would be the same as writing off an item of equipment that had payed for itself. Whatever the traffic problems, two new bridges, that have been the life long dream of many men, are finally realities. The San Francisco Oakland Bay Bridge, shown in the foreground of this plate, is a true scale drawing of that marvelous structure, and a monument to the men who built it.

FIG.1

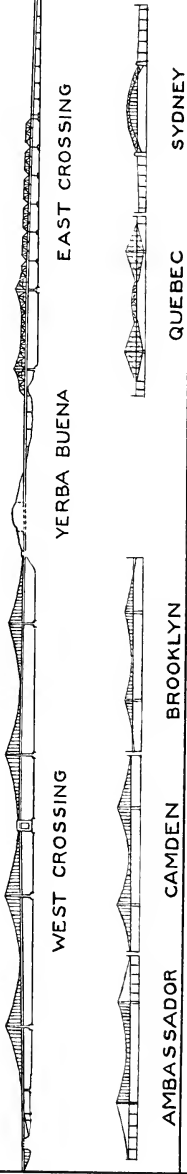

FIG.2

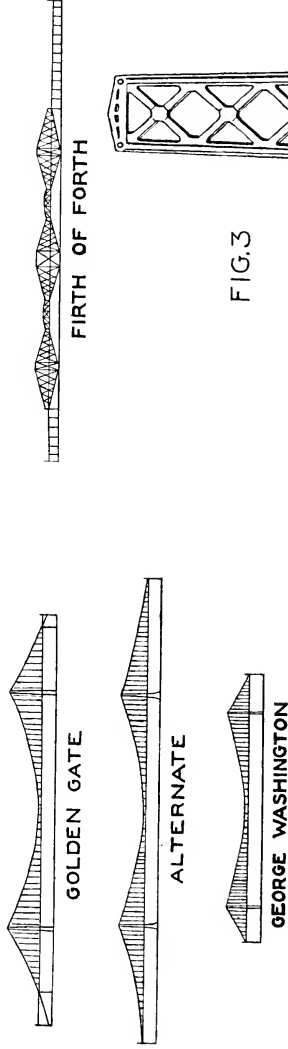
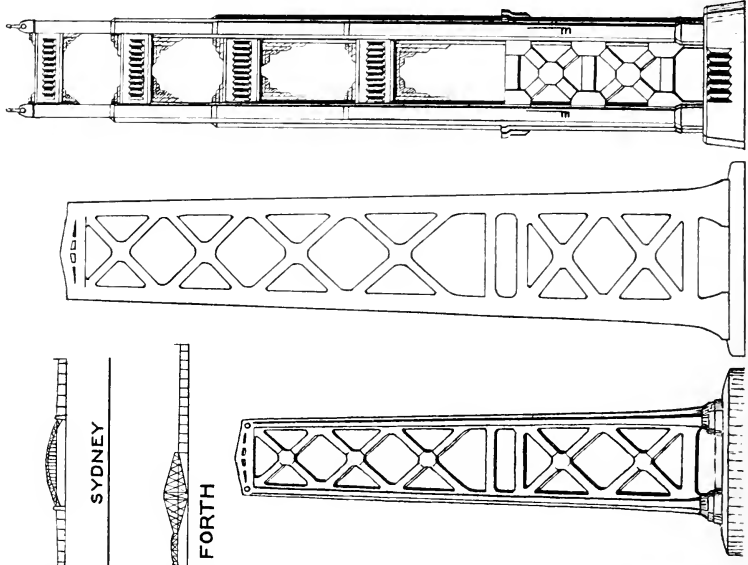
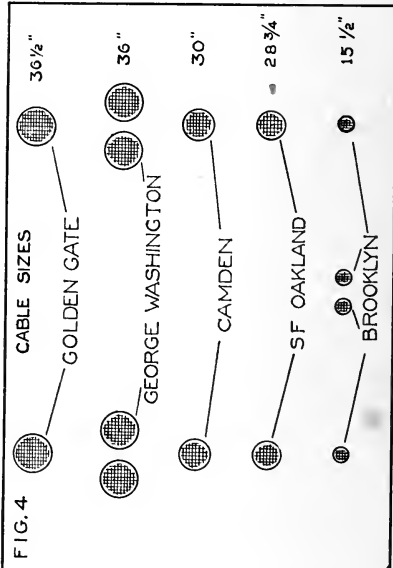

FIG.3



GOLDEN GATE

ALTERNATE TOWER

BAY BRIDGE

BROOKLYN BRIDGE

CENTER ANCHORAGE

XXVIII—THE WORLD'S LARGEST BRIDGES

Fig. 1 is a silhouette of the San Francisco Oakland Bay Bridge, looking north, and is drawn to a scale of approximately 3,500 feet to the inch. The San Francisco approach, from 5th Street to the anchorage, is 4,200 feet long. The west crossing, from the San Francisco anchorage to the island, is 10,450 feet, just short of two miles. The island crossing is 2,950 feet long, 540 feet of which passes through a tunnel. From the east shore of the island to the toll plaza, shown in Plate I, the distance is 19,400 feet. From the toll plaza to the Oakland terminal, the distance is 6,500 feet. These distances, summed up, reach a total of 43,500 feet, which is equivalent to $8\frac{1}{4}$ miles. Below the west crossing, and drawn to the same scale, are shown silhouettes of the Ambassador Bridge of Detroit, the Camden Bridge of Philadelphia, and the Brooklyn Bridge of New York. These bridges are 3,640 feet, 3,536 feet, and 3,470 feet long, respectively, and are all cable suspension bridges.

SOME CREDIT GOES TO OTHER STRUCTURES

Below the east crossing, and drawn to the same scale, are shown silhouettes of the Quebec Bridge, Canada, and the Sydney Harbor Bridge, Australia. The Quebec Bridge is the largest cantilever span bridge in the world, with a clear span of 1800 feet, as against 1400 feet for the Bay Bridge. The Firth of Forth Bridge, Scotland, comes second with a clear span of 1710 feet in each of the two cantilevers it is composed of. This places the cantilever span of the Bay Bridge in third place. The Sydney Harbor Bridge is of the arch type of construction, with a clear span of 1750 feet, and has a total length of 3,770 feet. Omitting the island crossing, the Bay Bridge is longer than the 5 bridges shown below it, all placed end to end. The Golden Gate Bridge, Fig. 2, with its clear span of 4,200 feet, is the largest single span bridge in the world. Had the west crossing of the Bay Bridge been spanned with a single suspension span, as shown in the alternate drawing, its clear span would have been 4,100 feet between towers, but the side spans would have been longer than those of the Golden Gate Bridge. The George Washington Bridge, New York, has a clear span of 3,500 feet between towers.

CABLE SIZE A FACTOR OF DESIGN

Fig. 3 is a comparison of tower heights, drawn to a scale of approximately 100 feet to every $\frac{1}{2}$ inch. The Golden Gate towers top them all, with a total height of 759 feet to the tip. The alternate tower is purely speculative, and approximates the height and size of a tower that would fit in with the alternate shown in Fig. 2. The 519 foot Bay Bridge tower dwarfs the Brooklyn Bridge tower, which is 273 feet tall. It is interesting to note that the 281 foot height of the center anchorage of the Bay Bridge is greater than the height of the Brooklyn Bridge towers. These towers are of stone, and to provide for deflection, the cable saddles slide back and forth on rollers. Fig. 4 is a comparison of cable sizes, drawn to an approximate scale of $\frac{1}{16}$ inch to the foot. There are a number of factors that determine the size of the cables, such as clear span between towers, height of towers, width of roadway, etc. Although the span of the Golden Gate Bridge is 4,200 feet, as against 3,500 feet for the George Washington Bridge, this latter has almost twice the cross sectional cable area. The reason for this is due to the fact that the George Washington Bridge will eventually have two decks, each 110 feet wide, as against the single 90 foot wide deck of the Golden Gate. Although the Bay Bridge is a double deck structure, only two cables are necessary because its width is 66 feet, with a clear span of 2,310 feet between towers.

ORGANIZATION AND AUTHORITY

A catalog of all the various groups and organizations that attempted to promote the building of this bridge, together with their plans, would fill a book many times the size of this one. However, in May, 1927, a report on the project was submitted by a group of engineers, that had been engaged for the purpose by the civic authorities of San Francisco. These activities resulted in a recommendation that the project be made a state proposition. A commission was appointed in 1929 to further this recommendation. Later in the same year suitable legislation was passed by the California State Legislature, to wit, an act known as the California Toll Bridge Authority Act. By this act, the State of California was given authority to acquire toll bridges already in existence; or, to finance the construction of new ones. It is under the authority granted by this act that this San Francisco Oakland Bay Bridge has been built. Through the department of public works, the preliminary investigation and study was placed in the hands of the highway department engineers. They reported their findings to the commission, and after consultation with the Federal departments interested, the commission issued a set of recommendations. These recommendations, among other things, set forth the feasibility of building such a bridge, the restrictions and limitations required by the interested parties, and, determined upon the location where the bridge has actually been built.

FINANCE

The state legislature appropriated \$650,000 in 1931, to be used for surveys, and preliminary plans. It was during this period that the alternate plans and designs, mentioned elsewhere in this book, were worked out. The California Toll Bridge Authority was empowered to issue bonds to cover the cost of the construction of the bridge, and were issued against the tolls. The bonds, when issued, were taken up by the Reconstruction Finance Corporation, a Federal agency. One of the conditions imposed by the R.F.C. was that the state finance the approaches. One of the original estimates of its total cost was placed at \$77,200,000—\$55,000,000 for the bridge proper, \$15,600,000 for interurban car installation, and \$6,600,000 for approaches. A later figure placed the sum at \$77,600,000. The final cost will come close to this, but of course the exact figures cannot be determined until the last contract is paid off, and the interurban cars placed in service. Some of the major contracts include \$6,957,100 for the west crossing foundations, \$4,495,854 for the east crossing foundations, and \$1,036,500 for the San Francisco Anchorage. The contracts on the steel work, or super-structure, were let at \$13,732,471 and \$8,798,096 for the two crossings, respectively. The contract for the construction work on Yerba Buena Island was let at \$1,821,292. The contract for the field painting was let at \$835,000.

PERSONNEL

The bridge will be operated as a division of the state highway department. Built under private contract, its construction was supervised by engineers employed by the state, in much the same manner that an architect supervises the construction of a building after he has designed it. The engineers present on the job itself are known as field engineers. The field engineers that supervised its erection, both those employed by the state and by the contractors, were experienced bridge engineers, and if the general public could have understood the problems that were presented, they would have marveled at the skill displayed by these men in solving them.

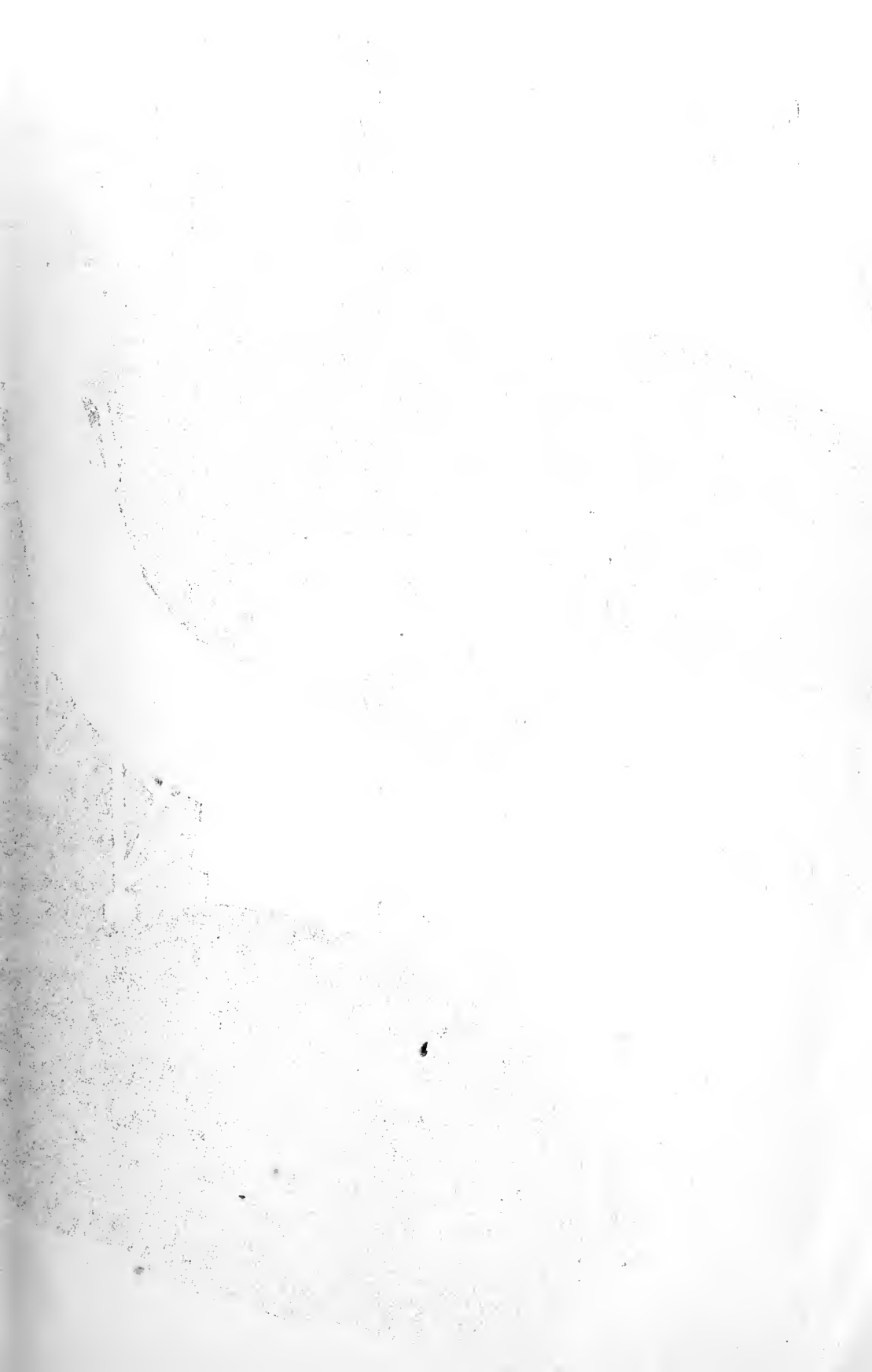

SAN FRANCISCO OAKLAND BAY BRIDGE

