

SF

963

H5

UC-NRLF



\$B 186 941

Journal of ...

By Richard ...

... ..

June 1, 1961

YD055065

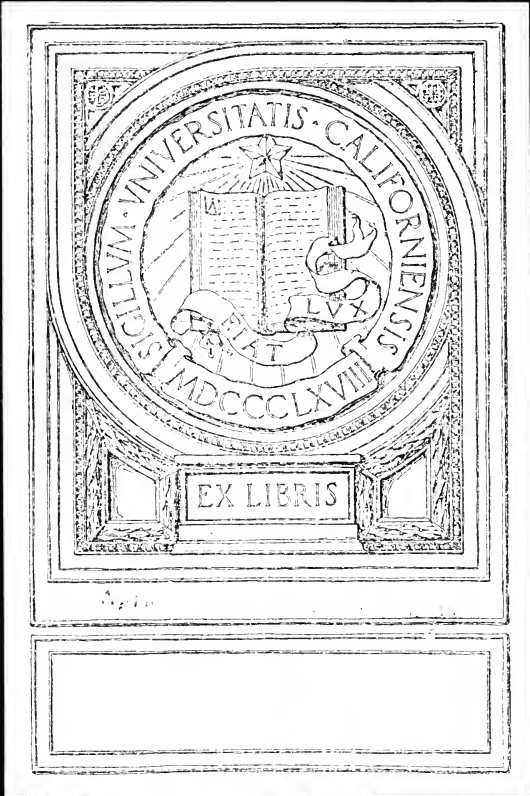

ISSUED BY THE
CALIFORNIA
Issued June 9, 1902.

U. S. DEPARTMENT OF AGRICULTURE.

FARMERS' BULLETIN No. 152.

SCABIES OF CATTLE.

BY

RICHARD W. HICKMAN, V. M. D.,

Chief of Quarantine Division, Bureau of Animal Industry.

[Revised edition: reprinted without change, February, 1915.]



WASHINGTON:
GOVERNMENT PRINTING OFFICE.
1915.

© 1980
ABSOLVIAO

LETTER OF TRANSMITTAL.

U. S. DEPARTMENT OF AGRICULTURE,
BUREAU OF ANIMAL INDUSTRY,
Washington, D. C., July 28, 1904.

SIR: I have the honor to transmit herewith revised copy of Farmers' Bulletin No. 152, "Scabies of Cattle," by Richard W. Hickman, chief of the Quarantine Division of this Bureau. This article was originally printed as Bulletin No. 40, Bureau of Animal Industry, and afterwards, in April, 1902, as Farmers' Bulletin No. 152, of which 145,000 copies have been printed and distributed. The remedies herein given for scabies, or mange, are those which have been tried and found most efficacious by this Bureau. The results of the most recent experiments are included in this revised edition of the bulletin, which, it is believed, will add still more to its usefulness.

Very respectfully,

D. E. SALMON,
Chief of Bureau.

Hon. JAMES WILSON,
Secretary of Agriculture.

TO THE
LIBRARY

SF.963

-145

BIOLOGY
LIBRARY
G

Agric. - Botany - World Library

LIBRARY OF
CALIFORNIA

CONTENTS.

	Page.
Preliminary statement.....	7
Cause of scabies, or mange.....	7
Form and life history of the scab parasite.....	8
Transmissibility of mange.....	10
Disinfection.....	10
Treatment.....	11
General directions.....	13
Small dipping plants.....	14
Materials for small plant.....	15
Advantages of the small dipping plant.....	18
Tank with heating appliance.....	19
Large dipping plant with swimming tank.....	20
Suggestions as to labor required.....	20
Handling of cattle in process of dipping.....	21
Suggestions as to construction and materials.....	23
Estimate of lumber required.....	25
Hardware, etc.....	26
A smaller or medium-sized plant with swimming tank.....	27
Notes on building dipping vat and dipping in oil.....	28
Mange in horses.....	30

ILLUSTRATIONS.

	Page.
FIG. 1. Dipping plant with cage and derrick	15
2. Vat	16
3. Cage	17
4. Sand glass	18
5. Tank with heating appliance	19
6. Plan of dipping plant with slide chute, viewed from above	20
7. Vertical section of dipping vat with slide chute	20
8. Plank showing beveled edge for calking	21
9. Sill and upright, showing method of joining	21
10. Showing a transverse section of swimming vat built of concrete, or brick and cement	23
11. Showing tank, with spring trap, as seen from above	23
12. Vertical section of swimming tank, showing trap down	23
13. Showing front view of spring trap and vertical section of swimming tank	24
14. Small or medium-sized dipping tank	28
15. Draining pens	28
16. Crook for handling cattle in vat	28
17. Crotch for ducking cattle	28

SCABIES OF CATTLE.

PRELIMINARY STATEMENT.

Numerous letters are addressed to the Department of Agriculture making inquiry with regard to scabies of cattle, also known as range itch, cattle itch, and cattle mange; the last is the correct name, the disease being mange, or scabies. This disease has prevailed to a considerable extent among the range cattle of the West and Northwest, and has been heard of in other portions of the country also, and inquiries are constantly received for instructions in its treatment.

CAUSE OF SCABIES, OR MANGE.

Scabies, or mange, of the ox is a contagious disease caused by a parasitic mite. Cattle are chiefly affected with but two varieties of these parasites, or mites, which belong to the class Arachnoidea. These are, first, the *Psoroptes*; second, the *Symbiotes*. The first is the one which most frequently affects them. It lives on the surface of the skin and by its biting gives rise to great irritation and itching. It is most frequent upon the sides of the neck and shoulders, at the base of the horns, and at the root of the tail. From these points it spreads to the back and sides, and may invade nearly the entire body. Its principal manifestations are more or less numerous pimples, exudation, and abundant scaling off of the skin, falling out of the hair, and the formation of dry, gray-brownish scabs. In the course of time the skin becomes thickened, stiff, wrinkled, and acquires the consistence of leather. When mange has spread over a large surface of the body, the animals lose flesh and become weak and anemic, rendering them constitutionally less able to withstand or combat the effects of the mites. At the same time the decreased vigor and lessened vitality of the affected animals favor more rapid multiplication of the mites and the further extension and intensification of the disease. Thus we have cause and effect working together, with the result that scabies, or mange, of cattle may in some cases prove fatal; especially are fatal terminations likely to occur in the latter part of a severe winter among immature and growing animals, or those of adult and full age when in an unthrifty condition at the time of becoming infected. Variations in the progress

of the disease have been noticed depending upon the season of the year, aggravation in winter alternating with improvement in summer.

The mite which causes cattle itch, or mange, is closely related to the mite which causes sheep scab; both belong to the same genus and species, but are different varieties. The sheep-scab mite will not attack cattle, nor will the cattle mite attack sheep or other animals. The itch mites are found to be very numerous upon affected cattle, and a very small quantity of debris from an actively infested area of the skin will often reveal a surprisingly large number of the parasites. These mites may be removed from an animal and retain their vitality for a long time. Specimens have been collected and kept in small glass bottles in the laboratory at the ordinary temperature of the room during the winter months, varying from 45° F. during the night to 80° F. during the day, which would live and remain active from eight to eleven days. Exposure to bright sunlight, however, would kill most of the mites in a few hours.

Seabies does not appear to affect cattle while they are doing well on grass, nor to attack those in good condition over three years old. The animals which suffer most are calves, yearlings, and two-year-olds, and those in poor condition. The first symptom of the disease is usually an intense itching of the skin about the neck or shoulders, which extends more or less rapidly, depending largely upon the health and vigor of the animal, along the back and sides and down the outside of the legs, but does not usually affect the inside of the legs nor the skin of the abdomen.

The other variety of this parasite which produces mange in cattle is the *Symbiotes*. This is known as Symbiotic mange, or tail mange. It remains generally localized upon the depressions on the back part of the croup and at the base of the tail. It may, however, extend over the whole surface of the body if the treatment of the disease and care of the affected animal are neglected. These cases, however, are rare. Foot mange is also exceptional in cattle. Tail mange has almost no spreading tendency, and its contagiousness is hardly noticeable. It yields readily to treatment, and any remedy that will destroy the activity of the parasite producing the Psoroptic, or common form of mange, will readily kill that causing the Symbiotic, or tail mange. It is possible for the different morbid conditions produced by these two varieties of parasites to exist in the same animal at the same time.

FORM AND LIFE HISTORY OF THE SCAB PARASITE.

The *Psoroptes*, the first variety referred to, live upon the surface of the skin, adhere to it, and suck the blood and lymph of the skin by means of their mouth organs, producing a more or less intense inflammation through the numerous stings which they inflict. This species

is characterized by its relatively greater size. Its general form is rounded or egg-shaped. It can be seen with the naked eye upon dark surfaces, and is very easily seen with the help of a magnifying glass. The head is elongated and pointed. The jaws are long, straight, and stinging. The legs are very long. The sucking cups, which are tulip or trumpet-shaped, are carried on the legs. In the male they are seen on the four pairs of legs; in the female, upon the first, second, and fourth pairs only. In their immature form the *Psoroptes* or common mange mites have three pairs of legs, while in the adult state they possess four. The latter with five joints are fitted with suction cups covered with fine hair and armed with claws or hooks. The head, thorax, and abdomen are not separated. The mouth parts are represented by mandibles or jaws. The skin surface is covered with scales, hair, spikes, or silky hair, etc.

Females, which are larger than males, lay from 20 to 24 eggs; at the end of 4 to 7 days the larvæ come out and, after having undergone 3 or 4 changes, arrive at the stage of reproduction from the fourteenth to the seventeenth day. If exposed to damp air, or placed upon wet manure, the mange mites continue to live from 6 to 8 weeks. Upon damp ground the eggs remain alive from 2 to 4 weeks. In a dry place they lose their vitality after 4 to 6 days. Moderate heat is favorable to their vitality and to the hatching of the mites.

In warm places under cover, and during the summer, their movements are more active and they multiply more rapidly than under the opposite condition. It has been estimated that one female alone may produce 1,500,000 individuals in 90 days.

Each animal species has its specific mange parasites, or mites; consequently the expression "mange" must necessarily be incomplete unless the variety of the parasite is indicated. Thus, of the Psoroptic variety, we have the ox mange mites, the horse mange mites, and the sheep mange mites.

In each of these animals we also have the Symbiotic, or tail, mange, and in each the variety would be designated as in the case of the Psoroptic or common form; but in neither variety is the contagion transmitted from one species of animal to the other. The tail-mange mites live especially upon the surface of the skin of the extremities, and exist in scabs in the outer layer of the skin. Their outlines are visible to the naked eye. The head is short and wider than it is long. The body is slightly egg-shaped and notched upon the outer edge. The legs are long and the sucking cups are shaped like a Roman shield, and are distributed in both the male and female, as in the case of the same organs on the legs of the common mange mites.

Sarcoptic mange is a more serious disease than either of those already described, but is not common to cattle. It would not, therefore, seem

important to refer to this form of mange parasite and occupy space in this bulletin except by a reference to the serious disease which is produced by this variety of mite through certain characteristics natural to it. We find Sarcoptic mange in the following domesticated animals: Horse, sheep, goat, dog, cat, and pig.

This variety dig galleries under the outer layer of the skin and live on the cells of the middle layer of the skin. They multiply in these galleries and occasion a very intense inflammation of the skin. Because of the depth to which the *Sarcoptes* burrow Sarcoptic mange is exceedingly hard to eradicate. It would, therefore, seem fortunate that this form of the disease is not common to cattle. It is rebellious to all medication, and very frequently recurrences of the disease are seen after treatment which has been prolonged for months.

TRANSMISSIBILITY OF MANGE.

Concerning the transmissibility of the different manges to animals and man, we find that all *Sarcoptes* may live for a considerable period upon man's skin, but the common mange mites, the first variety described, and the tail-mange mites, the second variety described, die very rapidly and occasion but slight irritations. The horse may contract Sarcoptic mange of the sheep, pig, dog, and cat. The ox takes the *Sarcoptes* of the horse, sheep, goat, and cat. The sheep contracts Sarcoptic mange of the goat. The dog takes the *Sarcoptes* of man, pig, cat, sheep, and goat. The pig contracts Sarcoptic mange of the goat. From this it will be seen that Sarcoptic mange, unlike the common and tail manges, is transmissible from one species of animal to another.

Mange is never developed except by contagion. The period of incubation—that is, the interval that elapses between the moment when the mites are deposited upon the surface of the body and the appearance of the disease on the skin—varies according to the number of mites transmitted. When in small numbers, the first manifestations of mange are sometimes seen as late as four to six weeks, while at other times the disease may be clearly apparent at the end of 15 days. Contamination takes place either by direct contact—that is, immediate, as on pasture, at the stable, etc.—or by intermediary agents.

DISINFECTION.

What has already been said with regard to the contagious character of scabies in cattle—of the number of scab mites which may be found in a small quantity of the débris of the skin and their ability to live and remain active for a considerable length of time under unfavorable conditions—will indicate the importance of the thorough disinfection of corrals, sheds, or other buildings in which affected cattle may have been kept. It is therefore necessary, in order to attain success in the treat-

ment of this disease, to destroy parasites which have fallen off or have been dislodged from the animals, as well as those that are upon them; otherwise there is danger of their becoming reinfected from the premises after the effects of the remedy applied to the animals have disappeared.

TREATMENT.

Methods in operation for the treatment of scabies in sheep have become more or less familiar to all people interested in sheep husbandry, and it may be said that the same treatment so successfully applied in ridding sheep of scabies has been found equally efficacious in the treatment of scabies of cattle.

In 1898 the Bureau of Animal Industry issued Bulletin No. 21, entitled "Sheep scab: Its nature and treatment," which gives a description of this disease in sheep, its cause and treatment, with numerous formulas for the preparation of dips, and illustrations of the methods of applying them, together with directions for their use on both a large and small scale. The treatment of such large animals as cattle, which are difficult to handle, because of their size and the conditions under which they live—the latter making them more or less intractable—would require a considerable amount of any preparation to wet thoroughly all parts of their bodies. Next to effectiveness, therefore, small expense is the first object that must be considered. In the treatment of cattle for scabies, it seems fortunate that the dips of lime and sulphur, both of which are inexpensive, have proved effective and entirely satisfactory.

During the past few years many thousands of cattle have been successfully treated for mange in different States of the Middle West and Middle Northwest under the observation and supervision of inspectors of this Bureau; Dr. A. D. Melvin, Assistant Chief of the Bureau, and Dr. Robert H. Treacy, inspector, having submitted plans and specifications, which will be found further on.

The dip previously used contained an excess of lime, and frequently proved quite irritating to the eyes and tender parts of the skin; hence the lime-and-sulphur dip now adopted and recommended for the treatment of scabies of cattle is made with the following ingredients:

Flowers of sulphur	pounds..	24
Unslaked lime	do.....	12
Water	gallons..	100

Place the unslaked lime in a mortar box or some suitable vessel and add enough water to slake it and form a lime paste or lime putty. Sift into this lime paste the flowers of sulphur and stir the mixture well. Be sure to weigh both the lime and the sulphur, and do not trust to measure them in a bucket or guess at the weight. Place the sulphur and lime paste in a kettle or boiler with about 25 or 30

gallons of boiling water, and boil the mixture for two hours at least, stirring the liquid and sediment. The boiling should be continued until the sulphur disappears, or almost disappears, from the surface. The solution is then of a chocolate or liver color. The longer the solution boils the more the sulphur is dissolved, and the less caustic the ooze becomes. Some writers advise boiling from thirty to forty minutes, but this is not sufficient; a good ooze can be obtained only by boiling from two to three hours, adding water when necessary. Pour the mixture and sediment into a large tub or barrel, placed near the dipping vat and provided with a bung-hole about 4 inches from the bottom, and allow it ample time (from two to three hours or more if necessary) to settle.

The use of some kind of a settling tank provided with a bung-hole is an absolute necessity, unless the boiler is so arranged that it may be used for both boiling and settling. An ordinary kerosene oil barrel will answer very well as a small settling tank. To insert a spigot about 3 to 4 inches from the bottom is an easy matter. Draining off the liquid through a spigot has a great advantage over dipping it out because less commotion occurs in the liquid, which therefore remains freer from sediment. When fully settled, draw off the clear liquid into the dipping vat and add enough warm water to make 100 gallons. But under no circumstances should the sediment in the barrel be used for dipping purposes. A double precaution against allowing the sediment to enter the vat is to strain the liquid through ordinary bagging as it is drawn from the barrel or settling tank.

The above directions are for the quantity of dip given in the preceding formula. Any multiple of the constituents may be used, depending upon the capacity of the boiler, vessels, and tank to be filled, but let it be repeated that there should be no guessing about the proportions; that the directions for the preparation of the dip as here given should be closely followed, care being taken that boiling be continued for the full time recommended.

Another good method for making this dip, highly recommended by experienced inspectors, is to mix the lime and sulphur in a mortar box, then slake the lime thoroughly and put the mixture in the cooking tank (which should contain one-fifth the total quantity of water required for the dip), after the water in the cooking tank is nearly boiling. If the mortar box is not at hand the lime and sulphur may be mixed and slaked in the cooking vat and the water then added for cooking. The mixture must be boiled for at least two hours, stirring often. Then add enough water to replace that which has boiled away, so as to have the original proportion of water. Allow to settle two hours, or longer if possible, and draw off the clear liquid for use in dipping.

The liquid obtained by these processes contains calcium sulphides in solution and now only requires the addition of sufficient clear water to reduce to the proper strength for dipping. Flowers of sulphur must be used and the lime must be of good quality.

GENERAL DIRECTIONS.

Soft water is better than hard water for dipping, but if it can not be obtained the hard water may be softened by adding potash or lye, but no more should be added than sufficient to cut the water.

The average depth of the liquid used in a dipping vat is from $5\frac{1}{2}$ to 6 feet, and the amount of dip necessary to obtain that depth should be ascertained before preparing the dip, in order that the requisite amount of the liquid may be prepared.

In 1 gallon there are 231 cubic inches. In order to find the number of gallons contained in a dipping vat multiply together, in inches, the average length, the average breadth, and the depth, and divide by 231, and the result will be the number of gallons. To obtain the average length of vat, add the length at the bottom to the length at the top of dip—or water line—and divide by 2; obtain the average width in the same manner. The depth should be taken at the center of vat, and should be from the bottom to water or dip line.

Be sure to measure only the space filled by the dip, and not above that line. The cooking vat should also be measured. It is convenient to have rods marked, showing the number of gallons at various depths.

Mix the dip thoroughly in the dipping vat by stirring lengthwise in the vat, also from top to bottom. A large hoe is a good instrument to use in stirring. After the dip is thoroughly mixed, take the temperature at different parts of the vat; see that it is uniform, and, if too hot or too cold, add hot or cold water with proper proportion of dip until the right temperature is obtained; be careful to have all well mixed. The temperature of the dip when used should be from 102° to 110° F.

To ascertain the temperature, take some of the dip out of the vat in a bucket, hold the thermometer in it, and read the temperature while it is in the fluid. The dip must be changed as soon as it becomes filthy, regardless of the number of cattle dipped in it, and in no case should it be used when more than ten days old. When there is any doubt as to the good quality and proper strength of the dip, or if it seems to have deteriorated by standing, by freezing, or by being fouled by use, do not depend upon it, but throw it away, clean out the dipping vat, and make new dip. In emptying the vat the entire contents must be removed, including all sediment and droppings and other foreign matter.

In order to attain success in the treatment of mange, care and thoroughness of method must be observed. Animals that have been exposed should be dipped as well as those that show distinct evidences of the disease. After the lapse of ten days or two weeks following the first dipping, the animals should be subjected to a second dipping, in order that parasites which may have survived the first treatment, or which may have gotten on the animals from corrals, sheds, buildings, or elsewhere, may be destroyed. Careful examinations of thousands of cattle, thirty to forty days after being put through the dip for the second time, have failed to reveal evidence of scabies on any of them.

The dip liquid in the tanks during the whole dipping process should be kept at the temperature before stated—from 102° to 110° F. Each animal should be kept two minutes in the dip, and be put completely under twice during that time. All bad cases should be hand-rubbed and kept in the dip four minutes.

Pregnant cows have been treated, as well as cattle of all ages, from calves to full-grown steers, with the loss of but one animal in one of the swimming tanks. This was a steer which for some unknown reason seemed to be unable to swim and was drowned. It would appear that the dipping of cows, when proper care is taken—especially to prevent crowding in the chutes—has no appreciable effect upon abortions, as a comparison with previous years showed that the dipping had not increased the average number of abortions regularly occurring among these herds before dips were used.

SMALL DIPPING PLANTS.

Of the various dipping plants in use, there are probably three that need description: (1) The small dipping plant, with cage for lowering cattle into dipping tank, which is inexpensive and suitable for use by a community of farmers; (2) the larger dipping plant with swimming tank, such as will be needed if large numbers of range cattle are to be treated; (3) and a small or medium-sized plant with swimming tank. A suitable plant for a community of farmers has been built for \$150, while a large swimming tank will cost about \$350.

Such plants as those in operation 18 miles north of Steele, N. Dak., known as the Langedahl, and the William Nelson plant at Menoken, Burleigh County, N. Dak., would seem to be admirable examples of the smaller kind. The former plant, with the exception of the tank, was built by farmers. A thrashing engine may be used for heating purposes by connecting a 1½-inch pipe to the whistle intake, the whistle being removed, and the pipe joined to the union. These plants have a capacity of 200 head per day. The cost, without engine or labor, excepting the labor to build the tank or vat, was about \$150. One

person can easily lower the loaded cage by taking a hitch around a post, and it may be raised, as shown in illustrations, either with engine or with horses.

MATERIALS FOR SMALL PLANT.

Following are the illustrations (figs. 1-5) and list of materials for the smaller plant, the tank of which may be filled with dip made as per preceding formula for about \$7.50. The drawings from which the illustrations were made and the list of materials were furnished by Dr. Robert H. Treacy. Sliding or roller gates are used, hung on the ends of the alley or chute, at both the entrance and exit of the

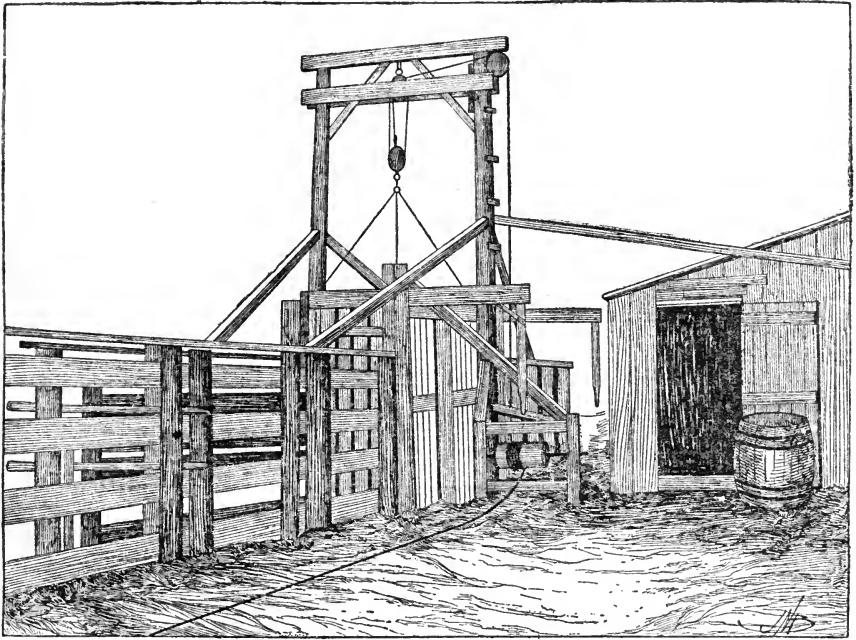

FIG. 1.—Dipping plant with cage and derrick. Derrick 16 ft. high above ground. Derrick posts 4 ft. in ground, 6 by 6 in. by 20 ft. long. Braces 4 by 4 in. by 10 ft. long; 2 double-leaf 6-in. blocks at top of derrick, and 1-leaf 5-in. pulley at top of derrick under crosshead; 100 feet of 1-in. rope.

cage. This is thought to be a decided improvement over having the gates hung by hinges at either end of the cage. Barn-door rollers may be used. The rope from the hoist works over a drum, with a brake, and may be drawn by horses or a stationary engine, so the cage can be lowered by the same man who operates the front gate, as shown in the diagram.

Entrance pen and chute.

65 plank 2 inches x 6 inches x 16 feet.

28 posts.

18 braces 4 4 4

Tank, or vat.

800 feet good 2-inch plank.
 400 running feet tongue strip.
 10 pieces 4 inches x 4 inches x 16 feet.
 2 pieces 2 6 16
 10 pounds lead.

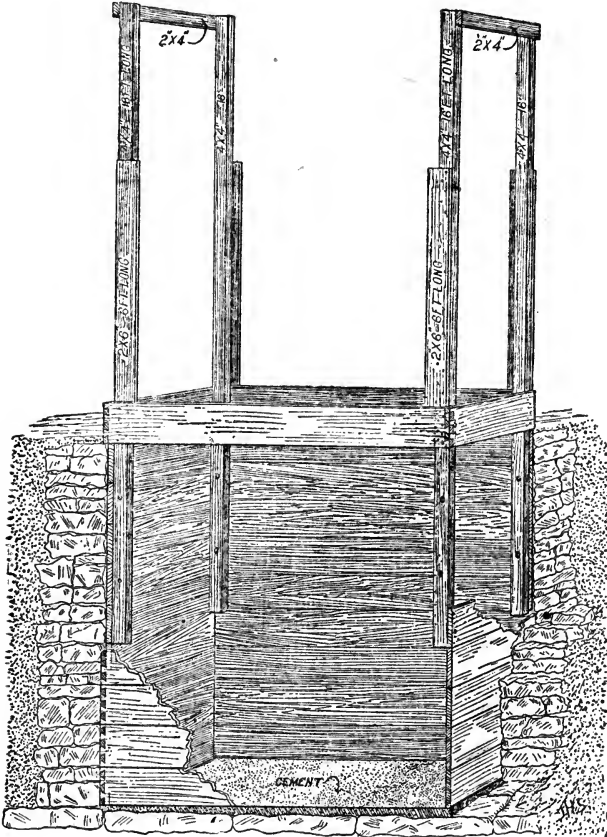

FIG. 2.—Vat. Tank 10 ft. deep, 4 ft. wide, 9 ft. in ground. Should contain from 5½ to 6 ft. of dip. Standards 4 by 4 in. by 16 ft. long, bolted to tank inside, to extend 6 ft. inside of tank, to act as guides to cage; 2 by 6 in. plank 6 ft. long nailed to outside of standards; 2 by 4 or 2 by 6 in. braces across top of standards. The tank should be built of 2-in. plank and joined with a tongue, the ends of the tank mortised in, the joints coated with lead. The braces are 4 by 4 in. The tank, being placed in the ground and packed solid, does not require much bracing. The tank should be laid in cement bottom, with stone and mortar about sides.

Cage.

8 pieces 4 inches x 4 inches x 16 feet.
 8 pieces 2 4 16
 12 pieces 2 10 16
 10 pieces 1 10 16
 4 half-inch iron rods, with ring in each end, 5½ feet long.
 2 half-inch iron rods, with ring in each end, 4 feet long.
 3 pairs of heavy hinges.

Derrick.

2 pieces 6 inches x 6 inches x 20 feet.		
1 piece 6	6	10
6 pieces 4	4	12
2 pieces 1	6	10

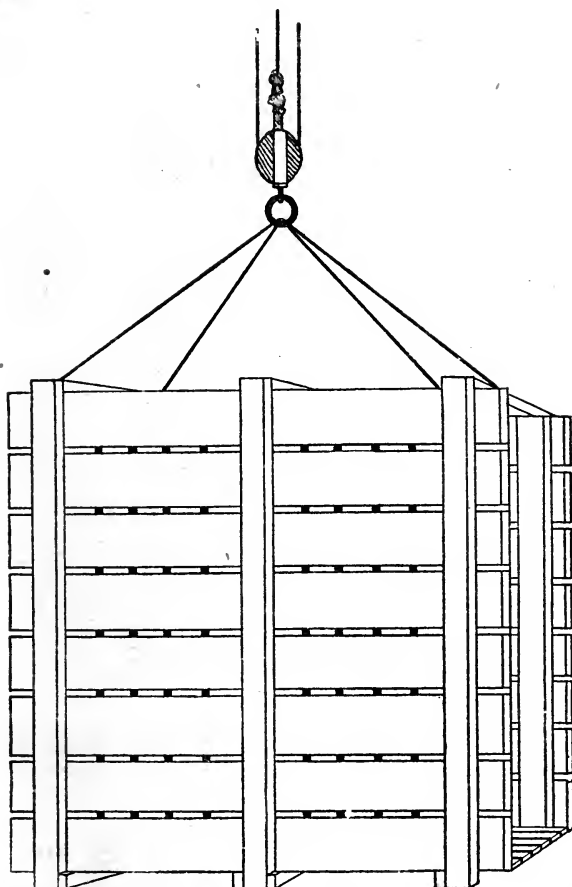

FIG. 3.—Cage. Eight ft. long, 8 ft. high, 3½ ft. wide—outside measurement; 2-in. plank used for outside, boarded up and down inside with 1-in. boards to keep animals from climbing up sides. Plank 2 in. apart. Inside boards 2 in. apart, and 1-in. cracks in floor to allow free escape of dip fluid; or, as ends are both open, cage may be framed as in fig. 1.

Drip chute.

10 pieces 2 inches x 6 inches x 14 feet.		
4 pieces 2	12	14
4 pieces 4	4	16
1 pair heavy hinges.		
1 gallon tar.		

Holding pen.

32 cedar or oak posts.
200 pounds wire.
5 pounds staples.

Hardware and incidentals.

- 100 pounds 20-penny spikes.
- 20 pounds 40-penny spikes.
- 2 6-inch double-leaf blocks.
- 1 5-inch single-leaf block.
- 100 feet 1-inch rope.
- 25 feet 1½-inch iron pipe.
- 1 galvanized-iron heating tank (5 barrels capacity).
- 4 oil barrels.

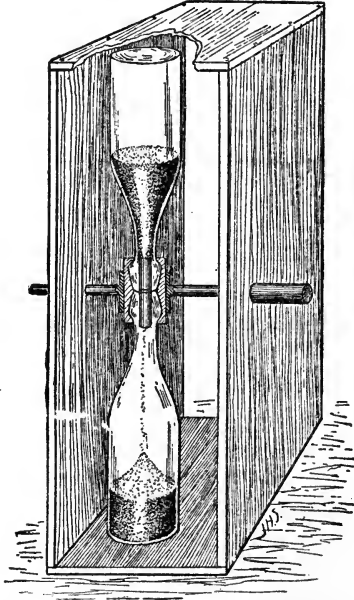

FIG. 4.—Sand glass. For timing the animals in the dip. Is made of two ordinary ketchup bottles connected by a hollow wooden cork, placed in a box, and the box hung on a pin through the center to revolve, as shown in the illustration.

ADVANTAGES OF THE SMALL DIPPING PLANT.

A plant of this capacity will answer very well in a community where various owners have bunches of cattle ranging from 80 to 100 head or less. Among its chief advantages over the larger swimming tank are cheapness in construction, because of its size, and proportionately smaller expense in operating; the dip can be kept at the required temperature with facility, because of its lesser volume, and the submersion of the animals, as well as the length of time it is desired to keep them in the dip, can be more easily regulated.

In communities where mange does not exist, and where numbers of small herds are infested with lice, a plant of this character might be constructed and used with profit to the cattlemen. Many of the cattle that were dipped during the past year because of having been exposed

to mange, or scabies, by being herded with those affected, showed much improvement in condition soon after dipping, although they had not shown distinct evidence of being affected with mange.

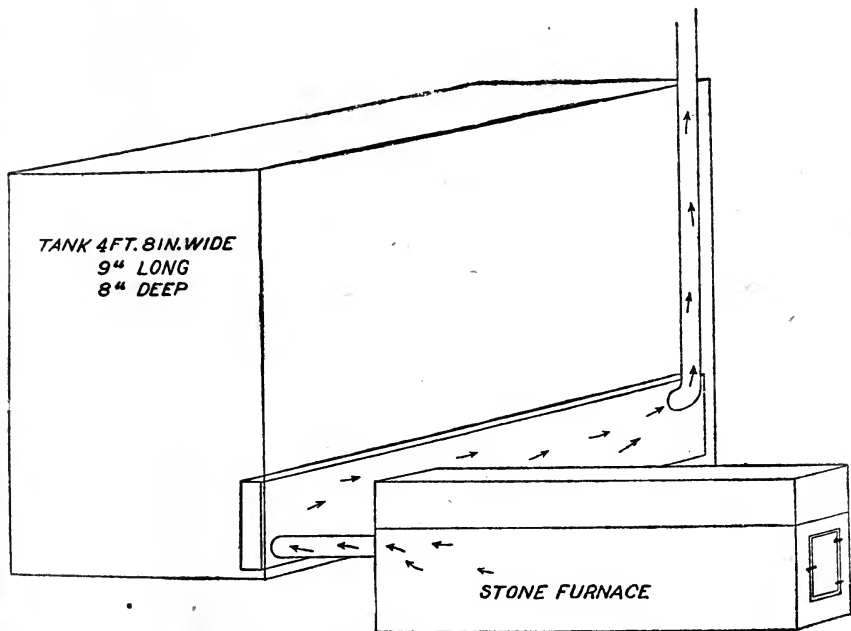

FIG. 5.—Tank with heating appliance.

TANK WITH HEATING APPLIANCE.

In some localities where steam for heating the liquid in the dipping tank is not readily available, an oblong radiator made of heavy galvanized iron, set inside of the tank 1 inch from the side, is successfully used. This radiator, or heater, should be set so that the dip may circulate around it, with the furnace as shown in the figure. The furnace is made of stone and should be 26 inches wide inside and 8 feet long. On top a cooking vat is placed, made of 14-inch plank on the sides and a galvanized iron bottom 30 inches wide. The cooking vat is 8 feet long by 14 inches high and 30 inches wide. The radiator is connected with the furnace by a 6-inch pipe. Heat circulation is established by means of a stack leading out and up from near the farther end of the radiator (see diagram). Galvanized stovepipe may be used for the stack. The cage is made of the usual width—3 feet 6 inches wide outside—and the tank 8 inches wider than when steam heat is used, so that space may be allowed for the radiator. The radiator must be protected by guides or standards—guides in the middle or, preferably, standards in the corners of the tank.

LARGE DIPPING PLANT WITH SWIMMING TANK.

The following diagrams and notes are for the construction of a swimming tank where large numbers of cattle are to be dipped. These are in accordance with the drawings received from Dr. Louis A. Klein, inspector, Fort Worth, Tex., through the courtesy of Mr. K. Roby, engineer of the Fort Worth Stock Yards Company, and Dr. R. H. Treacy, inspector, Bismarck, N. Dak., the drawings for the swimming tank with spring trap having been made by Mr. J. A. McDugal, Mandan, N. Dak.

SUGGESTIONS AS TO LABOR REQUIRED.

Excavations.—Excavate for the vat, as shown by the drawings, to the proper depth; level the bottom of the pit for the sills of the vat. After the vat is completed and the outside has been coated with coal tar, fill in around the vat, using the surplus earth to grade the sides of the vat a little above the natural grade, sloping slightly from the vat. Dig all holes required for the gate and fence posts.

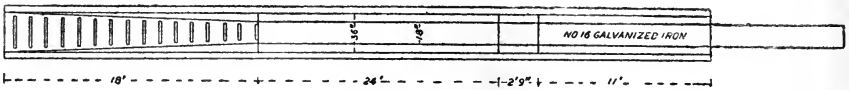

FIG. 6.—Plan of dipping plant with slide chute, viewed from above.

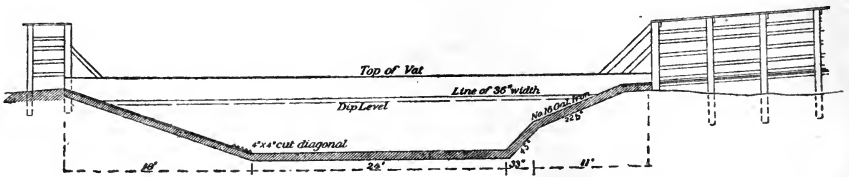

FIG. 7.—Vertical section of dipping vat with slide chute.

Carpenter work.—All work should be done in a skillful and workmanlike manner; the framework of the vat to be bolted and spiked together; the plank of sides, ends, and bottom of the vat and dripping floor to have edges beveled for the calking as per detail, well driven together and well spiked with 20d. wire nails, using 40d. nails on the 3-inch plank. Calk all seams with oakum, well driven in with a calking iron, and pitched. The exit, or inclined end, of the vat to have a 3-inch bottom plank; all other plank of the vat and dripping floor to be 2 inches thick. Sides of vat to be braced with anchor braces extending back 6 feet from each upright as in smaller swimming tank. (See notes, p. 28.) The exit end of vat and dripping floor to be cleated with $1\frac{1}{2}$ x 3 inch strips, well nailed to floor and bottom, or with 4 inch x 4 inch cut diagonal, as shown in figure 7.

Gates and fence.—The gate post should be set 4 feet in the ground and the fence post 3 feet 6 inches. Set all posts plumb and to a line; well and thoroughly tamp the earth around the posts. The bottom of all posts should be coated with coal tar before being set. Gate posts, 8 x 8 inches, with 6 x 8 inch tie framed and drift-bolted to the posts. Fence posts, 6 x 6 inches. The gates should be bolted and spiked together and braced. Hang with $\frac{1}{2}$ x 3 x 36 inch strap eye-and-bolt hinges,

bolt running through posts and hinges bolted to gates. Gates should have $\frac{1}{2}$ x 3 x 16 inch iron hasp bolted to gates and a suitable bolt staple, with iron pin and chain for locking.

Fence.—Rails, or ribbons, of 2 x 6 inches, with 2 x 8 inch cap, spiked at each bearing with two 40d. wire nails. Posts set 8 feet on centers, or nearer where distance may require.

Lumber.—All lumber should be No. 1 pine or fir dimension, free from shakes, bark, large pitch pockets, unsound knots, or other imperfections that materially impair its strength, durability, and use for which it is intended.

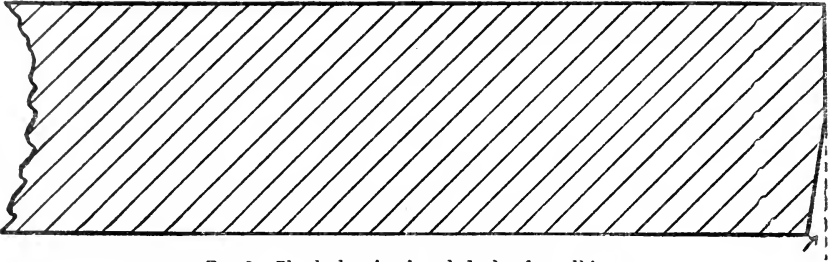

FIG. 8.—Plank showing beveled edge for caulking.

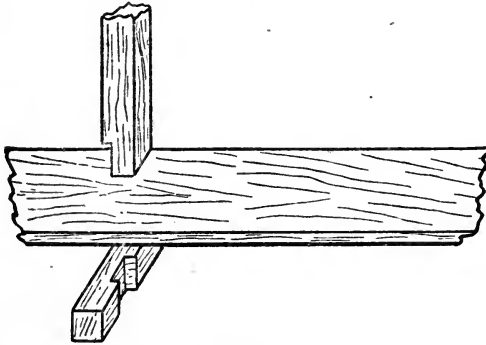

FIG. 9.—Sill and upright, showing method of joining.

Drainage.—The vat should be fitted with a 2-inch waste pipe fitted in the bottom with gate valve and elbow, and 20 feet of pipe to run horizontally under ground, with a fall of 2 feet in 16 feet, draining to a suitable point, from which the drainage may be continued by an open ditch.

Floor of pens.—If the owner decides to floor the catch pen and holding pen, the floor should be of 2-inch plank nailed to 4 x 4 inch joist or sleepers let into the ground and leveled.

HANDLING OF CATTLE IN PROCESS OF DIPPING.

Though the tank may be sufficiently long to hold more than 4 head of full-grown cattle at a time, it will be found desirable not to put more than that number in the tank at once, or a proportionate number of young cattle. If more than 4 full-grown cattle are placed in the dipping vat together, the pressure caused by the cattle in the rear,

swimming against those in front, may be so great as to seriously interfere with the proper handling of the animals while in the vat.

The incline or slide at the entrance end of the dipping vat should start on a level with the ground or chute, and extend below the surface of the dip. The pitch or drop of the incline is indicated in the accompanying diagram (fig. 7), and should be no more than is necessary to prevent the cattle from standing still or backing up when on it. The floor of the incline should be made of smooth, hard lumber that will be slippery, and while in use should be kept wet with the dip. If of soft wood or masonry, it must be covered with sheet steel or galvanized iron. The chute connecting with the incline at the entrance of the vat need only be long enough to afford ample room for the number of cattle that will be placed in the dip at one swim. When the dipping vat is filled with cattle the chute should be at once refilled with the number of cattle required for the next swim. At the proper time these cattle are released from the chute into the dipping vat, and the process repeated. This method insures having the proper number of cattle in the vat at each swim, and prevents overcrowding and consequent accidents, which may happen with long chutes filled with cattle when the cattle become frightened and the men lose control of them.

To prevent the cattle from leaving the vat until the proper time, a gate must be placed at the foot of the incline leading out of the dipping vat, and this gate should be so constructed that it will slide up and down in a frame built for that purpose. As the gate must be strong and heavy it should be counterweighted, so that one man can work it easily.

When cattle are going into the dipping vat they will often jump from the incline as far forward in the vat as they can, sometimes alighting on the backs of cattle that have preceded them into the vat and injuring them. This can be prevented by hanging a curtain across the vat in such a manner that it will prevent the animal from seeing the vat in front of the curtain, and he will therefore see no place to jump to. The curtain should be hung about 6 or 7 feet in front of the foot of the incline leading into the vat, with the bottom about $2\frac{1}{2}$ or 3 inches above the surface of the dip, the object being to induce the animal to endeavor to pass under the curtain instead of striking against it. The lower part of the curtain must be made of cloth or similar material. Empty sulphur sacks will answer. But the upper part should be made of light wood to prevent the wind from blowing the curtain out of position. If wood is used for the upper part of the curtain, it must be hung on pivots, so that it will yield readily if an animal strikes against it.

SUGGESTIONS AS TO CONSTRUCTION AND MATERIALS.

This vat may be built of wood, brick, concrete, or galvanized iron, and should be at the bottom 16 to 18 inches wide, inside measurement, 34 to 36 inches wide at the water line, and may be continued to the top at the same width; 36 inches width is desirable where cattle with wide horns are to be dipped. When built on the above lines, with a total depth of $7\frac{1}{2}$ feet, the splash boards may be dispensed with.

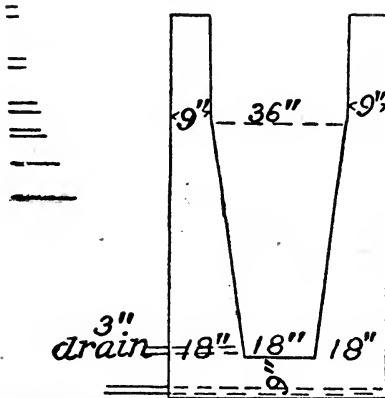

FIG. 10.—Showing a transverse section of swimming vat built of concrete or brick and cement.

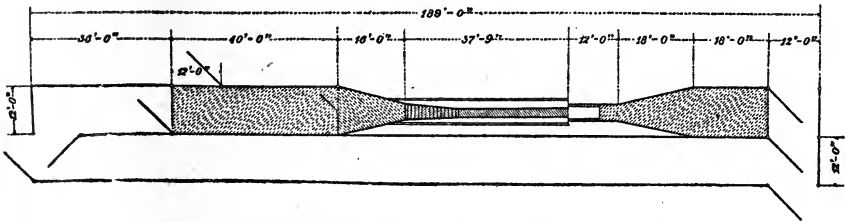

FIG. 11.—Showing tank with spring trap, as seen from above.

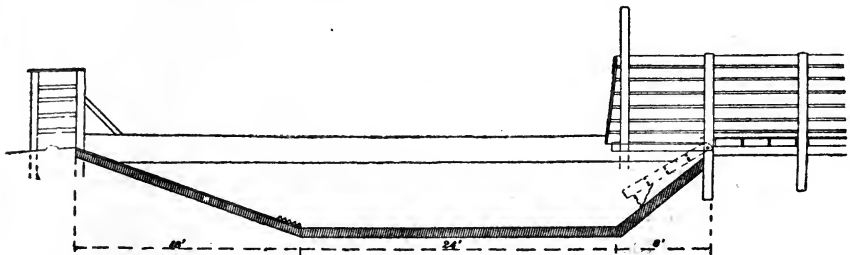

FIG. 12.—Vertical section of swimming tank, showing trap down.

Where an automatic drop is used for dropping cattle into the dip, the dipping tank must be wide enough to permit the trap to drop inside to a sufficient depth to throw the cattle into the swim.

Trap.—The trap is 8 feet long, 30 inches wide, with 4 x 6 inch sills, which should be dressed to about $3\frac{3}{4}$ x $5\frac{3}{4}$ inch and 2 x 6 inch cross ties, planked on top with smooth, hard lumber. This vat is 48 inches wide at the top, 18 inches wide at the bottom, and shaped as shown in the diagram. The tank will contain 5 to $5\frac{1}{2}$ feet of dip liquid when in use, and should be fitted with splash boards made of 2 x 12 inch plank. For economy in filling, this tank can also be made narrower at top, except at trap end. Construct the trap 30 inches wide, 8 feet long. Trap should

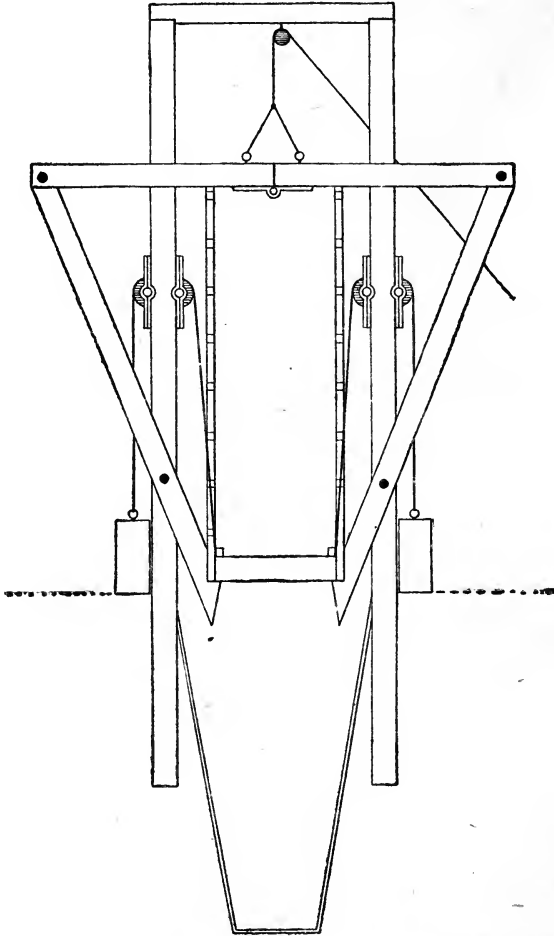

FIG. 13.—Showing front view of spring trap and vertical section of swimming tank.

swing on a $1\frac{1}{2}$ -inch steel bar or a $1\frac{1}{2}$ -inch gas pipe by holes bored through sills, 3 inches from their ends, as shown in figure 10. To prevent these holes from breaking out, a 2 x 6 inch crosspiece may be used, with strap irons $\frac{1}{4}$ x $1\frac{1}{2}$ inch spiked over both ends, as a means of strengthening. Two staples may also be used to pass around the $1\frac{1}{2}$ -inch pipe or steel bar to take part of the strain and prevent the pipe or bar from bending.

ESTIMATE OF LUMBER REQUIRED.

It is estimated that the following bill of lumber, hardware, etc., will serve as a guide in the construction of this dipping plant, a few changes only having to be made, depending on whether the slide chute or trap is preferred.

Sills.

5 pieces 4" x 4", 12 ft. long=80 ft. board measure.

Uprights.

12 pieces 4" x 4", 16 ft. long=256 ft. board measure.
4 " 4" x 4", 12 ft. " = 64 ft. " "

Splash plank.

8 pieces 2" x 12", 12 ft. long=112 ft. board measure.

Anchor braces.

8 pieces 2" x 6", 12 ft. long=96 ft. board measure.
4 " 4" x 4", 16 ft. " =86 ft. " "

Sides.

7 pieces 2" x 12", 18 ft. long	} =1,146 ft. board measure.
2 " 2" x 12", 16 ft. "	
7 " 2" x 12", 14 ft. "	
28 " 2" x 12", 12 ft. "	

Ends.

5 pieces 3" x 12", 12 ft. long=180 ft. board measure.
2 " 2" x 12", 12 ft. " = 48 ft. " "

Bottom.

2 pieces 2" x 12", 24 ft. long	} =96 ft. board measure.
or	
4 " 2" x 12", 12 ft. "	

Platform or trap.

1 piece 4" x 6", 16 ft. long=32 ft. board measure.
1 " 2" x 6", 12 ft. " =12 ft. " "
1 " 2" x 12", 16 ft. " =32 ft. " "
1 " 2" x 6", 8 ft. " = 8 ft. " "

Trigger.

3 pieces 2" x 6", 12 ft. long=72 ft. board measure.

Scaffold.

2 pieces 6" x 6", 16 ft. long=96 ft. board measure.
1 piece 4" x 6", 10 ft. " =20 ft. " "

Sides of runway.

10 pieces 2" x 8", 16 ft. long=214 ft. board measure.
1 piece 2" x 12", 16 ft. " = 32 ft. " "
1 " 2" x 6", 8 ft. " = 8 ft. " "

Gleats.

9 pieces 1½" x 3", 16 ft. long=54 ft. board measure.
Total, 2,744 feet board measure.

Gates.

Posts	896 feet = 14 pcs. 8" x 8" x 12' No. 1 pine or fir.
Tie beams	448 8 6 8 14 "
Ribbons	480 40 2 6 12 "
Braces	144 8 2 6 18 "
Battens or rails.....	{ 96 6 2 6 12 "
	{ 128 4 4 6 16 "
Total	2,192 feet.

Fence.

Posts	2,010 feet = 67 pcs. 6" x 6" x 10' No. 1 pine or fir.
	{ 240 20 2 6 12 "
Ribbons	{ 140 10 2 6 14 "
	{ 1,760 110 2 6 16 "
	{ 450 25 2 6 18 "
	{ 64 4 2 8 12 "
Caps	{ 32 2 2 8 14 "
	{ 469 22 2 8 16 "
	{ 120 6 2 8 18 "
Total	5,285 feet.

NOTE.—Oak or cedar posts are to be preferred. If round cedar posts are used, substitute 10-inch round posts for the 8 x 8 inch and 8-inch round posts for the 6 x 6 inch posts as above.

For catch pen.—There should be a plank floor in the catch and holding pen, but if only a limited number of cattle are to be dipped, this may be omitted.

If it is decided to floor these pens, the following material should be added to the foregoing lumber bill:

For holding pen.....	{ 240 feet = 15 pcs. 4" x 4" x 12' No. 1 pine or fir.
	{ 850 " 2" pine or fir plank, 12" x 18'.
	{ 240 " = 15 pcs. 4" x 4" x 12' No. 1 pine or fir.
	{ 960 " 2" plank 16'.
Total.....	2,290 feet of additional lumber.

Cottonwood lumber may be used where the market price of same would make it practicable.

HARDWARE, ETC.**Vat and dripping floor.**

42 carriage bolts, $\frac{1}{2}$ " x 6", with washers.

40 " " $\frac{1}{2}$ 8 "

18 " " $\frac{1}{2}$ 4 "

40 lbs. 20d. common wire steel nails.

10 " 30 " "

15 " 50 " "

1 sheet No. 14 sheet steel 30" x 84" with 1 gross 1" No. 10 screws, if trap is of soft wood.

20 lbs. oakum.

40 " pitch.

10 gals. coal tar.

5 feet $1\frac{1}{2}$ " gas pipe or steel bar, for trap.

2 pieces strap irons $\frac{1}{4}$ " x $1\frac{1}{2}$ ".

2 iron staples.

Vat and dripping floor—Continued.

- 21 feet 2" wrought-iron pipe, with couplings.
- 1 elbow, 2".
- 1 flange for securing pipe to bottom of tank, 2".
- 1 gate valve, 2".

Gate and fence.

- 8 pairs eye-and-bolt hinges, heavy, $\frac{1}{2}$ " x 3" x 36".
- 8 hasps, $\frac{1}{2}$ " x 16" x 3", with bolt staple, for 8" posts.
- 48 bolts, $\frac{1}{2}$ " x 3".
- 20 " $\frac{1}{2}$ 4 $\frac{1}{2}$
- 68 " $\frac{1}{2}$ 6
- 160 " $\frac{1}{2}$ 4
- 32 driftbolts, $\frac{1}{2}$ " x 12".
- 20 lbs. 30d. common wire nails.
- 65 " 40 " " "
- 16 gals. coal tar.

NOTE.—If catch and holding pen is to be floored, add to the above 30 lbs. of 30d. wire nails and 5 gallons coal tar.

A SMALLER OR MEDIUM-SIZED PLANT WITH SWIMMING TANK.^a

Doctor Melvin's immediate association with the work of dipping cattle, both for mange and Texas fever, through his personal supervision of the erection of plants and their use in various sections of the country, suggested to him the advantages in many localities of a smaller swimming tank than the preceding (see figs. 14 and 15), such as he has found to be serviceable and economical in dipping with either crude Beaumont petroleum (see paragraphs 5, 6, and 7 of Bureau of Animal Industry, Order No. 121^b) or lime-and-sulphur dip,

^aSupplied by Dr. A. D. Melvin, Assistant Chief, Bureau of Animal Industry.

^bBureau of Animal Industry, Order No. 121, paragraphs 5, 6, and 7.—5. Notice is hereby given that cattle infested with the *Boophilus annulatus*, or southern cattle tick, disseminate the contagion of splenetic, southern, or Texas, fever; therefore, cattle originating outside of the district described by this order or amendments thereof, and which are infested with the *Boophilus annulatus* ticks, shall be considered as infectious cattle and shall be subject to the rules and regulations governing the movement of southern cattle.

6. Stock-yard companies receiving cattle infested with said ticks shall place such cattle in the pens set aside for the use of Southern cattle; and transportation companies are required to clean and disinfect all cars and boats which have contained the same, according to the requirements of this Department.

7. Cattle in said district may be shipped after having been properly dipped in Beaumont crude petroleum, under the supervision of an inspector of the Bureau of Animal Industry, without further restriction, excepting such as may be enforced by local authorities at point of destination, provided that application be first made to this Department, and permission granted to establish dipping stations, and that after being dipped the cattle are examined and certified by an inspector of the Bureau of Animal Industry; and further provided that the cattle when dipped be shipped in clean cars and not driven through the infected district or unloaded therein, except at such point as may be duly designated in regulations of this Department.

when the larger swimming tank would not be required; also a crook and crotch (see figs. 16 and 17), with directions for use in submerging, guiding, and facilitating the handling of cattle while in process of dipping.

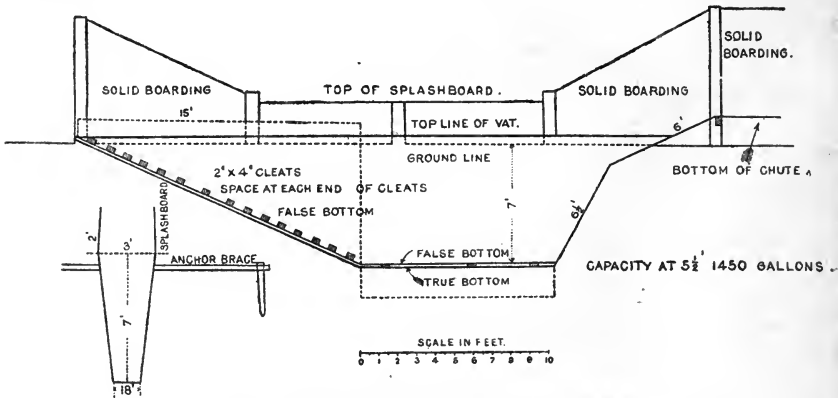

FIG. 14.—Small or medium-sized dipping tank.

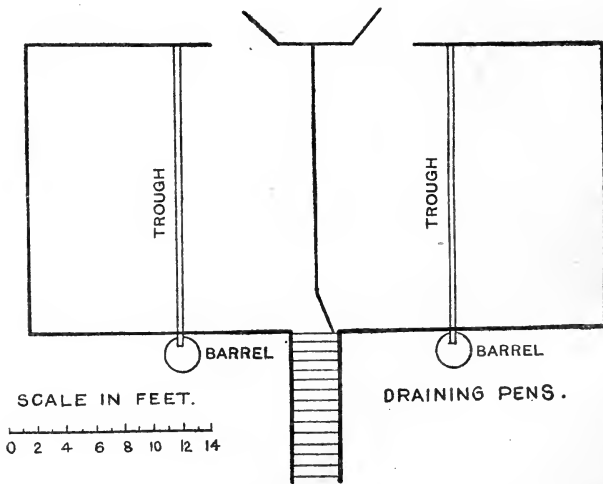

FIG. 15.—Draining pens.



FIG. 16.—Crook for handling cattle in vat.



FIG. 17.—Crotch for ducking cattle.

NOTES ON BUILDING DIPPING VAT AND DIPPING IN OIL.

Vat to be built of 2-inch tongued and grooved boards, or 1-inch tongued and grooved flooring, doubled, with tar paper between, and joints broken; all joints made tight with white lead or by calking.

Uprights 4 inches by 6 inches, 2 feet 6 inches from center to center, with anchor braces extending back 6 feet from each upright.

Solid boarding extending from each end of vat toward center to catch splash and prevent cattle jumping over, as shown in plan; also tight boarding on either side of vat 2 feet high, 1-inch flooring to catch splash.

False bottom to prevent springing of true bottom.

Sheet iron on floor of slide.

Strong fence around draining pen, 7 feet high; lower 4 feet of which should be built solid. Strong, tight flooring, inclining to center of each pen, with gutter emptying into barrel on outside of fence; this allows dirt to settle and not enter vat.

False bottom to floor of pens having 2-inch space between boards and built in sections so they may be easily removed and floor cleaned; also to prevent cattle slipping. Gate to swing on end of division fence nearest vat, so as to close either draining pen; wooden stick (or handle) attached to free side of gate by hinge so as to be opened and closed from outside. Draining pens 20 feet square; this is large, so as to permit oil to drain off cattle and be used again.

By dipping young cattle last less oil is required, but sucking calves should be dipped with their mothers, for if separated for a time the mothers are liable not to know their calves. Avoid crowding cattle forward so fast as to cause them to jump upon one another while in the vat.

Provide shade and plenty of water during hot weather, and furnish shelter from winds during cold weather, with plenty of feed. Be careful not to overdrive or handle roughly cattle that have recently been dipped. Do not dip cattle when they are wet.

The crook shown in figure 16 is 12 inches in diameter, with a wooden staff 6 feet long. It is to be used in assisting young stock through the vat and in turning them around should they become headed the wrong way in the vat.

A crotch 5 feet long may be used in crowding the animal's head under the oil when necessary (see fig. 17), and a pail filled with oil should be at hand to throw over the head in case head can not be immersed. Complete immersion is all that is necessary, but it must be complete. Thin oil should be used, as thick oil is more or less injurious to the animals.

The crude Beaumont petroleum contains in solution, in its natural state, a considerable amount—ranging from 1½ to 2 per cent—of sulphur, and is a valuable remedy for hand treatment with mop, rag, or sponge to keep scabies in check during the winter when the weather is too cold to admit of the more thorough treatment by dipping. This oil, when thoroughly applied to mangy cattle, softens the scabs

or crusts, kills the mange parasites, and facilitates the healing of the abraded skin and its return to a normal condition. Cattle have likewise been dipped in Beaumont crude petroleum for the cure of mange with very satisfactory results.

Galvanized-steel dipping tanks are in use at a number of places in the different States.

It is to be observed that petroleum from different wells in the Beaumont region varies considerably, some wells producing a thick, heavy oil as low as 15° gravity Baumé, other wells producing a light oil 22° to 23° gravity, and some even higher, a production recently showing 29½°. The Bureau experiments with the different oils have shown that the thick, heavy oil of low gravity is apt to irritate the skins of animals dipped in it, sometimes producing quite serious results, while the light oil is more bland and not liable to injure the animals. It is therefore important that only the light, higher-gravity oil should be used for dipping purposes. In ordering, the kind of oil should be distinctly specified as Beaumont crude petroleum of 22½° to 24½° Baumé, containing 1½ to 1¼ per cent sulphur, and that 40 per cent will distil over when the oil is heated to a temperature of 200° to 300° C.

MANGE IN HORSES.

Many reports are being received as this bulletin goes to press of the prevalence of mange among horses, especially those on the ranges. In some outbreaks this may be Psoroptic mange; in others it may be Sarcoptic mange, depending upon the origin of the infection, since the two varieties have been reported as existing among horses in different sections of the country. As already noted, the *Sarcoptes*, unlike the *Psoroptes*, which live on the surface of the skin, burrow down and form galleries in the middle layer of the skin—retenucosum—in which they principally live, lay their eggs, and in which the young mites are hatched; consequently, they may not be reached by the dip liquid used, except it be of an oily, penetrating nature. Beaumont crude petroleum would seem to meet the indications in Sarcoptic mange, and has been successfully used in the treatment of a number of horses badly affected with this form of the disease by thoroughly mopping them all over with the oil, using for this purpose a cloth or brush. The dipping of horses in Beaumont crude petroleum has not been tried, as no opportunity has as yet been presented. It has been observed, however, that irritation of the skin has been produced in those that have been hand treated, likewise in cases of cattle that have been dipped, especially in the soft parts of the skin, of the flanks, and inside of elbows. If horses are dipped, they should not be kept in the oil longer than one minute, and the head and ears may be hand dressed

instead of ducking the horses. One thorough treatment with the Beaumont crude petroleum will generally be found sufficient, as the oil remains in the coat, having been noticeable by feeling with the hands and fingers thirty to forty days after treatment when the animals had not been exposed to rain.

In exaggerated cases of the disease in which the skin had become stiff, corrugated, and cracked it has likewise been observed that the oil facilitates the healing of these lesions and a rapid return of the skin to a soft, pliable, and normal condition.

As the life history and characteristics of the Psoroptic mange mite of the horse, *Psoroptes communis equi*, are practically the same as in the case of the common mange mite of cattle, *Psoroptes communis bovis*, it may reasonably be expected that an efficient remedy for mange of cattle may be used with confidence in treating Psoroptic mange in the horse. As previously stated in this bulletin, mange flourishes best in winter and under conditions adverse to the animals attacked. It is therefore easily detected in the winter and spring by its effects on the animals, while during the summer months animals may be harboring the parasites without showing, by their coats or otherwise, evidences of infection. Hence the importance of the treatment of all exposed animals in the fall of the year, even though they have been thoroughly treated in the winter or spring. Fall treatment should not, therefore, under any circumstances be neglected.

In the treatment of horses for mange dipping is recommended, when practicable. If no facilities for dipping are at hand the remedy should be applied by spraying or mopping in a thorough manner, in order that it shall be effective, not forgetting the necessity for rubbing in well the dip liquid in all badly affected cases, or in badly affected patches of each individual case.

Sarcoptic mange of cattle, if it occurs, must be extremely rare in this country, as no case has ever been brought to the attention of this Bureau, while in the horse it is found to exist with comparative frequency, and, unlike the Psoroptic variety, it can be conveyed from the horse to man. In the Army soldiers have at different times suffered from the disease through the Sarcoptic horse mange parasites having been communicated to them from horses. The disease thus communicated to man, however, tends to spontaneous recovery in from fifteen to forty days. When transferred from the horse to other kinds of animals (sheep and pigs) Sarcoptic mange has failed to produce irritation, and when this form of the parasite is transferred from the horse to the dog and cat it lives but a few days. Notwithstanding this fact, Sarcoptic mange of the dog (*Sarcoptes scabiei*, variety *canis*) is the most common form of mange of the dog.

[PUBLIC—No. 229.]

AN ACT To enable the Secretary of Agriculture to establish and maintain quarantine districts to permit and regulate the movement of cattle and other live stock therefrom, and for other purposes.

Be it enacted by the Senate and House of Representatives of the United States of America in Congress assembled, That the Secretary of Agriculture is authorized and directed to quarantine any State or Territory or the District of Columbia, or any portion of any State or Territory or the District of Columbia, when he shall determine the fact that cattle or other live stock in such State or Territory or District of Columbia are affected with any contagious, infectious, or communicable disease; and the Secretary of Agriculture is directed to give written or printed notice of the establishment of quarantine to the proper officers of railroad, steamboat, or other transportation companies doing business in or through any quarantined State or Territory or the District of Columbia, and to publish in such newspapers in the quarantined State or Territory or the District of Columbia, as the Secretary of Agriculture may select, notice of the establishment of quarantine.

SEC. 2. That no railroad company or the owners or masters of any steam or sailing or other vessel or boat shall receive for transportation or transport from any quarantined State or Territory or the District of Columbia, or from the quarantined portion of any State or Territory or the District of Columbia, into any other State or Territory or the District of Columbia, any cattle or other live stock, except as hereinafter provided; nor shall any person, company, or corporation deliver for such transportation to any railroad company or to the master or owner of any boat or vessel any cattle or other live stock except as hereinafter provided; nor shall any person, company, or corporation drive on foot, or cause to be driven on foot, or transport in private conveyance or cause to be transported in private conveyance, from a quarantined State or Territory or the District of Columbia, or from the quarantined portion of any State or Territory or the District of Columbia, into any other State or Territory or the District of Columbia, any cattle or other live stock, except as hereinafter provided.

SEC. 3. That it shall be the duty of the Secretary of Agriculture, and he is hereby authorized and directed, when the public safety will permit, to make and promulgate rules and regulations which shall permit and govern the inspection, disinfection, certification, treatment, handling, and method and manner of delivery and shipment of cattle or other live stock from a quarantined State or Territory or the District of Columbia, and from the quarantined portion of any State or Territory or the District of Columbia, into any other State or Territory or the District of Columbia; and the Secretary of Agriculture shall give notice of such rules and regulations in the manner provided in section two of this act for notice of establishment of quarantine.

SEC. 4. That cattle or other live stock may be moved from a quarantined State or Territory or the District of Columbia, or from the quarantined portion of any State or Territory or the District of Columbia, into any other State or Territory or the District of Columbia, under and in compliance with the rules and regulations of the Secretary of Agriculture, made and promulgated in pursuance of the provisions of section three of this act; but it shall be unlawful to move, or to allow to be moved, any cattle or other live stock from any quarantined State or Territory or the District of Columbia, or from the quarantined portion of any State or Territory or the District of Columbia, into any other State or Territory or the District of Columbia, in manner or method or under conditions other than those prescribed by the Secretary of Agriculture.

SEC. 5. That every person who forcibly assaults, resists, opposes, prevents, impedes, or interferes with any officer or employee of the Bureau of Animal Industry of the United States Department of Agriculture in the execution of his duties, or on account of the execution of his duties, shall be fined not less than one hundred dollars nor more than one thousand dollars, or be imprisoned not less than one month nor more than one year, or by both such fine and imprisonment; and every person who discharges any deadly weapon at any officer or employee of the Bureau of Animal Industry of the United States Department of Agriculture, or uses any dangerous or deadly weapon in resisting him in the execution of his duties, with intent to commit a bodily injury upon him or to deter or prevent him from discharging his duties, or on account of the performance of his duties, shall, upon conviction, be imprisoned at hard labor for a term not more than five years or fined not to exceed one thousand dollars.

SEC. 6. That any person, company, or corporation violating the provisions of sections two or four of this act shall be guilty of a misdemeanor, and on conviction shall be punished by a fine of not less than one hundred dollars nor more than one thousand dollars, or by imprisonment not more than one year, or by both such fine and imprisonment.

Approved, March 3, 1905.

Gaylord Bros
Makers
Syracuse, N. Y.
PAT. JAN. 21, 1938

14 DAY USE
RETURN TO DESK FROM WHICH BORROWED

BIOLOGY LIBRARY

This book is due on the last date stamped below, or
on the date to which renewed.

Renewed books are subject to immediate recall.

DEC 6 1961

NOV 22 1961

279
!

UNIV

LD 21-50m-6,'60
(B1321s10)476

General Library
University of California
Berkeley

