

2. 11. 1956
Z. P. Metcalf



LIBRARY OF

Dr Z P Metcalf

1885-1956

12

THE WILEY TECHNICAL SERIES

FOR

VOCATIONAL AND INDUSTRIAL SCHOOLS

EDITED BY

JOSEPH M. JAMESON

GIRARD COLLEGE

THE WILEY TECHNICAL SERIES

EDITED BY

JOSEPH M. JAMESON

TEXT BOOKS IN AGRICULTURE

NOW READY

- Market Gardening.** By F. L. YEAW, Manager, Oasis Farm and Orchard Company, Roswell, N. M. Formerly Professor of Market Gardening, Massachusetts Agricultural College. vi+120 pages, 5 by 7. 36 figures. Cloth, 75 cents net.
- Studies of Trees: Their Diseases and Care.** By J. J. LEVISON, Department of Parks, Brooklyn, N. Y. 5 $\frac{1}{4}$ by 8. x+253 pages, 156 half-tone illustrations. Cloth, \$1.60 net. (Also 8 by 10 $\frac{1}{2}$, loose leaf.)
- Agricultural Drafting.** By CHARLES B. HOWE, Bushwick Evening High School, Borough of Brooklyn, New York, N. Y. viii+63 pages, 8 by 10 $\frac{3}{4}$. 45 figures, 26 plates. Cloth, \$1.25 net.
- Exercises in Farm Dairying.** By Professor C. LARSEN, Department of Dairy Husbandry, South Dakota State College. Loose Leaf. 8 by 10 $\frac{1}{2}$. 69 Exercises. Complete, Paper cover, \$1.00 net.
- Field and Laboratory Studies of Soils.** By Professor A. G. McCALL, Department of Agronomy, Ohio State University. viii+77 pages, 5 by 7 $\frac{1}{4}$. Cloth, 60 cents net.
- Field and Laboratory Studies of Crops.** By Professor A. G. McCALL, Department of Agronomy, Ohio State University. viii+133 pages, 5 by 7 $\frac{1}{4}$. 54 figures. Cloth, 85 cents net.
- The Chemistry of Farm Practice.** By T. E. KEITT, Professor of Soils, Clemson Agricultural College. xii+252 pages, 5 $\frac{1}{4}$ by 8. 81 figures. Cloth, \$1.25 net.
- Soil Entomology.** By DEAN E. D. SANDERSON and Professor L. M. PEAIRS, West Virginia University. vii+356 pages, 5 $\frac{1}{4}$ by 8. 233 figures. Cloth, \$1.50 net.

For full announcement see list following index.

5000 4-2-17

SCHOOL ENTOMOLOGY

AN ELEMENTARY TEXTBOOK OF ENTOMOLOGY

*FOR SECONDARY SCHOOLS AND
AGRICULTURAL SHORT COURSES*

BY

E. DWIGHT SANDERSON

AND

L. M. PEAIRS

FIRST EDITION

NEW YORK

JOHN WILEY & SONS, INC.

LONDON: CHAPMAN & HALL, LIMITED

1917

Copyright, 1917

BY

E. DWIGHT SANDERSON AND L. M. PEAIRS

PRESS OF
BRAUNWORTH & CO.
BOOK MANUFACTURERS
BROOKLYN, N. Y.

INTRODUCTION

ENTOMOLOGY is briefly defined as the study of insects in all their relations and activities. Its importance is due to the numbers of species and the abundance of individuals in the insect group. In both these respects insects form by far the greater portion of our land fauna. Various estimates place the number of species of insects at from one to ten millions and the number of individuals is far beyond calculation. Of these species nearly a half million have been named and described.

The range of insects is almost universal on land, but only a few forms are marine in habitat. Intensively speaking, their range is equally great. In any given locality insects may be found inhabiting every conceivable situation and living on the greatest variety of foods.

When we consider the vast numbers of insect forms and their wide distribution and range in food habits it seems inevitable that many of these forms should clash with man, and this is indeed the case. Many of the earth's products which are most useful and highly desirable to man are attractive to insects as well. Man, in his assumed character of the dominant animal, claims prior right and such insects as affect his welfare or comfort are listed as pests.

Less account is taken by man of his insect allies, those forms which minister directly to his needs, or those which, in a roundabout way, add to his pleasure or his revenues.

The extent of insect injuries in the United States has been carefully estimated by experts in the U. S. Department of Agriculture and these estimates place the total annual loss at not far from the stupendous sum of one billion dollars. This estimated loss is divided among various classes of products. Of these, grain and forage crops are the heaviest sufferers, bearing about one-third of the total; the live stock industry assumes another third; truck crops stand one-sixth the total loss. After these come, with smaller totals, cotton, fruit, tobacco, forests and miscellaneous products.

In addition to the tangible monetary losses occasioned by the activities of the insects which attack crops, must be considered the less definite, but none the less real, importance which is based on their disease-carrying faculties, the study and knowledge of which has been confined to the more recent years.

No one can estimate the actual importance of the mosquitoes in terms of dollars. The money loss to the nation in any year from malaria is undoubtedly great, but the importance of the insects which transmit it from one person to another would not be based on the consideration of money at all. Nor is the comfort of the inhabitants of the mosquito-ridden lands a financial problem, primarily, although land values undoubtedly increase rapidly when the mosquito-breeding places are destroyed.

The house-fly, carrier of filth as it has long been known to be, and carrier of disease from a more recent conviction, likewise is not a problem of the pocketbook. Both are, in the larger sense, problems of the higher civilization, and both add to the importance of the study of insects and present this in an entirely different light than the one of the billion dollar annual loss.

On the other hand are the beneficial forms. Those that operate directly are familiar to all, the producers of honey and of silk being the best known. Of far more value even than these are the ones which fertilize the flowers and make possible the production of seeds and fruit. Take away the insects and a large part of our flora would disappear through inability to propagate itself without the aid of insects.

But the student of entomology does not necessarily make the economic importance of the subject his prime motive for taking up the study. To many the charm of the subject lies, not in the consideration of the hundreds of forms that have a direct bearing on the welfare of man, but rather, in the thousands and thousands whose claim to interest lies in the fact that they are a part of the great scheme of nature and that the study of them will, like few other studies, bring one into close touch with nature. The economic phases of the subject are acquired in a perfectly natural and logical manner through the study of the life histories of the most common forms, since many of these are at the same time the most injurious.

To inculcate in the young student a love of nature and to stimulate the faculties to observe what is going on in the great world of nature, nothing is better than the study of insects. This forces the student to take an interest also in the kindred subject of botany, since there are few plants that are not directly affected by insects and which will not be involved in the studies of the biology of the many forms.

Entomology may be studied to the best advantage in the spring, summer and fall, but the subject is by no means closed during the winter months, as there are many

insects whose entire life histories cannot be studied without continuation of the observations throughout the year.

This work aims to present the subject in a simple fashion so that the student of the secondary schools can use all that is given. It attempts to make the student acquainted with only the more important groups and does not go as deeply into the scientific phases of classification and structure as a work intended for more advanced students should.

Neither does it give as much attention to details of description of species as a work of larger scope could. The aim is rather to present the general idea of the subject so that it can be covered in the time that the schools may reasonably be expected to allot to it. Brevity is secured rather by omission than by any lack of accuracy in the statements included. The classification employed is the one in general use and the one best known to the greater number of entomological students who will be likely to use the work for a text. Its greater simplicity warrants its use rather than the more scientific arrangements and nomenclatures employed by the most modern writers.

The chapters on economic entomology are presented with the same object: to give as concise an idea of the more common injurious forms as is possible in a limited space. Here again, brevity is secured by the omission of the less important and less generally distributed species rather than by slighting those that are considered.

The junior author is responsible for the preparation of Part I, and the senior author for Part II.

E. D. S.
L. M. P.

June, 1916.

CONTENTS

INTRODUCTION.....	PAGE iii
-------------------	-------------

PART I

GENERAL ENTOMOLOGY

CHAPTER		
I.	DEFINITION OF THE SUBJECT.....	1
II.	INSECT STRUCTURES.....	4
III.	INSECTS AND THEIR NEAR RELATIVES.....	19
IV.	THE DEVELOPMENT OF INSECTS.....	28
V.	THE LOWER ORDERS.....	34
VI.	NEUROPTEROID ORDERS.....	41
VII.	ORTHOPTERA.....	48
VIII.	HEMPTERA.....	56
IX.	LEPIDOPTERA.....	72
X.	COLEOPTERA.....	107
XI.	DIPTERA.....	131
XII.	HYMENOPTERA.....	142
XIII.	THE INSECT COLLECTION.....	163

PART II

ECONOMIC ENTOMOLOGY

XIV.	INSECTS AFFECTING MAN AND DOMESTIC ANIMALS.....	175
XV.	INSECTS AFFECTING HOUSEHOLD GOODS AND STORED FOOD PRODUCTS.....	214
XVI.	FIELD CROP INSECTS.....	236
XVII.	GARDEN INSECTS.....	266
XVIII.	ORCHARD INSECTS.....	287
XIX.	INSECT CONTROL.....	323
APPENDIX.....		339
INDEX.....		345

SCHOOL ENTOMOLOGY

PART I—GENERAL ENTOMOLOGY

CHAPTER I

DEFINITION OF THE SUBJECT

1. Entomology Defined. Entomology is the study of insects and may properly include facts of any kind whatsoever that pertain to insects or any of their activities.

2. Insect Characteristics. Insects are animals belonging to a branch of the animal kingdom known as the **Arthropoda**. These animals all have, in their perfect state, bodies made up of ringlike plates called *segments*, and they have, on some of these segments, jointed legs. In some members of the branch the segments are so nearly grown together that they are not distinguishable. In some stages of others, the legs are lacking, but all members of the branch have, at some stage of their existence, at least, traces of both these characteristics. The branch includes, besides the insects, spiders and their relatives, centipedes and millipedes, and crayfish and lobsters and their relatives, of which there are many varied forms.

3. Classification. Each one of these groups forms what is known in Zoology (Zoology is the study of all

animals and includes Entomology) as a *class*. The members of any class that are alike in their general form and structure are placed together in the first sub-division of any class and constitute what we call an *order*. Those forms in any order that show close resemblance group together and form a family and the members of a family that are even more similar form a *genus* (plural *genera*). The last division in animal, or plant, classification is the *species*. Members of any genus which are exactly alike or as nearly alike as the offspring from a single parent form, constitute a species. An additional character of a species which is, by the way, difficult to define exactly, is that members of the same species will interbreed and produce young like unto themselves which will, in turn, breed and produce fertile young. Some species will show variation on account of climate, of their food, or from some other external cause, but still retain their power to interbreed and produce like young. Such differences are recognized under the name of varieties. In Zoological classification we have, first, the

Animal Kingdom, divided into

Branches, composed of

Classes, each embracing one to several

Orders, in which are varying numbers of

Families, which contain

Genera, and finally the

Species.

4. Names. The classification of any animal shows all the above divisions. The scientific name, which is always Latin in form for the sake of uniformity, is composed of the name of the genus, capitalized, followed by the name of the species, not capitalized, and then the name of the man who first described and named the ani-

mal. This last is frequently omitted as it serves no purpose except for the student of classification. Names of all the various sub-divisions are Latin in form. Family names *always* have the termination *-idæ* and may be so recognized as no other scientific names are given that ending. Super-family names end in *-ina*, or *-oidæ*, but are not so distinctive, since other names may be found with similar termination. Sub-family names end in *-inæ*. Generic, specific and order names may have any accepted Latin termination.

CHAPTER II

INSECT STRUCTURES

5. Definition for an Insect. The characters of the branch to which insects belong have been given. The characters which are possessed by all insects are embraced in the definition for an insect which is as follows:

An insect is an Arthropod which has three distinct regions to the body, the head, the thorax and the abdomen. It bears, on the head, one pair of antennæ or feelers, on the thorax, three pairs of legs, and, usually, one or two pairs of wings.

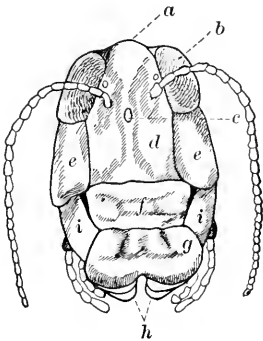

FIG. 1.—Head of Grasshopper, Front View.

a, vertex; *b*, compound eye; *c*, ocellus; *d*, front; *e*, cheeks or genæ; *f*, clypeus; *g*, labrum; *h*, edges of maxillæ and labium; *i*, mandibles.

6. The Head. The insect body is made up of a variable number of segments, but this variation is always in the third region or abdomen. The head consists always of a single segment. This is made up of a skull-like single piece to which are attached the antennæ and the mouth parts and in which are found the eyes. This skull is called the *epicranium*. The antennæ are extremely varia-

ble. They are jointed but the number of joints ranges from a single one to several hundred. They may be almost too small to be seen or several times as long as the body.

Their purpose is primarily for feeling, but many forms have organs of smell located in the antennæ. Male mosquitoes hear with the antennæ and the sense of taste, being closely related to smell, may be found in some, although this is by no means certain.

The eyes of insects are of two kinds, *simple* and *compound*. Some forms have both, some only the one or the other and some have neither, being entirely blind. The compound eyes are borne by all the common insects. They consist of a great number of separate lens-like structures crowded together to make one eye. Each one of these has its own field of vision, the object as seen by the insect consisting of a great number of separate parts thrown on its retina and forming a mosaic showing the shape of the object. There may be from a very few, fifteen, to as many as fifty thousand separate lenses or facets to the compound eye. In many insects the eyes take up the greater part of the head. The simple eyes, more frequently called *ocelli*, vary in number from one to several. They are small and their uses are not certainly known.

On the lower or anterior edge of the *epicranium* are attached the mouth-parts. These are, in the typical insect, an upper lip or *labrum*, a lower lip or *labium*, a pair of jaws or *mandibles*, one on each side just below the labrum, and just below these, a pair of supplementary jaws or *maxillæ*. On each

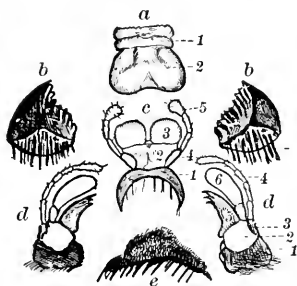

FIG. 2.—Mouth-parts of Chewing Insect (Grasshopper).

a, labrum; 1, clypeus; 2, labrum proper; *b*, mandibles; *c*, labium; 1, submentum; 2, mentum; 3, ligula; 4, palpiger; 5, palpus; *d*, maxillæ; 1, cardo; 2, stipes; 3, palpifer; 4, palpus; 5, lacinia; 6, galea; *e*, hypopharynx.

maxilla is a finger-like structure called a *palpus*. The labium bears a similar pair of *palpi*. In the insect which has its mouth-parts modified for sucking these parts will

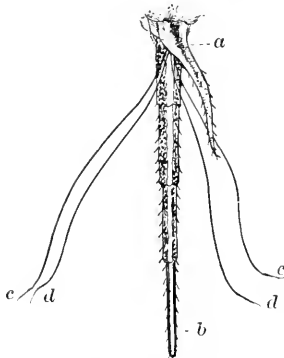

FIG. 3.—Mouth-parts of Sucking Insect, (true bug).

a, labrum; *b*, labium; *c*, mandibles; *d*, maxillæ.

not be so readily recognized and some of them may be absent. Most of them may be identified by their relative position at the point of attachment to the head, as this never varies.

The part of the epicranium that lies between the eyes and the base of the labrum is designated as the *front*. To either side of the front are the cheeks or *genæ*. The highest point of the epicranium, just at the limit of the front, is the *vertex*. Back of the vertex, eyes and cheeks

lies the *occiput*. This fits into the front or *anterior* margin of the thorax.

7. The Thorax. The thorax of an insect is composed, always, of three segments. The first of these is the *prothorax*, the middle one is the *mesothorax*, and the last or *posterior* segment, is the *metathorax*. Each of these bears one pair of legs (in the perfect insect or adult). The front wings, where there are two pairs, are borne on the mesothorax, and the second pair of wings is attached to the metathorax. Where one pair of wings only is present it is the front pair.

The top of a thoracic segment is called the *notum* of that segment, the side is the *pleuron* and the bottom plate the *sternum*.

An insect's leg is composed of several joints or seg-

ments. The first one, joining the body, is the *coxa*. This is usually small and rounded. Next to the coxa is a small, sometimes indistinct but sometimes two-jointed, part called the *trochanter*. The first large joint is the thigh or *femur*. Then comes the *tibia*, usually long and slender, then the *tarsus* or foot. The tarsus has several joints

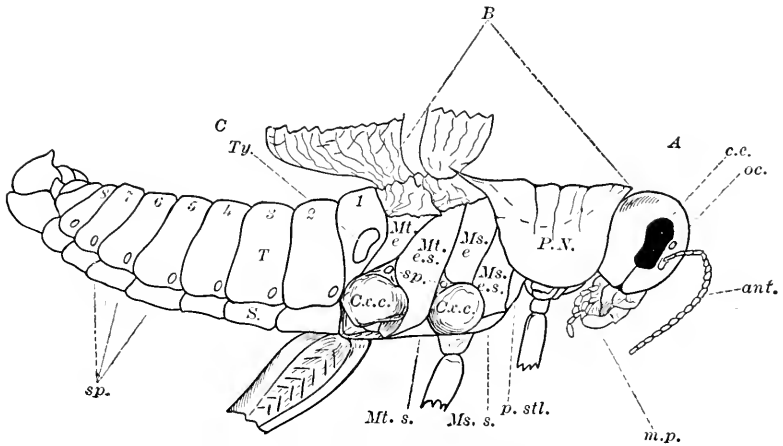

FIG. 4.—Grasshopper, from Side, Showing Main Parts of Skeleton of Typical Insect.

A., head; *c.c.*, compound eye; *oc.*, ocellus; *ant.*, antenna; *m.p.*, mouth-parts; B., thorax; P.N., pronotum; *p.stl.*, prosternellum; *Ms. s.*, mesosternum; *Mt. s.*, metasternum; *Cr. c.*, coxal cavity; *Ms. es.*, meso-episternum; *Ms. e.*, meso-epimeron; *Mt. es.*, meta-episternum; *Mt. e.*, meta-epimeron; *sp.*, spiracle; C., abdomen; (segments numbered); T., tergite, S., sternite; Ty., tympanum or ear; *sp.*, spiracles.

and usually ends in a claw of one or two parts. Between the two parts of the claw there is often found a small, pad-like affair, the *empodium*.

The wings are, typically, flattened sacks with very thin walls, strengthened with tubes or veins between the walls. The veins form important characters in the study of some groups and are given names. The margins

and angles of the wings are also named. Fig. 5 shows a typical wing with the names of the veins, margins and angles.

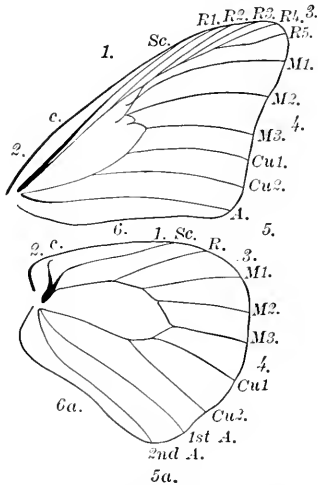

FIG. 5.—Wings of Butterfly Showing Veins and Margins.

1, costal margin; 2, humeral angle; 3, apical angle or apex; 4, outer margin; 5, inner angle; 5a, anal angle (hind wing); 6, inner margin; 6a, anal margin (hind wing). C., costal vein; Sc., sub-costal vein; R., radial vein (and branches); M., median vein; Cu., cubital vein; A., anal veins.

8. The Abdomen. The abdomen of an insect consists of several segments which are generally more typically ring-like than in the rest of the body. At the tip of the abdomen, and formed by modifications of some of the segments, is the egg-laying organ, *ovipositor*, of the females and the external generative organs of the males. These may be so retracted within the body as to be not prominent. With few exceptions, there are no other appendages on the abdomen of adult insects.

Along the sides of the segments of the thorax and abdomen are small holes, called *spiracles*. They are the external openings of the breathing tubes which will be described in the discussion of the internal anatomy.

In any part of an insect's body, where two plates or segments come together and make a flexible union, the union is called a *joint*. If the plates have grown firmly together the line of union is a *suture*.

9. The Body Wall. The body wall of insects is hardened with a substance called *chitin*. This serves to give it stability of form and protects the insect. This

body wall is not only the covering of the insect but also the skeleton, there being no hardened framework inside the body as is the case with the higher animals. An external skeleton like this is an *exoskeleton*. From this exoskeleton there are inward projections which serve as attachments for the muscles and other internal organs. The possession of the exoskeleton enables the insects to keep their form after death and renders preservatives unnecessary for any but the softest bodied species.

10. Internal Organs. Internally insects differ widely from the higher animals. Yet they have organs and systems of organs constructed for the performance of similar functions. The names applied to these organs are, as a rule, the same as for the organs in the higher animals having similar uses.

The systems of internal organs in an insect as well as in other animals, are grouped according to function. The more important of these groups are: *Digestive, Circulatory, Respiratory, Nervous, Reproductive* and *Muscular*. The *Excretory* system is distinguished by some writers. In addition, there are the fat-bodies, certain connective tissues and special organs.

11. The Digestive Tract. Young insects, and many adults, have the interior of the body almost completely taken up by the *digestive tract*. This is, primarily, a tube running the length of the body. As the tube is often longer than the body it is found to be more or less convoluted. Different parts of this tube are modified and are given names according to their uses. The anterior end forms the *mouth* and the back part of the mouth cavity is the *pharynx*. Mouth and pharynx are for reception of food and serve the same purposes as in higher animals. Salivary glands are found in insects. These are usually

slender tubes opening into the mouth cavity. The pharynx narrows rapidly and merges into the *œsophagus* or gullet. This corresponds exactly to the *œsophagus* in vertebrates, and is merely a passageway for the food on its way to the stomach. In the thoracic region the *œsophagus*

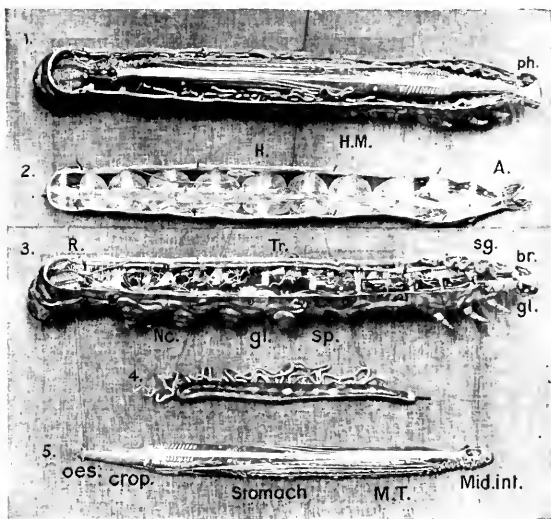

FIG. 6.—Internal Structure of a Caterpillar.

1. Dorsal view with upper wall removed, showing organs in place. *ph.*, pharynx.
2. Inner surface of upper wall showing organs of the circulatory system. *A.*, aorta; *h.*, heart or dorsal-vessel; *H.M.*, heart muscles or "Wings of the Heart."
3. Digestive organs removed, exposing organs of nervous and respiratory systems. *Br.*, brain or supra-œsophageal ganglion; *s.g.*, salivary gland; *gl.*, ganglion; *Tr.*, Trachea; *n.c.*, nerve cord; or central nervous system; *sp.*, spiracles; *R.*, rectum or posterior part of the intestine.
4. Silk gland removed. The location of the gland may be seen in the upper figure.
5. The alimentary canal, removed. *oes.*, *Æsophagus*; *M.T.*, Malpighian tubules; *Mid-int.*, mid-intestine. From photographs of an "Azoux model" of the silk-worm.

widens out into a pouch-like structure called the *crop* which is followed by the *proventriculus*. Following the *proventriculus* is the *stomach* proper or *ventriculus*. Here the food is digested, much of the digestive fluid being

secreted by the glandular walls of the stomach. Most insects have several pouches opening into the stomach near its union with the proventriculus and pouring into it some of the digestive juices. After the stomach comes the *intestine*. In some forms it is merely a straight tube, but in others it is very much curved and convoluted. Generally it is divided into more or less distinct regions which are termed the *mid-intestine*, the *ileum*, the *colon*, and the *rectum*. Some absorption takes place through the walls of the mid-intestine, but this process is started and largely completed in the stomach. At the point of union between the intestine and the stomach arise a great number of very fine, convoluted tubes. These are the *kidney-tubules* or Malpighian tubes. They are supposed to function as kidneys and to be excretory. They, with the intestine, form the excretory system, such as it is, of insects.

12. The Circulatory System. The circulatory system differs greatly from that of vertebrates. There is a so-called *heart* which consists of a long tube lying just beneath the dorsal wall or back of the insect. The front end of this tube is called the *aorta* and is the only blood vessel in the body. Blood is drawn into the heart from the body cavity, where it fills all space not taken up by the organs, through valves along the side of the heart. A system of muscles causes an alternate contraction

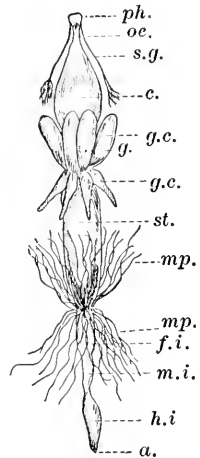

FIG. 7.—Digestive System of an Insect.

ph., pharynx; *oe.*, oesophagus; *s.g.*, salivary gland; *g.c.*, gastric caeca; *g.*, gizzard or pro-ventriculus; *st.*, stomach or ventriculus; *m.p.*, Malpighian tubules; *f.i.*, fore-intestine; *m.i.*, mid-intestine; *h.i.*, hind-intestine; *a.*, anus.

and expansion in the heart by means of which the blood is forced forward through the aorta and a sluggish circulation is kept up. The blood bathes all the tissues of the body and carries food to them. This is its sole function except that it may take up some of the waste products. These are, in turn, taken from the blood by the kidney-tubules and carried out of the body through the intestine. The blood does not carry oxygen to the tissues as it does in the vertebrates. For this reason the slow circulation found in insects suffices, even for those forms that are most active, where it would not do for the active vertebrates.

13. Respiratory System. Respiration is the function of insects which is most different from the same function in other animals. The respiratory system consists of tubes, opening through holes in the sides of the thoracic and abdominal segments, and branching and subdividing into tubes that ramify throughout the body after the fashion of capillaries. These carry the oxygen to all the tissues and from them carry off the carbon-dioxide and other gaseous wastes. The breathing tubes are called *tracheæ*, and their external openings *spiracles*. There are generally large tracheal tubes along each side of the body and branches are given off in each segment. The small tracheal tubes end in thin walled sacks in the tissues and through these the gases are exchanged by osmosis. The blood receives only such oxygen as is required for its own purification. The air is forced from the tracheæ by muscular contraction. The tracheal tubes themselves are lined with elastic coiled threads and when the pressure from this contraction is relieved the elasticity of the walls causes the tubes to regain their normal shape, thus drawing more air into the body.

14. Nervous System. The central nervous system consists of two nerve cords running the length of the body and resting on the ventral or lower wall. Typically, there is an enlargement of these cords in each segment. These enlargements are called *ganglia*. Each ganglion gives off nerves which supply the motor impulses and receive the sensations for that segment. In the head the two cords separate, one running on each side of the œsophagus. Above the œsophagus they unite again and form what is usually the largest ganglion of the body and is called the *brain*. From this ganglion nerve fibers go to the compound eyes, the ocelli and the antennæ and the labrum. There is a separate fiber for each facet of the compound eyes which, as we have seen, might require as high as fifty thousand for each compound eye and this will explain the larger size of the ganglion. There is, in the head, a second ganglion below the œsophagus which innervates the mouth-parts. This is the *sub-œsophageal ganglion* while the so-called brain is the *supra-œsophageal ganglion*. From the latter arises also the sympathetic nervous system which consists of a few fibers running posteriorly along the top of the alimentary canal and carrying the impulses incident to digestion.

15. Reproductive System. The reproductive system is similar in its organization to that of the vertebrate animals. It consists primarily of two sets of fine tubes communicating with the outside of the body through passages at first distinct but later united. In the females each one of these sets of tubes forms what is called an *ovary*. Eggs develop in each tube and, when fully grown, pass out into the *oviduct*, a passageway into which all the egg-tubes open. From the oviduct, the egg is carried to the *vagina*, which is formed by the union of the oviducts from both

ovaries and which leads to the *ovipositor* or external termination of the female reproductive organs. Somewhere in the vagina is a sort of sac or pouch in which the fertilizing element, received from the males during copulation, is stored. This sac is the *spermatheca*. As the egg passes over the opening of the spermatheca it receives, through minute holes in one end, called the *micropyle*, the sperm cells by which it is fertilized. *Parthenogenetic* individuals lack the spermatheca.

The reproductive organs of the male are similar to those of the female but are much smaller because the sperm cells are very much smaller than the ova or egg cells. The collections of tubes forming, in the females, the ovaries, are called, in the males, *testes*. In these the sperm cells are formed. The *seminal tubes*, as the separate elements of the testicle are called, open into a duct called the *vas deferens*. The two *vasa deferentia* unite to form the *ejaculatory duct* paralleling the vagina as the vasa deferentia parallel the oviducts. There is in the walls of this duct, usually, a pouch formed by the invagination of the wall and used for the storage of the seminal fluid until needed. This is named the *seminal vesicle* and corresponds to the spermatheca in the female. The external organ through which the male reproductive organs open is the penis. There may be specially developed claspers or other structures used in copulation. They are homologous with the modifications of the ovipositor for boring, etc.

Ovipositors show the most varied forms. They are adapted for depositing the eggs in every possible situation. The eggs, too, are of many different kinds. Stinging organs are modifications of the ovipositor and usually are connected with specially developed poison sacs which add to their efficiency. They are adapted for two purposes,

protection and overcoming other insects which serve as food for the larvæ.

16. The Muscular System. Insects have a wonderfully developed system of muscles. As many as two thousand separate muscles have been identified in certain larvæ. The muscle tissue is soft and watery in appearance in the living insect and is made up of striated fibers ending in tendon-like cords which are attached to the different organs and to the hardened processes projecting inward from the skeleton for this purpose. The strength of these muscles seems to be much greater in proportion to their size than is the case in other animals and many wonderful tales are told of the muscular power of insects. Some of these may easily be verified by original observation.

17. The Fat-Body. Much of the space in the body cavity of some forms of insects is taken up by the *fat-body*. This is tissue similar to the fatty tissue of the vertebrates and serves much the same purposes, namely, storage of food and, to a degree, support for the more delicate organs. The fat-body consists of cells of rather large size, arranged in masses which are usually distinct in the different segments.

18. Special Organs and Adaptations. There are specializations, external and internal, of the most varied nature, which are usually directly connected with the functions of one or other of the above-mentioned systems of organs. Among these there are few that are more striking than those of the respiratory apparatus. These are frequently adaptations for an aquatic habitat. The most simple of the arrangements by means of which an insect is enabled to obtain air while beneath the surface is that by means of which the insect can carry a bubble of air

down with itself and remain submerged until the supply is exhausted. This is usually accomplished by means of hairs on the under side of the body which retain the air bubble. The air supply is sometimes imprisoned underneath the wings. Next to this in simplicity is the tube which reaches to the surface of the water and into which the tracheæ open. The insect can remain under water indefinitely at the depth which corresponds to the length of this tube. Mosquito larvæ and pupæ and water-scorpions are so equipped.

Insects that are most truly aquatic are provided with *tracheal gills*, structures which can take up from the water the oxygen necessary for the insect. These differ from the true gills of fish and crayfishes in that the oxygen thus secured is carried to the tissues through tracheal systems exactly similar to those of ordinary insects while in the case of the true gills the blood is carried to the gills as it would be to lungs.

Tracheal gills show many forms. Dragon-fly nymphs have gills that consist of a large number of tracheal tubes in the lining of the rectum. Water is drawn into this, the air taken up and the water expelled, often with some force so that it serves generally as a means of propulsion. Damsel fly nymphs have gills in the leaf-like plates at the tip of the abdomen. Other forms, notably the helgramite or larva of *Corydalis*, have tracheal gills consisting of tufts of hair-like tracheæ projecting from the body, the location varying with the insect.

Organs of special sense have many special structures. The sense of feeling is often dependent upon hairs connecting with nerve fibers at different places on the body. The antennæ are, primarily, the main organs of feeling. The sense of taste has organs located partly within the

mouth as with the vertebrates, and frequently accompanied by specialized hairs which may be found on the palpi, outside the mouth cavity. The *hypopharynx* is the main organ for the sense of taste.

The sense of smell is known to be located in the antennæ of many species. In others its organs are not certainly identified. Hearing organs occur in highly unexpected places. Male mosquitoes hear with the antennæ. An ear drum or tympanum is located on the first segment of the abdomen in grasshoppers, while it is found on the tibia of some crickets. In some insects the location of the sense of hearing is not known, but it seems certain that all forms are able to perceive sound. Of all the special senses smell is usually most highly developed.

Many forms of body covering are noted. These are largely protective. The body hairs of some insects are connected with poison glands or are barbed or covered with some irritating substance. The larvæ of the Brown-tail moth have barbed hairs which cause an itch or rash on the human skin and so render them a great nuisance.

Scent glands are often present. These may be protective or they may serve to attract the mates. The latter is the case in certain moths while in many bugs and some beetles and butterflies the scents secreted protect from natural enemies by making the insects distasteful.

A special structure of much interest is the silk-producing apparatus. This consists of a pair of silk glands opening through little holes just beneath the mouth. These glands resemble the salivary glands but are larger. Other glands secrete such substances as the honey-dew of Aphids and related insects, the wax covering of the scale insects and *Lac*, also a product of scale insects.

Light-producing or luminescent insects have special structures for the production of light which are not well understood. The light is thought to be the result of a very finely developed process of oxidation whereby practically all the energy from the oxidation is made into light instead of into heat. These structures are closely connected with the respiratory system.

External projections from the skeleton are frequent and do not usually appear to serve any useful purpose. They may be either ornamental or merely vestiges of structures that were, formerly, of use to the species.

CHAPTER III

INSECTS AND THEIR NEAR RELATIVES

THE Branch **Arthropoda** includes, besides insects, several related groups which are usually considered with the insects and which should be familiar to the student of insects for the purposes of comparison if for no other reason.

19. Crustacea. The *Crustacea* are forms which are usually aquatic, breathe by means of true gills as do the fishes, and have at least five pairs of jointed legs, the anterior or front pair, in most common forms, bearing pincer-like claws and being used as weapons rather than as feet. Their bodies are made up of only two main parts as the head and the thorax are grown together and form what is known as a *cephalothorax*.

Our best known Crustaceans are the *crayfish*, or "crawfish," the *lobster*, *crabs*, *shrimps* and the terrestrial form called *sow-bug* or *pill-bug*. Their economic importance is not great. Sow-bugs injure greenhouse crops at times and in the Southern States the crayfish is injurious to agriculture in the marshy districts. These injuries are counterbalanced by the importance of the class as food for man. Lobsters and crabs are highly prized in America while crayfish and shrimps are also used for food and many forms are important as food for fishes.

20. Myriapoda. *Myriapoda* are the Arthropods with the greatest number of feet. They are commonly called

“hundred-legged worms” and “thousand-legged worms” or *centipedes* and *millipedes*.

The centipedes have one pair of legs to each segment, are generally flattened and have the legs attached near the edges of the segments. Millipedes are oval or cylindrical, have two pairs of legs per segment and have these attached near the median line of the segments on the under side. Both forms have one pair of antennæ and have bodies composed of head and an unspecialized chain of segments representing thorax and abdomen.

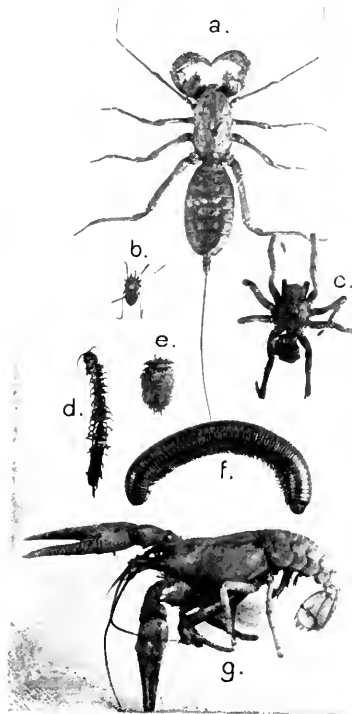

FIG. 8.—Some Relatives of Insects.
Reduced.

a, the tailed Whip-scorpion (class *Arachnida*, order *Pedipalpi*); b, Harvestman (*Arachnida*, *Phalangidea*); c, Spider (*Arachnida*, *Araneida*); d, Centipede (*Myriapoda*, *Chilopoda*); e, Sow-bug or Pill-bug (*Crustacea*); f, Millipede (*Myriapoda*, *Chilognatha*); g, Cray-fish (*Crustacea*).

Myriapoda are of slight economic importance. Millipedes sometimes feed on vegetation extensively enough to be injurious, while centipedes are predaceous and feed mostly upon insects. Some forms of centipedes, especially in tropical and subtropical

countries, are provided with poison glands and may injure man seriously by their bites.

21. Arachnida. *Arachnida* is the most important of the Arthropod classes excepting the insects. The class includes *Spiders*, *Mites* and *Ticks*, *Harvestmen* or "daddy-long-legs," *Scorpions* and many other less common forms.

Arachnids have four pairs of legs, no antennæ and only two body regions, the head and thorax being combined as in the *Crustacea*. They are typically land animals.

The *Spiders* (order *Araneida*) spin webs of silk which has been used commercially to a very limited extent.

They are predaceous and feed on insects. Except for occasional bites which they inflict upon man, they may be considered beneficial.

Mites and *Ticks* (*Acarina*) are of considerable importance. Mites are usually very small and feed on both plants and animals. They cause gall-like growths in plant tissues and may do great damage. The pear-leaf blister-mite is possibly the most important example in the eastern United States. Many mites are parasites on domestic animals. The mites on poultry are the best known forms with this habit. Others cause sheep-scab* and other diseases of



FIG. 9.—A Tarantula (*Arachnida*, *Araneida*). Greatly reduced.

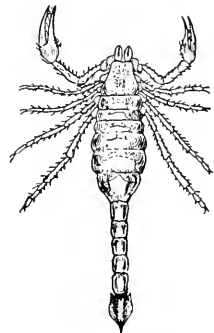

FIG. 10.—Scorpion (Class *Arachnida*, order *Scorpionida*).

* See page 203 Part II.

domestic animals. Ticks, which are merely large mites, are external parasites on many animals. One species, the *Texas-fever Tick*, carries the organism causing Texas fever



FIG. 11.—The Pear-leaf Blister-mite (*Arachnida, Acarina*). Highly magnified. After Parrott.

in cattle from animal to animal and is a serious hindrance to the stock-raising industry in the Southern States. Other forms transmit the Rocky Mountain Spotted-

fever, which is a serious, and often fatal, disease of man. Still others have similar and equally serious habits in other parts of the world. (See page 209.)

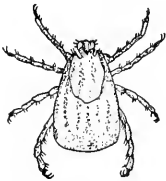

FIG. 12.—A Tick (Class *Arachnida*, order *Acarina*). Enlarged.

Some forms of mites are beneficial as parasites of injurious insects.

Harvestmen are the long-legged forms commonly known as "daddy-long-legs" and found in the woods and fields all over the country. Their economic importance is extremely slight.

Scorpions are found in the more southern portions of the United States, but occur as far north as northern Kansas. They have the posterior part of the abdomen narrowed into a tail-like appendage terminated with a sting with which they can inflict more or less painful wounds.

Other Arachnids are *Pseudo-scorpions*, found in moist situations, frequently under bark, small in size and very inconspicuous; *Jointed-spiders*, found only in the Southwest, and a few others which are still more rare in our fauna.

It is not advisable to take up here the further classification of the Arthropods, other than insects, into orders

and families, although the differences between the members of the several classes are often very striking.

22. Hexapoda. The class *Hexapoda*, or the insects, is by far the most important group in the branch, and as it is the one which claims the major part of our attention, a discussion of the characters upon which their arrangement into orders and families is based is here given.

The grouping of insects into orders is based largely upon variations in three characters namely, those of the wings, of the mouth parts and of the metamorphosis. A combination of the description of the wings, the type of mouth and the nature of the development, whether direct or indirect, will place any insect in its proper order. Tables for the identification of adult insects may employ certain other characters on account of the fact that the nature of the transformations cannot be determined from a specimen in the cabinet.

Families are identified by means of characters that vary within each order. In some cases the only characters that can be used appear to be those of the wing-venation. Since these present difficulties that are too great for the beginner they will be omitted. In other orders, families are distinguished by characters of the antennæ, of the tarsi and of various parts of the head and thorax. Greater refinements of these same characters serve to define the genera and to some extent the various species. Species may be separated in many cases by differences in color and size, these characters being not available for use in the case of the larger groups because the color and size in a genus, for instance, may vary as greatly as it does in the entire family. No attempt is made here to separate the insects into their natural groupings lower than families

and in many cases the orders will not even be divided into the families.

The number of orders of insects recognized by the various authorities ranges from seven, in the earlier classifications, to over twenty, in the latest works. We recognize here twenty, that number being chosen because it seems to suit the needs of the present occasion better than the greater number of the most modern authorities, even though the latter schemes are doubtless much more nearly scientifically correct. The names employed are those in most general use. The table appended will enable the student to identify to the order any of the common insects.

Of the twenty orders here mentioned, six may be considered as major orders, the others being less important because of fewer species and less economic importance. The major groups are the *Orthoptera*, the *Hemiptera*, the *Lepidoptera*, the *Coleoptera*, the *Diptera* and the *Hymenoptera*. Any attempt to rank these according to their degree of importance would be futile, although the *Coleoptera* includes the greatest number of species.

The complete list of orders is as follows:

<i>Thysanura</i>	<i>Orthoptera</i>
<i>Ephemerida</i>	<i>Hemiptera</i>
<i>Odonata</i>	<i>Neuroptera</i>
<i>Plecoptera</i>	<i>Mecoptera</i>
<i>Isoptera</i>	<i>Trichoptera</i>
<i>Corrodentia</i>	<i>Siphonaptera</i>
<i>Mallophaga</i>	<i>Lepidoptera</i>
<i>Euplexoptera</i>	<i>Coleoptera</i>
<i>Siphunculata</i>	<i>Diptera</i>
<i>Physopoda</i>	<i>Hymenoptera</i>

TABLE FOR SEPARATING THE ORDERS OF INSECTS

- A. Wingless Insects.
 - B. With biting mouth-parts.
 - C. Mouth-parts poorly developed. *Thysanura*.
 - CC. Mouth-parts well developed.
 - D. Parasitic on warm-blooded animals. **Bird lice.**
Mallophaga.
 - DD. Not parasitic.
 - E. Ant-like in general appearance.
 - F. White, soft bodied, colonial. **Termites.**
Isoptera.
 - FF. Darker in color, bodies firm, in colonies or solitary. Ants and some wasps—*Hymenoptera*.
 - EE. Not ant-like in form.
 - F. Very small, light in color, frequenting old books and dry vegetable matter. **Book lice.**
Corrodentia.
 - FF. Larger species not occurring as above.
 - G. Head prolonged into a beak. **Boreus.**
Mecoptera.
 - GG. Head not prolonged into beak.
 - H. Hind legs fitted for jumping. Wingless grasshoppers, etc. *Orthoptera*.
 - HH. Hind legs not fitted for jumping.
 - I. Bodies and legs very long and slender.
Walking sticks. *Orthoptera*.
 - II. Bodies not elongated.
 - J. Bodies flattened. Lobes at tip of abdomen. **Roaches.** *Orthoptera*.
 - JJ. Bodies variable but without lobes at tip of abdomen. *Coleoptera*.
- BB. With sucking mouth-parts.
 - C. Bodies covered with scale-like hairs. Wingless moths.
Lepidoptera.
- CC. Bodies not covered with hairs.

- D. Parasitic upon man or warm-blooded animals.
 - E. Hind legs fitted for jumping. **Fleas.** *Siphonaptera*.
 - EE. Hind legs not fitted for jumping.
 - F. Beak, fleshy, unjointed. **True lice.** *Siphunculata*.
 - FF. Beak jointed.
 - G. Tick-like forms, parasitic. **Sheep tick,** etc. *Diptera*.
 - GG. Not tick-like. Bedbugs. *Hemiptera*.
 - DD. Not parasitic; generally found on living plants. Plant lice, scale insects, etc. *Hemiptera* (*Homoptera*).
- AA. Winged insects.
 - B. With two wings.
 - C. With sucking mouth-parts. *Diptera*.
 - CC. Mouth-parts not for sucking.
 - D. Rudimentary mouth-parts.
 - E. Size almost microscopic, halteres present. Males of *Coccidæ*. *Hemiptera*.
 - EE. Size larger, no halteres. *Ephemerida*.
 - DD. Biting mouth-parts.
 - E. Wings hard and horny. *Coleoptera*.
 - EE. Wings flexible, many veins. *Orthoptera*.
 - BB. With four wings.
 - C. Mouth-parts for sucking.
 - D. Wings covered with scale-like hairs. *Lepidoptera*.
 - DD. Wings not covered with scale-like hairs. *Hemiptera*.
 - CC. Mouth-parts not for sucking.
 - D. Wings equal.
 - E. Bodies very long and slender. Wings narrow.
 - F. Antennæ inconspicuous. **Dragon-flies,** etc. *Odonata*.
 - FF. Antennæ prominent. **Ant-lions,** etc. *Neuroptera*.
 - EE. Bodies shorter.
 - F. Wings with few veins.

- G. Wings fringed with long hairs. Size usually less than one-eighth inch in length. Mouth-parts indeterminate in type. **Thrips.** *Physopoda.*
- GG. Wings without fringes. Very easily broken off or shed by the insect. **Termites.** *Isoptera.*
- FF. Wing veins more numerous.
 - G. Finely netted wings. *Neuroptera.*
 - GG. Wings with fewer cross veins. Head prolonged into a beak. **Scorpion-flies,** etc. *Mecoptera.*
- DD. Wings unequal in size.
 - F. Wings entirely membranous.
 - G. Front wings longer than the hind wings.
 - H. Wings finely netted. Abdomen with long tail-like filaments. *Ephemerida.*
 - HH. Wings with fewer cross veins.
 - I. Hind tarsi with two or three segments. **Psocids.** *Corrodentia.*
 - II. Hind tarsi with four or five segments. *Hymenoptera.*
- GG. Hind wings broader than front wings.
 - H. Wing veins with hair-like scales. *Trichoptera.*
 - HH. Wings without scales along veins. Hind wings folded. *Plecoptera.*
- FF. Front wings leathery or hardened.
 - G. Front wings leathery but flexible and usually partially transparent. *Orthoptera.*
 - GG. Front wings hardened, seldom flexible. *Coleoptera.*

CHAPTER IV

THE DEVELOPMENT OF INSECTS

23. Metamorphosis. The changes which an insect undergoes during its progress from the newly hatched form to the adult vary in degrees of complexity and are commonly grouped into two types. The more simple type is spoken of as *incomplete metamorphosis* or *direct development*. The word *metamorphosis* signifies change in form. Therefore, the correct inference is that the change in form in this type of development is not complete.

The second and more complex type of development is that known as *complete metamorphosis* or *indirect development*. In this case there is a complete change in form and appearance between the earlier stages and the adult.

24. Direct Development. A description of the development of the grasshopper is commonly given to illustrate the direct type. Here, as in practically all insects, the first stage is the egg. From the egg hatches a form which may easily be recognized as a young grasshopper, even though the proportions are distorted and there are no wings. The form just hatched is known in this case as a *nymph*, and the same term is applied to all the succeeding stages of the insect before it reaches the final or adult stage and becomes what is called an *imago*.

Each succeeding nymphal stage resembles the adult form more than did the one preceding it. In one of the earlier stages the wings make their appearance in the form of small pads on the thorax. These become

more and more prominent in each succeeding stage, but are never used until the adult stage. The possession of power of flight is a certain proof that any insect is an adult.

The different nymphal stages are separated or limited by moults which occur at more or less definite intervals.

These moults consist of the casting of the skins. The skin of a newly hatched or freshly moulted insect possesses a certain amount of elasticity, but does not grow. When the growth of the insect has about taken up all the stretching power of the skin, a new skin forms beneath the old one, the old one bursts and the insect makes

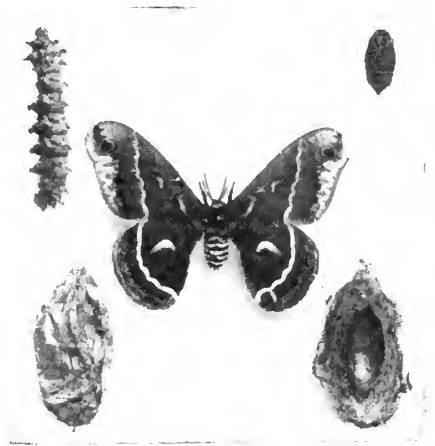

FIG. 13.—Metamorphosis of a Moth (*Samia cecropia*), showing Larva, Pupa, Cocoon and Adult. Much reduced.

its way out. The cast skin is called the *exuvia*. The more striking changes in the appearance which occur during the course of development come with these moults. The final moult liberates the adult form which does not moult and does not grow. Many of the adults do not even feed

25. Indirect Development. Where the development is indirect there is a great difference in the process. The form which is hatched from the egg bears, in most cases, not the slightest resemblance to the parent form. There would be no reason to suspect that the two belonged even

to the same class of animals and the young must, in each case, be connected with their parents by observations of their life histories.

The familiar form illustrating the indirect development is the common house-fly or any butterfly. Here the newly hatched young is worm-like and in one case entirely footless and more or less helpless. These young are called *larvæ*. The larvæ grow and moult from time to time as do nymphs, but they show little change in form. Their colors may change and there is often some change in the covering of the body.

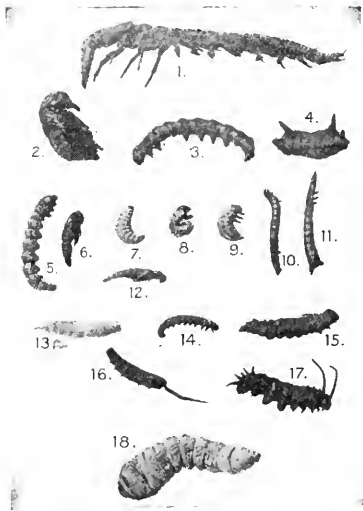

FIG. 14.—Early Stages of Insects.
Reduced.

1, Helgrammite or Dobson-fly larva (*Neuroptera*); 2, Pupa of the Spotted Pelidnota (*Scarabæidæ*); 3, Cutworm (*Noctuidæ*); 4, Slug-caterpillar (*Eucleidæ*); 5, Corn ear-worm (*Noctuidæ*); 6, Pupa of round-headed wood-borer (*Cerambycidæ*); 7, Chestnut worm (*Curculionidæ*); 8, Larva of Rose-chaffer (*Scarabæidæ*); 9, Larva of Colorado potato-beetle (*Chrysomelidæ*); 10, 11, Larvæ of Click-beetles (*Elateridæ*); 12, Pupa of Click-beetle; 13, Larva of Flesh-fly (*Muscina*); 14, Imported Currant Saw-fly larva (*Tenthredinidæ*); 15, Red-humped Apple-caterpillar (*Notodontidæ*); 16, Maggot of Drone-fly (*Syrphidæ*); 17, Larva of *Papilio philenor* (*Papilionidæ*); 18, Giant Root-borer (*Cerambycidæ*).

ened, smooth, and of a more or less oval, shape.

Within the pupa-case all the changes between the larval form and the adult form are accomplished.

The casting of the pupal skin and the emergence of the adult constitutes the final moult in the cycle where the development is indirect. The *life cycle* is completed with the laying of eggs by these adults.

26. The Purpose of Metamorphosis.

The purpose of metamorphosis, especially the complete type, is explained as are other specializations. It seems to be to the advantage of the insects to have the different vital functions

performed at different periods of the life of the insects instead of all at the same time. The larval stage is devoted to feeding and growth and the storage of



FIG. 16.—Larva of Imperial Moth

food material for the adult stage. The pupal stage is solely for change in form and structure to adapt the insect for the functions of the adult which are reproduction and spread.

There are intermediate forms of metamorphosis. In these the nymph may not resemble the adult even to such a degree that it may be recognized. However,



FIG. 15.—Typical Pupa of a Sphinx Moth.

when there is no sharply defined resting stage, as the pupal stage, the development is still said to be direct.

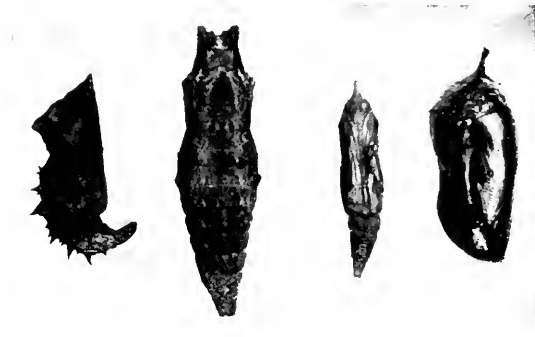

FIG. 17.—Chrysalids of Butterflies.
1, 2, *Papilionidæ*; 3, *Pieridæ*; 4, *Nymphalidæ*.)

In almost all cases where the development is direct the young forms have compound eyes, but larvæ, properly



FIG. 18.—Larvæ of the House-fly. Enlarged.

speaking, never have more than ocelli and are often entirely blind. This will ordinarily serve as a distinctive point in cases of doubt.

Larvæ are of the most varied forms. Butterfly or moth larvæ are called *caterpillars* and have false legs on



FIG. 19.—Pupæ of the House-fly. Slightly enlarged.

the abdomen. Fly larvæ, larvæ of snout-beetles and most Hymenopterous larvæ are footless. Ordinary beetle larvæ have usually the three pairs of true legs.



FIG. 20.—Larvæ of the Mourning-cloak Butterfly.

Many larvæ will not be identified, even to the order, by the beginning student, but close observation will soon enable one to recognize the more common forms.

CHAPTER V

THE LOWER ORDERS

UNDER the general heading of the lower orders may be considered all the less important forms which do not have apparently close relationships. They are widely different in structure and habits and are so grouped for the sake of convenience only.

27. Thysanura. Thysanura are the most primitive of insects. They have no wings and their mouth-parts are of very rudimentary nature, adapted only for chewing soft substances or for feeding superficially on dried matter. They have no compound eyes. On the tip of the abdomen are appendages of some sort, either filaments or modifications of the same which enable the insects to leap considerable distances. Those with the filaments are known as *Bristle-tails*, while the others are called *Spring-tails*. They may have, also, rudimentary appendages on nearly all the segments of the abdomen. The most common of the bristle-tails is called the *Fish-moth* or silver-fish. (Fig. 21, 1.) It is found in houses, in the pantries or bathrooms or in rooms where the wall paper is loose. It feeds on starchy material such as the dried paste beneath the paper and on some foods, and may be listed as a minor household pest. This insect is of a silvery color and is covered with minute scales.

Several spring-tails are common, but, on account of their small size, are not noticed. One of these may be found, especially in the early spring, beneath the loose

bark scales of old apple trees where there is plenty of moisture. Others may be found during the summer on decaying wood.

Still others are classed as injurious and attack certain of our garden crops. Their injury is rarely serious. One form, called the *Snow-flea*, is found in the early spring on the surface of patches of snow.

28. Corrodentia. Certain small insects called *Book lice* and *Psocids* form this order, which is of slight importance. The book-lice are minute and may be found on books, mainly in dark places and

where the books are not frequently used. The Psocids (Fig. 21, 4) are winged and live on plants. They resemble large plant-lice more than any other common insects, but have biting mouth-parts, while the plant lice suck sap.

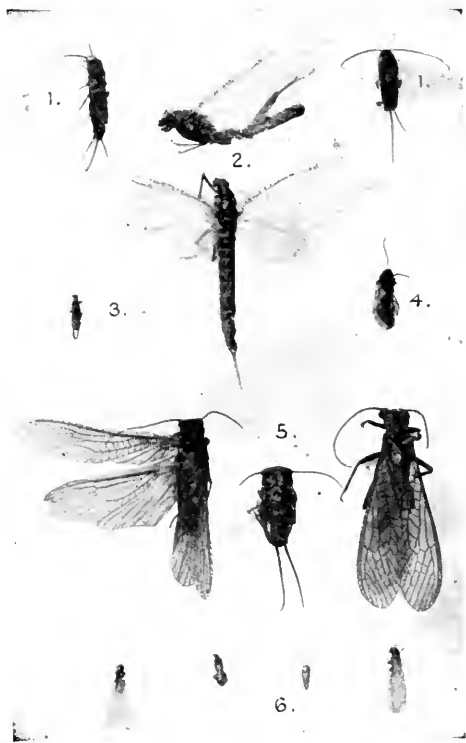

FIG. 21. Slightly reduced.

1, Fish-moths (*Thysanura*); 2, Mayflies (*Ephemeroptera*); 3, Earwig (*Euplexoptera*); 4, Psocid (*Corrodentia*); 5, Stone-flies with nymph (*Plecoptera*); 6, Termites or white-ants (*Isoptera*).

29. **Isoptera.** *The Termites* or *White ants* (Fig. 21, 6) form this order. They live in the central and southern parts of the United States but are more at home in the



FIG. 22.—Work of Termites in Root of Cherry Seedling.

tropics, where there are many species. Only one or two species are found in this country. They are not ants, nor are they structurally related to them, but get their common name from a certain superficial resemblance in form and from their habits. Colonies may be found in dead and decaying trees and in stumps, fence posts and logs. They attack growing plants at times and are often injurious, especially to appleseedlings. Termites frequently eat into the foundations and at times go on up into the superstructures of houses where they mine and do great damage. They are wingless during the greater part of the year and are of a dead white color, except their jaws and a part of their heads.

There are different classes of individuals, males and females, workers and soldiers, in the colony.

The true males and females, or kings and queens, appear in the spring. They are dark colored and fly from the nest in great swarms, mating and forming new colonies. They have at first, four long, narrow and delicate wings, poorly attached to the bodies. After the flight the wings fall off or are

gnawed off. The function of these individuals is reproduction only.

The workers are of both sexes but are not fully developed sexually. They do all the work pertaining to the colony and are blind and avoid the light. They are wingless. Soldiers are like the workers but have extraordinarily large heads. Their function is said to be the defense of the colony, but there is considerable doubt as to their efficiency.

30. Mallophaga.* The members of this order are called *Bird-lice* or *Biting-lice*, but are found as often on various species of mammals as on birds. They are wingless, have biting mouth-parts and rather slender, flattened bodies. They feed on feathers, hair and scales of the epidermis. They injure their hosts rather by irritating them than in any other way. Different kinds may be found on poultry and on most of the domestic animals, as well as on many kinds of wild birds and mammals.

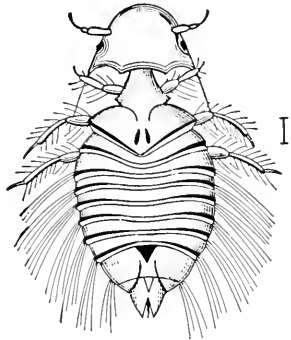

FIG. 23.—A Bird-louse (*Mallophaga*). Highly magnified.

31. Siphunculata.† This group is composed of the *True lice* or the *Sucking-lice*. They resemble the bird lice superficially but are usually broader and more flattened and have short fleshy beaks by means of which they suck blood from their hosts, which are mammals. Three species attack man and some others are known to attack marine mammals, thus invading a field in which insects

* See Fig. 142, page 200, Part II.

† See Figs. 140 and 141, pages 198, 199, Part II.

are rare, the ocean. This order is usually classed as a sub-order of the Hemiptera under the name Parasitica, but it seems more logical to place it separately, as it has little in common with the other Hemiptera.

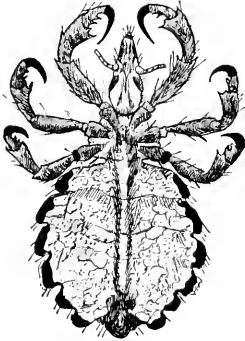

FIG. 24.— True Louse
(*Siphunculata*).

folded in a very complex fashion under the front pair where they are completely concealed. The common name is derived from an old English superstition that they got into people's ears and injured them.

33. Siphonaptera. The *Fleas* are probably more nearly allied to the true flies than to any other group of insects. They are wingless, compressed laterally so that they stand "on edge," so to speak, and have strongly developed hind legs which enable them to leap great distances. They feed through a sucking tube and are parasitic, most species attacking mammals, although

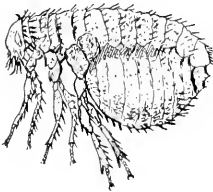

FIG. 25.— A Flea (*Siphonaptera*).

there is one species that attacks hens. Unlike all the other orders in this group, the fleas develop indirectly. Their larvæ are footless and worm-like and are not well

known. Those of the common species that attack man and domestic animals are known to feed on minute particles of organic matter in the dust in the cracks in floors and in other similar situations, even in the dust on the ground, where it is protected from moisture. Fleas have recently been proven to be active agents in the spread of diseases, notably the Bubonic plague, which is carried by the rat-flea.

34. Physo-poda. *Thrips*. Many writers give the name *Thysanoptera* to this order, but we prefer the name used

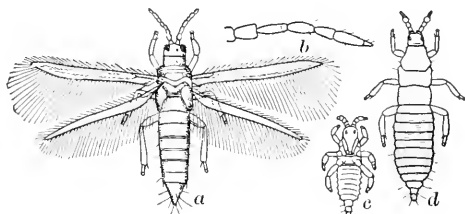

FIG. 26.—Tobacco Thrips, Adult and Nymphs (*Physo-poda*). After Howard, U. S. Dept. Agr. Highly magnified.

here because of the confusion that may result from the use of a name so much like *Thysanura*.

The *Thrips* are very small insects with narrow wings fringed with long hairs. The mouth-parts are not strongly developed, but are fitted for chewing the softer plant tissues, and, to a certain extent, for sucking the sap from them. The development is direct. These insects are usually not numerous and even when abundant are not often observed on account of their very small size, most forms

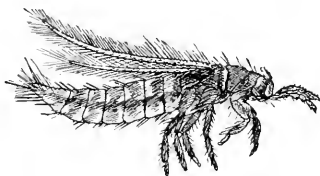

FIG. 27.—Rose Thrips (*Physo-poda*). Greatly enlarged.

being less than an eighth of an inch in length and quite slender. There are several injurious species. Most of these are found in the tropical or sub-tropical countries. Citrus fruits, in Florida and California, often suffer from their work. We have also one species that attacks pears, others in greenhouses, on carnations, one on onions and one attacking roses, spoiling the appearance of the blossom.

CHAPTER VI

NEUROPTEROID ORDERS

OLDER writers on entomology placed several groups of insects which we now class as separate orders together in the old order *Neuroptera*. About the only character common to all the members of the group was the possession of membranous wings with many veins. Even this character was by no means absolute. Later writers divided the group into *Neuroptera*, proper, and *Pseudo-Neuroptera*,* the former including those groups which developed indirectly and the latter those with direct development. Both divisions normally have biting mouth-parts, although in each group some are found with mouth-parts obsolete or rudimentary.

35. Pseudo-Neuroptera. Three orders of insects having membranous wings, direct development, biting mouth-parts and aquatic nymphs are included here.

Plecoptera. Insects with four wings, the front pair rather narrow, the hind pair broader and folded lengthwise, hidden, while at rest, beneath the front pair. The mouth-parts usually well developed but sometimes nearly obsolete and the nymphs living under stones in running water which habit gives the adults the common name of *Stone-flies*. Adults may be found in spring and early summer about the streams in the evening and are fre-

*Some groups at times placed with the Pseudo-Neuroptera we prefer to consider elsewhere. These are the Termites and the Booklice and their relatives.

quently attracted to lights in considerable numbers. Nymphs may be secured by lifting flat stones from running streams and examining the under sides of these where they will be found clinging closely. Common stoneflies belong to the family *Perlidae*.

Ephemera. The *May-flies* are delicate insects with four wings which have finely netted veins. The front wings are large and the angles are considerably produced. The hind wings are small and sometimes disappear entirely. In the adults the mouth-parts are rudimentary. At the tip of the abdomen are two or three thread-like tails as long as, or longer than, the entire body. The nymphs are soft bodied and live on the bottoms of streams, usually where the current is sluggish. The adults live only a short time. They may be found along streams clinging back downward to leaves and twigs and are attracted in immense numbers to electric lights. Floors of bridges are *often* covered to a depth of an inch or more with these insects on warm nights in early summer. They are called also *Shad-flies* and *Day-flies*. The family name is Ephemeridæ and both it and the order name are suggested by the short life of the insect.

Odonata. *Dragon-flies* and *Damsel-flies*. The members of this order are better known than the other Pseudo-Neuroptera as they fly by day and are numerous wherever there is water. They have long narrow wings, finely netted veined, and slender bodies. The nymphs live in the water on the bottoms of ponds and in sluggish streams. The Dragon-flies (*Anisoptera*), are the larger members of the order. Their wings are nearly the same width from base to tip and they have very powerful flight. They are variously called *Mosquito-hawks*, *Snake-doctors*, *Snake-feeders*, *Mule-killers* and *Devil's darning-needles*.

Dragon-fly nymphs are rather stout-bodied and live near the bottoms of ponds or streams, and are, at times,

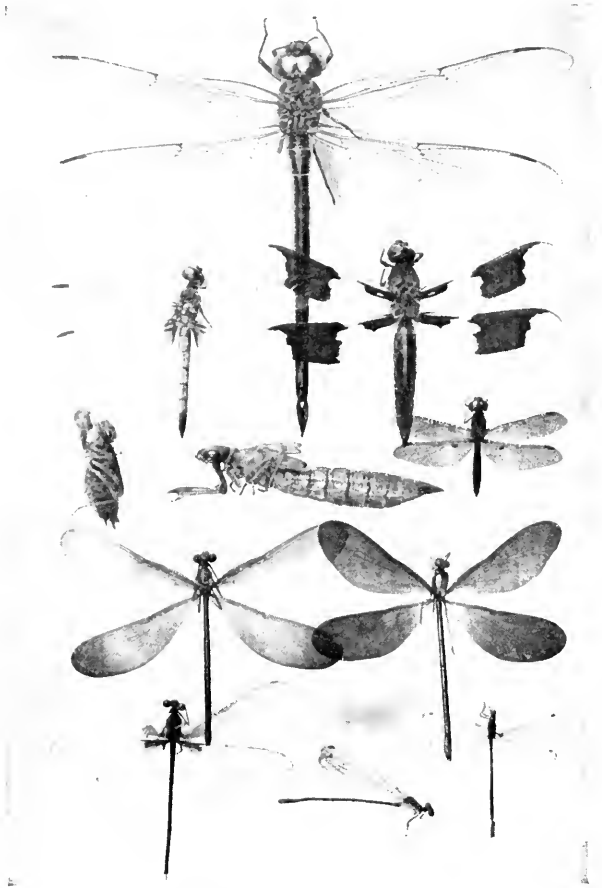

FIG. 28.—Types of *Odonata*. Above, Dragon-flies with nymphs; below, Damsel-flies. Reduced one-third.

found buried in the mud. They swim by forcing water from the anal tube, in the walls of which are located the

trachea by means of which they breathe. They feed on other small animals in the water. These nymphs have very curiously constructed mouths. The lower lip is prolonged and hollowed out so that the rest of the mouth-parts and the lower part of the head fit into it. Food is captured in this "soup-bowl" and carried to the jaws. (See Fig. 28.)

Damsel-flies (*Zygoptera*), are smaller than the dragon-flies and have the abdomen much more slender. They have the wings suddenly narrowed at about one-fourth of the distance from the base to the tip so that they seem to be stalked. When at rest they hold their wings in a vertical position, slanting backward over the back while the dragon-flies hold theirs spread out horizontally.

Damsel-fly nymphs are also more slender than the dragon-fly nymphs. They have three long and narrow, oval, leaf-like tracheal gills.

Nymphs of both the above groups are easy to obtain and make excellent aquarium material.

36. Neuroptera Proper. Three orders may be included in this group. All have membranous wings, some with netted veined wings, others with the veins mostly longitudinal. The mouth-parts are typically biting. The development is indirect and the larvæ have various forms and food habits, some being aquatic and some terrestrial.

The order **Neuroptera** in the strict sense includes the largest and most numerous members of the group. They have finely netted wings usually long and rather narrow. The largest form is the *Corydalis* or Dobson-fly. This insect has a wing expanse of five inches or more. The females have strong jaws but in the males these are greatly prolonged and shaped like a very slender cow-horn. They are not dangerous and their pinch is scarcely painful. Larvæ of the *Corydalis* live under stones in

swiftly running water and are known as "helgrammites." Fishermen prize them for bass bait. As it takes them three years to mature they may be found at all seasons of the year, either in the water or under stones near the water's edge. The adults are attracted to the lights during June and July.

Several other species of this family (*Sialidæ*), are aquatic, but most of the remaining Neuroptera are found on land in all their stages.

The *Ant-lion* (*Myrmeleonidæ*), or more popularly the "Doodle-bug," makes small funnel-shaped pits in sand or dry, powdery, decaying wood. Small insects fall into these pits, aided by slides on the steep sides, and are captured and eaten. The ant-lion has strong curved jaws through which it sucks the blood from its victims. Its body is stout

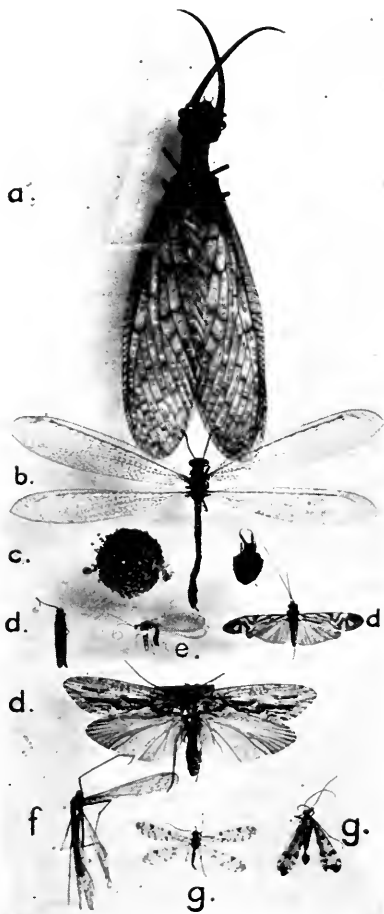

FIG. 29.—Neuropterous Insects.

Reduced.

a, Dobson-fly, *Corydalid cornuta* (*Neuroptera*); b, Ant-lion, adult; c, Ant-lion, cocoon and larva (*Neuroptera*); d, d, Caddice-flies (*Trichoptera*); e, Aphis-lion or lace-wing fly (*Neuroptera*); f, *Bittacus* sp., and g, Scorpion-flies, *Panorpa* sp. (*Mecoptera*).

and oval, being mostly abdomen. It digs its pits by getting the sand on its head and flipping it sharply backward, turning slightly after each "flip." The adults resemble the damsel-flies, but have larger antennæ and fold their wings roof-like. The wings are not so distinctly stalked.

Aphis-lions or lace-wing flies (*Chrysopidæ*) have very thin, lacy wings and are usually green in color. They may be found flying in shrubbery throughout the summer. The eggs are laid on long slender stalks fastened to leaves or branches so that the hungry young first hatching may not destroy those as yet unhatched. The larvæ resemble the ant-lions but are more slender and have usually some yellow or red markings. They may be found in colonies of plant-lice on which they feed, thus earning the name of aphis-lions. The adults are also called "golden-eyes," from the brilliant golden color of the eyes.

Mecoptera are given the name of *Scorpion-flies*. They have narrow wings with few cross veins. The head is somewhat prolonged, forming a beak on which the mouth is situated. The abdomen is slender and in the males of some species is so formed at the tip as to resemble the sting of the scorpion. The larvæ are not often encountered and are caterpillar-like, having at least eight pairs of pro-legs on the abdomen. Two groups in this order are common, one the true scorpion-fly, another (*Bittacus*), which has no distinctive common name but which superficially resembles the crane flies.

Trichoptera, or *Caddice-flies* are usually small, moth-like insects with long antennæ and wings sparsely clothed with hairs, which adds to their moth-like appearance. The wings have few cross veins. The mouth-parts are rudimentary in the adults.

The larvæ are aquatic and are called *Caddice-worms*. They live in running water and form cocoons of various materials, twigs, sand, pebbles and silk, which they spin as do caterpillars. These are often attached to the under sides of stones. The larvæ are caterpillar-like, but may be recognized by their habitat and by the absence of the pro-legs.

CHAPTER VII

ORTHOPTERA

NEARLY all the groups of insects classed as Orthoptera are well known. This is probably more true of this order than of any other. Included here are the *Grasshoppers* or *Locusts*, the *Katydid*s, the *Crickets* and the *Roaches*. Less common are the *Walking-sticks* and *Praying mantids* or *Rear-horses*.

37. General Characteristics. Some species and individuals of other species are wingless, but there are typically four wings. Of these, the front pair is narrow and leathery and the hind pair broad, folded fan-like and concealed and protected by the front pair when at rest. The mouth-parts are well developed and formed for chewing, grasshoppers having been accused, with some truth, of attacking pitch-fork handles and the edges of scythes.* Orthoptera develop directly and as a rule the young resemble the adults in form and habits.

38. Acrididæ. The grasshoppers, or true locusts, include the worst insect pests the world has known. Records of them appear in the earliest history and their ravages are recorded from all parts of the world. No insects have ever produced such wide-spread desolation and misery as the various migratory forms of these insects. Just here it may be noted that the terms *grasshopper* and *locust*

*The author can vouch for the fork handle but not for the scythe, although farmers have told him in good faith that grasshoppers dulled their scythes by gnawing the edges.

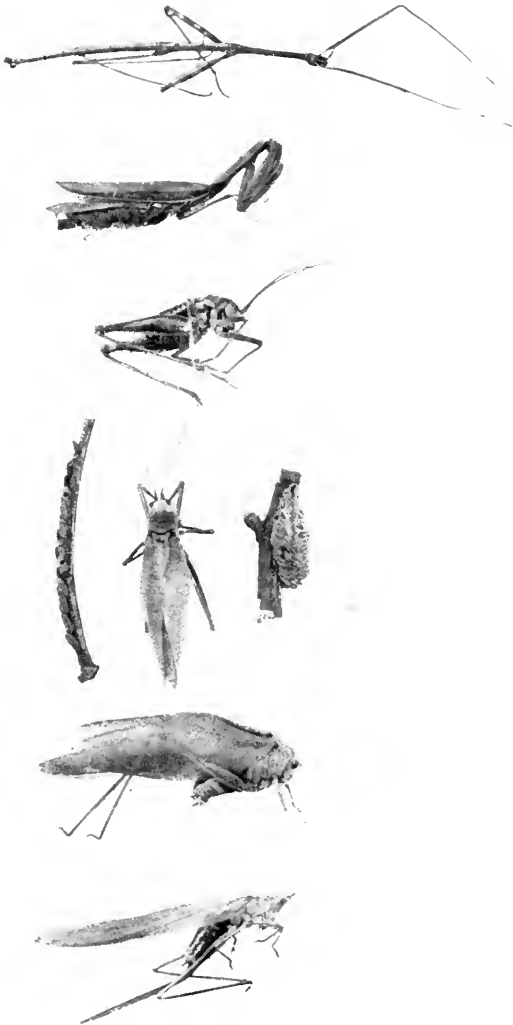

FIG. 30.—Types of *Orthoptera*. Reduced about one-half.

1. Walking-stick (*Phasmida*); 2. Praying-mantis (*Mantida*); 3. Cave cricket (*Locustida*); 4, right, egg mass of Praying-mantis; left, eggs of Katydid on twig; center and 5, Katydids (*Locustida*); 6, Long-horned grasshopper (*Locustida*).

are synonymous, in spite of the fact that in the United States the term locust has been applied to an entirely different insect, the *Cicada*. This misapplication of the term results in confusion, because in the literature of the

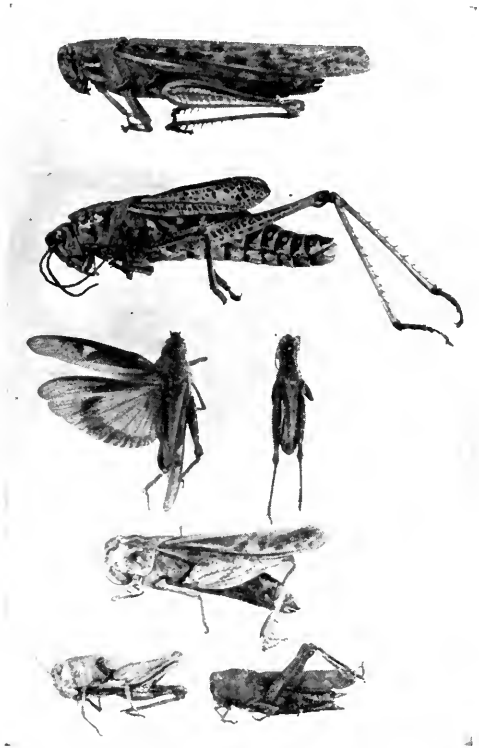

FIG. 31.—Types of *Orthoptera*. Grasshoppers (*Acrididæ*).

world the term locust signifies grasshopper. Grasshoppers scarcely need characterization. The fact that they have antennæ shorter than the body will suffice to separate them from the family *Locustidæ*.

Locusts are mentioned in the the book of Exodus as the eighth plague of Egypt and at various other places in the Bible and in secular literature. The forms that attract the most notice are the migratory ones. One migratory species in the United States has done enormous damage in times past and is still occasionally injurious, and other species have the migratory habit to a degree. The chief one is the *Rocky Mountain Locust*. In its flights it spread from the Rocky Mountain region eastward almost entirely covering the plains regions to the Mississippi. It also invaded the agricultural sections of Idaho, Utah and Nevada. Non-migratory species are injurious every year, but their damage is not so universal as was that of the migratory kind. They are successfully combated by the use of poisoned bran-mash where they occur in great numbers. Grasshopper eggs are laid in masses in the soil and the winter is usually passed by this stage. Some hatch in the fall and pass the winter as young nymphs which may be seen hopping about on warm days in winter and in early spring. Common species are the *American Acridium*, the *Carolina locust*, and the *Differential locust* or *Alfalfa grasshopper*.*



FIG. 32.—A
“Grouse-locust”
(*Acrididae*).

39. Locustidæ. This family is rather unfortunately named, as it includes the katydids and long-horned grasshoppers, *not* the locusts. Its members are grasshopper-like in form but are in general more delicate and have antennæ longer than the body. Some kinds are wingless, but ordinarily the wings are longer than is usually the

* See page 241, Part II, for detailed descriptions of injurious species.

case with the grasshoppers. The best-known species are the common *Katydid*s, which have wings broad at the base, giving them a hump-backed appearance, and are green in color. They live mostly in trees, where they eat foliage. Eggs of katydids are also placed on twigs. They are a blue-gray in color and are a flat oval, about one-eighth inch long. They are laid in a row on a twig and overlap slightly. There are usually about a dozen in a row. These eggs are sometimes mistaken for scale insects although there is no real similarity. Some of the meadow-grasshoppers resemble katydids, but are not hump-backed. Others are brownish in color and still others have very peculiar pointed heads. Most of these live on grasses and weeds. Some cricket-like forms, living in cellars and caves, called *Cave Crickets*, are yellowish-brown in color and wingless, and belong to this family.

40. Gryllidæ. *Crickets* are of various forms, but differ from the Orthoptera so far considered in that they are flattened on top and hold their wings flat on the body rather than roof-like. They are usually stout bodied, but not necessarily so. Many are wingless.

The common *Black Crickets* found in houses, in fields, under stones and rotting logs, are well known to all. The *Tree Crickets*, slender, light in color, rather small in size, and with long wings, are not so well known. Neither are the *Mole Crickets*, curious forms with front feet resembling those of a mole, which burrow in the ground after the fashion of their namesake. Fig. 31 illustrates these forms well enough to identify them.

41. Blattidæ. (See Page 214, Part II.) Roaches are the scourge of many households and it is as household pests that they are best known, although many are found in the woods, in decaying logs, and under stones, where they

are harmless. Roaches in a house do little real destruction, but spoil food by running over it and eating parts of it. They often seriously injure book-bindings by gnawing them. They hide in cracks and crevices and in holes made for plumbing. In old houses it is next to impossible to be entirely rid of them. Many roach destroyers, usually in the form of powders, are sold and some are said to be efficient. Old houses, even if entirely freed from roaches, will always be likely to be soon reinfested from neighboring houses.

There are several species of roaches but all that live in houses are similar in habits and appearance. Both winged and wingless forms may always be found.

42. Phasmidæ and Mantidæ. Two very peculiarly formed groups of insects are the *Phasmids* or "Walking-sticks" and the *Mantids* or "Rear-horses." The former are elongated, have very long and slender legs and antennæ and are wingless.* They are usually green or brown in color and



FIG. 33.—Types of *Orthoptera*

1, 2, 3, and 4, Roaches (*Blattidæ*);
5 and 6, Tree-crickets; 7, Mole-cricket;
8, 9, Ground-crickets (all *Gryllidæ*).

* Many tropical species have wings.

when at rest on a twig or grass stem look so much like the plant that they are very difficult to detect. They are plant eaters, but rarely do much damage.

The *Mantis*, or *Praying Mantis* has a long slender thorax, an abdomen which becomes, when full of food, or eggs, very much distended and broadly oval, but is at other times rather slender, and short wings. It captures and kills other insects. The front legs are fitted for grasping the victims and the thorax is carried nearly erect with the front feet in a "prayerful" attitude. This position gives rise to the common name. Eggs of this insect are placed in masses on twigs of trees and cemented together, the masses being over a half inch long and about one-quarter inch high. They are more frequently observed than the eggs of most other *Orthoptera* as they are more conspicuous.

TABLE FOR THE DETERMINATION OF THE FAMILIES OF
ORTHOPTERA

- A. Legs fitted for jumping.
 - B. Antennæ shorter than the body.
 - Grasshoppers.** *Acrididæ.*
 - BB. Antennæ longer than body.
 - C. Wings carried, when at rest, in a vertical or roof-shaped position. Ovipositors sword-shaped, curved upward or straight.
 - Katydids, etc.** *Locustidæ.*
 - CC. Wings in a position approximately horizontal, flat on the back. Ovipositors slender, spear-shaped.
 - Crickets.** *Gryllidæ.*
- AA. Legs not fitted for jumping.
 - B. Bodies flattened and oval.
 - Roaches.** *Blattidæ.*

BB. Bodies elongated.

C. Front legs fitted for grasping prey. Prothorax carried somewhat erect.

Praying Mantids. *Mantidæ.*

CC. Front legs not fitted for grasping. Body and legs very long and slender. Wingless.

Walking-sticks. *Phasmidæ.*

CHAPTER VIII

HEMIPTERA

THE order *Hemiptera* is made up of insects having sucking mouth-parts and direct development. They have, typically, four wings but many kinds are wingless and the males in one group have two wings only. The order is made up of two sub-orders that are so dissimilar in appearance, structure and habits, that they may be considered separately.

43. Heteroptera. The members of this sub-order are the *true* bugs and are the only insects to which the name *bug*, not in combination with some other word, is properly applied. Most bugs are winged. The front wings are thick and narrow at the base and are broader and thinner and overlap at the tips. They are usually carried rather flat on the back, though some forms have strongly arched backs. The beak is strong and arises from the front part of the head. The habits are varied. Some bugs are predaceous, some are plant-eaters and seriously injurious. Several families, which we shall consider together as the "Aquatic Bugs," live in or about the water.

Aquatic Bugs. Several families, which need not be considered in detail, are aquatic. The largest of our bugs are those known as the *Giant Water-bugs* or, sometimes, as the "electric-light bugs." These are about three inches long by one inch broad, flattened, brownish in color, with legs fitted for swimming. They are frequently attracted to the electric lights and may also be found swimming near

the bottoms of pools. There is a smaller species which is less abundant.

On the surface of the water of quiet pools and even

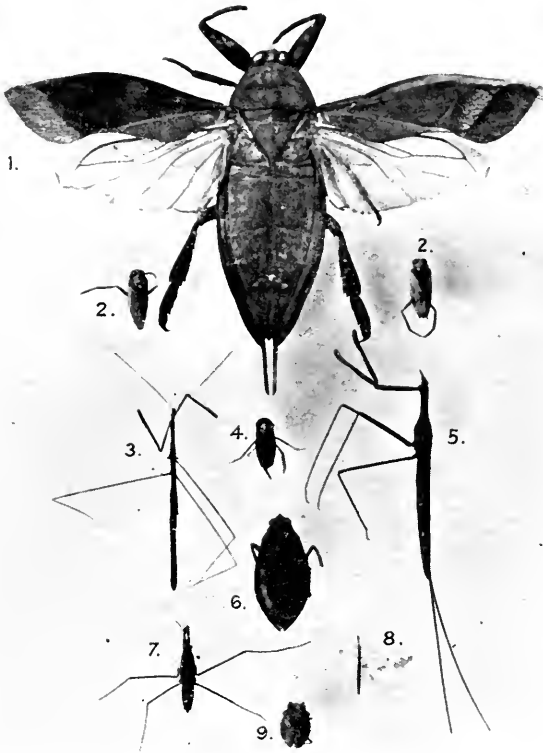

FIG. 34.—Types of True Bugs (*Heteroptera*). Slightly reduced.

1. Giant water-bug (*Belostomida*); 2, Back-swimmers (*Notonectida*); 3, Thread-legged bug (*Emesida*); 4, Water-boatman (*Corisida*); 5, Water-scorpion (*Nepida*); 6, *Belostomida*; 7, Water-strider (*Hydrobatida*); 8, Marsh-treader (*Limnobatida*); 9, Toad-shaped bug (*Galgulida*).

on running streams may frequently be seen numbers of spider-like creatures with slender bodies and long legs.

These are the *Water-striders* (*Hydrobatidæ*). They may be either winged or wingless. Among the local names for these bugs may be mentioned "Water-spiders," "Water-skippers" and "Skaters."

Two families of medium to small insects, generally found swimming below the surface of the water, are the *Water-boatmen* (*Corisidæ*), and the *Back-swimmers* (*Notonectidæ*). Both have oar-like legs and powerful beaks capable of inflicting painful stings. The boatmen are flattened while the back-swimmers have "V"-shaped backs and swim upside down, the angle of the back making a sort of keel. Both these families are generally distributed in ponds and are easily recognized. Still another water-bug is the *Water-scorpion* (*Nepidæ*). The more common species of this family has a very slender body, long legs and a long breathing tube projecting from the tip of the abdomen. When at rest, a water-scorpion hangs head downward in the water with the breathing tube just reaching the surface. The common form is more than three inches long, including the tail. Several other families of water bugs are less numerous and less conspicuous.

Land Bugs. The land bugs are of the most varied shapes and habits. The most numerous and widely distributed are the so-called *Leaf-bugs* (*Capsidæ*). Sweep through the grass with an insect net in midsummer and you will find in the net a large number of small insects. Many of these will easily be seen to be true bugs of which the great majority are leaf-bugs. They are generally small and usually green or brownish in color. Some are of economic importance, but no one form is especially injurious. The *Tarnished Plant-bug* is widely distributed and injures fruits of various sorts, especially pears.

Probably the best known of the bugs are the *Stink-*

bugs (*Pentatomidæ*). They may be recognized by their form and also by their peculiar and unpleasant odors. Many of us, unfortunately, know them also by their taste, as they frequently get on berries. In form they are rather short and broad with moderately arched backs. They are of medium to large size and in color usually vary from green to many shades of brown. In this family again, we have many forms that are somewhat injurious, but few that are notably so. The brightly colored *Harlequin Cabbage-bug* is often a serious pest in the South. It is recognized by its red, black and yellow colors. Many species in this family, known as *Soldier-bugs*, are predaceous and destroy injurious larvæ. Most common among these are the green soldier-bug and the spined soldier-bug.

The *Squash-bug* family (*Coreidæ*) takes its common name from the well-known garden pest, the squash-bug.

Members of this family are rather longer and narrower than the stink-bugs and are small to medium in size with

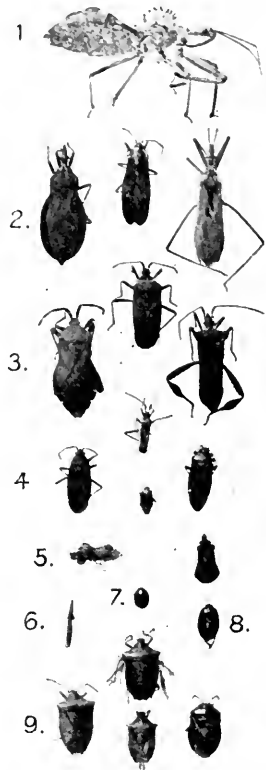

FIG. 35.—Types of True Bugs (*Heteroptera*). Slightly reduced.

1. The Wheel-bug (*Reduviidæ*);
- 2, *Reduviidæ*; 3, *Coreidæ*; 4, *Cap-sidæ*; 5, *Phymatidæ*; 6, Stilt-bug (*Berytidæ*); 7, Negro-bug (*Corime-lanidæ*); 8, Burrower bug (*Cydnidæ*); 9, Stink-bugs (*Pentatomidæ*).



FIG. 36.—Types of True Bugs (*Heteroptera*). Enlarged.

1. Lace-bug (*Tingitidae*); 2. Negro-bug (*Corimelaenidae*); 3. Bed-bug (*Acanthiidae*); 4. Flat-bug (*Araçidae*); 5. Chinch-bug (*Lygaeidae*); 6, 7. *Lygaeidae*; 8, 9. Leaf-bugs (*Capsidae*); 10. Stilt-bug (*Berytidae*).

a few large species included in the family. Many have the powerful odor found in the preceding group and are, on this account, often mistaken for them. The box-elder bug of the Middle West and the leaf-footed bugs of the South are members of this family.

The *Assassin-bugs* (*Reduviidae*) are, in general shape, much like the squash-bugs, but give the impression of being softer and more delicate. Their legs are longer and more slender and heads and beaks are also often more slender, although the beaks may be short and powerful. Assassin-bugs are, as their name implies, predaceous, and capture and eat large numbers of other insects. Some forms get in houses and even attack man. They may be considered, in general, as beneficial insects.

One of the most serious pests the grain grower of the Middle States has to fight is the *Chinch-bug*. (See page 238, Part II.) This insect is one of the smaller members of a family (*Lygaeidae*) which takes its common name from this species. Lygaeids are intermediate between the squash-bugs and the assassin bugs in form. They range from very small to medium in size and are usually of dark colors. They are generally plant eaters but, with the one exception, are not serious pests.

Still another well-known bug is the common *Bed-bug* (*Acanthiidae*). It is less

than one-quarter inch in length, very much flattened, wingless, and dark brown in color. It feeds, as is well known, on human blood. The individual unfortunate enough to encounter it will recognize it without trouble.

Two very peculiarly shaped bugs are the representatives of families known commonly as *Thread-legged bugs* (*Emesidæ*) and *Stilt-bugs* (*Berytidæ*). Both have very slender bodies and long, slender legs. The common stilt-bug has a body about three-eighths inch in length while the thread-legged bug is much larger. Its body is more than an inch long and its legs are much longer. The stilt-bugs may be found rather commonly in grass and on shrubs but the thread-legged bugs are rare and more frequently found in old barns and other open buildings.

44. Homoptera. The second sub-order of the *Hemiptera* is different in many ways from the true bugs. Here the wings are either membranous or thickened, but in either case are the same throughout. The beak is attached to the back margin of the under side of the head and often seems to arise from just between the forelegs. The backs are typically "V"-shaped or rounded and the wings do not overlap as in the bugs. There are some highly specialized forms in the group which will not be recognized by the characters given above, but rather by their own peculiarities.

Cicadas. The *Cicadidæ* or the *Cicadas*, sometimes called Harvest-flies or Jar-flies, are the largest of the *Homoptera*. To this family belongs the *Periodical Cicada*, better known as the seventeen-year locust. So much has been written regarding this insect that a description of its appearance or habits would seem superfluous. The species that appear every year are larger and take only two years to develop. As there are two broods, we have

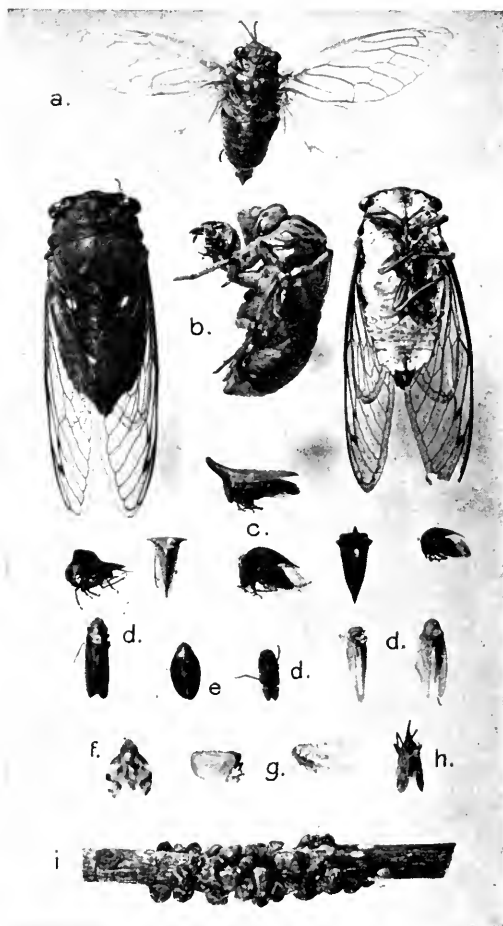

FIG. 37.—Types of *Homoptera*. Slightly reduced.

a, Periodical Cicada; *b*, Harvest-flies with nymph (*Cicadidæ*); *c*, Tree-hoppers, (*Membracidæ*); *d*, Leaf-hoppers (*Jassidæ*); *e*, *f*, Frog-hoppers (*Cercopidæ*); *g*, *h*, *Fulgoridæ*; *i*, Lecanium scale (*Coccidæ*),

some members of the species with us every summer. The males in this family possess, at the base of the abdomen, two drum-like organs with which they produce their characteristic song or "shrill." Cicadas are, as a rule, harmless, but the periodical cicada does great injury to fruit trees by splitting the twigs to deposit its eggs. Fortunately it does not come often enough to be a serious menace to the fruit industry.

Plant-hoppers. Several families of homopterous insects constitute a group generally spoken of collectively as the plant-hoppers. Broadly speaking, we may include in this group the *Spittle insects* (*Cercopidæ*), forms which, in young stages, live concealed in a frothy secretion which resembles spittle, and are found on several common weeds; the *Lantern-flies* (*Fulgoridæ*), among which are a few moth-like forms and, in the tropics, some others that are luminescent, but which *do not* include our fire-flies; and the more important and numerous *Leaf-hoppers* (*Jassidæ*), and *Tree-hoppers* (*Membracidæ*). All of these families have the power of leaping but they are otherwise sufficiently distinct for easy recognition. The *Jassidæ* are slender, small, and have pointed heads. The tree-hoppers are stouter bodied, larger and have heads nearly concealed beneath the prothorax when seen from above, and usually cut



FIG. 38.—Types of Homoptera. Slightly enlarged.

1, 6, Leaf-hoppers (*Jassidæ*); 2, 8, *Cercopidæ*; 3, 4, Tree-hoppers (*Membracidæ*); 5, 9, *Fulgoridæ*; 7, Plant-louse (*Aphididæ*).

off squarely or rounded, not pointed. They have also very strange growths on the prothorax which almost entirely covers the head and projects backward and covers the greater part of the wings and the abdomen. Its varied shapes are often ludicrous and laughable and give the insects the locally common name "Brownie-bugs." Both

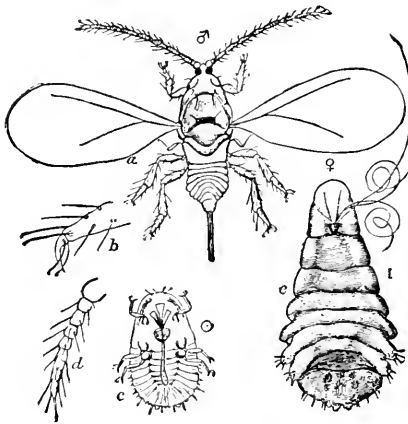

FIG. 39.—Different Stages of a Scale-insect. After Howard, U. S. Dept. Agr. Highly magnified.

a, Adult male; c, Young nymph; e, Adult female from beneath.

families of hoppers are plant eaters and attack many economic plants. Possibly the worst common forms are the leaf-hoppers on the grape and the apple and the tree-hopper, known as the "Buffalo tree-hopper." Many tree-hoppers are injurious from their egg-laying habits, damaging twigs in this way, but are harmless so far as their feeding is concerned. Leaf-

hoppers, on the other hand, feed like the plant lice and are even more difficult to control because they are much more active.

By far the most important of the *Homoptera* and, indeed, among the most important of all insects are the two families known as *Scale-insects* (*Coccidæ*), and plant-lice or *Aphids* (*Aphididæ*).

Scale Insects will not be at first recognized as insects or even as living animals by the amateur. They are ap-

parently, for the greater part of their lives, inanimate objects on the bark of trees. They are usually less than one-eighth of an inch in diameter, oval or circular in outline, and more or less flattened. The young and the adult males have eyes and appendages and move about. Other stages fasten themselves to the host-plant by means of their beaks and also by a waxy secretion. They are protected either by a separate scale which is formed over them from secretions of their bodies, but not attached to them, or by a hardening of the body wall itself. Scales in the latter group are known as unarmored scales while the others are called armored scales. Scale insects feed for the most part on shrubs and woody plants, but some are found on grasses



FIG. 40.—San Jose Scale on Apple Bark



FIG. 41.—The Tulip Scale.

and on ferns and other greenhouse plants. *Mealy bugs*, which are also Coccids, feed on herbaceous plants. Some

of the worst pests of the fruit-growing industry are to be found in this family. In the armored group we have the *San José Scale*, the *Oyster-shell Scale*, the *Rose Scale* and a host of others. (See page 287, Part II.) Among the unarmored forms are the *Cottony-cushion Scale*, the *Terrapin Scale* or *Peach Lecanium* and others. There is scarcely a woody plant that is not subject to the attacks of one or more species of scale insects. Fortunately, fairly effective means have been devised for the control of these insects.



FIG. 42.—Cottony Maple-scale on Leaves of Soft Maple.

Plant-lice are small in size, oval or egg-shaped, winged or wingless. They live in colonies and are often found in enormous numbers on plants. They often kill the leaves

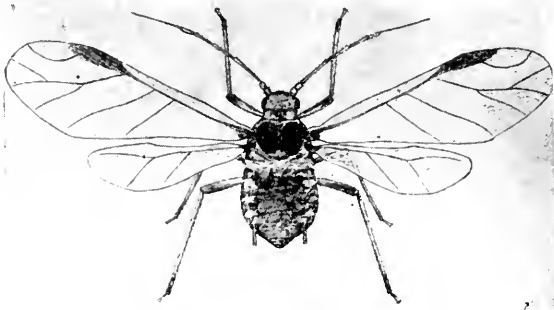

FIG. 43.—A Winged Plant-louse (*Aphididae*). Greatly enlarged.

and may do great damage. Some species live on the roots of plants for at least a part of their life-cycle. They

are remarkable for the numbers of the plants they attack, few groups of plants being entirely immune, and for their methods of reproduction and their fecundity. In this group is illustrated the phenomenon of *parthenogenesis* or reproduction by the females without the intervention of males. Accompanying this phenomenon is another, alternation of generations. In brief, a typical life cycle for an aphid is as follows: In the autumn or at some other time during the year, true males and females appear. These mate and the females produce true eggs, just as do insects of other groups. These eggs, when they hatch, usually in the spring, produce wingless females which in turn, without the intervention of males, give birth to living young. These, upon becoming grown, produce other living young, all females, and either winged or not. These forms are spoken of as the agamic females. During the summer the sexual individuals appear as noted above. The males are either winged or not, but the true females, which produce the winter eggs, never have wings. There may be more than a dozen generations in a year without any of the sexual individuals and in some species the sexual forms have never been found. The number of progeny which might, theoretically,



FIG. 44.—Woolly-aphis on Apple Seedling. (Photo by W. E. Rumsey.)

be descended from one of the winter eggs if all survived and reproduced, would, at the end of the season be beyond human comprehension. They are rivaled in fecundity only by some of the scales and by other insects, notably the May-flies.



FIG. 45.—Gall Formed by Plant Lice (*Pemphigus* sp.), on Leaf Stem of Cottonwood.

Aphids secrete from the abdomen through the intestine, a sweet sugary substance called honey-dew. This honey-dew is a favorite food of ants and any plant infested by aphids will be found to be frequented by ants which are at times accused of doing the damage which is actually caused by the plant-lice. The ants do sometimes injure us indirectly on account of their fondness for the honey-

dew. One species, for example, cares for the eggs of the corn-root aphid during the winter and in the spring places them on the roots of suitable food plants. Many remarkable and often fanciful tales are told of the care exercised by ants over their little green "cattle" as some people are pleased to term the aphids.

For further discussion of some species and the remedies used, see pages 295, 302, Part II.

TABLE FOR THE DETERMINATION OF COMMON FAMILIES OF

HEMIPTERA.

- A. Front wings thicker at the base than at the tip; beak attached to the front of the head. **True bugs.** Sub-order. *Heteroptera.*
- B. Antennæ very short, usually concealed beneath the head.
- C. Legs oar-like, fitted for swimming.
- D. Back somewhat V-shaped, light in color. **Backswimmers.** *Notonectidæ.*
- DD. Back more flattened; color darker.
- E. Size usually larger than medium. One-half inch to over two inches. **Giant Water Bugs.** *Belostomidæ.*
- EE. Length less than one-half inch. **Water Boatmen.** *Corisidæ.*
- CC. Legs not oar-like but very long and slender; abdomen fitted with a long breathing tube at the tip. **Water Scorpions.** *Nepidæ.*
- BB. Antennæ longer than head.
- C. Bodies very slender or linear.
- D. All legs long and slender.
- E. Last joint of antennæ enlarged. **Stilt-bugs.** *Berytidæ.*
- EE. Last joint of antennæ slender.
- F. Length about one-half inch. About water. **Marsh-treaders.** *Limnobatidæ.*
- FF. Length one inch or more. Not aquatic. **Thread-legged bugs.** *Emesidæ.*
- DD. Front-legs not used for walking and shorter than the others. Aquatic, found running on surface of water. **Water-striders.** *Hydrobatidæ.*
- CC. Bodies of broader shape, not linear.
- D. Antennæ four-jointed.
- E. Wing-covers lace-like, size small. **Lace-bugs.** *Tingitidæ.*

EE. Wing covers variable or absent.

F. Beak three-jointed.

G. Common forms wingless. **Bedbugs.**
Acanthiidae.

GG. Generally winged. Not resembling bedbugs.

H. Front femora greatly thickened.
Ambush-bugs. *Phymatidae.*

HH. Front femora not thickened. **Assassin-bugs.** *Reduviidae.*

FF. Beak four-jointed.

G. Front legs fitted for grasping. Wings rudimentary. *Nabidae.*

GG. Front legs fitted for walking.

H. Membrane of wings without cells but with a large number of more or less interwoven veins. *Coreidae.*

HH. Membrane with few veins and usually with one or more closed cells at the base.

I. Membrane with four or five simple veins and sometimes with one cell. *Lygaeidae.*

II. Membrane with two or three cells. Otherwise without veins.
Leaf-bugs. *Capsidae.*

DD. Antennæ five-jointed.

Stink-bugs. *Pentatomidae.*

(Several other minor families having five-jointed antennæ will not be included here.)

AA. Front wings of similar texture throughout. Sub-order *Homoptera.*

B. Size large; length greater than one-half inch. *Cicadidae.*

BB. Size smaller.

C. Front wings slightly thickened or covered with a waxy secretion.

D. Prothorax projecting backward over the wings.
Tree-hoppers. *Membracidae.* ☺

- DD. Prothorax normal. **Leaf-hoppers.** *Jassidæ*.
- CC. Wings entirely membranous or lacking.
 - D. Wingless or with only one pair of wings. Wingless forms scale-like and, except in the very early stages, without power of motion. **Scale insects.** *Coccidæ*.
 - DD. Wingless or with two pairs of wings. All stages active. **Plant-lice.** *Aphididæ*.

CHAPTER IX

LEPIDOPTERA

45. General Characteristics. The order *Lepidoptera* includes those insects which are commonly known as moths, millers and butterflies. They are recognized by their four wings, usually rather broad, which are covered with very fine powdery scales. These scales also cover the bodies of the moths and, in part, the butterflies. Moths and butterflies have indirect development, the young forms being known as *caterpillars*. Caterpillars, like other larvæ, are worm-like, but may be distinguished from all other common larvæ by the fact that they possess three pairs of true legs on the thoracic segments, and, in addition to these, at least one pair and usually as many as five pairs of pro-legs. The only other common insects which have pro-legs are the larvæ of the sawflies and these always have more than five pairs. (From six to eight pairs. See Sawflies, page 154.)

46. Moths and Butterflies distinguished. Moths and butterflies are easily distinguished from each other by several characters. The most constant of these is the form of the antennæ. In the butterflies these are always enlarged at the tips or clubbed. In the moths they are never clubbed, although they may have various forms, some being thread-like, and some feathery.

There are no characters by means of which the larvæ of the two groups may readily be separated, but the pupæ are quite different. Pupæ of moths are generally smooth

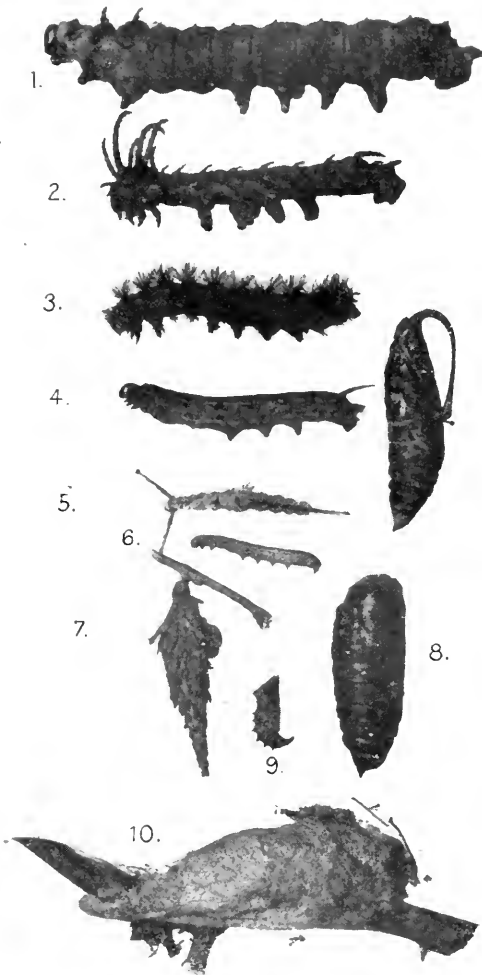

FIG. 46.—Early Stages of *Lepidoptera*. Two-thirds natural size.

1, Larva of Imperial moth; 2, Half-grown larva of Regal moth; 3, larva of the Eyed Tiger-moth; 4, larva and pupa of a Sphinx moth; 5, Tussock-moth larva; 6, small Cutworm; 7, Bagworm cocoon; 8, Cocoon of Regal moth; 9, Chrysalis of a *Papilio*; 10, Cocoon of *Cecropia* moth.

and are usually enclosed in some kind of cocoon or, at least, in an earthen cell. Those of butterflies are either angular or smooth, but are never enclosed in cocoons. They are generally suspended by a button of silk at the tip end of the abdomen and a silken girdle about the middle of the body or by the button alone, from some twig, branch, or weed. Some forms seek protection from the weather and may be found under trash in the winter, but many are in exposed situations.

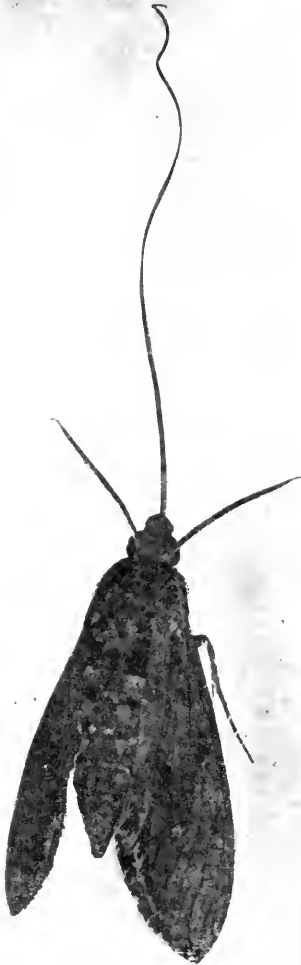

FIG. 47.—Sphinx Moth with Mouth-parts Extended.

Adults in this order have sucking mouth-parts, often poorly developed, formed from the maxillæ, which are elongated and grooved on the inner faces which join and form the sucking tube. In some moths this sucking tube is much longer than the insect itself. It is usually not adapted to piercing but is used to suck up liquids like the nectar from flowers, the juice from rotting fruits or from even less attractive substances. The larvæ have chewing

mouth-parts and are voracious feeders. They attack a great variety of substances ranging from the most succulent foliage to dried grains and wood of trees. Many are of great importance to farming and to other industries. The adults are rarely of direct importance but are of great popular interest.

47. Micro-Lepidoptera. Three extensive super-families of moths are commonly grouped together under this heading on account of their general similarity and small size. In contra-distinction to these all other Lepidoptera are called the "Macro-Lepidoptera."

The families or super-families comprising this group all contain species of considerable importance. Some of these may be used to illustrate the families. The first of the groups is the *Pyralidina*. The moths in this group are often fairly large for "Micros." Their wings are usually rather regular in outline and often folded or rolled about the body when at rest. The larvæ have a great diversity of food habits. Many of them

FIG. 48.—Types of Moths. *Micro-Lepidoptera*. Natural size.



feed on leaves and roll or fold the leaves for protection, thus acquiring the name *Leaf-rollers*, which is sometimes applied to the family as a whole. Others feed on leaves without rolling them and still others feed on fruits or vegetables. Several species feed on stored grains and their products and are among the most serious of the pests attacking



FIG. 49.—Melon-worm moth. One of the Larger *Pyralidina*. Enlarged.

these substances. Among the more important Pyralids are the *Mediterranean Flour-moth*,* which feeds mainly in wheat products in flouring mills; the *Indian meal-moth*,* of habits somewhat similar to the preceding species; the *Meal Snout-moth*, larger than the others and feeding on a

greater variety of products; the *clover-hay worm*, which injures old clover hay in mows or in the bottoms of stacks; the *melon-worm* and the *pickle-worm*, two rather large and strikingly colored species which attack melons and other plants in the same family; the *Grape Leaf-folder*; the *bee-moth*; *Case Bearers* and many species of *leaf-rollers*.

The *Tortricina* are uniformly small, having wings usually cut off more squarely at the ends than the other "Micros" and frequently having the wing margins scalloped. When at rest they show an outline more nearly rectangular than the other families in the group. Among

* See page 230, Part II.

the *Tortricids* are some species even more important than in the foregoing family. The most widely known of these is the *Codling-moth* or the apple-worm. (See page 319, Part II.)

Other Tortricids are the *Bud-moth*, which injures the early shoots of the apple in the spring; the *Strawberry Leaf-roller* and other, so-called leaf-folders and leaf-crumplers.

The *Tineina* are the smallest of the Lepidoptera. They may be recognized by their narrow wings fringed with long hairs.

Most of the plant eaters in this family are leaf-miners, feeding between the two epidermal layers of the leaf and forming mines of various shapes, often characteristic of the species. Very few common plants are not subject to the attacks of at least one species of leaf-miners, although not many are seriously injured by such attacks. The Tineids which probably attract the most notice are the common *Clothes Moths*.* There are several species of these, but they are similar in their general appearance. They may be best controlled by placing all clothing made of woolsens, silk, feathers and fur, in a large goods box with a tight lid, preferably on a back porch and fumigating with carbon bi-sulphide at the rate of one-half pound to the hundred cubic feet of space. Leave the clothes in the box for twenty-



FIG. 50.—The Codling Moth, a Type of *Tortricina* Greatly Enlarged.

* See page 220, Part II.



four hours, air them and replace in the closets, which should have been cleaned and sprinkled with benzine in the meantime. Repeat this operation twice, at intervals of three weeks, and clothes moth work will be eliminated. Carbon bisulphide is explosive but is safe if handled like gasoline.

The *Angoumois Grain-moth* is a *Tineid* and works in grain, both stored and in the field. In stored grain it, as well as the other moths mentioned, may be destroyed

FIG. 51.—Types of Moths. Reduced.

1, Eyed-Tiger-moth (*Arctiidae*); 2, 3, Carpenter-moths (*Cossidae*); 4, Slug-caterpillar moth (*Eucleidae*); 5, Tent-caterpillar moth (*Lasiocampidae*), 6, 7, 8, Clear-wing moths, (*Sesiidae*).

by fumigation as for the clothes moth. (See page 231, Part II).

48. Sesiidæ and Cossidæ. Two families of moths have wood-boring larvæ but are otherwise distinct. The Sesiids are rather small, have very slender bodies and narrow wings often almost entirely free from scales for which reason the moths are commonly called the clear-wings; many of them look much like wasps. The ever-present and destructive *Peach-tree Borer** is the most common member of this family. Others are the *Squash-vine Borer*, the *Currant-borer*, the *Lilac-borer*, a small species on maple, and many others. There is no good remedy for these insects when they are numerous.

Cossidæ are commonly called *Carpenter Moths* on account of the habits of the larvæ. They are large, stout-bodied, have rather long and narrow fore-wings and small hind-wings. There are few species and they bore mostly in locust and other shade and forest trees.

The larvæ in both the above families are typical caterpillars, usually white in color. The Cossid larvæ are sometimes somewhat hairy while the Sesiids are rarely noticeably so.

49. Noctuidæ. This family is the largest in the order, not in size of the individual but in the number of species and of individuals. It also contains a greater number of destructive forms than any other family. A few species are quite large; others are as small as some of the "Micros," but the great majority are of medium size. A few are brightly colored and striking in appearance but many more are of dull, inconspicuous colors. The great majority of the moths, which are attracted to light and, under the appellation of millers, invite our commiseration for

* See page 297, Part II, peach-tree borers.

their singed wings and suggest one of our most time-honored metaphors of the candle and the moth, are Noctuids.



FIG. 52.—Types of *Lepidoptera* Moths. Reduced one-third.

Third figure, *Notodontidæ*; others, *Noctuidæ*.

On a window in a dark night their eyes appear luminous from the lighted room. This gives rise to a name frequently used, "Fiery-eyes." Others call them "Owlet-moths," but it is simpler to speak of them as Noctuids and thus to eliminate an unnecessary name which adds little to the description. If the adults in this family are familiar objects, the larvæ are no less so. Among the common ones may be listed the various species of *cutworms*. (See page 286, Part II.) The *Army-worms* so called because of their habit of traveling, when numerous, from field to field in large bodies, like armies; the *Corn Earworm* (see page 253, Part II), known to every cook that ever prepared "roasting ears," except in the far north, and known on other plants under different names such as the "cotton boll-worm," the "tomato fruit-worm," "tobacco bud-worm," etc.; the *Cotton-worm* (see page 257,

Part II), injurious to cotton in the South, but in the adult stage more or less familiar to the people of the North, whither it migrates in countless numbers in the fall of the year. One of the cabbage worms, the *Cabbage looper*,* is a Noctuid, and to complete the list would require the mention of a large proportion of the two thousand species which exist in our fauna.

Larvæ of Noctuidæ may be for the most part very well illustrated by the common *cut-worms*, dull colored, smooth or even greasy in appearance, an inch or more long and nearly as thick as a lead pencil, voracious feeders appearing mostly at night and remaining concealed during the day.

A few species in this group are larger and of rather striking appearance. Notable among these are the *Catocalas*. These expand from two to three inches, have dull-colored forewings which are often almost indistinguishable from the bark upon which they usually rest, and brilliantly marked hind wings, different shades of red and yellow bands alternating with black or gray.

50. Arctiidæ. The *Tiger-moths* are not so abundant as the Noctuids, there being comparatively few species, but they are likely to attract nearly as much attention on account of the more striking appearance of both adults

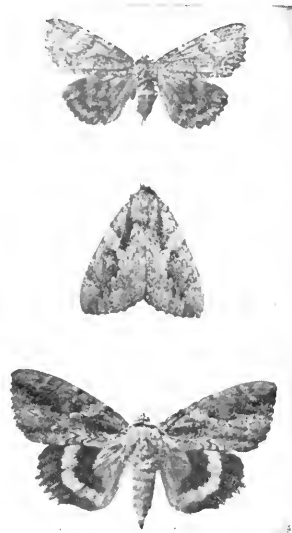

FIG. 53.—Underwing Moths (*Noctuidæ*). Reduced one half.

* See page 284, Part II, cabbage caterpillars.

and larvæ. The adults are moderate sized moths with



FIG. 54.—Types of Moths (*Arctiidae*). Reduced.

1, *Isabella* Tiger-moth; 2, the Tiger-moth; 3, the *Acræa* moth; 4, the Tessellated Tiger-moth; 5, the *Clymene* moth.

the wings rather narrower and more pointed than those of the Noctuids. Otherwise they are similar in the conformation of the bodies. In color the tiger-moths are either light or strongly marked. Some are pure white, some white with yellow, black or red markings; some, the typical tiger-moths, are black, marked with red or orange bands and spots.

Larvæ of *Arctiidae* are hairy caterpillars which have colors of about the same range as those shown by the adults. Few species are injurious. The most important one is the *Fall Web-worm* which feeds on foliage of shade and fruit trees in late summer and early fall and forms unsightly webs over the ends of branches, the worms living in colonies within these webs.

The most commonly noticed of the Arctiid larvæ is the larva of the *Isabella Tiger-moth*. This is a red and black, hairy caterpillar about an inch and a half in length which is seen in the fall hurrying about from place to place. It is so common that it has given rise to the saying "Hurrying like a caterpillar in the fall." It is also supposed by many people to foretell the nature of the

approaching winter, the varying amount and distribution of the black color indicating a mild winter or the reverse. Other tiger-moth larvæ are common at the same season but they are found on the foliage of several weeds.

51. Notodontidæ. The members of this family also in many ways resemble the Noctuids. The number of species is comparatively small and few are injurious. The most common among the Notodontids are the members of the genus *Datana*, of which there are several species. They are noticed in the larval stage when they are variously called "walnut-worms," "maple-worms" and "yellow-necked apple-caterpillars." It is just as easy and much more distinctive to speak of them as *Datanas* and the generic name is quite widely used as a common name. *Datana* moths are of moderate size, and of light-brown color, marked with narrow bands of darker brown. Their wings have scalloped outer margins. The larvæ, when full grown, are dark in color but are marked with several narrow yellow stripes running the length of the body, and with a patch of yellow just back of the head.



FIG. 55.—Larva of the Isabella Tiger-moth.



FIG. 56.—Larvæ of a *Datana* Moth (Yellow-necked Apple-caterpillars).

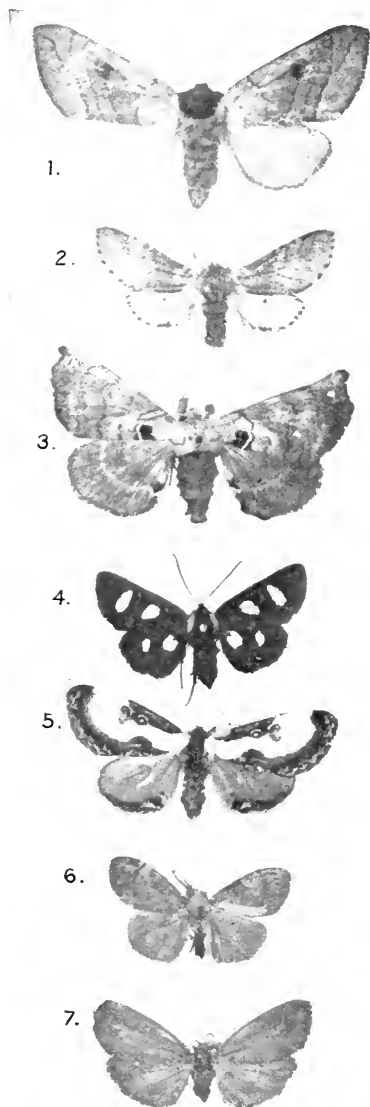

Still more distinctive as the resting position. Both ends of the body are raised so that the side view of the insect presents an outline almost semicircular, which renders it very easy to recognize. These larvæ may often be found in great clusters in the forks of branches where they go to moult. They are most abundant in late summer and occasionally are seriously injurious. (See page 315, Part II, for further description.)

52. Liparidæ. Students will generally encounter only one or two members of this family. These are the Tussock-moths. The more common species is the *White-marked Tussock-moth*. Its

FIG. 57.—Types of Moths.
Slightly reduced.

1, 2, and 3, *Notodontidæ*; 4, Eight-spotted forester (*Agaristidæ*); 5, Beautiful wood nymph (*Agaristidæ*); 6, Tussock-moth (*Liparidæ*); 7, *Lithosiidæ*.

most conspicuous period is during the larval stage. The larva feeds on several common shade trees as well as on some fruit trees. It is light in color and bears several characteristic tufts of hair. One row of these, down the middle of the back, is composed of short white hairs growing in dense tufts. Just back of the head is a pair of long pencils of blackish hairs while at the posterior end of the body a single similar pencil is found. Other scattered hairs are all over the body. Just back of the head, between the bases of the black pencils, is a bright red band and the head itself is reddish in color. These larvæ make cocoons composed partly of their own hairs and attached to leaves. The females are wingless and deposit their eggs in masses on the outside of the cocoons where they may be found during the winter and spring.

In the New England states the two worst insect pests, the *Gypsy moth* and the *Brown-tail moth*, are the common representatives of this family. They are so well known, where they occur, that they do not need description here. They are not native American insects, but were brought over from Europe and were accidentally liberated.

53. Agaristidæ and Lithosiidæ. The *Agaristidæ* and the *Lithosiidæ* are two families which compare in general outline and proportions with the Noctuids. There are few species, not of great importance, which may attract the attention of the beginner on account of the striking beauty of their forms. Among these, in the first family, are the *Eight-spotted Forester*, black, with eight yellow spots on the wings, below medium size and feeding, in the larval stage, on various vines, as grape and Virginia creeper; and the *Beautiful Wood-nymph*, a still more striking species, which may be recognized from the figure. (See Fig. 57, 4 and 5, page 84.)

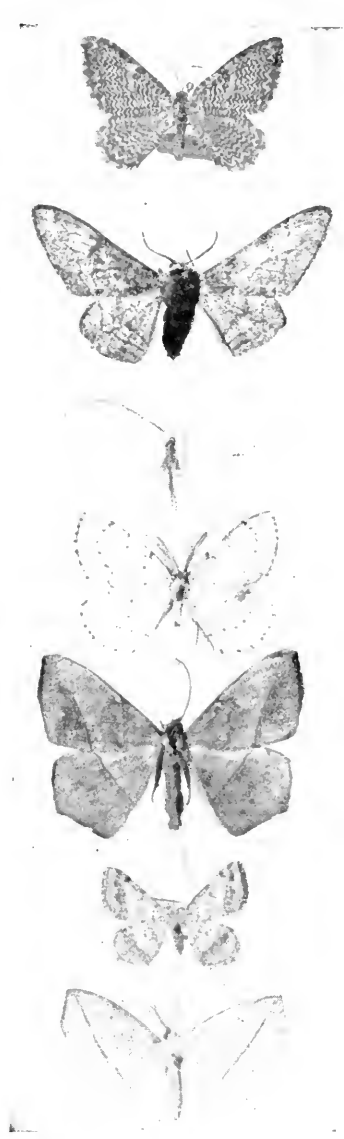

The family *Lithosiidæ* will probably be encountered in the form of one small species, which is colored a delicate, though somewhat faded, pinkish red, and striped with black. There is no really appropriate common name for this insect.

54. Geometridæ. This family is well known to all. The larvæ, variously called "span-worms," "inch-worms" and "measuring-worms," were among the earliest of our insect friends. Their presence upon our clothing was welcomed as presaging new clothes and we were not even squeamish about letting them crawl on our fingers. They lack the three pairs of pro-legs in the middle of the body and so must travel by looping themselves along, hence, another common name the "loopers." They are the most slender of the caterpillars, are frequently green, but

FIG. 58.—Types of Moths (*Geometrina*). Slightly reduced.

often striped and sometimes colored to imitate twigs or stems where they rest, so that they appear, when standing straight out from the resting place, as is their habit, like little spurs from the twigs.

There are many species of the loopers and several are distinctly injurious. The adults have slender bodies and usually rather broad and very thin wings, the appearance indicating delicacy and frailness quite different from the more robust Noctuid-like forms in the preceding families. Their colors are usually sober but not dark. The light grays predominate but not a few are green. The forewings are frequently scalloped.

Important species are the *Canker-worms*,* injurious on orchard and shade trees, and loopers which feed on currants, gooseberries, raspberries and many other plants and quite frequently are named for the plants on which they feed.

Bagworms (*Psychida*) are represented by one or two common species only. The most common one of these is the *Evergreen Bagworm* which feeds on apple, and on junipers, maples, locusts, and many other shade trees. The males are small, clear-winged moths which are seldom seen. The insect will be identified by the bag which it makes and in which the greater part of the life is spent. The females never leave the bags but deposit their eggs within them and die. Young larvæ make small cone-shaped bags, which they "wear" all the time, enlarging them as they grow, finally attaching them to twigs and pupating within them. The figure will enable the reader to recognize the insect. This species is often seriously injurious. A smaller species feeds on maples and is less conspicuous and troublesome.

* See page 311, Part II.



FIG. 59.—Cocoons of the Bag-worm Moth (*Psychida*).



FIG. 60.—Nest of Tent-caterpillars (*Lasiocampidae*). Compare with Fig. 61. Reduced.

Slug-caterpillars (*Eucleidae*) represent another rather small family which is known much better through its larvæ than through the moths. The moths are usually dark colored, though some species are marked with rich greens and are very beautiful. The larvæ are not like ordinary caterpillars, but the legs are reduced in size so much that the insect crawls on the under surface of its body much like the common slug or a snail. These slug-caterpillars are usually brightly colored and take the most bizarre shapes. All are small. One species is clothed with spines that are slightly poisonous and irritating. This is the "saddle-back," so-called from the marking on the back which suggests a green saddle on a rich, dark reddish saddle-cloth. It feeds mainly on apple and some ornamental shrubs.

Tent-caterpillars (*Lasiocampidae*) are represented by

one or two species and may be injurious. A description of the most important species will be found on page 313, Part II.

55. Sphingidæ. The *Sphingidæ* are commonly called sphinx moths, hawk-moths, and humming-bird moths. The first name, as also the family name, is sug-



FIG. 61.—Nest of Fall-web-worms in Small Apple Tree (*Arctiidæ*). Reduced.



FIG. 62.—Larvæ of the Catalpa Sphinx. Reduced.

gested by the fancied resemblance of the larvæ of this family, in their characteristic resting position, to the Egyptian sphinx. The adults are large, have stout bodies of regular shape, the abdomen resembling a long and sharply pointed bullet, and have wings which are long, narrow and powerful. The general appearance and graceful flight

gives rise to the name *Hawk-moth*. From their feeding habits comes the name *Humming-bird moth*. They have extremely long tongues, adapted for sucking nectar from the deepest flowers, like honeysuckles and morning-glories. As the weight of these moths' bodies would not be supported by the flowers it is necessary for them to hover or poise in the air over the flowers while they feed. They may be seen at twilight on any summer evening and are also attracted to the electric lights. The larvæ are large,



FIG. 63.—The Tomato-worm Sphinx Larvæ. Greatly reduced.

have stout fleshy bodies and usually have a backward projecting horn at the posterior end of the body. They are sometimes called *Horn-worms*. At rest they hold the front end of the body up almost at right angles to the abdomen and remain motionless for long periods. The most common examples are the Horn-worms which attack tomatoes and tobacco.* The *White-lined Sphinx* and the *Clear-wing Sphinx* are also abundant.

* See page 278, Part II.

56. Saturniina. This super-family includes the largest of the common moths. There are several families. The *Bombycidae* includes the *Mulberry Silk-worm* which has been domesticated and furnishes the silk of commerce. The insect is no longer found in the wild state. It is reared in China and Japan, in India and in the Mediterranean countries, notably France and Italy. The silk industry has been started in the United States, but has not proven profitable, largely on account of the high cost of labor, the worms requiring constant care.

Several of our most showy moths belong to the *Saturniidae*, or giant-silk-worm family. Among these are the *Cecropia*, the *Polyphe-mus*, the *Promethea*, the *Io*, the smallest of the common species, and the *Luna*. The latter is of

a delicate green color, large size, and possesses on the hind wings long and gracefully curved tails which



FIG. 64.—Types of Moths (*Sphingidae*).
Reduced.

- 1, The Modest sphinx; 2, Achemon sphinx;
3, Pandorus sphinx; 4, Tomato-worm moth;
5, the Lined sphinx; 6, Tersa sphinx.

make it easily the most striking of the moths in appearance.

The *Ceratocampidæ* are called the Royal Moths and include the *Regal moth*, probably the largest of the whole group, the larvæ of which is called the *Walnut-worm* or the "hickory horned-devil," and the *Imperial-moth*. The *Regal* is of a rich, reddish brown color, spotted with yellow, while the imperial is yellow with variable purplish-brown shadings. Both have rather narrower fore-wings than the Saturniids. Smaller species of this family are the *Rosy Dryocampa* and the *Senator*.



FIG. 65.—Types of Moths (*Saturniidæ*).
Reduced.

1, *Cecropia*; 2, *Io*; 3, *Polyphemus*; 4, *Luna*;
5, *Promethea*, male.

With the exception of the *Rosy Dryocampa* and the *Cecropia*, which are sometimes injurious to shade trees, none of these species can be considered of economic importance, but the family will, nevertheless, remain one most generally interesting on account of the large size of its members.

57. Butterflies. Butterflies comprise two super-families, the *Papilionina* or true *Butterflies* and the *Hesperiina* or *Skippers*. They differ from moths in the antennal characters already mentioned, in the fashion of holding the wings while at rest and in the fact that they fly exclusively in daytime while moths usually fly at night.



FIG. 66.—Larva of Polyphemus Moth. Reduced.

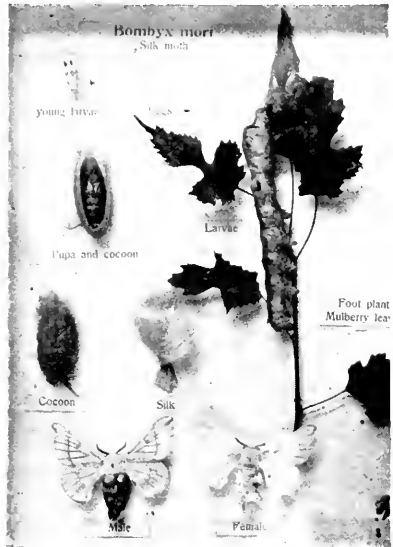

FIG. 67.—Stages of the Mulberry Silk-worm Moth. Reduced.

Other characters are less tangible but are, to the expert, no less distinctive. Skippers usually have the antennal club ending in a hook. They have an erratic, jerky method of flight and when at rest usually hold the hind wings horizontal while the front wings are held vertical, like the wings of the true butterflies, and the bodies give the impression of being stouter and more hairy.

Their larvæ may be recognized by the fact that the bodies are very much constricted behind the head and so have distinct necks.

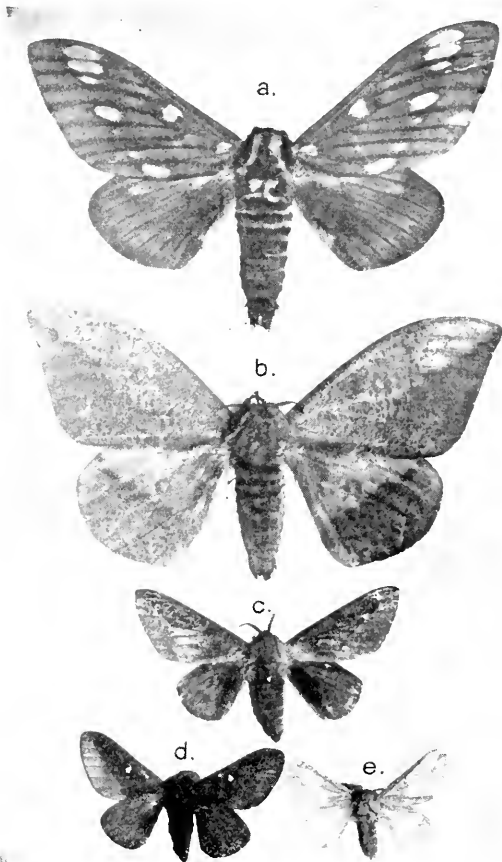

FIG. 68.—Types of Moths (*Citheroniidæ*). Reduced.
a, Regal; *b*, Imperial; *c*, Honey-locust Moth; *d*, Stigma Moth; *e*, Rosy Maplemoth.

58. Papilionidæ. The *Swallow-tails* comprise, with a less common group *Parnassians*, the family *Papilionidæ*. They

may easily be recognized, as they are the largest of our butterflies, and have tail-like projections on the hind wings. The larvæ have scent organs on the first thoracic segment. These are two orange-red, horn-shaped, extrusible structures which are thrust out when the insect is disturbed. They give off a strong and unusual, but not exactly unpleasant, odor. Swallow-tail pupæ or chrysalids are supported by the button of silk at the tail end and by the girdle around the middle. They are angular and have two short projections at the front end of the body. Swallow-tail larvæ are rarely numerous enough to be injurious.

The species common over the greater part of the eastern United States are few in number. The *Black Swallow-tail* is probably the most common and is the smallest. Its larvæ feed on celery, rue, parsley and similar plants. The ground color is black and on the hind wings are numerous yellow spots and some shading with light metallic blue. The *Tiger Swallow-tail* or *Turnus* is



FIG. 69.—Larvæ of the Rosy Maplemoth. Reduced.

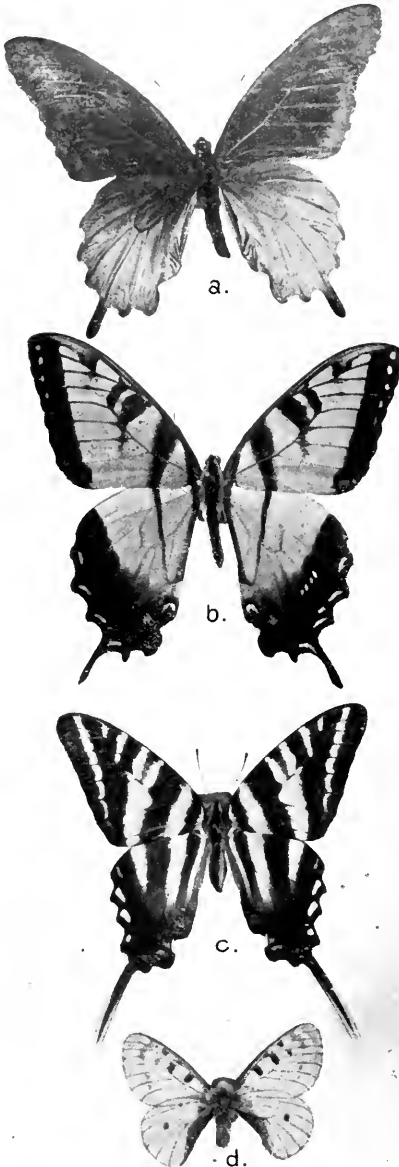

the largest common species. The color is yellow with black markings except in certain females, which may be black. They are distinguishable from the "Black Swallow-tail" by their larger size. *Ajax* or the Zebra is a showy species with white wings striped with black and marked with red. The tails are longer and narrower in this species than in the others and it is otherwise unmistakable. The larvæ feed on paw-paw.

Troilus is black with olive green shading on the hind wings. It has no pure yellow markings

FIG. 70.—Types of Butterflies (*Papilionidæ*).
Reduced one-half.

a, *Papilio philenor*; b, *P. turnus*; c, *P. ajax*; d, *Parnassius* sp.

above. The tails are more rounded in this species than in the others.

Philenor is black on the fore wings but the hind wings are the color of green "changeable" silk above and of greenish-blue silk spotted with large orange-red spots below. It also is unmistakable.

Cresphontes is common in the more southern portions of the country. It is the largest of our butterflies and is, in general, black with conspicuous yellow markings above, while it is yellow with black markings beneath. It is a very handsome and showy insect. Its larva feeds on citrus trees in the South, where it is called the "orange puppy."



FIG. 71.—Types of Butterflies. (*Papilionidae*). Reduced one-half.

a, *Papilio turnus glaucus*; b, *P. troilus*; c, d, *P. polyzenes*; e, *P. cresphontes*.

In the northern part of its range it feeds on prickly ash (*Xanthoxylon*).

59. Pieridæ. This group includes all our common yellow and white butterflies. They are mostly of medium to small size and may at times be injurious. There are many species, but only a few which are important. The larvæ are usually green and are not conspicuous. The pupæ resemble those of the *Papilios*, but have only one pointed projection from the anterior end of the body and are, of course, smaller. The best-known species is the "imported cabbage-worm" or *Cabbage Butterfly*.* There are other native and imported species which closely resemble this one in general appearance and habits.



FIG 72.—Larva of *Papilio cresphontes*.

The more common yellows are the *Clover Butterflies* or "sulphurs" of which there are many species. Their larvæ may be found in clover fields and one species seems to be becoming a pest in alfalfa fields. Several kinds, smaller than the ordinary clover butterflies may be noted. Among these will be the *Dainty Sulphur*. The largest of our Pierids is a beautiful insect with wings of pure unmarked sulphur yellow. It is called the *Cloudless sulphur*. Another

* See page 282, Part II.

species common on the hills of the Middle West is the *Dogs-head*, a form slightly larger than the common sulphur but with the black markings so arranged as to picture a dog's head in profile on each front wing, though some imagination may be necessary to see the picture.

A group of whites which have the tips of the front wings suffused with orange is known as the orange-tips and forms the third group of Pierids. They are less common than the whites and yellows.

60 Lycaenidæ. The *Gossamer-wings* are the smallest and most delicate of the butterflies. Included here are the "blues," the "coppers" and the "hair-streaks." The larvæ are small and slug-like. The chrysalids are supported like those of the two families already described, but they are never angular in outline. The early stages in this family are seldom seen. There are several species of the blues that are familiar objects. They frequent moist places and often are found about the culverts in a country road. They may also be seen flying over any meadow. Some of the blues have very delicate tails on the hind wings. This is true also of several "hair-streaks." Their larvæ feed largely on plants in the pea family.



FIG. 73.—Types of Butterflies. First four, *Pieridæ*; last four, *Lycaenidæ*. Reduced one-half.



The "hair-streaks" may be bluish or slaty black above, but are lighter beneath and are marked with delicate lines of white or red on the under side. There are many species, but few are common. They are usually slightly larger than the blues.

The "coppers" may be dull colored, black, brown or tan, but generally have some portion of the wings coppery with metallic luster. There are but two or three species which we may consider common. They are less delicate than the other groups of the family, but are by no means robust.

61. Nymphalidæ. With the exception of a few subtropical forms which occur in the Far South,

FIG. 74.—Types of Butterflies (*Nymphalidæ*). Reduced about one-half.

a, a Fritillary; b, the Thistle butterfly; c, the Red Admiral; d, the Mourning-cloak; e, the Red-spotted Purple; f, the Viceroy; g, the Monarch; h, the Regal Fritillary.

all the remaining species of butterflies may be ascribed to this group, which is by far the most extensive of the butterfly families. It is divided into several sub-families, which are widely distributed.

The larvæ have varied shapes and habits. Many are clothed with spines or fleshy filaments, others are of unusual and irregular shapes; few are difficult to recognize, although it is hard to characterize them as a group. The pupæ or chrysalids also vary in shape but they always hang from the tip of the abdomen and lack the girdle. Not many species in the family have economic importance. The large reddish-brown butterfly with black markings, abundant everywhere throughout the summer, is the "monarch." It is the only common representative we have of one sub-family (*Euplœina*). It is found practically all over the habitable world, but survives the winter only in the warmer portions of this country, migrating northward in the spring and early summer. The larva feeds on milkweed. It is a smooth, greenish-yellow caterpillar with narrow black markings and has a pair of long, fleshy filaments at each end of the body.

Another cosmopolitan species in a different sub-family is the *Thistle-butterfly*. This is of medium size, of brown color with markings of black, white and red, lighter, and marked with bluish, eye-like circles beneath. Its larva is a spiny caterpillar which feeds on thistles. The *Red-admiral*, nearly related to the preceding, is distinguished by the red bar across the angle of the fore wing, and the *mourning cloak*, another relative, by its larger size, bluish-purple color and golden margin of the wings. The *Fritillaries*, *Silver-spots*, or *Argynnids*, include many forms varying in size from small to quite large, but all resembling

each other in general color, brown with black markings above and with silver spots on the under side of the hind wings, and all having wings of regular outline. Our largest common ones are *Cybele* and *Idalia*, the latter having the hind wings nearly all black. The *Angle-wings* include several more common species and the name itself briefly describes them.

The *Wood-nymphs* are dull brown in color, frail in appearance and faintly marked with round black spots or with circles. The *Meadow-browns* are similar but deeper colored and marked on the angle of the fore wings with yellow circles or spots.



FIG. 75.—Larva of Viceroy Butterfly Preparing to Form Chrysalis.

The “purple emperors” are moderately large and are normally purplish black with white markings. The common one is *Astyanax*. This is almost entirely purple, but has small white and reddish markings near the angles of the wings. Another one just as common is the *Viceroy*, so called because it departs from the color of its nearest relatives and has acquired almost

exactly the coloration of the monarch. This is explained as a process of natural selection due to the fact that the monarch is distasteful to birds while the group to which the viceroy belongs is not. By acquiring the color of the monarch the viceroy acquires also a certain degree of immunity from bird attack. This selective process is termed mimicry.

62. Hesperina. The skippers have been sufficiently described already. While our species are rather numerous they are difficult, for the most part, to separate. The larvæ have been mentioned but the chrysalids or, rather, pupæ, differ from those of other butterflies in that they

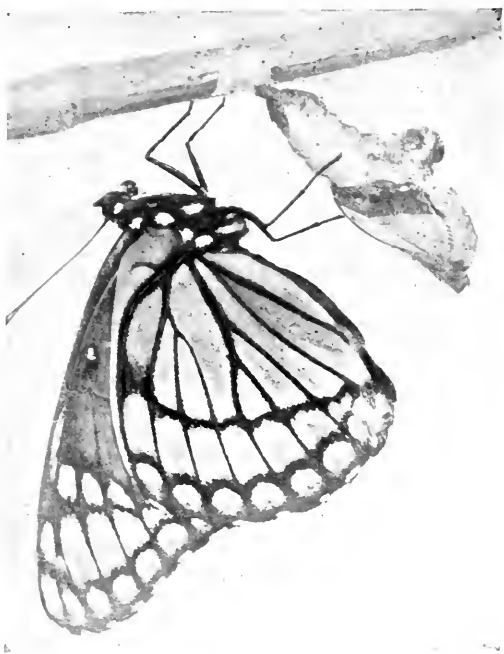

FIG. 76.—Viceroy Butterfly Emerging from Chrysalis. Slightly enlarged.

are enclosed in poorly constructed, flimsy silken cocoons. Most skippers are of brownish or brownish-black color. A few are nearly white or silvery. Many have extensive markings of a yellow tan color. Our largest skipper is the *Silver-spot*. This insect expands more than two inches,

is of dark brown color and has a conspicuous silvery spot on the under side of the hind wing where it furnishes a



FIG. 77.—Types of *Lepidoptera*. Skippers (*Hesperiina*). Reduced about one-third.

means of ready recognition for the insect at rest. The beginning student will know the rest of the skippers as a group rather than individually.

TABLE FOR THE SEPARATION OF SOME OF THE MORE IMPORTANT GROUPS OF

LEPIDOPTERA.

(On account of the wing-venation characters involved in the determination of some families, no attempt will be made to make this table complete.)

- A. Antennæ with a knob or club at the tip. **Butterflies and Skippers.**
- B. Club with a recurved hook. **Skippers.** *Hesperiina.*
- BB. Antennal club without hook. Mostly **Butterflies.** *Papilionina.*
- C. Size large, hind wings with tail-like projections. **Swallow-tails.** *Papilionidæ.*
- CC. Size variable. Hind wings without the tails, except in smaller forms.
- D. Colors white or yellow with or without black markings. **Pierids.** *Pieridæ.*
- DD. Colors not white or yellow.
- E. Size small; colors usually blue or bluish; or coppery with metallic reflections. Many forms with very delicate tails on hind wings. Wings very thin and delicate. **Gossamer-wings.** *Lycænidæ.*
- EE. Size and color variable but never as described above. Usually medium to large forms. Front legs abortive, not fitted for walking. *Nymphalidæ.*
- AA. Antennæ without knob at tip. **Moths.**
- B. Moths with a frenulum, Bristle or bristles at base of hind wing, overlapping base of front wing.
- C. Wings more or less transparent.
- D. Size small; body dark in color, short and stout. Wings transparent, short and rounded. Front wings noticeably larger. Larvæ forming bag-like cocoons. **Bag-warm moths.** *Psychidæ.*
- DD. Bodies slender. Wings long and narrow, of more nearly equal length. Hind wings or both fore

and hind wings, clear. **Clear-wing moths.** *Se-
siidæ.*

CC. Wings entirely clothed with scales.

D. Size uniformly small to very small. Wings usu-
ally narrowed; hind wings nearly as large as the
fore wings. *Micro-Lepidoptera.*

E. Wings fringed with delicate hairs. Size usu-
ally very small. *Tineina.*

EE. Wings not fringed. Size usually larger. *Tor-
tricina* and *Pyralidina.*

DD. Size usually larger than the *Micros.*

E. Size larger than medium; body stout. Front
wings long and rather narrow; hind wings
small.

F. Outer margin of front wings long. **Car-
penter moths.** *Cossidæ.*

FF. Outer margin of front wings short. **Hawk-
moths.** *Sphingidæ.*

EE. Moths with size variable but usually medium.
Wings usually of normal proportions.

Several common and important families
belong here. These can be distinguished
further only by wing-venation.

Notodontidæ.

Arctiidæ.

Noctuidæ.

Liparidæ.

Agaristidæ, etc.

BB. Moths without a frenulum on the hind wings.

C. Size medium to very large. Wings usually rather
broad. **Giant silk-worms,** etc. *Saturniina.*

CC. Size smaller. Bodies stout and hairy. **Tent-cater-
pillar,** etc. *Lasiocampidæ.*

CHAPTER X

COLEOPTERA

CHILDREN and adults alike are attracted by the beautiful colors of the butterflies and moths; farmers notice and take an interest in any insect forms that threaten their crops; philosophers have for ages past studied the social insects; we are all forced to give a certain amount of attention to flies and mosquitoes and to other forms that disturb our comfort, and medical science is taking an interest in the same forms, of late years, for rather different reasons; but entomologists have, almost since the beginning of the science, shown a decided preference for the beetles. This is because of the number of species, the order including more forms than any other one order, their ease of collection, their universal distribution, and because of their hard body covering which renders them easy to mount and permanent in collections. The order has been better classified than any other of the large orders and is easier to study.

63. General Characteristics. Beetles have four wings, the front pair hardened and forming a shield-like covering for the membranous hind wings. They have biting mouth-parts and develop from grubs, indirectly. Their entire body covering is, like their wing-covers, or "elytra," hardened rather more than is the case in other insects.

There are two sub-orders; the first, called *Coleoptera Genuina*, *Genuina*, or merely *Coleoptera*, includes all the species which do not have snouts; the second, *Rhyn-*

chophora, includes the snout beetles. Larvæ of *Coleoptera* are typically six-footed, with sometimes a sort of pro-leg at the tip of the abdomen. Some of the borers have lost their feet through disuse. The larvæ of snout beetles are entirely footless. They are stout bodied, usually slightly curved beneath and humpbacked. They are distinguished from some Hymenopterous larvæ mainly by their more distinct heads and stouter jaws. Larvæ of *Genuina* have many forms, some fleshy and cylindrical, others hardened like the adults and of dark colors and still others intermediate between these two types.

64. Food Habits. Adults and larvæ of some beetles are plant eaters, and are, many of them, among our most important insect enemies. Many beetles are scavengers, feeding on decaying animal and plant substances. One is parasitic on beavers, but animal parasites are rare among the beetles. Many beetles bore in solid wood, both dead and alive, and many burrow in the ground and live on the roots of plants.

As might be expected from the number of species there are many families, and a considerable proportion of these may be recognized from a few simple characters. Space will not permit the mention of all, even of the common forms, but those families having the greatest number of important species will be briefly described.

65. Cincindelidæ. The *Tiger-beetles* are usually of medium size and somewhat flattened in form, with the elytra broader than the pro-thorax and head. All species have fairly long legs and bright colors. The common species exhibit almost no variation in form and little in size, the easily noted differences being in color. They are encountered in warm, sunny situations, along paths, dusty roads and railroad tracks, where they fly up and

alight again some ten or fifteen yards ahead of, but always facing the disturber. The larvæ are fleshy, white and cylindrical. They live in holes in the ground, and from the mouths of these burrows capture other insects. They are held in the holes by a forward projecting hook on the abdomen near the posterior end. Tiger-beetle holes may be found in great numbers in banks or even in level ground. The adults are also predaceous and capture other insects. Tiger beetles have five-jointed tarsi on all legs and thread-like antennæ.

66. Carabidæ. *Ground-beetles* have also five-jointed tarsi and thread-like antennæ. They are, in a very general way, flattened and have long legs, like the tiger-beetles. No one acquainted with the tiger-beetle form will mistake them for ground-beetles and other families are easy to distinguish from these two. Ground-beetles are generally black, but some are bright colored, metallic green and some shades of red and yellow being present in many species. They range from small to very large. As the name implies, they are found on the ground, under logs, stones and trash piles. They are attracted to lights



FIG. 78.—Types of Beetles. Ground-beetles (*Carabidæ*). Reduced one-third.

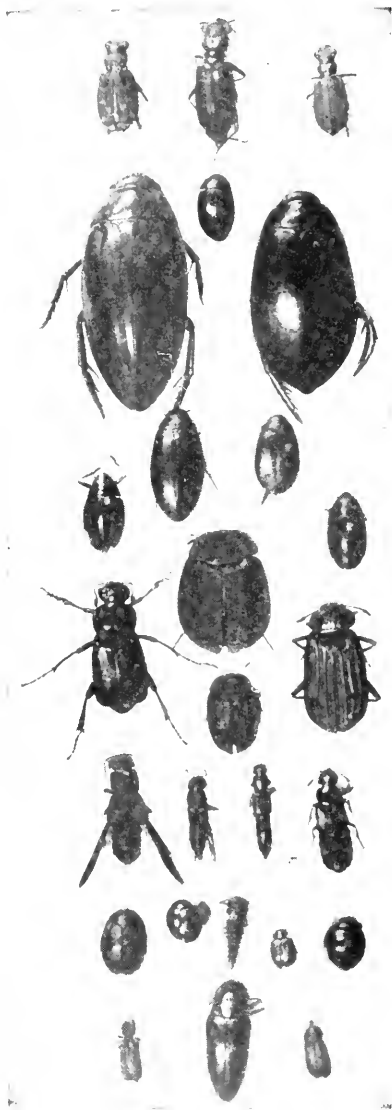

in great numbers. Some of the ground-beetles are distinctly valuable as destroyers of injurious caterpillars, notably, those of the gypsy-moth. In numbers of species the ground-beetles are near the head of the list, there being about a thousand from the United States.

67. Aquatic Beetles.

There are three common families of beetles that are aquatic in habit. They may be recognized by their regular oval outlines, their legs fitted for swimming, and the uniformly dark colors, as well as by the habitat. The *Whirligig-beetles* (*Gyrinidæ*), are

FIG. 79.—Types of Beetles.
Slightly reduced.

Upper row, Tiger-beetles (*Cicindlidæ*); next two rows, Aquatic forms (*Hydrophilidæ*, *Gyrinidæ*, and *Dytiscidæ*); fourth row, Carrion beetles, (*Silphidæ*); fifth row, *Staphylinidæ*; sixth row, Lady-bug beetles and larva (*Coccinellidæ*); lower row, left, *Ptinidæ*; center, *Erotylidæ*; right, Larder beetle (*Dermestidæ*).

the small beetles that are seen swimming in numbers on the surface of the water, the common name coming from the habit of swimming rapidly in circles. The scientific name for the family is also suggestive of this habit. They do not exceed three-eighths of an inch in length and some common forms are not more than half that long. They are called "money-bugs" and "sweet-bugs" by children.

Larger, usually, than the whirligig-beetles are the *Water-scavengers* or *Hydrophilidæ*. They are pointed oval in shape, both ends of the body being narrowed in about the same degree. On the under side of the thorax is a long spine-like process that serves as a keel. They live mostly under the surface of the water and fly to the lights at night. One of the largest species may, in some localities and at certain times, be collected by the hundreds under a single electric light near the water. The common form is more than an inch long and shining black in color.

Predaceous diving-beetles (*Dytiscidæ*) rival the *Hydrophilids* in size but are flatter and have the heads more squarely cut off. They also lack the keel. The larger species are of a dull olive-green color, marked with yellow and smaller ones are black and yellow, sometimes being mostly yellow. They also may be attracted to lights. Their larvæ are called *Water-tigers*. They are long and slender, pointed at the rear end, and have powerful jaws. They are, without exception, the fiercest animals that live in the water. The larva of the largest common diver is three inches in length.

68. Scavenger Beetles. Several families of beetles, not typically scavengers, include species that feed on refuse and carrion. In two families, however, almost all forms feed on decaying organic matter. These are the

Carrion-beetles (*Silphidæ*), and the *Short-winged Scavengers* (*Staphylinidæ*). Carrion-beetles are stout bodied or broad and flattened and have clubbed antennæ. Their elytra and body walls are not so hard as in most beetles. They feed, as larvæ and as adults, on decaying flesh. The stout-bodied forms have wing covers shortened but not to the same degree as in the next family. The stout-bodied carrion beetles are called burying-beetles. They take the bodies of small animals such as mice and roll or drag them to suitable places, where they bury them and in them deposit their eggs, thus providing food for their young. The more flattened species work their way under the bodies of heavier animals where they feed and lay their eggs, both adults and larvæ frequently being found in the same animal.

The *Staphylinids*, sometimes called rove-beetles, have very slender bodies and extremely short wing covers. These characters alone will distinguish them. They resemble earwigs but do not have the forceps-like appendage of the earwigs. In habit they vary. The majority feed on decaying vegetable matter, but many others eat carrion and are found with the carrion-beetles.

69. Coccinellidæ. The *Lady-bugs* get their scientific name from the food habit of a large number of the species. These prey upon scale insects or Coccids and the name for this family signifies Coccid-killers. Many of them prey also upon aphids and other small insects. They have almost hemispherical, usually brightly colored bodies, the colors predominating being orange, yellow and red with black dots. Some species are pure black, others have only a few orange or red spots on a black ground color. All are small and many are among our best-known beetles. They, like the measuring worms, are among the

few insects of early memory with which we were on friendly terms. Many harmless superstitions and rhymes describing them, some dating back hundreds of years and originating in widely different localities, are connected with the lady-bugs.*

Lady-bug larvæ are soft-bodied, dull-colored with brighter spots, rather stout and with pointed abdomens. They are found in colonies of aphids and scales, often with the adults. Eggs and pupæ may be found in the same situations. Some few species of lady-bugs feed on foliage. One attacks beans, another squash vines. They are not important as pests of these plants and ordinary control measures easily keep them in check.

Cucujidæ and *Dermestidæ* are of interest mainly as destroyers of stored products of various kinds. The former are slender, very much flattened species and the common pests belonging to the family are of very small size. The *Saw-toothed Grain-beetle* is the most abundant and destructive species. It attacks stored grain and grain products, and also such foods as dried raisins and currants. The Dermestids are small, stout-bodied insects of dark colors or checkered with red, white and black. The *Buffalo-moth*, attacking carpets and other products of wool, feathers and fur, is the larva of one of these beetles (*Anthrenus scrophulariæ*), and another member of the same genus attacks insects in collections and other museum

* "Maikatt
Flug weg
Stuff weg

Bring me morgen goet wedder med."

Folk rhyme from the Netherlands. Thorpe, "Northern Mythology."

"May-cat, fly away, hasten away,
Bring me to-morrow good weather with you."

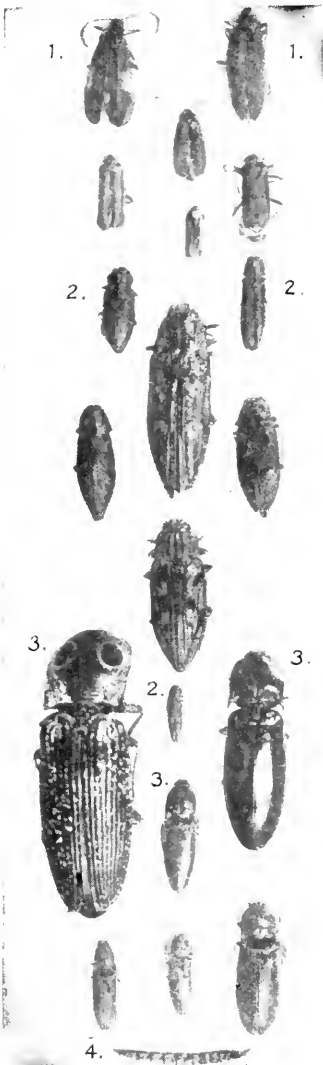

FIG. 80.—Types of Beetles.

1, Fireflies (*Lampyridæ*); 2, Metallic wood-borers (*Buprestidæ*); 3, Click-beetles (*Elateridæ*); 4, Larva of click beetle or wireworm.

specimens. A larger species, black, with shoulders of a dull yellow, is the *Larder-beetle* and destroys or spoils food-stuffs, mostly animal products. They will also, like other members of the family, act at times as scavengers, eating dead and decaying animals.

70. The Click-beetles (*Elateridæ*), are well known and are remembered with the lady-bugs, as friends of early days when they bore the name of "Snapping" or "Flopper" bugs. They are extremely hard-shelled, even for beetles, and have the joint between the prothorax and the rest of the body flexible and fitted internally with a sort of spring, by means of which they are enabled to spring, when resting upon their backs, some distance in the air and, sometimes after repeated trials, to come down right side up and ready to travel. They are of dark colors, black and olive-brown predominating. The largest common species is the *Eyed Elater*, black with gray mark-

ing and with two large, velvety, eye-like spots on the pro-thorax. Some shining black species rival this in size and are frequently seen.

Larvæ of click-beetles are slender, cylindrical, hard-bodied and waxy yellow in color. They are called wire-worms and live in the soil and in decaying wood. Some species injure the roots of plants and destroy sprouting seeds.

71. The Metallic Wood-Borers (*Buprestidæ*), also have a very hard body covering. They are generally heavier-bodied than the click-beetles, although some forms are very slender, and have the pro-thorax slightly narrower than the base of the wing-covers. The adults are sometimes found on flowers and on the sunny side of tree-trunks. Larvæ of Buprestids are wood-borers and are called, on account of the fact that the thoracic segments are very broad while the rest of the body is slender and cylindrical, *Flat-headed borers*. This designation separates them from other beetle larvæ which bore in wood. Some important orchard and forest-tree insects belong here. Among these may be mentioned the *Flat-headed Borer* and the *Red-necked Cane-borer*. (See page 294, Part II.)

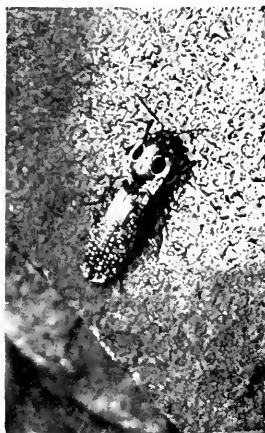

FIG. 81.—The “Eyed Elater” (*Alaus oculatus*). (After W. E. Rumsey.) Reduced one-half.



FIG. 82.—Flat-headed Wood-borers, Larvæ of *Buprestidæ*.

the *Red-necked Cane-*



FIG. 83.—Types of Beetles
(*Scarabidae*).

72. The Fireflies, Lightning-bugs or Lantern-bugs (*Lampyridæ*), differ from the other families in the group in that they are soft bodied and have soft elytra. The under side of the posterior abdominal segments of some species is luminescent and gives off flashes of light when the insect flies or even when it is at rest. As they fly at night they are quite conspicuous and attract attention. They form the basis for many superstitions. In the tropics are found many luminous species of this family as well as some Homopterous insects which have similar light-giving properties. There are many Lampyrids which are day fliers and not luminous. Among these are the soldier-beetles, slender, yellow beetles, marked with black, about five-eighths of an inch long, which are extremely abundant on goldenrod and other late summer flowers.

73. Lamellicorn Beetles. Two families called lamellicorn beetles have antennæ with clubs formed of thin, plate-like structures or lamellæ; hence the

name. The two families agree in being composed of large-sized beetles with stout bodies. There are, however, many quite small species.

Scarabæidæ. Most of the lamellicorn beetles belong to this family. The best-known species are large, but many more are small. Their stout, oval bodies and their antennæ, on which the plates forming the club fit close together like one piece, distinguish them from other beetles.



FIG. 84.—Rose-chafers (*Scarabæidæ*), on Apple-Leaves. Reduced one-half.

The number of species is large and their activities varied. The larvæ are fleshy, white, strongly curved grubs and live, for the most part, in the soil.

The group of Scarabæids embraces species which are scavengers. Some of these feed on animal matter, but the more common ones live in or about decaying vegetable matter and the excrement of domestic animals.

The most interesting of these scavengers are the *Tum-*



ble-bugs. These form balls of manure in which they lay their eggs, and which they roll off to some safe place and conceal in the earth. Related species make holes in the ground under a pile of manure and fill these holes with manure in which they lay their eggs. The tumble-bugs are typical Scarabæids and one of them was the sacred beetle or Scarab of the ancient Egyptians. Quite a complex system of mythology was built up about the habits of this insect. The student will find it interesting to consult some standard encyclopædia and there get additional information regarding these myths.

There are no beetles of large size more abundant than those known as *June-bugs* or *May-beetles*. They represent a second group of

FIG. 85.—Types of Beetles.
Three-fourths natural size.

a, Rhinoceros-beetle (*Scarabæidæ*):
remaining figures, stag-beetles (*Lucanidæ*).

Scarabæidæ. These common beetles are brown in color, oval in shape and from one-half to three-quarters inch in length. They appear in early spring and fly to the lights in great numbers. They do considerable harm to vegetation by eating foliage, in the adult stage, but it is as larvæ that they are the greatest nuisances. The common white-grub or "mully-grub" is the larval form of these insects. (See page 236, Part II.)

Rose-chafers or Rose-bugs are among the smaller Scarabæids. They are rather slender for this family and have comparatively long legs armed with many stout spines. Their larvæ resemble white grubs, but are smaller and flatter, although similarly curved. These larvæ live in the soil, where they do some damage, but the species commits the most of its depredations in the adult stage. The beetles appear about the time the roses bloom and injure them by eating both leaves and flowers. They are also pests of the grape, of apple and of a large number of our cultivated plants, mostly trees and shrubs, and will even eat the leaves of sassafras, which is generally avoided by insects. Rose-chafers are hard to kill, as arsenicals act on them slowly, and they may do most of their damage before the poisons cause their death. No remedy, other than spraying, has proven satisfactory.

Related to the rose-chafers are several species of *Flower-beetles*. One of these is green and brown in color and is called, in many parts of the South, the June-bug. It may more properly be termed the Southern June-bug. The flower beetles are more flattened than the other species we have considered. They are pointed toward the head and bluntly rounded at the posterior end. They frequent flowers and some of them fly with a loud buzzing noise and are so called *Bumble-beetles*. Another com-

mon leaf-eater is the *Spotted Pelidnota*. This is of a light brown color with a few round black dots on the wing-covers. It has much the shape of the June-bugs but is larger. It sometimes injures grapes by eating the foliage. Some very large beetles belong with the *Scarabæidæ*. Our largest species is the *Rhinoceros Beetle*. It is two inches long, very stout bodied, olive-green and black.

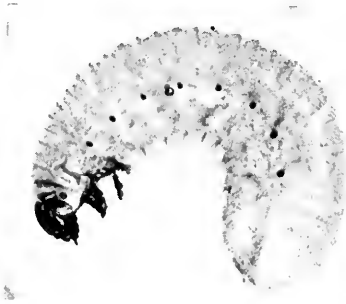

FIG. 86.—Typical “Lamellicorn”
Larva (*Lucanidæ*).

Two large horns are borne by the males, one on the head and one on the thorax, and these give the insect the appearance of a miniature rhinoceros. Related species in the West Indies are six inches in length.

Lucanidæ. The *Stag-beetles* compose the second family of the lamellicorns. They are a little more elongate and flattened than most of the *Scarabæids* and their antennal clubs are less compact. Their larvæ are similar, though usually larger, and are found in rotting wood. Males of some species have very strongly developed mandibles and are often called *Pinching-bugs*. There are few species and these are not important.

74. Cerambycidæ. These insects are called, as adults, the *Long-horned Wood-borers* and as larvæ, the *Round-headed Borers*. The adults are slender, elongate beetles with antennæ unusually long, sometimes several times as long as the bodies. They are among the most graceful and attractive of the beetles. They have tarsi that are ap-

parently four-jointed, the third joint being bilobed and the fourth joint almost concealed at the base of the lobes, and the fifth joint, which is longer, appearing to be the fourth. This character will not often be needed to identify members of this family. The larvæ bore in the solid wood of many trees and are often destructive. The *Round-headed Apple-tree Borer* and the *Locust-borer* belong here. (See page 292, Part II, and Fig. 211, page 293.)

75. Chrysomelidæ. The *Leaf-beetles*, as these insects are called, include many species, among which are a great number of the most destructive insects. They are small, usually rounded beetles. Some of them may be mistaken for lady-bugs, but the tarsi will distinguish them, as the tarsi in this family are the same as in the one preceding. The larvæ vary greatly in form. Some feed on the foliage of plants with the adults, others live in the soil and attack roots. The *Colorado Potato-beetle* is the best known and one of the largest of the Chrysomelids. (See page 276, Part II.) Many leaf-beetles have the hind legs strongly developed and are able to leap actively. These are the *Flea-beetles*. Different flea-beetles attack



FIG. 87.—Types of Beetles. Long-horned Wood-borers (*Cerambycidae*).

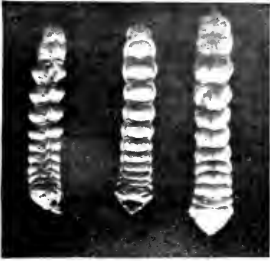

FIG. 88.—Round-headed Wood-borers, Larvæ of *Cerambycidae*.

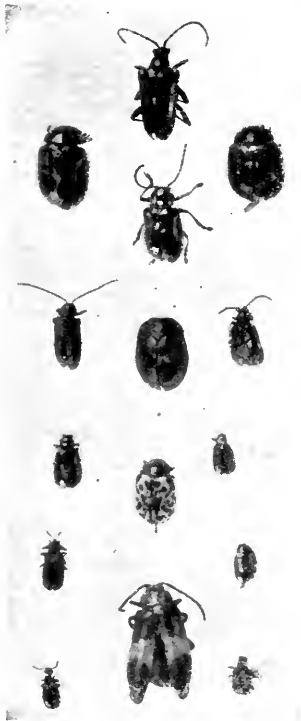

FIG. 89.—Types of Beetles. Leaf-beetles (*Chrysomelidæ*).

many crops. The small beetles attacking cucumbers (see page 272, Part II), and the one that works on asparagus are *Chrysomelids*. So is the *Elm Leaf-beetle*. One species works in the spring on apple foliage and later in the season on locust. Its larvæ mine in the leaves of the locust and the insect is called the *Locust Leaf-beetle*. It is brown with a black band down the middle of the back and is flatter than most of the leaf beetles, and somewhat wedge-shaped.

Bruchidæ include a few small species with tarsi like the *Cerambycidae* and with stout bodies and shortened wing-covers. Their larvæ feed within the seeds of peas, beans and other legumes. They will be recognized usually by their habitat. They are known as *Bean-* and *Pea-weevils*.*

76. Meloidæ. The *Blister-beetles* are soft bodied, elongate, cylindrical beetles with constricted prothorax and slug-

* See page 224, Part II.

gish movement. Some forms will blister the skin if crushed on it and this fact makes them of some value for medicinal purposes. These species supply the *Cantharides* or "Spanish-fly" of commerce. They feed on plants. The old-fashioned potato beetles are blister-beetles. Some kinds feed on clover and alfalfa, at times to such an extent as to be pests. Larvæ of blister-beetles have a curious and very complex development. First they are active and



FIG. 90.—Asparagus Beetle, type of *Chrysomelidæ*. Enlarged greatly.



FIG. 91.—A Blister-beetle or Oil-beetle, *Meloe*, sp. (*Meloidæ*). Twice natural size.

move about to search for the insect eggs upon which they feed. Later they attack different kinds of insects and become parasitic. They then become fleshy and sluggish. Some of them are of importance because they destroy grasshopper egg masses.

77. Tenebrionidæ. This family includes a considerable number of species, few of which are either important or conspicuous. The common name *Darkling-beetles* has been given to the family. The larger members resemble superficially the ground beetles, but have antennæ larger at the tip than at the base and have only four joints on

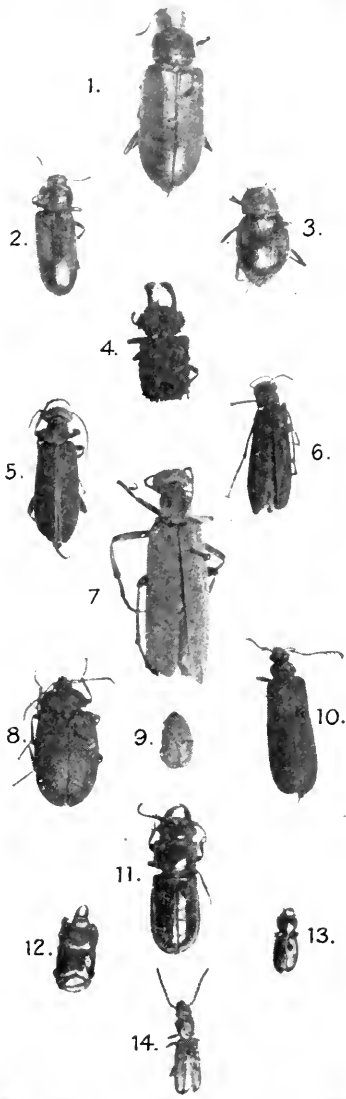

the hind tarsi. Most of these are found about decaying wood and under bark. Many species feed on fungous growths. A few Tenebrionids infest stored grains and grain products. The largest of these is the *Meal-worm*. It is nearly an inch long, slender and parallel sided and somewhat flattened. The meal worms themselves resemble wire-worms but are shorter and stouter and flattened on the under surface. They may be found in old feed bins where masses of partly spoiled grain have been left undisturbed. Some of the other grain beetles of this family are much smaller, about an eighth of an inch long, and are found in company with the saw-toothed grain beetle.

FIG. 92.—Types of Beetles.
Natural size.

1, 2, 3, and 4, *Tenebrionidae*; 5, 6, and 7, Blister-beetles (*Meloidae*); 8, *Melandryidae*; 9, *Lrucidae*; 10, *Pyrochroidae*; 11, *Spondylidae*; 12, *Histeridae*; 13, *Logositiidae*; 14, *Cucujidae*.

Several minor families of beetles, especially the smaller forms, are related to the Tenebrionids and may be found with them about fungi.

78. Rhynchophora. This suborder of beetles contains, as stated before, the *Snout-beetles*. These insects have the heads prolonged into more or less slender beaks on the tip of which are located the mouth-parts. The antennæ are frequently elbowed and are attached to the snouts. They have other more obscure points of difference from the other beetles. Several families of snout-beetles are recognized. Of these we will mention only the more important.

Curculionidæ. Most of the insects known as *Weevils* belong here, although the term weevil may be applied to certain others without impropriety. A better common name is *Curculios*. The curculios have snouts which are mostly long and slender but may be short. It is difficult to describe them so that the beginner may recognize them, although the family is of the greatest economic importance.

The *Plum-curculio* (see page 299, Part II), one of the worst insects that attacks fruits, the *Nut-weevils*, several species of which, belonging to the genus *Balaninus*, are found in chestnuts, hickory nuts, acorns and other native nuts,

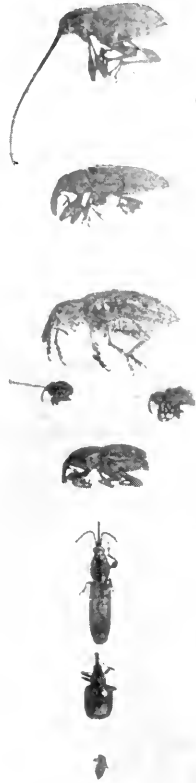

FIG. 93.—Types of Snout-beetles (*Rhynchophora*). Slightly enlarged.

1, 2, 3, 4, and 5, *Curculionidæ*; 6, *Cotandridæ*; 7, *Brenthidæ*; 8, *Rhynchitidæ*; 9, *Scolytoidea*.

the *Apple-weevil*, the *Apple-curculio*, the *Strawberry-Weevil*, the *Mexican Cotton Boll-weevil*, see page 259, Part II, an insect that invaded the Southern States by way of Mexico and has injured the cotton-growing industry of that region more than any other one factor, and the *Alfalfa-weevil*, also an importation, at present confined to some of the Rocky Mountain States, but a menace to the alfalfa crops of the country in future years, are all *Curculionidæ* and

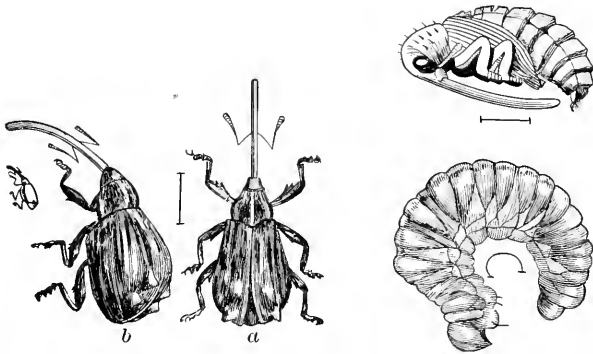

FIG. 94.—The Apple Curculio, Showing Different Stages (*Curculionidæ*). Enlarged. (After Riley.)

will serve to suggest the extent of the ravages of this family.

Calandridæ. The *Bill-bugs*, as the Calandrids are commonly named, include fewer species than the preceding family, but some are quite important. The most familiar examples are the common *Granary-weevils*, small, slender, brown beetles with rather prominent snouts curving forward and downward from the heads. These are everywhere found in stored grains. There are two species, one being called the *Rice-weevil*, but they are similar in appearance and habits.

In the Middle West, especially in muck lands, larger bill-bugs injure corn. They are nearly a half inch long and rather stout bodied, and are commonly called *Corn-Bill-bugs*.

Scolytoidea. This super-family, formerly classed as a family, includes a great number of species of small insects that attack and destroy shade, forest and fruit trees by boring between the bark and the wood. They are called the engraver-beetles because of the patterns on the wood made by their galleries. These can easily be seen by removing the bark from an infested branch. Another common name is the bark-beetles. The *Fruit-tree Bark-beetle* (page 291, Part II), is the best-known example. On account of the numerous small round holes which the emerging beetles make in the bark of an infested tree this insect is better known as the *Shot-hole Borer*. The group is, without doubt, the most important



FIG. 95.—Engraver Beetles (*Scolytoidea*). Work of these forms is shown in Fig. 96. Enlarged.

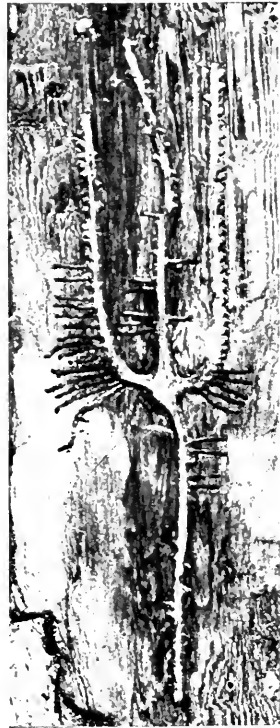

FIG. 96.—Work of Engraver-beetle (*Scolytoidea*).

of all insects from the standpoint of the timber industry. Some members of the bark-beetle family have other habits, as one which lives on the roots of clover.

TABLE FOR THE IDENTIFICATION OF THE MORE COMMON FAMILIES OF BEETLES

COLEOPTERA

- A. Heads prolonged into distinct snouts bearing the mouth-parts on the tips. **Snout Beetles.** *Rhyuchophora.*
- AA. Heads not prolonged into snouts.
 - B. Aquatic beetles, legs fitted for swimming.
 - C. Palpi longer than the antennæ; a keel-like structure frequently found on under side. *Hydrophilidæ.*
 - CC. Palpi not longer than the antennæ.
 - D. Eyes divided into two parts. *Gyrinidæ.*
 - DD. Eyes not divided. *Dytiscidæ.*
 - BB. Not aquatic in habit.
 - C. Found mostly on the ground, concealed under rubbish or running in the open.
 - D. Legs slender, antennæ thread-like.
 - E. Front vertical, mandibles pointing downward. *Cicindelidæ.*
 - EE. Front horizontal, mandibles pointing forward. *Carabidæ.*
 - DD. Legs usually shorter and stouter, antennæ not thread-like.
 - E. Scavenger beetles, found about decaying animal or vegetable matter.
 - F. Bodies slender, wing-covers very short. *Staphylinidæ.*
 - FF. Bodies stouter, wing-covers medium to long.
 - G. Antennæ gradually enlarged into a club or with sharply rounded, compact knob. *Silphidæ.*

- GG. Antennæ with club made of flattened plates, lamellate.
- H. Plates of antennal club separated.
Lucanidæ.
- HH. Plates of antennal club appearing as one piece. *Scarabæidæ*.
- EE. Not scavengers. Feeding usually on vegetation.
- F. Antennæ lamellate. *Lucanidæ* and *Scarabæidæ*, as above.
- FF. Antennæ not lamellate.
- G. Antennæ saw-like. Bodies usually slender oval.
- H. Body rather soft. *Lampyridæ*.
- HH. Body extremely hard.
- I. Pro-thorax with angles projecting backward and with process on prosternum projecting backward into groove on mesosternum.
Elateridæ.
- II. Pro-thorax generally narrowed slightly; surface of body less even than in previous family.
Buprestidæ.
- GG. Antennæ not saw-like.
- H. Tarsi with three joints easily seen. Small, oval, nearly hemispherical, black or yellow, red and orange mixtures. *Coccinellidæ*.
- HH. Tarsi with more than three visible joints.
- I. Tarsi with four visible joints.
- J. Antennæ usually longer than body. Medium to large in size, slender. Wood borers.
Cerambycidæ.
- JJ. Antennæ of normal length.
- K. Short, oval, seed-infesting species, usually found

in beans and peas. (Wing-covers short.) *Bruchi* 'æ.

KK. Usually small, oval or more slender. On foliage of plants. *Chrysomelidæ*.

II. Hind tarsi with four joints; front tarsi with five.

J. Bodies soft, cylindrical; prothorax narrowed. *Meloidæ*.

JJ. More flattened, harder bodies; dark colors; found on ground and in fungi. *Tenebrionidæ*.

CHAPTER XI

DIPTERA

79. General Characteristics. The flies (*Diptera*), constitute one of the six major orders. They have two wings, and sucking mouth-parts and they develop indirectly. The larvæ of most flies are called maggots. Flies have, in the place of hind wings, a pair of more or less conspicuous knobbed threads or balancers called *halteres*. Different common names are applied to many flies and groups of flies. Mosquitoes, gnats, midges, etc., are among these names. Many groups of flies have mouth-parts capable of piercing or "biting" the skin of animals. Mosquitoes and horse-flies are notable examples. Many other forms can eat only exposed liquid food, the sucking tube ending in soft flaps. Few adult flies attack vegetation but many feed on the nectar of flowers.

80. Importance to Man. Flies are important to man in a rather different way than most other insect pests. While many species attack growing crops and various food products, usually in the larval stage, their greatest importance comes from the fact that they attack man and domestic animals directly in the adult stage. In this way they cause not only great annoyance and economic loss, by rendering certain regions practically uninhabitable for civilized people, but even greater loss by carrying the organisms, which cause certain diseases. Some are parasitic on domestic animals and inflict much injury in this way. The discovery of the disease-carrying powers of many species

that were previously considered as merely annoying pests has opened up a new field in the study of insects known as Medical Entomology.



FIG. 97.—House-fly (above) and Stable Fly, Showing Lapping Mouth-parts and Piercing Beak. Enlarged.

81. Fly Larvæ. Fly larvæ are footless and sightless but fairly active in spite of these handicaps. They feed to some extent on growing plants, either on or in the roots, foliage, or fruit, but by far the larger number of them are scavengers, feeding on decaying animal and vegetable matter of every description. Some fly larvæ grow with extraordinary rapidity. This is especially true of the forms that feed on dead animals, probably

because the decaying flesh remains in a condition fit for food for a limited time only.

82. Classification. The classification of the Diptera is difficult for the beginner. This is largely because a use of most of the descriptions and tables for the order, involves wing-venation characters which are usually rather complicated and will not be considered here. It is somewhat difficult to characterize even the more common families so that the beginner can easily distinguish them. For this reason no attempt will be made to de-

scribe any but the most common and easily recognized forms.

83. Culicidæ. The *Mosquitoes*, which form this family, may be recognized by their slender bodies, long legs and by the fringes of scales which occur on the margins of the wings and on the wing veins. They are rather below the medium size although there are many flies which are much smaller. The habits of the common forms are well known. One species is directly and solely responsible for the transmission of yellow fever from one person to another, and the members of the genus *Anopheles* are responsible for the spread of malarial fever. Other species have to do with the transmission of several tropical diseases of man and animals.

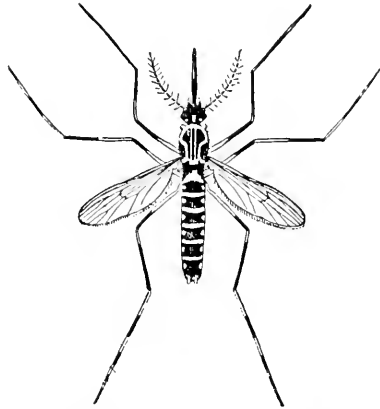

FIG. 98.—The Yellow-fever Mosquito (*Culicidæ*). (After Howard, U. S. Dept. Agr.) Greatly magnified.

Mosquito larvæ may be found in the water, usually, but not always, in stagnant water. They are commonly called wrigglers and may breed in any stagnant water, even in what may be caught by an empty tin can in a back yard. (See page 183, Part II, for a further discussion of mosquitoes.)

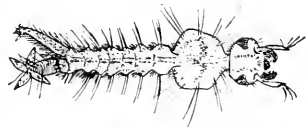

FIG. 99.—Mosquito Larva or "Wriggle-tail" (*Culicidæ*).

Mosquito larvæ may be found in the water, usually, but not always, in stagnant water. They are commonly called wrigglers and may breed in any stagnant water, even in what may be caught by an empty tin can in a back yard. (See page 183, Part II, for a further discussion of mosquitoes.)

84. Gnats and Midges. Several families of mosquito-like flies are variously spoken of as *Gnats* and *Midges*.

They are usually smaller than the mosquitoes and lack the fringes on the wings. Some of these are fungus eaters and are known as *Fungus-gnats* (*Mycetophilidæ*); others are largely plant eaters in the larval stage and form swellings or galls in the stems of their food plants. These are called *gall-gnats*.

Cecidomyiidæ.

To this family belongs the *Hessian-fly* (see page 250, Part II). Other families of gnats and midges include forms that attack man and domestic animals and are serious pests at

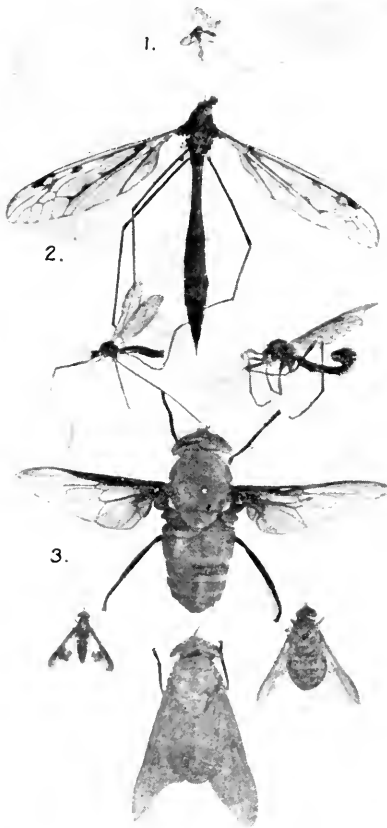

FIG. 100.—Types of Flies (*Diptera*).

1, A mosquito (*Culicidæ*); 2, Crane-flies (*Tipulidæ*); 3, Horse-flies (*Tabanidæ*).

certain seasons in some localities, particularly the far North.

85. Tipulidæ. The *Crane-flies* are not of great importance but deserve mention on account of their abundance, their

large size, and their peculiar form. The larger species are unmistakable. They have bodies resembling those of mosquitoes but with abdomen less regular in shape and they have extremely long legs. They fly over meadows and through underbrush in partially wooded tracts and are most numerous in the warm days of late fall. It is next to impossible to secure specimens with the full complement of legs, since they are so loosely attached that the least touch serves to detach them. Crane-fly larvæ live in the soil and are said to be injurious to the roots of plants in the Western States.

86. *Asilidæ*.

This is another family which includes many large species.

The common name for them is *Robber-flies*. They have slender, tapering, humpbacked bodies and rather short and stout legs. They are predaceous and capture and kill other insects of many kinds, frequently overpowering and eating grasshoppers twice their size. The beginner may not distinguish robber-flies from certain

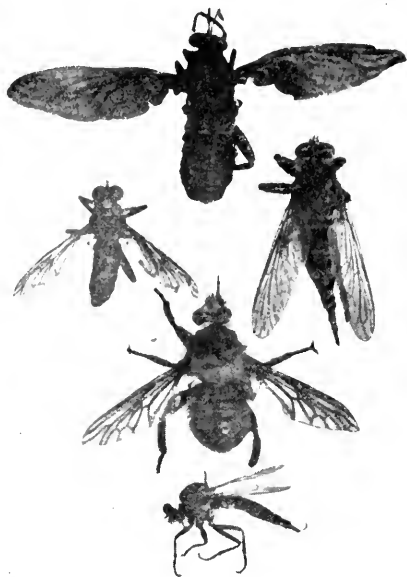

FIG. 101.—Types of Flies. Above, a Midas-fly (*Midaidia*). Lower figures, robber-flies (*Asilidæ*). Slightly reduced.

other large flies, the Midas-flies (*Midaidæ*), which are, however, less numerous in species and individuals.

87. The Horse-flies. *Tabanidæ*. The mosquito form and its modifications may be taken as the type of one group of fly families. The other type is represented by the horse-flies. They have broad, short and rather flat bodies and short legs. They are medium to large in size and have exceedingly powerful flight. They may oftentimes be noticed circling easily around a horse in full gallop. While few definite characters other than those of wing venation can be cited to identify the horse flies, it may still be noted that they give the impression of having firm bodies of regular outline, the abdomens taper usually to a blunt but definite point, and the hind angles of the large compound eyes are usually slightly produced backward forming an angle and giving the hind margin of the head a strongly concave shape. The larvæ live in wet soil or in the water.

Many species are annoying to horses* and cattle and even to man. Some are called *Ear-flies*, some *Gad-flies*, this name being applied also to some of the bot-flies, mentioned later, and one small species with banded wings is called the *Shad-fly*, or the *Deer-fly*, and frequently annoys man in low, wooded regions near the water.

88. The Black-flies, so-called (*Simuliidæ*), are intermediate in form between the mosquito-like type and the house-fly type, having fairly slender bodies and short legs. The family includes several species which attack man and may be very annoying, and also some species that attack domestic animals and poultry. The *Buffalo-gnat* and the *Turkey-gnat*, both well known in the South in the regions which they infest, are examples of forms having the latter habit. They inflict severe losses in the

* See page 200, Part II.

infested regions. Members of this family will be known to beginners rather by habits than by structures.

89. Bee-flies (*Bombyliidæ*), and the **Soldier-flies** (*Stratiomyidæ*), frequent flowers. The latter are not always abundant, but are often noticeable on account of their bright color markings. Yellow and green bands and stripes are common in this family. The soldier-flies are of small to medium size. Their larvæ are usually aquatic. The bee-flies present many variations. Some species are quite hairy, many have very long beaks and feed on nectar. Banded wings are also characteristic of many bee-flies. The habit

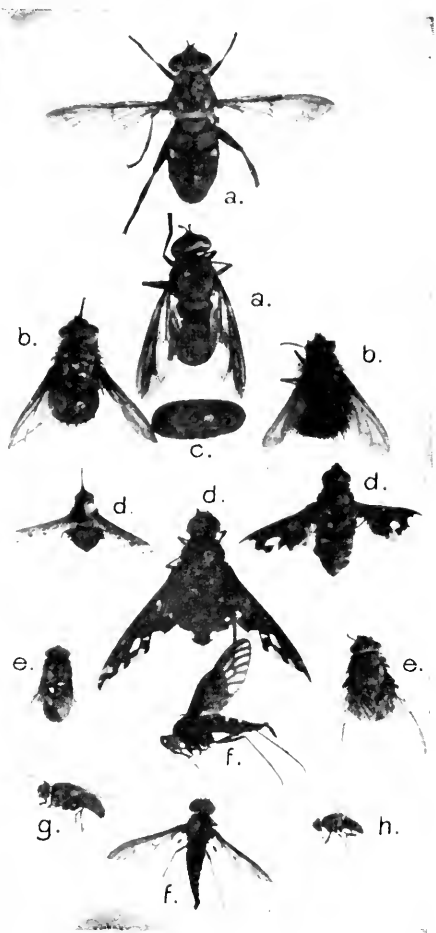

FIG. 102.—Types of Flies (*Diptera*). Natural size.

a, *Syrphidæ*; b, *Tachinidæ*; c, Puparium of *Tachinidæ*; d, Bee-flies (*Bombyliidæ*); e, *Muscidæ*; f, Snipe-flies (*Leptidæ*); g, House-fly, and h, Stable-fly (*Muscidæ*).

of hovering or remaining poised in the air is well developed here but should not lead one to mistake bee-flies, for some of the *Syrphidæ* which have a similar habit. Bee-flies, and certain syrphus-flies as well, mimic some of the bees and wasps.

90. Snipe-flies (*Leptidæ*), are not of great importance, but may be mentioned because of a few of the more abundant forms. These have bodies shaped like those of mosquitoes but much larger and heavier. The legs are relatively short and the wings, while narrow, are powerful. One species which is usually common has the top of the thorax clothed with thick orange yellow or golden hairs.

91. The Syrphus-flies (*Syrphidæ*), as these are commonly called, are very numerous and have many different forms. They present a greater number of bee-like forms than do the bee-flies themselves. Some resemble bumblebees very closely; others look more like the honey-bee, one species being known as the *Drone-fly*, on account of the similarity. The typical members of the family are of small to medium, or even large size, have flattened and rather broad bodies, and colors usually, at least in part, yellow or green or both. They hover or poise in the air, sometimes over flowers or other food, more often apparently over nothing in particular. Some species bite animals and man and are called *Sweat-flies*. They are often confused with sweat-bees, which are, properly, true bees and sting, while the sweat-flies pierce the skin with their mouth-parts. The wound from the fly bleeds slightly, while the bee sting does not. Larvæ of syrphus-flies are, many of them, predaceous, feeding on plant lice. These larvæ have bodies tapering toward the heads, slightly flattened and scalloped along the margins. They may be green with yellow markings. Other syrphus-fly larvæ are entirely different. The

larva of the drone-fly is aquatic and is known as the "Rat-tailed Maggot," on account of the long, tail-like breathing tube. They may be found in masses in stagnant water. The family, as a whole, may be considered as beneficial.

92. **Bot-flies, Warbles, Gad-flies or Heel-flies** as the *Æstridæ* are variously called, are parasites of domestic and wild mammals. The adults are usually hairy and somewhat bee-like. The best-known adult is probably that of the *Horse-bot*, which lays its eggs on horses in late summer and always causes the animals attacked to become excited. Other species attack sheep and cattle. (See page 191, Part II.) This family includes most of the insects which are internal parasites of the higher animals.

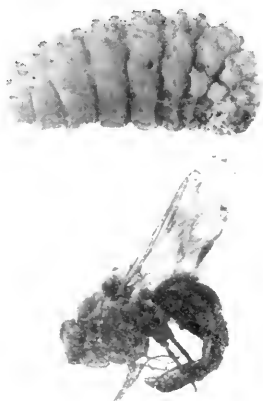

FIG. 103.—Above, Larva of the Ox-warble; below, Horse Bot-fly. Slightly enlarged.

Hippoboscidæ. These insects are external parasites, in the adult stage, upon mammals and birds. They are either winged or wingless, usually the latter, and have flattened, louse-like, bodies. The larval stages are passed within the bodies of the adult females and emerge from them only when fully grown and ready to transform to the pupa. The so-called *Sheep-tick* (page 202, Part II), is our most common member of this group.

93. **Muscina**. The largest and by far the most important group of flies includes those that were formerly

all classed as one family, the *Muscidæ*, of which the *House-fly* is typical. This family is now considered as a super-family and has been divided into several families. Some of these it will be well to consider separately.

The *Tachina-flies* (*Tachinidæ*), are, for most part, parasitic on other insects. Their larvæ attack grasshoppers, many kinds of caterpillars and other insect forms. The adults are like the house-fly in general shape, but may be stouter bodied, are often considerably larger, and are usually clothed with short, stout bristles, especially prominent on the abdomen. As a whole this group is beneficial.



FIG. 104.—Parasitic Diptera. Enlarged.

1, Sheep bot-fly (*Estridæ*); 2, Louse-fly from hawk (*Hippoboscidæ*); 3, "Sheep-tick" (*Hippoboscidæ*); 4, Pupa of "Sheep-tick."

Flesh-flies (*Sarcophagidæ*), may be, as larvæ, either parasites or scavengers. Many have habits similar to the Tachinids while others feed on decaying animal matter. Flesh-fly eggs are often hatched within the bodies of the females, the young larvæ being born alive. Flesh-flies may be small, but are usually of medium size or larger.

Anthomyiids (*Anthomyiidæ*), are flies smaller in size than the average for the super-family. They resemble the common house-fly in conformation but may be more slender and bristly. The maggots feed on decaying or living vegetable matter. The ones attacking the roots of cabbage, onions, radishes and related crops are the most important forms. Dull colors prevail in this group.

The *Fruit-flies* (*Trypetidæ*) include numerous species

of small flies. They may be brightly colored and many of them have wings banded and spotted in a very attractive manner. Their bodies are slender and their legs inclined to be long. The larvæ feed on decaying or fresh fruit and some species are serious pests. Especially is this true of one called the *Mediterranean Fruit-fly*, which attacks certain sub-tropical fruits. Considerable sums of money are being expended to keep this fly from becoming established in the state of California.

Muscidæ. The typical Muscids are included in this family which is represented by the common *House-fly*, (see page 175, Part II), the *Stable-fly* the *Blow-fly*, *Horn-fly*, and many other common species. Larvæ of this group are the familiar maggots which may be found in decaying animal or vegetable matter of any description. They are white, taper to a point at the head end, and, though footless, are quite active. The pupæ are smooth, oval, or cylindrical with rounded ends. The family is important on account of the numbers of species and of individuals and the annoyance they cause man and animals, as well as for its part in the spread of many diseases. Some forms, notably the *Screw-worm Fly* larvæ, get into flesh wounds of animals and cause serious inflammation and even death. This insect is most abundant in the Gulf States.

[*Diptera*. On account of the great difficulty of identifying, with any degree of certainty, even the more important groups of flies without the use of minute characters of the antennæ and difficult structures of the wings, no attempt will here be made to formulate a table for the use of the beginning student. He will have to identify the more common forms by means of the descriptions and the figures accompanying them.]

CHAPTER XII

HYMENOPTERA

THE bees, the wasps, the ants and a host of other smaller insects comprise this order. It ranks second to none in its biologic and economic importance. In its

economic status it is rather beneficial than otherwise, which will be brought out later in the discussion of the different groups.



FIG. 105.—Swarm of Bees Clustered in Grape-vine.

94. General Characteristics. *Hymenoptera* have four wings, membranous throughout, which usually have few veins. With few exceptions the front wings are the larger. A row of hooks on the hind wing, which fasten in a fold in the front wing, hold the two together so firmly that the beginner may easily mistake them for one wing. The mouth-parts of *Hymen-*

optera are formed typically for biting. In many instances there is also a modification of some parts of the mouth to form a sucking tube. Many of the best-known members of the group have this adaptation. Development

is indirect. The larvæ of all but two groups of Hymenoptera are footless, usually fleshy, white, grub-like, creatures. Some of the exceptions are caterpillar-like, but may be known by the fact that they have more than five pairs of pro-legs. Where the larvæ are helpless they are either cared for by the adults until they are fully

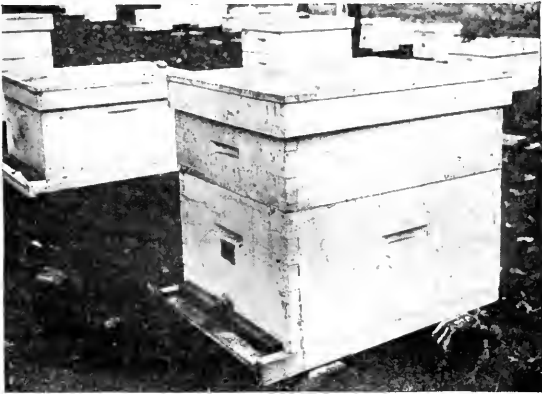

FIG. 106.—A Modern Bee-hive Supported on Hollow Tiles.

grown or the eggs are placed in or on the food, and left there.

95. Sub-Orders. There are two sub-orders. In one, the females have the ovipositor modified into a stinging organ. In the other, the ovipositor is fitted for boring plant tissues to deposit the eggs and is not used as a weapon. The one sub-order is called the *Stinging-Hymenoptera* or *Aculeata*; the other, the *Boring-Hymenoptera* or *Terebrantia*.

96. The Stinging Hymenoptera. All the commonly observed members of the order are classified in this sub-order. While they are all properly called stinging *Hy-*

menoptera it must be understood that there are many forms in the group which do not sting or possess stinging organs. All the members of this division, except two little known and rather rare families, are placed in four super-families, each one including several families. They will be considered here under the super-family headings.

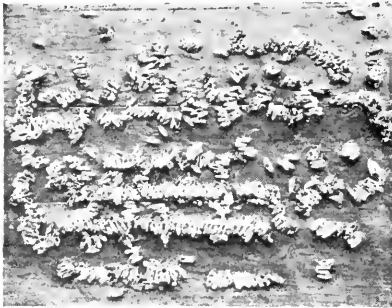

FIG. 107.—Cocoons of the Bee-moth in the Top of a Hive (*Lepidoptera*, *Pyralidina*).

97. Apoidea. This group includes all the *Bees*. There are several families, but they have many characters in common. Bees may almost always be recognized as such, even by the beginner, by the conformation of the body. In addition to this, most of them have the basal segment of the hind

tarsus flattened and armed with hairs and bristles, and adapted for carrying pollen. Bees are generally stouter bodied than the wasps and are frequently hairy. The bodies are commonly more flattened than is the case with the wasps. The habits of bees vary considerably. Many are social, but a much larger number of species is solitary in habit. Most bees feed on pollen and nectar secured from flowers, and on such other sweet substances as they may find.

The most common of the social bees is the hive-bee or *Honey-bee* (*Apis mellifera*), which occurs throughout the civilized world in a domesticated condition. Its habits and social organization have been more widely studied

than those of any other insect and volumes have been written concerning it. There are three different classes of individuals in a bee colony; the true males, called *drones*, the fully developed females or *queens*, and the *workers*, which are females not fully developed sexually. In a colony there is one queen, a varying number of drones, and in a strong swarm, many thousand workers. The drones serve no purpose aside from the fertilization of the queens and they are produced in numbers far in excess of the needs for this function. The queens lay the eggs for the production of workers and other queens while unfertilized queens and workers produce eggs which develop into drones.

The workers do all the work of the colony, build comb, gather nectar, pollen and certain other substances used in the hive, and care for the larvæ or brood. They keep the hive clean and also regulate the temperature somewhat by "fanning" with their wings. From the nectar they manufacture honey and wax.

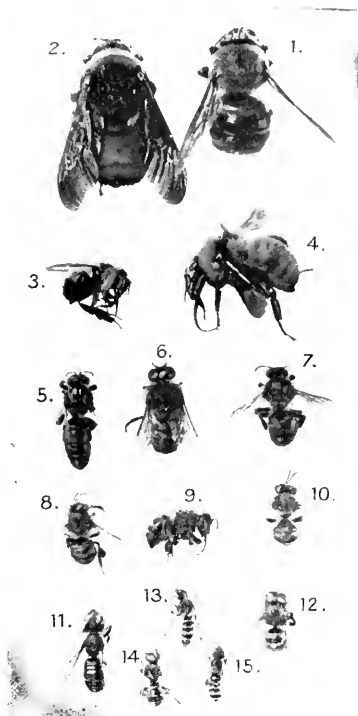

FIG. 108.—Types of *Hymenoptera* Bees (*Apidae*). Enlarged.

1, Carpenter-bee; 2, 3, 4, Bumblebees; 5, 7, Honey-bee, queens; 6, Drone-bee; 8, 9, 10, workers; 11-15, Solitary-bees.

Queens are produced from eggs which are just the same as those which normally produce workers. The larvæ destined to form queens are fed with a specially prepared food called "royal jelly" and the cells in which they develop are altered to suit the needs of the larger individual. When a new queen emerges in a hive she may be killed by the old queen or may herself kill the old queen. Fre-



FIG. 109.—A Cut Bee-tree, Showing Combs in the Cavity.

quently, however, neither is killed but the old queen leaves the hive and takes with her a large number of the workers. These find a suitable situation and form a new colony. The division of a colony in this manner is called *swarming*. Queen raising, swarming and other operations of the colony are done artificially by the modern bee raiser or apiculturist.

Bees, especially honey-bees, are important not only for

the commercial products, honey and beeswax, which they furnish, but, to a much greater extent, because of the part they play in the fertilization of flowers. Many of the valuable cultivated plants do not set fruit or produce seed properly where there are not enough bees to provide for their fertilization. Many flowers have remarkable adaptations of structure to insure pollination by the bees. Honey-bees are found wild in all the countries where the domestic bees have been carried, as escaping swarms live in hollow trees or caves. In South America there are found honey-producing bees which do not sting. This apparent advantage is minimized by the fact that they defend themselves by biting.

Bumble-bees or "Humble-bees" are larger and more hairy than the honey-bees and differ somewhat in their social organization. Only the queens live through the winter. They start the new colonies in the spring and do all the work of the colony until such time as the workers develop. Their nests are usually built on the ground or under stones and are concealed with grass and weeds. Their honey is stored in small oval sacks and is not used commercially. There are workers and males and, at times, several queens in one nest. The queens are the largest individuals in the nests and are much more active than the honey-bee queens. The over-wintering females are fertilized in the fall.

Bumble-bees are able to cross-fertilize certain plants whose flowers are too deep for the shorter tongues of the honey-bees to reach. A common plant of this type is the red clover.

Some bees bore in solid wood and make their nests in the galleries which they construct. These are solitary. One borer (Fig. 108, 1), or *Carpenter-bee*, resembles the

bumble-bees in size and general appearance. Other bees dig burrows in the ground, mainly in the sides of steep banks. Such bees are solitary, in the strict sense of the term, but frequently a bank will contain the burrows of hundreds of these bees. Some of the miners form colonies, all members of which use one entrance to the nests, the nests being separate for each individual. Professor Comstock likens the abodes of the two classes of miners here mentioned to villages of many separate houses and to city apartment houses with many dwellings in one house. There are bees which have a semi-parasitic habit, the females laying their eggs in the nests of other bees and leaving them to be cared for by the "hosts." These are termed "guest-bees" or *inquilines*.

While we are accustomed to consider the economic status of insects from the standpoint of the damage they may do, the consideration of the fact that the bees are indispensable to the production of many of our most valuable crops, should show us that insects, as a whole, are indispensable and make us more tolerant of the injurious species, if it be necessary that we have both kinds to have the beneficial ones.

98. True Wasps. Wasps (*Vespoidea*) are distinguished from bees by the tarsi, which are not fitted for carrying pollen, and by the more slender forms of most of the species. They are separated from the next group (digger-wasps) by the resting position of the wings. In the true wasps the front wings at rest have one longitudinal fan-like fold; in the digger-wasps the front wings are not folded.

Some of the true wasps are social and resemble the bumble-bees almost exactly in their social organization. All the insects commonly called *Hornets* and *Yellow-jackets* are true wasps.

The social wasps make nests of a substance closely resembling paper which is formed from wood pulp as is paper. These nests may be of many forms and may be found in different situations. The most common ones are found about houses. They are roughly circular, consist of a single layer of cells opening downward and are attached to a ceiling, or to some overhanging structure that will afford a degree of protection, by a single stalk. The wasps that make these nests are brown in color, more than an inch long and of rather slender and very elegant form. They belong to the genus *Polistes*. Other social wasps make nests composed of several layers of cells, all enclosed by an outer wall, the whole structure being oval in form and gray in color. Some of these nests, made by the insects best known as yellow-jackets, are found in the woods, attached to limbs of trees. Others, made by hornets, may be found either on trees or on the ground, or



FIG. 110.—Types of *Hymenoptera*. Three lower figures, Ants (*Formicoidea*); others, True wasps (*Vespoidea*). Slightly reduced.

even under stones or in cavities in the ground. Hornets and yellow-jackets are well known for the fighting propensities they display when their nests are disturbed and for the effectiveness of their stings. They belong to the genus *Vespa*.

Solitary wasps belonging to this family have many forms of nests. Some of the most interesting of these are



FIG. 111.—Underground Nest of Hornet (*Vespa*).

made of mud and attached to twigs and to stems of plants. They are shaped like miniature jugs and often are almost perfect in their molding. Each contains a single larva. Still other wasps have nesting habits like some of the solitary bees, being miners, wood-borers or carpenters, making nests of bits of vegetation and pieces cut from leaves. Most solitary wasps feed on nectar and pollen, but provision their nests with insects or feed the young directly with other insects. The same is true of the social wasps.

99. Sphecoidea. The *Digger-wasps* include a considerable number of families. They have similar food and nesting habits. All are solitary, most forms are miners and construct their nests in the ground but some live in the stems of plants.

Nests of digger-wasps are provisioned with insects or with spiders, which have been stung by the wasps until they

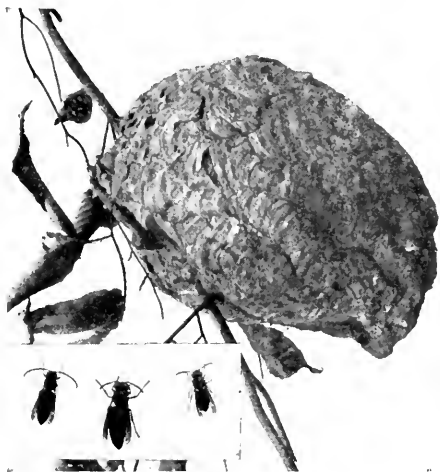

FIG. 112.—Hornets and their Nest.

are in a comatose condition. They live until the larvæ are ready to use them as food. In this manner fresh food is provided. One family of these wasps preys almost exclusively on spiders; others prefer different kinds of insects; one large species captures cicadas or harvest-flies and is known as the cicada-killer.

To the digger-wasp family belong the *Mud-daubers* or *Mud-wasps* and the *Thread-waisted Wasps*, also usually mud-masons. Their nests, in and near houses, especially in chimneys, are well known to all.



FIG. 113.—Types of *Hymenoptera*.
Digger-wasps (*Sphecoidea*).
Slightly reduced.

100. Ants. (*Formicoidea*.)

The ants are best known as wingless creatures because it is only at certain times in the year that the winged individuals appear. These winged forms are the true males and females. They mate, found new colonies and either die or lose their wings. In spite of the fact that ants are almost invariably small insects, and, while numerous, not more so than many other forms of equal size that escape attention almost entirely, they are, on the contrary, among the best known of insects and have received much more study than any other forms except, perhaps, the bees. The reason for the existing general interests in ants is, without doubt, their social habit and communal organization. Of nearly three thousand described species, none is known to be solitary.

In the ant colony are found several kinds of individuals; the males and females, the workers and the soldiers.

Workers are infertile females not fully developed. There may be different sizes of workers, the soldiers themselves being workers with greatly developed heads and jaws. Ants have a wide variety of food habits and live in greatly different situations. Some burrow in the ground, others in wood; some construct nests on the stems of plants. Many ants are almost omnivorous, but most species have a weakness for sweets of all sorts. This fact often renders them very annoying and destructive in dwellings. Some ants are farmers or harvesters. They are often called agricultural ants and are popularly, but erroneously, supposed to plant the crops which furnish their food. Several ants have the habit of making slaves of the workers of other species. In some the slave-making habit is of such long standing that they have forgotten how to care for their own nests, and when they cannot obtain slaves they perish.

Much has been written about the communal organization found in ant colonies and many writers ascribe to ants intelligence of a human order and altruism of an even higher degree. Undoubtedly, ants do possess very highly developed instincts; their colonies are well organized and their daily functions are performed in a most efficient manner. At the same time there is, in the mind of the writer, ample proof that the first gleams of anything that may be called intelligence has yet to appear in any insect type. The basis for the assumption that ants possess intelligence has been the difficulty of explaining certain of their actions on the ground of instinct alone. There are other actions that are even more difficult to reconcile with the idea that these insects have the slightest intelligence, and added to that is the physiological reason of the lack of a structure comparable to the brain of the thinking animal.

Ants have, aside from their philosophical interest, a considerable importance as economic insects. Some are destructive to vegetation, others are indirectly injurious because of their assistance to plant-injuring aphids, still others are household pests and are injurious to foods and stored products. The injurious species are most prominent in tropical and sub-tropical countries, where it is often almost impossible to protect stored products from their attacks. Ant colonies, in houses, may be destroyed by the use of a poisoned syrup and they may be kept from tables and cupboards by so-called "Ant tape." (See page 219, Part II.)

101. Terebrantia. The *Boring Hymenoptera* may be known by the possession of two-jointed trochanters on the hind legs as well as by the lack of the sting in the females. They embrace many forms and their food habits are even more variable than their structures. They are roughly classed as plant eaters and as parasitic insects, but this classification is not entirely satisfactory, because some members of the parasitic groups attack plants. The plant-eaters include the *Horn-tails* or *Wood wasps* (*Siricidae*), the *Saw-flies* (*Tenthredinoidea*), the *Gall-flies* (*Cynipoidea*), and in part the *Chalcis-flies*, (*Chalcidoidea*). The parasitic forms are grouped as the *Chalcis-flies*, the *Ichneumon-flies* (*Ichneumonoidea*), and the *Proctotrypids* (*Proctotrypoidea*). Many members of these groups last mentioned are very difficult for anyone but a specialist to recognize.

102. Horn-tails and Saw-flies. The *Siricidae* or *Horn-tails* are named from the peculiar short, stout and prominent boring organ borne by the females. They are comparatively large in size, and have no constriction between the thorax and abdomen. The latter character

separates them from all other *Hymenoptera* except the saw-flies, and these do not have the boring organ. The larvæ are white and grub-like and bore in the solid wood of different trees, notably hickory, locust and the coffee bean. Not many species occur and these may easily be known by the description here given.

Tenthredinoidea. The *Saw-flies* have, at the most, a very slight constriction between the thorax and the abdomen. They have also rather flat backs and broad hind wings. The females have a short saw-like organ used to form a cavity for the reception of the eggs which are placed most within leaves or in growing stems. Saw-flies are variable in size, ranging from one-fourth inch to over one inch in length. The larvæ of saw-flies are caterpillar-like or slug-like. The slug-like forms

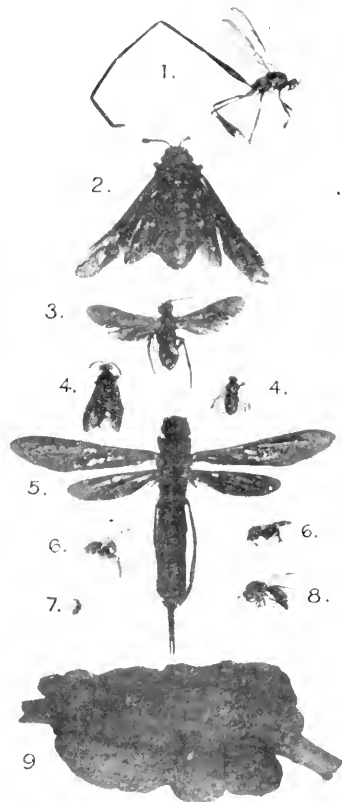

FIG. 114.—Types of *Hymenoptera*.
Slightly reduced.

1, *Pelecinus polyturator* (*Pelecinidae*); 2, 3, and 4, Saw-flies (*Tenthredinidae*); 5, Horn-tail or Pigeon Tremex (*Siricidae*); 6, 6, and 7, Gall-flies (*Cynipidae*); 8, Cuckoo-fly (*Chrysididae*); 9, Gouty-gall on blackberry, formed by gall-fly (7).

usually become more like caterpillars at their last molt. They have six to eight pairs of pro-legs. Their food is the foliage of plants. The slug-like forms have very short legs and are covered with a slimy substance. They are usually larger through the thoracic region and taper toward the tip of the abdomen. Many saw-fly larvæ have the curious habit of curling the tip of the abdomen forward and downward, often looping it partly around the twig or the edge of the leaf upon which they rest.

Important species of saw-flies are the *Imported Cur-rant-worm*; the *Pear-slug* (see page 316, Part II), which attacks pears and cherries, and skeletonizes their leaves, causing them to turn brown and fall off; the *Rose-slug*, similar to the pear-slug but smaller, and many species attacking shade and forest trees. Slugs may easily be killed with arsenate of lead or by dusting them with almost any dust.

103. Gall-flies. The gall-flies, *Cynipoidea*, form another of the highly specialized and unusually interesting groups which are found so frequently in this order. The adults are almost all small, often with metallic colors. They have the abdomen compressed laterally and somewhat telescoped. It is not by the adults, which are at best inconspicuous, nor even by the larvæ, but by the abnormal growths which the larvæ produce on plants, that our attention is attracted to this group of insects. Many dwellings are produced on plants by insects of other orders and all are known as galls. Some are caused by Diptera, the gall-gnats, some by small moths and many others by plant lice, but the great majority of galls are produced by members of this family. They are found on stems and leaves of oak, on hickory leaves, on rose twigs, on blackberry canes and on other plants. In form

they are extremely diverse. Some are globular, others cone-shaped and others irregular in shape. Eggs are laid by the female under the bark or in the leaf and the gall growths are induced, no one knows just how, by the presence of the young larvæ feeding in the plant tissues. Some gall-flies are parthenogenetic; that is, reproduce without males for one or more generations, and, in fact, there are species that are not known ever to produce males. Others exhibit a peculiar phenomenon called alteration of generations. First there will be produced a generation of both males and females. The young from these develop into forms that are all females and resemble in no way either of the parent forms. They may also produce galls in different plants and of widely different appearance. The appearance of the galls and the insects which form them sometimes deceives students of these forms and causes them to be classified in different genera from their parents. The next generation will, however, be composed of both males and females identical with the first individuals, their grandparents.

104. The Parasitic Hymenoptera or *Parasitica*. The remaining groups of Hymenoptera, while containing some non-parasitic forms, may best be studied as the so-called *Parasitica*, they being, for the most part, parasitic on other insects. They vary from large size, one species with its ovipositor being more than six inches long, to the smallest of insects, some being almost too small to be seen with the naked eye and developing within the eggs of insects which are, in the adult stage, themselves considered as very small species.

The larger *Parasitica* belong to the family *Ichneumonidæ*. These may be wasp-like in shape and size; they may have abdomens very much compressed later-

ally and have very long, thread-like ovipositors. The larger forms parasitize caterpillars and other larvæ and pupæ.



FIG. 115.—Parasitic *Hymenoptera*. Note parasitized cocoon and mass of pupæ. Reduced about one-half.

One, possibly the most remarkable form in the group, has an ovipositor several inches in length with which it bores through solid wood to deposit its eggs in the galleries of the horn tail-larvæ (page 154), which it parasitizes and kills. Members of the family *Braconidae* may attack caterpillars and, when full grown, form small silken cocoons on the outside of the body of the host. Others in the same family pupate within the host. One sub-family confines its attention almost exclusively to the plant-lice and scarcely a species of these insects

has not one or more parasites belonging to this sub-family.

In the super-family *Proctrypoidea*, we find the smallest of the parasites and among the smallest of insects. Here are found the egg parasites and some of numerous parasites of the scale insects.

Chalcis-flies (super-family *Chalcidoidea*), may parasitize species in many different groups, mainly of the smaller insects. They may infest scale insects and many egg parasites belong to this division.

Parasitic *Hymenoptera* of many of these groups may attack other parasites. In such case they are called secondary parasites. Secondary parasites may in turn

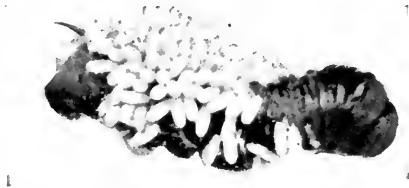

FIG. 116.—Sphinx Larva Parasitized by *Braconids*.
Pupæ attached.

be parasitized and their parasites are called tertiary parasites. It is thought that there are even quaternary parasites or forms that attack the tertiary parasites.*

In addition to the parasitic forms, there are some plant-infesting species belonging to the *Chalcis-flies*. These may be both beneficial and harmful. The *Wheat Joint-*

* “Big fleas have little fleas to bite 'em,
Little fleas have lesser ones, and so *ad infinitum*.”

“So naturalists observe, a flea
Has smaller fleas that on him prey;
And these have smaller still to bite 'em,
And so proceed *ad infinitum*.”

Swift. “A Rhapsody.”

“Great fleas have little fleas on their backs to bite 'em,
And little fleas have lesser fleas, and so *ad infinitum*,
And the great fleas themselves, in turn, have greater fleas to go on;
While these again have greater still, and greater still, and so on.”
DeMorgan, “A Budget of Paradoxes,” p. 377.

worm (*Isosoma tritici*), and the *Wheat Straw-worm* (*I. grande*) are both more or less serious pests to the wheat crop. Other species feed on seeds of plants before they ripen. One Chalcidid is beneficial because of its habit of feeding on figs of certain sorts. The structure of the fig is such that for cross-fertilization the presence of this insect (*Blastophaga grossorum*), is necessary. The females of the insect carry pollen from fertile blossoms of the "caprifig" to the infertile blossoms of the valuable Smyrna fig. The insects breed in the "caprifigs" and

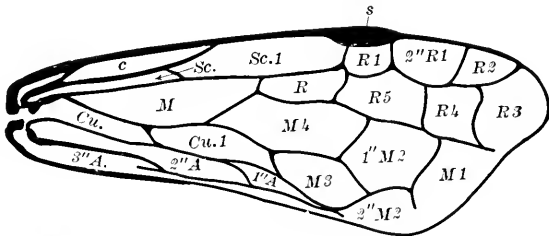

FIG. 117.—Wing of Hymenopterous Insect. Letters indicate names of the cells and of the veins on the anterior margins of the cells.

c, costa; Sc, sub-costa; R, radius; M, median; Cu, cubitus; 1''A, first anal; 2''A, second anal; 3''A, third anal; s, stigma.

merely visit the Smyrna figs while in search of suitable places for egg laying, but, as they often, in mixed groves, come from the pollen-bearing flowers, they carry pollen with them and in their activities within the infertile sorts, dust this into their flowers. The process is called "caprifigation." The discovery of the above facts and the importation and colonization of the *Blastophaga* in southern California has enabled growers there to produce Smyrna figs of the best quality where they were formerly unable to compete with the imported product. It serves as an example of the extremely varied problems connected with the science of entomology.

Chalcis-flies in plants often produce swellings and abnormal growths called galls, but these are not to be confused with the true Cynipid galls.

TABLE FOR THE DETERMINATION OF THE MORE IMPORTANT GROUPS OF

HYMENOPTERA.

- A. Abdomen of female provided with an organ for boring or sawing. Trochanters of the hind legs with two segments. Sub-order *Terebrantia*.
- B. Abdomen not at all or slightly constricted where it joins the thorax.
 - C. Abdomen of female furnished with a prominent boring organ. Mostly larger species. **Horn-tails.** *Siricidae*.
 - CC. Abdomen of females furnished with less prominent sawing organ. Usually smaller. **Saw-flies.** *Tenthredinidae*.
- BB. Abdomen constricted at the union with the thorax.
 - C. Wings almost entirely without veins in many species. Size small, colors often metallic; abdomen short. *Chalcidoidea*.
 - CC. Wings with more distinct venation. Size variable.
 - D. Abdomen very much compressed laterally segments usually appearing as if telescoped together. **Gall-flies.** *Cynipidae*.
 - DD. Abdomens more slender; fore wings without a stigma.* *Ichneumonoidea*.
- AA. Trochanters of the hind legs consisting of a single segment. Females often with a stinging organ.
 - B. With what appears to be a knot or hump on the petiole or stem connecting the thorax and the abdomen. **True Ants.** *Formicoidea*.

* See Fig. 117.

- BB. Without the knot-like structure on the petiole.
- C. First segment of the posterior tarsi hairy and adapted for carrying pollen. Bodies frequently hairy and rather stout. **Bees.** *Apoidea*.
 - CC. First segment of posterior tarsi not adapted for carrying pollen. Usually naked forms or with few hairs. (Exceptions are not rare.)
 - D. With the fore wings having a single longitudinal fold or pleat when at rest. **True Wasps.** *Vespoidea*.
 - DD. Front wings not folded when at rest. **Digger-wasps.** *Sphecoidea*.

CHAPTER XIII

THE INSECT COLLECTION

For the beginner as well as for the older student of entomology, the collection of insects is the most fascinating phase of the work. It necessitates getting out into the open. It develops the powers of observation and affords at the same time a profitable study and a never-failing source of amusement. And it need not be confined to the warm months. The winter insect fauna is extensive enough to furnish the excuse for many rambles over the snowclad landscape. Winter studies of insects are not only possible, but extremely necessary for the person who wishes to learn of insects not only in their active stages, but throughout their entire lives.

105. Collector's Outfit. The collector's outfit may be simple or elaborate. The one who learns to take and care for specimens with the simplest possible apparatus will be least likely to lose desirable specimens on account of lack of equipment. The first necessity is the killing-bottle. The standard killing-bottle is made of any wide-mouthed bottle into which is put a little pure potassium cyanide. *This substance is a deadly poison*, but no danger attends its use if its nature is borne in mind and the simplest care is exercised.

To make up a four-ounce cyanide bottle, pour a scant teaspoonful of small lumps of the cyanide into the bottle. Next, mix some plaster of Paris with water until it is just thin enough to pour readily. Cover the

cyanide in the bottom of the bottle with this. Allow the plaster to set and to dry thoroughly, place some absorbent paper loosely in the bottle and keep tightly corked to prevent its losing strength. This bottle will be effective for an entire season and cannot harm one who handles it unless it is broken. Discarded bottles should be buried.

In addition to the cyanide bottle one should have small boxes or tobacco tins for living specimens, others for the specimen taken out of the cyanide bottle, where they should be left only until they are certainly dead, and some tubes of alcohol or formalin in which to place specimens which are to be preserved in liquid. All larvæ should be taken alive or placed in the liquid, never in the cyanide jars. There should be several cyanide jars for the different types of insects. Moths and butterflies should be kept separated from other insects in the jars and not more than one or two specimens of these should go into the same jar at one time.

Any bag or knapsack in which a sufficient quantity of these materials can be carried safely is a good collecting bag.

Many collectors, especially beginners, think of the net as a most necessary part of the equipment. The experienced collector uses a net for comparatively few of his captures. Specimens which can be taken without the net are likely to be taken in better condition if it is not used. Experience alone will teach where it must be used. Satisfactory nets can now be purchased very cheaply, or they can be made at home. The requisites are: a bag of any light but strong material, from eight to twelve inches in diameter and from twelve to twenty inches deep; a strong metal ring firmly attached to a light handle not more than three feet long. Special nets

may be desired with longer handles. A large and strong clasp knife or, better, a sheath knife, may well complete the outfit for ordinary general collecting.

Experience, again, must teach where the insects are to be found. It should be borne in mind that there are few situations where some sort of insect life does not exist. Special equipment for collecting aquatic forms is required. This can always be improvised and no collection should be

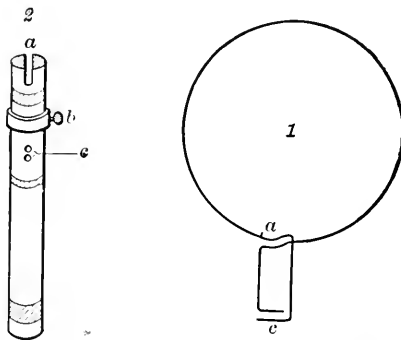

FIG. 118.—Design for Insect-net Frame.

1, Heavy spring-wire ring; 2, detail of end of handle; *a*, groove into which the wire at *a*, on figure of ring fits; *b*, clamp; *c*, holes into which ends of the wire at *c* on the ring fit.

considered representative which does not include the insect life of the near-by waters.

Electric lights are quite a prolific source of specimens for the collector, but they teach nothing of the habits of the insects except that they are attracted to lights and are night flyers.

106. Mounting Specimens. The equipment for mounting and preserving the specimens may, like the collectors outfit, be either simple or elaborate. For adult specimens pins are usually considered necessary, and a place to keep the pinned specimens is no less so. Insect pins must be

purchased but are fairly cheap and within the reach of all. Never try to mount specimens with ordinary pins. Aside from the pins nothing needs be purchased. Cigar boxes, lined with pith or corrugated pasteboard, make very satisfactory storage places for the beginner's collection and not a few insects in the larger collections are stored in such receptacles. From these one may go up the scale through the homemade boxes with either glass

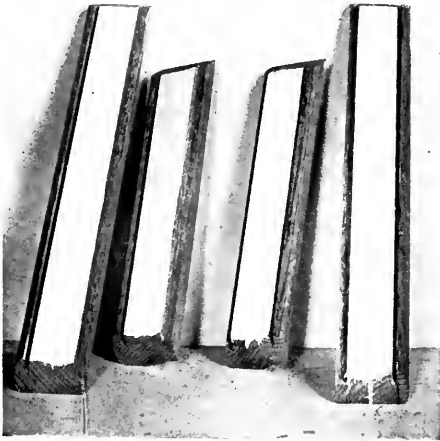

FIG. 119.—Details of the Frame Work for an Exhibition Case to be Made at Home or in the School Laboratory.

or wooden cover, the homemade or purchased cabinet, with drawers for the specimens, the specially made box of the "Schmitt" type to the most modern metal boxes in metal cabinets. Very cheap and serviceable exhibition cases with glass tops, suitable for home use or for the rural or even the city school, may be made at home or by the local carpenter. Get at any planing mill some strips of "nosing" about two and three-quarters inches

wide by three-quarters thick. Have a groove one-eighth inch wide and three-eighths deep, cut two and three-eighths inches from the flat edge. Cut these strips in a mitre box into lengths suitable for the size cases desired, twelve inches by sixteen or eighteen is a good size. Varnish outside and paint white inside. Now, for bottoms, take two thicknesses of corrugated pasteboard, such as is used for packing. Cut these to the size of the inside of the frame. Tack or glue them to a board cut just the size of the outside of the frame. Paste clear white paper over the pasteboard and a very neat pinning surface is secured. Glass may be secured cut so that it will just fit in the grooves already cut in the frame pieces. The frame is completed by nailing the corners together with small finish nails. This should be done before the varnishing of the outside. The inner surfaces should be painted before the nailing is done. The bottom may be fastened with brads or with small hooks. The specimens are pinned in the desired order on the bottom and the frame then placed over them. They are then in good shape for preservation and may be placed on the wall for an exhibit.

A box as described may be made in the manual training department of any school, and makes an excellent exercise for the members of the class. The cost for materials should be less than twenty-five cents per box.

These boxes are suitable mostly for adult insects, but some of the other stages may be kept in them also. Some forms will have to be kept in liquid. These are not usually so suitable for exhibition purposes and may be stored as convenient. Vials with specimens in liquid are frequently pinned right in the boxes with the adults and should be so kept where they are in such condition as to show anything of the original form and color.

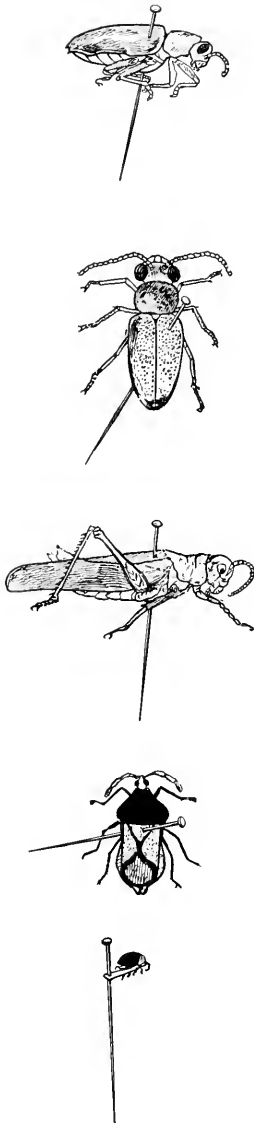

107. Method of Pinning Insects.

The preparation of the specimens for the cabinet or exhibition case requires some care, lots of patience, and as much practice as one can get. Beetles should be pinned through the right wing cover, near the base. So should grasshoppers and their relatives. All other insects should be pinned through the middle of the thorax between the bases of the front wings. The pin should be so placed as to have the head of the insect slightly higher than the opposite end, and about one-fourth or one-fifth of the length of the pin should be allowed to project above the body of the insect.

Different sizes of pins are made so that the different insects may be accommodated. Nevertheless, there are many kinds that are too small to be pinned without serious damage. These may be mounted on points. Points are made usually of stiff paper or light cardboard cut into "points" one-fourth inch long and about one-

FIG. 120.—Methods of Pinning Insects.

1, Beetle, showing slant of body on pin; 2, beetle showing where pin is inserted; 3, grasshopper, showing where pin is inserted; 4, true bug, showing where pin is inserted; 5, pointed insect, showing method of pointing.

sixteenth inch wide at the base and tapering to a point, the width of the point depending to some extent on the size of the insect to be mounted. These points are pinned, the pin being placed as near to the base as possible. The insect is glued to the other end of the point, glue, shellac or Canada balsam being used for the sticking material. The point is so arranged that it reaches only to the middle of the under side of the insect, the insect being in such a position that the head points forward while the insect is to the left of the pin.

Still smaller insects may be mounted in Canada balsam or glycerine on glass slides for study under the microscope.

All insects collected should be labeled. For pinned insects this is accomplished by pinning small slips of paper with the desired data on the pin just beneath the insect. Several such slips may be used. The data placed on the slips should include the date, the locality and the name of the collector, the latter being the least important. In many cases the name of the plant upon which the insect was found is added. Notebook data may be and should be more extensive. It is a good plan to have accession

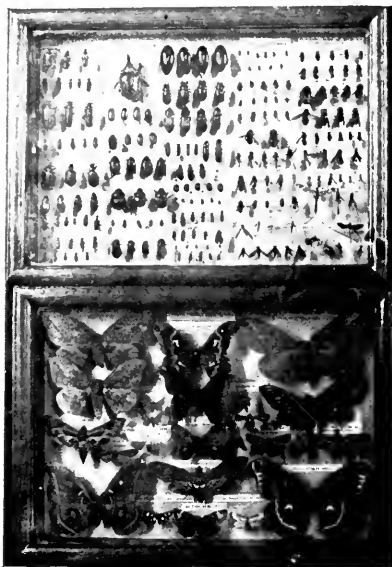

FIG. 121.—Insect Collection Arranged in Home-made Exhibition Cases.

numbers pinned on each specimen, these numbers referring to similar numbers in the notebook under which all the data are recorded. For reared specimens this is the only way to keep full accounts of the life histories of the specimen. Card note systems are much more convenient than the older notebooks, but the collector will make his own choice in this.

108. Spreading Board. Moths and butterflies must be spread on a spreading board which is another requisite

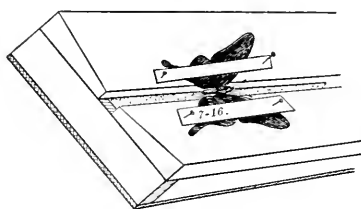

FIG. 122.—Spreading Board Showing Manner of Placing the Specimen for Drying.

for the outfit. The spreading board consists essentially of two smooth pieces of board, which must be of some soft wood, wide enough to accommodate the wings of the specimens, placed with a groove between them for the body of the insect. Below this groove

must be some soft material for the pin to stick in and support the insect. The boards must be arranged so that the insect's wings will slant upward from the body very slightly. These parts are mounted so that they will be firm. The figure accompanying the description will suggest the details of construction.

Insects placed on the spreading board should be pinned so that the bases of the wings are at exactly the same height as the edges of the boards. The front wings are laid flat on the board and pinned with their hind margins at right angles to the body, and the hind wings are then drawn forward so that their front margins are concealed beneath the front wings. Next a strip of blotting paper or other material is pinned over the wings, care being taken

to see that no pin goes through the wing tissue. The original temporary pins are taken from the wings and the specimen is allowed to dry for several days. When thoroughly dry the wings will remain in position. Specimens must be spread before they dry out and the wings "set." Otherwise they must be relaxed and this is never a satisfactory operation. Grasshoppers and other insects are sometimes placed on the spreader and have only the wings on one side spread, but generally the only insects spread are the Lepidoptera and some Neuropterous forms.

109. Breeding-cage. Life-history collections are of the greatest value and students should be encouraged to get all stages of as many insects as possible. This is sometimes easiest done by getting eggs or larvæ and keeping them in breeding cages while they undergo their transformations. Many things may serve as such breeding cages. The qualities required are some ventilation and proper moisture and temperature, as well as regular feeding. A simple breeding-cage for small insects is a lantern globe set on a flowerpot filled with soil and having a piece of cheesecloth tied over the top. Food may be given day by day or may be furnished by plants grown in the pot.

Larger cases may be made specially. A very satisfactory one is figured. It is merely a box made to fit a window. The outer side is enclosed with wire screen, while the doors are of glass. There may be two or more compartments in such a cage. It is better to have galvanized iron pans made to fit the bottom. These may be filled with sand or soil or they may contain water. In the latter case the breeding-cage makes an excellent aquarium for aquatic forms. Local conditions will govern the form of breeding-cage most used. The main

thing is not the cage but the careful attention given the insects. Without this care and the observation it involves the greater part of the value of rearing insects will be lost.

Much more might be said on the subject of rearing insects as well as about the apparatus for the collector and the equipment in the laboratory. Just as good results may be expected, however, from allowing the stu-

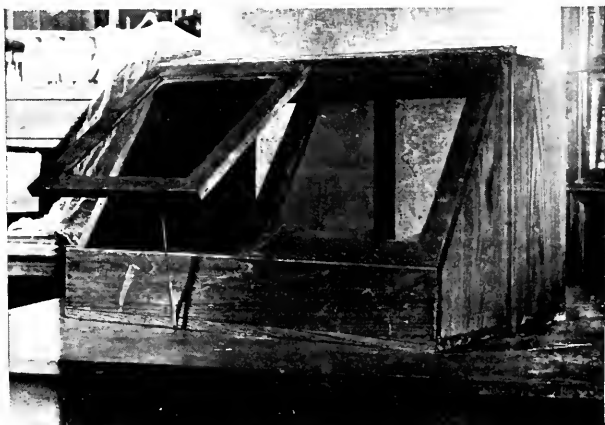

FIG. 123.—Window Breeding-cage.

dent to work out his own methods, merely being careful to see that the conventional methods of mounting are followed so that the specimens will not lose their value for exchange with other collections. While all the equipment here described is simple and inexpensive and it is not necessary to have anything more elaborate, it does add to the satisfaction of the work if some of the materials can be purchased from the manufacturers of entomological supplies, as these are in better position to make goods

exactly adapted to the needs of the subject than the amateur can be.

110. Protection from Injury. The collection, after it is completed is subject to the attacks of many pests and may also be injured by dust, mold, rusting of pins and a variety of causes.

Boxes with tightly fitting lids are the best protection against the insect pests but even these will not entirely prevent injury, as the insects will steal into the boxes while



FIG. 124.—A Group of Butterflies Arranged in a “Riker Mount” on Cotton for Decorative Purposes.

they are opened for study. These pests are most abundant and destructive in warm weather but work to some extent throughout the year, especially in warm rooms.

To free the collection from pests requires a considerable amount of care. If the boxes are not tightly closed, cigar boxes for instance, they may all be placed in a large, paper-lined goods box for which a tight lid has been made, and fumigated. The best substance for this fumigation is carbon bisulphide. This will be still more effective if the boxes are opened slightly before they are placed in

the fumigating box. Place the carbon bisulphide in an open dish near the top of the box. Use at the rate of about one ounce to ten cubic feet of space. Be sure to have the temperature at least 65° to 70° F. Keep fire away as the material is explosive. Repeat the fumigation once every month or six weeks during the warm weather, or whenever any signs of the injurious insects appear.

As protection against mold and similar troubles be sure to have the insects reasonably dry before they are closed up tightly and permanently, then keep the collection in a dry place. Insect boxes must be handled with care at all times to avoid breaking legs, antennæ and other delicate structures from the specimens by jarring.

111. Microscopes. In addition to the equipment necessary for collecting and mounting insects a little more is required for their study. Of this, the most important part is the microscope or lens. The most useful lens will be a hand lens magnifying about twenty diameters. Provided with such a lens the student will seldom need a compound microscope. A good plan for a beginning course in entomology is for the class to be furnished with two or three compound microscopes and for each member of the class to have his own hand lens.

PART II—ECONOMIC ENTOMOLOGY

CHAPTER XIV

INSECTS AFFECTING MAN AND DOMESTIC ANIMALS

112. House Flies (26).* The house fly is too well known to need description. It will hardly be confused with any other species except, possibly, the stable fly (p. 180), from which it may be distinguished by the absence of the strong piercing mouth-parts—which enable the latter species to bite—and by the six dark lines on the thorax. Smaller flies belong to other species, contrary to the popular notion that little flies grow larger as the season advances. Careful counts have shown that practically 99 per cent of the flies found in dining-rooms are house flies.

“*Musca domestica* commonly lays its eggs on horse manure. This substance seems to be its favorite larval food. It will oviposit on cow manure, but we have not been able to rear it in this substance. It will also breed in human excrement, and from this habit it becomes very dangerous to the health of human beings, carrying, as it does, the germs of intestinal diseases such as typhoid fever and cholera from excreta to food supplies. It will also lay its eggs on other decaying vegetable and animal material, but of the

**Musca domestica* Linn. Family *Muscidae*, see page 141. Numbers in parentheses refer to publications cited in Appendix A, which should be consulted for more detailed information.

flies that infest dwelling houses, both in cities and on farms, a vast proportion come from horse manure." (Howard.) Where horse manure is not available it commonly breeds in other manure or in fermenting vegetable material or slops.

The eggs hatch in about twenty-four hours, the larvæ or maggots become grown in from five to seven days, and the pupal stage lasts about the same time, so that a complete generation may develop in from ten days to two weeks, depending upon the temperature. Each female lays about

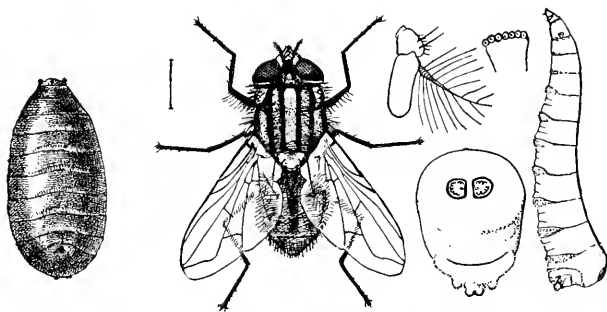

FIG. 125.—The common house fly (*Musca domestica*). (After Howard, U. S. Dept. Agr.)

Puparium at left; adult next; larva and enlarged parts at right. All enlarged.

120 eggs in a batch and may lay four times, so that it is evident that the species multiplies with extreme rapidity. The adult flies hibernate over winter in attics, barns, etc., and the pupæ may hibernate in the soil or under manure or straw. It is evident, therefore, that the first flies which appear in the spring should be vigorously combated so as to prevent the countless numbers to which they will give rise later.

"In army camps, in mining camps, and in great public works, bringing together large numbers of men for a longer or shorter time, there is seldom the proper care of excreta,

and the carriage of typhoid germs from the latrines and privies to food by flies is common and often results in epidemics of typhoid fever. . . . In farmhouses in small communities and even in the badly cared-for portions of large cities typhoid germs are carried from excrement to food by

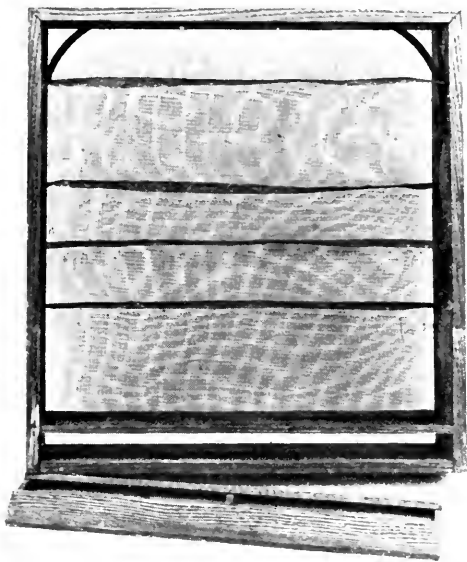

FIG. 126.—Window fly trap showing bait tray removed.

flies, and the proper supervision and treatment of the breeding places of the house fly become most important elements in the prevention of typhoid.

“In the same way other intestinal germ diseases are carried by flies. The Asiatic cholera, dysentery, and infantile diarrhea are also carried. . . . There is strong cir-

cumstantial evidence that tuberculosis, anthrax, yaws, ophthalmia, small-pox, tropical sore, and parasitic worms may be, and are, so carried. Actual laboratory proof exists in the cases of a number of these diseases, and where lacking, is replaced by circumstantial evidence amounting almost to certainty." (Howard.)

The screening of windows and doors and the use of sticky fly-papers are preventive measures known to all. A two per cent solution of formaldehyde will destroy the flies and may be placed in shallow saucers to which they will be attracted. Adding milk or syrup and dropping in a piece of bread will make it more attractive. Where flies or mosquitoes become too numerous they may be destroyed by fumigating with pyrethrum powder. About one pound should be used for every 1000 cubic feet of space. Place the powder on pans, dampening with a little kerosene into cone shapes, to facilitate burning. Make all windows and doors as tight as possible, light the cones, and leave over night. The fumes are not poisonous to persons and will not injure furnishings. The chief effort in the control of house flies should be directed toward preventing their breeding in horse manure, for a single stable will supply flies for a whole neighborhood. As far as possible manure should be kept in a tight box or pit which can be properly screened where necessary. Recent experiments * of the U. S. Department of Agriculture (26) have shown that the eggs and maggots in the manure may be destroyed by the use of borax or calcined colemanite. Ten ounces of borax or 12 ounces of calcined colemanite should be used for every 10 cubic feet (8 bushels), of manure immediately upon its removal from the barn. Apply the borax with a flour sifter or any fine sieve, particularly around the edges of the pile, for there is where most of

* Bulletin 118, U. S. Department of Agriculture.

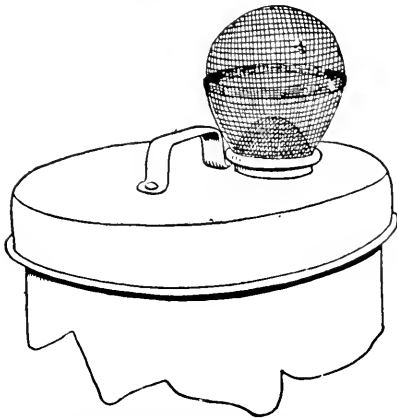

FIG. 127.—Top of garbage can with small balloon fly trap of the Hodge type attached. (After Bishopp, U. S. Dept. Agr.)

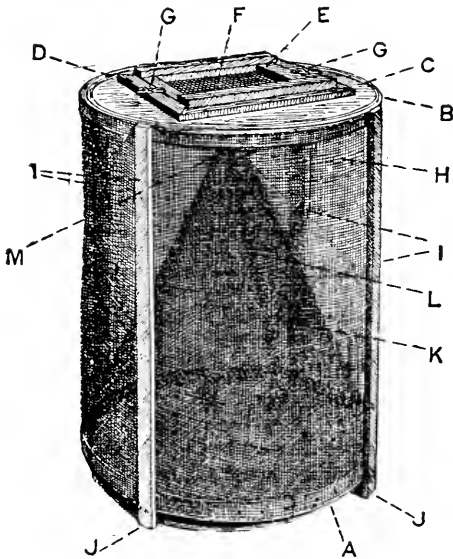

FIG. 128.—Conical hoop fly trap; side view. (After Bishopp, U. S. Dept. Agr.)

A, hoops forming frame at bottom; B, hoops forming frame at top; C, top of trap made of barrel head; D, strips around door; E, door frame; F, screen on door; G, buttons holding door; H, screen on outside of trap; I, strips on side of trap between hoops; J, tips of these strips projecting to form legs; K, cone; L, united edges of screen forming cone; M, aperture at apex of cone.

the eggs are laid and where the maggots congregate, and sprinkle two or three gallons of water over the treated manure. Such treatment should be given with each addition of fresh manure to the pile, but where it is kept in closed boxes, less frequent treatment will be required. This treatment is cheap and is well worth while. A maggot-trap has also been devised (see 26), for the treatment of horse manure, by which the maggots may be easily and cheaply removed from horse manure.

Sanitary privies are absolutely necessary for the prevention of the spread of disease by flies in country districts (39). These should be required in all public places such as schools, railway stations, etc., and private owners should install their own in self-defense. The "wet system" should be used so that the surface may be kept covered with kerosene and all possibility of fly-contamination be thus prevented. Fly traps (see 40c) should be used on garbage cans, and can be bought at most hardware stores. These will catch quantities of flies and similar home-made traps placed in barn windows, in barns, and wherever flies assemble, will very materially aid in reducing their numbers.

113. The Stable Fly (27).* The stable fly is so called on account of its habitual presence in stables, where it becomes a serious nuisance by biting cattle and horses. It closely resembles the common house fly, but may be distinguished by its strong mouth-parts, which enable it to make a sharp "bite," and by the black spots on the abdomen (Fig. 129). On this account stable flies are sometimes called "biting house flies" by those who do not distinguish them, and the saying has come that "flies bite before a storm," because the stable flies enter houses and are more annoying just before a storm. The stable fly has recently come into prom-

* *Stomoxys calcitrans* Linn. Family *Muscidae*, see page 141.

inence as the possible means of the transmission of infantile paralysis, though this indictment now seems unsubstantiated, and probably is the means of transmitting other diseases.

The life history is much the same as that of the house fly, but development takes place more slowly, the complete life cycle requiring three or four weeks under favorable conditions. Although the larvæ live in horse manure they have

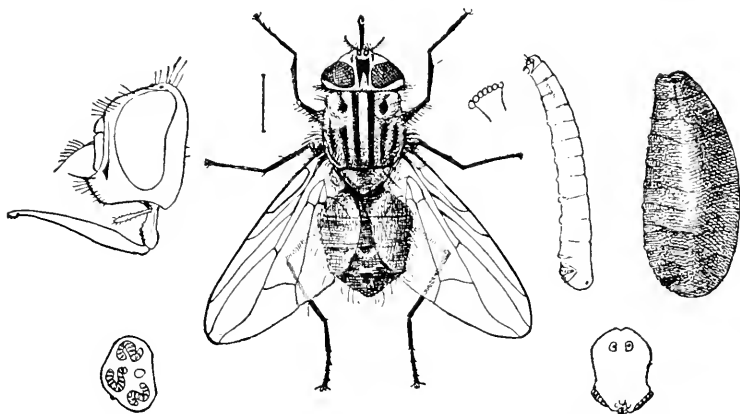

FIG. 129.—The stable fly or biting house fly (*Stomoxys calcitrans*). Adult, larva, puparium, and details. All enlarged. (After Howard, U. S. Dept. Agr.)

been found much more abundant in straw, particularly oat straw, and in manure where straw has been used liberally.

The same methods of control as advocated for the house fly are advisable around stables, and the leaving of strawy manure in piles and allowing the barnyard to become knee deep in it, furnish the best conditions for the development of these flies. In the grain belt, where large loose stacks of straw are scattered over the fields, heavy summer and fall

rains will make them ideal breeding places for the stable fly. Animals scatter the straw and add manure, which makes conditions more favorable. It is important, therefore, that straw which is to be fed be stacked with the sides nearly vertical and the tops rounding, so as to shed rain. All straw not required for feed should be burned or, better, scattered

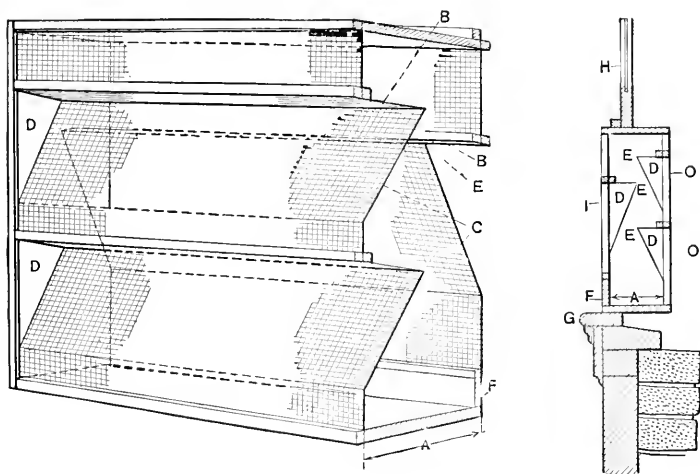

FIG. 130.—Hodge type window trap. At left, trap with end removed to show construction; at right, cross-section of trap placed in a window. (After Bishopp, U. S. Dept. Agr.)

A, end of trap; *B*, upper side of folds in screen; *C*, lower side of folds in screen; *D*, portion of end of trap sawed out and returned after attaching screen; *E*, holes along apex of folds; *F*, door for removing dead flies; *G*, window sill; *H*, upper window sash; *I*, inside entrance for flies; *O*, outside entrances.

over the fields and plowed under. Stacks not used during the winter should be destroyed in the spring, before the flies commence to multiply rapidly. In portions of a stack of straw in Gainesville, Texas, in March, 1913, as many as 300 pupæ were found in a single cubic foot of straw.

The flies may be caught as they enter or leave the stable by means of traps built in the window frames, as devised by

Prof. C. F. Hodge (see 40c). They should be placed in windows on the brightest side of the barn and near to the cows or horses within. Other windows should be darkened by hanging canvas or sacks over them, so as not to interfere with ventilation, but so as to drive the flies to the lighter window. Fig. 130 shows the construction of the trap. At the bottom a space about one-fourth of an inch wide, running entirely across the window, is left on both sides of the frame. Above this is placed a roof or ridge of screen wire having holes large enough for the flies to pass through punched through its top at two-inch intervals. To capture the house flies suitable bait is placed in the pans beneath this ridge. The flies ascend through the holes and are then unable to escape. The sides of the trap are also made of wire screening bent inward and upward in two horizontal folds across the window, one toward the bottom and one toward the top. The ends of the screen are tacked tight and a series of small holes are punched along the inner edge of each of the folds. The angles of these folds should not be too sharp and less than 45° or the flies will not go up the angle. In trying to go in and out of the window the flies enter the holes at the apex of the fold, but are then unable to escape, as on the inside the holes are on the projecting ridge and are not found by the flies, which seek the light. Portable traps made on much the same plan may be used within the stable.

114. Mosquitoes (28, 34, 38, 46, 57).* Formerly mosquitoes were regarded merely as aggravating nuisances, but in recent years we have come to learn that certain species are among the most important carriers of disease, so that the whole problem of mosquito control has assumed new interest. The common house mosquito † (46), is entirely innocent of carrying disease, so far as we know, but about

* Family *Culicidae*, see page 133.

† *Culex pipiens*.

fifteen years ago it was demonstrated that nearly related species of the genus *Anopheles* are responsible for the transmission of malarial fever and that the dreaded yellow fever is spread by the yellow-fever mosquito.* Indeed, these diseases are spread entirely by mosquitoes. As a result of this knowledge Havana and Panama have been practically freed from yellow fever, and large areas of country, formerly almost uninhabitable on account of malaria, have been reclaimed. The yellow-fever mosquito is strictly a southern species, but different species of the malarial mosquitoes are found in all sections of the country. The latter (*Anopheles*) may be distinguished from the common mosquitoes by the fact that their wings are marked with blackish spots, the palpi of the females are as long as the proboscis or beak, and when they rest on a wall or ceiling the body is held at an angle from the surface, while those of the common species are parallel to it.

Mosquitoes usually hibernate as adults in houses, barns, or whatever retreats they can find. With the first warm days of spring the females lay their eggs on the nearest permanent pools and then die. The larvæ of different species have quite different food habits and hence are found in different places, but practically all live in stagnant water, and do not develop in damp grass or vegetation as commonly supposed. The common house mosquito breeds in rain barrels, open tanks or cisterns, in puddles, ditches, tin cans, ponds, etc. Occasionally a clogged eaves trough will harbor enough water to allow a generation to mature in the water collected. The eggs are laid on the surface of the water and hatch in a day or two. The larvæ are the well-known "wrigglers," and feed on small animals and vegetable life in the water. Those of the house mosquito may be seen

* *Aedes calopus* Meig.

hanging from the surface of the water, through which they breathe by means of a long air-tube attached to the tip of abdomen, while those of the malarial mosquitoes lie parallel

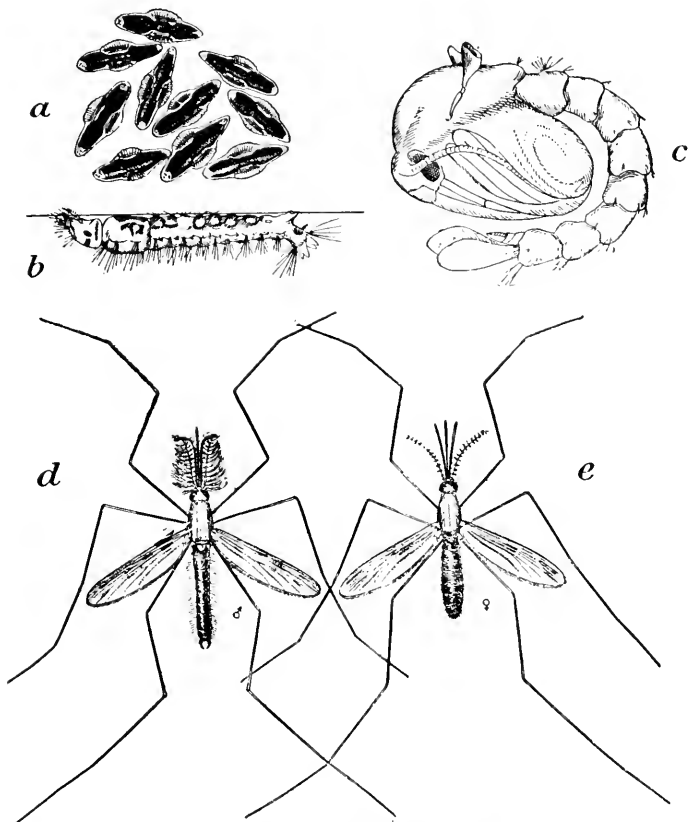

FIG. 131.—A malaria mosquito (*Anopheles quadrimaculatus*). (After Howard, U. S. Dept. Agr.) All greatly enlarged.
 a, eggs; b, larva; c, pupa; d, male, and e, female adults.

to the surface and do not have the air-tube. When grown the larvæ change to the curiously shaped pupæ (Fig. 131), which have breathing tubes attached to the thorax. In hot

weather the complete life cycle may be completed in two weeks and as each egg-mass contains from 75 to 200 eggs, mosquitoes multiply very rapidly. It is only the females which have piercing mouth-parts enabling them to "bite," the mouth-parts of the males being more feeble and being used for sucking vegetable juices, which are, doubtless, the natural food of both sexes. The males may be distinguished from the females by their feathery antennæ.

The best means of mosquito control is to prevent the development of the larvæ, which may be done by abolishing their breeding places or so treating them as to kill the larvæ. In many sections where mosquitoes have been a plague, notably in New Jersey, large areas have been drained or filled at public expense for this purpose. Usually many breeding places may be found which can very easily be eradicated. The introduction of fish will aid in ridding ponds of mosquitoes. Where this is not possible breeding places should be treated with low-grade kerosene, fuel-oil, or some larvacide, which will destroy the larvæ and pupæ through their breathing tubes. Use twelve ounces of kerosene to fifteen square feet of surface, or one-half cupful for a barrel. Houses should, of course, be screened and in some places it will be necessary to screen verandas with fine-meshed screening. Rain-barrels, cisterns and other water receptacles should be screened. Possibly the best repellent for mosquitoes is oil of citronella and for their bites nothing is better than ammonia. Where they have become over-numerous in a room they may be destroyed by burning pyrethrum powder (page 178). Rooms and cellars may also be fumigated with "culicide" (38) or by burning sulphur (page 336).

115. Fleas. The fleas (29, 51) most commonly annoying in houses are the common cat or dog flea.* The adults are

* *Ctenocephalus canis* Curt. Order *Siphonaptera*, see page 38.

wingless, have the body strongly compressed laterally, are provided with sucking mouth-parts, and have strong hind legs which enable them to jump considerable distances. The female lays her eggs in the hair of the dog or cat, from which they become scattered, and the young develop in cracks of the floor, under carpets, in rubbish, etc. In such

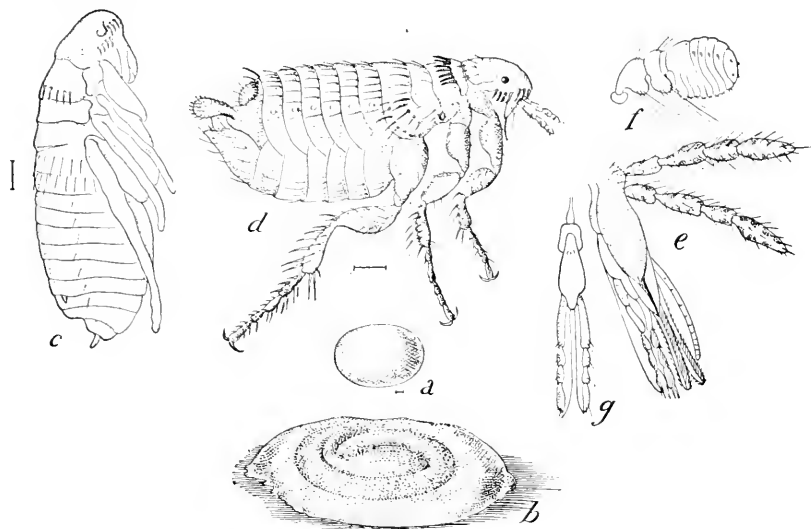

FIG. 132.—Cat and dog flea (*Ctenocephalus canis*). (After U. S. Dept. Agr.)

a, egg; b, larva in cocoon; c, pupa; d, adult; e, mouth-parts of same from side; f, antenna; g, labium from below. b, c, d, much enlarged. a, e, f, g, more enlarged.

situations the larvæ feed on either animal or vegetable matter. The larvæ are slender, worm-like creatures, scarcely an eighth of an inch long, are quite active, and become grown in about two weeks. They then spin delicate, silken cocoons, in which they transform to pupæ and from which the adults emerge in a few days. In warm, damp weather a whole generation may develop in a fortnight, although or-

dinarily about a month is required. Often when a house in which a cat or dog has been kept is closed up for the summer, the fleas will multiply rapidly and the house will be found alive with them when opened.

Where cats or dogs are kept they should be provided with a rug on which to sleep and this should be given a frequent shaking and brushing. Dusting the hair of a dog or cat copiously with pyrethrum powder over a paper will cause many of the fleas to fall off partly stupefied and they may be destroyed. The best means to rid these animals of fleas is to dip them in a tepid bath containing creolin or carbolic solution. Where houses become infested they should be thoroughly cleaned and gasoline or benzine should be injected into the floor cracks. Badly infested houses may be rid of fleas by fumigating with hydrocyanic acid gas (see page 336).

116. Bedbugs. Probably no other insect is so thoroughly detested as the bedbug * (32) by the good housewife, who oftentimes considers herself disgraced by its mere presence. Such a feeling is hardly warranted, for they are often introduced by servants or are brought in after traveling, but failure to get rid of them as soon as possible certainly is disgraceful. The full-grown adult is about one-fourth of an inch long by half as wide, of an oval shape, reddish-brown in color, wingless, and has a very characteristic, disagreeable odor. Bedbugs are mostly nocturnal in their habits, and after feeding upon the sleeping individual will again conceal themselves in crevices. Partial relief from them may sometimes be secured by keeping a light burning. The small whitish eggs are laid in masses in the hiding places and from them the small whitish young emerge in a week or two. The length of time for the development of the adult depends

* *Cimex lectularius* Linn. Family *Acanthiidae*, see page 60.

upon the food supply, as they are able to go for long periods without food.

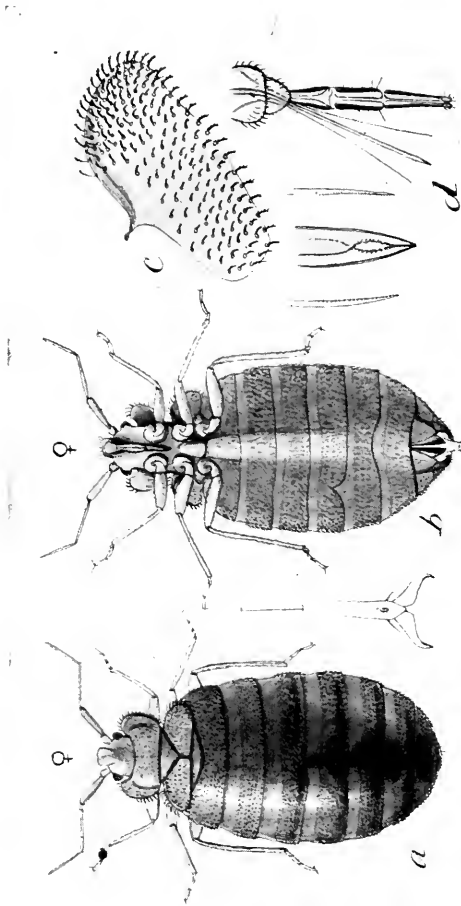

FIG. 133.—Bedbug (*Cimex lectularius*). (After U. S. Dept. Agr.)
a, adult female, gorged with blood; *b*, same from below; *c*, rudimentary wing pad; *d*, mouth-parts;
a, *b*, much enlarged; *c*, *d*, highly magnified.

The best remedy under ordinary circumstances is gasoline or kerosene. Every crevice in and about beds, and in

adjacent woodwork should be liberally treated. Another application should be made in about two weeks. Unless the walls and woodwork have become very badly infested, thorough and persistent treatment will be effective, but in such a case the building should be fumigated with hydrocyanic acid gas (see page 336).

117. Horse Bots.* Horses running in pasture are commonly infected with bots. They are the maggots of a large, brown, hairy fly, looking much like a bee, with a wing expanse of about three-fourths of an inch. Horses instinctively become nervous upon the approach of these flies, which lay their small yellowish eggs, sometimes called "nits," on the hair of the fore legs, shoulders and flanks. When the horse licks these parts the eggs hatch and the little maggots attach themselves to the tongue and then work their way down the alimentary canal to the stomach. Here they attach themselves to the walls, often occurring in such numbers as to form large patches. They continue growth during the winter and the next spring they pass out through the intestines with the excrement and burrow into the ground, where the pupal stage is passed. The adult flies emerge a month or so later, there being but one generation a year. The exact amount of damage which the bots do is a matter of some dispute, but it is evident that when present in large numbers they must irritate the lining of the stomach and must absorb considerable nutriment both from the stomach wall and the food in it. Cases have been observed in which they have penetrated the wall of the stomach and caused death.

During late summer horses kept in pasture should be examined every two weeks and the eggs destroyed or removed. This may be effected by washing the eggs with

* *Gastrophilus equi* Fab. Family *Æstridæ*. See page 139.

dilute carbolic acid, one part to thirty of water, by rubbing the eggs over lightly with kerosene, or by clipping the hair or shaving the eggs off with a sharp razor. Farmers some-

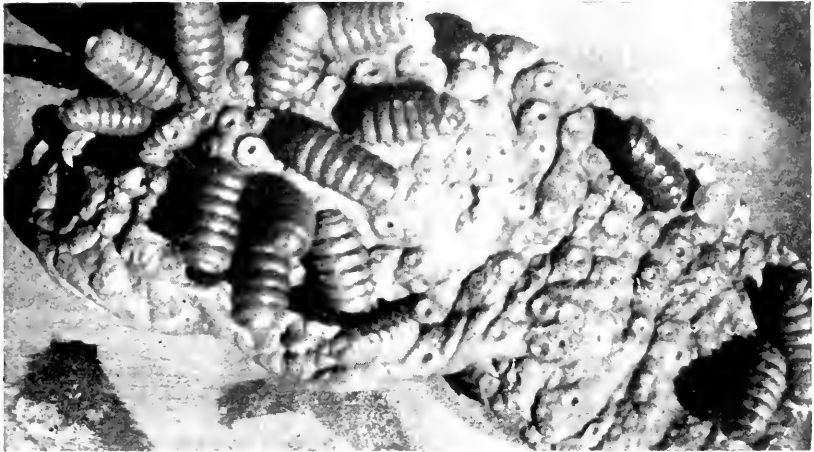

FIG. 134.—Portion of stomach wall showing points of attachment of bots. (After Osborn, U. S. Dept. Agr.)

times hang a piece of frayed rope from the throat-latch of a horse in pasture, and claim that the flies will deposit most of their eggs on it, and thus do no harm to the horse. If there are indications of the bots doing such serious injury as to require internal treatment a veterinarian should be consulted.

118. The Sheep Bot-fly or Head Maggot.* The sheep bot-fly looks something like an overgrown house

fly, the upper part of the head and thorax being dull yellow, covered with small specks so as to give it a brown appearance,



FIG. 135.—Horse bot-fly.

* *Estrus ovis* Linn. Family *Æstridae*. See page 139.

and the abdomen is velvety dark brown variegated with straw color. The fly has no mouth-parts and so takes no food. The female lays the young maggots (the eggs having been hatched in the body of the parent), in the nostrils of the sheep. The attacks of the flies make the sheep frantic and they will lie down and bury their noses in the dust, throw dust in the air, and huddle together to try and ward off the attack. The young larva works its way upward into the frontal sinuses, the cavities between the plates of bone over

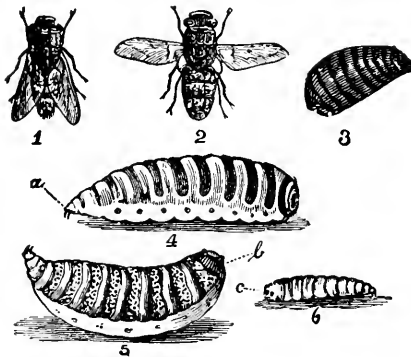

FIG. 136.—Sheep bot-fly (*Estrus ovis*).
(After Riley.)

1, 2, flies; 3, pupa; 4, full-grown larva.

the eyes. It requires about ten months for the larva to become mature, when it crawls back into the nose and is sneezed out. Going an inch or two below the surface of the soil it transforms to the pupa, from which the adult fly emerges in from four to six weeks. When the grubs become

numerous in the frontal sinuses they often cause very serious injury, animals so affected losing their appetite, becoming emaciated, discharging thick mucus from the nose, etc.

No entirely satisfactory method of control is known. The best means is to smear coal-tar on the sheep's noses. If one has but a few sheep this can be done now and then by hand. Otherwise, place logs in which holes are bored with a two-inch augur here and there in the pasture. Keep these holes about half full of salt and the edges smeared with coal-tar, so that it will get on the sheep's noses. Plowing a deep

furrow across the pasture so that the sheep may stick their noses in the dust when they are attacked is recommended. Inasmuch as the flies are abroad only in the sunshine and in the heat of the day, any kind of cheap shelter which will afford shade and into which the sheep may run will prove a welcome refuge for them from the flies. Four posts with any sort of a roof and bagging hanging loose down the sides will be sufficient. When the maggots become established in the head there is practically nothing which can be done to remove them except an operation—trephining—which must be done by a skillful veterinary surgeon and will only be practicable for valuable breeding stock.

119. The Ox Warble.* The ox warble (21), also known as “bot-fly” or “heel-fly,” is the cause of “grubby” hides of cattle and in the grazing regions of the West and Southwest is the cause of considerable loss to both hides and beef. Cattle allowed to run in pasture for the summer are always more or less affected with the grubs, particularly if the owner is not careful to destroy them. The holes in the hides, and the loss in weight and quality, make the warble one of the worst insect pests of cattle.

The adult fly is about the same size and of much the same appearance as the honey-bee. It is about a half inch long, blackish, and clothed with hairs. The edge of the head and thorax and the base of the abdomen are covered with whitish hairs. The upper part of the head and thorax and the middle of the abdomen and legs are blackish-brown. The tip of the body is reddish-brown. The flies lay their eggs on cattle, not infrequently on the flanks and elsewhere, but mostly just above the hoof, which latter habit has given them the name “heel-fly.” The presence of one of the flies causes intense excitement among the cattle, often stampeding

* *Hypoderma lineata* Villers. Family *Estridae*, see page 139.

them through shrubbery or water to escape. As the fly causes no pain it is evident that this fright is instinctive. When the animal licks the parts on which the eggs are laid, the eggs hatch and the young larvæ are taken to the mouth, as in the case of the horse bot. They then penetrate the walls of the œsophagus and migrate through the connective tissues of the body for several months, working their way to

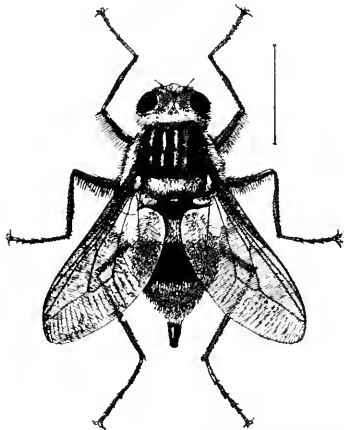

FIG. 137.—Ox warble (*Hypoderma lineata*), female, natural size indicated by side line. (From "Insect Life.")

beneath the skin on the neck and then backward until they become lodged beneath the skin in the region of the back. The larva now makes a hole through the skin so as to secure air for breathing. It develops rapidly, subsisting on pus and serum which its presence induces, and causes a characteristic swelling or tumor. When full grown it is an inch or more

long so that it may cause considerable irritation. It then works its way out through the hole which it had made, drops to the ground, which it may enter, or it may change to the pupa on the surface. The final transformation to the adult fly takes place from three to six weeks later, there being but one generation a year.

Various oils and repellent substances have been recommended for smearing on cattle to prevent the attacks of the flies, but it seems that there is no very conclusive evidence of their efficacy, and it is certain that the applications must be made every few days, so that such treatment is

entirely impracticable for cattle in a large pasture. The best means of control is to examine the cattle carefully in the winter and spring and to remove the maggots from beneath the skin as soon as they are in evidence. This can be done by exerting a gentle pressure with the fingers on either side of the hole and thus squeezing the maggot out. A cheap pair of tweezers will aid in removing the younger

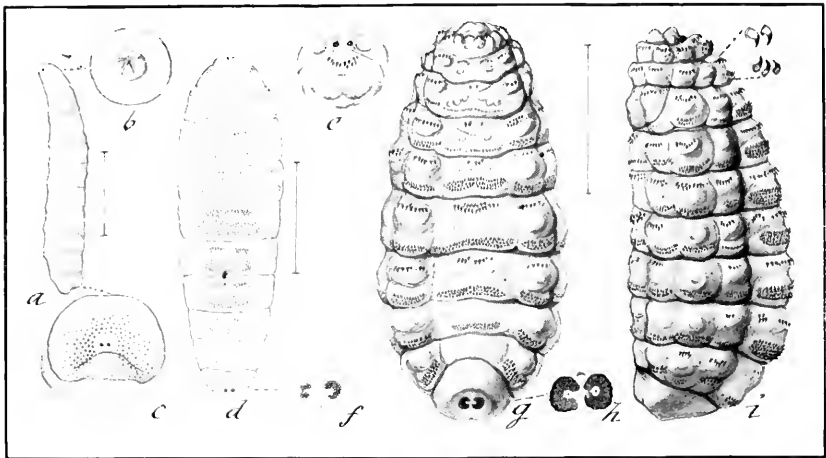

FIG. 138.—Ox warble (*Hypoderma lineata*). (From "Insect Life.")

a, second stage of larva from back; *b* and *c*, enlargement of extremities; *d*, ventral view of third stage with details of extremities at *e* and *f*; *g*, dorsal view of mature larva with enlargement of anal spiracles at *h*; *i*, the same, lateral view; natural size indicated by side lines.

ones. Inject a few drops of cresol or carbolic solution in the wound after removing the maggot. It is sometimes recommended to kill the maggots by applying grease and other substances which will stop up the breathing hole and kill them beneath the hide, but this is liable to cause festering.

120. The Horn Fly.* The little horn flies (23), which cluster upon the horns of cattle, are among their most

* *Hamatobia serrata* Rob.-Desv. Family *Muscidae*. See page 141.

troublesome enemies. The horn fly resembles a very small house fly, but like the stable fly (page 180), it has piercing mouth-parts which enable it to pierce the skin and suck out the blood, which forms its normal food. When the horn flies assemble in large numbers on the shoulders and elsewhere out of reach of the head or tail, they cause great annoyance,

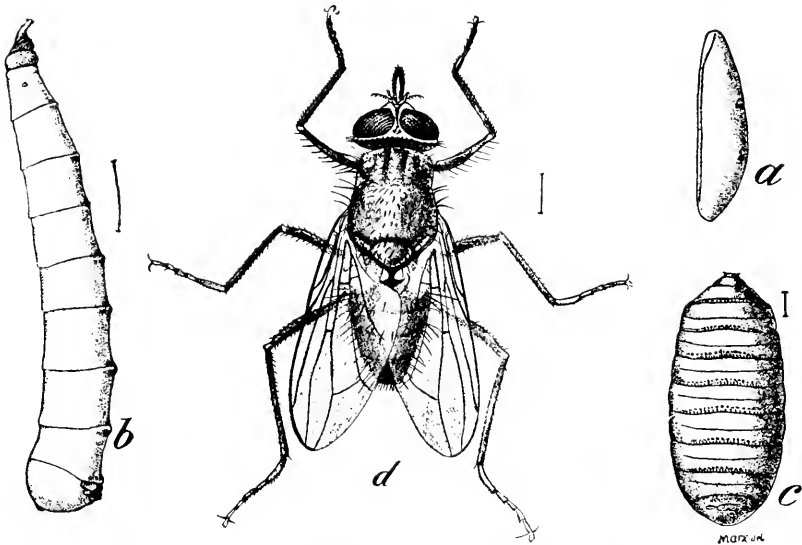

FIG. 139.—Horn-fly (*Hematobia serrata*). Much enlarged. (After Marlatt, U. S. Dept. Agr.)

a, egg; *b*, larva; *c*, puparium; *d*, adult in resting position.

and have been thought to reduce the milk flow materially and in many cases to cause loss of weight.

The flies lay their eggs upon freshly dropped cow dung. The eggs hatch in about a day and the little white maggots feed in the dung and become grown in a week or ten days. They then change to pupæ just at or below the surface of the ground, and the adult flies emerge a few days later, the whole life cycle requiring about two weeks.

Various proprietary repellent solutions are in common use for protecting cattle from flies. The principal objection to them is that repeated applications are necessary to be effectual. If it is desired to use such sprays, a home-made solution will be cheaper and equally effective. Use either one part of pine tar with three parts of crude cottonseed oil or fish oil, or three parts of crude carbolic acid to one hundred parts of either of these oils. Cottonseed oil is less offensive than fish oil, and cheaper. These may be applied with a hand atomizer or sponge, but an atomizer or small spray pump will use less material and apply it more evenly. By having a man stand on either side of the door to spray the cows as they enter the barn, dairy cows may be quickly treated and the flies kept out of the barn. There seems to be some question, however, as to the real efficacy of these repellents, and whether they are really worth the cost. Such experiments as have been carefully conducted are rather inconclusive (24) on this point, but indicate that whether the fly-sprays are profitable or not remains to be determined. Undoubtedly they afford some relief for a day or two.

Preventive measures seem more promising. If the development of the maggots in the cow manure can be prevented, no flies will occur. In small pastures where the manure is often dropped in particular places, it is entirely feasible to send a boy around the field every few days and let him spread out each dropping with a shovel, so that it will dry out quickly in the sun. This is more necessary in wet weather. At the barn, sprinkle lime or land plaster over the manure every day or two, which will aid in preventing the development of the maggots. Probably the borax treatment advised for the house fly (page 178) will be found even more effective.

121. Cattle Lice. Two or three species of lice commonly affect neglected cattle and one inhabits hogs. Of these the first three belong to the true lice.* The most common is the so-called *Short-nosed Ox Louse*.† It is a bluish or dark gray color, about one-sixth of an inch long, and of the general shape shown in Fig. 140. These lice frequent the neck and shoulders of cattle, which sometimes become badly rubbed

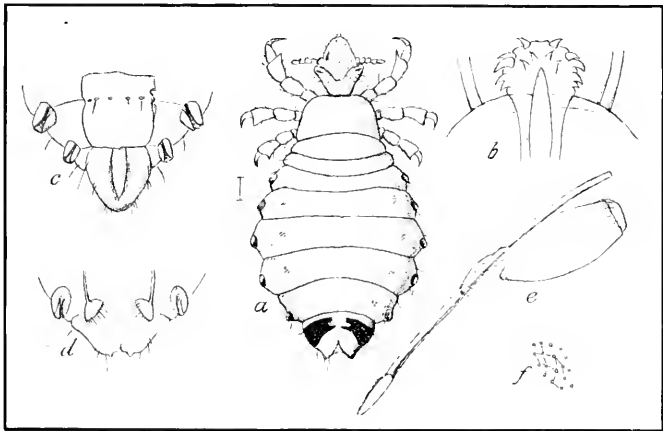

FIG. 140.—Short-nosed ox-lice (*Haematopinus eurysternus*). (U. S. Dept. Agr.)

a, female; b, rostrum; c, ventral surface of the last segments of male; d, same of female; e, egg; f, surface of same greatly enlarged.

by their efforts to be rid of them. The eggs are laid upon the hair near the skin, and the young resemble the adults in both structure and habits. The *Long-nosed Ox Louse* ‡ is very similar, except that the snout is more prolonged, but it does not seem to be so injurious. Another somewhat larger species of the same genus affects hogs.§ It is about

* *Siphunculata*, see page 37.

† *Haematopinus eurysternus* Nitzsch.

‡ *Haematopinus vituli* Linn.

§ *Haematopinus urius* Nitzsch.

one-fourth of an inch long, or a gray color, the body broadly oval and the head narrow.

The *Biting Cattle Louse** is so called because its mouth-parts are fitted for biting instead of sucking, it belonging to the same order as the common hen louse. They are recognized as "little red lice" by cattle men, in contrast to the bluish sucking species. They are more common in spring, but are not injurious unless occurring in very large numbers.

Spraying the affected animal with kerosene emulsion diluted ten times, or with tobacco extract (Black-leaf 40, 1 part to 800), or rubbing the affected parts with sulphur, lard and sulphur, or lard and kerosene, will destroy these lice. Usually these parasites are introduced into a herd on animals which have been neglected, which should be treated at once so as to prevent further spread. Recent ex-

periments at the West Virginia Agricultural Experiment Station indicate that one of the best means of eradicating these lice is by the use of blue ointment. On cattle the hair should be clipped close to the skin on a space half the size of one's hand. On hogs apply about two square inches, using only enough to smear over the skin and rub on with the finger. Apply the ointment in the crotches, back of the ears, behind the shoulders or any place where the animal cannot lick it. The ointment is a mercury preparation which can be

* *Trichodectes scalaris* Nitzsch. Order *Mallophaga*. See page 37.

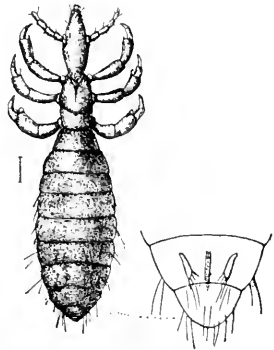

FIG. 141.—Long-nosed ox-lice (*Haematopinus vituli*). (U. S. Dept. Agr.)

Female, under surface of last segments of abdomen of same, showing brushlike organs. Enlarged.

secured cheaply at any drug store. Its exact effect on the parasites is not known, but it has proven effective in ridding animals of them and when used as directed there have been absolutely no symptoms of any injury to the animals.

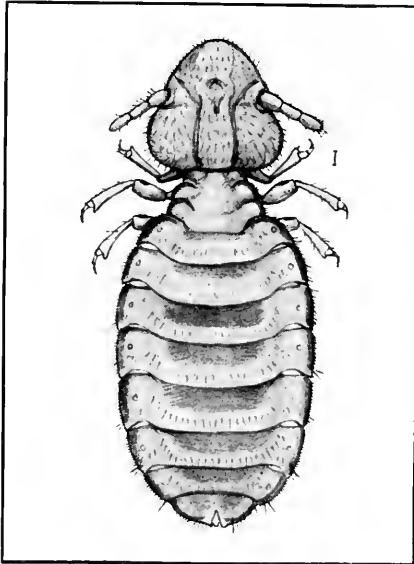

FIG. 142.—The biting cattle-louse (*Trichodectes scalaris*), enlarged. (U. S. Dept. Agr.)

122. Horse Flies.*

The large black horse flies or gad-flies (48) are well-known pests of both horses and cattle, which they torture with their bites. Only the females, having piercing mouth-parts, are bloodsuckers, the males feeding on the pollen of flowers. The large *Black Horse Fly*† is about one inch long and has a wing expanse of two inches. It has a short broad head, large eyes, a thick body, a short oval abdomen and large

powerful wings, which enable it to keep up with the swiftest horse. Particularly along shady roads in woodlands these flies are often so abundant as to make driving difficult. The smaller *Greenheads*,‡ so called from their large green eyes, are more common near the water and are well known

* Family *Tabanidæ*. See page 136.

† *Tabanus atratus* Fab.

‡ *Tabanus lineola* Fab.

to every boy who has been swimming. Not only are the attacks of these flies annoying to animals, but it is quite probable that such diseases as anthrax may be carried by blood-sucking flies from infected to healthy animals.

The larvæ are long, pointed maggots, most of them living in water or in swampy places or along the edges of streams

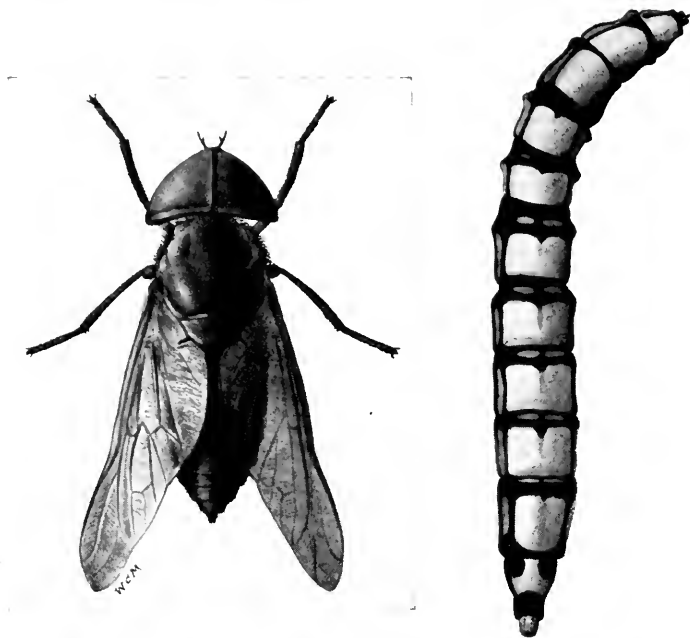

FIG. 143.—The black gadfly (*Tabanus atratus*). (After Garman.)

a, Male, b, larva—both twice natural size.

or ponds, and are carnivorous. In some parts of the country where there are large swamp areas, as along the Gulf Coast, in Louisiana and Texas, these flies appear in such numbers as to make it impossible to keep cattle at certain seasons.

Nets or light covers and ear-nets will be appreciated by

horses where these flies are abundant. Various repulsive ointments have been suggested, but are of doubtful value. In sections where the flies are particularly troublesome, the draining of marshy lands may remove their breeding places as well as those of mosquitoes.

123. The Sheep Tick.* The sheep tick is one of the best-known pests of the sheep. It is not really a tick, but a wingless fly. It is about one-fourth of an inch long when grown,

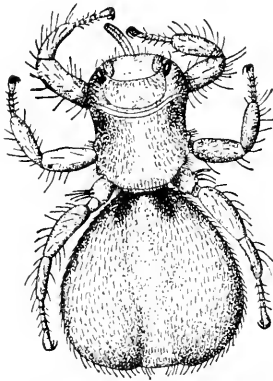

FIG. 144.—The sheep tick.
(Ky. Agr. Exp. Station.)
Greatly enlarged.

and of a reddish-brown color. The head is small and sunken into the thorax. The middle of the thorax is rather slender and the abdomen is broad. This species is distributed over the world and lives only on sheep. These insects are peculiar in that the eggs hatch and the larvæ develop within the body of the female, which gives birth to pupæ, from which the adults soon emerge. When the old sheep are sheared the ticks usually migrate to the unshorn lambs. They may cause considerable damage to sheep if abundant, which is often indicated by the lack of growth and poor condition, and when they mass on lambs their injury is often very serious.

The only satisfactory method of control is to dip the sheep just before shearing and again in the fall before going into winter quarters. Any of the cresol or creosote dips, lime-and-sulphur, or the tobacco dips, whose labels state that they are approved by the U. S. Department of Agriculture, may be used as directed by the manufacturer.

The only satisfactory method of control is to dip the sheep just before shearing and again in the fall before going into winter quarters. Any of the cresol or creosote dips, lime-and-sulphur, or the tobacco dips, whose labels state that they are approved by the U. S. Department of Agriculture, may be used as directed by the manufacturer.

* *Melophagus ovinus* Linn. Family *Hippoboscidae*. See page 139.

Sheep should stay in the dip at least two minutes, so as to get thoroughly wet, and the head should be ducked under. Sheep introduced into the flock should be dipped so as to prevent the introduction of ticks and other insect pests. Spraying the pens or enclosures with zenoleum, cresol, or any similar creosote preparation, or with kerosene emulsion, will kill all wandering ticks and scab mites and is, therefore, a good practice.

124. The Sheep Scab Mite.* The little mites (35, 49) which cause sheep scab are not true insects, but belong to the same class as spiders and all true mites. However, they are commonly considered among the insect parasites of sheep, of which they are probably the most important. The mite is so small as to be scarcely recognizable without a magnifying glass, the females being about one-fortieth of an inch long and the males about one-sixtieth or about the size of this period (.). They are light gray in color and resemble minute spiders in shape, and have four pairs of legs, to the third pair of which are attached some long thread-like appendages. A female lays from 10 to 20 eggs which hatch in from four to ten days. A new generation appears about every two weeks so that the pest increases with enormous rapidity and a sheep will soon become badly infested. Sheep are the only animals affected.

The first symptom which will indicate the need of examination for scab mites, is the rubbing of the back, sides, or tail of the sheep against some object, or its biting at these parts, due to the itching caused by the mites. The infected spot may at first be very small so as almost to escape attention, consisting first of a yellowish, dandruff-like substance, but if it is scratched the sheep will respond with a nibbling motion of the mouth. Large patches are soon formed if the

* *Psoroptes communis* Furst. Class *Arachnida*. See page 21.

animal is not treated. The innumerable little mites sucking from the skin cause an intense irritation and a consequent secretion of a large amount of serum. This forms at first a dandruff and later a thick scab. As this goes on the wool drops off, the sheep loses flesh, and presents a very unkempt appearance. If badly infected and untreated, sheep may be killed by the injury. The only sure diagnosis of the

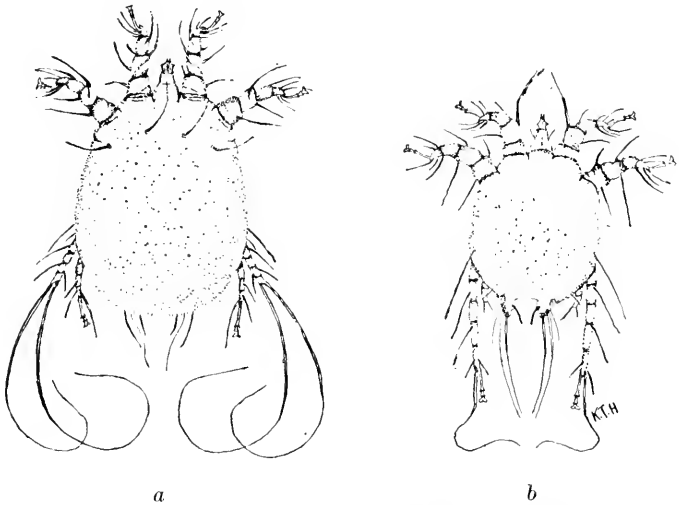

FIG. 145.—The sheep scab mite (*Psoroptes ovis*). (After Good, Ky. Agr. Exp. Sta.)

a, female; *b*, male—both very greatly enlarged.

scab is to find the mites. This can be done by placing some of the suspected scabby material on a black background in a warm place, when the small mites may be detected crawling around, the more readily by the aid of a magnifier. The scab mites are spread from one animal to another by contact and by the sheep coming in contact with sides of cars, fences, or other objects against which scabby sheep have

rubbed. The most common source of infection is securing sheep from stock yards. It is well, therefore, always to dip sheep as soon as received.

The same dips as recommended for the sheep ticks will be satisfactory if used according to directions, and one dipping will kill both, as well as sheep lice. The tobacco dip should contain at least seven one-hundredths of 1 per cent of



FIG. 146.—The sheep in the middle of the group is affected with a slightly advanced case of sheep scab, as is seen by the tufted wool and bare spots on fore flank and crows. The other two sheep represent advanced stages of the disease. (Ky. Agr. Exp. Station.)

nicotine when used. A nicotine-and-sulphur dip containing not less than 5 100 of 1 per cent nicotine and 2 per cent sulphur has been proven satisfactory in extensive tests. The dipping should be repeated in ten or twelve days to kill the mites hatched since the first dipping. It is best to have the dip warm, about 100 to 105° Fahrenheit. If scabby sheep are taken from buildings, the buildings should be disinfected before returning healthy sheep to them. Pas-

tures kept free from sheep and exposed to sunlight do not remain infectious for more than thirty to sixty days.

125. Poultry Lice. Several species of biting-lice are common upon poultry, but the most common is the *Hen-louse* * (25). It is about one-twentieth of an inch long, pale dull yellow with darker marks on each side of the body, though often reddish or pinkish in color after feeding. The

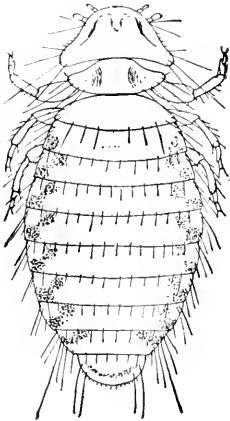

FIG. 147.—The common hen-louse (*Menopon pallidum*). Greatly enlarged. (U.S. Dept. Agr.)

small eggs or “nits” are attached to the feathers near the quill and may hatch in about eight days, or under unfavorable conditions, may lie dormant for several months. The young lice are much the same as when full grown. All of these biting lice bite off the scales of the skin and the edges of the feathers, but do not suck the blood. The claws of their feet are sometimes very sharp, however, and by continual scratching may draw blood which is readily eaten by the lice and accounts for their occasional reddish color. They are quite hardy and may live a long time without food. They spread rapidly from one hen to

another on the roosts, from the nests, and from a hen to her chicks, a setting hen in a foul nest furnishing them ideal food. Little chicks are most susceptible and may die from their attacks. The species on pigeons and geese are different, as the species of bird lice usually have but one host.

To kill the lice on young chicks rub a pinch of lard under the wings and a little on top of the head. A dust made of

* *Menopon pallidum* Nitzsch. Order Mallophaga, see page 37.

ten pounds of sulphur to a half bushel of air slaked lime, mixed together, should be used for dusting the hens and nests and be mixed with the dust bath. A thorough spraying of the house with kerosene emulsion as advised for mites will also be valuable. In a recent circular Dr. C. A. Lueder (50) states that the lice may be killed by treatment with blue ointment according to the following directions: "Remove some feathers from the back part of the body near the vent. Take a pinch of ointment a little larger than a pea and thoroughly rub a portion of it where the feathers were removed. Distribute the balance evenly on the shanks of the legs and the lice will disappear. Blue ointment should be applied during the month of December and again about one month before brooding season. Blue ointment is a medical preparation containing mercury, which is poisonous when taken into the system by the mouth or absorbed through the skin in large quantities. Young animals are very susceptible to mercury, therefore none should be used on young chickens. Healthy fowls six months old may be treated."

126. Poultry Mites. The *Chicken Mite** (25) is the most common mite affecting poultry and belongs to the same order of mites as that causing the sheep scab (p. 203). It is an oval, flattened mite about one-twentieth of an inch long, of a pale gray color with darker spots, unless it has been feeding, when it is more or less reddish with blood. The eggs are laid in cracks and crevices where there is some manure or filth and the young mites feed largely, if not entirely, on filth. They become grown in about ten days and, therefore, increase rapidly. The mites remain on the poultry only while feeding and then retire into crevices, being most active at night. Dark, damp houses are much worse infested than those with good ventilation and plenty of sunlight.

* *Dermanyssus gallinae* Redi. Class *Arachnida*, see page 21.

The walls and roof of the poultry house should be brushed clean of all dust and filth. The litter and nests should be kept clean and fresh. Clean the house, scraping the roosts, dropping boards and floors clean, and then spray with 10 per cent kerosene emulsion, lime-sulphur mixture or with a whitewash made as follows: Take six pounds of powdered sulphur and eight pounds of lump lime and place in a

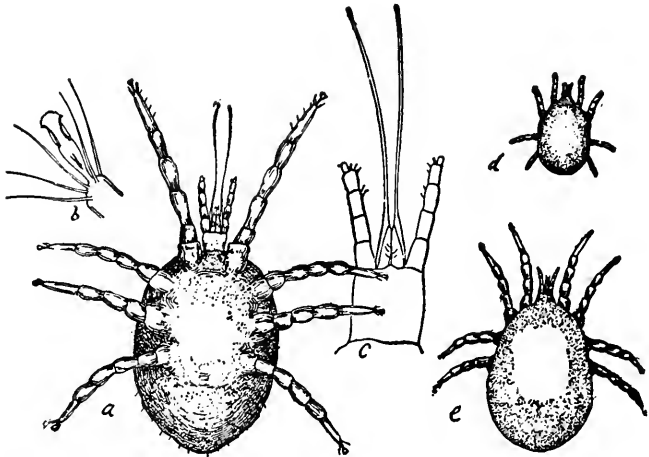

FIG. 148.—The chicken mite (*Dermanyssus gallinae*). (U. S. Dept. Agr.)

a, adult; *b*, tarsus; *c*, mouth-parts; *d* and *e*, young—all enlarged.

wooden tub. Add enough boiling water to slake and keep the lime from burning and stir continually until cool. Add more boiling water to make a whitewash. To every gallon of whitewash add one pound of table salt and four ounces of creolin. Another application should be made in four or five days to kill any mites which may hatch.

Another common mite is the one which causes "scaly leg" and which attacks the feet, legs, comb and neck of

poultry, and is often known as the *Itch Mite*. This is a much smaller species, which burrows beneath the skin and causes scales as does the sheep scab mite (p. 203). Under these scales the mites live and multiply.

Wash the legs of affected fowls with warm soapsuds for twenty minutes so as to soften the scales so that they may be gently rubbed off without bleeding. Then apply lard and kerosene, sulphur ointment, or an ointment made of naphthalene crystals (moth balls), powdered and mixed with nine parts of lard. An application of coal tar to the scales on the legs has caused them to drop off without bleeding and seems to be effective. Blue ointment has also been used as described for hen lice (p. 206), with excellent effect.

127. The Cattle Tick.* The cattle tick (22) is best known as being the carrier of Texas or tick fever. This disease is the most serious obstacle to the cattle industry in the South and, therefore, to a better general agriculture. The U. S. Bureau of Animal Industry (22) states "that the Texas-fever tick is responsible for about \$40,000,000 of loss annually to the people of the infested country, and that it lowers the assets of the South by an additional \$23,500,000." It is confined to the Southern States, and as shown in Fig. 150, its range has been materially restricted by an active campaign carried on by the Federal and State Governments for its eradication.

The fully grown adult ticks may be a half inch long and are oval in shape. The head is much smaller than that of other ticks found on cattle, and is reddish-brown or chestnut in color. The body color varies from dull yellow to an olive brown; often being mottled with yellow or brown or streaked with wavy lines of these colors. There is a groove

* *Margaropus annulatus* Say. Class *Arachnida*, see page 21.

on either side at the front and three grooves toward the rear of the body.

The adult female when gorged with blood and eggs, drops

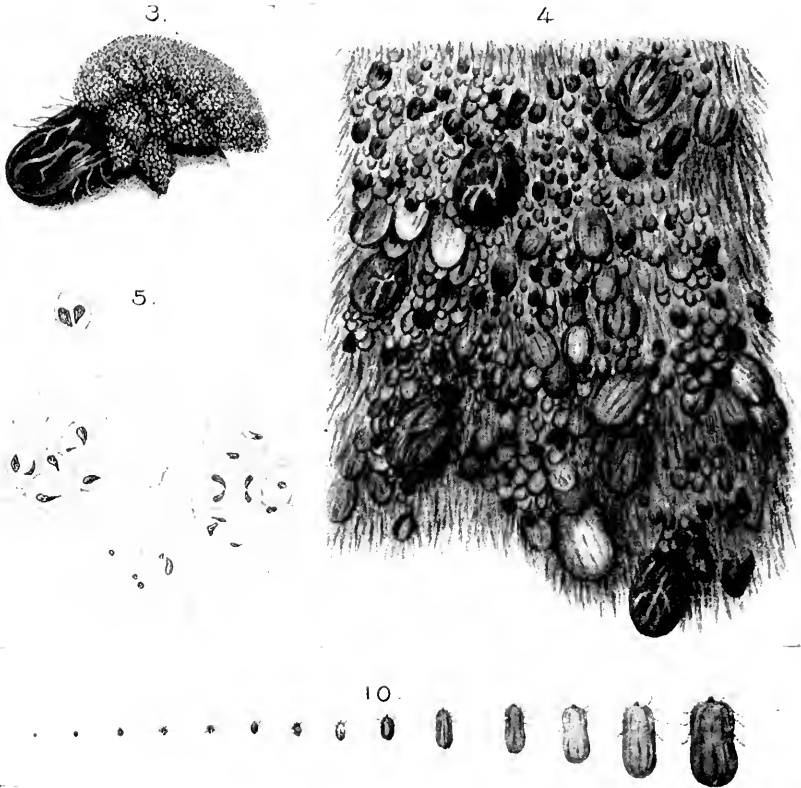

FIG. 149.—The cattle tick (*Margyropus annulatus*). (U. S. Dept. Agr.)

3, mature female with eggs; 4, hide covered with ticks; 5, blood cells containing Texas fever protozoa; 10, various stages of cattle ticks—natural size, except 5, which is enlarged 1000 times.

to the ground and there lays her eggs to the number of 1500 to 3000. From these light-brown eggs small larvæ or seed ticks hatch in from two to six weeks, depending on tempera-

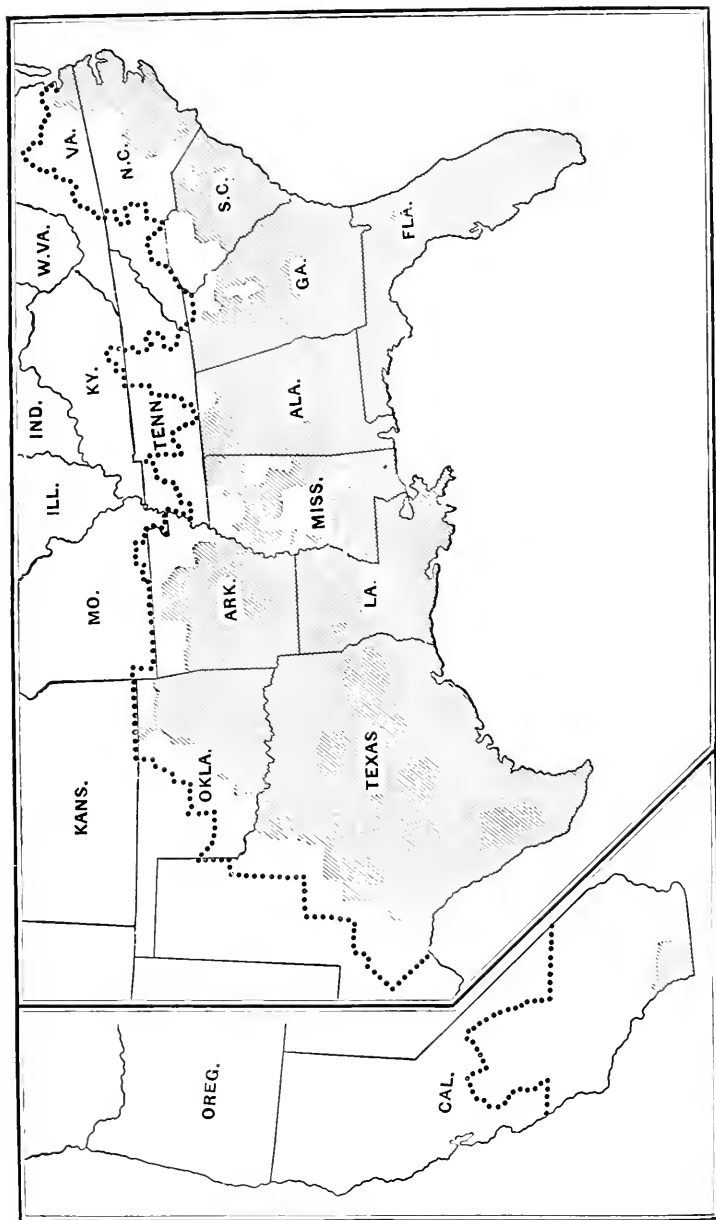

Fig. 150.—Map showing areas quarantined on account of Texas fever and areas freed from ticks; dotted lines show boundary of infected area at beginning of tick eradication in 1906; white areas below dotted line indicate territory that has been freed from ticks and released from quarantine. (1914.) (U. S. Dept. Agr.)

ture and moisture conditions. The young seed ticks crawl around on grass, weeds, etc., waiting for a chance to attach themselves to an animal; failing in which they die. They are, however, exceedingly resistant and may live for three or four months in summer or from September to April in an open winter. When cattle are found they attach themselves to the soft skin inside the thighs or flanks, and on other tender and protected parts of the body. They obtain their nourishment by sucking the blood and though so small as to be scarcely visible, may transmit the fever at this stage. The complete life cycle requires from six to ten weeks in warm weather and much longer during the cold seasons. The fever is caused by a small protozoan organism which lives in the red blood corpuscles of the affected animal, breaking them down and causing a high fever. These microscopic organisms are transmitted by the female ticks through their eggs to the young ticks, which then infect the cattle to which they become attached.

The ticks may be eradicated (see 36), either from the pastures or from the cattle. Possibly the greatest advances in tick-eradication have been made in recent years by means of cleaning the pastures of them. Pastures may be freed by excluding all cattle, horses, and mules until the young ticks have died of starvation, or the animals may be left on the pasture and then treated at regular intervals so as to destroy the ticks and thus prevent the engorged females from dropping to the ground and reinfesting the pastures. Ticks which get on the animals will be destroyed by the treatment and those which fail to do so will die in the pasture. On the other hand, animals may be freed from ticks by treating them with a substance which will destroy the ticks or they may be rotated on fields free from ticks until all the ticks have dropped. The methods of rotating pastures and the

time for starving out the young ticks in different latitudes and at different seasons have been quite carefully determined, so that it is possible to proceed to eradicate the ticks from large areas at very small cost (see 36). For destroying the ticks the cattle are washed, sprayed or dipped in crude oil emulsion or arsenical dip. Dipping is much the most satisfactory and is the method usually adopted for herds of any size. The crude oil emulsion is made like kerosene emulsion, using one pound of hard soap, one gallon of soft water and four gallons of crude Beaumont petroleum for making the stock solution and then diluting it to make an emulsion containing 20 or 25 per cent of oil. The arsenical dip is made by the following formula:

Sodium carbonate (sal soda).....	24 pounds
Arsenic trioxide (white arsenic)....	8 “
Pine tar.....	1 gallon
Water sufficient to make 500 gallons.	

For further necessary details of dipping see reference 36 (p. 340)

CHAPTER XV

INSECTS AFFECTING HOUSEHOLD GOODS AND STORED FOOD PRODUCTS

128. Cockroaches (31).* Roaches are undoubtedly among the most offensive of all household pests and are usually present only in old houses or where cleanliness has been neglected. In restaurants, boarding houses and on ship-board they often become very serious pests. They are so

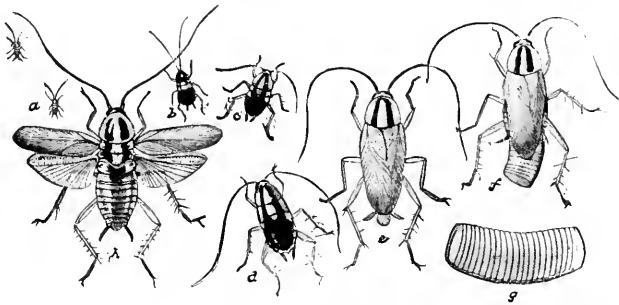

FIG. 151.—The German roach (*Blattella germanica*). (From Riley.)

a, first stage; *b*, second stage; *c*, third stage; *d*, fourth stage; *e*, adult; *f*, adult female with egg case; *g*, egg case, enlarged; *h*, adult with wings spread. All natural size except *g*.

well known as hardly to need description, but there are three species which may be distinguished. The *German Roach* or *Croton Bug* † is so-called because it was imported into New York City about the time of the installation of the Croton water system and, as the roaches crawl through the holes made in floors for water pipes, they spread more

* Family *Blattidae*, see page 52. † *Ectobia germanica* Linn.

rapidly and were also often known as "water-bugs." This species is a light-brown color with dark, brownish-black markings as shown in Fig. 157, and is somewhat less than an inch long when full grown. The *Oriental Roach** is a black species, an inch or more long. The female has only rudiments of wings and the wings of the male extend from one-half to three-quarters to the tip of the abdomen. The *American Cockroach* † is a native species, about one and one-half inches long. It is reddish-brown and the wings extend beyond the end of the abdomen. The *Australian Roach* ‡ is much like the last species, but smaller, and has a brighter and better defined band of yellow on the prothorax, and a yellow dash on the sides of the upper wings. It is the most abundant species in Florida and some of the Southern States.

Roaches are fond of warm places and, therefore, frequent kitchens and pantries. They are largely nocturnal in habits and hide in cracks, back of wainscoting, etc., in the day. They feed on all sorts of materials, attacking all kinds of food products, and often do serious damage to bookbindings. Otherwise, the real damage they do is not so serious as the disagreeable roachy odor they leave and the presence of their excrement and cast skins wherever they have been.

"One of the most effective simple means of ridding premises of roaches is dusting with commercial sodium fluorid, either pure or diluted one-half with some inert substance such as powdered gypsum or flour. With the use of some dust gun or blower the sodium fluorid can be thoroughly dusted over the shelves, tables, floors and runways and hiding places of the roaches."—Marlatt (31).

* *Periplaneta orientalis* Linn.

† *Periplaneta americana* Linn

‡ *Periplaneta australasie*.

Equal parts of chocolate and borax scattered in the haunts of the roaches is claimed to be one of the best means of destroying them. Badly infested buildings should be fumigated with hydrocyanic acid gas (see p. 336). Much may be done by a thorough cleaning of the premises and then stopping up all cracks and crevices which furnish them shelter. Rooms may also be fumigated by burning pyrethrum powder as suggested for flies and mosquitoes (p. 178). An ingenious method of destroying roaches used in Australia is by placing a saucer of flour 3 or 4 parts, and plaster of Paris, 1 part, where the roaches may feed on it and near by a saucer of water, both being supplied with bridges of cardboard or sticks to give easy access. The roaches feed on the mixture and when they become thirsty and drink the plaster sets in the intestines and causes death. Phosphorus paste, obtainable at drug stores, if spread thinly on bits of card or paper and placed in the runways of the roaches will destroy many of them, but should not be left where domestic animals or children may be affected.

129. House Ants * (33). Several species of ants are common household pests, where they are usually more of a nuisance than the cause of much real damage. They are all social species with the general habits described on page 152.

The *Little Red Ant* † is the most common species and is practically cosmopolitan in its distribution. It very commonly makes its nests in the walls of houses or beneath the floors where they are difficult to eradicate. Owing to its small size, being only about one-twelfth of an inch long, it is able to go through very small openings, but only by following the workers may the nests be located and if permanent relief is to be secured the nests must be destroyed.

* Family *Formicidæ*, see page 152. † *Monomorium pharaonis* Linn.

The *Little Black Ant* * is 3/16 of an inch long. It very frequently occurs indoors, where it often is as troublesome as the last species, but it ordinarily makes its nests under stones in the yard or in the field. It may be recognized by the little pyramids of fine grains of soil which surround its entrances. By tracing the ants to the outdoor colonies they may be readily destroyed.

Another much larger species which sometimes invades the house is the *Black Pavement Ant*,† a species quite com-

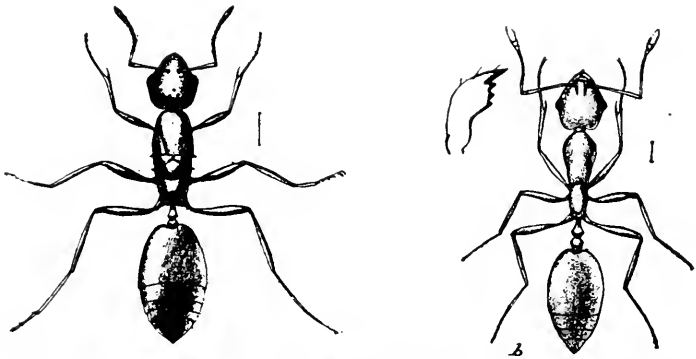

FIG. 152.—The little red ant (*Monomorium pharaonis*). Enlarged.
(From Riley.)
a, female; b, worker.

mon in Eastern cities. These ants are about one-half inch long and commonly make their nests under sidewalk pavements and stones where they are hard to reach.

In recent years the *Argentine Ant* ‡ has been introduced into Louisiana and has spread to parts of Mississippi, Alabama, Texas and California. It threatens to become one of our worst insect pests over a large section of the country, for

**Monomorium minimum* Buckley.
†*Tetramorium cæspitum* Linn.
‡*Iridomyrmex humilis* Mayr.

although it is most troublesome in the house it attacks various crops. It is a small species, about one-tenth of an inch long, of a uniform brown color. The nests are built beneath and in the walls of houses, under stones, in hollow trees, and

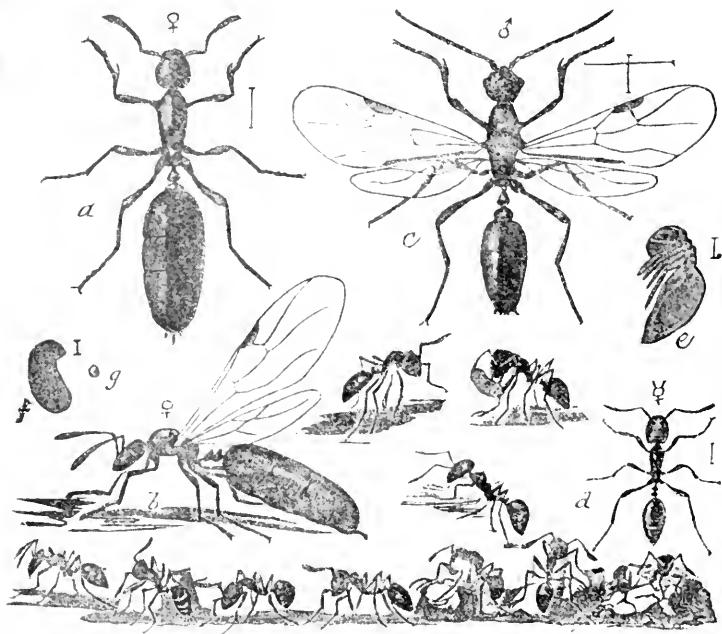

FIG. 153.—The little black ant (*Monomorium minutum*). (After Marlatt, U. S. Dept. Agr.)

a, female; *b*, same with wings; *c*, male; *d*, workers; *e*, pupa; *f*, larva; *g*, egg of worker—all enlarged.

in various other places. These ants occur in enormous numbers and swarm into houses and over everything. They are not only practically omnivorous, but do not hesitate to attack a person, and although their bite is not severe, scores of them soon make themselves decidedly disagreeable and

may be positively dangerous to infants. Wherever this pest appears it should be vigorously combated.

One of the best means of controlling the last species, which should be equally effective for others, is by means of a poisoned syrup. Dissolve 125 grains of arsenate of soda in a little water and add it to a syrup made of one pound of sugar dissolved in a quart of water. After boiling the solution saturate a sponge with it and place it in a glass jar with a perforated cover. This enables the ants to reach it, but it is not open to animals or children. The ants will enter the jar and feed on the syrup and even carry it to their nests.

A method of destroying colonies of ants in their nests is to saturate the upper surface of the nest with a solution of cyanide of potassium made at the rate of one ounce to a gallon of water, but this does not seem to be effective against the Argentine ant. Injecting carbon bisulphide into the nests is even more effective where the nests can be found and it can be used. In many cases kerosene, crude petroleum or boiling hot water poured on the nest will destroy the colony. A favorite way of ridding pantries of ants is to trap them on a sponge saturated with syrup or sugar water. The ants will swarm through it, and when it is well covered drop the sponge into boiling water; then wash it thoroughly of dead ants and repeat. Where this is kept up, they will soon leave. To prevent ants from crawling up table legs and into refrigerators, place the legs in small dishes of kerosene, being sure that the article does not touch anything else. Corrosive sublimate seems to be very offensive to ants and throughout the South "ant-tape" is sold, which is placed around the legs of tables or around anything to be protected from ants. It is merely tape soaked in a saturated solution of corrosive sublimate. It may be made by heating an

excess of crystals of corrosive sublimate in water in a granite or porcelain vessel (not iron), then cooling and filtering through cotton. Soak cotton tape or heavy cotton string in this for several hours and then dry. It must not come in contact with any iron, tin or aluminum. Corrosive sublimate is poison and should be handled with care. Naphthalene, gum camphor, carbolic acid, and gasoline are also said to be objectionable to ants and when sprinkled about their haunts will help drive them away.

130. The Clothes Moths. The little yellowish moths which sometimes flit about a light at night will quickly set

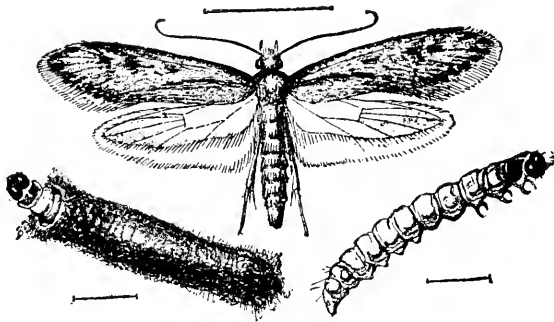

FIG. 154.—The clothes moth (*Tinea pellionella*). Enlarged. (From Riley).

Above, adult; at right, larva; at left, larva in case.

the good housekeeper to looking over her furs and woollen clothing for the presence of clothes moths (30). The moths themselves are entirely harmless, but she has learned from experience that where they occur some injury is probably being done, and that if they are not destroyed, they will give rise to further trouble. Other moths are frequently confused with clothes moths but usually the latter may be distinguished by the fringe of long hair on the hind wings,

characteristic of the family to which they belong. The most common species is the *Case-making Clothes Moth*,* whose larva constructs a portable case for its protection. The adult moth expands about half an inch, its head and fore wings are grayish-yellow, with darker spots in the middle, and the hind wings are white or grayish. The larva is a dull white caterpillar about three-eighths of an inch long when grown, and lives within a tube-like case made from the material on which it feeds, and lined with silk. The larvæ feed on woolens, carpets, furs, feathers, etc. There is but one generation a year, the moths appearing in July and August. The *Webbing* or *Southern Clothes Moth* † is the more common species in the latitude of Washington, D. C., and southward. It is about the size of the preceding species, but the fore wings are uniformly pale yellowish without darker spots. Its larva does not construct a case, but spins a silky web wherever it goes. When grown it makes a cocoon of silk with bits of wool intermixed, within which the pupal stage is passed. This species has two generations, the first moths appearing in June and the second generation in August and September. The *Tapestry Moth* ‡ is a much rarer species in this country. It is larger, expanding three-fourths of an inch, and is easily distinguished by its more striking coloration. The head is white, the bases of the fore wings are black, and the remainder a creamy-white more or less obscured with gray. This species is more common on heavier cloths, carpets, horse blankets, tapestries, etc., but also affects feltings, furs, skins, and the woolen upholstery of carriages. Its larva eats into the material which it infests, lining its burrows with silk.

* *Tinea pellionella* Linn. Superfamily *Tineina*, see page 77.

† *Tinea biselliella* Hummel.

‡ *Trichopaga tapetzella* Linn.

Clothes moths are usually injurious only when articles are put away and left for some time. Articles in use are rarely attacked. Exposing stored articles to air and sunlight, with a vigorous brushing and shaking are old methods of moth control. Moth balls, naphthalene, cedar chips, and other repellents are often used and are more or less effective if the materials are free from the moths when stored. The best means of preventing injury is to see that articles to be stored are placed in tight receptacles which are "moth-proof." The heavy paper bags sold by clothiers for this purpose are satisfactory. Large, heavy, paste-board boxes may be secured very cheaply and after packing away the winter clothing in them, the cracks may be sealed by gumming a strip of wrapping paper over them, thus making the boxes moth-tight. Infested articles which must be returned to storage may be fumigated with carbon bisulphide, by placing them in a trunk, and trunks or closets harboring the moths should be fumigated with the same material. For the protection of valuable furs and woolens, furriers are now making use of cold-storage, which entirely prevents the development of insect pests.

131. The Carpet Beetle.* The adult carpet beetle is a small, oval, blackish beetle, about one-eighth of an inch long, mottled with grayish-white, having the inner margin of each wing-cover, where the wing-covers meet on the back, marked with a narrow red line from which three short projections extend laterally. The beetles are most commonly noticed in the spring when they will fly to the windows if they have developed in the house. Out of doors they are found on the blossoms of spiræa and other plants, where they feed upon the pollen. The small whitish eggs are laid upon the cloth or other material upon which the larvæ will

* *Anthrenus scrophulariæ* Linn. Family *Dermestidæ*, see page 113.

feed. The larvæ are about one-fifth inch long when grown and are covered with thick tufts of coarse brown hairs, longer at the sides and at the two ends, which have probably given the insect its common name of *Buffalo Moth*. They feed on furs and feathers, but preferably on woolens, and frequently on the under sides of woolen carpets, especially where they can conceal themselves in floor cracks.

Where rugs can be substituted for carpets there is much less liability of injury by this pest, as well as by fleas. Infested

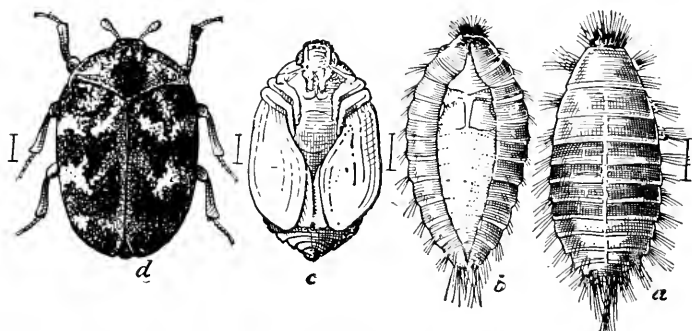

FIG. 155.—The carpet beetle (*Anthrenus scrophulariæ*). (From Riley.)
a, larva, dorsal view; *b*, pupa within larval skin; *c*, pupa, ventral view; *d*, adult. All enlarged.

carpets should be steam-cleaned wherever possible so as to destroy the eggs. If this is not possible, heating the carpet to 125° will probably be fatal to all eggs and larvæ. Cracks should be soaked with gasoline and then filled with a crack-filler. The same methods of control and prevention as advised for clothes moths (page 222), will also prove effective.

A nearly related species known as the *Black Carpet Beetle** has very similar habits. It is a black or rusty-black, slightly downy, oval beetle about $3/16$ of an inch long and

* *Attagenus piceus* Oliv. Family *Dermestidæ*.

half as wide. The larvæ are about $\frac{5}{16}$ inch long when full grown, are reddish-brown, taper somewhat posteriorly, and bear a tail-like brush of brown hairs half as long as the body.

132. The Pea-Weevil.* The common pea-weevil occurs wherever peas are grown throughout the world and is the cause of "buggy" peas. It does but little damage in the more northern latitudes and seedsmen secure their seed from Canada and northern Michigan and Wisconsin. The weevil is of an oval shape, about one-fifth inch long and half as wide, of a blackish ground color, variegated with black

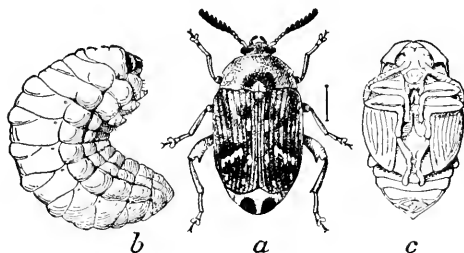

FIG. 156.—The pea-weevil (*Bruchus pisorum* L.) (From Chittenden, U. S. Dept. Agr.)

a, adult beetle; *b*, larva; *c*, pupa—all enlarged.

and white markings as shown in Fig. 156. The abdomen projects beyond the wing-covers and is marked with two black spots at the tip. The weevils appear in the fields when the peas are in bloom and lay the eggs on the surfaces of the young pods. The young larva bores through the pod into the seed, in which it grows rapidly. When grown it is about one-fourth of an inch long and half as wide, is a fleshy, nearly cylindrical, strongly wrinkled, white grub, with a brown head and very short stubby legs. It makes a round hole in the pea, leaving the thin surface membrane as a covering and then transforms to the pupa within the pea.

* *Bruchus pisorum* Linn. Family *Bruchidae*, see page 122.

The adult weevils may emerge in from nine to seventeen days. In more southern latitudes the weevils leave the seed in August, but in the North they remain in the seed over winter and are in it when planted. There is only one generation a year and this species does not reproduce in dry peas.

One of the best means of destroying the weevils, where it can be done, is simply to hold the peas over for a year, so that the weevils will emerge in the bags and finally die. A remedy which many Canadian farmers have used successfully is to drench the seed with kerosene, using about half a gallon to five bushels of peas. It is applied by placing the peas on a floor where they can be shoveled over to insure even treatment of all. When seed to be used for planting is found infested with live weevils they may be destroyed by pouring the peas into a pot of scalding hot water. The water should be drained off at once and the peas cooled immediately by pouring into cold water. The same result may be secured by heating the seed to 145° Fahrenheit and then cooling. Probably the best remedy is fumigation with carbon bisulphide, using one pound to 100 bushels of seed, or one ounce to 100 pounds. A kerosene barrel is a convenient receptacle in which to fumigate small quantities, requiring about three ounces of bisulphide. For further directions for use, see page 335.

133. The Common Bean-weevil.* The common bean-weevil is the principal pest of the bean in the United States. The adult weevil is about one-eighth of an inch long and is covered with a fine gray-brown or olive pubescence, and the wing-covers are mottled, as shown in Fig. 157. It may be distinguished from the pea-weevil by the larger thorax and by the two small teeth next to the large tooth at the tip of the hind thighs. The eggs are inserted in the bean-pods

* *Bruchus obtectus* Say. Family *Bruchidae*, see page 122.

by the females through any openings caused by drying and splitting, or are laid loosely among the shelled beans. The larva feeds within the bean and becomes a fat footless grub as shown in the illustration. The pupal stage is also passed within the bean. Experiments have shown that the complete life cycle may require from twenty-one to eighty days, according to the temperature. Probably about six generations occur annually in the latitude of the District of Columbia, and fewer farther north. A number of weevils may

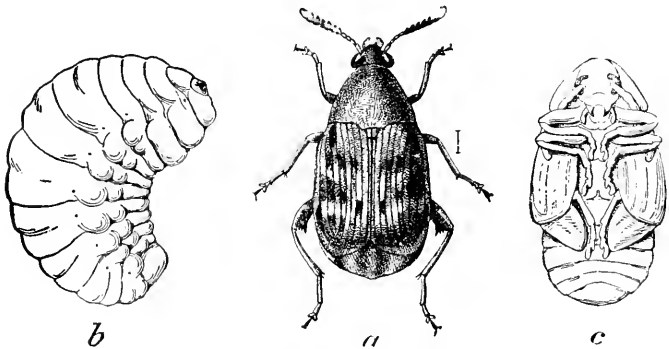

FIG. 157.—The common bean-weevil (*Bruchus obtectus* Say). (After Chittenden, U. S. Dept. Agr.)
a, beetle; *b*, larva; *c*, pupa—all greatly enlarged.

infest a single bean. Weevily seed should never be planted as but a small percentage will germinate. Infested seed may be thrown lightly into water, when that badly infested will float and can be destroyed.

Either heat or fumigation as advised for the pea-weevil will be effective, except that it is useless to hold the seeds over, as this species breeds in the stored seed.

134. Grain-weevils and Grain-beetles (45). The term "weevil" is commonly applied to almost any insect affecting stored grain, but it should be used only for the true snout-

beetles, of which the *Granary-weevil* * and the *Rice-weevil* † are the most common. They are small, brown, wingless beetles, from one-eighth to one-sixth of an inch in length, with long snouts which are of great service in boring into the kernels of grain. By means of them the females puncture the grain and then insert an egg in the cavity. The larva hatching from this is without legs, somewhat shorter than the adult, white in color, and of a very robust build, being almost as broad as long. It soon devours the soft interior of the kernel and then changes to a pupa, from which the adult beetle emerges in about six weeks from the time the egg was laid.

Only a single larva inhabits a kernel of wheat, but several will often be found in that of corn. Not only do the larvæ injure the grain, but the beetles feed upon it, and then hollow out a shelter for themselves within the hull.

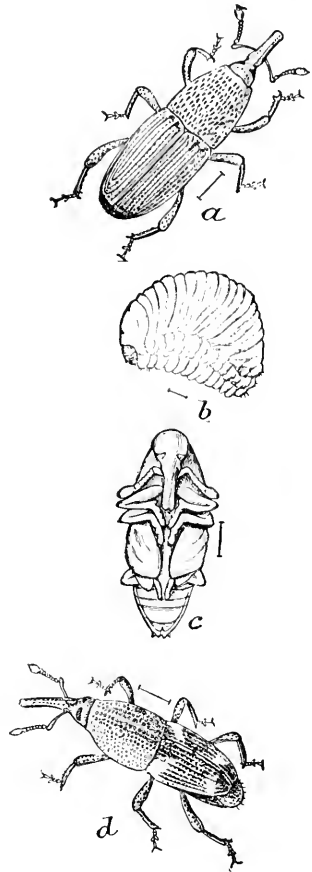

FIG. 158.—The grain-weevil (*Calandra granaria*). (After Chittenden, U. S. Dept. Agr.)

a, beetle; b, larva; c, pupa; d, the rice weevil (*C. oryza*): beetle—all enlarged.

* *Calandra granaria* Linn.

† *Calandra oryzae* Linn. Family *Calandridæ*.

The beetles are quite long-lived, and thus do considerable damage. As there are three or four broods in the North and six or more in the South, it has been estimated that the progeny of one pair would amount to 6000 insects in a single season.

Another beetle very common in the granary, but of quite different appearance, is the *Saw-toothed Grain-beetle* * (Fig. 159). It is a cosmopolitan pest and is nearly omnivor

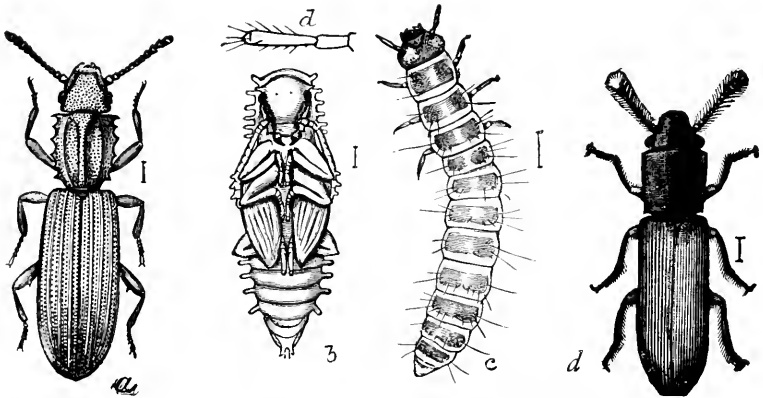

FIG. 159.—The saw-toothed grain-beetle (*Silvanus surinamensis*).
(After Chittenden, U. S. Dept. Agr.)

a, adult beetle; b, pupa; c, larva—all enlarged; d, the red or square-necked grain-beetle (*Cathartus gemellatus*).

ous. The beetle is only about one-tenth of an inch long, very much flattened, of a dark-brown color, and may be easily recognized by the six saw-like teeth on each side of the thorax. The larva is of a dirty-white color, and quite dissimilar from that of the granary weevil. Having six legs to carry it about, it is not satisfied with a single seed, but runs about here and there, nibbling at several. When full grown the larva glues together several grains or fragments into a

* *Silvanus surinamensis* Linn. Family *Cucujidæ*.

little case, and inside of this transforms to the pupa and then to the beetle. There are from three to six or more generations during a season, according to the latitude.

The *Red* or *Square-necked Grain-beetle* * is about the same size as the last species, but is a reddish-brown color, and the thorax is almost square, nearly as broad as the abdomen and not notched at the sides. It breeds in corn in both the field and granary, first destroying the germ, so that it is particularly injurious to seed corn.

The *Cadelle* † also has the bad habit of first attacking the germ of the kernel, and going from one kernel to another destroys a large number for use as seed. It has the good trait, however, of feeding on other injurious grain insects. The beetle is about one-third of an inch long, oblong, flat, and nearly black. The larva is a fleshy, whitish grub, nearly three-fourths of an inch long when grown, with a brown head, the thoracic segments marked with brown and the abdomen ending in two dark horny processes.

The larvæ of two species of beetles ‡ are very common in bran and meal, as well as other grain products, and are commonly known as meal worms. They are used for bird food and are grown in quantity by bird stores. The beetles are about one-half inch long, *T. molitor*, being a shining black and somewhat lighter than *T. obscurus*, which is a dull black. Running lengthwise of the wing-covers are sixteen furrows. The larvæ, or meal-worms, are about one inch long, yellowish in color, cylindrical, and have a hard, shiny skin. At the tip of the abdomen are two small dark-colored spines. They grow rather slowly and may live for a long

* *Cathartus gemellatus* Duv. Family.

† *Tenebriodes mauritanicus* Linn. Family *Trogositidæ*.

‡ *Tenebrio obscurus* and *Tenebrio molitor* Linn. Family *Tenebrioidæ*, see page 123.

time without food and in very dry material. There seems to be but a single generation in a year.

135. Flour and Meal-moths (37). The larvæ of several small moths sometimes infest grain in store, but usually prefer flour, meal and food products. The most destructive of these is the *Mediterranean Flour Moth*.* It was imported from Europe in the '70's and has now become generally distributed over the United States. The adult moth expands about an inch, the fore wings are a lead-gray color with transverse blackish markings, and the hind wings are dirty

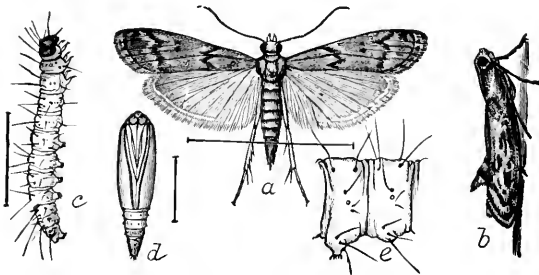

FIG. 160.—The Mediterranean flour-moth (*Ephestia kuehniella*). (After Chittenden, U. S. Dept. Agr.)

a, moth; b, same from side, resting, c, larva; d, pupa—enlarged; e, abdominal joint of larva—more enlarged.

whitish with a darker border. The caterpillars feed in cylindrical silken tubes which makes them a great nuisance in mills, where the machinery becomes clogged with the felted flour. The life cycle ordinarily occupies about two months, but may be completed in thirty-eight days.

∨ The *Indian Meal-moth* † (Fig. 161) larvæ, like the grain-beetles, have a special liking for the germ of wheat grains. They spin a fine silken web as they go from seed to seed, to which the seed becomes attached and to which the excre-

* *Ephestia kuehniella* Zell. Family *Pyralidæ*. See page 75.

† *Plodia interpunctella* Hbn. Family *Pyralidæ*.

ment also clings, so that much more grain is spoiled for food than is really injured. The moth expands about three-fourths of an inch, the inner third of the fore wings being a light grayish and the outer portion a reddish-brown with a coppery luster.

The *Meal Snout-moth* * (Fig. 162), is of a light brown color, the thorax, base, and tips of the fore wings being darker brown. The wings expand nearly an inch and are other-

wise marked with whitish lines as shown in the figure. It is very similar to the last-mentioned species in its habits, constructing long tubes with silk and particles of the food in which it is living. The life-history is completed in about eight weeks, and four generations may occur in a year. The moisture of "heated" grain is most favorable for the development of this pest, and it need not be feared if grain is kept in a clean, dry place.

The worst pest of stored grain in the South is the *Angoumois Grain Moth*.† It

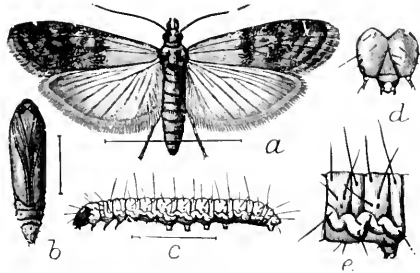

FIG. 161.—The Indian meal-moth (*Plodia interpunctella*). (After Chittenden, U. S. Dept. Agr.)

a, moth; b, pupa; c, caterpillar—enlarged.



FIG. 162.—The meal snout-moth (*Pyralis farinalis*)—twice natural size. (After Chittenden, U. S. Dept. Agr.)

* *Pyralis farinalis* Linn. Family *Pyralidae*, see page 78.

† *Sitotroga cerealella* Oliv. Family *Gelechiidae*.

receives its name from a province in France where it wrought havoc in 1760. It occurs throughout the South and as far north as Pennsylvania and Ohio. Wheat, corn, oats, rye, barley, sorghum-seed, and even cow-peas are injured. The moths quite closely resemble clothes moths (page 220), expanding nearly three-fourths of an inch, being of a yellowish-buff color, marked with black, and with the same broad fringe on the hind wings. The moths

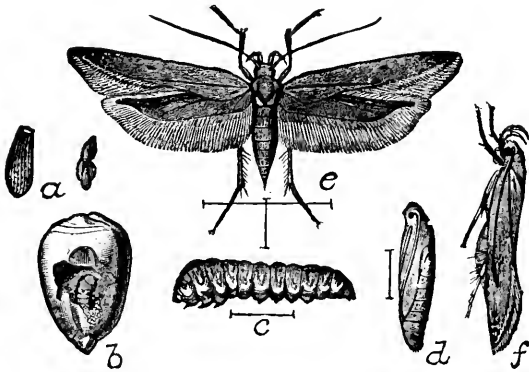

FIG. 163.—The Angoumois grain-moth (*Sitotroga cerealella*). (After Chittenden, U. S. Dept. Agr.)

a, eggs; *b*, larva at work; *c*, larva, side view; *d*, pupa; *e*, moth; *f*, same, side view.

emerge from infested grain in late May or June, when they fly to the growing grain, on which each female lays from 60 to 90 eggs. The young caterpillars bore into the kernels, where they feed and become full grown in about three weeks. Full grown caterpillars are about one-fifth of an inch long, white in color, with a yellowish head, and have four pairs of soft prolegs on the middle of the abdomen. The second brood of moths appears about harvest time. They lay their eggs in July, depositing them on the wheat in the stack. The caterpillars hatching from these eggs may

remain in the grain over winter, but in warm seasons a third brood of moths may be developed by early September. This species continues to breed within doors all winter, although feeding stops in very cold weather. The number of generations depends entirely upon latitude and weather. In the South there may be as many as eight in a year.

Corn is frequently attacked, but not until it is ripe and husked, and then but rarely when husked in October and November and stored outdoors in slatted cribs. Seed-corn stored in barns, and in the South in almost any situation, is often badly injured.

Aside from the loss in weight, grain when badly infested becomes unfit for milling purposes, and will even be refused by cattle and horses, which should not be urged to eat it, though hogs and fowls will readily consume it.

Grain should be threshed as soon after harvest as possible and placed in tight bins or sacks. Infested grain should be fumigated with carbon bisulphide as soon as threshed. Sacked grain will not heat if infested, and the moths cannot get out and are stifled. If placed in bins, they should be made tight and if the grain heats perceptibly, it should at once be fumigated with carbon bisulphide. Corn should be husked before storing. Barns and storehouses should be cleaned up from scattered grain before April first, and infested grain should be kept tightly covered in the spring so that no moths will spread to the field.

136. Control of Grain Insects. Cleanliness is prerequisite to freedom from grain pests. Wherever dust, dirt, rubbish, sweepings of grain and its products, are allowed to accumulate, ideal conditions for the reproduction of grain insects are afforded. It is highly desirable where grain is to be stored on the farm, that a separate building be provided

at some distance from other buildings. It should be constructed of matched flooring so as to be as near insect-tight as possible. The doors should fit tightly, closing on a rabbet, which may be covered with felt or packing. The windows should be covered with fine wire screening to prevent the passage of insects. The floors, walls and ceiling should be made smooth, with no cracks in which insects may hide. It is important that the building be dry, well ventilated and as cool as possible, as reproduction is much more rapid in a warm place, and infested grain will heat more quickly. It is desirable to store grain in bulk, as a smaller surface is thus exposed to infestation, and the moths do not penetrate far beneath the surface. The best means of destroying insects in the small granary is by fumigating with carbon bisulphide (page 335). The room or bin in which it is to be used should be made tight. Bins may be covered with blankets. The liquid may be poured directly on the grain, which it will not injure. Care should always be exercised that no fire comes near the place fumigated, as the gas is exceedingly inflammable. Mills and storehouses which are badly infested are often fumigated with hydrocyanic acid gas (page 336). Prof. R. I. Smith has shown that sulphur dioxide, produced by burning sulphur slightly dampened with alcohol, will kill most grain insects, but injures the germinating power of the grain. "It was found that the fumes produced by burning $2\frac{1}{2}$ pounds of sulphur either in moist or dry atmosphere of 1000 cubic feet space, for twenty hours, would kill all exposed adult insects and practically all the young stages in the grain, but that this also destroyed its germinating power. . . . While this treatment cannot be recommended for general fumigation, there is no doubt of its being the easiest and cheapest method of fumigating corn cribs, granaries and similar places whenever they are being cleaned out

and freed of insects in preparation for the reception of more grain.”

The heating of grain was one of the earliest means known of combating grain insects, but has been little used in this country. Recently, however, Prof. Geo. A. Dean (52), has shown that by super-heating mills they may be rid of insect pests much more quickly and cheaply than by fumigation, and with no risk from fire or from cyanide poisoning. His experiments show that if the temperature surrounding an insect be maintained above 120° F., with a normal amount of moisture, that in a very few minutes it will be killed. This promises to become one of the most practicable methods of cleaning mills and may be used for small quantities of grain, where there are facilities for heating it or placing it in a superheated room.

CHAPTER XVI

FIELD CROP INSECTS

137. White Grubs.* The large grubs (15) with brown heads and enlarged curled-up abdomens, which are thrown out in plowing sod land, are commonly known as *white grubs*. Although there are numerous species, they are all very similar in general color and form and are the larvæ of different species of the large brown May-beetles or June-

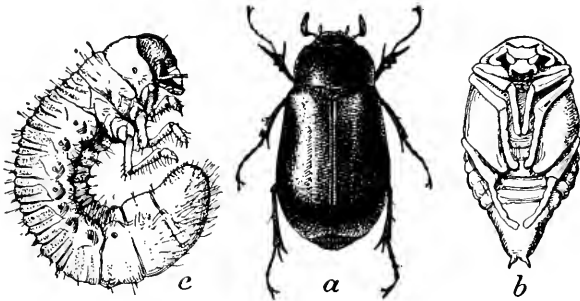

FIG. 164.—A May-beetle (*Lachnosterna arcuata*). (After Chittenden, U. S. Dept. Agr.)

a, beetle; b, pupa; c, mature larva—enlarged one-fourth.

bugs, which frequently fly to lights in late spring. White grubs are most abundant in sod land and often seriously injure old meadows, but their injury is most commonly noticed on corn, strawberries and garden crops.

The eggs are laid one to five inches below the surface of the soil in grass lands, though sometimes in corn land or gardens, and hatch by midsummer. The young grubs feed

* *Lachnosterna* spp. Family *Scarabæidæ*. See page 118

upon the plant roots available and grow slowly, as they require two years or more to become full grown. In the fall they go deeper in the soil and by the first freeze they are from seven to fourteen inches deep. The next year they do much more serious damage and crops are often ruined on sod land which has been planted to corn, strawberries or garden crops. As many as thirty-four grubs have been found in a single hill of corn in an Illinois field in sod the previous year. When the grub is two or three years old it forms a cell from three to ten inches below the surface and there changes to the pupa during midsummer. In August or September the adult beetle wriggles out of the pupal skin but remains in the earthen cell until the following spring, when it emerges fully hardened. Thus three full years are required for the life cycle, although grubs in all stages of development may be found in the soil every year. The adult beetles feed at night upon the foliage of various trees and hide in the soil during the day. Different species have favorite food plants, but all the common deciduous shade and forest trees are more or less eaten, maple and poplar particularly.

A frequent rotation of crops, following sod with some crop not particularly injured by the grubs, will form the most important general means of control, as allowing land to remain in grass for several years furnishes them ideal conditions for multiplication. Deep plowing and thorough harrowing in late fall, winter and early spring will break up many of the pupal cells and destroy the tender beetles, both by burying and crushing them and by exposing them to abnormal conditions. Swine will gorge themselves on the grubs on badly infested land and if confined so that they can thoroughly root it over, will effectively clean it of them. Flocks of turkeys or chickens following the plow destroy

large numbers, as do crows and blackbirds. Lanterns hung over pans or tubs of water with a surface film of kerosene, placed near the trees on which the beetles feed, will catch large numbers of them on warm nights.

138. The Chinch-bug * (16). Though individually insignificant, when assembled in countless myriads chinch-bugs have, doubtless, done greater injury to the farmers of the Mississippi Valley than any other insect attacking grain crops, the total damage from 1850 to 1909 being estimated at

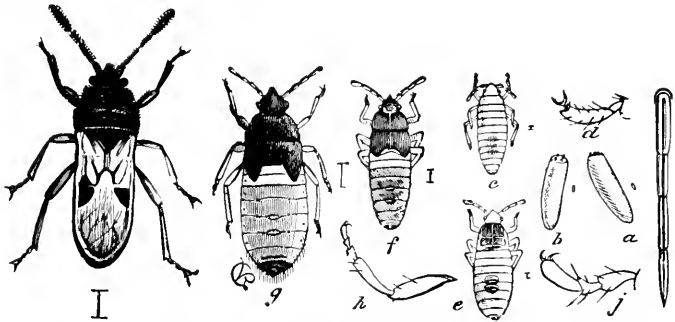

FIG. 165.—The chinch-bug (*Blissus leucopterus* Say). (After Riley.)

Adult at left; a, b, eggs magnified and natural size; c, young nymph; e, second stage of nymph; f, third stage; g, full-grown nymph or pupa; d, h, j, legs; i, beak through which the bug sucks its food.

\$350,000,000. The principal injury is to small grains and corn in the Central and North Central States, though occasionally injury occurs in the Eastern States, particularly to old timothy meadows. The adult chinch-bug is about one-fifth of an inch long with a black body. Its white wings lie folded over each other on the abdomen, and are marked by a small black triangle on their outer margins, while the bases of the antennæ and legs are red. The young bugs are yellowish or bright red, marked with brownish-black, becoming darker as they grow older.

* *Blissus leucopterus* Say. Family *Lygaeidae*, see page 60.

The bugs hibernate over winter in clumps of grass, in the butts and in old shocks of corn, or under whatever rubbish is available. In early spring they feed upon grass and small grains. The females lay their small yellowish-white eggs upon the roots or bases of the stalks, each laying from 150 to 200 eggs from the middle of April until June first. The eggs hatch in about three weeks. The young bugs often do serious injury to small grains and grasses and become full grown about the time the former are harvested. When the small grains are harvested the bugs spread to corn, but curiously enough, although the adults are winged they usually travel from field to field on foot. Eggs are then laid on the corn, between the leaf-sheaths and the stalks, and hatch in about ten days. This second brood matures in August and September and hibernates over winter, although where corn is not available the whole season may be passed on grass.

The burning over of grass land and the grass along fences, hedges and roads, as soon as it becomes dry enough in late fall and early winter, is of prime importance for destroying the bugs after they have gone into hibernation, and if thoroughly done by co-operative effort over large areas, will be the cheapest and most effective means of control. The removal of all corn stalks from the fields and plowing the butts under deeply, or, where the bugs are very abundant, raking out the butts and burning them, will be of importance in some sections.

It is practically impossible to combat the bugs successfully on small grains and grass, but the migration to corn may be effectually checked. This may be done best by running a line of thick, viscid road oil (No. 7 of the Standard Oil Co., Whiting, Ind.), around the field to be protected. The soil should be prepared for this oil line by plowing a back furrow

and packing the top with a roller or beating it hard; or a strip of sod may be prepared by scraping away the grass with a scraper and then smoothing with shovels or hoes; or a dead furrow may be run and the oil line run on the smooth bottom. In any case it is important to have a fairly smooth, hard surface for the oil line so as to conserve the oil and make an effective barrier. The oil line may be run by pouring the oil from a watering-can with the mouth stopped down, so as to make a line about the thickness of one's finger. Along the outside of this line post holes, a foot deep, should be sunk every few feet. The bugs crawling along the oil line, which they will not cross as long as it is intact, will fall into the post holes, where they will collect and may be crushed or otherwise destroyed. In place of the post holes the bugs collecting along the line have sometimes been destroyed with a blast torch. Coal tar may be used instead of road oil, but is more expensive and must be renewed more frequently.

Where immediate action is necessary and road oil or coal tar are not at hand, the corn may be protected in dry weather by a dust furrow. Plow a deep furrow around the field to be protected and thoroughly pulverize the soil by dragging a heavy log back and forth through the furrow, making the sides as steep as possible. Sink post holes every few feet in the bottom. In attempting to climb this furrow the bugs will slide back to the bottom and will collect in the holes, where they may be killed. The dust furrow will be of no value in showery weather and is most effective on light soils in hot weather.

For destroying the bugs which pass the barriers and for those which may hatch on the corn, a spray of rosin soap, one pound to six gallons of water, has been found very effective, and should be used on the outer rows, so as to prevent the field from becoming generally infested.

Extensive experiments in the use of fungous diseases for the control of the chinch-bug were conducted for many years, but have resulted in proving the impracticability of their artificial use.

Where chinch-bugs are abundant the farmer should prepare to devote himself and as many hands as necessary to fighting them promptly if he would check their migration and save his corn crop, for delay may mean ruin.

139. Grasshoppers * (40*d*). Almost every year in some part of the country crops are destroyed by hordes of hungry grasshoppers, or locusts, as they are called in Europe. In the '70's vast areas in the Mississippi Valley were devastated by the clouds of Rocky Mountain Locusts which migrated down from the table lands of the Rocky Mountain region, but in recent years this species has practically disappeared from the United States. Several species are commonly de-

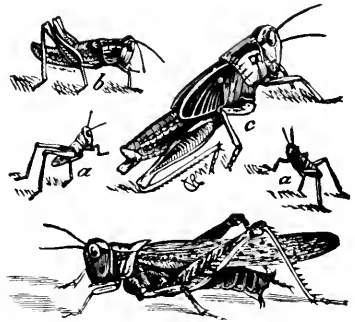

FIG. 166.—Rocky Mountain locust; adult and different stages of growth of young. (After Riley.)

structive throughout the country. One of the most common is the small *Red-legged Locust*,† which is found in almost every meadow. Very similar in both size and appearance is the *Lesser Migratory Locust*,‡ so-called on account of its flying in large numbers from one point to another. Another similar and closely related species is the *California Devastating Locust*,§ which has usually been the most de-

* Family *Acrididae*, see page 48.

† *Melanoplus femur-rubrum* Har.

‡ *Melanoplus atlantis* Riley.

§ *Melanoplus devastator* Scud.

structive species in that State. The *Two-striped Locust* * is somewhat larger and is characterized by two yellowish stripes extending from the eyes along the sides of the head to the extremities of the wing-covers. Our largest winged

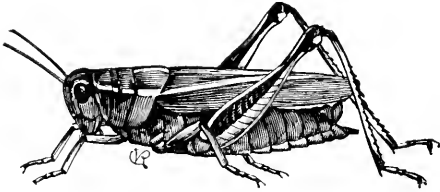

FIG. 167.—The two-striped locust (*Melanoplus bivittatus* Scud.). (After Riley.)

species is the *American Acridium*.† It is a Southern species, being common south of the Potomac and Ohio rivers, where it has often become quite destructive.

Throughout the Mississippi Valley from Illinois southward, the *Differential Locust* ‡ has become one of the most common and destructive species and its habits may be described to illustrate those of most of the other common

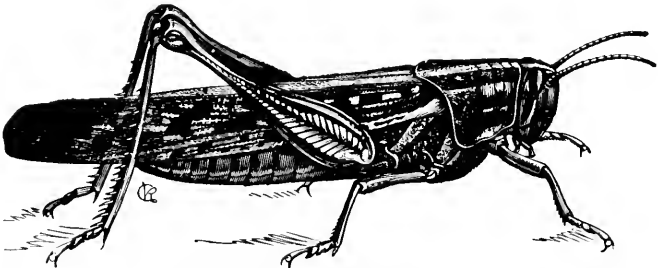

FIG. 168.—The American acridium (*Schistocerca americana* Scud.). (After Riley.)

species. The young grasshoppers hatch in late spring and are a dusky brown color, marked with yellow, resembling the adults in shape, but lacking wings. During their growth

* *Melanoplus bivittatus* Scud.

† *Schistocerca americana* Scud.

‡ *Melanoplus differentialis* Thos.

they moult five times at intervals of ten days to two weeks and are full grown by midsummer. The adults of this species are $1\frac{1}{2}$ inches long with a wing-expanse of $2\frac{1}{2}$ inches and a bright yellowish-green color. The head and thorax are olive-brown; the fore wings are much the same color without markings but with a brownish shade at the base; the hind



FIG. 169.—The differential locust (*Melanoplus differentialis* Thos.).
(After Riley.)

wings are tinged with green; the hind thighs are bright yellow, with four black marks, and the hind shanks are yellow with black spines and a ring of the same color near the base. The adults at once attack whatever crops are available, often finishing the destruction of those injured by them as nymphs, but in a few days their appetites seem to become somewhat appeased and they commence to mate and wander in search of suitable places for laying the eggs. Relatively few eggs are laid in cultivated ground, the favorite places being neglected fields grown up in grass and weeds, the edges of cultivated fields, private roadways, banks of ditches and small streams, and pasture lands. It is doubtless due to these egg-laying habits and the abundance of food on uncultivated land that this species always increases enormously on land which has been flooded and then lies idle for a year or two. Most of the eggs are laid in August and early Sep-



FIG. 170.—Egg-mass of the differential locust—enlarged.

tember. Each female deposits a single egg mass (most other species lay several egg masses), of about 100 eggs just beneath the surface of the soil. During this season the females may frequently be found with the abdomens thrust deep in the soil, as the process of egg-laying requires some time. The eggs are yellow and arranged irregularly in a mass which is coated with a gluey substance to which the earth adheres, and which protects them from variable conditions of moisture and temperature.

Deep plowing in late fall or early spring effectually buries the eggs too deep for the young nymphs to emerge. On alfalfa land thorough disking is often used for the same purpose. Thorough harrowing in the fall so as to pulverize the soil for the depth of an inch will break up many of the egg masses, though it is not as sure a control as plowing them under.

When the young emerge, they may sometimes be destroyed by burning over stubble, grass and rubbish where it is present in sufficient quantities, or by augmenting it with straw, which may be done to advantage on cold days when the nymphs are congregated in such shelter. Plowing a badly infested field in a square, working toward the center so as to drive the young nymphs inward, will result in burying many of them in the furrows, and the last may be burned or trapped in holes as described below. Dust furrows may be made as described for chinch-bugs and handled in the same manner, the little hoppers drifting to the bottom, where they are killed by the heat on a hot day or are caught in the post-holes sunk every few feet in the bottom. This method may be used to advantage in plots of corn, cotton, or garden truck which have already become infested, by running furrows around the field and occasionally through it, and then driving the young hoppers toward them. This may readily be

done by a number of children armed with branches. Where ditches containing water are available the young hoppers may be destroyed by oiling the surface of the water with kerosene emulsion and then driving them into the ditches, for even if they succeed in crawling out they will succumb to the oil.

Where the young hoppers have congregated in large numbers on the edges of fields, in patches of weeds, etc., they may be destroyed by spraying them with kerosene or crude petroleum either pure or, preferably, in an emulsion, and the weeds and grass along fences and in neglected fields should be thoroughly treated with a strong arsenical spray or dust.

On pastures, small grains or any crops permitting their use, immense numbers of nymphs may be caught by the use of hopperdozers, which may be utilized where the use of poisoned bran would not be possible. The hopperdozer consists of a shallow pan, mounted on runners or wheels, containing water with a surface of kerosene or crude petroleum, and, if larger than about three feet square, is usually provided with partitions to prevent slopping. The back and sides are high and sometimes are made of canvas. "A good cheap pan is made of ordinary sheet iron, eight feet long, eleven inches wide at bottom, and turned up a foot high at the back and an inch high in front. A runner at each end, extending some distance behind, and a cord attached to each front corner, complete the pan (Fig. 171). It is easily pulled by two boys, and by running several together in a row, one boy to each rope, and one to each contiguous pair, the best work is performed with the least labor." Larger hopperdozers are drawn or pushed by horses.

Poisoned bran mash has been used against both nymphs and adults, using from one to two pounds of Paris green to 25 pounds of bran. Poisoned horse-droppings have been

used very successfully, especially in the Northwest and in Canada. One part of Paris green is mixed with 100 parts of horse manure by measure. Enough water is added to make the mass soft without being sloppy. The mixture is scattered over the fields from a wagon or stone-boat with a paddle. In Minnesota a similar mixture has been found cheaper and more satisfactory. It is made of one pound of arsenite of soda, 120 to 150 pounds of horse manure and one

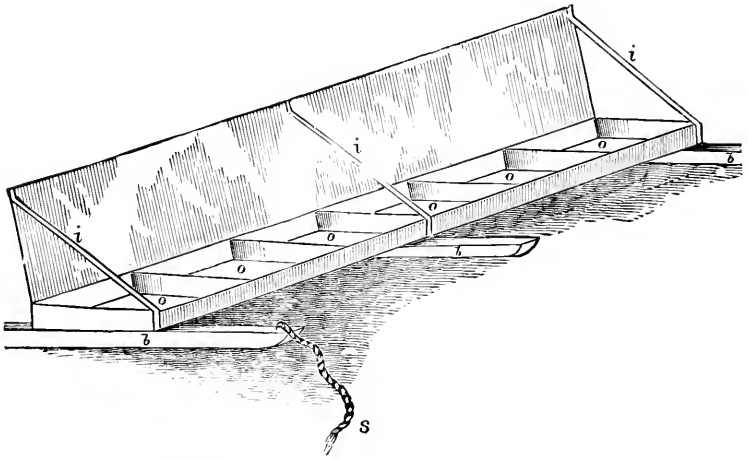

FIG. 171 —The Price oil-pan or hopperdozer, with partitions to prevent slopping. (After Riley.)

pint of cheap molasses. Dissolve the arsenite of soda in water and then add to the manure, stirring well.

140. Grain Aphides.* The *English Grain-aphis*,† the most common aphid affecting wheat and other small grains, is a large green species which occasionally increases so rapidly, just as the heads are ripening, as to injure seriously the quality and weight of the wheat. The wingless females are

* *Family Aphididae*, see page 66.

† *Macrosiphum granaria* Buckton.

about one-tenth inch long, with black antennæ as long as, or longer than, the body. They are a yellowish-green color and the long nectaries projecting from either side of the abdomen are black. The winged females are about the same length, the antennæ are a third longer than the body, which is of the same general coloration except that the lobes of the thorax are brownish or blackish and the abdomen is marked with four or five transverse blackish spots in front of the nectaries.

The *German Grain-aphis** is commonly associated with this species and has very similar habits. It may be distinguished by its lacking the blackish markings on the abdominal segments.

These aphides appear on the

young wheat in the spring and multiply rapidly on the leaves until the grain commences to head, when they crowd among the ripening kernels. As the small grains ripen the aphides migrate to various grasses and are not in evidence during summer, but later migrate to volunteer oats and wheat, upon which they breed until fall wheat is available.

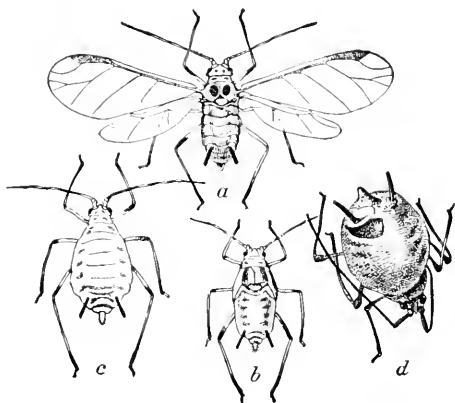

FIG. 172.—The German grain-aphis (*Macrosiphum cerealis* Kalt). (After Riley, U. S. Dept. Agr.)

a, winged migrant; *b*, nymph of same; *c*, wingless parthenogenetic female; *d*, same showing exit hole of parasite—enlarged.

* *Macrosiphum cerealis* Kalt.

The *Oat Aphis* (6), has been discussed (page 304), as an apple pest, but should be here noted, as it is widely distributed on wheat and oats. The wingless females congregate in the axils of the leaves, around the crown, and on the upper roots, injury seeming to be worse in winter, when they often cause the plants to turn yellowish. In the South this species



FIG. 173.—“Green bugs” on oat seedling—enlarged.

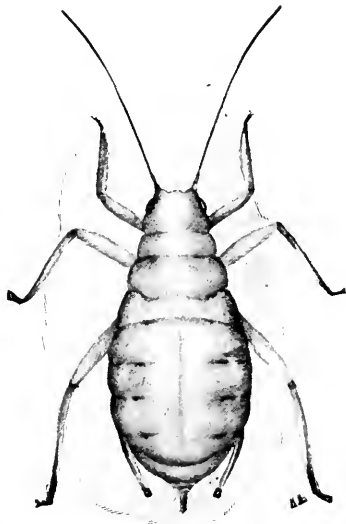

FIG. 174.—Spring grain-aphis (*Toxoptera graminum*). Adult wingless female greatly enlarged. (After S. J. Hunter.)

continues to reproduce on small grains without having an alternate sexual generation on the apple.

The *Spring Grain-aphis* or *Green Bug* * (17), although widely distributed, has been seriously injurious only from Kansas southward, although damage has occurred in the Carolinas and Tennessee and elsewhere. The wingless

* *Toxoptera graminum* Rond.

female is from one-twenty-fifth to one-fourteenth inch long, yellowish-green, with a median line slightly darker, and eyes and most of the antennæ black. The winged female is slightly larger and of the same coloration except that the head is brownish-yellow and the lobes of the thorax are blackish. The agamic females multiply rapidly in summer, for during its life of about a month each female will give birth to fifty or sixty young, which commence to reproduce in the same manner when about a week old. Reproduction is slower in winter, but in an open winter a few individuals will soon give rise to infested spots from which countless individuals will spread over the field and entirely ruin it by the middle of April in northern Texas. As

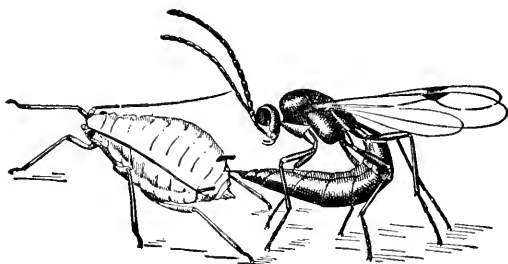

FIG. 175.—*Lysiphlebus* parasite in act of depositing eggs in the body of a grain-aphis—much enlarged. (After Webster, U. S. Dept. Agr.)

the food supply disappears almost all the young develop wings and immense clouds of winged females are carried northward by the winds, so that an outbreak in early spring in the South leads to infestation further north. As soon as they multiply they again spread northward. Progressing thus in 1907, they reached southern Minnesota by July.

Grain aphides are prevented from becoming so overabundant as to cause frequent injury by the attacks of small wasp-like parasites. These little parasites lay their eggs in the aphides, which are soon killed by the growing larvæ. These parasites reproduce even more rapidly than the

aphides, but only at a temperature some ten degrees higher than that required by the green bug. In cool wet weather the aphides increase rapidly and may become destructive

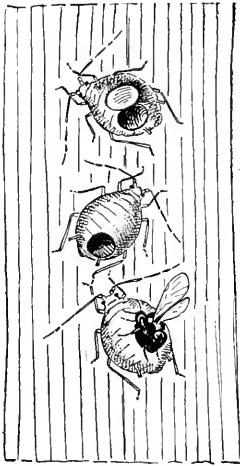

FIG. 176.—Dead “green bugs,” showing hole from which the matured parasite of *Lysiphlebus* emerges. The top figure shows the lid still attached, but pushed back; the bottom figure shows the parasite emerging. Enlarged. (After Webster, U. S. Dept. Agr.)

before warmer weather enables the parasites to become sufficiently numerous to check them.

All of these grain aphides multiply in the fall on volunteer oats and wheat. Their destruction in early fall and the abandonment of the practice of growing volunteer oats in the Far South, are, therefore, of prime importance for their control. Where small spots of young grain plants have been injured the aphides may be killed by spraying with a 10 per cent kerosene emulsion, soap solution one pound to six gallons, or Black-leaf-40 tobacco extract, one part to 900 parts of water, to which should be added one pound of soap to each 100 gallons. Such spots may also be covered with straw and burned, or be plowed under. It is of considerable importance, particularly with the green bug, to observe small spots when injury first occurs and to

treat them so as to prevent further spread.

141. The Hessian Fly.* The most destructive of any of the insects attacking wheat is the *Hessian Fly*, a small midge which received its name from the fact that it was first

* *Mayetiola destructor* Say. Family *Cecidomyiidae*.

discovered on Long Island, in 1779, just where the Hessian troops had landed three years before. It has been estimated that it reduces the wheat crop by 10 per cent every year and frequently 25 to 50 per cent is lost in restricted localities.

The adult flies are small dark-colored gnats about one-

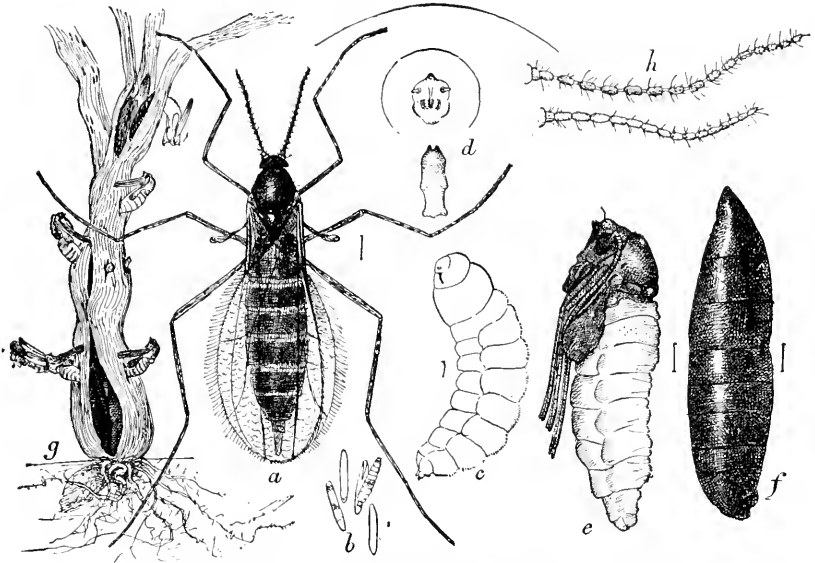

FIG. 177.—The Hessian fly (*Mayetiola destructor*). (After Marlatt, U. S. Dept. Agr.)

a, female fly; *b*, flaxseed stage or pupa; *c*, larva; *d*, head and breast-bone of same; *e*, pupa; *f*, puparium; *g*, infested wheat-stem showing emergence of pupae and adults—all greatly enlarged.

tenth of an inch long, so small as commonly to escape observation. The females lay their small reddish eggs usually on the upper surface of the leaves. The maggots hatching from these in the fall burrow beneath the sheath of the leaf at its base, causing a slight enlargement at the point of attack. In the spring they usually stop at one of the lower

joints, but always become fixed in the plant, absorbing its sap and destroying its tissues. The dark color of the leaves, the absence of central stems and the stooling out of the plants are among the indications of injury in the fall or winter wheat. Later many plants yellow and die. The spring maggots attack the laterals, or tillers, which have escaped the fall brood, so weakening them that the stems break and fall before ripening and cannot be readily harvested.

The maggots become grown in about a month, when the skin shrivels and turns brown and inside it is formed the pupa. This outside case composed of the larval skin is known as the "puparium," and this is commonly called the "flax-seed" stage from its resemblance to that seed. The winter is passed in the pupal stage and the flies emerge in April or May. The summer brood remains in the "flax-seed" stage in the stubble during the late summer and the flies emerge when the first wheat is planted in the fall.

The principal means of control is by the late planting of wheat in the fall. The flies appear within about a week and then disappear and if planting be delayed so that the wheat will not be up until after that time, there will be but little injury. Dry weather in late summer and early fall delays the appearance of the flies and the farther south, the later they appear. In average seasons it will probably be found safe to sow wheat in the latitude of northern Michigan soon after September 1st; in southern Michigan and northern Ohio about September 20th; in southern Ohio after the first week in October; in Kentucky and Tennessee, October 10th to 20th, and in Georgia and South Carolina, October 25th to November 15th. The exact time will also depend upon the altitude, every 100 feet of altitude making the date about one day earlier. As the infesta-

tion of the fall wheat comes from the stubble it is important to disk the stubble immediately after harvest and three or four weeks later plow the land at least six inches deep, so that all stubble and volunteer wheat will be well buried. The land should then be refirmed and worked into a good seed bed, keeping it mellow and free from volunteer wheat. The importance of the best possible preparation of the land and the destruction of volunteer wheat cannot be over-emphasized.

142. The Corn Earworm or Cotton Bollworm * (18). This is practically the only insect seriously injuring the ears of field corn. In the South it is so abundant on sugar corn as to make it very difficult to secure uninjured ears, and in the Middle States it greatly reduces the profit in growing corn for the cannery. In the South it bores into the half-formed cotton bolls, often materially reducing the crop, and is, therefore, known as the *Cotton Bollworm*. In tomato-growing sections it is called the *Tomato Fruitworm*, from its habit of eating into the green fruits and in tobacco regions it is the *Tobacco Budworm* on account of its injury by boring into the buds and seed-pods. Numerous other crops such as beans, peas, and many garden and forage crops are also attacked.

The moths have a wing expanse of about $1\frac{3}{5}$ inches and are quite variable in color and markings. Some are dull olive-green while others are yellowish and with almost no markings. Typically the wings are bordered with dark bands, the wing-veins are black and the fore wings are spotted with black. In the Gulf States the moths appear in April and in the Middle States early in June. The eggs of the first generation are laid on corn, peas, beans, or whatever food-plants are available and hatch in from three to five

* *Heliothis obsoleta* Fab. Family *Noctuidæ*.

days. They are light yellowish, and prettily corrugated. The caterpillars of the first generation often attack corn when it is about knee-high, feeding in the axils of the tender leaves so that when they unroll they bear rows of holes.

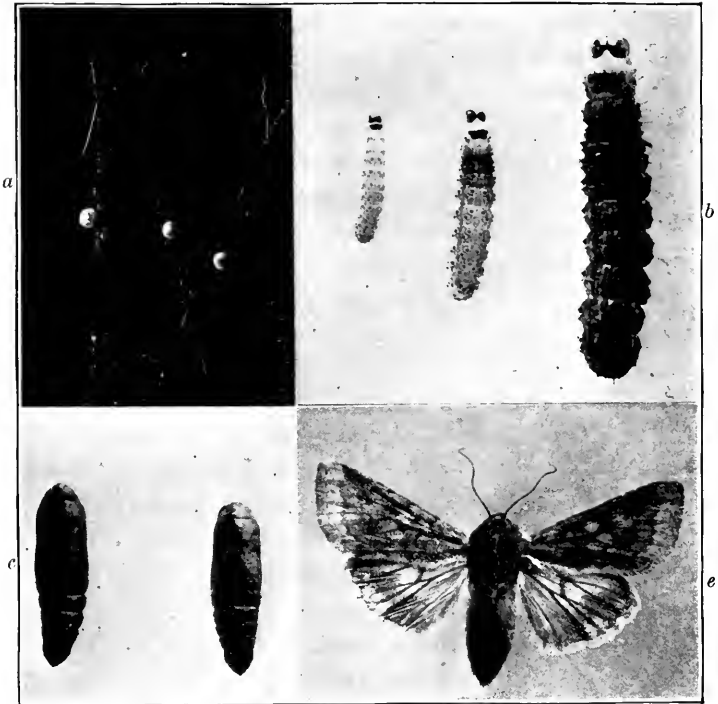

FIG. 178.—The corn ear-worm (*Heliopsis obsoleta* Fab).

a, eggs on corn-silk; *b*, the first three larval stages; *c*, pupa from below; *d*, same from above; *e*, adult moth—all enlarged; *b*, about twice natural size.

The caterpillars are also quite variable in color, ranging from a light green, through rose color and brown to almost black, and being either striped, spotted or perfectly plain. They become grown in about two and a half weeks and are then from $1\frac{1}{4}$ to $1\frac{1}{2}$ inches long. The grown caterpillar burrows into

the soil for two to five inches and after making an upward burrow nearly to the surface for the escape of the moth, changes to a pupa at the bottom of the burrow. During the summer the moths emerge in about two weeks, but the last generation in the fall passes the winter in the pupal stage. The second generation of moths appears about mid-

summer in the latitude of Delaware and Kansas. The caterpillars of the second generation in the South and of the third farther north prefer to lay their eggs on corn silk and tassels and do serious injury by eating out the tips of the ears. From 2 to 3 per cent of the corn crop of the country, valued at from \$30,000,000 to \$50,000,000, is thus destroyed annually, and the annual damage to cotton is estimated at

\$20,000,000. In the Gulf States there are four or five generations, the larvæ of the third and fourth generations being the most injurious to cotton in August and September. This is also the season when tobacco is worst injured.

Inasmuch as the pupæ pass the winter in the soil, the most practical means of control is to plow infested land in



FIG. 179.—Bollworm at work on cotton bolls, boring into grown boll—slightly reduced. (After Quaintance and Brues, U. S. Dept. Agr.)

late fall or during the winter, and to harrow thoroughly. This breaks up the pupal cells, crushing some, and exposing others to the elements. Field corn which is planted early is much less injured than that planted later. Where the caterpillars of the first generation are noticed in the axils of the young corn, they may be destroyed by sprinkling powdered arsenate of lead in the axil. The same method should



FIG. 180.—Bollworm boring into green tomato. (After Quaintance and Brues, U. S. Dept. Agr.)

be used for destroying the worms in tobacco buds. Thorough spraying with arsenate of lead will prevent injury to tomatoes. As with corn, cotton planted early and quickly matured is but little injured. Dusting cotton foliage with powdered arsenate of lead will destroy the young caterpillars where they are sufficiently abundant to warrant. As the moths prefer to lay their eggs on corn silk, cotton may be protected by the use of strips of late corn planted through the fields so as to act as a trap crop. About June first plant

several alternate rows of Mexican June corn and cow-peas, in strips, through the cotton, so that the corn will be in silk about the first of August when the moths of the third generation are laying their eggs. They will be attracted to lay on the corn in preference to the cotton and the cow-peas will furnish them both food and shelter. As soon as the worms become fairly grown, the corn and cow-peas should be cut and fed to stock, and the land plowed to destroy any which may have pupated. Planting small areas of corn and cow-peas here and there on large plantations will have much the same effect. They may follow early crops such as potatoes, oats or wheat.

143. The Cotton Worm.* The cotton worm (19) is the most serious insect pest of cotton foliage and prior to the advent of the boll weevil was the worst enemy of the cotton plant. When very abundant these hungry caterpillars will strip the foliage over considerable areas in a few days and will eat the buds and even attack the twigs so that only prompt action will save the crop. Fortunately the worst damage is usually not done until early fall, and inasmuch as only early cotton can be grown wherever the boll weevil occurs and no effort is made to secure a late or "top-crop," the real injury by the cotton worms, in the boll weevil region, is not as serious as formerly.



FIG. 181.—Cotton worm moths, natural size. (Photo by Dr. W. E. Hinds.)

During the winter months the adult moths hibernate in

* *Alabama argillacea* Hubn. Family *Noctuidæ*.

the southern portion of the cotton belt. The moth is a grayish-brown color with a wing expanse of about $1\frac{1}{3}$ inches. The wings often have a purplish luster and are marked with darker lines, as shown in Fig. 181. Early in the spring they lay their eggs on volunteer cotton, as many as 500 eggs being laid by one moth. The caterpillars feed greedily on the tender foliage and become grown in from one to three

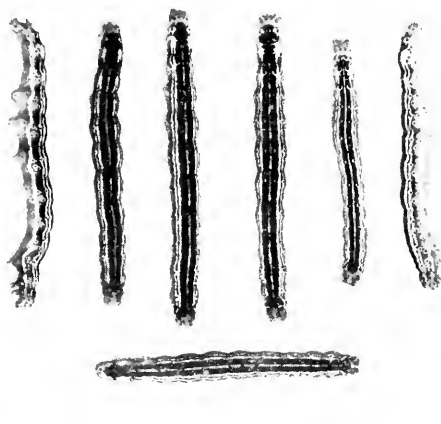

FIG. 182.—Cotton worms, natural size. (Photo by Dr. W. E. Hinds.)

weeks. When grown they are $1\frac{1}{2}$ inches long, greenish, striped with black and marked with numerous small black dots. The mature caterpillar draws together the edges of a leaf and within the fold spins a thin silken cocoon in which it transforms to a pupa, from which the moth emerges in from one to four weeks.

Like most of the Noctuids the moths fly only after sunset, but unlike others their mouth-parts are so formed that they are adapted to piercing the skin of ripe fruits and suck-

ing their juices. They are strong fliers and the later broods are often carried northward by the winds in large numbers, even as far as Canada. The moths of the first generation in the spring fly northward, and from eggs deposited by them another generation develops in due time, which, in turn, flies northward, and thus by late summer the worms are found throughout the whole cotton belt. At least seven generations occur along the Gulf Coast and three at the northern limit of cotton growth. Considering the number of eggs laid by each female, it is evident that the species will multiply very rapidly, and it has been estimated that the progeny of one moth, if there were no mortality, would amount to over 300,000,000,000 individuals after four generations, which, if placed end to end, would encircle the earth at the equator over four times.

The usual remedy has been to dust the plants with Paris green. Powdered arsenate of lead would, undoubtedly, be as effective. Dusting machines which will cover four rows at once have been in common use where injury is frequent. It may also be applied with powder guns. It has most commonly been distributed by being shaken from bags fastened at the ends of a pole and carried by a man on horseback.

144. The Mexican Cotton Boll Weevil * (20). Probably no one insect has been so seriously and continuously injurious over so large a section of country as the boll weevil. As its name indicates, it is a native of Mexico, whence it spread into Texas about 1890. Since then it has spread steadily eastward until it now inhabits nearly all of the cotton belt west of Georgia, and in the course of another decade, will, doubtless, cover the Eastern Cotton States. In 1904 the writer made a careful estimate of the loss caused by the boll weevil in Texas, which showed that it amounted to \$25,000,000

* *Anthonomus grandis* Boh. Family *Curculionidæ*.

per annum and had cost the State \$100,000,000 up to that time. The amount of injury has not increased in proportion to the spread of the pest, and although no careful estimates have been made recently, the total annual loss for the cotton belt, as a whole, cannot be less than \$50,000,000

per annum, and in some years it has, doubtless, been double that amount.

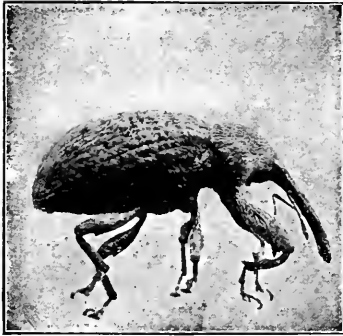

FIG. 183.—The cotton boll weevil
—enlarged.

The boll weevil is a small brownish beetle about one-fourth inch long, including the snout which is half as long as the body. It may be distinguished from nearly related species and other common weevils by the two teeth at the tip of the femora of the fore legs (Fig. 183). It feeds only on

cotton and weevils found feeding on other plants are certainly of other species.

The weevils emerge from hibernation from the time cotton is up until it begins to "square." During the spring they feed on the foliage, particularly the tender terminals. As soon as the squares are formed the females lay their eggs in them, laying four or five a day, and depositing an average of about 140. The egg hatches in about three days and the grub feeds within the square, which usually fails to develop and falls to the ground. The larva becomes grown in seven to twelve days and then changes to the pupa, which lasts three to five days. Thus, from egg to adult requires from two to three weeks, depending upon climatic conditions, but a full generation requires six weeks, and there are not over

four or five generations a year. The larva is a footless white grub with a brown head and feeds entirely within the squares or bolls. Many squares are destroyed by the feeding punctures of the adult weevils. The squares are preferred both for food and egg-laying, but in late summer and fall, as they all become infested, the bolls are attacked, as many as fifteen larvæ having been found in a single boll. With the first killing frosts the adult weevils go into hibernating quarters. In seeking places for hibernation the weevils fly from field to field, and it is at this season that the principal migration takes place. They may hibernate in hedges,



FIG. 184.—The cotton boll weevil, natural size, showing variation in size and color.

woods, corn-fields, haystacks or farm buildings, particularly about seed houses or similar situations. Others crawl into cracks in the soil in cotton fields, under grass, into Spanish moss on trees, weeds or trash, into empty cotton burrs, and in the more southern sections may hibernate in the injured bolls.

By far the most important measure in the control of the boll weevil is the destruction of the plants in the fall as soon as the cotton can be picked. This both destroys the weevils and prevents their increase. The stalks should be plowed out and burned as soon as possible. It is well to plow out all but a row here and there upon which the weevils will

concentrate, then as soon as the piles are dry enough to burn, cut the remaining rows and burn at once. In this way the great bulk of the adult weevils and all of the immature states in the squares and bolls are destroyed. The few escaping weevils will be starved out before the weather becomes cold enough for them to hibernate, or will be so weakened as



FIG. 185.—Cross-section of cotton square showing egg and opening through which it was laid—greatly enlarged.

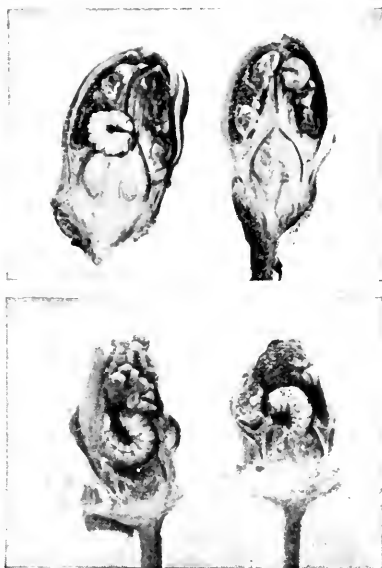

FIG. 186.—Cotton squares broken open, showing the boll weevil larvæ within—enlarged.

to die in hibernation. Thus it has been shown by Professor Wilmon Newell, in Louisiana, that where the weevils were forced into hibernation on October 15th only 3 per cent survived the winter, but that when the destruction of the stalks was put off until after December 15th, 43 per cent survived, with proportional numbers at intervening dates. Further-

more, the development of the late broods which furnish the majority of the weevils which hibernate is effectually prevented. The removal of the plants also facilitates winter plowing, which aids in producing an early crop the next year. Many experiments of the experience of practical planters have shown that the destruction of the stalks in the fall is of primary importance in the control of the weevil, particularly upon bottom lands. The defoliation of the plants by the cotton worms (page 257), secures much

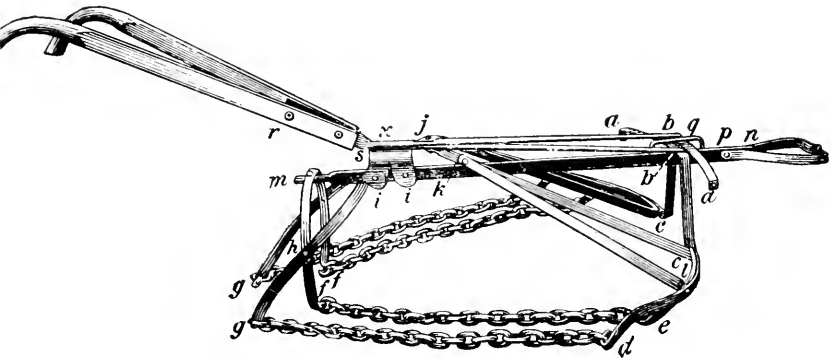

FIG. 187.—Chain cultivator for use in drawing weevil-infested squares to center of row. (After Hunter, U. S. Dept. Agr.)

the same result as the destruction of the stalks, by removing the food-supply of the weevil. Therefore, when the worms appear in weevil-injured fields late in the season, planters should not poison the worms, for they will aid in preventing the increase of weevils, and no further crop can be secured.

Injury may be largely avoided by making an early crop before the weevils have become sufficiently abundant to do serious damage. Everything possible should, therefore, be done to hasten early maturity. Land should be plowed in winter and a good seed bed prepared. Plant as early as

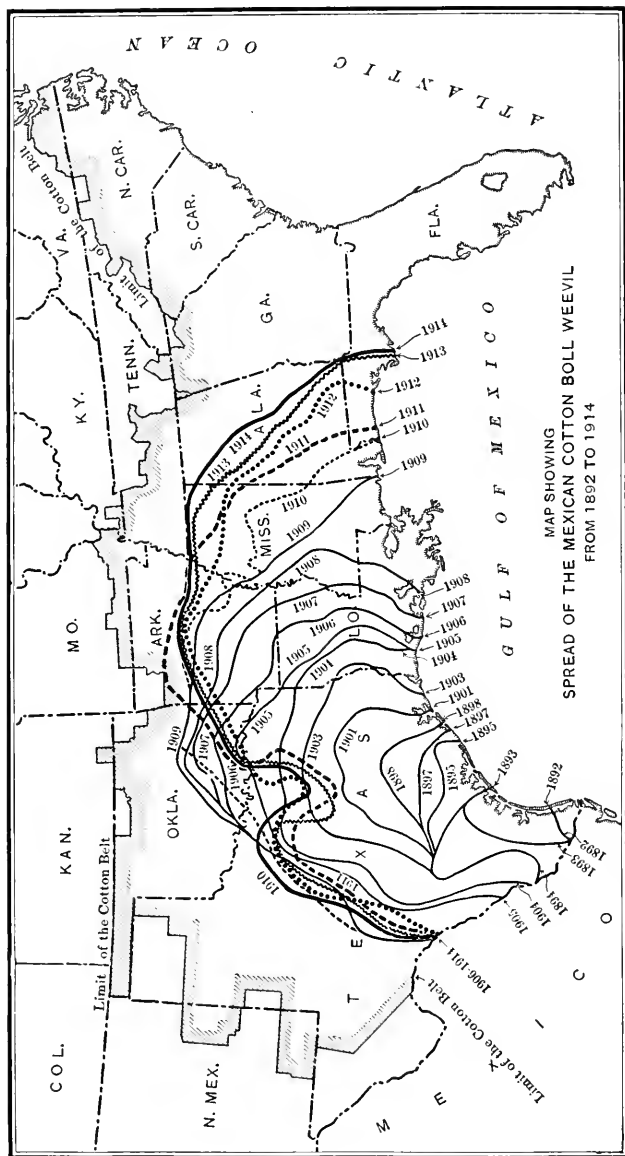

FIG. 188.—Map showing the spread of the cotton boll weevil from 1892 to 1914.

Prepared by the Bureau of Entomology, U. S. Department of Agriculture. The line for each year was determined by field examinations of agents of the Bureau of Entomology and the State Entomologists of the several States.

possible with safety from frost. A liberal use of commercial fertilizers will hasten maturity. Only early maturing varieties should be planted, and selected seed of open-growing sorts is to be preferred. Chop out the plants as soon as possible. Frequent light cultivation should be given so as to keep the soil well stirred. Deep plowing and cultivating close to the rows should be avoided as it causes the dropping of the squares.

When infested squares fall to the ground and lie on the unshaded hot soil the larvæ or pupæ within them are soon killed by the heat. As many as 40 per cent have been found killed in some fields. The rows should, therefore, be planted fairly wide apart, and varieties producing a minimum of shade are preferable, as are those which readily shed their squares when injured. As most of the squares drop beneath the plants where they are shaded, any means of scraping them into the centers of the rows will aid in their destruction. For this purpose a chain cultivator as described by Hunter (*l. c.*) (Fig. 187), has proven very efficient for this purpose. The chains may be attached to ordinary cultivators by special attachments. An arm or projection that will brush the plant should be attached to whatever cultivator is used so that the squares will be knocked to the ground, as the effect of the heat is greater the earlier the squares drop.

CHAPTER XVII

GARDEN INSECTS

145. Cutworms.* The larvæ of several species of moths, which are more or less similar in general appearance and habits and which feed on low-growing vegetation, cutting off the stems just at the surface of the ground, are commonly

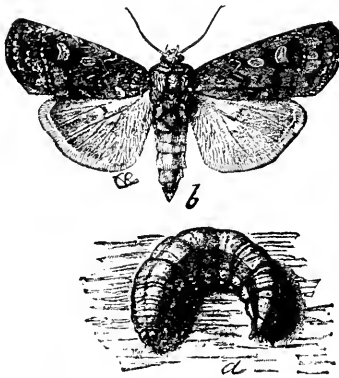

FIG. 189.—The dark-sided cutworm (*Agrotis messoria*). (After Riley.)

known as *Cut-worms*. They should be distinguished from the white grubs (page 236), which are often wrongly called cutworms on account of their similar habits. Some species prefer certain crops, but most of them are almost omnivorous, though most injurious to garden crops and to corn, cotton, tobacco and similar crops grown in hills or rows.

The adult moths have dark fore wings, variously marked with darker or lighter spots and narrow bands, as illustrated, and expand from one to two inches. The wings are folded over the back when at rest. Most of the larger, dark-colored moths which fly into lights in summer, commonly called “moth-millers,” are cutworm moths. Like their larvæ they feed at night, sipping the nectar from flowers.

* Family *Noctuidæ*, see page 80.

The females lay their eggs on grass land or where a crop has been allowed to grow up in grass and weeds in late summer. The little larvæ which hatch from these eggs in late summer feed on the roots of whatever vegetation is available until frost, when they go deeper in the soil and curl up snugly in small earthen cells, where they hibernate until spring. They then attack any vegetation with surprising voracity, often subsisting on grass and weeds which have been turned under until a planted crop is available. They become full grown by late spring or early summer and are then from $1\frac{1}{2}$ to 2 inches long, of a

dull brown, gray or blackish color, often tinged with greenish, and more or less marked with longitudinal strips, dots and oblique dashes, these markings harmonizing in color with the soil. They have three

pairs of true legs and five pairs of abdominal prolegs. The larvæ pupate in cells a few inches beneath the surface and the moths emerge during midsummer, in the Central and Northern States and earlier farther south. There is usually only one generation in the North, but there are commonly two and sometimes three in the South.

It is evident from their life history that one of the best means of control is thorough plowing and harrowing in late fall and early spring, so as to keep the land fallow and thus starve out the larvæ. This is particularly true for staple

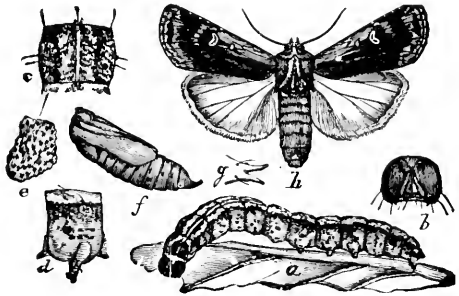

FIG. 190.—Granulated cut-worm (*Agrotis annexa*). (After Howard, U. S. Dept. Agr.)
a, larva; f, pupa; h, adult—natural size.

crops, such as cotton, corn and tobacco, on which it is expensive to use other means. Poisoned bran mash (see page 329), is an effective remedy for cutworms, particularly in gardens. It should be applied a few days before the plants are set or before the seed plants appear. Sow the mash broadcast late in the afternoon so that it will be moist when the worms feed at dusk. Keep poultry away from fields so treated. Clover which has been dipped in water containing one-third pound of Paris green per barrel may be used in the same way, particularly along borders of fields next to grass. Market gardeners commonly protect plants by means of tin cans from which the bottoms have been removed or by paper cylinders, which are sunk into the soil around the plants. Garden plants may sometimes be protected from cutworms by dipping in arsenate of lead, three pounds to the barrel, when setting them, as advised for flea beetles.

146. Plant Lice or Aphides. Almost every garden crop is attacked by one or more species of plant lice, which multiply so rapidly that if they are not promptly controlled serious injury results.

Cabbage Aphis * (44). Cabbage, turnips and other cruciferous garden crops are frequently found covered with disgusting gray, waxy masses of cabbage aphides. The eggs of this species are laid on cabbage during October and November and, in central New York, hatch the next April. Herrick and Hungate observed twenty-one generations from early April until December. During the summer the wingless females become full grown in about two weeks and live for about forty-six days, during which time they will give birth to about forty young. Generations of winged females appear, particularly on crowded plants, and spread the pest. They live only about ten days and bear

* *Aphis brassicæ* Linn. Family *Aphididae*, see page 66.

from seven to thirteen young. The wingless female is covered with a grayish waxy coat, the body being a grayish-green, marked with eight black spots down either side of the back. The antennæ are green with black tips and the eyes, legs, and tail are black. In the South viviparous reproduction continues all winter and in the North many, doubtless,

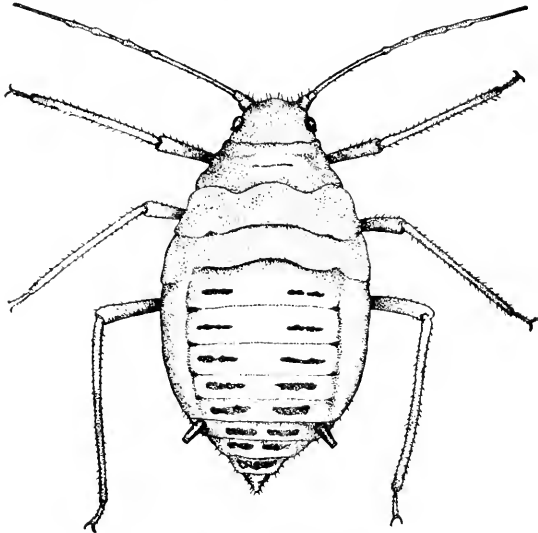

FIG. 191.—Cabbage aphid (*Aphis brassicae*, Linn.). (After Herrick and Hungate.) Very greatly enlarged.

survive the winter on cabbages stored in pits. The latter might readily be destroyed by fumigation.

Spinach Aphis.^{*} This species often becomes destructive to spinach, celery, lettuce, cabbage and various greenhouse crops. It is the same as the Green Peach Aphis, which see (page 306).

Pea Aphis † (7). Large green plant-lice often become so abundant on the foliage and pods of garden peas as to kill

^{*} *Myzus persicae* Sulz.

† *Macrosiphum pisi* Kalt.

the plants. They pass the winter on clover and vetches, sometimes becoming so numerous as to do serious injury. The winged females migrate to the peas about the time they are six to eight inches high, and give birth to young which develop into wingless, viviparous females. Both wingless and winged females occur throughout the season, the latter predominating whenever food becomes scarce. The winged forms are about one-eighth of an inch long with wings expanding two-fifths of an inch. The body



FIG. 192.—The pea-aphis (*Macrosiphum pisi* Kalt). Winged and wingless viviparous females and young—enlarged.

is a pea-green color, the eyes are red, and the legs, antennæ and honey-tubes are yellowish tipped with black. The wingless females are similar, but somewhat broader. A female becomes grown in about eleven days after birth, lives about twenty-five days, and bears about 50 young, though sometimes 100 are born. Sixteen generations have been observed between March 23d and October 4th in Central Illinois. The best means of

avoiding injury by this species is to grow early varieties. Brushing the aphides from the vines with a pine branch and following with a cultivator, will destroy many of them on a hot summer day.

Melon Aphis * (8). The melon aphid may be found on various weeds such as shepherd's purse and pepper grass in early spring and on melons and other cucurbs soon after they start growth. If allowed to multiply unchecked it will often become so abundant as to ruin a crop just as the melons are commencing to ripen. The wingless females are about one-fifteenth of an inch long, varying in color from light yellow or tan to olive or deep green, appearing almost blackish;

* *Aphis gossypii* Glover.

the legs and antennæ are pale whitish-yellow, and the rather long, tapering honey-tubes are jet black. The winged female has black spots along the sides of the abdomen. In the South this species is also a serious pest of young cotton. No true sexual forms or eggs of this species have been observed, but reproduction by agamic females goes on through-

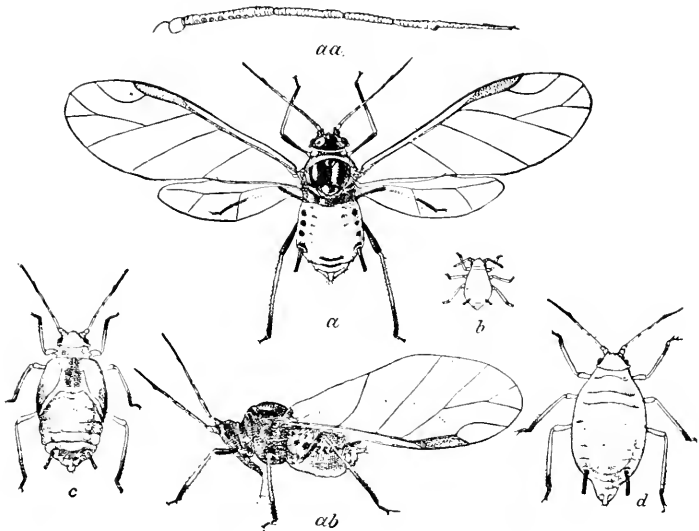

FIG. 193.—The melon aphid (*Aphis gossypii* Glov.). (After Chittenden, U. S. Dept. Agr.)

a, winged female; *aa*, enlarged antenna of same; *ab*, dark female, side view, sucking juice from leaf; *b*, young nymph; *c*, last stage of nymph of winged form; *d*, wingless female—greatly enlarged.

out the summer as with other aphides, winged forms appearing whenever the food-plant becomes overcrowded.

Control. Much the same remedies may be used for all of these species. Spraying with contact insecticides will destroy most of them, but the aphides must be hit to be killed, and spraying must be done while the plants are small and before

the foliage is curled by the aphides or it will not reach them. Kerosene emulsion containing from 5 to 8 per cent of kerosene is the oldest spray, but should be used with caution on melons and peas. Whale oil soap, one pound to six gallons of water, is entirely safe and equally effective. "Black-leaf" extract of tobacco containing $2\frac{7}{16}$ per cent of nicotine is effective when applied one part to 65 or 70 of water. Prof. Franklin Sherman, Jr., states that any good laundry soap used at the rate of one pound dissolved in three gallons of water is effective against the cabbage aphid. Where water under pressure is available in a small garden, many species may be held in check by washing with a strong stream from a garden hose. Cabbage plants infested in the seed bed should be dipped in a soap solution when planted.

147. Flea-beetles.* Almost all of the common garden crops are attacked by small beetles, which from their power of making long, quick jumps, are known as flea-beetles.

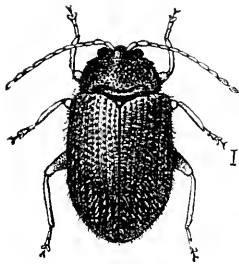

FIG. 194.—Potato flea-beetle, greatly enlarged (After Chittenden, U. S. Dept. Agr.)

The *Potato Flea-beetle* † (45) attacks potato⁶ and tomato plants when they are but a few inches high and often so riddles the foliage as to cause the plants to wilt and sometimes to necessitate replanting tomatoes. It is only one-sixteenth inch

long and is jet black, except the yellowish antennæ and legs. The beetles hibernate under rubbish, leaves, etc., and in the spring come forth and lay their eggs on the roots of common weeds of the nightshade family, such as the horse-nettle, or "Jimpsion" weed, etc. The larvæ mine in the roots of these plants

* Family *Chrysomelidæ*, see page 121. † *Epitrix cucumeris* Harris.

and transform to pupæ in earthen cells among the roots, from which the beetles emerge to attack the foliage. The larvæ are very slender, elongate, white worms. Occasionally they mine into the tubers, doing considerable damage and causing pimply potatoes, as has been observed in New York and Colorado. There are two or three generations each year, but the exact life history has not been fully determined.

The *Tobacco Flea-beetle* * (10) does similar damage to the same crops throughout the South as well as to tobacco and egg plant. It is a small species, one-twentieth inch long, light brown in color with a dark band across the wing-covers.

Bordeaux mixture forms an excellent repellent for these little beetles. Potatoes and tomatoes should be sprayed with Bordeaux mixture for the control of fungous diseases, and arsenate of lead or Paris green for the Colorado potato beetle as soon as they are six inches high. The spray should be applied liberally so as thoroughly to coat the plants. Tomatoes are more susceptible to injury and may well be dipped in arsenate of lead, one pound to ten gallons of water, when planting. The destruction of the weeds upon which the larvæ commonly develop is obviously important in preventing their multiplication.

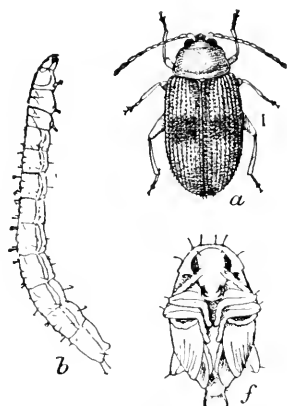

FIG. 195.—Tobacco flea-beetle (*Epitrix parvula*). (After Chittenden, U. S. Dept. Agr.)

a, adult beetle; b, larva, lateral view; f, pupa—enlarged about fifteen times.

* *Epitrix parvula* Fab.

Two other species with very similar habits are the *Pale-striped Flea-beetle* * and the *Banded Flea-beetle*. † They often appear in enormous numbers and seem almost omnivorous in their food-habits, being particularly injurious to young corn and tomatoes, but also attacking beans, beets, potatoes, egg plant, melons, crucifers, and almost all garden crops. The pale-striped flea-beetle is about one-eighth inch long, cream colored, with the wing-covers marked with

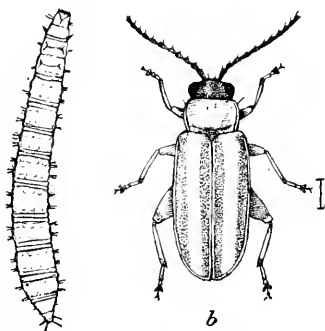

FIG. 196.—The pale-striped flea-beetle (*Systema blanda* Mels.). (After Chittenden, U. S. Dept. Agr.)

a, larva; b, beetle—much enlarged.

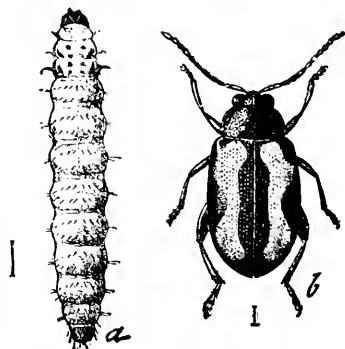

FIG. 197.—The striped turnip flea-beetle (*Phyllotreta vittata* Fab.). (After Riley, U. S. Dept. Agr.)

a, larva; b, adult—greatly enlarged.

three stripes of light brown and the eyes and abdomen are black. The banded flea-beetle is very similar, but the dark stripes are expanded and darker, so that it appears to be a polished black with two white stripes. Their habits and life history are very similar to the preceding species so far as known. They are best controlled by thoroughly spraying the affected plants with Bordeaux mixture containing three pounds of arsenate of lead to the barrel. Powdered arsenate of lead dusted over the plants will doubtless be effective.

* *Systema blanda* Melsh

† *Systema teniata* Say.

A number of species attack cabbage and other cruciferous crops. The *Striped Turnip Flea-beetle*,* one of the most common, is polished black with each wing-cover marked with a broad wavy band of pale yellow. The small white larvæ have sometimes injured the roots of cabbage and turnips, but probably they usually feed on the roots of cruciferous weeds. Where the plants

are sprayed properly for the cabbage worms there will usually be little trouble with flea-beetles. Otherwise, spray with arsenate of lead, three to five pounds to the barrel, or dust with powdered arsenate of lead. Where injury is anticipated it will be well to dip the plants, as advised above for tomatoes. Where plants are attacked in the seed-

bed, screening tightly with cheesecloth is advised. By thoroughly dusting the plants with air-slaked lime, land plaster, tobacco dust,

ashes, or any similar dusts, applying them in the early morning while the dew is on the plants, they may be protected as long as they are kept thoroughly covered.

The *Spinach Flea-beetle* † is a larger species, one-fourth inch long, and is commonly injurious to beets and spinach. It is shining black with a greenish or bluish luster, the prothorax and abdomen are red or reddish-yellow, and the legs

* *Phyllotreta vittata* Fab.

† *Disonycha xanthomelana* Dalm.

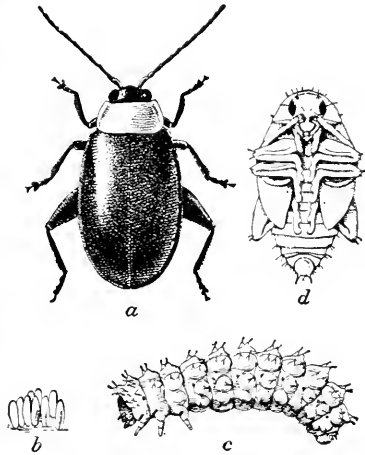

FIG. 198.—The spinach flea-beetle (*Disonycha xanthomelana* Dalm.). (After Chittenden, U. S. Dept. Agr.)

a, beetle; b, egg mass; c, larva; d, pupa
—five times natural size.

and antennæ are pale yellowish. The larvæ feed on the foliage and pupate in the earth. The second generation is usually the most injurious in late summer. This species is readily controlled by spraying with arsenate of lead.

148. Colorado Potato Beetle.* The Colorado potato beetle (11), is now so well known that it hardly needs description, although in many parts of the Gulf and Pacific Coast



FIG. 199.—The Colorado potato-beetle (*Leptinotarsa decemlineata* Say.).
(After Riley.)

a, eggs; b, larva; c, pupa; d, beetle; e, elytra or wing-cover of beetle; f, leg of beetle.

States it does little if any injury. The adult beetles pass the winter in the earth, where they hibernate until spring sunshine brings them forth. As soon as the young potato plants appear the females deposit their yellow eggs in masses on the foliage, each laying about 500 in the course of a month. At the same time the beetles are doing considerable damage by eating the young plants, sometimes attacking both potato and tomato plants in such numbers as to destroy

* *Leptinotarsa decemlineata* Say. Family *Chrysomelidæ*.

them. As a rule, tomatoes are not so much injured later in the season.

The eggs hatch in from four to seven days and the young grubs gorge themselves on the tender foliage, increasing in size with astonishing rapidity and becoming full grown in about three weeks. The grubs then enter the soil and a few inches below the surface hollow out cells in which they transform to pupæ, from which the adult beetles emerge in one or two weeks. Thus, in summer, the whole life cycle requires from four to six weeks. After feeding a few days the new beetles deposit eggs which give rise to a second generation of grubs. These transform, in the same manner as described, into the beetles which hibernate. Through the Middle States, where most injury is done, there are two generations a year, but in the South there may be three generations and in the North there is but one.

When the young plants are attacked by the old beetles, they should be sprayed with arsenate of lead 5 pounds to 50 gallons. Potatoes should always be sprayed about every two weeks with Bordeaux mixture for the control of diseases and if this is done, the potato beetle may be easily controlled by adding a half pound of Paris green or three pounds of arsenate of lead to each barrel, for the first two or three sprayings. Paris green is often dusted on the vines, usually mixed with 50 times its weight of flour, land plaster or air-slaked lime, and applied while the plants are wet with dew. However, dusting is more expensive and less efficient than spraying, except where peculiar local conditions make spraying impracticable, and burning of foliage often results, particularly when the dust is carelessly applied.

Cleaning up the vines and plowing potato land in the fall as soon as the crop is dug will aid in reducing the numbers of the hibernating beetles.

149. Tomato Worms. The most common caterpillars injurious to tomatoes are the large *Horn-worms*, which also affect tobacco (10). Two species* are common, one being more abundant in the North and the other in the South, but they are very similar both in appearance and habits. The full-grown larvæ are about three inches long, of a dark green

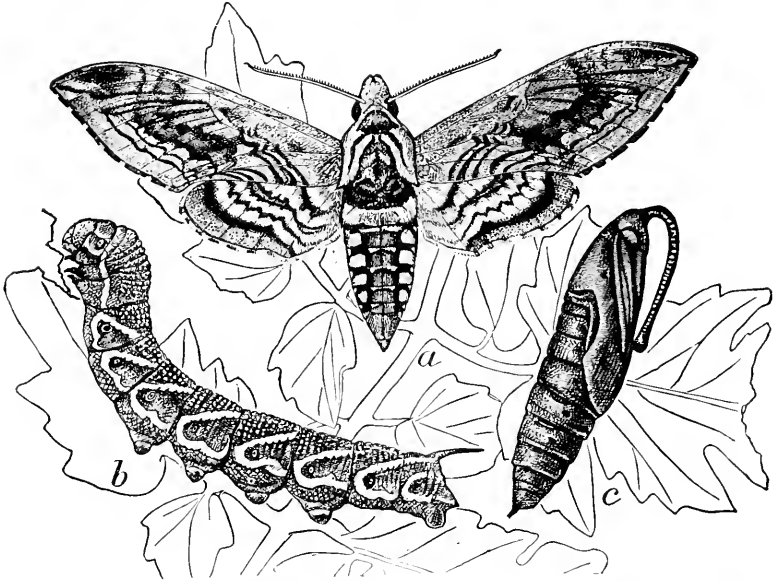

FIG. 200.—Northern tobacco-worm, or “hornworm” (*Phlegethontius quinquemaculata*). (After Howard, U. S. Dept. Agr.)
a, adult moth; b, full-grown larva; c, pupa—slightly reduced.

color with white stripes on the side of the body, those on the northern species being a V-shape, while the Southern species has simple oblique bands. At the tip of the abdomen is a stout horn which gives them the name “horn-worms.” The larvæ become grown in about three weeks, when they

* *Phlegethontius quinquemaculata* Haworth (Northern), family *Sphingidae*, see page 89 and *P. sexta* Johansenn (Southern).

pupate in the soil, the pupæ being commonly called "horn-blowers." The adult moths emerge about three weeks later during midsummer. In the tobacco belt there are two generations a year, but in the North there is but a single generation and in the Gulf States there may be three. The adult is a large gray moth, marked with black, white and yellow, with a wing expanse of about five inches and may often be seen gathering nectar from petunias and similar flowers. From their size and flight they are often called "humming-bird moths." The large caterpillars rag the foliage of tomatoes or tobacco and will quickly do considerable damage. When carried into the barn they sometimes injure tobacco as it dries. On small patches the easiest method of control is hand-picking. Tomatoes should always be sprayed with Bordeaux mixture and arsenate of lead for diseases and other insects, which treatment will also control these larvæ. Tobacco and tomatoes which have not been so sprayed should be dusted with powdered arsenate of lead (12), diluted with at least an equal bulk of dry wood ashes, applying $3\frac{1}{2}$ to five pounds per acre. Or it may be used as a spray, two pounds to the barrel. (See page 253 for Tomato Fruit-worm.)

150. Striped Cucumber-beetle.* The little yellow beetles with black heads and three black stripes on the wing-covers, which appear just as the young melon and cucumber plants are up, are known to every gardener. They swarm over the plants and very frequently are so numerous as to necessitate replanting.

The beetles hibernate over winter and emerge two or three weeks before cucurbs are up, during which time they feed on various flowers. After feeding on the young melon plants for a few days the females commence to deposit their

* *Diabrotica vittata* Fab. Family *Chrysomelidæ*, see page 121.

eggs in crevices of the soil. During a month a female will lay 100 eggs, which hatch in a week to ten days. The larva is a slender, white, worm-like grub about three-tenths of an inch long, with a dark head and anal plate. They bore into the cucurb roots, often tunneling into the base of the stem, and sometimes mine into melons lying on damp soil. Injury to the roots is rarely very serious, though occasionally cucumber and melon vines are killed. The larvæ become

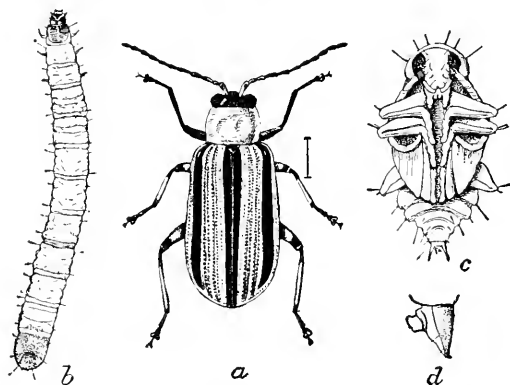

FIG. 201.—The striped cucumber beetle (*Diabrotica vittata* Fab.).
(After Chittenden, U. S. Dept. Agr.)
a, beetle; *b*, larva; *c*, pupa; much enlarged.

full grown in about a month, when they transform to pupæ in small, earthen cells, from which the beetles emerge in one to two weeks. In New England there is but one generation a year, the new beetles appearing in early fall, but in the Middle States there are two generations, the first appearing about midsummer.

A few plants may be protected from the beetles by covers of netting. A barrel hoop cut in two and crossed and the ends fastened to another hoop makes a good frame. Cone-shaped covers of wire screening may be made and kept from

year to year. Many growers sow the seed in rows rather thickly and then thin out to the desired distance after the worst injury is over. Others make several plantings in each hill at intervals of a week, but the former plan will ensure earlier growth. Plants may be protected by keeping them well covered with almost any sort of dust, which must be applied to both the upper and lower surfaces of leaves while the dew is on. This must be repeated as the dust is blown or washed off and as the plant grows. Air-slaked lime mixed with sulphur, and tobacco dust, have been found beneficial. Bordeaux mixture repels the beetles, but seems to have a stunting effect on the young plants. Thorough spraying with arsenate of lead, three to five pounds per barrel, seems to repel the beetles better than any other substance. Possibly dusting with powdered arsenate of lead would be as satisfactory. Cleaning up and destroying the vines as soon as the crop is gathered will deprive the beetles of food and force them to seek other hibernating places, thus increasing the mortality.

151. Squash Bugs.* Where leaves of squash and melon vines are found to be wilting here and there just as they are commencing to run, a careful examination will usually reveal the presence of a slate-colored bug (13), about three-fourths inch long, the common squash bug. At night or early in the morning the bugs are usually found beneath rubbish or clods of earth. The brownish eggs are laid in characteristic masses on the under surfaces of the leaves, and hatch in from one to two weeks. The young bugs are brilliantly colored, the antennæ and legs being bright crimson, the head and anterior thorax a lighter crimson, and the posterior thorax and abdomen a bright green, but in a little while the crimson changes to jet black. They become full grown in four or five weeks. In the North there is but a single gener-

* *Anasa tristis* DeG. Family *Coreidae*, see page 59.

ation and the adults hibernate, but in the South there are two or three generations.

The eggs are readily seen and may be picked off and destroyed. The adults are sucking insects and cannot be killed by insecticides, but

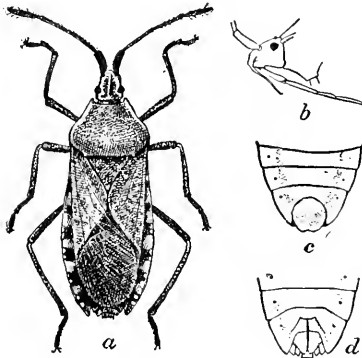

FIG. 202.—The squash-bug. (After Chittenden, U. S. Dept. Agr.)

a, mature female; *b*, side view of head, showing beak; *c*, abdominal segments of male; *d*, same of female; *a*, twice natural size; *b*, *c*, *d*, more enlarged.

may be collected in early morning from beneath small boards and other rubbish used as traps. The nymphs may be killed by spraying with kerosene emulsion. Cucumbers and melons may be protected by planting early squash among them, as the bugs prefer the squash vines and may be collected from them. Cleaning up the vines in the fall is of importance in

reducing the number which will hibernate.

152. Cabbage Caterpillars. *Imported Cabbage Worm* * (14). One of our most common garden pests is the well-known cabbage worm, whose parent is the common white cabbage butterfly. It was imported from Europe into Quebec about 1860, and has since spread to all parts of the country. The butterflies are among the first to emerge in the spring. The females may be distinguished by having two black spots on each fore wing, while the males have but one. Both sexes have the tips of the fore wings and a spot on the front margin of the hind wings black. Eggs are laid by the females as soon as the food plant is available, and

* *Pontia rapæ* Linn. Family *Pieridæ*, see page 98.

hatch in four to eight days. The eggs are yellowish, prominently ridged and laid singly on end. The larvæ gorge themselves on the foliage and grow rapidly, becoming full grown in from ten days to two weeks. When mature they are about $1\frac{1}{4}$ inches long, of a velvety green color, very sim-

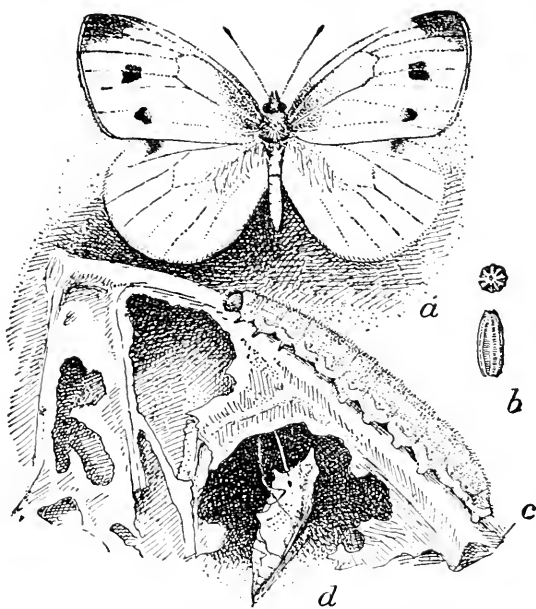

FIG. 203.—The cabbage butterfly (*Pontia rapa*). (After Chittenden, U. S. Dept. Agr.)

a, female butterfly; *b*, above, egg as seen from above; below, egg as seen from side; *c*, larva in natural position on cabbage leaf; *d*, suspended chrysalis—*a*, *c*, *d*, slightly enlarged; *b*, more enlarged.

ilar to the foliage, with a faint yellow stripe down the middle of the back and a row of yellow spots on each side. The chrysalis or pupa is attached to the leaf by a strand of silk and is at first greenish and then light brown in color. In the summer the butterflies emerge from the chrysalids in one to two weeks, but the chrysalids of the last generation

hibernate among the old stalks and rubbish in the fields. In New England there are three generations and in the South probably five or six.

Southern Cabbage Butterfly.^{*} Before the appearance of the imported species this was the more common in the South,

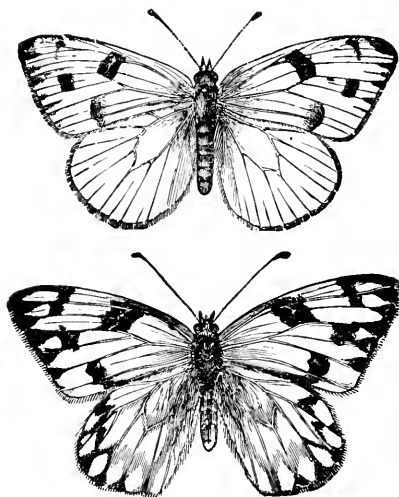

FIG. 204.—The Southern cabbage butterfly (*Pontia protodice* Boisid.). (After Riley.)

a, male; b, female.

but has now been largely replaced. The male butterfly is very similar to the female of the former species in general appearance, but the female is much more heavily marked with black. The caterpillar is a greenish-blue color with four longitudinal, yellow stripes and covered with black dots. The habits are very similar to those of the last species.

Cabbage Looper.[†] The cabbage looper strips the foliage in much the same manner as the former species. It is so called on account of its “looping” habit of walking, like that of a measuring-worm, due to the absence of legs on the third and fourth abdominal segments. The larvæ are pale to dark green in color, marked with several longitudinal white lines and might readily be mistaken for the imported cabbage worm were it not for their looping gait. Cabbage and cauli-

^{*} *Pontia protodice* Boisid. Family *Pieridæ*, see page 98.

[†] *Autographa brassicæ* Riley. Family *Noctuidæ*, see page 81.

flower are the favorite food-plants, but lettuce, peas, celery, beets and various other garden crops and weeds are often attacked. Injury to cabbage seems to be worse in late summer. The full-grown larva spins a very thin transparent white cocoon on the leaf where it has been feeding and in it transforms to the pupa from which the moth emerges in from one to two weeks in summer. The pupæ of the last generation hibernate. The moth has a wing expanse of about $1\frac{1}{2}$ inches. The fore wings are grayish-brown mottled with white and black, and just inside the center is a characteristic white spot. A prominent tuft arises from the thorax when the moth is at rest.

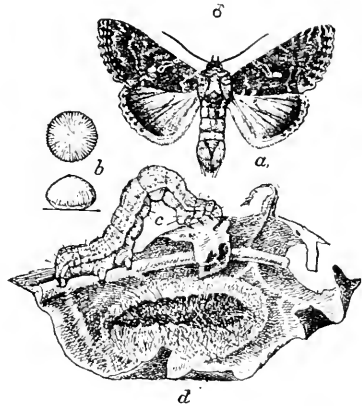

FIG. 205.—The cabbage looper (*Autographa brassicae* Riley). (After Howard and Chittenden, U. S. Dept. Agr.)

a, male moth; *b*, egg from above and from side; *c*, full-grown larva in natural position feeding; *d*, pupa in cocoon—natural size; *b*, enlarged.

Control. Spraying or dusting with arsenate of lead is the most satisfactory remedy for all of these caterpillars. This should be applied as soon as the plants are set, and they should be kept well covered until the heads are half formed. If this is done the young larvæ will be killed before they burrow into the heads and there will be but little danger from them later. Plants should not be dusted with large quantities of arsenate of lead or Paris green after the heads are well formed, nor is there any occasion for this. Various contact insecticides will kill these caterpillars, but their use

necessitates hitting each one, which is often difficult, and they have not been found as satisfactory as poisons. As the pupæ usually pass the winter on the old stumps and foliage it is evident that they and all rubbish should be destroyed and the field plowed as soon after the crop is removed as possible.

CHAPTER XVIII

ORCHARD INSECTS

153. The San José Scale and Other Scale Insects.

Probably no one insect has done such widespread injury to orchard trees as the San José Scale.* (2). The injury is often due to the fact that its presence is not suspected until the tree is badly damaged. The trunk and branches of badly affected trees have a rough grayish appearance as if covered with ashes. By scraping the surface the soft, juicy, yellowish insects will be revealed beneath the covering scales. The scales may most readily be detected on the fruit and leaves, on which a bright red ring appears around each scale. If a single female insect is examined, for which a magnifying glass will be needed, it is found to be covered by a small grayish-black, circular scale. Beneath this scale may be seen a small, soft, oval, orange-colored object, looking very little like an insect, which is the female; the scale being merely a waxy covering. The male scale is smaller and somewhat elongated.

When the males become fully developed they transform into small two-winged flies. In late spring they emerge at night and fly to the females. A month later the females commence to give birth to live young, which look like tiny yellow mites. They crawl around for a few hours and then stick their mouth-parts into the bark and their scales form over them. They become full grown in about a month and there are several generations in a year, so that a tree with

* *Aspidiotus perniciosus* Comst. Family *Coccidae*, see page 64.

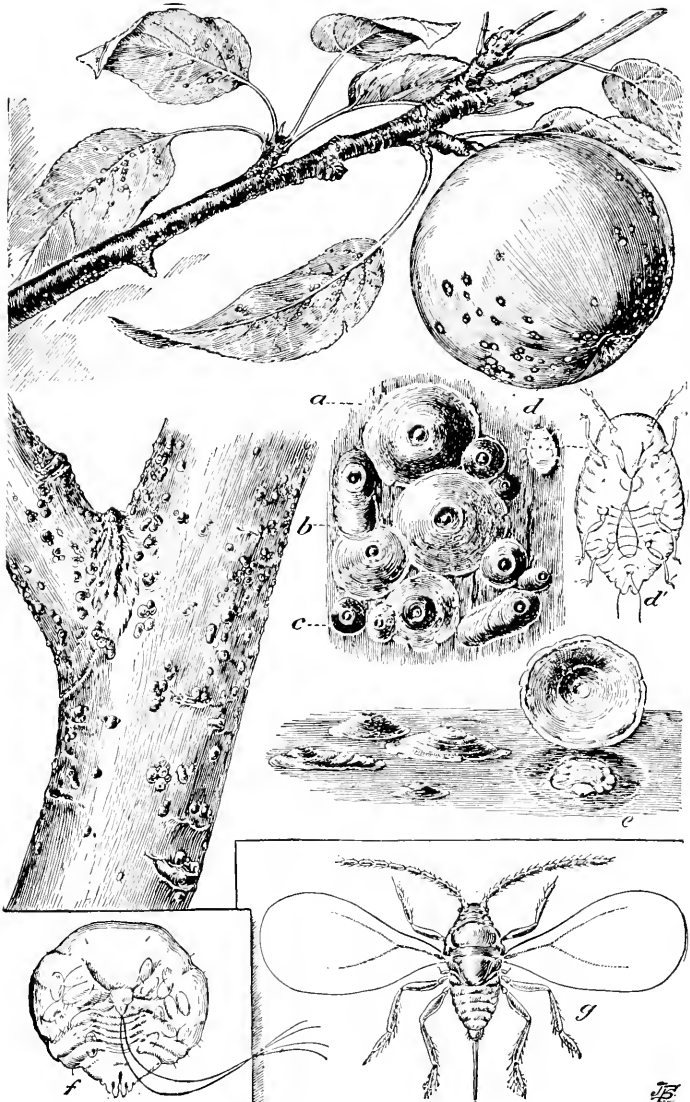

FIG. 206.—San José scale. (After Quaintance, U. S. Dept. Agr.)

a, adult female scale; *b*, male scale; *c*, young scales; *d*, larva just hatched; *d'*, same, much enlarged; *e*, scale removed, showing body of female beneath; *f*, body of female insect, more enlarged; *g*, adult male of the San José scale.

but few scales in the spring may be covered by them in the fall. Badly infested trees die in a year or two. All of our common orchard trees are subject to attack.

This pest may be controlled by spraying while the trees are dormant. This will be more effective if they have been pruned and headed in and the rough bark scraped from the trunks and limbs.

Every scale must be hit to be killed, so that every bit of the tree must be thoroughly covered. Lime-sulphur mixture seems to be the best spray, as it also destroys various fungous diseases and some insects' eggs. Miscible oils are also used extensively and have a certain advantage on hairy apple shoots and on badly infested trees, as they are more penetrating. They are used diluted ten or twelve times

for winter spraying. Kerosene or crude oil emulsion, containing 20 to 25 per cent of oil, is also satisfactorily used. The best time to spray is just after the trees have dropped their foliage in the fall and in the spring while the buds are swelling, but before the foliage appears. No summer spray has yet been tried which more than checks the development

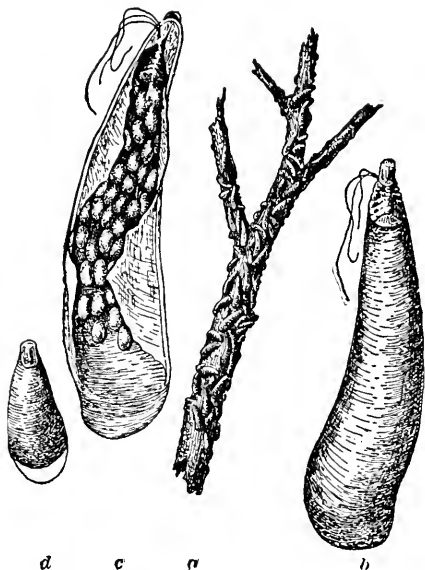

FIG. 207.—The oyster-shell scale (*Lepidosaphes ulmi* Linn.). (After Howard.)
 a, female scales on twig; b, female scale from above; c, same from below showing eggs; d, male scale—enlarged.

of the scale, for sprays which will kill all the scales usually injure the foliage.

Another scale insect very common on old apple trees and also on a number of shade and forest trees, particularly maple and poplar, is the *Oyster-shell Scale* * (3), so called on account of its oyster-shell shape. The mature female scale is about one-eighth inch long, of a dark brown color,



FIG. 208.—The scurfy scale (*Chionaspis furfura* Fitch). (After Howard, U. S. Dept. Agr.)

a, females; b, males—
natural size.

shaped as shown in Fig. 207. The male scale is much smaller. This species is not so injurious, but not infrequently stunts or kills young fruit and shade trees. It is essentially different from the last species in its life history, as the females lay eggs beneath the old scales, under which the eggs pass the winter. They hatch in late spring or early summer shortly after apple blossoms drop and the subsequent development is much the same, but there is only one generation a season in the North and two in the South. The same sprays may be used against this species as advised for the San José scale, but they should be applied just before the buds burst in the spring. If this

has been neglected, spray with kerosene emulsion containing 15 per cent kerosene, or miscible oils diluted 25 to 30 times, just as the eggs are hatching.

Another species fairly common on apple, pear, and other orchard trees, but rarely doing much injury, is the *Scurfy Scale*.† The female is a dirty-gray color shaped as shown in

* *Lepidosaphes ulmi* Linn.

† *Chionaspis furfura* Fitch.

Fig. 208, while the male scale is much smaller, snowy white, and with three distinct ridges. The life history is similar to the last species and it is controlled by the same means.

154. The Fruit-tree Bark-beetle.* The fruit-tree bark-beetle (4, 41), is often known as the "shot-hole borer" from the fact that an affected tree looks as if it had been struck with a charge of bird shot. More or less gum often exudes from these holes on stone fruits. Injury is largely due to allowing dead and dying trees to stand in or near the orchard,

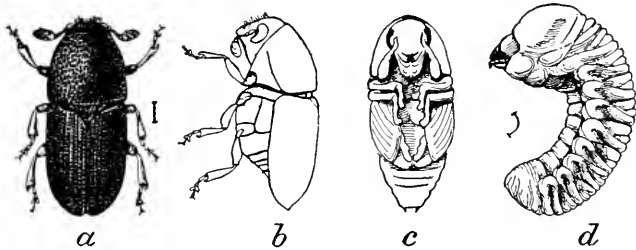

FIG. 209.—The fruit-tree bark-beetle (*Scolytus rugulosus*). (After Chittenden, U. S. Dept. Agr.)

a, b, beetle; c, pupa; d, larva—enlarged.

as such trees are most subject to attack, and healthy trees are not usually injured in well-cared-for orchards. The holes are caused by the exit of the small parent beetles and the entrance of the females to lay their eggs. The beetle is about one-tenth inch long, and of a black color, except the tips of the wing-covers and parts of the legs, which are red.

The beetles emerge in the spring. Between the bark and the sap-wood the females eat out small burrows along the sides of which the eggs are laid. The larvæ excavate little side-galleries which branch out and widen as they increase in size. They become full grown in about three

* *Scolytus rugulosus* Ratz. Family *Scolytidae*, see page 127.

weeks, when they form cells at the end of their burrows and transform to pupæ, from which the adult beetles emerge and eat their way out through the bark about a week later.

The destruction of all dead and diseased wood and the burning of prunings is the most important factor in the control of this pest. Affected trees should be liberally fertilized so that they may better withstand injury. The best means of preventing the beetles from laying their eggs seems to be to whitewash the trees in early spring, again in mid-summer, and again in October. Use a good thick whitewash and add one-fourth pound of common salt or Portland cement to each pailful to make it more adhesive.

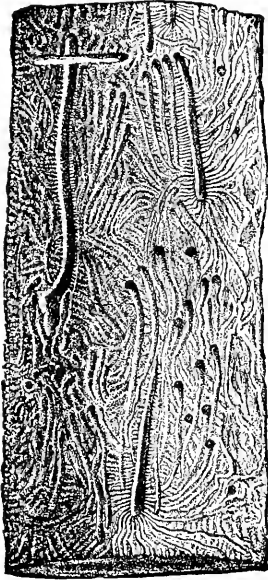

FIG. 210.—Work of the fruit-tree bark-beetle, showing the main galleries, the side or larval galleries, and the pupal cells. (After Ratzeburg.)

155. Apple-tree Borers.

Young apple and quince orchards are often seriously injured by the *Round-headed Apple-tree borers** which burrow into the heart wood and often girdle the trees. Their presence may be detected by the retarded growth of the trees, a yellowing of the

foliage, the sawdust castings at the entrance of the burrows, and the discolored bark over the burrows, from which sap sometimes exudes. Injury is most severe in

* *Saperda candida* Fab. Family *Cerambycidae*, see page 120 and No. 40a, Appendix A.

neglected and stunted orchards where grass and weeds are allowed to grow up.

The adults are handsome beetles about three-quarters of an inch long with long antennæ, silvery white beneath and light brown above marked with two white stripes. The females emerge from late May to mid-July and lay their

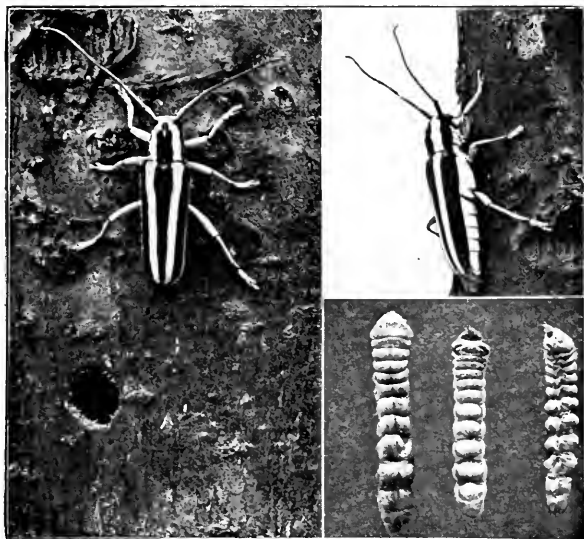

FIG. 211.—The round-headed apple-tree borer (*Saperda candida* Fab.) larva, adults, and exit hole—natural size. (After Rumsey and Brooks.)

eggs in the bark of the trees. The larvæ hatch out two or three weeks later and feed on the sap-wood just under the bark, working down toward the base of the tree. The next year the larvæ work in the sap-wood and the third season they penetrate into the heart-wood and will often riddle a small tree with their cylindrical burrows. The third spring

the larvæ transform to pupæ from which the beetles later emerge, leaving large round holes in the bark. The full-grown larva is a whitish-yellow grub about three-fourths of an inch long, legless, with the body segments strongly constricted.

The females may be prevented from egg-laying by wrapping the trunks of the trees with wire-netting, building paper, or wood veneer. Paper or wood wrappings should be applied about May 1st and removed in late summer. These wrappings should be tied tightly to the tree just below the crotch and should extend into the soil. If wire netting is used it should be held well out from the trunk by a layer of cotton at the upper end. Painting the trunks with a thick soap solution to every ten gallons of which has been added a pint of crude carbolic acid, is said to prevent the beetles from laying their eggs. Others advise a thick whitewash to which a little cement has been added, or a paint made of pure white lead and linseed oil. Such washes should be applied by the middle of May and as often thereafter as may be necessary to keep the bark well covered. Where the borers have gotten into the heart of the tree it is difficult to cut them out without damaging the tree, but they may sometimes be reached by injecting a little carbon-bisulphide into the burrow and stopping the opening with mud. Sometimes a girdled tree may be saved by bridge-grafting.

The *Flat-headed Apple-tree Borer* * is more common and prefers weakened or diseased trees. The larva is about one inch long and the thorax is very broadly expanded so as to look like the head, which gives it the name of flat-headed borer. The larvæ work just beneath the bark where they hollow out broad flat channels, which may be detected by the discoloration of the bark. The larvæ become full grown

* *Chrysobothris femorata* Fab. Family *Buprestidæ*, see page 115.

in a single year and leave the trees in early summer through elliptical exit holes. The adult beetle is about one-half inch long, of a dull metallic-brown color above, under the wing-covers bright metallic greenish-blue, and the wing-covers taper sharply at the tip. The beetles are active in the day and may often be found on logs or trees.

Injury by this species is not so common if trees are kept in a healthy condition, but where it occurs it may be combated the same as the round-headed borer except that the washes should be applied higher on the trunks and on the lower limbs as far as they can be reached.

156. The Woolly Apple-aphis.*

The woolly apple-aphis will be found clustered in bluish-white, cottony masses, looking like patches of mold, on the smaller apple twigs, particularly water-sprouts, and around wounds or scars on the trunk or limbs. Their presence in these places is usually in indication that others are upon the roots where they cause gall-like swellings so that the roots soon become a mass of knots and die in a year or two if the injury continues. When badly infected a tree becomes sickly, the foliage turns yellow, and if not killed outright, it falls an easy prey to borers and other pests.

In the spring the aphides found on the roots and under bits of bark on the trunk are those which have successfully

* *Eriosoma lanigera* Hausm. Family *Aphididae*, see page 66.

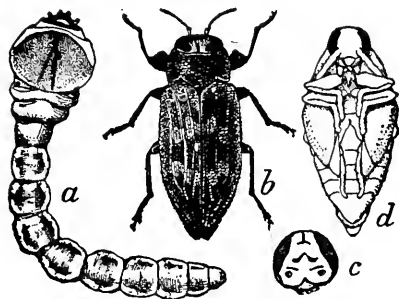

FIG. 212.—The flat-headed apple-tree borer (*Chrysobothris femorata* Fab.). (After Chittenden, U. S. Dept. Agr.)
a, larva; b, beetle; c, head of male; d, pupa
—twice natural size.

hibernated there over winter. As the foliage appears the root aphides migrate to the new wood and upward to the foliage where they feed and rapidly multiply. During the summer all are wingless, reddish-brown females which are covered with a white waxy secretion which forms a cottony mass over the colony. In the course of a fortnight each female gives birth to about 100 young, each of which becomes

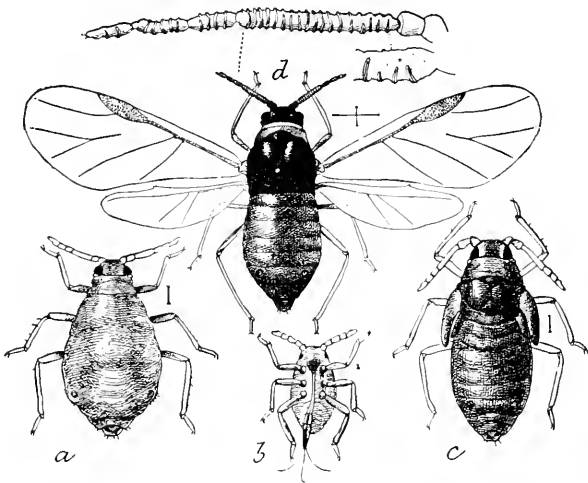

FIG. 213.—The woolly apple-aphis (*Eriosoma lanigera* (Hausm.).
(After Marlatt, U. S. Dept. Agr.)

a, agamic female; *b*, young nymph; *c*, last stage of nymph of winged aphid; *d*, winged agamic female with enlarged antenna above—all greatly enlarged and waxy excretion removed.

a full-grown female in eight to twenty days, and then in turn gives birth to a similar number. Thus they increase rapidly during the summer. Early in the fall a winged generation appears which migrates to elm trees. Each of these winged females gives birth to from four to six wingless males and females. These true sexes mate and the females each lay a single egg in the crevices of the bark. The winter egg

hatches in the spring and the female attacks the opening leaf, on which she gives birth to scores of young and soon causes the leaf to twist up or "rosette." These young become winged and migrate to the apple, where they give birth to a wingless generation which lives on the twigs, and which, in turn, gives rise to a fifth generation which crawls down to the roots, and seems to do the most damage of any during mid-summer.

The aphides may be destroyed on the foliage by spraying with 7 per cent kerosene emulsion, miscible oils diluted 30 or 40 times, or tobacco extracts, "Black-leaf 40" being used, one part in 70 of water. A strong spray must be used so as to penetrate the waxy covering and wet the aphides. A winter spray of miscible oil, kerosene emulsion, or lime-sulphur will destroy the hibernating aphides on the trunk if applied so as to go beneath loose bark. Where injury is being done to the roots, the earth above them should be removed for 6 or 8 inches deep and enough 10 per cent kerosene emulsion or dilute tobacco extract should be applied to wet the soil thoroughly. Dilute miscible oil might be used in the same way and some success has been secured with lime-sulphur mixture. Where tobacco stems or dust may be secured cheaply, they should be applied in the same way. The surface earth should then be replaced. Nurserymen commonly use tobacco dust in the trenches along the rows and also destroy the aphides on the foliage by spraying. Means of controlling this pest have never been satisfactorily determined, but as its migration to and from the elm tree has been only recently discovered, it is believed that greater advance in methods of control may soon be expected.

157. The Peach-tree Borer.* (42). Possibly as many peach trees are killed by borers as by any other pest. Their

* *Sanninoidea exitiosa* Say. Family *Sesiidae*, see page 79.

presence may be detected by the mass of gummy, gelatinous material, more or less mixed with soil which exudes from the crown of the injured trees, and by the yellowing of the foliage. The larvæ feed upon the soft inner bark of the lower trunk, crown, and adjacent roots, and often so girdle a tree that if

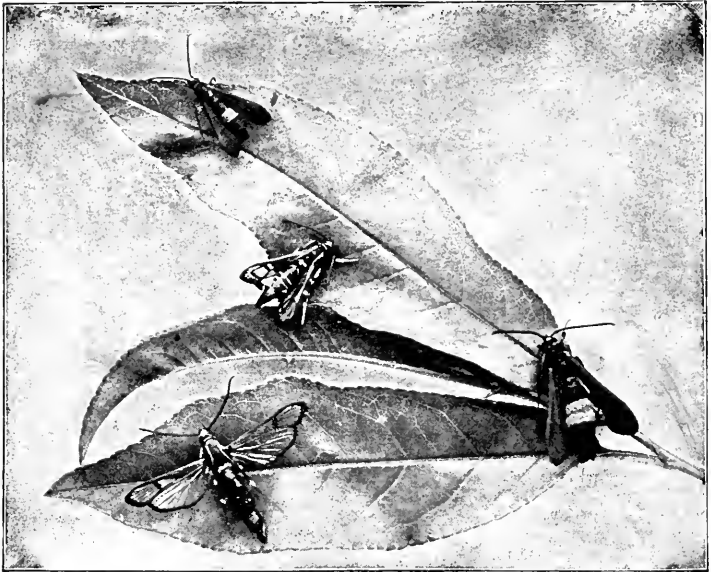

FIG. 214.—Peach tree-borer moths (*Sanninoidea exitiosa* Say)—natural size. The upper one and the one at the right are females, the other two males. (After Slingerland.)

not treated it will soon die. Such trees are also more susceptible to bark beetles and diseases.

The adults are clear-winged moths looking very much like wasps. The females are deep steel-blue with a broad orange band across the abdomen, the wings expanding about $1\frac{1}{2}$ inches. The males are smaller and the abdomen is

marked with three or four narrow yellow stripes. They emerge during the late summer, and the females lay their eggs on the bark near the base of the trees, a single one laying from 200 to 800. The larvæ hatch in ten days and enter the soft bark in which they feed until winter. They resume feeding in the spring and masses of gum exude from their burrows. The full-grown borer is light yellowish, about one inch long, with a brown head and legs, and five pairs of pro-legs on the abdomen. The mature larva constructs a cocoon near the surface of the soil, usually on the trunk near the burrow, which is composed of particles of excrement and bark bound together with gum and a thin lining of silk. In this it transforms to a brown pupa from which the moth emerges in about three weeks.

One of the best means of control is to mound the soil around the trunks of the trees in late summer, thus forcing the moths to deposit their eggs well up on the trunk. In the early fall level down the earth to facilitate finding the larvæ. This makes it much easier to find the young larvæ and the trees are not so badly infested when thus treated. Various washes and wrappers have been recommended for the peach borer, but it is yet to be demonstrated that any are generally successful. After reducing the number by mounding, the grower must dig the borers out by hand in the fall and again in late spring, using a sharp knife and strong wire, or a blacksmith's hoof-knife.

158. The Plum Curculio.* One of the most common pests of the stone and pome fruits east of the Rocky Mountains, is the *Plum Curculio* (1), whose larva is the common whitish worm found in peaches, plums and cherries. The larva is a footless grub (this distinguishes it from the cod-

* *Conotrachelus nenuphar* Herbst. Family *Curculionidae*, see page 125.

ling moth larva), about one-third of an inch long, whitish, with a small brown head, and usually lies in a curved position. The adult is a thick-set snout beetle, about one-fourth of an inch long, brownish in color, marked with gray and black, and with four black ridged tubercles on the wing-covers.

The beetles commence to emerge from hibernation in the spring just as apple trees blossom or just as peach blossoms have dropped and feed a little on the buds and unfolding

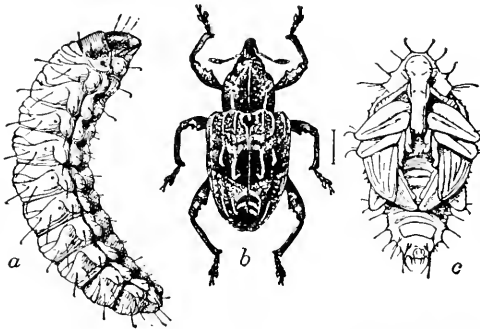

FIG. 215.—The plum curculio (*Conotrachelus nenuphar* Herbst.). (After Chittenden, U. S. Dept. Agr.)

a, larva; b, beetle; c, pupa—all much enlarged.

leaves and blossoms, but mostly on the young fruit as soon as it is set. The females at once commence to lay eggs in the young fruit. The female first eats out a hole with her snout and deposits her small, oval, white egg in the cavity.

She then cuts a small segment around it so that the growth of the fruit will not crush it. This gives rise to the characteristic crescent-shaped mark, which has given the insect its name of "little Turk." During her life of about two months a female will lay 100 to 300 eggs and will make as many more feeding punctures from which the gum will often exude on stone fruits. The eggs hatch in from three to five days and the larvæ become grown in from two to three weeks. They then enter the soil and form small cells, an inch or two below the surface, in which they transform to the white pupæ from

which the adult beetles emerge in three or four weeks, or during late summer and early fall.

Injured peaches and plums usually drop to the ground, but cherries stick to the tree and are small and gnarled or eaten out by the larvæ. In apples the larvæ seem to develop only in those which fall to the ground, the rapid growth of the apples on the tree probably crushing the eggs. The egg-scars and feeding-punctures make the apples gnarly, summer varieties sometimes being rendered worthless, and even winter sorts are much blemished by the scars. Injury to peaches and apples by the feeding-punctures of the newly emerged beetles is often fully as serious.

Clean cultivation during the summer will destroy many of the pupæ in the soil. On plums and cherries the

beetles may be collected in early morning by spreading a sheet (often mounted on a frame) beneath a tree and giving the tree a quick jar, whereupon the beetles will feign death



FIG. 216.—(After Chittenden, U. S. Dept. Agr.)

1, young plums showing crescent-shaped egg punctures of the plum curculio; 2, adult curculio on young peach—four times natural size.

and drop to the sheet, and may be dropped in a can of water and kerosene.

Chief dependence for control, however, is now placed on spraying with arsenate of lead, two pounds to fifty gallons. On apples the usual sprayings for the codling moth will give all the benefit possible. On peaches the first spraying should be given about ten days after the blossoms fall, and a second spraying two weeks later, the arsenate of lead being added to self-boiled lime-sulphur mixture applied for controlling the rot and similar diseases. Practically the same applications as for peaches will probably be found satisfactory for plums and cherries. Only neutral arsenate of lead, *i.e.*, that having little or no soluble arsenic, should be used on stone fruits, as a slight amount of soluble arsenious acid will burn the foliage badly.

Orchards near woodlands are always more badly injured, and where weeds, grass, and trash are abundant the beetles find more suitable quarters for hibernating and are more abundant. Cleaning up the orchard and its surroundings is, therefore, important for this and other insect pests.

159. Leaf Aphides.* Nearly every plant is attacked by some species of aphid and fruit trees are no exception. The rapidity with which these little plant-lice multiply has already been explained (page 270), and is the reason they often become so destructive. Insignificant individually, they will reproduce so rapidly that in a week or two the leaves are covered with them and the growth of the tree is seriously checked. The more common species may be recognized by their coloration and habits, and though they differ somewhat in their life histories, most of them are controlled by the same general methods.

Three or four species are common upon the apple.

* Family *Aphididae*, see page 66.

The *Apple-aphis** (5, 58), or green apple-aphis, is of a bright green color with the tips of the antennæ, the honey-tubes, and the tail jet black. The small oval black eggs are found around the buds of the trees during the winter and hatch just as the leaf buds are bursting in the spring. The young aphides soon cause the young leaves to curl. They excrete a large amount of sticky honey-dew. This attracts ants, which feed upon it, and on it grows a sooty black fungus which gives the infested tree a characteristic appearance. During the summer some of the generations develop wings and spread to neighboring trees, but only apple, pear and quince are attacked. In the fall the true males and females appear, each of the latter laying a single winter egg.

The *Rosy Apple-aphis*† (5) is larger than the last species, and is commonly of a rosy color, though the wingless females vary from salmon or tan color to slaty-gray or purplish-black. The wingless female is about one-tenth inch long, the abdomen being dark reddish-brown, covered with a powdery substance which gives it a deep blue color, the middle being lighter yellowish, and she becomes darker with age.

* *Aphis pomi* DeGeer.

† *Aphis sorbi* Kalt.



FIG. 217.—The apple-aphis—
winter eggs on twig.

The life history is much like the last species, except that the third generation in the spring is winged and migrates to some unknown food plant, upon which it subsists during the summer and from which it migrates back to the apple in the fall. Its injury to the apple foliage is similar to that of the last species, but when over-abundant it seems to be even more injurious to the young fruit.

The Oat-aphis * (6) is found on the apple, pear and quince in the spring and fall and on small grains and grasses. The wingless females are distinctly smaller than the previous species and are of a light green color, marked with transverse diamond-shaped bands of darker green across the abdominal segments. The honey tubes are shorter, and are distinctly enlarged at the middle and flared at the tip. The

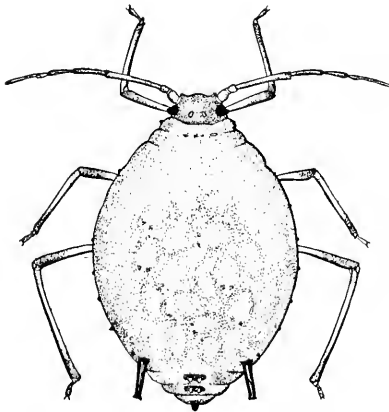

FIG. 218.—The rosy apple-aphis, wingless, viviparous female—greatly enlarged.

winged females may be distinguished from those of the other species by the very short second fork of the median vein at the tip of the fore wings. The second and third generations in the spring are winged and migrate to small grains and grasses. In the fall many of the aphides return to the apple on which the winter eggs are laid, while others pass the winter at the base of the grain plants, except in the far North. This species does not curl the foliage of the apple so badly and seems

**Aphis avenae* Fab.

to be more abundant on the flower buds and blossoms than the other species.

The *Black Peach-aphis* * (42) attacks the roots, tender shoots and foliage of the peach. Young trees suffering from its attacks on the roots have a yellowish sickly foliage and are often much injured before its presence is suspected. Usually, however, the numerous aphides on the leaves will indicate the probability of their also being on the roots. In early summer the aphides cluster on the tender shoots at the crotch of the tree and on the lower limbs and soon form a disgusting black mass over the young leaves, which are tightly curled up from the injury. On young trees, both in the nursery and orchard, this injury is sometimes so severe as to kill or severely check the growth. Injury to trees seems to be worst on light sandy soils.

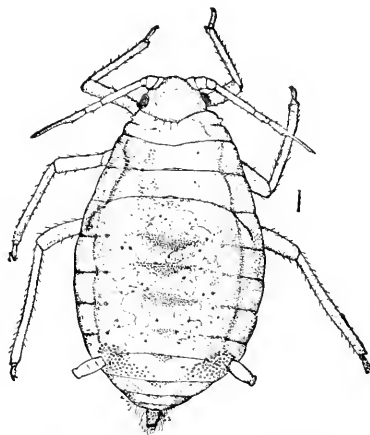

FIG. 219.—The oat-aphis, wingless, viviparous female—greatly enlarged.

Both winged and wingless forms are found on the foliage, but only wingless ones occur on the roots. They are about one-twelfth of an inch long and shining deep brown or black in color when mature. The partly grown aphides, which form the larger part of most colonies, are reddish-yellow or amber colored. The life history of this species is not well known, as neither the sexual forms nor the eggs have been observed. Like the other species it appears on the foliage

* *Aphis persicae-niger* Er. Sm.

as soon as the buds burst in the spring. During the mid-summer the aphides are more common on the roots, particularly on the smaller and more tender roots.

The *Green Peach-aphis* * is well described by its name. The winter is passed in the egg stage on any of the stone fruit trees. The first generation in the spring is a deep pink color, but the second and third are yellowish-green. Aphides of the third generation are winged and are about one-

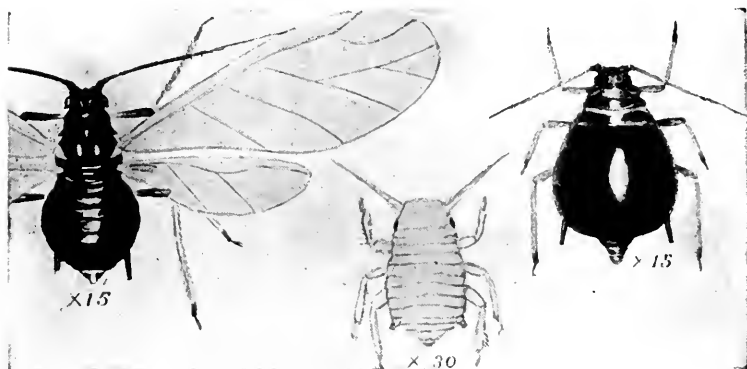

FIG. 220.—The black peach-aphis (*Aphis persicae-niger* Er. Sm.).
(After Gillette and Taylor.)

Winged viviparous female; young female, first instar; apterous viviparous female—much enlarged.

twelfth inch long, with the head, antennæ, thorax, honey-tubes, a large spot on the center of the abdomen and smaller spots in front of the honey-tubes, blackish. This third generation migrates to various common succulent vegetables such as cabbage, rape, turnip, tomato, celery and a long list of food plants, being troublesome in greenhouses the year round. In the fall, migrants return to the peach. Injury to the peach seems to have been most common in the Southwest, though it has been observed in other sections.

* *Myzus persicae* Sulz.

The *Mealy Plum-louse* * is a light green species covered by a bluish-white mealy powder. It has a long narrow body marked with three longitudinal stripes of a darker green. The honey-tubes are short, thick, and slightly constricted at the base. The aphides migrate to certain grasses upon which they feed during the summer and return to the plum or prune in the fall and there deposit their winter eggs.

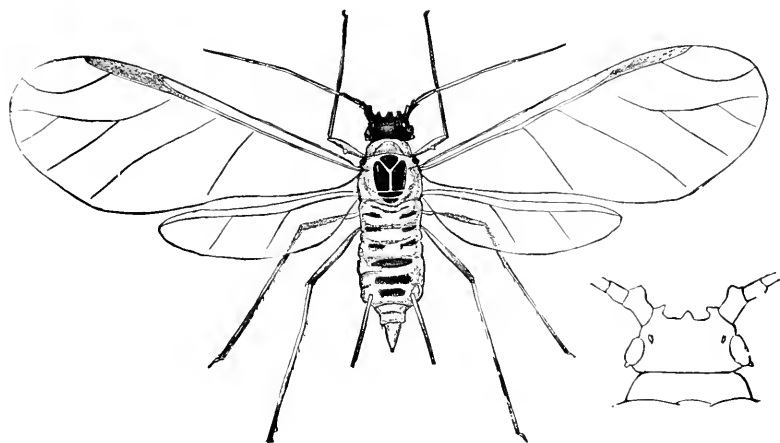

FIG. 221.—The hop plant-louse. (After Riley, U. S. Dept. Agr.)

Third generation on plum—the generation which flies to the hop—enlarged; head below at right—still more enlarged.

The *Hop Plant-louse* † also passes the winter in the egg stage on the plum and migrates to hops, which are often seriously damaged. Only rarely is it sufficiently abundant to do much injury to plum foliage. The wingless forms are light green or yellowish-green with no distinctive markings, while the winged forms have the head, thoracic lobes and a few dashes on the abdomen black. The species may be readily distinguished by the prominent tubercle which pro-

* *Hyalopterus arundinis* Fab.

† *Phorodon humuli* Schrank.

jects from the head on the inside of the base, and a less prominent one on the basal segment, of each antenna.

The *Rusty-brown Plum-louse* * is readily distinguished from others common on the plum and prune by its dark rusty-brown color, with the base of the antennæ, tibiæ and tail a contrasting white. This species has done considerable injury in the Southwest and also in New England, so that it is evidently widely distributed. It migrates to various common grasses upon which it feeds during the summer and

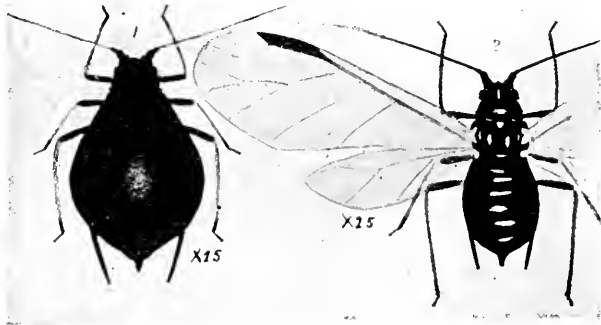

FIG. 222.—The black cherry-aphis (*Myzus cerasi* Fab.). (After Gillette and Taylor.)

1, apterous viviparous female; 2, winged viviparous female—enlarged.

returns to the plum in the fall. The wingless egg-laying female and the male are almost black.

The *Black Cherry-louse* † has long been known as a pest of the cherry in all parts of the country, and seems to be peculiar to this food-plant. Both the winged and wingless forms are deep shining black, the body is rather broad and flat and the honey-tubes are unusually long and cylindrical. The habits of the species are somewhat like those of the black peach aphid in the way in which the aphides cluster on

* *Aphis setariæ* Thos.

† *Myzus cerasi* Fab.

the smaller sprouts near the crotch before spreading to the rest of the tree, and in the disgusting black masses of curled foliage, dripping with honey dew and swarming with ants, which they soon cause.

Control. Most of these aphides may be controlled by much the same treatment. Spraying the trees in the winter with lime-sulphur wash as for the San José scale (page 289), will kill a large percentage of the eggs and thus materially reduce the numbers, though it cannot be depended upon for complete eradication. With all of these aphides it is important to spray them in the spring just as the buds are bursting and before they become secreted in the foliage which soon curls around them, and thus protects them from being hit by the spray. Early and thorough spraying is essential; spraying after the foliage is curled is of but little value. Kerosene emulsion, diluted to contain 7 per cent of kerosene, dilute miscible oils, whale-oil soap 1 pound to 5 or 6 gallons of water, or tobacco extracts, will destroy the aphides, though the exact strength must be varied with the species. The most successful spray for aphides of all sorts seems to be a tobacco extract known as Black-leaf 40 or Nicotine Sulphate. The spray used against aphides should be applied with some force so as to penetrate the expanding buds. Where Bordeaux mixture is being applied for plant diseases, either whale-oil soap or tobacco extracts may be added to it for the control of aphides. Lime-sulphur solution has not proven satisfactory for the destruction of aphides on foliage.

160. Orchard Caterpillars. Several hundred species of caterpillars have been listed as attacking the foliage of our common fruit trees, but a few are so common as to require attention almost every year.

The *Fall Webworm* * is so-called because its webs usually

* *Hyphantria cunea* Drury. Family *Arctiidae*, see page 81.

festoon the injured trees in August and September. All of the common fruit trees, various shade trees, and even some

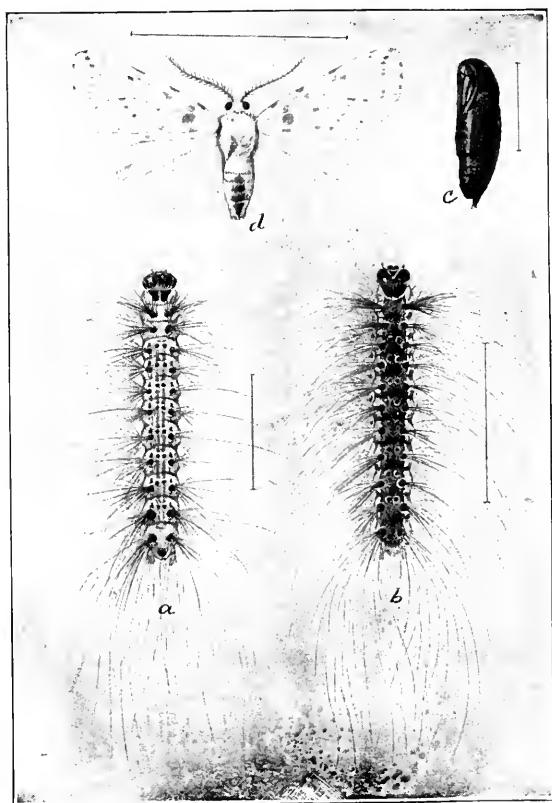

FIG. 223.—The fall webworm (*Hyphantria cunea* Dru.). (After Howard, U. S. Dept. Agr.)

a, light form of full-grown larva; *b*, dark form of same; *c*, pupa; *d*, spotted form of moth—all slightly enlarged.

of our garden vegetables are commonly attacked. The grown caterpillars are about an inch long, covered with long black and white hairs, and vary in color from yellowish with

black and yellow tubercles, to almost black. The moths have a wing expanse of about $1\frac{1}{4}$ inches, and are pure white or more or less spotted with black. In the North the moths emerge late in June and lay their eggs in late July. Four or five hundred eggs are laid in a patch on a leaf, and hatch in about ten days. The young larvæ at once spin a web over the foliage on which they are feeding, which is enlarged as necessary, so that before long it may cover a whole limb. These webs are usually first noticed in early August in the north and a month earlier in the Middle States. Within the web the surfaces of the leaves are eaten off until they are left dry and brown. The caterpillars then leave and form a new web on a fresh branch, so that before long a tree may become covered with the webs. The caterpillars become grown in four to six weeks and then find secluded places under the bark, in rubbish at the base of the tree, or just under the soil, and there spin flimsy silken cocoons in which they transform to small brown pupæ, which hibernate over winter. In the Middle States and farther south there are two generations each year, the first generation of caterpillars appearing in June and July and the second in August and September.

Orchards which are well sprayed with arsenate of lead for the codling moth will rarely be troubled with this caterpillar, but when unusually abundant it will be well to spray with arsenate of lead for this and other leaf-eating caterpillars just as they are hatching from the eggs, which will be about August first in the North.

The *Canker Worms* * (1) are also common pests of orchard and shade trees, particularly of old orchards which have been in sod and have not been sprayed. They are among the most common of the "loopers" or "measuring

* *Paleacrita vernata* Peck and *Alsophila pomctaria* Harris. Family *Geometridæ*, see page 87.

worms" and are the larvæ of two nearly related species of moths, very similar both in appearance and habits. The spring canker worm is so-called because its eggs are laid by the females in March and April and hatch a month later, while the fall canker worms hatch about the same time from

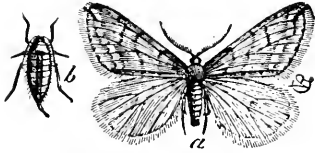

FIG. 224.—The spring canker worm (*Paleaerita vernata*).
a, male moth; b, female moth—both natural size.

eggs laid the previous November or December. The female moths are wingless and look much more like spiders than ordinary moths. The male moths have delicate wings of a dark gray color, expanding about an inch. The fore wings of the spring canker worm male are crossed with

three rather indistinct darker lines, while those of the fall canker worm are crossed by two whitish bands. The young caterpillars commence to feed on the leaves just as they are expanding, and if abundant will soon devour all but the mid-ribs. They have a habit of dropping from the trees and



FIG. 225.—Eggs of spring canker worm—twice natural size.
(After W. E. Britton.)

hanging suspended on strands of silk. They become full grown in four or five weeks and are then about an inch long, slender, cylindrical, varying from ash-gray to green or yellow, but mostly dark greenish-olive or blackish, marked with narrow pale lines down the back and a whitish stripe along

each side. The spring canker worm has but a single pair of pro-legs on the middle of the abdomen, while the fall canker worm has two pairs of pro-legs. The mature caterpillars enter the soil to a depth of two to five inches, where they hollow out earthen cells in which they change to pupæ.

In old sod orchards where the canker worms are always worst, their pupæ may be destroyed by plowing and thorough cultivation during the summer. The most effective means of destroying the caterpillars is to spray with arsenate of lead, three pounds to the barrel, just as the foliage has fairly expanded. A second spraying just after the blossoms drop will complete the control.

The *Tent Caterpillar** (1, 9, 43), is common on wayside apple and cherry trees everywhere east of the Rockies. The little caterpillars hatch just as the leaf-buds are expanding in the spring and they at once commence their characteristic tent-shaped web at the nearest crotch. All the caterpillars from one egg-mass co-operate in spinning the tent which furnishes them a shelter at night and during cold and wet weather. The tent is gradually enlarged by adding new layers of silk, the caterpillars living beneath the outer layers, but no foliage is included as in the webs of the fall web-

* *Malacasoma americana* Fab. Family *Lasiocampidae*, see page 88.

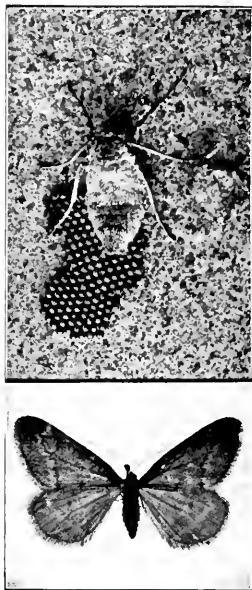

FIG. 226. — Wingless female moth and egg mass, and winged male moth of the fall canker worm—twice natural size. (After W. E. Britton.)

worm. When several colonies occur on a tree the caterpillars will soon strip it of foliage, and not infrequently neglected trees will be more or less defoliated every year. The caterpillars become grown in about six weeks and are then two inches long, deep black in color, with a white stripe down the back, and on each side of each segment is an oval pale blue



FIG. 227.—Egg mass of the tent caterpillar.

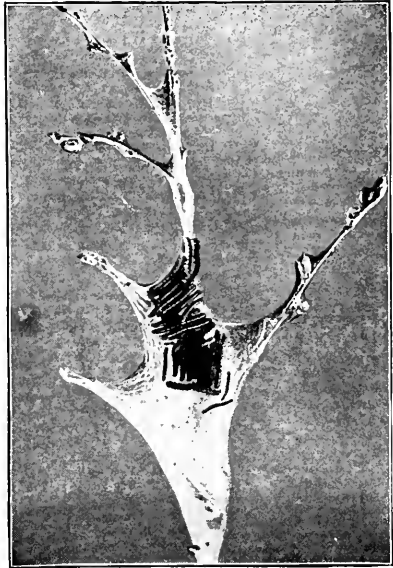

FIG. 228.—Half-grown tent caterpillars on tent—reduced in size.

spot with a broader velvety black spot immediately in front of it, giving somewhat the effect of an eye-spot. Having found a suitable place under loose bark or rubbish or in a fence corner the caterpillar spins a thin cocoon of tough white silk in which it transforms to the pupa. About three weeks later the adult moths emerge and the females lay their eggs on the tips of the twigs. The moths are of a brownish color,

with two nearly parallel white bands extending obliquely across the fore wings. The wings of the females expand about $1\frac{1}{2}$ inches, while the males are smaller and may be distinguished by their feathery antennæ. The egg-mass is from one-half to three-fourths inch long, and contains about 200 eggs, placed together on end. It is covered with a glue which gives a tough glistening surface to the whole mass, and forms a knot-like band around the twig.

The egg-masses may be easily found and pruned off during the winter. It is well to leave them in the orchard in a box covered with netting so that the parasites may escape. Neglected apple and cherry trees should be de-



FIG. 229.—The tent caterpillar moth. (After Lowe.)

stroyed, as they merely harbor this and other pests. Spraying with arsenate of lead just as the foliage comes out will readily destroy the caterpillars.

The *Yellow-necked Apple Caterpillar*.* In late summer one often finds a mass of caterpillars, huddled together as if confessedly guilty, on the defoliated tip of an apple

* *Datana ministra* Drury. Family *Notodontidæ*, see page S3.

limb. These usually belong to this species. The yellow-necked apple caterpillar is about two inches long, with a black head and the next segment a bright orange-yellow; down the middle of the back runs a black stripe and on either side of the body are three stripes of black alternating with four of yellow. If the limb is jarred or

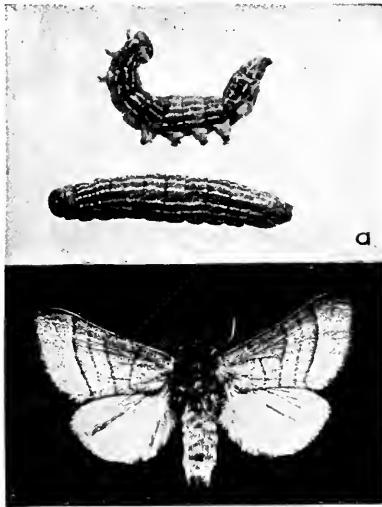

FIG. 230.—The yellow-necked apple caterpillar (*Datana ministra* Dru.); mature larvæ and moth—natural size.

on the foliage during midsummer. The moths have a wing expanse of about two inches, the fore wings being a reddish-brown color crossed by three to five darker lines, and the head and thorax being chestnut brown.

161. The Pear Slug* (40). The pear slug is an old European pest which is now found throughout the United States and in many parts of the world. Its work is usually

* *Caliroa cerasi* Linn.—Family *Tenthredinidæ*, see page 155.

a caterpillar is touched, it at once assumes a characteristic position, throwing the head and tail into the air with a jerk and clinging to the limb with the pro-legs, as shown in Fig. 230. The caterpillars become grown in four or five weeks and then enter the earth for from 2 to 4 inches, where they transform to naked brown pupæ. The moths emerge the next year from May to July, and the females lay their eggs in masses

recognized by the browning of the leaves of pear and cherry, or sometimes plum, where it has eaten off the surface of the leaves.

The parent insect is a small saw-fly, about one-fifth of an inch long, glossy black, with four iridescent wings, crossed by a smoky band at the middle and folded over the back when at rest. The flies appear by the time the foliage is well out, by mid-April in Maryland and late May or early

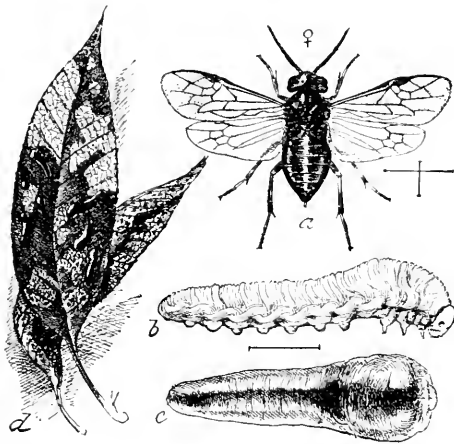

FIG. 231.—The pear slug (*Caliroa cerasi* Linn.). (After Marlatt, U. S. Dept. Agr.)

a, adult female saw-fly; *b*, larva with slime removed; *c*, same in normal state; *d*, leaves with larvæ—natural size; *a*, *b*, *c*, much enlarged.

June in Iowa and New England. Like other saw-flies, the female has a strong ovipositor with saw-like teeth at the tip, with which she cuts a little blister-like cell beneath the upper surface of the leaf, in which the egg is deposited (Fig. 232).

The bodies of the half-grown larvæ are dark blackish-green, covered with a viscid, slimy substance which has given them the name of slugs. The head is dark brown, and

the anterior segments are much expanded, concealing the head and legs. There are seven pairs of legs on the abdomen, the usual pair at the tip being wanting, so that it is slightly elevated. The slugs eat off the surface of the leaf until only a network of veins, held together by the brown epidermis of the lower surface, is left. Injured leaves drop and trees are often nearly defoliated, thus seriously injuring the growth

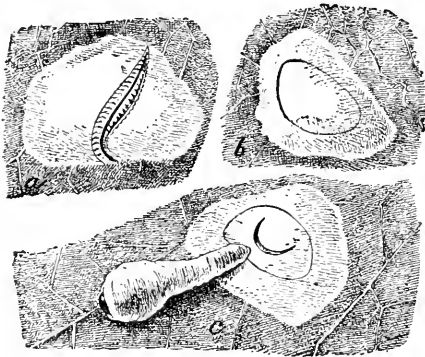

FIG. 232.—Illustrating method of oviposition and emergence of the pear slug. (After Marlatt, U. S. Dept. Agr.)

a, cutting of cell beneath epidermis, showing the tip of the ovipositor; *b*, the cell after the egg has been deposited; *c*, same after escape of the larva—all much enlarged.

and fruiting of the tree. The larvæ become grown in about twenty-five days and are then about one-half an inch long. After the last moult the larva becomes a light orange-yellow color, without the slimy covering, but it almost immediately enters the soil where it forms a small cell and transforms to the pupa. Some of the larvæ of each generation and all of those of the last generation remain in the soil over winter and transform to pupæ the next spring. In the North there are but two generations, the second larvæ appearing in August. In the latitude of the District of Columbia, the second generation of larvæ are most injurious about the middle of July, and there is probably a third generation later.

The best means of control is by spraying with arsenate of lead, which quickly destroys the larvæ. They may also

and fruiting of the tree. The larvæ become grown in about twenty-five days and are then about one-half an inch long. After the last moult the larva becomes a light orange-yellow color, without the slimy covering, but it almost immediately enters the soil where it forms a small cell and transforms to the pupa. Some of the larvæ of each

be killed by contact insecticides. Whale-oil, or other soaps, 1 pound to 2 gallons of water, or kerosene emulsion containing 10 per cent kerosene, are effective. Hellebore, 1 part to 5 parts of air-slaked lime, may be used as a dust or as a spray 1 pound to 50 gallons of water. In gardens where water under pressure is available, the slugs may be washed off by a strong jet from a hose, as they are frequently washed off by heavy rains and are much less injurious in wet seasons.

162. The Codling Moth.* The common apple worm (1) is well-known almost everywhere apples are grown and is the most serious insect enemy of our most valuable fruit. Where spraying is not practiced it often destroys 25 to 50 per cent of the crop and in 1907 Prof. A. L. Quaintance estimated the total loss due to this insect in the United States at \$12,000,000.

The adult moths are rarely seen as they fly at dusk and closely resemble the bark of the apple on which they rest during the day. They are small grayish moths with a wing expanse of about three-fourths of an inch. The wings are crossed with numerous fine lines of gray and brown, and bear a large bronze-brown spot near the tip.

When the larvæ leave the apples in the fall they burrow into corky crevices of the bark and there spin their white silken cocoons in which they hibernate over winter. In this stage large numbers of them are destroyed by woodpeckers. About the time apples blossom the larvæ transform to small brown pupæ, from which the moths emerge in two or three weeks. The females then lay their eggs largely on the leaves. The eggs are difficult to see, being about the size of a pin-head, and look like small white blisters on the leaves.

* *Cydia pomonella* Linn. Family *Grapholithidæ*, super-family *Tortricina*, see page 76.

They hatch in from five to ten days or about three to four weeks after the blossoms fall. The young larva feeds a little on the tender parts of a leaf, then crawls to the nearest apple, which it usually enters through the blossom end, and

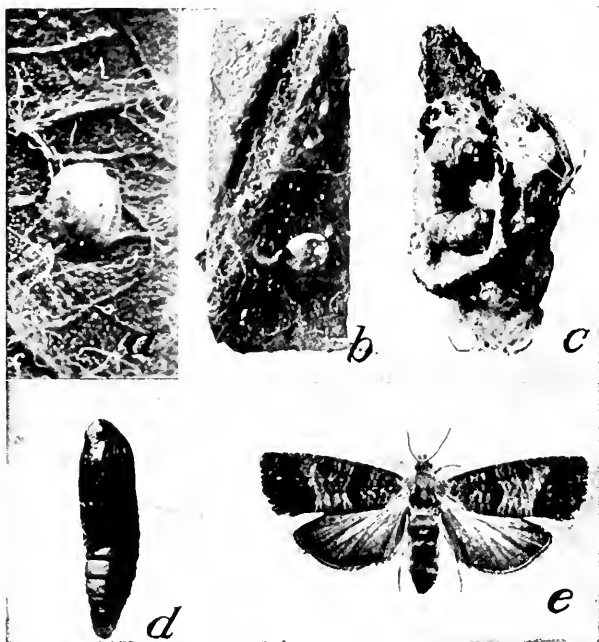

FIG. 233.—The codling moth (*Cydia pomonella* Linn.).

a, egg—greatly enlarged; *b*, young larva, hatching from egg; *c*, larva in winter cocoon on inside of a bit of bark; *d*, pupa—original; *e*, moth—after Slingerland—all much enlarged.

bores directly into the core where it devours the seeds. In three or four weeks it eats its way out through the side of the apple leaving its characteristic “worm-hole.” The full grown larva is about three-fourths of an inch long, whitish or pinkish in color, with a brown head and faint tubercles over

the body, and with three pairs of true legs on the thorax and five pairs of false-legs on the abdomen. In New England and the Northern States there is but a single generation each year (at most only a very small second generation), but in the Middle States a considerable proportion of the larvæ pupate at once and a second generation of moths emerges in August, while farther south all transform to a second generation. The larvæ of the second generation feed mostly on the surface of the apple, thus giving entrance to diseases which cause its decay.

Although scraping off the loose bark from the trunks of the trees and keeping them smooth so as to give less favorable conditions for the hibernation of the larvæ, and the attraction of birds to the orchard during the winter, will aid in subduing the codling moth, its control is now accomplished almost entirely by proper spraying with arsenicals. Paris green and various other arsenites were formerly much used, but arsenate of lead has now practically superseded them in commercial use. In spraying for the codling moth the object of the first spray is to fill the calyx cavity, through which the young larva enters the apple, with the poison so that it will be killed before it enters the flesh of the apple. To accomplish this the trees should be sprayed just as soon as the blossoms fall with arsenate of lead, using three pounds of the paste to 50 gallons of water. The spray must be applied with sufficient force so that it will be driven through the trees and will enter the blossoms pointing inward on the side of the tree away from the sprayer. A second spraying should be given about three weeks later, just as the eggs are hatching, to destroy the young larvæ feeding on the leaves. Obviously this should be applied so as thoroughly to cover the leaves above and below. In the West and South, where the second generation of larvæ is troublesome, a third spray-

ing about ten weeks after the petals fall and a fourth three weeks later will be found advisable. With thorough spraying not over 2 or 3 per cent of the picked fruit should show any injury from codling moth. Both the first and second sprays are usually combined with Bordeaux mixture or lime-sulphur solution for the control of fungous diseases.

CHAPTER XIX

INSECT CONTROL

WHEN one considers the multitude of different insect pests which attack all of our cultivated plants it becomes self-evident that methods for their control must be almost equally varied. However, there are a few fundamental principles which will greatly aid in planning how to combat them.

First among these is the fact that it is essential to prevent injury rather than to destroy the insect pests after damage has been noticed, for usually by the time they have been killed they have badly injured the plant. Thus it is obviously important to have a knowledge of the more common insect enemies of any given crop and to plan for their control as a part of the culture of the crop.

In the control of insects affecting the staple crops which are grown over large areas in an extensive manner, it is impracticable to use insecticides and various mechanical methods which can be used profitably in the orchard or garden. Staple crop insects must be controlled, if at all, by general methods of farm practice which may be carried out as a feature of the culture of the crop, but which will fatally interfere with their development. To accomplish this successfully it is necessary to know the life history of each insect so as to know just when it is most vulnerable and how a given procedure affects it, as may be appreciated from the description in the preceding pages.

Against insects affecting orchard and garden crops which have a higher value per acre, the use of insecticides and mechanical devices will also prove profitable, but to determine which will be effective we must know somewhat of the insect's anatomy and habits, for it is entirely useless to apply an arsenical poison for insects whose mouth-parts are so constructed as to make it impossible for them to eat it.

163. Methods of Farm Practice for Insect Control.*

(a) **Crop Rotation.** Many insects feed on only one crop. Evidently, therefore, if a field be planted in a different crop, they will have to migrate from it and a very considerable mortality will result, while if it were left in the same crop they would have ideal conditions under which to multiply. Thus the western corn root-worm may be practically controlled by not growing corn on the same land for two successive years, for it feeds only on corn and is not injurious where rotation is practiced. Injury by the Hessian fly to wheat and by the chinch bug to corn is also very materially reduced by frequent rotation. Care should be taken to arrange a rotation in which plants nearly related botanically do not follow each other, for they are usually attacked by the same insects. Thus, white grubs, wire-worms and cut-worms live in sod land, where they often become exceedingly abundant. If the land be put in corn these pests will concentrate on the fewer plants and do serious injury, whereas if it had been planted in some small grain, buckwheat, cow-peas, potatoes or some other crop which they do not affect, the land could then be safely planted in corn the next season. The same principle applies to various garden crops.

* See F. M. Webster, *Farm Practice in the Control of Field Crop Insects*, Yearbook, U. S. Department of Agriculture, 1905, and *Some Things that the Grower of Cereal and Forage Crops Should Know About Insects*, Yearbook, U. S. Department of Agriculture, 1908, page 367.

(b) **Time of Planting.** Early planting or the use of early-maturing varieties often enables the farmer to secure a crop before its pests have become most abundant. This has been repeatedly demonstrated with the cotton boll weevil and the cotton bollworm or corn earworm. Early cabbage plants seem to be less injured by maggots and early varieties of peas escape the aphids. On the contrary, late planting sometimes enables a crop to escape its enemies, as in the case when wheat is sown too late in the fall for the Hessian fly to lay its eggs on it.

(c) **Weeds.** In many cases immature insects feed upon some common weed and the adults attack a cultivated crop, or they may multiply on weeds in neglected fields and then migrate to a crop. "Volunteer" plants of the host crop should be considered as weeds, for they afford food to insect pests in the same way. Thus the corn root-aphis lives on the roots of smartweed and other weeds and grasses until corn is available, and cutworms feed on whatever vegetation is found before corn is planted, so that these pests are more or less starved out on land kept free from weeds. The cotton boll weevil feeds on volunteer cotton in the early spring and the Hessian fly oviposits on volunteer wheat in late summer and early fall. Seedling apple, peach and cherry trees may also be considered as weeds from the standpoint of insect control.

(d) **Fertilization and Culture.** There seems to be no evidence that any of our common fertilizers have any effect as insecticides, but it is well known that plants which have been weakened from any cause are more subject to insect attack, while vigorous plants will often survive injury, so that liberal fertilization is often of considerable importance, particularly with insects affecting the roots or boring in the stems. In the same way, thorough preparation of the soil

and good culture may give a crop such favorable conditions as to enable it to withstand insect injury which would be fatal to plants of weaker growth.

(e) **Clean Farming.** The insects peculiar to a crop often feed and multiply in the refuse left on the land after the crop is harvested and then hibernate over winter beneath it. All remnants of a crop, such as stubble, vines, leaves or stumps, should be removed from the field or turned under as soon after harvest as possible. Numerous examples have been cited in the preceding pages of insects which hibernate in stubble or under the remains of the crop.

(f) **Burning.** Stubble and refuse may often be gathered into piles in which the insects will congregate and then be burned. The burning of grass land is often resorted to for the control of army-worms, chinch-bugs, and grasshoppers, but should only be practiced where they occur in sufficient numbers to warrant it. Strawberry beds are sometimes burned over to destroy the eggs of the root-aphis, and the aphides affecting small grains may sometimes be controlled when they occur in small spots by covering them with straw and burning.

(g) **Plowing.** Deep plowing and thorough harrowing are often exceedingly effective in the control of many insects which pass some one stage in the soil. Late fall and winter plowing is particularly beneficial, as the cells in which the insects pass the winter are so broken up that they are exposed to freezing and thawing and excessive moisture. Thus cutworms pass the winter in the soil in the larval stage; the cotton bollworm or corn earworm in the pupal stage; May beetles and click beetles hibernate as newly transformed beetles; and grasshoppers' eggs pass the winter just under the soil; but all are largely destroyed by thorough plowing and harrowing, as has been described.

(h) **Trap Crops.** It sometimes happens that one plant or variety is preferred by an insect and can be used for attracting it from the plants to be protected. For instance, the cotton bollworm prefers to lay its eggs on corn. If a few rows of corn be planted here and there through the cotton field so as to come into silk about the time moths which normally lay on cotton are flying, the eggs will be laid on the corn, which can then be cut and fed to stock, and the cotton will be protected. In a similar manner radishes are sometimes used as a catch crop for the maggots affecting cabbage and onions, while kale makes an excellent catch crop for the harlequin cabbage bug.

164. Insecticides. Substances which destroy insects are commonly called insecticides and may be divided into four classes:

1. *Poisons* kill by being eaten and are usually composed of some form of arsenic and are, therefore, called arsenicals.

2. *Contact Insecticides* kill either by clogging up the spiracles, the openings of the respiratory system, or by entering the trachea, and thus causing suffocation, or by their corrosive action on the skin.

3. *Gases* are used for fumigating buildings, stored products, greenhouses and similar structures infested with insects where other means are not practicable.

4. A fourth class of substances used against insects may be known as *repellents*. They are not real insecticides, for they do not kill the insects but merely prevent them from attacking the plant or animal to which they are applied.

1. Poisons. Poisons are applied to the food of the insect and must be eaten to be effective. It is evident, therefore, that they are effective only against biting insects, or those which lap up their food from the surface, and that they can be of no use against the sucking insects, such as the true

bugs, which suck the juices from beneath the surface. Poisons may not always, however, be the most effective means of combating biting insects, for some caterpillars are sometimes effectually checked by use of contact insecticides.

Paris green is a green crystalline powder composed of the aceto-arsenite of copper. When properly made it should contain at least 50 per cent arsenic oxid (As_2O_5), and there should be as little soluble arsenic as possible. Various State laws require that there be not over $3\frac{1}{2}$ per cent soluble arsenic, but even that amount often injures tender foliage. Paris green is rather a coarse powder, settles readily in water, and is washed off by drenching rains when used alone. It is usually applied at the rate of from 3 to 8 ounces to a 50-gallon barrel of water, 5 ounces to the barrel being satisfactory for most purposes. If stirred up into a paste with a little water it will mix more readily and uniformly. Add an equal weight of quick lime, slightly more will do no harm, which will help neutralize any soluble arsenic.

Arsenate of lead is sold both as a white paste and as a powder. To be of standard grade the paste should contain at least $12\frac{1}{2}$ per cent of arsenic oxid and not over $\frac{3}{4}$ per cent water-soluble arsenic oxid, and not over 50 per cent water. Owing to the small amount of soluble arsenic it may be used in much larger quantities than other arsenicals and on tender foliage which others would injure. From 2 to 8 pounds of the paste per 50-gallon barrel of water are used, 2 to 3 pounds per barrel being sufficient for most of the pests of the orchard and garden. Only about half as much of the powdered form is required. Arsenate of lead remains in suspension in water better than Paris green and is much more adhesive. It has, therefore, very largely displaced Paris green and is superior to it for most purposes.

Formerly London purple, arsenite of lime, and other arsenicals were much used, but the above are practically the only arsenicals now having a general use.

Arsenate of Lime. Recently the U. S. Bureau of Entomology has reported favorably upon a home-made substitute for arsenate of lead, made of lime and sodium arsenate, according to the following formula:

“Stone Lime (90% CaO).....	55 pounds
Sodium arsenate, fused (dry powdered) 65% As ₂ O ₅	100 pounds
Water.....	26 gallons

“Place the stone lime in a wooden container and add a small amount of water, just enough to start slaking. When slaking is well under way, pour in the sodium arsenate, which should first have been dissolved in hot water. Keep stirring until the lime has thoroughly slaked. Sufficient water should be added from time to time to prevent burning. The resulting arsenate of calcium should contain about 18 per cent of arsenic oxid, or slightly more than in average arsenate of lead paste. In making this compound, one should know approximately the calcium oxid and arsenic oxid of the materials employed and vary the formula accordingly.

“In the experience of the Bureau of Entomology, arsenate of lime, made according to the above formula, compares favorably with arsenate of lead in killing effect, and has not caused injury to foliage of plants treated. This new insecticide, however, must still be regarded in its experimental stage. Its cheapness over arsenate of lead is its principal recommendation.”

Poisoned Bran Mash. For combating grasshoppers and cutworms arsenic is often employed mixed in a bran mash.

Mix one pound of Paris green or white arsenic colored with a dye with 25 pounds of bran or middlings. Stir a quart or two of cheap molasses into a gallon of water and moisten the bran, stirring thoroughly, until it makes a stiff mash. Do not add so much water that the mash will be thin and will cake when exposed. Sow broadcast on infested fields. Keep poultry out of fields thus treated.

Hellebore. The powdered roots of white hellebore are often used as an insecticide in place of arsenicals, especially for currant worms and similar saw-fly larvæ and other insects affecting crops soon to be eaten, as the hellebore is much less poisonous to man and animals. It may be applied dry, diluted with 5 or 10 parts of flour, or as a spray one ounce to a gallon of water. It is too expensive for use except on a few plants in the yard or garden and, like pyrethrum, it deteriorates with age.

When properly applied arsenical insecticides are entirely harmless to man and animals. It has been shown by chemical analysis that cabbages properly dusted with Paris green contain so small an amount that one would need to eat twenty-eight of them at once to be poisoned. Of course, instances of poisoning are occasionally recorded, for ignorant people sometimes seem to think that an extra large amount of poison will kill the insects "deader" and, therefore, apply an unnecessary amount, particularly when dusting.

2. Contact Insecticides. Contact insecticides are used against insects with sucking mouth-parts and against soft-bodied biting insects, which may be more readily destroyed by them than by arsenicals. The chitinous skin of an insect is not easily corroded and in many cases a substance strong enough to penetrate this skin will also injure foliage; hence only soft-bodied insects can be safely combated with corrosive substances on foliage. It is absolutely essential

that contact insecticides hit the insects which they are to destroy, for the mere spraying of the foliage is of no value whatever.

Kerosene emulsion is one of the oldest remedies for plant lice and other sucking insects and is often used because it is readily made and the materials can always be secured. Dissolve one-half pound of hard soap (or one quart of soft soap) in one gallon of boiling water. Add two gallons of kerosene and churn by pumping back and forth into itself for five or ten minutes until the oil is thoroughly emulsified, forming a creamy mass with no drops of free oil visible. This stock solution can then be diluted so that the resulting mixture will contain the desired per cent of kerosene. Thus for aphides one part of the stock solution should be diluted with 10 to 15 parts of water, giving 4 to 6 per cent of kerosene in the spray, while for a winter wash for the San José scale it should be diluted only three or four times, giving 16 to 22 per cent kerosene. It should be applied with a nozzle throwing a fine spray. There are other formulas for making the emulsion with buttermilk and it may be made with crude oil instead of kerosene.

Miscible Oils are made by making petroleum soluble by the addition of vegetable oils, "cut" or saponified with an alkali, and are really a sort of liquid petroleum soap which will combine readily with water. They are used principally as winter washes against the San José scale, for which they are diluted 8 to 10 times. For a summer wash they have been used effectively against plant lice and other insects for which kerosene emulsion would be used, diluted 25 to 30 times.

Whale-oil and Other Soaps. Any good laundry soap made into a thick solution one-half pound per gallon is an excellent remedy for aphides on house plants and small bushes.

Whale-oil or fish-oil soap has been used extensively against scale insects and plant lice, particularly by nurserymen and florists. The best brands are made from caustic potash rather than caustic soda and should not contain over 30 per cent of water. For most aphides one pound to six gallons is effective.

Pyrethrum, Buhach, or Persian insect powder, is made by pulverizing the petals of the pyrethrum blossom, and kills insects by clogging their breathing pores. It is used chiefly for household pests and in greenhouses and small gardens. It deteriorates rapidly with age and should be kept in tight cans. On this account large users buy directly from the only American manufacturers, the Buhach Producing Co., Stockton, Cal. It may be used as a dry powder, pure or diluted with flour, or in water at the rate of one ounce to two gallons, which should stand a day before using. For immediate use it should be boiled for five or ten minutes. It is often burned in rooms to destroy mosquitoes and flies, as it leaves no odor after the room has been aired.

Tobacco. A tobacco decoction may be made by steeping tobacco leaves, stems, or refuse in water at the rate of 1 pound to 1 or 2 gallons, and then diluting for use according to the strength of the tobacco and the insect to be combated. Tobacco decoction is much used for dipping plants infested with aphides and as a spray against aphides and similar soft-bodied insects. Various extracts and solutions of tobacco are now manufactured for use against plant lice, among the best of which is "Black-leaf 40" or Nicotine Sulphate, and are more satisfactory than home-made solutions on account of their uniform strength. Tobacco dust has been widely used against root-feeding aphides by removing the surface soil and applying a liberal dressing and then covering. The rains leaching through the tobacco carry the tobacco

water to the affected roots and destroy or repel the aphides.

Lime-sulphur Solution. This is now the leading remedy for the San José scale, as well as the pear leaf blister-mite, and has been found to kill a large percentage of aphid eggs. It is also an excellent fungicide, and spring applications just before the buds open are very effective in killing out the wintering spores of various fungous diseases.

The usual formula is, unslaked stone lime, 20 pounds; flowers (or flour) of sulphur, 15 pounds, water to make 50 gallons. Stir up enough water with the sulphur to make a thick paste. Slake the lime in the vessel in which it is to be cooked with a small quantity of hot water. Then add the sulphur paste to the slaking lime. Add 10 or 15 gallons of water and boil for forty-five minutes. The mixture may then be diluted to make a barrel of 45 or 50 gallons, straining it carefully into the spray barrel or tank. A large iron kettle or hog-scalding may be used for boiling the wash, or where steam can be made available a steam pipe may be run into several barrels and the wash boiled in them. Such barrels may well be placed upon a platform so that the wash may be drawn from them directly into the spray-tank. The leading manufacturers and dealers in insecticides are now selling concentrated lime-sulphur solution which is all ready for use by merely diluting to the desired strength. In many communities a central plant makes the wash and can sell it with a fair profit at a low rate.

Home-made Concentrated Lime-sulphur. In recent years many large growers have been making their own concentrated lime-sulphur solution, and where the quantity to be used warrants, a considerable saving may be effected. The usual formula calls for 50 pounds of fresh stone lime, 100 pounds of commercial ground sulphur and water sufficient

to make 50 gallons. In making this mixture it is important that only high-grade, pure lime should be used, and lime with less than 90 per cent calcium oxid (CaO), should be discarded. The following directions are given by the New York Agricultural Experiment Station:

“In making, slake the lime in about 10 gallons of hot water, adding the lumps of lime gradually to avoid too violent boiling and spilling over. . . . The sulphur must be thoroughly moistened and made into an even, fluid paste without lumps (before adding to the lime). . . . Pour in the sulphur paste gradually during the slaking, stirring constantly to prevent the formation of lumps, and when the slaking has finished add the full amount of water and boil gently for one hour. If kettles and fire are used, more than the required amount of water may be used at first, to compensate for evaporation, or the volume may be kept constant by adding successive small quantities to hold the mixture at the original level, as shown by a notch on a stick resting on the bottom of the kettle, and marked when the mixture first begins to boil. When boiling with live steam the mixture will be more likely to increase in volume than to decrease, so that no water need be added.

“This concentrate will keep with little change, unless the weather is below 5° F., if stored in filled, stoppered barrels. Even in open receptacles there will be no loss if the surface be covered by a layer of oil to prevent access of air. Each boiling should be tested with a Baumé hydrometer * and its density marked on the barrels or other containers.”

Below is given a table from which can be determined the amount of dilution for concentrates for each degree Baumé

* These hydrometers, made specially for testing lime-sulphur mixture, may be obtained from the Bausch & Lomb Optical Co., Rochester, N. Y., and other dealers in laboratory glassware.

from 20 to 36, and the corresponding specific-gravity reading.

*Dilution table for concentrated lime-sulphur solutions.*¹

Degrees Baumé.	Specific gravity.	Number gallons concentrated lime-sulphur to make 50 gallons spray solution.		
		Summer or foliage strength.	Winter or dormant strength.	
			San José scale.	Blister mite.
36	1.330	1 $\frac{1}{4}$	5 $\frac{1}{2}$	4 $\frac{3}{4}$
35	1.318	1 $\frac{1}{4}$	5 $\frac{3}{4}$	5
34	1.306	1 $\frac{1}{2}$	6	5
33	1.295	1 $\frac{1}{2}$	6 $\frac{1}{4}$	5 $\frac{1}{4}$
32	1.283	1 $\frac{1}{2}$	6 $\frac{1}{2}$	5 $\frac{1}{2}$
31	1.272	1 $\frac{1}{2}$	6 $\frac{3}{4}$	5 $\frac{3}{4}$
30	1.261	1 $\frac{3}{4}$	7	6
29	1.250	1 $\frac{3}{4}$	7 $\frac{1}{4}$	6 $\frac{1}{4}$
28	1.239	1 $\frac{3}{4}$	7 $\frac{1}{2}$	6 $\frac{1}{2}$
27	1.229	2	8	6 $\frac{3}{4}$
26	1.218	2	8 $\frac{1}{2}$	7 $\frac{1}{4}$
25	1.208	2	8 $\frac{3}{4}$	7 $\frac{1}{2}$
24	1.198	2 $\frac{1}{4}$	9 $\frac{1}{4}$	8
23	1.188	2 $\frac{1}{4}$	9 $\frac{3}{4}$	8 $\frac{1}{4}$
22	1.179	2 $\frac{1}{4}$	10 $\frac{1}{4}$	8 $\frac{3}{4}$
21	1.169	2 $\frac{1}{2}$	11	9 $\frac{1}{4}$
20	1.160	2 $\frac{1}{2}$	11 $\frac{1}{2}$	9 $\frac{3}{4}$

¹From Farmers' Bulletin 650, U. S. Dept. Agriculture.

3. Gases. *Carbon Bisulphide* is extensively used against insects affecting stored goods and grains, and for root-feeding insects. It is a clear, volatile liquid giving off fumes heavier than air. It may be thrown directly onto grain without injury to it or placed in shallow dishes. For grain in store in fairly tight rooms apply five to eight pounds to every 100 bushels, distributing the bisulphide over the surface or in pans containing not over one-half of one pound each. Make the enclosure as tight as possible, covering the grain with blankets or other tight cover, if necessary, and leave for twenty-four hours. Recent experiments have shown that the vapor is

much less effective at low temperatures and that the dosage must be greatly increased at temperatures below 60° F. For fumigating buildings "there should be about one square foot of evaporating surface to every twenty-five square feet of floor area, and each square foot of evaporating surface should receive from one-half to one pound of liquid." For fumigating clothing or household goods, place them in a tight trunk and place an ounce of liquid in a saucer just under the cover. The gas is exceedingly explosive; allow no fire or light of any kind around the building or enclosure until it has been well aired. The fumes should not be inhaled, for though not seriously poisonous, they have a suffocating effect and will soon produce dizziness and a consequent headache. Carbon tetrachloride is now used for some purposes in much the same manner as carbon bisulphide, and is not so explosive.

Hydrocyanic Acid Gas is used for the fumigation of nursery trees and plants, certain greenhouse insects, pests of dwelling houses, storehouses, mills, etc., and in California for scale insects on fruit trees. It is made by combining cyanide of potassium, sulphuric acid and water. The gas is slightly lighter than air and is a most deadly poison. It should be used only by thoroughly competent and careful persons who are fully advised as to the method of use for the particular purpose desired. Concerning its use advice should be sought from the State Agricultural Experiment Station, or from the State Entomologist, or from the Bureau of Entomology of the U. S. Department of Agriculture.*

Sulphur Dioxid. The fumes of burning sulphur, mostly sulphur dioxid, have long been recognized as a standard remedy for the fumigation of dwellings and barracks for insect pests. Successful fumigation for the bedbug has been

* See Appendix A, No. 40.

reported when stick sulphur has been burned at the rate of two pounds per 1000 cubic feet of space. The chief objection is the strong bleaching effect of the fumes in presence of moisture and their destructive action on vegetation. The germinating power of seeds is quickly destroyed, but they are not injured for food. One to five per cent of the gas, with an exposure of twenty-four hours, is effective for most seed and grain pests. It cannot be used on vegetation or for moist fruits, and tarnishes brass, nickel or gilt and may bleach fabrics.

Tobacco Fumes. Tobacco is extensively used as a fumigant for aphides in greenhouses and for certain plants, such as melons, by using it under covers. Several forms are now commonly used. Tobacco or nicotine extracts are sold under various trade names and are volatilized by heating either with a small lamp or by dropping hot irons into the dishes containing the fluid. The same material may be purchased in the more convenient form of paper which has been saturated with the extract and which is burned according to directions, a certain amount being sufficient for so many cubic feet of space. These tobacco preparations are excellent for the fumigation of household plants, which may be placed in a closet and then fumigated according to the directions of the particular brand employed. Melon vines, young apple trees, bush fruits, and similar outdoor crops may be effectively rid of plant-lice by fumigating with tobacco-paper under a frame covered with canvas or muslin sized with glue or linseed oil.

4. Repellents include any substances which may be applied to a plant or animal to prevent insect attack. A popular notion that any vile-smelling substance will repel insect attack seems to have very little evidence for its support. Tobacco dust, air-slaked lime, or even fine road dust, thor-

oughly covering a plant will prevent the attack of various flea-beetles and leaf-eating beetles, but to be effective the plants must be frequently dusted and kept well covered. Bordeaux mixture, our most widely used fungicide, when liberally sprayed on potatoes and tomatoes, acts as a repellent to keep off the little black flea-beetles which often seriously damage the young plants.

The various fly-sprays which are used for spraying cattle to prevent the annoyance of flies act merely as repellents. Blue ointment is sometimes used against animal parasites, evidently affecting them as a repellent.

Fruit trees are often painted with a thick soap solution containing 1 pint of crude carbolic acid to 10 gallons as a repellent for the adult borers which lay their eggs on the bark.

Naphthalene or moth balls and similar substances used for driving away household insects are effective as repellents.

Various proprietary insecticides are frequently offered for sale with wonderful claims for their effect as repellents, but only in rare cases are they of any value except for use as dust as already suggested.*

* For further discussion of insecticides see Farmers' Bulletin 127, U. S. Department of Agriculture.

APPENDIX A

PUBLICATIONS ON INJURIOUS INSECTS

THE following publications may be secured free of charge by writing to the Secretary of Agriculture, Washington, D. C., or to your Congressman or Senator, for those published by the United States Department of Agriculture, and to the several state agricultural experiment stations, whose post-offices are given below, for those published by them. The numbers are those used in parentheses () in the text.

Published by the U. S. Department of Agriculture

1. The More Important Insect and Fungous Enemies of the Fruit and Foliage of the Apple. Farmers' Bulletin 492.
2. The San José Scale and Its Control. Farmers' Bulletin 650.
3. The Oyster-shell Scale and the Scurfy Scale. Farmers' Bulletin 723.
4. Orchard Barkbeetles and Pinhole Borers. Farmers' Bulletin 763.
5. The Aphides Affecting the Apple. Circular 81, Bureau of Entomology.
6. The Oat Aphis. Bulletin of the U. S. Dept. Agriculture, No. 112.
7. The Pea Aphis. Circular 43, Bureau of Entomology.
8. The Melon Aphis. Circular 80, Bureau of Entomology.
9. The Apple-tree Tent Caterpillar. Farmers' Bulletin 662.
10. The Principal Insects Affecting the Tobacco Plant. Farmers' Bulletin 120.
11. The Colorado Potato Beetle. Circular 87, Bureau of Entomology.
12. Arsenate of Lead as an Insecticide Against the Tobacco Hornworms. Farmers' Bulletin 595.

13. The Common Squash Bug. Circular 39, Division of Entomology.
14. The Imported Cabbage Worm. Circular 60, Bureau of Entomology.
15. Common White Grubs. Farmers' Bulletin 543.
16. The Chinch Bug. Farmers' Bulletin 657.
17. The Spring Grain Aphis. Circular 93, Bureau of Entomology.
18. The Cotton Bollworm. Farmers' Bulletin 290.
19. The Cotton Worm. Circular 153, Bureau of Entomology.
20. The Boll Weevil Problem. Farmers' Bulletin 512.
21. The Ox Warble. Circular 25, Division of Entomology.
22. Texas or Tick Fever. Farmers' Bulletin 569.
23. The Horn Fly. Circular 115, Bureau of Entomology.
24. Repellents for Protecting Animals from the Attacks of Flies. Bulletin 131.
25. Mites and Lice on Poultry. Circular 92, Bureau of Entomology.
26. House Flies. Farmers' Bulletin 679.
27. The Stable Fly. Farmers' Bulletin 540.
28. The Yellow-fever Mosquito. Farmers' Bulletin 547.
29. Fleas as Pests of Man and Animals. Farmers' Bulletin 683.
30. The True Clothes Moths. Farmers' Bulletin 659.
31. Cockroaches. Farmers' Bulletin 658.
32. The Bedbug. Farmers' Bulletin 754.
33. House Ants. Farmers' Bulletin 740.
34. Some Facts About Malaria. Farmers' Bulletin 450.
35. Sheep Scab. Farmers' Bulletin 713.
36. Methods of Exterminating the Texas-fever Tick. Farmers' Bulletin 498.
37. Some Insects Injurious to Stored Grains. Farmers' Bulletin 45.
38. Remedies and Preventives Against Mosquitoes. Farmers' Bulletin 444.
39. The Sanitary Privy. Farmers' Bulletin 463.
40. The Pear Slug. Circular 26, Division of Entomology.
- 40a. The Roundheaded Apple-tree Borer. Farmers' Bulletin 675.
- 40b. Hydrocyanic Acid Gas Against Household Insects. Farmers' Bulletin 699.
- 40c. Flytraps and their Operation. Farmers' Bulletin 734.
- 40d. Grasshopper Control. Farmers' Bulletin 747.

**Published by State Agricultural Experiment Stations
(for addresses see below)**

41. Orchard Bark Beetles and Pin Hole Borers. Bulletin 264, Ohio Agricultural Experiment Station.
42. Insects Injurious to the Peach Trees of New Jersey. Bulletin 235, New Jersey Agricultural Experiment Station.
43. The Apple-tree Tent Caterpillar. Bulletin 177, Connecticut Agricultural Experiment Station.
44. The Cabbage Aphis. Bulletin 300, Cornell University Agricultural Experiment Station.
45. Potato Flea-beetle. Bulletin 211, Maine Agricultural Experiment Station.
46. The House Mosquito. Bulletin 216, New Jersey Agricultural Experiment Station.
47. Insect Pests of the Household. Bulletin 253, Ohio Agricultural Experiment Station.
48. An Outbreak of Gadflies in Kentucky. Bulletin 151, Kentucky Agricultural Experiment Station.
49. Sheep Scab. Bulletin 143, Kentucky Agricultural Experiment Station.
50. Some Common Poultry Parasites. Circular, West Virginia Agricultural Experiment Station.
51. Insect Pests of the Household. Bulletin 253, Ohio Agricultural Experiment Station.
52. Mill and Stored Grain Insects. Bulletin 189, Kansas Agricultural Experiment Station.
53. Making and Using Concentrated Lime-sulphur Wash. Bulletins 329 and 330, New York Agricultural Experiment Station.
54. The Chinch Bug. Bulletin 191, Kansas Agricultural Experiment Station.
55. The Corn Earworm. Bulletin, Kentucky Agricultural Experiment Station.
56. The Hessian Fly. Bulletin 188, Kansas Agricultural Experiment Station.
57. The Mosquitoes of New Jersey and their Control. Bulletin 276, New Jersey Agricultural Experiment Station.
58. Plant Lice Injurious to Apple Orchards. Bulletin 415, New York (Geneva) Agricultural Experiment Station.

Addresses of State Agricultural Experiment Stations and of State Entomologists.

Teachers and Students should write to the experiment station and state entomologist of their state for all available publications concerning insects.

Alabama, Auburn.	Montana, Bozeman.
Arizona, Phoenix.	Nebraska, Lincoln.
Arkansas, Fayetteville.	Nevada, Reno.
California, Berkeley.	New Hampshire, Durham.
California State Horticultural Board, at Sacramento.	New Jersey, New Brunswick.
Colorado, Fort Collins.	New Mexico, State College.
Connecticut, New Haven.	New York, Geneva.
Delaware, Newark.	New York Cornell University Agricultural Experiment Station, Ithaca.
Florida, Gainesville.	New York State Entomologist, Albany.
Georgia, State Entomologist, Atlanta.	North Carolina, State Entomologist, Raleigh.
Hawaii, Honolulu.	North Dakota, Agricultural College.
Idaho, Moscow.	Ohio, Wooster.
Illinois, State Entomologist, Urbana.	Oklahoma, Stillwater.
Indiana, Lafayette.	Oregon, Corvallis.
Indiana State Entomologist, Indianapolis.	Pennsylvania, State Zoologist, Harrisburg.
Iowa, Ames.	South Carolina, Clemson College.
Kansas, Manhattan.	South Dakota, Brookings.
Kentucky, Lexington.	Tennessee, Knoxville.
Louisiana, Baton Rouge.	Texas, College Station.
Maine, Orono.	Utah, Logan.
Maryland, College Park.	Virginia, Blacksburg.
Massachusetts, Amherst.	Washington, Pullman.
Michigan, East Lansing.	West Virginia, Morgantown.
Minnesota, University Farm St. Paul.	Wyoming, Laramie.
Mississippi, Agricultural College.	Wisconsin, Madison.
Missouri, Columbia.	

APPENDIX B

Books on Injurious Insects

- Insect Pests of Farm, Garden and Orchard, E. Dwight Sanderson. John Wiley & Sons, New York, 1912.
- Insects Injurious to Vegetables, F. H. Chittenden. Orange Judd Co., New York, 1907.
- Manual of Fruit Insects, M. V. Slingerland and C. R. Crosby. Macmillan Co., New York, 1914.
- Insects Injurious to the Household, Glen W. Herrick. Macmillan Co., New York, 1914.
- Injurious Insects, W. C. O'Kane. Macmillan Co., New York, 1912.
- Handbook of Medical Entomology, Riley and Johannsen. Comstock Publishing Co., Ithaca, N. Y., 1914.
- Medical and Veterinary Entomology, Herms. Macmillan.

Books Valuable for Reference Shelves in the Library of the Secondary School

- Manual for the Study of Insects, Comstock. Comstock Publishing Co., Ithaca, N. Y.
- American Insects. Kellogg. Henry Holt & Co., New York.
- The Insect Book, Howard. Doubleday, Page & Co., New York.
- The Moth Book, Holland. Doubleday, Page & Co., New York.
- The Butterfly Book, Holland. Doubleday, Page & Co., New York.
- Directions for the Collection and Preservation of Insects, Banks. U. S. National Museum, Bulletin 67, Washington, D. C. Also, Farmers' Bulletin 606, U. S. Department of Agriculture.
- Many more are valuable and desirable; the ones cited are the most generally useful and, with the ones mentioned in the previous list, will make a very adequate library for the ordinary school on the subject of insects.

Dealers in Collectors' Supplies and Laboratory Materials

Ward's Natural Science Establishment, Rochester, N. Y.

The Kny-Scheerer Co., New York.

The Simplex Net Co., Ithaca, N. Y.

Bausch & Lomb Optical Co., Rochester, N. Y.

Spencer Lens Co., Buffalo, N. Y.

Central Scientific Co., Chicago, Ill.

Southern Biological Supply Co., New Orleans, La.

INDEX

- Abdomen, 8
Acanthiidae, 60, 188
ACARINA, 21
Acrilidae, 48, 241
ACULEATA, 143
Adaptations, 15
Adult, 28
Aedes calopus, 184
Agaristidae, 85
Agrotis annexa, 287
 messoria, 286
Ajax butterfly, 96
Alabama argillacea, 257
Alfalfa grasshopper, 51
 weevil, 126
Alsophila pometaria, 311
American Acridium, 51
Anasa tristis, 281
Angle-wing butterflies, 102
Agoumois grain-moth, 78, 231
ANISOPTERA, 42
Anopheles, 133
Antennæ, 4, 16
Anthomyiidae, 140
Anthonomus grandis, 259
Anthrenus scrophularia, 222
Ant-lions, 45
Ants, 152
 Argentine, 217
 black pavement, 217
 house, 216, 340
 little black, 217
 little red, 216
Aorta, 11
Aphididae, 64, 246, 268, 295,
 302
Aphids, 64
Aphis, apple, 303, 339, 341
 black peach, 305
 cabbage, 268, 341
 cherry, black, 308
 English grain, 246
 German grain, 247
 green peach, 306
 hop, 307
 mealy plum, 307
 melon, 270, 339
 oat, 248, 304, 339
 pea, 269, 339
 rosy apple, 303
 rusty brown plum, 308
 spinach, 269
 spring grain, 248, 340
 woolly apple, 295
Aphisavena, 304, 339
 brassica, 268
 gossypii, 270, 339
 persica-niger, 305
 pomi, 303, 339
 setaria, 308
 sorbi, 203
Aphis lions, 46
Apis mellifera, 144
APOIDEA, 144
Apple-aphis, 303, 339
 woolly, 295

- Apple-caterpillar, yellow-necked, 315
 Apple cureulio, 126
 Apple-tree borers, 292, 340
 Apple weevil, 126
 Aquatic beetles, 110
 Aquatic bugs, 56
 ARACHNIDA, 21, 203, 207, 209
 ARANEIDA, 21
Arctiida, 81, 309
 Argynnid butterflies, 101
 Army-worms, 80
 Arsenate of lead, 328, 339
 Arsenate of lime, 329
 ARTHROPODA, 1, 19
Asilida, 135
Aspidiotus perniciosus, 287, 339
 Assassin-bugs, 60
 Astyanax butterfly, 102
Attagenus piccus, 223
Autographa brassica, 284

 Back-swimmers, 58
 Bag-worms, 87
Balaninus, 125
 Bean-weevil, 122, 225
 Beautiful wood-nymph, 85
 Bed-bugs, 60, 188, 340
 Bee-flies, 137
 Bee-moth, 76
 Bees, 144
 Beetles, 107
Berytida, 61
 Bill-bugs, 126
 Bird-lice, 37
 Biting cattle-louse, 199
 Biting-lice, 37
Bittacus, 46
 Black-flies, 136
 Black swallow-tail, 95
Blastophaga, 160
 Blister-beetles, 122

Blattida, 52, 214
Blissus leucopterus, 238
 Blow-fly, 141
 Blue butterflies, 99
 Body-covering, 17
 Boll weevil, 259, 340
 Bollworm, 253, 340
Bombycida, 91
Bombyliida, 137
 Book-lice, 35
 Boring *Hymenoptera*, 143, 154
 Bot-flies, 139
Braconida, 158
 Brain, 13
 Bran mash, poisoned, 329
 Breeding cages, 171
 Bristle-tails, 34
 Brownie-bugs, 64
 Brown-tail moth, 85
 larvæ, 17
Bruchida, 122, 224, 225
Bruchus obtectus, 225
 pisorum, 224
 Bubonic plague, 39
 Bud-moth, 77
 Buffalo-gnat, 136
 Buffalo-moth, 113, 223
 Buffalo tree-hopper, 64
 Bugs, 56
 Buhach, 332
 Bumble-bees, 147
 Bumble-beetles, 119
Buprestida, 115
 Burning, 326
 Burying beetles, 112
 Butterflies, 72, 93

 Cabbage aphid, 268, 341
 butterfly, 98
 caterpillar, 282, 340
 looper, 81
 worm, 282, 340

- Caddice flies, 46
 worms, 47
 Cadelle, 229
Calandra granaria, 227
 oryza, 227
Calandridæ, 126, 227
Caliroa cerasi, 316
 Canker-worms, 87, 311
 Cantharides, 123
 Caprifigs, 160
Capsidæ, 58
Carabidæ, 109
 Care of collection, 173
 Carolina locust, 51
 Carpenter-bee, 147
 Carpenter-moths, 79
 Carpet-beetle, 222
 Carrion beetles, 112
 Case-bearers, 76
 Caterpillars, 33, 72
Cathartus gemellatus, 229
 Catocalas, 81
 Cattle-lice, 198
 Cattle-tick, 209
 Cave-cricket, 52
Cecidomyidæ, 134, 250
Cecropia, 91
 Centipedes, 20
 Cephalothorax, 19
Cerambycidæ, 120, 292
Ceratocampidæ, 92
Cercopidæ, 63
 CHALCIDOIDEA, 154, 159
 Chalcis-flies, 154, 159
 Cherry, black louse, 308
 Chinch-bug, 60, 238, 340, 341
Chionaspis furfura, 290, 339
 Chitin, 8
 Cresphonetes butterfly, 97
 Chrysalis, 32, 95
Chrysomelidæ, 121, 272, 276, 279
Chrysopidæ, 46
 Cicada, 50, 61
Cicindelidæ, 108
Cimex lectularius, 188
 Circulatory system, 11
 Classification of animals, 1
 insects, 23
 Clear-wing sphinx, 90
 Click-beetles, 114
 Clothes-moths, 77, 230, 340
 Cloudless sulphur, 98
 Clover butterflies, 98
 Clover-hay worm, 76
Coccidæ, 64, 287, 289, 290
Coccinellidæ, 112
 Cockroaches, 214, 340
 Cocoon, 30
 Codling-moth, 77, 319
 COLEOPTERA, 107
 Gemma, 107
 table of families, 128
 Collection, 163
 Colon, 11
 Colorado potato-beetle, 121, 276,
 339
Conotrachelus nenuphar, 299
 Copper butterflies, 99
Coreidæ, 59, 281
Corisidæ, 58
 Corn bill-bugs, 127
 Corn earworm, 80, 253, 341
 CORRODENTIA, 35
Cossidæ, 79
 Cotton boll weevil, 126, 259, 340
 bollworm, 80, 253, 340
 worm, 81, 257
 Cottony cushion-scale, 66
Corydalis, 16, 44
 Coxa, 7
 Crabs, 19
 Crane-flies, 134
 Cray-fish, 19
 Crickets, 48, 52

- Crop, 10
 Crop rotation, 324
 Croton-bug, 214
 CRUSTACEA, 19
Ctenocephalus canis, 186
Cucujida, 113, 228
Culex pipiens, 183
Culicida, 133, 183
Curculionida, 135, 259, 299
 Curculios, 125
 Currant-borer, 79
 Cutworms, 80, 286
 Cybele butterfly, 102
Cydia pomonella, 319
 CYNIPOIDEA, 154, 156
- Daddy long-legs, 21
 Dainty sulphur, 98
 Damsel-flies, 42
 Darkling beetles, 123
Datana, 83
 ministra, 315
 Day-flies, 42
 Deer-fly, 136
Dermanyssus gallinae, 207
Dermestida, 113, 223,
 Development, direct, 28
 indirect, 28, 29
 Devil's darning-needles, 42
Diabrotica vittata, 279
 Differential locust, 51, 242
 Digestive tract, 9
 Digger-wasps, 151
 DIPTERA, 131
Disonycha xanthomelana, 275
 Dobson-fly, 44
 Dog's-head butterfly, 99
 Doodle-bugs, 45
 Dragon-flies, 42
 nymphs, 16
 Drone-fly, 138
 Drones, 145
- Dryocampa*, 92
Dytiscida, 111
- Ear-fly, 136
 Earwigs, 38, 112
Ectobia germanica, 214
 Eight-spotted forester, 85
 Ejaculatory duct, 14
Elaterida, 114
 Electric-light bug, 56
 Elm-leaf beetle, 122
 Elytra, 107
Emesida, 61
 Empodium, 7
 EPHEMERIDA, 42
Ephestia kuehniella, 230
 Epicranium, 4
Epitrix cucumeris, 272
 parrula, 273
Eriosoma lanigera, 295
Eucleida, 88
 EUPLEXOPTERA, 38
Euplaxina, 101
 Evergreen bagworm, 87
 Exoskeleton, 9
 Exuvia, 29
 Eyed Elater, 114
 Eyes, simple, 5
 compound, 5
- Fall web-worm, 82, 309
 Fat body, 15
 Femur, 7
 Fertilization, 325
 Fiery-eyes, 80
 Figs and insects, 160
 Fire-flies, 116
 Fish-moth, 34
 Flat-headed borers, 115, 294
 Flea-beetles, 121, 272
 Fleas, 38, 186, 340
 Flesh-flies, 140

- Flies, 131
 classification, 132
 horse, 200
 house, 175
 stable, 180
 Flour-moths, 230
 beetles, 119
 Fly larvæ, 132
Formicidæ, 216
Formicoidea, 153
 Fritillaries, 101
 Front, 6
 Fruit-flies, 140
 Fruit-tree bark-beetle, 127, 291,
 339, 341
Fulgoridæ, 63
 Fungus gnats, 134

 Gad-flies, 136, 139
 Gall-flies, 154, 156
 Ganglia, 13
 Gases, 335
Gastrophilus equi, 190
 Genre, 6
 GENUINA, *Coleoptera*, 108
Geometridæ, 86
 Giant silk-worm, 91
 Giant water-bug, 56
 Golden-eyes, 46
 Gossamer-wings, 99
 Gnats, 131, 134
 Grain aphides, 246
 beetles, 124, 226, 228
 insects, 226, 340, 341
 moths, 231
 weevils, 226
 Granary weevils, 126, 227
 Grape-leaf folder, 76
 Grasshoppers, 48, 241, 340
 Green-bugs, 248
 Ground beetles, 109
 Grubs, 107

Gryllidæ, 52
 Gypsy-moth, 85
Gyrinidæ, 110

Hamatopinus curysternus, 198
 urius, 198
 vituli, 198
 Hair-streaks, 99
 Halteres, 131
 Harlequin cabbage-bug, 59
 Harvest-flies, 61
 Harvestmen, 21
 Hawk moths, 89
 Head, 4
 Heart, 11
 Heel-flies, 139
 Helgramites, 125
Heliothis obsoleta, 253
 Hellebore, 330
Hamatobia serrata, 125
 HEMIPTERA, 38, 56
 table of families, 59
 Hen-louse, 206
 HESPERIINA, 93, 103
 Hessian-fly, 134, 250, 341
 HETEROPTERA, 56
 HEXAPODA, 23
 Hickory horned-devil, 92
Hippoboscidæ, 139, 202
 HOMOPTERA, 61, 64
 Honey-bee, 144
 Honey-dew, 17
 Hop plant-louse, 307
 Hornets, 148
 Horn-fly, 141, 195, 340
 Horn-tails, 154
 Horn-worms, 90
 Horse-bots, 139, 190
 Horse-flies, 136, 200, 341
 House-fly, 140, 141, 175, 340
 Humming-bird moths, 89, 90
 Hundred-legged worms, 20

- Hyalopterus arundinis*, 307
Hydrobatidae, 58
 Hydrocyanic acid gas, 336, 340
Hydrophilidae, 111
 HYMENOPTERA, 142
 table of families, 161
Hyphantria cunea, 309
Hypoderma lineata, 193
 Hypopharynx, 17
 Humble-bees, 147

 Ichneumon flies, 154
Ichneumonidae, 157
 ICHNEUMONOIDEA, 154,
 Idalia butterfly, 102
 Ileum, 11
 Imago, 28
 Imperial moth, 92
 Imported cabbage-worm, 98
 Imported currant-worm, 156
 Inch worms, 86
 Indian meal-moth, 76, 230
 Insect boxes, 166
 control, 323
 definition, 4
 Insecticides, 327
 Internal organs, 9
 Intestine, 11
 Io moth, 91
Iridomyrmex humilis, 217
 Isabella tiger-moth, 82
 ISOPTERA, 36
Isosoma grandis, 160
 tritici, 160

 Jar-flies, 61
Jassidae, 63
 Joint, 8
 Jointed spiders, 22
 June-bugs, 118, 236

 Katydid, 48, 51, 52

 Kerosene emulsion, 331
 Kidney tubules, 11
 Killing bottles, 163

 Labium, 5
 Labrum, 5
 Lac, 17
 Lace-wing flies, 46
Lachnosterna, 236
 Lady-bugs, 112
 Lamellicorn beetles, 116
Lampyridae, 116
 Land-bugs, 58
 Lantern-bugs, 116
 Lantern-flies, 63
 Larder-beetles, 114
 Larvæ, 30, 33
Lasiocampidae, 88, 213
 Leaf beetles, 121
 Leaf-bugs, 58
 Leaf-hoppers, 63
 Leaf-rollers, 76
 LEPIDOPTERA, 72
 table of families, 105
Lepidosaphes ulmi, 290
Leptinotarsa decemlineata, 276
 Lice, bird, 37
 cattle, 198
 poultry, 206
 true, 37
Leptidae, 138
 Life cycle, 31
 Lightning-bugs, 116
 Lilac-borer, 79
 Lime-sulphur solution, 333
Liparidae, 84
Lithosiidae, 85
 Lobsters, 19
 Locust-borer, 121
 Locust leaf-beetle, 122
Locustidae, 50, 51
 Locusts, 48, 241

- Long-horned wood-borers, 120
 Long-nosed ox-louse, 198
 Loopers, 86
Lucanida, 120
 Luminescent insects, 18
 Luna moth, 91
Lycanida, 99
Lygaria, 60, 238
Lysiphlebus, 249

 MACRO-LEPIDOPTERA, 75
Macrosiphum cecalis, 247
 granaria, 246
 pisi, 269
 Maggots, 131
Maiacosoma americana, 313
 MALLOPHAGA, 37, 199, 206
 Malpighian tubes, 11
 Mandibles, 5
Mantida, 53
 Mantis, 54
 Maple-worms, 83
Margaropus annulatus, 209
 Maxilla, 5
 May-beetles, 118, 236
Mayetiola destructor, 250
 May-flies, 42, 68
 Meadow-browns, 102
 Meadow grasshoppers, 52
 Meal-moths, 230
 Meal snout-moths, 76, 231
 Meal-worms, 124, 229
 Mealy-bugs, 65
 Measuring-worms, 86
 MECOPTERA, 46
 Medical Entomology, 132
 Mediterranean flour-moth, 76, 230
 Mediterranean fruit-fly, 141
Melanoplus atlantis, 241
 bivittatus, 242
 devastator, 241
 differentialis, 242
 Melanoplus femur-rubrum, 241
Meloida, 122
 Melon aphid, 270
 Melon-worm, 76
Melophagus ovinus, 202
Membracida, 63
Menopon pallidum, 206
 Mesothorax, 6
 Metallic wood-borers, 115
 Metamorphosis, 28, 31
 Metathorax, 6
 Mexican cotton boll weevil, 259
 MICRO-LEPIDOPTERA, 75
 Micropyle, 14
 Microscopes, 174
Milvida, 136
 Midas-flies, 136
 Midges, 131, 134
 Mid-intestine, 11
 Millers, 79
 Millipedes, 20
 Mimicry, 102
 Mites, 21
 Mole-crickets, 52
 Monarch butterfly, 101
Monomorium minimum, 217
 pharaonis, 216
 Mosquitoes, 131, 133, 183, 340, 341
 Mosquito hawks, 42
 Moths, 72
 Moulting, 29
 Mounting insects, 165
 Mourning-cloak, 101
 Mouth, 9
 Mud-daubers, 151
 Mud-wasps, 151
 Mule-killers, 42
 Mully-grubs, 119
Musca domestica, 175
Muscida, 140, 141, 175, 180, 195
 MUSCINA, 139
 Muscular system, 15

- Mycetophilidæ*, 134
 MYRIAPODA, 19
Myrmeleonidæ, 45
Myzus cerasi, 308
 persicæ, 269, 306

 Natural selection, 102
Nepidæ, 58
 Nervous system, 13
 NEUROPTERA, 41
 Nits, 163
Noctuidæ, 79, 253, 257, 266, 284
Notodontidæ, 83, 315
Notonectidæ, 58
 Notum, 6
 Nut-weevils, 125
 Nymphs, 28
Nymphalidæ, 100

 Occiput, 6
 Ocelli, 5
 ODONATA, 42
 Oesophagus, 10
Estridæ, 139, 190, 191, 193
Estris ovis, 191
 Orange-tips, 99
 Orchard caterpillars, 309
 Orders of insects, 24
 ORTHOPTERA, 48
 table of families, 54
 Ovaries, 13
 Oviduct, 13
 Ovipositor, 8, 14
 Owlet-moths, 80
 Ox-warbles, 193, 340
 Oyster-shell scale, 66, 289, 339

Palaearcta vernalis, 311
 Palpus, 6
Papilionidæ, 94
 PAPILIONINA, 93
 PARASITICA, 38, 157

 Parasitic *Hymenoptera*, 157
 Paris green, 328
 Parnassians, 94
 Parthenogenesis, 14, 67
 Pea-aphis, 269
 Pea-weevil, 122, 224
 Peach scale, 66
 Peach-tree borer, 79, 297, 341
 Pear-leaf blister-mite, 21
 Pear-slug, 156, 316, 340
Pentatomidæ, 59
Perciplaneta americana, 215
 australasia, 215
 orientalis, 215
Perlidæ, 42
 Persian insect powder, 332
Phasmidæ, 53
 Philenor butterfly, 97
 Pharynx, 9
Phlegethontius quinque-maculatus,
 278
 sexta, 278
Phorodon humuli, 307
Phyllotreta vittata, 274
 PHYSOPODA, 39
 Pickle-worm, 76
Pieridæ, 98, 282, 284
 Pill-bugs, 19
 Pinching-bugs, 120
 Pinning insects, 168
 Plant galls, 156
 Plant-hoppers, 63
 Plant-lice (See Aphis), 64, 66
 Planting time, 325
 PLECOPTERA, 41
 Pleuron, 6
Plodia interpunctella, 230
 Plowing, 326
 Plum aphis, 307
 Plum euculio, 125, 299
 Plum, rusty brown, aphis, 308
 Poisons, 327

- Polistes*, 149
 Polyphemus moth, 91
Pontia protodice, 284
 rapae, 282
 Potato-beetle, Colorado, 276, 339
 Potato-bug, 121
 Potato flea-beetle, 272, 341
 Poultry-lice, 206, 340
 Poultry mites, 207, 340
 Praying mantis, 48, 54
 Predaceous diving-beetle, 111
 PROCTOTRYPOIDEA, 154, 158
 Promethea moth, 91
 Prothorax, 6
 Proventriculus, 10
 PSEUDO-NEUROPTERA, 41
 Pseudo-scorpions, 22
Psoroptes communis, 203
 Psocids, 35
Psychidae, 87
 Pupa, 30
 Purple emperor, 102
Pyrallidae, 230
 PYRALIDINA, 75
Pyralis farinalis, 231
 Pyrethrum powder, 332

 Queen-bee, 145

 Rat-tailed maggots, 139
 Rear-horses, 48, 53
 Rectum, 7
 Red admiral, 101
 Red-necked cane-borer, 115
 REDUVIDE, 60
 Regal moths, 92
 Repellents, 337
 Reproductive system, 13
 Respiratory system, 12
 Rhinoceros-beetle, 120
 RHYNCHOPHORA, 107, 125
 Rice-weevil, 126, 227

 Roaches, 48, 52
 Robber-flies, 135
 Rocky Mountain locust, 51, 241
 Rocky Mt. spotted-fever, 22
 Rose-chafers, 119
 Rose-scale, 66
 Rose-slug, 156
 Rosy Dryocampa, 92
 Round-headed apple tree-borer,
 121, 340
 Round-headed borers, 120
 Rove-beetles, 112
 Royal moths, 92

 Salivary glands, 17
 San José scale, 66, 287, 339
Sanninoidea crotiosa, 297
Saperda candida, 292
Sarcophagidae, 140
Saturniidae, 91
 SATURNIINA, 91
 Saw-flies, 154, 155
 Saw-toothed grain beetles, 113,
 228
 Scale insects, 64
Scarabidae, 117, 236
 Scarabs, 118
 Scavenger-beetles, 111
 Scent glands, 17
 Scent organs of butterflies, 95
Schistocerca americana, 242
 Scientific names, 2
Scolytidae, 291
 SCOLYTOIDEA, 127
Scolytus rugulosus, 291
 Scorpions, 22
 Scorpion-flies, 46
 Screw-worm flies, 141
 Scurfy-scale, 290, 339
 Seminal tubes, 14
 Seminal vesicle, 14
 Senator moth, 92

- Sesidae*, 79, 297
 Seventeen-year locust, 61
 Shad-flies, 42, 136
 Sheep bot-fly, 191
 Sheep scab-mite, 21, 203, 340, 341
 Sheep-tick, 139, 202
 Short-nosed ox-louse, 198
 Short-winged scavengers, 112
 Shot-hole borers, 127
 Shrimps, 19
Sialida, 45
 Silk glands, 17
 Silkworm, 91
Silphidae, 112
Silvanus surinamensis, 228
 Silver-fish, 34
 Silver-spot skipper, 103
 Silver-spots, 101
Simuliida, 136
 SIPHONAPTERA, 38, 186
 SIPHUNCULATA, 37, 198
Siricida, 154
Sitotroga cerealella, 231
 Skippers, 93, 103
 Slug-caterpillars, 88
 Smell, 17
 Snake-doctors, 42
 Snake-feeders, 42
 Snapping-bugs, 114
 Snipe-flies, 138
 Snout-beetles, 108, 125
 Snow-flea, 35
 Social-wasps, 149
 Soldier-bugs, 59
 Soldier-flies, 137
 Solitary-wasps, 150
 Sow-bugs, 19
 Spanish-fly, 123
 Span-worms, 86
 Special organs, 15
 Spermatheca, 14
 SPHECOIDEA, 151
Sphingida, 89, 278
 Sphinx moths, 89
 Spiders, 21
 Spinach aphid, 269
 Spinach flea-beetle, 275
 Spined soldier-bug, 59
 Spiracles, 8, 12
 Spittle insects, 63
 Spotted pelidnota, 120
 Spreading-board, 170
 Spring-tails, 34
 Squash-bugs, 59, 281, 340
 Squash-vine borer, 79
 Stable fly, 141, 180, 340
 Stag-beetles, 120
Staphylinida, 112
 Sternum, 6
 Stilt-bugs, 61
 Stinging *Hymenoptera*, 143
 Stinging organs, 14
 Stink-bugs, 58
 Stomach, 15
Stomoxys calcitrans, 180
 Stone-flies, 41
Stratiomyida, 137
 Strawberry leaf-roller, 77
 Strawberry-weevil, 126
 Striped cucumber-beetle, 279
 Sub-oesophageal ganglion, 13
 Sucking-lice, 37
 Sulphur butterflies, 98
 Sulphur dioxide, 336
 Supra-oesophageal ganglion, 13
 Suture, 8
 Swallow-tail butterflies, 94
 Swarming bees, 146
 Sweat-flies, 138
 Sympathetic nervous system, 13
Syrphida, 138
 Syrphus flies, 138
Systema blanda, 274

- Tabanida*, 136, 200
Tabanus atratus, 200
 lincola, 200
 Tachina flies, 140
Tachinida, 140
 Tapestry-moth, 221
 Tarnished plant-bug, 58
 Tarsus, 7
 Taste, 16
Tenebrionida, 123, 229
Tenebrio molitor, 229
 obscurus, 229
Tenebroides mauritanicus, 229
 Tent-caterpillars, 88, 313, 339, 341
Tenthredinida, 316
 TENTHREDINOIDEA, 154, 155
 TEREBRANTIA, 143, 154
 Termites, 36
 Terrapin scale, 66
 Testes, 14
Tetramorium carpitum, 217
 Texas-fever tick, 22, 209, 340
 Thistle-butterfly, 101
 Thorax, 6
 Thousand-legged worm, 20
 Thread-legged bugs, 61
 Thread-waisted wasps, 151
 Thrips, 39
 Tibia, 7
 Ticks, 21
 Tiger-beetles, 108
 Tiger-moths, 81
 Tiger swallow-tail, 95
Tinca bisellella, 221
 pelionella, 220
 TINEINA, 77
Tipulida, 134
 Tobacco fumes, 337
 Tobacco, insecticide, 332
 Tobacco bud-worm, 80, 253
 Tobacco flea-beetle, 273, 339
 Tobacco worms, 278, 339
 Tomato fruit-worm, 80, 253
 Tomato worms, 278
 TORTRICINA, 76, 319
Toxoptera graminum, 248
 Trachea, 12
 Tracheal gills, 16, 44
 Trap-crops, 327
 Tree-crickets, 52
 Tree-hoppers, 63
Trichodectes scalaris, 199
Trichophaga tapetzella, 221
 TRICHOPTERA, 46
 Trochanter, 7
 Troilus butterfly, 96
 True bugs, 56
 True lice, 37
 True wasps, 148
Trypetida, 140
 Tumble-bugs, 117
 Turkey-gnat, 136
 Turnus butterfly, 95
 Tussock-moths, 81
 Tympanum, 17
 THYSANOPTERA, 39
 THYSANURA, 34
 Underwing moths, 81
 Vagina, 13
 Vas deferens, 14
 Ventriculus, 10
 Vertex, 6
Vespa, 150
 VESPOIDEA, 148
 Viceroy, 102
 Walking-sticks, 48, 53
 Walnut-worms, 83, 92
 Warblers, 139
 Wasps, 148
 Water-boatmen, 58
 Water-scavengers, 111

- Water-scorpions, 58
 Water-striders, 58
 Water-tigers, 111
 Web-worm, fall, 309
 Weeds, 325
 Weevils, granary, 227
 rice, 227
 Weevils, 125
 Whale-oil soap, 321
 Wheat joint-worm, 159
 straw-worm, 160
 Whirligig-beetles, 110
 Whiteants, 36
 White butterflies, 98
 White-grubs, 119, 236, 340
 White-lined sphinx, 90
 White-marked tussock-moth, 84
- Wings, 7
 Wing-veins, 8
 Wire-worms, 115
 Wood-nymphs, 102
 Wood-wasps, 154
 Woolly apple-aphis, 295
 Worker-bees, 145
 Wrigglers, 133
- Yellow butterflies, 98
 Yellow-jackets, 148
 Yellow-necked apple caterpillar
 83
- Zebra swallow-tail, 96
 Zoology, 1
 ZYGOPTERA, 44

THE WILEY TECHNICAL SERIES

EDITED BY

JOSEPH M. JAMESON

A series of carefully adapted texts for use in technical, vocational and industrial schools. The subjects treated will include Applied Science; Household and Agricultural Chemistry; Electricity; Electrical Power and Machinery; Applied Mechanics; Drafting and Design; Steam; Gas Engines; Shop Practice; Applied Mathematics; Agriculture; Household Science, etc.

The following texts are announced; others are being added rapidly:

ELECTRICITY

THE ELEMENTS OF ELECTRICITY; For Technical Students.

By W. H. TIMBIE, Head of Department of Applied Science, Wentworth Institute. xi+556 pages, 5¼ by 8. 415 figures. Cloth, \$2.00 *net*.

THE ESSENTIALS OF ELECTRICITY; A Text-book for Wire-

men and the Electrical Trades. By W. H. TIMBIE, Wentworth Institute. Flexible covers, pocket size. xiii+271 pages, 5 by 7¼. 224 figures. Cloth, \$1.25 *net*.

CONTINUOUS AND ALTERNATING CURRENT MACHIN-

ERY. By Professor J. H. MORECROFT, Columbia University. ix+466 pages, 5¼ by 8. 288 figures. Cloth, \$1.75 *net*.

CONTINUOUS AND ALTERNATING CURRENT MACHIN-

ERY PROBLEMS. By W. T. RYAN, E.E., Assistant Professor of Electrical Engineering, the University of Minnesota. 40 pages, 5¼ by 8. Cloth, 50 cents *net*.

ALTERNATING CURRENT ELECTRICITY AND ITS APPLICATION TO INDUSTRY. By W. H. TIMBIE, Head of Department of Applied Science, Wentworth Institute, and H. H. HIGBIE, Professor of Electrical Engineering, University of Michigan. **First Course.** x+534 pages, 5½ by 8. 389 figures. Cloth, \$2.00 *net*.
Second Course. ix+729 pages. 5½ by 8. 357 figures. Cloth \$3.00 *net*.

ELECTRIC LIGHTING. By H. H. HIGBIE, Professor of Electrical Engineering, University of Michigan. (*In preparation.*)

HEAT AND HEAT ENGINEERING

HEAT; A Text-book for Technical and Industrial Students. By J. A. RANDALL, Instructor in Mechanics and Heat, Pratt Institute. xiv+331 pages, 5¼ by 8. 80 figures. Cloth, \$1.50 *net*.

GAS POWER. By C. F. HIRSHFELD, Professor of Power Engineering, Sibley College, Cornell University, and T. C. ULBRICHT, formerly Instructor, Department of Power Engineering, Cornell University. viii+198 pages, 5¼ by 8. 60 figures. Cloth, \$1.25 *net*.

STEAM POWER. By C. F. HIRSHFELD, Professor of Power Engineering, Sibley College, Cornell University, and T. C. ULBRICHT, formerly Instructor, Department of Power Engineering, Cornell University. viii+419 pages. 5¼ by 8, 228 Figures. Cloth.

HEAT AND LIGHT IN THE HOUSEHOLD. By W. G. WHITMAN, State Normal School, Salem, Mass. (*In preparation.*)

MECHANICS AND MATHEMATICS

ELEMENTARY PRACTICAL MECHANICS. By J. M. JAMESON, Girard College, formerly of Pratt Institute. xii+321 pages, 5 by 7¼. 212 figures. Cloth, \$1.50 *net*.

MATHEMATICS FOR MACHINISTS. By R. W. BURNHAM, Instructor in Machine Work, Pratt Institute Evening School. vii+229 pages, 5 by 7. 175 figures. Cloth, \$1.25 *net*.

PRACTICAL SHOP MECHANICS AND MATHEMATICS. By JAMES F. JOHNSON, Superintendent of the State Trade School, Bridgeport, Conn. viii+130 pages, 5 by 7. 81 figures. Cloth, \$1.00 *net*.

PRINCIPLES OF MECHANISM. By WALTER H. JAMES, Assistant Professor of Mechanical Engineering Drawing, Massachusetts Institute of Technology, and MALCOLM C. MACKENZIE, Instructor in Mechanical Engineering, Massachusetts Institute of Technology. (*In Press*).

ARITHMETIC FOR CARPENTERS AND BUILDERS. By R. BURDETTE DALE, Assistant Professor in charge of Vocational Courses in Engineering and Correspondence Instruction, Iowa State College. ix+231 pages, 5 by 7. 109 figures. Cloth, \$1.25 *net*.

SHOP TEXTS

MACHINE SHOP PRACTICE. By W. J. KAUP, Special Representative, Crucible Steel Company of America. ix+227 pages, 5½ by 8. 163 figures. Cloth, \$1.25 *net*.

PATTERN MAKING. By FREDERICK W. TURNER and DANIEL G. TOWN, Mechanic Arts High School, Boston. v+114 pages, 5 by 7. 88 figures. Cloth, \$1.00 *net*.

PLAIN AND ORNAMENTAL FORGING. By ERNST SCHWARZKOPF, Instructor at Stuyvesant High School, New York City. x+267 pages, 5½ by 8. Over 400 figures. Cloth, \$1.50 *net*.

DRAFTING AND DESIGN

DECORATIVE DESIGN. A Text-Book of Practical Methods. By JOSEPH CUMMINGS CHASE, Instructor in Decorative Design at the College of the City of New York and at Cooper Union Woman's Art School. vi+73 pages. 8 by 10¾. 340 figures. Cloth, \$1.50 *net*.

AGRICULTURAL DRAFTING. By CHARLES B. HOWE, M.E. viii+63 pages, 8 by 10¾. 45 figures, 26 plates. Cloth, \$1.25 *net*.

ARCHITECTURAL DRAFTING. By A. B. GREENBERG, Stuyvesant Technical High School, New York, and CHARLES B. HOWE, Bushwick Evening High School, Brooklyn. viii+110 pages, 8 by 10¾. 53 figures, 12 plates. Cloth, \$1.50 *net*.

MECHANICAL DRAFTING. By CHARLES B. HOWE, M.E., Bushwick Evening High School, Brooklyn. x+147 pages, 8 by 10¾. 165 figures, 38 plates. Cloth, \$1.75 *net*.

ENGINEERING DRAFTING. By CHARLES B. HOWE, M.E.
Bushwick Evening High School, Brooklyn, and SAMUEL J. BERARD,
Sheffield Scientific School, Yale University. (*In preparation.*)

DRAWING FOR BUILDERS. By R. BURDETTE DALE, Director
of Vocational Course, Iowa State College. v+166 pages, 8 by
10 $\frac{3}{4}$. 69 figures, 50 plates. Cloth, \$1.50 *net*.

AGRICULTURE AND HORTICULTURE

FIELD AND LABORATORY STUDIES OF SOILS. By Pro-
fessor A. G. McCALL, Ohio State University. viii+77 pages,
5 by 7. 32 figures. Cloth, 60 cents *net*.

FIELD AND LABORATORY STUDIES OF CROPS. By Pro-
fessor A. G. McCALL, Ohio State University. viii+133 pages,
5 by 7. 54 figures. Cloth, 85 cents *net*.

SOILS. By Professor A. G. McCALL, Ohio State University. (*In
preparation.*)

MARKET GARDENING. By Professor F. L. YEAW, Oasis Farm
& Orchard Company, Roswell, New Mexico. Formerly Professor
of Market Gardening, Massachusetts Agricultural College. vi+
120 pages, 5 by 7. 36 figures. Cloth, 75 cents *net*.

THE CHEMISTRY OF FARM PRACTICE. By T. E. KEITT,
Chemist of South Carolina Experiment Station, and Professor of
of Soils, Clemson Agricultural College. xii+253 pages, 5 $\frac{1}{4}$ by 8.
81 figures. Cloth, \$1.25 *net*.

STUDIES OF TREES. By J. J. LEVISON, Formerly Forester, Park
Department, Brooklyn, N. Y. x+253 pages, 5 $\frac{1}{4}$ by 8. 156
half-tone illustrations. Cloth, \$1.60 *net*.

AGRICULTURAL DRAFTING. By CHARLES B. HOWE, M.E.
46 pages, 8 by 10 $\frac{3}{4}$. 45 figures, 22 plates. Cloth, \$1.25 *net*.

SCHOOL ENTOMOLOGY. For Secondary Schools and Agri-
cultural Short Courses. By E. DWIGHT SANDERSON, Formerly
Dean, College of Agriculture, West Virginia University, and L. M.
PEAIRS, Professor of Entomology, West Virginia University. vii+
356 pages, 6 by 9. 233 figures. Cloth, \$1.50 *net*.

BIOLOGY

LABORATORY MANUAL IN GENERAL MICROBIOLOGY.

Prepared by the Laboratory of Bacteriology, Hygiene and Pathology. Michigan Agricultural College. xvi+418 pages, $5\frac{1}{4}$ by 8. 73 figures. Several tables and charts. Cloth, \$2.50 *net*.

COSTUME DESIGNING

COSTUME DESIGN AND ILLUSTRATION. By ETHEL H.

TRAPHAGEN, Instructor and Lecturer at Cooper Union, The New York Evening School of Industrial Art, etc. (*In Press.*)

PRINTING

PRINTING. A Textbook for Printers' Apprentices, Continuation Classes and for General Use in Schools. By FRANK S. HENRY, Instructor in Printing, Philadelphia Trades School. ix+318 pages. 153 figures. $5\frac{1}{4}$ by $7\frac{5}{8}$. Cloth, \$1. 25 *net*.

THE LOOSE LEAF LABORATORY MANUAL

A series of carefully selected exercises to accompany the texts of the Series, covering every subject in which laboratory or field work may be given. Each exercise is complete in itself, and is printed separately. 8 by 10½.

Important Notice

WILEY LOOSELEAF MANUALS

The sale of separate sheets of the Laboratory Manuals of the Wiley Technical Series has been discontinued. These Manuals will, hereafter, be sold only as a complete book with removal leaves. Descriptive literature will be sent on request.

CHEMISTRY

Exercises in General Chemistry. By CHARLES M. ALLEN, Head of Department of Chemistry, Pratt Institute. An introductory course in Applied Chemistry, covering a year's laboratory work on the acid-forming and metallic elements and compounds. 62 pages, 8 by 10½. 61 exercises. Complete in paper cover. Removal leaves. \$1.00 *net*.

Quantitative Chemical Analysis. By CHARLES M. ALLEN, Head of Department of Chemistry, Pratt Institute. 12 pamphlets. 8 by 10½. Complete in paper cover. Removal leaves. \$1.00 *net*.

Qualitative Chemical Analysis. By C. E. BIVINS, Instructor in Qualitative Analysis, Pratt Institute. 11 pamphlets, supplemented by *Work Sheets* by which the student is taught equations and chemical processes. Complete with work sheets in paper cover. Removal leaves. \$1.25 *net*.

Technical Chemical Analysis. By R. H. H. AUNGST, Instructor in Technical Chemistry, Pratt Institute. 19 pamphlets. 8 by 10½. Complete. Removal leaves. 85 cents *net*.

Exercises in Industrial Chemistry. By Dr. ALLEN ROGERS, Instructor in Qualitative Analysis, Pratt Institute. (*In preparation.*)

MECHANICS AND HEAT

Exercises in Mechanics. By J. M. JAMESON, Girard College; Formerly of Pratt Institute. 52 exercises. Complete in paper cover. Removal leaves. 85 cents *net*.

Exercises for the Applied Mechanics Laboratory. Steam; Strength of Materials; Gas Engines; and Hydraulics. By J. P. KOTTCAMP, M.E., Instructor in Steam and Strength of Materials, Pratt Institute. 8 by 10½. 58 exercises, with numerous cuts and tables. Complete in paper cover. Removal leaves. \$1.00 *net*.

ELECTRICITY

Exercises in Heat and Light. By J. A. RANDALL, Instructor in Mechanics and Heat, Pratt Institute. 17 exercises, with numerous cuts and diagrams. 8 by 10½. Complete in paper cover. Removal leaves. 34 cents *net*.

Electrical Measurements, A. C. and D. C. By W. H. TIMBIE. Head of Department of Applied Science, Wentworth Institute. 52 Exercises. Complete in paper cover, 85 cents *net*.

Elementary Electrical Testing. By Professor V. KARAPETOFF, Cornell University, Ithaca, N. Y. 25 exercises. Complete in paper cover. Removal leaves. 50 cents *net*.

Electrical Measurements in Testing. (*Direct and Alternating Current.*) By CHESTER L. DAWES, Instructor in Electrical Engineering, Harvard University. In charge of Industrial Electricity, Franklin Union, Boston. 39 Exercises. Complete in paper cover. Removal leaves. 75 cents *net*.

AGRICULTURE AND HORTICULTURE

Studies of Trees: Their Diseases and Care. By J. J. LEVISON, M.F., Lecturer on Ornamental and Shade Trees, Yale University Forest School, Forester to the Department of Parks, Brooklyn, N. Y. 20 pamphlets, 8 by 10½. \$1.00 *net*. A cloth binder for above sold separately. 50 cents *net*.

Exercises in Farm Dairying. By Professor C. LARSEN, Department of Dairy Husbandry, South Dakota State College. Loose leaf. 8 by 10½. 69 Exercises. Complete. Removal leaves. \$1.00 *net*.

Exercises in Agricultural Chemistry. By Professor T. E. KEITT, Clemson Agricultural College. (*In preparation.*)

DRAWING

AGRICULTURAL DRAFTING PROBLEMS. By CHARLES B. HOWE, M.E. A Manual for Students of Agriculture to Supplement the Text in Agricultural Drafting. 26 plates. 8 by 10½. In paper cover. Removal leaves. 50 cents *net*.

THE ORDERS OF ARCHITECTURE. By A. BENTON GREENBERG. A Manual for Students of Architecture to Supplement the Text in Architectural Drafting. 20 plates. 8 by 10½. In paper cover. Removal leaves. 50 cents *net*.

