

LIBRARY  
OF THE  
UNIVERSITY  
OF ILLINOIS

385

K635s8

v.13

Return this book on or before the  
**Latest Date** stamped below.

Theft, mutilation, and underlining of books  
are reasons for disciplinary action and may  
result in dismissal from the University.

University of Illinois Library

MAY 20 1985



BUILDING AND REPAIRING  
RAILWAYS.

---

SUPPLEMENT TO

**THE SCIENCE OF RAILWAYS**

---

BY

MARSHALL M. KIRKMAN.

---

PUBLISHED BY THE

WORLD RAILWAY PUBLISHING COMPANY.

---

NEW YORK AND CHICAGO:  
THE WORLD RAILWAY PUBLISHING COMPANY,

1904

COPYRIGHT BY  
THE WORLD RAILWAY PUBLISHING COMPANY  
1902, 1903, 1904.  
Also entered at Stationer's Hall, London, England.  
*All rights reserved.*

385

KG35.8.

V. 13.

## TABLE OF CONTENTS.

	PAGE.
INTRODUCTION, . . . . .	19
CHAPTER I. Railway evolution. The development of the railway illustrated, . . . . .	21
CHAPTER II. The reconnoissance—the first step in railway construction, . . . . .	47
CHAPTER III. The preliminary survey—the second step in railway construction, . . . . .	58
CHAPTER IV. The location—the third step in railway construction, . . . . .	83
CHAPTER V. Construction, . . . . .	90
CHAPTER VI. Standards of construction and material, . . . . .	147
CHAPTER VII. Constructing track, . . . . .	297
CHAPTER VIII. Maintenance of way, . . . . .	322
CHAPTER IX. Wrecks, . . . . .	441
CHAPTER X. Maintenance of bridges and buildings, . . . . .	455
CHAPTER XI. Construction and maintenance accounts, . . . . .	477
CHAPTER XII. Maintenance and operation. What cost is dependent upon, . . . . .	480
CHAPTER XIII. Maintenance. Fixed operating expenses, . . . . .	510
CHAPTER XIV. Maintenance. Cost of operating affected by facilities, . . . . .	524
CHAPTER XV. Maintenance. Things that enter into the maintenance of a railroad, . . . . .	530





## APPENDIXES.

<b>B.</b>	(1) Relation the various items of track labor bear to each other. . . . .	559
	(2) Relation that various items of track expenses bear to total track expenses. . . . .	559
<b>C.</b>	(1) Relation various classes of maintenance bear to total cost of maintenance . . . . .	560
	(2) Relation of the cost of maintaining the property of a road to all other operating expenses . . . . .	560
<b>D.</b>	Percentage of the total cost of operating due to maintenance of organization and the prevention of the destruction of the property from natural causes . . . . .	561
<b>E.</b>	Gauges of railroads that are or have been in use in different countries . . . . .	562
<b>F.</b>	Quantity of material required to lay one mile of railroad track on the basis named . . . . .	563
<b>G.</b>	Table showing increase in weight of locomotives from 1880 to 1900 . . . . .	564
<b>H.</b>	Detailed rules governing the location of railways. . . . .	565
<b>I.</b>	Detailed rules governing surveys and construction of railways and lists of supplies required in the field . . . . .	583
<b>J.</b>	Detailed rules governing construction of track of railways and various illustrations of rail sections, specifications and tables, giving details in regard to material used in construction . . . . .	597
<b>K.</b>	Table setting forth modern authorities on the location, construction, track and maintenance of railways . . . . .	629
<b>L.</b>	Bridges and buildings—Rules, tables and data . . . . .	644



## LIST OF ILLUSTRATIONS.

FIG.		PAGE.
<b>A</b>	Jessop's Cast Iron Fish Bellied Rail.....	24
<b>B</b>	The First Rail Chair, A. D. 1797.....	24
<b>C</b>	LeCann's Tram Rail, A. D. 1801.....	25
"	Wyatt's Hexagonal Rail, A. D. 1802.....	25
"	Tram Rail, A. D. 1803.....	25
"	Carlisle's Wrought (Rolled) Iron Rail, A. D. 1811.....	25
"	Losh & Stephenson's Edge Rail, A. D. 1816.....	25
<b>D</b>	Tram Rail with Stone Supports, upon which Trevit- hick's first locomotive ran.....	27
<b>E</b>	Birkenshaw's Wrought Iron Rail, A. D. 1820.....	28
"	Hetton Rail, A. D. 1824.....	28
"	George Stephenson's Fish Belly Rail, A. D. 1829.....	28
"	Rail, Designed by Robert L. Stevens, A. D. 1830.....	28
<b>F</b>	Standard Track, Camden & Amboy R. R., A. D. 1837...	30
"	Track of Camden & Amboy R. R., Rails Laid on Piling Through Marshes, A. D. 1837.....	30
"	Stevens' Rail, A. D. 1841.....	30
<b>G</b>	Stone Stringer and Strap Rail, A. D. 1833.....	31
"	Wooden Stringer and Strap Rail, A. D. 1837.....	31
<b>H</b>	Street Railway Construction.....	32
<b>I</b>	English Fish Belly Rail, A. D. 1832.....	34
"	Joint Chair and Wedge, A. D. 1832.....	35
"	Stone Block Rail and Joint Tongue, A. D. 1831.....	35
<b>J</b>	Stevens' Rail, Supported by Cast Iron Chair, A. D. 1837	36
"	Ring, Joint and Wedge, West Jersey R. R.....	36
"	Wooden Joint Block, A. D. 1860.....	36
"	Double Splice Bar, A. D. 1857.....	37
"	Erie Rail with Ends Stamped for Adams' Cast Iron Bracket Splice, A. D. 1857.....	37
"	Single Splice Bar, A. D. 1855.....	37
"	Double Splice Bar, A. D. 1856.....	37
<b>K</b>	Plain Splice Bar, A. D. 1870.....	38
"	Angle Splice Bar, A. D. 1868.....	38
"	Angle Splice Bar, A. D. 1875.....	38
"	Angle Splice Bar, A. D. 1879.....	38
"	Angle Splice Bar, A. D. 1880.....	38
<b>L</b>	An Early Frog Pattern.....	39

L	Frogs, A. D. 1825.....	39
"	Staple iron used as makeshift for frog, A. D. 1831.....	39
"	Frog, A. D. 1835.....	40
"	Wood's Rail Frog, A. D. 1859.....	40
M	Switches in Colliery Railroads, A. D. 1825.....	41
N	Section of English Permanent Way.....	41
O	Steel Tie. London & Northwestern Ry., A. D. 1885..	42
"	Metal "Pot" Tie. India, A. D. 1889.....	42
"	Metal Track, Queensland, A. D. 1889.....	42
"	Metal Track, Midland Ry., A. D. 1889.....	42
"	Metal Track, London & Northwestern Ry., A. D. 1889.....	42
"	Metal Track, Elferfield Ry., Germany, A. D. 1889.....	43
"	Metal Track, Great Central Ry. of Belgium, A. D. 1889.....	43
P	Thick Rectangular Rail, A. D. 1838.....	43
"	Latrabe's Compound Rail, A. D. 1841.....	43
"	First Rail Rolled in America, A. D. 1844.....	44
"	92-lb. Rail, A. D. 1848.....	44
"	T Rail, A. D. 1850.....	44
"	Pear Headed Rail, A. D. 1853.....	44
"	Pear Headed Rail, A. D. 1855.....	45
"	Pear Headed Rail, A. D. 1855.....	45
"	Compound Rail, A. D. 1855.....	45
"	Compound Rail, A. D. 1855.....	45
"	Compound Rail, A. D. 1855.....	45
"	Compound Rail, A. D. 1855.....	45
"	Box Rail, A. D. 1855.....	46
"	Barlow's "Saddle Back" Rail, A. D. 1856.....	46
"	Triangular Stringer Capped with Iron, A. D. 1857.....	46
1.	} Aneroid Barometers for Measuring Altitude.....	49
2.		
3.		
4.	Engineer's Pocket Instruments.....	50
5.	} Prismatic Compass with Clynometer Attachment....	50, 51
6.		
7.	Lock's Hand Level.....	51
8.	Abney's Hand Level and Clynometer.....	52
9.	Field Glasses.....	52
10.	Pedometer.....	53
11a, 11b, 11c.	Odometer.....	54, 55
12.	Engineers' Transit with Level and Vertical Arc.....	59
13.	" " " " " " Gradienter Attachment.....	60
14.	Engineers' Chain.....	61
15.	Engineers' Improved Tape Chain.....	61
16.	Steel Tape.....	62
17.	Ranging Rods or Poles.....	62
18.	Chesterman's Metallic Tape.....	63

19.	Engineers' Scale.....	63
20.	Protractor.....	63
21.	Transparent Protractor with R. R. Curves .....	64
22.	Engineers' Y Level.....	64
23.	Philadelphia Leveling Rod.....	65
24.	Leveling Instrument and Gradienter for Topographical Work .....	66
25.	Clynometer or Slope Instrument.....	66
26.	Form of Cross Section Book.....	93
26a.	Form of Quantity Book.....	93
27.	Graders' Plow.....	96
28.	Drag Scraper.....	96
29.	"    "    with Runners.....	97
30.	"    "    "    Bottom Plate.....	97
31.	Back Scraper .....	97
32.	Two Wheeled Scraper.....	98
33.	"    "    "    .....	98
34.	"    "    "    .....	99
36.	Side View of Grader, ditcher and wagon loader.....	99
37.	Rear " " " " " " " ".....	100
39.	Four Wheeled Scraper.....	101
40.	"    "    "    .....	101
41.	Two Wheeled Dump Cart.....	102
42.	End, Dump Wagon.....	102
43.	Bottom, " ".....	103
44.	Iron End, Dump Cart.....	103
45.	Embankment; built full width at Grade and out to the Slope Stakes.....	105
46.	Right and Left Hand Dump Cars.....	107
48.	Rotary Dump Car.....	107
49.	View showing the method of dumping a rotary Dump Car. ....	108
51.	Plan and Side and End Elevations of a Steam Shovel.....	109
54.	Steam Shovel Car.....	110
55.	Hard Pan Plow.....	110
56.	Showing the Slopes for an Earth Cut.....	111
61.	Example of Cristina Method of Tunneling.....	114
62.	Example of American System.....	116
63.	Air Compressor. ....	117
65.	Rock Drills for Tunnel Work.....	117
68.	Ventilation of Mt. Ceniz Tunnel.....	120
69-70.	Retaining Walls.....	121
71.	Showing How a Cut can be the Full Width at Grade and the Material Taken Out at Slope Stakes, and yet all the Material will not be Excavated.....	122
72.	Steam Pile Driver.....	125
72a.	Form of Force Report.....	130
72b.	Form of Estimate Book.....	131

73.	View Overhaul.....	139
74.	“ “ .....	133
75.	Track Laying or Iron Car.....	135
76.	Holman's Track Laying Machine ... ..	138
77.	Harris' “ “ “ “ .....	140
81.	Earth Ballast—Galveston, Houston & Henderson Ry..	155
82.	Gravel “ “ “ “ .....	156
83.	Earth “ Illinois Central Railroad.....	156
84.	Crushed Stone, 2 inches Diameter, on Quarry Spauls 4 to 6 inches diameter—N. Y. C. & H. R. R. R.....	156
85.	Ballast, Crushed Stone 2½ inches Diameter, Penn. R. R. ....	157
86.	Rock Cut Stone Ballast 2½ inches Diameter, C. & P. D. Branch of Penn. R. R.....	157
87.	Gravel Ballast, A. T. & S. F. Railway.....	158
88.	“ “ C. & N. W. “ .....	158
89.	Burnt Clay Ballast, C. B. & Q. R. R .....	159
90.	Hoosac Tunnel, Finished Masonry in Soft Ground....	159
91.	Section of Tunnel at Port Perry, P. V. & C. Ry.....	160
92.	“ “ “ on the Insbruck Bozen Line, Aus- tria.....	161
93.	“ “ “ used by Government Railway of East India.....	163
94.	Section of Iron Tunnel under the St. Clair River used by the Grand Trunk Ry.....	163
95.	Morrell Metal Tie.....	194
96.	Metal Tie used on the N. Y. C. & H. R. R. R.....	195
97.	Wolhaupter Tie Plate with Rib to Resist the Lateral Motion of the Rail.....	197
98.	Goldie Claw Tie Plate with Lug to prevent the Lateral Movement of the Rail.....	197
99.	The C. A. C. Tie Plate.....	198
100.	The Servis Tie Plate.....	198
101.	Wolhaupter Arch Girder Tie Plate.....	198
102.	Track Spikes .....	215
103.	Angle Bars used on a 7½ pound Rail of American So- ciety of Civil Engineers' Standard.....	217
104.	Continuous Rail Joint.....	217
105.	Weber Rail Joint.....	218
106.	Truss “ “ .....	218
107.	Common Sense Rail Joint.....	218
108.	C. & N.-W. Ry Joint Base Plate used to give lateral Stiffness to the Rail.....	219
109.	Track Bolts .....	222
110.	Styles of “Verona” Nut Locks.....	222
111.	The Elastic Self-Locking Steel Nut “National”.....	223
112.	Joint Spring Nut Lock.....	223
113.	Shows how a Rail Brace will fail to support the Rail where it cuts into the Tie or the Rail Brace is not properly designed .....	224

114.	Forged Steel Rail Braces.....	224
115.	Stub Switch showing Head Blocks and Ground Throw for Moving Switch Rails.....	225
116.	Split Switch with Pony Switch Stand suitable for Yards.....	226
120.	Rigid Filled Frog.....	227
121.	“ Chuck Filled Frog.....	228
122.	“ Steel Clamp Frog.....	228
123.	Rigid Plate Frog.....	229
124.	Spring Rail Frog with Anchor Block.....	229
125.	Eureka Spring Rail Frog.....	230
126.	Movable Point Crossing.....	231
129.	Crossing Frogs, Angle 60° to 90°.....	232
130.	“ “ “ 45° to 60°.....	232
131.	“ “ with Extra Heavy Angle Irons.....	233
132.	“ “ for Steam and Street Railroads.....	234
133.	Jump Crossing Frogs for Steam and Street Railroads.	234
134.	Ramapo Safety Switch Stand as it appears when Half Thrown by Hand.....	235
135.	Ramapo Safety Switch Stand as it appears when Half Thrown by Wheels Passing Through the Switch	236
136.	Three Throw Switch Stand.....	237
137.	Automatic Parallel Ground Throw Switch Stand.....	238
138.	Low Pony Switch Stand.....	238
139.	“ “ “ “ with Safety Bottom Cap.....	238
140.	Ground Throw Switch Stand with Weighted Lever...	239
141.	Designs for Targets or Signals to be used on Switch Stands.....	239
142.	Target Tripod for Switch Stands.....	240
143.	Haley Semi Steel Bumping Post.....	241
145.	Ellis Bumping Post.....	242
146.	Through Plate Girder Bridge.....	243
147.	Perspective View of Through Plate Girder Bridge....	243
148.	Through Plate Truss.....	243
149.	Deck Pratt Truss.....	245
150.	Through Warren Truss.....	245
151.	Deck Warren Truss.....	245
152.	Whipple Truss or Double Intersection Pratt.....	247
153.	Modified Form of Warren Truss.....	247
154.	Single Lattice Girder—Modified Form of Warren Truss.....	247
155.	Double Lattice Girder—Modified Form of Warren Truss.....	249
156.	Deck Baltimore Truss—Modified Form of Pratt Truss.	249
157.	Through Baltimore Truss—Modified Form of Pratt Truss.....	249
158.	Long Span Baltimore Truss—Modified Form of War- ren Truss.....	251

159.	Long Span Baltimore Truss—also known as the Arched Truss, the Bow String Truss, and the Camelback Truss.....	251
160.	Another Modification of the Warren Truss for Long Spans.....	253
161.	Duluth—Superior Bridge.....	253
162.	Bob Tailed Draw Bridge, Modified Form of Warren Truss, Short Span Counter-Weighted.....	255
163.	Scherzer Rolling Lift Bridge.....	255
165.	Cantilever Bridge.....	255
166.	Pile Trestle Bridge.....	256
167.	Framed Trestle.....	256
168.	Stone Arched Culvert.....	257
169.	Cast Iron Pipe Culvert without Wing Walls.....	257
170.	“ “ “ “ with “ “ .....	258
171.	Open Culvert.....	258
172.	Pump for a Deep Well.....	260
173.	Common Form of Setting up a Pumping Plant for a Water Station.....	261
174.	Combined Gasoline Engine and Pump.....	262
175.	Design for Railroad Pump House and Machinery, using a Gasoline Engine.....	263
176.	Water Tank supported by Wooden Posts or Bents....	264
179.	Automatic Stand Pipe or Water Column.....	265
180.	Track Tank.....	266
181.	Plan of a Coaling Station where Buckets are used....	268
182.	Transverse Section of a Clinton Coaling Station.....	269
183.	Cast Iron Turntable made by William Sellers & Co....	271
184.	Wrought Iron Turntable made by the King Iron Bridge Co.....	272
185.	A Turntable Center used by Wm. Sellers & Co.....	272
186.	A Special Sixteen Roller Center for Turntables.....	273
187.	Small Frame Depot with Living Rooms on Second Floor .....	275
188.	Small Frame Depot .....	276
189.	Frame Depot for a Moderate Sized Town .....	277
190.	Outbuildings for Small Depots.....	278
191.	Plan of a Brick Passenger Depot.....	280
192.	“ “ Stock Yard.....	281
193.	“ “ Roundhouse and Shops.....	282
194.	“ “ Brick Storehouse for Supplies.....	283
195.	“ “ Storehouse for Sand.....	284
196.	Elevation of a Bent of an Air Hoist Ash Pit.....	285
198.	Train Signal operated by the Station Agent.....	288
199.	Automatic Electric Signal.....	288
200.	Lever operated by the Engine to open and close the Electric Circuit.....	289
201.	Block Signal, Operated by the Telegraph Operator... ..	289
202.	Switch Lamp, Upper Draught.....	290



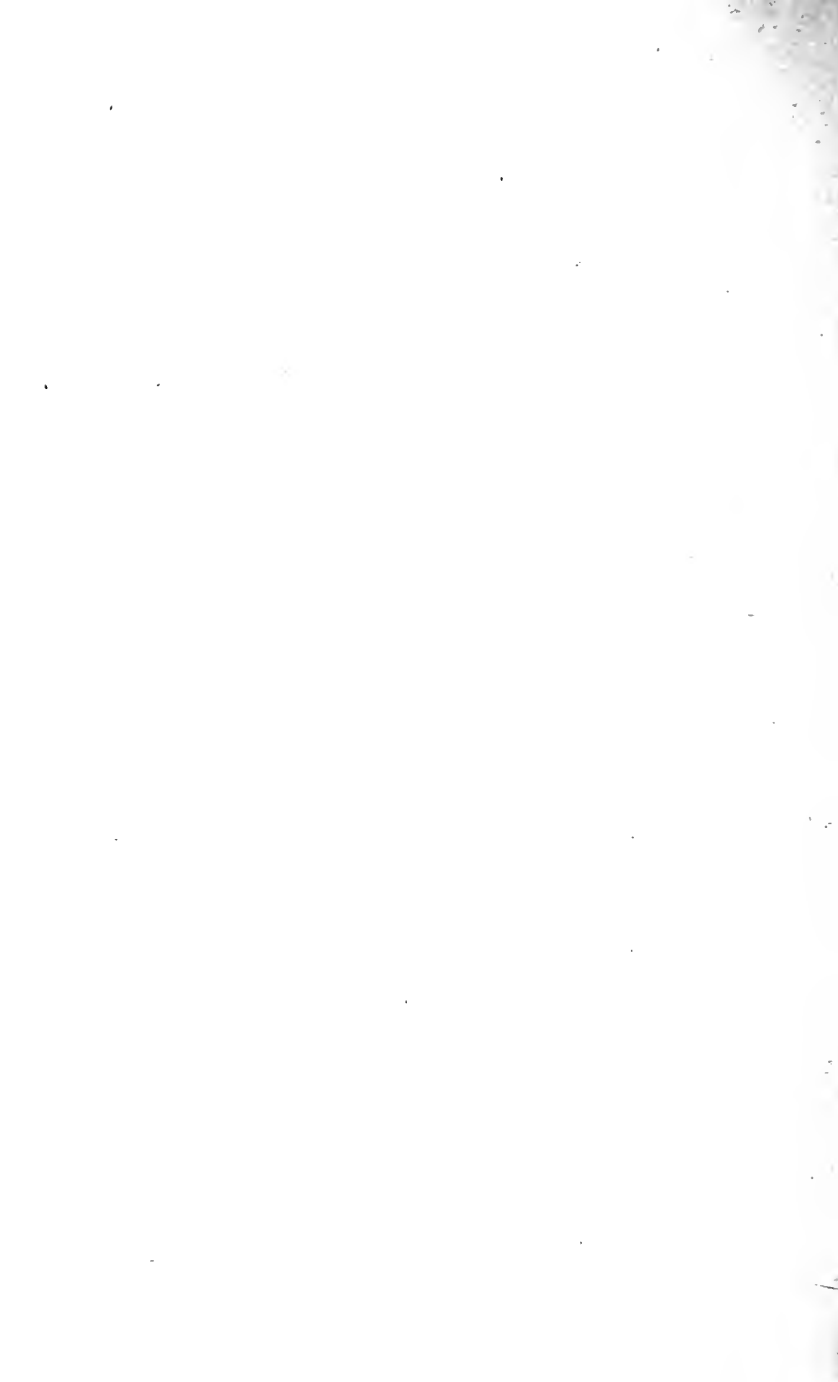
203.	Switch Lamp, Lower Draught.....	290
204.	Semaphore Signal Lamp, Upper Draught.....	291
205.	Barbed Wire Fence.....	292
206.	Page Woven Wire Fence.....	292
207.	Jones' Wire Fence.....	292
208.	Flexible Clamp, used in making Jones' Wire Fence...	293
209.	Cyclone Wire Fence and the Machine for Making it...	293
210.	Terra cotta Base Iron Posts for Fences and Signs.....	294
211.	Cattle Guard.....	295
212.	Climax Stock Guard.....	295
213.	Sheffield Cattle Guard.....	295
214.	Railroad Track Scales.....	296
216.	Plan of Tracks for a small Country Town.....	300
217.	Plan of Tracks for a Junction of Two railway Systems	300
218.	Plan of Tracks for a Junction of a Branch with the Main Line.....	301
219.	Plan of Tracks and Buildings for a Yard where Loco- motives are changed and where the grades alter, thus causing a change in the Tonnage of Trains each side of the Yard.....	301
220.	Combination Slip Switch Crossing, with Adjustable Tie Bars and Rigid Center Frogs, Operated from a Sin- gle Switch Stand with Rocker Shaft Connection....	302
221.	View of a Three Throw Split Switch.....	303
222.	Arrangement of the Switch Points for a Three Throw Split Switch.....	304
223.	Single Throw Split Switch No. 6; Rigid Frog 6 Feet Long.....	305
224.	Single Throw Split Switch No. 7; Rigid Frog 7 Feet Long.....	305
225.	Single Throw Split Switch No. 7; Rigid Frog 12 Feet Long.....	305
226.	Single Throw Split Switch No. 8; Rigid Frog 8 Feet Long.....	307
227.	Single Throw Split Switch No. 9; Rigid Frog 9 Feet Long.....	307
228.	Single Throw Split Switch No. 9; Rigid Frog 12 Feet Long.....	307
229.	Single Throw Split Switch No. 10; Rigid Frog 10 Feet Long.....	309
230.	Single Throw Split Switch No. 11; Rigid Frog 11 Feet Long.....	309
231.	Single Throw Split Switch No. 7; Spring Rail Frog 15 Feet Long.....	309
232.	Single Throw Split Switch No. 8½; Spring Rail Frog 15 Feet Long.....	310
233.	Single Throw Split Switch No. 9; Spring Rail Frog 15 Feet Long.....	310

234.	Single Throw Split Switch No. 10; Spring Rail Frog 15 Feet Long.....	310
235.	Three Throw Split Switch with No. 6 Rigid Frog 6 Feet Long.....	311
236.	Three Throw Split Switch with No. 7 Rigid Frog 7 Feet Long.....	311
237.	Three Throw Split Switch with No. 7 Rigid Frog 12 Feet Long.....	311
238.	Three Throw Split Switch with No. 8 Rigid Frog 8 Feet Long.....	312
239.	Three Throw Split Switch with No. 9 Rigid Frog 9 Feet Long.....	312
240.	Three Throw Split Switch with No. 9 Rigid Frog 12 Feet Long.....	312
241.	Three Throw Split Switch with No. 10 Rigid Frog 10 Feet Long.....	313
242.	Three Throw Split Switch with No. 11 Rigid Frog 11 Feet Long.....	313
243.	Plan of a Stub Switch.....	313
244.	Plan illustrating the use of a Cross-Over or Switch connecting the Two Main Line Tracks of a Double Track Road.....	314
245.	Plan of a Cross-Over.....	314
246.	Derailing Switch used to prevent a collision between a Train on the Main Line and Cars running off a Side Track onto the Main Line.....	315
247.	Sand Track; used to check the movement of Cars on a grade or when propelled by a high wind from running off a Siding to the Main Line Track.....	315
248.	Derail Switch Point used in connection with Inter- locking System of Guard Crossings.....	315
249.	Standard Guard Rail with Division Blocks and Bolts and Rail Braces.....	317
250.	Guard Rail with the Hook Guard Rail Clamp.....	318
251.	Guard Rail with the Sampson Adjustable Guard Rail Clamp.....	318
252.	Crossing Frogs used where two tracks cross at an acute angle.....	319
253.	Combination Slip Switch and Movable Center Points Switches and Movable Center Points operated by one Switch Stand.....	319
258.	Sectional Perspective View of Gates Stone Crusher....	334
259.	Gates Revolving Screen for screening Crushed Stone.	335
260.	Arrangement of Stone Crusher, Elevator, Screen and Storage Bins for a Railroad Ballast Plant.....	336
262.	Jenne Track Jack for heavy Ballasting, Surfacing and General Track Repairs.....	337
263.	Trip Jack.....	337
264.	Adze.....	340

265.	Chopping Axe.....	349
266.	Auger for boring holes in the ground for Fence Posts.....	340
267.	Broom for removing snow from Switches, etc.....	340
268.	Brush Hook for cutting down small Saplings.....	341
269.	Ballast or Napping Hammer.....	341
270.	Ballast Fork.....	341
271.	Brace and Bit.....	341
272.	Hand Car for Section Gang.....	342
273.	Push Car, with Removable Side and End Boards.....	343
274.	Track Chisel, for cutting Rails, etc.....	344
275.	Claw Bars.....	344
276.	Track Drill.....	344
277.	Self Feeding Rail Drill.....	345
278.	Hand File, for smoothing the ends of Rails.....	345
279.	Grindstone, Mounted and Treadle.....	346
280.	Grub Hoe, Mattock, Pick Mattock.....	346
281.	Hatchets and Hand Axe.....	346
282.	Hand Hammer.....	347
283.	Lantern.....	347
284.	Lining Bars, for Throwing Track.....	347
285.	Oil Can for Car Oil.....	347
286.	Spring Oiler for oiling Hand and Push Cars.....	347
287.	Track or Rail Punch.....	348
288.	Railroad Padlock used with a chain to Lock Hand or Push Cars by passing through the two Wheels on the same side of the Car and fastening the Chain by passing the Padlock hasp through two Links of the Chain.....	348
289.	Pick for loosening Earth, Clay or Hard Gravel.....	348
290.	Tamping Pick.....	348
291.	Rail Tongs.....	349
292.	Rail Fork.....	349
293.	Hand Saw.....	349
294.	Cross Cut Saw.....	349
295.	Scythes ( <i>a</i> ) Light; ( <i>b</i> ) Heavy.....	349
296.	Scythe Snaths.....	349
297.	Spirit Level.....	350
298.	Spike Pullers.....	350
299.	Spike Maul.....	351
300.	Stone Sledge Hammers.....	351
301.	Railroad Shovel for Tamping, etc.....	351
302.	Scoop Shovel.....	351
303.	Long Handled Shovel.....	351
304.	Track Lever or Lifting Bar.....	351
305.	Huntington's Track Gauge.....	351
306.	McHenry's Track Gauge.....	352
307.	( <i>a</i> ) Common Track Level; ( <i>b</i> ) Duplex Track Level.....	352
	( <i>c</i> ) McHenry's Involute Track Level.....	352

308.	Tamping Bar.....	353
309.	Torpedo.....	353
310.	Railroad Tool Chest.....	353
311.	Track Wrench.....	354
312.	Monkey Wrench.....	354
313.	Railroad Barrows.....	354
315.	Four Wheel Eclipse Light Weight Car.....	355
316.	Velocipede Car.....	356
318.	The Ware Tie Plate Surfacers and Gauge.....	365
319.	American Railway Ditching Machine.....	370
320.	Clarke Jeffrey Split Switch.....	371
321.	Transit Split Switch.....	373
322.	Channel Split Switch.....	374
323.	Lorenz Safety Split Switch.....	375
324.	Views of Different Connecting Rods.....	375
325.	Views of Different Kinds of Bridle Rods.....	376
326.	Ramapo Yoked Frog.....	376
327.	Strom Clamp or Yoked Frog.....	377
328.	Frog with Wood Foot Guard.....	378
329.	Frog with Iron Foot Guards.....	378
330.	Right Hand Turn Out.....	379
331.	Left Hand Turn Out.....	379
332.	Right Hand Frog.....	380
333.	To take the Angle of a Frog.....	380
334.	Head Blocks or Head Chairs for Stub Switches.....	381
335.	Bryant Portable Rail Saw.....	381
336.	Rail Bender and Straightener.....	382
337.	“ “ “ with Horse Power At- tachment.....	383
338.	Plan and Elevation of a joint to take up expansion and contraction of Rails.....	387
339.	Expansion Joint for a Bridge or difficult pieces of Track.....	387
342.	Plan and Section showing Piping necessary to fit a flat Car to sprinkle Track with Oil.....	388
344.	Rotary Snow Plow.....	411
345.	Inspection Hand Car.....	432
348.	Double or Four Wheeled Motor Car for Inspection Purposes.....	433
349.	35 Ton Steam Wrecking Crane.....	443
350.	15 Ton Double Mast Hand Wrecking Crane.....	443
351.	Automatic Lowering Jack.....	444
353.	Dudgeon's Hydraulic Jack.....	445
354.	Tilden Wrecking Frog.....	446
355.	Palmerton Wrecking Frog.....	446
356.	Elliot Car Replacers or Wrecking Frog.....	447
357.	Device for Splicing a Broken Chain.....	450
358.	Ship Auger Bits, used by Bridge Carpenters.....	457

359.	Boring Machine used where Heavy Timbers are Framed.....	457
360.	Crow Bar.....	458
361.	(a) Pinch Bar Without a Heel; (b) Pinch Bar with a Heel.....	458
362.	Shackel Bar used for Drawing Drift Bolts.....	458
363.	(a) Single Block; (b) Double Block; (c) Triple Block..	458
364.	Bridge Gang Hand Car.....	459
365.	Heavy Push Car for use of Bridge Crew.....	459
366.	Cant Hook.....	460
367.	Pevey.....	460
368.	Timber Grapples.....	460
369.	Hoisting Crabs or Winches. (a) Single Purchase; (b) Double Purchase.....	460
370.	Timber Trucks or Dollies.....	461
371.	Files. (a) Taper File; (b) Double End File.....	461
372.	House Raising Jack Screws.....	461
373.	Bilge Pumps. (a) Bottom Suction; (b) Side Suction..	462
377.	Steel Socket Bridge Wrench.....	462
378.	Wheel Wrench.....	463
379.	Rail Section.....	App. J 609
380.	Pennsylvania R. R. Standard Rail Section and Standard Joint.....	App. J 610
381.	New York Central & Hudson River R. R. Standard Rail Section.....	App. J 611
382.	Philadelphia & Reading R. R. Rail Section.....	App. J 612
383.	Argentine Gt. Western Ry. (South America) Rail Section.....	App. J 613
384.	Mexican Ry. Co., Ltd., Standard Rail Section..	App. J 614
385.	East India Ry. Co. India Standard Rail Section and Standard Joint.....	App. J 615



## INTRODUCTION.

### VALUE OF WIDE AND DIVERSIFIED EXPERIENCE IN CONSTRUCTING AND MAINTAINING RAILROADS.

It is not probable that questions relating to the Construction and Maintenance of railways will ever cease to interest or excite controversy. The subject is one of the greatest connected with the operation of railroads and is rendered more complex because of the dissimilarity of conditions under which they are built and worked. The more light, therefore, that can be thrown on the subject the more advantageous to those who own or operate these properties.

Because of this I do not feel that excuse is necessary for offering this book, apart, in addition to what I have already written on the subject in Volume III. of the "SCIENCE OF RAILWAYS," and elsewhere (with less particularity) throughout that work. To students this added matter will be of interest, as it will be to practical men engaged in operating railroads who seek increased knowledge and usefulness from the observation and experience of others. By this I do not mean to say, that what is written here represents my particular experience, because I have never been actively engaged in this department of the service, but it represents the experience and wisdom

of others who have been thus occupied, and have given the subject the benefit of the knowledge thus acquired. From all this the reader must not infer that the building and maintaining of railroads is treated superficially or only partially in this volume. On the contrary I have taken up the subject in order and fully as if nothing had ever been said in regard to it before. Many books I know have been written on the subject of Railway Construction by different men; many more will be written hereafter, and this without doing more than scratching the surface. The subject is too great, the problems too multiplex to be exhausted. Each writer however, will throw new and needed light on the subject and what each says will therefore be useful to owner and operator alike.

MARSHALL M. KIRKMAN.



## CHAPTER I.

### RAILWAY EVOLUTION. THE DEVELOPMENT OF THE RAILWAY ILLUSTRATED.

In depicting railways, an account of the conditions which lead up to them is interesting, not only in itself, but as affording a better understanding of the subject. The origin and growth of property go hand in hand with the birth and development of man. When we describe the condition of one we describe the condition of the other. The two are coexistent. Thus the business principles which we observe to-day were in the main established by the ancients, who were commercially inclined as we are, many hundreds of years ago. In the same way they originated in the main our utensils and methods. We have simply developed their primary thoughts.

In legal phraseology there are three kinds of property—real, personal and mixed. Railway property partakes of all these characteristics. The privileges it enjoys are such as are accorded it under the limited knowledge we have of its uses and needs. Its rights are exceptional because of its special duties and responsibilities. Its limitations are such as attach to common carriers. It represents a new departure in industrial effort; a progressive step greatly stimulative of

man's efforts. In other respects it presents no distinguishing features. It furnishes, however, another instance, if one were wanting, of the sympathetic tie that connects man's intellectual growth with that which he so greatly prizes, namely, material wealth.

The primary purpose of the permanent way of a railroad was to furnish a surface that should be at once hard, smooth and unchanging for wheels to run upon.

Railways had their origin in Great Britain in the tramways laid in the mining districts for conveying coal to the sea from the mines near Newcastle-on-Tyne during the seventeenth century. The rails were formed of scantlings of oak, straight and parallel to each other, connected by cross timbers also of oak and pinned together with oak treenails; on these, carts made with four rollers fitting the rails traveled, the carriage being so easy that one horse is said to have been able to draw four or five chaldrons of coal. The benefits derived from this manner of transporting coal suggested to the thinking man the employment of similar means for facilitating the conveyance of passengers and general merchandise.

A road graveled between the rails was at first provided as a foothold for the horses which drew the cars. The wheels were kept on the rails by guides, attached either to the wheels or to the rails. As stated, the earliest railroads were constructed wholly of wood.

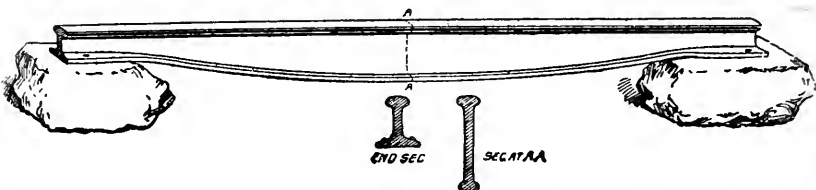
In comparing the first railroads with the con-

mon turnpike road, an early writer says: "A saving is made of seven-eighths of the power, one horse on a railroad producing as much effect as eight horses on a turnpike road. In the effect produced by a given power the railroad is about a mean between the turnpike road and a canal, when the rate is about three miles an hour; but when greater speed is desirable the railroad may equal the canal in effect and even surpass it."

Rails were first cast; afterward, early in the nineteenth century, they were rolled. In 1767 the first iron rail was cast at Colebrookdale, England. This was a great stride forward. It was three feet long, four inches wide at the top, and three inches high. This progressive step prepared the way for the locomotive when it should be evolved. However, the rail thus cast proved to be too light, but the difficulty was overcome by making the carts or wagons smaller and coupling a number of them together instead of having one big vehicle. Thus the train came into being. Shortly afterward it was found possible to cast a rail six feet long; in 1815 it had grown to fifteen feet; still later to thirty feet.

In 1789 William Jessop first introduced a rail with a smooth, level top, substituting a wheel with a flange for the old-fashioned form. This simple, yet ingenious, device at once revolutionized previous practices. Before, a flange or something of the kind had formed a part of the rail in order to keep the wheel on the track. This not only added to the cost of the rail, but rendered it less strong and more easily worn out.

The flanged wheel cleared the sky. In 1797 Jessop also contributed to the development of railroads by inventing the iron chair, which he inserted between the rail and the tie. Rails at this time were very light, and the load and speed were made to correspond.



Jessop's Cast Iron Fish-bellied Rail. A. D. 1789.—[NOTE: The attention of the reader is particularly called to the fact that in the accompanying illustrations not only the form of the rail is shown, but also the fastenings, splice bars, chairs, ties and other details of interest connected with the track.]

FIG. A.



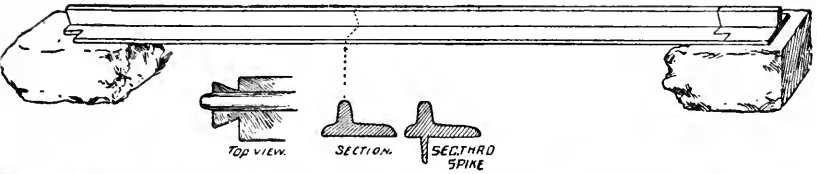
The First Rail Chair. Newcastle-on-Tyne, A. D. 1797.

FIG. B.

Figures A and B illustrate the Jessop rail and iron chair. Some of the various styles of rails used for tram roads are illustrated by Fig. C.

With the introduction of the locomotive to take the place of the horse commenced the development of the present railroad. This was about the year 1830.

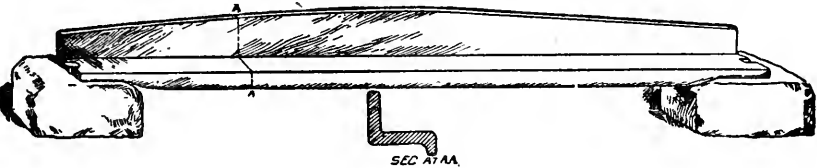
George Stephenson, while he did not invent the first successful locomotive, is, nevertheless,



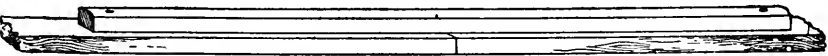
LeCann's Tram Rail, requiring neither bolts nor spikes. Wales, A. D. 1801.



Wyatt's Hexagonal Rail, North Wales, A. D. 1802.



Tram Rail, Surrey Railway, A. D. 1803.



Carlisle's Wrought (rolled) Iron Rail, A. D. 1811.



Losh & Stephenson's Edge Rail, Stockton & Darlington Railroad, A. D. 1816.

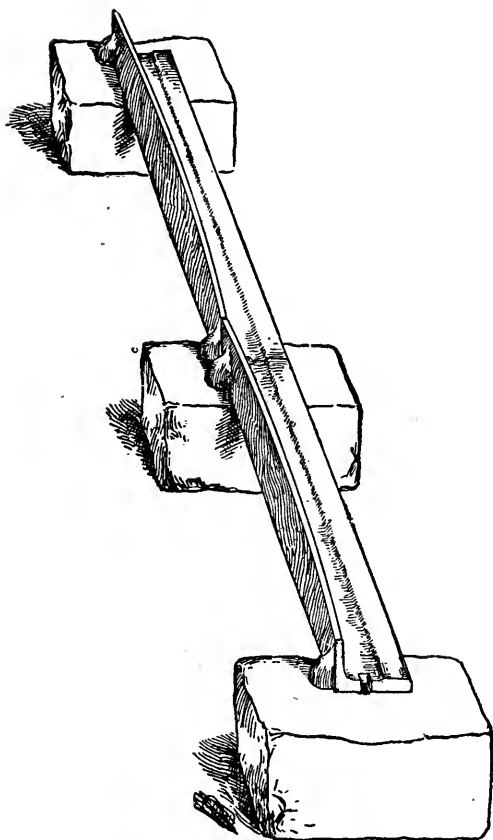
FIG. C.

quite generally accredited with being the father of this machine and, therefore, of the railway system. He did much to perfect the locomotive. As I have had occasion to remark elsewhere, his

prominence in connection with the opening of the Liverpool & Manchester railway, where for the first time the attention of the world was generally drawn to the railroad question, concentrated attention upon him, so that it was believed, though erroneously, that he invented the locomotive and operated the first successful one. The idea of the locomotive originated with Trevithick, in 1803, but it was not a financial success. Afterward, John Blenkinsop accomplished what Trevithick had been unable to do. Blenkinsop had constructed two locomotives which answered every requirement, so far as the action of steam and economy of operation were concerned, before Stephenson manufactured his first machine.

The locomotive followed naturally the invention of a suitable roadbed, as the wagon and carriage followed a suitable highway. The railway track, as referred to elsewhere, was first utilized in connection with the handling of coal. The bulk of the latter, and the necessity for cheapening its price, made some simple appliance for transporting it a matter of the greatest possible importance to the people of Great Britain. Horses were at first used, then steam. The cost of transportation over these tramways, or primitive railroads, is said to have been about ten per cent. of that over the common turnpike.

The character of the track on which Trevithick's first locomotive ran is illustrated by Fig. D. The character of the rails used for the first track on which locomotives were operated is shown by Fig. E. These rails were of light weight; in 1825



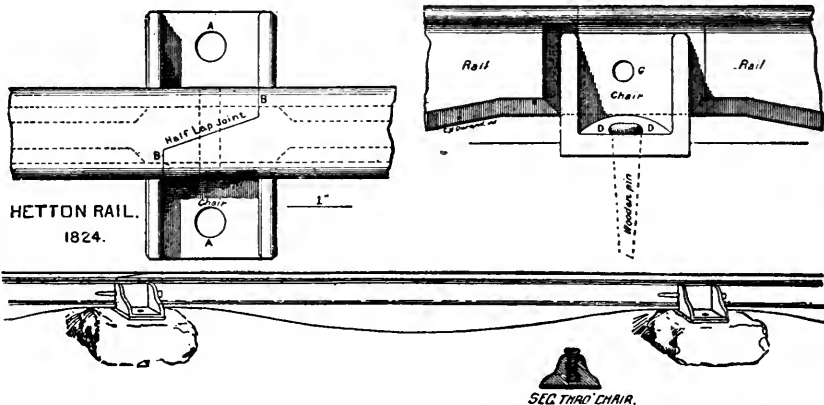
Fram Rail with stone supports, upon which Trevithick's first locomotive ran.

FIG. D.

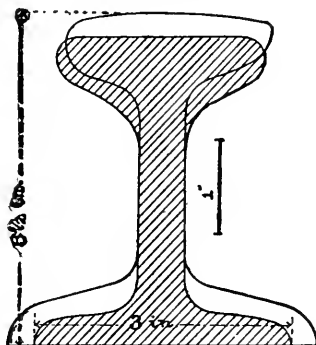
the average weight of rails per yard was about 28 pounds; in 1830 (about the time the locomotive was introduced) the weight was increased to 35 pounds per yard. As the weight of loco-



Birkenshaw's Wrought-Iron Rail, A. D. 1830.



George Stephenson's Fish-Belly Rail, Manchester &amp; Liverpool Railway, A. D. 1829.



Rail designed by Robert L. Stevens, A. D. 1830; adopted by American railroads. Shaded section shows rail as originally designed, 1830. Section not shaded shows rail as rolled, 1831. This rail was fastened to stone blocks with hook headed spikes; at the joints were iron tongues fastened to the stem of the rail, put on hot.

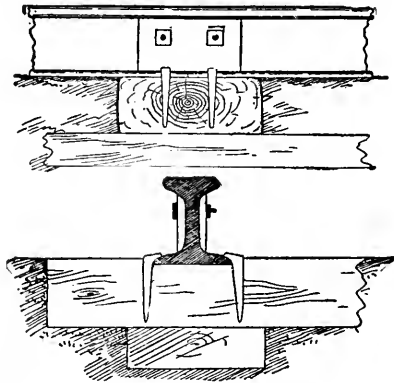
FIG. E.



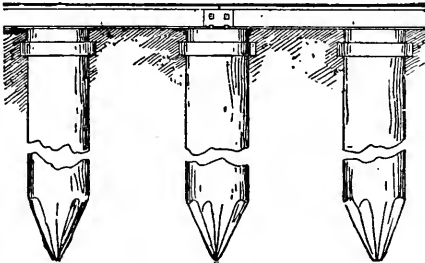
tives and speed of trains have increased, the weight of the rail has grown heavier. Ninety and even 100 pounds per yard is not uncommon in use now.

The method of supporting the rails on the tram road and the first railroad was generally stone blocks placed at their ends, as illustrated by Figs. A, B, C, D and E.

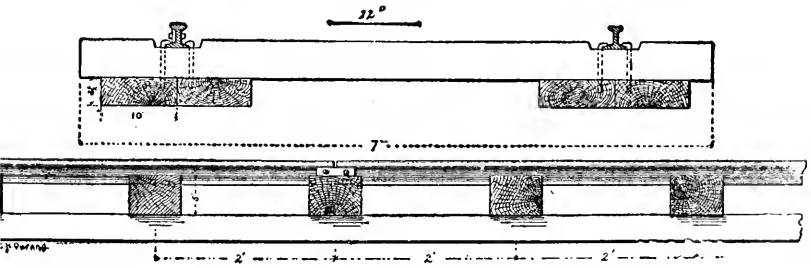
With the introduction of rolled wrought iron rails, in 1805, their length began to increase, and this led to the introduction of intermediate supports between the joints. The **T** rail, Fig. E, led to the use of cross ties, the early method of use is illustrated by Fig. F.



Standard Track of Camden & Amboy Railroad, A. D. 1837.



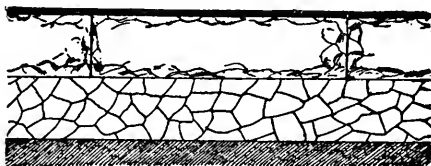
Track of Camden & Amboy Railroad. Rails laid on piling through marshes, A. D. 1837.



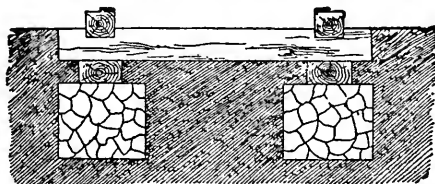
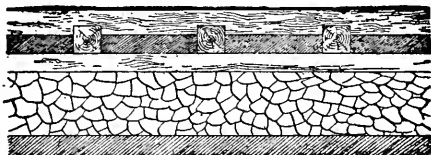
Stevens' Rail, Vicksburg & Jackson Railroad, A. D. 1841

FIG. F,

To cheapen construction, the strap rail was largely used on the early American railroads; it is illustrated by Fig. G.



Stone Stringer and Strap Rail, Baltimore & Ohio Railroad, A. D. 1833. This was a favorite American device.



Wooden Stringer and Strap Rail, Albany & Schenectady Railroad, A. D. 1837. A strap rail was used on many of the first railroads in America, particularly in the Central and Western States.

FIG. G.

The method of constructing track with stone blocks and stone stringers gave a rigid road bed and rough riding track which were very destructive to locomotives and cars. This led to the introduction of the T rail and the use of cross ties.\*

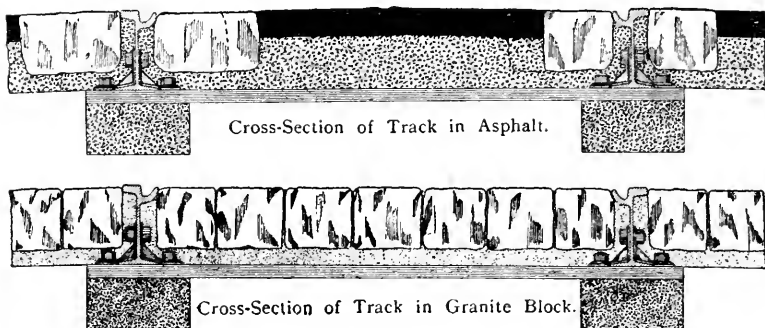


FIG. H.

#### STREET RAILWAY CONSTRUCTION.

The rails are laid on continuous beams of concrete made of cement, sand and broken stone. The track is held to gauge by steel ties spaced ten feet centers. The space between the rail and beam is solidly filled by ramming in a mixture of cement and sand. The space under the ties is filled with liquid grout.

This construction is somewhat of a departure from the usual practice in this country, and is found to be more durable and no more expensive than the usual wood tie construction.

The above used at Buffalo, N. Y., St. Paul, Minn., and Kansas City, Mo.

During the winter months the track of the steam railways is practically such as the above.

The failure of the early methods was due to poor track and poor rolling stock.

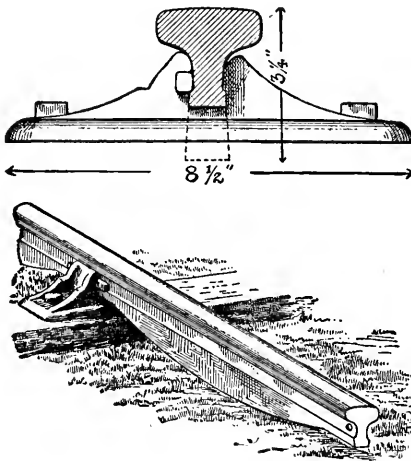
In connection with the construction of railway track, it is interesting to notice the methods

\*While the cross tie is generally used by railroads throughout the world, the Great Western Railway of England uses a longitudinal support for its rails. Such support was quite common in the early days of railroading, but has, as a rule, been abandoned.

adopted by street railways to secure a permanent way where expensive pavements are laid, as illustrated by Fig. H. The weight of the first locomotive on the London and Manchester R. R. was  $7\frac{1}{2}$  tons including the tender; in 1831 the weight of a goods train with engine was about 50 tons. The weight of a modern electric car and motor is from 33 to 58 tons; the additional weight of passengers when fully loaded is from 4 to 5 tons, making a total of 37 to 63 tons. We find that this rigid street car track with modern rails and rolling stock is giving a smooth riding track without injuring the rolling stock.

No rigid connection between the ends of the rails laid in a track was made until 1847. Prior to that time they were placed one against the other in a chair, especially designed for the purpose, called a joint chair. The ends of the rails were not held securely in this chair, but could slide past each other and were quickly ruined by the wheels jolting over the uneven surface. In 1847 fish plates for uniting the ends of the rails were introduced, and the device has since been generally adopted. By this means the rails are firmly held together, affording an even surface at the top. The fish plate, a strip of iron about an inch thick, was placed on either side of, but not touching, the web of the rail, the edges of the plate being made to perfectly fit the sloping sides of the head and foot of the rail. The fish plate is held in place by bolts, called fish bolts, which pass through the rail and the two fish

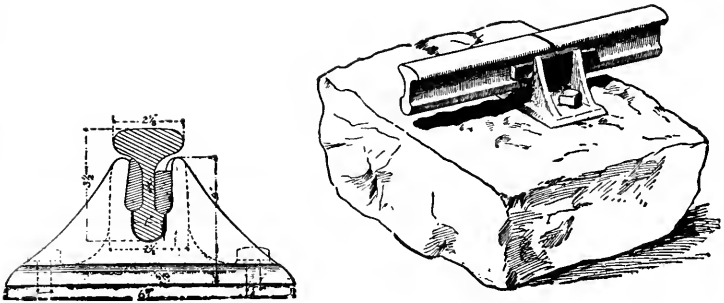
plates (one on either side of the rails), drawing the plates together and tightening their edges against the rail. The rail was further strengthened at the fish joint by the cross ties being laid nearer each other there than in other portions of the track. The efficiency of the fish joint depends upon the plates being kept securely in their place. They require to be frequently looked after and the bolts screwed up, as they are liable to work loose with the jar of the trains passing over them. Various styles of fish plates



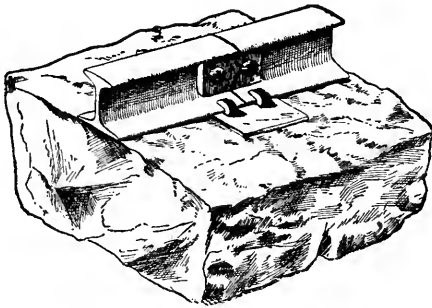
English Fish-belly Rail, New Jersey Railroad, A. D. 1832.

FIG. I.

and fastenings have been introduced, the object being to find some way for holding the bolt and



Joint Chair and Wedge, Old Portage Railroad, A. D. 1832.

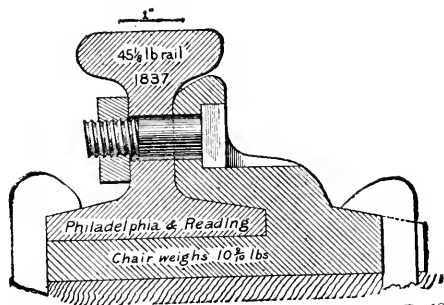


Stone Block, Rail and Joint Tongue laid on Camden & Amboy Railroad, A. D. 1831.

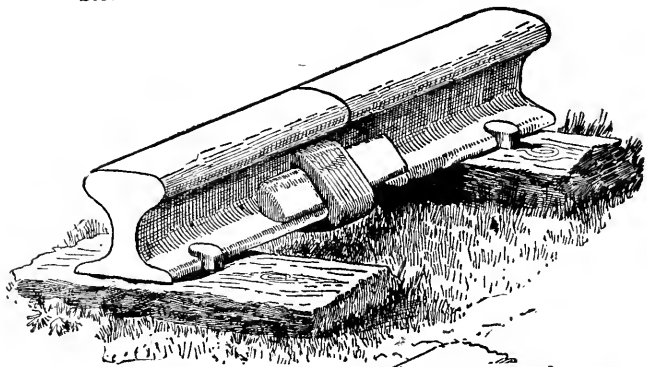
FIG. I.

nut firm after being screwed into place, so they cannot work loose.

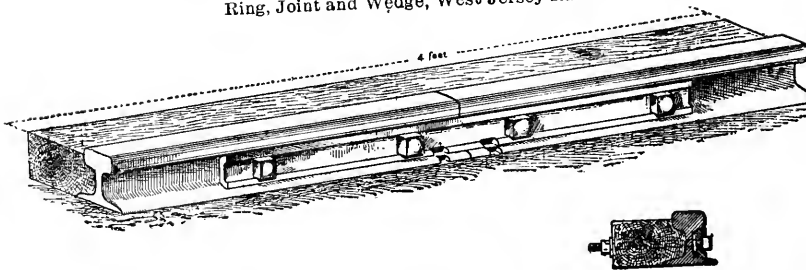
The early method of fastening rail joints is shown by Fig. I. The development of the rail joint fastening up to 1860 is illustrated by Fig. J.



Stevens' Rail Supported by Cast-Iron Chair, A. D. 1837.



Ring, Joint and Wedge, West Jersey Railroad.

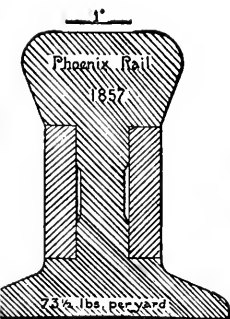


Wooden Joint Block, New Jersey Railroad, A. D. 1860.

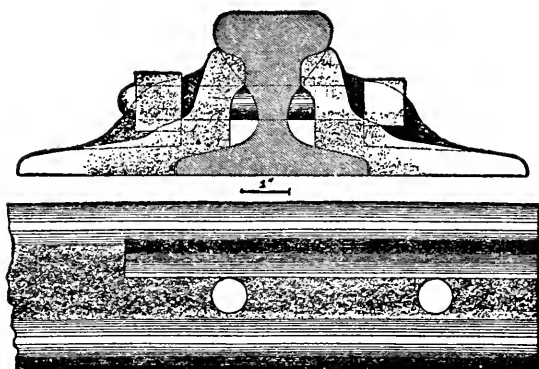
FIG. J.



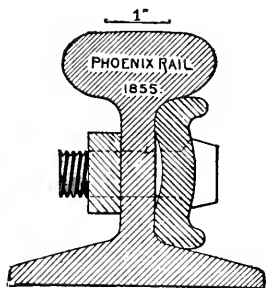




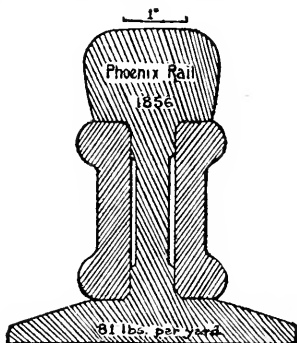
Double Splice Bar.



Erie Rail with ends stamped for Adams' Cast-Iron Bracket Splice, A. D. 1857.



Single Splice Bar.

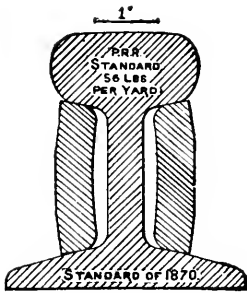


Double Splice Bar.

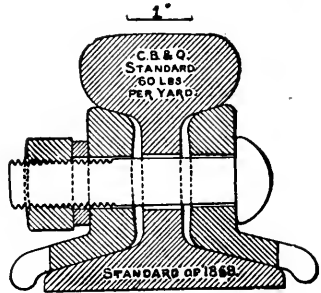
FIG. J.

The fish plate or splice bar, and the angle plate or angle splice bar, had come into general use by 1870. Fig. K. illustrates its development from 1860 to 1880.\*

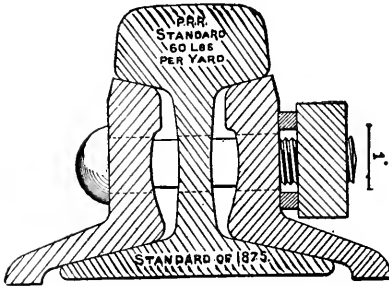
\*In another chapter the reader will find illustrations of the rail joints now in use. The best method of fastening the ends of rails is still much discussed.



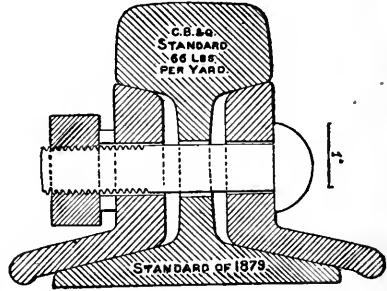
Plain Splice Bar.



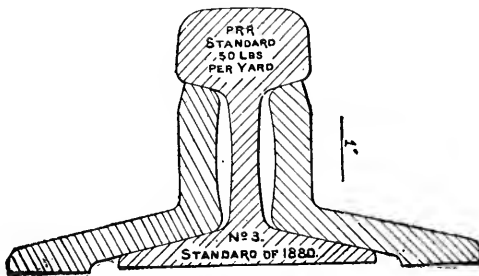
A. D. 1868.



Angle Splice Bar,



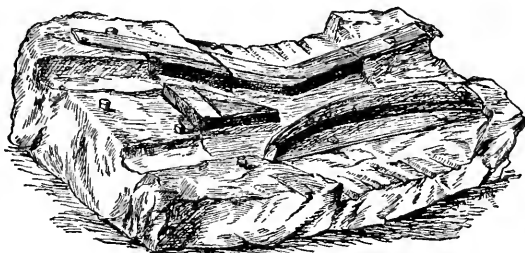
Angle Splice Bar.



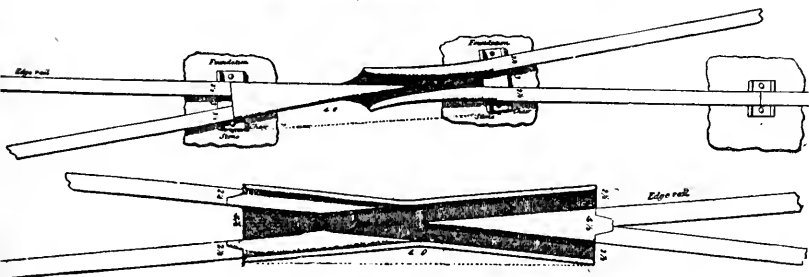
Angle Splice Bar.

FIG. K.

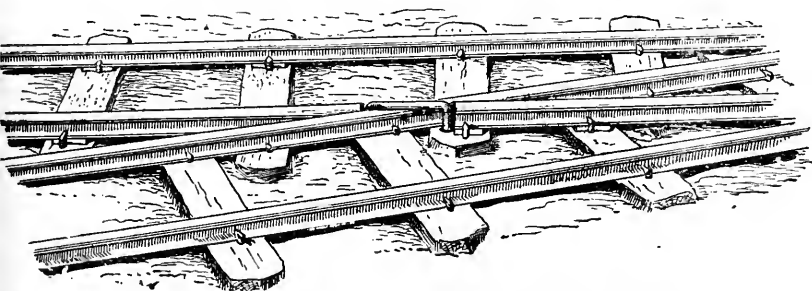
Early frogs and switches are illustrated by Figs. L and M.



An early Frog Pattern.

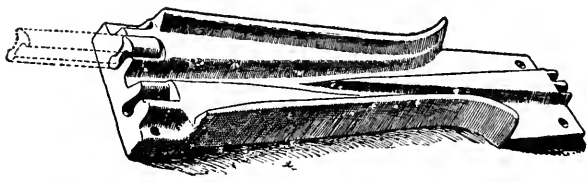


Frogs, Colliery Railroads of England, A. D. 1825.

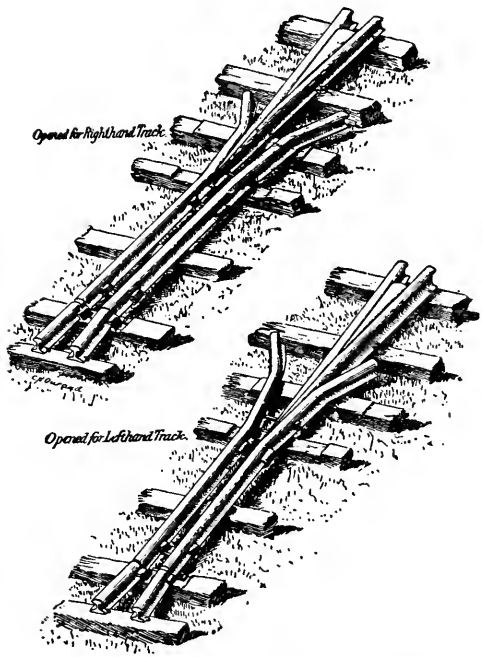


Staple Iron used as a makeshift for a Frog, Camden & Amboy Railroad, A. D. 1831.

FIG. I.

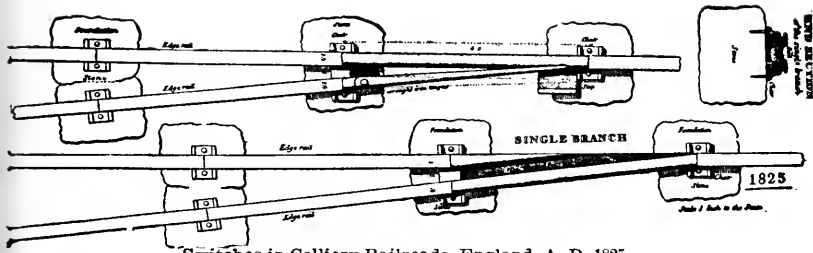


- Frog, Old Portage Railroad, A. D. 1835.



Wood's Rail Frog, New Jersey, A. D. 1859.

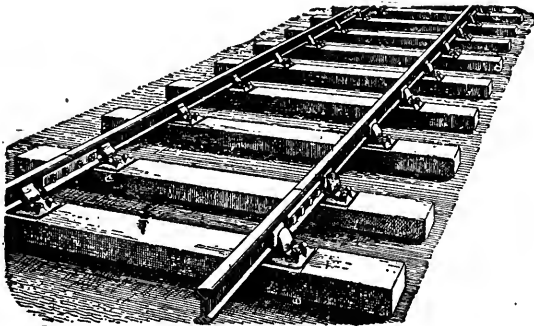
FIG. L.



Switches in Colliery Railroads, England, A. D. 1825.

FIG. M.

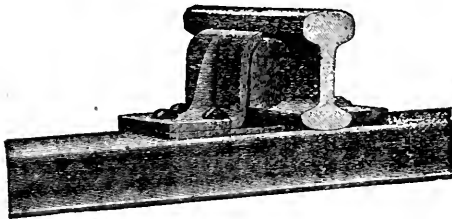
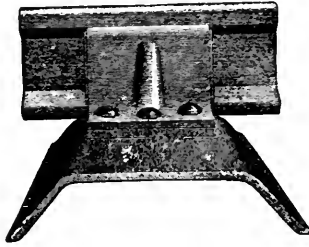
The Method of using bull head rails is shown by Fig. N.



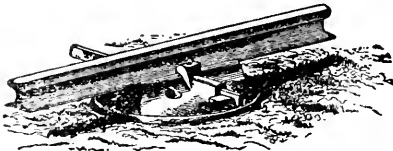
Section of English Permanent Way

FIG. N.

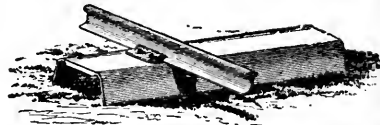
As timber became scarce in Europe and other countries, metal ties were adopted. Fig. O illustrates some of the styles used and the methods adopted for fastening the rails.



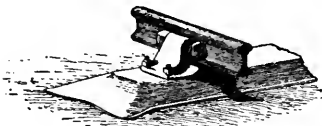
Steel Tie, London & Northwestern Railway, A. D. 1885.



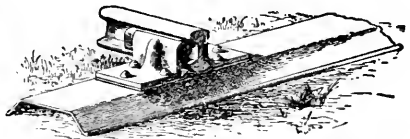
Metal "Pot" Tie, Midland Railway of India, A. D. 1889.



Metal Track, Queensland, A. D. 1889.



Metal track, Midland Railway, A. D. 1889.



Metal track, London & Northwestern, A. D. 1889.

FIG. O.

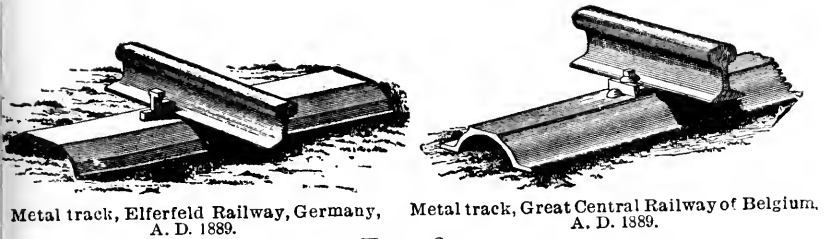
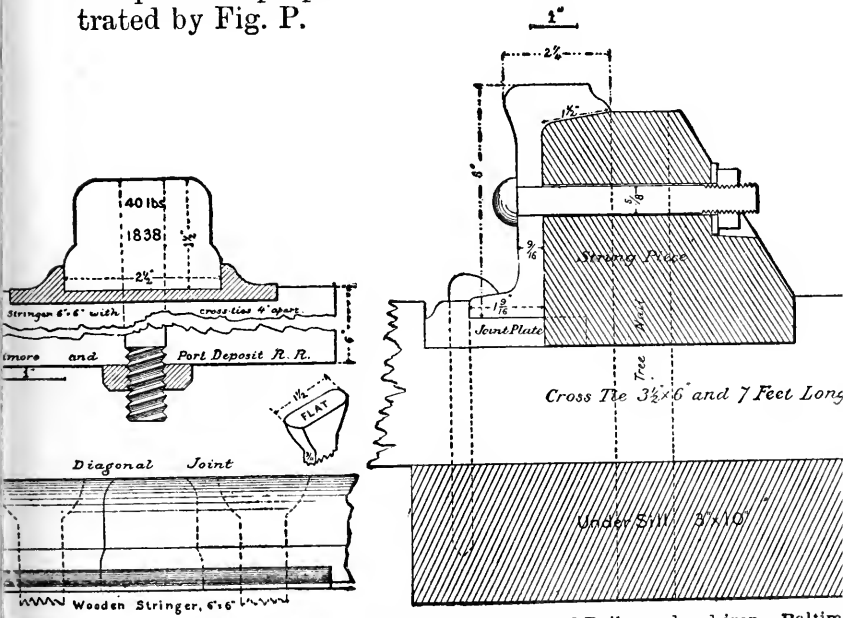


FIG. O.

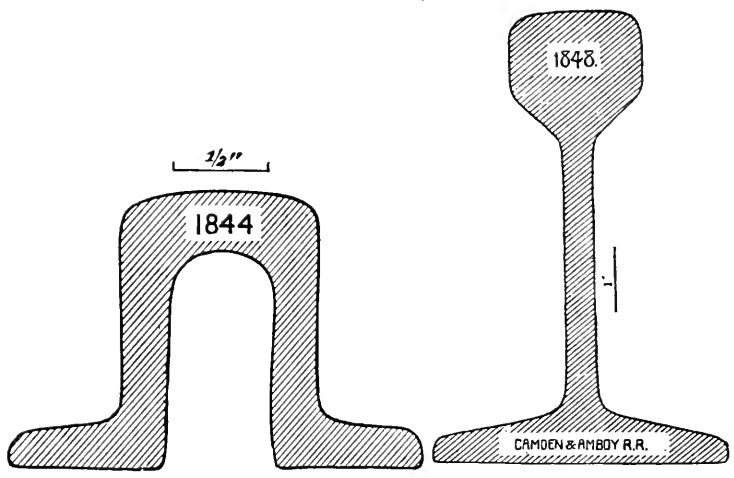
During the development of the T rail, from 1830 to 1860, there were a number of devices and patterns proposed, some of which are illustrated by Fig. P.



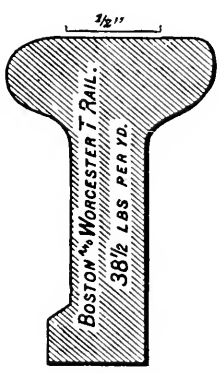
Latrobe's Compound Rail, wood and iron. Baltimore & Ohio Railroad, A. D. 1841.

FIG. P.

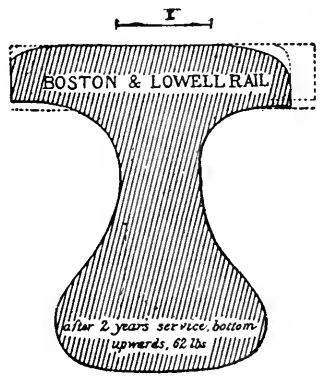
Thick Rectangular Rail, A. D. 1838.



First Rail rolled in America, Baltimore & Ohio Railroad. 92-pound Rail, 7 inches high.



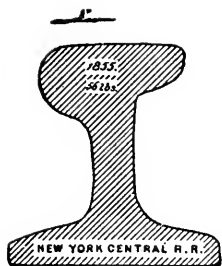
T Rail, A. D. 1850.



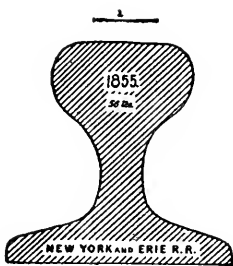
Pear-headed Rail, A. D. 1853.

FIG. P.





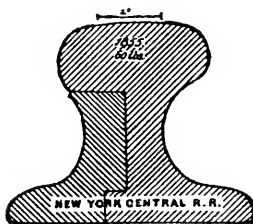
Pear-headed Rail.



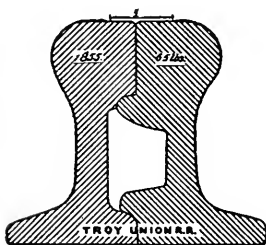
Pear-headed Rail.



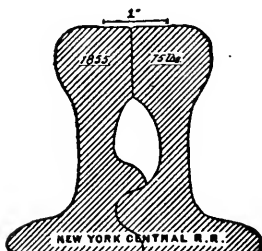
Compound Rail.



Compound Rail.

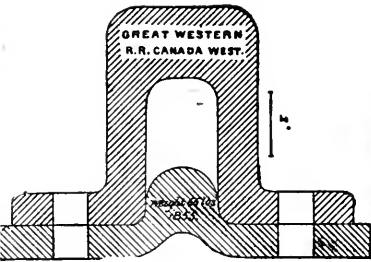


Compound Rail.

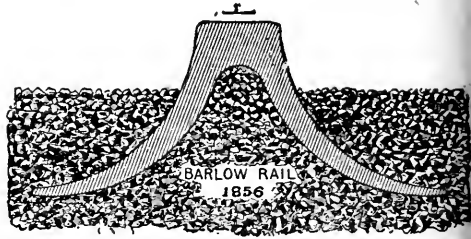


Compound Rail.

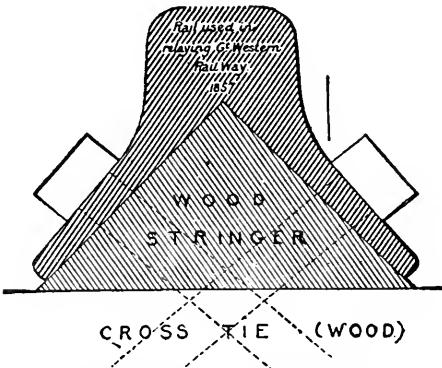
FIG. P.



Box Rail.



Barlow's "Saddle Back" Rail, laid without supports.



Triangular Stringer capped with iron.

FIG. P.

## CHAPTER II.

### THE RECONNOISSANCE.—THE FIRST STEP IN RAILWAY CONSTRUCTION.

In locating a new railway line or extending an existing one, many factors must be taken account of, such as the cost of the proposed line considered in relation to its probable revenue; the cost of operation and maintenance; and the financial resources of the owners. From an operating point of view it is desirable that the route shall be as direct as possible, a straight line drawn between the termini would be the ideal, but other considerations intervene, such as the most effective and profitable service that can be rendered the population within the territory, the cost of construction first and the expense of maintenance and operation afterward, the effect of the competition of existing or possible lines or other forms of transportation, etc.\*

When it is desired to construct a new line between given points or extend an old one to a certain point, the first things to know before it can

---

\*It is recorded that when a great railway line was projected in the Russian Empire, the route was a matter of much controversy. The emperor, however, solved the problem by taking a ruler and ruling a straight line between the termini. In countries like ours, however, commercial considerations are paramount, and no such heroic disposition of the matter is possible.

be determined upon are, what will be the best route to take, and the probable cost and character of the road required. To ascertain these it is necessary that the country to be traversed should be examined by engineers. This examination is called a reconnoissance, and is made under the direction of a civil engineer. \* It is of a preliminary character only and is not intended to give an accurate survey of the country. It is made to determine: (*a*) an approximate location for the proposed line; (*b*) that it is possible to ascend from a valley on a given grade, and get over the summit of the divide; (*c*) that it is possible to descend from this divide and cross the summit of the next on a given grade; (*d*) the elevation of the passes of the divides to the right and left, and (*e*) that the road can be built within certain limits of expenditure.

The method of making the reconnoissance differs, of course, according to conditions.

If the country proposed to be traversed is well known and has been settled, accurate maps and surveys of it can be readily obtained. Accordingly, the engineer provides himself with a map made preferably on the scale of one inch to a mile. Such a map, where a government survey has been made, will give the township and section lines; generally the sub-division of each section by farm fences enables any desired point to be accurately located. In cases where the coun-

---

\*The duties and peculiarities of a railway civil engineer are referred to more fully in the book "Railway Organization."

try has not been surveyed by the government, a map or plat will have to be made on a larger scale than that indicated—say two inches to a mile, so that the boundaries of farms and other properties can be clearly shown.

The engineer who makes the reconnoissance will require the following: an aneroid barometer (Figs. 1, 2 and 3), engineer's field books and



FIG. 1.



FIG. 2.

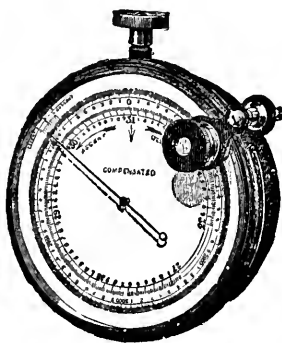


FIG. 3.

#### ANEROID BAROMETER FOR MEASURING ALTITUDES.

They indicate the weight or pressure of the atmosphere, from which the altitude above sea level is determined.

note books, drawing paper, a set of pocket instruments, (Fig. 4); a tin map case or two, a 100 ft. steel tape, a prismatic compass (Figs. 5 and 6); a hand level (Figs. 7 and 8); a field glass (Fig. 9). Provided with these instruments, the engineer travels the country mostly on foot, locating the controlling points. Upon his map he will depict not only the location of section lines

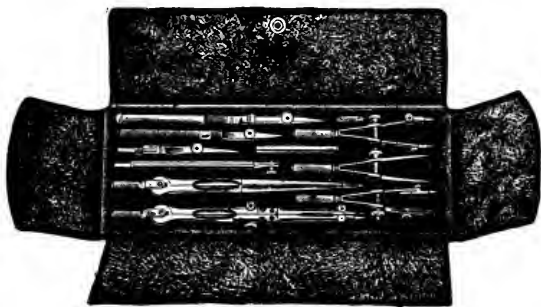


FIG. 4.

## ENGINEER'S POCKET INSTRUMENTS.

These generally embrace drawing pens and large and small compasses.



FIG. 5.

PRISMATIC COMPASS WITH CLINOMETER ATTACHMENT  
Used to take bearings.

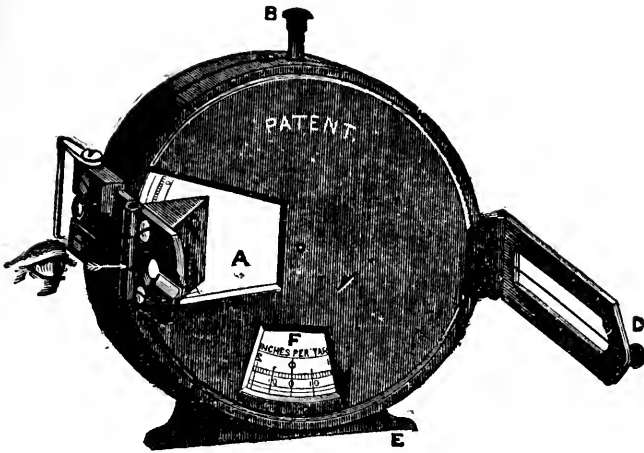


FIG. 6.

**PRISMATIC COMPASS WITH CLYNOMETER ATTACHMENT.**

Used to take angles of slopes.

The Prismatic Compass is used for taking the magnetic bearing of a line. The Clynometer attachment is used to take the slope of the surface of the ground with a horizontal plane.

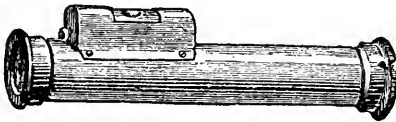


FIG. 7.

**LOCK'S HAND LEVEL.**

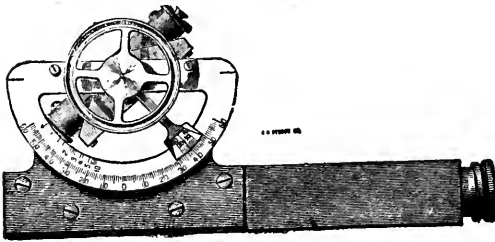


FIG. 8.

## ABNEY'S HAND LEVEL AND CLYNOMETER.

Hand Levels are used for the purpose of ascertaining points on the same level as the eye of the observer. The Clinometer attachment is used to take the slope of the surface of the ground with a horizontal plane.

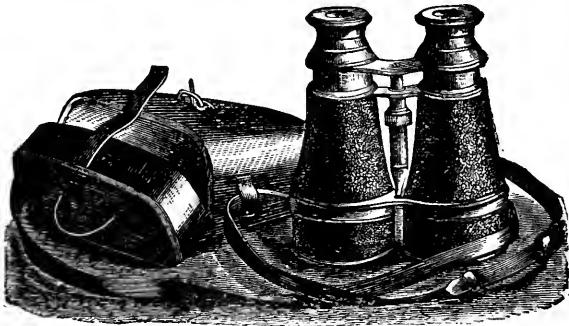


FIG. 9.

## FIELD GLASSES.

The Field Glass brings distant objects within view of the engineer.

and boundaries of farms and properties, but all water courses, ravines, hills, highways, towns, villages, etc. In his survey the engineer will ascertain by the use of his aneroid barometer along the summits of divides \* the low points or

\*In engineering parlance a "divide" is the line separating the water-sheds of two adjacent systems of drainage or rivers.



passes. He will ascertain the elevation of the valleys, and will take the elevation of spurs \* from the divides, also plat the contours † of the country at difficult points when necessary.

Where the country is unsettled and no government survey has been made, the method will differ somewhat from the foregoing. In such case the engineer must secure the elevation and distance of the controlling points, while in the former case the plats supplied him with the distances. In addition to the instruments specified he will need a pedometer (Fig. 10); and an odometer (Figs. 11A, 11B, 11C), and a good watch. He will not need to be provided

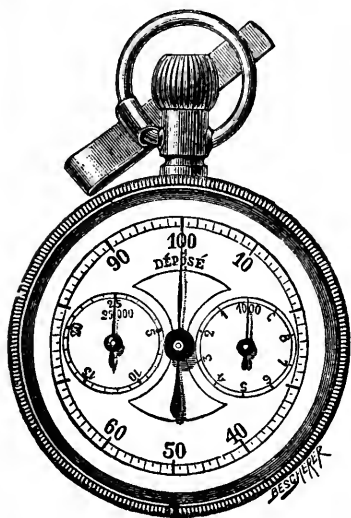


FIG. 10.

PEDOMETER.

Is a pocket instrument which records the distance the person carrying it has walked. In reality it records the number of steps taken, but by proper adjustment the distance traveled is indicated.

with instruments for determining latitude and longitude, for the problem has already been reduced to sections. For example, after making the summit of one divide, his problem is to cross

\*A "spur" is a ridge extending from a divide and separates the water-sheds of two branches of the same river.

†The contour of a country is indicated by lines laid down on a map showing the location of points of the same elevation.

the next valley and reach the summit of the next divide, using the desired grade and curvature. Any errors of distance made from one divide to another will not affect those beyond. In

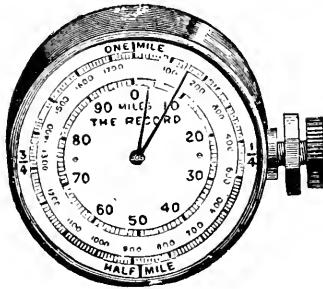


FIG. 11A.

ODOMETER.

Records the distance traveled by the tire of a wheel. In reality it records the number of revolutions, but by proper adjustment the distance traveled is indicated.

making such surveys camp outfits are necessary. These should be as light and simple as possible. If the country is even and sparsely settled, the engineer will probably take two ponies, one to carry his appliances, and the other to ride. When possible he

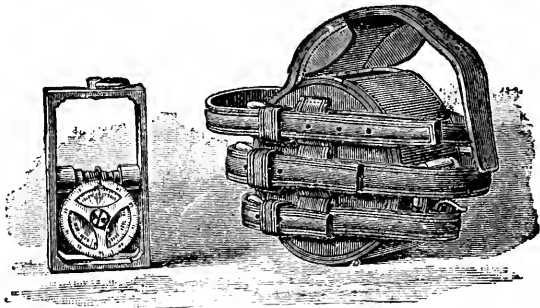


FIG. 11B.

ODOMETER.

Inside dial with leather case and straps.

secures a guide having local knowledge of the country.

In making a reconnoissance the most direct line should always be examined first, unless there is positive knowledge of some insurmountable difficulty. Should this be the case, of course the territory to the right or left will be examined. The short route, other things being equal, should

not, however, be too quickly abandoned. Rocky valleys, giving the impression of difficult and expensive construction, have often been summarily avoided, when afterward they have proved to be the cheapest location.

When the general direction of a proposed line crosses ravines or passes from a summit into a valley, follows a stream for some distance and

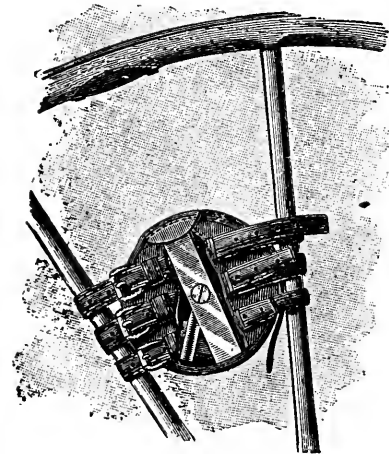


FIG. 11C.

ODOMETER.

Inside dial with leather case and straps.

then ascends another stream to a divide, it will be found advisable to look for a high line and keep on the summit, following a spur out to the stream, cross the stream by a viaduct to a spur on the opposite side and again take the summit. Such locations need careful comparison as to first cost and cost of operating and maintenance, and

in making a reconnoissance the engineer will give them most careful consideration.\*

Mountain and valley lines are not the most difficult to construct as is generally supposed. The greatest errors of location have been made on open prairies and foot hills of mountains on account of stopping exploration when a location giving the desired grades curvature and cost was found without endeavoring to find a better.

In making a reconnoissance the engineer will, as he proceeds, make calculations and notes showing the probable nature of the material to be handled *i. e.*, whether earth, loose rock, hard pan or solid rock, and the percentages of each at different cuts. This will be approximate only, but his observation will afford a basis upon which to estimate cost. He will note also the probable quantities of excavation, embankments and bridging per mile; the fuel supply; possibilities of business; the geological formation, the water supply; the timber available for ties, piling and bridging; the character of the rainfall, and the effect it may have on operation.

It is an axiom that nature always works along the line of least resistance. The engineer follows the same rule and makes use of the forces of nature to overcome difficulties. The highest compliment that can be paid a railroad civil engineer is for passengers going over a completed

---

\*On a railroad in north America a valley line as described above was built and afterward abandoned for a high line which saved 12 miles of track, and cost nearly a million dollars less than the valley line.

road to remark that the location and construction were easy, and required no great knowledge or skill, because the passenger is ignorant of the expensive bridging avoided and the deep rock cuts, the long tunnels and heavy fills, which were unnecessary on account of the skill displayed by the engineer who made the reconnoissance.

(NOTE:—The student requiring detailed information in regard to the methods of making a reconnoissance, and the use of the barometer, stadia, and gradienter to measure distance, will find a list of standard books on the subjects in Appendix K).

## CHAPTER III.

### THE PRELIMINARY SURVEY.—THE SECOND STEP IN RAILWAY CONSTRUCTION.

The reconnoissance having been completed and a report thereof made to the projectors, they will have the information needed to enable them to decide whether or not they will proceed with their venture. If their decision is in the affirmative and the outlook is favorable, the second step is now taken which is to make a Preliminary Survey; this duty falls to the lot of a civil engineer, generally called a locating engineer, who takes the field with his corps of assistants. The instruments the locating engineer will require in this work will be (*a*) a hand level, (*b*) an aneroid barometer, (*c*) a field glass, (*d*) a prismatic compass, (*e*) a pedometer and (*f*) a 50 ft. steel tape. The party will, of course, be furnished with the necessary stationery and kindred supplies.

The organization of the force making the preliminary survey will vary according to the character of the country and other considerations, such as the resources of the projectors and the degree of haste required, the latter factor being often controlled by financial considerations, or the probability of an invasion of the field by rivals.

If the proposed line is a new one, the chief engineer will probably take direct charge of the

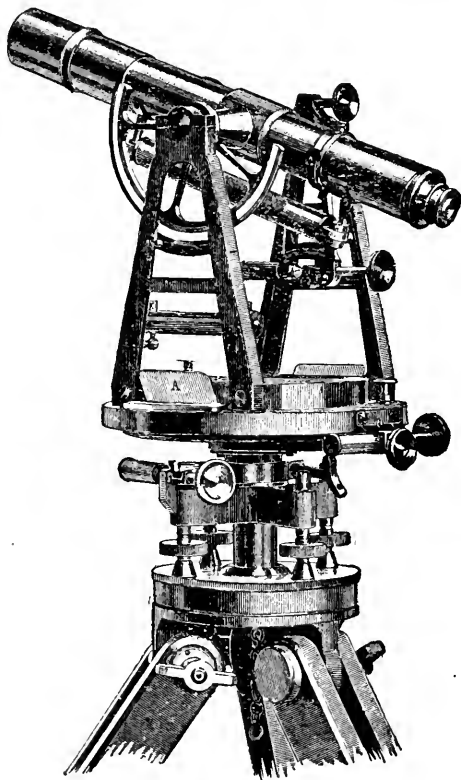


FIG. 12.

ENGINEER'S TRANSIT WITH LEVEL AND VERTICAL ARC.

Used to take vertical and horizontal angles; also to extend straight lines. The level enables approximate elevations to be taken within limited distances. The vertical arc is used for taking vertical angles.

work; if on the other hand it is an extension of an existing system, a locating engineer will have

charge, acting in subordination to the chief engineer of the system.

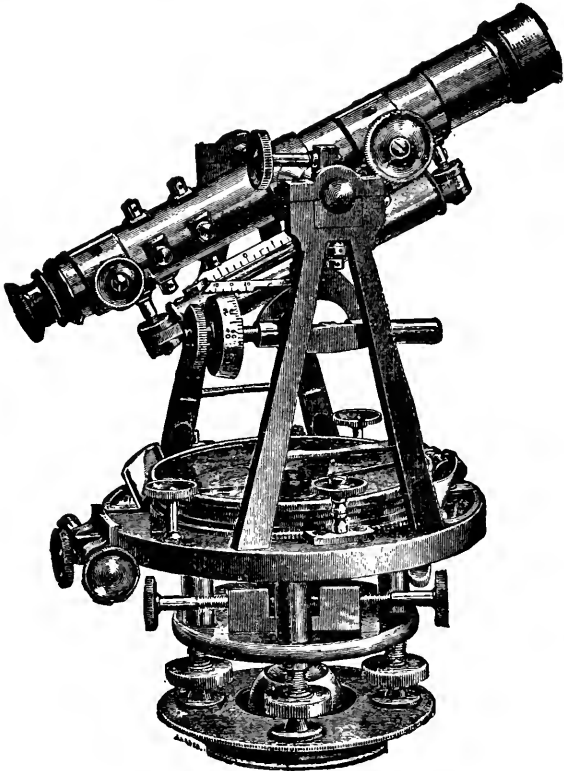


FIG. 13.

ENGINEER'S TRANSIT WITH LEVEL AND GRADIENTER ATTACHMENT.

The gradienter attachment is for the purpose of locating the axis of the telescope on a grade line parallel with the grade of the proposed road; in connection with a level rod it is also used to measure distances.

The organization of the force making a preliminary survey generally consists of (*a*) a tran-



sit party, (b) a level party, (c) topographers, (d) draughtsmen, (e) commissary and camp.

The transit party is generally made up of a transit man who, in the absence of the locating engineer, is in charge; the transitman is responsible for the accuracy of all angles, bearings and measure-



FIG. 14.

ENGINEER'S CHAIN.  
100 feet long, having 100 links.

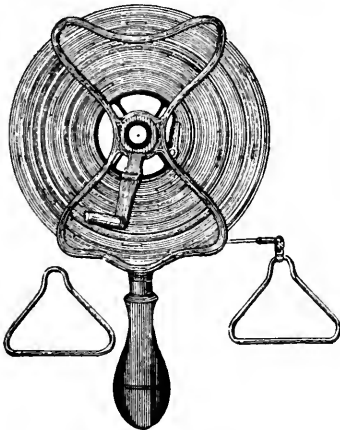


FIG. 15.

ENGINEER'S IMPROVED TAPE  
CHAIN.

ments taken; his assistants are a head flagman or chainman, a rear chainman, an axeman or stakedriver, and a rear flagman. The number of assistants will vary according to circumstances; thus, the number of axemen will depend on whether there is much or little timber or brush to be removed, etc. The instruments and supplies the transit party need are (a) a transit (Figs. 12 and 13), (b) an engineer's

chain (Figs. 14 and 15), (*c*) a 100 ft. steel tape, (Fig. 16), (*d*) two ranging poles or rods (Fig. 17),

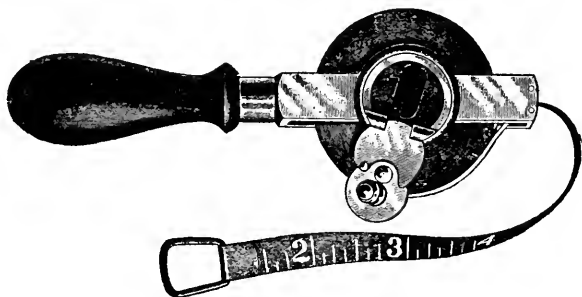


FIG. 16.  
STEEL TAPE.

(*e*) brush hooks, (*f*) axes, (*g*) transit books, (*h*) lead pencils, hard and medium, (*i*) kiel pencils,



FIG. 17.  
RANGING RODS OR POLES.  
Used in placing hubs.

(*j*) tacks for centers on hubs, (*k*) two 50 ft. Chesterman's metallic tapes (Fig. 18), (*l*) engineer's field book, (*m*) scratch blocks, (*n*) one sounding rod, 3 joints 8 feet each, (*o*) red and white flannel for signals, (*p*) drawing paper, (*q*) tin map cases, (*r*) scales (Fig. 19), (*s*) protractor (Figs. 20 and 21), (*t*) steel straight edge, (*u*) triangles, (*v*)

India ink and ink slab and carmine blue and neutral tint water colors, (*w*) set of, drawing instruments and drawing board.

The leveling party is generally made up of a leveler and a rodman, but if rapid work is to be done, the force can be increased to meet requirements. The leveling party is responsible for the correct elevation of the ground at all sta-

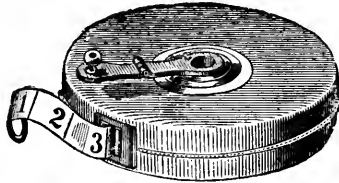


FIG. 18.

CHESTERMAN'S METALLIC TAPE.



FIG. 19.

ENGINEER'S SCALE.

Divided into 10, 20, 30, 40, 50 and 60 parts to the inch.

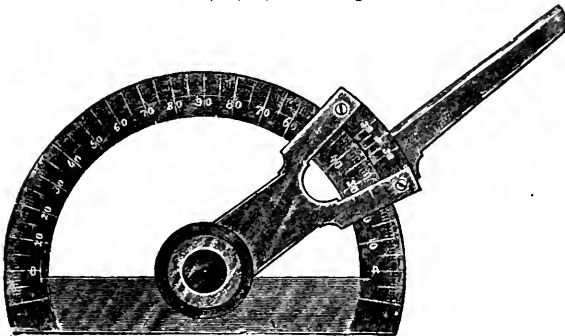


FIG. 20.

PROTRACTOR.

tions where stakes are driven, the elevation between the stakes where the slope of the ground

changes and the correct location of this point; the elevation of the water in streams; the elevation of

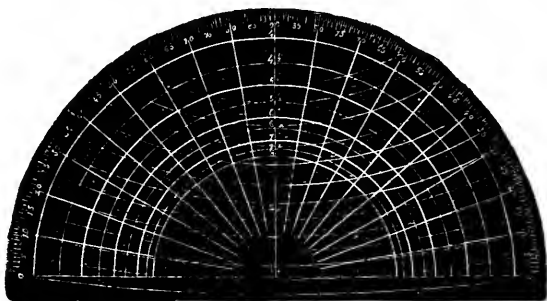


FIG. 21.

TRANSPARENT PROTRACTOR WITH RAILROAD CURVES.

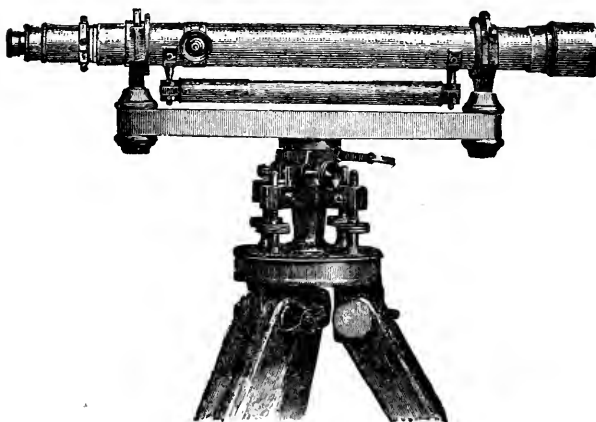


FIG. 22.

ENGINEER'S Y LEVEL.

For taking elevations and establishing benches.

high water during freshets; and the elevation of the beds of the streams which will enable cross

sections of the stream to be platted; the placing of benches at proper intervals and the correct elevation of them.

The leveling party will require the following: (a) a level (Fig. 22), (b) two Philadelphia leveling rods (Fig. 23), (c) one Chesterman's fifty-foot metallic tape, (d) nails to use in benches, (e) a hand axe with leather case and belt, (f) level books, (g) lead pencils, hard and medium, (h) profile paper (i) kiel pencils, (j) India ink and ink slab and carmine blue and neutral tint water colors, (k) scratch blocks.

The *topographical party* is most variable in its composition. Sometimes it is represented by the notes taken by the locating engineer and transitman, and at other times it may consist of a level man, rodman, chainman, and axeman. The topographical party is responsible for the data used in determining the rise or fall of the ground to the right and left of the line; the location of roads, buildings, streams, etc., laying to the right and left of the line, property lines and names of the owners of the property, also the section lines where a government survey has been made; the character of the material to be met with in the excavations, etc.



FIG. 23.

PHILADELPHIA  
LEVELING ROD.

The instruments and supplies required by the party will vary greatly according to the requirements of the case, but a complete equipment for the party would be as follows: (a) one level!

(Figs. 22 and 24), (b) one Philadelphia level rod, (c) one self-reading level rod, (d) one 100

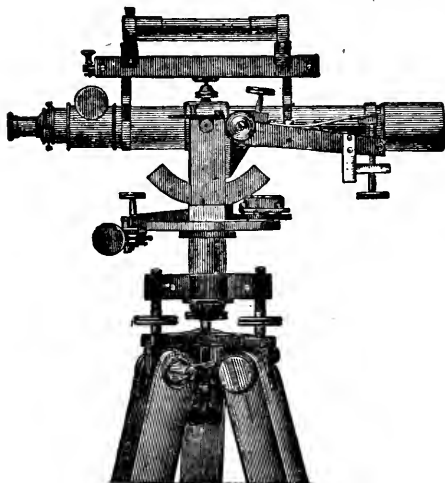


FIG. 24.

LEVELING INSTRUMENT AND GRADIENTER.

For topographical work. With this both elevations and distances can be taken.

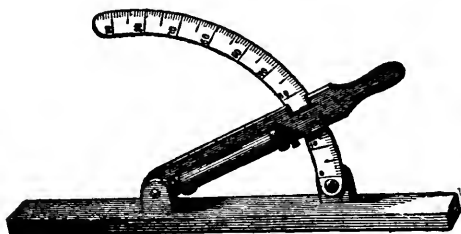


FIG. 25.

CLYNOMETER, OR SLOPE INSTRUMENT.

ft. steel tape, (e) one hand level, (f) one prismatic compass with clynometer attachment, (g)

one clinometer (Fig. 25), (*h*) topographical books, cross section books and cross section paper (10ths).

*The draughtsman* (or draughtsmen) accompanies the party to record the result of its operations by making the necessary drawings and maps. His accessories are (*a*) a set of drawing instruments, (*b*) protractor, (*c*) straight edge, (*d*) scale, (*e*) triangles, (*f*) lead pencils, hard and medium, (*g*) drawing paper, cross section paper and profile paper, (*h*) cross section books, (*i*) India ink, ink slab, carmine blue and neutral tint water colors, (*j*) camel's hair brushes, (*k*) drawing board and trestles, (*l*) thumb tacks.

*The commissary and camp party* is, of course, unnecessary in a well settled country, but is a most important adjunct in other cases; when it is necessary to make provision for feeding and housing the force it is of the greatest importance that intelligent provision be made for its health and comfort, as serious results may ensue if the survey be delayed through sickness or lack of subsistence.

The result of the reconnoissance will have enabled the projectors to decide the maximum grades and degrees of curvatures that will be acceptable; the average cost of the bridges proposed to be used; the cost per yard for earth, loose rock, solid rock and hard pan; the cost per mile of track; the cost of depots, water stations, coal sheds, etc., and the locating engineer will have been furnished with this data.

The detailed methods adopted in making a

preliminary survey will probably never be alike in any two instances; they will depend upon the genius and capacity of the engineer in charge, but there are several well defined plans or methods of operation, which may be described in general terms, as follows:

*First Method:* The engineer tries to get the preliminary line as close as possible to the ground to be occupied by the location. He has what is termed "an eye for country" and keeps the level party close up to the transit party, having the profile of the ground platted in the field; on this profile he lays down trial grade lines; side notes of the rise or fall of the ground are noted by him on the plat when he thinks they will assist him. A trial line is made from the point of commencement of the survey to the summit of the first divide; if it does not prove satisfactory, an examination of the map and profile is made, and with the side notes and knowledge of the lay of the country, such changes are made as the engineer thinks proper. The map of such a preliminary survey gives the alignment, streams, highways, buildings, and section lines bounding the property belonging to different owners, together with the names of the latter; ridges and bluffs are often indicated by hatched lines. This method is pursued from one controlling point to another. No attempt is made to show on the map any examinations that may have been made to ascertain whether a better line could have been secured to the right or left. In this case the management accepts the



line, if it fulfills the required conditions, depending upon the opinion of the engineer as to whether it is the best that can be secured.

*Second Method:* Under this method a step towards greater accuracy is secured by having a topographer and assistant added to the party who take side notes with hand level and tape line, locating the streams, highways, buildings, etc. The contours are also laid down on the map, and the line is revised as in the first method, but with the advantage of having more data regarding the lay of the ground.

*Third Method:* Under this method greater accuracy is secured. The topographer with a level, a rodman and a chainman proceeds to make cross sections of the country at right angles to the line at all points where the slope of the ground changes, carrying the cross sections out such distance as the engineer directs. This gives more accurate data from which to locate the contours, and gives the engineer fuller data from which to decide on the location of the line. This method also gives the engineer the means of furnishing the management with a map containing data which will enable it to call in a consulting engineer to criticise the line selected.

*Fourth Method:* This method is the one used by a large railway system in North America, and aims at greater accuracy than the preceding ones; it also tends to eliminate errors of judgment of the engineer in charge of the survey. The engineer proceeds with the survey as in the first method, and is furnished a topographer and assistants as

provided in the third method. The topographer is required to cross section the country at right angles to the line every three hundred feet, and carry the cross sections out at least 700 feet each side of the line. On each line on which cross sections are made, side elevations are taken every three hundred feet at a distance of one hundred feet right and left. By this method the elevation of the ground is secured on both sides of the line run at each one hundred foot station; and accurate data is secured to make a reliable contour map covering a stretch of country fourteen hundred feet wide or about one-quarter of a mile. This enables an expert to locate the best line from the map, and eliminate the errors of judgment of the one in charge of the survey.

*Fifth Method:* This method is used by one of the leading railroads of the world, and is radically different from any of the preceding ones. The engineer aims more to lay his line so that he can secure, at least expense, data to make a topographical map of an extended area of country. The preliminary survey is made quickly, and the method of taking the topography is rapid, and with a good topographer accuracy is secured. The maps and profiles are made as the survey proceeds, but generally the contours are not worked out in the field, although if necessary this can be done. When this method is observed it is usual to follow the preliminary survey with a location running out the tangents only, as shown by a location from the topographical map of the preliminary survey. On

this first location topographical notes are taken as on the preliminary. From the notes made from this location, a second topographical map is made, and from this second map the final location is made. Topographical notes are again taken on the second location and another map made, from which a study of the possibilities of improving and cheapening the line is made before construction commences. The method of taking the topography is to ascertain the angle which the surface of the ground slopes with a horizontal line and measuring the length of the slope to where the ground assumes another slope, take the angle of this slope and measure the length of it, etc.

The following is an outline in general terms of the details of a preliminary survey:

In starting the survey the first hub\* should be driven in the center line of the railroad which the new line is to connect with, and the angle taken with the center line of the existing railroad and the first tangent of the proposed road. This hub should be carefully referenced to some permanent objects so that it can be replaced if destroyed. Stakes should be set securely in the ground, the blazed side facing the first hub; the first stake should be set 100 feet from the hub and marked number one, the second stake should be set 100 feet from the first and marked num-

---

\*The term "hub" is used by engineers to distinguish the points over which the transit is placed—it is usually a large size stake driven flush with the ground; in a rocky bluff it may be a small hole in the rock or a plug driven in a crevice of the rock or a hole drilled in the rock.

ber two. In this way the transit party proceeds to set stakes every 100 feet, and puts the numbers on the blazed side facing the first hub. The numbers on the stakes thus show the number of one hundred feet from the point of commencement of the survey. Wherever the transit is set up a large stake or hub is driven, and a large tack or small nail driven in the point set by the transit man. At a distance of about eighteen inches from the hub a reference stake is driven giving the station of the hub, thus if the second hub on the survey is driven at a distance of 1006.3 feet from the first the reference stake would be marked 10+06.3, which would mean ten stations and six and three-tenths feet; the numbers on the reference stake should face the hub; all stakes should be set by the transit man.

When the survey has progressed to a point where the locating engineer wishes to change the direction, a hub is driven, and the back flag man holds his ranging pole on the tack of the hub next to the end of the line; the transit is set up on the last hub, the vernier of the transit set at zero, and a sight taken on the ranging rod held by the back flag man, the upper plate unclamped, and the telescope sighted to a hub on the new line ahead, and the angle read from the vernier; the magnetic bearing of both the first and second lines should be taken at this time. The transit man records the stations of all hubs where the transit is set up; also the angles of one line with another and whether turned to the right or left; also the magnetic bearings of both lines at hubs

where angles are taken or the direction of the survey changes. If there is no topographer, the transit man also takes the topographical notes, the transit book is ruled on the left-hand page for the notes of the line, and on the right-hand page for the notes of the topography.

The head chainman, who generally acts as head flagman, carries the head end of the chain and a ranging rod; after he has been given the line for a stake it is his duty to see that the axeman marks it correctly, and places it in the ground with the figures facing the right direction; while the axeman is driving the stake, the chainmen proceed. It is the duty of the hind chainman to note the numbers on each stake as he proceeds, and at once have the axeman correct any errors in numbering or direction of facing the stake. The leveling party also checks the numbers on the stakes; this is very important as the numbers on the stakes are the only means of determining the lengths of the lines composing the survey.

In commencing the levels a bench\* is established on some permanent object, and if the survey of a new line is being made, the height of the bench is assumed at an elevation above a datum plane, which the locating engineer is sure is lower than any part of the country he is going to make the survey in, to avoid the confusion of minus quantities. Where the elevation above sea level can be secured by the barometer or otherwise, it is better to make sea level the datum plane.

---

\*A "bench" is any permanent object on which an elevation is taken; the elevation of the first bench used in a survey is generally given an assumed elevation.

When the new line is an extension of an older system, the same datum plane should be used, as was adopted on the old one.

As the levels proceed, benches should be established at least once each mile; they should be on permanent objects, wherever such are possible to be secured. The projecting root of a tree when cut in the shape of a cone, with a nail driven in it, makes a good bench; the tree in this case should be blazed, and the letters B. M.\* with the elevation of the bench marked under them; stone sills of doors, water tables of buildings, etc., make good benches, though oftentimes nothing better than a hub can be secured. All benches should be marked plainly with the letters B.M. and the elevation. When a hub is used a reference stake should be driven as for a transit hub, and it should always be placed some distance to the right or left of the line, so as not to be mistaken for a transit hub.

The leveler should record all benches, giving their location and elevation: for example, station 52+26.5 B.M. 50 feet R. elev. 482.645 means that at a point 50 feet on the right side of the surveyed line, opposite station 52+26.5, there is a bench having an elevation of 482.645 feet above the assumed datum plane. The reference stake should have the figures facing the bench and the line.

The leveler should record all readings of the rod for back and foresight on benches and turning points (or temporary benches) and these

---

\*The letters "B.M." stand for Bench Mark.

readings should be taken to not less than two decimal points of a foot, but it would be better to read the rod to three decimal points. This can be readily done with a Philadelphia rod, after a little practice. The elevations of the ground should be taken at each one hundred foot station where stakes are driven, and at such intermediate points where the ground changes, as will enable a correct profile to be platted. In taking the elevations of the ground, the Philadelphia rod can be used as a self-reading rod, and the readings taken to the nearest tenth.

The rodman should have a level book in which to record all back and foresights on benches and turning points, and to record the location of benches. It is the duty of the rodman to see that the stakes are all correctly numbered consecutively; the leveler can assist in seeing that this is properly done.

As far as possible all back and foresights should be of an equal distance so that errors in setting the target will balance each other. Sights should not usually exceed five hundred feet in length, and in windy weather a less distance is preferable.

To insure accuracy it is necessary to have check levels run to detect errors in taking the elevation of benches; if the errors remain undiscovered it might not be possible, when the location came to be made, to reach a summit on the grade proposed, or the cost of the work might be greatly increased by heavier cuts and fills than the profile indicated.

Level books are ruled with six columns to a page, and the safest way to keep the notes is as follows: on the left-hand page use the first column for the station, second column for the back sight, third column for the height of instrument, fourth for the foresight, fifth for the reading of the rod on all points except benches and turning points, sixth for the elevation of all points on which the rod is held except benches and turning points. The right hand page should be used to give the elevation of benches, turning points and their description and location, and other miscellaneous notes as for example:

*Elevation 482.645 50 ft. Right of 52+26.5 B. M. on Chestnut Tree.*

*Elevation of surface of water in "Cobb's Creek."*

*Elevation of high water "Cobb's Creek" June 16, 1895.*

*Elevation of center of highway station 55+20.*

and any other notes of elevations of objects which may affect the location or construction of the road or be of use in future claims for damages.

By this method of keeping the notes, back and foresights can be added up on the first page, and the footings carried to the top of the second, and the footings of the second being the total of the first and second pages carried to the top of the third, the same as the footings of a cash book. The advantage is that the levelman at noon can in five minutes have his back and foresights footed up for the morning's work, and if the difference between them gives the elevation of his



last bench or turning point, he knows there has been no clerical error in his morning's work. If he now turns to his rodman and does the same thing with his notes and secures the same result, he knows he has been using the correct readings of the target, and has not misunderstood the rodman—a thing which can be easily done in windy weather. A check can be secured on the rodman's reading the target by using the Philadelphia rod; and when taking both back and fore-sights on benches or turning points, using the rod first as a self-reading rod the leveler can then tell whether the rodman gives the feet and tenths correctly. Where this method of taking levels is pursued, there should not be any mistake of importance made.

The leveler will often be required to plat his profile in the field, so that the locating engineer can determine whether the ground is rising too fast for the length of the line, or whether his line is too low in the valley; to do this the leveler must make use of the time the rodman is walking between stations to work out the elevation of the ground. This will enable him to act promptly when called upon for profile.

The person in charge of topography should be a man of judgment with a good eye for country, and for the salient points to take data which will enable the contours to be platted with the least difficulty and labor on the part of the draughtsman. He should keep his work up close to the level party, and have his notes clear and exact; in addition to securing data for the contours, he

should sketch the streams, highways, buildings, section lines, division fences of farms, and, if possible, secure and record the names of the owners of land. He should note the character of the soil, whether earth, loose rock, solid rock, etc., and note the outcroppings of bluffs.

The note books used in the field on one day should be left with the draughtsman to plat the notes on the following day, and the field force should use another set of note books for the following day, the two sets thus alternating between the field force and the draughtsman. To avoid confusion each man using a field book of any kind whatever should commence the day's work by recording the date and time of the day, also noting the day of the week and month, and the same thing must be done on closing at night, or when finishing one book and commencing another. The books should be lettered and numbered, and the commencing and closing station noted on the cover; also the letter or number of the line. Much confusion is sometimes caused by not observing these details, where the survey is in difficult country, and a number of trial lines have to be run.

Another point to be observed is never to erase any notes taken in the field; if any changes are to be made, the changes should be noted with a different colored pencil than is used in the field or with ink; further information may demonstrate the original notes to have been correct or, at least, that the alterations were incorrect. If field notes are copied into another book, the original

should be preserved, so that clerical errors in copying can be corrected.

The draughtsman being provided with the notes as outlined can keep the work up close, so that the locating engineer can know definitely what he is doing. After extending the survey for some distance, and reaching a controlling point where he feels satisfied the country on either the right or left does not present a more favorable point, he can make a careful examination of the maps, profiles, etc., and also of the country traversed with a view to making such changes as the data secured suggests. At this point in the survey, the location very often commences, and is made from the junction of the existing road to the controlling point mentioned. The peculiarities of location will be treated later.

If the survey is being conducted in a settled country, the party at this point in the preliminary survey moves on to a town or village near the next section of the survey, or if in a thinly settled section, camp is moved to a convenient location. The frequency of these changes depends on the character of the country. In an easy country they are often made daily, while in difficult country the party may have headquarters at a given point for many days. In addition to the work outlined above, the locating engineer has other duties to perform. Thus, the extreme high and low water levels must be noted of all streams crossed, and also cross sections of the streams must be secured; careful notes must be taken of the probable classification of the mate-

rial composing the cuts, as the question of water supply for locomotives may decide the choice of location; especially in arid countries must this be noted; the fuel supply must be considered, and in connection with this the geological formation must be noted not only for coal but minerals which may yield profitable business; the commercial possibilities of the country must be set forth and the localities suited for towns, yards and division points suggested. The locating engineer must be a man of resources, and ready to adapt old methods to new conditions, and he must also be able to devise new methods to meet conditions which are new to him if not to other engineers. Thus a rocky canyon where the instrument men can not get on the line of the proposed road even with the use of assistants and ropes, requires the surface of the cliff to be located both for line and levels by triangulating from the valley below the opposite side of the canyon, or from the top of the opposite bluff. The obstacle offered by a marshy plain too soft for men to walk over, and over which there is not enough water to float a boat, will sometimes tax the resources of the engineer, but it must be overcome. A heavily timbered country with a thick undergrowth of brush and vines, such as is the rule in tropical and semi-tropical countries, especially near streams, will call for a display of skill and resources.

Two maps of the preliminary survey should be made, one on a scale of one mile to an inch. This should be platted from co-ordinates, calcu-

lated in the same way as the latitudes and departures of a farm survey; such a map gives a comprehensive view of the entire route; the calculations for co-ordinates give a ready means to ascertain the distance across country between any two points of the survey and the direction to lay a line to make a survey of the cross cut. The usual maps on the scale of two hundred or four hundred feet to an inch can only cover sections of the survey, and do not give an opportunity to study the line as a whole.

It is always well to make examinations of the country from each terminus, as it frequently happens that another route and a better one is discovered by the locating engineer going back over the line from the end of the survey to the point of commencement.

The preliminary survey should be thorough, and all possible improvements in the line and grades tried, so that the work of location may be rapid and require but few changes.

Finally, the locating engineer must understand handling his men, and be able to get the maximum amount of work done with the minimum amount of friction among the members of the party; he must use tact with the people in the district through which the survey is being made; their local history and prejudices should be taken note of, and he should ascertain who are their leaders in forming public opinion.

Another point to be touched upon before proceeding to discuss the location is the methods adopted to determine which of two or more

routes will be the cheapest to operate, taking into consideration the first cost, the cost of operation and the cost of maintenance. The determination of this question is of the greatest importance, and is the one surrounded with the greatest difficulties; only those actually in the active management of railroads and those who have attempted to furnish a reliable means of reaching a decision realize the difficulties. The locating engineer on a preliminary survey must always keep this subject in his mind.

For further details and methods in relation to preliminary surveys as given by different engineers the reader is referred to Appendix K.

## CHAPTER IV.

### THE LOCATION.—THE THIRD STEP IN RAILWAY CONSTRUCTION.

The reconnoissance and preliminary survey having been made and the results reported to the projectors of the new line, they have definite data upon which to proceed. They now know enough to be in a position to estimate the cost of the proposed line; the grades and curves that are possible and the engineering obstacles that have to be overcome; they are also in a position to estimate the probable cost of operation.

The question that now has to be decided, the reconnoissance and preliminary survey having given them information as to all the available routes where the line can be most advantageously located, is, which will be the cheapest route, having regard to cost of construction first and cost of operation and maintenance afterward. When these questions have been decided, a party is put into the field to make the final location.

The organization of the locating party, the duties of the various members, and the instruments and supplies required will be practically the same as in the case of the preliminary survey, except that the transit party will lay out

spirals,\* curves, etc., in detail,† and will place stakes at each one hundred feet on curves the same as on the straight lines in the preliminary survey, and will carry the numbering along the measured distances on the tangents, spirals and curves. The duties of the leveling party will be the same as in the case of the preliminary survey. The services of the topographer will be needed now as then, indeed his notes will be more full and exact though they will not extend so far to the right and left as in the former case. The draughtsman will accompany the party as before, but his work will be done with more attention to detail, and his maps and profiles finished with greater care and exactness.

The locating party will make soundings at all watercourses to ascertain the depth of the rock or hard strata necessary for bridge foundations, and will lay the grade lines.‡ In conducting the

---

\*A "spiral" is a parabolic or elliptical curve placed between a tangent and a curve to secure the gradual change in the movement of a train from a tangent to a curve.

†The work of locating is often carried on at the same time as the preliminary survey. For detailed methods of laying spirals, the following authors may be consulted; J. C. Nagle, W. H. Searles, Van Nostrand's Science Series No. 110, C. R. Howard and C. L. Crandall. The calculations for laying out curves, changing the direction of tangents, locating compound and reverse curves, and similar problems, are given in a number of "Engineers' Field Books," among which may be mentioned those of W. H. Searles, J. C. Nagle, W. F. Shunk, C. S. Cross, J. C. Trautwine, and J. B. Houck.

‡Appendix H gives rules and values to enable a comparison to be made between two or more proposed routes. The amount of the reduction of grades on curves to make the resistance to the train correspond with that on the tangents has not yet been settled; opinions vary from 0.025 ft. per degree of curvature to 0.05 ft. The latter is, perhaps, the safer to use. The practice is generally to equate the grades on curves to the extent that they will not exceed the maximum grade.



work of locating, there are a number of methods which can be adopted on the trial lines, some of which may be mentioned, viz:

*First:* Running the tangents to an intersection and putting stakes in only on the tangents to the points where the curves commence and end, carrying the numbers on the stakes the same as if the curves were run. The level readings can be taken at the center and quarter points of the curve.

*Second:* Running the curves of the paper location without running the tangents to an intersection and going ahead or backing upon the curve to make the tangent fit the ground.

*Third:* Locating points on a curve by a long chord and backing the curve in.\*

The survey of inaccessible bluffs is referred to under the head of the preliminary survey, and the same remarks apply to the locating party. In such localities the constructing forces make a roadbed along the face of the bluff on the established grade, and the alignment is worked out to fit the roadbed.

As long tangents as possible should always be secured; a persistent examination of the country and study of the map and profile will often result in a much larger percentage of long tangents than is at first thought possible.

Absolute reverse curves should never be used, unless in very heavy rock work where the plac-

---

\*This is a convenient method in rocky country on the sides of bluffs where the transit man, his instrument and assistants have to be supported by ropes let down from the top of a bluff.

ing of a tangent between curves would entail heavy expense. Such cases will, however, be rare if proper care in selecting the location is taken.

Reverse curves should always have a tangent between them of sufficient length to enable the cars to gain their equilibrium after leaving one curve and before entering on another (see Appendix H).

The intersection of all grades should be connected by a vertical curve; there should never be a level grade laid through a cut, as in such case it is difficult to drain the water away from the cut.

All bridging that can possibly be dispensed with without unduly increasing the cost of grading should be avoided, especially where draw bridges are required over navigable streams; a considerable increase in the cost of grading can be allowed if it will enable the engineer to avoid a drawbridge.

Sharp curvature, like a succession of short tangents and curves, should, when possible, be avoided. Heavy cuts should be avoided if possible, as they cause trouble during snow storms.

The locating engineer, transit man and leveler must all take fuller information than on the preliminary survey regarding the following matters, viz:

Heights of high water and low water at streams, making careful cross sections of the larger ones; soundings must be made to determine the depth to hard pan or rock; inquiries must be made re-

garding the rainfall and such information as may throw light on the proper size to adopt for bridge openings. Section and property lines must be located both by the station at which they cross the survey and the angle with the line.\* The locating engineer must give his personal attention to noting the classification of the material in the cuts and possible borrowpits, the geological formation, the water and fuel supply, the rainfall, the commercial prospects, the possible town sites, yards and division points.†

The surveyed line should be divided into sections of about one mile each, and the amount of all excavation and embankment work calculated with its probable classification. Calculations must also be made of the amount of piling, square timber and wrought and cast iron required for the bridging for each opening.‡

Calculations must also be made for masonry of all kinds, such as that required for bridge abutments and piers, retaining walls, arch and open culverts, truss bridges of wood or iron and steel or plate girder bridges, depots, track and yards, round houses and shops. In fact, everything required to be done or constructed to complete the road for the running of trains must be carefully

---

\*This should be done with a transit and the distance measured from located line to the section corners, highways, buildings, streams, etc.

†The hubs can be referenced in by the locating party; but it is well to let the engineer on construction do this.

‡The number of openings may, however, be reduced afterwards, possibly, by changing the courses of streams and drains or ravines after the location has been decided on.

calculated, so that the estimated cost may be ascertained before actual construction commences.

The map of the completed location will show the alignment giving the point of curvature, the radius of the curve and total angle formed by the intersection of the tangents, the point where the curve ends and tangent commences, the centered hubs on the curves and tangents, the right of way required for the road, depot grounds, yards and borrowpits, the names of the property owners; also the plats of towns and villages, highways, section lines and location of section corners where a U. S. government survey has been made; also buildings and streams. In addition this map should give the contour lines, so that possible improvements can be studied in the office of the chief engineer. The profile should have the ground line drawn with India ink, and tinted on the ground or lower side with neutral tint; the grade line should be shown with carmine; the elevation at each change of grade and the rate of grade between each change should be given; the bridging and various openings should be marked and the character of the bridge or opening stated; high and low water should be shown with blue; the names of the streams given and the division points between sections shown. At the bottom of the profile the alignment should be given showing the width of the right of way, names of owners of the property, the roads, streams and towns and villages; the estimated quantities should be shown on each section with the classification, and the amount of excavation and em-

bankment in each cut and fill should be given.\*

For further details and methods in relation to location as given by different engineers the reader is referred to Appendix K.

---

\*In connection with this chapter the reader is referred to Appendix I, which treats on location, for more detailed information.

## CHAPTER V.

### CONSTRUCTION.

The route having been definitely located, proposals are invited from contractors to construct the road; agents are sent out to secure the right of way, and the engineering force, under the direction of the chief engineer, is placed in the field to plan and supervise the work of building. The official in immediate charge of the work is generally known by the title of Division Engineer.\*

The division engineer should be one experienced in methods of railway construction and of executive ability; he should have knowledge of the methods contractors adopt to do the work, and also of those which are sometimes resorted to to avoid doing it.

The headquarters of the division engineer should be located at such a point on his division that he can readily reach any point on it, and yet be convenient to the telegraph and postoffice; he is generally given a clerk and draughtsman.

---

\*It is well to state here that the titles given subordinate engineers vary so on different systems that it is difficult to tell from his title what are his duties. In this book whenever the title "Division Engineer" is used, it will indicate the engineer who reports directly to and receives orders from, the chief engineer; also the engineer having charge of constructing the road through one or more counties, or some forty or more miles of road. The title "Assistant Engineer" will indicate the engineer who receives orders from and reports to the "Division Engineer"; also the engineer who has direct charge of the construction of four to six miles of road, depending on the nature of the work.

The assistant engineer should be a man who has had some practical experience in railroad building; he should be gifted with a disposition that will enable him to secure obedience without contention with his assistants or the contractors or their employes; he should be competent, energetic, sober and reliable. He is generally given a rodman and chainman as assistants, both of whom must possess a fair education and be able to assist in making the calculations both on the line and in the office.

The division engineer is furnished by the chief engineer with a complete profile, map and record book of his division, and he in turn furnishes this data for the section under their jurisdiction to each of his assistant engineers. In the record books they will find notes of the alignment and levels giving all hubs, benches and turning points used by the party in the final location.

The first work of the assistant engineer is to check the alignment and see that all hubs and stakes are correctly located; also to put in such additional hubs as may facilitate work during construction.

The next step is to thoroughly reference all the hubs, placing the reference hubs at such points as appear least likely to be occupied by the construction forces for roads, borrowpits, runways, etc.\*

---

\*Reference hubs should be placed at equal distances on each side of center line, usually at right angles, from 50 to 75 feet out. It is also a good plan to place hubs about a foot back of cross-section stakes and points at the mouth of cuts about a foot below grade, at points on low fills, etc.

The levels must now be re-run, checking both the benches and elevation of the ground; new and additional benches must be established looking to security of location as in the case of reference hubs, especially will they be needed at grades of heavy cuts where they will be used often, at streams where bridge piers are to be built, etc.

The width of cuts and fills having been decided upon, the work of staking out for excavation and embankments will be proceeded with.\*

From the profile of the location the division engineer decides where the work shall be commenced, which is often at a point where heavy work is required; or, perhaps, if the season is dry, a marsh or swamp; or a rocky and difficult place which must be graded in order to enable the forces to get at work laying beyond it, etc. The assistant engineers commence cross-sectioning these points, and then extend their work to the points next to be occupied by the contractors until the entire work is cross-sectioned or staked out. The notes of cross-sectioning made in the field may be kept in the form, Fig 26.

In calculating quantities of excavation and embankment several methods are in vogue, some aiming to approximate the prismoidal formula and to compensate for curvature; the general practice, is, however, that known as averaging

---

\*The various standards for roadbed, track bridges, etc., are discussed in another chapter, only the actual work of construction being considered here.





the cross-sectioning, the division engineer will be examining the country to the right and left of the line to ascertain the area and nature of the territory to be drained, and thus be enabled to decide on the size of openings for bridges, culverts, etc. At this time he will also decide on the changes, if any, to be made in water courses, ravines, etc., to reduce the number and size of openings, if possible.\*

In deciding upon the size of openings the engineer must rely on his local knowledge; he must take into account the height of freshets, the cross-sections of streams at high water and the rate of fall of streams or valleys. This is one of the engineers perplexing problems; he does not want to have embankments washed out after the road is opened for business; neither does he want to build unnecessary bridges. The best he can do in a new country is to compare his opinion with the data given and size recommended by the engineer on location and preliminary survey, and act upon his best judgment.

The division engineer prepares a bill of material for all bridges and openings on his division and gives the location of each; these he sends to the chief engineer so that the material can be forwarded without delay.

---

\*There are engineers who use a formula to determine the size of openings for culverts and bridges, based on the area drained; as, however, the slope of the area drained, the porosity of the soil and other variable or unknown quantities cannot be taken into account in any formula, it is of doubtful value. The subject is one about which little is known even for cities where the size of sewers depends on it, and a formula good for one locality is worthless for another.

The first work of the contractor is to clear and grub the right of way; stumps and logs are removed from under embankments, but where the embankment is to be more than three feet in height, no grubbing will be required, cutting the stump off close to the ground will suffice.

The estimates for material for track, bridges required to be erected by false work, buildings, shops, etc., are made in the chief engineer's office, and the division engineer often has nothing to do with such work except to give track centers over his division.

At the point or points where the new line connects with a railroad, material yards are established, and in these the material for track, buildings and bridges, etc., is assembled, each kind of material being piled separately.\*

The methods adopted by contractors to do the grading depend, of course, on the nature of the material and the size of the cuts and fills.

Where embankments are light, i. e., fills not over ten feet, the material is generally taken from borrowpits on each side of the embankment leaving a berme† of not less than five feet between the bottom of the slope and the borrowpit. In this class of work the earth in the borrowpits

---

\*It sometimes occurs that material for large trestles or false works, or for use in cases where a number of streams cross the line close together, is hauled across the country from some other railroad to the place where it is to be used thus enabling the work to be done ahead of the tracklayers and so preventing delay.

†The "berme" is the space between the base of an embankment and the inside edge of the side ditch.

is loosened with a plow, and drag or wheel scrapers are used to haul it to place. (See Figs. 27, 28, 29, 30, 31, 32, 33, 34.)\*

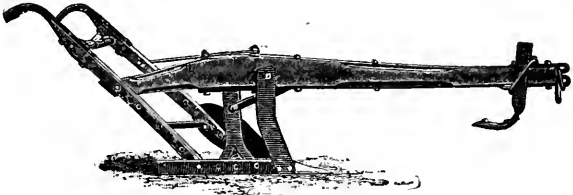


FIG. 27.

GRADERS' PLOW.

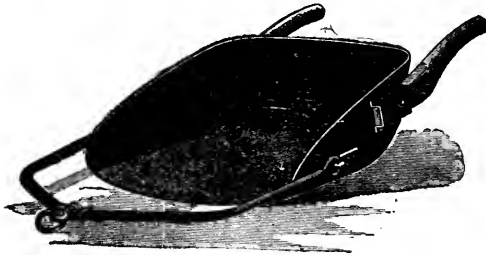


FIG. 28.

DRAG SCRAPER.

---

\*There is being introduced for this class of work machines known as "elevator graders and ditchers." These machines are drawn by six or more horses, and in suitable earth excavate the material in the borrowpit, elevate it and dump it in the embankment or into wagons (see Figs. 36 and 37.) The objection to making embankments direct from borrowpits with this machine is that the earth is loose in the embankment, and, consequently, great shrinkage ensues. Where, however, the machine loads wagons and they haul the dirt to the embankments this objection is removed. Embankments four to six feet high have been successfully made with this machine by having teams pulling harrows and rollers on the embankment to pulverize and compress the earth delivered on the embankment by the machine.

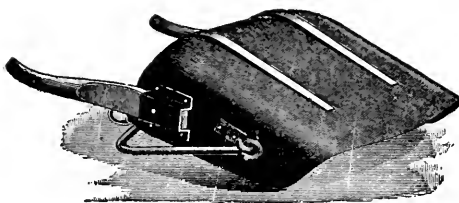


FIG. 29.

DRAG SCRAPER WITH RUNNERS

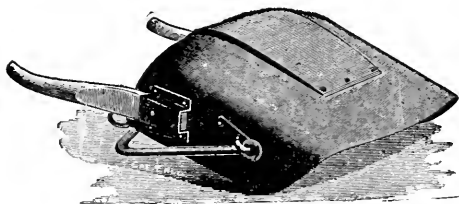


FIG. 30.

DRAG SCRAPER WITH BOTTOM PLATE.

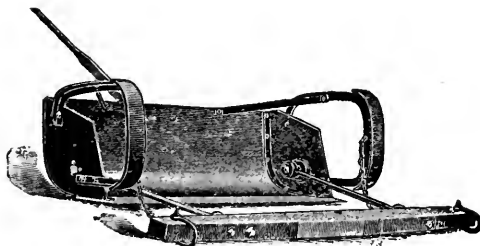


FIG. 31.

BACK SCRAPER.

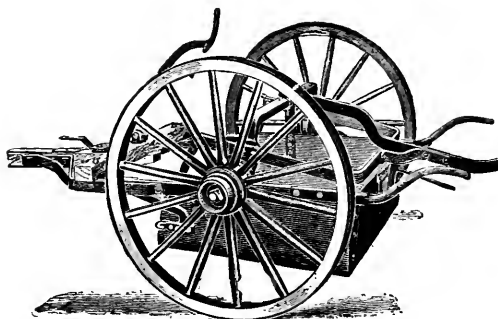
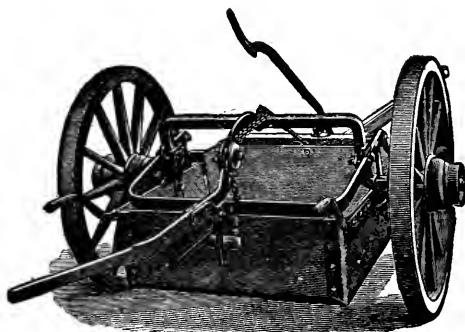


FIG. 32.

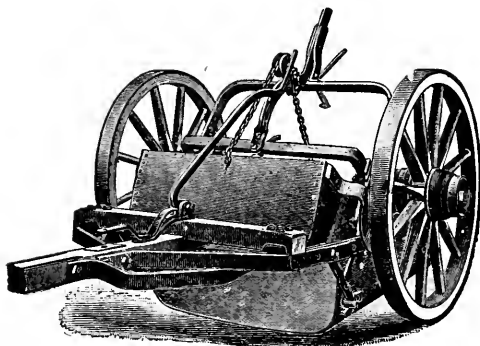
TWO-WHEELED SCRAPER.



END GATE CLOSED.

FIG. 33.

TWO-WHEELED SCRAPER.



End gate open.

FIG. 34.

TWO-WHEELED SCRAPER.

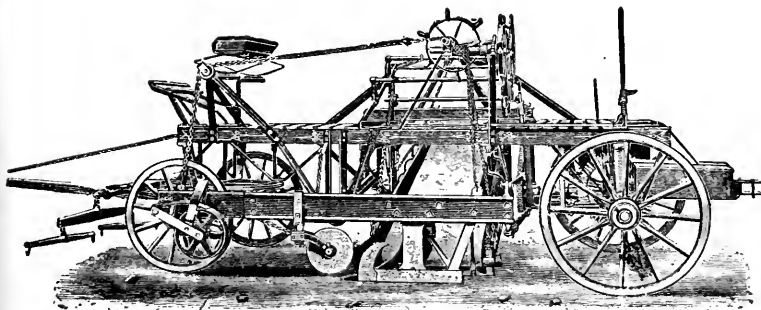


FIG. 36.

SIDE VIEW OF GRADER DITCHER AND WAGON LOADER.

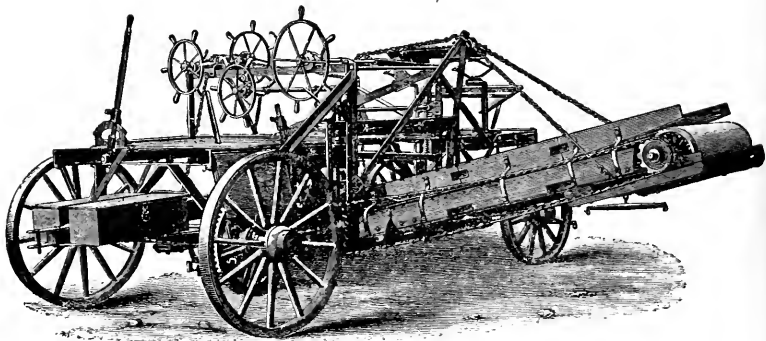


FIG. 37.

REAR VIEW OF GRADER DITCHER AND WAGON LOADER.

Heavy fills are generally made wholly from material excavated close by, but where the location has been made with the view of avoiding cuts as much as possible, the heavy fills will have to be made with material from borrowpits. In this case the bottom is put in with material borrowed on each side of the road and at the point of heavy fill; the top is made with material borrowed at the end near grade and hauled out on the top of the embankment and is built up in lifts of two or three feet at a time; the top material for the embankment is taken from the cut at the end, which is widened or used as a borrowpit on the side from which snow will come. Where the length of haul is considerable, four-wheeled scrapers, wagons and carts are used (see Figs. 39 to 44.)



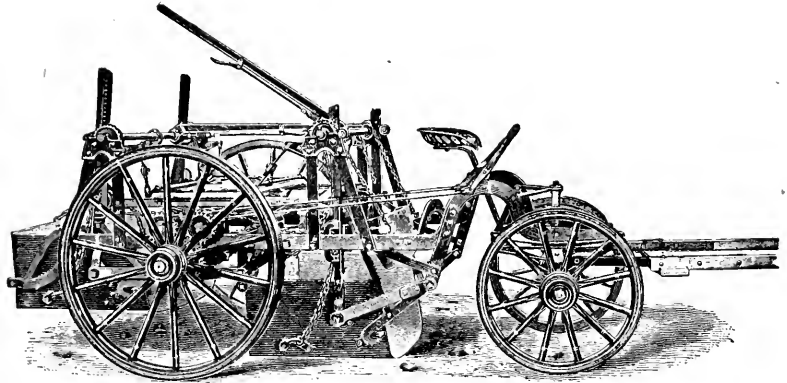


FIG. 39.

FOUR-WHEELED SCRAPER IN POSITION FOR LOADING  
FRONT PAN.

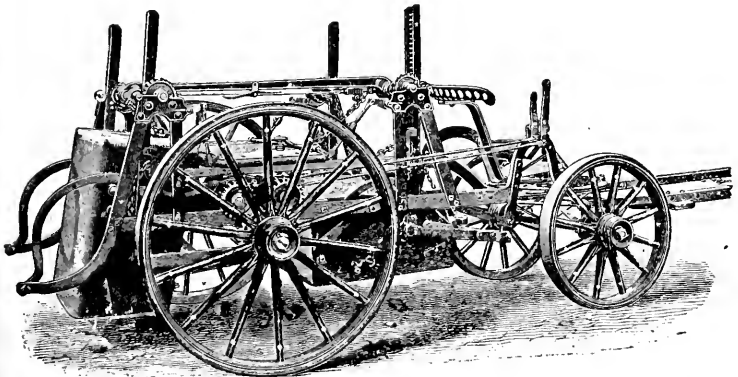


FIG. 40.

FOUR-WHEELED SCRAPER. REAR PAN DUMPED.

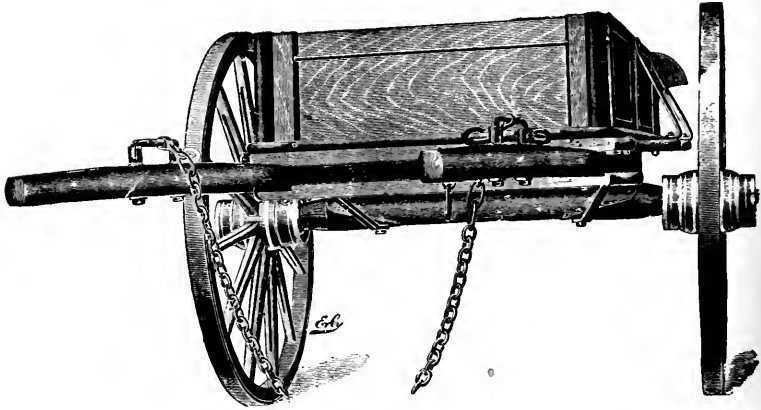


FIG. 41.

TWO-WHEELED DUMP CART.

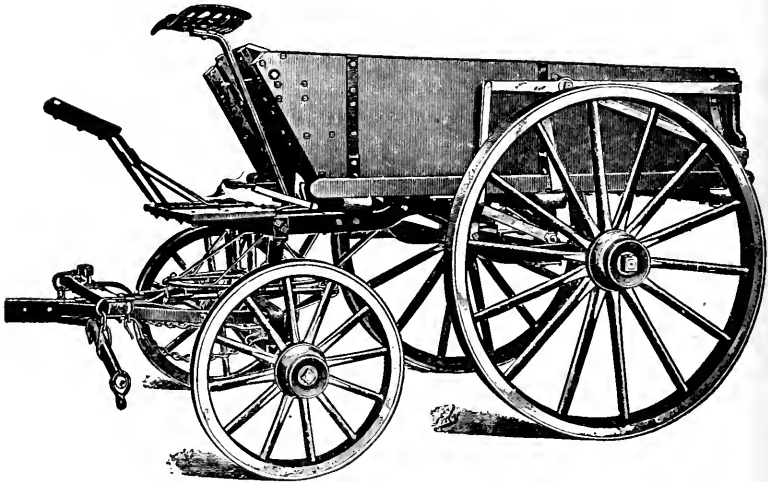


FIG. 42.

END DUMP WAGON.

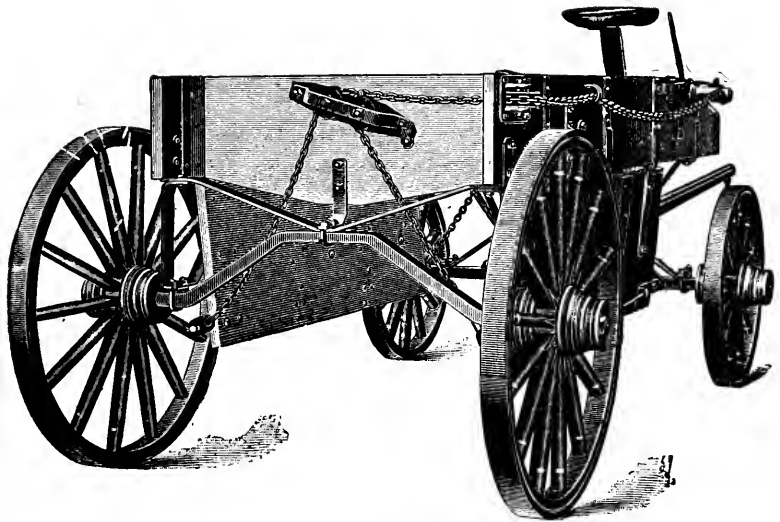


FIG. 43.

BOTTOM DUMP WAGON.

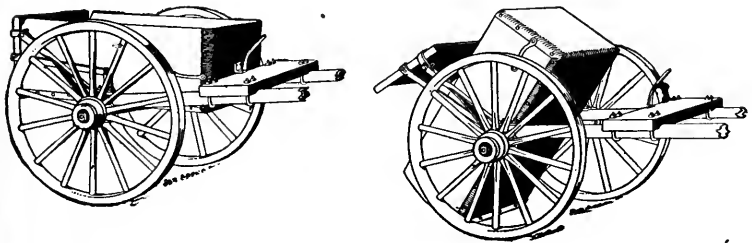


FIG. 44.

IRON END DUMP CART.

Embankments must be built up regularly, and carried up their full width as they progress, to ensure uniform settlement. The degree of settle-

ment of an embankment is an uncertain quantity, depending on the kind of material and the state of the weather when the work was done; if wet, the embankment will be more compact than if the weather was dry. The manner of doing the work also affects settlement, thus, if embankments are put up wholly with drag scrapers from the sides they will be the most compact; if put up by wheel scrapers from the side they will be less compact, while the poorest embankment is made by wagons and carts hauling from a cut or borrowpit at one end and building the bank in lifts of two or three feet at a time, the empty wagons returning on the top of the embankment. Wagon and cart embankments settle the most.

Frosted or frozen material, especially clay, should never be put in an embankment, unless provision is made to meet excessive and uneven settlement under the tracks afterwards. In case frozen clay is used, the embankment is liable to slide out laterally when thawing takes place. Stumps, logs and brush should never be allowed in an embankment.

The matter of providing for shrinkage on a new bank is largely one of individual opinion, based on experience. A good practice is to build the embankment so as to allow a shrinkage of one-tenth, i. e., an embankment in a ten-foot fill should be built eleven feet high. The bank should be the full width at the top and carried out full to the slope stakes at the base, and no sags should appear in the slope between the top or grade and foot of slope. In Fig. 45 the dotted

lines show how contractors will skim an embankment where material is scarce, the haul

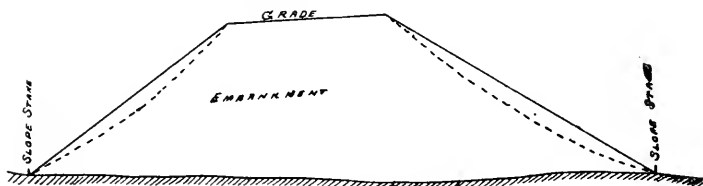


FIG. 45.

Embankment; built full width at grade and out to the slope stakes.

long, or the embankment high. Particular care must be taken at the bridges to have the ends of embankment, and also the slopes full. A good practice is to get more earth into an embankment than the section requires, especially at bridges, thus allowing for shrinkage and washing down of material. It must always be borne in mind that the cheapest material put in an embankment is that put in by the contractor before the track is laid, though this can be carried to extremes and be made to unduly increase the cost.

The material should be paid for as measured in excavation, and this is not only fairer, but makes the contractors' interests correspond largely with those of the owners.

In cases where an embankment has no openings through it except arched culverts and cast iron pipe drains, the addition of one-tenth per foot for shrinkage, as indicated, will increase the grade gradually at one end of the cut and decrease it gradually at the other, but this will cause

no inconvenience in operating trains. Where, however, there is an opening for a bridge, trestle or open culvert, the structure must be put at the established grade, and the embankment sloped off gently at each approach, so that trains will not drop suddenly from the embankment on to the bridge. The practice of building an embankment with shrinkage added and then putting the bridge to a grade to correspond with the top of the embankment as built, is faulty; the effect is to change the grade permanently and lose the object sought in giving shrinkage to the embankment.

Cuts are not handled by contractors in the same way as embankments; their methods vary according to the kind of material to be handled; whether the material must be placed in embankment or wasted; and the ingenuity of the contractor.

Contractors prefer, as a rule, to waste the material near the center of cuts, where the cuts are light and the material from borrowpits is convenient to the embankment. Engineers on the other hand may wish the excavated material all placed in the embankment rather than unnecessarily disfigure the landscape in a thickly settled country; they may decide it is cheaper to pay overhaul \* when necessary, than purchase extra right of way for borrowpits; or they may not wish the material wasted on the sides of cuts where the soil is liable to slide back into the cut or in-

---

\*The term "overhaul" is used to designate the length of haul in excess of the agreed length of free haul.

terfere with surface drainage. The length he has to haul material is a vital point with the contractor. The length of free haul that the con-

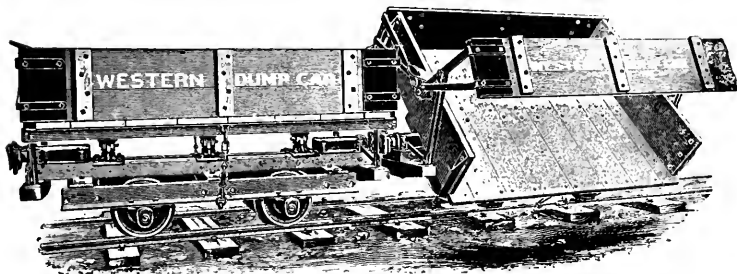


FIG. 46.

RIGHT AND LEFT HAND DUMP CARS.

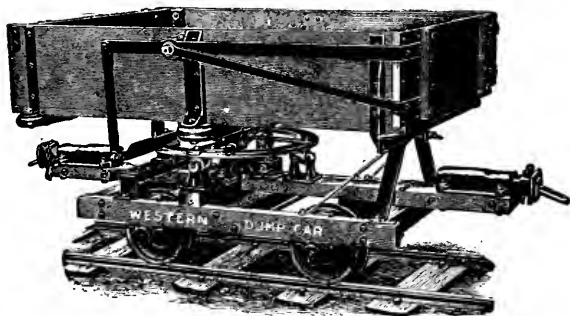


FIG. 48.

ROTARY DUMP CAR.

tractor must perform is decided upon in advance, and is known at the time the work is bid upon; a price is also agreed upon for each 100 feet that material is hauled in excess of the free haul.\*

\*The length of free haul is different with different roads, but one thousand feet is often adopted.

Earth cuts are handled in much the same manner as described for excavations for borrowpits. For large earth cuts the contractor often lays a narrow gauge track, and conveys the material in dump carts hauled by horses or a steam engine, as shown in Figs. 46, 48 and 49. The earth is

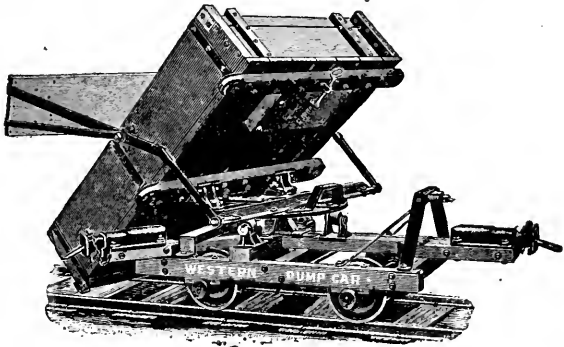


FIG. 49.

VIEW SHOWING THE METHOD OF DUMPING A  
ROTARY DUMP CAR.

excavated and loaded into the cars by picks and shovels or steam shovels, according to the extent of the cut (see Figs. 51 and 54). Where loose rock is encountered the work is conducted in much the same manner as earth. Hard pan is a cemented gravel, and is found in all stages of hardness from earth to solid rock; however, the latter occurs but seldom. It occurs sometimes in mass and again in veins from a few inches to several feet thick; as generally found it can be broken up with a specially designed plow (see



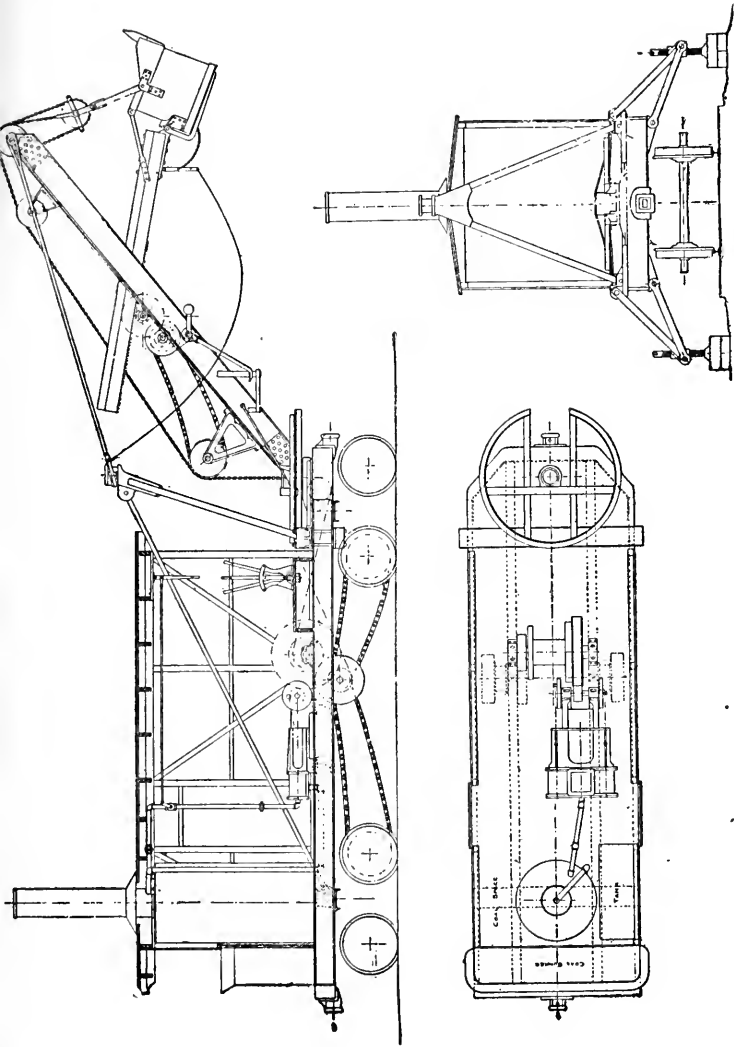


FIG. 51.

PLAN AND SIDE AND END ELEVATIONS OF A STEAM SHOVEL.

Fig. 55). If it is extremely hard, it is often blasted by explosives, but it does not break up

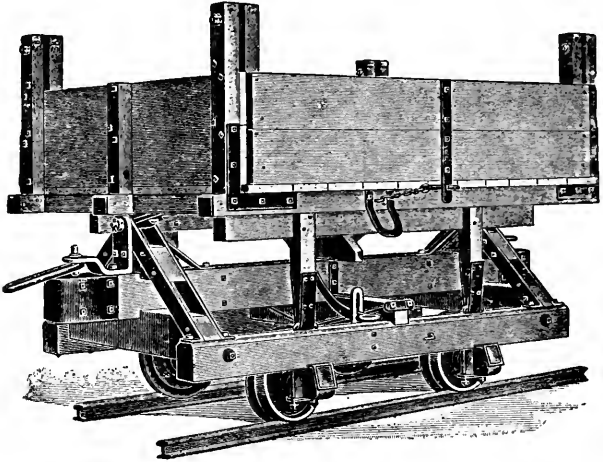


FIG. 54.

STEAM SHOVEL CAR.

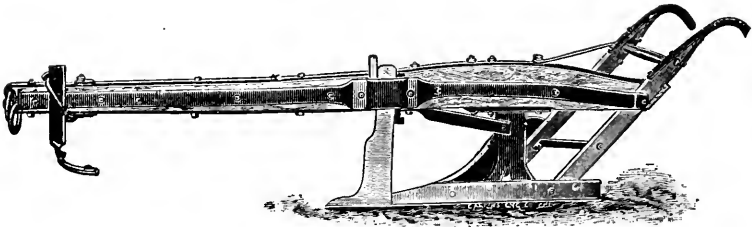


FIG. 55.

HARD PAN PLOW.

well; it "blows out," to use a grader's expression, in "hatfulls." It is sometimes removed by steam shovels where the deposit is large enough to warrant one being installed. Solid rock excavation

affords the contractor opportunity to exhibit his skill; a cut which has been cross-sectioned for earth when solid rock is encountered, must be re-cross-sectioned for rock. (See Fig. 56.)

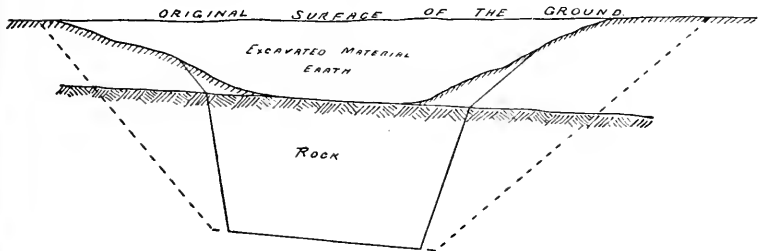


FIG. 56.

SHOWING THE SLOPES FOR AN EARTH CUT.

The dotted lines show the slopes for an earth cut. The full lines show the slopes for a rock and earth cut.

The methods adopted for removing rock from excavation may be stated in a general way as follows: Blasting with powder or any other convenient explosive, and reducing large pieces by block holes and small charges.\*

It is often found cheaper to use explosives plentifully and blow the upper part of the cut out beyond the slopes, so it does not have to be handled.†

\*The better way and cheaper is to arrange a ginpole or cheap derrick in the cut, and hoist the large pieces on to a damp cart frame, of which the sides are removed, and only break up the extremely large pieces by block holes and blasting.

†An extreme case of handling rock in this way occurred some years ago. Galleries were blasted out in the cut as in a mine, and a carload of powder used at one charge, blowing practically all the rock to be excavated beyond the slopes.

Where explosives have been used freely to break the mass of rock, steam shovels are sometimes used to load the broken mass on cars. The cars, carts, and wagons mentioned and illustrated are used in handling rock.

When building an embankment with rock, it is generally safe to calculate that the material in the embankment will occupy twenty-five per cent. more space than it did in the cut; it is also safe to use slopes of one and one-quarter horizontal to one vertical. But great care must be taken in building the embankment to keep the slopes at both the end and on the sides of the dump as even as practicable, so that the stones when dumped do not catch on each other and form holes thus honeycombing the bank. Should this take place it is liable to cause settlement of the bank under the track; if it is on the slope the stones will in time slip and take their natural position causing the side of the bank to slide from under the track. To prevent this long poles must be kept at a convenient place on the dump to be used by men standing to one side of the rocks lodged on the slope and bear them down without being themselves in the line of the sliding rock. This provision must be made when large masses are put in the dump, but it is not so necessary when stone is loaded in carts and cars by hand.

Rock dumps should not be brought to grade, but should be built to within three feet of grade and stone placed by hand to fill the openings; this should be followed by a course of smaller

stone, and on this should be placed spauls\* to bring the embankment to grade.

Tunnels should be avoided wherever possible; they are expensive to construct and maintain. The alignment requires great care in the instrument work, and a high grade transit must be used. While it is not always possible to lay a tangent through a tunnel, yet curves should not be used until it has been thoroughly demonstrated that a tangent is not possible without greatly increased cost; there should never be a level grade through a tunnel. In the construction of a short tunnel, the drilling can be done by hand at less expense than by compressed air drills. The conditions met with are so various and call for so many different methods to overcome the difficulties that no attempt is made here to go into detail.†

In a general way, however, it may be stated that the methods of excavating are as follows:

*a.* Excavation may begin at the bottom and proceed upward, or,

*b.* Excavation may begin at the top and proceed downward.

*c.* The entire area of the tunnel may be excavated.

*d.* A heart, kernel or core may be left standing. The methods of timbering may differ, as for instance:

---

\*"Spauls" are the small stones produced by blasting or the larger stones broken by sledges.

†For more exhaustive information the reader is referred to the work on tunneling by Henry S. Drinker, E. M.

- e. The tunnel may be supported by rafter timbering, or,  
 f. Longitudinal bar timbering may be used

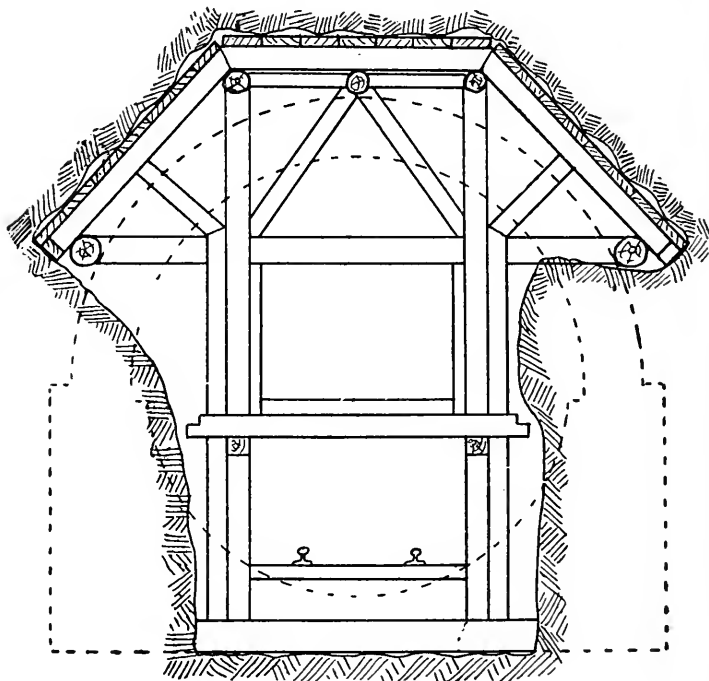


FIG. 61.

EXAMPLE OF CRISTINA METHOD OF TUNNELING.

The manner of building the masonry may differ, thus:

- g. The masonry may be begun at the foundations and the abutments erected before the arch, or,

*h.* The arch may be turned first and the abutments built last.

The engineer in charge of a tunnel must keep constantly in mind that there is always a pressure, more or less great, on the false work exerted by the material composing the hill or mountain in all directions—bottom, top and sides. In Europe there are five general methods used to support the roof of the tunnel during construction; they are known as the English, Belgian, German, Austrian and Cristina. The last has been used by Italian engineers in the Alps, and is fairly illustrated by Fig. 61. The other European methods have as many timber braces, etc., but the arrangement is different; the reader is referred to the work mentioned previously for the details of them.

One of the methods adopted in America is illustrated in Fig. 62. It was used on the Cincinnati Southern Railway. Air compressors and drills are illustrated by Figs. 63 and 65.

To hasten the construction of tunnels, shafts are often sunk and the work carried on from both sides of the shaft. Where shafts are used or at the end of a tunnel where the grade descends into the tunnel, pumping plants of liberal capacity must be installed to enable the working head to be relieved promptly of water, should a large quantity be encountered. The masonry will consist of the foundation, invert, abutments and arch; they must be of the best material and workmanship, laid with thin joints and paralleled beds or courses. The backing must be thorough-

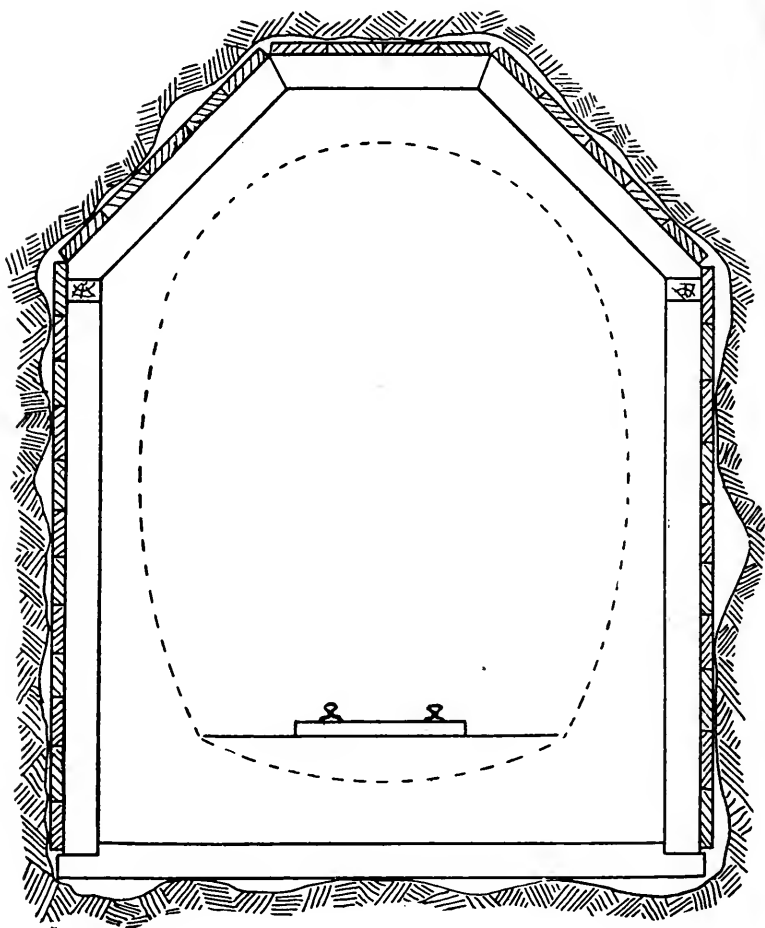


FIG. 62.

EXAMPLE OF AMERICAN SYSTEM OF TUNNELING



ly rammed between the rock or soil and the masonry, so that the pressure will be uniformly

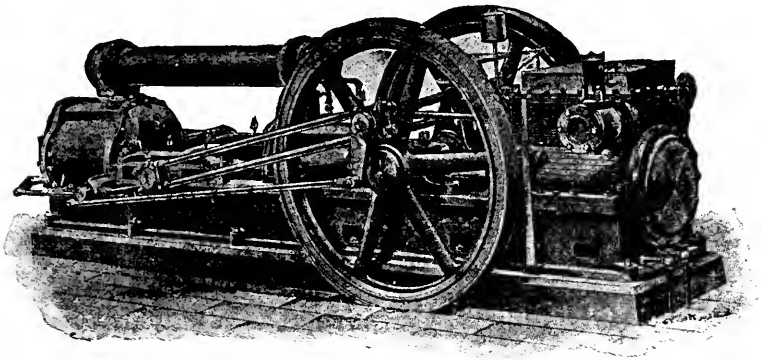


FIG. 63.  
AIR COMPRESSOR.

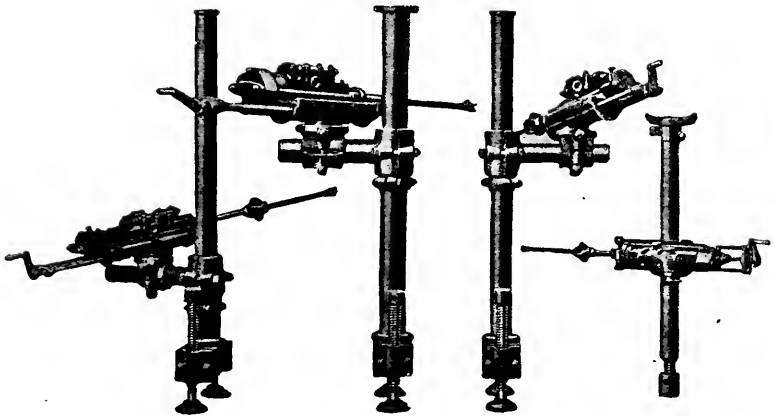


FIG. 65.  
ROCK DRILLS FOR TUNNEL WORK.

distributed over the masonry. Openings must be left in the masonry for drainage, and recesses

must be made at intervals for workmen to use when trains are passing through the tunnel. If the tunnel is long, provision must be made for ventilation; this is a difficult problem, and the methods tried have been numerous, such as shafts, a division of a double track tunnel by a partition, stacks with a fire at the base, blowers operated by steam, compressed air or water power. Fig. 68 illustrates the method of ventilating the Mont Cenis Tunnel.

Attempts have been made in Europe to use iron framing to support the roofs of tunnels, also for centers for the masonry; the methods are known as the *Menne* and *Ržiha* Systems. The inventors claim they are successful, but while timber is plentiful in America, these systems are not likely to be extensively used.

The Detroit River Tunnel for the Michigan Central Railroad is a case in which the tunnel was excavated by the use of a shield and compressed air, and the tunnel lined with cast iron made in segments of a circle and bolted together as put in position.

Earth banks, at all openings, bridges, crossings of streams and places where the water at any stage of a stream or river reaches the embankment should be protected by rip rap;\* the amount of rip rap used need not be alike in all cases, but a good failing and one not often made is to have too much. This rip rap should be a good hard stone of the largest size that can

---

\* "Rip rap" consists of broken stone placed on an earth bank to protect it from the wash of a stream or the action of waves.

be handled, and should at no place be less than two feet thick measured at right angles to the slope.

Where a railroad parallels a river which is subject to ice gorges and the ice floes are large, the rip rap should not be less than three feet thick, measured at right angles to the slope; in such cases, however, the opinions of experienced men differ regarding the size of rock to use.\*

Retaining walls should never be built too light. A safe practice is to make a retaining wall three feet thick at the top and batter the face three inches to the foot, or offset the back one foot to each four feet of height. Thus, a retaining wall fifteen and one-half feet high would be six feet ten and one-half inches thick at the base where the batter is made on the face, and where it is built by offsets on the back it would be six feet thick at the base and three feet thick at the top under the coping (see Figures 69 and 70).

---

\*A case in point was where a large river in the Atlantic Coast States of North America was paralleled on one side by a canal, and on the other side by a railroad. The railroad company used large stone hoisted on to dump carts by a derrick for the rip rap with the interstices filled with smaller stone. The canal company used for rip rap what is known by quarrymen as "one and two men stone" dumped without placing by hand. During an ice jam in the river, the railroad embankments at numerous points were carried away by the ice floes catching on the large rock and carrying the rock out of position. The action of the ice on the canal embankments was to displace the small stone where the large floes struck it, and the stone above at once slid down and replaced those carried away; the canal embankments were not damaged to nearly as great an extent as those of the railroad. The theory of the Superintendent of the canal was "*small stone make the best rip rap to stand an ice jam if you have enough of them.*"

Openings should be made in the wall to allow water to escape, if there is any indication of its being likely to collect behind the retaining wall. Figure 71 shows how contractors will take out a cut if not looked after.

Drainage is one of the main features the engi-

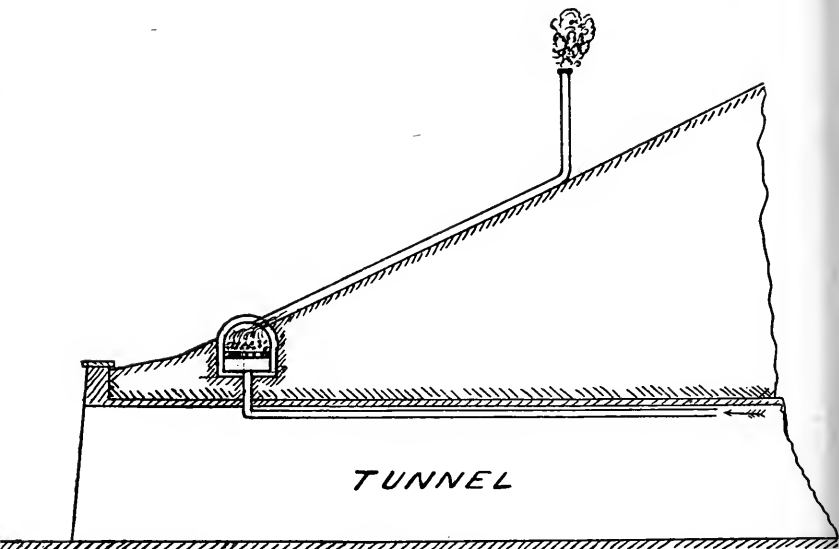
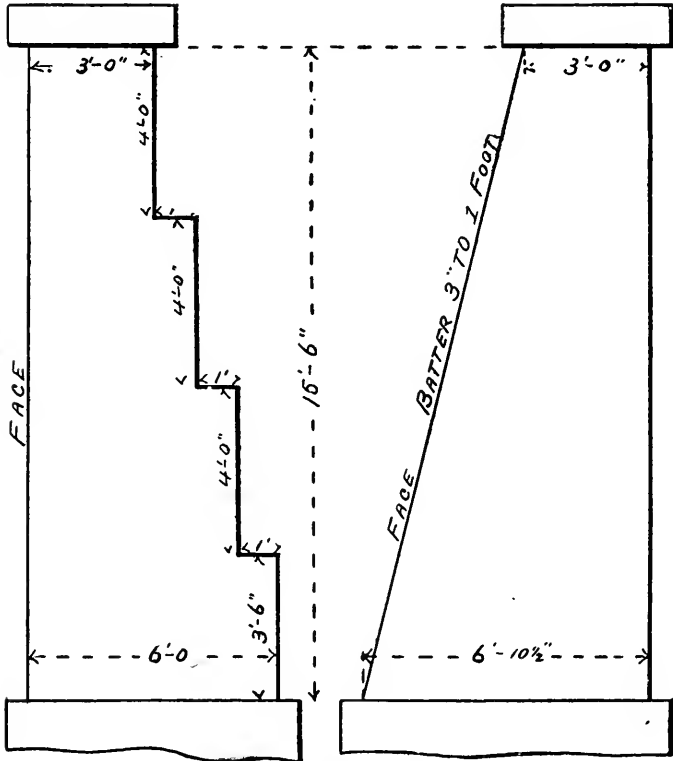


FIG. 68.

VENTILATION OF MT. CENIS TUNNEL.

neer must keep in mind; he must never lose an opportunity to get a dry road bed; all cuts should, therefore, be made with a grade through them; the character of the material through which a cut is made must carefully be examined, for if a water bearing strata of clay or gravel exists, prompt meas-

ures must be taken to prevent slides. This is done sometimes by making trenches up the slope at intervals through the cut and filling these trenches



FIGS. 69 AND 70.

RETAINING WALLS.

with small stone leading to the side ditches, or, better still, by putting in an under drain. Ditches well back from the slope must be made to carry

off the surface water to the end of the cut, and not allow it to pass down the slope into the cut. Borrowpits must be connected by ditches to give drainage to openings, and, where there are no borrowpits, ditches must be made to protect embankments from being washed by water coming down slopes. Where ditching is resorted to, to reduce

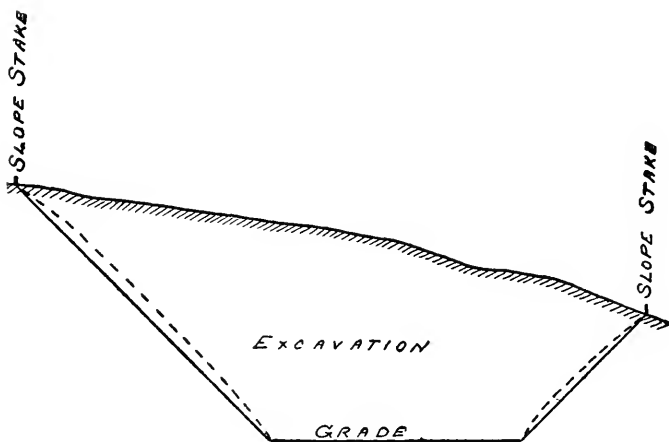


FIG. 71.

Showing how a cut can be full width at grade and the material taken out at slope stakes and yet all the material will not be excavated.

openings in embankments, ample berms must be left and the changes in direction made by easy curves. Where water is allowed to come down slopes against an embankment and flow off by a ditch through a knoll, the embankment must be reinforced by earth and, if possible, stone in sufficient quantity to keep the embankment from being softened by the water standing against it.

It must never be forgotten that a well drained roadbed is affected less by frost in winter, damaged less in rainy seasons and costs less to keep in good order.

The practice is to use cast iron pipe of the style used for water mains in cities, for culverts and small pile bent bridges; some roads, however, use wrought iron pipe for this purpose. Cast iron is admitted to stand corrosion better than iron or steel, and in time will probably be used to the exclusion of iron or steel riveted pipe.

Streams of considerable size can be carried under or through embankments by using several lines of large sized cast iron pipe, and building retaining walls of masonry or concrete at each end of the culvert. Care must be taken to have the earth packed firmly around the pipe and against the retaining walls, so that the water will be forced to pass through the pipe, and not be permitted to wash away the embankment. This applies with equal force to stone arched and open culverts.

Where stone cannot be secured to pave the spillway\* at the discharge end of cast iron pipe culverts, the original sod must not be disturbed for a distance of at least twenty feet on each side extending across the entire right of way. This is a choice point for the contractor to use for a borrowpit, and must be looked after closely.

Spillways and spaces between the walls of stone arched culverts and open culverts must be carefully paved with stone not less than eighteen

---

\*A "spillway" is the outlet of a culvert or drain.

inches long, set on end and close together, the interstices being filled with spauls.

All open culverts, bents of pile and trestle bridges and abutments of bridges should be at right angles to the track. If for any reason this cannot be done, the bridge seat must be so arranged that the end of the bridge will be at right angles to the track.

The location of the bents for pile and trestle bridges must be carefully made; this requires the center line of the railroad to be given for each bent, the axis of the bent transversely to the line of the railroad; and these points must be carefully referenced by hubs which will not be destroyed by contractors, workmen or timber haulers. In giving the location for driving the piling and the cut off for the piling, the work must be done deliberately and carefully, and all work of line and elevation re-run and checked.

Bridge abutments and piers require the greatest care in location; steel tapes only should be used, and they should be used with a spring balance. The tape should be stretched on a level piece of ground to the same tension and two hubs driven at the distance measured on the sight of the bridge and the distance measured between the hubs. Generally the length of spans is decided upon first. In such case the length of the spans should be carefully measured on level ground and hubs driven at the proper distances, and the measurement with a long steel tape and balance taken in the reverse order mentioned. Where the streams are of considerable width, the piers will have to



be located by triangulation, using a high grade transit for the purpose.

The foundations for pile and trestle bridges are secured by driving piles in the ground and sawing

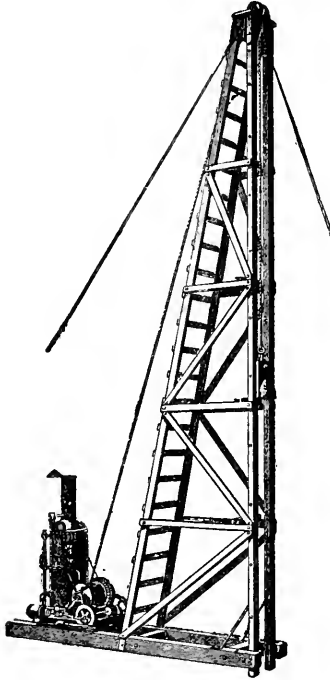


FIG. 72.

STEAM PILE DRIVER.

them off at the proper elevations for the caps of pile bridges and sills of trestle bridges; figure 72 gives a view of a pile-driver. The experience of the engineer is called into play to decide when

a pile has been driven sufficiently; the timber in a pile can be shattered by over-driving so it will possess very little strength to support a load; neither will it support the load if not driven sufficiently. Rules are given by Trautwine, Wellington and others regarding this subject; a rule much in use is to stop driving when six blows with a two-thousand pound hammer falling a distance of twenty feet fail to drive the pile over one inch. This rule, however, must be used with judgment. There have been cases where piles would settle a foot at each drop of the hammer, and, if left over night, they could not be started by the hammer, and yet these piles are today successfully supporting heavy trains on a trunk line.\* Again there are frequent cases where piling could not be secured of sufficient length to reach the bottom of the soft strata of cedar and tamarack swamps where the material did not possess the property of closing around a pile and supporting it as in the preceding case. In such cases the support for the roadbed has been secured by laying long logs transversely to the line of the road close together, and building an embankment on them.† There are yet other cases where the soil is of a nature that during a prolonged season of dry, hot weather the soil becomes so hard that a pile is with difficulty driven into it, yet during the rainy season this soil becomes soft and spongy. Great

---

\*This case was in marshy ground where quick sand settling around the pile gave it the necessary support.

†This is known as corduroying a swamp.

difficulty is encountered in such soils to get the piling down a sufficient depth during dry weather to support the load during wet seasons and not shatter the pile by overdriving.

The foundations for abutments and piers are secured in a number of ways; in a general way they can be given as follows:

(a) Where a pier is built outside of a stream during low water the earth is excavated below the water line, or to the rock; the water is kept out by pumps; where rock is not reached or a firm soil capable of bearing a weight of four to five tons per square foot, piling is driven, the tops sawed off and a timber grillage\* built on top to carry the masonry. Recently a mass of concrete about six feet thick, in which the tops of the piling project three feet, has been used instead of timber grillage.

(b) Where a pier is located in a stream of moderate depth of water, sheet piling is driven in two rows around the foundation, and the space filled with clay and rammed tight and the foundation secured as described above. In greater depth of water, piling is driven and the tops sawed off level at or near the bed of the stream, and a caisson sunk on to the piling and the masonry built in the caisson. Where the bed of the stream is rock, the foundation has been secured by making the bottom of the caisson to correspond with the irregularities of the rock and sinking the caisson

---

\*"Grillage" consists of square timbers placed on top of the piling to distribute the weight of the masonry evenly on each pile.

directly on to the rocky bed of the stream. Where there is great depth of water or an alluvial formation subject to changes of channel by floods, the pneumatic caisson is resorted to.\*

All piers and abutments require rip rapping and other necessary measures taken to protect them from damage by ice where the stream is subject to ice jams.

The masonry for piers, abutments and culverts, need not be of a quality known as first-class; but it must be well bedded and bonded and built solid, no voids being allowed. The bonding must apply to the backing as well as the face stone, so as to approach as near as possible to a monolith. The stone used should be large and the coping thick, and of a quality which will not deteriorate on exposure to the weather, or crush under the weight which it will have to support.

Where a stream is shallow, and subject to sudden overflow and drift, which would carry away false work, low water tracks are used to extend the road. These low water tracks leave the located line at each side of the valley and when possible are laid parallel to and a sufficient distance from the located line, so that they can be used to deliver material required for constructing the bridge. The low water track is carried across the stream on a low trestle securely anchored to the bed of the stream so that when a rise in the river takes place it will not be washed away. This low water track permits the rapid extension of the line and gives

---

\*This is a large subject and the reader is referred to the literature treating of it mentioned hereafter.

facilities to forward track and construction material, and it has even been used in operating the road for some months before the bridging was completed. High water in streams of this nature seldom interferes with the operating of trains for more than a few hours at a time, and the drift would carry away any trestle bridge or false work which obstructs the stream.

The approach to a bridge from a new bank should be supported on a mud sill; after the embankment has fully settled, piling or masonry can be used to replace the mud sill as desired. Masonry can be saved by omitting an abutment and making the approach to the first pier on a trestle, or better still, a plate girder.

The grade must be surfaced true before ballast is put on; or for track, if the ballasting is to be done after track laying. For this purpose the engineers give center and grade stakes, the grade stakes being placed every one hundred feet on tangents, and every fifty feet on curves. Two grade stakes are required for each center stake; one five feet each side of the center; on curves the grading should be made to conform to the elevation to be given the outer rail. The *inside grade stake to be depressed* as much below the grade line as the elevation to be given the outer rail, and the *outside grade stake to be raised the same amount*.\*

Monthly estimates are made as the work prog-

---

\*This is the method adopted by one of the Eastern Trunk Lines of North America and is believed by some to cause a train to ride more evenly when entering and leaving a curve.

resses and progress profiles made, showing the work done both in excavation and embankment. The resident engineer takes account of the number of men, teams, etc., in each gang as he passes over the work daily and makes a monthly report, as per accompanying form (72A), to the division

COLUMBIAN R <sub>r</sub> Co		STOCKDALE BRANCH					
FORCE REPORT FOR THE MONTH OF							190
THE FOLLOWING NUMBERS OF MEN, TEAMS, ETC REPRESENT THE AMOUNT WORKING ONE DAY.							
SECTIONS	PLOUGH TEAMS	SCRAPER TEAMS	WHEELED SCRAPER TEAMS	DUMP WAGONS	FOREMEN	LABORERS	REMARKS

FIG. 72A.

FORM OF FORCE REPORT.

engineer.\* At the end of each month the resident engineer gives line and grade over all work done during the current month, and the division engineer goes over the work and takes notes of the stations between which work has been done during the current month. The record he keeps is in the following form (72B).

The resident engineer furnishes the quantities

\*This report is generally called a "force report."

in a report to the division engineer, and he compares their quantities with those calculated in his office from the center heights and slope of the ground and with the force account.

The division engineer forwards the estimates for sections and also the force account for sections to the chief engineer, who compares them with the data secured from the preliminary survey

Section No 20		Estimate for June 1899
June 30-1899		R. Jones & Co. Contractors
Stations 1050 to 1060		$\frac{3}{4}$ Earth Exc. $\frac{1}{4}$ Loose Rock
		Retain for narrow cut at
		Stations 1055 to 1060 - 300 cu. yds.
		loose rock.
Stations 1060 to 1065		$\frac{1}{2}$ Earth, $\frac{1}{4}$ loose rock and
		$\frac{1}{4}$ solid rock - Retain for
		high point stations 1062
		to 1064 - 100 cu. yds. solid rock
LEFT HAND PAGE		RIGHT HAND PAGE

FIG. 72B.

FORM OF ESTIMATE BOOK.

and location and what is being accomplished by similar gangs of men on other divisions. By this method all parties are protected from charges of favoritism, and anyone returning the wrong quantities will be discovered; where the surveys have been made as outlined previously, the chief engineer has the means of determining the approximate quantities and classification.

The subject of classification of material is one

about which no two engineers will give the same decision, though they may not materially differ. There is no clearly marked line between earth and loose rock, or earth and hard pan, and there are cases where it is a question whether it is loose rock or solid rock. The method of estimating given here enables a second engineer to examine the work and intelligently criticise the opinion of the one making the estimate. The manner of estimating and calculating quantities varies with different roads. There have been cases where the resident engineer cross-sectioned the work, and each month made a report that the work was completed between given stations. The quantities were calculated at the office of a division engineer, and also the estimates made at the same office from the notes of the resident engineer. Under this method the resident engineer can look after a longer residency; but the force in the division engineer's office is increased and the advantage of a check on estimates between the two offices is lost.

Borrowpits should be cross-sectioned both before work is commenced and after its completion.

The amount to be paid for overhaul is calculated differently on different systems. The method generally adopted is to ascertain the free haul first, and then ascertain the center of mass in the cut beyond the free haul, and the center of mass in the fill beyond the free haul. The distance A. B. (see Fig. 73) less the free haul is the length of the overhaul, and the cubic yards of the mass C.



D. E. and F. in the excavation is the amount hauled. Another method is to find the center of mass of the entire amount in the excavation

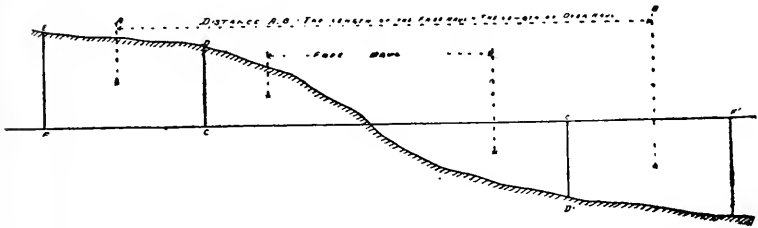


FIG. 73.

VIEW OVERHAUL.

hauled into the embankment, and the center of mass in the embankment (see Fig. 74). From this distance A. B. deduct the length of free haul

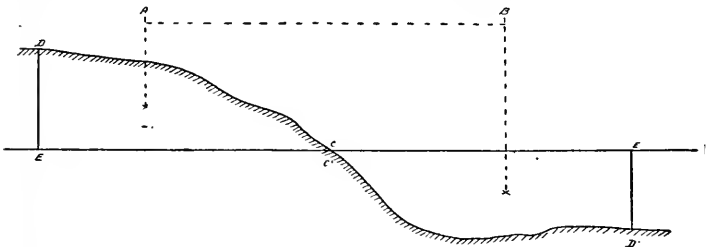


FIG. 74.

VIEW OVERHAUL

and use for the amount overhauled the entire amount taken out of the excavation.

Pipe culverts are paid for by a price per ton miles hauled, and a price per ton for placing, and the excavation for bedding them.

Stone arched and open culverts are paid for at a price per cubic yard for the excavation for foundation, and the masonry; the paving is paid for by the square yard of surface paved.

Bridging with timber is estimated as follows:

Piling is estimated at the length swung into the leads where the railroad company furnishes the bill of material and specifies the length of piling; otherwise the contractor is paid for the length of piling from the point to cutoff. Square timber is estimated by the number of feet, board measure, in the completed structure; a different price is paid for pine and oak, the quantities of each being kept separate. Iron such as bolts, spikes and other wrought iron is estimated by the pound, and cast iron washers and spreaders the same way. False work is sometimes included in the price for an iron or steel bridge; in cases where the railroad company puts it up to get construction material to the front, it is estimated the same as for wooden bridging but the price may be different. Retaining walls are estimated for by the cubic yard. Rip rap is estimated for by the cubic yard.

After the completion of the sections, a careful final estimate is made, but final payment is generally withheld until track is laid over the work.

Cuts and fills having been made, culverts, trestle bridges and false work erected and depot grounds graded a sufficient distance from the junction with the present railroad, the track laying force is in a position to commence work. The division engineers at the front estimate the date

the track layers will reach their respective divisions, and look over their divisions carefully with regard to the amount of material to move, and the forces employed in grading and bridging. Tardy contractors are urged to greater activity and every effort made to secure the completion of the grading and bridging before the track laying forces arrive. The chief engineer comes out over the line to give a personal inspection and hurry forward the work on heavy sections.

The manner in which the track is laid depends

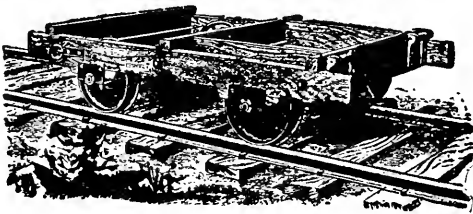


FIG. 75.

TRACK LAYING OR IRON CAR.

on the length of the new road and the character of the country. One method is as follows: A construction train brings the material to the front, and the ties are unloaded and hauled forward with teams, and placed on the grade; the rails are brought to the front on the cars which were used to bring them from the material yard. The necessary quantities of fishplates, bolts and spikes are placed on each car to lay the rails contained on the car. The rails are drawn over the end of the car and placed on a track-laying or iron car

(see Fig. 75). This car is pushed forward as fast as the rails are laid, the joints are half bolted and the rails quarter spiked; when the last pair of rails is drawn off the iron car, the engine pushes forward the train of construction material, and the iron car is reloaded. This operation is repeated until the head car of the construction train has been unloaded of rails, when the entire train is taken back to its siding and the empty car left there, and the next car loaded with rails becomes the first or head car next to the iron car.\* While the above is being done a gang of men is placing the splices or fishplates, bolts, nuts, nutlocks, and spikes. Another gang is throwing off the ties as fast as the teams can haul them ahead, and wherever the grade will permit, the ties are loaded direct from the cars to the wagons. By this method the ties are not hauled over five hundred feet. Behind the construction train is a gang of men completing the spiking. An average of one mile per day has been made in a good country by this method. The construction train at the front is made up as follows: The front cars are loaded with rails, splices, bolts and spikes, there being a sufficient number of cars to contain the necessary material for one day's work. Behind the iron

---

\*Where the run to a side track is too long and will cause delay in delivering track material to the track layers, two iron cars are used and the rails thrown from the cars to the ground along side of the construction train; the train pulls back and the rails are loaded on the iron car, the loaded iron car is taken to the front, the empty one having been taken off the track by being turned over and left standing on its side; the construction train is then brought forward and another lot of rails thrown off to load the second iron car.

cars come the cars loaded with ties; there being enough of these also for one day's work; these are followed by the boarding cars. By this method the only switching required is to set the head iron cars as unloaded on the side track. When the day's work is completed, the train is hauled back to the first siding, and the boarding cars left there while the engine takes the empties to the material yard and returns with another train load for the next day's work. Where the route of the new road is in a rough country which will not permit the ties to be hauled ahead by teams the manner of handling the ties is as follows: Two iron cars are used, the first one is loaded with six to eight rails and the necessary fastenings, and on top of braces placed above the rails are placed the necessary ties to support the rails without bending them while the construction train passes over. This car is pushed to the front by men or hauled by horses. While the track material on the first car is being laid, the second car is being loaded. The empty car is thrown off the track and stood on its side to permit the loaded one to pass. The ties for the iron car are loaded on the car containing the rails in such a manner that the rails can be pulled from under them; the ties to be placed under the rails after the construction train passes over are unloaded as the train proceeds. Behind the construction train there is a gang placing the ties omitted at the front. This gang also finishes the spiking.

In the construction of track, machines for the purpose are used called "Track Laying Ma-

chines." The Holman and the Harris machines are the principal ones. The Holman machine (see Fig. 76) is composed of a series of tramways 30 feet long and about 20 inches wide, fitted with heavy iron rollers. These tramways are attached to the sides of ordinary flat cars, without any changes, and are supported by adjustable iron stakes that fit into the pockets on the sides of the

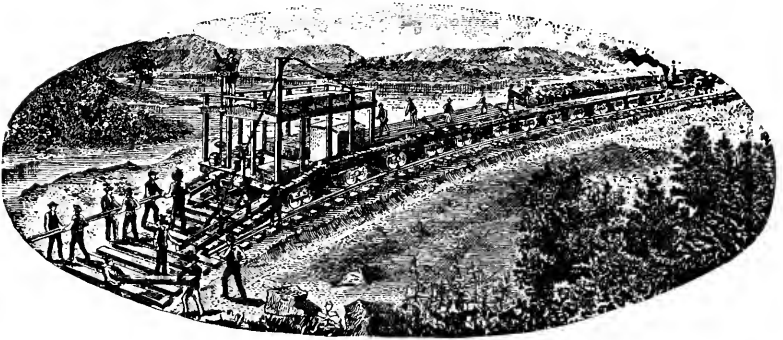


FIG. 76.

HOLMAN'S TRACK LAYING MACHINE.

cars, and, being connected, operate the full length of the train, the same as one continuous tramway. The ties and rails are thrown upon these tramways and rolled down to the front, where men receive and place them in position on the roadbed. The ties come down on the right hand side of the train and the rails on the opposite side. On the tie side, a chute, supported by a wire cable, runs out thirty-five feet in front of the train, which allows the men handling ties to be one panel ahead of the men handling rails

and consequently out of each other's way. A train of ten cars, viz: six of ties, three of rails and the tool car will carry all material required for a half-day's work, and from one-half to three-fourths of a mile of track. One and one-half miles of track per day can be laid with this machine, with from forty to fifty men and a capable foreman, provided the Railroad Company can deliver the material at the front fast enough and in proper shape. (Some expert foremen have laid two miles of track per day.) This includes full tying, laying the rails in position, joint, quarter and center spiking, putting on the fishplates or angle-bars and two bolts through the same. This leaves the track in safe condition for the construction train, and the balance of the work is finished behind the train without reference to or use of the machine. As fast as the panels are laid the train moves forward, 30 feet at a time, carrying all material with it, leaving nothing scattered along the line. The main object of the machine is to dispense with the use of teams in the distribution of material and also to reduce the cost of railway building. On the Northern Pacific Railroad 8,400 feet of track was laid in eight hours actual working time with one foreman and sixty-six men as follows: In front of machine 1 tie man, 8 tie carriers, 2 bolters, 4 spikers, 1 chute man, 6 rail carriers and 2 nippers. On train, 2 men unloading rails, 2 men pushing rails, 16 men handling ties. Behind train, 2 spacers, 8 spikers, 3 bolters, 4 nippers, 4 liners and 1 peddler. On this day the boarding train was about five miles

in the rear; two hours were consumed in going to and from work and making up train, leaving eight hours actual working time.

The Harris machine (see Fig. 77) consists of a

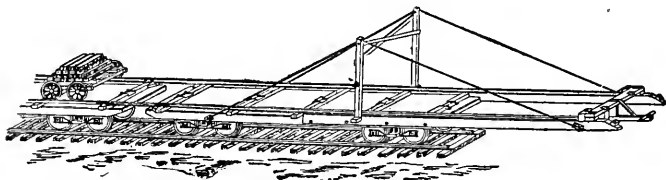


Fig. 77.

HARRIS' TRACK LAYING MACHINE.

continuous tramway or track (about eight feet six inch gauge) laid and spiked firmly upon the top of a construction train of platform cars. Upon this tram track runs a small automatic car, designed for carrying ties. Cast-iron rollers are placed in the center of all cars that are used for carrying rails. In fitting up cars for the machine five ties (ten and one-half feet long) are fastened firmly across each car. Rails are then selected from those to be laid in the permanent track, and spiked to the ties, thus making a track (eight feet six inch gauge) thirty feet long on each car of the train; short adjustable pieces of rails are placed between each pair of cars to connect the permanent rails, and which permit of their easy removal after the train has been unloaded, and their ready replacement again when the next train comes to the front. The front or pioneer car has a frame work or extension permanently fastened to it, which extends the tram track about



twenty feet ahead of the train. Across the front end of these extension timbers is fastened a double roller, about one foot lower than the cast-iron rollers on the pioneer and construction cars, for receiving and carrying the rails after leaving the train. The small automatic tie car has a movable top which unloads the ties automatically crossways the roadbed, enough at a time for sixty feet of track. Rails are loaded on the forward cars of the train, being piled between the cast-iron rollers and the tram track, half on each side of the car. On each car used for carrying rails sufficient joint fastenings, spikes, bolts, etc., are loaded for use of the track laying force in front of the train. The balance of the materials required to finish the track are carried on the tool and supply car next to the locomotive, and are distributed from this car as required. Ties are loaded crossways the rear cars of the train or those nearest the locomotive. Sufficient "short rails" for keeping joints even on curves are carried on the pioneer car, and are always convenient when required. When the train arrives at the "front" it is coupled to the pioneer car (which always remains at the end of the track). The men, in going forward from the tool car (where they generally ride) drop the short connecting rails into place, to make the tram track continuous and the machine is ready for work. There is absolutely no time lost during the day in getting the machine ready for work, or in removing any apparatus when the cars are unloaded. Ties enough for two lengths of rails, or sixty feet of track, are

loaded upon the automatic tie car and run on the continuous track over all the cars of rails to the front end of the extension timbers, when the front wheels of the car come suddenly in contact with the stop block. The top frame of the car (which moves on rollers) suddenly darts forward and dumps the ties instantly crossways the roadbed, and scatters them a distance of from twenty to forty-five feet ahead of the last track laid. The tie car is immediately run back and reloaded with ties, and returns in time for the next sixty feet layout. The ties are immediately put in their right places on the roadbed. Four rails, two for each side of the track are bolted together on the top of the train, and are run from the rollers of the construction cars to the double roller which carries them on a down grade until they are received on the roller of a low trestle or "dolly," which assists in carrying them on the same declining grade to the point opposite where they are to be laid into the track. The men on the ground immediately drop them on the ties and heel them into the angle plates (which have been fastened loosely to the last rails laid). Three ties on tangents and four on curves are quickly spiked, and the train moves forward over the sixty feet of track just laid. The process is repeated until the work is finished. The balance of the spiking, bolting and lining the track is performed after the train passes over it. When it is desired to lay a track at a speed of two and one-fourth or two and one-half miles per day, or at a speed of only one or one and one-fourth miles

•

per day, the above method of working the machine is varied somewhat to suit the circumstances. On the Chicago, Kansas & Nebraska Railway an average of 2.16 miles of track per day was made in laying 288 miles of track. The maximum grade was 52 feet per mile. The train was made up as follows for one-half day's work Harris Track Laying Machine:

5 cars of steel—76 rails per car.

5 cars of ties—270 ties per car.

10 cars of ties—for back filling two engines, one tool car, one caboose, one car of crossing plank, one car of telegraph material.

The force employed consisted of one foreman and 139 men as follows:

10 men on the cars delivering the ties over the front of the machine.

10 men on the car delivering the steel over the front of the machine.

35 men in front of the machine placing ties, handling steel, putting on fishplates ( $\frac{1}{2}$  bolted) and spiking two ties to a rail.

14 men handling ties out of the cars, and on the grade, placing them under the steel behind the train.

60 men back spiking and bolting.

5 men lining track.

5 men surfacing track.

The telegraph line was kept up with the track layers, poles were placed thirty to a mile; there were two wires put up. The force consisted of:

8 men digging holes.

3 men setting poles.

1 man putting on cross-arms.

1 man on the train distributing material.

2 men stringing wires.

The methods above described are varied according to the opinions of track laying foremen; the ties can be hauled by teams if desired where either machine is used. The track may be only half tied ahead of the construction train and other ties put in behind the train; these ties can be brought to the front by another train, thus lightening the load on a heavy ascending grade. The skill of the track laying foreman is shown in adapting his appliances to the changing physical conditions of the line.\*

A gang surfacing with earth or gravel as circumstances permit or ballasting and surfacing follows the track layers. The details of ballasting and surfacing and track work in general are taken up in another chapter.

Side tracks for depots should be graded by the contractor when grading the main line, and the track laying force should lay the sidings which they will require in handling their construction material and boarding cars. Track layers will often have to lay temporary sidings where depots are not located close together to avoid delays in coming back to switch the empty cars out and put loaded cars in the construction train.

The water supply having been decided upon, a force of men is at once put to work behind the

---

\*Appendix J gives details of the late practice in laying tracks, curving rails, etc.

track layers.\* The means of securing a water supply call forth the same skill as is displayed in obtaining that for a city, only of course, not on so extensive a scale. Springs, streams, impounding reservoirs, open wells both shallow and deep, artesian wells, siphons, are called into use as conditions suggest. The methods adopted to elevate the water are as various as the source of supply; windmills, steam pumps, pumps operated by gas, and hot air engines, hydraulic rams, or gravity from a supply in the hills or mountains adjoining may be adopted. The plant has to be built so that the supply will not be cut short during a severe winter, and must be cheap to operate.

The fuel supply has to be attended to at the same time as the water supply is being looked after. Coal sheds and chutes are usually located near a water station; this enables the train to take coal and water with the minimum amount of delay. Delays to trains can be reduced to a minimum by having the water tank or crane and coal sheds so located that west or north bound trains can take on their supply when stopping at stations, east or south bound trains doing the same at another set of stations.

While the water and coal supply is being provided for, the turntables must be placed in position as quickly as possible.

Next comes the erection of depots, warehouses and platforms, and these are followed by the

---

\*It is sometimes necessary to put them to work ahead of track to secure a supply of water for the construction train crew and engine.

roundhouses, shops and section houses. The hotels and eating houses, when erected by the railway company, are among the last to be put up. The offices for the division superintendents and their forces often form part of a depot or hotel, seldom a separate building.

The telegraph line is always kept to the front, and an instrument and operator located at the last siding at end of track, where the boarding-cars of the track-laying force are left at night, so that the foreman of the track-layers and the surfacing gang can be kept in communication with the superintendent of construction or chief engineer.

Fencing the right of way, depot grounds and yards is generally the last thing done.

---

(NOTE: A list of authors on Construction is given in Appendix K.)

## CHAPTER VI.

### STANDARDS OF CONSTRUCTION AND MATERIAL.

The standard sizes and quality of the various materials and devices which are used on a new line of railroad are largely determined before the reconnoissance is made, and are in every case definitely decided upon before the located line is finally adopted.

#### STRUCTURES.

The financial success of the enterprise will largely depend on the selection of the proper standards for the different structures along the line. Thus if it is decided to erect substantial structures for stations, shops, storehouses, etc., on a new line, the greatest care must be exercised, or it may be found that a substantial and costly structure has been placed at a point where very little business is being done.

Inasmuch as trading and manufacturing centers spring into existence at unexpected points, it is advisable to keep the first cost of the road down to the minimum, consistent with economy of operating. After the country has been developed and the character of the business determined, then more substantial and permanent structures can with advantage be adopted.

## GAUGE.

The gauge or distance between the rails, is the first point to be decided; a large majority of the mileage in America is four feet eight and one-half inch gauge, and it is perhaps safe to state that this is the gauge of the majority of the railway mileage of the world. Discussion as to the best gauge has been carried on ever since railway building commenced, and was quite spirited from 1870 to 1883, when there was a strong sentiment in favor of a narrower gauge than four feet eight and one-half inches, which was then and is now called the Standard Gauge. In 1880 there were 4,000 miles of railway having a gauge of three feet, and such lines were then and are now called narrow gauge.\*

The advocates of the narrow gauge claimed for it the following advantages;

First—Ability to haul heavier loads.

Second—Ability to pass around sharper curves.

Third—That the road could be constructed for less money, and

Fourth—That the paying load hauled was a larger percentage of the dead load hauled than on roads having standard gauge.

As the standard and narrow gauge roads existed and were operated in 1880, these claims were correct, but only the second and third are due to the gauge.

The load hauled by a locomotive depends on the relation existing between the horse-power

---

\*Appendix E gives a list of the gauges of railroads that are or have been in use in different countries.



and the weight on the drivers, as the load to be hauled increases, the weight on the drivers and the horse-power of the locomotive must be correspondingly increased; it is not economy to have the weight of the drivers designed for a greater load than the horse-power of the engine will pull; this would be a case of a dead load having no earning capacity. On the other hand, if the horse-power is greatly in excess of the weight on the drivers, the result is that the drivers spin round on the track (slip) when a load suitable to the horse-power is attached to the locomotive. The discussion of the gauges referred to taught the managers of the broad gauge roads that their locomotives could be designed to secure greater efficiency or economy. The second claim of the narrow gauge advocates possessed but small value, except in extremely rough and difficult country, and then only at exceptional points. The third claim, which they considered one of their strong points, is not so strong as it appears; where a new line is to be built to develop a country, and the business will be light for some years, the bridging, rails, locomotives and cars can be built of a light, cheap standard and the rolling stock kept on the line; bulk material, such as live stock, grain, wool, etc., can be handled in foreign cars of connecting lines, where the shipment is to a point off the line; this method saves the expense of transferring bulk shipments at terminals, and the bridging, track and rolling stock would cost about the same as for a narrow gauge. The saving in the

grading for a surface road averaging six feet cut and fill, placing fifty cents per yard for the average price paid per cubic yard of material moved, would be \$1,200.00 per mile. A light broad gauged road equipped as above described has, in addition to the advantage of handling bulk freight, the further advantage that the earnings can be used to equip it for heavy traffic as the business of the country is developed, and all improvements can be made to conform to the equipment used on the older roads.

At the time of the discussion in favor of the narrow gauge the capacity of the narrow gauge freight cars was a much higher percentage of the dead load than that of the broad gauge freight cars. This educated the managers of the broad gauge roads, and to-day there are freight cars of 80,000 pounds capacity and 36,000 pounds weight or dead load, while in 1880 the capacity was about the same as the dead load.

As a rule, all new lines built in a country where railroads already exist should be of the same gauge as existing ones. This will enable freight to be handled more cheaply than where there has to be a transfer from one car to another at terminals. The fact that there was a narrow gauge mileage of 4,000 miles in 1880 and a mileage of 3,000 miles in 1899 points conclusively to the fact that the standard gauge is more economical to operate.

#### CUTS AND FILLS.

The next point to be decided is the width at

grade of the cuts and fills. On a standard gauge road, the following table gives the widths used on some of the lines in North America:

Name of Road.	Embankment.	SINGLE TRACK.	
		Earth Excavation.	Rock Excavation.
New York Cent. & Hudson River .....	16 ft.	19 ft.	17 ft.
New York, New Haven & Hartford. ....	18 ft.	18 ft.	18 ft.
Lake Shore & Michigan Southern.....	16 ft.	23 $\frac{3}{4}$ ft.	
Baltimore & Ohio .....	17 ft.	19 ft.	18 ft.
Southern Pacific.....	16 ft.	19 ft.	
Northern Pacific. ....	14 ft.	20 ft.	16 ft.
Chicago & Nor.-We. t. ....	20 ft.	24 ft.	22 ft.
Tratman recommends .....	16 ft.	20 ft.	18 ft.
Often used on new lines with earth ballast .....	14 ft.	18 ft.	16 ft.

The slopes adopted are generally as follows:

For earth cuts.....	1	horizontal	to	1	vertical.
For rock cuts.....	$\frac{1}{4}$	"	to	1	"
For rock cuts over 30 feet cutting.	$\frac{1}{3}$	"	to	1	"
Earth embankments .....	1 $\frac{1}{2}$	"	to	1	"
Rock embankments.....	1 $\frac{1}{4}$	"	to	1	"

The slopes of earth cuts near depots in towns and suburban districts of large cities are often flattened to 1 $\frac{1}{2}$  to 1 and 2 to 1 and rounded off at the top and sodded.

*Narrow Gauge Sections.* The widths of cuts and fills for narrow gauge railroads can be made less than for a Standard gauge. A deduction of two feet can be made where the gauge is three feet.

*Controlling Points.* The points which control the width of rock cuts are the room required to

clear the lower steps on the platforms of passenger cars. The long cars and their truss rods are also a factor which has to be taken into account as clearance must be provided for them.

The character of the material through which an earth cut is made, and the amount of surface drainage into the cut, are the factors in determining the slope of an excavation and the width at grade. There are often cases where the surface drainage is diverted by ditches sometimes called berme ditches ten or fifteen feet back from the edge of the slope to the end of the cut to prevent the water running down the face of the excavation, and where the character of the material will stand a slope of  $\frac{1}{2}$  or  $\frac{3}{4}$  to 1. In such a case a large saving is made, but the engineer who attempts this must have had experience in handling material. There are some gravels and clays which will stand at a steeper slope than 1 to 1. However, with the clays, their lines of cleavage or seams may cause failures under the most promising circumstances.

Mr. Tratman in "Railway Track and Track Work" in treating on the widths at grade of cuts and fills says:

"The surface at subgrade is almost invariably crowned at the middle to drain off water to the sides, the only exception of which the writer is aware being on the Eastern Railway of France, where the surface is made slightly concave, and tile drains are led from the bottom of the hollow to the face of the bank. The roadbed may be formed in different ways to throw off the water

reaching it through the ballast: (1), it may have one or more planes from each side to the center; (2), it may have a curved surface with a rise of 3 to 6 inches for single track and 6 to 8 inches for double track; or (3) it may have a flat center portion with planes each side of the ditch. In regions of ordinary rainfall the best plan is to give a slope, as it will throw off water better than a flat curve. The more solid and compact the surface of the roadbed is made before the ballast is applied, the better will be the drainage, and the latest specifications prepared by Mr. Katte, Chief Engineer of the New York Central Railway require the subgrade to be as nearly homogeneous in composition and consistency as practicable for a depth of 18 to 24 inches, solidified to uniform resistance by thorough ramming or rolling, and truly graded in regular drainage planes, having a rise of 6 inches for a double track roadbed 27 feet wide on a bank. In some cases the roadbed is inclined on curves to give the proper superelevation to the track, but this practice is not general.

“In some cases the slope of the roadbed is continued to meet the toe of the slope in cuts, but with earth or other poor ballast and in country with ordinary rainfall, it is better to have a ditch reaching well below subgrade, so as to effectually drain the roadbed. The drainage of the track is effected by the ballast, the crowning of the subgrade and by side ditches in cuts, which latter carry away the water from the ballast and roadbed, and this drainage is one of the most import-

ant items in maintaining a good track, its importance increasing as the quality or quantity of the ballast decreases, and increasing also in relation to the extent of rainfall. Climatic conditions are, of course, to be considered in designing the form of cross-section of roadbed, heavy ditching not being required in dry regions with light soil. On roads through country with a moderate rainfall, the ditches should, nevertheless, be of ample capacity to carry off the storm water in occasional heavy rains. The ditches should be parallel with the track, not made to wind around stumps or boulders, and must be graded so as to pass all water freely and to thoroughly drain the roadbed and keep both ballast and roadbed firm and dry. The width should increase towards the ends, and if the standard width does not give sufficient capacity, the ditch should be widened on the outer side.

“The distance from the rail to the ditch varies according to the nature of the soil, and the bottom should be about 16 to 24 inches below the crown of sub-grade. An average arrangement in ordinary material is a distance of 7 feet from the rail to the edge of a ditch 24 inches wide on top, 18 inches wide on the bottom, with the bottom 8 inches below center of roadbed on single track, or 12 inches on double track. In wet cuts the ditches may be lined with cement, or in narrow cuts (especially where the earth slides or bulges) they may be lined with plank or old ties with struts across the top. Sub-drains of tile, brush, or wooden boxes may be laid as

required. Where it is necessary to carry water from the ditch on one side to the ditch on the other side of the track, or from a center ditch to the side ditches (as on double track) box drains of wood are laid in the ballast. These box drains are usually 12x12 inches inside, 12 to 16 feet long, made of 2-inch plank with the ends sloped to conform to the slope of the ballast, and having four or six flat strips 2x6x16 inches across the top. The ditches may be carried under road crossings by cast-iron pipe, clay, sewer or culvert pipe, or wooden box drains. The first is preferable, as wood soon rots and lets dirt fall in to clog the drain, and clay pipe is liable to be broken, as there is generally very little cover over it. The size of the pipe varies according to the amount of water to be carried, but is generally 6 to 10 inches, while the box drain is usually about 8x10 inches, having plank sides and bottom and a top of cross strips nailed close together."

Sections of the roadbed and ballast used on some railroads are shown in Figs. 81 to 89.

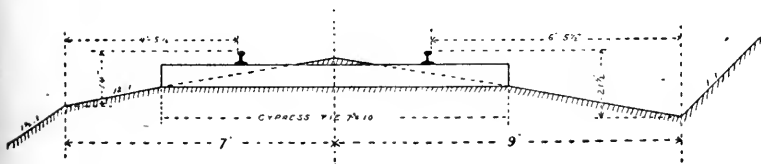


FIG. 81.

EARTH BALLAST.—GALVESTON, HOUSTON & HENDERSON RAILWAY.

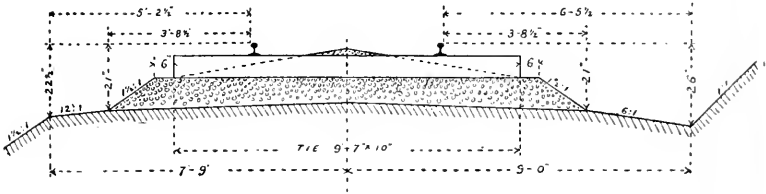


FIG. 82.

GRAVEL BALLAST.—GALVESTON, HOUSTON & HENDERSON RAILWAY

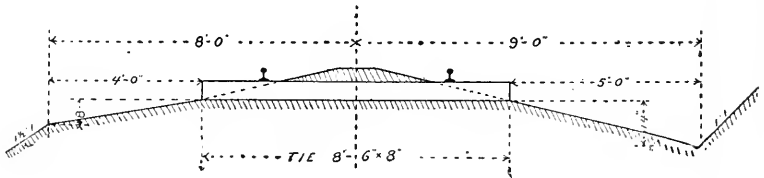


FIG. 83.

EARTH BALLAST.—ILLINOIS CENTRAL RAILROAD.

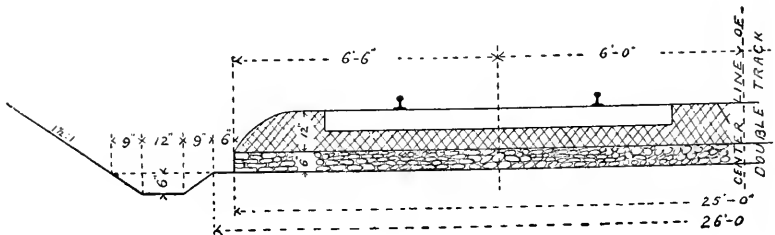


FIG. 84.

CRUSHED STONE, 2 INCHES DIAMETER ON QUARRY SPAULS 4 TO 6 INCHES DIAMETER.—N. Y. C. & H. R. R. R.



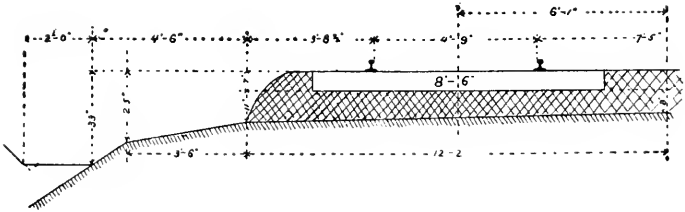


FIG. 85.

BALLAST, CRUSHED STONE  $2\frac{1}{2}$  INCHES DIAMETER.—PENNA. R. R.

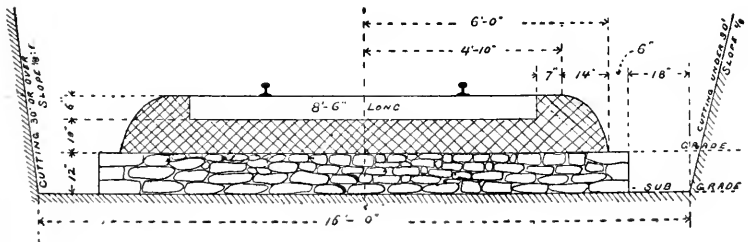


FIG. 86.

ROCK CUT STONE BALLAST,  $2\frac{1}{2}$  INCHES DIAMETER.—C. & P. D. BRANCH,  
PENNA. R. R.,

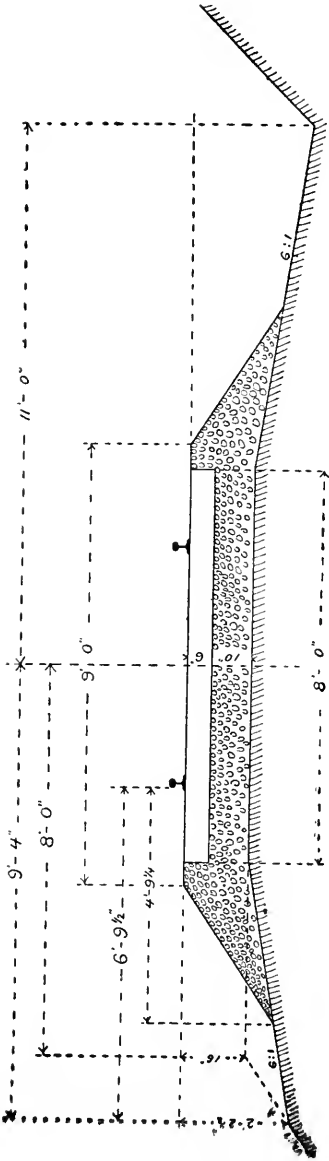


FIG. 87.

GRAVEL BALLAST.—A. T. & S. F. RY.

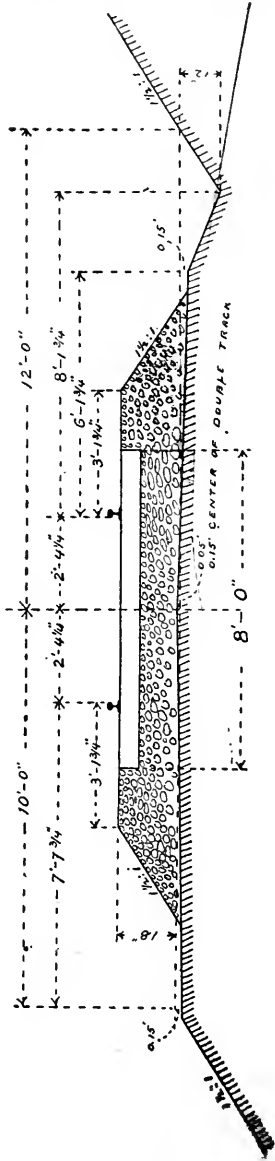


FIG. 88.

GRAVEL BALLAST.—C & N. W. RY.

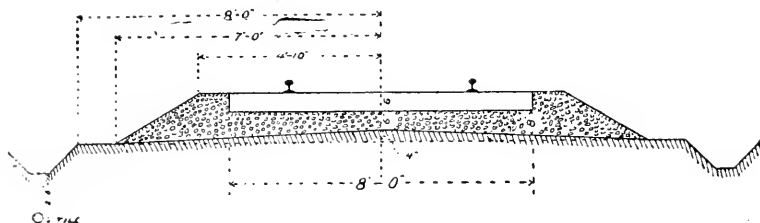


FIG. 89.

BURNT CLAY BALLAST.—C. B. &amp; Q. R. R.

The sections used in some of the American and foreign tunnels are shown in Figs. 90 to 94.

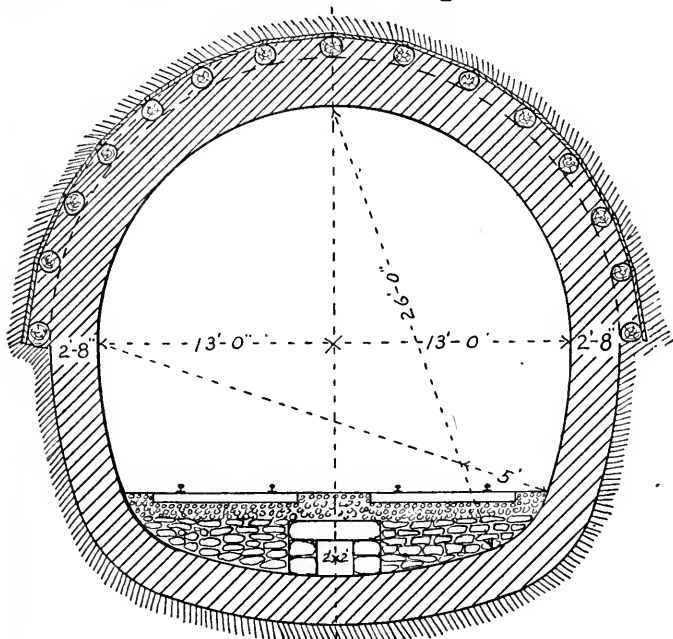


FIG. 90.

HOOSAC TUNNEL. FINISHED MASONRY IN SOFT GROUND.

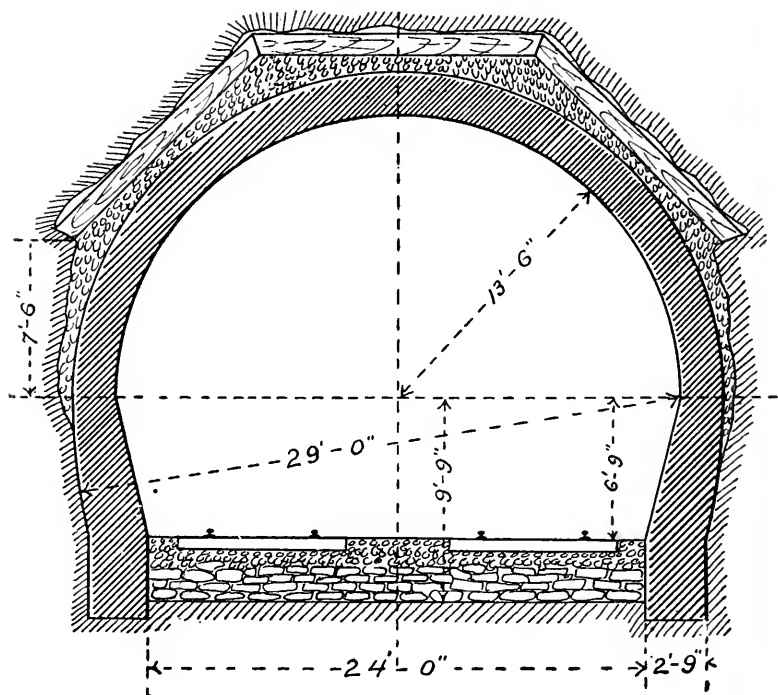


FIG. 91.

SECTION OF TUNNEL AT PORT PERRY.—P. V. & C. RY.

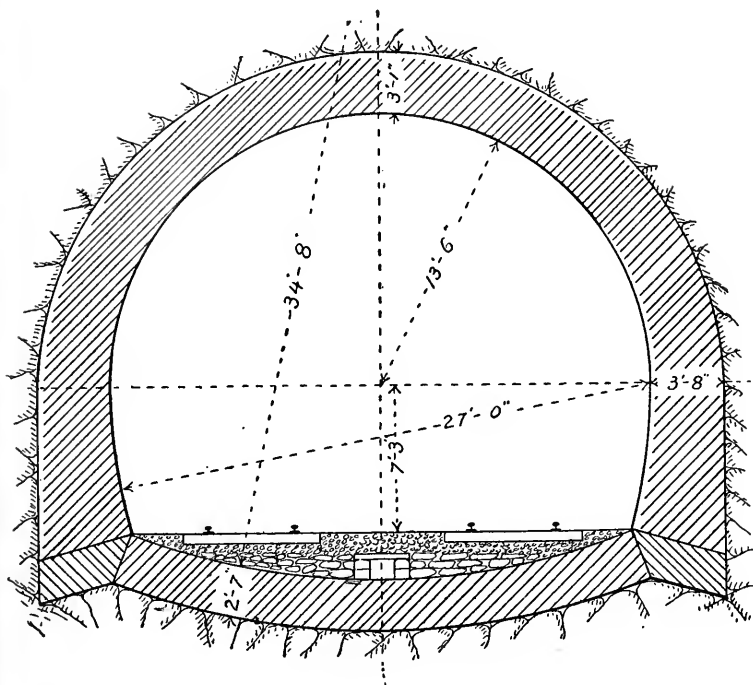


FIG. 92.

SECTION OF TUNNEL ON THE INSRUCK-BOZEN LINE OF AUSTRIAN  
SOUTHERN RY CO.

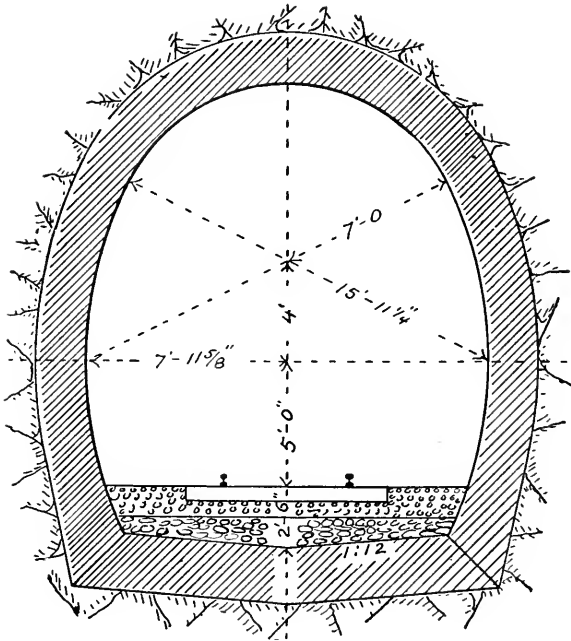


FIG. 93.

SECTION OF TUNNEL USED BY GOVERNMENT RAILWAY OF EAST INDIA.

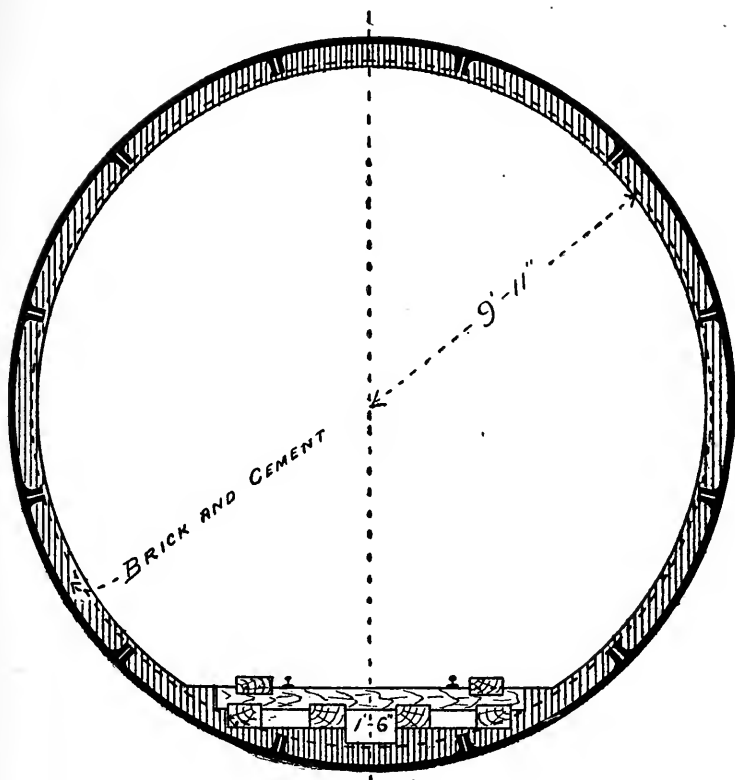


FIG. 94.

SECTION OF IRON TUNNEL UNDER ST. CLAIR RIVER USED BY  
GRAND TRUNK RY.

## BALLAST.

Newly constructed roads and the branches of some of the larger systems are largely ballasted with earth, or rather, are not ballasted at all,

either for the reason that financial conditions prevent or the traffic is so light as not to require it. In this case the methods adopted to support the track are fairly illustrated by the sections of the roadbed of the Galveston, Houston & Henderson Railway and the Illinois Central Railway where the earth is filled over the center of the tie level with the top of the rail, sloping out to the bottom of the tie at its end; this gives drainage by conveying the water off the bank rapidly, and permits the moisture under the tie to drain out at the end. The objections to this plan are that the earth over the center of the tie tends to rot it and the lack of support at the end makes it difficult to hold the track to line. However, in the country where these sections are used, the rainfall at some seasons of the year is heavy and continuous and the sections adopted are the best for such climatic conditions. Where the rainfall is not so great and where the ground is more or less frozen during the winter, the earth (and ballast also when used) is not placed on top of the tie.

The various kinds of ballast used can be classed as follows: Stone, slag, gravel, sand, cinders and burnt clay. The requirements of a good ballast are that it shall be durable; of a character that will allow water to drain off freely; that it will be free from dust and of such a quality and form that it will remain in position and hold the tie.

The material which most nearly fills all the above requirements is trap rock and the harder granites. However, circumstances compel the



adoption of the best means at hand, and any hard stone which will break into cubical form is used. Shales which break into flat sheets crush into powder, and do not give good drainage, they should, therefore, not be used. The practice of some roads is to lay a bed of large stone 6 to 9 inches thick on the subgrade, and on this place a layer of 6 to 10 inches of stone broken to a uniform size of  $1\frac{1}{2}$  to 2 inches; however, care must be taken to first fill the openings in the top of the large stone with spauls before placing the broken stone ballast. The ties are placed on top of the broken stone and broken stone filled in around them up to and level with the tops of the ties. Another method is to place the crushed stone directly on the subgrade; the Pennsylvania Railway do this, using 10 inches of stone under the tie. Some roads require the ballast to be broken to such a size that the largest stone will pass through a  $2\frac{1}{2}$ -inch ring and others through a 3-inch ring. The smallest size used must not be less than one inch cube. In these cases the stone is broken by a crusher and run through a screen which separates the different sizes. The larger size should be laid on the subgrade and the smaller size form the top of the ballast. On this subject Mr. Tratman states:

“In some cases a layer of gravel is laid upon a bottom layer of broken stone, but this is not general, and it is not to be recommended though claimed to combine the good drainage of stone with economy in material, as gravel is in general cheaper and more easily procured. The  $2\frac{1}{2}$ -inch

stone is sometimes covered with a top dressing of 1-inch stone, and the Pennsylvania Railway in some places lays small broken stone over the regular ballast and covering the ties, the purpose being to deaden the sound in the cars. The new steel ties for the New York Central Railway will be entirely covered with ballast except over the rail fastenings. This practice is not good with wooden ties as a rule, as it leads to rotting by keeping the ties damp, and prevents inspection, but in very hot, dry regions, it may be permissible in order to protect the ties from the sun. Stone ballast should be handled with forks and not with shovels so as to avoid putting dirt into the track, as the dirt hinders the drainage and affords a chance for weeds to grow. From a maintenance point of view it may be noted that stone ballast on a poor road involves greater expense for renewal and maintenance (perhaps at a time when little money is available) than when gravel is used.

“Slag.—Furnace slag or cinder is extensively used on roads in the vicinity of blast furnaces and iron works. It is about as durable as broken stone and in other ways almost as good, though it is sometimes said that ties decay in it more rapidly than in stone ballast. If properly drained, however, the difference is but small. It is considered that it should be as free from lime as possible, but a reported corrosion of rails on slag ballast does not seem to be substantiated. Mr. Mordecai, Assistant Chief Engineer of the Erie Railway, states that furnace companies are gen-

erally glad to supply the material free on cars at the furnaces, in order to get rid of it. It does not require a great deal of labor to break it up and costs about as much to put under the track as stone, possibly a little less. It should be broken to a 2-inch or 2½-inch ring, and like stone, it should be handled by forks, so as to be free from dust and dirt. There should be at least 10 inches of slag under the ties. The tamping is done in the same way as with stone, though Mr. Mordecai thinks that slag requires a little more tamping in the middle of the tie, so as to keep the track in good condition for easy riding. It gives excellent results, keeps the track in good line and surface, and does not heave as much as gravel. On the Chesapeake & Ohio Railway it has been used for some years, the average depth under the ties being 12 inches, and Mr. Frazier, Chief Engineer, states that it is very satisfactory and economical. The bulk of this slag is as small as ordinary gravel, and is loaded with a steam shovel. The engineer has been able to get it in this condition by arranging with the furnaces to pour the hot slag from the pots down an incline 30 to 40 feet, when the slag spreads out and cools very rapidly. This gives it the appearance of broken china, instead of the porous sponge-like appearance of the large lumps of slag handled in the ordinary way. On the Lehigh Valley Railway a 12-inch bed of slag is sometimes put under the ties, and then covered with anthracite ashes filled in between the ties. The cross-section is usually formed similar to that for broken stone,

and an important feature of slag ballast is that owing to the sharpness of its edges it checks people from walking on the track. It is extensively used in England, where it is run from a furnace onto a traveling belt and suddenly cooled by water, which hardens it and breaks it up at the same time. In view of its low cost and its excellence as ballast, it might well be adopted by many roads which now use an inferior gravel on their main tracks. If the traffic is heavy, the improved condition of track and the reduced cost of maintenance would probably warrant the expense for transportation of slag ballast from the furnaces.

“Burnt Clay—This has been used in England and other foreign countries for over twenty years, and its use is extending in this country—mainly in the West. The most suitable material is brick clay (or almost any clay that has not too much sand) and gumbo, or clayey earth, and experiments have been made with the ‘black wax’ earth of Texas. The site for burning is cleared of top soil, and a row of old ties, cordwood, etc., about three feet high, is laid the length of the kiln 500 to 4,000 feet. This is covered with a few inches of slack coal, or slack and lump mixed, upon which is thrown a layer of clay 9 to 12 inches thick. The wood is then lighted at intervals, the openings being closed when the fire is started. As the burning proceeds, another layer of coal is placed, and another layer of 6 to 9 inches of clay, and these layers are repeated from time to time until the

finished heap is about 20 feet wide and 10 feet high. One ton of slack coal will burn 4 to 5 cubic yards of clay, and the cost varies from 35 to 85 cents per cubic yard loaded on the cars. About 1,000 cubic yards per day can be burned in a kiln 4,000 feet long, about 50 men being employed. The work is usually done by contract, the company furnishing the land, side-track and coal. Partial estimates are given on kiln measurements, and the final estimate is made from car measurements when loaded out, so that worthless material is not paid for. The ballast is light (40 to 50 pounds per cubic foot), easily handled, gives good drainage, is free from weeds, is not dusty, and is in general satisfactory, requiring renewal in six to eight years. It is said to crush rather easily under the ties and to necessitate shovel tamping, but the writer does not consider that shovel tamping is necessary with any ballast under ordinary conditions. The cross-section is formed similar to that for stone ballast, and there should be at least 12 inches under the ties, as this ballast must be used liberally to give good results. Further particulars of the manufacture and use of this material are given in the writer's paper on 'Improvements in Railway Track' (Transactions, American Society of Civil Engineers, March, 1890), and in 'Engineering News,' New York, November 16, 1893. The cost per cubic yard of ballast in the track is about \$1.05, distributed as follows, the price for the first item being variable:

Contract price for burning.....	38 cents.
Average cost of coal.....	21 "
Loading on cars.....	8 "
Distributing.....	9 "
Putting under track.....	22 "
Interest and depreciation.....	4 "
Land .....	1 "
Miscellaneous expenses.....	2 "

Total cost per cubic yard.....\$1.05

“The burnt clay ballast used on the St. Louis, Keokuk & Northwestern Railway is a black, clayey soil or gumbo, and the railway company contracted for it burned in the pit, the company laying the necessary tracks, furnishing the old ties and slack coal for burning, and loading and hauling the burned ballast. The cost on cars at the pit was estimated at 65 to 70 cents per cubic yard, which is higher than usually estimated, but a number of small items were included which are sometimes overlooked. The burnt ‘black wax’ soil ballast on the Texas Midland Railway is said to cost \$1.00 per cubic yard in the track, and to have the advantage of being absorbent, so that in ordinary rainfalls most of the water is taken up by the ballast (which does not soften) and does not go through to the roadbed.

“Gravel.—This material is more used than any other in this country and is of very varying quality. It may be sandy and dusty or loamy (when weeds will grow, drainage will be affected and the track will heave) or else full of large stones, which make an irregular and rough riding track. The best gravel should be clean and coarse, and as far as possible of uniform size and quality. It does

not give as good drainage as stone, but a fairly coarse and clean gravel will be generally satisfactory. It is good economy to use plenty of gravel, giving at least 8 inches (or better 10 inches) under the ties, as it will enable a fairly good track to be maintained nearly all the year through without excessive work. It can be tamped by picks or bars, the latter being generally preferred, and is easily taken care of. In Europe the gravel is sometimes thoroughly washed by machinery to free it entirely from earth and sand.

“There are varying opinions as to the cross-section depending upon the quality of the material and the climatic conditions. Thus with good, clean, coarse gravel, or in warm, dry regions, it is better to make the section as with broken stone, bringing the ballast level with the tops of the ties and shouldering it out 6 to 12 inches from their ends. With inferior fine or loamy gravel (and this is the quality most generally met with) or where water and frost have to be considered, it is better to slope the ballast from the middle of the tie to the ends, to allow the water to drain off and not be held back by the rails, the ballast being one inch clear below the rail base. The slope may be made continuous with that of the roadbed to the ditch, and may be to the bottom of the end of the tie or a little higher, so as to leave part of the end embedded, but this latter arrangement is likely to retain water along the ends of the ties. In some cases the ballast is flat on top for about 3 feet, and then

slopes down under the rails to the bottom of the ties. Fine gravel is sometimes filled in 2 or 3 inches above the ties at the middle, but in wet country this keeps the ties damp and leads to rotting, though in dry country it may protect them from the sun and from hot engine cinders. The Houston & Texas Central Railway fills in the gravel between the rails to the level of the under side of the rail heads. On double track the ballast is usually sloped towards the middle of the roadbed to form a central drain which should be at least 6 inches below the ties, and is sometimes carried down to the surface of the roadbed. Cross box drains in the ballast carry the water to the side ditches. At stations on the Southern Pacific Railway the ties rest on 8 inches of ballast, and cinders are filled in nearly to the underside of the rail heads between the rails and between the main and side tracks.

“Cinders.—Engine cinders make a cheap and serviceable ballast which will last for some time under light traffic. Being porous it drains well and does not hold moisture. It is easily handled by the shovel, does not heave much with the action of the frost, and prevents weeds from growing. The principal objection is that it makes a very dusty track until after some length of service, when the rain and traffic compact the material very thoroughly. It is very generally used for sidetracks and yards. With a wet roadbed, and with earth or mud ballast in the spring, or in wet weather when the earth is too soft to fulfill its purpose, a good layer of cinders will much facil-



itate maintenance, and in very bad cases the mud holes or wet spots may be dug out and filled with cinders. The cinders should not be laid on earth ballast, however, when the frost is coming out of the ground or this action will be checked, and it will be late in the season before it is thoroughly out. In cross-section the ballast is sometimes formed the same as for broken stone, and on side tracks it may either be sloped down to form a drain between that and the main track as on the Baltimore & Ohio Railway, or be filled in level, as on the Erie Railway. The cinders are sometimes applied upon a bed of stone or slag ballast upon which the ties rest.

“Sand.—This makes a fairly good ballast under light traffic, but unless it is very coarse it requires constant attention and renewal, involving considerable maintenance work as it flows from under the ties with the pumping motion of the ties, and is gradually drifted away by the wind and washed away by the rain. It is generally shaped the same as gravel, but if well shouldered out from the ends of the ties and level with them as on the Minneapolis, St. Paul & Sault Ste Marie Railway (shaped the same as broken stone ballast) it will hold the track better, and there will be much less flowing from the ties. Owing to its instability it does not keep track well in alignment. It is convenient to handle and drains fairly well, but it heaves in winter, makes a dusty track, and is very hard on the journals and machinery. In India sand ballast is often covered with a layer of broken stone or broken brick to

prevent strong winds from blowing it away. Special grasses or bushes may also be used as wind breaks in sandy districts."

#### TIES.

The quality of the cross-tie has an important bearing on the stability and permanence of the roadbed and the cost of maintenance. Ties can be divided into three general classes: (*a*) wood untreated; (*b*) wood treated with a preservative process, and (*c*) metal.

The kinds of wood used for ties vary, of course, with every country. The different woods used in the United States for ties approximate the following proportions: oak, sixty-two per cent.; chestnut, five per cent.; pine, seventeen per cent.; cedar (red, white and California), seven per cent.; hemlock and tamarack, three per cent.; cypress, two per cent.; redwood, three per cent.; other kinds, one per cent.

The requirements of a good tie are: (*a*) ability to hold a spike against the strain exerted on the spike by the rail; (*b*) it must not be brittle and split when the spike is driven; (*c*) the wood should not yield or be compressed by the rail; (*d*) it should withstand the pressure of the ballast (when stone) without being crushed; (*e*) its size should give sufficient bearing surface to support the load imposed without the rail sinking into the tie, or the tie being pressed into the ballast, or become broken; (*f*) finally, it should be durable.

White oak makes the best tie, both for wear and durability; it generally fails from decay rather than wear; the life of a white oak tie is about eight years under heavy traffic, and sometimes twelve years under light traffic. Chestnut oak is the second best variety of oak, and lasts about seven years. The other varieties of oak are not of sufficient durability to be used much. Chestnut is equal in durability to white oak, but being a softer wood the rail cuts into it more, and it is not suitable for use on curves. Several varieties of pine are used, yellow and Louisiana and Texas long leaf pine being among the best; while they are not hard woods they do not decay rapidly, and their life on tangents is about seven years, where the traffic is heavy; under light traffic they have lasted ten years. Cedar ties give satisfaction with a light traffic when used on tangents, but the rail cuts into them and they do not hold the spikes well, especially on curves; their life can be placed at about eight years. Hemlock and tamarack are used in sections where they grow, on account of their cheapness; they are soft timber and do not hold the spikes well; the rail cuts into them, and they rot quickly; their life is probably from four to six years. Cypress may be classed with the long leaf pine as to wear and durability; it will average about eight years service. Redwood is very durable, but, being soft, its length of service is determined by the time the rail will cut into it and destroy it from wear; its ordinary life on the Southern Pacific Railway is

given from five years up, depending on the amount of traffic.

The cause of decay in timber is given clearly in the report of a committee on Preservation of Timber to the American Society of Civil Engineers on June 25th, 1885, which is as follows:

“Pure woody fiber is said by chemists to be composed of 52.4 parts of carbon, 41.9 parts of oxygen and 5.7 parts of hydrogen, and to be the same in all the different varieties. If it can be entirely deprived of the sap and of moisture, it undergoes change very slowly, if at all.

“Decay originates with the sap. This varies from 35 to 55 per cent. of the whole when the tree is filled, and contains a great many substances, such as albuminous matter, sugar, starch, resin, etc., with a large portion of water.

“Woody fiber alone will not decay, but when associated with the sap fermentation takes place in the latter (with such energy as may depend upon its constituent elements), which act upon the woody fiber and produce decay. In order that this may take place, it is believed that there must be a concurrence of four separate conditions:

“First—The wood must contain the elements or germs of fermentation when exposed to air and water.

“Second—There must be water or moisture to promote the fermentation.

“Third—There must be air present to oxidize the resulting products.

“Fourth—The temperature must be approximately between 50° and 100° F. Below 32° F. and above 150° F. no decay occurs.

“When, therefore, wood is exposed to the weather (air, moisture and ordinary temperature) fermentation and decay will take place, unless the germs can be removed or rendered in-operative.

“Experience has proven that the coagulation of the sap retards, but does not prevent, the decay of wood permanently. It is, therefore, necessary to poison the germs of decay which may exist, or may subsequently enter the wood, or to prevent their intrusion, and this is the office performed by the various antiseptics.

“We need not here discuss the mooted question between chemists whether fermentation and decay result from slow combustion (*Erema causis*) or from the presence of living organisms (*Bacteria*, etc.).”\*

The following table, giving the life of untreated wooden railway ties, is taken from Bulletin No. 9, Forestry Division, U. S. Department of agriculture:

## LIFE OF WOODEN RAILWAY TIES.

Railways.	Ties.	Av. life, years
Delaware & Hudson	White oak,	7 to 12
“	“ Chestnut,	5 to 10
Lake Shore & Mich. Southern	White oak,	6
Lehigh Valley	White and rock oak,	8
“	“ Cypress,	8
“	“ Chestnut,	8
“	“ Yellow pine,	7

\* Report A. S. C. E., June 25th, 1885, pp. 288 and 289.

Railways.	Ties.	Av. life, years.
Pennsylvania.....	White oak,	5 to 6
“ .....	Rock oak,	5 to 6
Allegheny Valley.....	White oak,	9
Central of N. J. ....	Oak,	3
“ “ .....	Yellow pine,	8
“ “ .....	Chestnut,	6
Baltimore & Ohio.....	Oak,	8
Boston & Maine .....	Chestnut, cedar and hemlock,	5 to 7
Michigan Central.....	Oak,	6 to 9
“ .....	Cedar,	6 to 9
“ .....	Tamarack,	4
“ .....	Hemlock,	4
Cleveland, Cincinnati, Chicago & St. Louis .....	White, burr and chestnut oak; wild cherry, honey locust and black walnut.	ab't 9
Alabama Midland .....	Yellow pine,	5 to 6
Nashville, Chattanooga & St. Louis.....	White or post oak,	6
Mo., Kas. & Texas.....	White, post and burr oak, cherry and sassafras,	6 to 8
Burlington, Cedar Rapids & Northern.....	White oak and cedar,	8½
Flint & Pere Marquette.....	Hemlock,	5
“ “ .....	White oak,	8 to 9
“ “ .....	Cedar,	8 to 10
Chicago & Alton.....	Oak,	8
“ “ .....	Cedar,	6
Chicago & Northwestern.....	White oak,	6 to 8
“ “ .....	Cedar,	10 to 12
“ “ .....	Hemlock,	5 to 7
Minn., St. Paul & Sault Ste Marie .....	Cedar and oak,	8 to 10

Railways.	Ties.	Av. life, years.
Minn., St. Paul & Sault		
Ste Marie .....	Hemlock and tamarack,	6 to 7
Minn., St. Paul & Sault		
Ste Marie .....	Red spruce,	6
Denver & Rio Grande.....	Yellow pine,	5
"  "  .....	Oak,	6 to 10
Union Pacific. ....	Pine,	5 to 8
"  .....	Red spruce	8
"  .....	White cedar,	8 to 9
"  .....	Pine (burnettized),	7 to 9
"  .....	Oregon fir and pine,	4 to 7
"  .....	Tamarack,	5
Louisville & Nashville.....	White and post oak,	7 to 8
Chicago, Burl'gton & Quincy..	Oak, cedar,	8
"  "  "  .....	.. Yellow pine,	5 to 7

**TREATED WOOD TIES.** In taking up the subject of ties and other timber treated with wood preservatives the investigator is confronted with a lack of reliable data. This lack of knowledge on the subject has retarded the adoption of preservative methods to a great extent.

Advances in the price of ties have brought out the fact that available supplies of the more durable hardwoods have been so far exhausted as greatly to diminish the possible supply. Timber owners have naturally not been slow to avail themselves of this fact and the railroads in many sections of the country are casting about for a remedy. An obvious solution is to follow European practice, and to resort to the chemical treatment of the more perishable woods, which are still abundant and comparatively cheap.

From a paper by W. W. Curtis, read before the American Society of Civil Engineers, May 17th,

1899, the inference may be drawn that the problem of treating the softer and cheaper woods, so as to secure a cross tie that will last sufficiently long to make the investment a financial success, has been solved for the United States. He says that "during the last twelve years something like 10,000,000 cross ties have been treated, and during the present year there will probably be 1,500,000 ties treated."

Poor's Manual give the mileage of railways in the United States on December, 31st, 1898, as follows:

Mileage.....	184,894.33 miles.
Second track, sidings, etc.....	60,344.54 "
Total track.....	<u>245,238.87</u> "

Taking 2,700 ties per mile and the average life of a tie as eight years, this would require nearly 83,000,000 ties yearly for renewals; besides which perhaps 17,000,000 more are required for new constructions; taking the average price of hard and soft wood ties at 40 cents each, and the average cost of labor in taking an old tie out and putting a new tie in the track at 15 cents, the cost of renewals alone to the railroads of the United States would be nearly \$45,650,000 per year. The only prospect of securing a reduction of this yearly expense appears to be in the adoption of ties treated by some preservative process, and the use of tie plates on ties made from the durable soft woods. It must not be forgotten, however, that cheapness of process is not the only consideration to be taken into account. The ob-



ject sought by treating the ties is to increase their life in the track, and this can only be secured by adopting some method which has been thoroughly tried and is honestly carried out. European experience covers a period of forty to fifty years, and in the United States it has been carried on on a considerable scale for over fourteen years. The results prove that wood can be effectually protected from decay for a period long enough to add fifty to one hundred per cent. to the life of the tie. An important point which railroads using preservative processes should insist upon being faithfully carried out is the record of the life of the tie. This is one of the most neglected though essential points. To determine this the tie should be stamped on the end with the date it was treated. In France and Germany a galvanized nail, having the date stamped on the head, is driven in the top of the tie in addition to stamping it and a similar practice is being adopted in the United States.

Where the ties are thus marked the only further requirement is to record where they were laid and when they are removed, and all that is necessary is a simple blank by which the section foreman can report the date the tie was stamped, what portion of the road it was removed from, and the cause of removal.\*

During the last one hundred years scores of processes have been experimented with, chiefly

---

\*The Southern Pacific Railway Company seems to have kept the most complete records of treated ties of any road in the United States.

in Europe, and hundreds of failures have occurred. It has been ascertained that the choice of chemicals to be employed is limited to a few, and that not only must the most appropriate process be selected, in view of the character of the wood to be operated upon, its cost or value, and its subsequent exposure, but also that minute care must be observed in the various operations incident to the process. The importance of this is evident when it is considered that time is the only sure test, and that ten or fifteen years must elapse before it is positively known whether a thorough success has been achieved.

In a general way the approved methods of preserving timber may be classed as follows:

Kyanizing—or use of corrosive sublimate.

Burnettizing—or use of chloride of zinc.

Creosoting—or use of creosote oil.

Boucherie—or use of sulphate of copper.

There are a number of other methods, but at present burnettizing and creosoting appear to be the most used in the United States.

There are a number of conditions which affect the value of preservative processes, as shown by the wide variation of the life of treated ties. Thus the time of the year the timber is cut and the amount of moisture in the tie at the time it is treated are among the known factors bearing on the results obtained by the treatment.

The theory of the process of wood preservation is to withdraw the moisture or sap and to intro-

duce into the pores of the wood an antiseptic to prevent decay. The American literature on the subject is limited; the report of the committee to the American Society of Engineers on June 25th, 1885, and the paper read by Mr. Curtis before the same Society on May 17th, 1899, are about as full as can at present be procured. On page 377 of the report above referred to, Mr. C. Latimer, Chief Engineer of the Atlantic & Great Western Railroad, stated that his experience showed "that white oak ties last eight years on the grade and nine years on bridges." "Eleven years ago the white oak ties cost fifty cents, to-day (1885) they cost forty-five cents per tie."\* The same engineer on page 378 states: "If any process can be obtained which will double or add fifty per cent. to the life of cedar or hemlock ties, of course there is an immense economy in it."

In regard to the price of cross ties, it must be borne in mind that while for a period of several years there may be no permanent change in the price, yet the source of supply is constantly being reduced, and each year a tie of poorer quality is being accepted; there must, therefore, come a time when contractors will realize that the source of supply is being reduced, and a permanent rise in the price will take place

---

\* A condition that tends to discourage investments in this direction is the uncertainty regarding the price that timber will command in the future. The cheapening of freight rates sometimes enables the supply of cross ties to be procured from districts which a few years before were considered inaccessible.

which will doubtless be followed by a period of approximately uniform prices. Thus considered oak ties may be said to have advanced from 16 to 65 cents per tie in the last forty years.

Preservative processes it must be remembered will augment the supply of wooden ties, inasmuch as some of the softer woods now rejected will be available when treated; thus the hemlock of the Northern States and the loblolly and short leaf pine of the Southern States properly treated will make excellent ties.

There can be no doubt that wood preserving processes have been measureably successful. In the paper of Mr. Curtis before referred to he states: "The experience of American roads with treated ties may be concluded to be generally favorable. The Atchison, Topeka & Santa Fe Railway officials, after twelve years trial on a large scale, believe they are getting from eleven to twelve years service from mountain pine having a natural life of about four years, while from natural (untreated) white oak they get but six years in heavy main line service, and from cedar ten years under light service." Good results with treated ties are also reported from the following roads: Union Pacific Railway; Chicago, Rock Island & Pacific Railway; Pittsburg, Ft. Wayne & Chicago Railway; Duluth & Iron Range Railway; Southern Pacific Railway. The experience of the English, French and German railroads is that pine ties are made to last from fifteen to thirty years by chemical treatment, the life depending upon the process adopted.

The cost of treating woods varies greatly in the different processes and methods; it is also affected by the price of chemicals used, the volume of the business done, the skill and efficiency of the men employed, cost of coal, etc. The railroad manager contemplating the adoption of a preservative process for his road will have to take into account the conditions on his line, considering the character of the timber he can procure, and to adopt the method and processes best suited for such timber. A German report on railways\* gives the following information:

## TIES TREATED BY CHLORIDE OF ZINC.

Kind of tie	Oak	Beech	Pine
Cost of crude tie	\$1.49	\$1.01	\$0.84
Absorption, lbs.	24.2	34	34
Cost of treatment	\$0.13	\$0.15	\$0.16
Total cost	\$1.62	\$1.16	\$1.00
Average life, years	15	9	12
Cost per year	\$0.108	\$0.13	\$0.083

## TIES TREATED BY CREOSOTE.

Absorption, lbs.	15.4	66	50.6
	24.3	79.2	79.2
Cost of treatment	\$0.21	\$0.50	\$0.43
	.29	.59	.57
Total cost	\$1.70	\$1.51	\$1.27
	1.78	1.60	1.41
Average life, years	24	30	20
	28	34	23
Cost per year	\$0.071	\$0.05	\$0.063
	.063	.047	.061

The life of ties can be prolonged to some extent by a study of the nature of the various

\* Published in the "Organ of the Progress of Railroads," Series 1897. Wiesbaden.

woods used. In this relation Mr. B. E. Fernow, of the United States Department of Agriculture, Forestry Division aptly points out that not only the different species of wood in practical use show varying durability, that is, resistance to decay, but the same species exhibits variation according to the locality where it is grown and the part of the tree from which the wood is taken, and even its age seems to influence durability. Young wood, he observes, is more susceptible of decay than old wood; sap wood is less durable than the heart. The idea that young wood is more durable because it is young, which seems to prevail among railway managers, must, he says, be considered erroneous. On the contrary, young wood, which contains a large amount of albuminates, the food of fungi, is more apt to decay, other things being equal, than the wood of older timber. Sound, mature, well grown trees yield more durable timber than either young or very old trees. Rapid growth exhibited in broad annual rings and due to favorable soil and light conditions, yields the most durable timber in hard woods, and only as far as the growth in the virgin forest has been slow, ought there to be a difference in favor of second growth timber. In conifers, however, slow growth with narrow rings, which contain more of the dense summer wood in a given space, yields the better timber. In piling ties, he recommends that they should be placed in squares, with not over fifty ties in a pile, in such a manner that one tier shall contain six to nine

ties, separated from each other by a space equal to about the width of the tie; the next tier to consist of one tie placed crosswise at each end of the first tier. The bottom tie should consist of two ties, or better, poles, to raise the pile from the ground. The piles should be five feet apart. The piling ground should be somewhere in the woods, or at least away from the sun, wind and rain, so as to secure a slow and uniform seasoning. If dried too rapidly, the wood warps and splits, the cracks collect water, and the timber is then easily attacked and destroyed by rot. He points out that the best method of obtaining proper seasoning, in a shorter time, without costly apparatus, is to immerse the prepared timber in water from one to three weeks, in order to dissolve and leach out the fermentable matter nearest the surface. This is best done in running water—if such is not at hand, a tank may be substituted, the water of which needs, however, frequent change. Timber so treated, like raft timber, will season more quickly, and is known to be more durable. The application of boiling water or steam is advantageous in leaching out the sap. Referring to the decay of railway ties, he ascribes the lack of durability to two causes, viz.: (1) a mechanical one, the breaking of the wood fiber by the flange of the rail and by the spikes, and (2) a chemical or physiological one, the rot or decay which is due to fungus growth. These causes work either in combination or, more rarely, independently. The cutting of the wood may be prevented by the use of

tie plates. The damage caused by the spikes may be lessened as pointed out elsewhere. In reference to drainage he suggests that rock ballast is best drained, and hence the best record comes from such roadbeds; gravel is next best, and clay or loam the worst. On the other hand, where soft wood ties like chestnut are used, the hard rock ballast, while unfavorable to decay, reduces their life by pounding and cutting. Sand ballast seems to vary considerably; a sharp, coarse, silicious (not calcareous) sand with good underdrainage should be next to gravel, while some reports give a heavy black soil and loam as better than sand. The reason why sand, although offering good drainage, is favorable to decay, may be sought in its great capacity for heat, which induces fermentation. Referring to wood preservatives, Mr. Fernow says in France wooden ties are universally subjected to preservatives; that similar practices are quite general in England and throughout Europe, caused by the scarcity of wood, and its great cost. He ascribes lack of interest in the subject in the United States to ignorance, to unwise economy, to cheapness of wooden ties, and to the fact that the flange cutting of the rail is even more destructive than decay. He recommends the use of tie plates in order to prevent this.

The following table gives the size of ties used by some of the railroads in the United States:

Railway.	Length.		Width. Inches.	Thickness. Inches.
	Fect.	Inches.		
Pennsylvania Railway . . . . .	8	6		7
Southern Pacific Cypress . . . . .	10	0	10	7



Railway.	Length.		Width. Inches.	Thickness. Inches.
	Feet.	Inches.		
Southern Pacific Cypress.....	9	0	10	7
“ “ Pine.....	8	0	8	6
Atchison, Topeka & Santa Fe ..	8	0		6
Chicago & Northwestern.....	8	0	8	6
New York Central.....	8	0	8	7
Pittsburg & Lake Erie.....	8	6	9	7

Ties are spaced differently on different roads. The following table gives the spacing used to a thirty foot rail by some of the roads in the United States:

Pennsylvania, Main Line.....	14 wide ties.
“ Sidings.....	12 ties.
Northern Pacific.....	16 “
Chesapeake & Ohio.....	18 “
Central Ry. of New Jersey.....	16 “
Southern Pacific, Main Line .....	17 “
“ “ Branches .....	15 “

The joint ties should be the largest ones and should be more closely placed than the others to give a better bearing for the rail ends.

The following table gives the number of ties per mile of single track:

#### CROSS TIES PER MILE.

Center to Center.	Ties per Mile.
18 inches.....	3,520
21 “ .....	3,017
24 “ .....	2,640
27 “ .....	2,347
30 “ .....	2,112
No. of ties per 30-ft. rail 12.....	2,112
“ “ “ “ “ 14.....	2,464
“ “ “ “ “ 16.....	2,816
“ “ “ “ “ 18.....	3,108

Metal ties have been used to a large extent in some countries where timber is scarce or decays rapidly. There is a great variety of styles and patents, but in a general way they can be classed under three heads, viz:

*Longitudinal Supports.* This method is accomplished by placing iron plates under each rail, and holding the two rails together by means of rods or iron bars. The metal plates are of various designs and dimensions. This method has been used more in Germany and Austria than anywhere else; the Germans are not, as a rule, satisfied with it and it is being abandoned. The method is still favored by some Austrian roads.

*Bowls and Plates.* This is a modified form of longitudinal supports. Cast iron bowl shaped plates are used in place of wrought iron or steel plates in the longitudinal method; these are connected by rods or bars of iron to hold the rails to gauge—they are mostly used in India and South America.

*Metal Ties* are the third style and these are designed after the wooden cross tie, with such changes as become necessary in a change from wood to iron or steel. This form of metal tie is more largely used than any other.

The latest reliable data of the mileage of metal ties in use in Europe is given in Bulletin No. 9 United States Department of Agriculture, Forestry Division, and the figures given there are used in the following tables:

## SUMMARY OF TRACK IN EUROPE LAID WITH METAL TIES.

Countries.	Longitudinal, miles.	Cross tie, miles.	Total miles, 1894.	Total miles, 1890.
England.....		73	73	70
France.....		128	128	52
Holland.....		322	322	329
Belgium.....		176	176	115
Germany.....	3,580	8,025	11,605	8,787
Austria & Hungary..	62½	154	216½	123
Bosnia.....		12	12	
Switzerland.....		480	480	397
Spain.....		7	7	7
Portugal.....		1	1	½
Sweden & Norway...		½	½	½
Denmark.....		18	18	18
Russia.....	2	7	9	
Turkey (Europe).....		71	71	71
“ (Asia).....		309	309	
Greece.....		28	28	
Totals.....	3,644½	9,811½	13,456	9,970

## SUMMARY OF TRACK LAID WITH METAL TIES BY GEOGRAPHICAL DIVISIONS.

	1894		1890	
	Miles of metal track	Total miles of track.	Miles of metal track	Total miles of track.
Europe.....	13,456	137,000	9,970	132,071
Africa.....	2,401	5,675	1,290	5,200
Australia.....	234	12,000	186	10,640
Asia.....	14,586	22,000	9,314	19,106
South America	4,416	21,500	3,764	20,701
Central “				
West Indies				
Mexico				
North America.....	2*	190,000	2	174,000
Totals.....	35,095	388,175	24,526	361,718

\*Ten miles of track on the New York Central Railway are not included; the metal ties were purchased but were not yet laid.

The following countries are the principal users of metal ties:

Countries.	Mileage, 1894.
British India.....	13,655
Germany.....	11,605
Argentine Republic.....	3,638
Cape Colony.....	906
Egypt.....	866
All other countries.....	4,425
Totals.....	<u>35,095</u>

The report already referred to gave the following mileage of metal ties in the United States in the 1894 Summary of Railways using metal ties in the United States:

Roads.	Length in feet of track laid with metal ties.	
	1894.	1899.
Chicago & Western Indiana....	1,000	none
Delaware, Lackawanna & West- ern.....	250	
Long Island.....	950	
New York Central.....	1,320	Further use disc't'd.
Philadelphia & Reading.....	5,280	none
Minor experiments (estimated). 500		Use discontinued.
Totals.....	<u>9,300</u>	

European practice has proven the metal tie to be economically successful under the conditions which prevail there.

To prevent the metal tie being lifted by frost or lowered when the ground thaws, the ballast must allow the water to drain off and through it readily; the German practice is to drain the water off down to a point below the frost line. The ballast should be stone broken to go through a 2-inch ring. The tie should be well bedded in

the ballast to hold it in line. The experience abroad with metal ties, is that more labor is required in tamping them the first year or two than in the case of wooden ties, but after this they require much less labor to tamp them than wooden ties do. There are several causes which have prevented the introduction of the metal ties into the United States, the greatly increased first cost over wooden ties being the principal one; to assist in overcoming this they have been made too light to stand the effects of corrosion. The cost of metal ties weighing 100 pounds was in 1894 from \$2.00 to \$2.25 per tie, depending on the method of fastening the rail to the tie. Another reason for their unpopularity in the United States is that they have been tried on roadbeds not properly ballasted and drained for metal ties and have been looked after by section men who were not favorably impressed with their utility. Further it may be stated that in a number of cases their trial was on too small a scale.

It is doubtless true that the use of the metal tie is probably a factor which will not receive practical consideration from the hands of railroad managers in the United States for sometime in the future. The line along which present economical practice points is the use of tie plates and rail braces on our untreated ties and this will probably be followed by a more general use of preservative processes to lengthen the life of the wooden tie.

Following are some illustrations of metal ties: Fig. 95 illustrates the metal tie used by the Dela-

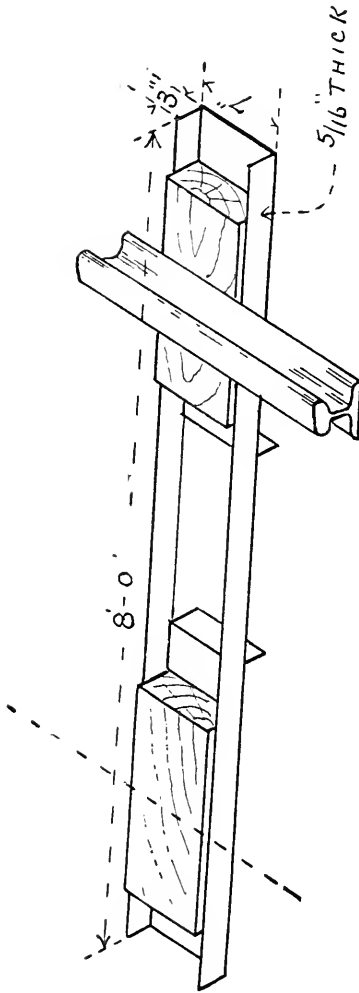


FIG. 95.

## MORRELL METAL TIE.

Used on Delaware, Lackawanna & Western Ry. The rail rests on a creosoted wooden block and the rail and block are securely bolted to the tie.

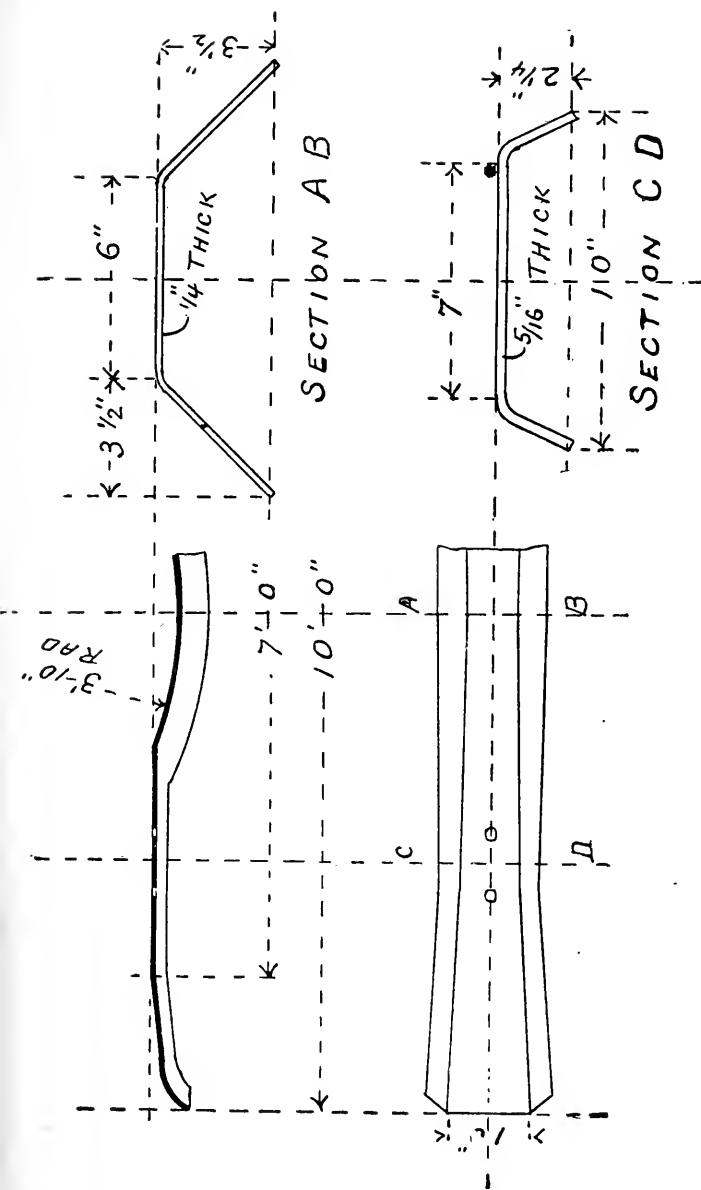


FIG. 96.

METAL TIE.

Used on the New York Central &amp; Hudson River Railroad. Designed by Walter Katte, C. E.

ware, Lackawanna & Western Railway. Fig. 96 illustrates the metal tie used by the New York Central Railroad.

The literature on metal ties is well given by Bulletins Nos. 4 and 9, United States Department of Agriculture, Forestry Division Synopses of reports on their use in the Netherlands and Switzerland in the Engineering News for 1898.

#### TIE PLATES.

To prolong the life of the cross-tie by preventing the rail from cutting into the tie, tie plates have been introduced. There are three general styles, based on the following principles: First, ribs are placed on the under side of the tie plate running in the direction of the length of the plate, these are driven into the tie and separate, but do not break up the fiber of the wood; with this style of tie plate the greatest resistance to the movement of the plate is in the direction of across the tie or in the length of the rail; the spikes on both sides of the rail being connected by the tie plate, both resist the lateral movement of the rail and are assisted by the friction and end resistance of the ribs pressed into the tie. The spikes used with this tie plate are subjected to the wearing action of the rail, but to a less extent than without it. Some forms of this style have a rib which comes in contact with the outside of the rail base to assist the spikes in resisting the lateral motion of the rail. Fig. 97 illustrates an example of this style. Second, lugs are placed on the under side in such a posi-



tion that their largest surface is resisted by the end wood of the tie when there is a lateral press-

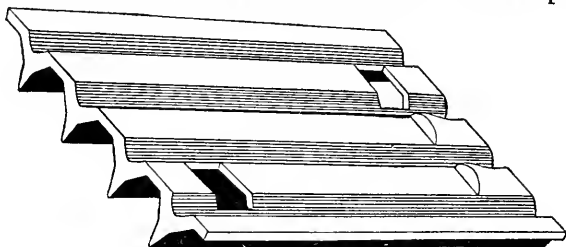


FIG. 97.

WOLHAUPTER TIE PLATE.

With rib to resist the lateral motion of the rail.

ure produced by a passing train; on the top of the plate there is placed a lug against which the outside of the base of the rail is placed. The lateral movement of the rail is resisted by the spikes as in the first case, and also the greater resistance of the lugs against the end wood of the tie. The base of the rail, during its lateral movements, is resisted by the lug on top of and extending across the plate, thus relieving the spikes of the wearing action of the base of the

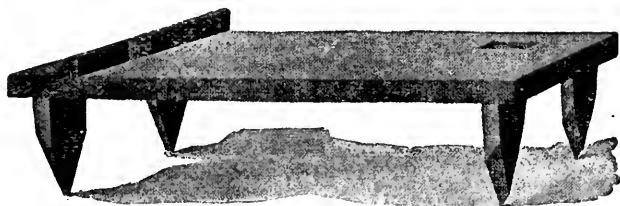


FIG. 98.

GOLDIE CLAW TIE PLATE.

With lug to prevent the lateral movement of the rail.

rail. Fig. 98 illustrates an example of this style. Third, this method aims to have the



FIG. 99.

THE C. A. C. TIE PLATE.

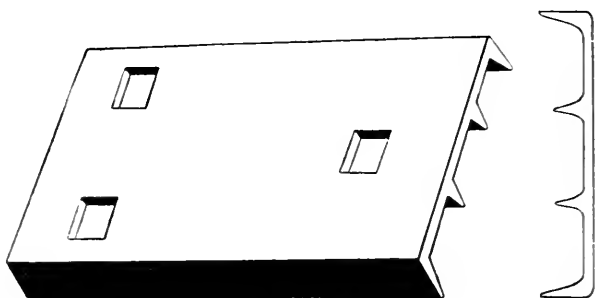


FIG. 100.

THE "SERVIS" TIE PLATE.

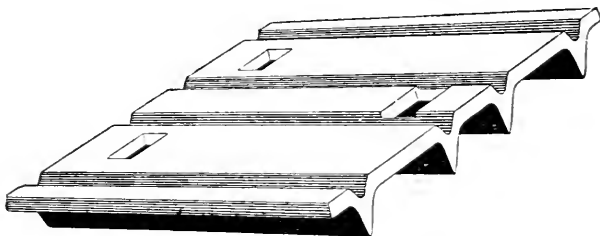


FIG. 101.

WOLHAUPTER ARCH GIRDER TIE PLATE.

plate bolted or spiked to the tie and the rail fastened rigidly to the tie plate. This is Sandberg's type of tie plate. Figs. 99, 100 and 101 illustrate other makes of the first two styles. The same objection applies to the third style of tie plate, which was found to the use of screws instead of spikes to fasten the rail to the ties; by the use of screws the rails were held rigidly to the tie and the wave action produced by the train on the rail caused the tie to work more (or pump the ballast) than where spikes were used, thus increasing the cost of track repairs.

Where tie plates are not used on all the ties in a track they will be found of special benefit under the following conditions: On heavy grades and sharp curves they prevent the cutting of the tie and canting the rail and preserve the gauge without the use of rail braces. In tunnels where the moisture tends to soften the tie, they prevent the rail cutting into it and preserve the gauge. On swampy ground where the roadbed yields under the weight of the train, they prevent ties being cut into by the rail, which leads to excessive creeping of the rails. On long bridges, elevated roads, in busy freight yards, where trains are frequent, track deteriorates rapidly, and the cost of labor making repairs and renewals is large. At road and street crossings where the planking keeps the ties moist they deteriorate quickly.

Ties which have been cut into by the rail can be used again by adzing them down, plugging the spike holes with hard wood and using a tie plate.

Of the various styles each has its advantages and objections. The friends of the first style claim that the metal is not properly distributed in the second and they will sometimes buckle when a heavy transverse strain is produced by a passing train on a curve; those favorable to the second style claim that the lack of a shoulder to support the base of the rail and not having the resistance of the end wood of the tie to oppose a movement of the tie plate does not hold the track to gauge as well as the second style of plate and permits the spikes to be injured more. There are, it may be said, conditions where each claim is well founded, and the selection of style will depend on the conditions of traffic, grade and alignment.

#### RAILS.

The rails now used are manufactured of steel, iron having gone out of use on account of the greater length of life of steel and the price being reduced to a point where there is no longer a saving in the use of iron. Formerly each road had its own standard section for the rails used. This resulted in a great variety of forms of sections, some of which, however, were practically the same, differing only in minor details.

In 1873 the American Society of Civil Engineers appointed a committee to report upon the forms, sizes, manufacture, tests, endurance and breakage of rails and also the comparative economy of iron and steel. In 1883 the same body appointed another committee to consider the

proper relation to each other of railway wheels and rails. This led to the appointment of a third committee to prepare designs for standard rail sections. In Appendix J there is a cut showing the section adopted and the dimensions for rails of different weights. Mr. E. E. R. Tratman in his work on "Track and Track Work" speaks of rails as follows: "Tie plates should be used with heavy traffic, as the attempt to get a very wide base support in the rail flange usually results in a section which is not adapted to good rolling. Flat-topped rail heads have been advocated, but the metal in the head does not get so much work or squeeze from the rolls, and is thus of less dense texture on top than is desirable. This was found with rails rolled in England 25 or 30 years ago for the New Orleans & Chattanooga Railway. In addition to this, the lateral play of the wheels would soon wear the top to a curved section. The usual top radius is 12 or 14 inches, though the Chicago, Milwaukee & St. Paul Railway makes it 18 inches, and any radius less than 12 inches is objectionable. The best distribution of the metal is probably that of the American Society of Civil Engineers recommended sections, provided that the rails are of good material and thoroughly rolled, the rolling being as slow and cold as practicable.

"The rapid increase in weight of locomotives and cars and train loads has led to the use of heavier and stiffer rails in the sense of girders to carry the increased loads, but in many cases without correspondingly wider heads to sustain

the increased wheel pressure ratios per square inch of surface contact between rails and wheels. The result in some such cases has been that the metal of both tires and rails has been overtaxed, excessive wear and flow taking place, and neither wheels nor rails giving as good service as had been expected. With this in view, Mr. P. H. Dudley designed a set of rail sections whose type is shown by the 100-lb. rail of the New York Central Railway. It will be noticed that the fillets are of large radius, and that the narrowest part of the web is above the centre line. This gives extra resistance to twisting, so that the head will not bend over the web, nor the web over the base. The following is from a statement by Mr. Dudley:

“The static pressures under passenger car wheels on rail heads  $2\frac{1}{4}$  to  $2\frac{3}{8}$  inches wide, range from 30,000 to 100,000 lbs. per square inch, while those of locomotive driving wheels range from 110,000 to 150,000 lbs. To sustain such wheel pressures without undue flow and wear, requires not only broad heads, but a high grade of metal in the rails. Comparisons of tire records on the New York Central Railway before and after the use of the Dudley 80-lb. rail ( $5\frac{1}{8}$  inches high, 5 inches width of base,  $2\frac{3}{4}$  inches width of head and  $\frac{5}{16}$  inch corners of head) show that with an increase of 40 per cent. in weight per driving wheel the mileage per  $\frac{1}{16}$  inch of wear per tire is about the same for the heavier locomotives on the 80-lb. rails, as formerly for the lighter locomotives on the 65-lb. rails. The former carried

17,600 lbs. per wheel, and averaged 19,300 miles per  $\frac{1}{8}$  inch wear of tire. The latter carried 13,360 lbs. per wheel, and averaged 19,400 miles per  $\frac{1}{8}$  inch wear. Since the general use of this 80-lb. rail, the locomotives rarely go to the shop to have the driving wheel tires turned unless other repairs are needed, the wear of the tires no longer determining when the engines must go to the shop, as was the case when running on the 65-lb. rails. The mileage before re-turning the tires is from 150,000 to 185,000 miles. These facts show the value of the broad heads in increasing the life of tires as well as of rails.

“Mr. Sandberg, the European rail expert, favors wide heads, with large corners, and his type of section is represented by the 72-lb. rail of the Canadian Pacific Railway. In 1894 he changed his sections somewhat in detail, his modified 100-lb. rail being  $5\frac{3}{4}$  inches high,  $6\frac{1}{4}$  inches wide, with a head 3 inches wide, having  $\frac{1}{2}$ -inch top corners. He increased the width of the head, but retained the round form with large corners and a top radius of 6 inches. He admits that sharper corners may be used with the American type of rolling stock, having the short, rigid wheel base of the trucks instead of the long, rigid wheel base of European cars with fixed axles, but it may be doubted whether this distinction is of much importance. The width of rail base was increased, so as to avoid the use of tie plates, for while he advocates their use, he has found it difficult to get them introduced by European railways. The rail section has suffered in consequence, and even

with oak ties (and almost certainly with softer ties) the rails will still cut under heavy traffic and wheel loads. One reason for the disfavor with which tie-plates are regarded in Europe is probably the size and weight and cost, and the difficulty of securing flat plates firmly to the tie, so as not to cause rattling. It may be mentioned that some of the so-called Sandberg 'Goliath' rails are modified from the original to a section for which Mr. Sandberg disclaims responsibility.

"*Double-Head Rails.* In Europe the double-headed rail, carried in cast-iron chairs, was early designed, having two symmetrical heads, so that the rail could be reversed and both ends be utilized for wear. Some of the sections were of hour-glass section, with two pear-shaped heads. The indentation of the lower head by the chairs, however, made the turned rails very rough riding, and the rails were also found liable to break, so that as early as 1858 the bull-head section was introduced, having the lower head only large enough to give a seat in the chair and a hold for the wooden key or wedge which secures the rail in the chair. Some years ago about ten miles of 80-lb. iron double-headed rails were laid on the Boston & Worcester Railway (now part of the Boston & Albany Railway), but after ten years' service the track was relaid with T-rails. The bull-head rail is now the standard in England, and is also used somewhat extensively in European countries, India, etc. The Pennsylvania Railway has some of the 90-lb. bull-head rails of the London & Northwestern Railway, laid for ex-



perimental purposes, some on steel ties, and others in cast-iron chairs on wooden ties, but this track has not been able to stand the heavy traffic on this road. One of the great objections to these rails is that they require two heavy cast-iron chairs (weighing 26 to 56 pounds each) on every tie, merely to hold the rail up. These chairs involve much really useless material, and the wear of the rails in the chairs limits their life, being even more than the wear at the joints. Many of these rails have rounded heads, but in some of the modern heavy sections the head has vertical sides and sharper top corners.

Many countries now recognize the disadvantages of the bull-head rail, and are adopting a more economical, but equally efficient track of T-rails on metal tie plates. In England, however, the erroneous idea very generally prevails that a T-rail track is in itself unsafe, and this has even led to the introduction of double-head rails for colonial railways, involving much unnecessary expenditure, which would have been better applied to the construction of a greater mileage of a more suitable type of track. The English track, as built, is very strong and substantial, but very expensive, and an equally good track can be made and maintained at less expense with heavy T-rails. Mr. Freund, of the Eastern Railway of France, has made investigations from which he concluded that theory and experiment show that a T-rail secured to oak ties by screw spikes is as safe from lateral displacement as a bull-head rail in chairs or a T-

rail with tie plates on pine ties. He further concluded that the T-rail comes nearer to giving its proper service than the bull-head rail, because the life of the latter is limited by the wear of the surfaces in contact with the chairs, and not by the wear of the running surface. In most European countries, except England, T-rails are extensively used, but they are very generally of poor design and very much too light for the traffic, and the consequent poor results in service are among the reasons for the disfavor with which the T-rail section is regarded for main tracks in Europe. European engineers are not, as a rule, well informed as to modern American track, or the successful results of service of good rails under severe conditions of fast, heavy and continual traffic. In some cases a narrow-based T-rail has been adopted, carried in cast-iron chairs, very similar to those for double-headed rails, and secured by large wooden keys, which make an objectionable fastening."

In Appendix J the sections of rails used by several American and foreign roads are given; these sections differ from that adopted by the American Society of Engineers, some very materially. Some fifty American roads, most of them western, have adopted the standard section recommended by the American Society of Engineers.

The tendency is toward heavier rails. In speaking of this, and the road-bed on which they are used, Mr. Tratman remarks: "In regard to the growing increase in the use of heavy rails, it may be pointed out that while it is most desira-

ble to have rails of ample weight for the traffic, the rail is only one part of the track, and that improvements in ballast, ties, fastenings, joints, etc., are of equal importance in the construction and maintenance of a first-class track. The laying of rails should also be very carefully and thoroughly done, though this is a point that is frequently neglected to a greater or less extent. For instance, new rails carelessly laid on old ties may be given a wavy surface, or permanent set, due to careless handling or to uneven bearing surfaces, which cannot afterwards be remedied and will materially reduce the beneficial results intended to be obtained by the new rails. With an ordinarily good track, on which light rails are replaced by heavier rails, the work of maintenance and renewals should be very much reduced, owing to the increased weight and stiffness of the rails, which reduces the deflections, so that the joints can be kept in better condition. The number of ties should not be reduced for heavier rails, as the rail should not be independently considered as a bridge or girder resting upon piers. A fairly large number of ties and fastenings greatly facilitates the maintenance and adjustment of surface, line and gauge to ensure an easy riding track, more so than when the supports and fastenings are 33 to 36 inches apart, as with English track." There have been some trials of rails longer than 30 feet, which is the standard length. Some roads are experimenting with 60-foot rails and others with 45-foot rails. At this date the experience is not considered favorable to

their adoption, as the expense of handling them proves to be greater per ton or foot than for the 30 foot lengths, beside which they become bent more easily.

The street railway companies have made continuous rails by electric welding, and some experiments in this line have been made by steam railroads. Mr. Tratman describes one as follows: "Continuous rails, with the ends welded together in the track, are being tried on street railways, and some experiments have been made on steam railways with rails laid without expansion spacing and spliced by riveted angle bars. In June, 1889, Mr. T. T. Gleaves laid on the Durham Division of the Norfolk & Western Railway, three miles of the continuous 'self-surfacing' track patented in 1886 by Mr. P. Noonan, a section foreman. The rails were 56-lbs. per yard, laid on ordinary ties completely buried in the earth, and the spike heads were left  $\frac{3}{8}$ -inch clear above the rail base, so that the wave motion or undulation of the rails would not affect the spikes or ties. As this motion was in advance of the wheels, there was no battering of the ties, and the motion of a train was said to have been as smooth and easy as on heavy rails in stone ballast. The joints were secured by splice bars with  $\frac{3}{4}$ -inch rivets, making the rails continuous and without any allowance for expansion. At each end of the three-mile section were switch points to allow for the expansion of long stretches of rail, and at frogs and switches at stations of course the rails could move longitudinally. The track

was turfed over, and three-inch terra cotta drain tiles were inserted to carry the water out beyond the track. After being laid, the track was not lined or surfaced for eighteen months, the only maintenance expense being for a watchman, although engines weighing 104,000 lbs. were frequently run over it at a speed of fifty miles per hour. The ties were found to decay more quickly by being buried in the earth and becoming water-logged, as might have been expected, and the track got somewhat out of surface, owing mainly to the fact that it was not laid on a compact roadbed, but in wet clay cuts and on banks that settled in sags. During the same period of eighteen months, there were expended \$1,890 in labor for keeping the adjoining three-mile sections in fair condition. With such a track on good ballast some interesting results might be expected."

The Illinois Steel Company's standard specifications for steel rails adopted January 1st, 1897, are as follows:

**SECTION 1.** The section of the rail throughout its entire length shall conform to the American Society of Civil Engineers Standard ( ) pounds per yard.

The fit of the fishing or male templet shall be perfectly maintained. When the rolls are new the section of the rail may be one sixty-fourth ( $\frac{1}{64}$ ) of an inch low. As the rolling proceeds, a variation not exceeding one-thirty-second ( $\frac{1}{32}$ ) of an inch in excess of height over templet may be permitted in a delivery of ten thousand (10,000) tons of rails, after which the rolls must be reduced to standard height of such sections. The standard of measure to be Brown & Sharp United States Standard Steel Vernier Caliper Rule.

#### WEIGHTS.

**SEC. 2.** The weight of the rail shall be kept as near to ( ) pounds per yard as is practical after complying with Section No. 1. The rails shall be accepted and settled for according to actual weights.

**LENGTHS.**

SEC. 3. The standard length of rail shall be thirty (30) feet, at a temperature of seventy (70) degrees Fahrenheit. Shorter rails having length of twenty-nine (29) to twenty-two (22) feet, inclusive, shall be accepted to the extent of ten (10) per cent. of the entire order.

A variation in length of one-fourth ( $\frac{1}{4}$ ) inch over or under the specified length will be allowed.

**CAMBERING AND STRAIGHTENING.**

SEC. 4. Care to be taken in cambering the rails so as to reduce the amount of work in the straightening press to a minimum. The rails must be straight in all directions as to both surface and line, without twists or kinks.

**FINISH.**

SEC. 5. The rails must be smooth on the head and base, and free from all mechanical defects and flaws, and must be sawed square at the ends; the burrs made by the saws must be carefully chipped and filed off, particularly under the head and on the top of the flange, to insure proper fit of the angle bars.

**DRILLING.**

SEC. 6. The drilling for the bolts to be in strict conformity with the blue print attached, or the dimensions given.

Holes imperfectly drilled to be filed to proper dimensions. All holes must be accurate in every respect.

**BRANDING.**

SEC. 7. The section number, name of maker, year and month, to be rolled on the side of the web. The number of the heat to be stamped in the side of the web.

**CHEMICAL COMPOSITION.**

SEC. 8. The chemical composition of standard rails under seventy (70) pounds per yard to be as follows:

Carbon .....	.37 to .45
Phosphorous not to exceed.....	.10
Sulphur not to exceed.....	.05
Silicon.....	.07 to .15
Manganese.....	.70 to 1.10

The chemical composition of rails seventy (70) pounds and over per yard to be as follows:

Carbon.....	.45 to .55
Phosphorous not to exceed.....	.10
Sulphur not to exceed....	.05
Silicon.....	.10 to .20
Manganese.....	.80 to 1.00

## TEST INGOTS.

SEC. 9. From each heat one test ingot shall be cast  $2\frac{1}{2} \times 2\frac{1}{2} \times 6$  inches long. This to be drawn down at one heat by hammering to a test piece three-eighths ( $\frac{3}{8}$ ) inches square by eighteen (18) to twenty (20) inches long. The same when cold to be required to bend to a right angle without breaking. This bar must be bent by blows from a hammer.

## CUTTING TO BLOOMS.

SEC. 10. After cutting off or allowing for the sand on the top end of the ingot, at least twelve (12) inches more of seemingly solid steel shall be cut off that end of the bloom. If after cutting such length the steel does not look solid, the cutting shall be continued until it does.

## INSPECTION.

SEC. 11. The inspector representing the purchaser shall have free entry to the works of the manufacturer at all times while his contract is being filled and shall have all reasonable facilities afforded to satisfy him that the rails are being made in accordance with these specifications.

The manufacturer shall furnish daily the carbon determinations of each heat and a complete chemical analysis of at least one heat of each day and night turn in which each element is to be determined.

## NO. 2 RAILS.

SEC. 12. The requirements for No. 2 rails shall be the same as for No. 1, except that they will be accepted with a flaw in the head not exceeding one-fourth ( $\frac{1}{4}$ ) inch, and a flaw in the flange not exceeding one-half ( $\frac{1}{2}$ ) inch in depth.

No. 2 rails to the extent of five per cent. (5%) of the entire order will be received.

The aim of manufacturers of rails is to produce hardness to resist wear and toughness to resist fracture. Carbon gives the metal hardness, and each individual designer has his particular opinion as to the exact amount of carbon to use to procure the best result. The heavier the rail the larger the per cent. of carbon which must be used. Silicon makes the steel fluid and dense, this producing solid ingots and reducing crystallization. Sulphur tends to make the metal seamy and phosphorous makes it brittle. Manganese is

used for chemical purposes. Not only the opinion of the designer, but the chemical constituents and their proportions in the ores used together with the weight of rail to be produced, affect the proportions of the chemical constituents of the rail. The economical question in the specifications of steel rails has been stated very clearly by Mr. Ashbel Welch, Chairman of the Rail Committee of the American Society of Engineers as follows: "An unwise saving of a dollar to the manufacturer, or a little unfaithfulness in the workman, will probably reduce the value of the rails ten or twenty dollars. Ten or fifteen per cent. added to the ordinary work on rails would double their value. An expert rail maker knows this very well, but he cannot put the \$10 extra work on a ton in order that it may be worth \$60 more to the purchaser, who will not allow him any part of the \$10 out of the \$60 he makes. The railway agent who purchases may also know all this, but he cannot follow his own judgment, for he knows his directors will say he paid \$10 more than the market price. It is thus that the interests of stockholders are sacrificed."

The life of steel rails cannot be determined by the number of years they have been in use; those on one road may have had, during a given period, two or three times the number of trains passing over them than those in another road had. The tonnage which has passed over the rail is a better means of comparing the relative value of the rail and its life. Mr. A. M. Wellington states on this subject: "The life of first-class 60 to 80-



pound steel rails was given by Wellington in his 'Economical Theory of Railway Location' (1887) as about 150,000,000 to 200,000,000 tons. There are from 10 to 15 lbs. of metal, or  $\frac{3}{8}$ -inch to  $\frac{5}{8}$ -inch depth of head available for wear, and abrasion takes place at the rate of about 1 lb. per 10,000,000 tons, or  $\frac{1}{16}$ -inch per 14,000,000 to 15,000,000 tons of traffic. The rate of wear is increased about 75 per cent. by the use of sand by the locomotives. The failure of modern rails, as a rule, is due more to deformation of section at and near the joints than to abrasion proper, and this deformation and crushing are largely due to the heavily loaded driving wheels, the wear from which is estimated at 50 to 75 per cent. of the total. Heavy freight engines may have three or four driving axle loads of 30,000 to 38,000 lbs. on a wheel base of 12 to 15 feet. The area of contact between the driving wheels and rails is an oval about  $1 \times \frac{3}{4}$  inch, or with worn tires or worn rails  $1 \times 1\frac{1}{2}$  inches, with an area of 1.07 square inch. The maintenance of rails ought not to exceed  $\frac{1}{2}$  cent or 1 cent per train mile, but it is very generally as much as 3 cents, owing partly to work on side tracks. About half the metal in the rail head is available for wear, but the full depth of wear is not obtainable in main track, as the rails would then be too rough for service; about  $\frac{1}{4}$ -inch is the limit of wear in main track, the rails being then removed to branch or side tracks."

In Appendix J the following tables relating to rails and fastenings are given:

Table No. 1; Tons per mile and feet of track per ton, of rails of different weight per yard.

Table No. 2; Number of splice bars and bolts for one mile of single track.

Table No. 3; Number of fastenings required to a ton of rails of different weight per yard.

Table No. 4; Pounds and kegs of railroad spikes required for one mile of track, given for different sized spikes and rails of different weight.

Table No. 5; Gives the weight per 1,000 for standard track bolts of various sizes, and for bolts with square and hexagon nuts.

Table No. 6; Gives the average number of track bolts of various sizes in a keg of 200 pounds.

Table No. 7; The amount of expansion of steel rails and the size of the shim for each change of ten degrees of temperature from 30 to 130 Fahrenheit.

Appendix J also gives the practice of the Northern Pacific Railway, in allowing for expansion; here the rule specifies that the thermometer must be read in the shade, which would make the allowance for expansion greater than if the reading was taken in the sun and is a safer practice.

#### SPIKES.

There have been numerous methods tried to fasten the rail to the cross-tie. Screws of different patterns and other devices have been tried, but the general practice is to use the ordinary railroad spike shown in Fig. 102, cut A. This is

not, however, an altogether satisfactory spike, but when the first cost and cost of maintenance are taken into consideration, it is considered more satisfactory than anything yet produced. Fig. 102, cut C, shows the way the fibre of the wood is damaged by driving an ordinary railroad spike into a cross-tie. The Goldie spike, Fig. 102, cut B, illustrates a spike designed to accomplish all that the ordinary railway spike does and yet not damage the fibre of the wood to so great an extent.

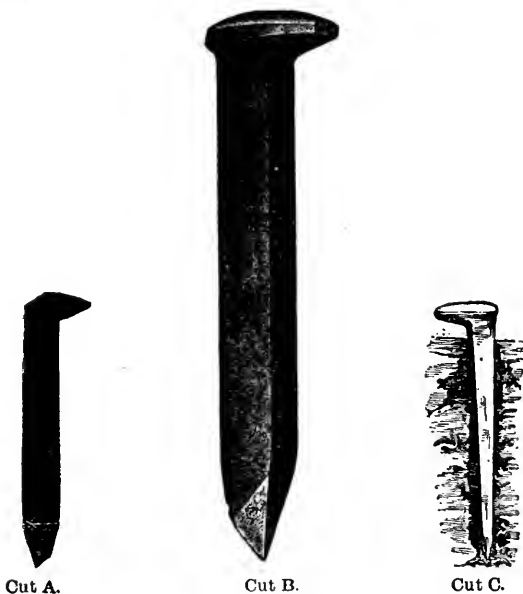


FIG. 102.

The holding power of the spike depends on the nature of the tie, the conditions under which the

spike is driven, and the length of time it has been in the track.

The force exerted by the rail when a train passes over it tends to lift the spike out of the wood; this takes place on a tangent, and is independent of any lateral pressure produced by the swaying motion of the train. The holding power of newly driven spikes has been found by experiments to vary from 1,500 pounds to 7,000 pounds, the latter being one of those cases, probably, where the conditions were more favorable than exist in actual practice. In a good oak or pine tie the resistance of a newly driven spike for a 75-lb. rail would probably be about 3,500 pounds.

#### RAIL JOINTS AND FASTENINGS.

The best method of fastening the rails together is a controversy not yet settled. There are a number of different methods in use. With the constantly increasing weight of engines the method of connecting the rails becomes a vital question.

The fish plate is used only where the traffic is light and heavy locomotives have not yet been introduced. The angle bar (Fig. 103) is a decided improvement on the fish plate, and is used by roads having a moderately heavy traffic; it gives lateral stiffness to the joint and a greater bearing surface on the tie. The continuous rail joint (Fig. 104) gives a greater bearing on the tie and a support to the base of the rail in addition to the advantages of the angle bar; this form of joint

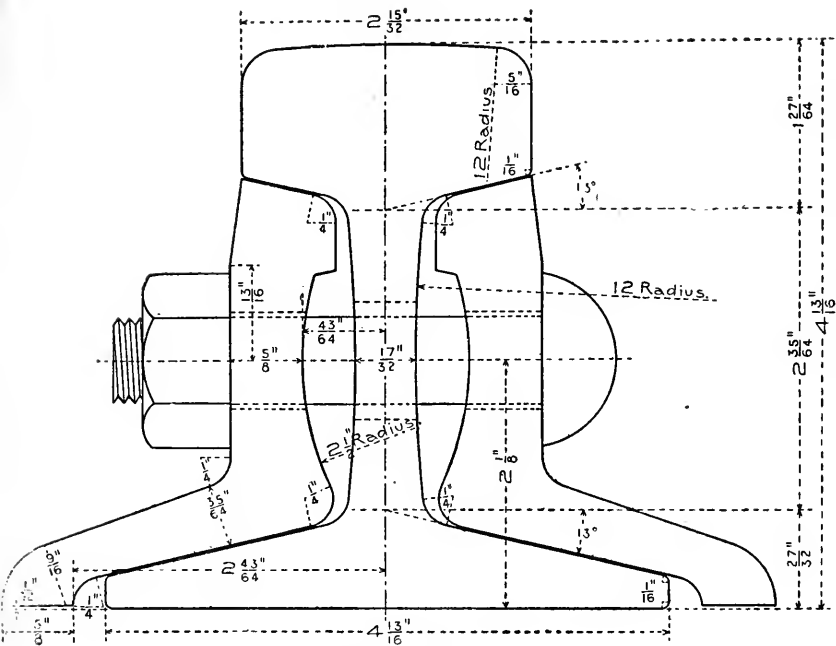


FIG. 103.

Angle Bars used on a 75-lb. rail of American Society of Civil Engineers' Standard.

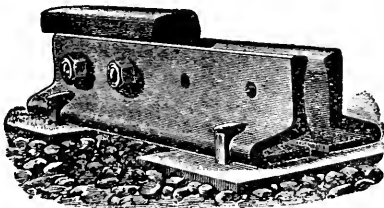
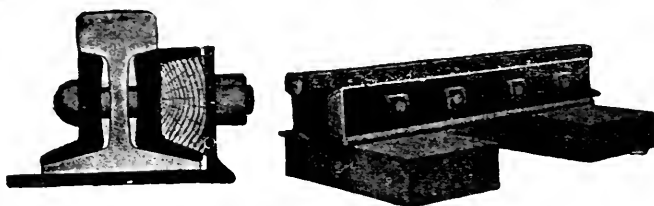


FIG. 104.

· CONTINUOUS RAIL JOINT.

is used on a number of roads some of which have the heaviest engines and greatest number of trains in this country. Figures 105, 106, and 107 represent the Weber rail joint, the Truss rail joint and the Common Sense rail joint, all de-



Section

Side View.

FIG. 105.  
WEBER RAIL JOINT.

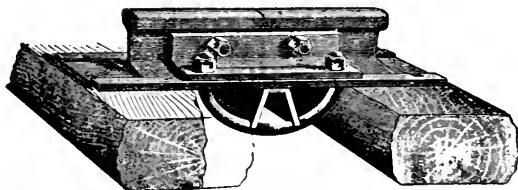
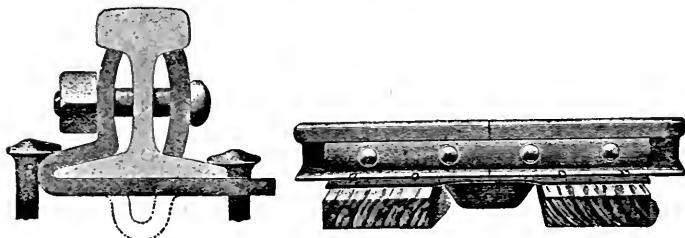


FIG. 106.  
TRUSS RAIL JOINT.



Section.

Side View.

FIG. 107.  
"COMMON SENSE" RAIL JOINT.

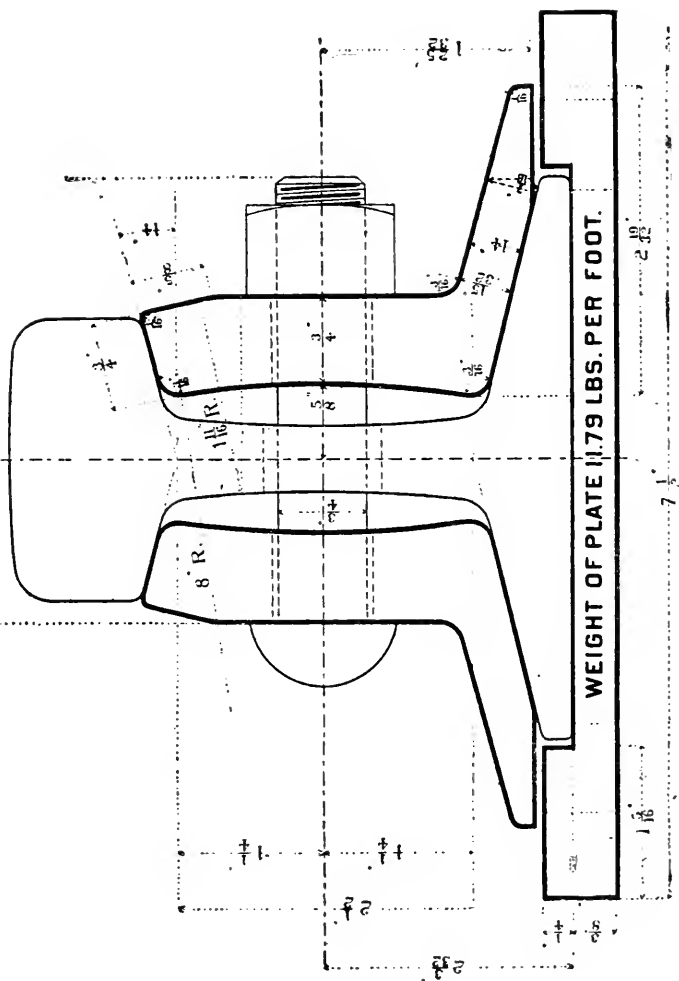


Fig. 108.

Joint Base Plate used to give lateral stiffness to rail—Chicago & Northwestern Ry.

signed to accomplish the same object as the continuous rail joint. They are used by roads having heavy traffic. Fig. 108 gives a view of a joint adopted by the Chicago & Northwestern Railway Company to secure the advantages claimed for the continuous rail joint without having to discard the angle bars; the objectionable feature with this fastening is that the upward wave motion has no greater resistance at the joint than with the angle bar alone; the plate assists in preventing the joint becoming low and adds lateral stiffness when the spikes are well driven.

There are two functions to be performed by rail joints. One is to resist the rapid blows from the wheels of the engines and cars of fast passenger trains, and the other the slower blows from freight trains. The weight on the driving wheels of the new passenger locomotives of the high speed type is less than the new style of locomotives for freight. The latest style of freight locomotives for the Illinois Central Railway, for instance, will have a weight on each driver of 24,000 pounds, while the new high speed passenger locomotives for the Lake Shore & Michigan Southern Railway will have a weight on each driver of 22,000 pounds. A 60,000 pound capacity car fully loaded will have from 11,000 to 12,000 pounds weight per wheel. In the case of a tonnage train consisting of a twelve wheel engine and one hundred loaded cars (as on the Illinois Central Railway) passing over a rail joint, there will be four blows of 24,000 pounds made by the engine and 260 blows of from 11,000 to 12,000



pounds made by the wheels of the freight cars. When this is considered the importance of a good rail joint becomes apparent.

The length of rail joints varies from 48 inches with six bolts to 24 inches with four bolts. The spacing of the ties under the rail joints is not uniform; some roads place the joint between the ties, others place a tie directly under the joint; theoretically the former will permit the rail to respond to the wave action more fully than the latter, and those advocating the first style of spacing the ties claim it makes an easier riding track on account of the wave motion of the rail not being so greatly interfered with. The question of even\* and broken† rail joints appears from the practice to tend to a decision in favor of even joints on tangents and broken joints on curves.

Track bolts are made to a standard size; some roads, however, have their own design. In Appendix J, Table No. 5 gives the weight per 1,000 bolts with square and hexagon nuts. Table No. 6 gives the sizes used for rails of different weight, and the number in a keg of 200 pounds. Fig. 109 illustrates the styles of track bolts used.

The constant vibration at rail joints when trains are passing over them, causes the nuts to turn and the bolts to become loose; this prevents

---

\* When both rails in a track are laid so that the joints are directly opposite each other, the track is said to be laid with "even" joints.

† When the joint in one rail is laid opposite the center of the other rail, the track is said to be laid with "broken" joints.

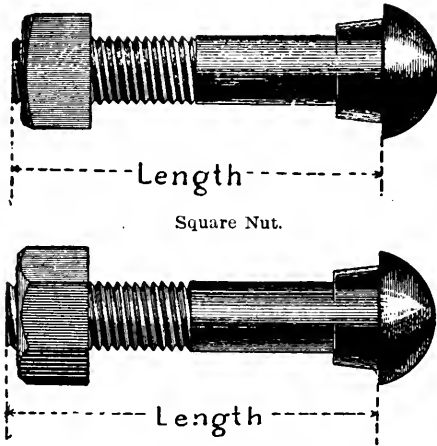


FIG. 109.  
TRACK BOLTS.

the joint fastening from doing the work for which it was designed. To overcome this, various styles of nut-locks have been used; in a general way they can be placed in four classes:

*First*—The use of washers partially made of rubber or papier mache.

*Second*—Metal washers with a spring action which are designed to keep the nut pressed tight against the threads of the screw on the bolt. (Fig. 110 represents the "Verona" nut-lock, which is of this type.)

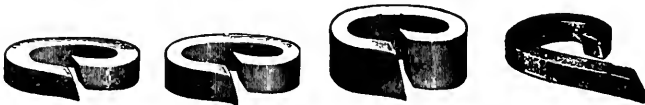


FIG. 110.

STYLES OF "VERONA" NUT LOCKS.

*Third*—An elastic nut designed to clasp the bolt and hold this nut in position by the increased friction between the threads on the nut and bolt. (Fig. 111 represents the “National,” which is of this class.)

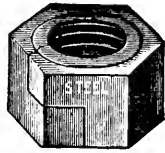


FIG. 111.  
Elastic Self-locking  
Steel Nut (“National”)

*Fourth*—A nut with an elongated base forming a spring to keep the nut pressed tight against the threads on the bolt. (Fig. 112 represents the

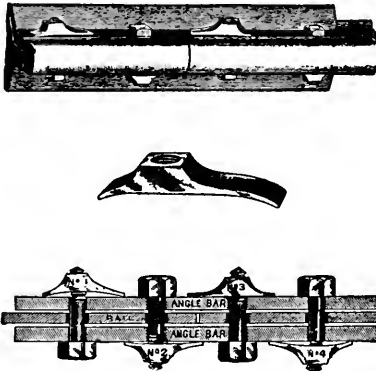


FIG. 112.

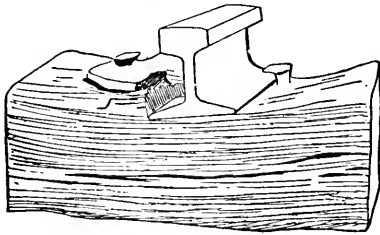
JOINT SPRING NUT LOCK.

joint spring nut of this class.) Loose nuts not only mean loose and low joints, but wear on the angle bars and rails and broken joint bolts, and hence are to be obviated.

#### RAIL BRACES.

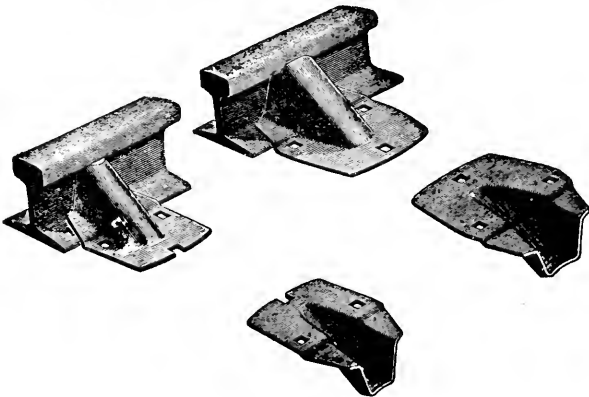
To keep the track to gauge, rail braces are used on curves, and, if soft wood ties are used,

they can be used to advantage on tangents. They should always be used for the guard rails and lead rails of turnouts or switches. They should be well designed for their work, or the outer edge of the rail will cut into the tie, as shown by Fig. 113. Two designs of forged steel braces for rails are shown in Fig. 114. The tie



**FIG. 113.**

Shows how a rail-brace will fail to support the rail where it cuts into the tie, or the rail brace is not properly designed.



**FIG. 114.**

**FORGED STEEL RAIL BRACES.**

plate when used reduces to some extent the necessity for rail braces by giving a hard surface into which the edge of the base of the rail will not cut when a lateral strain is exerted by the train; it also assists in holding the track to gauge by bringing the resistance of the spikes on both sides of the rail to oppose a lateral movement of the rail.

#### SWITCHES.

In the selection of switches there are three styles to choose from, the stub switch, the split switch and switches of special design or patents, varying from the first two. The stub switch consists of two movable rails connected by rods to hold them to gauge and cause both rails to be moved parallel when thrown by the lever; the ends of these rails rest on a head block or chair. The main line rails and the rails leading to the side track are held firmly by the head block or chair, Fig. 115 represents this style of switch. The split switch is known as the old English Point Switch, which has been in use in

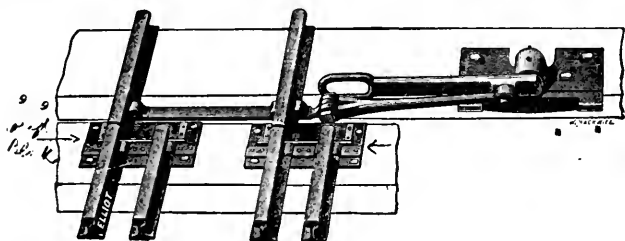


FIG. 115.

STUB SWITCH.

Showing head blocks and ground throw for moving switch rails.

England since 1830 and is now coming into general use in the United States. The Lorenz Switch and the Clarke-Jeffrey Switch are split switches. Fig. 116 illustrates this style. The

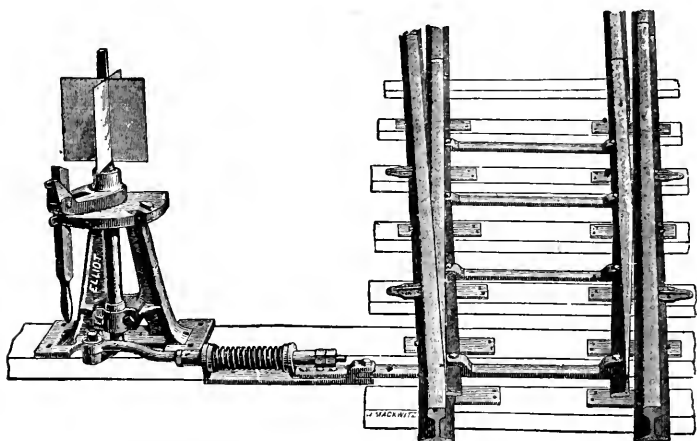


FIG. 116.

SPLIT SWITCH.

With Pony Switch Stand.—Suitable for yards.

third class of switches is designed for special purposes; are protected by patents and they mostly aim to give a continuous rail for the main line. MacPherson's Improved Safety Switch and Frog is devised to lift the train over the rail of the main line without the use of a frog when being switched on to a siding. This switch is in use on some of the great railroad systems. The Wharton Switch is designed to leave the main line rails unbroken at the switch stand, but a

frog is used where the inside rail of the side track crosses the main line rail. It has been in use for a number of years and is well known. The Duggan Switch is designed to accomplish the same purpose as the Wharton Switch, by having the switch rail work in a vertical instead of a horizontal plane.

The principal objection to the stub switch is that the pounding of the ends of the rails at the head block by the passing wheels causes the rails to bind at the head block when the expansion becomes great, and thus brings about the derailment of trains. Their use should be confined to side tracks, but they are not to be recommended for use even there.

Frogs can be placed in three general classes: rigid, spring rail and swing rail. The manufacturers of frogs and switches make about four styles of rigid frogs. Fig. 120 illustrates a filled

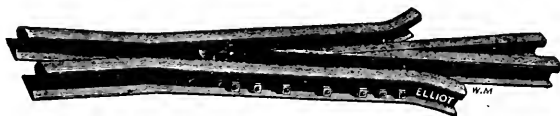


FIG. 120.

RIGID FILLED FROG.

frog. These frogs are made in two styles; in one of them the metal between the rails is in two pieces, and the other two pieces where they come together at the point of the frog are welded together, thus making a stiffer frog and giving more support to the point. Fig. 121 represents a chuck filled frog which is lighter than the filled

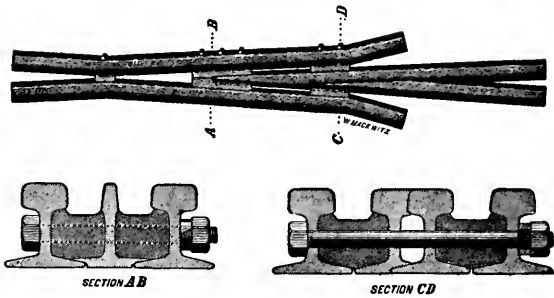


FIG. 121.

RIGID CHUCK FILLED FROG.

frog and suitable for yards or a road with light traffic. Fig. 122 represents a clamped frog, the

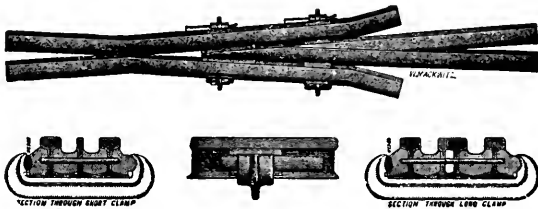


FIG. 122.

RIGID STEEL CLAMP FROG.

clamps being made of steel. This is sometimes called a yoked frog. Fig. 123 represents a frog riveted to a plate  $\frac{5}{8}$  to  $\frac{3}{4}$  inches thick, the rivets being countersunk on the under side of the plate to give a flat bearing on the ties. In addition to the styles of rigid frogs mentioned, some roads have styles of their own, differing somewhat in detail, and the various makers also differ in the details of manufacture and style. Rigid frogs



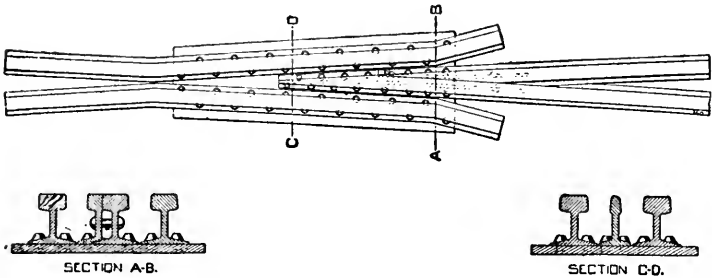


FIG. 123.

RIGID PLATE RIVETED FROG.

should not be used in main track of roads doing a large business; they may, however, be used on branches and in yards to advantage to reduce the expense of construction.

Spring rail frogs have been called into use to prevent the pounding at the frog and secure a smooth riding main track; the spring rail frog is considered to have overcome the weak point in the track caused by a frog of the rigid type. Fig.

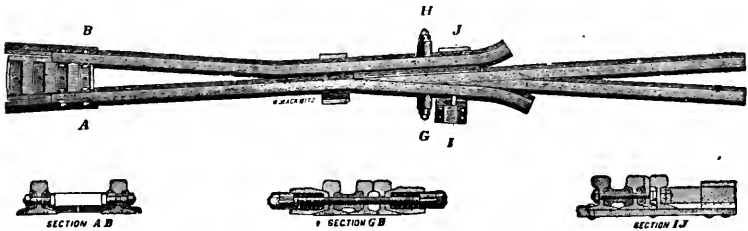


FIG. 124.

SPRING RAIL FROG WITH ANCHOR BLOCK.

124 represents one style of a spring rail frog, the block at A B is so combined with the track rails

and rails in the frog that it forms a frame to prevent the loose spring rail from creeping; the spring rail is channeled to prevent worn wheels from striking it. Fig 125 represents the "Eureka"

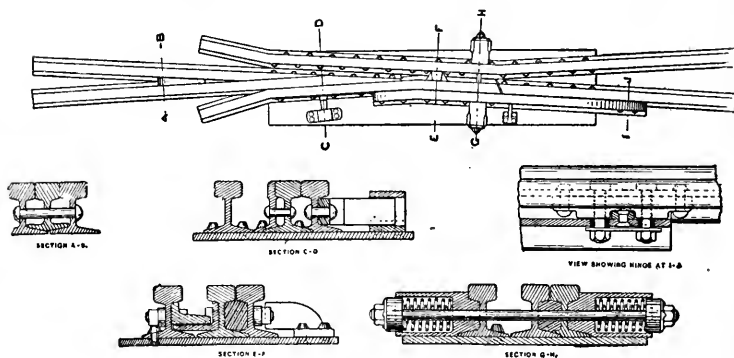


FIG. 125.

"EUREKA" SPRING RAIL FROG.

Spring Rail Frog. All four ends are spliced solidly together as in a rigid frog. The hinge rail is attached to the main rail by a bolt hinge (see section I J); this allows the rail to move freely and prevents its creeping; it is attached to the movable part of the running rail by strong bolts passing through both rails and a wrought iron filling (see section E F). This makes this movable part strong throughout. Manufacturers have a number of other styles of spring rail frogs, and some roads have patterns of their own.

Spring rail frogs and movable points are being used in place of frogs to secure a smooth riding track. Fig. 126 represents a movable point crossing, which is used in place of a frog by connect-

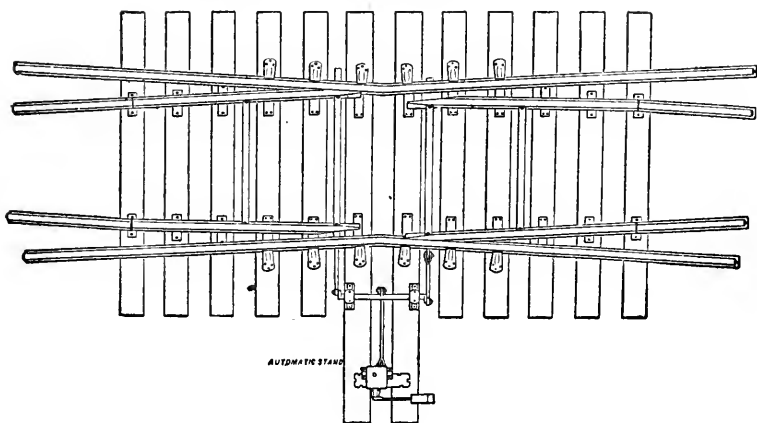


FIG. 126.

## MOVABLE POINT CROSSING.

ing the levers at the movable point with the switch stand. The Coughlin switch rail frog is designed to leave the main line track unbroken at the frog, there being no guard rail or frog required for the main line. The principle of this spring rail frog is in use on the Lehigh Valley Railway and Western Maryland Railway. It can be used with the split switch or Wharton points. The spring rail frog used with the McPherson improved safety switch accomplishes the same object that the Coughlin switch rail frog does, except that a guard rail is required on the main line track.

On account of the varying angles at which roads cross each other, crossing frogs have to be especially made in each instance. They are made of steel rails cut to length and shape, and fitted

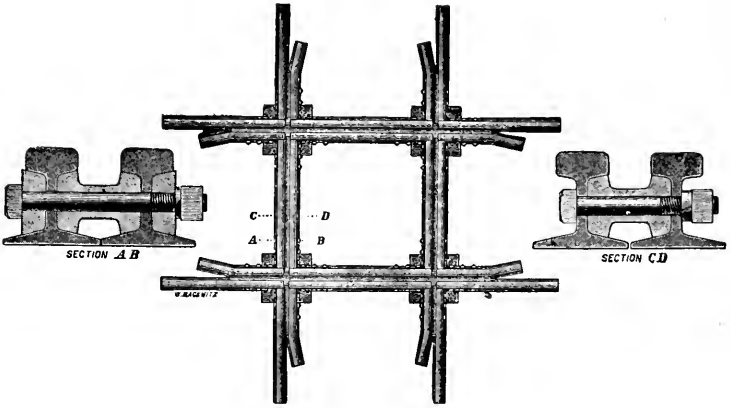


FIG. 129.

CROSSING FROGS. ANGLES 60° TO 90°.

and strongly bolted together. Fig. 129 represents one type of crossing frog; the rails butt against each other and are solid filled throughout, and

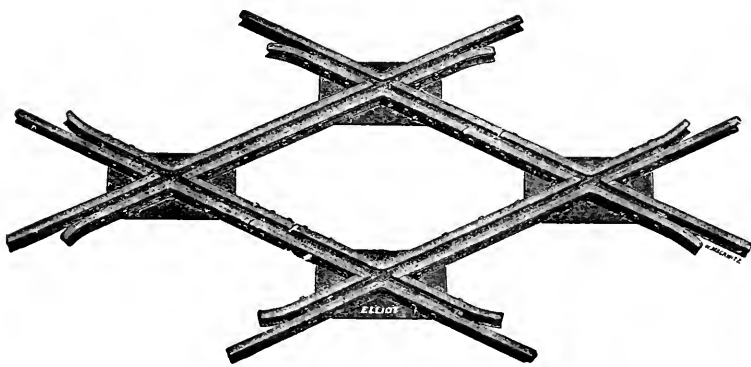


FIG. 130.

CROSSING FROGS. ANGLES 45° TO 60°

securely clamped with angle bars having six bolts through them; the corners are supported by heavy bottom plates. In Fig. 130 the crossing differs from the preceding one, in that the rails at the obtuse angles are solid instead of being butts.

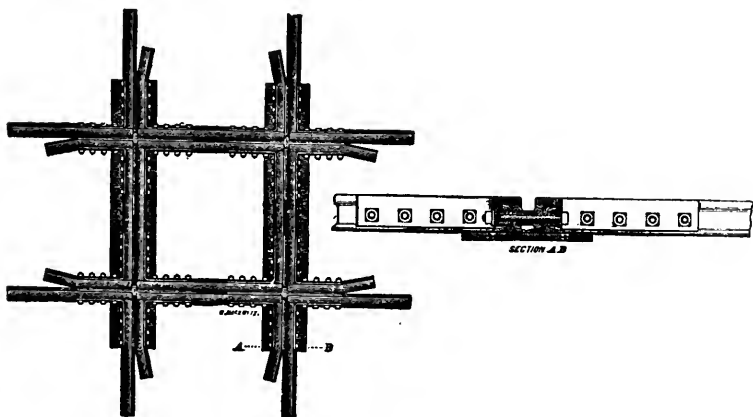


Fig. 131.

CROSSING FROGS WITH EXTRA HEAVY ANGLE IRONS.

Fig. 131 represents a crossing where the angle irons are very heavy and have eight bolts; bottom plates extend the length of the crossing or can be put under the corners only as desired. Fig. 132 is the same crossing shown in Fig. 129, only modified for a street railroad. By making the flangeway on the street railroad as narrow as possible, the life of the crossing is increased. Fig. 133 represents another style of crossing for a steam and street railroad, this is known as a jump crossing, the rail of the steam railroad not

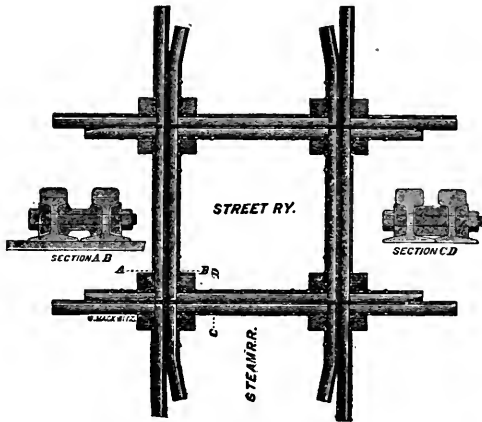


FIG. 132.

CROSSING FROGS FOR STEAM AND STREET RAILROADS.

being grooved for the flanges of the wheels of the street cars.

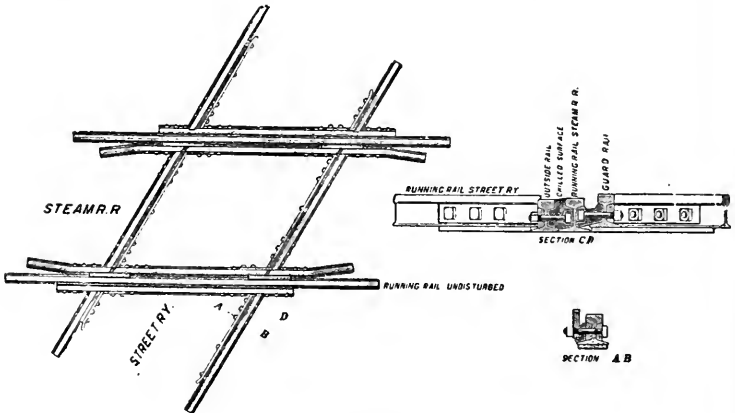


FIG. 133.

JUMP CROSSING FROGS FOR STEAM AND STREET RAILROADS.

Switch stands are so arranged that they throw the switch and display a signal at one operation; the signal is arranged to indicate a clear track on the main line or show the train crew that the switch is open to enter the siding. With all split and safety switches where the train can trail through and open the switch, an automatic or safety switch stand should be used to prevent either the points of the switch or the switch rod being damaged. Figs. 134 and 135 illustrate a

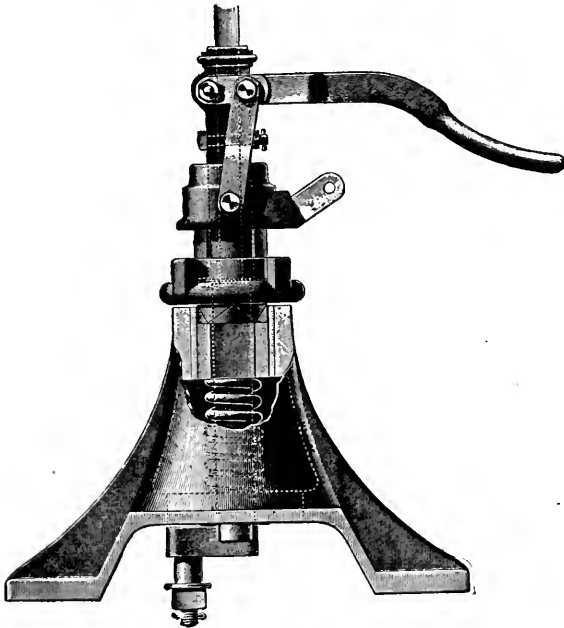


FIG. 134.

"BANAPO" SAFETY SWITCH STAND, AS IT APPEARS WHEN HALF  
THROWN BY HAND.

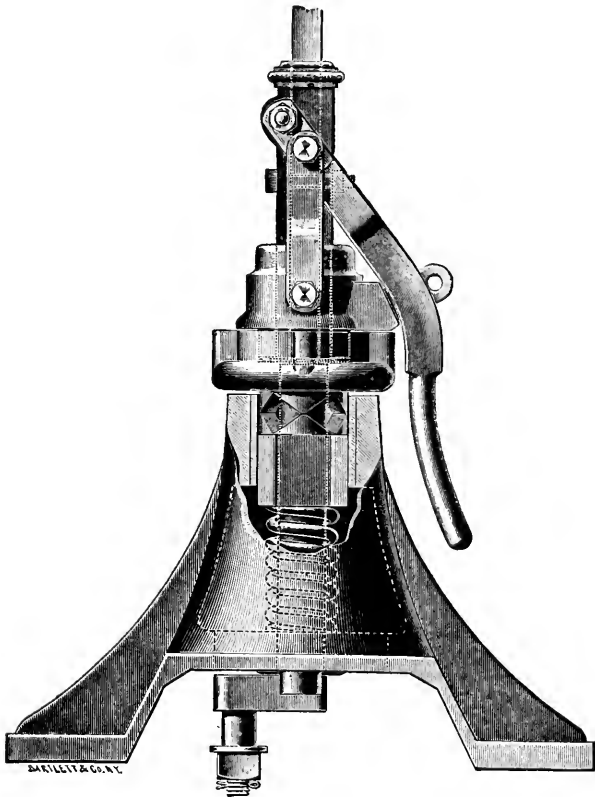


FIG. 135.

"RAMAPO" SAFETY SWITCH STAND AS IT APPEARS WHEN HALF THROWN BY WHEELS PASSING THROUGH THE SWITCH.

safety switch made by the Ramapo Iron Works. This firm have recently added an adjustable crank to their safety switch stand; it assures the switch stand of being able always to fit the throw of the



switch, and to take up any lost motion that may accumulate from wear and avoid the necessity of adjustable head rods, or of shimming out the rod to keep the gauge. There is an endless variety of switch stands, and the types only will be given here. Fig. 136 represents a switch stand for a

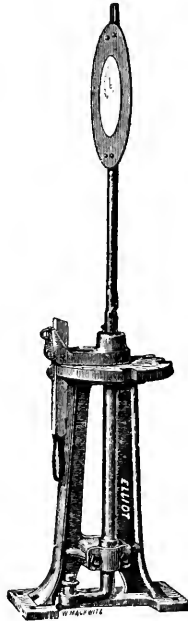


FIG. 136.

THREE-THROW SWITCH STAND.

three-throw switch which can be used on the main line or in a yard where there is room for a high switch stand. In a large yard it is better to use low switch stands, as high ones are liable to

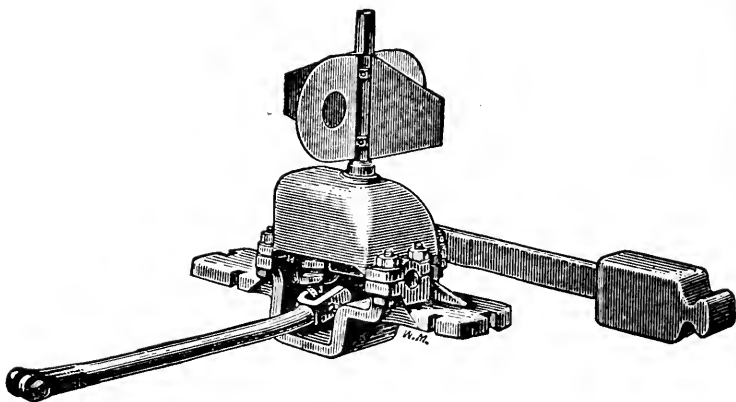


FIG. 137.  
AUTOMATIC PARALLEL GROUND-THROW SWITCH STAND.

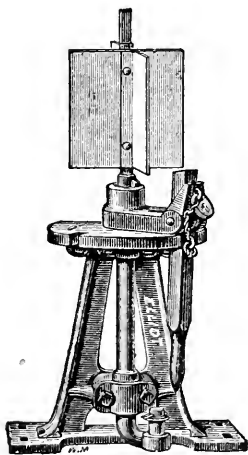


FIG. 138.  
LOW PONY SWITCH STAND.

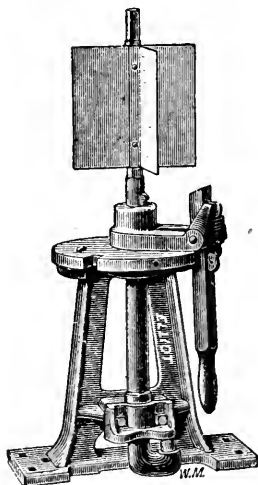


FIG. 139.  
LOW PONY SWITCH STAND  
WITH SAFETY BOTTOM CAP.

prevent the signals on other switch stands from being seen. Figs. 137 to 140 illustrate such stands.

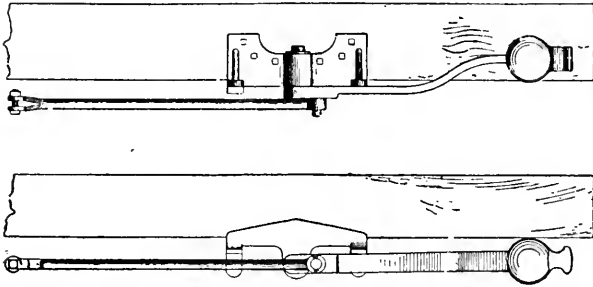


FIG. 140.

GROUND-THROW SWITCH STAND WITH WEIGHTED LEVER.

Some of the various designs for signals or targets on switch stands are given in Fig. 141, and Fig. 142 illustrates a method of elevating the signal or target at a dangerous point.

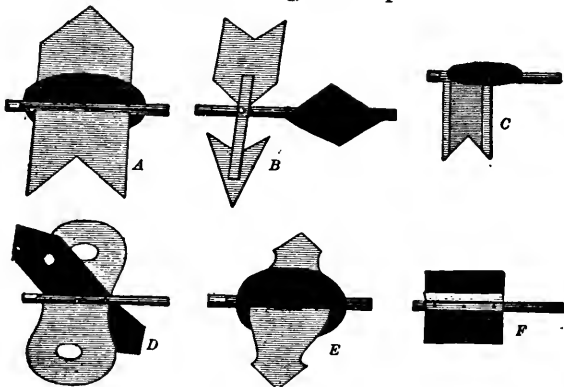


FIG. 141.

DESIGNS FOR TARGETS OR SIGNALS TO BE USED ON SWITCH STANDS.

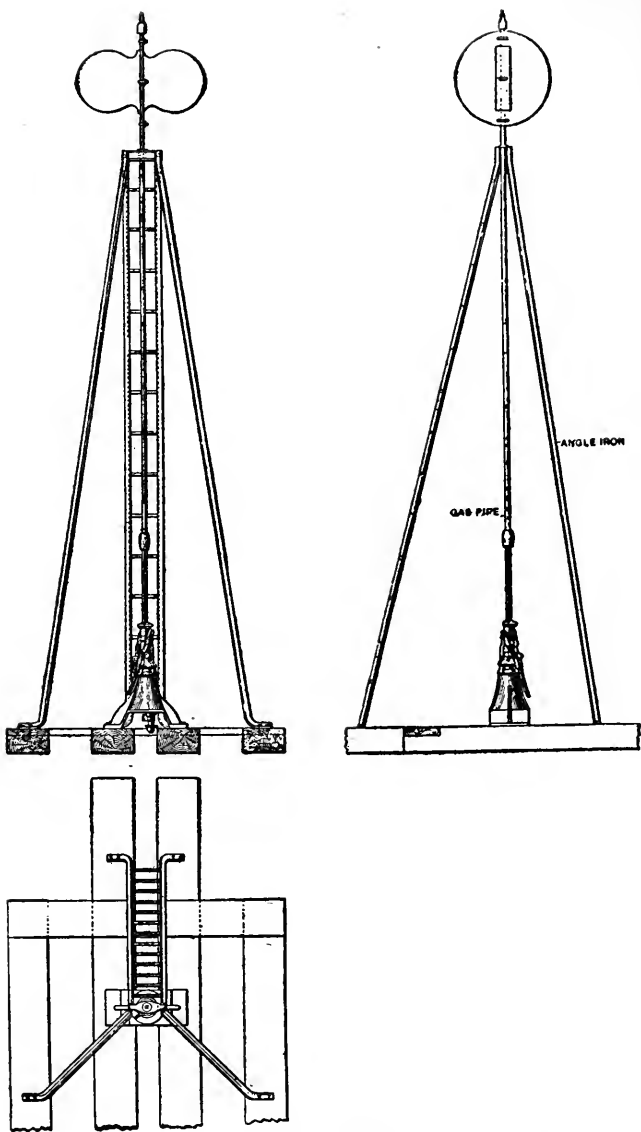


FIG. 142.  
TARGET TRIPOD FOR SWITCH STANDS.

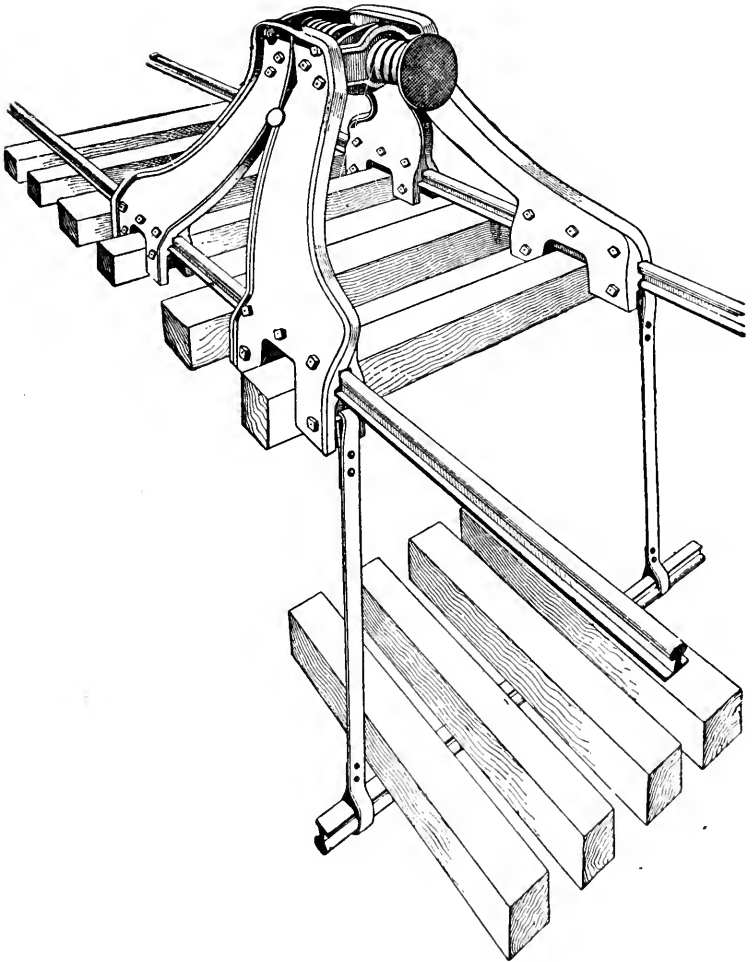


FIG. 143.

"HALEY" SEMI-STEEL BUMPING POST.

## BUMPING POSTS.

There are several designs of bumping posts, the latest are of metal. Fig. 143 illustrates the Haley post which is made of semi-steel, and the spring is made of coil spring steel. The impact is received on a plunger and the blow taken up by two double coil springs, thus reducing the shock on rolling stock to a minimum. The anchorage under the rails shown in the cut can in some cases be omitted. The Haskell bumping post is made of steel rails and cast steel. The main or base rails form support for diverging braces, and it can be securely anchored. The Ellis bumping post, Fig. 145, is a wooden one,

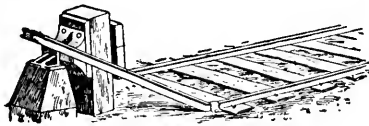


FIG. 145.

"ELLIS" BUMPING POST.

which has been in use for about ten years on a number of roads.

## BRIDGES.

The selection of bridges must be largely left to specialists and each stream crossed will have to be considered separately; one stream must be crossed with the grade line high above flood water; here a deck bridge can be used with advantage, thus reducing the cost of piers. (See Figs. 149, 151 and 155.) At another crossing

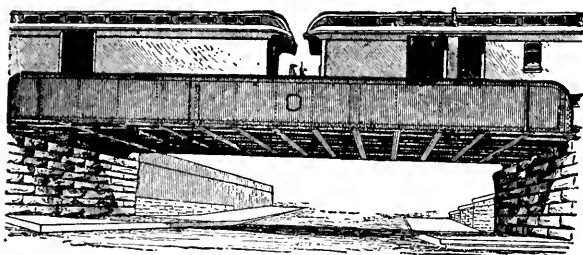


FIG. 146.

THROUGH PLATE GIRDER BRIDGE.

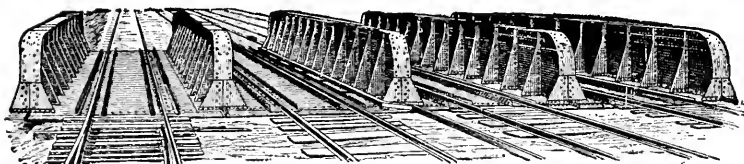


FIG. 147.

PERSPECTIVE VIEW OF THROUGH PLATE GIRDER BRIDGE.

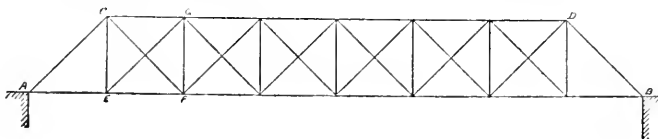


FIG. 148.

THROUGH PRATT TRUSS.

A B is the lower chord, to which the bridge floor is attached.

C D is the upper chord.

A C and B D are the end posts.

C E F G and all such verticals are called intermediate posts or verticals and are known as vertical members.

C F E G and all such diagonals are called tie-braces or tension braces when the strain is a tension or pull and a tiestrut or strut-tie when the strain is a compressive one or a push—in either case they are known as oblique members.

the grade line is so low that a through bridge can only be used. (See Figs. 148 and 150.) Again the nature of the stream may prevent false work from being used in the erection of all or part of a bridge and resort will have to be made to a cantilever style. (See Fig. 165.) The stream may be navigable and the channels change at different stages of the river, necessitating a high bridge or two or more draw spans. (See Fig. 160.) The width of the stream and the amount of shipping using the stream may be such that a biscular bridge must be resorted to. (See Fig. 163.)

Some of the points which must be considered in designing a bridge are: The relation between the length and the height of the truss, so that the metal will be economically used in the chords and braces. The width of the pannel must be so proportioned, that unnecessary expense will not be incurred for connections for the floor system and lateral bracing; no rule can, however, be laid down for this; it is necessary for the designer to study each peculiar case. The lateral diagonal and portal bracing require careful attention, also the floor system. The decision as to whether the bridge is to be pin connected or riveted connections depends on conditions; more rapid erection can be accomplished with pin connections; at busy terminal points or near yards where a number of trains pass over bridges and there is danger of derailment, a lattice riveted bridge can be used to advantage; with this style one of the members may be disabled with-



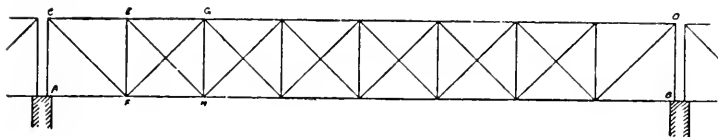


FIG. 149.

## DECK PRATT TRUSS.

A B is the lower chord.

C D is the upper chord to which the bridge floor is attached.

A C and B D are the end posts.

E F, G H, etc., are vertical members.

C F, E H, F G, etc., are oblique members.

In the Pratt Truss the aim is to place the oblique members at an angle of  $45^\circ$  that being the most economical angle; but sometimes the height of the truss E F is greater than the length of the panel F H and this feature has to be waived to secure economy in other directions.

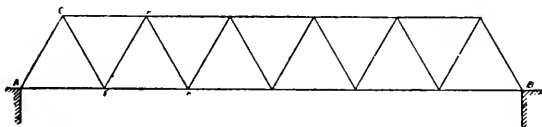


FIG. 150.

## THROUGH WARREN TRUSS.

A B is the lower chord, to which the bridge floor is attached

C D is the upper chord.

A C and B D are the end posts.

C E, E F, F G, etc., are oblique members.

The Warren truss has no vertical members. The principle of this truss is a combination of equilateral triangles which geometrical figure is the stiffest form of framing; however, there are cases when the length of the panels A E, E G, etc., and the height of truss or vertical distance between the top and bottom chords are such that another form of triangle has to be adopted; in such cases the designer tries to make the angle E A C and A E C as near  $45^\circ$  as possible.

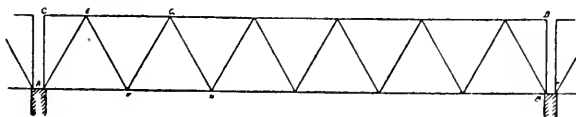


FIG. 151.

## DECK WARREN TRUSS.

A B is the lower chord.

C D is the upper chord to which the bridge floor is attached

A C and B D are the end posts.

A E, E F, F G, G H, etc., are the oblique members.

out stopping traffic over the bridges. (See Figs. 154 and 155.) The forms of truss used in modern practice are as follows: Plate girder is used for short spans; under special conditions it can be used for spans 75 to 100 feet long, however, it is used mostly for spans of 50 feet or less. Figs. 146 and 147 illustrate a plate girder bridge. For longer span than can be economically built with a plate girder, a Pratt or a Warren truss of simple type would be used (See Figs. 148 to 151.) These trusses may be used up to 150 feet span, as the span increases modifications of these trusses are made to afford points for supporting the floor system as shown by Figs. 152 to 157. When the span becomes what is styled a long span, reaching say over 300 or 400 feet, further modifications are found to give economical construction; these modifications are shown by Figs. 158 to 160. The 525 foot span erected at Henderson, Kentucky, in 1885 was a truss similar to that illustrated by Fig. 158.

The following bridges were built with a truss similar to that represented by Figs. 158 and 159.

Havre de Grace,	Maryland,	in 1886,	span 515 feet.
Ceredo,	W. Virginia,	" 1893,	" 521 "
Covington,	Kentucky,	" 1888,	" 550 "

The truss used for the bridge at Memphis, Tenn., erected in 1892, was similar to that shown by Fig. 160. The channel span was a cantilever having a span of 791 feet and the two spans west of the channel were each 621 feet.

The cantilever, arch and bowstring bridges are merely modifications of the trusses described;

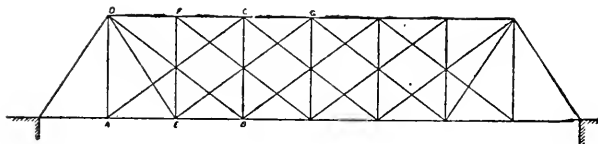


FIG. 152.

## WHIPPLE TRUSS OR DOUBLE INTERSECTION PRATT.

The height required for the clearance of a train is about 18 ft. above the rail, and in the preceding trusses (Figs. 148 to 151) the panels are made to approach as near as possible to this distance. As the length of the span is increased, the height of the truss must be increased, and to place the oblique members at or near an angle of  $45^\circ$  in a Pratt truss or  $60^\circ$  in a Warren truss, the length of the panel must be increased. Modifications must now be made of the simple trusses to afford intermediate points to support the floor system. The Whipple truss is a modification of the Pratt truss made for this purpose; A B C D represents a panel of a Pratt Truss; an extra vertical E F and extra obliques D E and E G are added to afford support to the point E to support the floor system.

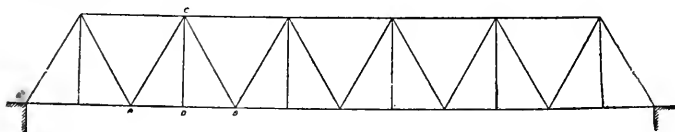


FIG. 153.

## MODIFIED FORM OF WARREN TRUSS.

As the length of the Warren truss is increased and the height of the truss also increased, making the points A and B of the triangle A B C too far apart to support the floor system, a vertical C D is added to support the floor at the point D.

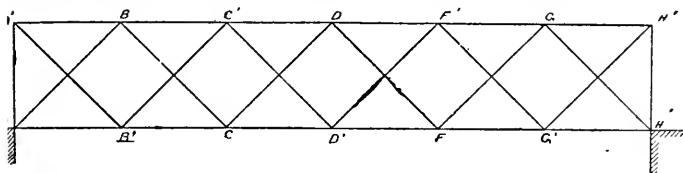


FIG. 154.

## SINGLE LATTICE GIRDER—MODIFIED FORM OF WARREN TRUSS.

This is another method of accomplishing what is illustrated by Fig. 153, and in addition stiffens the upper chord; this is two Warren trusses A B C D F G H and A' B' C' D' F' G' H' placed together; the latter one affords points B' D' G' for supporting the floor system and points C' and F' for supporting or stiffening the upper chord.

the cantilever is merely two spans placed with say their centers on piers, the shore ends anchored and the space between the two spans over the stream or canyon bridged by a truss bridge; the cantilever may be a deck or through bridge; Fig. 165 illustrates a cantilever bridge. The arch bridge is merely a truss with the lower chord built in the form of an arch. The bowstring bridge generally has the top chord in the form of an arch, though sometimes the lower chord is in the form of an inverted arch; Fig. 159 illustrates a bowstring bridge. The draw bridge illustrated by Fig. 161 represents the usual style with a center pier and a channel on each side of the center pier. Where a pier is not allowed to be built in the channel, bob-tailed draw bridges having the short span weighted are sometimes used, see Fig. 162. There has recently been introduced another style of draw bridge especially suitable to be used in a narrow channel, known as the Scherzer rolling lift bridge; the advantages over the old styles are as follows: (a) No center piers obstructing the channel. (b) No dock space wasted. (c) When opened it completely closes the roadway and prevents a train from running into the draw. It can be designed as an arch or cantilever. Fig. 163 illustrates this.

There are two general methods of determining the strains or loads the various members of a bridge are subjected to; one is by plating the loads or strains and is called "Graphical" statics or "Graphical Method." The other method is a

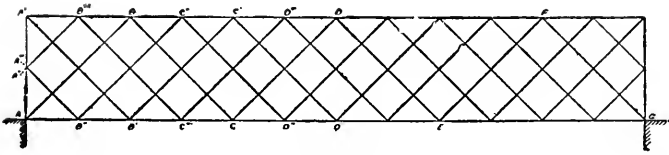


FIG. 155.

## DOUBLE LATTICE GIRDER—MODIFIED FORM OF WARREN TRUSS

Where the length of the truss becomes too great to use the form shown by Fig. 154, this form can be used to support the intermediate points  $B'' B' C'''$  on the lower chord and  $C'' C' D'''$  on the upper chord,  $A B C D E F G$  being the simple Warren truss with three others— $A' B' C' D'$ , etc.  $A'' B'' C'' D''$ , etc.  $A''' B''' C''' D'''$ , etc., added.

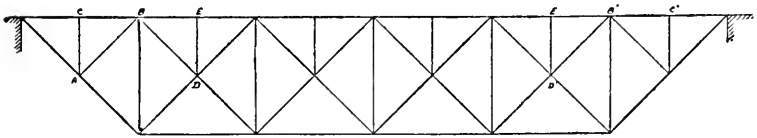


FIG. 156.

## DECK BALTIMORE TRUSS—MODIFIED FORM OF PRATT TRUSS.

This is Fig. 148 inverted to make a longer span for a deck bridge than Fig. 149 is suited for; the floor system is supported by the addition of oblique members  $A B$  and  $A' B'$  and vertical members  $A C D E$ , etc.

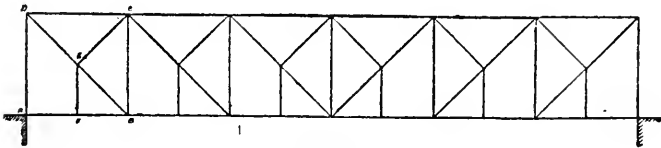


FIG. 157.

## THROUGH BALTIMORE TRUSS—MODIFIED FORM OF PRATT TRUSS.

This is another method of accomplishing what is done by the Whipple truss (Fig. 152.) The panels as  $A B C D$  have but one oblique  $D B$ , to this is added the oblique  $C E$  and the vertical  $E F$  to support the floor system at  $F$ .

mathematical one, based on the laws of mechanics.\*

The various members of a bridge must be so designed and connected that the strains will be in the direction of their axis; all strains tending to buckle or shear the members must be avoided in making the design, and in the erection care must be taken that all members are placed as designed, no shortening or lengthening to be allowed, as this would tend to throw a greater strain on some members than they were designed to bear. The manufacture of steel has reached such a high standard that the bridge designer knows definitely what duty it will perform, and bridge designing has become as near an exact science as can be expected of anything produced by human agency. The expansion and contraction of the bridge is allowed for by an arrangement of rollers on which one end of the bridge rests.† The piers to support the bridges can be masonry or iron cylinders filled with concrete, the selection of the style to adopt depending on local conditions.

Wooden truss bridges are now seldom used on new lines. Pile bridges and frame trestles are now used to cheapen the cost where there is much filling required; they are, however, used as temporary structures especially on lines which do much business; they are replaced as the re-

---

\*The details of these two methods are treated very fully by A. J. DuBois and Merriman and other authors. see Appendix K.

†The expansion of rails on draw bridges is discussed under the subject of track.

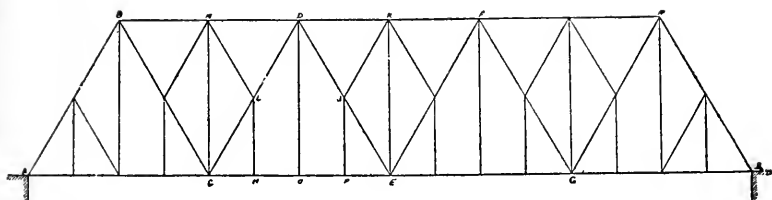


FIG. 158.

## LONG SPAN BALTIMORE TRUSS—MODIFICATION OF WARREN TRUSS.

This is a method in a long span of supporting the floor at three intermediate points in a panel as is done by the double lattice girder Fig. 155, A B C D E F G H I is the simple Warren truss, oblique members J K L M, etc., and vertical members C M, N L, O D, F J, E K, etc., are added to support the floor system at N O P, etc., and to stiffen the upper chord at M K, etc.

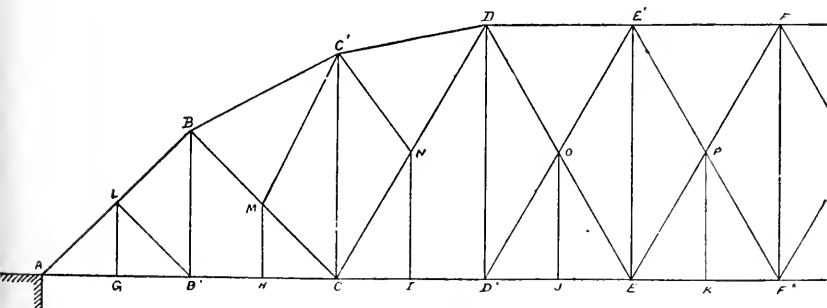


FIG. 159.

## LONG SPAN BALTIMORE TRUSS—ALSO KNOWN AS THE ARCHED TRUSS, THE BOWSTRING TRUSS AND THE CAMELBACK TRUSS.

As shown by panel D D' and E E' this is modified form of a Pratt Truss; A B, B C, C D, D E, E F, etc., D' E', E' F', etc., are the oblique members of the Pratt truss; B B', C C', D D', E E', F F', are the vertical members of the Pratt truss. To support the floor system at G H I, etc., the oblique members L B', M C', N C', and the vertical members L G, M H, N I, O J, P K, are added. The pressure exerted by the top chord is carried to the abutment at A by the members already alluded to, and the segment of a circle or arch made by the members A B, B C', and C' D, of the top chord which act as an arch. This form of truss is suitable for long spans and is economical in the use of metal.

sources of the company permit by earth embankments, or in the case of heavy fills, by steel viaducts and arched culverts with earth embankments. Fig. 166 illustrates a pile trestle, while Fig. 167 illustrates a framed one; in each of the illustrations short stringers reaching from the center of one bent to the center of the adjoining bent are used; where long stringers reaching from the center of one bent to the center of the second bent are used and are laid with broken joints, a stiffer structure is secured, and the labor in erecting is less than with short stringers; the short stringers have the advantage of costing less and require less labor to replace them when it becomes necessary to make renewals. The stringers are fastened to the caps in Fig. 166 by both passing through a corbel which is drift bolted to the cap. Another method is shown in Fig. 167; here the stringers rest directly on the cap and blocks are placed between them, the stringers are bolted to the blocks and the blocks are drift bolted to the cap.

The longitudinal bracing shown in Fig. 167 is dimension timber instead of planking, similar to that used for sway braces as shown in the end elevation; this is a departure made by the Chicago, Burlington & Quincy Railroad on one of its new lines. This method makes a stiff bracing and is economical in the use of timber. A stone arched culvert, well designed and the masonry properly laid, is a "permanent structure" in the fullest sense of the term, and this fact is more generally appreciated by the Eastern trunk lines



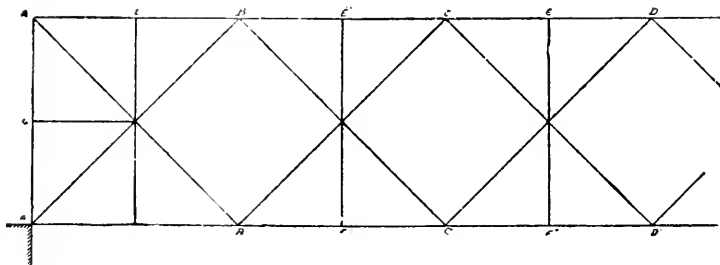


FIG. 160.

ANOTHER MODIFICATION OF THE WARREN TRUSS FOR  
LONG SPANS.

This is type of the truss used for the bridge across the Mississippi River at Memphis, Tenn. The lower chord is 75 feet above high water. The span is 621 feet.

This is a modification of the lattice girder, Fig. 154: to adapt it to long span bridges, the vertical members, E F, E' F', etc. are added to support the floor system at F F', etc., and to stiffen the upper chord at E E', etc; the horizontal brace H G is added to stiffen the end post A A'. With this truss and the arched truss, Fig. 159, the floor system has to be made stronger than for the others, illustrated, as the distances apart of the points of support are greater.



FIG. 161.

DULUTH-SUPERIOR BRIDGE.

This draw bridge is made of two trusses connected with a tower on the draw or center pier by tie or tension braces.

Four track bridge (two steam railroad and two electric tracks) consisting of center draw span, 485 feet, and two side spans, 300 feet each. Total weight, 3, 230 tons.

Draw span operated by electrical power.

NOTE—The essential point is to show the draw span.

than by the Western ones. The arched culvert can be built with one or more spans, and all streams except the larger ones can be crossed with them.

Fig. 168 illustrates an arched culvert. The proper thickness to give the arch will depend on the span  $S$ , the rise  $R$ , and the amount of fill  $A$ . The proper thickness  $B$  of the side walls depends on the pressure on the arch. Taking a given depth of fill as the length of the arch is decreased the amount of masonry in the wing walls is increased. It is the engineer's duty to determine the length which is the most economical, and this cannot be tabulated except for cases where the ground is level transversely with the line of the road.

Cast iron pipe laid through an embankment can be used to convey a fair sized stream, or the drainage of considerable area of country. These pipes are used from one foot to three feet in diameter, and several lines of pipe can be laid together when necessary to secure the proper capacity. They are generally made in twelve-foot lengths, but some roads have the larger sizes made in six-foot lengths. Fig. 169 illustrates a cast-iron pipe culvert and Fig. 170 illustrates one with wing walls at the inlet and outlet.

Drainage is secured through low embankments by open culverts. In such cases the track can be supported by wooden stringers or steel **I** beams, Fig. 171 illustrates an open culvert.

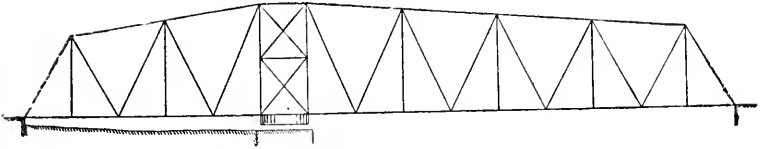


FIG. 162.

**BOB-TAILED DRAW BRIDGE—MODIFIED FORM OF WARREN TRUSS,  
SHORT SPAN COUNTER-WEIGHTED.**

This draw bridge also consists of two trusses similar to Fig. 153, but in this case the end posts are connected to the tower and form a part of the tower.

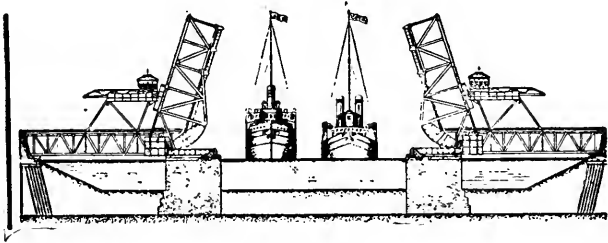


FIG. 163.

**SCHERZER ROLLING LIFT BRIDGE.**

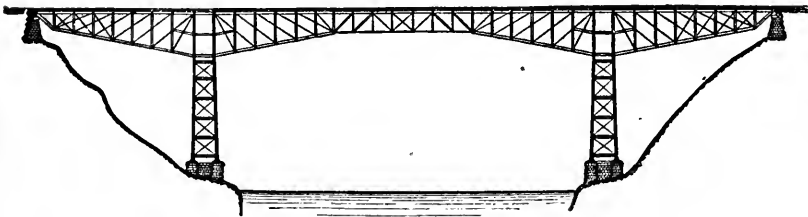


FIG. 165.

**CANTILEVER BRIDGE.**

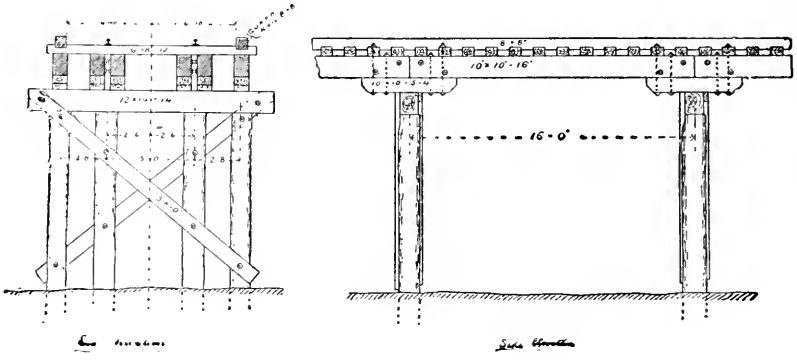


FIG. 166.

PILE TRESTLE BRIDGE.

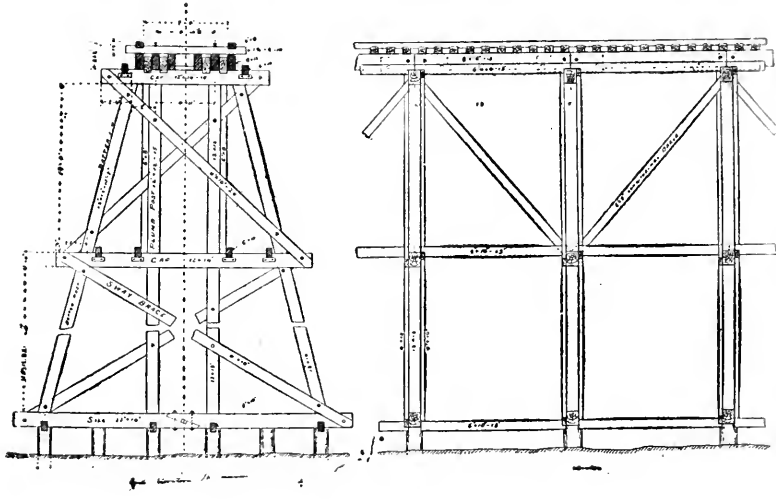


FIG. 167.

FRAMED TRESTLE.

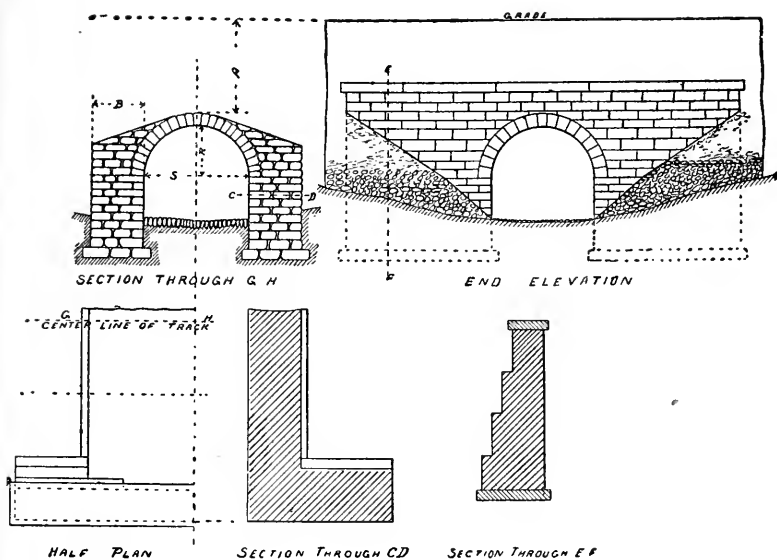


FIG. 168.

STONE ARCHED CULVERT.

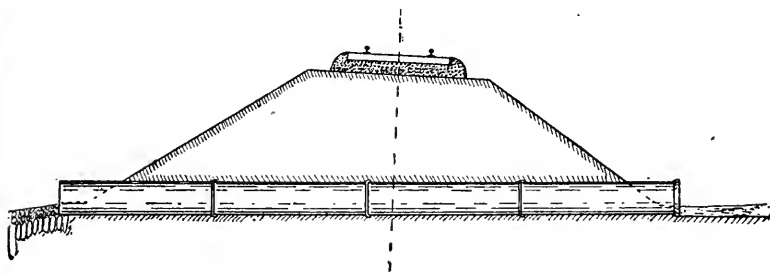


FIG. 169.

CAST IRON PIPE CULVERT WITHOUT WING WALLS.

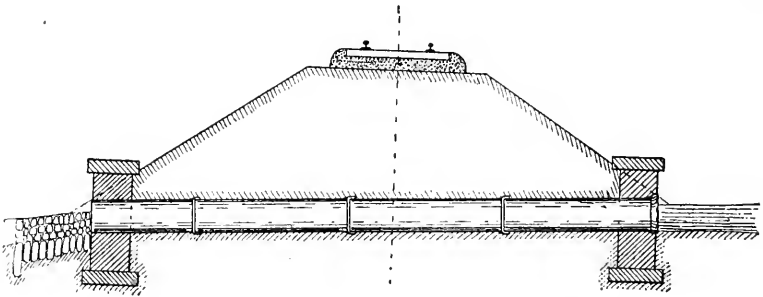


FIG. 170.

CAST IRON PIPE CULVERT WITH WING WALLS.

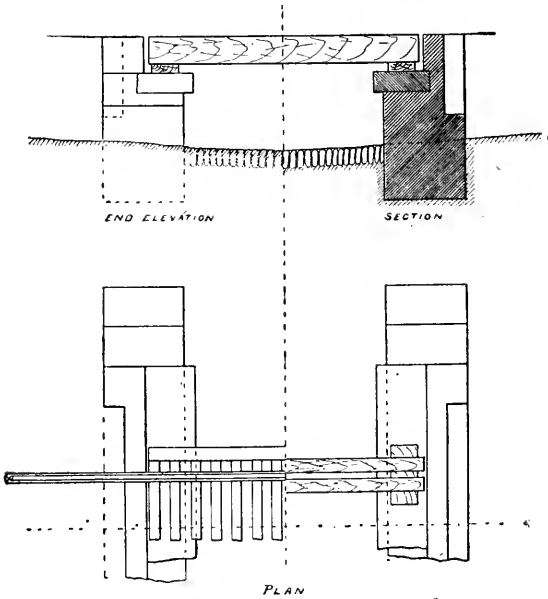


FIG. 171.

OPEN CULVERT.

## WATER SUPPLIES.

The importance of the water supply has been discussed in a previous chapter, the selection of pumps, storage tanks and accessories will here be considered. Windmills, probably, are used more as a source of power to pump water for railroads than all other appliances in the United States; the other sources of power are steam and gas. Wheels as large as 30 feet in diameter are used on windmills; their stroke is from 2 to 24 inches and the plungers of the pumps are from 2 to 10 inches in diameter.

Where larger supplies of water are required than a windmill can be relied upon to give, a steam and gas or gasoline pump can be used. The gas or gasoline pump has only been recently introduced for this purpose. A steam pump for deep non-flowing artesian wells is illustrated by Fig. 172. When pumping from a well, pond or stream by a steam pump, the pumping plant required is shown by Fig. 173. Fig. 174 represents one of the makes of gasoline engines and pumps designed for railroad water supply. A design for a pump house and machinery is shown in Fig. 175; this shows a gasoline engine belted to a pump.

To supply locomotives with water large amounts are required at intervals more or less frequent depending on the number of trains. To obtain an economical plant, provision must be made for storing the water as it is pumped and running the pumping plant steadily; this per-

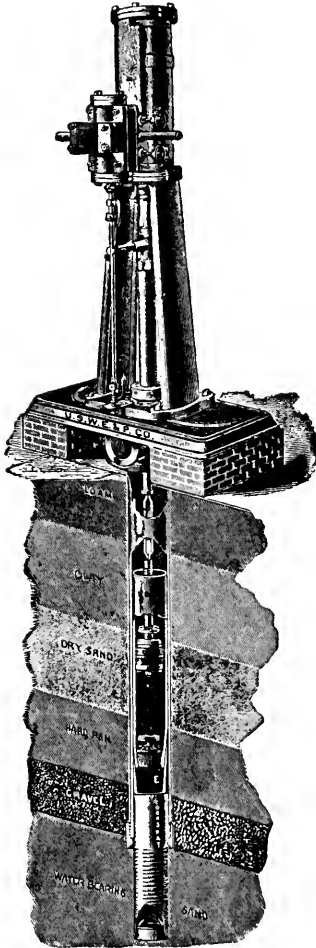


FIG. 172.

PUMP FOR A DEEP WELL.



mits of a small pumping plant being used, and on a branch or where but few trains are run one man can attend to pumping water for several water stations. The water tanks generally used are 16 feet high and 24 feet in diameter and contain 50,000 gallons. They should be placed high enough above the rail to give the water sufficient force to fill the tender rapidly and not unnecessarily delay trains; some roads are placing the bottom of the tank twenty feet above the rail. The tanks are made of wood and are supported on wooden or iron posts. Fig. 176 illustrates

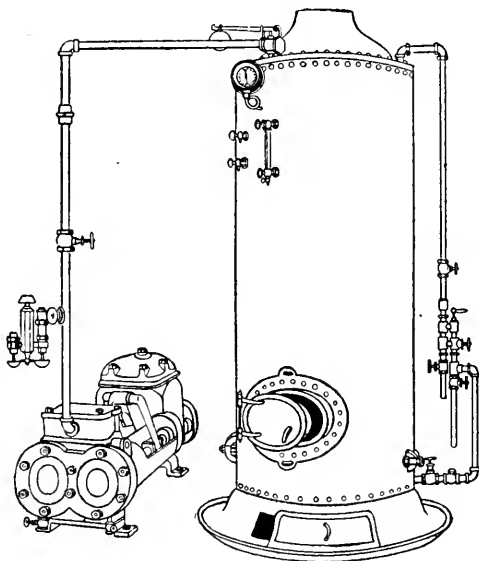


FIG. 173.

COMMON FORM OF SETTING UP A PUMPING PLANT FOR A WATER STATION.

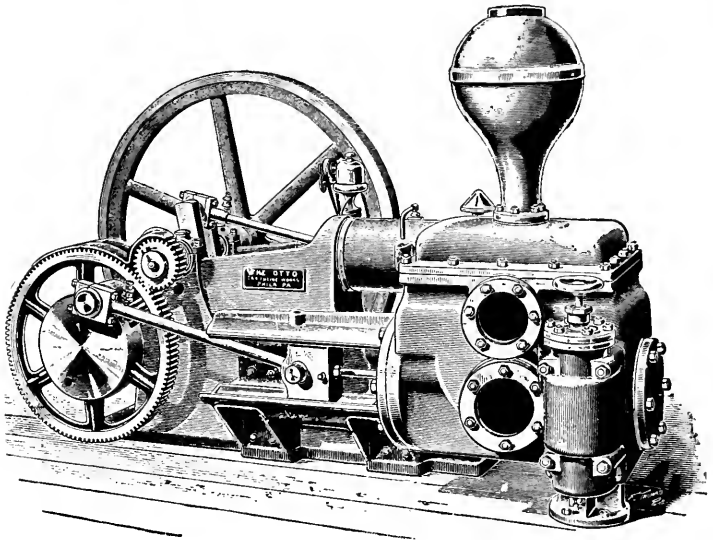


FIG. 174.

## COMBINED GASOLINE ENGINE AND PUMP.

one supported by wooden posts. Some, however, are supported by wrought iron columns and the advisability of using steel in place of wood for constructing railroad water tanks is being discussed.

A submerged water station consists of a cylinder submerged in a well, the cylinder contains a movable piston; the top of the cylinder is connected with a pipe which leads up to a post where it can be coupled to the boiler of a locomotive; when steam is turned on the piston is depressed and water is forced out of the cylinder through a pipe leading to a stand pipe. Mr. E.

H. McHenry, Chief Engineer of the Northern Pacific Railway, is the inventor and it is in use on the Northern Pacific and Duluth, Missabe & Northern Railways.

Where the water supply is procured from an elevated point and is piped to the track or from a city water-works, a stand pipe or water column is used; where the road is a double track one water column can be placed between the tracks;

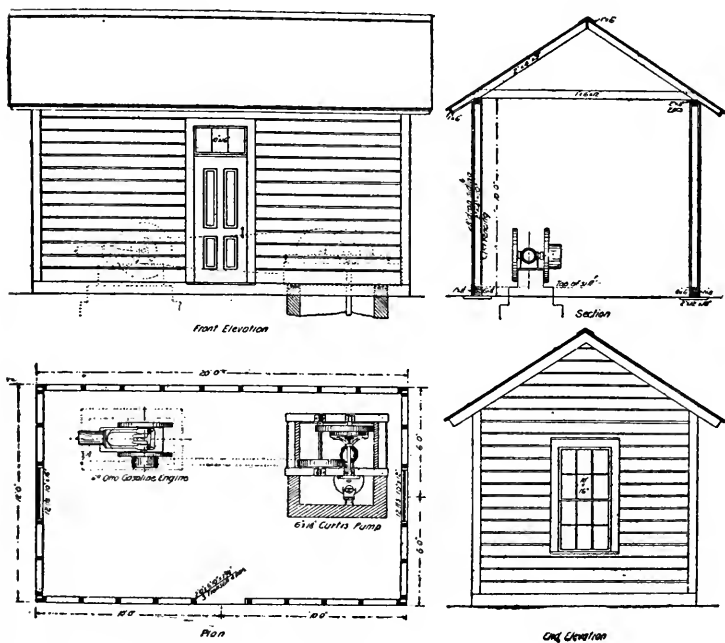


FIG. 175.

DESIGN FOR R. R. PUMP HOUSE AND MACHINERY, USING A GASOLINE ENGINE.

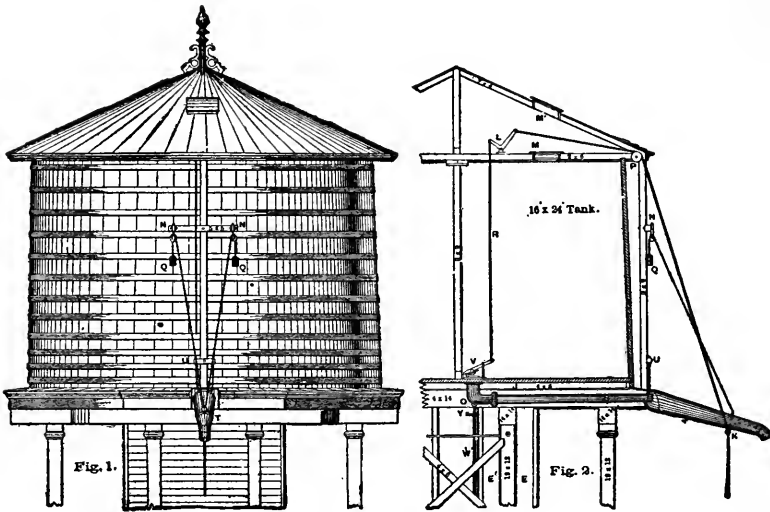


FIG. 176.

WATER TANK, SUPPORTED BY WOODEN POSTS OR BENTS.

however, less delay to the trains is secured by using two, as stated in the chapter on construction.

An automatic water column or stand pipe is illustrated by Fig. 179. There are several makes on the market. To secure satisfactory service the supply pipe should be large, some roads using a 12 inch supply pipe for a 10 inch water column. There must be a sufficient head of water to give the necessary force to discharge the water rapidly and not detain trains. The column must have a quick opening valve, be readily adapted to high or low pressure, be frost proof, should turn automatically to its position parallel with the track,

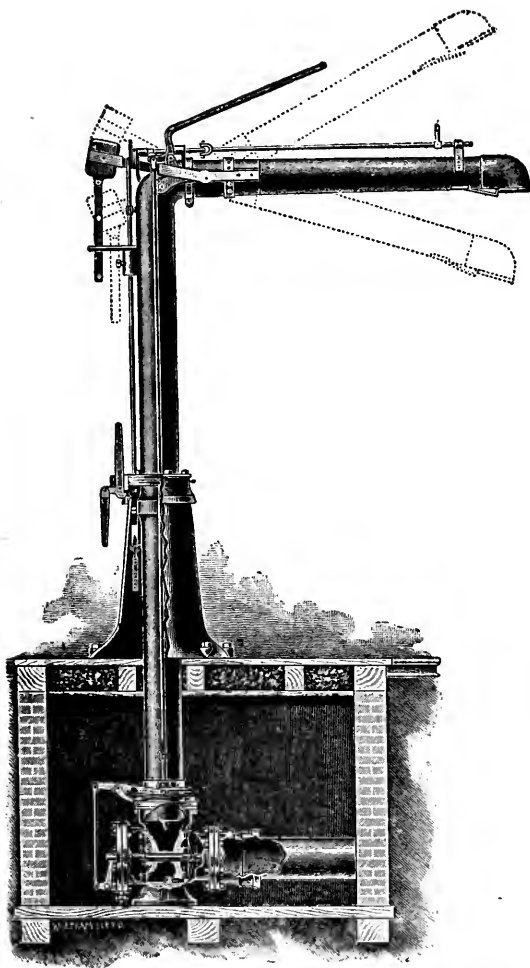


FIG. 179.

AUTOMATIC STAND PIPE OR WATER COLUMN.

the valve should be balanced, it should rotate easily and should drain automatically after use.\*

To enable fast trains to take water without making a stop "Track Tanks" are resorted to; they consist of a shallow tank 6 to 7 inches deep in the clear and 1200 to 1400 feet long. The approach at each end is sloped so that loose rods on passing trains will not catch and damage the tank. The train can take water when moving at a speed of 45 miles per hour; this is done by lowering a scoop attached to the tender, which, with the force and velocity at which the train is moving, causes the water to flow into the tender, the tank is sloped up at the ends to prevent the scoop damaging it. Track tanks are so placed that water can be taken about every 30 miles run by the train. The difficulty met with

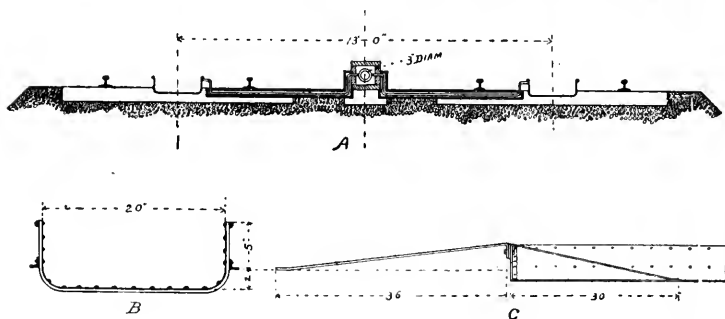


FIG. 180.

TRACK TANK.

A—Cross section of roadbed. B—Cross section of tank. C—Partial longitudinal section of tank.

\*Table No. 8, Appendix J, gives the capacity of single acting and duplex pumps and the fittings required.

is to prevent their freezing and two methods have been adopted to overcome this: one is to inject live steam at points along the line of the tank about 40 feet distant from each other. The other method is to tap the tank at the center and connect it with a suction pipe of a pump and pump the water out of the center of the tank, pass it through a heater and return it at each end of the tank; the latter method gives the best results. Track tanks are in use on a number of roads. (See Fig. 180 which gives details.)

#### COALING.

The method adopted for storing and handling coal is important; a badly arranged coal station may require an unnecessary amount of labor in handling the coal which in the course of a few years would equal the cost of the plant. There are three general methods in use. The one used the most consists of a shed about 20 feet wide having the main line on one side and a side track for coal cars on the other. The side next to the siding is boarded up as high as the sides of the gondolas or coal cars. The length of the shed depends on the amount of coal required to be stored. At the center of the shed a platform is erected having a hand crane on it and space for the storage of coal buckets, which are made of iron and contain one-half ton of coal each. A narrow gauge track is laid along one side of the shed, if the shed is much wider than 20 feet the track should be laid in the center. The coal buckets are placed on cars to move them to and

from the crane to the coal pile; as fast as they are loaded they are placed on the platform, which is the same height above the rail as the top of the tender. Fig 181 shows a plan of such a coal-

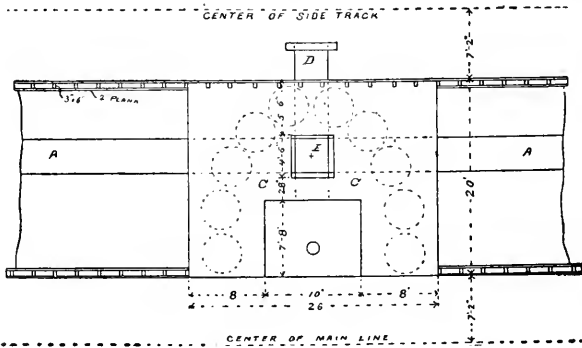


FIG. 181.

PLAN OF A COALING STATION WHERE BUCKETS ARE USED.

ing station, which is arranged to save handling part of the coal by shoveling it direct from the car into the buckets which are placed on a car on the track D, the buckets being hoisted through the opening E on to the platform C. The track A is used for the car when the buckets are loaded from the coal stored in the shed. Another style used more extensively on lines having a large traffic is an elevated coal shed with pockets containing enough coal to coal up a tender; these stations can be arranged to unload the cars by dumping from the side or bottom. However they are generally arranged for the cars to be unloaded by hand as a large amount of the coal



is handled by cars having no arrangement for dumping. These stations can be placed between the two main line tracks of a double track road; the coal cars are pushed up an incline track on a grade of 5 or 6 per cent. to the coal shed which is on trestles or the side of a cut. Fig. 182 re-

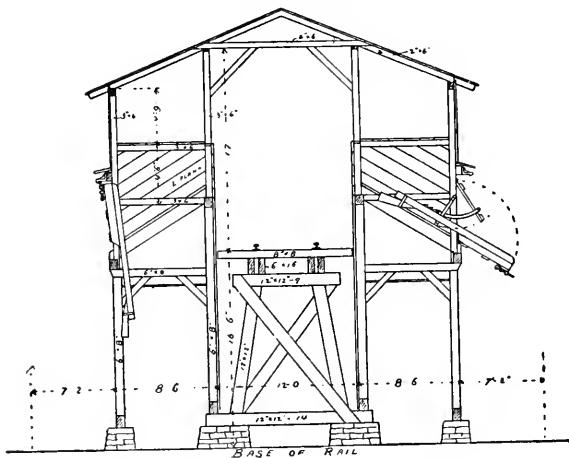


FIG. 182.

TRANSVERSE SECTION OF A CLINTON COALING STATION.

presents a section of such a coaling station. Where the traffic becomes so heavy that four or more tracks are required, the coal for locomotives is placed in the tender of the locomotive from a bridge spanning the tracks. The storage shed is elevated on a trestle or the side of a cut, a track laid in the coal shed passes over a turn-table where a track from the shed leads to the bridge over the main line tracks. Scales are placed at

a point where all coal taken from the shed can be weighed. The coal is loaded into cars of a style which can be easily dumped; under the rails on the bridge there is a hopper terminating in a spout to which a movable section is attached. The operation of loading a tender is as follows: The cars are kept loaded and are pushed from the coal shed out on the track leading to the bridge, when a train pulls up with the tender under a hopper the movable spout is let down, the coal cars are run to the hopper and the coal dumped and the empty car pushed forward, leaving room for a second car to discharge its load into the hopper. In this way the necessary number of cars to load the tender are rapidly unloaded, the movable spout is raised and the train proceeds. Where the men are trained for the work the operation is very rapid. The empty cars are run back into the coal shed, being switched around those which were not unloaded.

The skill of the engineer is displayed in adapting the various plans to the conditions of the business and the topography of the country—aiming always to reduce the cost of labor and detention of trains to a minimum.

#### TURNTABLES.

With the increased weight and length of engines, the styles of turntables in use a few years ago are not able to do the work required of them at present. Attention is now being given to improving the bearings at the center to secure a distribution of the weight of engine and turn-

table, so that the table can be quickly and easily turned. Turntables are now made from thirty to seventy feet in length, and of both wrought and cast iron. The two styles are illustrated by Figs. 183 and 184. Turntable centers are illustrated by Figs. 184, 185 and 186.

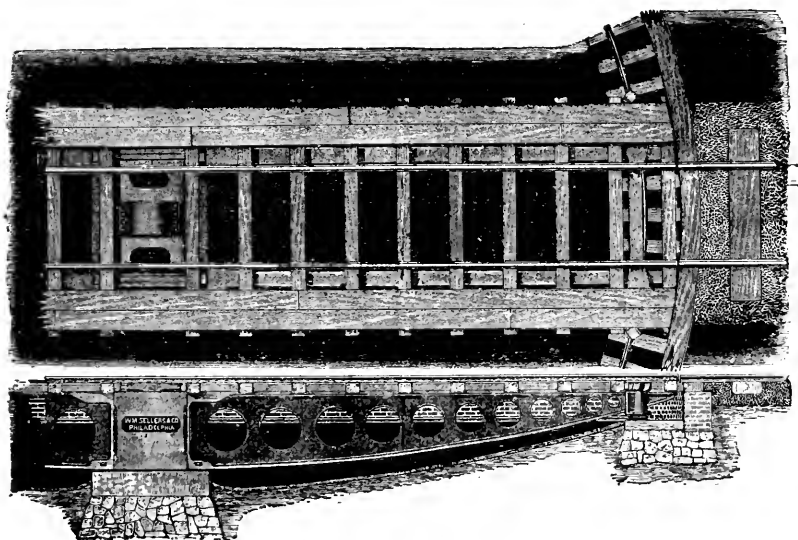


FIG. 183.

CAST IRON TURNTABLE.

(Made by William Sellers & Co., Philadelphia, Pa.)

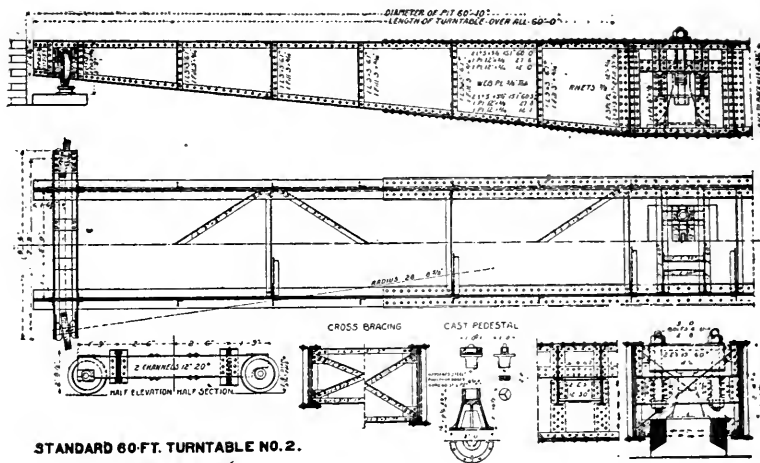


FIG. 184.  
 WROUGHT IRON TURNTABLE.  
 (Made by the King Iron Bridge Co.)

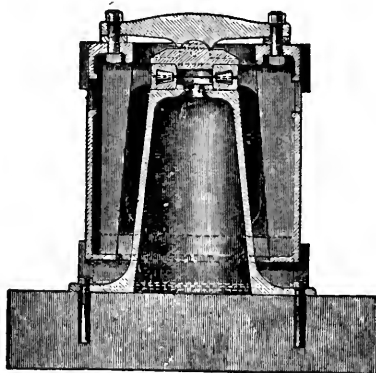


FIG. 185.  
 A TURNTABLE CENTER USED BY WILLIAM SELLERS & CO.

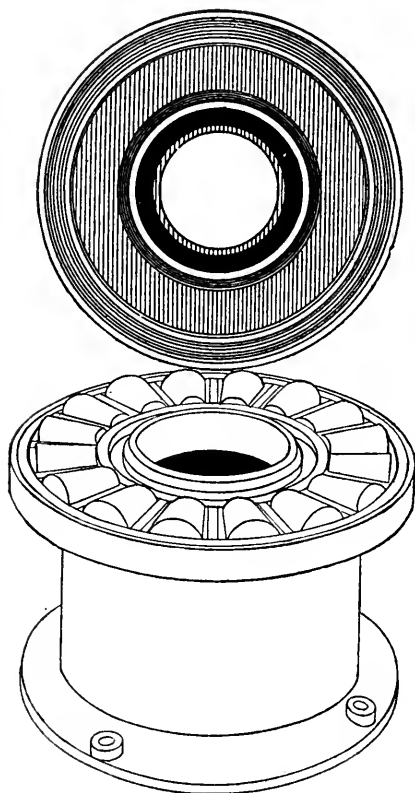


FIG. 186.

SPECIAL SIXTEEN ROLLER CENTER FOR TURNTABLES.  
(Made by C. L. Strobel.)

BUILDINGS.

In regard to the character of the buildings to be erected, the uncertainty of the development of the country must be borne in mind. Another point to

be considered is the effect produced by improvements made in the arrangement of the interiors, decoration, methods of lighting, heating and ventilation, improvements in plumbing and sewerage; in private dwellings the improvements along these lines have been such that a period of about ten years makes a residence, once modern and desirable, old-fashioned and undesirable unless remodeled. It is altogether probable this improvement of design, etc., will continue at a more rapid rate in the future than in the past. While railroad structures are probably not affected so much by this improvement as dwellings, yet on account of competition it must be considered. For this reason it is not the greatest economy to erect buildings of a character to last for a long period. It is also difficult to design a building for the present, and provide for extensions to be built when business increases; the increased business often takes place along unexpected lines and is of a character which could not be anticipated. The growth of the country and the expansion of business, while increasing the receipts of a railroad, also greatly increase the expenditure made to provide facilities to handle the business. These reasons tend to make careful railway managers use buildings which the public are protesting against and which they are not satisfied with. For the larger buildings such as terminal depots, general offices, depots both passenger and freight at large cities or manufacturing centers, hotels and even offices and shops at division headquarters, it is impossible to lay down any general

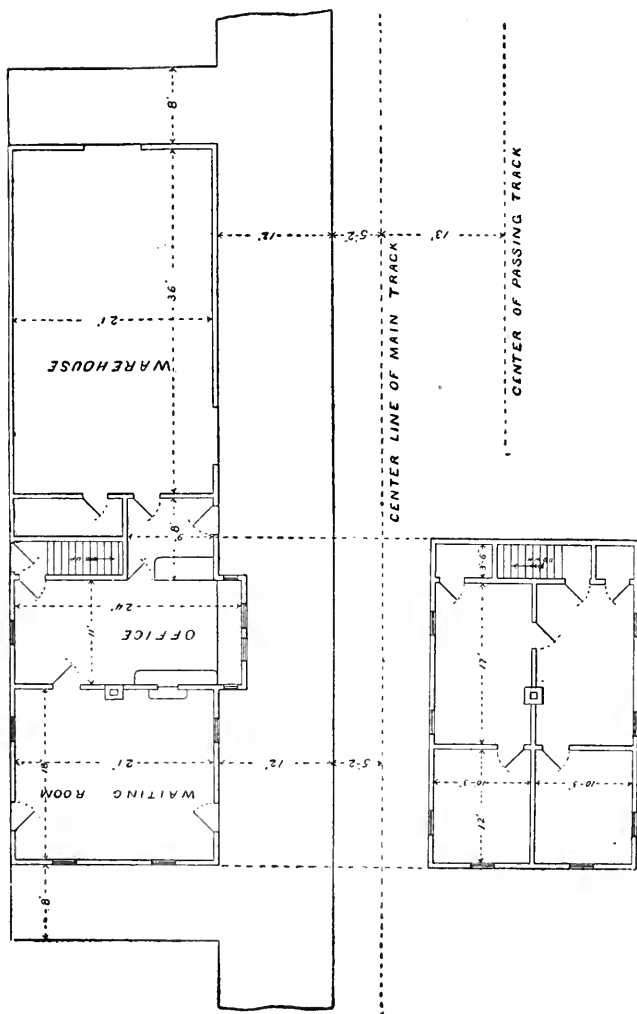


Fig. 187.

SMALL FRAME DEPOT WITH LIVING ROOMS ON SECOND FLOOR.

plan to be adopted, as the conditions are so different.

Fig. 187 is a plan of a frame depot suitable for a new line in a sparsely settled country. Living rooms are provided for the agent and his family; a passing track but no house track is provided for.

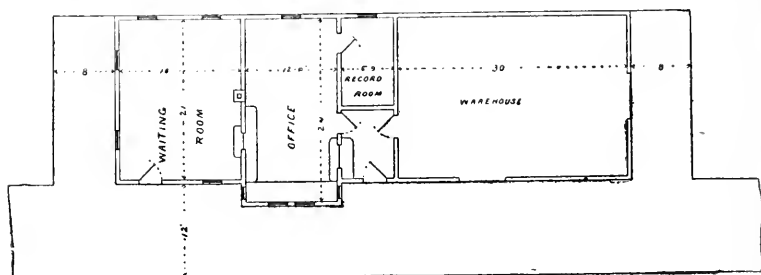


FIG. 188.

SMALL FRAME DEPOT.

Fig. 188 is a plan of a frame depot suitable to be used where business is light or moderate and where the agent's family can secure a house away from the depot to live in.

Fig. 189 is a plan of a frame depot for a station doing a fair business. A house track is provided for, which can also be used as a team track for carload freight.

All of these depots when built in a northern climate should be set on a stone foundation or some other provision made to keep the floors warm. The floor of the warehouse should be of two-inch plank and the waiting rooms, offices and living rooms double floored, the top one being of



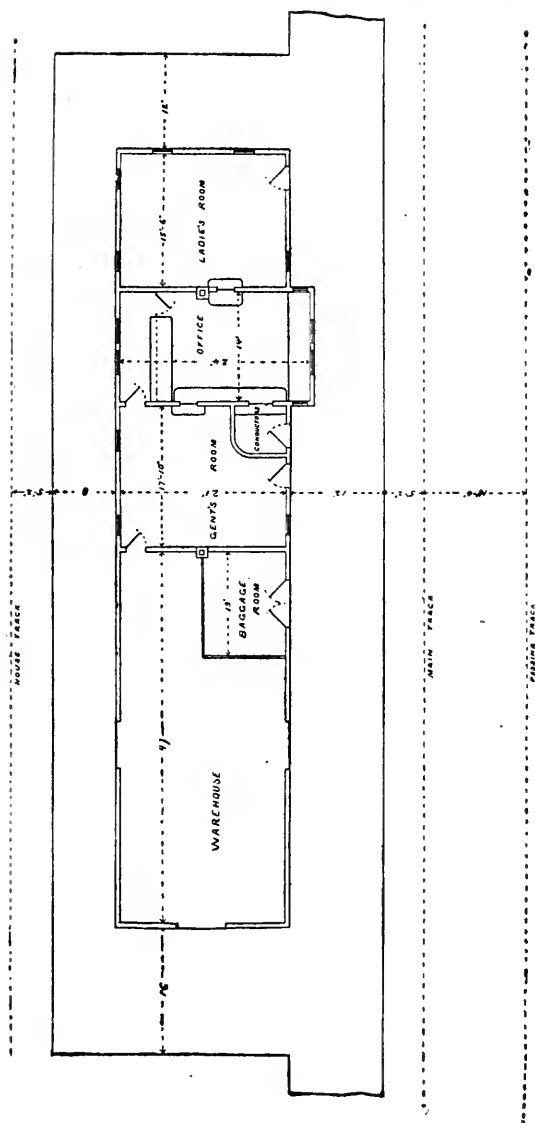


FIG. 189.

FRAME DEPOT FOR A MODERATE SIZED TOWN.

hard maple. The doors in the warehouse should be sliding, six feet wide and seven feet high; the other outside doors should be three feet wide and seven feet high. The inside doors can be two feet six inches wide and seven feet high. No windows should be placed in the warehouse, they afford opportunity for petty thieves to ascertain whether fruits, etc., are on hand and tempt them to pilfer. A transom should be placed over the end door. The waiting

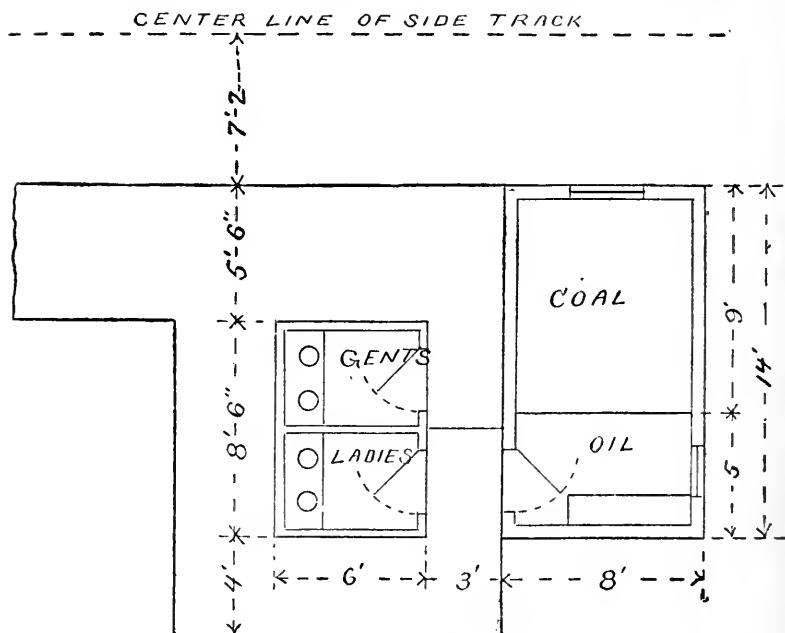


FIG. 190.

OUTBUILDINGS FOR SMALL DEPOTS.

room and office windows are often made of twelve lights, each eight by sixteen inches, which give a good light for clerks to work in; one feature about windows in a room where clerks are employed is to have them well up above the floor, as the light is required on the books and papers the clerks are working on and not on the floor.

Coal and oil should never be kept in a depot. Fig. 190 illustrates out buildings for small depots. In these provision is made for storage of coal and oil and for filling lamps.

When the business becomes so large that the freight and passenger business cannot be accommodated in one station building, a passenger station should be erected. Fig. 191 illustrates a brick one which has been found convenient. One roof covers all the buildings and extends six and one-half feet beyond the outside walls all around, thus affording shelter and leaving the platform unobstructed by posts or columns. The building can be heated by steam or hot water from a boiler in the baggage room. Where the ticket sales are large the ticket seller should have but one ticket window to attend. Where there is a roof over the platform there should always be a window placed in the office above the platform roof to give light for the clerks to work during cloudy weather or when a train is standing in front of the depot; the importance of this can only be realized by those who have to work in such offices where there is no window above the platform roof.

The present practice is tending toward placing station platforms on a level with the top of the

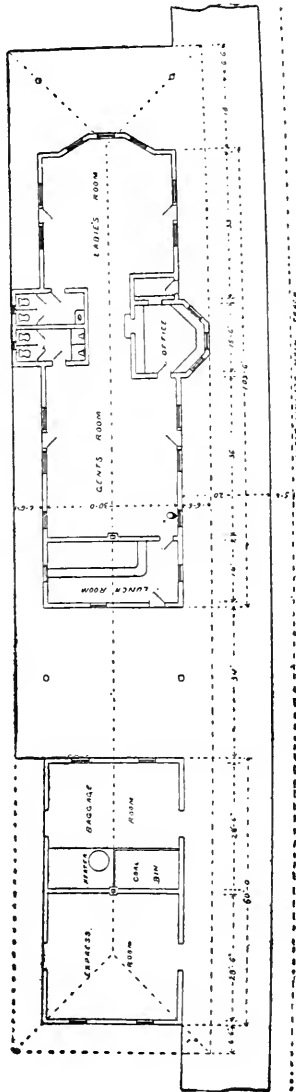


FIG. 191.  
PLAN OF A BRICK PASSENGER DEPOT.

rail and making them of vitrified brick; however, very good results have been secured with small limestone screenings; they pack hard and wear well and can be cheaply repaired.

Fig. 192 illustrates a stock pen used by a

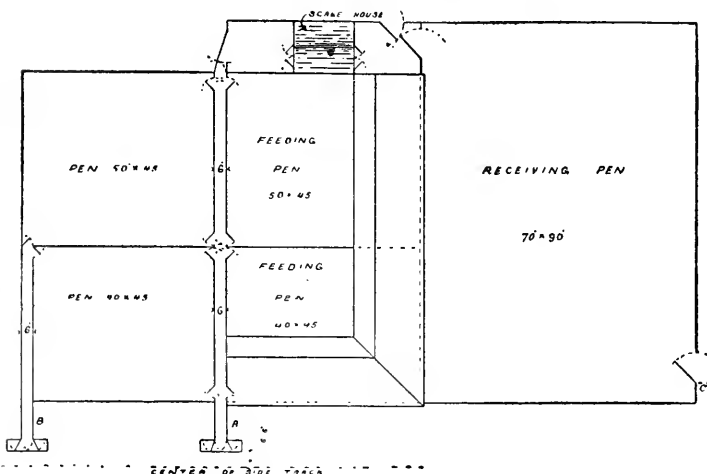


FIG. 192.

PLAN OF STOCK YARD.

NOTE—Where stock pens are built on an extensive scale (as at points where large shipments are made), the alleyway should be 12 feet wide, so that teams can be driven through with loads of hay, and the feed be distributed in the receiving or feeding pens.

country stock buyer; provision is made for receiving pens, feeding pens with sheds and loading pens; the addition of the second runway B enables two cars to be loaded at one time. This plan can be varied to suit the volume of business; where range cattle are to be shipped it will be necessary to add a fence C. D. to enable the herders to get the cattle into the pens.

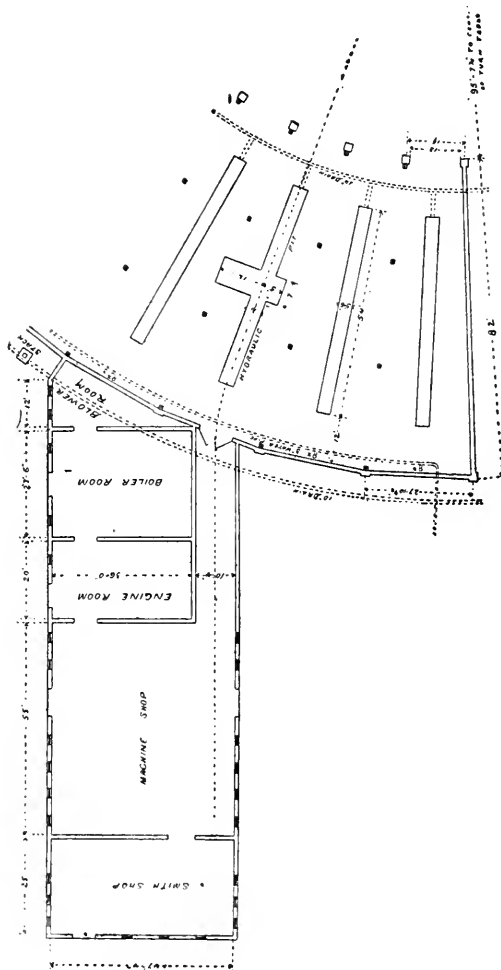


FIG. 193.

PLAN OF ROUNDHOUSE AND SHOPS.

Fig. 193 is a plan of a roundhouse and small repair shops. The roundhouse is heated by indirect radiation from a coil of steam pipes placed in the blower room; the air is driven by a blower through the coils of steam pipes and conveyed to the roundhouse in overhead sheet iron pipes and discharged in the pits under the locomotives. Provision is made by a wrought iron pipe placed overhead and steam hose couplings to take the live steam from a locomotive which has just come in and convey it to one that is about to go out. The hydraulic pit for removing drivers is really a part of the machine shop. In the blower room are placed air compressors for handling the sand and operating the ash lift. Fire hydrants H are placed in each stall.

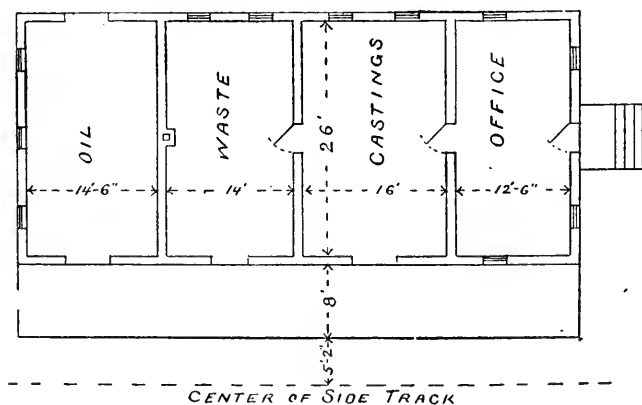


FIG. 194.

PLAN OF BRICK STOREHOUSE FOR SUPPLIES.

A brick storehouse is illustrated by Fig. 194. The oil room is paved with stone flagging, and no wood work is in the room except the window frames; some roads provide for the storage of oils in tanks set in the ground, the oil being pumped out as required.

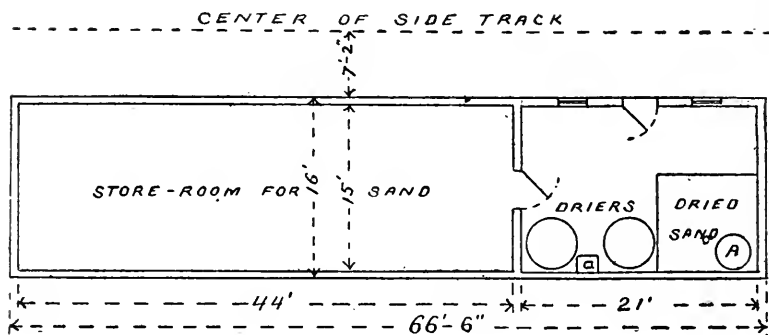


FIG. 195.

## PLAN OF STOREHOUSE FOR SAND.

A sand house is illustrated by Fig. 195. The dried sand is placed in a hopper A, and carried by a current of air (which only takes up the fine sand) to an elevated tank; from this tank the sand box on the locomotive is filled by gravity in the same way that water is supplied to a tender.

## ASH PITS.

To reduce the expense in loading ashes at roundhouses, air hoist ash pits have been introduced. Fig. 196 illustrates the method of using compressed air for this purpose. The bucket F



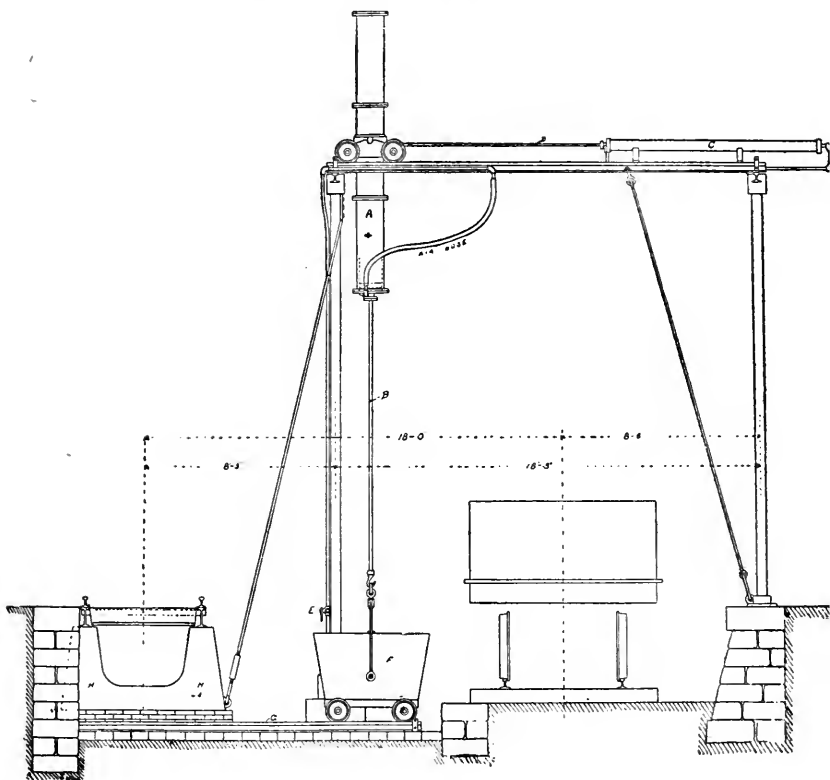


FIG. 196.

ELEVATION OF A BENT OF AN AIR HOIST ASH PIT.

is placed under the locomotive when the ashes are drawn; it is then pushed down the inclined track G to the position shown in Fig. 196, and is attached to the piston rod B which works in the cylinder A; the attendant then turns a valve at E, and the compressed air causes the piston and

piston rod B to rise in the cylinder A, thus lifting the bucket F and the attached truck level with the top of the car; another valve at E is then opened and the compressed air is admitted into the cylinder C drawing in the piston rod D, and bringing the cylinder A and bucket F over the car. The bucket is then dumped and the ashes discharged into the car. The attendant then reverses the air in cylinder C, and the cylinder A and bucket F are brought back to the original position; by reversing the air in cylinder A the bucket F is lowered on to track G and can then be run under the track supported by the cast iron yokes H where it is in position to be filled again. A number of these bents can be placed together, and the operation can be carried on continuously. By this method one man can do the work heretofore requiring a gang of men, their number depending on the number of locomotives handled. Where the ashes are handled without an air hoist, the track is lowered, so that the journals of the car wheels are on a level with the bottom of the ash pit to afford easy shoveling.

#### PAVEMENT OF TEAM TRACKS IN FREIGHT YARDS.

The paving to be used at team tracks in freight yards is quite an item of expense. The cheapest pavement is broken stone, having the large size in the bottom and the small size on top, covering the latter with a layer of screenings or fine gravel; no rolling is required, the traffic can make the road. The greater part of the cost of street improvements in cities is caused by the

impatience of the public to have a perfect surface to the macadam at once; the same conditions can be secured later by allowing the traffic to do the work performed by the steam roller. Brick pavement is cheaper than granite, and where the soil is thoroughly compacted and is sandy no concrete base is required, two courses of brick on sand will answer; under other conditions six inches of concrete and one course of brick should be used. Where good hard burnt bricks cannot be secured and a first-class pavement must be laid granite or trap blocks should be used.

#### SIGNALS.\*

The method of signaling to adopt will depend on the amount of traffic and number of trains. A light business can be handled by signals displayed at telegraph offices indicating clear track or a stop required for train orders; such signals are operated by hand by the operator from the office. Fig. 198 represents a style of this kind.

Where there are a number of fast trains some automatic system should be resorted to; in this case the power to operate the signals is obtained from electric batteries and the circuits are opened and closed by the passing trains. Fig. 199 illustrates the signal used—a white disc indicates the track is clear to the next signal or block, a red one indicates the train has not yet reached the next signal or block. Fig. 200 shows the lever

---

\* The subject of signaling is fully treated in the volume, "Train Service."

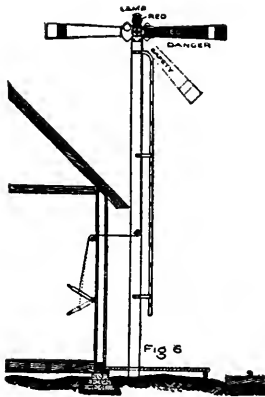


FIG. 198.

TRAIN SIGNAL OPERATED BY  
STATION AGENT.

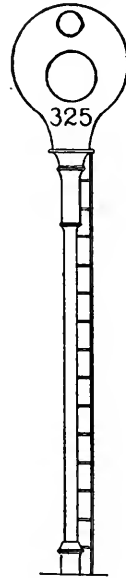


FIG. 199.

AUTOMATIC ELECTRIC  
SIGNAL.

operated by the engine to open and close the electric circuit. Another method used to accomplish the same purpose is illustrated by Fig. 201. By this method the operator displays a danger signal after the train has passed his tower and leaves it at danger until he is notified by the operator at the next tower that the train has passed, when he changes it for clear track. The first method costs more to install but is safer and less expensive to operate. Both methods are called the Block System. At crossings,

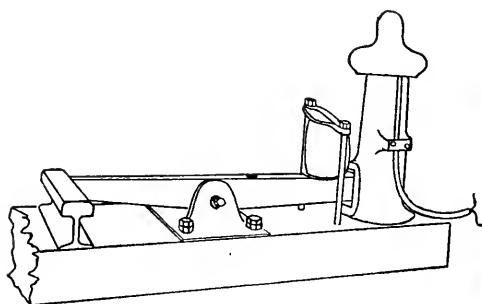


FIG. 200.

LEVER OPERATED BY ENGINE  
TO OPEN AND CLOSE  
ELECTRIC CIRCUIT.

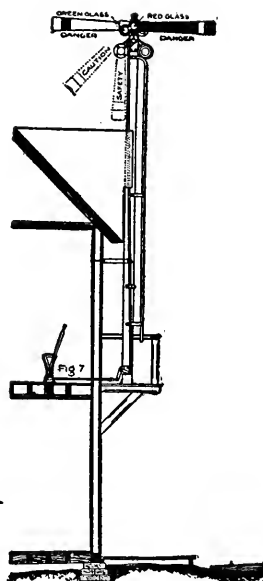


FIG. 201.

BLOCK SIGNAL OPERATED  
BY TELEGRAPH OPERATOR.

yards and terminal points interlocking plants are used, the principle applied here being an arrangement by which the switches are thrown by levers placed in a tower and are operated by hand; the mechanism is so arranged that switches, where any two or more opened at the same time might lead to a collision or derail a train, are locked so only one can be opened, and to open a second one of the set the first must be closed. The signals for clear track or

danger are operated at the same time the switch is thrown. Fig. 141 illustrates some of the signals used on switch stands to indicate in the day time clear track or danger; at night lanterns are placed on the switch stands displaying a red light for danger and a green light for clear track; it is not advisable to use a white light for clear track, as the white light in a lantern may be taken for the signal on a switch stand. The difficulty with a switch light is to get one which

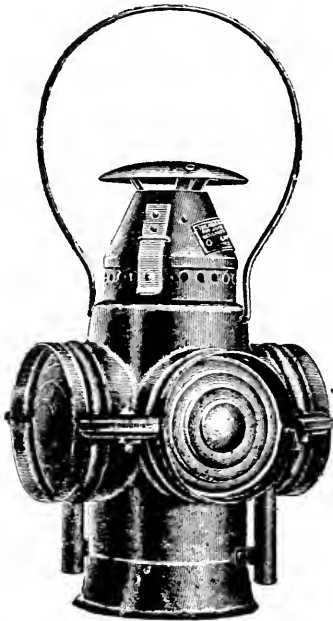


FIG. 202.

SWITCH LAMP UPPER  
DRAUGHT.

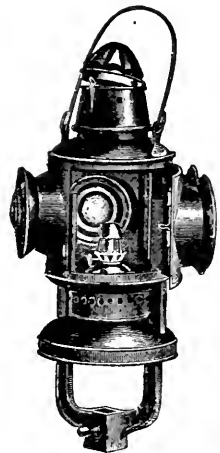


FIG. 203.

SWITCH LAMP LOWER  
DRAUGHT.

will not blow out under all conditions, often a lantern which will not remain lighted on the signal at a telegraph office will give satisfaction on a switch stand. The manufacturers make them with a down draught and an up draught. Figs. 202 and 203 represent these styles. The character of lamps used on a semaphore with the block system is illustrated by Fig. 204; in this

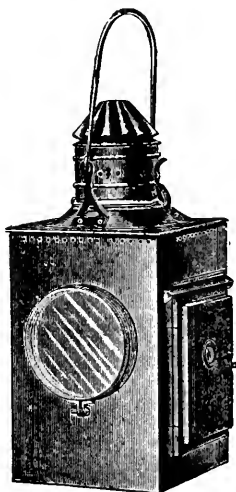


FIG. 204.

SEMAPHORE SIGNAL LAMP—UPPER DRAUGHT.

case the light displayed by the lantern is white and the colors red and green are produced by colored lenses attached to the semaphore Fig. 201.

FENCES.

For a number of years the barbed wire fence was the principal one used to enclose the right of

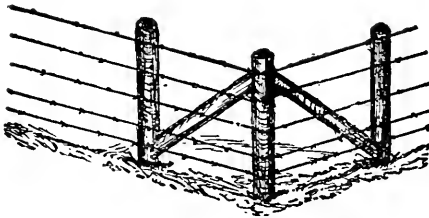


FIG. 205.

BARBED WIRE FENCE.

way—Fig. 205 represents this style of fence. The barbed wire fence was followed by the woven wire fence, the McMullen, Lamb and Page being of this class. Fig. 206 represents the

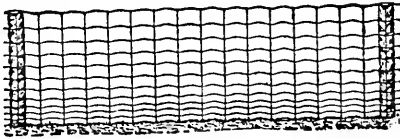


FIG. 206.

PAGE WOVEN WIRE FENCE.

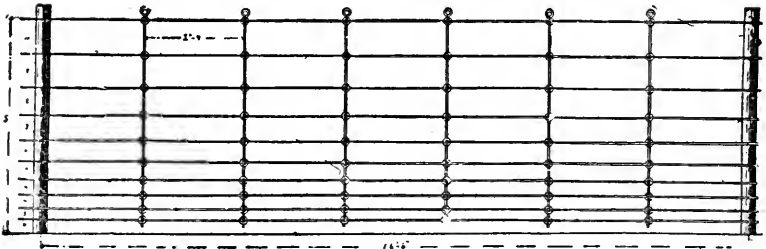


FIG. 207.

JONES' WIRE FENCE.



Page Woven Wire Fence. There is now coming in use for railways a wire fence woven on the field; the Jones and Cyclone being of this type. Figs. 207, 208 and 209 illustrate them. In



FIG. 208.

FLEXIBLE CLAMP USED IN MAKING JONES' WIRE FENCE.

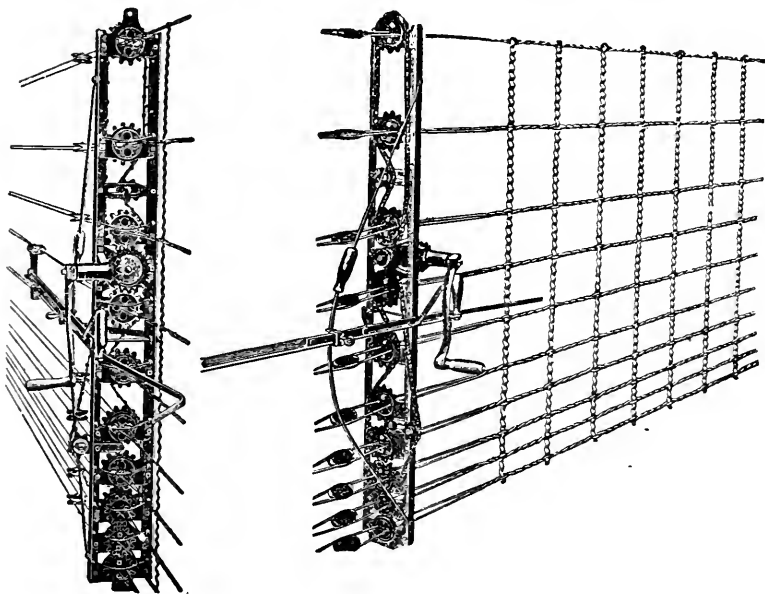


FIG. 209.

CYCLONE WIRE FENCE AND THE MACHINE FOR MAKING IT.

place of cedar posts, which have been exclusively used until recently, iron posts are now being introduced; the weak point with an iron post is its rusting in the ground. To overcome this The Indestructible Post Co., of Brazil, Ind., are making terra cotta bases, which are set in the post holes and the inside partially filled with a thin grout of portland cement; in this grout the iron post is set, thus leaving only that part of the post which can corrode above the ground where it can be inspected and painted. Fig. 210 represents this style of base.

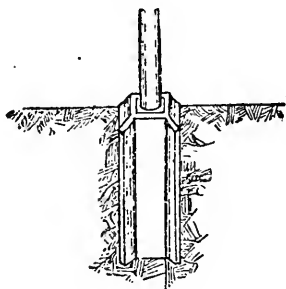
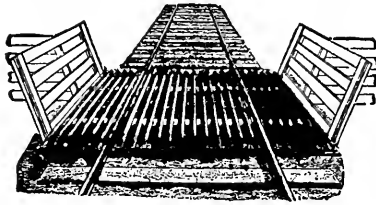


FIG. 210.

TERRA COTTA BASE FOR IRON POSTS FOR FENCES AND SIGNS.

CATTLE GUARDS.

To completely fence in the right of way, a cattle guard is necessary to be placed where the fence line crosses the track at crossings. Formerly cattle guards were mere open pits and the track was carried over them on beams of wood with the edges chamfered. They were found to be expensive to maintain and have been aban-



American Cattle Guard.

FIG. 211.  
CATTLE GUARD.

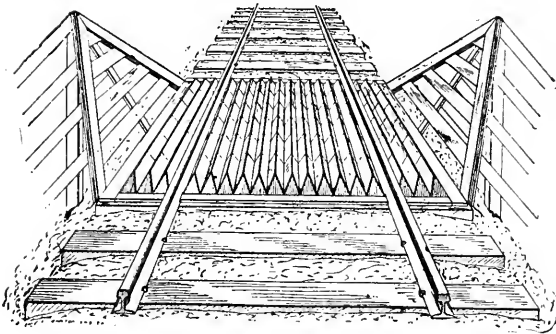


FIG. 212.  
CLIMAX STOCK GUARD.

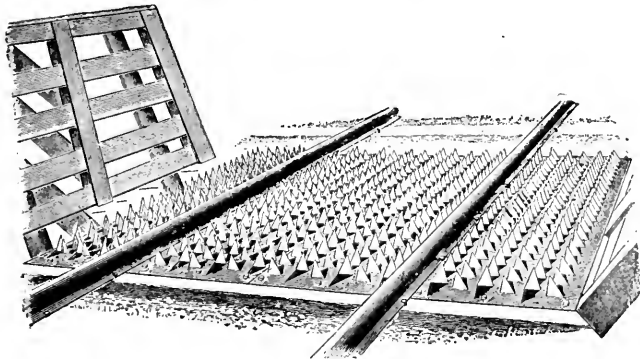


FIG. 213.  
SHEFFIELD CATTLE GUARD.

done, surface guards being now used almost exclusively. Figs. 211, 212 and 213 represent some of the styles used.

#### TRACK SCALES.

The revenue of a railway is based on the rate per 100 pounds, and it is therefore vital to have the weights correct. Car load freight is weighed on track scales, and as the traffic becomes heavy and the schedule faster, the delay caused by weighing becomes annoying to shippers. To overcome this and permit rapid weighing an attachment to the track scales has been made and is known as the Automatic Weighing and Recording Attachment. Fig. 214 gives a view of one make of track scales.

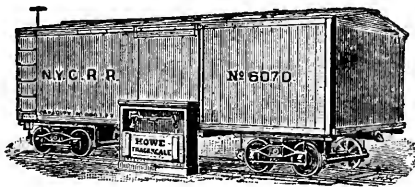


FIG. 214.

RAILROAD TRACK SCALES.

## CHAPTER VII.

### CONSTRUCTING TRACK.

When the work of the tracklaying force with the track machine, as described in another chapter, is finished, the track is far from being completed. The tracklaying force has left only the main line with such sidings as were necessary for handling material and the construction trains. Some of these sidings were temporary and designed only to meet the needs of construction operations; such will have to be abolished. Another and smaller force follows the tracklaying force, its mission being to complete the track (without the tracklaying machine) by laying the required permanent sidings, passing tracks, house tracks, team tracks, private tracks, switches, cross-overs, derailing devices, guardrails, frogs, etc., and, if necessary, widening the gauge and making the necessary elevation of rails at curves, so that the track may be in condition for the operation of trains.

Passing tracks should be located as decided, jointly, by the engineering or construction department and the operating department; they should be made somewhat longer than the largest tonnage train, or trains will be delayed in passing. If possible they should be placed at summits or where there is enough length of level or

light grade for the locomotive to work to advantage before a heavy grade is reached. It is desirable on many accounts that passing tracks should be at stations, but if business does not demand a depot and an agent at such points, provision should be made for a telegraph operator to be stationed thereat for the purpose of attending to orders relative to the movement of trains.

Water stations should, if possible, be placed at passing tracks, so that through trains will be delayed as little as possible. It is, however, a difficult problem to secure at one point favorable conditions for a water station, proper grades, the best location for a station, and the proper distance between passing tracks to get the most economical service from locomotives and train crews.

House tracks are not essential at small depots where a limited amount of business is done and where carload lots can be handled on a passing track as is sometimes done on branches or on a track to an elevator or warehouse. Where the business warrants a house track, and trains are not frequent, as on branches, the house track can be used as a passing track. When, however, the business at a station becomes large, both house tracks and passing tracks will have to be provided.

Team tracks are necessary when the volume of business is such that a track or tracks are required exclusively for carload shipments.

Transfer platforms are necessary at points where carload lots of merchandise are to be dis-

tributed into cars for way or local freights; this operation in the conduct of traffic, takes place under the following conditions:

(1) At junction points of two railway systems.  
(2) At junctions between the main line and branches. (3) Some lines at terminal points or large jobbing centers load merchandise into the cars promiscuously for points over say 300 miles distant, and run these cars out by fast freight. This freight and the freight picked up by the local freights is distributed at a certain point into cars for local freight trains running beyond the 300 mile point.

Private track or tracks to manufacturing plants, elevators, warehouses, etc., are laid as the business develops, and provision should be made in the original plan of yards and switches for such growth as far as possible.

The arrangement of tracks as often used at a small town is shown in Fig. 216. Fig. 217 gives the arrangement of tracks at a junction of two systems where the business is conducted by a joint agent. An arrangement of tracks at a point where a branch connects with the main line is shown by Fig. 218; in this case it is assumed that the locomotives on the main line run through or are not changed at this point. For a point where locomotives are changed on account of the length of run or change of grade, Fig. 219 represents the tracks, buildings, etc., often used. These plans are only intended to present the essential requirements; the arrangement of the tracks in actual practice will depend on the topographical

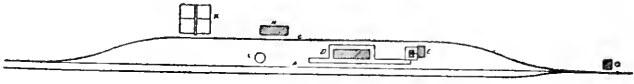


FIG. 216.

PLAN OF TRACKS FOR A SMALL COUNTRY TOWN.

A—Main line track. B—Passing track. C—House track. D—Depot.  
 E—Coal and oil house and out buildings. G—Section foreman's tool house.  
 H—Elevator and warehouse. K—Stock pens. L—Water tank.

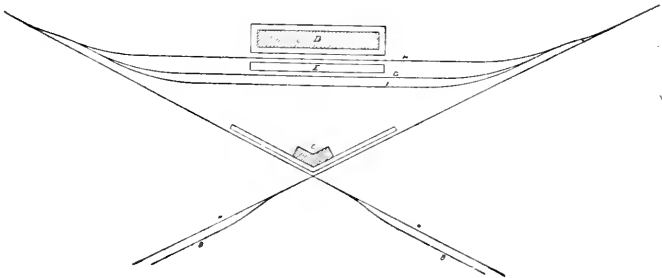


FIG. 217.

PLAN OF TRACKS FOR A JUNCTION OF TWO RAILWAY SYSTEMS.

A A'—Main line tracks. B B'—Passing tracks. C—Passenger Depot.  
 D—Freight Depot. E—Transfer platform. G—Transfer track. H—House  
 track also team track. I—Siding connecting main line tracks.

conditions or lay of the ground, the character and volume of the business, the local conditions as to whether the point is a manufacturing, mining or agricultural center, etc.

The main line should have as few switches in it as possible, and to this end three throw switches are largely used; the cost of yards can be reduced and economy in handling cars secured by the use of three throw and slip switches; however, where



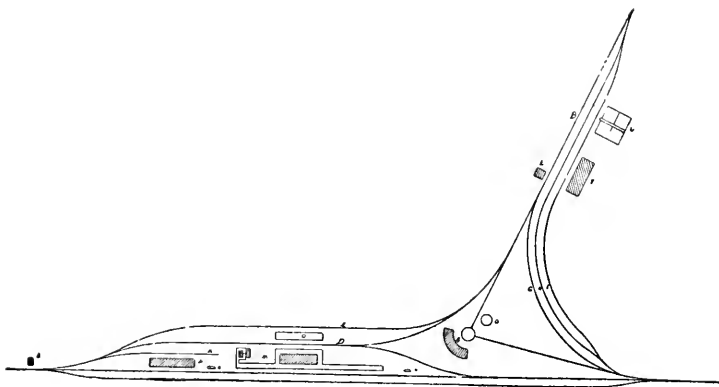


FIG. 218.

PLAN OF TRACKS FOR A JUNCTION OF A BRANCH WITH THE MAIN LINE.

A—Main line. B—Branch. C—Passing track. D—House track. E—Transfer track. G H and I—Sidings. K—Coal track. M—Depot. O—Transfer platform. P—Coal shed. Q—Water tank. R. R—Stand Pipes. S—Roundhouse. T—Elevator and warehouse. V—Stock pens. L and L'—Section foreman's tool house.

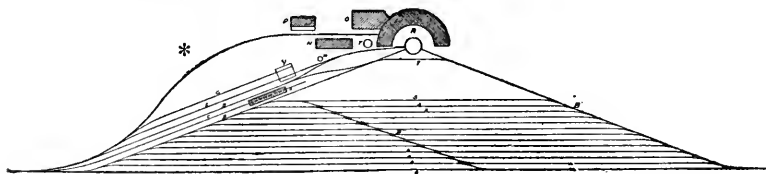


FIG. 219.

PLAN OF TRACKS AND BUILDINGS FOR A YARD WHERE LOCOMOTIVES ARE CHANGED AND WHERE THE GRADES ALTER, THUS CAUSING A CHANGE IN THE TONNAGE OF TRAINS EACH SIDE OF THE YARD.

A—Main line track. BB' B''—Lead tracks. C—Coal shed track. D and B—Coaling tracks for locomotives. E—Ashpit track for cleaning fire boxes of locomotives. G—Track for ashes cars. \*—Track to machine shop, storehouse and sand shed. I—Track connecting the lead tracks B and B' so locomotives can reach the sand shed M, ash pits L and coal shed K without using the turntable. K—Coal shed. L—Ash pit. M—Sand tank. N—Sand shed and sand dryer. O—Machine shop. P—Storehouse. R—Roundhouse. S—Sorting and storage tracks. T—Water tank.

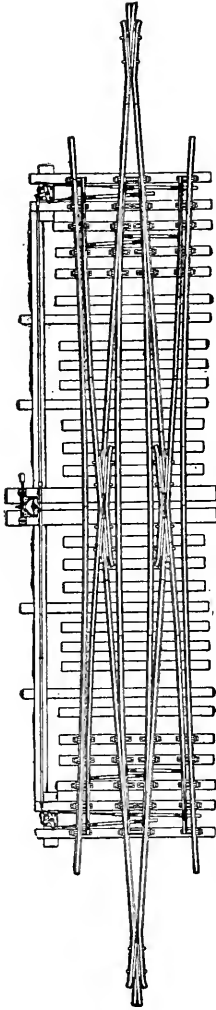


Fig. 220.

COMBINATION SLIP SWITCH CROSSING WITH ADJUSTABLE TIE BARS AND RIGID CENTER FROGS,  
OPERATED FROM A SINGLE SWITCH STAND WITH ROCKER SHAFT CONNECTION.

there is no interlocking plant and they are operated by a switchman, an error on his part when not observed by the engineer will result in derauling the engine, if nothing worse. In Fig. 219,

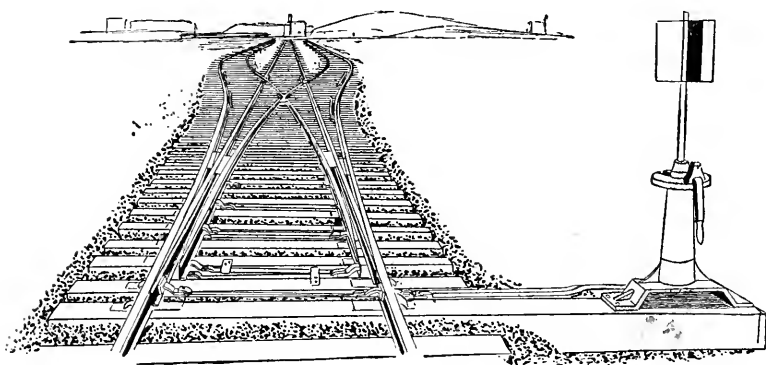


FIG. 221.

VIEW OF A THREE THROW SPLIT SWITCH.

by adding a third lead track B, and using slip switches, cars can be taken from the center of the storage tracks to the main line or from one storage track to another. Fig. 220 illustrates the construction of a combination slip switch crossing. A view of a three throw split switch is given by Fig. 221 and Fig. 222 shows the construction at the switch points.

In laying out sidetracks and yards, the correct location of the frogs and rails from the headblocks to the frogs and from the frogs to the sidings is a mathematical problem, though it is often done by

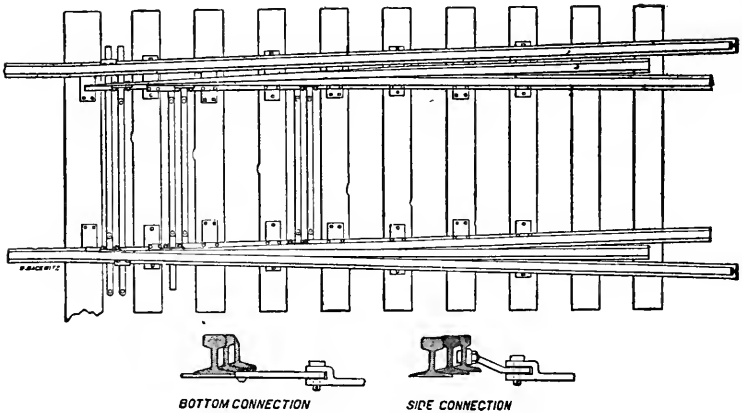


FIG. 222.

ARRANGEMENT OF THE SWITCH POINTS FOR A THREE THROW SPLIT SWITCH.

the section foreman's eye, often to the injury of the rails and rolling stock.\*

Often in practice the frog angle and switch point of a split switch and the rail thrown and frog angle of a stub switch are taken as part of the curve of the rail from the headblock to the frog. This is not mathematically correct, especially with the angle of the frog. The Elliot Frog & Switch Company have given dimensions in detail for laying out switches where the switch point and frog angle are taken as tangent to the curve of the rail from the headblock to the frog; Figs. 223 to 230 are single throw split switches

\*The authors on railway location and problems connected with laying out curves, etc., give the mathematical demonstrations of side track work. See Appendix K.

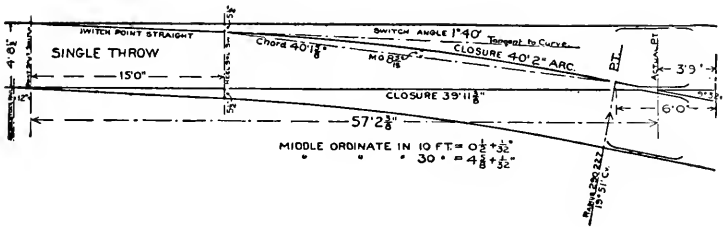


FIG. 223.

SINGLE THROW SPLIT SWITCH No. 6; RIGID FROG 6 FEET LONG.

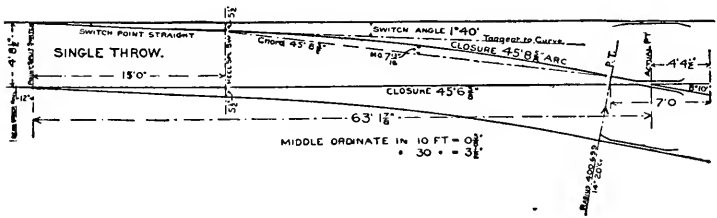


FIG. 224.

SINGLE THROW SPLIT SWITCH No. 7; RIGID FROG 7 FEET LONG.

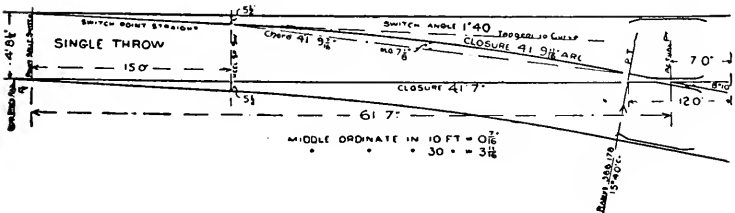


FIG. 225.

SINGLE THROW SPLIT SWITCH No. 7; RIGID FROG 12 FEET LONG.

and rigid frogs, while Figs. 231 to 234 are for the same style of switch but with a spring rail frog. Plans with details for the location of the crotch or center frogs and their number for three throw split switches are given in Figs. 235 to 242.

A number ten frog is probably more often used in the main line than any other, for the reason that a very good (though not a mathematically correct) switch can be obtained by using two thirty foot rails between the switch point and the frog, and thus avoiding cutting rails. In Appendix J, Table No. 9, is given a list of switch ties for single throw split switches, using frog Nos. 4 to 11 inclusive. Table No. 10, Appendix J, gives a list of switch ties for three throw split switches using frogs, Nos. 6 to 11 inclusive. Stub switches are used to some extent at present on branches and in yards. The names of the parts of a stub switch are given in Fig. 243 and in Appendix J, Table No. 11, is given the data to lay out a single and a three throw switch for a standard gauge. Table No. 12, Appendix J, gives the data for laying out a single and three throw switch for a narrow (three foot) gauge. A bill of switch ties for standard gauge single throw stub switches is given in Table No. 13, Appendix J, while Table No. 14 gives a bill of switch ties for a narrow (three foot) gauge, single throw stub switch. The tables and data so far given are for switches in a straight track. Where the main line is curved, special calculations are required for each case, and the solutions of such problems are given in the work previously referred to.

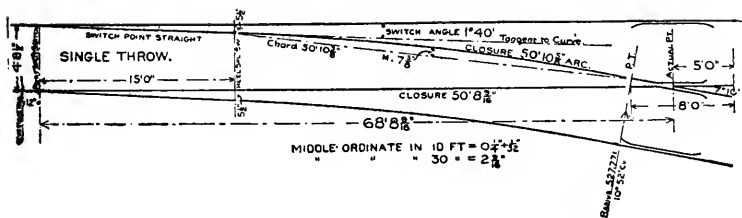


FIG. 226.

SINGLE THROW SPLIT SWITCH No. 8; RIGID FROG 8 FEET LONG.

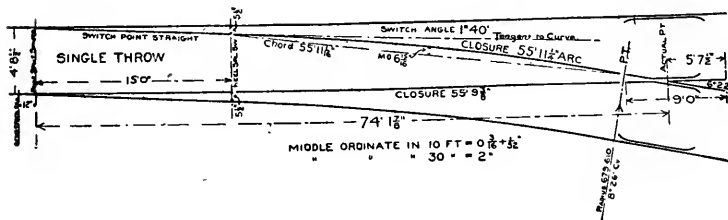


FIG. 227.

SINGLE THROW SPLIT SWITCH No. 9; RIGID FROG 9 FEET LONG.

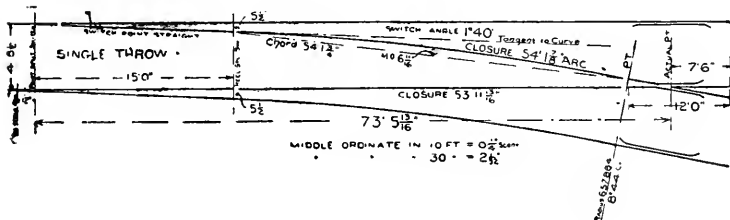


FIG. 228.

SINGLE THROW SPLIT SWITCH No. 9; RIGID FROG 12 FEET LONG.

Crossovers are necessary on double track railroads to enable west or north bound trains to reach sidings on south or east bound tracks and *vice versa*. Fig. 244 illustrates a crossover and its use. Fig. 245 is a plan of a crossover. The length of the leads are given in Figs. 223 to 230 and the distance  $D$  between the points of the frogs in the main line track is given in Table 15, Appendix J. A rule often used by track men to calculate the distance between the points of frogs at crossovers is as follows: From the distance between the gauge lines of parallel tracks, subtract the gauge of the track, multiply the remainder by the number of the frog, and the result will be the distance between the points of the frogs. Care should be taken to place crossovers so that trains will run through the switches as shown in Fig. 244 and not against the point of the switch; this reduces the liability of accidents from derailment. Derailing switches should be placed on all side tracks where the grade is such that cars are liable to run onto the main line. The safest construction is to place derailing switches at all sidings connected with the main line; high winds will cause light box cars to move on a side track, or careless switching when a fast train is due has occasioned freight cars to run into a switch and caused accidents. Fig. 246 illustrates a derailing switch operated from the switch stand which operates the main line switch; when the switch is set for the main track the derailing switch is set to throw a moving car off the siding on the opposite side from the main line track.



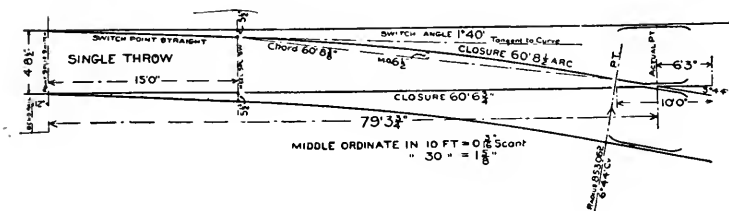


FIG. 229.

SINGLE THROW SPLIT SWITCH No. 10; RIGID FROG 10 FEET LONG.

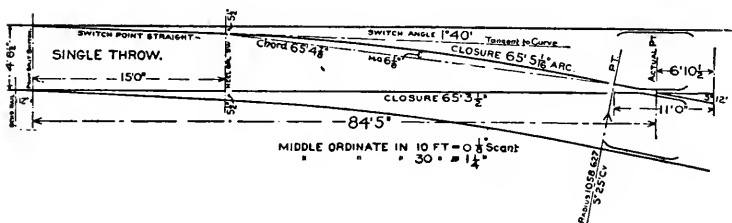


FIG. 230.

SINGLE THROW SPLIT SWITCH No. 11; RIGID FROG 11 FEET LONG.

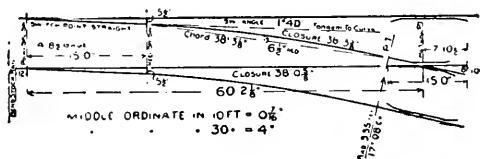


FIG. 231.

SINGLE THROW SPLIT SWITCH No. 7; SPRING RAIL FROG 15 FEET LONG.

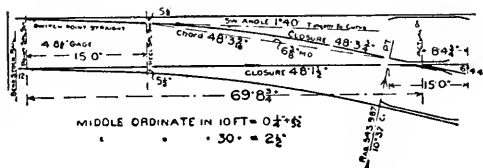


FIG. 232.

SINGLE THROW SPLIT SWITCH No. 8½; SPRING RAIL FROG 15 FEET LONG.

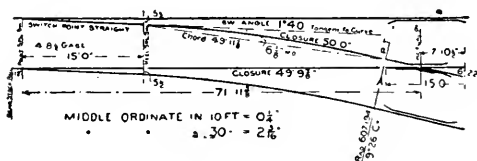


FIG. 233.

SINGLE THROW SPLIT SWITCH No. 9; SPRING RAIL FROG 15 FEET LONG.

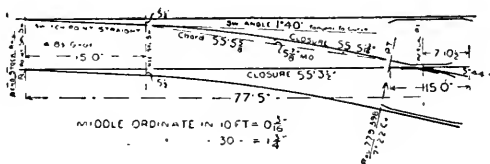


FIG. 234.

SINGLE THROW SPLIT SWITCH No. 10; SPRING RAIL FROG 15 FEET LONG.

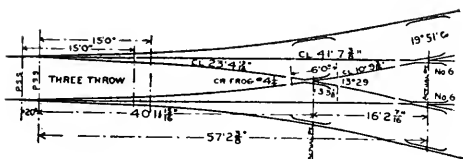


FIG. 235.

THREE THROW SPLIT SWITCH No. 6; RIGID FROG 6 FEET LONG.

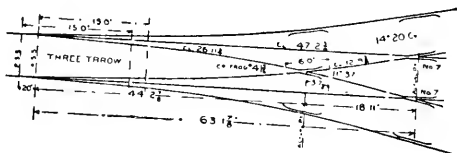


FIG. 236.

THREE THROW SPLIT SWITCH WITH No. 7; RIGID FROG 7 FEET LONG.

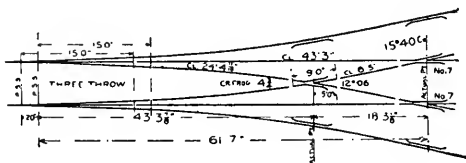


FIG. 237.

THREE THROW SPLIT SWITCH WITH No. 7; RIGID FROG 12 FEET LONG.

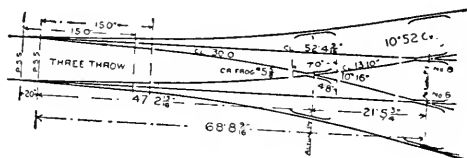


FIG. 238.

THREE THROW SPLIT SWITCH WITH No. 8; RIGID FROG 8 FEET LONG.

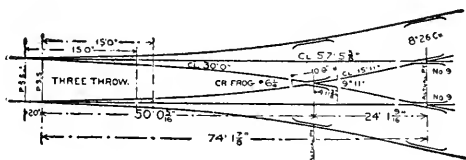


FIG. 239.

THREE THROW SPLIT SWITCH WITH No. 9; RIGID FROG 9 FEET LONG.

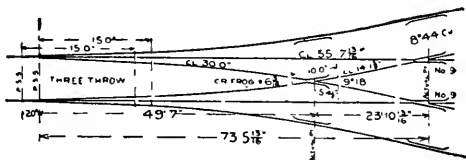


FIG. 240.

THREE THROW SPLIT SWITCH WITH No. 9; RIGID FROG 12 FEET LONG.

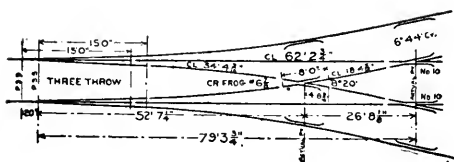


FIG. 241.

THREE THROW SPLIT SWITCH WITH No. 10; RIGID FROG 10 FEET LONG.

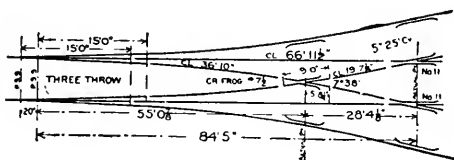


FIG. 242.

THREE THROW SPLIT SWITCH WITH No. 11; RIGID FROG 11 FEET LONG.

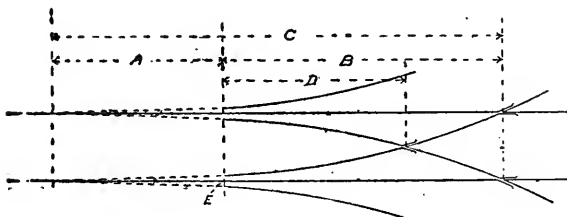


FIG. 243.

PLAN OF A STUB SWITCH.

A — Switch rail. B — Toe of switch to point of frog. C = A + B = Heel of switch rail to point of frog. D = Toe of switch to point of crotch frog. E = Throw of switch.

There has recently been introduced sand tracks, similar to that illustrated in Fig. 247 for checking the movement of cars on side tracks and also to take the place of bumping posts. A derailing

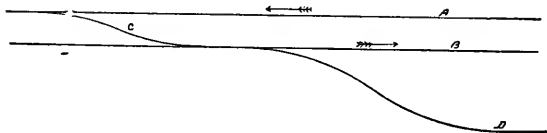


FIG. 244.

PLAN ILLUSTRATING THE USE OF A CROSS OVER OR SWITCH CONNECTING THE TWO MAIN LINE TRACKS OF A DOUBLE TRACK ROAD. C IS THE CROSS OVER CONNECTING TRACKS A AND B TO ENABLE A TRAIN ON TRACK A TO REACH SIDING D.

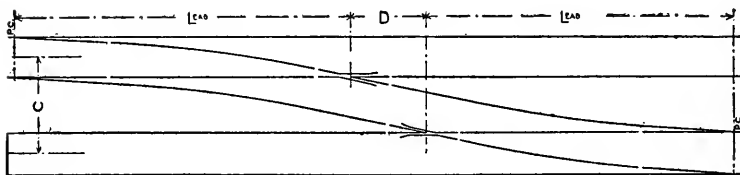


FIG. 245.

PLAN OF A CROSS OVER.

switch used in connection with an interlocking plant to protect railroad crossings is illustrated by Fig. 248.

Guard rails should be placed at all frogs, both at the main line rail and the rail leading to the siding. They should be securely spiked to the

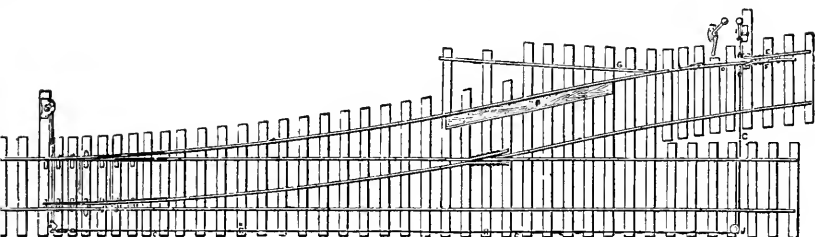


FIG. 246.

DERAILING SWITCH USED TO PREVENT COLLISION BETWEEN A TRAIN ON THE MAIN LINE AND CARS RUNNING OFF A SIDE TRACK ONTO THE MAIN LINE.

This switch is connected and operated by the movement of the Main Line Switch. The cut shows the switch set for the Main Line and the Derailing Switch set to throw a car moving out of the siding from the track. When the switch is set for Siding the Derailing Switch closes automatically.

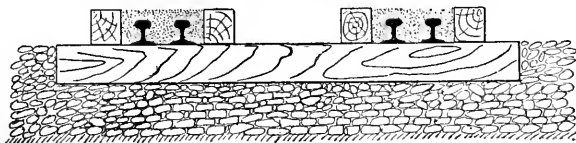


FIG. 247.

SAND TRACK; USED TO CHECK THE MOVEMENT OF CARS ON A GRADE OR WHEN PROPELLED BY A HIGH WIND FROM RUNNING OFF A SIDING TO THE MAIN LINE TRACK.

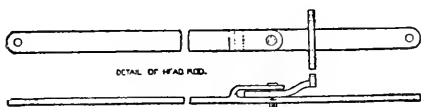
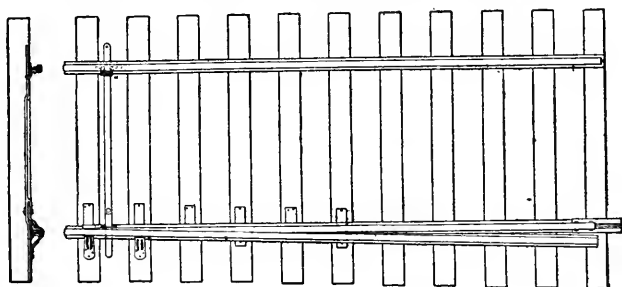


FIG. 248.

DERAILING SWITCH POINT USED IN CONNECTION WITH INTERLOCKING SYSTEM OF GUARD CROSSINGS.

tie and braced so they cannot turn over. Fig. 249 illustrates a guard rail braced with rail braces; Figs. 248 to 251 illustrate methods of stiffening guard rails by attaching them to the main line rail.

In addition to what has already been said in regard to crossing frogs, it is well to note here that it sometimes occurs that two roads cross at an acute angle; in such cases the crossing can be made by using crossing frogs as shown in Fig. 252. Crossings of this character are liable to occur at yards and terminal points. To secure a smooth main line track, movable center points instead of a rigid frog have been introduced. Fig. 253 illustrates a combination slip switch crossing with movable center points, the switch points and movable frog points are operated together. The motions are positive, the frog points always corresponding with the switch points, thus avoiding any mistake on the part of the switchman. This combination of switches and frog points is desirable where the crossing is at an angle of less than ten degrees.

The question of widening the gauge on curves has been discussed ever since railroads were first constructed, and no conclusion has yet been arrived at. The Roadmasters' Association made enquiries on this subject in 1897, and found no two railroad systems were using the same width of gauge for curves of the same degree, and some roads laid track on both curves and tangents to the same gauge. The present practice of gauging wheels for standard gauge cars leaves a clear-



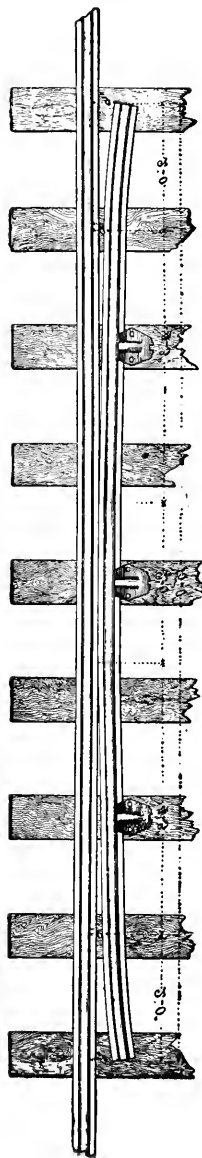


FIG. 249.

STANDARD GUARD RAIL WITH DIVISION BLOCKS AND BOLTS AND RAIL BRACES.

ance of five-eighths to seven-eighths of an inch on a four feet eight and one-half inch gauge on a tangent. In 1898 the Roadmasters' Association recommended commencing to widen the gauge on curves with a seven degree curve. Table No. 16, Appendix J, gives the amount recommended by this Association for widening the gauge for different degrees of curvature.

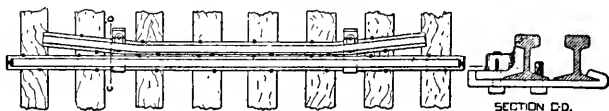


FIG. 250.

GUARD RAIL WITH THE HOOK GUARD RAIL CLAMP.

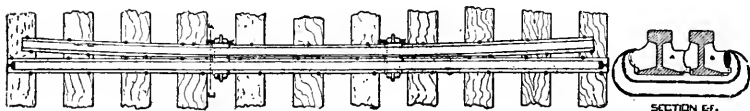


FIG. 251.

GUARD RAIL WITH THE SAMPSON ADJUSTABLE GUARD RAIL CLAMP.

Elevating the outer rails on curves is done to counterbalance the centrifugal force or that force which tends to cause the train to mount the rail and proceed in a tangent or straight line. The proper theoretical velocity can readily be calculated when the radius of the curve and the velocity of the train are known using the formula  $E = \frac{KV^2}{32.2R}$  in which E equals the elevation of the outer rail, G the gauge in feet, V the velocity of

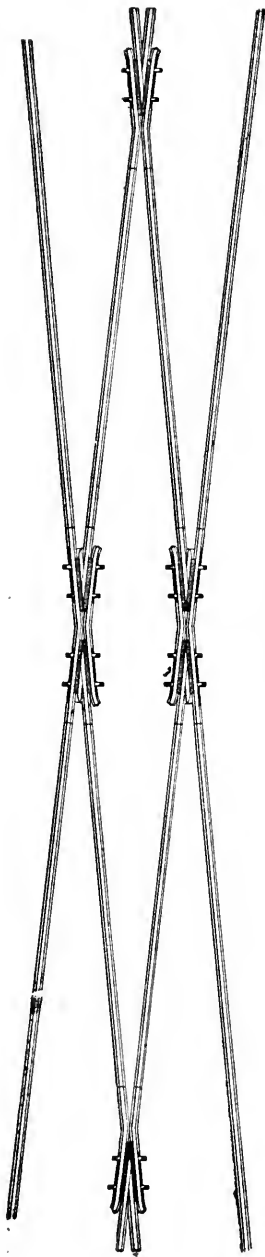


FIG. 252.

CROSSING FROGS USED WHERE TWO TRACKS CROSS AT AN ACUTE ANGLE.

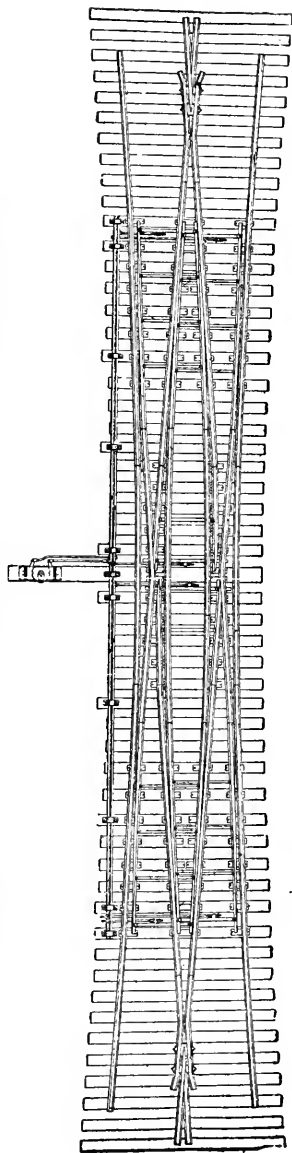


FIG. 253.

COMBINATION SLIP SWITCH AND MOVABLE CENTER POINTS, SWITCHES AND MOVABLE CENTER POINTS OPERATED BY ONE SWITCH STAND.

the train in feet per second, and  $R$  the radius of the curve in feet. In practice, however, the problem is a difficult one to solve, and with mixed trains running on the same track, probably never will be. The difficulty lies in the fact that other conditions besides keeping the train on the track have to be taken into account. Steel rails are expensive, and it is also expensive work to take worn ones out of the track and replace them with new ones. To get the full life of the rails on a curve, the wheels of the rolling stock (that is the cars and locomotives) should pass around a curve in the same manner they do on a tangent. When the outer rail on curves is elevated to give safe and easy riding track for fast passenger trains, the slower passenger trains and freight trains are bearing heavily on the inner rail, and wearing it out faster than the outer rail. On a single track road the problem is further complicated where there is a curve on a grade; descending trains pass over the curve at a high speed while ascending ones pass over it at a low speed especially where the grade is a heavy one. Table No. 17, Appendix J, gives the theoretical elevation of the outer rail on curves of different degree or radius, and for trains at different velocity for both standard and narrow gauge. In practice no standard gauge track should be given more than  $6\frac{1}{2}$  inches elevation, and on single track such elevation should be made as will most nearly conform to all speeds but favoring passenger trains.\* Table No. 18,

---

\*Further information on this subject will be found in the first article in Appendix J.

Appendix J, gives the ordinates for bending rails of different lengths to curves of different radius for track and switch constructions. The chapter on Maintenance of Way will contain some data which, while properly being a part of track construction, also is a part of the work coming under the supervision of the Roadmaster and his employes. There also was discussed in the chapter on Standards some subjects belonging to track. In Appendix J will be found further detailed information as to the minutiae of track.

## CHAPTER VIII.

### MAINTENANCE OF WAY.

All the steps leading up to the building and complete construction of a railroad have now been described, and we may suppose that the property is performing its functions, and that trains hauling passengers and freight are daily passing over its tracks. But after a railroad has been completed in as thorough and economical a manner as the resources of the management will permit and it is turned over to the operating department, experience shows that over 23 per cent. of all the expense of operating the road is required for maintaining the track, bridges, culverts, buildings, fences, gates and crossings, and over 15 per cent. for maintaining the equipment in good order so that operations may be continued with economy and safety.\*

The problem of maintenance of track is constantly becoming more and more difficult by reason of the increased weight of rolling stock and the heavier loads hauled.†

---

\* Appendix G, Table 1, gives a tabulated statement of the weights of the largest locomotives in 1880 and 1890. Passenger locomotives in the past twenty years have increased 65 to 70 per cent. in weight, while freight locomotives have increased over 100 per cent.

† Appendices B, C, and D give further information on this point.

This increase in weight was started by the discussion on the relative merits of standard and narrow gauge from 1870 to 1883, and has been helped along by the effort to cheapen the cost of handling the freight traffic by increasing the tonnage hauled by a locomotive and train crew.

In 1880 it was thought that 12,000 pounds was all that could be put on a driver without crushing the rail; to-day there are several locomotives whose drivers support a weight of over 24,000 pounds. To meet this condition, steel rails have been increased in weight from 60 to 100 pounds per yard. The effect of this heavy rail is to make it act as a girder, thus throwing the weight carried on a larger number of ties.

The increased bearing surface secured by the use of wide ties is shown by the table No. 19, Appendix J, which shows that 16 ties having an eight-inch face, or 14 ties having a nine-inch face, have as large a bearing surface on the ballast as 18 ties having a seven-inch face.

The following table gives the number of ties which can be placed under a thirty-foot rail, leaving ten inches in the clear for tamping, and also the percentage of increased bearing surface for ties 8, 9, and 10 inches wide over ties 7 inches wide.

Width of tie.	No. to a 30-ft. rail.	Percentage of increased bearing surface on the ballast over a tie 7 inches wide.
7 inches	21	
8 "	20	9 per cent.
9 "	19	16½ "
10 "	18	22½ "

To support the new class of heavy locomotives and tonnage trains with loaded cars weighing 90,000 to 100,000 pounds, wider ties must be used on well ballasted and drained roadbeds. By increasing the thickness of the tie to seven inches it can be made eight feet six inches long, and thus secure additional bearing surface; ties nine and ten feet long have been used on earth ballast where there are seasons of prolonged rainfall.

In addition to the destructive force exerted by passing trains, there are other causes tending to destroy the track, viz.: wet cuts and badly drained roadbeds, creeping of the rails, heaving and settling of the roadbed by freezing and thawing, natural decay of the ties and corrosion of the rails and fastenings caused by the elements.\*

*Organization of Force.*—The organization of the force in charge of the important duty of maintaining the track of a railway, which, as we have seen, costs almost 25 per cent. of the oper-

---

\*I remember going over a piece of road in the eastern part of Dakota in 1874 that had been abandoned for some time. The train consisted of an engine and two cars, and three days were required to travel eighty miles. The weeds and grass were from 6 inches to six feet in height. Everywhere the roadbed was tunneled with the burrows of jack rabbits and squirrels. The weeds and grass rendered the track so slippery that it was necessary for laborers to place sand and gravel on the rails as we proceeded. Water was procured with the aid of syphons from ponds along the road and the trestles and bridges swayed under the weight of the train like trees in a tempest. When eventually this particular piece of track was opened for business, it was found necessary to rebuild it entirely, although the abandonment had only extended over a period of five years.



ating expense, and upon which force depends very largely the financial success of the railroad, has not, as a rule, received the attention its importance demands.

On some systems the maintenance of way department is directly under the engineer, in other cases directly under the superintendent, and in other cases there is a division of authority. The roadmasters, who are the officials in actual charge of the track, in some cases report direct or through the engineer to the superintendent, and in other cases report to an officer who in turn reports to the engineer.

The tendency is to place men in charge of maintenance of way who have had a technical training; but before they can be of any great service they must also have received a practical training. All men who graduate from a technical school or college do not possess that practical turn of mind essential to the successful engineer.

Some railroad systems place the young engineers in section gangs where they can learn the practical work and are then advanced to section foremen, supervisors of several gangs of section men, and then to roadmasters; this method secures men who have both practical and scientific knowledge and who have proved their adaptability to the work and ability to manage men. There are two distinct features to be considered in the organization of the roadway department. The first is the execution of that which is to be done; the next, the inspection of that which has

been done. Under some circumstances, the duties of execution and inspection are combined in one individual; in the broadest sense, however, there should be no community of interests between the inspector and the man who is directly responsible for the work. The man who executes or directs the execution of work is naturally inclined to magnify its excellence and excuse its imperfections, but he who views it with the practiced eye of a critic, whose judgment is not tempered with self-interest, will give an estimate of certain and just value. Road inspection will therefore be considered under a separate heading, as a distinct system, instituted to meet the increasing exaction of modern railroading.

In the organization of the roadway service there should be no division of authority or responsibility; all orders should proceed from a responsible head, and all reports should ultimately reach his office and be consolidated by him for the information of superior officers. This head is variously termed the roadmaster, superintendent of roadway, engineer, etc. Under this officer come the supervisors, division roadmasters, or assistant engineers, as the case may be; also timber inspectors, pump inspectors, and frequently bridge and building inspectors; then come the gang foremen, etc., who in turn employ their own laborers. Under such an organization, with a proper system of rules and accounts, a road may be extended to almost unlimited proportions by a simple addition to the number of divisions and subdivisions,

and an enlargement of the central office. A division roadmaster or supervisor is rarely capable of supervising more than one hundred miles of single track or fifty miles of double track road. On our more important lines, a section of single track should not exceed six miles, and section-houses should be placed as near a telegraph office or station as possible.

The foreman should have the care of track and property of the company on his section, and should be held accountable for their proper care and maintenance.

As far as possible the roadmaster should lay out the work for his foremen. Foremen should be shown the value of thorough system, of planning the week's work ahead so as to economize time and to accomplish a little more than the proper week's allowance. For this reason it is very essential for the roadmaster to establish the proper allowance of labor, and to issue in advance of requirements the necessary material. Foremen should not be permitted to work portions of a day at points widely separated, as the loss of time in going from one place to another will easily consume a large percentage of the day's time. The regular inspection, which foremen should be required to make at least twice a week over every part of their sections, should be made in such a manner that they will use as little time away from their regular work as possible.

The following rules for the guidance of employes in the roadway department are in the main generally appropriate.\*

---

\* I copy them substantially as I find them.

*General Rules.* —Each employe whose duties require it must have the book of rules with him while on duty.

Any employe who does not clearly understand the rules must ask an explanation of his superior officer.

Employes must report violations of rules by other employes which endanger life or property, or which prevent them from discharging their own duty.

Employes while on duty must refrain from profane or violent language, personal altercation, and from using intoxicating drinks.

Each employe is hereby warned that while on the tracks or grounds of the company, or in working with or being in any manner on or with its cars, engines, machinery or tools, he must examine, for his own safety, the condition of all machinery, tools, tracks, cars, engines, or whatever he may undertake to work on or with, before he makes use of or exposes himself on or with the same, so as to ascertain, so far as he reasonably can, their condition and soundness; and he is required promptly to report to his superior officer any defect in any track, machinery, tools or property of said company affecting the safety of anyone in operating upon or with the same.

Supervisors, inspectors, foremen and conductors must keep a daily record of their occupation, showing in detail the work done, material used, and the time of each person employed under their immediate supervision.

Red must not be worn in a conspicuous manner.

Supervisors, conductors, section foremen and foremen of all other gangs, during work hours,

must not leave their respective division, train, section or gang, without written permission from the roadmaster.

In case of accident to train or road, the highest officer in the roadway department, or the oldest foreman in continuous service present at the time will have charge of the work until relieved by some one higher in authority.

Supervisors must pass over their divisions on trains, and foremen over their sections on hand cars, during stormy weather, and must know that all is safe before allowing trains to pass. Conductors must keep in telegraphic communication with the roadmaster and the master of trains during the continuance of storms, and be prepared to move on shortest notice.

Hand cars must not be towed at the rear of trains, and must not be on the track after dark, nor in foggy weather unless protected by proper signals in front and rear.

Standard plans and specifications for the construction and location of all structures will be furnished and officers and foremen must inform themselves of such standards and work entirely in conformity with them.

Trains must be expected at all times.

Foremen and officers must provide themselves with reliable watches before entering upon their duties, and see that they are always in order and conform to standard time.

When watchmen are left with danger signals, they must be supplied with tools and required to work.

When dangerous places are found, or while work is being done that renders the road unsafe for the passage of trains, the person in charge

must attend to the placing and maintaining of danger signals on the engineer's side of track in both directions. In no case must they be nearer than fifteen telegraph poles, and on a continuous down grade in the direction of the work the signal must be placed at least twenty telegraph poles from the work. When such points come on a curve, the signal must be placed at the further end of the curve. If either signal cannot be clearly seen from the work and from an approaching train, a watchman must be left with it.

Whenever signals of the roadway department are disregarded, immediate report must be made to the roadmaster.

Slow boards must be posted at a distance of ten telegraph poles on each side of the place where the speed is to be reduced.

When two or more hand cars may be following each other over the road, they must maintain an interval of at least two telegraph poles apart.

*Supervisors or Assistant Roadmasters:* Must test track levels once a week, and see that they are used in surfacing track; must see that foremen are supplied with the full number of tools required; and that they are in proper order; must carry with them on their hand car a standard track gauge, an ax, six torpedoes, a red and white lantern, and a red flag; must examine switches, frogs and turntables once a week, and see that they are in proper order; must see that turntables and car guards are provided with proper means to securely lock them; must see that their foremen are provided with the proper forms for making reports, and with copies of all rules and schedules; must pass over their respective divis-

ions at least once a week on a hand car, once a week on an engine, and as often as possible on the rear of a train; must see that signs are placed where required, and are kept in proper order; must see that fences are kept in proper order.

Reports of the resignation, discharge, removal, suspension, transfer, death, injury, sickness, or marriage of any foreman must be sent at once to the roadmaster.

*Foremen:* Must be familiar with the regular code of signals and the proper position and use of torpedoes; must work when their entire attention is not required in directing their men; must report promptly in detail to the supervisor any accidents to persons or trains; must notice the signals carried by passing engines; must examine every switch, frog and guard rail on their respective sections at least three times every week, and keep them in good order.

The length of a section and the number of men allotted to each gang should be governed by local conditions, whether single or double track and the volume of traffic. A section of double track should be about four miles long, and of single track about six miles long. On roads having a large traffic, each section gang should consist of a foreman and one and one-half men per mile of double track, with an additional allowance of one man for every two miles of sidings. On single track each gang should consist of a foreman and one man per mile of track, with an additional allowance of one man for every two miles of sidings. Taking these proportions as a basis, sections may be varied in length as locality and circumstances make necessary. Generally speaking no section should be so reduced in

length that its proportionate allowance of force would be less than six men and a foreman. Watchmen should be counted extra. All extra work should be calculated to be done by a special gang and ballast train; or extra men should be allowed section foremen. Each section should have a tool house large enough to accommodate a hand car and a full complement of tools.

*Ballasting.* Ballasting when done on a large scale, as is the case when changing from an earth roadbed to one of gravel, slag or broken stone, is done by special gangs, and when repairs to the ballast are done on a small scale the work is done by the section gang.

Tracks should be laid alongside of a gravel bank of sufficient capacity to allow switching a train of empty cars alongside the steam shovel, while the loaded ones are being taken out, the object in view being to proportion the forces so that all can work steadily and have no interruptions caused by the steam shovel being idle waiting for empty cars, or the gang placing the ballast under the ties being idle waiting for ballast. By using a steam shovel to load the cars with gravel, and a ballast unloader the force on the gravel train can be reduced to a small train crew.

Wherever a change is being made from an earth roadbed to one ballasted with gravel, slag or stone, the earth between and at the ends of the ties should be cast out on to the slopes of the embankments and removed entirely from cuts and placed where the embankments are narrow; the aim should be to secure a roadbed as near the standard section as possible before the ballast is put on.



There have recently been introduced special cars for handling ballast. Thus the Rodgers ballast car dumps the ballast in the center of the track, the last car in train of ballast cars having a plow for cleaning and flanging the track. The amount of ballast to be distributed is regulated by the amount of opening given to the doors of the hopper in the bottom of the ballast car and the speed of the train. When a large amount of ballast is to be deposited, it is done by running the ballast train over the track two or more times.

Another car for handling ballast is the Goodwin Steel Gravity Dump Car. It is dumped by one man by means of compressed air which operates to move the dumping attachments of all the cars in the train at the same time. The ballast can be dumped all on one side of a rail or both sides, or all on the outside of both rails or all on the inside of both rails.

When the ballast used is broken slag or stone, care should be taken to have a sufficient supply to draw from before putting the surfacing gang at work. It is advisable in case of any class of ballast to have a sufficient quantity distributed along the track before the surfacing gang is put to work in order to guard against delays in delivery.

A plant is required to prepare stone ballast which should be located at a quarry; storage bins should be provided of capacity sufficient to load at the least a train of cars; it is still more economical, however, to have the capacity of the plant such that when the cars are put in service they can be kept continuously employed until the work is completed.

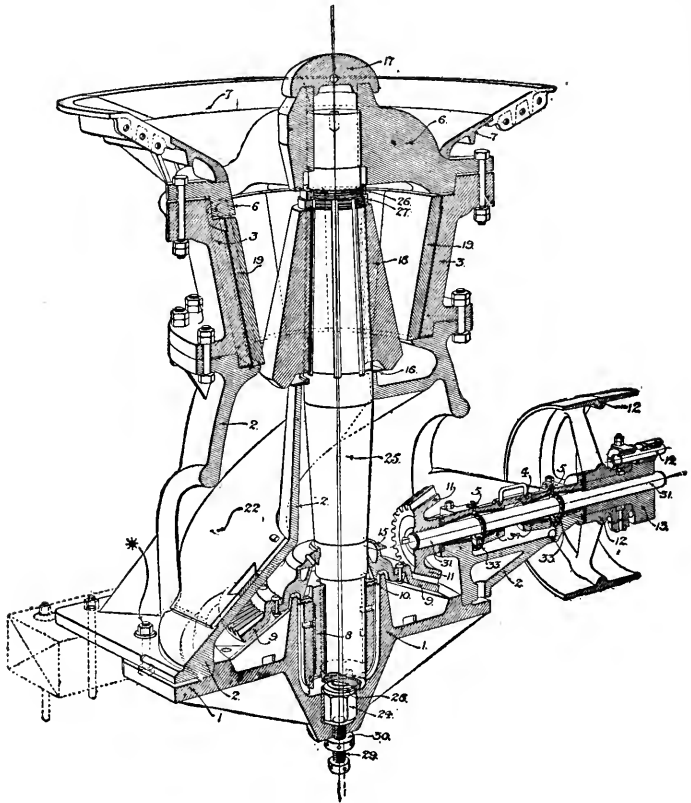


FIG. 258.

SECTIONAL PERSPECTIVE VIEW GATES STONE CRUSHER FOR BALLAST.

REFERENCE TABLE.

The names of the several parts designated by numbers in the above illustration may be found in the following table:

1. Bottom Plate.	12. Band Wheel.	25. Main Shaft.
2. Bottom Shell.	13. Break Hub.	26. Upper Ring Nut.
3. Top Shell.	14. Break Pin.	27. Lower Ring Nut.
4. Bearing Cap.	15. Oil Bonnet.	28. Steel Step.
5. Oil Cellar Cap.	16. Dust Ring	29. Lighter Screw.
6. Spider.	17. Dust Cap.	30. Lighter Screw, Jam Nut.
7. Hopper.	18. Head.	31. Counter Shaft.
8. Eccentric.	19. Concaves.	33. Oiling Chain.
9. Bevel Wheel.	22. Chilled Wearing Plates.	
10. Wearing Ring.	24. Octagon Step.	
11. Bevel Pinion.		

A large sized Gates stone crusher is illustrated by Fig. 258; this is of the rotary style which is taking the place of those having a jaw worked by a reciprocating motion. The drawing gives the details of the crusher and Fig. 259 shows the

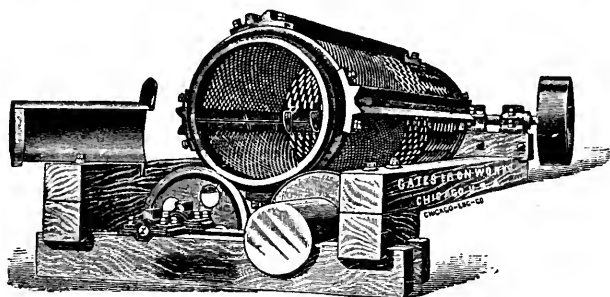


FIG. 259.

GATES REVOLVING SCREEN FOR SCREENING CRUSHED STONE.

rotary screen used to separate the crushed stone into the various sizes desired.

A plant with storage bins and three loading tracks is shown by Fig. 260. To economically operate this plant the loading tracks should be on a light grade sufficient to easily move the loaded cars by hand; the empty cars should be placed at the high end of the siding and run under the storage bins by hand. After they are loaded they should be run by hand to the lower end of the loading tracks, thus avoiding the use of a switch engine.

A portable railroad ballast plant is often used where rubble stone can be obtained without quarrying as is often the case along rocky bluffs

and hillsides. After the supply of rubble stone has been exhausted at one point the plant can be readily moved to another.

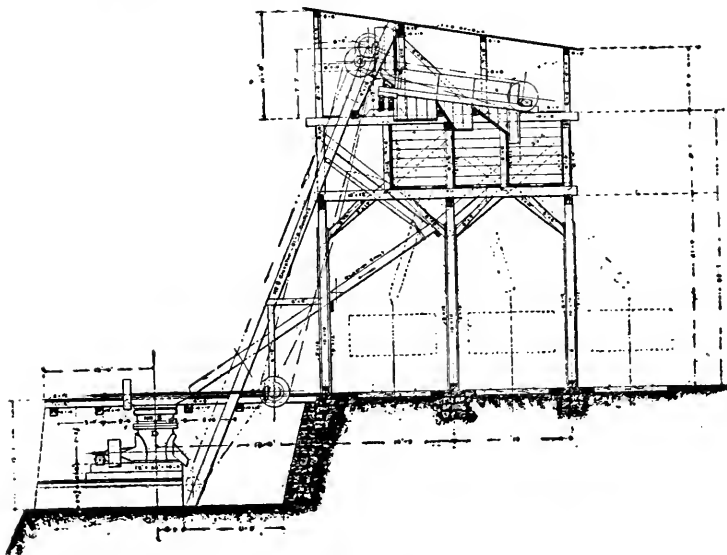


FIG. 260.

ARRANGEMENT OF STONE CRUSHER, ELEVATOR SCREEN AND STORAGE BINS FOR A RAILROAD BALLAST PLANT.

Placing the ballast under the ties should be done by lifting the track six inches at a time by two track jacks, one at each rail and opposite each other. If the lift is more than six inches at a time, the joints and fastenings are liable to be injured. Fig. 262 illustrates a Jenne track jack and Fig. 263 illustrates the trip jack—both styles are made with long, narrow bases, so they can be placed between the ties.

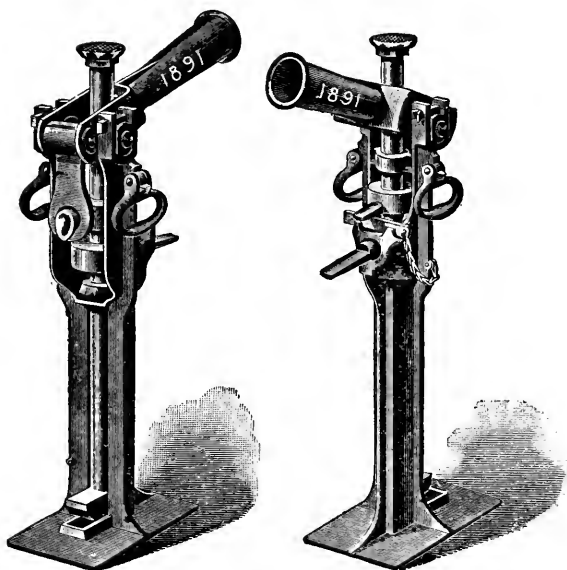


FIG. 262.

JENNE TRACK JACK FOR HEAVY BALLASTING, SURFACING AND GENERAL TRACK REPAIRS.



FIG. 263.

TRIP JACK FOR BALLASTING, SURFACING AND GENERAL TRACK REPAIRS.

*Tools.* The following list of tools for a section gang of six men is made from a list of tools used by roads in the Eastern, Central and Western States.

Name of Tools.	Number Required.	Illustrated by Figure Nos.
Adzes .....	2	264
“ handles.....	3	
Axes .....	1	265
“ handles.....	1	
Auger for post holes.....	1	266
Brooms.....	2	267
*Brush hooks.....	1	268
* “ “ handles.....	1	
*Ballast hammers .....	4	269
* “ forks .....	6	270
*Brace and bits. ....	1	271
Cars, hand. ....	1	272
“ push .....	1	273
Chisels, track.....	6	274
Claw bars.....	3	275
Ditch line 100 feet long .....	1	
Drills, ratchet or track drills.....	1	276-277
Files .....	2	278
Flags, red.....	4	
“ green.....	2	
“ white.....	2	
Grindstone.....	1	279
*Hoes, grub or mattocks.....	1	280
Hatchets or hand axes.....	1	281
*Hammer, hand, for nails.....	1	282
Lanterns, red.....	2	283
“ green.....	2	283
“ white.....	2	283
Lining bars, wedge point.....	4	284
Oil can.....	1	285
Oiler.....	1	286
Punches.....	1	287
Pinch bars .....	4	
Padlock and chain.....	1	288
Picks, earth .....	6	289
“ “ handles.....	4	
* “ tamping .....	6	290
“ “ handles.....	4	
Rakes.....	2	

Name of Tools.	Number Required.	Illustrated by Figure Nos.
Rail tongs.....	3	291
“ forks.....	2	292
Saws, hand.....	1	293
* “ cross cut.....	1	294
Scythes.....	4	295
“ snaths.....	4	296
“ stones.....	2	
*Spirit level.....	1	297
*Square, tie.....	1	
*Spike puller.....	1	298
“ mauls.....	4	299
“ “ handles.....	4	
*Sledges.....	2	300
“ handles.....	2	
Shovels.....	6	301
“ scoop.....	6	302
“ long handled.....	1	303
*Track lever or lifting bar.....	1	304
“ jacks.....	2	262-263
“ gauges.....	2	305-306
“ level board.....	1	307
*Tamping bars.....	4	308
Torpedoes.....	12	309
Tape line 50 feet long.....	1	
*Tool boxes.....	1	310
Wire stretchers.....	1	
Wrenches, track.....	4	311
“ “ monkey.....	1	312
*Wheel barrows.....	3	313
Water bucket.....	1	
“ dipper.....	1	
“ keg.....	1	
Shims	} furnished as required	
Spike hole plugs		

The tools marked with an \* are not required by all section gangs; a brush hook and grub hoe will be needed in a timbered country but not in a prairie section of the country; ballast or napping hammers and sledges will be needed where the country is rocky and ballast is often made of the rocks found along the right of way, but will

not be required where the country is barren of stone.

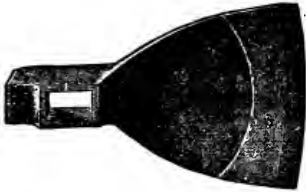


FIG. 264.  
ADZE.



FIG. 265.  
CHOPPING AXE.



FIG. 266.  
AUGER FOR BORING HOLES IN  
THE GROUND TO PLACE  
FENCE POSTS IN.



FIG. 267.  
BROOM FOR REMOVING SNOW  
FROM SWITCHES,  
FROGS, ETC.



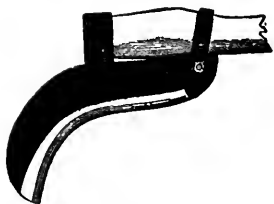


FIG. 268.

BRUSH HOOK FOR CUTTING  
DOWN SMALL SAPLINGS.



FIG. 269.

BALLAST OR NAPPING HAM-  
MER TO BREAK MEDIUM  
SIZED STONE TO PROPER  
SIZE FOR BALLAST;  
WEIGHT ABOUT FOUR  
POUNDS.



FIG. 270.

BALLAST FORK FOR HAND-  
LING SLAG OR STONE BAL-  
LAST, SO THAT THE FINE  
DIRT WILL NOT BE  
SHOVELED WITH  
BALLAST.

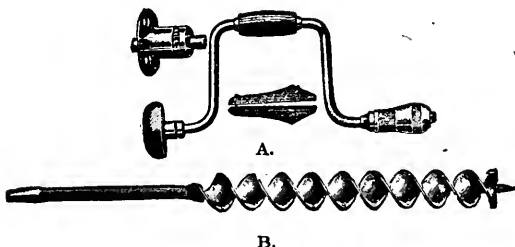


FIG. 271.

BRACE A AND BIT B FOR BORING HOLES IN TIES WHERE SPIKES  
HAVE BEEN DRAWN PREPARATORY TO PLUGGING  
THE SPIKE HOLE.

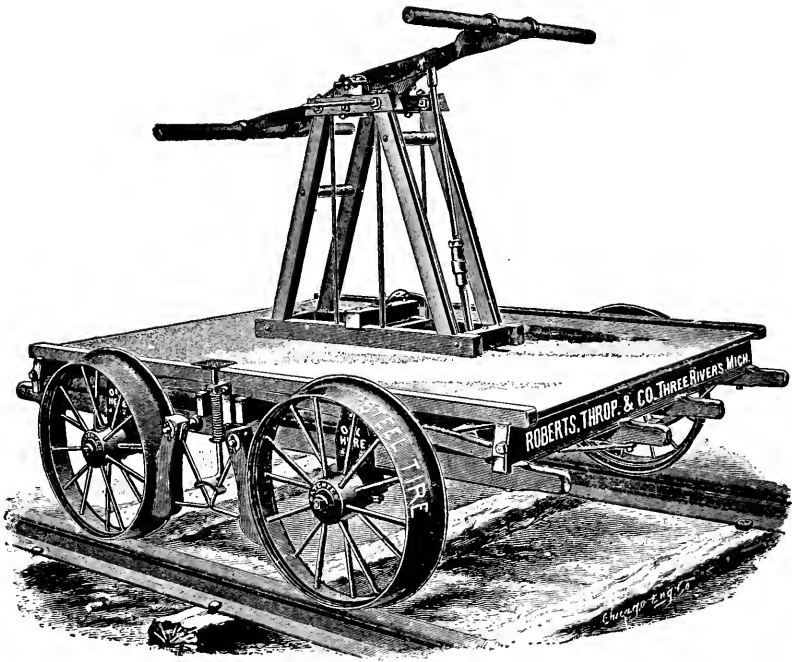


FIG. 272.

HAND CAR FOR SECTION GANG.

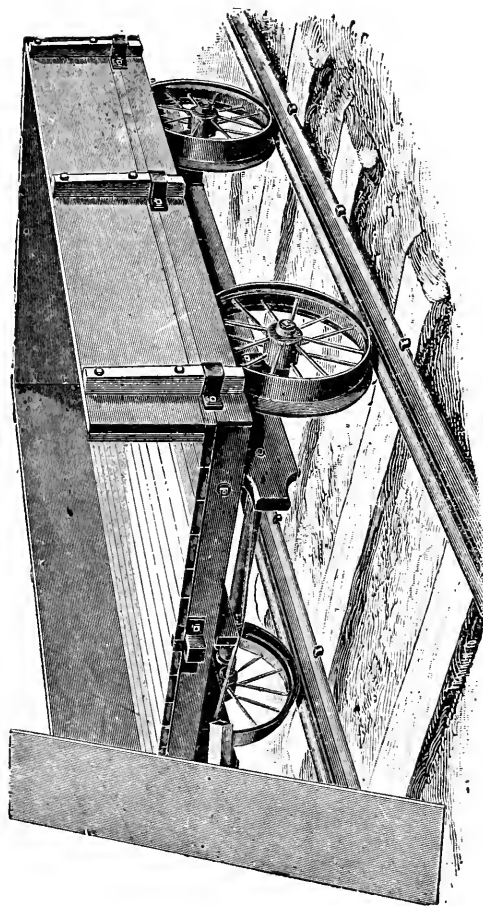


FIG. 273.

PUSH CAR WITH REMOVABLE SIDE AND END BOARDS.

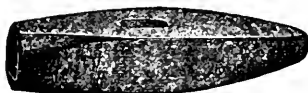


FIG. 274.

TRACK CHISEL FOR CUTTING RAILS, ETC.

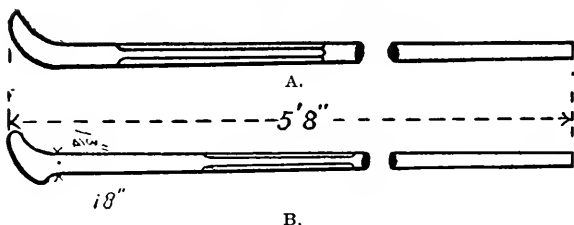


FIG. 275.

CLAW BARS. A—HAVING NO HEEL. B—WITH A HEEL. USED FOR PULLING SPIKES AND BOLTS.

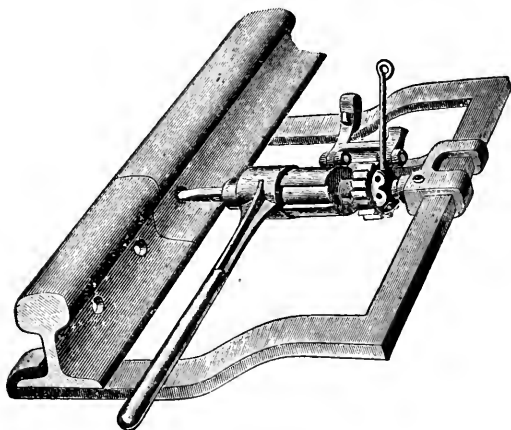


FIG. 276.

PERFECTION TRACK DRILL FOR DRILLING BOLT HOLES IN RAILS. FEED AUTOMATIC OR HAND AS DESIRED.

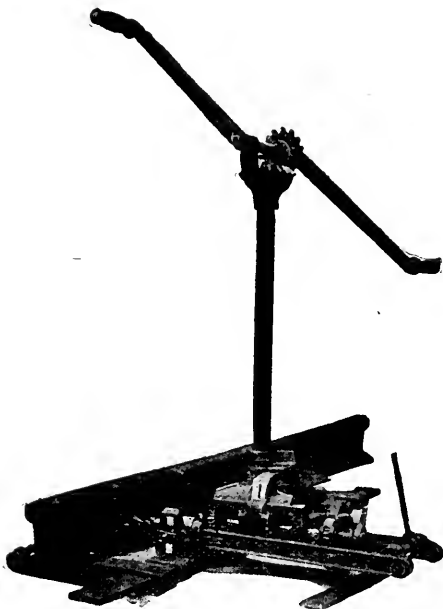


FIG. 277.

Q AND C SELF-FEEDING RAIL DRILL. OVER OR UNDER RAIL  
CLAMPS USED AS PREFERRED.



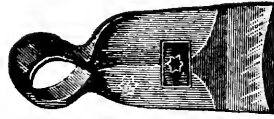
FIG. 278.

HAND FILE FOR SMOOTHING THE ENDS OF RAILS BEFORE  
PLACING THEM IN THE TRACK.



FIG. 279.

HERCULES GRINDSTONE  
MOUNTED WITH TREADLE.



A.



B.



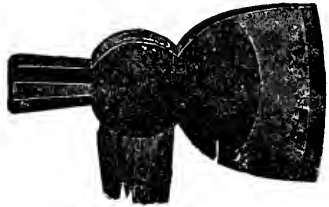
C.

FIG. 280.

GRUB HOE. (A) FOR CUTTING THE  
ROOTS OF SMALL SAPLINGS.  
MATTOCK. (B) SOMETIMES PRE-  
FERRED TO A GRUB HOE.  
PICK MATTOCK. (C) SOMETIMES  
PREFERRED TO A GRUB HOE.



A.



B.



C.

FIG. 281.

HATCHET. (A) WITH A CLAW FOR DRAWING NAILS.  
" (B) WITH A NOTCH IN FACE FOR DRAWING NAILS.  
HAND AXE. (C) FOR LIGHT CHOPPING.

Any of these can be used for the same purpose as a hand hammer.



FIG. 282.

HAMMER FOR NAILING AND  
DRAWING NAILS.

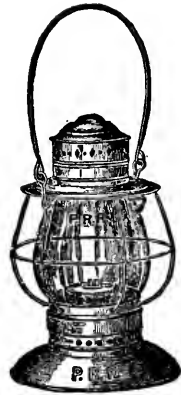


FIG. 283.

RAILROAD LANTERN.  
The color of the light depends  
on the color of the glass  
globe used.

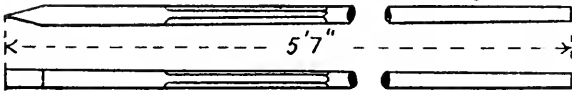


FIG. 284.

LINING BARS FOR THROWING TRACK WHEN LINING IT.



FIG. 285.

OIL CAN FOR CAR OIL.



FIG. 286.

SPRING OILER FOR OILING  
HAND PUSH CARS.



FIG. 287.

TRACK OR RAIL PUNCH.



FIG. 288.

RAILROAD PADLOCK

Used with a chain to lock hand or push cars by passing the chain through the two wheels on the same side of the car and fastening the chain by passing the padlock hasp through two links of the chain.



FIG. 289.

PICK FOR LOOSENING EARTH, CLAY OR HARD GRAVEL.



FIG. 290.

TAMPING PICK WITH ONE POINT ENLARGED FOR DRIVING THE BALLAST UNDER THE TIES; THIS IS USED FOR TAMPING STONE AND SLAG BALLAST.



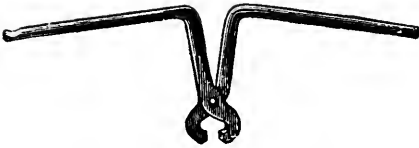


FIG. 291.

RAIL TONGS FOR LIFTING RAILS.

The head of the rail is gripped by the curved ends and the long bent ends serve as handles for the workmen to carry the rail.



FIG. 292.

RAIL FORK FOR TURNING RAILS.

The slotted end is run over the base and the fork handle is used as a lever or the tapered end of the handle placed in the bolt hole and the slotted end is used as a lever to turn the rail.



FIG. 293.

HAND SAW.

Used in repairing gates, fences and other light work.



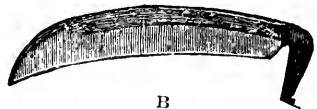
FIG. 294.

CROSS CUT SAW.

Used in removing heavy drift from culverts and bridges and other heavy work.



A



B

FIG. 295.

SCYTHES.

A. Light, for grass and weeds.  
B. Heavy, for bushes and small saplings.



FIG. 296.

SCYTHE SNATHS OR HANDLES.



FIG. 297.

SPIRIT LEVEL FOR DETERMINING THE TRUE HORIZONTAL OR PERPENDICULAR.

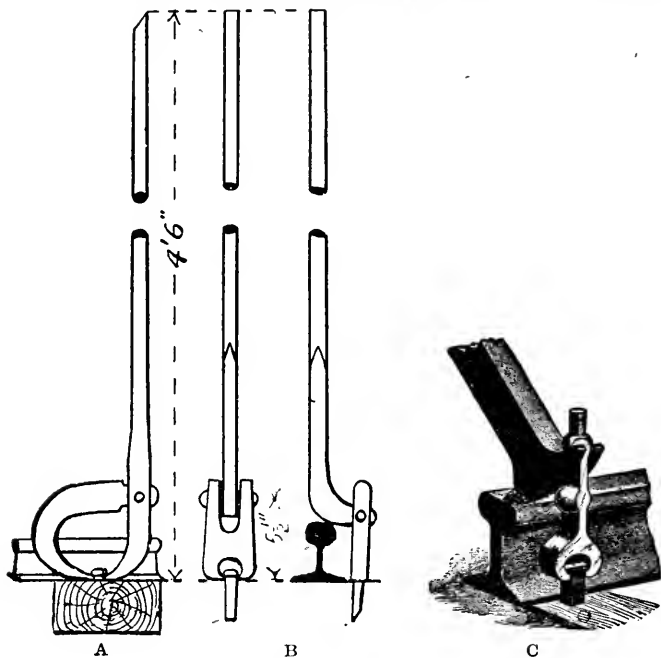


FIG. 298

SPIKE PULLERS.

- A. Cant hook or centennial bar, works on the same principle as a cant hook is used to turn a piece of timber.
- B. Shackle Bar—This uses the rail as a fulcrum and aims to pull the spike without bending it. The common claw bar is mostly used for pulling spikes. See Fig. 274.
- C. Is an attachment which can be used with a claw bar, etc. Will draw spikes from between contiguous rails, guard rails, switches, frogs, and at platforms; can also be used on bridges and in tunnels and cuts; can be attached to any claw bar, and will bend the spike less than when pulled in the usual way. Is made of tempered steel, and is light, strong, durable and cheap.



FIG. 299.

SPIKE MAUL.

For driving spikes into the ties.



FIG. 300.

STONE SLEDGE HAMMER.

Used to break boulders or rocks sliding into cuts and other work of this class.



FIG. 301.

RAILROAD SHOVEL.

For tamping earth, sand and some varieties of gravel ballast and for ditching, etc.



FIG. 302.

SCOOP SHOVEL.

For handling gravel, cinders, snow or other light material or very soft wet earth which will run off an ordinary shovel.



FIG. 303.

LONG HANDLED SHOVEL.

For digging deep trenches or deep holes as for telegraph poles.



FIG. 304.

TRACK LEVER OR LIFTING BAR, USED FOR HEAVY TRACK WORK.



FIG. 305.

HUNTINGTON'S TRACK GAUGE.

Can also be used to square ties with the rail, though there are roads having a special tool for squaring the ties with the rail.



FIG. 306.

## MCHENRY TRACK GAUGE.

It is similar to the Huntington Gauge shown in Fig. 305, the special feature being the arrangement for accurately gauging curves which is now left almost entirely to guess work. Five steel shims, each  $\frac{1}{8}$ -inch thick (shown in enlarged end cut) each representing three degrees of curvature, provide for properly gauging curves up to 15 degrees. For straight track the shims are pushed up out of the way. The change is easily and quickly made.

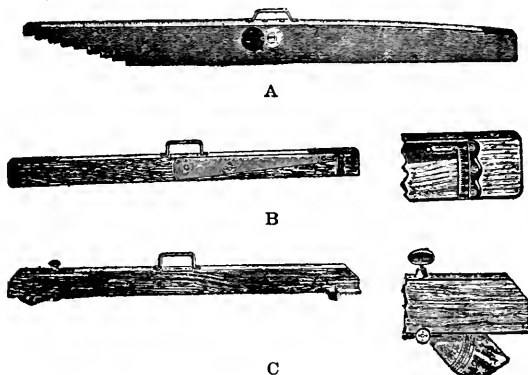


FIG. 307.

## A—COMMON TRACK LEVEL.

B—DUPLEX TRACK LEVEL. Contains two level glasses, one fixed in the board, the other attached to a movable indicator arm. By moving the indicator arm until the level glass attached to it comes true, it will show on the scale exactly how much out of level the track is. For use on curves it can be set at the proper elevation for the outside rail which can then be raised until the bubble indicates level position. It is convenient and accurate. This level can be arranged to serve also as a track gauge.

## C—MCHENRY INVOLUTE TRACK LEVEL.

In this level, means for adjustment are provided and it can be used on dead level or for elevations up to six inches. The proper amount of elevation is secured by means of a steel plate fitted into a slot at one end of the level. This plate is curved in such a way as to raise the level from the rail to the full limit of six inches while keeping the contact point with the rail at the same relative position.

In addition to these styles, a board six inches wide, fifteen feet long, and one and one-half inches thick, having two spirit levels is used to test the levels across two tracks, to detect low joints before they are noticeable to the eye and to detect any vertical or horizontal bending of the rails.

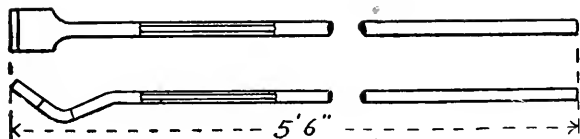


FIG. 308.

TAMPING BAR USED TO TAMP ALL CLASSES OF BALLAST EXCEPT SLAG AND STONE.



FIG. 309.

TORPEDO.

Used to give warning to an approaching train during foggy weather or at night that the track has been damaged or that there is some obstruction ahead; it contains an explosive which gives a loud noise when the engine passes over it, thus warning the engineer.

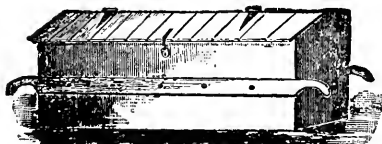


FIG. 310.

RAILROAD TOOL CHEST.

Chest 6 feet long, 2 feet 2 inches broad, and 2 feet 4 inches high, of good heavy, seasoned pine lumber with hardwood handles on either side, cover of two thicknesses of matched plank running different ways with a strip of canvas between, making it water-tight; all has one coat of good metallic paint, and chest has hasp, staple, lock, etc., complete. The following list of tools for gang of—say 6 men is generally sent with the chest:

- |                  |                 |                     |
|------------------|-----------------|---------------------|
| 1 Red Flag.      | 2 Tamping Bars. | 1 Track Level       |
| 1 Green Flag.    | 2 Lining Bars.  | 1 Rail Fork.        |
| 1 White Lantern. | 2 Spike Mauls.  | 1 Pair Track Tongs. |
| 1 Red Lantern.   | 6 Shovels.      | 3 Chisels.          |
| 1 Adze.          | 2 Picks.        | 1 Oil Can.          |
| 1 Claw Bar.      | 1 Track Gauge.  | 1 Water Pail.       |
| 1 Axe.           | 1 Track Wrench. | 1 Drinking Cup.     |

The list of Tools here given is largely used by the railways on the prairies of Illinois and adjoining states.



FIG. 311.

TRACK WRENCH.

Used to tighten the nuts at rail joints; the tapered end is used to insert in the bolt holes of the splices and rails to bring them into line for inserting the bolt.



FIG. 312.

MONKEY WRENCH.

This can be adjusted to fit nuts of different sizes.

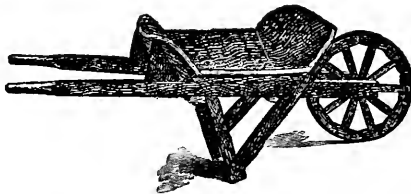


FIG. 313.

RAILROAD BARROW.

The policy of trying to provide every appliance to meet any and all emergencies is not wise; precaution against accident can be carried so far as to incur so great an expense that the road would be embarrassed financially. Some railway systems furnish each section gang only such tools as are necessary in actual work and a small stock of tools for emergency work is kept at the headquarters of the roadmaster.

The character of a workman may be determined by his tools. If found in proper order and ready for any emergency, he may be classed as a first-class foreman. Good tools are necessary for good work. Foremen should be provided with

suitable boxes and racks for their tools and should not allow them to become mixed.

There should be a systematic inspection of tools by the roadmaster. Every foreman should be required to have his full number of tools in efficient condition at all times. Spirit levels should be tested and adjusted at each inspection.

*Hand Cars.* At stations where there are yards requiring a number of switch lights, section men on some roads are required to put them up and take them down. To facilitate this work cars especially designed are used; Fig. 315 illustrates

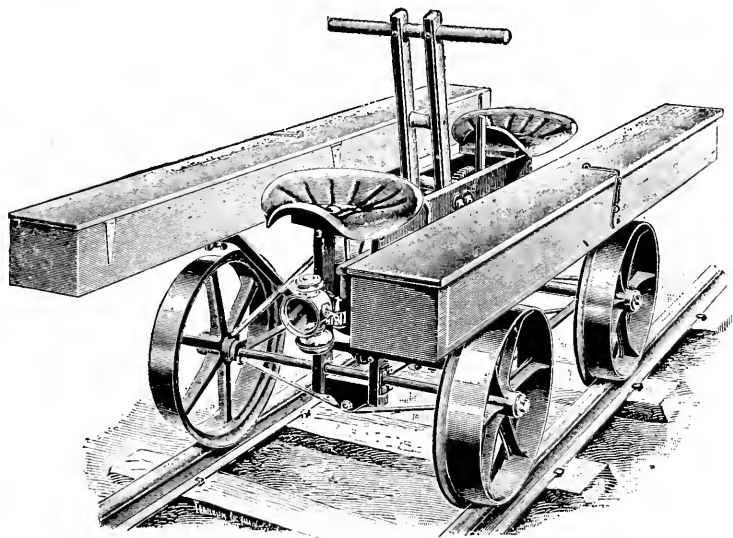


FIG. 315.

FOUR-WHEELED ECLIPSE LIGHT WEIGHT CAR, WITH HEAD-LIGHT AND BOXES FOR LANTERNS AND TOOLS SUITABLE FOR TUNNEL USE.

a car suitable for taking out a large number of switch lights; it is also equipped with a head light and can be used for tunnel work.

The roadmaster should be provided with a velocipede to enable him to get over his territory or to make a close inspection of special portions of it. FIG. 316 represents such a car—it can be

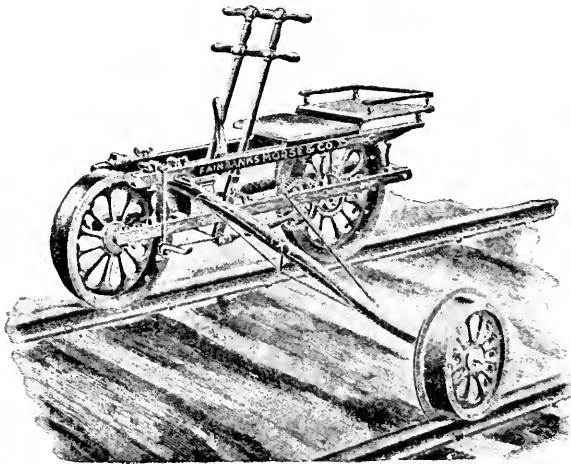


FIG. 316.

VELOCIPEDA CAR.

carried on the platform of a baggage car or in the baggage car as desired.

*Drainage.* Drainage is by far the most important factor in maintaining a good track, water being its worst enemy; the duty of every section foreman is to lead it away from the roadbed. Time spent in perfecting the drainage will be re-



paid by decreasing the labor required on other work.\*

The roadbed in cuts and on fills should be kept in such a condition that the water falling on it during rains or melting snow will run off at right angles and not run down the grade in gullies or depressions so that large quantities run off at one point, thus cutting away the embankment.

*Bolting.* Bolting should be done by placing two bolts in each splice and tightening sufficiently to hold the rail to line; afterward the remaining bolts should be placed as soon as possible: the nuts will require tightening several times during the first sixty days on new track, but they should not be tightened with such force as to injure the threads or grip the rail so tight as to prevent expansion.

*Spiking.* Spiking should be done by driving the spike vertically to a true bearing against the rail base and driving should be stopped when the spike comes to a tight bearing on the rail or the head of the spike will be damaged.†

*Lining.* Lining should be done to stakes set by the engineer. One rail should be lined up from the track centers, and the other rail lined by bringing it to the proper gauge with the line rail. Where track is badly out of line it should be thrown only part of the distance at one movement, shifting the entire length a foot or eighteen

---

\*This subject was discussed in the chapter on Construction and what was stated there applies with equal force to the maintenance of way.

†See "Spiking" in first article of Appendix J.

inches at a time and repeating this until it is brought approximately to line. When the line rail is brought to the exact line at one point the following procedure should be adopted: Set up a stake, rod or spirit level on end so one edge comes against the gauge side of the rail, then proceed to bring the line rail to line at another point some 150 to 200 feet distant from this point to the first one, direct the section men which way to throw the track, throwing first the joints then the centers and quarters; when the track is brought close to line the foreman must put his eye close to the rail to detect bends which cannot be seen standing; after one section is lined take up another and so proceed through the entire work. To correct errors the sections should be lined from both ends. The outer rail on curves must be the line rail and the widening of gauge made with the inner rail. On curves the alignment must be watched closely and in the absence of the engineers' center stakes the curvature should be tested by the rule given in table No. 18, Appendix J. Gauging the track must be given careful attention.\* Joints and centers should be gauged first and afterwards as many points as may be necessary to bring the rail into true gauge with the line rail; track gauges must be placed at right angles to the line rail and their accuracy must be tested by the roadmaster at least once during the season. Track on curves must be gauged frequently to keep it in gauge.

\*In this connection the reader should note what is said in chapter on "Track" and in Appendix J. Also Table No. 16, Appendix J.

*Surfacing.* Surfacing must be done to stakes set by the engineer. When the work is being done in long stretches a straight edge or long track level must be placed on the tops of the stakes on each side of the track and the track raised by track jacks so that the rail touches the level. The ties at this point should then be thoroughly tamped. The same method of procedure will be adopted at the next pair of engineers' stakes and so on. The intermediate rails can be brought to grade by placing blocks four to six inches high at each of the above points and by the foreman sighting from one block to the other and a section man holding a third block between the joints and centers of all the rails to be brought to grade; this latter work should be done on the line rail; then with a long straight edge or track board the points between the joints and centers can be brought to grade. The other rail can be brought to grade with the track level. This level should often be tested by reversing it on a level surface. Where the length of the track to be surfaced is short or only slightly out of surface in spots and the amount to be lifted is small, a track jack need not be used—the lifting in such cases can be done with bars. On curves and spirals the proper elevation must be given.\*

At bridges the track should never be raised above the exact grade; no allowance should be made at such places for the trains bringing the track to grade. Once a year a general surfacing

---

\*See elevation of outer rail on curves in chapter on "Track", Appendix J and Table No. 17, Appendix J.

should be done over the entire section; the track should be raised just enough for proper tamping; section men are inclined to raise it too much if not carefully watched. Where the ballast is stone, slag or coarse gravel, the track will have to be raised one to two inches to secure thorough tamping, while with sand, cinders, earth, or fine gravel a rise of one-half to one inch can be made by tamping without disturbing the bed of the tie. This work can be done to advantage after the renewal of ties which should be early in the season and again before winter.

*Tamping.* Tamping is done at the same time as surfacing. The amount of track lifted off its old bed for surfacing and tamping at any one time should never be of a greater length than can be fully tamped between trains; both rails should be brought to surface before the tamping is fully done. Earth, sand and gravel ballast can be tamped by two men on opposite sides of the tie working with a shovel pressing the ballast by a prying motion under the tie; more satisfactory work, however, is done by finishing the tamping with tamping bars. Coarse, clean gravel, slag and stone ballast requires more force to drive it under the tie and a tamping pick is used for this purpose. On new track the full length of the tie should be tamped, on old track a foot each side of the rail should be tamped firmest and the center of the tie but slightly or not at all, this prevents the track from becoming center bound, which increases the tendency to get out of line, and also the liability of the ties breaking at the center.

Joint ties should be tamped first and the others afterwards, bringing the rail to grade with the joint. The ties at crossings, switches and frogs should be tamped very thoroughly.

Low joints will be a frequent trouble in track on a new road and the uneven settlement of the embankments will require a great deal of extra labor and watchfulness on the part of the section force.

*Tie Renewals.* Tie renewals are generally decided by the roadmaster jointly with the section foreman. These renewals should never be in long continuous stretches, but on the basis of what is known as "spotting" the ties. The section foreman should go over his section and mark those ties which he thinks are unfit for further service; afterward the roadmaster accompanies him and he decides the number of ties to report for each mile and section; and the management decides how many their resources will permit them to allow for the next season. When ties are renewed in long continuous stretches, a large percentage of them again require renewal at the same time. This is liable to occur during a period of financial depression, while if the renewals were made on the method called "spotting," careful attention to the tie renewals could be so managed as to greatly decrease the expenses at such a period. New ties are distributed as ordered by the roadmaster in the early spring or late winter months, so that the section force can commence putting them in the track as soon as the frost is

out of the ground. Mr. Tratman states:\* “ For tie renewals in gravel ballast, the ballast is cut away from the ends of the ties and loosened along their sides. The spikes are then drawn and the rails raised slightly by jacks, just enough to allow of the old tie being knocked out and a new one slipped in on the same bed. The ballast should not be dug out under the tie unless the new tie is of greater thickness (which it should not be), as the less the tie beds are disturbed the better for the maintenance of the track surface. This general rule may, however, be modified where only one or two ties are to be renewed in a rail length, but in this case a loosening of the side of the tie bed will usually enable the old tie to be taken out and the new one put in without much disturbance of the bed, and without the disturbance of the adjacent track which is incidental to raising by jacks. With stone, slag or coarse gravel ballast, which is liable to fall onto the tie bed when the tie is removed, it is necessary to dig out the ballast at one side of the tie, and to knock the tie sideways into this trench. Some foremen prefer this plan with earth or common gravel, but the amount of digging required is liable to disturb and loosen the ballast. This plan may, however, be employed when two adjacent ties have to be renewed. If the ties are not uniform, the larger ones should be selected for the joints and for curves; and the wider end should be placed under the outer rail on curves. The ties

---

\*“Railway Track and Track Work,” Tratman, pp. 295, 296.

should be properly spaced, placed square across the track (or radially on curves) and their ends should be lined at one side of the track. It is rarely economical to turn old ties except where tie plates are to be applied, and then it is probably better to turn the ties than to adze out new seats on the old worn faces. If the traffic is heavy, each tie should be tamped and have the outside spikes driven at once. Otherwise, a number of ties may be renewed in succession; one man going ahead to cut the earth or gravel from the ends of the ties, two men pulling spikes, and two men raising the track with jacks. If only one jack is to be had, the rail first raised should be blocked up, and the jack then put under the other rail. When 20 or 30 ties have been thus put in, three men are sent back to do the spiking, one holding up the ties with a bar and two driving the spikes. The new ties should be tamped each day as put in, the tamping being done thoroughly with a bar or pick. The ballast is then filled in between the ties and dressed to proper shape. If the new ties are shovel-tamped, or only partially tamped with bars and then left to be finished a few days later, the old ties will be disturbed and a soft spot probably caused, especially if rain falls before the tamping is done. No train should be allowed to pass over untamped track, the foreman taking it for granted that it is safe. At the end of each week the ties removed should be properly piled on the right of way, at a convenient distance from the track if they are to be loaded on cars, or midway between

the track and the fence if they are to be burned. They should not be left in the ditches or scattered about the right of way. Ties may be burned in small piles of 5 to 10 or in large piles of 50, but the former is usually the better and safer plan. The piles should not be near the track as the intense heat is injurious to the paint and varnish of cars. Large piles should be burned in damp weather to reduce the danger from fire, and in all cases the burning piles should be watched to prevent fire from spreading to fences, fields, etc."\*

*Tie Plates.* Tie plates of various styles and their use have been described in another chapter. The method of preparing the tie to properly bed them, and the method of placing them true to gauge, will now be stated. The Ware tie plate surfacer and gauge is probably more used than any other; it admits of both ends of a tie, however roughly hewn, being brought to the same plane at points where tie plates are to be embedded or rails to rest. The tie plates can be embedded into the ties before they are placed in the track and when hewn ties are used, whether tie plates are used or not, they can be properly surfaced at the points where the rails are to rest, in advance of the work of putting ties into the track. The Ware tie plate surfacer and gauge is illustrated by Fig. 318.

To practically apply this tool, it is to be first adjusted so that the heads 1 and 2 will be the

---

\*The reader is referred to Appendix J for practice of Pennsylvania and Northern Pacific Railways.



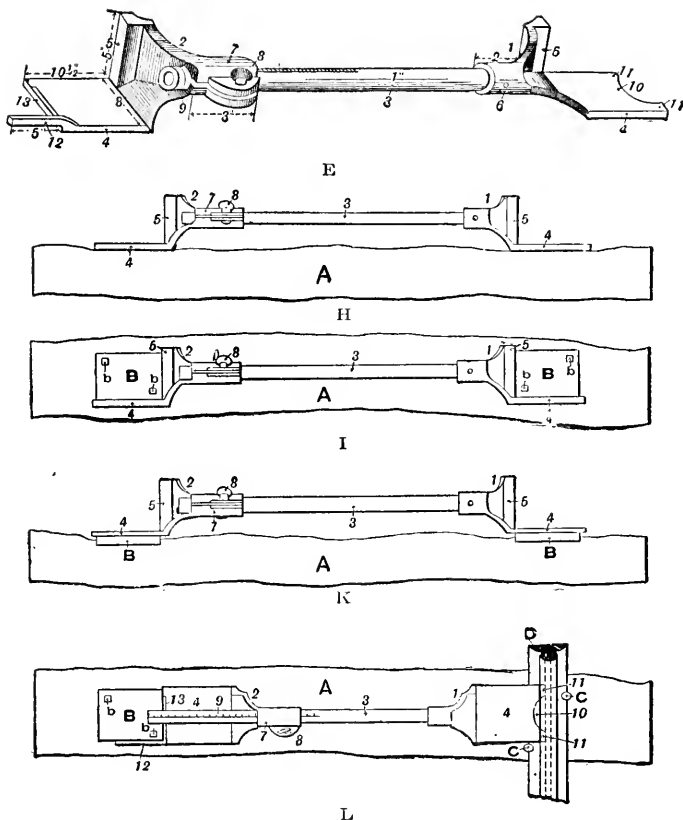


FIG. 318.

THE WARE TIE PLATE SURFACER AND GAUGE.

E is a perspective of the combined Tie Plate Surfer and Gauge.

H is an elevation of the tool showing its use on a tie to ascertain the level of the same at points where the tie plates are to be embedded.

I is a plan showing the tool as used to square and gauge the tie plates.

K is an elevation showing the tool as used for testing the level of the embedded tie plates.

L is the plan showing the implement as used for gauging tie plates after ties are put in the track.

proper distance apart to correspond with the desired track gauge and with the dimensions of the tie plates that are to be used. The surfacers, 4, are brought accurately into the same plane, and the thumb screw, 8, is then tightened to secure the adjustable head.

Where hewn ties are to be used, it will generally be necessary to determine the level of the points where the tie plates B are to be embedded or set. This is accomplished by laying the instrument on the tie, as shown in H, with the surfacers 4 placed flatwise on the proposed locations of the tie plates. If these points are found to be not sufficiently in the same plane, the surfacers 4 will indicate the uneven places that will have to be leveled with an adze. The tie being shown to be level, or substantially so, at required points, the tool will then be turned partly over, as shown in I, so that the straight edges 5 will be in contact with the spots where the tie plates B are to be located. Each straight edge 5 forms a square with the inner face of the adjacent surfacers.

One of the plates is then put into the angle formed by the straight edge 5 and inner side of the surfacers 4, on what is known as the line end of the tie. Thus, this tie plate is accurately squared to the position to be occupied by the rail. The tool is then removed, leaving the tie plate in position, and this tie plate can be set or embedded into hardwood ties by the means of a suitable wooden beetle without the use of anything to protect the most frail tie plate from injury.

The tool is then put back on the tie in the position represented in I, so that the second tie plate can be placed to accurately conform to the required position with relation to the tie plate previously set. The tool having been again removed, this second tie plate will now be embedded the same as the first.

If desired, the tool can now be applied as shown in K, with the surfacers 4 turned flatwise, to test the surface level of the tie plates. The position and level of these tie plates being found satisfactory the tie is now ready to be placed in the track.

It will be obvious that by the aid of this tool the plates can be quickly and accurately applied to a tie at the required gauge or distance apart before the tie is placed in the track and in such relation to the rail bases that there will be no difficulty in subsequently entering through the holes B the spikes that are to secure the rails.

To apply tie plates to ties already in the track, see L, from which will be seen that the fixed head 1 has the end of its surfacers 4 made on a concave or arc 10 with end points 11 in the same plane; this will enable that end of the instrument to be placed closely and accurately against the web or base of the rail that is already in the track. Thus, if it is desired to apply tie plates to ties that are in the track, the spikes must be drawn from the rails under which they are to be embedded and the rails moved out on the end of the ties, the same as is usually done in the work of changing rails. By this means

the rail is entirely out of the way of embedding plates. If the ties, at points where the plates are to be set, are known to be sufficiently level to allow the plates to be properly embedded, the work of embedding can now proceed, by first placing the fixed head 1 as shown in L and the adjustable head 2, having been previously adjusted to the required gauge by the means of thumb screw 8, a tie plate will be placed against the square end of surfacer 4 of the adjustable head and against 12 where it will be ready to embed as before described.

For economical and expeditious work of applying plates in this way, it has been found advisable to get as many spikes drawn as safety will allow, plug all spike holes and do all adzing possible before disturbing the rails. Then, when there is sufficient time between trains to allow of such work being done, put all the men with claw bars at work to draw the remaining spikes and move the rails out on the end of the ties as before described, then organize the men three in a gang, one man to carry the gauge and place the plates in the square; the other two men with wooden beetles settle the plates into the ties. The first blow, at least, should be given by a man standing at right angles with the longitudinal ribs of the tie plate, if such plates are being used; this will cause the plate to settle more accurately. When sufficient number of plates have been embedded to allow rails to be moved into position, turn back one of the embedding gangs to move the rails in onto the plates and spike them; thus

keeping the different parts of the work going at the same time, so that should an unexpected train arrive there would be little delay in making the track passable. By using this method plates can be embedded with surprising rapidity and perfectness.

*Rails and rail joint fastenings.* Rails and rail joint fastenings were discussed in the chapter on "Standards" and the reader is referred to that chapter.

*Ditches and embankments.* All ditching in cuts, dressing up of embankments and ballast should be done in a manner to retain the standard cross sections adopted. Under no conditions should earth be taken off the shoulder of an embankment to be used in raising track or ballasting; neither should earth be taken from the slopes to build out the shoulder of an embankment—this leads to a slackness in the slope as shown in the chapter on "Construction," Fig. 45. The bermes should not be robbed to secure material for slack embankments, they keep the water away from the roadbed and aid in drainage.

Small repairs to embankments can be made by the section gang cleaning ditches in the cuts and taking the material with a push car to the point it is needed on the embankment. When the slopes of embankments need extensive repairs it is cheaper to put on a work train or a gang with teams, plows and scrapers, if the embankment is not over 6 to 8 feet high. This gang should take the material from the ditch or on the outside of the ditch; under no circumstances should the

berme be disturbed. As the freezing of winter followed by the thawing and rains of spring brings down large quantities of material from the slopes of some cuts, various devices have been designed to aid in saving labor in removing it. Fig. 319 represents the American Railway Ditching Machine, which is designed to do this work.

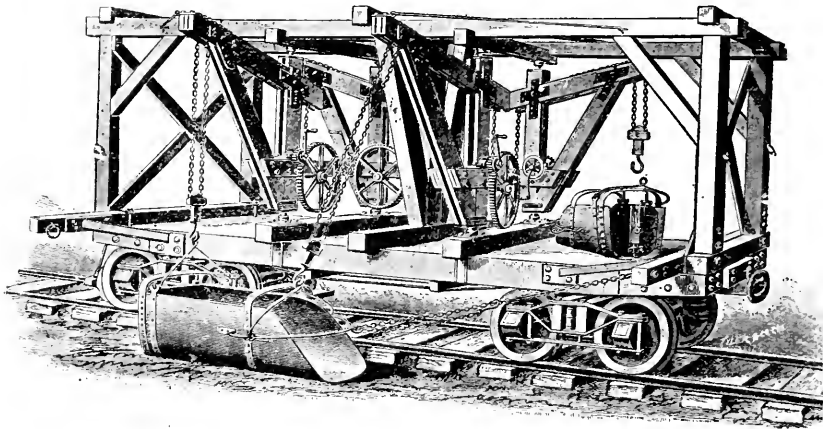


FIG. 319.

AMERICAN RAILWAY-DITCHING MACHINE.

For cleaning and ditching mud cuts. For scraping in dry cuts after same have been plowed. Simple in construction and economical in operation. Durable and easily handled; it can be quickly moved out of the way of passing trains. Reversible, works either way without turning car or engine. Will scrape both ditches at the same time. The buckets are used in the same manner as an ordinary scraper.

Directions for using the American Railway Ditching machine.—If possible use an air-brake locomotive with this machine. See that slack between car and engine is well taken up, so as to prevent unnecessary jerking. Strengthen spring-hangers in the ordinary car, as the strain, at times, is quite severe. This result can be accomplished by putting in additional hangers. Use as small a wheel on car as possible; 20-inch wheels are the best size, although the ordinary flat car wheel will do the work.

*Switches.*—Switches were discussed in a general way in the chapter on "Standards," and

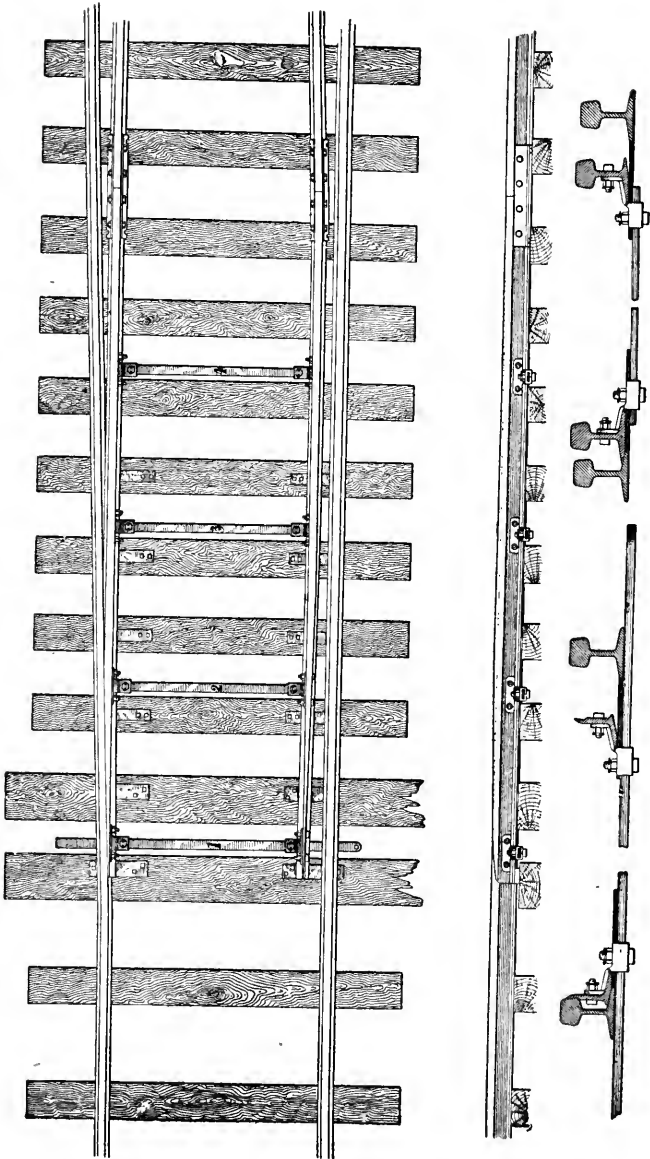


FIG. 320.

CLARKE JEFFREY SPLIT SWITCH.

more in detail in the chapter on "Track," to both of which the reader is referred. A Clarke-Jeffrey Split Switch is illustrated by Fig. 320. This is the original split switch first used in the United States; the improvements introduced by various makers have had for their purpose the taking up of the wear of the switch points, thus preserving the true gauge and reducing the liability of the flanges of the wheels entering between the rail and switch point. The bridle rods have been modified to give greater stiffness in order to preserve the gauge, and in the Transit Split Switch (Fig. 321) they have been reduced to one and placed alongside a tie, thus facilitating the operation of tamping the ties and not being in the way of snow and ice. The Channel Split Switch (Fig. 322) has no bridle rods. The slide plates, in some cases, are extended across the track from rail to rail, and planed out for the base of the rail to set in, thus preserving the gauge (see Figs. 321 and 322). There are makes of switch stands which admit of this being done. Fig. 135 represents one. The adjustment for the wear of the points is taken up by some makers at the switch stand; Fig. 321 shows a method of doing it with the head and bridle rods.

Fig. 323 illustrates the Lorenz Safety Split Switch. The peculiarity of this switch consists in the safety appliance being a heavy spring attached to a bridle rod at the point of the switch; this spring is strong enough to cause positive motion of the switch points, yet when a car from a siding runs into the switch, the spring will give



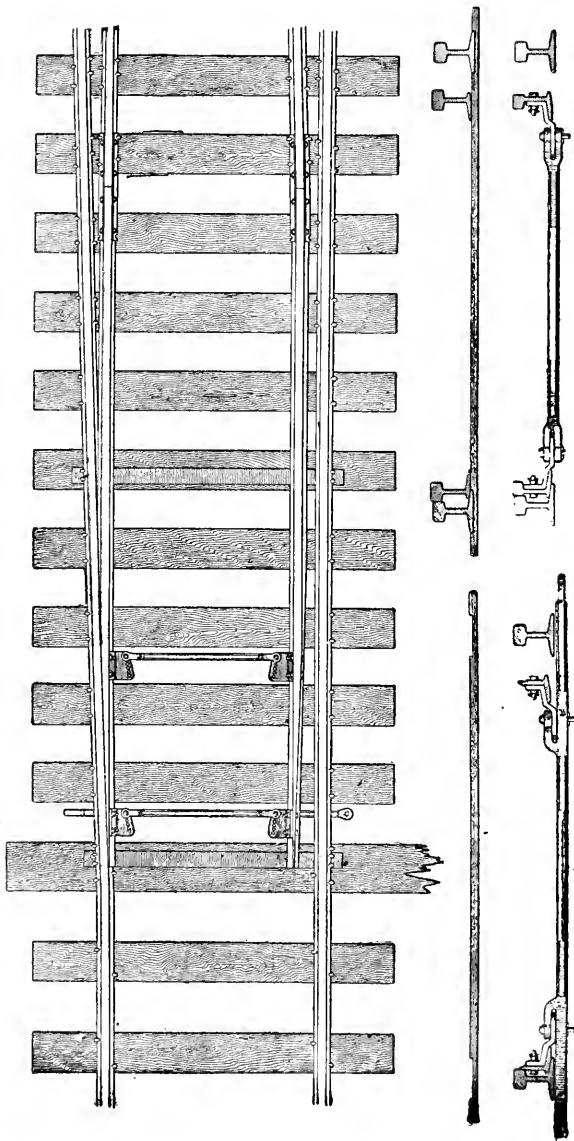


FIG. 321.  
TRANSIT SPLIT SWITCH.

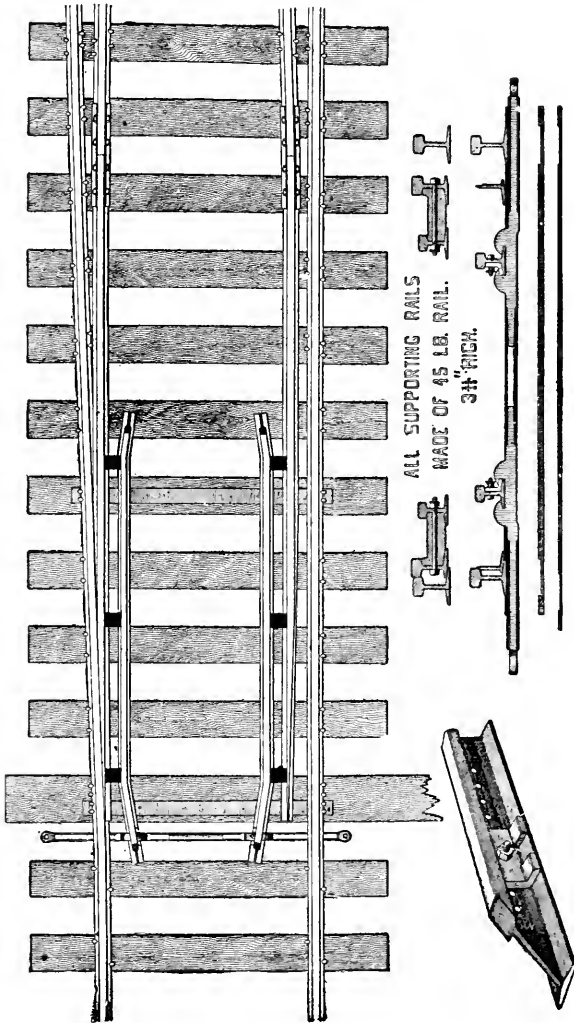


FIG. 322.

CHANNEL SPLIT SWITCH.

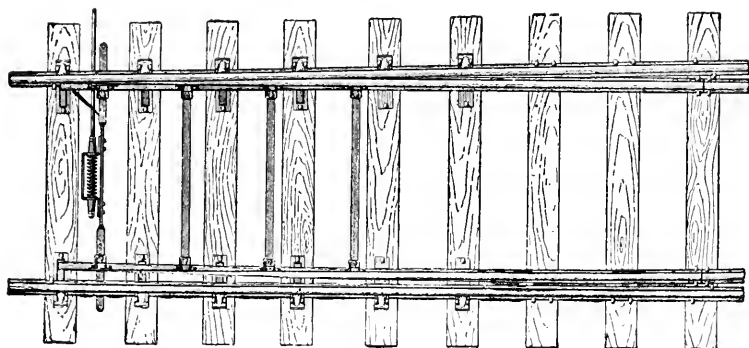


FIG. 323.

LORENZ SAFETY SPLIT SWITCH.

and permit the car to pass through and the spring will throw the switch points back to their original position.

Illustrations of some of the various styles of connecting rods to connect switches with switch



Rigid Connecting Rod with Safety End, used with Switches that have large pin on Head Rod with Safety Clip, as used on the Doddridge Safety Switch.



Rigid Connecting Rod with Jaw End, used with Head Rod having Flat End.



Spring Connecting Rod.

FIG. 324.

VIEWS OF DIFFERENT CONNECTING RODS.

A is used with the bridle rod.

C is a substitute for the spring on the Lorenz switch.

stands are given in Fig. 324, and an illustration of some of the bridle rods and methods of attaching them to the rails of stub switches and switch points of split switches is given in Fig. 325.

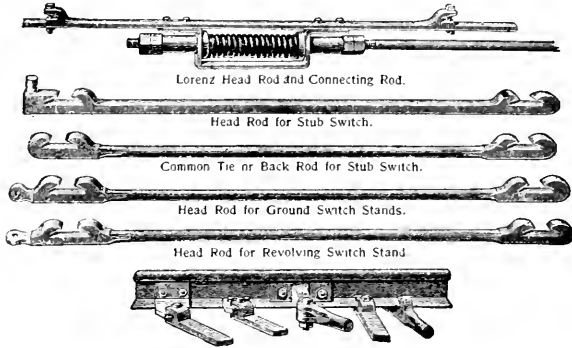


FIG. 325.

VIEWS OF DIFFERENT STYLES OF BRIDLE RODS AND METHODS OF CONNECTING THEM TO THE RAIL.

*Frogs.*—Frogs were discussed in the chapter on “Standards:” Figs. 326 and 327 illustrate two styles of yoked frogs. One is made by the Ramapo Iron Works, and the other Strom frog by Pettibone, Mulliken & Co. Both aim to prevent

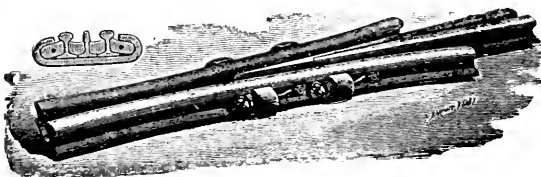


FIG. 326.

RAMAPO YOKED FROG.

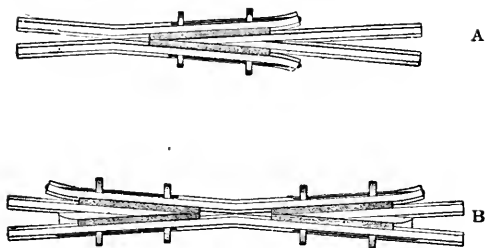


FIG. 327.

## STROM CLAMP OR YOKED FROG.

A—For sidings.

B—For crossings at small angles.

the yoke slipping by different methods. In the Ramapo frog the clamp is turned up flatwise, and is anchored by a rod bolted to the rail; this rod passes through the yoke key, and a nut screwed tight against the key and fastened by a nut lock. The cut represents the point and wing rails connected by a notch, though they can be planed straight as with the Strom frog if desired. With the Strom frog the main point of difference is that the clamp or yoke is bent edgewise and the ends of the clamps are forged to fit the rail sections, thus doing away with the yoke key; the yokes are driven on tight, and anchored by stay rods which pass over the end of the wing rails and through the yokes. Cotters are placed in the stay rods to prevent the yokes or clamps from slipping.

Foot guards are required at all frogs, and guard rails to prevent section and train men from getting their feet fastened so they cannot escape from approaching trains. Fig. 328 illustrates a

frog having wooden foot guards, and Fig. 329 illustrates the use of iron foot guards.

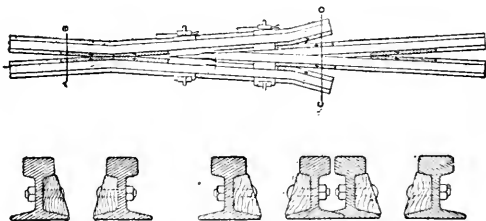


FIG. 328.

FROG WITH WOOD FOOT GUARDS.

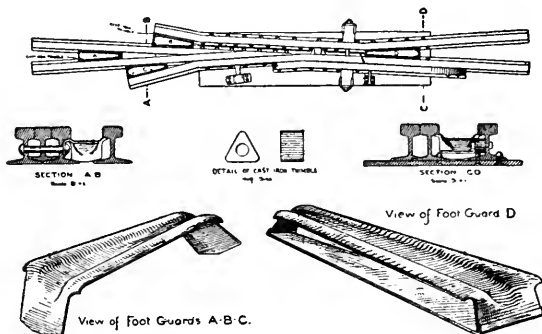


FIG. 329.

FROG WITH IRON FOOT GUARDS.

Ordering frogs and switch points or tongues often leads to confusion on account of the section foreman or clerk not thoroughly understanding when they are right or left hand. A good rule is to stand at the head block and look towards



Fig. 330.

ILLUSTRATION OF A RIGHT HAND TURNOUT GIVING THE NAMES OF THE DIFFERENT PARTS OF THE SWITCH.



Fig. 331.

ILLUSTRATION OF A LEFT HAND TURNOUT GIVING THE NAMES OF THE DIFFERENT PARTS OF THE SWITCH.

the frog; if the frog is on the right hand it is a right hand frog, or if it is on the left hand it is a left hand frog; the same rule applies to the switch points or tongues of a split switch and to the head blocks of a stub switch. Fig. 330 illustrates a right hand switch and Fig. 331 illustrates a left hand one. The names of the different parts of a frog and their uses are illustrated by Fig. 332. Instructions for taking the angle of a frog are given in Fig. 333. Tables No. 11 and 12,

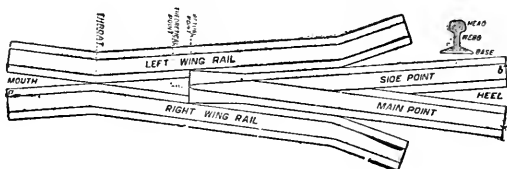


FIG. 332.

## RIGHT HAND FROG.

With the names of the different parts; the names would be the same with a left hand frog only the main and side points would change positions. The main point connects with the main line rail and the side point with the side track rail.

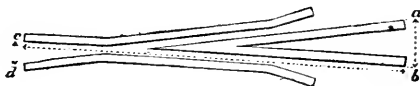


FIG. 333.

## TO TAKE THE ANGLE OF A FROG.

Measure A-B and C-D and add them together, then divide the distance B-C by their sum.

Example: Distance A-B=8", C-D=4", then  $8+4=12$ . The distance B-C=72",  $72 \div 12=6$  or No. 6 Frog.

Caution. In measuring be careful that all measurements are made on the running line.



Appendix J, give the angles of frogs of different numbers. Headblocks or headchairs are made of either cast or wrought iron. Fig. 334 illustrates

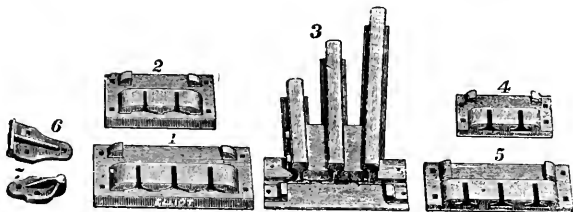


FIG. 334.

HEAD BLOCKS OR HEAD CHAIRS FOR STUB SWITCHES.

Nos. 1 and 2 for right hand main line rail.

Nos. 4 and 5 for left hand main line rail.

Nos. 2 and 4 for single throw switch.

Nos. 4 and 5 for three throw switch.

Nos. 6 and 7 cast iron rail braces.

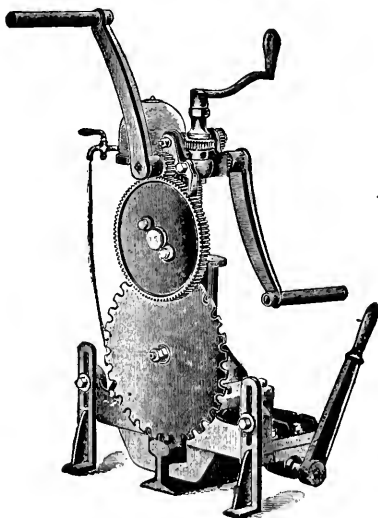


FIG. 335.

BRYANT PORTABLE RAIL SAW,

Capable of sawing a rail up to 100 lbs. per yard.

a pair for single and three throw switches. The chapter on "Track" and the tables in Appendix J give instructions about laying out side tracks. In laying out sidings and placing guard rails it is often necessary to cut the rails—this should always be done with a rail saw. Fig. 335 illustrates a Bryant portable rail saw and the rails should be properly curved before laying them. Fig. 336 and 337 illustrate rail benders.

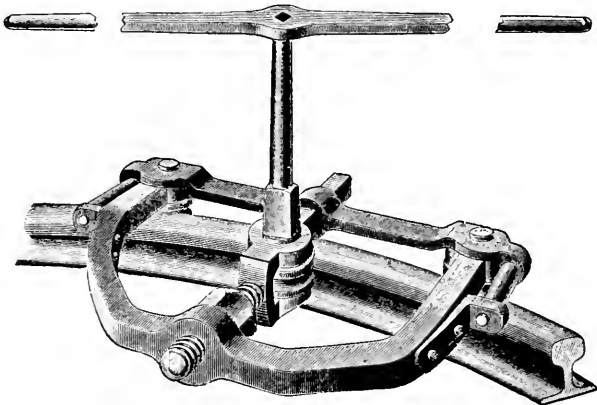


FIG. 336.

RAIL BENDER AND STRAIGHTENER.

Place Bender over rail as shown above, turn up nut on center screw with long wrench furnished with each machine, until set for desired curve, then place socket wrench on pin in center roller, put long lever on top of socket and then one or more men at each end of lever can turn center roller, which causes the machine to move forward on rail, bending same as it moves. To straighten rails, place machine on opposite side of curve and then operate as above. The number of men necessary to do the work is governed by weight of rail and curvature desired.

Switches and frogs require constant attention to keep them in good working order and safe for fast trains; in the winter the ice and snow must

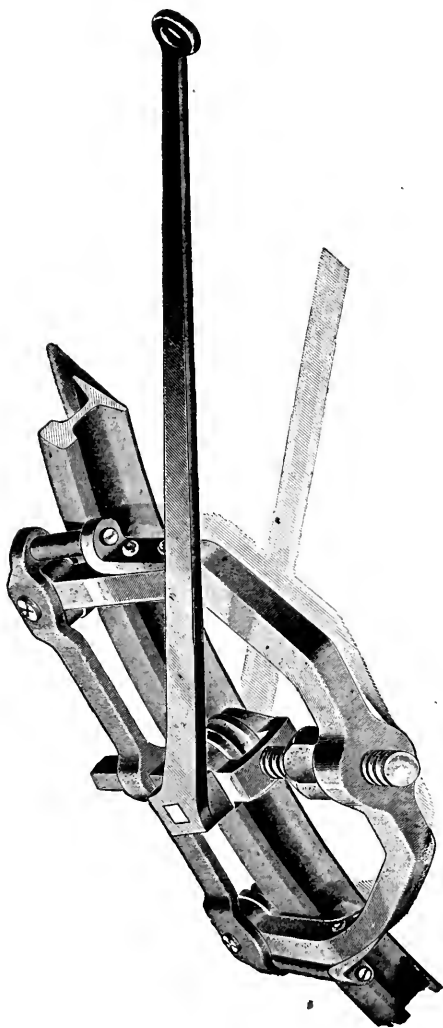


FIG. 337.

RAIL BENDER AND STRAIGHTENER. WITH HORSE POWER ATTACHMENT.

This is the same as Fig. 336 with an attachment added so the labor can be performed by a horse

be removed promptly after each storm. The Roadmasters' Association in 1898 recommended for split switches—points fifteen feet long properly reinforced and provided with stop lugs, two adjustable tie bars, a wrought iron plate extending through under both rails with rail braces, slide plates under main rail heavy enough not to bend and to have rail braces on the outside.

*Creeping rails.* Creeping rails are another source of trouble in maintaining track.\* Creeping takes place at switches more frequently than anywhere else. It is not so troublesome, however, with the split switch as with the stub switch. The Roadmasters' Association discussed this subject at their annual meeting in 1898 and came to the following conclusion:

The creeping is not alike for both rails; in double track roads the rails creep in the direction of the traffic; the movement is greater on down than up grades and is worse where tracks have to be laid over marsh or soft yielding sub-soil. On single track it is most noticeable on down grades, and where there are descending grades from both directions, the rails creep down and come together in the valley. On curves the outer or high rail creeps the more and where there are successive reverse curves especially on grades, the creep starts on tangents at the approach and continues on the high rail to end of first curve, then the opposite rail on reverse curve shows the more creep. In other words the high rail in each

---

\*The movement of the rail in the direction of its length is called "creeping."

successive curve is found to creep more than the low rail. The cause of creeping is because of a rolling load passing over the rail which depresses the track directly under it and produces a corresponding elevation and depression ahead and behind it which may be likened to a wave motion. Mr. F. A. Delano, Superintendent of Freight Terminals of the Chicago, Burlington & Quincy Railroad assisted by Mr. J. E. Howard of the Watertown Arsenal found by experiment that the ground near a locomotive weighing 110,000 pounds on a track having sixty-six pound rails resting on oak ties, seventeen to a thirty-foot rail, and in gravel ballast, the greatest depression was 0.161 inch under the middle driver. Under similar conditions, but with cinder ballast instead of gravel, the depression under the middle driver was 0.230 inch. The depression of the ground caused by 125,000 pound locomotive under the above conditions with gravel ballast at a point opposite the main driver was as follows:

Distance from the rail,	31 inches,	depression	0.047 inch.
“ “ “ “	61 “	“	0.013 “
“ “ “ “	91 “	“	0.001 “

With the track depressed under the weight of an engine a corresponding rise just ahead of it to be afterwards depressed as the engine approaches it and passes over it produces a violent wave motion under high speed which is the cause of creeping rails. The movement of the rail tends to carry the tie with it and where the ballast is not filled up to the top of the tie at the end, the tie acts as a lever, the balance at the center being

a fulcrum and the twisting of the tie in the track tends to tighten the gauge; this takes place more at the joint ties and more particularly where the rails are laid with broken joints. This tendency to move the ties takes them off their well tamped bed, and tends to produce a creeping of the whole track which will lead to a general disintegration and destroy the alignment and surface, which will require a large amount of hard work to place the track in proper condition again. There is not at present any known method of preventing rails from creeping, but the evil can be lessened by resorting to devices for anchoring the rails at the joint by spiking the tie through the slot in the angle bar; the larger the number of ties thus spiked, the more firmly the rail is secured. Some roads having rails laid with broken joints use sections of an angle bar, bolted to the rail opposite the joint and spike the tie through the slot in these sections of the angle bar; this tends to prevent the tie from twisting and tightening the gauge. One end of a flat bar of iron turned half round is sometimes placed inside the nut of track bolts at the joint, and the other end spiked to a tie to secure greater resistance. At entrances to yards or points where the rails creep much, some roadmasters anchor the rails by spiking a piece of strap iron to three or more ties, the spikes being placed in holes bored in the strap iron. The vertical and lateral motions can be retarded or reduced to a minimum by having a stiff rail in section to transmit the load over the greatest possible surface of ties and bal-

last with good broad ties placed as close together as good tamping will permit; the spikes should be well driven and the ballast dressed off as full as possible at the end of the ties. Figs. 338 and 339 represent plans sometimes adopted to allow for the expansion and contraction at difficult points.

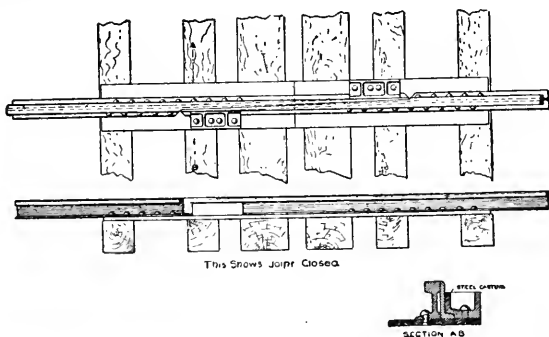


FIG. 338.

PLAN AND ELEVATION OF A JOINT TO TAKE UP THE EXPANSION AND CONTRACTION OF RAILS.

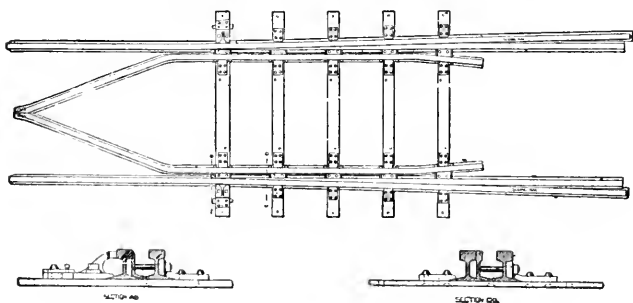


FIG. 339.

EXPANSION JOINT FOR A BRIDGE OR DIFFICULT PIECE OF TRACK.

Used on bridges and at points where expansion and contraction of rails is such that they cannot, without considerable trouble, be kept in line. This device is also used where creeping of rails is troublesome.

*Track Sprinkling.*—Oil has recently been tried to reduce the dust caused by fast passenger trains; the oil used is residuum of crude petroleum, having a high fire test, low gravity and only a faint smell. The first application requires about 2,000 gallons per mile, and about 500 to 600 gallons per mile per year will keep the ballast dustless, after tie renewals, etc. The sprinkling train is run at a speed of about  $3\frac{1}{2}$  to 4 miles per hour. In front is a flat car fitted with a 2-inch pipe across between the rails and a 2-inch swing pipe on each side, all these pipes having slots on the under side. The supply is brought from a tank car to these pipes by a 4-inch main. The regulating valves and swing pipes are all controlled by levers or handles on the flat car. With piping swung out, a distance of 15 to 20 feet of roadbed may be sprinkled.\* Those who have

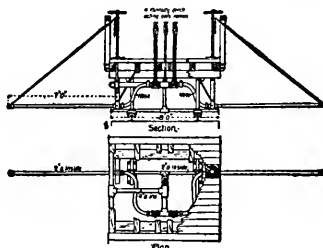


FIG. 342.

PLAN AND SECTION SHOWING PIPING NECESSARY TO FIT A  
FLAT CAR TO SPRINKLE TRACK WITH OIL.

\* This practice originated with Mr. J. H. Nichol, Assistant Engineer of the W. J. & S. Ry., in 1897, and has since been followed on the Penn. R. R., Boston & Maine R. R., Long Island Ry., and Chicago, Bur. & Quincy R. R.



used it claim it not only lessens the dust, thus saving the journals, but it causes the water to run off the roadbed better, giving a dryer ballast, prevents weeds from growing and preserves the ties. Fig. 342 shows the plan and elevation of a flat car, indicating the method of arranging the pipes filled for the purpose of sprinkling track with oil.

*Crossings.*—Road crossings should never, if possible to avoid it, be made where the track is laid in a cut. They should be of ample width and easy grade; they are generally made by planking spiked to the ties; good results, however, have been secured by placing a plank at each rail and filling in between the planks with broken stone. The place between the planks should only be sufficient to give clearance for the flanges of the car wheels. A cattle guard should be placed each side of the crossing, and fences run from the cattle guard to the right of way fence.

*Signs.*—Signs are required for a number of purposes. They are of two classes, one warns the public and the other guides and warns the trainmen. At all side tracks low posts called clearance posts are placed. These indicate that cars on a siding should not be placed beyond them, as they are liable to interfere with passing trains on the adjoining track. Yard limit posts are placed each side of a yard to indicate to approaching trains the track under the jurisdiction of the yardmaster. Posts with signs having the name of the station are placed each side of a station

and one mile from it. The station name is more noticeable to passengers when placed on the ends of the station than when on or in front of it. Mile posts, with the number of miles from a terminal point, should be set in the right of way near the fence to mark the beginning and ending of each mile. The sections allotted to section gangs are numbered, and posts giving the number of the sections on each side thereof should be set at the ends of all sections. Farm crossings are sometimes designated by a sign having a large **X** plainly painted on it; this is placed 100 feet from the farm crossing. Road crossings should have a whistling post placed 1,000 feet from the crossing and a sign at the crossing warning the public to look out for trains. Railroad crossings not protected by an interlocking plant should have signs placed 400 feet distant each way on both roads, notifying all trains to come to a stop before going over the crossing. Draw bridges should have signs placed 600 feet each side.

*Shimming.*—“When the ballast is frozen in the winter it cannot be tamped, and if the track is heaved by frost the surface is made uneven both transversely and longitudinally. This must be tested by a level for the former and by sighting or the use of a long straight-edge for the latter. In such cases wooden plates or shims must be placed between the rail and the tie to bring the rail up to proper surface. The upper face of the tie should not be adzed to lower the rail, unless this is absolutely necessary, but the shims should be placed on the lower ties. Shimming is

also required with soft ballast that is so soft after heavy rains that tamping is impracticable, the ballast and roadbed being so saturated that no other method of surfacing is effective. In some very bad cases, or in accidents, blocking must be used under the ties, but this should be avoided when possible, and the foreman must see that this blocking is not forgotten and left in place, but that it is taken out when the shims are removed or when the ballast has dried out sufficiently to give the track a proper bearing. As the frost comes out of the ground and the ground settles, thinner shims must be substituted for the thicker ones to prevent surface bending of the rails. The shims should never be left in place after the spring; and as fast as they are removed the spike holes in the ties should be properly plugged. Heaving is most troublesome in earth and clay, but is also felt in gravel. Where much trouble is experienced from heaving, it will usually be found economical to apply gravel ballast liberally; as the spiking and shimming injure the ties and spoil the permanent surface of the track. The shims may be cut by the section men, but it is better to use those cut by machinery having two spike holes bored diagonally opposite one another. They are about 6 inches wide, and the length should be at least equal to three times the width of the rail base, so as to give ample room for spiking and keeping the spikes clear of the angle-bars. The thickness is from  $\frac{3}{4}$ -inch to 2 inches. If a raise of more than 2 inches is required, a piece of 1-inch to 3-inch

plank should first be spiked to the tie by boat-spikes, the plank being about two feet long, or as long as the tie if both rails have to be shimmed. Upon this plank should be placed shims to bring the rail to the required level, these being fastened by long spikes passing through shims and plank into the tie. With specially high shimming it is well to place rail braces outside the rails, especially on curves. Where tie plates are used, the plates should not be taken off, but the shims placed on them, and if the shimming is high a tie plate may be placed on its top. The tie should be adzed to give a level seat for the shims. Spiking should be attended to as fast as the shimming is put in, and if a whole rail length is to be shimmed, the joint, center and quarter ties should be first shimmed and spiked."

*Fencing.*—"In setting fences, the distance from the center line of the track may be measured by a tape, and the line of fence set off by a cord or chain 100 to 200 feet long, having tags at the post spacing. When this is stretched a small hole is cut at each tag as a guide to the post setters. The post holes should be of uniform depth, gauged by a stick, and the height of the post above ground may be gauged by a stick having a flat piece nailed on the bottom. This latter stick may also have notches for the fence wires, to hold them at the proper spacing while being stapled to the posts. On curves the position of each post should be measured from the center of the track, and a mark made or stake driven. For wire fencing, posts may be set and tempor-

arily braced at intervals of from 40 to 80 rods (660 to 1,320 feet) and one wire stretched first as a guide for the other posts. On the inner side of a curve the wire should be on the track side of the post or on the track and field sides of alternate posts. The wires are attached to a straining post and set up by a stretcher, but in the absence of this tool a lining bar may be used, placed diagonally, with the top inclined towards the anchor post, and the wire being looped around the bar. In summer the wires must not be drawn too tight. With board fences the alternate posts may be set first, 16 feet apart, and a line of boards nailed along them will serve as a guide for lining the intermediate posts. The boards should be on the farm side of the posts. The material and labor per mile for a four-board fence with posts 8 feet apart, and a five-wire fence with posts 16 feet apart, are about as follows:

## Board fence;

660 posts.

1,320 boards, 1 x 6 inches, 16 feet long, 10,560 feet B. M.

660 battens, 1 x 6 inches, 4 feet long, 1,320 feet B. M.

250 pounds nails.

65 days' labor for one man.

## Wire fence:

330 posts.

26,400 feet of wire at 440 pounds per strand, 2,200 pounds.

75 pounds staples.

27 days' labor for one man.

“In the ‘Trackman’s Helper,’ by Mr. Kindelan, it is stated that the average day’s labor for one man on a six-board fence, including setting posts, is 8 to 10 panels where the boards meet on the post, or 13 to 15 panels where they lap

on opposite sides of the post. On a four-wire fence with 16-foot panels, the average is about 15 panels. These figures vary, of course, with the details of the work and character of the men. The cost per 100 rods (1,650 feet) for fence building and repairs, with labor at \$1.50 per day, has been estimated as follows: Five-wire fence: \$6.00 for removing old fence and posts; \$16.50 for putting in new posts 3 feet to 3 feet 6 inches deep and stringing wires. Board fence: \$4.50 to \$5.00 for removing old fence and posts; \$32.00 for putting in new posts 8 feet long (set 3 feet deep) and putting on seven boards; or \$42.00 for posts 10 feet long (set 3 feet 6 inches deep) and putting on nine boards. The painting or daubing of advertisements on board fences is very objectionable, and at least one road has forbidden it, making a practice of painting out such disfiguring marks."

*Clearing Right of Way.*—"All grass, weeds and brush on the right of way should be cut at least once a year, and preferably twice a year. This should be done in the months which are most suitable, according to the latitude, but being in any case done before the seeding time of the plants. After the grubbing, cutting and mowing, the material should be raked into heaps and burned as soon as it is dry enough, care being taken that the fire is not allowed to extend to fences, trestles or adjoining land. Old ties, splice bars, tools, etc., found during this clearing up should be removed and properly disposed of. If the brush on the right of way is allowed to

grow too long it is liable to cause accidents, concealing cattle which may stray on the track in front of a train, while it is also liable to catch fire in dry weather, such a fire being hard to check or stop. Reports of locomotives which throw sparks badly, and of fires started by sparks from locomotives, should be made by the section foreman and roadmaster. The spark arresters of locomotives should be examined frequently in hot, dry weather, when standing crops, weeds on the right of way, etc., are liable to catch fire. Where the right of way is covered with good grass, it may be mowed and used or sold for hay under the direction of the roadmaster.

“The grass and weeds in the ballast and along the sides of the roadbed have also to be cut or pulled up, and this is tiresome and unpleasant work, though necessary for keeping a good looking track. A long handled sharp hoe is better than a shovel if there is much of this work to be done. Where this work is only done periodically on lines not kept in the best condition for appearance, it may be economically done by machinery. On the Intercolonial Railway the wings of a snow plow have been fitted with vertically adjustable steel cutters, 13 inches deep, 9 feet long and  $\frac{7}{8}$  inches thick. The first cut is made with the wings half open, cutting the ballast slope. The second cut is made with the wings spread to their full extent, forming the berme at the level of the subgrade and plowing the stuff down the bank. Formerly two or three furrows were plowed with a farm plow and a pair of horses,

the sods being thrown down the bank by trackmen with forks. The above machine is hauled by a locomotive, and can clean 20 to 25 miles of track in a day, making a cut on each side 3 feet to  $9\frac{1}{2}$  feet from the rail and to a depth of 2 feet below the top of the rail. The crew consists of two men to extend or close the wings, and two men to raise and lower the cutters at crossings, switches, etc. Such a machine is specially valuable on single track roads with limited section forces, and it can be made out of a wing snow plow, or by attaching wings and cutters to a box car. Many ditching machines can be adapted to this work, as they are made to trim off the ballast slopes.

“The Sheffield weed-cutting hand car has two toothed cutter bars (like those of a reaping machine) projecting from a frame between the wheels. The position is regulated by levers, and the knives will cut close to the ground and to a distance of eight feet from the rail. They fold together and swing up to a vertical position at the side of the car when passing an obstruction. It will work on level ground or on slopes, and when worked by four or six men it will cut along four or five miles per day. The machine should be in charge of a man with some knowledge of machinery and having some skill in handling such a machine. He may be given a certain length of track to look after (say 100 miles) and he should be familiar with that division. When the time for cutting comes, the section foremen are instructed to see that all portable obstruc-



tions, old ties, etc., are removed from a strip at least ten feet wide from the rail. The man in charge takes men from each section gang to work over the section, making a straight run over his entire division, and then returning in the same way to cut on the other side of the track. This work can be done two or three times in a season, saving much labor and expense. The machine will work best when the weeds are growing rapidly and are soft and tender. It has cut weeds 10 feet high with stalks 1 inch thick, though it would hardly do this continuously and such work would be hard on the men. Under ordinary conditions, however, the car can be run at good speed and the work is not severe.

“Various methods have been tried for killing the grass and weeds growing in the ballast, but though such methods would be advantageous in saving time and labor expended in the back-aching work of cutting weeds with a shovel or hoe, none of them has yet so combined efficiency and low cost of operating as to be really practicable for general work. Such a method would be specially advantageous for roads having many weeds and few section men, which is the condition of many roads in the south and west. Brine, gasoline or oil burners, steam jets and electricity are among the means experimented with in this direction. In experiments with electricity on the Illinois Central Railway a ‘brush’ 10 feet long and 4 inches wide was made of fine bare copper wires and suspended from the front of a flat car so that it would almost touch the ground. Another car

contained an engine, dynamo, transformers, etc., steam being taken from the locomotive. The cars were run at a speed of about 5 miles per hour, and two trips were found sufficient to kill all the vegetation, an advantage of this process being that the roots were absolutely killed. The brush was in short sections, insulated from one another, so that all the current would not be discharged through any one weed, etc., forming a more than usually good conductor. A current of 10,000 volts was found to be most satisfactory. For general work, however, the cost of this method would be prohibitive. Burning weeds with jets from burners using crude oil and compressed air has been tried on the Minneapolis, St. Paul & Sault Ste. Marie Railroad. The apparatus was mounted on a self-propelled flat car and could work over ten miles per day, consuming 15 to 20 gallons of oil per mile. A strong solution of brine, delivered from a sprinkling attachment on a water tank car was tried at one time on the Atchison, Topeka & Santa Fe Railway. It effectually killed the weeds, but caused a slime on the rails which led to slipping of the engine wheels and corrosion of the rail, and it was therefore abandoned.

“In some few cases with earth ballast, it is considered well to let the grass grow, merely cutting it down so low that it will not get on the rails. Where the weeding is done by hand it should be extended to a ‘grass line’ 5 or 6 feet from the rail, this line being set out by a cord and stakes,

or marked by a cutter fixed to an arm bolted to the hand car.”\*

*Snow.* “Section foremen should ascertain the condition of the track in their charge immediately after every snow storm (or wind storm) which would be liable to drift snow upon the track and report to their roadmaster the depth and length of snow drifts in all the cuts on their sections. It is of the greatest importance that snow reports be sent promptly to the roadmaster by telegraph in order that the officers of the road may be able to make necessary preparations to clear the track. When there is no snow in the cuts on a section it should be reported clear of snow. Section foremen should clear-away snow which has drifted upon side tracks as soon as possible after a storm, and the snow on switches and in frogs and guard rails should be shoveled off, and the track for the full length of the switch lead and moving rails should be swept clean. This work should never be delayed, because all freight trains will need to do switching as soon as the road is open for traffic.

“During the winter months, when snow falls or is drifted into cuts two or more feet, section foremen should take their men, just as soon as possible after the storm, and remove from the track sufficient snow at the ends of all drifts to leave a clean flange and a clear face of snow at least 18 inches deep at both the approach and run out end of the drift. It is a notorious fact that a great many engines, when bucking snow,

\* “Railway Track and Track Work,” Tratman. pp. 307-311.

run off the track when coming out of, or running into a snow drift. This is generally caused by hard snow or ice in the flanges, as the engine, on being suddenly relieved of the weight of the snow, easily mounts the rail on a hard flangeway and runs off the track.

“Whenever the track becomes full of snow in the winter and needs flanging out, section foremen should take their men and flange out the track at the tops of the heaviest grades first, and next at all places on their sections where it is most difficult for an engine to pull a train. Those parts of a section which need flanging least, such as high dumps, level track, or sags between grades, should always be left till the last.

“On roads where snow lies on the ground during the winter months, section foremen should open up all ditches, culverts, and other water ways which pass along or under the track. Culverts which are apt to be covered with snow in the winter can easily be located when the thaw comes if a long stake is driven close to the mouth of each culvert early in the fall of the year, before any snow falls on the ground.

“In cuts that are full of snow on each side of the track, leaving only room enough for trains to pass through, foremen should make a ditch in the snow when it begins to melt in the spring, about six feet from the rails on each side of the track, so that when the water begins to run it will not injure the track by running over it.

“If there are any snow fences for protection along cuts, they should be watched closely, and

whenever a fence is found which has been drifted full of snow or nearly so, a wall four feet high along the top of the highest part of the drift should be built with blocks of snow taken from the inside face of the drift. As long as the weather remains cool, a wall built of blocks of snow will give as good protection to a cut as the same amount of ordinary snow fence would. Snow walls should be made strong and thick and their height increased on the worst cuts in proportion to the force of men that can be spared to do the work; double lines of snow wall, fifty feet apart, should be used where they will be beneficial.

“On the majority of Northern railroads the amount of snow which falls upon the ground during the winter months is not so great as to require the building of snow sheds, but to protect the cuts along the track from filling with snow, fences are built along the tops of the cuts at a sufficient distance from the track to catch the snow when it is drifted, and prevent it from being blown into the cuts and blocking the track. The efficiency of a snow fence, as a protection against snow, depends on its strength, durability, height, how far it is from the track, and the manner in which it is arranged along the top of the cuts.

“A snow fence, no matter how well made, or of what material, will rot and become useless in eight or ten years, at the latest. The yearly cost of repairing snow fences, the first cost, and the interest of the money invested, should all be

considered before putting up a snow fence on any railroad cut; and where the work of grading down a cut on each side of the track, so that it will not hold snow, can be done for an amount of money equal to the cost of the items above referred to, the grading of the cut should be done in preference to the building of a snow fence. In many sections of the Northwest a cut which is only two or three feet higher than the track rails can be graded from the right of way limits down to a level with the bottom of the track ties, and the dirt wasted on the fills near at hand for less than it would cost to maintain a snow fence on the same cut.

“Even when the cost of putting a cut into such a condition that it will not hold snow is somewhat greater than that of maintaining a good snow fence, the difference is in favor of grading, on account of the benefit the track derives from it. Snow fences are not needed at deep cuts which from their top slope back into a valley within a short distance from the side of the track; nor are snow fences much good as a protection where the ground slopes with an incline off from the track, unless the fence is close enough to carry the wind above the cut, or catch the snow before reaching the cut. Snow fences are not needed on cuts where heavy timber or underbrush grows close along each side of the track, the only snow in such cuts being that which falls directly upon the track and cannot be prevented. But where the ground is level for some distance from the track, or on a gently roll-

ing prairie, cuts are liable to fill up with snow if not properly fenced. Snow fences should be set up at such a distance from the track that the edge of the snow drift inside of them will not reach within thirty feet of the track when the fence is drifted full. The fence should be set about eleven or twelve feet from the track for each foot in height of fence. The height of the snow fence should regulate its distance from the track. If a snow fence is set too far from the track for its height, the wind, after passing over the top of the fence, soon strikes the ground on the inside of the fence and gathers all the snow before it into the cut, and part of the snow which blows over the fence is also carried upon the track.

“A snow fence is seldom set up on each side of the track unless the road is so situated as to be exposed to storms from both directions.

“Storms from the northwest, north, and northeast are the most prevalent throughout the Northwest, and, as a general rule, the north sides of railroads running east and west, and the west sides of railroads on roads running north and south, need the most protection from snow and need the most snow fence. Where two snow fences are put up on one side of the track, they should run parallel with each other, and there should be a space of at least 100 feet between them. Unless a very large quantity of snow is drifted the outside fence will hold it all.

“Very good results have been attained by setting out the snow fence next to the track in the

following manner: If the snow fence is of ordinary height, set it up seventy-five feet from the nearest track rail. Enough of the snow fence should run parallel with the track to reach the full length of the cut, no more. After this part of the fence is up, a wing should be turned on each end of it, approaching the track gradually until the extreme end of each wing extends 100 feet beyond the end of the cut, at a distance of about fifty or sixty feet from the track rail.

“When a cut ends abruptly on the beginning of a high fill, the wing on that end of the snow fence should be turned in towards the track before the end of the cut is reached, or at least soon enough to protect the cut from a quartering storm. A snow fence built parallel with the track and without a wing on the end of it, is of very little use when a storm blows nearly along the track, as most of the snow on the inside of the fence is apt to be blown into the cut. New ties which are received for repair of track the following Spring can be distributed and used advantageously to make a temporary snow fence on cuts where needed. The ties may be laid along in line with their ends lapping each other, about one foot slats or pieces of board can then be put across the ends of the ties where they lap and a new line of ties laid along on top of them until the snow fence is of the proper height.

“Clearing the track of snow in the winter belongs to the roadmaster’s department. No man should be trusted with full charge of a snow plow outfit unless it be known that he understands the



best methods to be employed in opening up the road for traffic after a blockade. The man in charge of a snow plow outfit should be informed of the exact condition of the road, the depth of snow, the length of drifts, and the location of the same, as nearly as possible, before starting on the road. He should have good live engines and willing engineers. The plow itself should, like the engine and engineer, be the best that can be procured and of a pattern that could throw snow out of a cut eight or ten feet deep. Small plows, fenders, or other makeshifts, which are only good to clean the rails of light snow, or gouge a hole through a big cut should be left at home and not taken out to buck snow. When there is a large quantity of it to be moved, the extra time and labor expended in shoveling and pulling such craft out of the snow would purchase a good plow in one trip over the road. Another engine and car with a conductor, train crew and shoveling gang, should follow close behind the snow plow during the day time, and should be coupled in behind the plow when running after dark. The second engine should be used as a helper in striking deep snow, and to pull out the plow engine whenever it is stuck fast in a snow drift. All cars attached to the helper engine should be left behind on the clear track when both engines run together to buck a drift of snow. The pilot should be removed from the engine which is used for a helper so that a close coupling can be made when both engines are used together. The less slack there is between

two engines coupled together the less liability is there of the hind engine pushing the front engine off the track. This is most liable to happen on a curve track, or where hard snow is encountered. Two engines should never be allowed to buck snow with a long car coupling between them or with a caboose or other car between the engines, as either arrangement endangers the lives of the men on the train and often results in a wreck. There is no necessity for using two engines behind the snow plow to buck snow which one engine can as well throw out. If the snow is not too hard one good heavy engine and plow will clear the track of a snow drift three to five feet deep and from five to eight hundred feet in length, at one run.\*

“Two good locomotives coupled together behind the plow, managed properly, will remove any snow which it is advisable to buck. Snow drifts which are higher than the plow cannot be cleared from the track successfully without first shoveling the snow off the top of the drift, except when the drift is very short. Where the top of the snow drift is shoveled off, it should be opened wide enough to allow the plow to throw out of the cut the snow left in it. On roads where a flanger is used and made to pull behind an engine on a train, it should be sent with the snow plow

---

\*On account of the invention of the rotary snow plows it is not likely that snow plowing with a plow on the front of a locomotive will be done to any great extent in the future, especially where cuts are deep and long and snow is hard. But when the snow is soft and not too deep on the track the old way of getting rid of it is still apt to be practiced.

helper and used to clean out the snow left between the track rails by the snow plow. When the snow is reported hard, those in charge of snow plow outfits should be very careful to have their engines and plow in as perfect condition as possible. They should run no risk; every snow drift should be examined before running into it, and each end should be shoveled out enough to leave a clean flangeway and a face that would let the plow enter under the snow and keep it down upon the rails. The tendency of hard snow is to lift the plow up over the top of the drift and throw the engine off the track. Whenever the ends of the drifts are not faced as before mentioned there is always great danger when entering or leaving short, shallow drifts of hard snow, while, on the contrary, there is little or no danger in plowing soft deep snow at the greatest speed the engine can make.

“The engines with a snow plow outfit should always take on water and fuel to their full capacity at every point on the road where a supply can be obtained, no matter whether it is liable to be used or not. When it is at all probable that progress will be slow on account of hard or deep snow, a car loaded with coal should be taken along by the helper engine. If there is plenty of snow the supply of water can easily be made in the engine tanks by commencing to shovel snow into them before they are more than half empty.

“Every snow plow, engine and helper engine should be supplied with a piece of steam hose

which can be attached to the syphon cock and reach from it to the water hole in the back of the tank. With this hose an engine steaming well can quickly make a full tank of water from snow shoveled into the tank. It is also useful to thaw out the machinery or clean the track rails of ice.

“In plowing snow the length of runs and the speed of the engine should always be in proportion to the depth and length of the snow drifts. If the drifts are deep and long and likely to stick the plow, a good long run should be taken on the clear track so that the plow engine may acquire its greatest speed before striking the drift. A good engineer who has had some practice in bucking snow will so handle his engine that very little shoveling by the men will be needed.

“It is not advisable to start out on the road with a snow plow outfit during a heavy storm, but everything should be ready to make a start as soon as the storm is over. The snow plow should be attached to the best and heaviest engine in service on the division where it is used.

“The man in charge of a snow plow outfit should use his best judgment and have his wits about him at all times, that he may not be caught on the road with a dead engine or be wrecked, and block the road for other trains. It is much better for the Company's interests and those of all others concerned when all accidents are avoided, even should it take much longer time to open up the road.

“The engineer of the snow plow engine should sound the whistle frequently when approaching

a cut, so that section men if working there will be warned in time to get out of the cut. When the snow plow is making repeated runs for a big snow drift, the signal to come ahead should never be given until all the snow shovelers have left the cut. It is very difficult for men to climb out of a cut where the snow is deep, and many accidents have occurred where approaching trains have failed to warn the men in time, or where the men have neglected to look out for the danger until it was too late. If the men with the snow plow are always on the alert and careful and conscientious in the discharge of their duties, the safety of all concerned will be assured and the work will progress rapidly.

“When a snow drift is so long and deep that it may stick the snow plow twice, the best policy is to shovel out snow enough from the approach end of the drift to enable the snow plow to go through in the second run. In this way the labor of digging out the engine a second time may be avoided.

“All very hard snow should be broken up by the men and the crust thrown out before striking it with a snow plow. The shock felt when a snow plow strikes a hard drift is sometimes very great and often damages the machinery or knocks the plow from the track. The force of concussion may be materially lessened by having the men clean a good flange way, and then shovel out of the face and top of the drift enough snow to make a gradual incline of about one foot to the rod. Besides reducing the force of the shock

the above method of preparing a hard snow drift enables the snow plow to open a much greater distance at a run.\*

*Snow Plows.* The Rotary snow plow is illustrated by Fig. 344. The leading features of the 'Rotary' are:

1. The machinery of the Rotary is much simpler, very much stronger, and is better adapted for the work it has to perform than that of any other steam snow plow or excavator.

2. The machinery of the Rotary is underneath the floor of the pilot house and cab, and is securely fastened to the extra heavy steel and iron frame which carries the machine, and is so covered with iron plates as to secure absolute safety to those operating it.

3. Owing to the perfect mechanical principles upon which the Rotary is constructed, its weight is properly distributed over its trucks and varies but a few thousand pounds when in working order.

4. The Rotary is the only steam snow plow which has a perfect working ice cutter and flanger which will absolutely protect it from derailment by snow or ice.

5. The Rotary is the only steam snow plow which cuts the snow from the bank and discharges the same at a single revolution.

6. The Rotary is the only steam snow plow ever operated which has not spread the rails and broken down bridges, and is consequently the only steam snow plow which can be run out ahead of trains with safety.

---

\*"The Trackman's Helper." Kindelan, pp. 240-253.

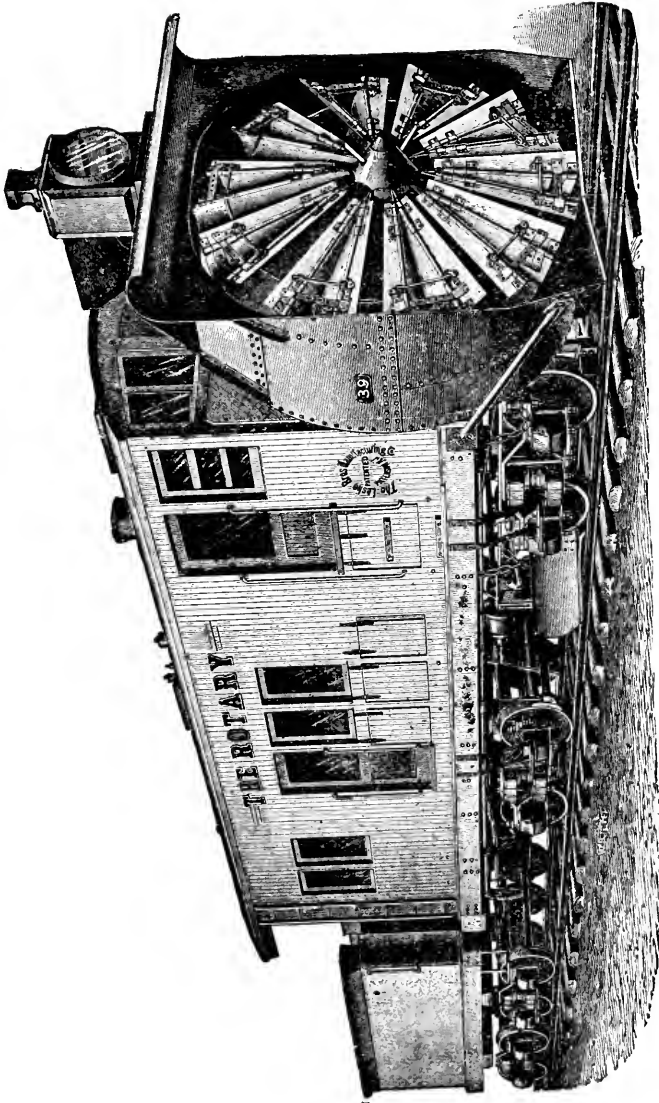


FIG. 344.  
ROTARY SNOW PLOW.

*Seasons' Work.* "As to the seasons for doing the different kinds of work, it may be said that general improvements, tile drainage, reballasting, etc., can best be carried on from late spring to late autumn, but all such work should, as far as possible, be planned and arranged for beforehand, so that the track may not be disturbed for reballasting just after the section gang has completed a thorough surfacing. Work trains and floating gangs for ditching, ballasting, widening cuts, etc., and special gangs on new interlocking plants, rearrangement of yards, repairing or building structures, etc., may be worked at any time from the end of one winter to the beginning of another. For the ordinary work on the sections no set rules or program of procedure can be formulated, as the requirements vary in different sections of the country. In general, however, the year may be divided into four seasons, and the work done during these seasons practically as outlined below:

*Spring.* "As soon as the winter is over, all likelihood of snow past, and the frost coming out of the ground, the work of reducing and removing the shims should be commenced. The frost will, of course, remain longer in the roadbed in cuts than on exposed banks. Low joints must be raised, spikes driven, bolts tightened, cattle guards and road crossings cleared and repaired, ditches cleaned, fences repaired, portable snow fences taken down and piled, rubbish and old material cleared from the right of way, and the necessary lining and surfacing done to put



the track in good condition previous to the more extensive work later in the season. At the same time sign posts and telegraph poles are straightened, fences repaired, and side tracks and yards overhauled. The gang (if not already increased) is then increased to its maximum number and the work of renewing ties is commenced, the ties having been previously distributed on the section. About four days a week should be spent in putting in the ties, all ties being fully tamped as soon as they are in place. The other two days are spent on other necessary work. On some roads the tie renewals are done quickly at the beginning of the season, while on others this work is spread out through the season. The former is by far the better plan, as the continued disturbance resulting from the latter plan is very detrimental to the maintenance of good track. When the ties are all in, the work of thorough lining and surfacing preparatory for the heavy summer traffic is commenced. The lining is done first on account of the bad line resulting from the tie renewals, but the surfacing should follow very closely. The gauging is done at the same time. Ballasting is done after the new ties have been put in. In surfacing, care must be taken not to raise the track too much, but only to give a uniform surface, the track being raised out of a face only about once in four or five years.

*Summer.* “Besides the work of surfacing, rail renewals may be done at any convenient time between spring and winter. The new rails are sometimes laid before the ties are renewed, but

it is better to put the ties in first and have them thoroughly tamped up, especially if there are many bad ties. A general inspection of spikes, bolts, nuts and nutlocks is then to be made. All worn, bent, broken or improperly driven spikes are removed, the holes plugged, and new spikes are driven. Broken or loose bolts are made good. Switches and switch connections, frogs, guard rails, etc., need to be carefully inspected and repaired. As fast as the regular surfacing is completed, the ballast should be dressed to the standard cross-section, and the toe of slope lined to a 'grass line' about 5 feet 6 inches from the rail. Tile drainage, correction of signs, and general work not interfering with the track itself can best be done during the summer. Spare time can also be spent in trimming up yard tracks, and clearing yards and station grounds.

*Autumn.* "Weeds should be cut at least once a year and the best time for this is just before seeding. The grass on the right of way should be mowed, bushes cleared and trimmed, and in cases where fires cause trouble, a fire guard may be formed by plowing a narrow strip about 50 feet on each side from the track. Burnt or decayed trees likely to fall near the track should also be removed, and the dry brush, old ties, etc., may now be burned. Old material should also be cleared up. About a month before the commencement of the winter or rainy season, a general surfacing, lining, gauging and dressing of the track should be done starting at the farther end of the section and working steadily to the other end. The

track itself should be put in condition at the same time and the spikes and joints seen to. When this is done ditching must be undertaken, the ditches being cleaned out and improved where necessary to give the necessary width and grade. The more thoroughly this work is done the better will the track be during the winter. Trenches should also be cut under switch rods to prevent water or snow collecting around them and freezing. The culverts and waterways must then be cleared of brush and obstructions, and any signs of scour or undermining looked for, while streams should be examined above and below the culverts and any obstructions removed. After this there is plenty of work to be done in cutting and burning weeds, repairing fences, repairing and erecting snow fences, and stacking additional portable snow fences where they will be needed. Track signs and telegraph poles have to be inspected and cattle guards and crossings cleaned up. Yards and side tracks may be profitably cleaned, drained, leveled up and repaired before the snow falls.

*Winter.* "The winter work with reduced track forces is largely that of inspecting the track and making small repairs; also looking after the spikes, bolts, frogs and switches. Such work will occupy the time between snow storms or in fine weather. During snow storms the switches, frogs and guard rail flangeways must be kept clear as also all signal and interlocking connections. Salt is used to melt the snow but oil afterwards should be applied to all moving parts, such as slide

plates, bell crank levers, etc., as the salt water has a tendency to rust the iron, making the parts move hard. In heavy snow storms the section men must work in clearing the track and help the snow gang or shovelers. In the intervals of fine weather rails, ties, lumber, fence material, etc., may be distributed, ready for spring work. Heaving of the track by frost has now to be expected, and proper precautions must be taken to keep the track in surface by shimming, while in very bad places blocking may be necessary. The ditches should be examined as soon as any thaw sets in, and kept clear of ice or packed snow, so as to allow free passage for the water.”\*

*Changing Rails.* On roads having heavy traffic, it is customary to change rails on Sundays, preparing the track on week days. On roads with light traffic, rails can be changed at any time. One side of the track should be changed at a time.

*Preparing Track Material for Sunday Work.* Rails and splices generally require to be filed on the ends to a uniform surface, so as to remove projections; this work is therefore included in preparing the track, though properly speaking it should be done at the mill. The following is the organization of men for such work, namely: The first thing to be done is to put four men on the car of splices, two on each end, to file and inspect the splices, each man having a small bench to lay the splice on to facilitate the filing; after they are filed they should be thrown on a car, laying them at right angles to each other the full length of the splice; this will facilitate their being

---

\*“Railway Track and Track Work,” Tratman, pp. 288-289

counted. When the men have sufficient room on the car they are filing on, they should pile the splices behind them in like manner. Rails, splices, bolts, nut locks and plugs should be distributed at the same time as the rails. It is necessary, however, to have half of the cars which are loaded with rails turned on a turntable or Y block to admit of their being unloaded, with the brand on the outside of the rails as they will be put in the track.

*Unloading Rails.* Care should be exercised in unloading rails. Rails, on gondola cars especially, should be let down to the ground on skids, and each skid should be provided with a pulley on the upper end, placed below its surface; a rope with a hook sufficiently large to receive a rail should be used through this pulley for lowering the rails to the ground; each skid should be provided at its lower end with a round iron projection, around which the rope is turned for the purpose of controlling the rails while being lowered. Two men on the ground, operating the ropes raise the hooks to the upper end of the skids, when one foreman and twelve men (handling seventy-six-pound rails) will place the rail in the hooks and lower the same to the ground. The first named two men, in addition to lowering these rails, will lift the skids as the car is moved ahead. On another car are the rails for the other side of the track, the men being similarly organized. Unloading a rail on each side prevents moving the train so often and obviates the men passing from one car to another. Time may be saved by unloading two rails from each car before moving the train ahead, unloading the next two rails one rail length ahead of the last two.

Two men on the splice car will distribute the splices, bolts and nut locks, and two men with a basket will distribute the plugs from the supply car.

*Filing Rails, Etc.* As soon as the rails are unloaded, men should be set at work to file the ends of the rails underneath the heads and upper side of the base. After the rails are unloaded, the men should be organized as follows, namely: One foreman and eight men with tongs should string the rails along the outer edge of the ties; one man with an adze should level any projecting ends of same, and one man should tack-spike all unspliced ends of each four rails. For six-bolted splices, six men should bolt the rails and lay the splices, bolts and nut locks at each unspliced end. Four men should remove all the bolts that can be removed with safety from the rails in the track; these men should also put the nut locks, or washers and nuts, on each bolt as it is removed. Four men should pull the spikes that can be pulled with safety, those remaining being left slightly started. On tangents, four spikes to each rail are sufficient to leave unpulled, leaving one of these spikes at each joint; on curves, six spikes to the rail should be left, and one in the slot hole. These spikes should be pulled on the inside when the same sized rails are to be used, and when of different base, the inside of one rail and outside of the other should be pulled, which will admit of their being laid retaining the same gauge. When pulling spikes on curves, they should be pulled on the side having the ties cut down the least, which will more readily admit of ties being adzed. Four men should be at work score-adzing each tie on the

side from which the spikes are removed, keeping well on the outside of the spikes. As each sub-gang finishes its work, it should clear the ballast between the ties and underneath the rails; the other foreman should look after the sub-gangs, except rail stringers. Two boys should be engaged in carrying water for the men. In all, forty men will prepare in the above manner one mile of track per day. On double track, one track should be used to distribute from, allowing schedule trains to pass on the other, flagging all other trains and allowing them to pass as they arrive.\*

*Jointing Rails.* As it is impossible to change rails and have them joint on the old ties, it is necessary that these ties be changed to admit of the slot holes being spiked, and thus prevent the rails from running.

*Moving Old Track.* Improvements of line, especially double tracking, when the old line is being improved at the same time, render it necessary to either take up and relay the old track or move it over to the new line. When the change

\* GANG FOR CHANGING RAILS ON SUNDAY.—The same gang of men that prepared the track at the rate of one mile per day will change the rails at the same rate, organized as follows, namely;

Men removing bolts.....	4
Men throwing out rails.....	2
Men adzing ties.....	13
Men spiking rails, joint slot holes, quarters and centers.....	4
Foremen.....	2
Men pulling spikes.....	4
Men plugging spike holes.....	2
Man guiding and testing adzing with single-headed spotting boards with face one-half inch broad.....	1
Water boys.....	2

As adzing is more or less on account of ties being cut into, these men will require to be increased or diminished accordingly. The remainder of the spiking can be done by this gang the next day, as well as tamping up all ties that are loose or low, especially the joint ties. They should also go over all bolts with wrenches and tighten them up.

of line is within twenty feet throw, it is cheaper to move the track than to take it up and relay. This work, like changing rails, is usually done on Sundays. It is, however, possible to be done in the week, if there is an occasional half hour or so between trains. It requires skill and scientific ability.

*Proper Care of Engineers' Stakes.* Grade stakes set by engineers for top of rail for new line should be set so as to be clear of the track when it is being moved to place. If, however, the same grade is to be retained, the foreman in charge should put two intelligent men to transferring the level of the lower rail, using a long straight edge and track level for this purpose. The engineers' center line stakes are liable to be in different positions relative to the old track to be moved, necessitating the latter passing over these stakes in many cases. In order to obviate as much as possible the liability of their being moved, they should be driven sufficiently low to clear the bottom of the rail. Another manner of dealing with these stakes is to pull the spikes out of each tie surrounding the same, so as to allow of the track being moved and leave those ties untouched. This, however entails considerable expense. Another manner of dealing with these stakes is to transfer them so as to be entirely clear of the track when moving. Too great care cannot be taken with these stakes, in order to facilitate the lining and surfacing of the track so changed.

*Preparing Track for Sunday Work.* The bed for the track on a new line should be ballasted and leveled off on tangents, and elevated on curves so that the bed will be within two inches



of the bottom of the ties. It is necessary to prepare this bed with more than ordinary care, so that when the track is moved over to its new position trains can be allowed to pass without the necessity of holding them until the track is tamped. All trains, however should run slowly over this track. When old track is to be thrown entirely clear of the old bed, it is not necessary to dig it out between the ties, but only to loosen it up with a pick, so as to make it easier to throw. This loosening might be omitted, but in that case it would take half as many more men to pull the track out of the old bed. If old track is to be thrown less than the length of a tie, the part occupying the old bed should be dug out slightly below the bed of the ties, and the remainder loosened with a pick. This being done, the track is ready to be thrown.

*Moving the Track on Sunday.* It is necessary that good judgment be used in determining what amount of track can be moved to allow necessary trains to pass without being held, and also to determine the proper place to cut the track so as to prevent the necessity of pulling it longitudinally more than one foot each way. The men may be divided into sub-gangs of not more than thirty men with two foremen each, and a certain piece of track allotted to them. This number of men will admit of being divided, using one gang behind the other in throwing the track, or have one surfacing while the other is finishing the lining and surfacing later. When throwing the track it should not be moved more than twelve inches at any time; this saves the rails and splices and prevents twisting the ties. Rail cuts, to allow for expansion or contraction,

should be at the center of curves, or at as many more places as the degree of the curve and distance to be thrown render necessary. Not less than six men should be placed at each cut, so as to employ three in cutting rails and three drilling; they should first remove the splices from two joints, one on each rail, and pull the spikes on the sides opposite to which the track is thrown so that the ties will be taken along as the track is moved. In order to pass trains after curves have been moved, the line should be changed on the tangents by reversed curve. When the track is in place, two men in each gang with sledge hammers should be put at work tapping the ties to proper space and square to the rail. Track in cinder may be tamped only with shovels and tamped with bars later, after it has consolidated.

*To Move Track During the Week.* After the track is prepared, it is necessary to know how much shorter or longer it will be when moved. This can be ascertained by setting temporary stakes. They should be placed on the line of rail where its position will be when changed, measuring along this new line to the similar rail of the old track, after which this latter rail should be measured between the same points; thus the difference between them is obtained. This can only be done correctly by using a steel tape. When moving track during warm weather, the track to be changed should be first examined, and for every tight or close joint one-eighth inch allowed for expansion; the sum of these allowances must be taken into consideration in ascertaining the difference between the two rails. The rails should then be cut and drilled ready for use. When the time selected

to make the change arrives, and the last schedule train has passed, gangs should begin to throw the track, always throwing toward the point or points cut loose. As soon as the throwing of the track is started, the rails at these points are replaced by those already cut. When the track is finally thrown to position, the ends can be spliced and bolted.

*Policing.* "This work includes the general maintenance of the roadway in neat and proper condition, and is to be attended to continually. Weeds must be kept cut and trimmed to the grass-line; ballast properly dressed and sloped; ditches cleaned; rubbish picked up, and spare material properly placed. Combustible material must be kept cleared from around bridges, trestles, signal posts, etc., dirt and gravel must be removed from bridge seats and trestle caps, and care taken to prevent ballast from working over onto the bridge abutments or falling into streets below. Large loose stones may be neatly piled around the bases of signal posts, sign posts, etc., to keep vegetation from growing. All trees that are in danger of falling on the track, or that interfere with the passage of trains, or obscure the view must be removed or trimmed. If they are on private land, and the owners object to such work, a report must be made as to the circumstances. Any interference with or obstruction of ditches, culverts, etc., by land owners must be prevented or a report made thereon.

"All old track material, links and pins, or other material from cars, old ties, rubbish, etc., must be picked up and removed from the track,

all scrap being carried to the section tool house to be properly sorted and properly disposed of. All scrap iron, lumber, etc., must be neatly piled on platforms. New material, such as rails, ties, etc., must be properly piled or stacked, and no material should be thus piled within eight feet of the track.

“Care should be taken to have a neat and tidy appearance of the section, with track full spiked and bolted, switches cleaned and well oiled, cattle guards and road crossings in good condition, fences in repair and wing fences at cattle guards kept whitewashed, ballast evenly and uniformly sloped and free from weeds, sod line cleanly cut at foot of slopes, and grass and weeds not allowed to grow too high before cutting. Side tracks in yards should also be kept free from weeds and rubbish, old paper, scrap, etc. Station grounds also must be kept neat. Signs must be upright and in good repair. Section houses must be clean and tidy with tools, track material, scrap, etc., properly sorted and placed.

“Every possible means, consistent with general attention to track work, should be taken to keep people from walking on or at the side of the track, and from using the railway as a public path. This is specially necessary near cities where the traffic is heavy. In such cases where people habitually walk on the track, a liberal covering of coarse broken stone or slag, or even cinders may be laid upon the ballast between the rails and tracks and upon the berme at the edge of the roadway. This will soon drive off those

persons who cannot comfortably walk on the ties. This matter is far too often neglected, and railways are themselves partly responsible for the habit which the public has acquired of treating the tracks as a public way.

*Station Grounds and Buildings.* "In order to have a good reputation for the road on the part of the public, it is very desirable that the grounds at stations should be kept clean and tidy and free from rubbish. On some roads this work is delegated to the station agent, who has his men attend to it, while on other roads it is part of the section gang's work. The latter is the better plan if the force is sufficient and the work is done by direction of the roadmaster, the station agent not being given authority to employ the section men for this purpose when he thinks proper. On roads having stations with lawns, flower beds and nice grounds, a special force is sometimes kept to attend to them. For instance the Boston and Albany Railway has on each of its principal divisions a gardener with 5 to 12 men who grade, plant and seed the grounds, and take care of them. These men cut the grass with lawn mowers and do the weeding, trimming of shrubbery, etc. They also attend to places where the banks are graded and seeded. This force is included in the roadway department. The Pennsylvania Railway also employs landscape engineers and a large force of gardeners and spends large sums of money in making and maintaining attractive grounds. As a result it has a reputation for the appearance of its stations. Some

western roads including the Fremont, Elkhorn & Missouri Valley Railway have adopted the policy of making a "park" at most of the stations, sodding the ground and planting trees. It is especially important to have attractive grounds and pleasant surroundings at important stations and at junctions where passengers may have to change trains or to stop over for connecting trains.

"In all ordinary cases, however, much may be done by foremen and station agents who are not averse to putting in a little time in improving the appearance of the station grounds. The agent especially should see that the grounds and platforms are kept free from old papers and other rubbish. A plot of turf, cinder or gravel pathway, a flowerbed, a creeper on the building or on a pile of rock work, can be had with little trouble and have a great effect upon the general appearance of a station. The approaches and surroundings on the town side of the station should be cared for as well as the grounds on the railway side. The platforms should be convenient and in good repair and the fences kept in repair. Many a division superintendent and roadmaster can aid materially in maintaining a good appearance along the road by fitting up a car with brake pumps and paint tanks for painting by compressed air, the work being done rapidly and economically by a few men, and being applicable to stations, freight-sheds, ice-houses, pump houses, section houses, signal houses, signal towers, cabins, station fences, signal posts, and signs, etc., and also

for whitewashing cattle guard fences, interior of sheds, etc.

“The yards, spaces between the tracks, etc. at stations should be neatly leveled, and covered with ashes, and should be kept in order by the section men, but strict rules should be made and enforced against the scattering of ashes and cinders from engines (which should be dumped at specified points) the sweeping of rubbish and dirt from the station onto the track, and the sweeping out of refuse and dirt from the cars upon the track. Every station should have a can or bin for waste paper and rubbish which should be emptied at intervals into a dirt car; similar receptacles should be provided at yards or places where cars are cleaned. At large terminal yards one man may be kept busy cleaning up paper and rubbish. It is a good plan to have station inspectors to see that the stations, waiting rooms, closets, etc., are kept in proper and sanitary condition, and that the grounds are properly cared for. Cleanliness should be enforced in every case, but the standard of appearance will, of course, vary according to the financial condition of the road and the size of the force. The same is true of section boarding houses and tool houses.

*Old Material.* “In all renewals and the periodical policing of the track, cleaning up of yards, etc., it must be borne in mind that new material must be properly used and cared for, and not wasted, and also that no old material should be simply thrown away as useless. Even if really

useless for railway purposes, the material in the aggregate has a certain selling value, which, if the material is thrown away, is wrongfully lost to the Company. These remarks apply also to the wreckage and scrap resulting from train accidents and the burning of cars. Record must be kept of the disposal of all scrap and old material.

“Old rails should not be left hidden in the grass and weeds of the right of way, but properly piled for shipment as they may be used for side tracks or branches, sold for scrap, or even made into new rails of somewhat lighter section by heating and rerolling. Old ties have rarely much value, but if thrown away, sold, burnt, used for cribbing, etc., all unbroken spikes should first be pulled, and when ties are burned the ashes should be raked over for spikes. In piling old rails, the splice bars and bolts should all be removed, good splice bars sorted in pairs and broken bars kept separate. Nuts and bolts, if good, should be kept together, but broken bolts should have the nuts removed and kept separate. Many spikes that now go from the track to the scrap heap (or down the bank) might be used over again if properly driven in the first place and properly drawn. Foremen should be careful to see that all track and car material, etc., is picked up regularly and that their men do not get in the habit of flinging old bolts, spikes, etc., down the bank. In removing bolts, the nuts should be unscrewed properly, the bolt taken out, and the lock and nut put back on the bolt. If, however, the nut is so rusted or wedged on the bolt that



it will not unscrew, it is more economical to knock off the nut with the end of bolt in it, with a sledge, than to waste time in forcing the wrench. Only good discipline and good management of men can insure the exercise of proper judgment as to when to knock off nuts in this way. If a wedge or rusted bolt has to be knocked out, care should be taken not to hit the head of the rail.

“At the section tool house the scrap should be piled and sorted (as described under ‘Policing’) nuts taken off broken bolts, etc., this work being done in wet or stormy weather or when the men cannot work on the track. All scrap iron, lumber, etc., must be piled neatly on platforms, car scrap, links, drawbars, couplers, etc., being kept separate. Small scrap, such as bolts, nuts and spikes, may be kept in shallow boxes or in old spike and bolt kegs. Rails may be piled on the right of way at mile posts, but should not be piled with splice bars and bolts left on. Old ties may be stacked on the right of way until permission is given to burn them, the ties removed being piled at the end of each day’s work and not left in the ditch or on the roadbed.

“Under this heading it will be appropriate to refer to the treatment and disposal of the material found in the general scrap pile at the division points or main shops, which subject has been discussed by Mr. J. N. Barr of the Chicago, Milwaukee & St. Paul Railway in a paper before the Western Railway Club. The style of material delivered for the scrap pile is significant of the

character of the men sending it, as for instance one man who is somewhat careless and finds it easier to use new material than to sort out the serviceable from the unserviceable scrap at his tool house, will send in many old bolts and nuts that are good for further use. In some cases it may be advisable to go to the expense of putting in a set of small rolls, to bring odd sizes of iron to standard sizes for bolts, plates, etc.; a shear (perhaps operated by an airbrake cylinder with 4 feet lever and 6 inch jaw) for cutting rods, or even to build a small furnace for heating angles, etc., to be rerolled. Of course it must be borne in mind that while with a single large scrap pile at one large central shop it may be economical to carefully sort and handle the material and treat it as above noted, this may not be the case with several smaller piles at divisional shops. Also, that in some cases an article made by treating scrap may be more expensive than a newly purchased article of the same kind. These are matters for the exercise of judgment and calculation in order to insure real economy.

“In most scrap piles there is a great proportion of bolts. These may be sorted as to their diameters and length and stored in compartments. Stub ends of  $\frac{3}{4}$ -inch to 1-inch bolts, about  $5\frac{1}{2}$  inches long, may be used for making track bolts, a bolt heading machine at the shops being equipped with suitable dies. Nuts may be cleaned of rust by pickling in a weak solution of hydrochloric acid and then used again, or if damaged they may be slightly compressed by dies in a bolt

heading machine and then retapped. Plates and shapes may be utilized for small plate girders to cross culverts, etc. Lining bars, crawbars, wrenches, etc., may be successfully made from scrap steel tires, and the slide plates for switches may be made from elliptic springs, the plate being heated to a cherry red and then put in a bulldozer, where it is sheared off and has two square holes punched at one operation. Old flues, which bring little as scrap, make good fencing for station grounds, posts for track signs, or grates for cinder pits, where fireboxes are cleaned out. Old fish plates or plain splice bars may be sheared to length and stamped to shape for rail braces.

“In sorting, care should be taken to pick out any new or practically uninjured material which may, by accident, or carelessness have got in with the scrap. When sorted the stuff should be arranged so as to be easily seen and got at, but discrimination should be exercised so as not to store a lot of miscellaneous material on the chance of its being of some possible use eventually.”\*

*Inspection.* Inspection of tracks should be made daily by the track walker, twice a week by the section boss, and once a week by the roadmaster. Figs. 345 and 348 illustrate inspection cars suitable for roadmasters, engineers, superintendents and others when examining track or other portions of the property distant from depots. The following is a description of a motor inspection car, designed for inspection purposes.

---

\* “Railway Track and Trackwork,” Tratman, pp. 311-315.

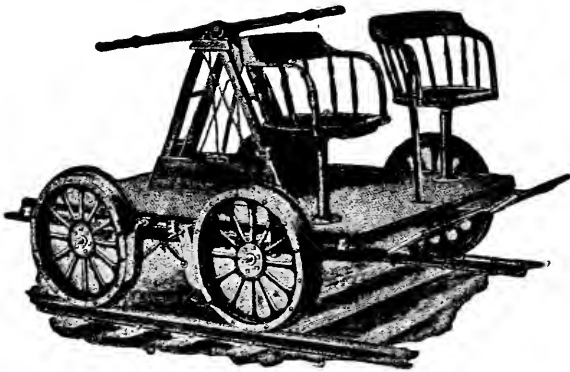


FIG. 345.

## INSPECTION HAND CAR.

Especially designed for light uses in track work; made as light as possible, consistent with strength. Two revolving chairs on front platform. Weight, with chairs, 470 lbs; without chairs, 390 lbs. Wheels, wood centre, light pattern, 22 inches diameter, or 20-inch light steel, as desired.

The car weighs about 300 pounds and can be quickly put on and removed from the rails by one man, being so arranged that it can be pushed about on one wheel by lifting up one end.

Gasoline and an electric battery supply the motive power. The battery consists of a series of eight dry cells, which with proper care will run the car over 900 miles.

To start the car is simply to turn on the gasoline, move a lever which connects the battery with the cylinders—the work of but a few seconds. To stop—the gasoline and battery are turned off and the brakes applied.

As it can be started in a few seconds, as frequent stops as desired can be made and no delay

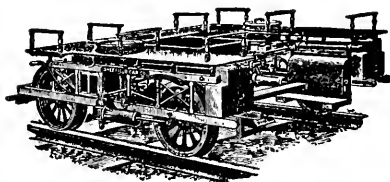


FIG. 348.

DOUBLE OR FOUR- WHEELED MOTOR CAR, FOR INSPECTION PURPOSES.

A variation of the Motor car is the double type. In this case two complete single three-wheeled motor cars are used, and after discarding the third wheel, together with the arm and brace rod, the two main frames are joined by a seat that runs across the front of both, containing ample room for four persons. Back of this, but between the two main frames, is a platform upon which a considerable amount of hand baggage or tools can be carried if desirable. At the rear of the car the two driving axles are united by a connecting shaft having universal couplings, by which means any propelling impulse communicated to either of the rear drivers is received by both. There is also on each of the main frames a rear seat for an operator, making a capacity on the device for six persons. Each main frame having its full double engine, there is ample power for use of the car with its full load under all ordinary circumstances.

These double cars are so arranged that they can be disconnected at any time and used as two three-wheeled cars.

experienced when ready to proceed. A speed of over thirty miles an hour can be developed on a straight level track, so that the car affords a quick and satisfactory means of getting over the ground. The speed is always under the control of the operator, and the car can be run as fast or as slow as desired. It is inexpensive to operate. A gallon of gasoline will ordinarily run the car over seventy-five miles. Provision is made for carrying with the car four gallons, or sufficient for a run of about 300 miles. It will carry three persons; the operator who sits in the rear, and two passengers on the front seat, which is shown open in the cut, but which folds up for convenience when not in use.

On some railroad systems there is an annual inspection, this generally is done in the Fall. This inspection covers track and the property generally.

“The annual inspection of the Wabash Railway is conducted to determine the condition of each section and division of main track and sidings, in the following particulars: 1, line and surface; 2, level; 3, joints, ties and switches in the main track; 4, drainage; 5, policing; 6, siding (meaning all tracks outside of the main track, and these must be inspected, marked and kept separately from markings on main track). These conditions shall be determined by a system of marking for every mile of road; 10 shall indicate perfection; 5 shall indicate a condition unsafe for a speed of 25 miles per hour, and 0 the worst possible condition, intermediate numbers being used to indicate intermediate conditions.

“The annual report shall show the total expense for labor for the year on each mile of main track, and each mile of side track, the rating being determined as hereinafter set forth. The yard sections shall be classified together for the first and second premiums the same as the districts.

“The final rating of each section, for classification, shall be made as follows: The conditions noted under the markings Nos. 1, 2, 3, 4 and 5 shall be reduced to an average rating, which, in a column of the report shall represent the general average for conditions noted on main track. The general average of conditions under marking

No. 6 in its column, will indicate the general average of conditions noted on all sidings.

“Sections having iron rail shall be allowed one point over steel rail, sections having steel rail in service eight years and upwards, half a point, provided this difference does not increase the result above 10. This point will be added to final average and will not be noted by the inspectors. The sections on each division roadmaster's territory showing the highest general average shall be rewarded by a premium of \$35.00 to the section foreman and the second highest average by \$25.00.

“1. Line.—True line means straight line on tangents and uniform curvature on curves so far as the eye can detect. When these requirements are fulfilled the condition must be represented by 10.

“Continuous and very apparent deviations from the true alignment over the entire length of one mile, which would limit the maximum speed for the safe passage of trains to 25 miles per hour, must be represented by 5. A condition of alignment which would be difficult for a train to pass, should be recorded as 0.

“Conditions intermediate between those described above shall be indicated in the proper ratio representing these conditions.

“Surface. True surface means a uniform grade line between changes of grade, and the conditions must be noted as in regard to line.

“2. Level. The inspector must watch the level index and must note unusual oscillations of

the car due to unlevel track on tangents, want of uniformity of elevation on curves, or unequal gauge.

“If the inspector can detect no vibration or oscillation of the car due to unlevel track on tangents, and want of uniformity on elevation of curves, he will record the condition as 10 and intermediate conditions must be recorded as already noted.

“3. Joints, ties and switches. A perfect joint is one that is fully bolted and tight. Ties must be properly spaced as per standard plan, and fully spiked with four spikes in each tie. Ends of ties, one side must be parallel with rail. Switches must be placed exactly as shown in standard specifications. When these are fulfilled the condition must be represented by 10 and intermediate conditions recorded as already noted.

“4. Drainage. The ditches shall be uniform and free from obstruction, and with sufficient incline to afford proper drainage. Ballast should be uniform and equally distributed. Any condition less than described in the foregoing will be represented by such fraction of 10 as it bears to the required condition.

“5. Policing. This shall consist of the following items, and a perfect condition in all these respects shall be represented by a marking of 10.

“A. Cross ties and iron must be piled according to the general rules.

“B. Grass, bushes and weeds should be kept cut close to the ground within limits of right of way, and not allowed to grow closer than within



6 feet of the rails. Stumps and logs should be cleared from within limits of right of way.

“C. Road crossings must be in accordance with standard plans and must be clear and safe for the passage of animals and vehicles.

“D. Signs must be placed in position as required in standard clearance diagram.

“E. Cross and line fences shall be kept in repair after being constructed by fence gang. They shall be of standard plans. Cross fences and cattle guards shall be clear of all grass and weeds, and shall be whitewashed.

“Any conditions less than prescribed in foregoing subdivisions will be represented by such fraction of 10 as it bears to the required condition.

“Expense. The section which is maintained at the least expense shall receive 10 points. The amount of expense on each section to be determined as follows: From the aggregate expense of the year shall be deducted the cost for extra work, such as placing ties, rails, ballast and ditching for which credit will be made as follows: Ties in rock ballast credited at 20 cents per tie; ties in gravel, cinder or earth ballast 8 cents per tie; rock ballast credited at \$2.50 per car; other ballast at \$1.00 per car; rail laid credited at \$1.50 per 100 feet, ditching at \$1.00 per 100 feet. After this deduction is made the section showing the least expense will be marked 100, which, divided by 10, will give the rating of that section. For each additional \$10.00 of expense over the lowest section for all other sections, deduct one point from 100 points, the remainder after being

divided by 10 shall be the rating of that section regarding expenses on the general report, and shall be recorded as the average expense of all miles on that section.

"The inspection committee shall consist of six or more persons or shall be arranged as shown on the accompanying form. (The form or card is 9½ inches long and 6 inches high with ten lines under the heading.) The general superintendent will assign duties to inspectors on the day of inspection. The placing of different members of general committee on the several sub-committees will be performed by the officer in charge of inspection. Each member of these committees will be furnished with a form showing the conditions which he must note upon which he must indicate the rating of each mile.

"The officer in charge of inspection shall take up all forms when rating has been placed thereon, and make a general report to the general superintendent showing the rating of all sections as hereinbefore described, showing the names of all persons entitled to a premium. The general superintendent will then cause the awards to be made, and have signs placed on sections to which premiums have been awarded, which will indicate the standing of that section on each subdivision.

"The form of the report is as follows, being printed on sheets about 12 inches wide and 24 inches high. The line of the first prize is printed in heavy faced type and that of the second prize in italics."\*

---

\* "Railway Track and Track Work." *Tratman*, pp. 337-340.

District.	Section.	Miles.		Committee No. 1. 2 persons.				Committee No. 2. 2 persons.		Committee No. 3. 2 persons.			Expense.	Remarks.
		Main track.	Side track.	Line.	Surface.	Sidings.	Joints and ties, switches in main track.	Drainage.	General.	Policing.	Fences.	Rating		
				1	2	3	4	5	6	7				

..... Foreman. .... Inspector.

FORM OF INSPECTION MARKING CARD. WABASH RY.

District.	Section.	Location.	Name of Foreman	Total expense for labor.	Length, miles.	Expense per mile for labor.	Line.	Surface.	Slidings.	Joints, ties and switches, main track.	Drainage.	General.	Expense.	Average rating.	Premium Section.	Re-marks.	Roadmaster.
6th	200 210	Ritchie.....	N. Anderson.	\$981.16	6.0	\$163.2	9.3	9.3	6.9	8.8	8.8	8.6	9.5	8.742	...	.....	John McKeown.
		Essex.....	J. Donahue...	894.99	6.0	149.16	8.9	8.8	8.5	9.2	9.2	9.0	9.6	9.6	9.028	210	1st prize.
7th	211 212	Reddicks...	Thos. Ferriter	901.91	6.0	150.31	9.1	9.1	7.0	9.3	9.1	9.2	9.6	8.914	...	.....	"
		Campus.....	J. F. Ricketts.	975.56	6.0	162.59	9.2	9.1	7.0	9.3	9.4	9.2	9.5	9.5	8.957	212	2d prize.
	213	Essington..	Michael Gust	1,083.25	6.0	180.54	9.2	9.1	7.0	9.3	9.3	9.0	9.3	8.885	...	.....	"

FORM OF RECORD OF TRACK INSPECTION. WABASH RAILWAY.

## CHAPTER IX.

### WRECKS.

So long as human beings are fallible and the material with which they work falls short of perfection, accidents will occur in the operation of the most scientifically constructed railroads. Hence every railway company, anticipating the inevitable, provides for the disaster that must sooner or later occur. To accomplish this there should be kept at each division headquarters a wrecking outfit consisting of a tool car and derrick car. These cars should at all times be in charge of one competent man who should be a mechanic. He should have a list of the tools required and should see that they are all on hand and in first class condition for active service at any moment. There should be 15 to 20 men selected from the shop and yard force who can be used at wrecks. These men should hold themselves ready to be called out at any time. Their duties should be assigned them when organizing the force; thus one should be an engineer capable of handling a locomotive; two or three should be able to make all kinds of splices, hitches and knots with ropes; others should be familiar with the use of hydraulic and other jacks, etc.

The following is a list of tools which should be kept on a wrecking or tool car:

Heating stove.	Scoop shovels.
Hand saws.	Pinch bars.
Axes.	Cold chisels.
Adzes.	Clevises.
Wheel gauge.	4 pairs rubber boots.
Steel wrenches.	Pair patent frogs.
Soft and chipping hammers.	Iron-bound wedges.
Track shovels	Red flags.
30-inch steel bars.	Red, white and green lanterns.
12 torches.	Oil and waste for packing.
16-foot ladder.	6 baskets (grain) 2-bushel.
Assorted sizes drift bolts.	6 water pails.
Coupling links and pins.	Standard journal brasses for foreign cars.
8-inch and 12-inch pony jacks.	2 hydraulic lifting jacks, 15 and 20 tons.
Standard frogs.	2 ratchet lifting jacks and levers.
Switch chains.	A few hundred of spare 1-inch to 2½-inch guy lines and snatch blocks.
Torpedoes.	A small coil of telegraph wire and a few insulators and other telegraph supplies necessary to start an emergency office.
Portable stretcher.	A full set of edge tools, the personal property of the foreman of the wrecking crew.
2 gallons alcohol.	
Packing hooks and spoons.	
12 grain sacks, 2-bushel.	
Water barrel.	
Cross-cut saws.	
Hand axes.	
Sledge hammers.	
12 and 15-in. monkey wrenches.	
Spike mauls.	
4-inch rolling line.	
Picks.	
1 pair of climbers.	

The following tools should be kept on the derrick car:

- 1 truck line, 2½ inches diameter, 250 feet long.
- 1 truck line, 2½ inches diameter, 200 feet long.
- 2 second-hand steel rails.
- 4 iron bound wedges.
- 6 switch chains.
- 3 truck chains.
- 2 wire cables, 1½ inches diameter.

A thirty-five ton steam wrecking crane is illustrated by Fig. 349. Some roads, however, still

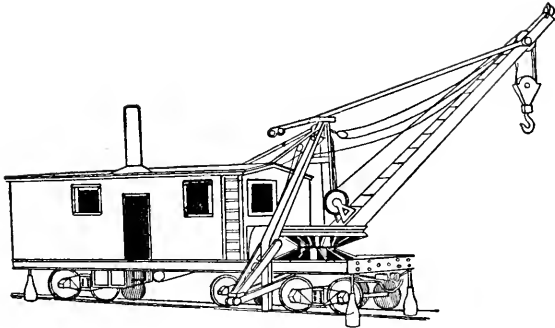


FIG. 349.

## 35-TON STEAM WRECKING CRANE.

Unusual stability is obtained by the powerful steel jack-arms which are hinged to base of A-frame. These jack-arms extend to a lateral base of 19' and are arranged to fold up when not in use. The car is also provided with two additional jacks and four rail clamps. Ample stability is obtained for all ordinary loads by means of jack-screws and rail clamps. It is only necessary to let down the jack-arms when heavy loads are to be lifted and swung to the side. For the lifting of the maximum load in extreme side positions, it is necessary to still further anchor the machine by means of side guys to the top of A-frame, and ring bolts are provided in the head for this purpose.

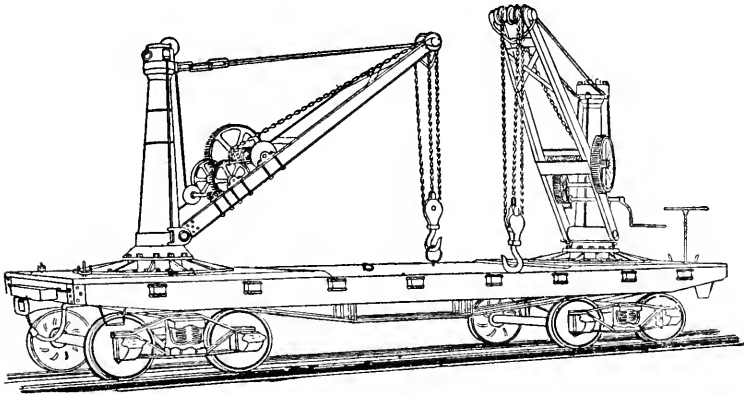


FIG. 350.

## 15-TON DOUBLE MAST HAND WRECKING CRANE.

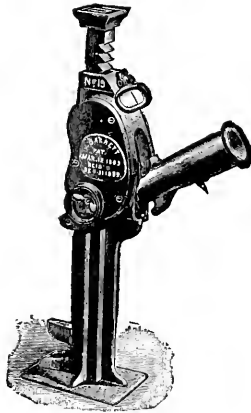


FIG. 351.

## AUTOMATIC LOWERING JACK.

This car repairing and wrecking jack is fast taking the place of the slow, cumbersome hydraulic jacks, for lightly loaded and empty cars, etc. It is more portable, more easily applied, and less liable to derangement, and in fact is in every way superior. It is stanch and tall. Forged steel raising rack for reaching under car beds and lifting same above obstruction. By means of its side lug it can grapple low set loads with equal facility. Lifts and lowers on downward stroke of lever only. The direction can be quickly reversed at will of operator. Height when rack is down, 28 inches; rise of lifting rack, 17½ inches; size of forged steel rack, 2x1¾ inches; weight, 90 pounds.

use hand wrecking cranes. Fig. 350 represents a car equipped with two 15-ton hand cranes, though sometimes only one crane is placed on the derrick car. A jack for lifting loads is shown in Fig. 351. Fig. 353 illustrates a hydraulic jack capable of raising 30 to 40 tons.

Various styles of wrecking frogs are illustrated by Figs. 354 to 356.

When a wreck occurs the first duty of the officer in charge of running trains is to order the wrecking train and crew and all available sec-



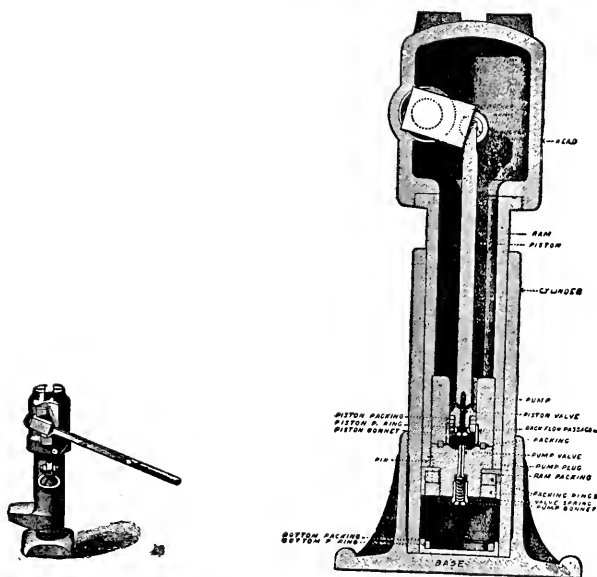


FIG. 353.

## DUDGEON'S HYDRAULIC JACK.

Showing construction and names of parts.

tion men to the scene. The first duty of a section foreman when he receives notice that there has been an accident and he is wanted there, is to collect his men and take his hand car and all his portable tools, even those which he thinks he is not likely to use. He should not go short of tools, expecting that the other foremen there will have enough. The other foremen may think the same, and valuable time will be lost by the want or forethought of both. The following specific directions are given to trackmen by an authority on the subject.\*

\*Kindelan, "The Trackman's Helper."

“When a track foreman arrives at the scene of the accident he should proceed immediately to do whatever work, in his judgment, would contribute most to putting the track in a passable condition for other trains, notwithstanding the absence of his superior officers, who may not be

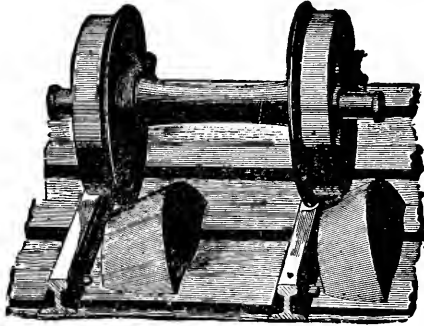


FIG. 354.

TILDEN WRECKING FROG.

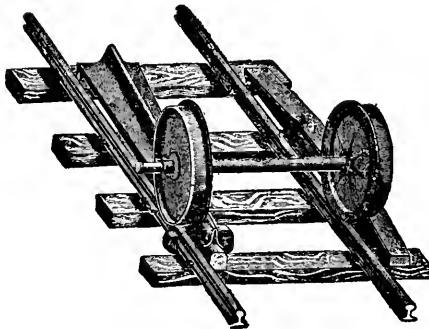


FIG. 355.

PALMERTON WRECKING FROG.

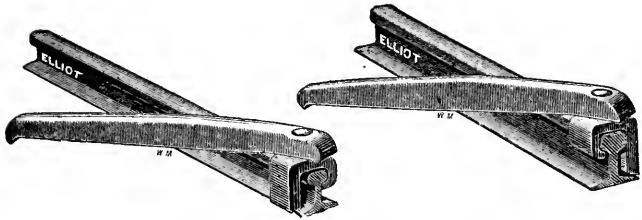


FIG. 356.

## ELLIOT CAR REPLACERS OR WRECKING FROG.

able to reach the wreck for several hours. If the track is torn up and the cars do not interfere, put in ties enough to carry a train safely over where you can. If the rails are bent out of shape secure some from near by if it is possible. If this cannot be done, get as many as possible of the damaged rails to their proper shape and spiked down in the track.

“If a small bridge or culvert has given way, crib it up with ties until you can cross it with track. If you cannot procure the ties along your section and many are not needed, remove a part of the ties from the track where it is full tied and where it will leave a sufficient number in the track to make it safe for the passage of trains.

“In the same manner if you are short of bolts and spikes and too much time would be lost by going after them, borrow some from track where they can be spared and fix track to let trains pass.

“If one or both trucks beneath a car should leave the track at once and turn across it as is often the case, uncouple from car and hitch a

switch rope to the corner of the truck and to the draw head of the car next to the one which is off the track. Then pull the truck into a position parallel to the track, after which it can be put on the rails with the wrecking frogs.

If the car should be loaded very heavily, it might be advisable to raise the end with jacks before squaring the truck. If the right man undertakes this job, the train need not be delayed over thirty minutes.

“Sometimes when a car leaves the track, the center pin breaks or is so badly bent that it cannot be used again. This often happens on the road where there is nothing at hand to remove the crooked pin. In such a case, if the car is empty or not heavily loaded, it is best to roll the truck from beneath the car off the track, and haul the car into the station carefully supported on that end by the regular coupling pin and link.

“When the ends of a broken center pin do not project the end of a car can be jacked up, the truck placed in position, and the end of the car again allowed to rest in its place on the truck, after which, if watched carefully, the car can be hauled a long distance.

“It often happens that a car gets off the track in such a place that it is impossible to get the help of an engine to pull it on again without considerable delay. When a case of this kind occurs and there are other cars on the track near by, take the car nearest to the one off the track and couple the two together with a chain or rope long enough to give plenty of slack. Then get to-

gether what men are available and push the car which is on the track close to the wrecked car. When you are ready to pull the wrecked car up on the track, start the car which is coupled to it away from it as fast as the men can push it. The jerk, when the slack of the line is taken up, will pull the car on the track as well as an engine can do it. If you have men enough, use for the motive power, two or more cars if necessary. This is what is called 'slacking a car onto track.'

"When cars have got off the track and are still on the ties, it is best to put blocks or ties between those in the track to keep the wheels from sinking between the ties. By doing this at once before attempting to put the cars back on the track, will generally save considerable time and labor.

"If an engine or car mounts the outside rail of a sharp curve, and persists in running off the track, oil the rails thoroughly where the most trouble is experienced. This will generally allow the engine or car to go around the curve without leaving the track.

"Very rusty rails on a curve track which has not been used for some time, often cause the wheel to mount the outside rail of a curve, the surface not being smooth enough to allow the wheels to slide.

"If at any time you find the connecting rod of a stub switch broken, or you want to use the switch and have no switch stand, slip a car link between the ends of the lead rails, allowing enough of it to project to hold the ends of the

moving rails in place, or take a piece of plank of the right shape and use it in the same way as the link. This is better.

“When the car trucks are thrown some distance from the track in a wreck, the quickest method of putting them on the track again if you have no derrick car, is to take bars and turn them almost parallel to the track, but with one end a little the closest to the track. Hitch a rope to this end of the truck and to the engine or the nearest car which is coupled to the engine, and the truck will pull onto the track easily, if there is nothing to obstruct its passage.

“A link made of iron or steel and fashioned after the pattern shown in Fig. 357 is very handy

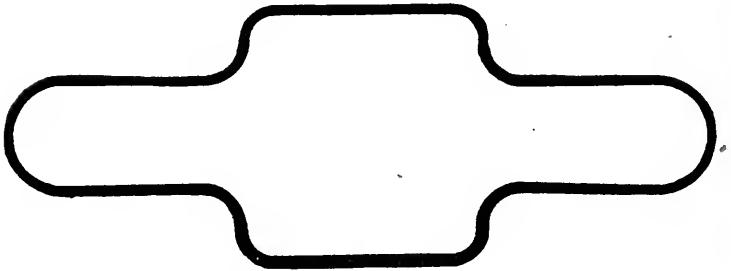


FIG. 357.

DEVICE FOR SPLICING A BROKEN CHAIN.

to have when at a wreck pulling cars or engines with a chain. If a chain breaks the two broken ends can be brought together, and fixed in this link as if held with a grab hook.

“When car trucks are sunk in soft ground at a wreck, and there is no derrick car or other lift-

ing apparatus at hand, a good way to handle them is to place a tie cross way in the ground about four or five feet from the truck then place two more long ties or timbers with their centers resting across the first tie and their ends in front of the truck wheels. The truck can then be pushed up on top of the long ties as if on a track. When it is centered over the bottom tie, the truck can be easily turned to run in any direction.

“Trackmen in charge of a ballasting outfit if they are new in the business are often at a loss to know the quickest way to put a plow back on the cars if it should accidentally be pulled off on the ground. The best way to do in such a case is to roll the plow or pull it with the engine and cable into the same position on the track that it would occupy on the cars; then raise up the snout of the plow until you can back the end of a car under it, hook the end of the cable to the plow, block the car wheels and pull the plow on to the car with the engine.

“If the hind truck of any kind of a car should by accident be derailed, broken or rendered useless, the car should be taken to the next station by uncoupling it from the cars behind it. Remove the disabled truck from the track; then take the caboose jacks and raise the body of the car enough to slip a tie under it across the track rails; let the car down upon the tie, and by running carefully the car can be hauled to the station or side track, sliding on the tie.

“It is always best when a wrecked car is loaded, to remove the load, or transfer it to another car

on the good track. Outfits starting to go to a wreck should provide themselves with all the tools and appliances necessary for this purpose.

“Car-truck center-pins which have been twisted or broken in a wreck may be removed by going inside the car and cutting away with a hammer and cold chisel the iron ring which forms the head and shoulder of the pin. The pin may then be driven down through the bottom of the car.

“There should always be a man on hand at a wreck to look after such jobs, and promptly remove all break-beams, hanging irons, etc., so as not to delay the work after the cars are picked up or ready to be put on the track.

“When pulling on a chain or rope with a locomotive at a wreck care should be taken not to have too much slack, as chains break easily. The same is true of switch ropes, but when they are new or not much worn, they will stand a greater slack strain than a chain will. Wire cables are preferable to either a chain or a rope for pulling, and they will stand a much greater slack strain, if not allowed to become twisted out of shape.

“There is always danger of chains or switch ropes breaking when engines are pulling on them at a wreck, and those working near should not be allowed to stand too close to them.

“What is generally termed ‘a dead man’ is a device sometimes used to anchor a guy or stay rope where wrecking cars, engines or derricks have to do very heavy hoisting or pulling. It is made by digging a trench five or six feet at a proper distance from the track and parallel to it.



A narrow cross trench is then dug, slanting upward from the bottom and middle of the first trench to the surface of the ground. A good track tie or heavy timber is then buried in the first trench, and the rope is passed down through the cross trench and secured to the timber.

“The first thing to do with a wrecked engine, if the frame is good, is to take jacks and put the engine in an upright position, such as it would occupy if standing on the main track. It may then be blocked up and raised sufficiently to place under it rails and ties, forming a temporary track. The main track should then be cut at a rail joint, and lined out in an easy curve until the ends of the rails are in line with the temporary track. The tracks should then be connected, and the engine pulled upon the main track. If the engine stands at such an angle as to require a very sharp curve in the track over which it is pulled, put plenty of oil on the track rails, and elevate the outside rail of the curve.

“If the engine is only off the rails and still on the track ties, additional rails may be spiked down to the ties in front of the wheels like a switch lead, and connected with a pair of the track rails. The engine may be pulled on again over this lead and the main track closed. This method is quicker and better for putting a derailed engine on the track when more than one truck is off the rails, than using frogs or blocking.

“The first thing to do at any wreck of importance, where cars block the main track, is to use the first locomotive which can be put into serv-

ice, and with switch ropes pull clear of the tracks all cars, trucks or other wreckage which cannot be readily put back on the track with the facilities at hand for doing such work. Proper care should be taken, in doing this part of the work, not to injure freight in the cars. When necessary, remove it from the wrecked cars to a place of safety, and pull the cars and truck into a position alongside the track, where it will be handy for the wrecking car to pick them up after it arrives.

“The moment the track is clear of wreckage, the track force should go to work and repair it, and quickly put it in good condition for trains.

“Track foremen should not allow their men to become confused or mixed up with the other gangs of men which are present at a wreck, except when it is necessary for more than one gang of men to work together; even then the foreman should keep his own men as much together as possible, so as to always be able to control their actions and work them to the best advantage.

No matter what part of the work at a wreck a foreman is called upon to do, he should act promptly, and work with a will to get the wreck cleared up, and the track ready for passage of trains with as little delay as possible.”

## CHAPTER X.

### MAINTENANCE OF BRIDGES AND BUILDINGS.

The organization of the Bridges and Buildings Department of a railroad corresponds with that of the Maintenance of Way Department, the official known as the Superintendent of Bridges and Buildings corresponding to that of Roadmaster in the Maintenance of Way Department. Their relations to the operating and engineering departments are similar.

The Superintendent of Bridges and Buildings is given more mileage than the Roadmaster; it varies from 300 to 400 miles of single track; where the road is a double track one, and bridges are frequent, the mileage is decreased; where, however, the bridges are of iron and the culverts of stone or iron, the mileage can be increased.

The general repair work under the supervision of the Superintendent of Bridges and Buildings requires three gangs of men, each of which is in charge of a foreman known as the bridge foreman or boss carpenter. The number of men employed in the gang of each boss carpenter will depend largely on circumstances and the number of bridges and buildings under his supervision. Where a road is located in a thickly settled country, no special outfit is required except a tool car; in a thinly settled country, however,

each gang will require a boarding outfit, which generally consists of four or more cars, the first for cooking, the storing of provisions and the sleeping rooms for the boarding boss; the second for a dining room; the third provided with bunks for the men to sleep in; and the fourth for the tools.

The tools required by a gang of bridge carpenters consist of:

Name of Tool.	No. of Fig.	Name of Tool.	No. of Fig.
Adzes .....	264	Lanterns, white.....	283
Axes, chopping .....	265	Level, spirit.....	297
“ hand.....	281	“ track.....	307
“ broad.....		Oil can.....	285
Augers.....	358	Oiler.....	286
Brace and bits.....	271	Pump, bilge.....	373
Boring machine.....	359	Pick, earth.....	289
Bars, claw.....	275	Pile driver.....	
“ crow.....	360	Padlock, R. R.....	288
“ pinch.....	361	Saws, hand.....	293
“ shackle.....	362	“ cross cut.....	294
Blocks and falls.....	363	Spike, maul.....	299
Cars, hand.....	364	“ puller.....	298
“ push.....	365	Sledges.....	300
Cant hooks.....	366	Shovels.....	301
Peveys.....	367	“ long handle.....	303
Timber grapples.....	368	Track lever or lifting bar..	304
Crabs, hoisting or winches	369	Track gauge.....	305
Dolleys.....	370	Torpedoes.....	309
Files.....	278 and 371	Tape line 50 feet long.....	
Flags, red.....		Tool box.....	310
“ green.....		Wheel barrows.....	313
“ white.....		Water buckets.....	
Grindstone.....	279	“ dipper.....	
Hammer, hand.....	382	“ keg.....	
Jacks, hydraulic.....	353	Wrenches, track.....	311
“ screws.....	372	“ monkey.....	312
Lanterns, red.....		“ bridge.....	377
“ green.....		“ wheel.....	378

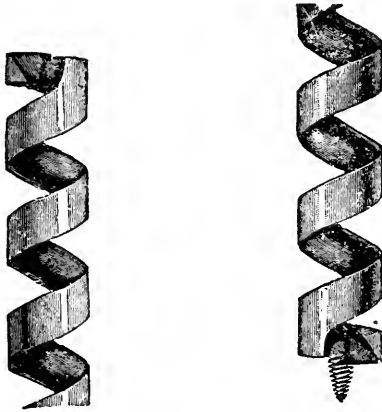


FIG. 358.

SHIP AUGER BITS, USED BY BRIDGE CARPENTERS.

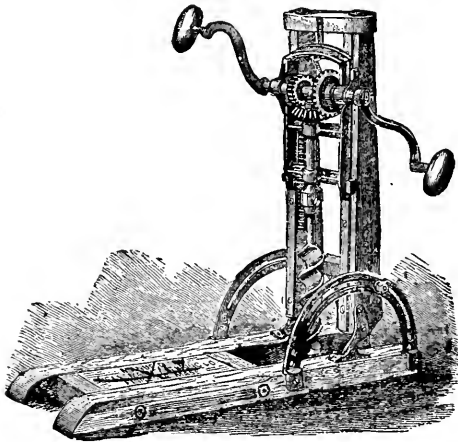


FIG. 359.

BORING MACHINE, USED WHERE HEAVY TIMBERS ARE FRAMED.



FIG. 360.  
CROW BAR.



A



B

FIG. 361.

A PINCH BAR WITHOUT A HEEL.  
B " " WITH A HEEL.



FIG. 362.

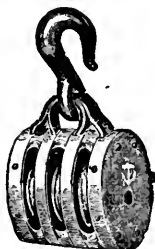
SHACKEL BAR, USED FOR DRAWING DRIFT BOLTS.



A



B



C

FIG. 363.

A. SINGLE BLOCK.  
B. DOUBLE "  
C. TRIPLE "

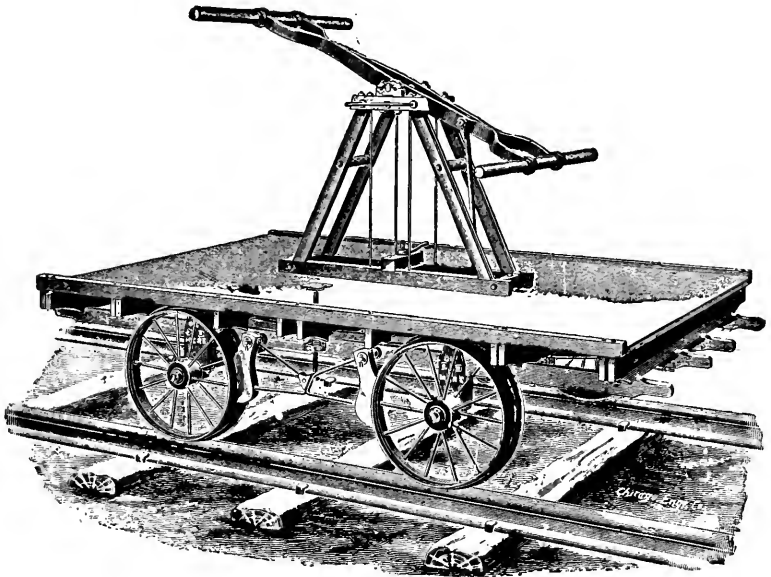


FIG. 364.

BRIDGE HAND CAR, CONSTRUCTED TO CARRY A LARGER GANG OF MEN THAN THE HAND CAR USED BY A SECTION GANG.

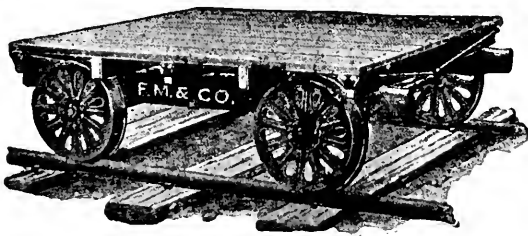


FIG. 365.

HEAVY PUSH CAR FOR USE OF BRIDGE CREW.



FIG. 366.

CANT HOOK USED FOR ROLLING HEAVY TIMBER.



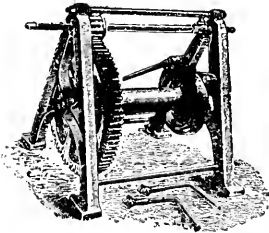
FIG. 367.

PEVEY. CAN BE USED AS A CANT HOOK OR CROW BAR IN HANDLING TIMBER.

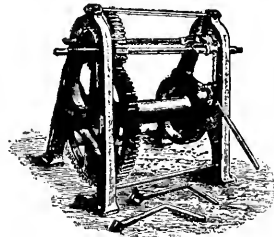


FIG. 368.

TIMBER GRAPPLES OR LOG HOOKS FOR CARRYING HEAVY TIMBER.



A



B

FIG. 369.

HOISTING CRABS OR WINCHES.

A. Single Purchase.

B. Double Purchase.

Used in connection with blocks and falls in hoisting heavy timbers and raising framed bents.



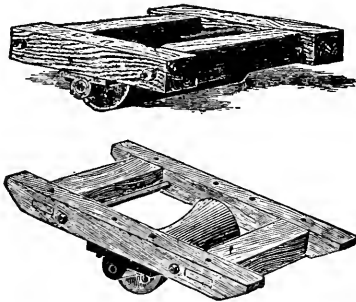


FIG. 370.

TIMBER TRUCKS OR DOLLIES. USED IN HANDLING HEAVY TIMBER.



FIG. 371.

A. TAPER FILE.  
B. DOUBLE END FILE.  
For sharpening saws.



FIG. 372.

HOUSE RAISING JACK SCREW.

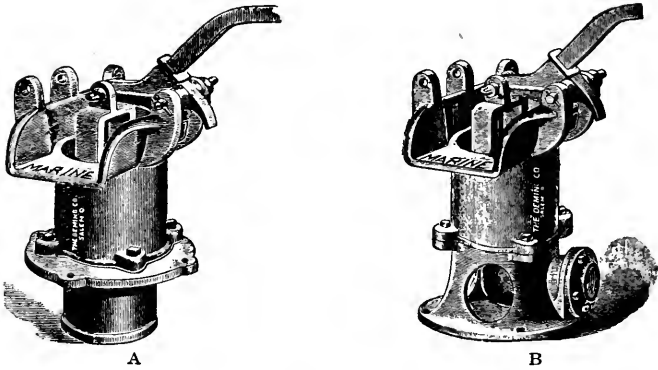


FIG. 373.

BILGE PUMPS.

A. Bottom Suction. B. Side Suction.  
For pumping out foundations.

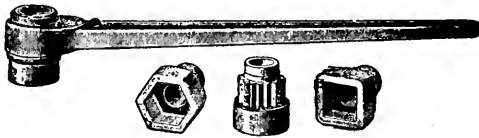


FIG. 377.

STEEL SOCKET BRIDGE WRENCH.

For tightening nuts on large bolts.

There are also required several tool chests of carpenter tools for use when building or repairing depots. It is not necessary to provide each gang with all of the above mentioned tools; while they are necessary some of them will be used only occasionally, and they can be left in charge of the division storekeeper to be issued for use as occasion requires.

The number of each kind of tool required varies with the size of the gang and the char-

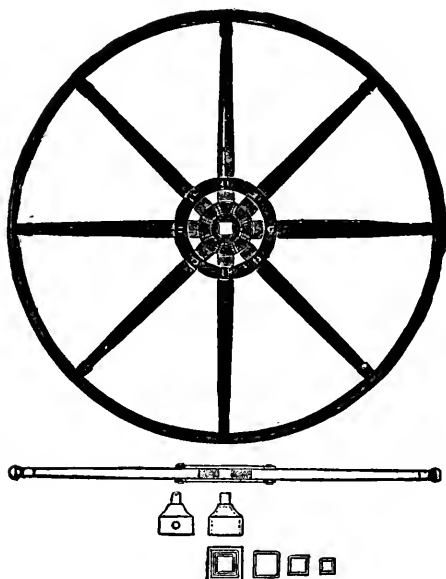


FIG. 378.

WHEEL WRENCH.

Used to tighten nuts on rods which pass through a number of pieces of timber as caissons or cofferdams.

acter of the repairs or new work which is being done. The aim should be to issue only such as are needed and keep the others in the division storehouse where they can be issued as required.

The length of time timber lasts in bridges in the United States was given by a committee which reported to the Association of Railway Superintendents of Bridges and Buildings at their annual meeting in 1899, and is given in Appendix L.

It is the custom of some engineers on new constructions to place the ends of stringers of the first and last bents of a pile or trestle bridge on mud sills. After the embankment is thoroughly settled, piling is driven in the embankment and a cap put on these piles the same as for other bents in the bridge, and the stringers are placed on these caps. This is the first repair work generally required on a new line.

Two general inspections of all bridges and buildings should be made annually; one in the spring when the frost has come out of the ground, and the other in the fall before freezing weather. These inspections should commence at the end where the bridge numbers commence, and each structure should be inspected in the order in which it is numbered. Inspections should be made by the engineer, superintendent of bridges and buildings and the bridge foreman.

The spring inspection should be made to detect damage caused by frost, ice gorges, etc., during the severe weather of the past winter, and also to ascertain the work necessary to be done during the following summer.

The fall inspection is to ascertain if the work laid out in the spring has been properly done, and that the structures are secure; also to ascertain what renewals and repairs are necessary to be made during the following year, so that an estimate of the material and labor required can be made to guide the managers of the property in providing for the outlay for the following year.

Inspections should cover the following points:

Bridge abutments, piers, arched culverts, stone box culverts and retaining walls should be examined for indications of settlement in the foundation, cracks in the face, in the seams or in the stone, and the walls getting out of line on account of the pressure of the embankment being too great for their strength. The foundations should have careful inspection to detect scour of the stream, and the rip rap should be examined to see if it is of sufficient quantity and so placed that during a freshet the current will not wash it away. Iron pipe culverts should be inspected to find if there is any opportunity of the water passing through the embankment along the outside of the pipes, thus undermining the embankment. The outlets of iron pipe culverts, stone arch and box culverts, require inspection to ascertain whether the paving is being undermined and washed down. The inlets to these openings require inspection to ascertain whether they are liable to be choked up by freshets bringing down brush and drift which will cause the water to flow over the embankment.

All dirt and rubbish on bridge seats should be noted.

Timber structures should be carefully examined for decayed and broken members, and all such members noted and their exact location given for the guidance of the foreman of the gang making the repairs. The bracing or framed bents, both longitudinal and sway bracing, should be carefully examined to ascertain that they

are securely fastened to the sills, caps, plumb and batter posts.

Wooden truss bridges should be examined for cracks in the cast iron attachments, such as angle blocks, chord boxes, and post shoes; any indication of the displacement of these members should be carefully looked for; also indications of openings in bottom chords or crushing of the timber in the top of the chord; shearing of clamp daps should be noted and the nuts on all bolts should be tight. The truss rods must be kept taut but not strained, and their adjustment made when there is no load on the structure. The camber should be true and uniform for both the top and bottom chord. Under a live load the deflection should not be excessive and should be the same for both trusses, this should be tested by an instrument. As provision should always be made for the protection of wooden structures from fire, barrels of water or other extinguishing devices are kept in proximity to wooden bridges and other structures. In making inspections these should be noted, to ascertain that the means for preventing or extinguishing fires are kept in proper order.

When inspecting iron bridges, the inspectors should ascertain if the bed plates and rollers are clean, and if the rollers stand so they will move squarely back and forth with the truss; the connections between floor beams and trusses must be examined for splitting of the connecting angles; in case of suspended floor beams particular attention must be given to see if they are tight against

the post bed or free to move. The tension can be tested by springing the tension members. Examination should be made to detect distortion or crookedness in members. Counter, lateral and vibration rods must be kept taut but should not be strained, and must be adjusted when there is no load on the bridge. The center line of all tension members should be in the line of the strain. The posts, lateral struts and top chords should be straight and free from twists. Field driven rivets should be lightly sounded to see that they are tight, and any movement indicated by rust streaks or other signs in any of the members should be noted. The camber of both the top and bottom chords should be regular and similar. Under a live load the deflection should not be excessive and should be the same for the two trusses in the same span.

Buildings and platforms should be inspected for decay in sills, and the foundations should be examined; defects in chimneys should be looked for and the condition of the roof, the fastenings for doors and windows require careful examination. The condition of the floors, siding and plastering must also be noted.

Coal sheds and water tanks should be inspected for decayed timber and defects in foundations.

Overhead bridges for highways require the same inspection as truss bridges.

The foreman of the section gang should go over his section during and after each rain storm, and not only carefully examine the roadbed, but the bridges and culverts; he should remove drift from

the openings and any loose brush and drift which is liable to be washed down and stop up a culvert or drain; the tendency of streams to change their channel should always be carefully considered; the extreme high water should be marked in a permanent manner and the engineer advised so he can take the elevation. After the water has run off the section foreman should again look over the openings for damage done to foundations, rip rap, the outlets of culverts and for any tendency of the water to pass through an embankment on the outside of a pipe or stone culvert.

From the data secured during the fall inspection, estimates of material and the cost of labor required to make the improvements and renewals are made. These estimates are presented to the managers of the property who decide upon the work which will be done during the following season, and the material is ordered for such new structures or repairs as the managers decide upon. The material is delivered as directed by the Superintendent of Bridges and Buildings, the object being to have as small an amount of money as possible tied up in material laying in yards, and on the right of way where it is liable to be destroyed by fire or to be stolen. There should however, be a sufficient supply of material at division headquarters to make small repairs to bridges in case of washouts or other accidents. The material for repairs to large bridges caused by accidents such as fires, freshets, or collisions, should be kept at the general headquarters of the



road. This method reduces the amount of idle money locked up in material to a minimum; where the railway system is a large one, material for extensive repairs to large structures can be kept at two or more points.

The records kept by the Superintendent of Bridges and Buildings should give the date when the piling was driven and the length from the point to the cut off, so that he can judge as to the security of the foundation. The date when all sills, plumb and batter posts, caps, corbels, stringers, ties and guard rails were placed in bridges should be kept in a convenient manner for ready reference, and this record book should be taken along when the inspections are being made.

The first aim of the Superintendent of Bridges and Buildings should be to secure a good foundation for all his repair work; to keep the structure thoroughly braced both while making the repairs and afterward.

All joints should be made to fit snug and the bearing should not come on one corner or edge of a stick of timber, but should come evenly over the whole section of the stick as a plumb post in a trestle or a diagonal or a member of the top or bottom chords of a Howe truss. The caps of a pile bent or the sills and caps of a framed bent should be square with the track on a tangent and radial to the track curve. No repair work should be allowed which throws the strain on a member outside of its center line, thus tending to bend or buckle the member.

In truss bridges the floor beams should always be placed at right angles to the track, this not only makes better riding track, but distributes the load uniformly between each truss. The main and counter braces should always be in their proper condition on the angle blocks before adjusting the truss rods.

“When the span has the required camber and the counter braces are tight, those individual rods in each panel which may be slack should be tightened until each rod in the panel is strained in proportion to its area. When the rods are slack, counter braces loose, and camber less than required, commencing at first set of rods at either end of truss, tighten them evenly, not enough to buckle the counter braces, but enough to so firmly fix the ends of these against the angle block that an ordinary blow with a maul will not start them from proper position, following which, treat the first panel at the opposite end of truss in the same manner. This done, adjust the second panels from each end, and so on, working alternately from each end of the truss toward the center until each set of rods has been put in adjustment. Regardless of how much care has been taken to get the tension on all rods even, many rods will be found to require a second adjustment in order to leave the truss in perfect condition.”

“Be very careful not to overstrain small rods by exerting too much force on them.

“The force required to tighten a large rod is sufficient to break a small one, and good judgment should be exercised to the end that each rod be strained only in proportion to its size.

“Do not attempt to increase the camber in a span by tightening the rods if the counter braces are all tight against the angle blocks. While it is possible to increase the camber in this manner, the result is accomplished at the expense of high initial strain on the rods, buckled counter braces, broken angle blocks, and sheared packing keys and clamps in the chord, each and all of which are much more dangerous than want of camber.

“In practice it frequently occurs that the camber can be somewhat improved, in adjusting a truss, by slacking off the rods slightly in three or four panels each side of the center of the truss, before commencing at the ends of the truss to finally adjust the rods.

“In order to permit the angle blocks to be readily placed in position, the seats for same in the chords are frequently framed with play enough to allow them to move slightly from their original position when subjected to the thrust from the main braces, the bottom angle block moving toward the end of the truss, and the top angle block toward the center of the truss. As this increases the length of the panel in the direction of the main brace, and shortens it in the direction of the counter brace, it is obvious that, in order to preserve the original camber of the truss, new braces should be provided throughout, but usually the movement of the angle block is so slight that, while seriously affecting the camber, the angle of the brace is not changed enough to be noticeable as regards its bearing against the angle block.

“In such cases the counter braces can be shortened sufficiently to bring the truss to required camber without injurious effect on the truss.

“In no instance should this be done without first receiving the sanction of the Bridge Superintendent.

“In adjusting the end panel rods of long heavy trusses, it is advisable to take up a portion of the dead load by means of a screw jack placed under the panel to be adjusted, which relieves the strain on the rods and assists in raising the truss to its proper position.

“The object in doing this is readily apparent from the fact that the wrench can be applied to only one rod at a time, and unless some assistance is given it, half the weight of the truss between it and the opposite abutment is thrown upon the rod.

“A block should be placed between the jack and the chord of sufficient length and strength to distribute the thrust from the jack over all the strands of chord to avoid any movement of the strands upon one another.

“Always remove the jack before allowing trains to pass over the bridge.

“When jack screws cannot be used, nuts should be turned a very little at a time on each rod in rotation. Nuts on truss rods must be screwed up by applying a steady pressure to the wrench, no advantage being taken of the slack between the socket and nut to produce a blow on the nut by an oscillating movement of the wrench, as it not only destroys the shape of the nut, but has a tendency to injure both nut and rod.

“Always support the truss by a post or bent placed under the next panel before removing the end panel main braces and the old abutment block, and do not remove it or allow trains to pass over the bridge until the new block and braces are in place and the truss is again in adjustment.

“Where a broken angle block in bottom chord is to be replaced with a new one, a post or bent must be placed under the next panel point toward the center of the truss, sufficiently strong to support the portion of the truss which would otherwise be unsupported if the braces were removed. When it is impracticable to support the truss in the above mentioned manner, two rods should be provided of sufficient length to run diagonally and in line with the counter brace from the top of the truss over the panel point in which the angle block is to be replaced, to the bottom of the truss under the next panel point toward the center of the truss with heavy wooden gibs top and bottom.

“The gibs must extend several inches beyond the chord on each side and have holes bored through them at the proper angle, so that when the rods are in place there will be one on each side of the truss. The rods are to be tightened until the load on the truss rods is removed, when the main and counter braces, truss rods and angle block can be removed and replaced.

“In replacing an angle block in the top chord support the panel point in which the angle block is to be changed in the same manner, taking care

to leave in all braces which do not abut on the angle block to be replaced.

“No train should be allowed to cross the bridge until the truss is in adjustment and the support, if from the ground, is removed.

“Angle blocks are frequently broken by the shrinkage in the timber of the chord allowing the gib to bear against the ends of the angle block tubes. In this case hard wood shims of sufficient thickness must be placed between the gibs and chord to keep the gibs away from the tubes. In doing this do not slack the truss rods until temporary rods passing through strong wooden gibs have been put in place, one on each side of the chord, as near to the panel point as possible to keep the truss in shape while the rods are loose.

“If more convenient a post can be placed under the panel point, which is to be removed before allowing trains to cross, and truss must be in adjustment for either method before allowing trains to cross.

“The recurring adjustment of the truss and lateral rods in a deck truss, and the inevitable reduction in the distance between the chords resulting from it, makes it necessary to shorten the transverse braces from time to time so that they may not be excessively strained. They must be kept tight, but not tight enough to buckle the timber or displace the strands, against which they abut from their proper position in the chord, as this would result in broken keys and clamps.

“Lateral rods must always be kept tight enough so that an ordinary blow with a maul will not start the ends of the braces from position on seats. The braces must be sufficiently well fastened at center intersections so as not to fall out, even though rods may be slack.

“When it is necessary to use a pile driver in a through span, the end set of laterals must always be in place for the passage of trains, and not more than two intermediate sets of bottom or three of top laterals may be left out during the passage of a train.

“When strengthening a weak chord with reinforcing strands, the key-ways must be framed in both chord and strand, and enough new laterals framed to avoid the necessity of having out at one time more than two contiguous sets of laterals during the passage of trains.

“Speed of trains must be very slow while lateral system is incomplete.

“Camber blocks must always fill the space between the floor beams and stringers, so that each floor beam will take its portion of the load on the stringer.”\*

When it is necessary to reline the track on bridges the engineer should give the centers required.

Overhead bridges should be given a clearance of 22 feet above the rail, the large furniture and vehicle cars having a height of  $14\frac{1}{2}$  to  $14\frac{3}{4}$  feet from the rail to the running board; all structures

---

\* Rules of Southern Pacific Company.

having a less clearance should be raised; if this is impracticable, whips\* or telltales should be placed 150 feet each side of the approach to the structure.

No work should be done during foggy weather or a snow storm, and the bridge foreman and his men should be familiar with the rules of the operating department.†

---

\* Whips are knotted cords hanging from a support across the track: when a train man is struck by them, he knows it is necessary to sit down on the running board of the car or get between the cars to avoid being struck by an overhead bridge or the top work of a through bridge.

† Bridges are also discussed in the chapters on Construction and Standards, and also in Appendix L.



## CHAPTER XI.

### CONSTRUCTION AND MAINTENANCE ACCOUNTS.

No treatise on the construction and maintenance of railways would be complete without a reference to the accounts that are kept and the statistics that are made by railway companies in regard to these features. The field is a large one and, on systems of any magnitude, requires the services of a distinct bureau of the accounting department, the attaches of which are not only found at headquarters, but scattered along the line. This bureau keeps account of every item of material received and disbursed and of all labor expended. It ascertains the cost of each individual structure and improvement, and keeps accurate account of every item of money and labor expended on structures and sections of the track, distributing them to appropriate accounts. Minute Classifications of Construction and Operating Expenses are kept. Thus the general Construction Classification is made up of accounts as follows, to one of which every item of expenditure on Construction is charged: Ballasting, Block Signals, Board of Construction Force, Bridges, Trestles and Culverts, Buildings, Furniture and Fixtures, Clearing and Grubbing, Construction Supply Depots, Construction Trains, Discount, Docks and Wharves, Electric Light

Plants, Electric Motive Power Plants, Engineering, Exchange, Fences, Frogs and Switches, Gas-making Plants, Grading, Interest, Interlocking Switches, Legal Expenses, Miscellaneous Expenses, Miscellaneous Track Material, Rails, Real Estate, Right of Way, Road Crossings and Signs, Rolling Stock, Shop Machinery and Tools, Sidings, Stationery Bond Shares and other forms, Stock Yards, Telegraph, Ties, Tracklaying and Surfacing, Transportation of Material, Transportation of Men, Tunnels, Contra-Construction Earnings. This may be further elaborated as the needs of railways require. The Classification of Operating Expenses (including Maintenance) is divided into four grand divisions as follows: I. Maintenance of Way and Structures; II. Maintenance of Equipment; III. Conducting Transportation; IV. General Expenses. These main divisions are sub-divided according to the needs of the management and the requirements of the Federal and State Government Commissions. Thus the Interstate Commerce Commission requires "Maintenance of Way and Structures" to be sub-divided into ten accounts, to one of which every expenditure on Maintenance of Way and Structures is charged; viz.: (1) Repairs of roadway; (2) Renewals of rails; (3) Renewals of ties; (4) Repairs and renewals of bridges and culverts; (5) Repairs and renewals of fences, road crossings, signs and cattle guards; (6) Repairs and renewals of buildings and fixtures; (7) Repairs and renewals of docks and wharves; (8) Repairs and Renewals of telegraph; (9) Stationery and printing; (10) Other expenses.

The subject, it will thus be seen, is so vast that it is impossible to treat it adequately in one chapter. The reader will, however, find a full exposition of it in the author's work entitled, "Disbursements of Railways."

## CHAPTER XII.

### MAINTENANCE AND OPERATION—WHAT COST IS DEPENDENT UPON.

[NOTE.—For a full understanding of the maintenance and operation of railways, a knowledge of accounting in connection therewith is desirable. The reader will find this important branch of the subject in the book "Disbursements of Railways."]

The tendency of railway operations from the start has been to lessen cost and reduce rates.

The expense of maintaining a railroad is dependent upon cost of material and labor, condition of the property, amount and kind of traffic, nature of the climate, character of bridges, culverts, buildings and platforms, nature and adequacy of ballast and drainage, and finally the weight and texture of the rail. These comprise the principal items.

Cost of conducting traffic depends upon the grade and alignment of road, quantity and nature of the traffic, adequacy of the company's facilities, cost of labor, character of the latter, etc.

The maximum price is paid for labor in America; the minimum price in India.

The rapid development of railways in America is attributable to the intelligence and economy exercised in their construction and operation, and

to the fortitude of railway owners and the skill and boundless ambition of railway managers.

A railway, like the human body, is constantly undergoing change, yet so gradually as not to be noticeable. Not only does everything wear out, but many things are put away while yet stable to give place to something better. Thus diminutive engines have been supplanted. This last change necessitated a better roadbed, heavier rails, better fastenings and stronger bridges and culverts.

Track scales that answered every requirement in the early history of carriers have long since been replaced by others capable of accommodating greater loads and longer vehicles.

Necessity has been the mother of invention. To need a thing has been to induce its invention and introduction. This is seen in the truss bridge, the swivel truck by which railway vehicles adjust themselves readily to the track, the equalizing beams of locomotives, by which their adhesion is increased and their hauling capacity multiplied, and so on, and in an incomprehensible number of ways, improvements in railway appliances are not confined to any particular department of the service. They cover every field, from the tie used to the form of check with which dividends are paid. They are seen in the substitution of steel for iron; of the fish bar for the old-fashioned chair; of sixty-ton locomotives for those that weighed six; in improved forms of axles, springs, splices, spikes, signals, the tread flange and center

of wheels, and other appliances. Each in its way tended to render transportation quicker, safer and cheaper, and therefore more generally used.

To know the cost of maintaining a particular property as compared with another property, is not to possess anything of value, unless we have accompanying details. Greater outlay one year may be offset by lowered expenses the succeeding year. Differences are also occasioned by varying cost of material. Use occasions wear and tear; hence a property that is used much wears out more quickly than one that is not. To compare the cost of maintenance of two or more roads intelligently, we must know how far the differences are inherent and how far the result of management or traffic.

The cost of maintaining railways is relatively less each year. This is due to the better establishment of the roadbed, cheaper material,\* higher skilled labor and kindred causes.

Effectiveness requires that ultimate perfection should be the aim of railway management. Long delays may intervene, and many makeshifts based on the character of the business and the income of the property adopted, but the building up of the property to a perfect standard should be and is the aim. It involves systematic organization; a machine capable of intelligent and consecutive

---

\*In Great Britain there was a decrease of fifty-four per cent. in the cost of material per mile of road in 1885 as compared with 1876, and this notwithstanding the increased mileage of trains.

action. Nothing creditable or permanent can be attained in any other way. Work without system involves the affairs of a railroad in the same confusion that similar work involves other industries. It is not an unusual thing in the history of a railway to see the greatest perfection attained in one branch of the service while everything else will be comparatively crude.

This fact, while illustrating capacities, shows how distinct the different departments of a railroad are from each other, while acting in unison for the attainment of a common end. Men are not alike blessed with wisdom, experience or capability. The ignorant, the dull, the obstinate and the vicious, while not numerous in railway life, still abound. They are stumbling blocks and retard the efforts of their more amiable brothers.

In the progress of work on a railway much depends on the general manager; but capability here cannot supply the place of mediocrity, indifference or worthlessness elsewhere. To overcome the inertia, there must be active co-operation throughout every part of a property, and its supervision must be wise, intelligent, faithful and constant. In no other way can a systematic organization be built up or maintained or the best results achieved.

Unfortunately we have no means of fitting men for railway business as we have for making lawyers and doctors. Railway men are educated in the business after they enter the service. This involves long apprenticeship, capable instruction

and competent instructors. Over every department of railway service there must extend the active supervision of a single man, supplemented by capable assistants. In this way only can efficiency be secured. An organization thus effected must supplement its labors by exhibits of results, so that comparisons may be made. Without these comparisons it will oftentimes be impossible to distinguish between capable, industrious and economical men and those of a contrary character.

In railway operations, prevention is a guiding factor. To stop the leak in the roof promptly, to strengthen the crumbling wall without delay, is to prevent disintegration, very likely accident. This applies to the track, equipment, buildings, bridges, fences and other structures of railways as much as it does to the houses of citizens. Not only is the destruction of property prevented by such measures, but cost of maintenance is reduced. Moreover, if action is not prompt, those intrusted with the work become disheartened by the great expense and the immensity of the field.

The question of railway maintenance is by no means simple. Its proper understanding involves a knowledge of every detail of railway construction and operation; acquaintance with the topography of the country, its climate, population, financial resources and distance from the base of supply. We must also be familiar with methods of taxation, the personnel of the force, extent and nature of the company's appliances,



and the amount and kind of its traffic. These are fundamental. Maintenance means something more than preservation of the track, bridges, buildings and other structures. It also means the building up and maintaining of a competent and trustworthy organization and the proper grouping of forces, without which a property is cumbersome and unwieldy.

Features incidental to railway maintenance are the differences, inherent and otherwise, in railway construction, and the consequent differences in cost of operating and maintaining that follow. They form a part of the question, and therefore engage the attention of those concerned. Their comprehension is, moreover, necessary to a proper comparison of results. Because of this let us glance, for a moment, at some of the differences between railroads.

The disbursements of a railroad are influenced, favorably or otherwise, by the peculiarities of the country through which it passes, and until these are determined we cannot estimate the cost of maintaining or operating. The circumstances surrounding the cost of constructing a road first, and operating and maintaining it afterward, change with every succeeding mile. The distinction is more marked in some cases than in others, but it exists everywhere and at all times. In one case it will be the difference between a road located upon the summit of a mountain and another located in a valley, or between one that surmounts a steep and dangerous ascent and one constructed

upon a perfectly level plain. In another case it will depend on the elasticity of the roadbed, the sufficiency of the drainage, the quantity and quality of the ballast, or the manner in which the latter is applied. Instances of difference have no limit. However small, they affect the cost of maintaining and working.

The differences in cost will vary from a few cents per mile to hundreds of dollars. The extent of the difference can only be anticipated by a careful survey of the property. In some cases it will be so marked as to make itself perceptible to the dullest comprehension; in others it will be discernible only to experts in such matters.

A road with costly bridges, high embankments, precipitous grades, sharp curves and extended tunnels will, it is manifest, cost more to maintain and operate than a line devoid of these costly features.

In considering relative cost, as affected by the peculiarities of a country, I can only notice the more important differences. Generally, it may be stated as true that a road traversing a level country, adapted to grazing or agriculture, is more cheaply worked than a line differently located. Its drainage may be difficult, and a supply of ballast not easily obtainable, except at considerable expense, but such objections are felt more or less on all roads. They are more than offset by the obstacles to be surmounted on a line located in a hilly country. Moreover, a company whose property is favorably located, as

regards grades and alignment, can haul the maximum load. It has been demonstrated that upon a line favorably located a locomotive can perform three times the service possible upon a line unfavorably situated in this respect. Moreover, wear and tear of equipment is less. Accidents are also diminished. The expense of keeping the road in good condition is much lighter. Many other differences might be cited.

On the other hand, the drainage of a road which winds around the edge of a mountain range is more easily provided for than on one traversing an alluvial plain.

The first presents highly favorable circumstances for economical and effective drainage, the latter rarely does. To a superficial observer, the difference in cost of operation and maintenance between a track susceptible of perfect drainage and one that is not is never rightly estimated. Imperfect drainage, besides being an evil in itself, implies collateral evils. The roadbed is hard to maintain, ties rapidly decay, rails speedily become unfit for use. A large force, relatively, must also be kept constantly employed, while frequent renewals of the track itself are required. Cost is multiplied in many directions.

For these reasons engineers are careful to make provision for good drainage, whenever possible. In many instances, however, the nature of the soil or the character of the country render it impossible. In such cases the burden on the carrier becomes a permanent one.

No other phase of railway operations possesses such a variety of aspects as the question of drainage. None requires greater knowledge and skill. It is not only essential that the person in charge possesses the practical qualities of an engineer, which enable him to utilize to the utmost the topographical features of the country, but he must understand the action of water upon different kinds of soil; must be able to distinguish between that kind of soil which will absorb water without especial detriment to the roadbed and that which must be quickly relieved of the burden. He must also understand the law of capillary attraction and take necessary measures to remove the track beyond the reach of its influence.

Questions of temperature are prime factors. In a cold region the cost of generating steam is greater than in a milder climate. The load hauled is also less, while broken and defective rails and damaged machinery and appliances multiply in number indefinitely. Absence of elasticity in a frozen roadbed increases wear and tear of equipment and hastens the destruction of track. To these must be added the cost of keeping the track free from snow and ice in a cold climate. The disbursements on this latter account appear in cost of snowplows, supplies, wages, use of locomotives and cars, added cost of fences and snowsheds, and, finally, in delay of business. Upon many lines located within the snow belt the expense of keeping the track free from snow and ice forms a considerable propor-

tion of the total cost. From this and kindred expenses, lines further south are happily free. On the other hand, however, the latter have their own disadvantages, such as rapid deterioration from insects and climatic causes.

Differences in cost of fencing also affect maintenance and operations. Upon some roads no fences are practically required in America; upon others their erection and maintenance are difficult and expensive. A company contiguous to supplies is put to less expense for fence material than a line located at a distance. Moreover, the laws defining a legal fence are not the same in every state. Relative cost is thus further complicated.

Cost of maintaining and operating is vitally affected by the number and character of the grades. Every foot of ascent entails extra expense. A line that requires a heavy engine to move a minimum load cannot be worked as cheaply as a line more favorably located. Cost varies upon railroads according to the nature of the country, the judgment exercised in locating the line and the money expended in overcoming construction obstacles. Experts do not agree as to the ratio of expense each foot of elevation occasions, but it is relatively much greater when the rise is abrupt than when gradual. Thus, cost of a maximum grade of one hundred feet to the mile is more than where the grade is fifty feet. Nor is the collateral outlay which gradients entail relatively the same. Differences in cost of maintaining track are particularly noticeable. Cost

of fuel, lubricants and wear and tear of machinery are also heightened.

The curvature of a track, hardly less than its grades, affects the cost of maintaining and working, though the fact is not so generally recognized.

Another important feature is alignment. Defective alignment adds to the cost of property in the first place and the expense of maintaining and working it afterward. The inconvenience continues without sensible diminution until the mistake is remedied, but as defective alignment oftentimes involves questions of management and policy as well as cost of correction, it follows that such defects are generally of much longer standing than they would be if they came within the duty of the practical men who look after the track. An acute defect these latter may remedy, but errors in alignment affecting considerable sections of a line they may not notice, or if they do, are oftentimes unable to demonstrate the practicability of their views.

Many other differences affect cost. Thus a company that is compelled, either by the nature of its traffic or the peculiarities of its line, to sever and reunite its trains at intervals is put to greater expense for maintenance and operation than one that does not. This expense will vary according to the length of the haul, the amount and character of the load and the particulars of a local nature that affect the transfer. Such expenses represent in a measure, it may be said, the difference between cost of handling through and local

business. However, many terminal expenses involved by the latter are wanting.

Relative cost is affected by density of population, more especially the frequency with which towns, villages and cities occur. It is also influenced by the number and character of the tunnels, viaducts and road crossings. Every tunnel, viaduct and road crossing increases cost in the same sense that a line dotted with signals and crowded with watchmen cannot be worked as cheaply as a road running through a country where these precautions are unnecessary.

Anything that interferes with the free movement of trains, or that increases or diminishes the speed best suited to the load hauled, adds to cost. Thus the amount of fuel required by a locomotive to start its load is relatively much greater than the amount required to keep it in motion once it is started. Experts have estimated the loss of power occasioned by stopping a train traveling at the rate of twenty-five miles an hour as sufficient to carry it a mile forward on its journey. Consumption of fuel, it is also to be remembered, is only lessened, not avoided, while a locomotive is thus idle. Further than this, the wages of employes experience no abatement, while the extra cost of wear and tear of road and equipment, incident to the interruption, are considerable in every case. Finally, it may be said that anything which retards the business of a railroad, increases its cost or multiplies the restrictions under which its trains are operated, adds to the cost of doing

business and lessens by just so much the facilities of the public. The interests of the public, not less than owners, require that railroads should be harassed by as few restrictions as possible.

---

Particulars of construction act and react on the operating expenses of railroads. Cost is never the same relatively upon any two lines.

The same influences that contribute to swell the first cost of a road serve in the majority of cases to increase its operating expenses afterward.

In investigating the subject of railway economy, each enterprise must be judged according to its environment. In no other way can its status be accurately ascertained.

The causes which produce differences in the cost of operating properties are so numerous and so complex that I can only notice the more important. This partial analysis will be useful, not for the information of experts, but for those whose facilities for observing the multitudinous details of railway operation are limited.

The influences that occasion differences in cost of operating open up incidentally the whole vista of railway administration. I shall consider but one phase here and only the more salient features of this.

And first, in regard to supplies. To ascertain the cost of these, including fuel, the expense of handling and the cost of transportation must be added to first cost.



The first cost of fuel is very small in many cases, but the expense of hauling and the absence of economical facilities for unloading from the cars, and afterward placing it upon the tenders, makes the final cost very great, much greater even than is discernible from the accounts. The expense is aggravated in the case of many companies by their having no return load for their cars. Much of the cost of fuel appears in the returns under foreign headings and thus remains unknown. In portraying the expenses of a railroad we cannot, if we would, group in the accounts or elsewhere, under one head, all the expenses incident to a particular article of material.

To the first cost we must add the shrinkage, and in the case of fuel and oils this is very great. The cost of substituting new material for old, in the case of repairs and renewals, must also be remembered. With many classes of material the cost of substitution equals or exceeds the first cost. It is considerable under the most favorable circumstances. The disbursements, for instance, that attend the substitution of new track material for old material of the same kind are very great. This is noticeably so with rails and ties. It is measurably the same with machinery and fixtures that appertain to bridges, buildings and other structures.

To ascertain the cost of any kind of material we must consider it relatively. Thus, in weighing the value of a particular quality of fuel we

must consider its heating capacity and effect upon the locomotive. These, therefore, and not the price asked for the coal by the dealer, finally determine the cost of the article.

To purchase an article without considering the collateral effect is, in many cases, to occasion a loss out of all proportion to the main transaction.

Ability to pay for material promptly affects sensibly the price for which it can be bought.

Interest on money invested in supplies also forms a part of cost.

The time expended upon an article, and the accounting it involves, must be considered; nor must the cost of storage and the outlay for insurance be overlooked.

Thus, a multiplicity of things are to be considered before the final cost of an article can be known.

Roads operated in the immediate vicinity of markets buy more cheaply than lines located at a distance. Their presence exercises a favorable influence on the dealer. They are, moreover, able to keep better posted in reference to the market.

A company that concentrates its purchases can buy upon more advantageous terms than one that intrusts its purchases to a number of persons or to officers not skilled in the way of buying cheaply.\*

---

\* No one ever connected with a railway company in a responsible position, it may be said in this connection, can have failed to be impressed by the great importance which the responsible managers of railroads attach to the organization and

The necessities of a company, real or imaginary, sometimes induce it to purchase supplies of inferior quality. When this is so the loss occasioned thereby can only be traced indirectly, as in the case of fuel, already referred to. At different periods in the history of railroads the rails were, in many cases, of inferior quality. Times were not propitious, business was unprofitable and the companies were poor. The desire to buy at a low figure, therefore, was strong. This was particularly true of the intermediate period between the use of iron and Bessemer steel. Manufacturers had, to a certain extent, lost the art of making the former cheaply and well and were not yet able to produce the latter at a rate the railroads were able to pay. The effect of the use of poor rails at this time was quickly discernible.\* It was seen in many ways outside of the cost of keeping the track in repair. It was perceptible in the disbursements for injuries; in the fees of coroners and surgeons; in the account for losses and damages to property; in expenditures for legal services, nurses and medicines; in repairing broken down bridges and culverts; in renewals

---

performance of the duties connected with the purchase of supplies; to the limiting of the purchases to as few officials as possible, and to the placing in such positions only men experienced in the wants of railroads and in the knack of buying cheaply; men withal accustomed to the discharge of acts of trust and of long tried and approved integrity.

\* The length of time a rail will last is dependent (even upon a line having light traffic) upon its quality, the care with which it is laid, the number and quality of the ties and the character of the roadbed.

of equipment, machinery and tools; in outlay for labor of various kinds; in fuel used, and, finally, in diminished receipts.

Many companies were slow in discovering the loss occasioned by the use of poor rails, and not a few were dilatory in effecting a remedy after the discovery. Why? Because it requires a knowledge of railways that every proprietor does not possess, to enable him to appreciate the fact that unless he maintains a good roadbed and track favorable results will not long attend the operations of his property.

The smoothness and elasticity of a track affect directly the cost of keeping the rolling stock in condition, so that the cost of a poor track is quite as apparent in expenditures for keeping the equipment in serviceable order as in the disbursements for the track itself.

Only an experienced and sagacious manager can withstand the seductive glamour of an article of prime necessity offered at a low rate. The fact that its ultimate cost, if of poor quality, will be out of all proportion to the temporary saving is lost sight of. The immediate reduction in the cost of operating and the glory of effecting the reduction is too great for a weak man to withstand. This would not be the case to the extent it is if so great a proportion of the loss suffered in consequence of the purchase of inferior material were not covered up under foreign headings and remained, therefore, unsuspected. The track of a railway is the largest single expense, and it

is in connection with this that the greatest, and in many instances the most unadvised, efforts at economy are attempted. The harm that ensues is apparent in collateral expenses, but it is impossible to determine the amount of these even approximately. Actual outlay for track involves the cost of transporting the new material and the removal of the old, the cost of loading and unloading, the expense of handling, the withdrawal of the old material and the insertion of the new in the track; the value of the new supplies, less the amount received for the old; the material destroyed and injured in making renewals; the wear and tear of tools; in the delay of business, and the increased wear and tear arising from imperfect alignment of track which the changes temporarily occasion. These are the principal items. Their cost to a company cannot, in every case, be ascertained, but whatever the amount may be it is aggravated by the use of poor rails, whether inadvertently or otherwise. It is only by keeping such facts in mind that we can appreciate the importance to a company of purchasing good material. Only a wealthy company, it is apparent, can do otherwise without endangering its safety.

What I have said in relation to inferior rails applies also to inferior ties. A poor rail may be sold, but a tie is practically worthless when no longer fit for use in the track.\* Besides the fact

---

\*Huntington, in his unique treatise on railroad track, however, points out, though in a somewhat forced way, some of the

that a worn-out tie possesses no value, its removal is difficult. The alignment of the track is also seriously disturbed.\*

The expenses attending a poor bridge are relatively greater than those of a poor rail or tie. The cost of removing such a structure may, indeed, exceed the original outlay. Leaving out of consideration, however, the cost of maintenance of cheap bridges, the incidental outlay they involve for persons killed or injured, property destroyed or damaged and the injury suffered by equipment (to say nothing of loss of revenue a company suffers by the distrust engendered in the mind of the community) is out of all proportion to the saving effected by the erection of an unsafe structure of this kind.

In reference to structures of a temporary character, such as depots, platforms, roundhouses, workshops and water stations, that we find

---

uses to which old and worn-out ties may be put, namely: "To patch temporarily broken fences; to make footings for washing embankments; for temporary platforms for piling rails; fuel for drying sand at sand stations; fuel for sectionmen. Sawing up old ties for wood is also profitable to a company in many localities." They may also be used by a company for starting fires and other purposes.

\* Ties manufactured from what we call soft woods are not only not able to withstand the wear and tear of a heavy business, but they decay much more quickly than oak and other hard wood ties. The cost, however, of transporting the latter and inserting them in the track is not greater than for the former; it is, therefore, manifestly for the interest of every company to use the latter when the difference in the purchase price is not greater than the subsequent difference in the length of time the ties will last.

clustered about many new enterprises, the incidental loss to the company erecting them in many cases far exceeds the cost of a first-class edifice. It follows, therefore, that the erection of such structures is inexcusable, except in those instances (not so frequent as supposed) where the necessities of a company render it unavoidable.

The injury to rolling stock and machinery by the use of inferior lubricants aptly illustrates the folly of buying material of inferior quality. The difference in first cost is oftentimes so marked, however, as to secure the purchase of the latter article. When this is so the charge upon the books for lubricants appears as a reduction of outlay and is quite likely to excite the admiration of directors and owners. The actual cost is never known, but comparisons will exhibit increased consumption. The destruction engendered will appear in the returns under other headings, which seemingly have no connection with it. The extra outlay will be seen in disbursements for repairs and renewals of equipment, for new axles, brasses and other parts of machinery, and in all the accounts incident to the working of trains, such as repairs of equipment, disbursements for people killed and injured; losses, damages, and services of lawyers and doctors. The increased cost may be traced step by step through all the labyrinths of the service, in the stoppage of trains, in the diminished usefulness of the plant, and in the myriad of expenses incident to the detention of

business. Every conceivable expense follows in the train of hot journal boxes, broken axles, torn up tracks, derailed trains and kindred mishaps that ever attend the use of poor lubricants.

In connection with the cost of wheels, axles, frames, springs, bolts, nuts and kindred appliances, we find, as in the case of oils, that the relative cost of a good and a bad article is not alone manifest in the first price. The cost of the poor article will further appear in added disbursements for people killed and injured, losses and damages and all the multitudinous expenditures that attend accidents to trains.

Other interests, foreign to the immediate purpose, attend the use of supplies. It frequently occurs that the purchase of material is made to facilitate the securing of business or the placating of someone. When this is so, the price represents the value of the article and the benefit derived from its purchase. Many other things, such as a desire to foster local interests, affect the source from which supplies are drawn, inducing the purchaser, it may be, to pay a rate above the market price. In such cases, of course, the indirect gain is expected to offset the direct loss. Practices of this kind are of frequent occurrence. Generally, however, it may be said that the emergency that warrants going out of the general market to purchase presupposes an extreme case, and one, therefore, not to be considered as a factor in a general review of the procurement of railway material.



The interests of a railroad are identical with those of the country in which it operates. It endeavors, consequently, in every way to advance the affairs of its co-laborers—the local producer and consumer. But this assistance, however valuable and real, never appears under specific headings on the books of the railroad. When aid is extended, as I have shown in the purchase of supplies, the added cost cannot be fixed, under any head, in the accounts. Separation, therefore, is not attempted; the total price paid for the material is charged to operating expenses, although a portion might, with more propriety, be charged to traffic. Particular operating accounts are thus burdened with disbursements foreign to their purpose.

Before attempting to fix the cost of operating a company's property, it is apparent from the foregoing, we must know the circumstances attending its purchase and use of materials, including prime cost, indirect cost, distance supplies are hauled, cost of hauling, service of equipment, expense of substitution, storage, shrinkage, interest, insurance, etc.

The difference between affairs as they exist and as they are supposed to exist in the purchase and use of supplies, illustrates very fairly the difference between practice and theory in railway operations. To the amateur the railway problem is like a shallow cistern that may be dipped dry with a drinking cup, but to the practical worker and thinker it represents, in its economy, the problems of a mighty sea.

Management of railroads requires that those who direct affairs shall be men trained in the discharge of business, fitted to govern, whose judgment has been trained by years of observation, practical work and restraint. Men self-controlled and self-contained, forcible, luminous in their conception of great problems, and yet capable of employing simple and economical expedients. They must possess, in fact, the business ability of the trader with the executive force of the general and statesman. They must be educated in minor offices. No railway can afford to educate an officer in the position of an officer; it is at once too expensive and too demoralizing.

---

The cost of working a property is greatly affected by the quality of the traffic and the length of haul. This is, perhaps, more particularly the case with freight than passenger business, for the reason that the former entails current expenses unknown to the latter.

The expenses of railway companies now entailed for loading, unloading and storing freight are, in many respects, foreign to the original intent and purpose of common carriers, and, in many instances, not necessarily a part of their office.

In some countries, notably in Great Britain, railway companies contract with teaming companies or employ carts of their own to haul

merchandise to and from stations. Much of the freight, however, is loaded by the shipper directly upon the cars.\* The freight rate charged by English companies does not uniformly include either the cost of loading, unloading or covering the goods. When such services are performed by the railway it makes a special charge therefor. It also makes an additional charge, in many cases, for cost of building and working side tracks. In America, on the other hand, it is usual for the railroad companies to load and unload freight, and while they do not generally attend to the collection or delivery of freight at terminal points, they nevertheless place it in a secure warehouse, which they generally own and control.†

No direct charge is made in America for loading or unloading, no matter what the length of haul. Nor is anything exacted specifically for the use of a company's warehouses, except in those cases where goods remain for an unreasonable length of time. A charge for demurrage is made in the case of cars that are not unloaded

---

\* The box or inclosed freight car so universally in use in America is little known upon English lines, the flat or open car being used by them, merchandise loaded upon it being covered, when necessary, with a tarpaulin. This vehicle is much lighter than the box car; indeed, it is much shorter and lighter than our flat or open car.

† The exception to this rule is in the case of express companies, who conduct what in England is denominated "the parcels traffic;" these companies not only collect much of the freight transported by them, but deliver it (in large towns) to the consignee, the charge for this service (within certain limits) being embraced in the general rate.

within a specified time, if it is the duty of the consignee to unload the freight.

No charge is made by American companies for the use of side tracks.

In England a special charge is made when traffic is hauled but a short distance. Thus, the rate for six miles, or any fraction thereof, may be the same as for twelve miles. This is in addition to the supplementary charge for loading, unloading, etc. Our custom with respect to this class of business is doubtless in practice not materially different, but the basis for the charge is not so well understood. The omission operates in favor of the shipper.\*

The practices in this country in connection with loading, unloading and care of freight have assumed the habit of a fixed custom, though the duty does not properly fall within the province of a carrier. This is demonstrated, if demonstration were necessary, by the discrimination which companies make against particular classes of freight, a discrimination the public acquiesces in. It is, perhaps, true that the labor can be performed by the railway to better advantage and at less expense than by its patron, but this does

---

\* In reference to the manner of settlement between the different lines for through traffic, or that which passes over several lines of railway, it is said to be the custom in England to deduct from the gross amount charged for performing the service a specified sum for terminal expenses, varying in amount as between London and provincial towns; this sum is apportioned between the companies receiving and delivering the traffic, after which the balance is divided upon the basis agreed upon, whatever it may be.

not alter the fact. It was at one time supposed that the community would provide cars required to do business, and would attend personally to the loading and unloading of freight, while the railway company would provide the track, and in some cases the motive power.

It is the office of a carrier to transport the freight that is offered, not necessarily to load and unload it; that is the business of the owner. However, it is my purpose in this connection to notice the custom, not to suggest its change or modification.

Practices are not uniform as to the articles which owners must load or unload, but vary according to real or supposed necessities of business. Usually, however, our carriers discriminate only against coarse articles of freight, such as are bulky and not easily damaged, such as coal, grain, lumber, ores, pig iron and similar articles.

From the foregoing it is apparent that a company's outlay for station labor, warehouse and yard room is largely dependent upon the character of its business. If made up of freight which the carrier undertakes to handle, the terminal charges will be much greater than in other cases.

These charges are incidental in character and contemplate an outlay for grounds, tracks, warehouses, platforms, yards, elevators, depots and other machinery necessary to the economical and expeditious discharge of business. They vary so

greatly that before attempting to compute the expense of conducting a traffic their cost must be carefully ascertained.

Terminal facilities, moreover, that cost but little at one point may involve enormous outlay at another. Thus, depot grounds and yard room that can be provided for a few dollars in an interior town, cost millions of dollars in a great city. The interest upon the capital invested in these facilities, whatever it may be, becomes a fixed charge upon the property and must not be overlooked in determining the cost of doing business.

In reference to cost of handling different kinds of traffic, the greatest difference exists, but the extent of this difference is little appreciated. Thus, the expense for station labor in connection with the movement of fifty thousand cars of coal, earning perhaps a million of dollars, will hardly be more than that for handling a few crocks of butter or the worn-out effects of an itinerant preacher. Differences of this character continually occur in the operations of railroads and will ever confound those who seek to make a law or institute a practice that place them upon a common level. As soon might we prescribe a given quantity of food, drink, air or clothes for men, without reference to their appetite, health, labor or size. Terminal expenses, permanent and otherwise, are not governed by the revenue derived from a business, but are the same in all cases, whether the traffic is desirable or otherwise.

Nor are terminal expenses affected by the length of the haul. Thus, it costs as much to handle a consignment of merchandise destined to a neighboring town as to a point a thousand miles away; the number of laborers is the same, the clerical force the same, the facilities the same, the risk of accident and theft the same.

The through traffic of railroads may be said to represent the long haul in contradistinction to local business, which represents the short haul, and while the terminal expenses are the same in either case, local traffic necessitates frequent stoppage of trains, with all the expenses incident thereto. They form a sensible burden, never to be lightly considered or overlooked in estimating the difficulties and expenses of operating.

Within certain bounds the profitableness of a business is dependent upon the length of haul. It is an aphorism in railway management that the equipment of a company earns money only when in motion. Anything, therefore, which retards that motion, acts to the disadvantage of a carrier.

To continue: the station facilities necessary to accommodate the suburban travel of a metropolitan road must be quite as elaborate as for a more profitable business—for long haul traffic, for instance. The expense that attends it is much greater than for ordinary traffic, because it is fixed in cities or their immediate neighborhood, where values have reached the highest point. This business, instead of paying a higher

rate than traffic requiring less costly accommodations, is awarded a less rate. This difference is oftentimes more than is justified by the quantity handled. A low rate is given from a desire to stimulate traffic. It represents also the difference between wholesale and retail business. Suburban residents represent an average haul each day equal to so many trains (a fixed quantity), while isolated passengers, gathered at widely separated points, represent the retail element of trade.

While it is true that terminal expenses incident to traffic must be considered in fixing the rate, it is also true that no recognized or uniform practice can be observed. The judgment of the compiler of the tariff, based on the peculiarities of the business, must determine the rate for the time being. A more formal basis is not practicable.

Few companies could provide the terminal facilities they do if their trade were wholly local. The profits they derive from through business enable them, for the moment, to carry the burden of the less profitable traffic.

It is a generally accepted belief that the local business of a road is the more remunerative, for the reason that it is not subjected to the disturbing influences which surround through traffic. This was the case at one time, but long ago ceased to be so. Multiplicity of roads paralleling and intersecting each other oftentimes compels them to compete for local business quite as much as for through traffic.



The cost of soliciting business is to some extent a terminal expense. It varies greatly upon different lines. The expense of one line for advertising and soliciting agents, for illustration, will be treble that of another. This difference may be occasioned by the disadvantages of the company's line or the special character of the business.

It will be seen from the foregoing brief and imperfect consideration of the subject that special items of cost connected with the handling of traffic cannot be overlooked in studying the disbursements of railways. This fact should be remembered by legislators and others in attempting to enforce uniform rates and conditions. Each company must be considered apart and the conditions attending its traffic duly and exhaustively studied.

## CHAPTER XIII.

### MAINTENANCE—FIXED OPERATING EXPENSES.

Expenditures do not grow relatively with a traffic. The outlay upon a heavily worked line is not proportionately as great as upon a line less busy. One of the reasons is that a large proportion of the disbursements of a company comes under what are called fixed expenses. Many expenses of this character are not affected at all, or only remotely, by an increase or decrease in business. However, these expenses are never the same relatively upon different roads.\*

The fixed expenses of a railroad may be termed the minimum cost of operating. After they are provided for, every dollar of income a property can be made to earn without increasing such expenses, represents, obviously, a decided gain. This is well understood and represents a principle

---

\*The term fixed expenses or charges is used in a double sense in railway nomenclature; first, it applies generally to the operating expenses, interest and rentals of railroad companies, and, second, to those expenses connected with the immediate working of the property that are not affected at all, or only lightly, by the amount of its traffic, such as superintendence, salaries of station agents, flagmen at crossings, bridge tenders, etc. The last named should be called "fixed operating expenses" or "fixed expenses," while the former should be called "fixed charges."

that lies at the foundation of the practice of granting a relatively low rate when the traffic is unusual in quantity or can be handled without adding relatively to cost.

A brief summary of fixed expenditures may be properly given here; and, first, I may mention those relating to organization. This must be maintained with little, if any, reference to the amount or profitableness of the business done. All of a company's affairs are dependent upon the preservation, unimpaired, of its legal status. This obligation is imperative, and while the disbursements on this account may be small compared with many others, they are, nevertheless, considerable.

Many expenses intervene, without much, if any, reference to the amount of traffic. Thus the mail must be carried and delivered punctually, no matter how small it may be; the convenience of the public must also be provided for at stations and elsewhere, and the number of specified trains (which the custom of the country or the charter of the company compels it to operate) must be run each day. In matters such as these the discretion of the management is very limited indeed.

The outlay incident to the movement of trains is the same for wages of men engaged, whether the cars are loaded to repletion or travel comparatively empty. This is also true, relatively, of other train expenses, such as fuel, oil, lights, attendance, wear and tear, etc. Someone, also,

must be on hand at stations to open the company's waiting rooms, see that they are kept clean and comfortable, preserve order in and about the buildings, keep the platforms and track unobstructed, ticket such passengers as present themselves, receive and discharge goods, and answer questions asked by patrons.

The wages paid the incumbents of these offices must moreover be such as to secure faithful men, competent to perform the maximum amount of service required. And so it is with the organization of the force as a whole—with general and local officers, superior and petty heads, including foremen and others. Each must, in his place, be competent to perform, at a moment's notice, the greatest amount of service that the necessities of the company require. An exigency arises and passes in railway life like the flight of an express train. There is no time for consultation, no time to study text-books, no time to examine rules and regulations, or to write to superior officers for instructions; the company at such times must have someone on the spot competent to act. Such necessities must be provided for without reference to the general run of business, and in so far as this is so, they constitute a fixed expense.

An agency that may, at any moment, be called upon to handle a hundred carloads of freight cannot be intrusted to the care of a person who could perhaps manipulate half that number with facility, but would break down under greater responsibility. The agent must, in his turn, select

subordinate servants with a view to like contingencies. What is true in this respect of the agent and his assistants applies with equal force to conductors of trains, foremen of shops, track bosses and superintendents of bridges. It applies, with redoubled force, to managers. The exigencies of railway service require men of special training, of peculiar qualifications, of minute practical knowledge. There are no exceptions to this rule in any department or branch of the service. Supervisory officials, especially those in immediate charge of the property, must be as well skilled as the directing manager. They must possess general knowledge, as well as particular acquaintance with the immediate position they hold. This involves intimate acquaintance with the property as a whole—its defects, resources and peculiarities. This presupposes long association, years of observation and thought. Attainment is impossible otherwise. Without prolonged association the knowledge officials bring to the discharge of their duties is incomplete, oftentimes impracticable.

The personnel of a railroad organization may not, therefore, be changed hastily or unadvisedly without detriment, for the property is the creature of the operative and its value dependent upon his capacity and fidelity. He must ever be considered in forming an estimate of its present or prospective value.

In every department of railway service we discover carefully selected men of capacity and

resources, the superiors of their fellows, singled out with reference to present and prospective emergencies. From the character of these men we may judge intelligently of the discernment and trustworthiness of the managers.

The importance of the duties (present and prospective) performed by various classes of officials is apparent in the compensation allotted them. The official in charge of a pass high up on a mountain side, or having the care of a difficult morass or hazardous piece of track, no matter where it may be located, is paid a higher rate of wages than his neighbor, whose skill and responsibility are less. Selections in every case are based on fitness. A track foreman who might be trusted in the absence of danger could not be depended upon to act with intelligence and precision in case of a wreck or the washing away of a roadbed. A bridge superintendent who understands how to keep in repair the property intrusted to his charge under ordinary circumstances, might be exceedingly awkward if called upon at a moment's notice to construct an entire structure. In the same way a conductor who might know how and when to start or stop a train, how tickets should be collected or cars received into or detached from a train, would not, perhaps, know what to do in case his train was thrown from the track or lost its rights. All these things are thought of and anticipated.

In the selection of men to fill petty offices of responsibility, as well as those of greater degree,

every varying circumstance must be carefully considered by the appointing power. Selection or continuance in the service require, frequently, extra wages. Thus extra wages are paid sometimes to meet exigencies that never arise. These we may term constructive expenditures. They are much the same upon all lines, without reference to the business done.

The cost of caring for a property is not affected by what it earns to so great an extent as is generally supposed. A competent and trustworthy manager must in any event be employed to look after its affairs. The amount paid him is dictated by the extent of the property and the ability and faithfulness of the man. This is true to a certain extent of all the officers of a company. The salaries of minor officials are more dependent upon the business done. This is also true of subordinate servants, but a large proportion constitutes a fixed expense, not dependent, except remotely, upon the amount or profitableness of the business.

At the headquarters of every company an expensive force must be maintained. It is made up of assistants, and is the subsidiary brain of the enterprise, without which the organization would fall to pieces of its own weight. It consists of skilled men. They carry on the general business of the company as between the corporation and the public; also as between the former and employes on the line of the road. They are, as a rule, discreet and able men, well disciplined

in their offices, and commanding the respect of the public and the obedience of the employes of the company on the line. The number and salaries of these assistants are not materially influenced by the fluctuations of trade, except when it extends over a considerable period of time. They may be said to be fixed in the offices they occupy. Increase or decrease of traffic does not affect them. The explanation of this is found in the difficulty of filling their places. The knowledge they possess is the result of laborious training and years of familiarity with their particular duties. Except when business is depressed for a very considerable period, it is inexpedient as well as expensive for a company to make any change or reduction in its general office force. A reduction of wages is practicable, but not a reduction in number.

The traffic of a company may be paralyzed by a great storm, or its business disturbed by the failure of a crop or through the diversion of trade, without lessening its fixed expenses.

Up to a certain point, addition to traffic is not followed by corresponding increase in either the number or wages of employes. There is no increase in the number or pay of watchmen at crossings and bridges, track patrol, or persons in charge of tunnels or bridges. No increase in the number of agents at stations, of the principal ticket sellers, of the men employed in connection with the customary trains, of foremen and their assistants, busied in keeping the track in order,



or of the force at shops and roundhouses and depots of supply.

When, however, traffic increases beyond a certain point, expenditures for wages will increase beyond what the profitableness of the added traffic warrants. This increase will continue until the traffic again reaches a point where the maximum amount of labor is exacted.

Within certain limits, the elasticity of every organization enables it to accommodate an increase of business without addition to its number, just as a considerable increase is possible in the number of guests at a hotel without any addition to the number of attendants. Let us suppose the maximum of this increase to be fifty guests. This number may be added without increased cost for service to the proprietor, but at this point the addition of a guest will necessitate the employment of an additional clerk, another waiter, an assistant porter, and so on through the list of attendants. This outlay is, of course, out of all proportion to the added income and has, therefore, the effect of increasing the relative cost of operating the house. It is, however, unavoidable, and so it is in the working of railroads. We will suppose a passenger train is added to the list of those already operated by a company. Only a small percentage of the patrons of this new train is made up of new passengers. The traffic of the line simply readjusts itself to the increased facilities. The convenience which the new train offers

the public will add a few passengers, but there is no marked addition to the business, and until there is an increase commensurate with the added facilities the company is a loser, for the reason that under the new order of things its train service is performing only the minimum labor of which it is capable, while before it performed the maximum amount. The same rule applies to freight trains and is noticeable in all departments of the service. At a certain time in the growth of a traffic, it thus appears, the outlay is much greater than the income. Subsequent growth of business may warrant the increase, or it may not. In determining such questions (and they are of continual occurrence in the operations of a railroad) the judgment of the officer upon whom the responsibility rests is sometimes colored and confused, so that intelligent action is not to be expected in every case. So far as the writer's observation extends, the only means of testing the possibilities of a company's traffic is to add new trains.

There is this to be remembered in connection with additions made to the number of employes of a well appointed railway company (in contradistinction to a new enterprise), its well disciplined organization enables it to utilize the cheapest quality of labor of the kind it needs. This is impossible in the other case. The first only requires an increase of mechanical force, not of constructive ability. The effect of such addition is, of course, to reduce the average cost of doing

business; a consummation every manager labors unceasingly to bring about.

The effect I have pointed out of determinate expenses or cost as it is influenced by labor of a certain character is quite as marked in other departments of the service. Thus, disbursements for interest on bonds are not affected even remotely by fluctuations of business. This is equally true in many instances of taxes, assessments being based on the supposed value of the property rather than upon its revenue producing qualities.

Many of the guaranties also which business compels a company to enter into are not affected one way or another by earnings.

The amount paid for rent of buildings and grounds is only nominally affected by the increase or decrease of earnings. Any permanent decline of business in the end necessitates a readjustment of contracts and leases, but as agreements connected with buildings and grounds are usually entered into for a series of years, the expenses they entail cannot be hastily diminished.

Also the cost to a company of keeping its fences, gates and crossings in order is not increased or diminished, perceptibly, by the business it does. The amount disbursed for these purposes is dependent upon other causes, over which a company has very little control.

The expense of maintaining the permanent structures of a company depends quite as much upon natural influences as upon the business

done. Under the most favorable circumstances bridges and culverts will crumble, buildings will fall to the ground, fences, gates and crossings will succumb to climatic and other influences, embankments and cuts will be rendered unsafe, ditches will fill up, the roadbed will require ballast and careful attention, and ties will decay and the rails become unfit for use. All these things will occur, whether business be light or heavy, if a constant stream of money is not poured out day by day.

The expenses of a company also depend largely upon the nature of renewals. These, it is apparent, will be influenced by the length of time the property has been in operation and the thoroughness with which it was originally constructed.

At first, cost of maintenance will be very light upon a well constructed road, but with the lapse of time it will steadily increase, the maximum being reached at the point at which the average durability of such property is reached. This period will vary in different sections and under different circumstances, according to climate, nature of material used and amount of business done. Under ordinary circumstances, the average should not be reached under ten years, or whatever time may represent the average durability of rails, ties, spikes, equipment, platforms, fences, buildings, bridges, culverts and similar property.

Generally, it may be said that the amount of business determines the duration of equipment, while weight and speed measurably determine the duration of rails.

Turning to another feature of the case (the machinery of railroads), the difference between the wear and tear of that used and unused is not nearly so great as it would seem at first glance. The cost of preserving unemployed machinery in good order is not noticeably less, as every manufacturer is aware, than the cost of keeping it in order when employed.

The subtle influences of idleness are as destructive to man's work in this case as idleness is to man himself. The machinery he constructs with such infinite care and labor requires constant attention, otherwise it quickly becomes worthless.

The amount of fuel necessary to haul the minimum load of a train is a fixed charge. The fuel consumed by a locomotive hauling thirty cars is not relatively as great as when hauling one-third that number, yet the appurtenances necessary to the successful operation of the train are practically the same; the lubricants used upon the locomotive are substantially the same; the lights and furniture are the same; the conflagrations which the locomotive causes are the same; the accidents are the same; the number of incautious people killed or injured is the same; the number of cattle run over and crushed is the same; the number of switches to be turned at meeting points is the same; the wages of the train force

are the same; the telegraphic orders that pass back and forth between different train officials are the same; all the varied expenses connected with the use of water are practically the same.

As I have stated, the cost of keeping up the organization of a company is not noticeably different, whether the business is large or small, productive or otherwise. The expenses which the laws require must be met without reference to receipts; bulletins must be posted as the law prescribes; tariffs must be promulgated, agreements made, notices of elections posted, trustees remunerated, traveling expenses met, complicated and expensive returns rendered, lawyers employed, and insurance duly looked after.

These expenses are in the main inherent and in no wise dependent upon the productiveness of business. When, therefore, we see a partially loaded train winding its way across the country, or remark a yard filled with idle equipment, we must not conclude that the owner has reduced his expenses to conform to the business he is transacting, or that it is possible for him to do so. On the contrary, we may truthfully believe that many of his expenses have not been lessened at all. And we may remember another fact, namely, that the owners are never disregardful of the circumstance that profits arise out of the business that is carried on after the fixed expenses have been met, and hence in fostering business they need no spur. To them, therefore,

may safely be left the development of the business of their lines. Out of it grows their profit; without it their roads are worthless. No one is so much interested as they, no one so wise in the solution of vexed questions.

## CHAPTER XIV.

### MAINTENANCE—COST OF OPERATING AFFECTED FACILITIES.

The cost of operating a road is affected favorably or otherwise according as its facilities are ample or not.

To enable a company to secure the most favorable results possible it must be able to carry forward its repairs and renewals at the most opportune season of the year and have appliances fitted to their economical and rapid performance. It must be in good condition financially and possess machinery fitted to its wants and adequate to carry on its work.

Many of the differences noticeable in the cost of working railway properties are attributable to differences in facilities.

A company that is not provided with adequate equipment for doing its business suffers many expenses that would under other circumstances be avoided. In addition to this loss, the traffic that it cannot for the moment accommodate will, when it can, seek other channels, and thus its revenue will be lost. Moreover, current expenses will be increased in many cases, while loss of business will swell the percentage of operating expenses to revenue.



A superabundant equipment, on the other hand, is unprofitable to its owner. Its possession involves loss of interest on cost and the expense of keeping it in order. In addition to this, the effort to find employment for it is quite likely to lead its owners into excesses, of one kind or another, but mainly in the direction of unnecessary rate cutting and other foolish competitive efforts.

The disposition of railway companies to encroach upon each other, coupled with a belief inherent in the breasts of many of those who serve them that they can create business, has been the cause of many of the disasters that have wrecked railway properties.

What I have said in reference to the necessity of restricting the machinery and rolling stock of a company within necessary bounds, applies equally to its property as a whole. While a property must be maintained at a point commensurate with the needs of business, it must stop there. Contingent wants that may never occur should not be anticipated, but left to be met when the exigency arises.

While owners thus restrict themselves they will remember that prosperity cannot be attained or maintained without adequate facilities. When needs are inadequately provided, revenue that should accrue for extending and strengthening the property is lost. A company thus unhappily situated cannot compete successfully with an alert rival. It is avoided by many who would, under other circumstances, give it support, while

its expenses are swollen unnecessarily by its improvidence.

Railway managers, it may be said, understand the importance of keeping a property in good condition. The difficulty is, and always will be, to make the owners equally alive to the fact. Absorbed in the prospect of a dividend, secure in the belief that the management will provide the necessary ways and means for meeting renewals and improvements, they lack apprehension and interest. They do not refuse to make provision for the company's wants, they simply ignore the matter. To meet together from time to time and authorize an expected dividend, is too often the consummation of earthly responsibility on their part. They listen with approval to the remarks of the chairman, congratulate the manager upon his energy and efficiency, and disperse, leaving him to get along as best he can. Thus, his wishes are disregarded and the strength of the property wasted. The truthfulness of this is apparent in many ways and it is needless to say that the losses resulting are always disproportionate to the saving effected.

Innumerable instances might be cited, if necessary, to illustrate the necessity of a company supplying itself with needed appliances. Thus, a company that does not possess adequate tracks, convenient sidings or sufficient yard room cannot handle its traffic with the celerity and economy it could if it possessed such facilities. Again, the company that is able to make its track

repairs and renewals at the period of the year most advantageous for such work will be able, manifestly, to do so more economically than its less fortunate neighbor. It is essential, above all things, to the prosperity of a company, that it should be able to make its repairs and renewals as occasions for them arise. An unsafe bridge, an insecure culvert, or a defective axle or wheel may involve the destruction of a train which, with collateral losses, will amount to thousands of dollars. And it must be remembered that the losses that result to a company from accidents of this kind can never be known, for the reason that they entail loss of public confidence in the methods of a company. Thus, to the known loss there must be added indirect loss occasioned by diversion of traffic.

It is in details of operation that losses accruing from improvident management are most marked. Thus, a battered rail in the track of a busy line will so rack the equipment passing over it that the cost of repairs will many times outweigh the value of a new rail. The same is true of a line imperfectly ballasted, or one where the alignment is wrong.

The cost of keeping locomotives and machinery in good condition is very much dependent upon the carefulness with which they are kept cleaned and housed when not in use. The rolling stock that is kept well painted and in good repair is not so expensive to maintain as the equipment that is neglected and, while present outlay for repairs,

cleaning, housing and painting may be a burden, it will result in more satisfactory returns to owners than a contrary course.

What I have said in reference to machinery and rolling stock applies to every branch of the service. Thus, the increased disbursements to meet interest on money expended for overhead bridges or viaducts at busy points is, in many cases, more than counterbalanced by freedom from accidents and saving in wages and other expenses.

The wisdom of providing needed appliances for conducting business is perceptible, everywhere, in reduced expenses. Thus, the introduction of a new piece of machinery, a copying press, a patent ink, a new blank or other contrivance intended to simplify or cheapen, frequently renders a reduction of the force possible, or prevents an increase otherwise unavoidable. Innumerable illustrations of this nature might be cited.

The usefulness and perpetuity of a plant is indefinitely heightened and prolonged by its maintenance at a high state of efficiency. This is particularly the case with machinery and equipment, as I have noticed. Such property should be maintained at the maximum state of efficiency. The life of a car, locomotive or stationary engine may be greatly prolonged by prompt repair of the various parts as rendered necessary, while neglect will hasten the general breaking up. The necessity of maintaining property is well understood by managers; but they are often

overruled in the matter, not being allowed the funds necessary to carry on needed repairs. There can be no doubt of the shortsightedness of such a policy, and a company thus administered is an unsafe enterprise to invest in.

## CHAPTER XV.

### MAINTENANCE—THINGS THAT ENTER INTO THE MAINTENANCE OF A RAILROAD.

Railway maintenance presents itself under various aspects, such as the preservation of the material property, the maintenance of the rights of railways under their charters or acts of incorporation, the building up of the esprit de corps of the forces (a matter of vital importance to the public, the owner and the employe), the education of officers and employes in the things that pertain to railway operations, and so on.

All these phases of the subject receive more or less attention throughout these volumes. They are a part of the science of railways and not the less important because not forming a part of the daily thoughts of officers and employes.

The particular phase of railway maintenance which I wish to consider in this chapter relates mainly to the effect of certain influences.

I have mentioned in another place the possibility that through the unwise exactions of labor it may some time be found necessary to close up a railway, or group of railways, for a longer or shorter period, because of the impossibility of procuring men to operate them. Such a contingency does not seem likely, nor did it seem likely

a few years ago, when a great system, extending over several states, was suddenly paralyzed for a similar reason. Yet the event actually occurred. Moreover, the circumstances were such as to suggest the possibility of its recurrence. Let us suppose that for some reason every railroad man, or the great bulk of them, struck, as they did in the particular section I have referred to. In such event, the operation of railroads would be impossible. No other course would be left to owners but to shut up their property.

Where labor has the disposition to organize and act in concert over a great extent of country, everything is possible. The nineteenth century is peculiarly the age of possibilities of this nature. Centralization is its watchword. We observe it in the growth of corporations, manufactories and other enterprises. It was the concentration of capital, perhaps, that suggested the centralization of labor—the delegating to an agent the right to arbitrarily control the many. The co-operative organization of labor, however, is more extended than that of capital. The latter is necessarily restricted and isolated in its efforts. Labor groups great masses of men employed far apart over wide areas of country. If these organizations are not wisely governed, they will ultimately involve a corresponding centralization of capital. Certainly they will render the continuance of business under existing conditions impossible. Not only will the railway system be broken up, but all other

industrial interests will be disturbed, and in many cases destroyed.

In the event railways were closed under circumstances such as I have named, the duration of the suspension would depend very largely on the disposition and ability of the people to protect those who sought to reopen them. Meanwhile the calamities that would grow out of the upheaval would require many years to heal.

What conditions would attend a general cessation of railway operations? Could the owners of railroads permit their property to lie idle? Do railroad companies possess the passive element that is so great a source of strength to capital invested in other enterprises? It is here that a secret of the power of capital lies. Its growth, beneficent influence and perpetuity depend upon the possession of this source of strength. When no longer able to exercise this negative force, it will cease to exist.

What is the effect of idleness upon railroad property? Wherein does it deteriorate? What is the extent of the deterioration? What outlay does the maintenance of a railway involve? Should owners suffer a great loss in the effort to maintain the rights of their property, or should they effect an immediate settlement with disaffected employes, on the best terms possible? It is upon such questions that the contingency of a railway company closing its affairs for six months, or a year, or two years, may hinge, and upon the wisdom and courage governing those



making the decision, the future of mankind may depend.

Let us suppose that a railway company decides, in view of the fact that it can no longer operate its property in harmony with what it considers to be its interest and the interest of the public, to close its business until such time as its just rights are accorded.

What would be the expense of maintaining its property under such conditions? The question is an interesting one and suggests careful inquiry.

In the event of the suspension of a railway, what would be the effect upon the property? What would be the minimum amount it would be necessary to expend to preserve it from serious deterioration? These questions cannot be definitely answered. Having no income, cost, it is manifest, would have to be raised by assessments if no reserves were laid by to meet such contingencies. But in regard to reserves: Is it not incumbent upon every company to possess, according to its ability, a reserve fund of this nature? Is it not a part of the machinery of maintenance? The fund need not be unproductive. Judiciously placed, it will be a source of income as well as strength. Its effect, moreover, will be evinced in the market value of a company's securities. It will be in the nature of a guaranty, enabling its possessor to meet every call upon him. With such a fund taxes could be paid, sinking funds met, interest on mortgages satisfied, and the expense of maintenance

provided for a period proportionate to the extent of the fund, without reference to current receipts.

It may be assumed, I think, in the event a company found it necessary to suspend business, that the great bulk of its bondholders would waive interest payments for awhile. The reserve fund would provide for the balance. The amount of the fund should depend upon the amount of taxes, interest, tolls, sinking funds and expense of maintenance. Expenditures for the last named purpose are imperative. They must be met as they accrue, otherwise the owner suffers enormous usury for neglect to preserve his property. Would the cost of maintenance be so great as to prevent the proprietor meeting it? I think not, if he possessed a moderate reserve fund.

Stripped of all glamour, railway property differs very little from other property used in manufacturing, except that it is scattered over a wide territory. In the case of private manufacturers, their property lies within a narrow limit and when not in use the gates are shut and the public excluded, so that, no matter how great its value, its guardianship is compassed within the care of a watchman. He not only serves to protect the property, but helps to prevent its deterioration. Unfortunately, this simple disposition is impossible in the case of railroad property. Widely scattered, it is everywhere exposed. Its greatest security lies in the difficulty of destroying or removing it. This renders it possible for

the police force of a country to look after its protection (if it is so inclined) without material outlay. This feature would be of especial value to a company compelled to stop business. Only that portion of its property endangered by fire would require especial guardianship. Even here the risk would be slight. Moreover, in considering the safety of railroad property under conditions such as I have named, we must remember that the state must aid the proprietor, he being a taxpayer. In the event it does not, it must reimburse him for any damage he suffers. Losses, therefore, that arise from the acts of mobs or lawless combinations must be reimbursed and thus will not fall upon the proprietors of railroads, except in so far as they are taxed with others. The exercise of reasonable precautions in the preservation of the property of a railroad is, however, under all circumstances a duty. This duty railway companies have never disregarded. So that, in the event they closed their properties, they would still continue to exercise general and constant watchfulness. The expense of this would be chargeable to maintenance. Would the duty require special watchmen, or would the force required to keep up the organization be sufficient? I think the latter. In determining, therefore, the force necessary to maintain a property, we also cover its protecting force, except in isolated cases.

The maintenance of the property of a railroad involves many things not capable of demonstra-

tion in advance; contingencies that we cannot foresee nor estimate, because dependent upon circumstances and the peculiar features of a property.

In considering the cost of maintaining a road, the cost of maintenance of organization must not be overlooked. This latter, however, in the case of a property closed to business, would depend upon whether the cessation was for a long or short period. If the former, the cost would not be nearly so great as if the stoppage were for a short period. If the cessation were likely to extend over a long period, the traffic organization, or that portion of the force connected with or growing out of the conduct of business, could be wholly dispensed with, or so greatly reduced as to be no longer distinguishable as an organization. If, however, the stoppage were only for a short or indefinite period, it would be necessary to preserve at least the nucleus of an organization, such portion of the force as would render the resumption of business practicable without great delay.\*

If the stoppage were likely to continue over a long period, many expenses that under other circumstances would be necessary, might be avoided. Thus the cost of keeping up the road at a point that would permit the daily movement

---

\* Unless, indeed, it was assumed that the whole force might be brought together again at will, in which event the whole traffic force might be dispensed with. This is what would probably be done.

of trains at ordinary rates of speed would not be required. It would not be necessary to repair from day to day the inroads of storms or the damages caused by frost, and expenses attending the use of bridges, culverts, buildings and machinery might be wholly avoided, or it would be necessary at best to give them only cursory attention. Effort would be directed merely to preserving the property from permanent injury. Thus maintained, considerable time would be required to place it in shape for resuming active operations when the embargo was lifted. Buildings would have to be put in order, tracks repaired, bridges and culverts looked after, and a thousand things attended to before general resumption would be possible. The delay would be unavoidable, as the resources of the strongest company would not warrant it in keeping up its property at the maximum point of efficiency throughout an indefinite period. In attempting, therefore, to determine the cost of maintaining a property without reference to traffic, all the conditions must be known. If resumption of business were likely to occur within a reasonable time, the expense of maintenance would not be much less than during active operations.

The disintegration of property from natural causes is very nearly the same, whether used or not. If cessation of business were likely to extend over an indefinite period, the advisability of reducing expenses would be so great that we

may be sure every outlay would be cut down to the lowest possible figure.\*

The maintenance of a property covers many great expenses arising from natural causes. Little has been done to determine the amount of these expenses aside from traffic. Few things are less understood. Every expense being primarily due to traffic, no attempt has been made to effect a separation. Business being the incentive to construct a railway, the whole cost of operating is properly chargeable thereto. Thus, rates must conform to cost, or if they fall short bankruptcy follows. Many expenses do not depend except primarily on traffic, but in attempting to separate the cost of maintenance arising from natural causes from that due to traffic, I do not wish to be understood that such expenditures are distinct from traffic or that traffic has no obligation to bear the burden.

Any attempt to separate the fixed expenses of maintenance from those occasioned by traffic must be largely speculative, but a separation, however imperfect, cannot but possess great interest to those who own and operate railways. It enables them to view many questions from a higher standpoint than they otherwise would, and proves valuable in directing inquiry into other

---

\* It is possible, in the event a railroad company found it impossible to operate its property, that the wisest course to pursue would be to dismiss the whole force. Such a course, it is probable, would be thought the safer one to pursue and the one most likely to bring about a quick and satisfactory settlement.

and collateral subjects. Knowledge is not of so much value for a specific thing as for its contingent revelations and the thoughts it suggests. And so it will prove here. Even the most imperfect statement of the expenses of maintenance of railways affords suggestions in other directions to those who do not regard the information in itself of value. Thus, while a manager may not care what relation fixed expenses of maintenance bear to total expenses, yet the information is valuable to him in other directions or in special instances. Take the case of track rails for illustration. Experts with whom I have communicated as to the relative deterioration of rails from climate and traffic, have stated that a rail would remain fit for use forever, if trains were not run over it. Others put the deterioration from climatic causes at two per cent. ; others again at five per cent., and so on. As a matter of fact, the deterioration of rails from climatic causes, while not great, is marked and cumulative. Deterioration of other material is much greater. However, I cannot enter here into a scientific discussion of the effect of climatic influences upon material. I am not competent to do so. I merely cite the case of rails to illustrate the lack of information on the subject by those whose duties lie wholly in this particular department.

The natural decay of railway property is, in many cases, much greater than the damage occasioned by use. Where the business is great the

relation of fixed expense of maintenance to traffic is, of course, less.

Whatever a property suffers from natural decay is a fixed expense. Cost of organization is also, to a certain extent, a fixed charge. It is, however, never the same. It is much less, relatively, for a company actively engaged than when the contrary is the case, for the reason that in the former instance a proportion of the cost is merged in current business. Thus, a superintendent will not only maintain the property, but also superintend its business. In either case he is essential, and while he must possess greater diversity of knowledge to enable him to attend to both these duties than to either singly, yet the increased cost is not great.

The number of skilled laborers required in the operations of railroads is much greater than is supposed. They form, to a certain extent, part of the organization, but embrace many men not usually classed under this head. Everyone understands that an engineer must be technically qualified; the value of skill upon the part of the fireman is also understood. The necessity of technical knowledge on the part of machinists is equally well known; but minor officials, clerks and foremen must also possess technical skill of a high order, coupled with a practical knowledge of the property and its business. This is not so well known. No class of labor possesses so much technical knowledge as the clerical force of a railroad, and by clerical force I mean the body of



employes concerned in the movement of traffic, including those connected with accounts and finances. They are the fingers of the organization, and, in a great sense, its intellectual force. The affairs of a railroad are so great, and extend over so wide a range of thought, that managers can do little more than use the information the clerical force collects. This force, however, in the event of the stoppage of business on a railroad, would have nothing to do, and, therefore, would be dispensed with. But only those who have watched the growth of a railroad, and the patience required to build up an efficient force, can estimate the loss its abandonment would finally entail. However, necessity does not recognize distinctions of this kind. If, therefore, through upheavals of labor or other disorders, a railway were compelled to suspend business indefinitely, it would come out of the struggle stripped of its organization in this respect. No attempt, therefore, need be made here to determine the fixed expenses for such railroads on this account.

A fixed expense of Organization (or Management) under normal conditions is the pay of officers and employes necessary to the conduct of traffic. This force embraces the management, heads of departments and chiefs of bureaus and their immediate assistants. Those, in fact, possessing a knowledge of the departments and versed in the company's affairs. Such a force cannot be secured at will, and business cannot be

carried on without it. It grows with the corporation, and should become more efficient every year. The necessary force of a road also embraces the agents at stations, and if business is great, their immediate assistants; those, in fact, who possess high technical knowledge. They constitute a fixed charge. Those engaged in mechanical or simple work about the offices, warehouses and other buildings do not, as they may be replaced at will.

The cost of watching a property is not a fixed expense, or at least is only partially so, as this duty may be performed by employes who form a part of the fixed cost. The nucleus of a train force is a fixed expense of maintenance. In the case of conductors and baggagemen it embraces, let us say, ten per cent. of the force. The skill of this body constitutes the nucleus of a complete organization. In the same way ten per cent. of the engineers and firemen may be denominated as fixed. Such a train force would prove ample to guard the rolling stock and machinery and maintain it in a high state of efficiency.

The technical force retained by a company (under the conditions I have named) may be further utilized in the physical maintenance of the property, and thus serve a double purpose. Employes occupied in soliciting business do not constitute a fixed expense. Similarly, operating expenses covering personal injuries, contingent expenses, stationery, printing, supplies, advertising and lubricants belong to traffic, or

if any portion is a fixed expense it is nominal only.

The forces of a railroad that constitute a fixed charge will find, in the main, active employment, even if the property is closed. However, it does not necessarily follow that there would be no reduction in the wages of this force. On the contrary, it is probable that a very large reduction would be made. The necessity of such a course and its justness would be apparent, and would be cheerfully acquiesced in. The amount of this reduction would, it is probable, approximate fifty per cent. That it would involve hardship, goes without saying, but as this hardship would extend to the owners of the property as well, it would be borne cheerfully. If the suspension were likely to be of long continuance, the reduction would be even greater. However, fifty per cent. may, I think, be estimated as the average. In reference to the force it would be necessary to discharge (in the event of suspension), it is probable the majority of the men would await re-employment. This would certainly be the case if the stoppage were not likely to be of long duration, or if the circumstances attending dismissal did not involve personal animosities. It would be apparent to men thus situated that their interests would be more likely to be conserved by awaiting re-employment than by seeking engagement elsewhere. It might be necessary in some cases (as it would indeed be both politic and wise wherever possible), to allow this wait-

ing force a small sum monthly. Such a course would be eminently humane, if the resources of a company permitted. I assume, of course, in suggesting this gratuity, that harmony of relationship exists between employer and employe.

The best of feeling should ever be maintained between railroad companies and their employes. It is possible, indeed probable, that the latter may have more or less grievances, real and imagined, but that these grievances are such as to justify indifference or disloyalty is impossible. Nor can they be so great as not to be more likely to be amicably arranged by conciliatory measures than by strikes or other violent means. The interest of the proprietor in those who operate his property is too intimate, too vital, to permit him to disregard their welfare or to refuse to remedy just causes of complaint.

And above all, employes should not, in enumerating their own grievances, forget those of the employer. No intelligent person who has observed the operation of corporations carried on by hired agents but must have noticed innumerable instances of neglect on the part of such agents, of manifest inefficiency, gross wastefulness, inattention to duty, idleness, and other evidences of disregard of the interests of the owner. Every such instance is a legitimate and proper subject of complaint on his part, and while he may seek to prevent such acts, still his efforts in this direction, no matter how watchfully or intelligently directed, can never be wholly successful.

Employes, therefore, while enumerating their grievances, should not be unmindful of those of their employer.

In the case of a railroad, the identity of the proprietor is so covered up in the multiplicity of owners, in the rules and regulations of the service, and in the acts of managers and others, that we cannot wonder the employe sometimes forgets there is an owner—a man like himself; and in doing so fails to recognize his rights and forgets his own duties and responsibilities. If the owner possessed greater personality, were present on the ground, were a person to whom the employe could listen and might appeal, he would appreciate his existence more vividly. In considering, therefore, the relations which exist between capital and labor in connection with railroads, the first thing for the employe to do is to dismiss his prejudices; to remember that if he has grievances, so also has the owner, and that, as a rule, the grievances of the latter are more real than those of the employe. No railway employe, not blinded by passion, but knows that he is, as a rule, fairly treated.

The grievances of employes are often more imaginary than real, and when real come, not from the owner, as a rule, but from those he is compelled to trust. The remedy does not, therefore, lie in indiscriminate attacks upon property, but in an appeal to owners.

Too great care cannot be exercised by employes of corporations not to confound the owner with

the manager. The owner will never, it is safe to say, willfully or persistently disregard the welfare of his employes. Their interests are so inalienably connected with his, that to treat them unfairly would be suicidal. This truth is not always remembered by employes. No one who is dependent upon the good will and fidelity of others for the maintenance of his interests, like the owners of railroads are, can afford to permit them to remain in ignorance of his good intentions. On the contrary, his duty and interest alike demand that he should cultivate such relations with them as may, at all times, assure them of his friendly interest in their welfare.

Men who intrust the management of their property to others must do so unqualifiedly, but such delegation of power should never extend to the relinquishment of the right and duty of looking after the welfare of their employes. A proprietor will ever consult his welfare by such manifestation of interest in his servants, and any neglect to fulfill this cardinal duty of ownership will redound to his injury. By many owners manifestation of such interest is thought to be subversive of discipline. The answer to this is that when an owner cannot come in contact with his employes without jeopardizing discipline, it ought not to require an outbreak of his servants, or the destruction of his property, to convince him that there is a defect somewhere in the method of administering his property. Discipline that is dependent upon terrorism, upon ostracis-

ing (or sequestrating) the employe, upon separating him from the acquaintance or sympathy of the owner, is a gross perversion of responsible methods of government, and wherever practiced may be accepted as evidence of a disregard of the rights of owners. If the history of corporations in the United States teaches one fact more clearly than another, it is that the owners of corporate property must personally interest themselves in the affairs of their employes, lest their personality be forgotten and their property lost.

Ownership of property presupposes the duty of guardianship, including a paternal interest in the operative, and its preservation to the owner will ever depend upon the general and wise exercise of his duty in this regard.

Continuing our examination of the cost of maintaining a railroad. This cost is much increased by the interference offered by traffic. Thus, repairs of track are retarded by the passing of trains and the diverting influences that attend their movement. Necessary repairs to equipment and machinery are oftentimes delayed because of the pressing need for their use in handling traffic. Many other instances might be cited if necessary.

Insurance of property is a fixed expense, except in so far as it covers current traffic. Practices in regard to insurance are not uniform. In some cases it is the policy to insure everything. Other companies restrict their insurance to particular instances of special importance,

Others, again, do not insure at all. I do not know that the circumstances likely to attend a cessation of business would be such as to require that a company's policy in this respect, whatever it might be, should be changed. Risk from the movement of trains and the conduct of business generally would, it is apparent, be much less than under normal conditions, while damages arising from the acts of mobs would have to be made good by the government. No two companies view the question of insurance from the same standpoint, and no estimate can, therefore, be made as to the extent of a company's expenditures in this connection. After considerable observation of the effect of insurance and non-insurance, I should not think a company justified in expending a large amount in this direction unless its surplus were abundant and well assured. The magnitude of its interests renders it quite proper for it to assume risks of this nature. The cost of insuring the property of a company may be reduced to the minimum, in the event of stoppage of business from a strike or otherwise. Whatever is paid in this direction constitutes a fixed charge.

Considered from the standpoint of organization and proprietorship, the taxes of a property constitute a fixed expense without reference to the basis upon which they are predicated. In this last respect the widest differences exist. In some cases taxes are based on real and personal property. In others upon earnings. The amount and



value of outstanding capital is sometimes the factor. When the tax is based on property, the levy would be the same if the road were not operated, though it is possible a reduction might be made under such circumstances. Certainly it should be, as it is manifest that property of this kind which is earning nothing is, constructively at least, worth nothing and ought not to be taxed except upon a nominal basis. Practically, however, only a small reduction would probably be made. When taxes are based on earnings, it is manifest that a cessation of business would mean cessation of taxes, unless the stoppage were so prolonged as to suggest some other basis. In any event, however, the extent of a company's obligations for taxes, whatever they may be, become, in the case of an idle property, a fixed charge.

It is impossible to determine accurately what proportion of the cost of maintaining railway property arises from climatic causes. Two methods suggest themselves by which to estimate the amount. The first is by a survey of the property in which every feature shall be ascertained. This method is the best when practicable. But, unfortunately, it is not generally practicable. The second that suggest itself is the relation which cost of maintenance bears to the total cost of operating. It is only approximate and not reliable for our purpose.

Different properties are affected by different climatic influences. Thus, the railways of the North and the South have dissimilar conditions to

meet. Those of each section necessitate peculiar outlays. Thus, deterioration of wood in the South is much more rapid than in the North, but, on the other hand, Northern roads suffer greatly from frost and the abrupt changes peculiar to a cold country. The conditions most favorable to the preservation of material are a mild, dry climate, but it is probable the roads of the South have, on the whole, advantages over those of other localities in the cheapness with which they operate and maintain their properties.

More than anything else, fixed expense of maintenance is dependent upon quality of material, the measure of intelligence evinced in locating and constructing a line, and finally the skill exercised in protecting the property. The nature of the structure is important; stone is more durable than wood; brick more lasting than grout. But the duration of the structure is largely dependent upon the care with which it is constructed and looked after. This rule applies to the roadbed and its ballast as fully as to buildings and other structures.

The cost of keeping rolling stock in repair is greatly increased by deterioration from natural causes. This deterioration is greater when the plant is actively employed than if carefully housed, as much of it would be if not in use. The facilities of railroads every day become more ample, but they do not as yet generally contemplate placing passenger and freight cars under cover when not in use. This adds greatly to the cost

of their maintenance. Referring to the cost of preserving equipment, an interesting writer on the subject says: "A locomotive taken into the shop and covered with tallow would be ready for service with very slight repair to the stack and other parts. The atmosphere would have a greater effect upon freight cars, and it would be necessary to paint them at periods (probably of considerable length), even if not in use, as they would suffer from dry rot and other causes. With regard to passenger cars on the same basis, the percentage would not be so great as freight cars, as the material and finish are better, but they would require a coat of varnish, at long intervals, to preserve the outside paint."

The wear and tear of equipment from traffic is, of course, proportionate to its use, but cost will ever depend largely upon the intelligence and promptness with which repairs are made. If locomotives are not properly painted, cleaned and housed; if passenger cars are not kept cleaned, painted and varnished; if freight cars are not kept painted and repaired as needed; if machinery is not carefully looked after, the deterioration will be rapid and marked. The telegraphic plant of a company, including lines, furniture, tools, machinery, batteries, instruments and other appurtenances, suffers constant deterioration from natural causes, and although lines are much better constructed than formerly, the deterioration has only been lessened, not obviated.

It is apparent from the foregoing that differences exist, and ever will exist, as to the outlay of railroads, that arise from natural causes. Accurate data, therefore, in regard to a particular road will not be conclusive in regard to others. It will, however, afford an approximate estimate in many cases, for however greatly railways differ from each other in particular things, they are generally uniform. If, therefore, data were obtainable for several railroads, this average would afford a glimpse, at least (but not more), of railways similarly situated. I have this data for a period of twenty years, for railways thirty-five hundred miles long, located in a temperate climate, subject to such extremes of heat and cold as are to be found in the great lake region of the United States. Conditions here, as regards wages and cost of material, are those of American railways generally. The results are embodied in the appendix hereto.\* They show the relation that particular items of maintenance bear to the total cost of maintenance. Also the proportion that cost of maintenance bears to other expenses. They also show cost arising from climatic causes, and the expense of maintaining a nucleus of organization. I have not attempted to give the aggregate cost in dollars and cents, but to show the relation which cost bears to the current cost of operating, so that the reader has only to ascertain what each operating expense

---

\* Appendices C and D.

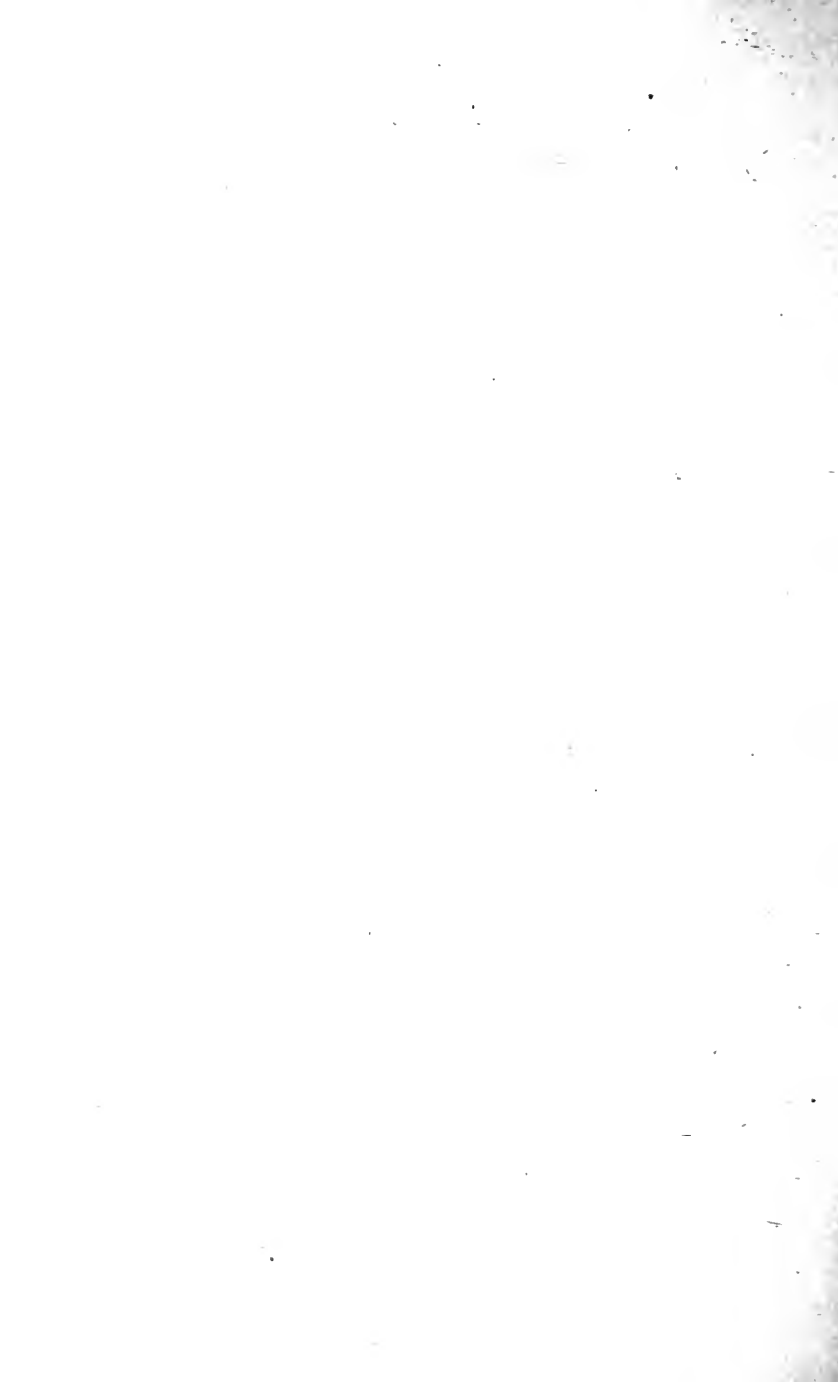
amounts to upon a road to ascertain approximately what the fixed expense is.

The maintenance of a railway involves, as I have pointed out, innumerable things. Some I have specified; others only hinted at. It involves, directly and indirectly, the books, blanks, forms and stationery of a company; its furniture, fixtures and appliances; a proper system of accounts; the telegraph; responsible methods of handling money; the purchase, inspection, care and use of material; the proper employment of labor; the government of the corporation; the handling of traffic; the issuance of tariffs and classifications; the movement of trains; above all, the maintenance of the track. I have said much about the latter. The theme is an important one. That of equipment and machinery is nearly, if not quite, as great. This subject, however, I refer to in the book devoted to Equipment, and so shall not discuss it here further than to point out that cost is dependent here, as elsewhere, upon the care and foresight exercised. Paint, and its accessory, varnish, I may say in a word, are important agents in this connection. Material of this nature must be of the best quality, though the difference in cost between good and bad material will constantly tempt the purchaser to buy the latter. In the preparation of paints, ingredients require to be carefully weighed and measured. The material must also be pure and finely ground. The colors used require to be harmonious and permanent. Work

of this nature cannot be hurried. Thus, varnish must be thoroughly dry and hard before being exposed to the weather, and in order to secure this ample covered space, well lighted, ventilated and heated, is required. If conditions necessitate it, artificial means of drying must be resorted to. In order to secure the best results, the varnish, after it is applied, should be well rubbed in, so as to close the pores. In England, where much attention has been given the subject, a coat of raw linseed oil, from which all the fatty material has been extracted, is applied to the varnish. In cleaning, care must be taken to avoid harmful or destructive methods, such as the use of very hot water or chemicals, otherwise the varnish on a car may be quickly ruined after the vehicle leaves the shop. In painting, questions of color are not, as would seem at first glance, entirely matters of taste. Advocates of light colors claim that the varnish holds better in such cases, that it is easier to clean, wears better, and does not absorb the heat as much as dark colored paint. On the other hand, dark colors show the dirt less and require less material.

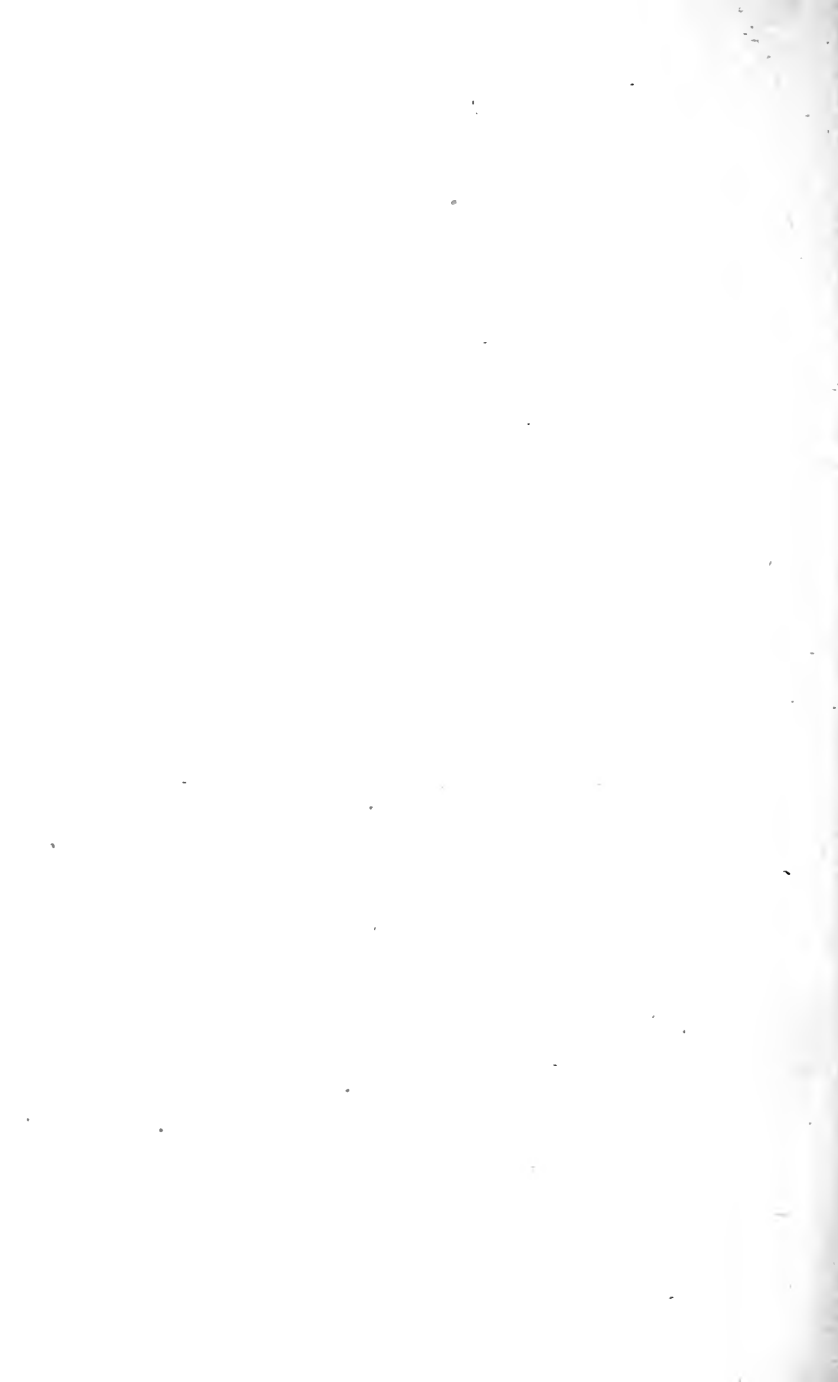
In concluding, I repeat what I have so frequently had occasion to call attention to, namely, that cost of maintaining railroads (and operating them as well) is dependent upon the nature, location and business of properties, the thoroughness with which they are built and the effectiveness and foresight exercised in keeping them in order.

I have not attempted to elaborate the subject unduly, but to point out its more salient features and the line of inquiry to be considered. I have sought also, indirectly, to make clear to those who impose obligations upon railroads the necessity of their discriminating; of tempering the wind to the shorn lamb; of remembering that while the enforcement of arbitrary enactments without reference to local conditions will simplify official labors, the result will be disastrous to the properties concerned. The business of a railroad, like every other business, is a matter of detail and must be so considered. It is just as proper to make hats of a uniform size for all men as to prescribe fixed conditions for railroads. As well might the expenses of the government be collected by a uniform charge per head on men, women and children, without reference to their ability to pay, as to seek to make one railroad the measure of other railroads.





# APPENDIXES.



## APPENDIX B.

### RELATION THE VARIOUS ITEMS OF TRACK LABOR BEAR TO EACH OTHER.

Labor, handling rails.....	3.68 per cent.
Labor, handling ties.....	9.56 "
Labor, ballasting.....	12.31 "
Labor, ditching.....	4.78 "
Labor, freshet repairs.....	.92 "
Labor, watching track.....	1.25 "
Labor, clearing track of snow and ice.....	6.62 "
Labor, clearing track of weeds and grass.....	7.35 "
Labor, general repairs to track (including cutting rails).....	53.53 "
	100.00

### RELATION THAT VARIOUS ITEMS OF TRACK EXPENSES BEAR TO TOTAL TRACK EXPENSES.

Labor, handling rails.....	2.23 per cent.
Labor, handling ties.....	5.79 "
Labor, ballasting.....	7.35 "
Labor, ditching.....	2.89 "
Labor, freshet repairs.....	.45 "
Labor, watching track.....	.67 "
Labor, clearing track of snow and ice.....	4.01 "
Labor, clearing track of weeds and grass.....	4.45 "
Labor, general repairs of track (including cutting of rails).....	32.52 "
Rails, ties, miscellaneous track material and tools.....	39.64 "
	100.00

## APPENDIX C.

### RELATION VARIOUS CLASSES OF MAINTENANCE BEAR TO TOTAL COST OF MAINTENANCE.

Maintenance of track.....	44.25	per cent.
Maintenance of bridges and culverts.....	6.68	"
Maintenance of buildings.....	6.98	"
Maintenance of fences, gates and crossings...	2.46	"
Maintenance of equipment.....	39.63	"
	<hr/>	
	100.00	

### RELATION OF THE COST OF MAINTAINING THE PROP- ERTY OF A ROAD TO ALL OTHER OPERATING EX- PENSES.

Maintenance of property .....	38.62	per cent.
Other operating expenses.....	61.38	"
	<hr/>	
	100.00	

## APPENDIX D.

PERCENTAGE OF THE TOTAL COST OF OPERATING DUE TO  
MAINTENANCE OF ORGANIZATION AND THE PREVENTION  
OF THE DESTRUCTION OF THE PROPERTY FROM NATURAL  
CAUSES.

NAME OF ACCOUNT.	PERCENTAGE OF THE TOTAL OPERATING EXPENSE THAT COMES UNDER THE HEAD OF FIXED CHARGES.
Renewal of rails.....	2
Renewal of ties.....	70
Repairs of roadway and track....	57
Repairs of bridges, culverts and cattle guards.....	75
Repairs of buildings.....	70
Repairs of fences, road crossings and signs.....	95
Repairs of locomotives.....	8.5
Repairs of passenger cars.....	9
Repairs of freight cars.....	10
Telegraph expenses (main- tenance).....	10
Agents.....	50
Clerks.....	25
Train force.....	12.5
Salaries general officers and their chief assistants.....	50
Law expenses.....	50
Oil, waste and tallow.....	1
Stationery and printing.....	1
Contingencies (and miscella- neous).....	1
Insurance.....	10
<b>FIXED CHARGES OTHER THAN OPERATING.</b>	
Taxes.....	100
{ Except where taxes are based on earnings, or special reductions can be secured.	
Interest on funded debt.....	100
Sinking fund requirements.....	100
Leases, contracts and agreements.	100

## APPENDIX E.

### GAUGES OF RAILROADS THAT ARE OR HAVE BEEN IN USE IN DIFFERENT COUNTRIES.

	GAUGE.		GAUGE.		GAUGE.		GAUGE.	
	Ft.	In.	Ft.	In.	Ft.	In.	Ft.	In.
Australia.....								
New South Wales.....	4	8½						
Victoria.....	5	3						
South Australia.....	5	3						
Queensland.....	3	6						
Austria.....	4	8½						
Argentine Republic.....	1 Me tre		5	6				
Belgium.....	4	8¾						
Brazil.....	1 Me tre		3	6	4	0		
.....	4	3						
.....	5	6	4	8½	5	3		
British India.....	1 Me tre		5	6				
Canada.....	*4	8½	*5	6	*3	6	*3	0
Cape Colonies.....	3	6						
Ceylon.....	5	6						
Chili.....	5	6						
Denmark.....	4	8½						
Egypt.....	3	6	4	8½				
France.....	4	8½						
Great Britain.....	†4	8½	‡7	0	*3	0	*3	6
.....	*5	0	*5	2	*85	3	*5	6
.....	*6	2						
Holland.....	4	8½						
Hungary.....	4	8½						
Ireland.....	5	3						
Italy.....	4	8½						
Japan.....	3	6						
Mexico.....	*3	0	*4	8½				
New Zealand.....	5	3						
North Germany.....	4	8½						
Norway.....	3	6	4	8½				
Nova Scotia.....	4	8½	5	6				
Panama.....	*5	0						
Peru.....	4	8¾						
Portugal.....	5	6						
Russia.....	5	0						
Spain.....	5	6						
Sweden.....	4	8½						
Switzerland.....	4	8½						
Tasmania.....	3	6						
Turkey.....	4	8½						
.....	*2	0	*5	9				
.....	‡3	0	‡4	8½	*1	9	*4	8¾
United States.....	4	10	*5	0	5	6	5	3
.....	¶6	0	8	0	*3	1½	*3	6
Uruguay Republic.....	4	8½						

\* Gauges in use at present time, January, 1897.

† Standard Narrow.

‡ Standard Broad.

§ Standard of Ireland.

|| Mount Washington.

¶ Sterling Mountain.

## APPENDIX F.

QUANTITY OF MATERIAL REQUIRED TO LAY ONE MILE OF  
RAILROAD TRACK ON THE BASIS NAMED.

DESCRIPTION.	WEIGHT PER YARD.	TONS.	NUMBER.	SIZE.
Rails .....	65 lbs.	$102\frac{43}{1000}$	352	30 feet in length.
	72 "	$113\frac{143}{1000}$	352	30 " " "
	80 "	$125\frac{715}{1000}$	352	30 " " "
	85 "	$133\frac{571}{1000}$	352	30 " " "
	90 "	$141\frac{428}{1000}$	352	30 " " "
Ties .....			3,017	{ 6 inches thick, by 8 inches wide, by 8 feet long, laid at a distance of 21 inches from center to center of each tie.
Spikes .....			12,068	{ $5\frac{1}{2}$ inches long and $\frac{9}{16}$ inch thick, measured under head.
Base Plates....			352	
Angle Bars....			704	
Bolts .....			1,408	
Nut Locks....			1,408	
Tie Plates....			6,034	{ Number required provided a plate is put on each end of every tie. They are seldom used continuously, however, but, as a rule, only on bridges, trestles and curves.

Ballast to the depth of 12 inches under the ties, with a surface of 10 feet, requires 3,060 cubic yards for one mile of track

## APPENDIX G.

Table showing increase in weight of locomotives from 1880 to 1900, those given being the largest and heaviest of their respective dates.

1880.

Name of R. R. using the Locomotive.	Wt. on drivers lbs.	Total Wt. lbs.	Driving Wheel Base.	Total Wheel base.	Class of Locomotive.
Boston & Albany.	52,000	77,000	.....	.....	8 wheel type. Consolidation. Fast Passenger.
Fitchburg....	93,800	108,750	14 ft. 9 in.	22 ft. 8½ in.	
Phil. & Reading*	64,250	96,200	6 " 6 "	21 " 1 "	

1900.

Illinois Central..	193,200	232,200	15 ft. 9 in.	26 ft. 6 in.	12 wheel freight.
Illinois Central..	194,000	214,000	16 " 3 "	24 " 5 "	Consolidation.
Union.....	208,000	230,000	15 " 7 "	24 " 0 "	Consolidation.
Lake Shore .....	133,000	171,600	16 " 6 "	27 " 4 "	10 wheel passenger.
Grand Trunk...	125,000	166,000	15 " 8 "	26 " 11 "	10 wheel passenger.
N. Y. Central...	126,000	164,000	14 " 8 "	26 " 0 "	10 wheel passenger.
Fitchburg.....	130,000	164,000	15 " 9 "	26 " 6 "	12 wheel or masto- don type.

\*Engines 411 and 506.



## APPENDIX H.

### DETAILED RULES GOVERNING THE LOCATION OF RAILWAYS.\*

#### ORGANIZATION.

The Construction Department will have charge of all surveys and construction in connection with the building of new railways or extensions of existing lines.

The Engineering Department will have charge of all surveys and engineering connected with the work of improving lines already built.

The organization of the Construction Department will be as follows: (1) Chief Engineer, reporting to the President. (2) Division Engineers, with jurisdiction as assigned by the Chief Engineer. (3) Assistant Engineers in charge of the construction of a line, or other work of importance, reporting to Division Engineers. (4) Locating Engineers, reporting to Division Engineers or to Assistant Engineers as directed. (5) Resident Engineers, in charge of the construction of a section of new road, or a subdivision of some work, reporting to Assistant Engineers. The organization of the Engineering Department will be as follows: (1) Chief Engineer reporting to the General Manager. (2) Division Engineers, having charge of the engineering work upon lines in operation, reporting to the Chief Engineer, and also acting as Division Engineers of the Construction Department upon special assignment by the Chief Engineer to such work. (3) Assistant Engineers, in charge of special work, reporting to Division Engineers.

The duties of the Engineering Department will be as follows:

1. To secure and maintain records of the physical characteristics of the railway, including roadbed, track, ballast,

---

\*These rules are in force on the Northern Pacific Railway.

bridges, culverts and other structures. The records should show number or quantity, location, type, dimensions, condition, cost and date of construction, in all necessary details.

2. To make general inspection of all such structures annually, and such other examinations in special cases as may be necessary at all times; to furnish reports on their condition, and estimates and recommendations covering repairs, renewals and replacements in the manner and on the forms prescribed.

3. To prepare and maintain correct station and right of way plats, standard track and other profiles, standard maps and plans, and all general engineering records.

4. To supervise and direct all work of special character, as assigned by General Manager and Chief Engineer.

5. To inspect and report condition of all ordinary and special work to insure compliance with standard plans and specifications.

6. To prepare plans, specifications and estimates for all duly authorized work, when necessary, to prepare forms of proposal and contracts for such work, and to award contracts when approved by the General Manager.

7. To furnish all necessary stakes, centers, elevations, cross sections and measurements required for the execution of routine or special work, and otherwise to aid and supplement the Division forces to the best advantage of the railway company.

Engineers will have no authority over roadmasters, bridge foreman or any regular force of the several Division Superintendents, except as it may be conferred upon them in special cases by the General Manager, General Superintendent, or Superintendent, but they must report to the proper official any neglect or failure to execute work in accordance with the duly authorized plans, specifications or instructions governing such work.

None other than routine work will be undertaken without formal and sufficient authority, confirmed by approved Improvement forms (1363), or by special direction of the General Manager, General Superintendent or Assistant General Superintendent transmitted through the Chief Engineer or the Division Engineers.

No work affecting safety or regularity of trains must be undertaken without previously notifying the Superintendent of the Division upon which the work is to be performed, and the subsequent execution of the work must conform to the orders, rules and regulations established by the Superintendent to insure safety.

All necessary track or bridge work in connection with such work will be performed by the division force, under the instructions of the Superintendent or his roadmasters or bridge foremen.

Salaries and wages of special forces employed under the direction of an engineer, unless specially excepted, will be carried on the Superintendents' rolls, the engineer making time returns in the manner prescribed by the standard rules in force on the Division.

Before the beginning of each season's work Assistant Engineers will be furnished with a list of the various improvements authorized. The limits within which track laying and ballasting are to be prosecuted should be ascertained in advance and levels run over such sections and profiles sent to the Division Engineer, plotted to a double vertical and single horizontal scale. The Division Engineer will locate the proper ballast grade line and Assistant Engineers will compute quantities in cubic yards of material required for bank widening, raising sags and ballast.

At the close of each season's work Assistant Engineers will furnish a detailed report of the various improvements completed, giving full notes and sketches wherever necessary.

#### LOCATION. (THEORY.)

"Engineering is the art of making a dollar earn the most interest."

A railway is a commercial enterprise and is constructed solely for profit.

The factors affecting profits are: 1. Gross earnings. 2. Operating expenses. 3. Fixed charges. The effect on such factors, of differences of route, location, details and construction cost must be determined before the final route of least cost and greatest value can be fixed.

The combined sum of operating expenses and interest charges is least when interest charges on additional expenditures are no longer saved in reduced cost of operating expenses, and when additional operating expenses are no longer saved, in reduced interest charges. Accordingly, the economic value of each factor affecting the cost of operating must be ascertained and carefully compared with its corresponding effect on construction cost, in order to secure the most economical ratio between operating expenses and construction cost.

The principal factors affecting cost of operation, with which the Engineer has to deal, are: Volume of traffic, gradients, distance, rise and fall, curvature and maintenance of railway, for which economic values are elsewhere given under appropriate heads.

The sums which may be profitably expended for improving the character of the railway location and construction vary most directly with the number of trains to be operated over the new railway, for which reason the "train mile" is usually adopted as the operating unit. The commercial effectiveness of "operation" is reflected in the average cost of transportation per net ton mile, which may be regarded as the commercial unit.

The least cost of transportation is secured when the lowest train mile cost is combined with the largest net tonnage per train. And the earning power of the invested capital is greatest when least cost and greatest net tonnage per train are combined with the lowest economic capital expenditure.

Under these conditions only does "a dollar earn the most interest."

#### GENERAL INSTRUCTIONS.

The rules governing location are intended for use in the field, and it is expected that they will be closely followed. The ability of the engineer will be determined by this standard.

Before any new road is located, the Chief Engineer will indicate the character and purpose of the line, and will give the number of trains for which the line is to be located. After the completion of the preliminary surveys he will also

determine the rates and proper adjustments of the ruling grades and the maximum degree of curvature to be adopted. All locations must be approved by the Chief Engineer before construction is begun.

Each railway location should be specially considered with reference to its effect upon receipts, operating expenses, and fixed charges, the character and direction of the expected traffic and the class and number of trains to be operated over it. The selection of route, adjustment of location details and character of construction will be determined in accordance with the ascertained conditions of lowest operating expense and least construction cost for each case.

Locating engineers will furnish weekly reports, stating progress and giving all other items of general interest pertaining to their work, especially information concerning present or prospective sources of traffic, its locality, character and amount.

Strict compliance with the instructions is expected concerning the preparation of maps, profiles, records and estimates.

Graphic tables for computing quantities on transverse slopes for use in preliminary estimates will be furnished by the railway company.

So far as practicable, all maps, profiles, estimates and general records will be completed while the surveys are in progress, avoiding all unnecessary accumulations at the close of the work.

Competent engineers will avoid much unnecessary loss of time and money by making preliminary reconnoissances in person, using pocket compass, hand level and "aneroid" when necessary. When there are several alternate routes careful examination will usually prove it unnecessary to make instrumental surveys over them all.

Rapid exploration lines, especially when in timber, should be run with compass bearings; in many cases the method of stadia readings will also expedite progress. The time-honored custom of conducting explorations from behind the transit should be changed for a more intelligent method.

The reconnoissance should be of an area rather than of a consecutive line, all lines or combinations of lines connecting controlling points being studied as a whole. It should be the

effort of the engineer to first ascertain the position, character and limiting effect of controlling points, natural or otherwise; afterwards connecting such points most advantageously, and finally filling in intermediate details to the best advantage.

No local conditions of rocky slopes, swamps, brush, timber, etc., should be allowed to unduly influence the Engineer as to their real effect upon the total estimate. He should also remember that alternate lines will be compared upon the basis of completed cost, and not on the cost to subgrade only, and finally that it is not the object of location to secure a line of uniform low cost, but of least total cost. It is a common error to reject routes with short sections of heavy construction cost in favor of more uniform although inferior routes of greater total cost.

The route of best grades and alignment should always be first projected, working back to the final and most economical route. Working in the reverse order usually results in inferior location.

The possibility of obtaining a very good line should not preclude the search for a better one; the greatest and most costly location errors occur most frequently in prairie regions.

Valley locations are usually projected from "point to point" on the line of shortest distance, when the stream is unimportant, otherwise the convex angles of the stream on one side and the slopes on the other form controlling points, if not modified by the additional latitude of choice afforded by the two sides of the stream, or any combination of same.

Bench, plateau or prairie locations are usually projected on routes of most uniform grade and direction between controlling points. Commercial centers, stream crossings and controlling elevations form the principal controlling points.

Mountain locations are subject to greater restrictions, and are usually fixed with reference to the position and height of the summit, the distribution and amount of rise and fall to be overcome and the relation between the adopted gradients and the corresponding length and cost of line.

The summit is, of course, the principal controlling point; other points are generally accidental or artificial, as determined by local topographical conditions and the rate of grade adopted for the descent. Such lines are usually located de-

scending from the summit along a uniform grade contour to an intersection with the "bottom" line of lower grades.

All locations should be made with regard to future permanent construction and every effort used to reduce the amount of temporary construction which may be required to the least limits. Many opportunities for stream diversion are neglected, even in cases where the cost of the bridging otherwise required is many times in excess.

When construction funds are limited, adopt lower standards of construction, lay temporary gradients and use short sections of temporary line around or over tunnels and sections of heavy work, if necessary to avoid sacrificing future benefits arising from a properly located route. Such lines may be economically revised at some future time, while the revision of a generally faulty "location" might involve such large expenditure as to make a remedy forever impracticable.

Exercise extreme care in fixing the locations for stations, water tanks, coaling plants and crossings, and in adjusting grades for same, to reduce the cost and disadvantages of train stops to the minimum.

Train stops on or near the foot of grades should always be avoided if possible, and when not avoidable for any reason, the rate of grade should be compensated to facilitate the starting of trains.

A proper reconnoissance report conveys a graphic impression of the features of the region and route traversed, and contains the fundamental elements affecting operation and construction cost. The engineer should separate the routes reported upon into natural divisions of similar characteristics, giving distances, grades and controlling points of each. He should describe, classify and approximately estimate the material to be moved and other work to be performed, giving averages per mile and totals for each section, and furnish an approximate estimate of the cost per mile and total cost of the completed railway. Small scale maps and profiles showing general features, elevations and distribution of ruling grades should accompany such reports, whenever necessary.

The fundamental principle of good location is common sense.

#### VOLUME OF TRAFFIC.

Fixed charges are but slightly, or not at all, affected by variations in volume of traffic. "General" operating expenses

are affected only by considerable changes of volume, while the more direct expenses of operation vary more or less closely with the tonnage or passengers transported.

The effect on cost of operation of the number of trains operated is much more direct, than of the actual number of passengers or tons transported, hence the effect on the cost per train-mile is used as the basis for all economic comparisons, and the actual cost per train-mile should be ascertained in all cases, when possible.

Under practical conditions, the first trains operated cost more, and additional trains cost less than the average cost of all.

The average cost per train-mile for the United States is probably not far from \$1, and this amount may be used for convenience, when more exact data are lacking.

When the number of trains is affected without affecting the total cars or tonnage, the cost per train-mile added or saved, may be assumed at 60 cents, in default of more exact data.

The cost of assistant engine service, extra cost of heavier engines and of all other items affecting the cost per train-mile, under special conditions, must be added or subtracted from the train-mile cost first assumed (see Ruling Grades).

If better estimates of cost are not available, estimate assistant engines at \$7,500 per annum (per day of 12 hours) and heavier engines in the ratio of 15 per cent. increase of cost per train-mile for doubling weights on driving wheels. The total cost of assistant engine service should be divided by the number of trains served.

Passenger trains are but little affected in number or length by some classes of rise and fall and gradients and should be excluded in all such cases.

For the purpose of comparison capitalize the annual cost of train expenses at 6 per cent.

#### DISTANCE.

Minor changes not aggregating over two miles, in an engine stage, do not usually affect train wages, nor track force; train expenses and renewals are slightly affected.

The capitalized value of this class of distance per daily train per annum may be considered as 25 cents per foot, to which should be added its construction cost, at say \$3 per foot, when the actual cost is not known.



Greater changes, but not adding to the number of engine districts usually increase both train wages and track force. The assumed value of this class per daily train per annum is 60 cents per foot (\$3,168 per mile). The actual construction cost should be added to the total thus obtained.

Considerable changes, adding to the number of engine districts and the number of trains operated, should be valued in accordance with the ascertained cost of similar service under similar conditions, but otherwise may be valued on the basis of \$1 per train-mile, equivalent to \$6.083 capitalized value per mile of distance per daily train per annum, adding all construction cost of railway and extra equipment to the amount obtained by multiplying this sum by the actual number of daily trains (each way).

The effect of distance on receipts is sometimes most serious, and a still further sum must be added in such cases, when the effect is sufficiently tangible.

#### CURVATURE.

The cost of operating curvature varies with the angular degrees of curvature operated, and is but little affected by the length of curve radius.

The operating value of curvature per degree is assumed at \$7 per daily train per annum, but to this should be added the commercial value of lost time, if any, and also all extra construction cost of rail-braces, tie-plates, spikes and guard rails.

Curves exceeding 14 degrees per station should not be used without due necessity and usually require both guard and "hold-up" rails for safety.

A maximum curve, unlike a maximum grade, is not limiting, and does not justify the use of similar curvature elsewhere on the same engine district.

All curves of 3 degrees and over must be provided with terminal transition curves, changing 1 degree with each chord of 50 feet. On mountain lines this rate of transition may be doubled if necessary.

Curves less than 300 feet in length will not be used.

The minimum tangents between reversing curves must not be less than the chord length of the transition curves; the minimum tangents between curves in the same direction must not be less than 500 feet.

Curvature on maximum gradients must be compensated at a rate not less than .04 feet per degree.

Use standard rules for super-elevation of outer rail.

#### RISE AND FALL.

The effect on operation of minor gradients and small undulations, within "velocity limits" is very small, and its capitalized value is assumed at \$2 per foot per daily train per annum (one way). Limiting curvature and train stops on grades of this kind will greatly increase the cost of operation, and should be avoided in any event.

The value of rise and fall on grades of considerable rise exceeding velocity limits, but not requiring use of brakes and sand, is \$7 per foot per daily train.

The value of rise and fall on grades requiring the use of brakes and sand is \$22 per foot per daily train, and \$30 per foot if on ruling gradients.

The limiting effect on train weights, of long sections of more or less continuous rise, may considerably exceed that due to maximum gradients. This effect occurs oftenest on valley lines with low ruling gradients.

Train weights may be limited either by ruling gradients which tax adhesion, or by time requirements, which tax the engine boiler.

The product of speed and train resistance is horse-power and with fixed conditions of speed and engine horse-power, the train resistance is also fixed. Hence, the train weights over the division may be fixed by the average scheduled speed, and the engine horse-power at limits far below those fixed by ruling gradients. Under such conditions the average and not the maximum resistance controls the train weights.

Compute engine horse-power by the simple formula.

$$P = \frac{R \times S}{375}$$

in which P is horse-power; R, resistance of total train in pounds; S, speed in miles per hour; and 375 a constant factor. (See Fig. 1 for horse-power of typical engines in use on the N. P. Ry, in 1898).

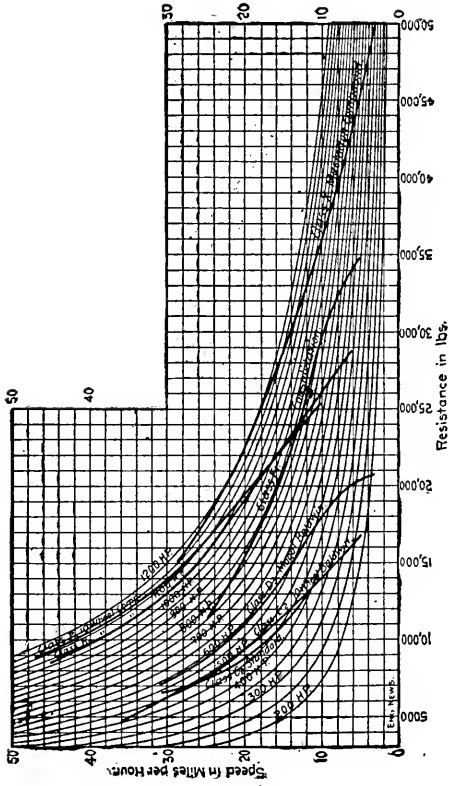


FIG. 1.

CURVES SHOWING HORSE-POWER OF STANDARD LOCOMOTIVES; NORTHERN PACIFIC RY.

TABLE OF MEAN CYLINDER TRACTIVE POWER.

Speed in miles per hour.....	{ Initial speed.....		45	40	35	30	25	20	15	
	{ Terminal speed .....									10
Class X.....	{ Mastodon compound. Weight on drivers, 150,000 lbs. eng. & tendr, 270,720 lbs. }	{ .....	.....	.....	.....	23,607	26,094	29,050	32,433	36,000
Class P.....	{ 10-wheel compound. Weight on drivers, 112,000 lbs. eng. & tendr, 249,500 lbs. }	{ 16,057	17,071	18,219	19,521	20,947	22,432	23,917	25,400	
Class R.....	{ 10-wheel compound. Weight on drivers, 128,000 lbs. eng. & tendr, 264,530 lbs. }	{ 15,575	16,618	17,819	19,212	20,822	22,545	24,267	26,000	
Class F 1.....	{ Consolidation. Weight on drivers, 135,000 lbs. eng. & tendr, 227,600 lbs. }	{ .....	.....	.....	.....	.....	18,934	21,659	25,100	29,300
Class D 3.....	{ Mogul, Baldwin. Weight on drivers, 85,900 lbs. eng. & tendr, 175,290 lbs. }	{ .....	.....	.....	.....	11,743	12,921	14,355	16,058	17,850
Class E 2.....	{ 10-wheel Baldwin. Weight on drivers, 76,700. eng. & tendr, 117,700 lbs. }	{ .....	.....	8,942	9,755	10,653	11,664	12,800	14,050	
Class C 2.....	{ Standard. Weight on drivers, 55,500 lbs. eng. & tendr, 154,260 lbs. }	{ .....	.....	.....	9,490	10,270	11,314	12,690	14,500	

Vertical curves are required on summits at all grade intersections not less than 50 feet in length for each change of one-tenth in rate of grade.

In "sags" the rate of change should not exceed 0.05 feet per station. In theory, the rate of change should be such as to maintain equality between the rolling resistance and the "acceleration of gravity" of each car throughout the varying rates of speed.

#### RULING GRADES.

Grades which limit the maximum weights and length of trains, are termed "Ruling Grades." Maximum grades, which may be operated by heavier engines, or by assistant engines, are not necessarily ruling grades.

The economic value of changes in rates of grades is determined by the relative total cost and number of trains, required on each rate of grade to transport the same number of cars and tons. The practical rule is as follows: Multiply the daily number of trains saved or added by the ascertained cost per train-mile, by the length of the division in miles, and by the number of days in the year, the result will be the annual saving or added cost, resulting from such change in rate. To obtain the capitalized value, divide this result by the proper interest rate.

When actual values are not known, assume the rate of 60 cents per train-mile (see Volume of Traffic), which capitalized at 6 per cent. is \$3,650 (one way only).

The cost of operating heavier engines, assistant engines and all other items of expense added or saved, should be computed in addition and capitalized, if necessary (see Volume of Traffic).

Every effort must be made to maintain the lowest practicable and economical rate of grade over the entire engine district.

When sections of high grade are unavoidable, it is frequently practicable to concentrate such "rise and fall" into short sections, which may be economically operated by use of assistant engines.

The ruling grade of each engine district should be adjusted with reference to those of the adjoining districts, or to conditions of local traffic, in such a manner as to avoid unnecessary "breaking and making up" of trains. When not practicable to secure this by grade adjustment alone a combined ad-

justment of grades and engine, weights will effect the same end.

The ratio of rates of ruling grades to each other at points of intersection should preferably be in proportion to the tractive powers of the available types of engines.

On sections of great rise and fall (mountain crossings, etc.) it should be the aim of the engineer to produce the maximum and minimum ruling grades to an intersection, if possible, and in any event to reduce the sections of different rates to the least number.

Ruling grades may be of different rates, but equal limiting effect, when adjusted for unbalanced volume of traffic.

Train stops on maximum grades must be compensated as fully as practicable, and not less than 3.5 feet in any case. Compensation is not only provided for the increase in starting friction over rolling friction, but in addition to permit trains to acquire speed more rapidly. Train stops near the foot of a long grade are most limiting in this respect.

#### VIRTUAL GRADES.

The motion of a train represents stored energy, derived from the engine or gravitation, and, under appropriate conditions, the power of the engine may be in part absorbed in imparting speed to the train, or augmented by the surrendered momentum of the train.

When rolling and grade resistances exceed the applied force, motion is retarded and energy released in definite proportions, and conversely, when applied force is in excess, motion is accelerated and energy imparted in like proportions.

The moving energy of the train at different speeds is given in Fig. 2 in terms of "Velocity Head," which is the vertical height, through which the train would be lifted, at each degree of speed by its momentum alone.

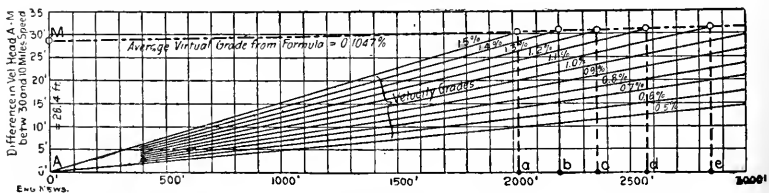


FIG. 2.  
DIAGRAM SHOWING LENGTHS OF VELOCITY GRADES.

Formula for Determining the Average Virtual Grade.

$$S_v = \frac{1}{20} \left[ \frac{T}{W} - R \right] \tag{1.}$$

$S_v$  = average virtual grade expressed in per cent.

$T$  = mean cylinder tractive power in lbs. for given initial and terminal speed.

$W$  = weight of train in tons of 2,000 lbs.; including engine and tender.

$R$  = mean train resistance in lbs per ton of train.

Note—The maximum virtual grade for a given train-load ( $W$ ) is found by inserting in above formula the train resistance ( $R$ ) and the cylinder tractive power ( $T$ ) for minimum speed (10 miles per hour).

Example: In above diagram is shown the length of velocity grades for engine Class D 3 Mogul, pulling a train weighing 1,250 tons (including engine and tender) for an initial speed of 30 miles and a terminal speed of 10 miles per hour.

The difference in velocity heads ( $A M$ ) taken from Table of Velocity Heads = 31.95 — 3.55 = 28.4 feet.

The average virtual grade ( $S_v$ ) is calculated from formula:

$$S_v = \frac{1}{20} \left[ \frac{T}{W} - R \right] = \frac{1}{20} \left[ \frac{11,743}{1,250} - 7.3 \right] = 0.1047 \text{ per cent.}$$

$T = 11,743$ , taken from table of mean cylinder tractive power.

$R = 7.3$ , taken from table of mean train resistance.

The length of velocity grades from  $A$  to  $a, b, c, d, e$ , etc., is found by construction, as shown in the above diagram, or may be found by calculation from the formula

$$l = \frac{d}{S - S_v}, \text{ in which } l = \text{length in stations of 100 ft.; } d = \text{difference in velocity heads for the given initial and terminal speed; } S = \text{actual grade in per cent., and } S_v = \text{virtual grade, as found from formula (1). The maximum virtual grade of the above example is}$$

$$= \frac{1}{20} \left[ \frac{17,850}{1,250} - 4.7 \right] = 0.479 \text{ per cent.}$$

Table of Mean Train Resistance in Pounds per Ton for Loaded Cars.

Speed		R.
Initial.	Terminal.	
45	10	10.6
40	10	9.4
35	10	8.3
30	10	7.3
25	10	6.5
20	10	5.8
15	10	5.2
10	10	4.7

Table of Velocity Heads.

(Velocity head = 0.0355  $v^2$ .)  $v$  = speed in miles per hour.

Speed	Velocity	Speed	Velocity
in miles	head	in miles	head
pr hr.	in ft.	pr hr.	in ft.
10	3.55	28	27.83
11	4.30	29	29.86
12	5.11	30	31.95
13	6.00	31	34.12
14	6.96	32	36.35
15	7.99	33	38.66
16	9.09	34	41.04
17	10.26	35	43.49
18	11.50	36	46.01
19	12.82	37	48.60
20	14.20	38	51.26
21	15.67	39	54.00
22	17.19	40	56.80
23	18.79	41	59.68
24	20.46	42	62.62
25	22.20	43	65.64
26	24.00	44	68.73
27	25.88	45	71.89

The engine tractive power is least at high speed and short "cut off," and greatest at low speed and "full stroke," as shown in Fig. 1.

The mean tractive power of these engines from different rates of speed to ton miles per hour is given by the table following Fig. 1, or may be deduced from the diagram.

The maximum available power for overcoming rolling and grade resistance is represented by the product of the train weight and its velocity head, added to the product of the mean engine tractive power, and the time or distance over which the power is exerted, illustrated, in short, in the effect produced by "taking a run at the hill."

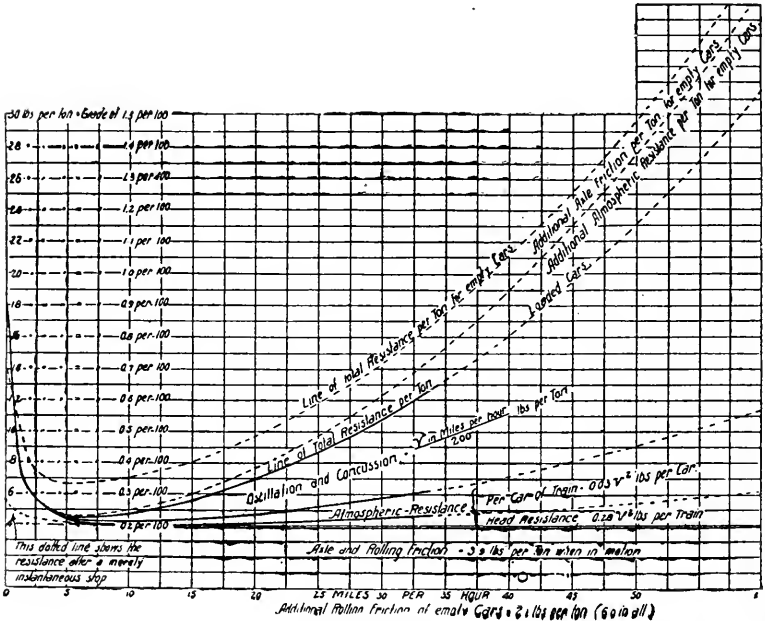


FIG. 3.

DIAGRAM OF TRAIN RESISTANCE IN POUNDS PER TON.

(From A. M. Wellington's Railway Location.)



Rolling resistance for trains at all speeds is given by Fig. 3, from which mean resistances between different rates of speed may also be readily computed.

The simplest rule for computing grade resistance is as follows: Resistance (in lbs. per ton) = rate of grade (in feet) x 20.

A gradient of equivalent resistance to the force exerted by the engine is the "virtual grade," or real resistance taxing the engine cylinders. The virtual grade line may be plotted with the assistance of Figs. 1, 2 and 3, or computed in accordance with the general principles before given.

"Momentum" or velocity grades may be used with due caution to avoid increasing rate of ruling grades, or to avoid large construction expenditures otherwise necessary. In all such cases train stops, grade crossing and limiting or dangerous curvature must be avoided.

Velocity grades requiring freight train speeds in excess of 30 miles per hour must not be used, nor should such grades be laid out for speeds in excess of that obtainable under ordinary working conditions.

#### MAINTENANCE AS AFFECTED BY LOCATION.

The cost and difficulty of maintaining track and roadbed may be greatly affected by the general characteristics and local details of the selected route, and all such conditions should receive careful consideration during the location of the route.

The greatest differences may exist, even between the two sides of the same valley, as one side may be subject to contingencies of drifting snow, slides, cloudbursts, stream encroachments or "washouts," from which the other side is wholly free. Conditions of greater shade, due to forest or bluffs, may cause longer duration of snow, frost and moisture, or local peculiarities of soil, and the character and number of lateral streams to be crossed may all contribute towards the increased cost of maintenance.

Additions to cost of maintenance arising from faulty details of "construction," may not be properly considered in connection with the subject of "Location," unless resulting directly

or indirectly from the character of the location, such as unnecessary increase in number and length of bridges, grade crossings in lieu of possible under or overcrossings, faulty arrangements of grades, affecting yard and station expenses, and other items of like character.

All additions to operating expenses, arising from such causes should be included in equations of alternate routes, capitalizing same if necessary, at the ruling rate of interest.

---

NOTE:—The table of Velocity Heads and the economic values given for "Distance," "Curvature" and "Rise and Fall" are derived from Wellington's "Economic Theory of Location," the values have been capitalized at 6 per cent.

## APPENDIX I.

### DETAILED RULES GOVERNING SURVEYS AND CONSTRUCTION OF RAILWAYS AND LISTS OF SUPPLIES REQUIRED IN THE FIELD.\*

#### SURVEYS AND CONSTRUCTION SURVEYS.

The railway company will furnish instruments, transportation, camp equipage and subsistence while parties are employed in the field. Each individual will provide himself with all personal articles, such as drawing instruments, clothing, blankets, etc.

All survey lines diverging from any constructed line must be connected with it by measurement, so that the initial point can be located upon the map of such constructed line.

Stations will be uniformly 100 feet long each, and numbered consecutively. It is not necessary to set stakes at each station in all cases on preliminary lines; this may be left to the discretion of the chief of the party. Mark stakes on alternate lines with distinguishing letter A, B, C, etc. Mark stakes on located lines "L." Mark point of curvature "P. C." or "P. S.," point of tangency "P. T." on the stakes of the beginning and end of all curves. Mark stakes at the "P. C." or "P. S." with the degree and direction of the curve.

Ties must be secured to all township and subdivision lines whenever crossed. Give station number of intersection, angle of intersection, distance along the line to the nearest corner or quarter corner. Whenever possible, make the intersection by running through between the two corners.

When line is located through villages or towns, take necessary measurements, tying the center line to the plats, and secure tracings of the town plats as contained in the county

---

\*These rules are in force on the Northern Pacific Railway.

registrar's office, with all dates and certificates contained in original, and send these copies to the office of the Chief Engineer.

Tie in all property and land lines and locate all buildings that are near the line.

Check all angles by needle reading, or by doubling the angle or both. Check all measurements by chain or tape. Check chains frequently by steel tape or level rod.

Keep all instruments in proper condition and good adjustment.

Always establish a substantial and permanent bench at the initial point of all surveys, and at short intervals along the line. Use the sea level datum, and if one has to be assumed, ascertain its relation with the standard datum at the first opportunity, and correct all elevations accordingly.

All level notes must be checked at the end of each day's work by adding the backsights and the foresights, and ascertaining the difference.

#### MAPS, PROFILES AND RECORDS.

Maps of located lines, made in the field, will be usually drawn to a scale of one inch to 800 feet; in broken and difficult localities, one inch to 400 feet. General maps to be sent to the office of the Chief Engineer may be drawn to a scale of one inch to 4,000 feet, etc. The maps will be made in conformity with the standard specimen sheets furnished from the office of Chief Engineer.

Maps, plans and profiles are to be drawn with the top of the paper to northward or westward, and the letters and figures are to be right side up toward the top or toward the left hand side of the paper, and must otherwise conform with the specimen profiles.

Maps and profiles should give names of all rivers and streams, names of owners or occupants of houses, ranches or farms passed by the line, etc. Put on all the information necessary to enable another person to fully identify any locality. Be certain to note on profile all extreme high or extreme low watermarks, wherever found, even if only approximate. The meridian should be drawn on all maps, both true and magnetic, when both are known.

On each drawing of any kind put name of engineer, initial of draftsman, date, place, etc. On both ends of the outside of the paper, give the title in full of the map, plan, sketch or profile.

Tracings of maps and profiles of all lines run must be sent to the office of the Chief Engineer, distinctly marked with the name of the line, streams, and all other information necessary to identify the locality.

Tracings of located lines showing government and property lines, streams and date of commencing and completing survey, must be made and sent promptly to the office of the Chief Engineer, as soon as each section of twenty miles has been finally located, for the purpose of filing map of definite location in the land office.

All changes of line made after the map of definite location has been filed in the general land office must be approved by the engineer in charge before being adopted, and as soon as made, reported to the Chief Engineer with a tracing of new and old line, and tracing profile of the part altered.

Topography on general maps should be given for a distance of 1,500 feet on each side of the center line, and further when necessary to show important features. In order to facilitate plotting contour topography, the notes should give distances of contours from the center line.

All courses of line must be given in reference to the true meridian, and for that purpose an observation must be taken upon starting the survey and the true course recorded in the field books, as the work progresses. An additional observation should be taken for the correction of meridional convergency whenever the extent of the survey shall attain a departure of one-half degree of longitude.

Curves and bearings of tangents shall be noted on the maps and profiles in the manner shown on the samples furnished. When practicable give true bearings instead of magnetic. State which is given.

To avoid cumulative errors, when platting lines, all angles must be laid off from some standard bearing, using the calculated course for this purpose. This can be done best by laying off any convenient bearing in the general direction of the sur-

vey and transferring all angles turned from this line by parallel rules or triangles, to the last point scaled. This will, on located lines, require all tangents to be calculated from intersection to intersection.

Indicate on the map, or otherwise, the width and extent of extra right of way necessary for stations, side tracks, "Ys," borrowpits, etc., on the line of the road.

Profiles, when completed, shall contain all the information called for on the sample copy furnished from the office of Chief Engineer, and arranged in the manner shown thereon. The original profiles must be made on the regular profile paper. Tracings must be made in sections of twenty miles from the original profile, and sent to the office of the Division Engineer, from which the necessary blue-prints will be made for contractors. Intersecting grades are to be connected by vertical curves, having a rate of change of grade per station of 0.05 feet, except on summit curves where the rate of change may be 0.1 foot, or more per station.

Profiles should show alignment drawn in red near the bottom of the paper. The direction of the curve is shown by drawing the radial lines to an intersection on their proper side, at the middle of the curve.

Progress profiles will be sent each month to the Chief Engineer's office, properly colored to show all work done to and included in the last estimate, on the part of the road in charge of the engineer. These profiles must show all work done during the preceding month; not only grading, but details of bridges and culverts built, with their exact location; description and location of all buildings, or structures of any kind, wells dug, main track, sidings, or "Ys" laid, etc. The depth that piles are driven below the surface of the ground should be indicated by dotted lines, showing the point of lowest pile in bent; the mud sills of trestles should be shown by a short heavy line, and on steep side hills the elevation of each mud sill should be indicated in the same way. Prints from "Solar" negatives of tracing profiles in the Chief Engineer's office will be furnished for progress profiles. The completed profiles will be retained in the office of the Division Engineer at the close of the work.

The standard progress colors are as follows:

January .....	Chrome yellow.	July .....	Sepia.
February .....	Carmine.	August .....	Emerald green.
March .....	Payne's gray.	September .....	Cobalt blue.
April .....	Deep chrome.	October .....	Vermilion.
May .....	Prussian blue.	November .....	Indian red.
June .....	Burnt Sienna.	December .....	Sap green.

Track profiles must be prepared in all cases when necessary for the guidance of the contractor, showing, in addition to the ordinary alignment notes of the profile, the number and length of rails to each tangent, the number of long and short rails in each curve, and the ordinates to which they are to be curved.

Field books must indicate each day's work, giving date. The flyleaf of each book must show in ink the name of the branch or division, nature of survey, kind of notes, name of engineer, name of instrumentman, or topographer, and the terminal points contained in the book. See that all subjects contained therein are properly indexed and that all notes of adopted or abandoned lines are properly marked as such. Have notes so plain that they may be understood by any one.

The original field notes should be sent in to the general office when the survey is completed. In case the original notes are not in good condition have them copied in new book, giving a revised and complete record of alignment, levels, topography, right of way notes and other data pertaining to the line.

Diaries will be furnished to engineers and instrumentmen on construction. Details of each day's work must be entered, giving dates of staking out work, commencement and completion of work on excavation, bridges and buildings; rise and fall of streams and other data of future value. These diaries must be returned to the Assistant Engineer at the close of the work.

#### RIGHT OF WAY.

As soon as the construction of a line has been ordered the Division Engineer will issue the necessary instructions for securing the right of way, which will be uniformly 100 feet in width, except where additional land is required for

station grounds, borrowpits, wide slopes or other purposes.

The right of way should be secured as rapidly as possible, contracts for same being taken and forwarded immediately to Division Engineer's office, where deeds and vouchers will be made.

The right of way agent will be under the orders of the Division Engineer, but will consult freely with the Assistant Engineer in charge of the line, and will make all agreements as to fences, cattle guards, road crossings, ditches, etc., subject to his approval.

The description of irregular tracts which are acquired by the company will be by metes and bounds, obtained by actual survey. The description of right of way through government subdivisions will be made in the following form:

A strip, piece or parcel of land 100 feet in width, situated in the northwest quarter of the northwest quarter of section 10, in township 2 north, range 1 west (S. 10, T. 2 N., R. 1 W.), Madison county, Montana, and having for its boundaries two lines that are parallel with and equidistant from the center line of the railroad of the ..... Railway Company, as the same is now located (and constructed). For a more particular description, reference may be had to the plat drawn upon and made a part of this deed.

The description of lots in platted tracts should be in the following form:

Lot seven (7), block six (6), in Smith's addition to Helena, Lewis and Clarke county, Montana, according to the recorded plat thereof.

All plats drawn upon deeds should give ties to the government survey points or to some fixed and indestructible points, so that the land can be located from the description and the plat.

As soon as the right of way has been definitely secured, plats of the same will be prepared in Division Engineer's office, conforming to standard scale and plan furnished by Chief Engineer, to whom they will be forwarded when completed, accompanied by the deeds.

#### ESTIMATES.

A careful estimate must be made showing the probable cost of every located line and of every structure or special



work upon which a report is ordered. Great precaution must be taken to include everything necessary to complete the work ready for operation or use. This applies to work to be done by both the Construction and Engineering Departments.

In case it is necessary to make the estimate before the exact quantities are determined, it must be replaced by another whenever the data can be obtained.

In monthly and partial estimates, make returns of grading to nearest ten yards, and masonry to nearest five yards.

Monthly statement (form 106), showing expenditures to date and comparison with the preliminary estimate, will be prepared by Assistant Engineer at the close of each month and sent to Division Engineer, who will note and forward to the Chief Engineer.

No estimate or statement of quantities will be given to contractors or sub-contractors not bearing the certificate of the Assistant Engineer.

The standard record book, form No. 62 of the Company, will be furnished each engineer in charge of a residency. The notes are to be written in ink, when final. The record should contain cross-section notes, and all other data pertaining to calculation of quantities, classification in detail, ground and grade elevations, alignment, material or labor accounts; and the data for every item embraced in the final estimate. A summary will be made giving the final estimate in sections of one mile, conforming to the mile-posts of the branch or division. The record must be kept up, as far as possible, while work is in progress, and must be turned in to the Assistant Engineer at the close of the work, and finally checked in the office of the Division Engineer.

#### GENERAL.

The plans and work of the company are its private property and must not be imparted to any one. Reports must be made to the immediate superior of the engineer or employee, and to no one else.

The rates of pay of all employees will be fixed by the Chief Engineer, and no change of rate so fixed shall be made without his authority first obtained.

Damage, destruction or loss of property of the Company through carelessness or wilfulness, must be made good by the individual at fault.

Engineers in immediate charge of parties are responsible for all Company property in their charge, and are expected to prevent extravagance and waste in the use of supplies of all kinds furnished by the Company.

Locating and resident engineers will forward a weekly report to their superior officers, reporting progress of work and all other general items of interest, pertaining to the work. This will be accompanied by the force report.

All engineers must make themselves familiar with the conditions of the contracts and specifications for work under their charge; they should attend to any reasonable request of contractors, furnish them heights, lines, stakes, plans, etc., whenever necessary, and in general do all things requisite to enable contractors to work to advantage and without delay.

During construction each line will be divided into residencies of convenient length, as directed by Division Engineer, each in charge of a Resident Engineer, and provided with such assistants, camp equipage, transportation and other outfit as may be necessary.

The nature of the work and the various facilities must be carefully considered as soon as the construction is ordered, so that competitive proposals may be obtained for everything that will be required.

Each Assistant Engineer in charge of a line will submit, for approval of the Division Engineer, a list of all buildings, sidings, Ys, etc., with proposed location of same, required on his work. The Division Engineer should submit all proposed plans for station or terminal facilities to the proper officials of the Operating Department for criticism, and their suggestions must receive careful consideration.

The arrangement of all stations and terminals and the appurtenant tracks, the location of water tanks, and all matters having a bearing upon the operation of any line, should also be submitted for criticism before construction.

Engineers must prosecute their work economically and will be expected to work to the estimates closely.

All structures will be built in accordance with the standard plans of the Company, and no deviation will be made from same except by authority of the Chief Engineer. Standard plans will be furnished from Chief Engineer's office, and at the close of each piece of work all that have been used on same, by engineers or contractors, will be returned to Division Engineer.

The usual classification of grading will be earth, loose rock and solid rock. If cemented gravel or soft rock in place or other distinctive material exists in considerable quantities, the fact must be reported to the Chief Engineer in order that it may have a proper classification assigned to it.

In staking out grading, have number of station marked on face of center stake, and cut or fill on its back. On slope stakes have cut or fill marked on the face, and number of station on the back.

Banks must be made full and regular. Care must be taken to avoid sags between stations. The roadbed throughout must conform strictly to the standard plan.

In regions swept by strong winds, where the snow-fall is liable to be great and drifting to occur, all structures will be put on that side of the track opposite the prevailing winds. Usually this will be the southerly side, and station buildings, water stations, switch stands and every kind of structure that can cause the formation of drifts, will be put on that side. Sidings and spur tracks should be put on the same side, where practicable.

When embankments are rip rapped to protect them from action of water, that part of embankment upon which the rip rap is placed should generally be made with slope not less than two to one. If the embankment has been finished at a steeper slope, the rip rap should usually be so placed that its exterior slope shall be two to one.

Surface ditches must be laid out with great care to prevent water from running down the slope of cut, or against embankments, or being carried to any point where it can act injuriously upon any part of the work. The ditches should be made of ample size; not less than one foot wide

at the bottom in any case; and if the area is considerable from which water may accumulate, they should be made two feet wide or more at the bottom. Material excavated in their construction should usually be thrown on the side toward the cut. In few matters is there more opportunity to show good judgment than in judiciously disposing of surface water about cuts. All cuts must have surface ditches and thorough drainage.

In turning streams care must be taken to make embankments across old channels strong enough to resist the action of currents. In such cases the width of the embankment should usually be made not less than ten (10) feet from the center line on the side against which the current will act, with slope of two to one. In cases of soft, spongy, or sliding material, this width should be increased on the exposed side. It should be borne in mind that it is less costly to build an embankment with excess of strength at first, than to have it washed out and be compelled to rebuild it.

In turning rapid, turbulent streams, take special and full precautions to prevent the new embankments from being washed away while building before they are high and strong enough for effectual resistance.

In building culverts and other waterways of perishable materials, ample allowance in size must be made for reconstructing them at a future time of durable materials. Wherever practicable iron culvert pipes should be hauled ahead and placed in position before the embankments are completed.

Vitrified tile pipe of double strength will be used under road crossings.

In building permanent box culverts of stone or brick, the smallest opening to be allowed is nine square feet, clear of all obstructions. The height of the opening of a culvert should never be less than its width. The greatest care should be taken to secure the foundations of all culverts and water conduits.

Stream diversions, even when of considerable magnitude, usually prove much cheaper in first cost and also in subsequent maintenance than the bridging otherwise required, particularly when the excavated material is used in embankments.

The natural "scour" of the stream may sometimes be relied upon to widen channel excavations of small original cross-section, but in all cases due precautions must be taken to insure final cross-sections of full and ample proportions.

Pile and trestle bridges, not required in part or in whole for waterway, are too frequently constructed in order to save time or to avoid real or supposed difficulties in forming the embankments. The maintenance cost of such bridges is many times in excess of that of embankments of equal first cost, and no bridges of this character should be built unless the cost of the embankments otherwise necessary exceeds both the first cost of such bridges and the subsequent cost of filling same by train or otherwise.

Thorough drainage is a maxim to be impressed on the mind and practice of every one engaged in construction, and engineers must beware of being deceived or misled in so-called "rainless districts," for experience proves that sometimes (perhaps at long intervals), most destructive and uncontrollable floods occur in such localities.

Top of bridge stringers will be set 0.25 foot above regular profile grade, and regular grade changed about 100 feet to meet it. This will apply in all cases, unless otherwise ordered.

In the construction of pile and trestle bridges a competent inspector should be retained, whose duty it shall be to keep a record of all piles driven. The inspector's record must show length of piles, depth to which each pile is driven, sinking in inches by the last three blows of the hammer, weight of hammer, and fall in feet of same, and amount of piles cut off.

Engineers should endeavor to secure, wherever practicable, at reasonable expense, undergrade or overhead highway crossings. Bridges and culverts can frequently be utilized at slight expense for undergrade crossings for stock by making necessary openings in right of way fence.

Before the completion of the work, all construction material left over and scattered along the line must be picked up and returned to the material yard. Refuse will be burned or otherwise disposed of.

## SUPPLIES FOR 14 MEN, 30 DAYS.

400 lbs. Flour.	25 lbs. Cheese.
50 lbs. Buckwheat flour.	50 lbs. Beans.
40 lbs. Oatmeal.	25 lbs. Rice.
30 lbs. Cornmeal.	10 lbs. Corn starch.
150 lbs. Sugar.	1 box Macaroni.
20 lbs. Salt.	10 lbs. Barley.
10 lbs Tapioca.	1 box Soap.
10 lbs. Sago.	1 bottle Lemon extract.
10 lbs. Baking Powder.	1 bottle Vanilla extract.
2 lbs. Mustard.	10 lbs. Currants.
1 lb. Pepper, ground.	1 box Raisins.
$\frac{1}{2}$ lb. Ginger, ground.	5 gallons Syrup.
$\frac{1}{2}$ lb. Cinnamon, ground.	6 bottles Pickles.
$\frac{1}{4}$ lb. Allspice, ground.	20 lbs. Onions.
100 lbs. Ham.	1 gallon Vinegar.
100 lbs. Bacon.	6 bottles Tomato catsup.
25 lbs. Dried beef.	1 case Corned beef.
25 lbs. Codfish.	3 lbs. Baking soda.
400 lbs. Potatoes.	50 lbs. Evaporated apples.
1 case Pears.	50 lbs. Dried peaches.
1 case Cherries.	50 lbs. Dried prunes or plums
2 cases Tomatoes.	$\frac{1}{4}$ lb. Nutmegs.
2 cases Peaches.	1 box Soda crackers.
2 cases Corn.	12 boxes Matches.
1 case Peas.	1 box Candles.
1 case Condensed milk.	2 lbs. Lye.
50 lbs. Coffee.	10 lbs. Sal soda.
10 lbs. Tea.	60 lbs. Butter.
40 lbs. Lard.	8 bottles Worcestershire sauce.
12 packages Yeast cakes.	1 case Coal oil.

Eggs, fresh meat and vegetables as required, if they can be obtained from the farming community.

## ENGINEER EQUIPMENT AND STATIONERY (FOR ONE FIELD PARTY).

1 Transit.	2 balls Twine.
1 Level.	2 yards Red flannel.
1 Chain, 10 extra links, 1 extra handle.	2 yards White flannel.
4 Flag poles.	1 Sounding rod, 3 joints, 8 ft. each.
2 Level rods.	6 6-H Pencils.
1 Hand level.	12 4-H Pencils.
1 Barometer.	12 No. 2 Pencils.
1 Pocket compass.	12 Timber leads.
1 Clinometer.	100 Manila envelopes, large.
1 Protractor, paper.	100 Manila envelopes, small.
48 Thumb tacks.	6 Colored pencils, red and blue.
6 Camel hair brushes.	12 Penholders.
1 Scale, triangular, decimal.	1 box Assorted pens.
1 Straight edge, 36 ins., steel, nickel plated.	12 Crow quill pens.
1 Drafting board and trestles.	1 Slab for india ink.
1 Stationery chest, tray and board.	2 Inkstands.
2 Hand axes and extra handles.	1 Pocket inkstand.
3 to 6 Axes and extra handles.	2 Pads letter paper.
1 Hatchet.	2 Pads notepaper.
	2 Pyramids pins.
	6 Rubber erasers.
	1 Steel eraser.

- |  |   |
|--|---|
| 1 Water keg, 2 gallons.                      | 3 quires Foolscap.                                    |
| 2 Brush hooks.                               | 3 quires Journal paper.                               |
| 2 50-ft. Tapes in cases, 2 without cases.    | 1 box McGill's paper fasteners.                       |
| 1 Bottle mucilage.                           | 50 sheets Cross-section paper, 10ths.                 |
| 2 Bottles India ink.                         | 4 Triangles, 10, 8, 7, and 5 ins., 30 and 60 degrees. |
| 1 stick India ink.                           | 30 yards Drawing paper, 24 ins wide.                  |
| 1 pint Combined writing fluid, stone bottle. | 1 roll Plate A profile paper, divided.                |
| 1 small bottle Red ink.                      | 1 roll Tracing cloth, 30 ins.                         |
| 2 doz. Shipping tags.                        | 1 Stylus book, with carbons.                          |
| 2 doz. Shipping tags.                        | 24 Time returns.                                      |
| 5 Transit books.                             | 1 Book of receipts.                                   |
| 10 Level books.                              | 1 Pad.  |
| 10 Typography books.                         | 1 Book rules and regulations.                         |
| 6 Scratch blocks.                            | 1 Book transportation rules.                          |
| 12 Blotters.                                 | 1 box Rubber bands, assorted.                         |
| 1 Time check book.                           | 2 Tin map cases, 6x36 ins.                            |
| 1 doz. Property reports.                     | 2 lbs. Keil.  |
| 1 block Vouchers.                            | 2 quires Legal cap.                                   |
| 12 papers Tacks, 8 oz., tinned.              |   |
| 3 quires Wrapping paper.                     |   |

In the case of extended explorations beyond civilization a necessary supply of medicines should be provided.

#### CAMP EQUIPMENT (FOR ONE FIELD PARTY).

- |                                    |   |
|------------------------------------|---|
| 4 Tents and files, 14x14 or 14x16. | 1 Flesh fork.                           |
| 1 Grindstone.                      | 1 Biscuit cutter.                       |
| 1 Monkey wrench.                   | 36 Teaspoons.                           |
| 1 Spade.                           | 36 Tablespoons.                         |
| 1 Hand saw.                        | 36 Knives.                              |
| 1 Cross-cut saw.                   | 36 Forks.                               |
| 1 Alarm clock.                     | 1 Carving knife.                        |
| 1 Two-gallon keg.                  | 1 Carving fork.                         |
| 1 Washtub, board and boiler.       | 1 Tea kettle.                           |
| 1 bundle Sail twine and needles.   | 1 Tea strainer.                         |
| 1 Sail palm.                       | 24 Coffee cups.                         |
| 10 yards Canvas.                   | 2 Candle lanterns.                      |
| 2 Three-cornered files.            | 3 Washbasins.                           |
| 1 Flat file.                       | 2 Dippers.                              |
| 10 yards Toweling.                 | 1 Lunch basket.                         |
| 1 Scrub brush.                     | 1 Dinner table.                         |
| 1 Broom.                           | 2 Trestles for tables.                  |
| 3 Candlesticks.                    | 1 Cook table.                           |
| 3 Stand lamps and 6 chimneys.      | 1 Sibley stoves, sheet iron.            |
| 2 Stewpans.                        | 1 Cook stove.                           |
| 1 Water pail.                      | 3 pieces pipe, with dampers.            |
| 2 Griddles.                        | 12 pieces Pipe without dampers.         |
| 1 Coffee mill.                     | 2 iron pots.                            |
| 4 Drip pans, 12x17.                | 1 Three-gallon coffee pot.              |
| 1 Five-gallon dish pan.            | 1 Two-gallon tea pot.                   |
| 1 Five-gallon bread pan.           | 1 Large frying pan.                     |
| 4 Large iron spoons, 12 ins.       | 1 Small frying pan.                     |
| 1 Soup ladle.                      | 2 No. 28 Stew kettles, galvanized iron. |
| 1 Cake turner.                     | 24 Pint cups.                           |
| 1 Steel.                           | 36 Plates.                              |
| 3 Butcher knives.                  | 1 No. 24 Stew kettles, galvanized iron. |
| 1 Chopping bowl.                   | 12 Pie plates.                          |
|                                    | 4 Three-quart Pans.                     |

- |                     |   |
|---------------------|---|
| 1 Chopping knife.   | 4 Four-quart pans.                          |
| 3 Pepper boxes.     | 4 Six-quart Pans.                           |
| 1 Sieve.            | 18 pint Pans.                               |
| 1 Steamer.          | 3 Tin pot covers.                           |
| 1 Colander.         | 2 Three-gallon Galvanized wa-<br>ter pails. |
| 2 Can openers.      | 1 Two-gallon Tin water pail.                |
| 1 Meat saw.         | 1 Pick and handle.                          |
| 1 Potato masher.    | 2 Mess chests.                              |
| 1 Rolling pin.      | 5 lbs. 10d. Nails.                          |
| 1 Nutmeg grater.    | 100 ft. $\frac{3}{4}$ -in. Manila rope.     |
| 1 Bread board.      |   |
| 10 yards Oil cloth. |   |



## APPENDIX J.

### DETAILED RULES GOVERNING CONSTRUCTION OF TRACK OF RAILWAYS\* AND VARIOUS SPECIFICATIONS AND TABLES, GIVING DETAILS IN REGARD TO MATERIAL USED IN CONSTRUCTION.

#### TRACK AND BALLAST.

Preparation of Roadbed.—The standard width of single track roadbed at sub-grade is 14 feet on embankments, 20 feet in earth cuts and 16 feet in rock cuts unless otherwise ordered.

All narrow banks must be widened to the standard width from centers, as established by the engineer.

Transition curves will be used at the end of all curves of 3 degrees and upwards. The rate of change per degree of curvature should preferably not exceed 1 degree for each chord of 50 feet in length, except on mountain grades, where the chord may be reduced to the minimum length of 25 feet, when necessary.

Short sags should be avoided, and in all cases vertical curves should be provided at grade intersections, for which the engineer will establish line and grade wherever required.

The roadbed at sub-grade should be crowned to facilitate drainage by raising the center 4 to 6 inches higher than the sides, making due allowance for ballast in establishing final grade elevation.

Ditches in cuts should be taken out in accordance with the standard cross-section as follows: In earth, 3 feet, wide at sub-grade, 1 foot deep, with side slopes 1 to 1. In rock 1 foot wide at sub-grade, 1 foot deep, vertical sides.

Material used for ballasting, widening banks or raising sags should be procured at points where the removal of

---

\* These rules are in force on the Northern Pacific Railway.

same will benefit the roadbed by widening cuts, reducing grades or ditching. Engineers will give this subject their special attention.

Ties.—The number of ties per rail will necessarily vary with the width of the ties furnished and will usually be from fifteen to seventeen ties per rail length. The minimum width between ties must not be less than ten inches. On construction, ties will be laid two feet c. to c., or 2,640 ties to the mile.

The best ties will be selected for use at joints, with faces not less than eight inches nor more than ten inches wide, and must be so placed that the outside bolt will come about the center of ties; the maximum spacing between ties at joints must not exceed ten inches.

“Rail cut” ties must be adzed to uniform bearing, old spike holes plugged, and joint ties properly spaced for suspended joints, after the new rails are laid, and before the ballast is distributed.

In order to maintain the standard gauge, three lines of spikes must be drawn if old steel rails are replaced by rails of wider section.

Distributing Rails.—The rails may be distributed either from the end or sides of train. If distributed from the sides, both ends of rail must be dropped simultaneously. Skids will invariably be used whenever necessary to unload into piles. In all cases the greatest care must be used to avoid injury to rails by dropping them on hard substances or uneven surfaces.

Curving.—Rails in curves of over 2 degrees must be separately curved, and before being placed in track. An Emerson rail bender or bender of similar type will invariably be used for this purpose. The sledging of rails is positively prohibited.

Particular care must be given to insure uniform curvature of the rail throughout its length, in accordance with the following table of middle ordinates:

Degs.	Ins.	Degs.	Ins.	Degs.	Ins.	Degs.	Ins.
1	$\frac{3}{8}$	6	$1\frac{7}{8}$	11	$2\frac{5}{8}$	16	$3\frac{3}{8}$
2	$\frac{1}{2}$	7	$1\frac{3}{4}$	12	$2\frac{1}{2}$	17	4
3	$\frac{1}{2}$	8	$1\frac{1}{2}$	13	$3\frac{1}{8}$	18	$4\frac{1}{4}$
4	$\frac{1}{2}$	9	$2\frac{1}{8}$	14	$3\frac{5}{8}$	19	$4\frac{1}{2}$
5	$1\frac{1}{8}$	10	$2\frac{3}{8}$	15	$3\frac{1}{4}$	20	$4\frac{3}{4}$

NOTE.—Ordinate at quarters equals three-quarters of middle ordinates.

**Placing Rails in Track.**—The rails must be laid to line and gauge, and placed in track consecutively, throwing out both rails from the old track ahead, as the new rails are laid when the track is relaid. Split points will be used for closing track for passage of trains. Accurate expansion cannot be secured if long stretches of rails are fastened up to one side of track and subsequently thrown into line, and this method is prohibited.

The track will be laid with even joints on tangents and broken joints on curves, except on sections of frequent curvature and short tangents less than 1,000 feet in length, where broken joints will be maintained throughout.

To pass from even joints on tangents to broken joints on curves, cut and use a rail according to the following rule:

Cut rail at point distant from center of rail one-half inch for each degree of central angle of curve, using short rail on inner side of curve. For consecutive curves with short intervening tangents, obtain the separate sums of right and left central angles, subtract the lesser from the greater, and the difference will be the required angle. Use short rail on inner side of this angle. The length of the short rail must not be less than ten feet.

“Short rails” may be used in inside line of rails in curves of large central angle, in order to maintain position of joints near center of outer rail, and in such cases the above rule must be modified correspondingly. Notes for length of cut or short rails will be furnished in advance by the engineer.

Track centers will be furnished by the engineer every 200 feet on tangents, every 50 feet on curves and every 25 feet on easement curves. The track must be laid to conform accurately to the line established.

To insure perfect alignment at rail ends, the rails should be brought squarely together, the splices placed and carefully bolted before spiking. Perfect alignment at rail ends is of great importance in order to prevent excessive flange wear.

The position of the brand on the rail is immaterial, whether right or left, inside or outside, but its position must be uniform with the contiguous rails, and the brand should not be alternated on the same line of rails.

When relaying track, a convenient method of unloading rails from end of car is by means of two 30-foot lines, equipped with grab hooks on each end, one end to be made fast to joints and the other end to slots in ends of rails, using the engine for moving the cars. This insures proper spacing, and is more economical than unloading from the sides. Use roller at end of car when drawing off rail.

Expansion.—Proper allowance must be made for expansion, according to temperature, as follows:

Temp.	Ins.	Temp.	Ins.
100°	0	40	$\frac{3}{16}$
80°	$\frac{1}{16}$	20	$\frac{1}{4}$
60°	$\frac{1}{8}$	0	$\frac{5}{16}$

Proper expansion must be secured by the use of iron shims, provided in accordance with the above specifications, except where track is laid on a steep grade, when sawed wooden shims of proper thickness will be provided. These shims must be left in place until track is full spiked, bolted and thoroughly anchored.

In order to prevent rails from "creeping," it is absolutely essential that each individual rail shall be so thoroughly anchored as to insure freedom from contact with adjoining rails. Creeping cannot be prevented if a number of consecutive rails are in contact.

Bolting.—The Harvey grip, or other approved form of bolt, should be used. At the time the rail is laid, two bolts should be placed in each splice, and tightened sufficiently to hold rails in line. The remaining bolts should then be placed and tightened as soon as possible. Nuts should be tightened a second or third time within thirty days after track is laid.

Inspect the rails before angle bars are tightened, and take out kinks or bends by the rail bender. The nuts must be screwed up firmly before joints are spiked.

Gauging.—The standard gauge will be as follows:

On tangents.....	4 ft. 8½ ins
On curves of 1, 2 and 3°.....	4 " 8¾ "
On curves of 4, 5 and 6°.....	4 " 8¾ "
On curves of 7, 8 and 9°.....	4 " 8¾ "
On curves of 10, 11 and 12°.....	4 " 9 "
On curves of 13, 14 and 15°.....	4 " 9½ "

The extra width of gauge on curves should be uniformly decreased or tapered off, on the easement curve, from point of full curve to point of tangent.

Joints and centers should be gauged first and the track gauge must be applied at as many points as may be necessary to insure perfect and uniform gauge.

Easement curves must be spiked to gauge at five different points within each rail length, and all track must be accurately gauged when spiked.

Suitable track gauges for use on tangents and curves, which will insure the retention of the proper gauge during the operation of spiking, must be used. All track gauges must be tested by the engineer or roadmaster at the beginning of the working season, and the date of inspection recorded.

Spiking.—Track must be full spiked, with inside and outside spikes driven in opposite sides of the tie. Spikes must be set half their own width from edge of rail and driven vertically to a full bearing on foot of rail. The prevalent practices of driving sloping spikes, or of giving them a final lateral blow to close the spikes against the rail will not be permitted. So far as possible the spikes will be driven in the best wood in the tie, which is usually at the outer edge, and must not be redriven in old holes.

Elevation.—The elevation (in inches) of outer rail upon curves will be made in accordance with the following table:

TABLE OF ELEVATION OF OUTER RAILS ON CURVES.

De- gree of curve	Rate of speed in miles per hour.								
	15.	20.	25.	30.	35.	40.	45.	50.	60.
	Superelevation.								
	ins.	ins.	ins.	ins.	ins.	ins.	ins.	ins.	ins.
1	$\frac{1}{8}$	$\frac{1}{4}$	$\frac{7}{16}$	$\frac{9}{16}$	$\frac{1}{2}$	$1\frac{1}{16}$	$1\frac{5}{16}$	$1\frac{9}{16}$	$2\frac{1}{8}$
2	$\frac{1}{8}$	$\frac{1}{4}$	$\frac{7}{16}$	$1\frac{1}{16}$	$1\frac{1}{8}$	$1\frac{5}{8}$	$2\frac{1}{8}$	$2\frac{1}{8}$	$3\frac{1}{8}$
3	$\frac{1}{8}$	$\frac{1}{4}$	$1\frac{1}{8}$	$1\frac{3}{8}$	$2\frac{1}{8}$	$3\frac{1}{8}$	4	$4\frac{1}{8}$	$7\frac{1}{8}$
4	$\frac{1}{8}$	$1\frac{1}{8}$	$1\frac{5}{8}$	$2\frac{3}{8}$	$3\frac{1}{4}$	$4\frac{1}{8}$	$5\frac{5}{8}$	$6\frac{3}{8}$	....
5	$\frac{3}{4}$	$1\frac{5}{8}$	$2\frac{1}{8}$	3	4	$5\frac{1}{4}$	$6\frac{1}{8}$	....	....
6	$\frac{7}{8}$	$1\frac{9}{8}$	$2\frac{7}{8}$	$3\frac{9}{8}$	$4\frac{3}{8}$	$6\frac{3}{8}$	....	....	....
7	$1\frac{1}{8}$	$1\frac{3}{4}$	$2\frac{3}{8}$	$4\frac{1}{8}$	$5\frac{3}{8}$	....	....	....	....
8	$1\frac{3}{8}$	$2\frac{1}{8}$	$3\frac{1}{8}$	$4\frac{1}{8}$	$6\frac{1}{2}$	....	....	....	....
9	$1\frac{5}{8}$	$2\frac{3}{8}$	$3\frac{1}{8}$	$5\frac{1}{8}$	....	....	....	....	....
10	$1\frac{7}{8}$	$2\frac{5}{8}$	$4\frac{1}{8}$	$5\frac{1}{8}$	....	....	....	....	....
12	$2\frac{1}{4}$	$3\frac{1}{8}$	$4\frac{1}{8}$	$7\frac{1}{8}$	....	....	....	....	....
15	$2\frac{3}{8}$	$3\frac{1}{8}$	$6\frac{1}{8}$	....	....	....	....	....	....
18	$2\frac{7}{8}$	$4\frac{1}{8}$	....	....	....	....	....	....	....
20	$2\frac{7}{8}$	$5\frac{1}{4}$	..	....	....	....	....	....	....

The greatest elevation must not exceed six inches unless otherwise directed.

The elevation of outer rail on curves must necessarily be adapted to speed and other local conditions with due regard to safety, comfort and economy of track maintenance, for all classes of trains.

The elevation on mountain grades should not exceed that required for 25 miles per hour.

The elevation of outer rail must not be continued beyond the tangent point, but should decrease uniformly along the easement curve from point of maximum curvature to tangent point.

To ascertain the elevation required at points on easement curves, trackmen are required to use a cord of standard length, the middle ordinate of which will be equal to the proper elevation, as follows:

Speed.	Length of cord.	Speed.	Length of cord.
20 miles per hour....	31.74 ft.	40 miles per hour....	63.48 ft.
25 miles per hour....	39.68 ft.	45 miles per hour....	71.42 ft.
30 miles per hour....	47.61 ft.	60 miles per hour....	79.35 ft.
35 miles per hour....	55.55 ft.		

This method is applicable to all curves, and aids in maintaining true alignment, as all ordinates should be equal on full centered portions of curves, and ordinates must decrease uniformly on easement curves from full elevation to zero at tangent point. In using the cord to ascertain elevation, it should be stretched and firmly held at both ends against the inner face of rail on inside of curve. The middle ordinate will then be equal to the required elevation and can be measured by a foot rule, or by attaching a short piece of graduated tape to the cord at its center.

All track levels must be tested by the engineer or roadmaster at the beginning of the working season, and the date of inspection recorded. Sluggish bubble tubes should be replaced.

Tie-plates.—The standard form of tie-plate will be used, with the standard 72-lb. rail section, in lieu of rail braces.

Tie-plates will be used whenever necessary to prevent tie cutting, generally on curves of 3 degrees or over, depending upon local conditions. The widest margin must invariably be placed on the outer side of rail.

On tangents and light curves, but two spikes will be used in each plate. On sharper curves, three or four spikes will be used, when necessary. In cases of unusual difficulty in maintaining gauge on mountain grades and sharp curves, before

applying tie-plates the ties may be dapped to allow a sufficient inclination to the rails to check any tendency of the rails to overturn, or to spread, observing due care to maintain gauge.

In laying these plates, the line side of the tie is marked, and the plate put on, the other plate being then put on in its proper position by gauging it from the line plate with a gauge rod having lugs to fit the spike holes. The plates may be forced into the tie by a hydraulic press, or in the track by striking vertically with a paver's rammer, or with a short section of rail provided with cross-bar handles. In putting plates on before the rails are laid, a wooden or metal block should be placed on the plate to distribute the blow. If put on after rails are laid, the rail may be lifted, the plate slipped in, an iron plate placed upon each projecting end of the plate, and these two plates struck simultaneously by two strikers with spike mauls; or, one end of the plate may be settled into the tie, and the free end then driven with a sledge, causing the flanges to plow their way through the wood under the rail.

**Rail Braces.**—Rail braces will be used when necessary with rail sections for which tie-plates are not provided, generally on curves of 4 degrees and upwards. On curves of less degree, double spiking will usually be sufficient. The braces should always be placed in pairs on the opposite ends of the same tie.

**Frogs and Switches.**—Switches must be put in track in accordance with the standard plans. When temporary sidings are put in, the main line rails must not be cut, but short closure rails must be provided to fill the space between frog and the adjacent rail. Double spiked short rails should be used for this purpose.

**Ballasting.**—All spikes should be driven down before ballast is distributed. Ballast should not be distributed until road-bed is of full width and all unsuitable material removed. When material is unfit for use as ballast, it should be cleaned out from bottom of tie and used for widening the banks. Where there is trouble in heaving, or wet spots, the material should be taken out to such depth and in such a manner as to insure perfect drainage. Care must be taken to avoid wasting ballast down the sides of slopes, or otherwise.

The depth of ballast will be determined in accordance with the local conditions, and the character and amount of ballast already in place, if any. In general, not less than 8 inches of good material will be required under ties.

**Tamping.**—Tamp the entire length of ties on new track. Special pains should be taken to insure thorough tamping from end of tie to 1 foot inside of rail. On old track the center should be filled and lightly tamped.

Tamp joint and second ties thoroughly. Thorough tamping of the second tie from joints is of equal importance with that required by the joint ties, and will prevent the formation of cracks starting from upper edge of splices by reducing the upward deflection of joints when a wheel is over the second tie.

Material for filling and ballasting must not be taken from slopes of embankments. When ballasting is completed the track must be in perfect line, surface and gauge, in accordance with the stakes furnished by the engineer.

**Ballast Cross-Section.**—Rock ballast should be filled in level with top of tie from center to 2 feet outside of rail, slopes 1 to 1.

Gravel ballast must be finished to the standard cross-section, which is as follows:

At the center and for 1 foot on each side thereof, the top of ballast will be even with the top of ties, and thence carried out with a straight uniform slope, passing 4 inches above bottom of ties at ends, to a point  $2\frac{1}{2}$  feet outside of rail, thence to an intersection with the roadbed, with slopes of  $1\frac{1}{2}$  to 1.

If material is used which is more or less impervious to water the slopes should be carried to an intersection with roadbed on a line with bottom of ties at ends.

The practice of crowning the ballast above top of tie at center causes dusty track and rots the tie at the center, and is not permitted, except when absolutely required for drainage on account of the character of material used for ballasting.

**Supervision.**—The engineer will furnish all necessary elevations, stakes and notes, and will make frequent inspections during the progress of track laying, in order to insure compliance with the specifications, promptly reporting defects to the roadmasters and superintendents.



## SPECIFICATIONS FOR STANDARD ROADBED AND TRACK.\*

1. Roadbed.—The surface of the roadbed should be graded to a regular and uniform sub-grade, sloping gradually from the center towards the ditches.

2. Ballast.—There shall be a uniform depth of six (6) to twelve (12) inches of well broken stone, or gravel, cleaned from dust, by passing over a screen of one-quarter-inch mesh, spread over the roadbed and surfaced to a true grade, upon which the ties are to be laid. After the ties and rails have been properly laid and surfaced, the ballast must be filled up as shown on standard plan; and also between the main tracks and sidings where stone ballast is used. All stone ballast to be of uniform size, the stone used must be of an approved quality, broken uniformly, not larger than a cube that will pass through a two and one-half ( $2\frac{1}{2}$ ) inch ring. On embankments that are not well settled, the surface of the roadbed shall be brought up with cinder, gravel or some other suitable material.

3. Cross-ties.—The ties are to be regularly placed upon the ballast. They must be properly and evenly placed, with ten (10) inches between the edges of bearing surface at joints, with intermediate ties evenly spaced; and the ends on the outside on double track, and on the right-hand side going north or west on single track, lined up parallel with the rails. The ties must not be notched under any circumstances; but, should they be twisted, they must be made true with the adze, that the rails may have an even bearing over the whole breadth of the tie. For all tracks on main line and branch roads the rules governing the use of cross-ties shall be as follows:

a. First-class cross-ties shall be used in tracks where passenger and freight trains run at full speed.

b. For tracks where the trains run at slow speed new second-class ties shall be used. For all tracks in yards, or temporary tracks laid for construction purposes or otherwise, second-class and cull ties, or good second-hand ties taken out of main track shall be used.

---

\*Used by the Pennsylvania Railroad Company.

c. On all running tracks where the weight of rail is seventy pounds per yard and over, fourteen ties shall be used to each thirty feet of track, and for all tracks in yards and for temporary use, not more than twelve ties shall be used for each thirty feet of track.

d. In removing cross-ties from the main tracks, they shall be taken out only as they become unfitted for service, in the manner generally known as "spotting ties," and not by entire renewals in continuous sections, and Sub-division Foremen will be held responsible for the proper observance of this rule. It shall be the duty of the Supervisor or his Assistant to walk over the track with the Foreman and personally inspect the ties to be renewed before he authorizes the same to be taken out and replaced with new ones.

4. Line and Surface.—The track shall be laid in true line and surface; the rails are to be laid and spiked after the ties have been bedded in the ballast; and on curves, the proper elevation must be given to the outer rail and carried uniformly around the curve. This elevation should be commenced from fifty (50) to three hundred (300) feet back of the point of curvature, depending on the degree of the curve and speed of trains, and increased uniformly to the latter point, where the full elevation is attained. The same method should be adopted in leaving the curve.

5. Joints.—The joints of the rails shall be exactly midway between the joint ties, and the joint on one line of rail must be opposite the center of the rail on the other line of the same track. A Fahrenheit thermometer should be used when laying rails, and care taken to arrange the openings between rails in direct proportion to the following temperatures and distances: At a temperature of zero ( $0^{\circ}$ ), a distance of five sixteenths (5-16) of an inch; at fifty degrees ( $50^{\circ}$ ), five thirty-seconds (5-32) of an inch; and in extreme summer heat, of say one hundred degrees ( $100^{\circ}$ ) and over, one sixteenth (1-16) of an inch must be left between the ends of the rails of thirty feet in length to allow for expansion. The splices must be properly put on with the full number of bolts, nuts and nutlocks, and the nuts placed on inside of rails, except on rails of sixty pounds per yard and under, where they shall be placed

on the outside, and screwed up tight. The rails must be spiked both on the inside and outside at each tie, on straight lines as well as on curves, and the spikes driven in such position as to keep the ties at right angles to the rails.

6. Gauge.—The gauge of the track shall be four feet eight and one-half inches at all points, excepting on curves of four (4) degrees and over, or on heavy grades against the traffic, or on tracks used exclusively for freight trains, where the gauge shall be four feet nine inches. The standard distance between gauge lines of the guard rail and the wing rail of frogs shall be four feet five inches in all cases.

7. Switches.—The switches and frogs should be kept well lined up and in good surface. Switch signals must be kept bright and in good order, and the distance signal and facing point lock used for all switches where trains run against the points, except on single-track branch roads.

8. Sidings.—All company sidings shall be kept in as good order as practicable, using for this purpose second-class rails and ties, or the partly-worn materials taken from main tracks. Owners of private sidings must be required to keep their sidings in safe condition for use at all times. Throw-off points must be used to prevent cars on siding being run or blown out on main tracks. For spur sidings the end should be curved away from the main tracks.

9. Ditches.—The cross-section of ditches at the highest point must be of the width and depth as shown on the standard drawing, and graded parallel with the track, so as to pass water freely during heavy rains and thoroughly drain the ballast and roadbed. The line of the bottom of the ditch must be made parallel with the rails, and well and neatly defined, at the standard distance from the outside rail. All necessary cross-drains must be put in at proper intervals. Earth taken from ditches or elsewhere must not be left at or near the ends of the ties, thrown up on the slopes of cuts, nor on the ballast, but must be deposited over the sides of embankments. Berme ditches shall be provided to protect the slopes of cuts, where necessary. The channels of streams for a considerable distance above the road should be examined, and brush, drift and other obstructions removed. Ditches, cul-

verts and box drains should be cleared of all obstructions, and the outlets and inlets of the same kept open to allow a free flow of water at all times.

10. Road Crossings.—The road-crossing planks shall be securely spiked; the planking on inside of rails should be three-quarters ( $\frac{3}{4}$ ) of an inch, and on outside of rails it should be one-eighth ( $\frac{1}{8}$ ) of an inch, below the top of rail, and two and one-half inches from the gauge line. The ends and inside edges of planks should be beveled off as shown on standard plan.

11. Policing.—Station platforms, fences and grounds at stations shall be kept clean and in good order, and the telegraph poles, mile posts, whistle boards, bridge boards and other standard signs kept in proper position, and trees near the telegraph line should be kept trimmed to prevent the branches touching the wires during high winds. All old material, such as old ties, rails, splices, car material, etc., shall be gathered up at least once a week and neatly piled at proper points. Briers and undergrowth on the right of way must be kept cut close to the ground.

12. Use of materials.—Proper judgment and caution must be exercised by Assistant Engineers, Supervisors and Foremen against extravagant use of materials, as they will be held strictly responsible for the same, and for any deviation from these specifications.

---

#### SPECIFICATIONS FOR CROSS-TIES.\*

No. 1 Pole Ties must be well and smoothly hewed or sawed out of sound, straight, thrifty timber; must be eight feet long, with sawed ends, and uniformly six inches thick between faces; each face side to be eight inches wide, or wider, at the narrowest place inside the bark, and the faces to be straight, truly lined and parallel with each other. Ties sawed six inches by ten inches wide, or wider, and free from wane, shakes or unsoundness of any kind will be accepted as No. 1.

No. 2 ties must be the same as No. 1, except that each face side of hewed or sawed pole ties may be not less than six

---

\*Used by the Chicago & Northwestern Railway Co.

inches, and of manufactured split ties, and of sawed ties not less than eight inches. No. 1 and No. 2 ties must be piled separately. Inspections monthly.

All Ties to be delivered on ground at or above the grade of railway track, within thirty feet of same, subject to the inspection and count of the Purchasing Agent, or any authorized Agent of the Company, whose action in counting and receiving or rejecting the ties offered shall be final and conclusive.

TABLE AND FIGURE giving dimensions of rails of the American Society of Engineer's Standard;

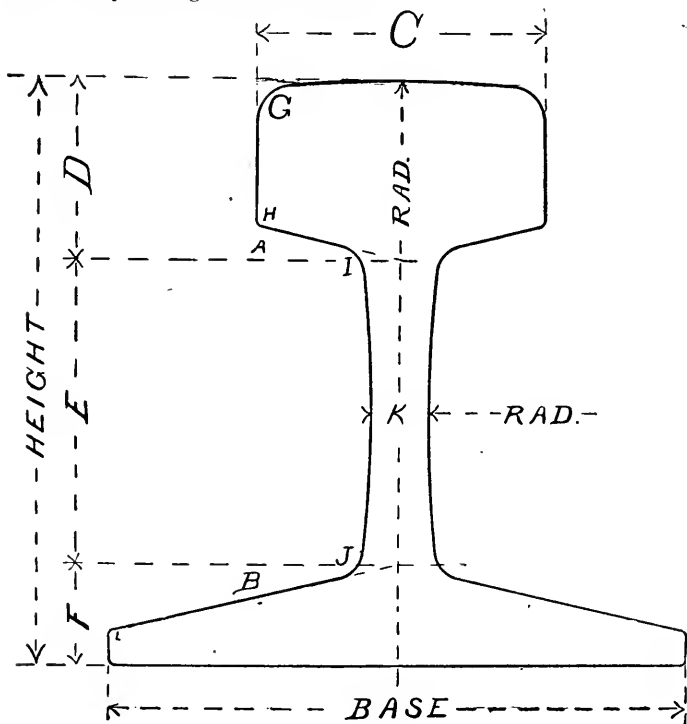


FIG. 379.  
RAIL SECTION.

	100 lbs. per yd.	90 lbs. per yd.	80 lbs. per yd.	75 lbs. per yd.	70 lbs. per yd.	65 lbs. per yd.	60 lbs. per yd.	55 lbs. per yd.
Percentage of Metal:								
In the Head .....	42	42	42	42	42	42	42	42
In the Web .....	21	21	21	21	21	21	21	21
In the Flange .....	37	37	37	37	37	37	37	37
Base, inches.....	5 $\frac{3}{4}$	5 $\frac{5}{8}$	5	4 $\frac{13}{16}$	4 $\frac{5}{8}$	4 $\frac{7}{16}$	4 $\frac{1}{4}$	4 $\frac{1}{16}$
Height .....	5 $\frac{3}{4}$	5 $\frac{5}{8}$	5	4 $\frac{13}{16}$	4 $\frac{5}{8}$	4 $\frac{7}{16}$	4 $\frac{1}{4}$	4 $\frac{1}{16}$
Rad of Web, " .....	12	12	12	12	12	12	12	12
" Head, " .....	12	12	12	12	12	12	12	12
Angle A, Degrees.....	13	13	13	13	13	13	13	13
Angle B, " .....	13	13	13	13	13	13	13	13
Dimension C, inches.....	2 $\frac{3}{4}$	2 $\frac{7}{8}$	2 $\frac{1}{2}$	2 $\frac{15}{16}$	2 $\frac{1}{2}$	2 $\frac{13}{16}$	2 $\frac{3}{8}$	2 $\frac{1}{4}$
" D, " .....	1 $\frac{5}{16}$	1 $\frac{11}{16}$	1 $\frac{1}{2}$	1 $\frac{13}{16}$	1 $\frac{1}{2}$	1 $\frac{5}{8}$	1 $\frac{1}{2}$	1 $\frac{1}{4}$
" E, " .....	3 $\frac{5}{16}$	2 $\frac{3}{8}$	2 $\frac{1}{8}$	2 $\frac{1}{8}$	2 $\frac{1}{8}$	2 $\frac{1}{8}$	2 $\frac{1}{8}$	2 $\frac{1}{8}$
" F, " .....	3 $\frac{1}{16}$	5 $\frac{9}{16}$	5 $\frac{7}{8}$	5 $\frac{1}{2}$	5 $\frac{1}{2}$	5 $\frac{1}{2}$	5 $\frac{1}{2}$	5 $\frac{1}{2}$
" G, " .....	1 $\frac{5}{16}$	1 $\frac{5}{16}$	1 $\frac{5}{16}$	1 $\frac{5}{16}$	1 $\frac{5}{16}$	1 $\frac{5}{16}$	1 $\frac{5}{16}$	1 $\frac{5}{16}$
" H, " .....	1 $\frac{1}{16}$	1 $\frac{1}{16}$	1 $\frac{1}{16}$	1 $\frac{1}{16}$	1 $\frac{1}{16}$	1 $\frac{1}{16}$	1 $\frac{1}{16}$	1 $\frac{1}{16}$
" I, " .....	1 $\frac{1}{4}$	1 $\frac{1}{4}$	1 $\frac{1}{4}$	1 $\frac{1}{4}$	1 $\frac{1}{4}$	1 $\frac{1}{4}$	1 $\frac{1}{4}$	1 $\frac{1}{4}$
" J, " .....	1 $\frac{1}{4}$	1 $\frac{1}{4}$	1 $\frac{1}{4}$	1 $\frac{1}{4}$	1 $\frac{1}{4}$	1 $\frac{1}{4}$	1 $\frac{1}{4}$	1 $\frac{1}{4}$
" K, " .....	1 $\frac{1}{16}$	1 $\frac{1}{16}$	1 $\frac{1}{16}$	1 $\frac{1}{16}$	1 $\frac{1}{16}$	1 $\frac{1}{16}$	1 $\frac{1}{16}$	1 $\frac{1}{16}$
" L, " .....	1 $\frac{1}{16}$	1 $\frac{1}{16}$	1 $\frac{1}{16}$	1 $\frac{1}{16}$	1 $\frac{1}{16}$	1 $\frac{1}{16}$	1 $\frac{1}{16}$	1 $\frac{1}{16}$

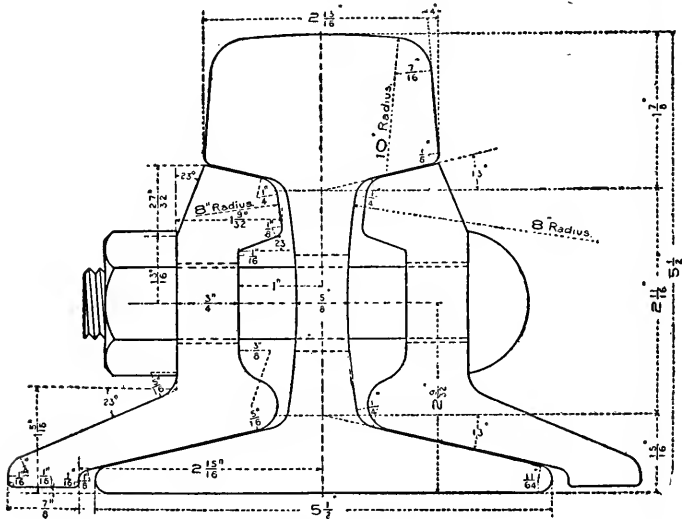


FIG. 380.

PENNSYLVANIA R. R. STANDARD RAIL SECTION.

100 pounds per yard and standard joint.

2 bars, 34 inches long, 78.7 lbs.

6 bolts, 3/8 x 4 1/4 inches, 7.5 lbs.

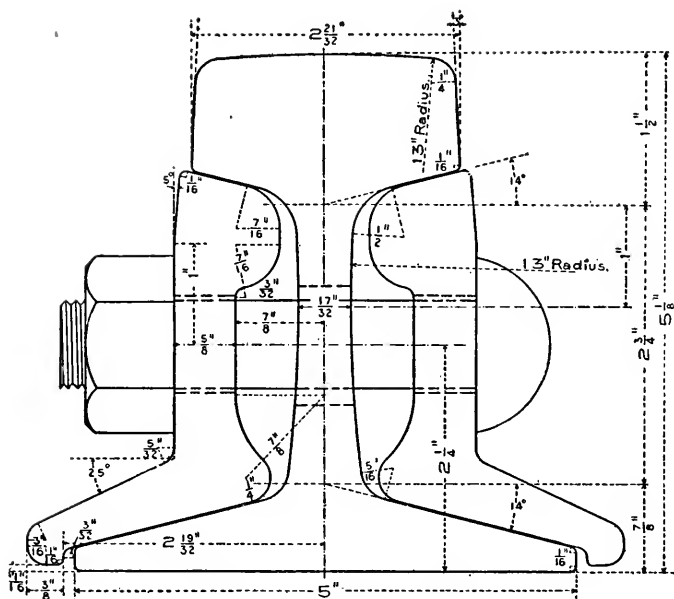


FIG. 381.

NEW YORK CENTRAL & HUDSON RIVER R. R. STANDARD RAIL SECTION.

Weight 80 pounds per yard.

Type P. H. Dudley section for rails, having fillets of large radius and the narrowest part of the web is above the center line.

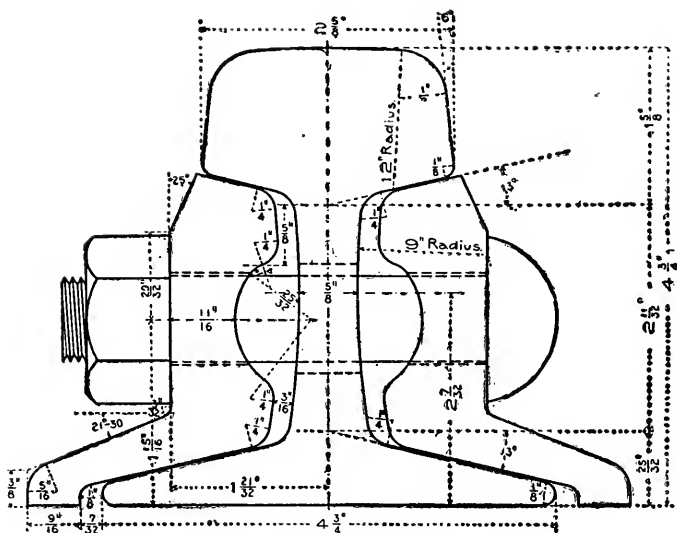


FIG. 382.

PHILADELPHIA &amp; READING R. R. RAIL SECTION.

79 pounds per yard.

Type of R. H. Sayre section for rails, with top corners of large radius and sides sloping outward from the top.



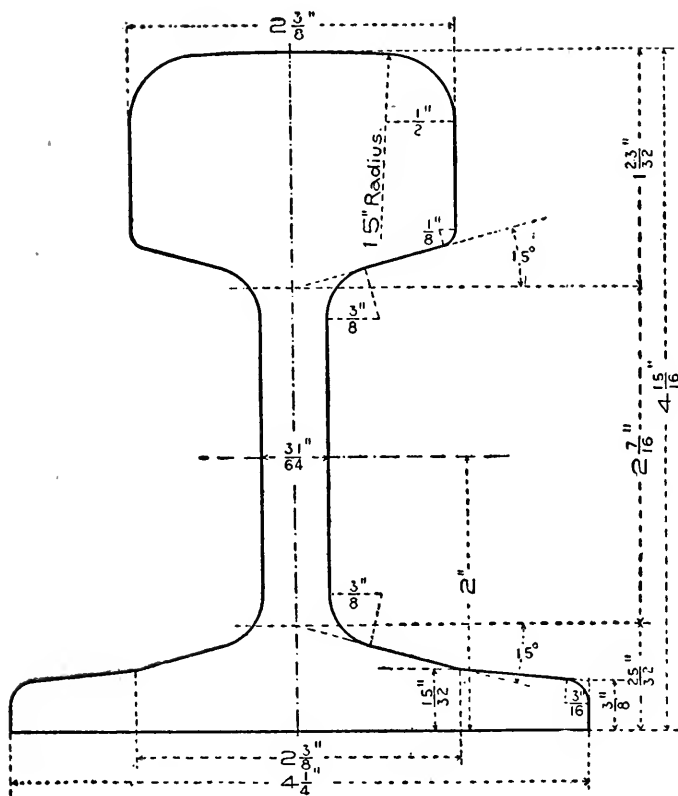


FIG. 383.

ARGENTINE GREAT WESTERN R'Y, SOUTH AMERICA  
STANDARD SECTION.

70 pounds per yard.

Type of Mr. Sandberg's section for rails, having wide heads with large corners.

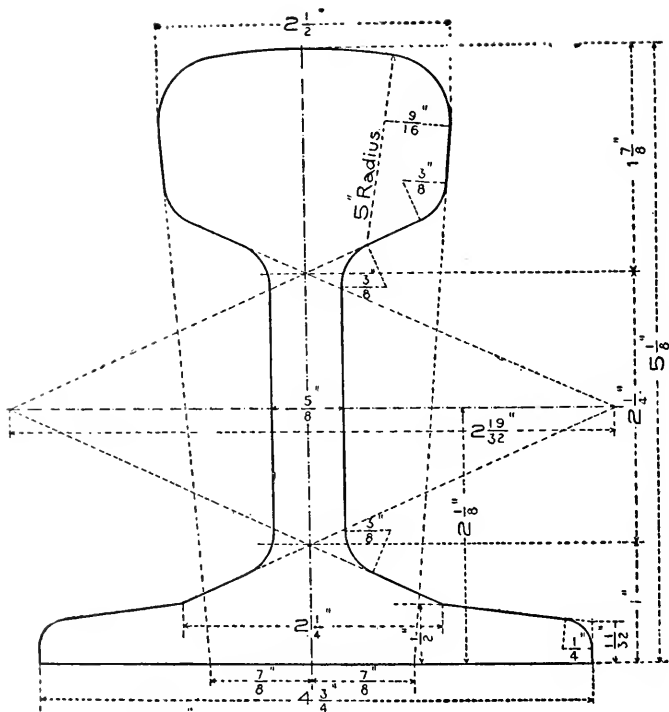


FIG. 384.

MEXICAN RAILWAY CO., LIMITED, STANDARD RAIL SECTION.  
82 pounds per yard.

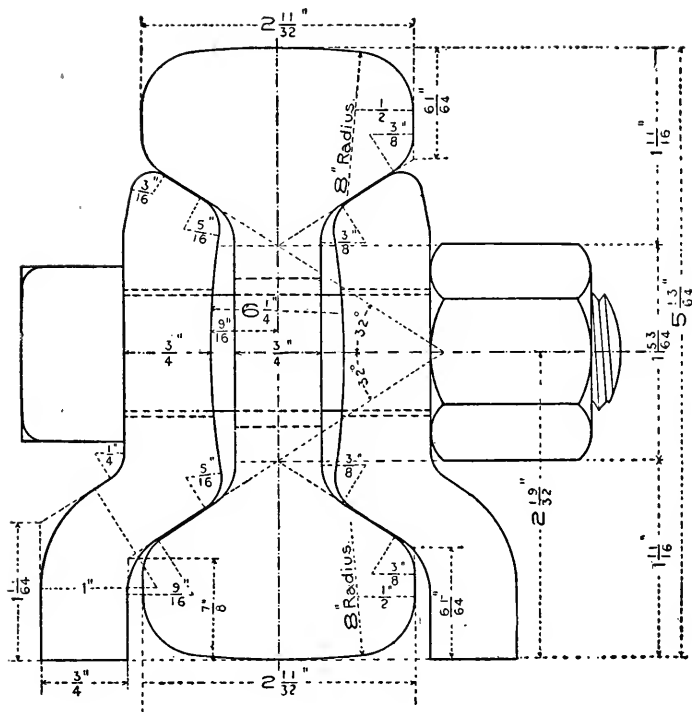


FIG. 385.

EAST INDIA RAILWAY CO., INDIA, STANDARD RAIL SECTION.  
75 pounds per yard.

Standard joint. 2 bars, 19 inches long, 34.0 lbs. 4 bolts, 1 in. x 4 1/4 in. long,  
6.5 lbs.

TABLE No. 1.

Tons per mile and feet of track per ton of rails of different weight per yard:

POUNDS PER YARD.	GROSS TONS PER MILE.	FEET OF TRACK PER TON OF RAILS.	POUNDS PER YARD.	GROSS TONS PER MILE.	FEET OF TRACK PER TON OF RAILS.
48	75.43	70.00	84	132.00	40.00
49	77.00	68.57	85	133.57	39.53
50	78.57	67.20	86	135.14	39.07
51	80.14	65.88	87	136.71	38.62
52	81.71	64.62	88	138.29	38.18
53	83.29	63.40	89	139.86	37.75
54	84.86	62.22	90	141.43	37.33
55	86.43	61.09	91	143.00	36.92
56	88.00	60.00	92	144.57	36.52
57	89.57	58.95	93	146.14	36.13
58	91.14	57.93	94	147.71	35.75
59	92.71	56.95	95	149.29	35.37
60	94.29	56.00	96	150.86	35.00
61	95.86	55.08	97	152.43	34.64
62	97.43	54.19	98	154.00	34.29
63	99.00	53.33	99	155.57	33.94
64	100.57	52.50	100	157.14	33.60
65	102.14	51.69	101	158.71	33.27
66	103.71	50.91	102	160.29	32.94
67	105.29	50.15	103	161.86	32.62
68	106.86	49.41	104	163.43	32.31
69	108.43	48.70	105	165.00	32.00
70	110.00	48.00	106	166.57	31.70
71	111.57	47.32	107	168.14	31.40
72	113.14	46.67	108	169.71	31.11
73	114.71	46.03	109	171.29	30.83
74	116.29	45.41	110	172.86	30.54
75	117.86	44.80	111	174.43	30.27
76	119.43	44.21	112	176.00	30.00
77	121.00	43.64	113	177.57	29.73
78	122.57	43.08	114	179.14	29.47
79	124.14	42.53	115	180.71	29.22
80	125.71	42.00	116	182.29	28.97
81	127.29	41.48	117	183.86	28.72
82	128.86	40.98	118	185.43	28.47
83	130.43	40.48	119	187.00	28.24
			120	188.57	28.00

TABLE No. 2.

Splice bars and bolts for one mile of track.

Length of Rail. Feet.	Number of Splice Bars Required.	Number of Bolts Required.		Number of Rails or Complete Joints.
		4-Hole Splice.	6-Hole Splice.	
24	880	1,760	2640	440
25	844	1,688	2532	422
26	812	1,624	2436	406
27	782	1,564	2346	391
28	754	1,508	2262	377
30	704	1,408	2112	352
33	640	1,280	1920	320

TABLE No. 3.

Number of fastenings required to the ton of rails.

Weight of Rail per yard.	24-foot Rail.	25-foot Rail.	26-foot Rail.	27-foot Rail.	28-foot Rail.	30-foot Rail.	33-foot Rail.
Pounds.	Joints.	Joints.	Joints.	Joints.	Joints.	Joints.	Joints.
12	23.33	22.40	21.53	20.74	20.00	18.66	16.96
16	17.50	16.80	16.15	15.55	15.00	14.00	12.72
20	14.00	13.55	12.92	12.44	12.00	11.20	10.18
25	11.20	10.74	10.32	9.95	9.68	8.96	8.14
30	9.83	8.94	8.60	8.29	8.00	7.46	6.78
35	8.00	7.68	7.38	7.11	6.86	6.40	5.81
40	7.00	6.71	6.45	6.22	5.99	5.60	5.09
45	6.22	5.96	5.74	5.52	5.33	4.97	4.52
50	5.60	5.37	5.16	4.97	4.79	4.48	4.07
55	5.09	4.88	4.69	4.52	4.36	4.07	3.70
56	5.00	4.79	4.61	4.44	4.28	4.00	3.63
60	4.66	4.47	4.30	4.14	4.00	3.73	3.39
62	4.51	4.33	4.16	4.01	3.86	3.61	3.28
64	4.37	4.19	4.03	3.88	3.74	3.50	3.17
65	4.30	4.13	3.97	3.82	3.69	3.44	3.13
67	4.17	4.00	3.85	3.71	3.58	3.34	3.03
70	....	....	....	....	....	3.20	2.90
75	....	....	....	....	....	2.98	2.71
80	....	....	....	....	....	2.80	2.54
85	....	....	....	....	....	2.63	2.39
90	....	....	....	....	....	2.48	2.26
95	....	....	....	....	....	2.35	2.14
100	....	....	....	....	....	2.24	2.03

TABLE No. 4.

Spikes required per mile of track.

Size Measured Under Head.	Average Number Per Keg of 200 pounds.	Ties Two Feet Between Centre and Four Spikes per Tie, Makes per Mile.	RAIL USED. Weight per yard.
Inches.		Pounds. Kegs.	
5½ x <sup>9</sup> / <sub>16</sub>	375	5632 = 28.16	45 to 100
5 x <sup>9</sup> / <sub>16</sub>	400	5280 = 26.4	40 to 56
5 x <sup>1</sup> / <sub>2</sub>	450	4692 = 23.46	40
4½ x <sup>1</sup> / <sub>2</sub>	530	3984 = 19.92	35
4 x <sup>1</sup> / <sub>2</sub>	600	3520 = 17.60	30
4½ x <sup>7</sup> / <sub>16</sub>	680	3104 = 15.52	25
4 x <sup>7</sup> / <sub>16</sub>	720	2932 = 14.66	25
3½ x <sup>7</sup> / <sub>16</sub>	900	2356 = 11.73	20
2½ x <sup>3</sup> / <sub>8</sub>	1342	1572 = 7.86	16
2½ x <sup>5</sup> / <sub>16</sub>	1800	1172 = 5.86	12

TABLE No. 5.

Giving the weight of standard track bolts; pounds per 1,000 bolts with square nuts.

Diam. inches	2 in.	2¼ in.	2½ in.	2¾ in.	3 in.	3¼ in.	3½ in.	3¾ in.	4 in.	4¼ in.	4½ in.	4¾ in.	5 in.	Diam. inches	Wt. of 1000 Nuts
½	260	274	288	302	316	330	344	358	372	386	400	414	428	½	112
⅝	352	370	388	406	424	442	460	478	496	514	532	550	568	⅝	146
¾	454	476	498	520	542	564	586	608	630	652	674	696	718	¾	218
⅞	626	658	690	722	754	786	818	850	882	914	946	978	1010	⅞	245
1	858	901	944	987	1030	1073	1116	1159	1202	1245	1288	1331	1374	1	374
1 ⅛	1155	1210	1265	1320	1375	1430	1485	1540	1595	1650	1705	1760	1815	1 ⅛	525
1 ¼	1595	1666	1737	1808	1879	1950	2021	2092	2163	2234	2305	2376	2447	1 ¼	747

Pounds per 1,000 bolts with hexagon nuts.

Diam. inches	2 in.	2¼ in.	2½ in.	2¾ in.	3 in.	3¼ in.	3½ in.	3¾ in.	4 in.	4¼ in.	4½ in.	4¾ in.	5 in.	Diam. inches	Wt. of 1000 Nuts.
½	253	267	281	295	309	323	337	351	365	379	393	407	421	½	93
⅝	327	345	363	381	399	417	435	453	471	489	507	525	543	⅝	122
¾	436	458	480	502	524	546	568	590	612	634	656	678	700	¾	182
⅞	597	629	661	693	725	757	789	821	853	885	917	949	981	⅞	216
1	822	865	908	951	994	1037	1080	1123	1166	1209	1252	1295	1338	1	316
1 ⅛	1087	1132	1187	1242	1297	1352	1407	1462	1517	1572	1627	1682	1737	1 ⅛	462
1 ¼	1513	1584	1655	1726	1797	1868	1939	2010	2081	2152	2223	2294	2365	1 ¼	685

TABLE No. 6.

Average number of track bolts in a keg of 200 pounds.

Size of Bolt.	Square Nut.	Hexagon Nut.	Weight of Rail.
1¼ x ¾	...	...	8 pounds.
1¾ x ½	940	...	12 and 16 pounds.
2 x ½	793	...	20 pounds.
2¼ x ½	763	...	25 pounds.
2½ x ½	733	...	25 pounds.
2½ x ⅝	390	425	30 pounds.
2¾ x ⅝	379	410	35 pounds.
3 x ⅝	366	395	40 and 45 pounds.
3 x ¾	250	270	
3¼ x ¾	243	261	
3½ x ¾	236	253	
3¾ x ¾	229	244	
4 x ¾	222	236	
3½ x ⅞	170	180	50 pounds and upwards.
3¾ x ⅞	165	175	
4 x ⅞	161	170	
4¼ x ⅞	157	165	
4½ x ⅞	153	160	

TABLE No. 7.

Showing amount of expansion of steel rails and thickness of shim required for a 30-foot rail, as given by Mr. W. C. Downing, Engineer of Maintenance of Way of the Vandalia Line.

Temperature Degree Fahrenheit.	VARIATIONS.		Thickness of Ex- pansion Shim in Inches.
	In Decimals of an inch.	In Fractions of an inch.	
— 30	.3744	24-64	6-16
— 20	.3510	23-64	6-16
— 10	.3276	21-64	6-16
0	.3042	19-64	5-16
10	.2808	18-64	5-16
20	.2574	16-64	4-16
30	.2340	15-64	4-16
40	.2100	14-64	4-16
50	.1872	12-64	3-16
60	.1638	10-64	3-16
70	.1404	9-64	3-16
80	.1170	7-64	2-16
90	.0936	6-64	2-16
100	.0702	5-64	1-16
110	.0468	3-64	1-16
120	.0234	1-64	1-16
130	.0000	....	....

The rails are supposed to be in contact at a temperature of 130 degrees Fahrenheit.

TABLE No. 8.  
Capacity of duplex and single acting pumps.

Size of Pump.			Gallons per Stroke of One Plunger.	Strokes per Minute of Each Plunger.	Gallons Delivered per Minute by both Plungers.	Diameter of Pipes.				Weight in Lbs.	Floor Space in Inches.
Diameter of Steam Cylinders.	Diameter of Water Plungers.	Length of Stroke.				Steam Pipe.	Exhaust Pipe.	Suction Pipe.	Discharge Pipe.		
3	2½	4	.06	100 to 200	12 to 24	¾	½	1¼	1	210	29½ x 11½
5¼	4¼	5	.31	100 to 150	62 to 93	1	1¼	3	2	570	39½ x 16
6	5	6	.51	100 to 150	102 to 153	1	1½	4	3	840	45 x 17
6	5¾	6	.67	100 to 150	134 to 201	1	1½	4	3	1240	49 x 17
7	6	10	1.22	75 to 150	183 to 366	1½	2	5	4	1790	72 x 23
8	7	12	2.00	75 to 125	300 to 500	1½	2	6	5	2780	79 x 28
8	8	12	2.61	75 to 125	391 to 652	1½	2	6	5	3720	82 x 35
8	10	12	4.08	75 to 125	612 to 1020	1½	2	8	7	6200	90 x 43
8	10	15	5.10	60 to 100	612 to 1020	1½	2	8	7	6300	96 x 43
10	8	12	2.61	75 to 125	391 to 652	2	2½	6	5	3940	82 x 35
10	10	12	4.08	75 to 125	612 to 1020	2	2½	8	7	6300	90 x 43
10	10	15	5.10	60 to 100	612 to 1020	2	2½	8	7	6400	96 x 43
10	12	12	5.87	75 to 125	880 to 1468	2	2½	10	8	10350	90 x 56
10	12	15	7.34	60 to 100	880 to 1468	2	2½	10	8	10800	96 x 56
12	10	12	4.08	75 to 125	612 to 1020	2½	3	8	7	6600	91 x 43
12	10	15	5.10	60 to 100	612 to 1020	2½	3	8	7	6800	96 x 43
12	12	12	5.87	75 to 125	880 to 1468	2½	3	10	8	10408	90 x 56
12	12	15	7.34	60 to 100	880 to 1468	2½	3	10	8	10990	97 x 56
12	14	15	9.99	60 to 100	1200 to 2009	2½	3	12	10	15930	97 x 56
12	14	18	12.00	50 to 85	1200 to 2039	2½	3	12	10	16550	122 x 56
12	15	18	13.77	50 to 85	1377 to 2340	2½	3	12	10	16550	126 x 57

The gallons delivered by a single acting pump are one-half the amount given in the table.



TABLE No. 9.

SWITCH TIES. Gauge, 4 feet, 8½ inches.				Number of Switch Ties for Split Switches, <i>Single Throw</i> , for Frogs of Following Numbers.							
Length.		Size.		4	5	6	7	8	9	10	11
Feet.	In.	Feet.	In.								
8	3	7	10	3	5	5	5	5	5	5	5
8	6	7	10	4	5	5	5	5	5	5	5
8	9	7	10	2	2	2	2	4	4	4	4
9	0	7	10	1	2	3	2	3	3	3	3
9	3	7	10	1	1	2	2	2	3	2	3
9	6	7	10	1	1	1	3	2	2	2	3
9	9	7	10	1	1	2	2	2	2	2	2
10	0	7	10	1	1	1	2	2	2	2	2
10	3	7	10								
10	6	7	10	1	1	2	2	2	2	2	2
10	9	7	10	1	1					2	2
11	0	7	10			2	2	2	3	2	2
11	3	7	10	1							
11	6	7	10	1	1	2	2	3	5	2	3
12	0	7	10	1	1	1	2	2	2	3	3
12	6	7	10	1	1	2	2	2	3	2	3
13	0	7	10	1	1	2	2	3	3	3	3
13	3	7	10	1							
13	6	7	10	1	1	2	2	2	3	3	3
14	0	7	10	1	1	1	2	2	2	3	2
14	6	7	10	1	1	2	2	2	2	2	3
15	0	7	10	1	1	1	2	2	2	2	3
15	6	7	10	1	1	2	2	3	3	3	2
Head Blocks, 16 feet, 0 in.; 10 in. x 12 in. Common Switch Stand.				1	1	1	1	1	1	1	1
Head Block, 16 feet, 0 in.; 10 in. x 12 in.				1	1	1	1	1	1	1	1

When automatic switch stands are used omit the first switch tie and use two head blocks.

When pony switch stands are used the head block should be 13 feet 6 inches long.

TABLE No. 10.

SWITCH TIES. Gauge, 4 feet, 8½ inches.				Number of Switch Ties for Split Switches, <i>Three Throw</i> , for Frogs of Following Numbers.					
Length.		Size.		6	7	8	9	10	11
Feet.	In.	Feet.	In.						
8	3	7	10	3	3	3	3	3	3
8	6	7	10	3	3	3	3	3	3
9	0	7	10	5	5	5	5	5	5
9	6	7	10	2	2	4	4	4	4
10	0	7	10	3	2	3	3	3	3
10	6	7	10	2	2	2	3	2	3
11	0	7	10	1	2	2	2	2	3
11	6	7	10	2	2	2	2	2	3
12	0	7	10	1	2	2	2	2	2
12	6	7	10					2	2
13	0	7	10	3	3	3	3	3	3
13	6	7	10					2	2
14	0	7	10	2	2	2	3	2	2
15	0	7	10	2	2	3	3	2	3
16	0	7	10	1	2	2	2	3	3
17	0	7	10	2	2	2	3	2	3
18	0	7	10	2	2	3	3	3	3
19	0	7	10	2	2	2	3	3	3
20	0	7	10	1	2	2	2	3	2
21	0	7	10	2	2	2	2	2	3
22	0	7	10	1	2	2	2	2	3
23	0	7	10	2	2	3	3	3	2
24	0	7	10	1	1	1	1	1	1
Head Blocks. 16 feet, 0 inches—10 in. x 12 in.				1	1	1	1	1	1

When automatic switch stands are used omit the first switch tie and use two head blocks.

When pony switch stands are used, the head block should be 13 feet 6 inches long.

TABLE No. 11.

Data for Stub Switches, 4 feet, 8½ inch Gauge, throw-off Switch Rail, 5 inches.

Frog No.	Frog Angle.	Degree of Curve.	Radius.	Switch Rail.	Toe to Frog Point.	Heel to Frog Point.	Number of Crotch Frog.	Angle of Crotch Frog.	Toe to Crotch Frog.
4	14° 16'	38° 54'	Feet. 150.2	Feet. 11.5	Feet. 26.4	Feet. 37.9	2.8	20° 21'	Feet. 15.1
5	11° 26'	24° 34'	235.0	14.1	33.2	47.3	3.5	16° 14'	19.2
6	9° 32'	17° 0'	338.7	16.8	39.8	56.6	4.2	13° 35'	23.0
7	8° 10'	12° 26'	461.8	19.6	46.5	66.1	4.9	11° 37'	26.9
8	7° 10'	9° 33'	600.0	22.3	53.2	75.5	5.7	10° 8'	30.9
9	6° 22'	7° 31'	761.6	25.1	59.7	84.8	6.4	9° 1'	34.7
10	5° 44'	6° 6'	938.6	27.8	66.3	94.1	7.1	8° 8'	38.4
11	5° 12'	5° 1'	1141.8	30.8	73.0	103.8	7.8	7° 22'	42.4
12	4° 47'	4° 13'	1358.2	33.6	79.6	113.2	8.5	6° 44'	46.4

TABLE No. 12.

Data for Stub Switches, 3 feet, 0 inch Gauge, throw-off Switch Rail, 4 inches.

Frog No.	Frog Angle.	Degree of Curve.	Radius.	Switch Rail.	Toe to Frog Point.	Heel to Frog Point.	Number of Crotch Frog.	Angle of Crotch Frog.	Toe to Crotch Frog.
4	14° 16'	63° 8'	Feet. 90.0	Feet. 8.1	Feet. 16.1	Feet. 24.2	2.8	20° 21'	Feet. 9.0
5	11° 26'	39° 4'	150.0	10.1	20.1	30.2	3.5	16° 14'	11.3
6	9° 32'	26° 48'	215.7	12.0	24.1	36.1	4.2	13° 35'	13.5
7	8° 10'	19° 34'	294.3	14.0	28.1	42.1	4.9	11° 37'	15.8
8	7° 10'	15° 0'	382.5	16.2	31.8	48.0	5.7	10° 8'	17.9
9	6° 22'	11° 50'	484.9	17.4	36.1	54.0	6.4	9° 1'	20.2
10	5° 44'	9° 35'	598.5	19.9	40.1	60.0	7.1	8° 8'	22.5
11	5° 12'	7° 54'	722.9	21.9	44.1	66.0	7.8	7° 22'	24.0
12	4° 47'	6° 40'	859.7	23.9	48.0	71.9	8.5	6° 44'	26.9

TABLE No. 13.

Bill of switch ties for standard gauge stub switches.

Size.	Length.	No. 6 Frog.		No. 7 Frog.		No. 8 Frog.		No. 9 Frog.		No. 10 Frog.	
		No. of Pieces.	No. of Pieces.	No. of Pieces.	No. of Pieces.	No. of Pieces.	No. of Pieces.	No. of Pieces.	No. of Pieces.	No. of Pieces.	No. of Pieces.
10 x 12	16 feet.	1	2	1	2	1	3	1	4	1	5
7 x 9	9 feet.	2	2	2	3	3	3	4	3	4	5
7 x 9	9 feet, 6 inches.	2	2	3	3	3	3	3	3	4	4
7 x 9	10 feet.	2	2	3	3	3	3	3	3	3	3
7 x 9	10 feet, 6 inches.	2	2	3	3	3	3	3	3	3	3
7 x 9	11 feet.	2	2	2	2	3	3	3	3	3	3
7 x 9	11 feet, 6 inches.	2	2	2	2	3	3	3	3	3	3
7 x 9	12 feet.	2	2	2	2	2	2	2	2	2	2
7 x 9	12 feet, 6 inches.	1	1	4	4	2	2	2	2	2	2
7 x 10	13 feet.	2	2	3	3	2	2	2	2	2	2
7 x 10	13 feet, 6 inches.	1	1	1	1	1	1	2	2	2	2
7 x 10	14 feet.	1	1	1	1	1	1	2	2	2	2
7 x 9	14 feet, 6 inches.	1	1	1	1	2	2	2	2	2	2
7 x 9	15 feet.	2	2	2	2	2	2	2	2	2	2
7 x 9	15 feet, 6 inches.	1	1	1	1	2	2	2	2	2	2
7 x 9	16 feet.	1	1	2	2	1	1	2	2	2	2

TABLE No. 14.

Bill of switch ties for a narrow (three foot) gauge single throw stub switch, using a number 10 frog.

6 pieces, 6 inches x 8 inches, 8 feet long.

6 " " " " 9 "

6 " " " " 10 "

4 " " " " 12 "

Cross ties in main track can be 6 inches x 7 inches, 6 feet long.

TABLE No. 15.

Table giving distance D Fig. 245 being the distance between the actual point of the frogs of a cross-over on 4-foot 8½-inch gauge.

TRACK CENTERS. "C."											
No. of Frog.	Ft. In.	Ft. In.	Ft. In.	Ft. In.	Ft. In.	Ft. In.	Ft. In.	Ft. In.	Ft. In.	Ft. In.	Ft. In.
6	11 6	12 0	12 6	13 0	13 6	14 0	14 6	15 0	15 6	16 0	
7	11 6½	14 5½	17 5½	20 5¾	23 5½	26 4¾	29 4¾	32 4¾	35 4¾	38 3¾	
8	13 7¼	17 1½	20 6¾	24 0¾	27 6¾	31 0¾	34 6¾	38 0	41 5¾	44 11½	
8½	15 7¼	19 7	23 6¾	27 6½	31 6¾	35 6	39 5¾	43 5½	47 5¼	51 5	
9	16 8	20 10¾	25 1½	29 4¾	33 7¼	37 10	42 0¾	46 3¾	50 6¾	54 9	
9	17 8	22 1¾	26 7¾	31 1¼	35 7	40 0¾	44 6¾	49 0¾	53 6	57 11¾	
10	19 8½	24 7¾	29 7¾	34 7¾	39 7¼	44 6¾	49 6¾	54 6¾	59 6¾	64 5¾	
11	21 9¾	27 3	32 9	38 3	43 8¾	49 2¾	54 8¾	60 2¾	65 8¾	71 2¾	

TABLE No. 16.

Widening the gauge of standard gauge track on curves as recommended by the Roadmasters' Association in 1898.

Degree of Curve.	Amount to Widen the Gauge.	Degree of Curve.	Amount to Widen the Gauge.
1 degree.....	0 inches	10 degrees.....	¼ inches
2 " .....	0 " "	11 " .....	¾ " "
3 " .....	0 " "	12 " .....	¾ " "
4 " .....	0 " "	13 " .....	¾ " "
5 " .....	0 " "	14 " .....	¾ " "
6 " .....	0 " "	15 " .....	¾ " "
7 " .....	⅛ " "	16 " .....	¾ " "
8 " .....	⅓ " "	17 " .....	¾ " "
9 " .....	½ " "	18 " .....	1 " "

TABLE No. 17.

Table giving the elevation for the outer rail on curves of different radius (or degree of curvature) for trains at a velocity of 15 to 55 miles per hour and for both standard and narrow gauge. This table is used by the Denver & Rio Grande Railway for the guidance of their roadmasters.

Degree	15 M. HOUR		20 M. HOUR		25 M. HOUR		30 M. HOUR		35 M. HOUR		40 M. HOUR		45 M. HOUR		50 M. HOUR		55 M. HOUR		Curve Degree
	N. G.	S. G.	N. G.	S. G.	N. G.	S. G.	N. G.	S. G.	N. G.	S. G.	N. G.	S. G.	N. G.	S. G.	N. G.	S. G.	N. G.	S. G.	
0° 30'																			0° 30'
1° 30'	1/8	1/8	1/8	1/8	1/8	1/8	1/8	1/8	1/8	1/8	1/8	1/8	1/8	1/8	1/8	1/8	1/8	1/8	1° 30'
2° 30'	1/4	1/4	1/4	1/4	1/4	1/4	1/4	1/4	1/4	1/4	1/4	1/4	1/4	1/4	1/4	1/4	1/4	1/4	2° 30'
3° 30'	3/8	3/8	3/8	3/8	3/8	3/8	3/8	3/8	3/8	3/8	3/8	3/8	3/8	3/8	3/8	3/8	3/8	3/8	3° 30'
4° 30'	1/2	1/2	1/2	1/2	1/2	1/2	1/2	1/2	1/2	1/2	1/2	1/2	1/2	1/2	1/2	1/2	1/2	1/2	4° 30'
5° 30'	5/8	5/8	5/8	5/8	5/8	5/8	5/8	5/8	5/8	5/8	5/8	5/8	5/8	5/8	5/8	5/8	5/8	5/8	5° 30'
6° 30'	3/4	3/4	3/4	3/4	3/4	3/4	3/4	3/4	3/4	3/4	3/4	3/4	3/4	3/4	3/4	3/4	3/4	3/4	6° 30'
7° 30'	7/8	7/8	7/8	7/8	7/8	7/8	7/8	7/8	7/8	7/8	7/8	7/8	7/8	7/8	7/8	7/8	7/8	7/8	7° 30'
8° 30'	1	1	1	1	1	1	1	1	1	1	1	1	1	1	1	1	1	1	8° 30'
9° 30'	1	1	1	1	1	1	1	1	1	1	1	1	1	1	1	1	1	1	9° 30'
10° 30'	1	1	1	1	1	1	1	1	1	1	1	1	1	1	1	1	1	1	10° 30'
11° 30'	1	1	1	1	1	1	1	1	1	1	1	1	1	1	1	1	1	1	11° 30'
12° 30'	1	1	1	1	1	1	1	1	1	1	1	1	1	1	1	1	1	1	12° 30'
13° 30'	1	1	1	1	1	1	1	1	1	1	1	1	1	1	1	1	1	1	13° 30'
14° 30'	1	1	1	1	1	1	1	1	1	1	1	1	1	1	1	1	1	1	14° 30'
15° 30'	1	1	1	1	1	1	1	1	1	1	1	1	1	1	1	1	1	1	15° 30'
16° 30'	1	1	1	1	1	1	1	1	1	1	1	1	1	1	1	1	1	1	16° 30'
17° 30'	1	1	1	1	1	1	1	1	1	1	1	1	1	1	1	1	1	1	17° 30'
18° 30'	1	1	1	1	1	1	1	1	1	1	1	1	1	1	1	1	1	1	18° 30'
19° 30'	1	1	1	1	1	1	1	1	1	1	1	1	1	1	1	1	1	1	19° 30'
20° 30'	1	1	1	1	1	1	1	1	1	1	1	1	1	1	1	1	1	1	20° 30'
21° 30'	1	1	1	1	1	1	1	1	1	1	1	1	1	1	1	1	1	1	21° 30'
22° 30'	1	1	1	1	1	1	1	1	1	1	1	1	1	1	1	1	1	1	22° 30'
23° 30'	1	1	1	1	1	1	1	1	1	1	1	1	1	1	1	1	1	1	23° 30'
24° 30'	1	1	1	1	1	1	1	1	1	1	1	1	1	1	1	1	1	1	24° 30'
25° 30'	1	1	1	1	1	1	1	1	1	1	1	1	1	1	1	1	1	1	25° 30'
26° 30'	1	1	1	1	1	1	1	1	1	1	1	1	1	1	1	1	1	1	26° 30'
27° 30'	1	1	1	1	1	1	1	1	1	1	1	1	1	1	1	1	1	1	27° 30'
28° 30'	1	1	1	1	1	1	1	1	1	1	1	1	1	1	1	1	1	1	28° 30'
29° 30'	1	1	1	1	1	1	1	1	1	1	1	1	1	1	1	1	1	1	29° 30'
30° 30'	1	1	1	1	1	1	1	1	1	1	1	1	1	1	1	1	1	1	30° 30'

Above elevations are in inches and represent the difference in height between inner and outer rails. The center line of track is to remain on the regular grade. On three rail track use standard gauge centers.  
For elevation on spirals--At the end of each chord use elevation for the degree of curve which that chord subtends.

TABLE No. 18.

Table of middle ordinates.\*

Degree of Curve	Radius.	LENGTH OF RAILS.										
		30	28	26	24	22	20	18	16	14	12	10
	Feet.	In.	In.	In.	In.	In.	In.	In.	In.	In.	In.	In.
1.	11460	1 8	3 2	5 4	1 6	3 6	3 4	1 2	3 2	1 4	1 4	—
1.5	5730	1 5	3 6	5 2	1 8	3 7	3 2	5 4	1 6	3 2	1 4	1 4
2.	3820	1 2	3 2	4 4	1 4	3 2	3 2	4 4	1 6	3 2	1 4	1 4
2.5	2865	1 1	3 2	4 1	1 3	3 2	3 2	4 1	1 6	3 2	1 4	1 4
3.	2292	1 1	3 2	3 8	1 3	3 2	3 2	3 7	1 4	3 2	1 4	1 4
3.5	1910	1 1	3 2	3 7	1 3	3 2	3 2	3 6	1 4	3 2	1 4	1 4
4.	1637	1 1	3 2	3 6	1 3	3 2	3 2	3 5	1 4	3 2	1 4	1 4
4.5	1433	1 1	3 2	3 5	1 3	3 2	3 2	3 4	1 4	3 2	1 4	1 4
5.	1146	1 1	3 2	3 4	1 3	3 2	3 2	3 3	1 4	3 2	1 4	1 4
5.5	1042	1 1	3 2	3 3	1 3	3 2	3 2	3 2	1 4	3 2	1 4	1 4
6.	955.4	1 1	3 2	3 2	1 3	3 2	3 2	3 1	1 4	3 2	1 4	1 4
6.5	882	1 1	3 2	3 1	1 3	3 2	3 2	3 0	1 4	3 2	1 4	1 4
7.	819	1 1	3 2	3 0	1 3	3 2	3 2	2 9	1 4	3 2	1 4	1 4
7.5	764.5	1 1	3 2	2 9	1 3	3 2	3 2	2 8	1 4	3 2	1 4	1 4
8.	716.8	1 1	3 2	2 8	1 3	3 2	3 2	2 7	1 4	3 2	1 4	1 4
8.5	674.6	1 1	3 2	2 7	1 3	3 2	3 2	2 6	1 4	3 2	1 4	1 4
9.	637.3	1 1	3 2	2 6	1 3	3 2	3 2	2 5	1 4	3 2	1 4	1 4
9.5	603.8	1 1	3 2	2 5	1 3	3 2	3 2	2 4	1 4	3 2	1 4	1 4
10.	573.7	1 1	3 2	2 4	1 3	3 2	3 2	2 3	1 4	3 2	1 4	1 4
11.	524.7	1 1	3 2	2 3	1 3	3 2	3 2	2 2	1 4	3 2	1 4	1 4
12.	478.3	1 1	3 2	2 2	1 3	3 2	3 2	2 1	1 4	3 2	1 4	1 4
13.	441.7	1 1	3 2	2 1	1 3	3 2	3 2	2 0	1 4	3 2	1 4	1 4
14.	410.3	1 1	3 2	2 0	1 3	3 2	3 2	1 9	1 4	3 2	1 4	1 4
15.	383.1	1 1	3 2	1 9	1 3	3 2	3 2	1 8	1 4	3 2	1 4	1 4
16.	359.3	1 1	3 2	1 8	1 3	3 2	3 2	1 7	1 4	3 2	1 4	1 4
17.	338.3	1 1	3 2	1 7	1 3	3 2	3 2	1 6	1 4	3 2	1 4	1 4
18.	319.6	1 1	3 2	1 6	1 3	3 2	3 2	1 5	1 4	3 2	1 4	1 4
19.	302.9	1 1	3 2	1 5	1 3	3 2	3 2	1 4	1 4	3 2	1 4	1 4
20.	287.9	1 1	3 2	1 4	1 3	3 2	3 2	1 3	1 4	3 2	1 4	1 4

Ordinates at quarters equal three-fourths of the middle ordinates.

\*The middle ordinate is the perpendicular distance from a chord or line stretched from end to end of the rail to the gauge side of the rail at the center of the rail.

The ordinate at the quarter point is the perpendicular distance from a chord or line stretched from end to end of the rail to the gauge side of the rail at the quarter point of the rail.

TABLE No. 19.

Giving the square feet of bearing surface ties eight feet long and of different width have on the ballast or roadbed.

NUMBER OF TIES TO A 30-FOOT RAIL.	LENGTH OF TIE EIGHT FEET.			
	Square feet of surface for ties of the following width.			
	7 inches.	8 inches.	9 inches.	10 inches.
14	65.24	74.62	84.00	93.24
15	69.90	79.95	90.00	99.90
16	74.56	85.28	96.00	106.56
17	79.22	90.61	102.00	113.22
18	83.88	95.94	108.00	119.88



## APPENDIX K.

BEING A TABLE SETTING FORTH MODERN AUTHORITIES ON THE LOCATION, CONSTRUCTION, TRACK AND MAINTENANCE OF RAILWAYS.\*

NAME OF AUTHOR.	SUBJECTS TREATED OF													
	1	2	3	4	5	6	7	8	9	10	11	12	13	14
	Reconnaissance.	Preliminary Survey.	Topography.	Use of Stadia.	Use of Gradient.	Location.	Transition Curves.	Quantities, Excavation and Embankments.	Construction.	Masonry.	Bridge and Buildings.	Track.	Maintenance.	Reconstruction.
Baker, I. O.....	*	*		*	*					*				
Berg, W. G.....	*	*												
Burr, W. H.....			*							*	*			
Butts, E.....				*		*								
Boller, A. P.....											*			
Houlton, S. B.....													*	
Bowser, E. A.....											*			
Crandall, C. L.....						*	*				*	*		
Crehore, J. D.....											*	*		
Crehore, Wm. W.....											*	*		
Cooper, Theo.....											*	*		
Cross, C. S.....	*	*	*								*	*		
Du Bois, A. J.....											*	*		
Davis, J. W.....								*			*	*		
Department of Agriculture.....								*	*		*	*		
Dillenbeck, C.....											*	*		
Drinker, H. S.....											*	*		
Elliott, W. H.....									*	*	*	*	*	
Foster, W. C.....								*	*	*	*	*	*	
Gieseler, E. A.....								*	*	*	*	*	*	
Greene, C. E.....								*	*	*	*	*	*	
Godwin, H. C.....	*	*									*	*		
Hermann, E. A.....								*	*	*	*	*	*	
Howard, C. R.....						*	*	*	*	*	*	*	*	
Howe, M. A.....							*	*	*	*	*	*	*	
Hudson, J. R.....							*	*	*	*	*	*	*	
Johnson, J. B.....	*	*	*	*	*			*	*	*	*	*	*	

\*The titles of the author's works with a brief description of the same, and the price, are appended to this volume. The World Railway Publishing Co., Chicago, Ill., is prepared to mail any of these books upon receipt of the price.

NAME OF AUTHOR.	SUBJECTS TREATED OF													
	1	2	3	4	5	6	7	8	9	10	11	12	13	14
	Reconnaissance.	Preliminary Survey.	Topography.	Use of Stadia.	Use of Gradient.	Location.	Transition Curves.	Quantities, Excavation and Embankments.	Construction.	Masonry.	Bridge and Buildings.	Track.	Maintenance.	Reconstruction.
Johnson, Bryan & Turneaure.....														
Kindelan, J.....	*	*	*										*	*
Merriman & Brooks.....	*	*	*											
Merriman & Jacoby.....	*	*	*											
Merriman, M.....	*	*	*											
Merrill, Wm. E.....	*	*	*											
Morison, G. S.....	*	*	*							*	*	*	*	*
Nagle, J. C.....	*	*	*						*	*	*	*	*	*
Osborn.....	*	*	*						*	*	*	*	*	*
Paine, G. H.....	*	*	*						*	*	*	*	*	*
Patton, W. M.....	*	*	*						*	*	*	*	*	*
Plympton, G. W.....	*	*	*						*	*	*	*	*	*
Paul, H.....	*	*	*						*	*	*	*	*	*
Reed, H. A.....	*	*	*						*	*	*	*	*	*
Searles, Wm. H.....	*	*	*						*	*	*	*	*	*
Shunk, W. F.....	*	*	*						*	*	*	*	*	*
Simms, W. F.....	*	*	*						*	*	*	*	*	*
Simms, F. W.....	*	*	*						*	*	*	*	*	*
Smith & McMillan.....	*	*	*						*	*	*	*	*	*
Spalding, F. P.....	*	*	*						*	*	*	*	*	*
Torrey, A.....	*	*	*				*		*	*	*	*	*	*
Tratman, E. E. R.....	*	*	*				*		*	*	*	*	*	*
Trautwine, J. C.....	*	*	*				*		*	*	*	*	*	*
Wellington, A. M.....	*	*	*				*		*	*	*	*	*	*
Whipple, S.....	*	*	*				*		*	*	*	*	*	*
Wright, C. H.....	*	*	*				*		*	*	*	*	*	*
Winslow, A.....	*	*	*				*		*	*	*	*	*	*
Henck, J. B.....	*	*	*				*		*	*	*	*	*	*

DETAILED DESCRIPTIONS OF WORKS OF AUTHORS REFERRED TO IN APPENDIX K.\*

**BAKER—Engineers' Surveying Instruments.**

By Ira O. Baker. Each instrument is considered separately, the best form of construction is discussed, the

\*The World Railway Publishing Company, Chicago, Ill., is prepared to mail any book mentioned herein, upon receipt of the price.

sources of error in use are pointed out, data are given as to the degree of precision attained in actual practice, and suggestions are made as to the most accurate, rapid, and convenient methods of using it. Second edition, revised and greatly enlarged. Bound in cloth, 400 pages, 5x7½ inches, 86 illustrations, copious index, 12mo, cloth .....\$3.00

Chapters: Chain and Tape, Tripod and Leveling Screws, Magnetic Compass, Solar Compass, Telescope, Vernier, Transit, Solar Transit, Plane Table, Stadia and Gradiometer, Spirit Level, Aneroid and Mercurial Barometers.

"A most excellent work."—*Engineering News*.

**BAKER—A Treatise on Masonry Construction.**

Containing materials and method of testing strength, etc., Combinations of Materials—Composition, etc.; Foundations—Testing the bearing power of soils, etc.; Masonry Structure—Stability against sliding, overturning, crushing, etc., etc., etc. Complete in one volume of about 500 pages, with 125 illustrations and eight or ten folding plates. By Ira O. Baker, C.E. Ninth edition, 8vo, cloth .....\$5.00

"If you wish the best book ever published in the English language on Masonry Construction, turn with confidence to this treatise."—*Building*.

"We should be doing injustice to both author and publisher did we not declare at once our conviction that this is the most valuable and complete Treatise on Masonry as yet published, at least in English."—*Engineering News*.

**BAKER.—D. Van Nostrand's Science Series.**

No. 91. Leveling: Barometric, Trigonometric, and Spirit. By Prof. I. O. Baker. 18mo, board.....50c

**BERG.—Buildings and Structures of American Railroads.**

A reference book for railroad managers, superintendents, master mechanics, engineers, architects and students. By Walter G. Berg, C.E., principal assistant engineer Lehigh Valley railroad. 534 pages, 700 illustrations, 4to cloth .....\$7.50

Preface.

- |   |  |
|---|--|
| Chap. I. Watchman's Shanties.                                     | XI. Sand Houses.                               |
| II. Section Tool Houses.  | XII. Oil Storage Houses.                       |
| III. Section Houses.  | XIII. Oil Mixing Houses.                       |
| IV. Dwelling Houses for Employés.                                 | XIV. Water Stations.                           |
| V. Sleeping Quarters, Reading Rooms and Club Houses for Employés. | XV. Coaling Stations for Locomotives.          |
| VI. Snow Sheds and Protection Sheds for Mountain Slides.          | XVI. Engine Houses.                            |
| VII. Signal Towers.   | XVII. Freight Houses.                          |
| VIII. Car Sheds and Car Cleaning Yards.                           | XVIII. Platforms, Platform Sheds and Shelters. |
| IX. Ash Pits.   | XIX. Combination Depots.                       |
| X. Ice Houses.  | XX. Flag Depots.                               |
|   | XXI. Local Passenger Depots.                   |
|   | XXII. Terminal Passenger Depots.               |

Appendix.

**BURR.**—A Course on the Stresses in Bridges and Roof Trusses, Arched Ribs, and Suspension Bridges.

Prepared for the department of civil engineering at the Rensselaer Polytechnic Institute. By Prof. W. H. Burr, Ninth edition, revised. With appendix on cantilevers. Nearly the entire section of swing bridges has been completely rewritten and considerably extended. Plates, 8vo, cloth .....\$3.50

"No better practical work on Bridge Stresses has yet appeared."—*Mechanical World* (London).

"The book will be valuable not only to the student of Bridge Engineering, but to the Engineer who is already in practice."—*Journal Railway Appliances*.

**BUTTS.**—The Civil Engineer's Field Book.

Designed for the use of the locating engineer. Containing tables of actual tangents and arcs, expressed in chords of 600 feet for every minute of intersection, from 0 deg. to 90 deg., from A1 deg. curve to A10 deg. curve inclusive. Also, tables of formulæ applicable to railroad curves and the location of frogs, together with radii, long chords, grades, tangents, natural sines, natural versed sines, natural external secants, etc. With explanatory problems. By Edward Butts, C.E. Second edition, revised, 12mo, morocco flaps.....\$2.50

"The work is a monument of patience on the part of the author, and should prove a labor-saving investment to the purchaser. It is a 'Henck' elaborated, and this is quite recommendation enough—to the practicing engineer."—*Engineering News*.

**BOLLER.**—The Thames River Bridge.

A report to the general manager of the New York, Providence & Boston railroad upon the construction of the Thames River bridge and approaches at New London, Conn. By Alfred P. Boller, chief engineer. Illustrated with numerous folding plates and a handsome heliotype of the bridge. Limited edition, 4to, paper.....\$5.00

**BOULTON.**—D. Van Nostrand's Science Series.

No. 82. The Preservation of Timber by the Use of Antiseptics. By Samuel Bagster Boulton, C. E. 18mo....50c

**BOWSER.**—A Treatise on Roofs and Bridges, with Numerous Exercises.

By Edward A. Bowser, professor of mathematics and engineering in Rutgers College. Partial table of contents:

CHAPTER I.—ROOF TRUSSES: 1. Definitions—2. The Dead Load—3. The Live Load—4. The Apex Loads and Reactions—5. Relations between External Forces and Internal Stresses—6. Methods of Calculation—7. Lever Arms—Indeterminate

Cases—8. Snow Load Stresses—9. Wind Loads—10. Complete Calculations of a Roof Truss.

CHAPTER II.—BRIDGE TRUSSES WITH UNIFORM LOADS: 13. Definitions—14. Different Forms of Trusses—15. The Dead Load—16. The Live Load—17. Shear—Shearing Stress—18. Web Stresses due to Dead Loads—19. Chord Stresses due to Dead Loads—20. Position of Uniform Live Load causing Maximum Chord Stresses—21. Maximum Stresses in the Chords—22. Position of Uniform Live Load causing Maximum Shears—23. The Warren Truss—24. Mains and Counters—25. The Howe Truss—26. The Pratt Truss—27. The Warren Truss, with Vertical Suspenders—28. The Double Warren Truss—29. The Whipple Truss—30. The Lattice Truss—34. The Parabolic Bowstring Truss—35. The Circular Bowstring Truss—36. Snow Load Stresses—37. Stresses due to Wind Pressure—38. The Factor of Safety.

CHAPTER III.—BRIDGE TRUSSES WITH UNEQUAL DISTRIBUTION OF THE LOADS: 39. Preliminary Statement—40. When the Uniform Train Load is preceded by One or More Heavy Excess Panel Loads—41. When One Concentrated Excess Load accompanies a Uniform Train Load—42. When Two Equal Concentrated Excess Loads accompany a Uniform Train Load—43. The Baltimore Truss—44. The Maximum Shears for Uniform Live Load—45. Locomotive Wheel Loads—46. Position of Wheel Loads for Maximum Shear—47. Position of Wheel Loads for Maximum Moment at Joint in Loaded Chord—48. Position of Wheel Loads for Maximum Moment at Joint in Unloaded Chord—49. Tabulation of Moments of Wheel Loads.

#### CRANDALL.—Railway and Other Earthwork Tables.

By Prof. Chas. L. Crandall. 8vo, cloth.....\$1.50

#### CRANDALL—The Transition Curve.

By Prof. Chas. L. Crandall, Cornell University. 12mo, morocco flap.....\$1.50

#### CREHORE.—Mechanics of the Girder.

A treatise on bridges and roofs, in which the necessary and sufficient weight of the structure is calculated, not assumed, and the number of panels and height of girder that render the bridge weight least for a given span, live load and wind pressure are determined. By John D. Crehore, C.E.. Illustrated by over 100 engravings, with tables, etc., 8vo, cloth.....\$5.00

"The Mechanics of the Girder for all the various shapes that it assumes before the Engineer, seems to have received here thorough and elegant treatment."—*Journal of Franklin Institute*.

The work is a valuable contribution to science and to the literature of bridge building."—W. H. SEARLES, C. E.

#### CREHORE, WM. W.—Tables and Diagrams for Engineers and Architects.

Fifteen tables and nine diagrams for making various calculations for structural work. List sent on request. Price, 25 to 50 cents each; complete set.....\$7.50

#### COOPER, THEODORE.—American Railroad Bridges.

Cloth, 7x9½ inches; 60 pp., 7 tables and 26 full-page and folding plates .....\$2.00

- "Specifications for Iron and Steel Highway Bridges."  
(1890.) Paper, 7x9½ inches; 23 pp.....25c
- "Specifications for Iron and Steel Railroad Bridges."  
(1890.) Paper, 7x9½ inches; 25 pp.....25c
- "Specifications for Steel Highway Bridges." (1896.) Pa-  
per, 7x9½ inches; 25 pp.....25c
- "Specifications for Steel Railroad Bridges." (1896.) Pa-  
per, 7x9½ inches; 24 pp.....25c

**CROSS, C. S.—Engineers' Field Book.**

Cloth, 4½x7 inches; 166 pp.; illustrated.....\$1.00

**DU BOIS.—The Stresses in Framed Structures.**

The present edition of this well-known work appears in a new form, greatly reduced in size and weight, rewritten and reset and printed from new plates. It contains the latest practice and much new matter never heretofore published. Swing bridges, the braced arch and the suspension system receive an entirely new treatment. New chapters are added upon erection, by John Sterling Deans, C.E., and high-building construction, by Wm. W. Crehore, C.E. Illustrated, with hundreds of cuts and 35 full-page and 14 folding plates. By Prof. A. Jay Du Bois. Tenth edition, 1 vol., 4to, cloth.....\$10.00

**DAVIS, JOHN W., C.E.—Formulae for the Calculation of Railroad Excavation and Embankment and for Finding Average Haul.**

Second edition. Octavo, half roan.....\$1.50

**DILLENBECK.—Specifications for Railway Stations.**

By Clark Dillenbeck. Stone and brick passenger stations, frame passenger stations, stone and brick freight houses, frame freight houses. Each occupying about 32 pages, 8x14 inches. Price 40 cents each; full set....\$1.50

**DRINKER.—Tunneling, Explosive Compounds and Rock Drills.**

Giving the details of practical tunnel work, properties of modern explosives, principles of blasting and descriptions and uses of the various rock drills and compressors, together with American and foreign systems of arching, and tables showing costs and dimensions of over 2,100 tunnels from every part of the world. By Henry S. Drinker. Profiles, maps and over 1,000 illustrations. Third edition, 4to, half bound.....\$25.00

"We think the comprehensive and thorough nature of the work will lead its readers to wonder, not that it has been delayed so long, but rather that it has been completed so soon. For the

conception and execution of such a work, Mr. Drinker deserves our thanks no less than our congratulations."—*Engineering and Mining Journal*.

#### Department of Agriculture.

Forestry Division of United States Department of Agriculture. Bulletin No. 4 (1890): "History and Use of Steel Ties."

Bulletin No. 9 (1894): "Steel Ties and Preservation of Timber."

#### ELLIOTT.—Block and Interlocking Signals.

#### FOSTER.—Wooden Trestle Bridges.

According to the present practice on American railroads, treating of pile bents, pile drivers, framed bents, floor system, bracing trestles of all kinds, iron details, connection with embankment and protection against accidents, field engineering and erection, preservation and standard specifications, bills of material, records and maintenance, working drawings. By Wolcott C. Foster, C.E. Second edition, revised and enlarged. 4to, cloth.....\$5.00

"The result is a book the like of which does not exist in any language, and which is often called for by practicing engineers and also in technical schools."—*Railroad Gazette*.

#### GIESELER.—Scales for Turnouts.

By E. A. Gieseler. Gives graphically the frog numbers, length of lead and degree of curvature for turnouts from 3 deg. to 42 deg. 30 min. Stiff cardboard, pocket size. More convenient and certain than tables. Price, with full directions for use.....25c

#### GREENE.—Graphics for Engineers, Architects and Builders.

A manual for designers and a text-book for scientific schools.

"Trusses and Arches." Analyzed and discussed by graphical methods by Chas. E. Greene, professor of civil engineering, University of Michigan. In three parts.

Part I.—"Roof Trusses." Diagrams for steady load, snow and wind. New revised edition (1890). 8vo, cloth .....\$1.25

"This new edition of the first part of Prof. Greene's work on Graphical Statics contains some considerable additions, modifications and rearrangements of material, tending to further improve the work, our favorable opinion of which is sufficiently indicated by the fact that the substance of the work is a reprint of a series of articles originally contributed to this journal."—*Engineering News*.

Part II.—"Bridge Trusses." Single, continuous and draw spans; single and multiple systems; straight and inclined chords. New revised edition (1891). 8vo, cloth .....\$2.50

Part III.—“Arches in Wood, Iron and Stone.” For roofs, bridges and wall openings; arched ribs and braced arches; stresses from wind and change of temperature. Third edition. 8vo, cloth.....\$2.50

“So eminently simple as to be exactly fitted for working Architects and Builders.”—Prof. GEO. L. VOSE.

“We can recommend Prof. Greene’s book as particularly adapted to students.”—*Engineering News*.

“An excellent little manual which we can decidedly recommend.”—*Engineering* (London).

**GODWIN.—Railroad Engineer’s Field Book.**

An explorer’s guide, especially adapted to the use of railroad engineers on location and construction and the needs of the explorer in making exploratory surveys. By H. C. Godwin. Second edition. Morocco flap.....\$2.50

“I have read with considerable care, and do not hesitate to pronounce it *far superior* to anything now published.”—Prof. J. B. JOHNSON, *Washington Univ., Dept. of Engineering, St. Louis*.

**HERMANN.—Steam Shovels and Steam Shovel Work.**

E. A. Hermann, M. Am. Soc. C.E. Cloth, 8vo, 98 figures. Price.....\$1.00

**HOWARD.—The Transition Curve Field Book.**

By Conway R. Howard, C.E. Containing full instructions for adjusting and locating a curve nearly identical with the cubic parabola in transition between any circular railroad curve and tangent. Simplified in application by the aid of a general table, and illustrated by rules and examples for various problems of location. 12mo, morocco flap.....\$1.50

“The methods indicated in this little work for locating transition curves are really simple, decidedly simpler than some others that have been put out, and the results good. Therefore it will prove a useful book to many engineers.”—*Engineering News*.

**HOWARD, C. R.—Earthwork Mensuration on the Basis of the Prismoidal Formulae.**

Containing simple and labor-saving method of obtaining prismoidal contents directly from end areas. Illustrated by examples and accompanied by plain rules for practical uses. Illustrated. 8vo, cloth.....\$1.50

**HOWE.—Retaining Walls for Earth.**

The theory as developed by Prof. Jacob J. Weyrauch, expanded and supplemented by practical examples, with notes on later investigations. By Malverd A. Howe, C.E. Third edition, entirely rewritten and enlarged (1896). 12mo, cloth.....\$1.25

“We commend this little volume to all Engineers of Construction.”—*Industrial Review*.

“An addition made in the present edition is a chapter on the supporting power of earth in the case of foundations; another is a formula for determining the breadth of the base of a retaining wall. The book is a useful one both for students and for engineers in practice.”—*Railroad and Engineering Journal*.



**HUDSON.—Tables for Calculating the Cubic Contents of Excavations and Embankments by an Improved Method of Diagonals and Side Triangles.**

By J. R. Hudson. New edition, with additional tables, 8vo, cloth .....\$1.00

"These tables are simple and accurate. The method adopted is illustrated by plain diagrams, and the tables are arranged for nearly every possible width of roadway and slope and cuttings on fills from zero to 50 feet."—*Engineering News*.

**HENCK, JOHN B.—Field Book for Railroad Engineers.**

**JOHNSON.—The Theory and Practice of Surveying.**

Designed for the use of surveyors and engineers generally, but especially for the use of students in engineering. By J. B. Johnson, C.E., professor of civil engineering, Washington University, etc., etc. Illustrated by upward of 150 engravings, with folding maps, tables, etc., etc. Eleventh edition, revised. 8vo, cloth.....\$4.00

"On the whole this is the best treatise on Surveying that we know of."—*Railroad Gazette*.

"Whatever branch of work the Surveyor is in, he will find this book valuable and exhaustive."—*American Engineer*.

**JOHNSON.—Stadia Reduction Diagram.**

Sheet, 22½x28½ inches.....50c

**JOHNSON—BRYAN—TURNEAURE.—Theory and Practice in the Designing of Modern Framed Structures.**

Sixth edition, revised and enlarged. 4to, cloth...\$10.00

Chapter	Part I--ANALYTICAL.	Chapter	Part II--STRUCTURAL.
I.	Definitions and Historical Review.	XVI.	Styles of Structures and Determining Conditions.
II.	Application of the Laws of Equilibrium to Framed Structures.	XVII.	Design of Individual Truss Members.
III.	Roof Trusses.	XVIII.	Details of Joints and Connections.
IV.	Bridge Trusses with Uniform Loads.	XIX.	Plate Girders.
V.	Bridge Trusses with Wheel Loads.	XX.	The Complete Design of a Roof Truss.
VI.	Conventional Methods of Treating Train Loads.	XXI.	The Complete Design of a Railway Bridge.
VII.	Lateral Truss Systems.	XXII.	The Complete Design of a Highway Bridge.
VIII.	Beams (including Continuous Girders).	XXIII.	The Detail Design of a Howe Truss.
IX.	Columns (including a New Formula.)	XXIV.	The Detail Design of a Draw Bridge.
X.	Combined Direct and Bending Stresses.	XXV.	Elevated Railway Structures.
XI.	Suspension Bridges.	XXVI.	Timber and Iron Trestles.
XII.	Draw Bridges.	XXVII.	Esthetic Bridge Designing.
XIII.	Cantilever Bridges.	XXVIII.	Iron and Steel Tall Building Construction.
XIV.	Elastic Arch Bridges.	XXIX.	Iron and Steel Mill Building Construction.
XV.	Deflection of Framed Structures and Distribution of Stresses Over Redundant Members.		
APPENDICES:	{ <ul style="list-style-type: none"> <li>A. The Use of Soft Steel in Bridges.</li> <li>B. Processes in the Manufacture and in the Inspection of Iron and Steel Structures.</li> <li>C. American Methods of Erection of Bridges and Structures.</li> </ul> }		

**KINDELAN.—The Trackman's Helper.**

Second edition. A practical guide to the section foreman. By J. Kindelan, Roadmaster, Mitchell, S. D. Price. \$1.50

**MERRIMAN—BROOKS.—Hand-Book for Surveyors.**

A pocket-book for the classroom and the field, including fundamental principles, land surveying, leveling, triangulation, and topographic surveying, with tables. By Profs. Mansfield Merriman and John B. Brooks, C.E. Pocket-book form. 12mo, morocco. . . . . \$2.00

"In Issuing this pocket-book the authors undoubtedly meet a demand. Works on surveying were plentiful enough, but none were in shape for handy use in the field. As arranged, this work can be used in the class-rooms of technical schools as well as by surveyors in the field. . . . The methods of testing and comparing instruments are given more fully than usual in works of this character.—*Engineering News*.

**MERRIMAN—JACOBY.—A Text-Book on Roofs and Bridges.**

Designed for classes in technical schools and for the use of engineers. By Prof. Mansfield Merriman, of Lehigh University, and Prof. Henry S. Jacoby, of Cornell University. In four parts.

Part I.—"Stresses in Simple Trusses." Fourth edition, revised and enlarged with three new chapters. 8vo, cloth . . . . . \$2.50

"The author gives the most modern practice in determining the stresses due to moving loads, taking actual typical locomotive wheel loads, and reproduces the Phoenix Bridge Co.'s diagram for tabulating wheel movements. The whole treatment is concise and very clear and elegant."—*Railroad Gazette*.

Part II.—"Graphic Statics." Third edition, enlarged. With five folding plates. 8vo, cloth. . . . . \$2.50

"The plan of this book is simple and easily understood; and as the treatment of all problems is graphical, mathematics can scarcely be said to enter into its composition. Judging from our own correspondence, it is a work for which there is a decided demand outside of technical schools."—*Engineering News*.

Part III.—"Bridge Design." A manual for students and for bridge draughtsmen. Second edition. 8vo, cloth. \$2.50

"It is a most useful handbook for the designer, and the photographic reproductions of working drawings in the plates leave nothing to be desired on the score of completeness and clearness. . . . It can be read with pleasure and profit by every engineer interested in bridge work."—*Indian Engineering*.

"The general processes treated by Professors Merriman and Jacoby have been fairly well written up before, but they certainly have not been so extensively elaborated either as to variety of application or as to faithful and painstaking detail."—*Engineering Record*.

Part IV.—"Cantilever, Continuous, Draw, Suspension and Arch Bridges." March, 1898. 8vo, cloth. . . . . \$2.50

CONTENTS: Continuous Bridges, Draw Bridges, Cantilever Bridges, Suspension Bridges, Three-Hinged Arches, Two-Hinged Arches, Arches without Hinges.

**MERRILL, COL. WM. E., U. S. A.—Iron Truss Bridges for Railroads.**

The method of calculating strains in trusses, with a careful comparison of the most prominent trusses, in reference to economy in combination, etc. Illustrated. 4to, cloth. Fourth edition.....\$5.00

**MORISON.—The Memphis Bridge.**

By George S. Morison. Oblong 4to.....\$10.00

**MERRIMAN.—Elements of Precise Surveying and Geodesy.**

By Mansfield Merriman, professor of C.E. in Lehigh University. Cloth, 9x6 inches; pp. 261; illustrated.....\$2.50

**NAGLE.—A Field Manual for Railroad Engineers.**

By J. C. Nagle, professor of civil engineering in the A. and M. College of Texas. 12mo, morocco.....\$3.00

CONTENTS: Reconnoissance; Preliminary Surveys; Location; Transition-Curves; Frogs and Switches; Construction; Tables.

**OSBORN.—Osborn's Specifications.**

General specifications for railway bridges. General specifications for bridge substructure. Specifications for metal highway bridge superstructure. Paper, 8x12 inches. Price of each.....25c

**PAINE.—The New Roadmaster's Assistant (1898 Edition).**

By George H. Paine. For twenty-five years "The Roadmaster's Assistant," by Huntington and Latimer, has been known throughout the world. Mr. Paine's new book is its worthy successor. About 300 engravings, practical and up to date in every respect. It is a necessary tool to every roadmaster and section foreman. Price.....\$1.50

**PATTON.—Practical Treatise on Foundations.**

By W. M. Patton, C.E. Twenty-one full-page plates, illustrated. 400 pages. 8vo, cloth.....\$5.00

CONTENTS: Foundation Beds, Foundations. Building Stone, Quarrying, Masonry, Arches, Keystone, Brick, Box Culverts, Cement, Mortar, Sand, Stability of Piers, Arch Culverts, Cost of Work, Dimensions of Piers, Timber Foundations, Cofferdams, Open Caisson, Soundings, Borings, Frame Trestles, Timber Piers, Means of Preserving Timber Joints and Fastenings, Timber Piles, Cost of Timber Trestles, Embankment of Earth on Swamps, Deep Foundations, The Open Crib, The Pneumatic Caisson, Construction of Pneumatic Caissons, Caisson Sinking, Combined Open Crib and Pneumatic Caisson, All-Iron Piers, Location of Piers, The Poetsch Freezing Process, Quicksand, Foundations for High Buildings.

**PLYMPTON, PROF. GEO. W.—The Aneroid Barometer; Its Construction and Use.**

Compiled from several sources. Fourth edition. 16mo, boards, illustrated, 50 cents; morocco.....\$1.00

**PAUL, H.—Railway Surveys and Resurveys.**

Pamphlet, 6x9 inches, 13 pages. Price .....25c

**REED.—Topographical Drawing and Sketching, Including Photography applied to Surveying.**

Illustrated with plates, colored and plain. By Lieut. Henry A. Reed. Fourth edition. 4to, cloth.....\$5.00

"This is decidedly the best work of its class that we have ever met with."—*Engineering News*.

"An expert at our elbow says that this is one of the best works on the subject in the English or any other language."—*Engineering and Mining Journal*.

"We can commend without reservation Lt. Reed's work."—*Franklin Institute*.

**SEARLES.—Field Engineering.**

A hand-book of the theory and practice of railway surveying, location and construction, designed for classroom, field and office use, and containing a large number of useful tables, original and selected. By Wm. H. Searles, C.E., late professor of geodesy at Ren. Polytechnic Institute, Troy. This volume contains many short and unique methods of laying out, locating and constructing compound curves, side tracks and railroad lines generally. It is also intended as a text-book for scientific schools. Pocket book form. Sixteenth edition. 12mo, morocco..\$3.00

"The book is admirable. The internal arrangements and appearance are excellent. It is an easy work to refer to and is plain and clear. There is no useless lumber in it. Every sentence belongs there."—Prof. DAVIS, *University of Michigan*.

**SEARLES.—The Railroad Spiral.**

The theory of the compound transition curve reduced to practical formulæ and rules for application in field work, with complete tables of deflections and ordinates for 500 spirals. By Wm. H. Searles, C.E., author of "Field Engineering," member of Amer. Soc. of C. E. Fifth Edition. Pocket-book form. Price .....\$1.50

"It should have a place in the library of every Civil Engineer in the world."—*Railway Age*.

**SHUNK, W. F.—The Field Engineer.**

A handy book of practice in the survey, location and track work of railroads, containing a large collection of rules and tables, original and selected, applicable to both the standard and narrow gauge, and prepared with special reference to the wants of the young engineer. Tenth edition. Revised and enlarged. 12mo, morocco, tucks..\$2.50

**SIMMS, W. F.—Practical Tunneling.**

Fourth edition, revised and greatly extended. With additional chapters illustrating recent practice by D. Kinnear Clark. With thirty-six plates and other illustrations. Imperial 8vo, cloth .....\$12.00

**SIMMS, F. W.—A Treatise on the Principles and Practice of Leveling.**

Showing its application to purposes of railway engineering and the construction of roads, etc. Revised and corrected, with the addition of Mr. Laws' practical examples for setting out railway curves. Illustrated. 8vo, cloth. . \$2.50

**SMITH—McMILLAN.—Manual of Topographical Drawing.**

By Lieut. R. S. Smith, U. S. A., late assistant professor of drawing in U. S. Military Academy. Revised and enlarged by Chas. McMillan, C.E., professor of civil engineering, college of New Jersey. With twelve folding plates, newly made (three colored), and new wood engravings. Third edition, 8vo, cloth. . . . . \$2.50

"This is a delightfully simple and practical work."—*Scientific American*.

"The scope of this work and the author's mode of treatment rise far beyond the ordinary handbooks of the same class."—*London Engineering*.

**SPALDING.—Hydraulic Cement; Its Properties, Testing and Use.**

By Frederick P. Spalding, assistant professor of civil engineering at Cornell University; member of the American Society of Civil Engineers. 12mo, cloth. . . . . \$2.00

CONTENTS: Hydraulic Lime; Classifications and Constitution of Cement; The Setting and Hardening of Cement; Its Soundness; Methods of Testing Cement; Tests for the Strength of Mortar; Tests for Soundness; Special Tests; Cement Mortar and Concrete; Appendix, containing Specifications for the Reception of Cement.

"For those who wish to acquire a working knowledge of cement and its treatment, and for those who desire to have in convenient form a general handbook on this subject, we can recommend this little book as worthy."—*Engineering Record*.

**TORREY.—Switch Layouts and Curve Easements.**

By A. Torrey, Prin. Asst. Eng., Michigan Central railroad. One hundred and twelve diagrams, showing graphically and by figures the leads, offsets and all dimensions for laying out switches for frogs of all numbers and for all combinations in common use, for both split and stub switches. The second part of the manual ("Curve Easements") gives exact and easily used instructions and data for easing transitions from tangent to curve, or between curves of different radii. No similar publication has ever before been made. It is a practical and necessary manual for track men. Price. . . . . \$1.00

**TRATMAN.—Railway Track and Track Work.**

By E. E. Russell Tratman, Assoc. M. Am. Soc. C. E.; asso-

ciate editor of Engineering News. 400 pages; over 200 illustrations. Price .....\$3.00

SYNOPSIS OF CONTENTS.

PART I.—TRACK: Roadbed—Ballast—Ties—Metal Ties—Rails—Joints—Fastenings—Frogs and Switches—Fences—Crossings—Track Signs—Track Tanks—Mail Cranes and Car Bumpers—Section Houses—Sidetracks—Yards and Terminals—Track Tools and Supplies.

PART II.—TRACK WORK: Organization—Tracklaying—Ballasting—Ditching—Maintenance Work (Surfacing, Lining, Relaying Rails and Ties, Policing, etc.)—Grades and Curves—Switch Work—Track Inspection—Bridge Department—Snow—Wrecking and Emergency Work—Records and Accounts.

**TRAUTWINE.—Civil Engineer's Pocketbook.**

Of mensuration, trigonometry, surveying, hydraulics, hydrostatics, instruments and their adjustments, strength of materials, masonry, principles of wooden and iron roof and bridge trusses, stone bridges and culverts, trestles, pillars, suspension bridges, dams, railroads, turnouts, turning platforms, water stations, cost of earthwork, foundations, retaining walls, etc. In addition to which the elucidation of certain important principles of construction is made in a more simple manner than heretofore. By J. C. Trautwine, C.E. 12mo, morocco flaps, gilt edges. Seventeenth edition, fiftieth thousand, revised and enlarged, with new illustrations. By J. C. Trautwine, Jr., C.E..\$5.00

"It is the best Civil Engineers' Pocketbook in existence."—*American Engineer.*

**TRAUTWINE.—The Field Practice of Laying Out Circular Curves for Railroads.**

By J. C. Trautwine, civil engineer. Thirteenth edition, revised by J. C. Trautwine, Jr. 12mo, limp morocco...\$2.50

"Probably the most complete and perfect treatise on the single subject of Railroad Curves that is published in the English language."—*Engineering News.*

**TRAUTWINE.—A Method of Calculating the Cubic Contents of Excavations and Embankments by the Aid of Diagrams.**

Together with directions for estimating the cost of earthwork. By John C. Trautwine, C.E. Ninth edition, revised and enlarged by John C. Trautwine, Jr. 8vo, cloth .....\$2.00

**TRAUTWINE.—Cross-Section Sheet.**

To be used with "Trautwine's Excavations." Sheet form. Price .....25c

**WELLINGTON, A. M.—Piles and Pile Driving.**

Paper, 4½x7 inches, 150 pages. Illustrated.....\$1.00

**WELLINGTON.—The Economic Theory of the Location of Railways.**

An analysis of the conditions controlling the laying out of railways to effect the most judicious expenditure of capital. By Arthur M. Wellington. Fifth edition. 8vo..\$5.00

"Mr. Wellington has done great service to the Railroad profession; more particularly to Engineers, Managers, and Superintendents, by bringing together in a single volume such a mass of valuable matter. It should be in every Railway Library."—*Railway Age*.

**WELLINGTON.—Excavation and Embankments.**

Price .....\$4.00

**WHIPPLE, S., C.E.—An Elementary and Practical Treatise on Bridge Building.**

8vo, cloth. Price .....\$4.00

**WRIGHT.—The Designing of Draw Spans.**

Comprising the calculation of stresses, sections required, determination of the most efficient details and the designing of operating machinery. With numerous examples from existing bridges. By Charles H. Wright, Edgemoor Bridge works. 8vo, cloth.

**PART FIRST.**—Part first deals particularly with Plate Girder Draws; gives tables of strength of Shafts, Gears, etc. Considers Deflection under various conditions of loading and for varying section of girder; Treats of Friction, Time of Operating and Turning, Latching and Wedging arrangements, etc. Much of the data given applies equally well to other types of Draw Spans.

**WINSLOW, A.—D. Van Nostrand's Science Series.**

No. 77. "Stadia Surveying." The theory of stadia measurements. By Arthur Winslow. 8mo.....50c

## APPENDIX L.

### BRIDGES AND BUILDINGS—RULES, TABLES AND DATA, DETAILED RULES GOVERNING BRIDGES AND CULVERTS.\*

#### BRIDGES AND CULVERTS.

Inspection.—The division engineers will make occasional examinations of the condition of all important bridges and culverts. In an emergency they will, on their own authority, report such repairs as they may deem necessary for safety, to the division superintendent for immediate attention. In other cases they will make their reports to the chief engineer, who will decide on the amount and character of the work to be done.

Great care must be taken by division engineers and supervisors of bridges and buildings, to whom the security of structures is intrusted, to make such inspections so thorough and the records thereof so complete as to convey definite and precise knowledge of the condition of each and every structure at the time of the last inspection.

There will be two regular inspections each year, as follows:

1. In January, by the supervisor of bridges for each division of all truss and large trestle bridges.
2. In September, by the division engineers and supervisors of bridges, of all bridges, culverts, waterways, etc.

In addition the supervisors of bridges must at all times make such other inspections as may be necessary to insure safety.

The September inspection must be made with special reference to obtaining information for estimating the cost of renewals and repairs, and for the material required for the ensuing year.

\*Adopted and in force on the Northern Pacific Railway.



The supervisors of bridges will forward the report of these inspections, with an impression copy of the same, to the division superintendent for approval. Division superintendents will forward both copies to the division engineer.

The supervisor of bridges will make such further inspections as he finds necessary to keep thoroughly posted as to the conditions and safety of all bridges and culverts on his division.

Division superintendents will arrange to obtain the record of extreme high water at the time of each flood, or extraordinary freshet, at all bridges, culverts and openings.

Section foremen should be instructed to go over their sections at such times and take the measurement from top of tie to the extreme high-water mark and report such measurements, giving the number of the bridge or opening, to the division superintendent.

Division superintendents will forward this information to the division engineers, who will retain copy and forward the information to the office of the chief engineer for record.

Supervisors of bridges will furnish the division superintendent monthly reports of all repairs and renewals of bridges and culverts executed during the month. These reports will be forwarded to the division engineer, who will check same against the inspection requirements, for the purpose of insuring compliance with such requirements.

At the completion of the work the supervisors of bridges will forward a report to the division superintendent, showing all changes in the class of structure, details of construction and length, height and position of structures; also the cost of labor and material expended. This report will be forwarded to the division engineer, who, after recording same, will send it to the chief engineer for final record.

Following the September inspection, estimates of the cost of repairs, renewals and replacements recommended for the ensuing year will be prepared by the division supervisors and division engineers, which will be tabulated and forwarded through the office of the chief engineer.

The character and extent of renewals and improvements will be determined from this report. Descriptions and esti-

mates will be given for permanent structures, wherever same appear desirable or economical.

This report will show the cost of necessary repairs recommended for the ensuing year; the average annual cost of such repairs; the total cost of the structure upon which repairs are recommended, and also the total cost and annual interest upon permanent structures when such structures are recommended.

All changes, additions or expensive renewals of bridges, culverts or other important structures shall be made only upon the properly approved plans and estimates of the chief engineer, who will make contracts for and superintend the work.

Instruction to Inspectors.—Note-books of inspection must be filled out at the structure after a careful examination has been made of each of the points itemized in the blanks, using, in cases where there are a number of spans in which defects are observed, a properly noted column for each span. When the spans are all in good condition one column only need be used, but the number of spans should be noted.

Designate the separate spans of a bridge by numbering them in the direction of the bridge numbers on the division, and the separate bents or piers in same manner, commencing with abutment, bank-bent or sill as number one. Designate the truss as the right or left, locating points on it by numbering the panels in the same direction as the spans are numbered.

When wooden structures are four years old, such members as by their position are particularly liable to decay must be tested by boring, the holes to be plugged up as soon as the inspection is completed.

When making regular inspections the inspectors will take a statement of the results of the last examination relative to such structures as required attention at that time, and in reporting on these structures, special notes must be made as to whether the repairs and recommendations of the previous examinations have been fully carried out or not, and whether the work is in accordance with the standard plans.

Instructions Regarding Inspection Reports.—(Numbers and directions in these instructions correspond with numbers and abbreviations on report blanks.)

1. Does waterway require straightening, cleaning out or enlarging above or below structure? Does structure afford ample waterway? Is rip rap needed to maintain channel or protect roadway?

2. Note line and surface, also condition of rails, joints and fastenings on bridge and approaches. See that rails are braced on curves where necessary, and that track on approaches is firmly bedded, avoiding shock or jolt to train as it passes on to bridge.

3. Note any rotten, split or otherwise defective bridge ties, giving number, size and kind.

4. See if guard rails are in line and bolted or spiked down tight.

5. Note condition of caps and stringers, particularly at points where they bear against other members.

6. Note if plumb and batter posts are crooked, split or decayed, and if bents stand plumb.

7. See if trestle towers or bents are properly sway-braced, and all braces longitudinal and transverse are drawn up tight and have sufficient bolts or spikes to hold them properly.

8. Note particularly the condition of piles where they enter the ground or water. See that they stand properly.

9. Examine each pier and abutment as to joints, settlement, imperfect stones, cracks or other defects; note if work needs pointing up, or if cracks have opened since last pointed; make such measurements as will locate position of cracks, and note on sketch on back of report blank. Condition of rip rap, if any. Is rip rap needed to prevent undermining? How much? Condition of pedestal stones, and whether bridge seat is clean and water drained off.

10. Note condition of culvert and retaining walls. See if they are yielding by settlement or bulging from the pressure of the embankment.

11. Condition of ring, or covering stone, of box or arch culverts.

12. Note condition of paving and rip rap, and that same is so placed that it cannot be undermined by washing.

13. Does pipe drain need head or tail wall to protect embankment from washing? And does it clear itself of water?

14. Does timber box need to be replaced with masonry, or culvert pipe? If so, give dimensions required to give ample waterway, and give height from bottom of stream to rail.

15. See if bed plates and rollers are clean, and if the latter stand so as to move squarely back and forth with the truss. See if pedestal takes an even bearing on rollers. Examine anchor bolts.

16. Observe particularly the condition of wall plates where bolster rests upon them. Note any appearance of crushing or decay.

17. Note condition of bolsters and corbels. See if holes are bored through them where they cover the spaces between chord sticks, to prevent the collection of water, and if there is any indication of decay where they are in contact with chord.

18. Angle blocks and all cast-iron members such as chord boxes, post shoes, etc., must be examined for cracks and for any indication of displacement by reason of daps splitting or timber crushing. A hole of  $\frac{1}{4}$ -inch in diameter, if drilled at the end of the crack, will frequently stop its extending farther.

19. Note particularly any appearance of opening of bottom chord joints. Wooden bridges over four years old should have gauge blocks at all joints in the middle half of the span, made by fastening two planed and squared blocks 1x2 inches, 6 inches long, to the chord sticks with screws, and scribing a fine line across both. Any movement of joints should be noted, giving location and amount, scribing a new line from the old one on the outside block across the inside block. See if clamp daps are shearing.

20. See that all chord and packing bolts are tight. Nuts on all bolts through guard rails, ties, stringers and floor beams must be secured in place by burring the thread of the bolt at two or three places with a center punch or cape chisel.

21. Note any signs of decay or crushing in packing blocks, and see that clamps and keys are in proper condition.

22. See if gib plates are distorted or crushing into the chords; if they are, give their location and dimensions, number, size and spacing of rods passing through them. Give size of rods over threads.

23. Note condition of sides and roof of covered bridges, or of chord and end post covering.

24. Notice particularly the connections between stringers and floor beams; see that connecting angles are not split, either in the angle or through in the line of the rivet holes. For wooden stringers, note condition as to soundness and bearings.

25. Notice particularly the connections between floor beams and trusses for evidence of imperfect bearing, or splitting of connecting angles. If suspended, notice if they are up tight against the post feet or free to move.

26. Test equality of tension in tie bars by springing them. Look for any signs of distortion or crookedness in bars of end panels of bottom chords. Howe truss rods, counter lateral and vibration rods must never be allowed to hang loose. They must not be adjusted while a load is on the bridge. They should be tightened enough to give close and even bearings, but must not be overstrained, as unnecessary strains are put on compression members if too much power is used in adjusting tension members. See that the center line of all tension members is the same as the line of strain.

27. Examine carefully, especially at the joints.

28. See if posts, lateral struts and top chords are straight and free from twists. On wooden bridges, see if braces are up in place, taking a square bearing at ends, and note if any warping is evident. Note their condition as to soundness.

29. Examine all lateral connections, and see that lateral tension members are straight. Examine bracing in iron trestles.

30. Make particular examination of all hangers, testing each nut to see that it is tight. A streak of white paint drawn across nut and bearing will indicate any movement. These nuts should be screwed up tight and secured by burring the thread of bolt and nut at two or three points with a center punch or cape chisel.

31. Note any pins which indicate the movement of any of the members coupling on them, or that have loose nuts. All pins and nuts should have a streak of white paint across nut and pin end.

32. All field driven rivets in floor beams and stringer connections should be lightly sounded to see that they are tight. Also lateral connection rivets in riveted trusses, and any intersection or other rivets which indicate by rust streaks, or otherwise, that there is movement at that point.

33. Note if there are any members, such as closed columns, pedestals, etc., which catch and retain water by reason of not having proper drain holes.

34. Note carefully the line of each truss by the top chord and by points on the floor beams equidistant from the center of the posts. Also note the camber by the top and bottom chords, whether it is true and uniform or irregular.

35. Look for loose rods, hangers, loose braces, unequal-sized timbers and other defects which require adjusting in order that each of the different parts may have proper bearings and carry its proper part of the load.

36. Note any undue vibration of the structure under live load.

37. Note excessive deflection of the structure under live load, seeing if the two trusses have the same deflection.

38. See if any rust spots are apparent under the paint. Note if structure needs repainting. Iron bridge work should be scraped and repainted as often as necessary to preserve from rusting.

39. Note such wooden structures as require barrels to add to their safety, giving number required. State condition of such barrels as may be in position. On all bridges of such magnitude as to require a watchman, there should be a foot plank between the rails securely fastened to the ties to facilitate crossing the bridge quickly in emergencies, such as fire or danger to trains. Note if ladders, either fixed or portable, are required for the safety of the structure or to facilitate inspection.

40. See if material, driftwood, weeds, grass or other rubbish is properly removed and burned, or otherwise disposed of.

List of abbreviations for class of structures:

W. B.—Wooden or timber box culvert.	P. B.—Pile bridge.
S. B.—Stone box culvert.	P. C.—Pile culvert.
S. A.—Stone arch culvert.	T. B.—Trestle bridge.
T. P.—Tile culvert pipe.	H. T.—Howe truss.
C. P.—Cast culvert pipe.	C. T.—Combination truss.
B. D.—Blind drain.	I. T.—Iron truss.
W. C.—Wall culvert.	D. S.—Draw span.
	P. G.—Plate girder.

## ERECTION OF STEEL BRIDGES.

General.—Engineers, inspectors and contractors are expected to make themselves thoroughly familiar with the general and special specifications governing the work.

All material received must be carefully checked, recorded and reported immediately upon receipt of same, in accordance with the rules. Shortages should be reported immediately. Material received should be checked against complete bill of material, and every effort made to avoid delay to the progress of the work, by failure to receive material, including false work, tools, etc., etc.

The engineer in charge must cause to be kept an accurate record of the cost of the work, including material and labor, keeping separately each class of work, such as rigging up, unloading, repairing, raising, fitting, riveting, cleaning, painting, framing, bolting, contractors' pay roll, character of plant, framing and erecting false work, and removal of same. A diary must be kept containing dates of commencing and completing different classes of work, and all other general information of value. A record, or copies of all orders, or instructions, issued or received during the progress of the work, and the daily force account should also be kept.

The engineer in charge must check all distances and elevations on plans, before laying out the work, and will be held responsible for any errors that may arise, through neglect on the part of himself or assistants, properly to verify and recheck, plans, points and elevations, given for the erection of the structure. Distances between centers and elevations of finished tops of masonry are especially important, and should be rechecked as often as may be necessary in order absolutely to insure against errors. The sum of the heights of the component parts forming the structure should be carefully checked against the total finished height, above assumed datum, to base of rail. The sum of all detail lengths must also be checked, with equal care, against the total length from the fixed initial point.

Insure that the material shall not be injured, nor dangerously strained during the operation of loading, unloading or handling same. All defects in workmanship or material must be remedied as soon as detected. A thorough inspection must be made for defects in painting, cleaning, reaming, spots of

shrivelled oil or paint, chips, burrs, sharp edges and black or rusty spots on steel, scale, cinders and scratches, particularly in joints and around rivet heads, brush hairs, or other foreign matter covered over with paint or oil; all such defects shall be remedied immediately, and noted in detail, to provide full information, in case of claims for extra compensation.

Slight bends in members shall not be straightened unless strictly necessary, on account of the danger of overstraining connections and rivets. Connection plates, if slightly bent or twisted, shall be straightened cold; if bent so sharply as to require heating, the whole piece thus heated shall be subsequently annealed. All shop rivets, or any piece of member thus straightened, shall be properly tested.

Particular care will be taken to insure free expansion and contraction, wherever provided for in plans. Any departure in dimensions, amount of camber or otherwise, of material received, from plans and specifications, must be noted and reported immediately.

All machine-fitted bolts shall be perfectly tight, and should be burred or otherwise checked to prevent nuts from becoming loose, and no unfilled rivet or bolt holes should be left in any part of the structure.

**Fitting and Chipping.**—The material must be assembled in accordance with the match marks, and no interchange of pieces must be made, unless absolutely necessary in order to avoid chipping and fitting, or serious delay.

Fitting and riveting of connections (especially angles) in cases where pieces are short or full, must be done in such a manner that the metal is not unduly strained or cracks caused.

Dishonest or incompetent workmen frequently fill cracks with paint, putty, cinders, dirt, oil or filings, for the purpose of deception. A close inspection must be made for this.

Wooden rams or mallets must be used in forcing members to position, in order to protect metal from injury or shocks.

Chipping of rivets, angle flanges and edges of plates, must be done without breaking out metal. Chipped edges must be finished off with a file, and all concave corners must be rounded off. Chipping with a sledge will only be permitted in exceptional cases, and must be done without leaving fractured edges.



**Riveting.**—In driving rivets the dolly and die should be placed directly opposite each other, at right angles to the riveted surface, to insure straight driving. Rivets must be driven while at an orange heat, and no burnt rivets should be used.

After riveting each rivet must be tapped with a hammer to insure that they are tight, and the heads must be well formed, concentric with center of rivet, and closely fitted against the riveted surface.

Defective rivets can usually be detected by their color, or by sound when tapped with a hammer, and all loose or burnt rivets must be immediately cut out and replaced.

In cutting out rivets be careful to ascertain that other rivets in proximity have not been loosened.

Tightening up, recupping or calking old rivets will not be tolerated, except that occasional recupping of shop rivets do not form part of important connections, or do not directly transmit stresses.

Countersunk rivets must be inspected after chipping heads, and no unnecessary chipping should be permitted.

**Painting.**—The specifications under the head of cleaning, oiling and painting must be strictly carried out.

An accurate account should be kept of the quantities and proportions used, of pigments, oils and other ingredients, and the quantities by weight or fluid measure, of the resulting mixtures, ascertained. A record should be kept of the quantity of paint applied, of each coat, and its proportion ascertained to area or weight of material covered.

Paint should be thoroughly worked in all corners and joints, and narrow openings, covering edges and sealing up all lines of contact between parts.

Unless otherwise specified, the ingredients and proportions of the mixture, for the three coats, shall be as follows:

**First Coat.**—30 lbs. pure lead to 1 gallon pure boiled linseed oil, 1-3 pint pure turpentine.

**Second Coat.**—25 lbs. pure lead to 1 gallon pure boiled linseed oil,  $\frac{1}{4}$  pint pure turpentine, lampblack, quantity not to exceed 12 ounces.

**Third Coat.**—15 lbs, dry pigment, Cleveland Ironclad, purple band No. 3, to 1 gallon of pure boiled linseed oil.

TABLE 1—Showing Life of Different Kinds of Plies Employed in Railway Bridges and Trustles in United States.\*

Kind of timber	Average life in years when driven in—		Dry land.	State.	Railway company furnishing report.
	Salt.	Water.			
Cedar, white.....	.....	.....	Over 20	Wisconsin.....	Chicago, Milwaukee & St. Paul.
Cedar.....	.....	28	16 to 20	".....	Chicago & Northwestern.
Cedar.....	.....	.....	20	".....	Chicago & Northwestern.
Cedar.....	.....	20	20	Wyoming.....	Union Pacific.
Chestnut.....	40	20	15 to 18	Me., N.H., Vt., Mass., Boston & Maine.	New York, New Haven & Hartford.
Chestnut.....	15	15	12	Illinois.....	St. Louis, Peoria & Northern.
Cypress.....	.....	.....	7	Massachusetts.....	Boston & Maine.
Oak.....	35 to 40	8 to 10	About 12	New Hampshire.....	Boston & Maine.
".....	.....	20	14	Rhode Island.....	New York, New Haven & Hartford.
".....	9	9	8	Ohio, Ind., Ill.....	Toledo, St. Louis & Kansas City.
".....	.....	8 (wtr line)	10	Illinois.....	Chicago & Eastern Illinois.
".....	.....	15 to 30	8 to 12	Illinois.....	Chicago & Eastern Illinois.
".....	.....	.....	8	S. Dak., Minn.....	St. Louis, Peoria & Northern.
".....	.....	.....	5 to 20	Wisconsin.....	Chicago & Northwestern.
".....	.....	25	20	".....	Chicago, Milwaukee & St. Paul.
".....	.....	20	10 to 14	".....	".....
".....	.....	10	15	".....	".....
".....	.....	20	8	".....	".....
".....	.....	20	12	Wyoming.....	Union Pacific.
".....	.....	20	10	Miss., La.....	New Orleans & Northeastern.
".....	.....	.....	6	Wisconsin.....	Chicago, Milwaukee & St. Paul.
".....	.....	.....	6	Minnesota.....	Duluth & Iron Range.
".....	.....	.....	7	Minnesota.....	Duluth & Iron Range.
".....	.....	.....	8	Wyoming.....	Union Pacific.
".....	.....	15	8	Me., N.H., Vt., Mass., Boston & Maine.	Boston & Maine.
".....	.....	10	7 to 8	Massachusetts.....	Boston & Maine.
".....	8 to 10	4 to 6	4 to 6	Colorado.....	Denver & Rio Grande.
".....	.....	10 to 15	7	Colorado.....	Colorado & Southern.
".....	.....	.....	7	Me., N.H., Vt., Mass., Boston & Maine.	Chicago, Milwaukee & St. Paul.
Tamarack.....	.....	18	10 to 12	Wisconsin.....	Chicago, Milwaukee & St. Paul.
".....	.....	.....	8	Minnesota.....	Duluth & Iron Range.
".....	.....	.....	8	Minnesota.....	Duluth & Iron Range.

\*Prepared by Committee of the Association of Railway Superintendents of Bridges and Buildings in 1899.

TABLE II.—Showing Life in Years of Different Kinds of Timber Employed in Railway Bridge Construction in the United States.\*

Kind of Timber.	—Exposed to weather—		—Protected from weather—		Truss.	State.	Railway furnishing report.
	Stringer.	Trestle.	Stringer.	Trestle.			
Long-leaf So. pine.	12 to 14	15 to 20	Indefinitely	Indefinitely		Me., N. H., Vt., Mass.	Boston & Me.
"	"	12 to 15	"	"		Massachusetts.	"
"	"	12 to 15	"	"		New Hampshire.	"
"	"	Good for about 15 years.	Practically as lasting as iron.	40 to 50	40 to 50	Rhode Island.	N. Y., N. H. & H.
"	"	16	18	15		Alabama.	Southern.
"	"	"	8	"		Miss., La.	N. O. & N. E.
"	"	"	"	8	20	So. Dak., Minn.	C. & N. O. (D. Div)
"	"	"	"	"		Illinois.	St. L., P. & N.
"	"	14	"	"		Ill., Ind., Ohio.	T. St. L. & K. C.
White Pine	10 to 12	10	14 to 18	Indefinitely.	Indefinitely.	Colorado	Colo. & South'n
"	"	"	"	"	40	Me., N. H., Vt., Mass.	Boston & Maine
"	"	"	"	"	40	Massachusetts.	"
"	"	10	10 to 12	"		New Hampshire.	"
"	"	10	10	"		Missouri.	C., M. & St. P. +
"	"	10 to 12	12 to 14	"	14	Ohio, Ind., Ill.	T. St. L. & K. C.
"	"	8 to 10	8 to 10	8 to 10	30+	Illinois.	Chic. & East. Ill.
"	"	10 to 12	13 to 15	16	20+	Wisconsin.	Chic. & N. W. n.
"	"	10	10	10		So. Dak., Minn.	"
Eastern pine.	12	12	"	"		Minnesota.	Dul. & I. Range.
Colorado pine.	10	5 to 15	"	"		Wyoming.	Union Pacific.
Norway pine.	10	"	"	"		Colorado.	Den. & Rio G.
Norway pine.	10	"	"	"		Wisconsin.	C., M. & St. P.
Spruce	6 to 7	8	8	"		Minnesota.	Dul. & I. Range.
Spruce	16	5 to 7	8 to 10	40	Indefinitely.	Me., N. H., Vt., Mass.	Boston & Maine
Oregon fir.	18	14	"	"		Massachusetts.	"
Oregon fir.	18	14	"	"		Wyoming.	Union Pacific.
Fir.	12	18 to 20	"	"		Colorado.	Den. & Rio G.
White oak.	7 to 8 ties and caps.	"	"	"		Ohio, Ind., Ill.	Dul. & I. Range.
"	14 to 18	"	"	"		Illinois.	T. St. L. & K. C.
"	"	"	"	"		Wyoming.	Chic. & East. Ill.
Red cypress.	12	"	"	"		Alabama.	Union Pacific.
		"	"	"			Southern.

\*Prepared by Committee of the Association of Railway Superintendents of Bridges and Buildings in 1899.  
 †Superior Division.

## INDEX.

Abutments.....	127
Angle Bars, Number Required for One Mile of Track.....	563
Ashpits.....	284
Ballast.....	155, 163
Ballasting.....	332, 603, 604, 605
Base plates, Number Required for One Mile of Track.....	563
Bolts, Number Required for One Mile Track.....	563, 616
"    Number of Per Keg.....	618
"    Track.....	221
"    Weight of Per Thousand.....	618
Bolting.....	357, 600
Borrowpits.....	95, 132
Bridges.....	24, 242
Bridges, Detailed Rules Governing.....	644
"    Maintenance of.....	455
Bridging Timber.....	134
Buildings.....	273, 425
"    Detailed Rules Governing.....	644
Burnt Clay Ballast.....	168
Buildings, Maintenance of.....	455
Bumping Posts.....	241
Camp Party.....	67
Cattleguards.....	294
Cinder Ballast.....	172
Clearing Right of Way.....	394
Coaling.....	267
Commissary Party.....	67
Construction.....	90
"    Accounts.....	477
"    Authorities on.....	629
"    Detailed Rules Governing.....	583
"    Material Used in.....	597
"    Standards of.....	147
Controlling Points.....	151
Crossings.....	389, 608
Crossovers.....	308
Culverts.....	123, 133, 254
"    Detailed Rules Governing.....	644
Curves, Elevation of Rails on.....	601, 626
"    Widening Gauge on.....	625
Cuts.....	92, 106, 150

Depots.....	276
"    Erection of.....	145
Development of Railway.....	21
Ditches.....	154, 369, 607
Drainage.....	120, 153, 356
Draughtsmen.....	67
Engineer, Assistant.....	91
"    Division.....	90
Engineers, Locating.....	47
Embankments.....	92, 103, 112, 118, 122, 369
Explosives—Use of.....	111
Estimates—Monthly.....	130
Evolution of Railway.....	21
Excavation.....	92, 106
Facilities—Effect of on Cost of Operation.....	524
Fences.....	291, 392
Field Supplies.....	583
Fills.....	100, 150
Foremen.....	331
Frogs.....	227, 303, 376, 603
"    —Early Forms of.....	39
Fuel Supply.....	145
Gauge.....	148, 607
Gauges Used in Different Countries.....	562
Grade—Surfacing.....	129
Gravel Ballast.....	170
Hand Cars.....	355
Joint, Ties.....	189
Joints, Introduction.....	19, 606
"    Early Forms of.....	33
"    Rail.....	190, 216
Leveling Party.....	63
Lining.....	357
Location.....	83
"    Authorities on.....	629
"    Detailed Rules Governing.....	565
Locating Party.....	83
Locating Railways.....	47, 83
Locomotives, Curves Showing Horse Power of.....	575
"    Increase in Weight of—1880 to 1900.....	564
Locomotive, Invention of.....	24
Lubricants, Effect of Quality of.....	499
Maintenance Accounts.....	477
"    Authorities on.....	629
"    —Cost of.....	480
"    —Fixed Operating Expenses.....	510
"    —Force.....	324
"    of Way.....	322
"    Relation of Various Classes to Total Cost of..	560

Maintenance —Rules Governing.....	328
“ Things that Affect.....	530
Material—Classification of.....	131
“ Effect of Quality of.....	495
“ Old.....	427
“ Standards of.....	147
Middle Ordinates, Table of.....	627
Narrow Gauge Sections.....	151
Nutlocks.....	222
“ Number Required for One Mile of Track.....	563
Overhaul.....	132
Operation—Cost of.....	480, 524
Operating, Cost of—Percentage Due to Maintenance of Or- ganization and the Prevention of the Destruction of the Property From Natural Causes.....	561
Operating Expenses, Fixed.....	510
Openings—Size of.....	94
Ordinates Middle, Table of.....	627
Piles, Life of Different Kinds of.....	654
Piling.....	134
Piers.....	127
Policing.....	608
Preliminary—Survey.....	58
Pumps, Capacity of.....	620
“ Water.....	262
Rail Braces.....	223, 603
“ Fastenings.....	215
“ Expansion Number for Rails per Ton.....	617
“ Section.....	609
Rails.....	200
“ Changing.....	416
“ Creeping.....	384
“ Curving.....	598
“ Dimensions of.....	609, 610
“ Distributing.....	598
“ Early Supports of.....	28
“ Early Forms of.....	22
“ Effect of Quality of.....	495
“ —Elevation of, on Curves.....	318
“ Expansion of.....	387, 619
“ Filing.....	418
“ Jointing.....	419
“ Number Required to Lay One Mile of Track.....	563
“ Placing in Track.....	598
“ Tons Used per Mile and Feet.....	616
“ Unloading.....	417
Reconnoissance.....	47
Resistance, Train.....	580
Retaining Walls.....	119, 121

Right of Way—Clearing.....	95
Roadbed.....	152, 597, 605
Roundhouses.....	283
Routes—Locating.....	55
Sand Ballast.....	173
Sand Houses.....	284
Scales, Track.....	298
Scrap.....	427
Season's Work.....	412
Shimming.....	390
Sidings.....	607
Signs.....	389
Signals.....	287
"    Switch.....	239
Side Tracks.....	144
Slag Ballast.....	166
Snow Fences.....	400
"    Plows.....	405, 410
"    Removing.....	399
Spikes.....	215
"    Number Required for One Mile Track.....	563, 617
Spiking.....	357, 601
Splice Bars, Number for One Mile Track.....	616
Stations.....	425
"    Coaling.....	267
"    —Erection of.....	145
Stakes, Engineers'—Care of.....	420
Stock Pens.....	281
"    Yards.....	281
Stone Ballast.....	164
Storehouses.....	283
Structures.....	147
Supervisors.....	328, 330
Supplies, Field.....	583
Surfacing.....	144, 359
Survey—Preliminary.....	58
Surveys, Detailed Rules Governing.....	583
Switches.....	225, 303, 370, 603, 607
"    —Early Forms of.....	39
"    Data for.....	623, 625
Switch Stands.....	235
Switches, Ties Required for.....	621, 622, 624
Tamping.....	360, 603
Tanks, Track.....	266
Targets.....	239
Taxes.....	
Terminals, Effect of Cost of.....	500
Ties.....	174, 598, 605
"    Bearing Surface on Ballast.....	628
"    Effect of Quality of.....	497
"    Metal.....	191

Ties, Number of to Rail.....	323
“ Number Required for One Mile of Track.....	563
“ Number Required for Switches.....	621, 622, 624
“ Renewals of.....	363
“ Size of.....	188
“ Specifications for.....	608
“ Spacing.....	189
“ Wood—Life of.....	177
“ Wood—Preservation of.....	179
Tie Plates.....	196, 602
“ “ Number Required for One Mile of Track.....	563
Timber, Bridging.....	134
“ Decay of.....	176
“ Life of Different Kinds of.....	655
Topographical Party.....	65
Tools, Track.....	338
Track, Authorities on.....	629
“ Bolting.....	357
“ Constructing.....	297
“ Construction of—Detailed Rules Governing.....	597
“ Drainage.....	356
“ —Early Method of Constructing.....	32
“ Expenses, Relation of Various Items to the Whole...	559
“ Inspecting.....	431
“ Labor, Relation of Various Items to Each Other...	559
Tracklaying.....	134
“ Machines.....	137
Track, Lining.....	357
“ —Moving During Week.....	422
“ Old—Moving.....	419
“ —Moving on Sunday.....	421
“ —Policing.....	423
“ —Preparing for Sunday Work.....	420
Train Resistance.....	580
Track Scales.....	296
“ Shimming.....	390
“ Spiking.....	357
“ Sprinkling.....	388
“ Surfacing.....	359
“ Tamping.....	360
Tracks, Team.....	286
Transit Party.....	61
Tunnels.....	113, 159
Turntables.....	270
Velocity Grades, Length of.....	578
Water Supply.....	144
“ Supplies.....	259
Way, Maintenance of.....	322
Wrecks.....	441
Wood for Ties.....	174



# MARSHALL M. KIRKMAN'S WORKS.

## THE SCIENCE OF RAILWAYS.

A Library of Reference and Instruction, portraying the methods and principles connected with the organization, location, capitalization, construction, maintenance, equipment, motive power, operation and administration of railroads, profusely illustrated with engravings of railway appliances expressly prepared for the work. It is a treasury of research and practical experience portraying truly and vividly the practices of the great art of railway transportation in their highest and best forms.

"A work having the unique distinction of being both comprehensive and thorough. It will never cease to be of great value."—Marvin Huggitt, President, Chicago & Northwestern Railway.

"There is nothing in railway literature to be compared with these books in extent or value."—Sir William C. Van Horne, Chairman Board of Directors, Canadian Pacific Railway.

"Of great value to railway employes and to investors and others interested in railway properties."—William H. Newman, President, New York Central & Hudson River Railroad.

"The author has a great reputation. His books are especially valuable to the profession."—Journal of the German Railway Administration Society.

"Useful to all who desire to gain some insight into the arcana of railway management."—Herapath's Railway Journal, London.

## PRIMITIVE CARRIERS.

A unique and rare work of art, in portfolio form, embracing fifteen hundred beautiful engravings portraying the primitive peoples of the world and their methods of carriage in every age and quarter of the globe.

"A more interesting series of illustrations it would be difficult to imagine, or one that could give more clear and positive instruction in the history of humanity."—New York Sun.

"A work of great merit and beauty."—Boston Globe.

"A superb volume, original in conception and unique in literature and art."—Chicago Tribune.

"The value of this vast collection is greatly enhanced by the explanations and the dates that are affixed to most of the illustrations, and by the brief historical essays that are prefixed to the several subdivisions."—New York Daily Tribune.

## THE ROMANCE OF GILBERT HOLMES.

A romance of the Mississippi Valley in the early days, told with captivating power. The critics declared it ranked with the best of its kind. Strong in plot, the most stirring adventures are interwoven with a love story which is idyllic and full of charm.

"Of the beauty and delicacy of the author's touch there can be no question."—Chicago Tribune.

"The book is delightful. Full of quotable things."—The Christian World (England).

"A vivid and stirring picture of adventure, incident and romance that holds the interest of the reader from the start. A pretty love story runs through the book, told with so much delicacy and tenderness that it is a distinct charm."—Baltimore American.

"The real strength of the book lies in the life-like portrayal of Abraham Lincoln and Stephen A. Douglas, as well as Jefferson Davis. The daring venture of introducing these men in a romance has been crowned with success."—The Philadelphia Press.

"A striking picture of a romantic period of American history. . . . Possesses the primordial attraction of a really idyllic love story developed with a delicate charm which stamps the writer as a literary artist."—The Empire (England).

## -ISKANDER.

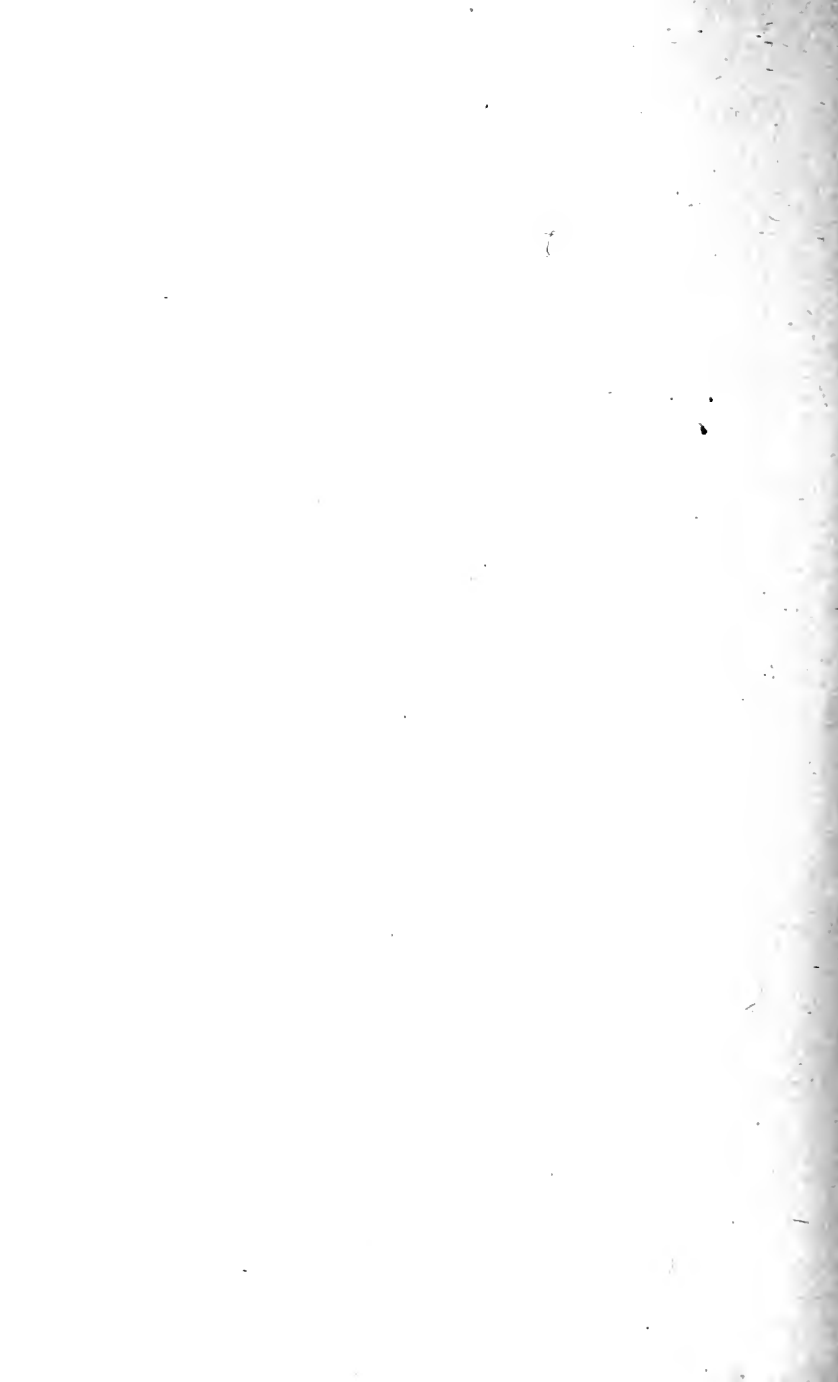
A romance of the Court of Philip of Macedon and Alexander the Great. Full to the brim with stirring achievements. A page of history rewoven with the warp and woof of love and hate and intrigue and conflict.

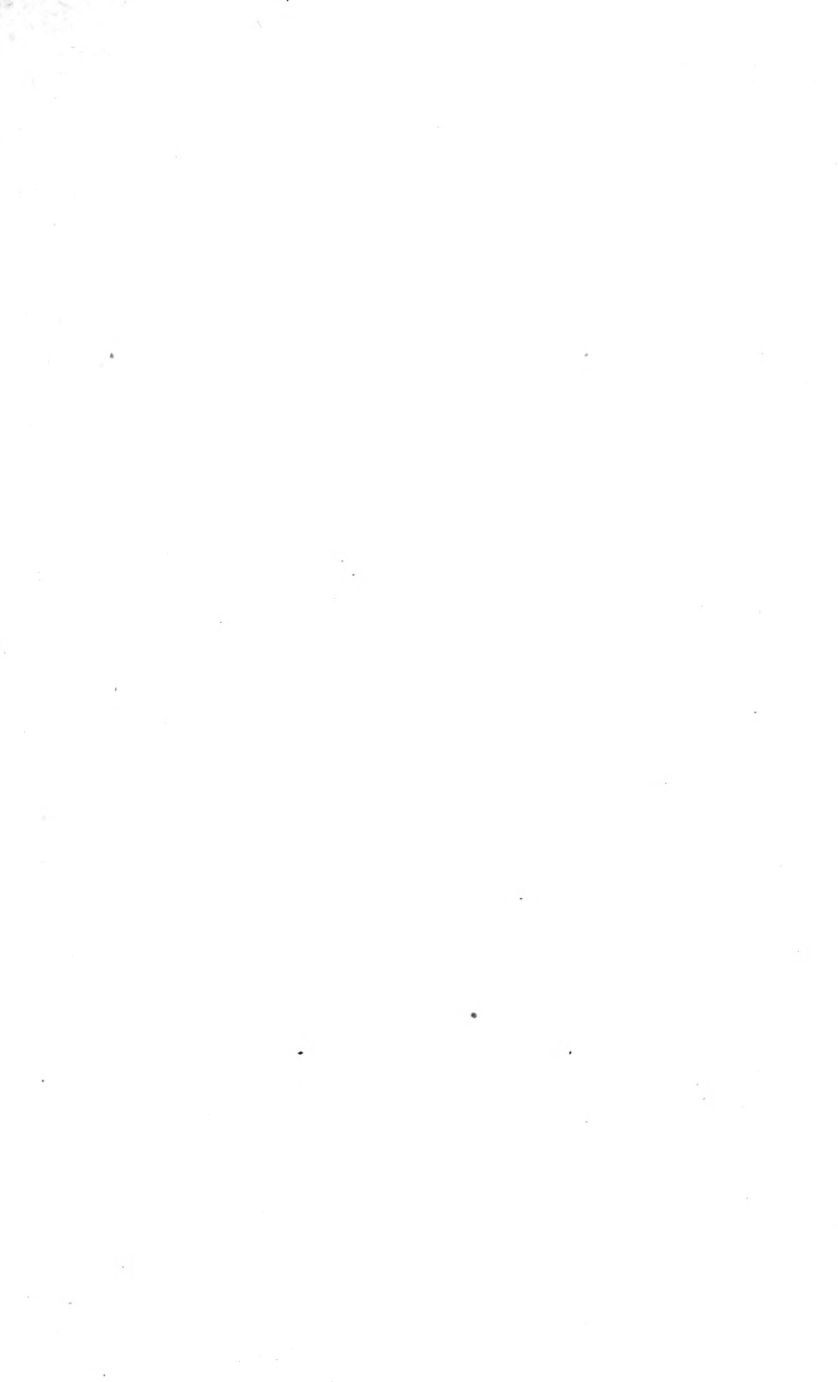
"A highly entrancing romance. Full of sound historical information and bristling with exciting incidents of war and conquest."—Aberdeen Free Press (Scotland).

"A delightful love story."—Philadelphia Inquirer

PUBLISHERS.

THE WORLD RAILWAY PUBLISHING COMPANY,  
CHICAGO.









UNIVERSITY OF ILLINOIS-URBANA



3 0112 084205845