

ROY  
6446

HARVARD UNIVERSITY



Library of the  
Museum of  
Comparative Zoology









THE  
SCIENTIFIC TRANSACTIONS  
OF THE  
ROYAL DUBLIN SOCIETY.

---

VOLUME III.—SERIES II.

---



DUBLIN:  
PUBLISHED BY THE ROYAL DUBLIN SOCIETY.  
PRINTED AT THE UNIVERSITY PRESS, BY PONSONBY AND WELDRICK,  
PRINTERS TO THE SOCIETY.  
1883-1887.





# CONTENTS.

The date of Reading will be found prefixed to each Paper. The date of Publication, as inserted in the following Table of the Contents of this Volume, is that when the Paper was laid in a printed form before the Society; or when, during the Vacation, it was forwarded to the Society's Booksellers.]

	PAGE
BALL, VALENTINE, M.A., F.R.S., F.G.S.	
On the Collection of the Fossil Mammalia in the Science and Art Museum, Dublin (Plate XI.), . . . . .	333
<i>[Published November, 1885.]</i>	
BELL, F. JEFFREY, M.A., Sec., R.M.S., F.L.S.	
The Echinoderm Fauna of the Island of Ceylon (Plates XXXIX. and XL.), . . . . .	643
<i>[Published November, 1887.]</i>	
BLACKBURN, REV. T., B.A., AND SHARP, DR. D.	
Memoirs on the Coleoptera of the Hawaiian Islands (Plates IV. and V.), . . . . .	119
<i>[Published February, 1885.]</i>	
BCEDDICKER, OTTO, Ph.D.	
On the Influence of Magnetism on the Rate of a Chronometer (Plate I.), . . . . .	1
<i>[Published September, 1883.]</i>	
Notes on the Aspect of the Planet Mars in 1884, accompanied by Sketches made at the Observatory, Birr Castle (Plate VI.), . . . . .	301
<i>[Published March, 1885.]</i>	
On the Change of the Radiation of Heat from the Moon, during the Total Eclipse of 1884, October 4, as Measured at the Observatory, Birr Castle (Plates IX. and X.), . . . . .	321
<i>[Published October, 1885.]</i>	
DAVIS, JAMES W., F.G.S., F.L.S.	
On the Fossil Fishes of the Chalk of Mount Lebanon in Syria (Plates XIV. to XXXVIII.) . . . . .	457
<i>[Published April, 1887.]</i>	

	PAGE
FITZGERALD, GEORGE F., M.A., F.R.S., F.T.C.D.	
On the Quantity of Energy Transferred to the Ether by a Variable Current, . . . . .	57
[Published March, 1884.]	
GRUBB SIR HOWARD, M.E., F.R.S.	
On a New Form of Equatorial Telescope (Plate II.), . . . . .	61
[Published March, 1884.]	
HULL, EDWARD, LL.D., F.R.S., F.G.S.	
On the Geological Age of the North Atlantic Ocean (Plates VII. and VIII.), . . . . .	305
[Published April, 1885.]	
LYDEKKER, R., B.A., F.G.S., F.Z.S.	
Catalogue of Vertebrate Fossils from the Siwaliks of India, in the Science and Art Museum, Dublin (Plate III.), . . . . .	69
[Published July, 1884.]	
SHARP, DAVID, M.D., F.L.S.	
On New Zealand Coleoptera, with Descriptions of New Genera and Species (Plates XII. and XIII.), . . . . .	351
[Published November, 1886.]	
<i>See also</i> BLACKBURN, REV. T.	
SOLLAS, W. J., M.A., LL.D., D.Sc.	
On the Origin of Freshwater Faunas : a Study in Evolution, . . . . .	87
[Published November, 1884.]	
STONEY, G. JOHNSTONE, M.A., D.Sc., F.R.S.	
On the Cause of Iridescence in Clouds, . . . . .	637
[Published May, 1887.]	

[OCTOBER, 1883.]

THE  
SCIENTIFIC TRANSACTIONS  
OF THE  
ROYAL DUBLIN SOCIETY.

VOLUME III. (SERIES II.)

---

I.—*On the Influence of Magnetism on the Rate of a Chronometer.* By OTTO  
BOEDDICKER, PH.D. Plate I.

---



DUBLIN:  
PUBLISHED BY THE ROYAL DUBLIN SOCIETY.  
PRINTED AT THE UNIVERSITY PRESS, BY PONSONBY AND WELDRICK,  
PRINTERS TO THE SOCIETY.  
1883.

*Price Two Shillings and Sixpence.*



SCIENTIFIC TRANSACTIONS  
OF THE  
ROYAL DUBLIN SOCIETY.

---

VOLUME III.

---

I.—ON THE INFLUENCE OF MAGNETISM ON THE RATE OF A CHRONOMETER. BY OTTO BÆDDICKER, PH.D.

[Read, December 18, 1882.]

I.

THE question lying in the title of the following Paper—viz., whether and how far magnetism is able to influence the rate of a chronometer—is nearly as old as the invention of chronometers itself, and since in 1798 S. Varley published the first observations and experiments it has occupied the attention and time of a considerable number of observers. In looking over all these observations, however, one cannot but remark that there has been very little progress made towards a final solution of the question, so that at present we are still nearly at the same point as that at which Varley arrived. The reason for this strange fact appears to me to be the very insufficient acquaintance with the observations and speculations made hitherto; and as it seems most desirable to take the subject up again for careful and thorough experimental investigation—and since these experiments can hardly be of any value unless based upon the results already arrived at—I intend to give here a general discussion of all the Papers concerning chronometrical magnetism that have come to my knowledge. In this way it might be possible to lay down such rules and to point out such precautions as appear to be necessary to make eventual experiments the least open to objections. I hope I may not have omitted any Paper of importance; if I have done so, I should be obliged for information, since the utmost completeness is, for obvious reasons, desirable.

## II.

Two observations gave rise originally to the suspicion of the possibility of a magnetic influence, which, therefore, may here also serve to define the question more precisely. It was, firstly, the well-known fact that chronometers frequently change their rates when transported from one place to another, especially from shore on board ship, and *vice versâ*; and, secondly, the discovery that the steel parts in the work of a chronometer, especially the spiral spring, and the cross-bar and corresponding steel rim in the balance, were frequently magnetic, and thus obviously subject to the same influences which act on a compass-needle.

As to the first point, I did not seek completeness, and it is not my intention to reproduce in full all the observations I have made, but rather to give some striking instances only, and the attempts at their explanation.

The most extensive observations of land and sea rates are by George Coleman (No. 4).<sup>\*</sup> He publishes (as an appendix to George Fisher's Paper, No. 5) a number of Tables, giving the land and sea rates of fourteen pocket- and forty box-chronometers. Besides these values—which frequently extend over different voyages, and go as far back as 1802—the table contains general remarks as to the performance of the chronometers, and the information as to whether the ship carrying the chronometer was iron- or copper-fastened. Excluding those box-chronometers, which are pointed out as indifferent or unreliable, there remain twenty-four instruments of iron-fastened and nine of copper-fastened ships, and it is perhaps remarkable, and of some importance, that six cases of losing have been observed in those first twenty-four, and four such cases in the other nine chronometers. It is, however, impossible to draw general conclusions from the Tables, as they are rather imperfect, and of some importance only by the considerable number of chronometers. Some cases, however, deserve mention: for instance box-chronometer No. 1, which went five and a-half years at the rate of 5<sup>s</sup> gaining on shore, and 5<sup>s</sup>.3 gaining on board; or box-chronometer No. 33, which “varied precisely the same quantity (losing) and the same way two succeeding voyages,” the difference being here 0<sup>s</sup>.4 to 0<sup>s</sup>.5. [There is a misprint in this case; the two rates on shore should be 0<sup>s</sup>.7 *gaining* and 0<sup>s</sup>.2 *losing*, as seen by the remark.] So we can conclude from Coleman's Tables—which may deserve a closer discussion—that a difference between land and sea rates frequently takes place, but that it does not always lie—not even in the same chronometer—in the same direction, though the gaining sense on board ship seems to prevail. A special connexion between the changes of rates and the ship's fastening is, in Coleman's Tables, hardly perceptible. More striking

<sup>\*</sup> The figures after an author's name refer throughout to the “Chronological List of Papers quoted” on pp. 52–55.

are the observations by Lieutenant Mudge, given in two Tables, containing land and sea rates of chronometers on board H. M. S. "Leven" (No. 2) on two consecutive voyages to the Cape de Verd Islands in 1819 and 1820–21. Of the four chronometers whose rates are given in the first Table, three lose upon their land rates by 2<sup>s</sup>.78, 4<sup>s</sup>.16, and 5<sup>s</sup>.33, respectively, and one gains by 3<sup>s</sup>.77. These differences are unmistakable, and only in the case of the second chronometer does it appear probable that a tendency to accelerate may be the reason of the observed change. The three other instruments do not admit of any such explanation; they show that the change of rate occurred rather suddenly, and that the new rates were kept very well, with only slight alterations. [Misprint in the difference of the second chronometer, which should be 4<sup>s</sup>.16 instead of 3<sup>s</sup>.22.] The second Table shows a difference of land and sea rates with some certainty only in the four first lines (where all the four chronometers lose upon their land rates), but the values are less defined than during the first voyage, and generally the chronometers do not show at all as equal and steady rates as they did before. As a third and extraordinary instance, I give the changes of rate as communicated by George Fisher (No. 5), which took place in the nine chronometers on board the "Dorothea" and "Trent," commanded by Captain Buchan, during their voyage to the North Pole in 1818. All these chronometers gained rapidly on their rates, determined in London previous to the ship's sailing, and, when landed on an island, the acceleration ceased immediately in some of them, and more gradually, but not less distinctly, in the remaining ones. One chronometer, by Baird, for instance, lost 3<sup>s</sup>.4 daily when on board; upon its removal on shore, its rate was (from August 16th to 26th) 18<sup>s</sup>.2, losing, and, again removed on board, it lost daily 6<sup>s</sup>.5. Another instrument (Pennington) gained rapidly on board, and began to lose immediately 1<sup>s</sup>.8 daily when on shore—nearly the same rate it had in London. The following short Table shows the more gradual changes as observed in some of the other chronometers immediately when landed, August 9th, 1818:—

Date.	No. 1. Earnshaw.	No. 2. Arnold.	No. 4. Barraud.	No. 5. Arnold.
Aug. 9	—	—	—	—
„ 11	+ 12 <sup>o</sup> .0	- 0 <sup>o</sup> .2	+ 8 <sup>o</sup> .1	- 33 <sup>o</sup> .5
„ 12	+ 10 .2	0	+ 7 .9	- 34 .2
„ 16	+ 7 .98	- 1 .85	+ 0 .8	- 36 .2
„ 20	+ 6 .2	- 5 .1	+ 7 .1	- 40 .9
„ 23	+ 5 .63	- 5 .2	+ 2 .8	- 37 .7
„ 26	+ 4 .02	- 6 .14	+ 4 .3	- 41 .5

The same circumstances occurred when the chronometers were landed upon a small island in Fair Haven, on the north coast of Spitzbergen, but Fisher finds it "needless to detail them."

On page 200 a Table is given containing the sea-rates of the nine chronometers, deduced by dividing the difference between the chronometer errors in London and Spitzbergen by the interval in days between them, and the probable approximate land-rates, obtained by taking the mean of the rates taken on shore before leaving England and those observed at Spitzbergen. "And although a mean between the rates of chronometers obtained at different times may not accurately be the mean rate they would have had during the interval of those times, from the continued variation to which they are subject," yet a comparison of these rates shows that the daily rates of all the chronometers had been accelerated on board ship by, respectively—

$$+ 4^s.2; + 3^s.7; + 4^s.5; + 1^s.3; + 9^s.6; + 0^s.43; + 6^s.43; + 9^s.8; + 7^s.35.$$

"This acceleration is not peculiar to high latitudes; it was observed very soon after the chronometers were put on board in the river."

Fisher adds some more instances, which it will hardly be necessary to reproduce. Especially the cases of acceleration in Harrison's time-keeper, in 1764, and a watch of Kendal, on Cooke's voyage towards the South Pole, in 1772-3-4, do not prove much, since it is well known that acceleration is peculiar to new chronometers, where (even in first-rate instruments) it not seldom lasts some years before it ceases, and that inferior chronometers show frequently a tendency to gain continually.

Fisher, on trying to explain the above changes of rates, adds that they cannot be attributed to the motion of the vessels, as the acceleration was observed when the ships were firmly beset with ice, or riding at anchor, without any perceptible motion; and that the temperature cannot be the cause either, since a two-hourly account of it, kept on board and on shore, did not show the least correspondence between the change of rates and the temperature at the time. He then proceeds to point out the ship's magnetism as the source from which the acceleration arose, which he makes probable by her action on a compass. The reason why I have given Fisher's observations so fully lies in their remarkable results, which will be referred to below, as also in their having called forward the criticism of Peter Barlow, which is now to be shortly reproduced.

In his first Paper (No. 6) he is surprised at the considerable amount of the changes of rate in the chronometers, as well as at their lying all in the same direction—acceleration on board ship. He is unable to find any sufficient reason why the ship's action should not be retarding as well, and remarks "that we are led strongly to suspect that the remarkable change in the rates of the nine chronometers of the 'Dorothea' and 'Trent,' reported by Mr. Fisher, must have



been produced by some extraordinary cause, not commonly operating on board ship."

A suggestion as to what this "extraordinary cause" may be, we find in his second Paper (No. 14), lying in the question—"Is it not probable, or at least possible, that what Mr. Fisher has attributed to an unusual acceleration in the ship was actually a corresponding retardation on shore, occasioned by the action of some terrestrial magnetic power below the surface of the earth of Fair Haven?" Such partial magnetic power is by no means rare. He adds some instances which have been communicated to him by very reliable observers. Captains Vidal and Mudge found the coast of St. Mayo (Cape de Verd Island) so magnetic, that the needle of their theodolite became perfectly useless. If the chronometers, Barlow remarks, had been rated on St. Mayo, one certainly would have found very different rates from those on board, and, since the observations are able to show the differences only, one would have attributed these changes naturally to the action of the ship. Thus, if the chronometers had lost on shore, one would have assumed an acceleration on board. This mistake, of course, would have been discovered upon rating the chronometers again in London; and it is much to be regretted that Fisher does not say whether this was done in his case, or whether the chronometers were allowed to run down as usual at the end of the expedition. The three following instances Barlow gives all concur in showing remarkable cases of a local action on the compass needle, generally observed on approaching the coast. With this may be compared the note of W. Mudge (No. 3) as to the magnetic influence of the islands of St. Mayo and the Great Salvage.

Fisher's observations are, certainly, most striking; and Barlow is right in finding the greatest difficulty in the general acceleration of *all* the chronometers. This is so much the more surprising when we compare these observations with those by Mudge, detailed above, where a tendency to lose was unmistakable. The explanation of the fact is by no means easy, though it is difficult to think of anything but magnetism. It is to be regretted that there is no special information as to the temperature, which, in spite of Fisher's remark, may have been of considerable influence; and also that he does not give a list of the London rates, by which alone an opinion as to the relative value and trustworthiness of the second Table could be formed. Barlow's suggestion is very ingenious, but its truth or value depends entirely upon observations to be made in Spitzbergen as to the local magnetic attraction, which, after all, does not seem to be so common as to justify such a supposition without proof.

A few more instances may be briefly cited. Arnold and Dent (No. 17) frequently observed that the rates of very good chronometers in their workshop differed from their rates at the Royal Observatory by a constant amount of two or three seconds. They give the rates of three instruments in a small Table as follows:—

No. 1.	No. 2.	No. 3.	Observations.
- 4 <sup>s</sup> ·5	- 0 <sup>s</sup> ·9	- 4 <sup>s</sup> ·5	} At the Royal Observatory,
- 5·1	- 1·1	- 4·2	
- 4·4	- 0·9	- 3·9	
- 4·1	- 1·4	- 4·1	
- 1·4	+ 2·6	- 6·1	} Elsewhere, immediately after removal,
- 1·4	+ 2·8	- 6·6	
- 0·9	+ 3·0	- 7·5	
- 0·9	+ 3·1	—	

which, certainly, show a marked and considerable difference. In Robert Fitz Roy's narrative (No. 20) I find the remark that five of the chronometers of H. M. S. "Adventure" accelerated, and the other four retarded, upon being brought on board. Captain King adds—"It would be difficult to assign any other reason for this change than the effect of the ship's local attraction." Fitz Roy, however, considers the temperature the chief, if not, "generally speaking," the only reason for "marked" changes of rate. "It often happens," he says (p. 326), "that the air in port or near land is at a temperature very different from that over the open sea in the vicinity, and hence the difference sometimes found between harbour and sea-rates. The changes so frequently noticed to take place in the rates of chronometers moved from the shore to the ship, and the reverse, are well known to be caused partly by change of temperature and partly by change of situation." To this we give his annotation † "This may be connected with magnetism."

Finally, there remains a pamphlet of M. Lesquen de la Ménardais, which, however, I know only from the criticism of it by E. Mouchez (No. 24) and Ansart-Deusy (No. 25). Lesquen thinks he is able to base upon his observations made at the Toulon observatory the following law:—"Les montres marines en marche retardent par un mouvement de translation ou tout autre équivalent, tandis le repos prolongé leur donne une tendance à l'avance d'autant plus marquée que ce retard a été plus fort." The facts from which this law is deduced are obtained by seven years' observations, which show, (1) that some hundreds of chronometers, when transported from Paris to Toulon (and the reverse), neither advanced nor retarded; (2) that some hundreds, when transported from Toulon on board the ships, lost, on the average, 0<sup>s</sup>·5 daily; (3) that some hundreds, transported from the ships to the Observatory, gained, on the average, 0<sup>s</sup>·5 daily. Mouchez considers it too early

to base the above law upon these facts, especially as they did not show anything but a very natural effect of temperature, for the chronometers shipped at Toulon have to pass lower latitudes and higher temperatures, hence retardation; and, returning, they come into lower temperatures, hence acceleration. Point (1) finds its explanation in the nearly equal temperatures at the Toulon and Paris Observatories; and Lesquen's last remark was an evident proof for Mouchez's explanation, since the acceleration with a decrease of temperature was the larger, the more a chronometer retarded with an increase of temperature. Ansart-Deusy, on the other hand, thinks Mouchez's explanation "s'il n'est pas entièrement faux, est au moins trop exclusif et trop absolu," and finds Lesquen's facts completely explained by the action of the ship's magnetism. Now, it is certainly true that Lesquen's law has very little foundation, for there is, generally speaking, an equal chance for a chronometer to lose or to gain when at rest; only in new instruments the acceleration will often prevail, as already remarked. It is the same with the translation, &c., of a chronometer. It is altogether impossible to give such a law perfectly regardless as to all the possible different powers acting on the instruments. For instance, temperature would, in most cases, perfectly obscure the changes of rate, if they existed as the law expresses; and magnetic action may just as well have a considerable effect. But there are other influences still, such as the thickening of the oil, which will act, generally speaking, retarding. Each chronometer is to be considered as a special individual, in its particular way subject to all the disturbing influences, and these must always be specially ascertained, and thus eliminated, in each chronometer, before anything like a general law is to be pronounced. Mouchez's explanation is affected by his desire to explain everything by temperature, and would do, as it stands, only for under-compensated chronometers. Ansart-Deusy has an equal tendency to explain everything by magnetism—as we shall see further on—so that his interpretation cannot claim very much confidence either.

The result of all these observations and discussions is, that systematic observations of changes of rate with changes of place—especially of "land and sea rates," on board steamers as well as sailing vessels—are still wanting, and that it would be highly valuable to extend them over as long intervals and as many chronometers as possible. The chronometers ought to be well compensated, and their compensation errors (or temperature errors) determined as often as possible. And the most scrupulous account is to be given as to all circumstances of possible effect—temperature to be read in max. and min. daily; position, proximity of iron, &c.; ship's course, ship's motion, and so on; it is impossible to be too detailed in this respect. If practicable, compass observations ought to be made in the chronometer's place in different positions of the ship as to the magnetic meridian, the reason for which precaution will be seen from the following parts of our investigation.

## III.

The observations which prove the magnetic state of different steel parts in the work of a chronometer are of considerable interest, as they show which parts are chiefly liable to become magnetic, and how the magnetic poles are situated, and because they contain some valuable suggestions as to how to avoid or to remove this cause of disturbance of a chronometer's rate. The first statement was given by S. Varley (No. 1), who was led, by the inferior performance of first-rate watches, to test their balances upon magnetic polarity. He took the steel balance out of a watch, removed the balance-spring, and put the balance into a poising tool, in order to observe the effect a magnet would have upon it. But before he could begin the experiments, and before he approached a magnet, he found that the balance in one position of the tool seemed to be out of poise (though in that particular examined before by a very careful workman), and, in another position of the tool, in poise. So, when placed vertically, the balance was in poise as often as its plane was east and west (and, of course, its axis north and south), and whenever it was placed north and south—"the only position in which the magnetic influence could make itself most apparent"—it was out of poise. Then the axis was placed in a vertical position, and the balance was found to have sufficient polarity to overcome the friction of the pivots, and to turn readily its north pole towards the north, "in every respect like an equally-suspended magnetic needle." And when now a magnet was approached, the north pole of the balance continued at rest before the magnet's south pole, and receded immediately when the north pole was presented.

Varley now—after having made some observations of rate-changes with the above balance—resolved always to try a steel balance before application. He laid them upon a slice of cork sufficient to make them float on water, but out of many dozens he could not select one that had not acquired polarity. Some of them had it in a weak degree, and not more than one or two out of the whole quantity had it so strong as the one with which he had made the above experiments.

Barlow (No. 3) communicates some experiments upon detached parts of a chronometer in the proximity of a mass of iron, and gives some ideas how always to distinguish if the balance or the approached iron is magnetic. I do not consider it necessary to repeat these rules, and of his experiments only the following facts are to be reproduced. A balance with its spring was brought near a piece of iron, and a slight repulsion in one and attraction in another position were observed, indicating a slight degree of magnetism in the balance or its spring. Mr. Frodsham—in whose workshop the observations were made—"had no doubt that such an action as we then noticed was amply sufficient to change the rate of the chronometer, of which the balance formed a part, when brought within the sphere

of attraction of such an iron mass." When afterwards a magnetic bar was presented to a balance (which had been proved free from magnetism), the latter arranged itself so that the cross steel-bar was directly in a line with the magnet; and, finally, two spiral springs were found to be sensibly magnetic, but their polar quality, though ascertained with a very light and sensitive compass-needle, and "rendered manifest in a very peculiar manner," is, unfortunately, not detailed. Barlow concludes by saying:—"I think it, however, highly probable that the form and office of the spring are precisely those most likely to create magnetism in it, and that when once acquired in this part of the machine, it will soon be transmitted to the balance itself, and consequently that there are but few chronometers which have been long in use that have not the balances impregnated with this subtle fluid, and which are therefore liable to a change of rate, more or less considerable, when taken on board ship or within the influence of a mass of iron." Scoresby (No. 8) found "very sensible magnetic properties, both attractive and repulsive," in seven detached chronometer balances, and adds the interesting remark: "In some of these balances the magnetism was very strong. One, with three arms, had a vigorous south pole at the extremity of each ray, and a common north pole at the centre. The other balances had generally two poles only, but in some the poles of the rim were not exactly coincident with the poles of the rays." Arnold and Dent (No. 17) observed that a series of freely-suspended balances adopted a fixed direction like a compass-needle, and found (by observing the oscillations) that the smaller the balance-arm, the stronger was the magnetic influence. This, of course, is only a consequence of the smaller weight, and therefore greater sensitiveness, of the balance. Wackerbarth (No. 27) remarked that the steel screw in the balance of a pocket chronometer had acquired strong magnetism. But by far the most extraordinary case is communicated by George Harvey (No. 9), which we have, therefore, to reproduce to a fuller extent. He observed (by means of an apparatus resembling that of Coulomb) the changes the intensity of terrestrial magnetism underwent in the neighbourhood of a chronometer. The first Table on the following page contains an abstract of his results.

Similar experiments were made in the neighbourhood of the chronometer as well as with single parts of it, which, however, it will hardly be necessary to give in full. It will suffice to say, that nearly all the steel parts were strongly magnetic. The inner rims of the arcs of compensation in the balance, as well as the steel time-screws which connected them with the transverse arm, were magnetic, particularly the screws, one having strong northern, the other strong southern magnetism. The balance-spring likewise exhibited vigorous polarity. It was the same with "the small wormed cylinders, on which the thermometer pieces moved." Every screw, of which there were ten large and several small ones in the frame alone, the chain, the axles of the different wheels and pinions, the arbor of the fusee, "exhibited the same active and permanent (magnetic) power,

undergoing no sensible alteration from change of position." Even the three hands possessed strong polarity.

*Power of Terrestrial Magnetism = 100. The Oscillating Cylinder one inch above—*

1. THE CENTRE OF THE CRYSTAL.			2. THE MIDDLE OF THE BOTTOM OF BOX.			2. THE MIDDLE OF THE SIDE.		
Directed towards North.	Observed Intensity.	Deviation from Mean.	Directed towards North.	Observed Intensity.	Deviation from Mean.	Side uppermost.	Observed Intensity.	Deviation from Mean.
XII.	90.79	+ 0.13	XII.	77.17	- 14.01	XII.	105.61	+ 12.85
IX.	102.29	+ 11.63	IX.	91.84	+ 0.16	IX.	89.61	- 3.15
VI.	90.69	+ 0.03	VI.	101.26	+ 10.08	VI.	91.78	- 0.98
III.	78.89	- 11.77	III.	94.94	+ 3.76	III.	84.05	- 8.71
Mean	90.66	—	Mean	91.18	—	Mean	92.76	—

The following Table shows, in the first and third columns, the arcs through which the balance was moved, when originally placed, so that the time-screws were in the direction of the magnetic meridian. The second and fourth columns show the corresponding deviations of a compass, the north pole of which was placed near the time-screw with southern polarity. When a needle of more delicate construction was employed, an inversion of poles took place the moment the time-screws had passed through an arc of  $90^\circ$ , and a deviation of the south pole immediately followed.

Balance Motion.	Comparative Deviation.	Balance Motion.	Comparative Deviation.
$0^\circ$	$0^\circ$	60	25
10	$4\frac{1}{2}$	70	30
20	$8\frac{1}{2}$	80	$36\frac{1}{2}$
30	12	90	$43\frac{1}{2}$
40	$15\frac{1}{2}$	100	$49\frac{1}{2}$
50	19	110	$54\frac{1}{2}$

Observations of another chronometer, which had been constructed with every possible care to avoid magnetism, showed, nevertheless, signs of magnetic intensity;

while another chronometer, “which had been frequently, for many months, employed in inquiries connected with magnetism,” led to the following result:—

*Coulomb's Apparatus (the Oscillating Bar) one inch above the Crystal.*

North.	Intensity.	Deviation from Mean.
XII.	100·13	+ 1·27
IX.	99·75	+ 0·89
VI.	97·54	− 1·32
III.	98·03	− 0·83
Mean	98·86	—

which proves, as Harvey remarks, that the application of magnets does not in all cases produce magnetic qualities of a very powerful kind.

If we look now over the suggestions which have been made for the removal of the magnetic qualities of the steel parts, the following are to be mentioned, besides the general and natural idea, to avoid steel in the fabrication of a chronometer, and to replace it by some other unmagnetic metal. We find gold (for the spiral), platinum, and brass, mentioned for this purpose. It is well known, also, that glass was tried by Arnold and Dent for the balance-spring. These experiments have, however, not been finally successful. Peter Lecount (No. 7) proposes to remove the magnetic properties by the action of fire, and to let the steel part cool carefully in a direction at right angles to the dipping needle or magnetic meridian, and to subject every steel part—not only the balance with its spring, but also the steel spindles of the fusee, of the barrel, &c.—to this manipulation. Similar is Scoresby's (No. 8) idea. He recommends “that the flat surface of the balance be the last part that is finished, and that it be ground and polished in the plane of the magnetic equator.” And again, “as the balances are now generally, I believe, wrought out of a solid piece of soft steel, encompassed by a rim of brass,” that they should be turned and blued (after polishing) in the same plane. He found that a sensible diminution of magnetism took place after grinding chronometer balances in the plane of the magnetic equator, or striking them in the same plane with a small smooth-faced hammer, while resting upon a hard flat substance. All these remarks of Scoresby seem to apply to small balances of pocket chronometers only. Harvey (No. 9) thinks Scoresby's method would be effective then only, when it could be applied to the other steel parts also; but the chain alone would be capable of imparting, in a short time, any magnetic qualities it might possess to

the balance. Finally, Abraham (No. 16) arrived, after many experiments and difficulties, at the following method of neutralising the magnetism in a chronometer's steel parts:—He dipped the apparatus to be deprived of magnetism into very fine iron filings, by which the situation of the magnetic poles became visible. On approaching a very strong magnet at the distance of from one inch to a quarter of an inch to the part covered with iron filings, one remarks at once an effect, if the magnet's pole and that of the steel piece are equal: the iron dust is removed gradually in the same degree as the magnetic power is neutralised. If the iron dust is quite fallen off one dips the steel piece again into it, in order to see if not by too long an exposure it acquired opposite polarity. If this is the case, it will be neutralised as before by means of the other pole of the magnet. Abraham states that, generally speaking, he performs the above experiment—be it the balance or some other steel part—in about one minute, and proves the efficacy of this proceeding by testimonies of competent men.

The above observations of magnetic qualities in a chronometer are sufficient to show that the utmost care is necessary in the manufacturing of a chronometer, in order to avoid polarity; and further on they make it highly probable that terrestrial and artificial magnetism have some effect upon a chronometer's rate; but they do not give by any means satisfactory information as to the special distribution of magnetism in the different steel parts. We do not know anything, for instance, about the balance spring; and what we know about the balance, especially Scoresby's remark, only shows how interesting further investigation would be. These observations could be easily made by chronometer manufacturers; it would be very important if they, by dipping the apparatus into iron filings, would, however roughly, indicate and note down the situation of the magnetic poles. As to the remedies or prescriptions how to remove the magnetic property, it is a matter of experiment and practice alone which of them will be the most effective. I think that an equal attention to all of them will be about the only way to success.

#### IV.

[S. VARLEY.—GEORGE FISHER.]

It will now be necessary to reproduce and discuss the observations of the rates of chronometers when under the influence of either terrestrial or artificial magnetism. I at first intended to give these two kinds of observations separately; but as this could not be done without frequent repetitions, since they continually refer to each other, I shall give them all in chronological order: only the methods of compensation proposed will be reserved for a special chapter. We have several series of observations of changes of rate with changes of position as to the



magnetic meridian by S. Varley (No. 1), Northcote (No. 18), Fisher (No. 19), and Airy (No. 22), besides some shorter notices and experiments, of which those of Arnold and Dent (No. 17) are especially to be mentioned. Experiments with soft iron are made by Peter Barlow (No. 6) only, and magnetic experiments are published by Fisher (No. 2), Scoresby (No. 8), Harvey (No. 10–13), Arnold and Dent (No. 17), Ansart-Deusy (No. 25), and Delamarché and Ploix (No. 26). Rules of precaution and for neutralising the influence of terrestrial magnetism are especially given by Barlow (No. 6), Scoresby (No. 8), and Airy (No. 22). Varley made some few but extraordinary observations of changes of rate in a watch, the balance of which had been found to be strongly magnetic (cf. p. 8, *seq.*) In one position, when the plane of the balance was horizontal, and its north pole (the balance being at rest), directed towards the north, the watch gained daily  $5^m 35^s$ ; in the reverse position, the balance—when at rest—having its north pole directed towards the south—the rate in twenty-four hours was  $6^m 48^s$  losing; the whole difference of rate between these two positions thus amounting to the considerable quantity of  $12^m 23^s$ . When, however, the steel balance was replaced by one made of gold, the rate was found “as uniform as could be expected, the watch having a duplex escapement, but no compensation for the expansion and contraction occasioned by heat and cold.” Varley’s instance of the action of *terrestrial* magnetism upon a magnetic balance, and consequently upon the watch’s rate, is doubtless quite an exceptional one, and in no case has such an extraordinary influence been observed again; and it is rather fortunate, that just the first observation published showed so strong an effect, thus increasing the general interest in the matter considerably. But still it is surprising that not before 1820, or twenty-two years afterwards, these observations were taken up again by George Fisher (No. 5), who thus gave occasion to a considerable number of experiments and discussions.

Fisher was induced by his observations, detailed before (p. 2), to ascertain how far the alteration of rates the chronometers underwent by their being transported on shipboard “could be reconciled with that observed in chronometers when under the influence of magnets placed in different positions with respect to their balances.” He made use of two watches (No. 1 and 2) with steel balances, and two (probably pocket) chronometers (No. 3 and 4), the latter by Arnold, and observed the changes of rate produced by approaching magnets of twelve inches in length, at a distance of two inches from the balance in four different positions and in the planes of the balances. The changes observed in the two watches No. 1 and 2 were very considerable; No. 1 gaining with both poles and in every position of the magnet but one, the maximum being  $72^m$  in twenty-four hours; No. 2 gaining with both poles and in every position, upwards, to  $21^m$  in twenty-four hours. The result obtained with the chronometers No. 3 and 4 is as follows:—

Figure of Dial.	North Pole.		Figure of Dial.	South Pole.	
	No. 3.	No. 4.		No. 3.	No. 4.
3	+ 0 <sup>m</sup> 34 <sup>s</sup>	+ 0 <sup>m</sup> 41 <sup>s</sup>	3	+ 2 <sup>m</sup> 18 <sup>s</sup>	+ 0 <sup>m</sup> 44 <sup>s</sup>
6	+ 1 28	- 1 43	6	+ 5 27	- 0 36
9	+ 5 22	+ 1 3	9	- 0 14	+ 0 41
12	+ 2 47	+ 1 12	12	- 1 2	+ 1 24

The first and fourth columns show the figure to which the magnet was applied, the other columns, the effect produced by the magnets during twenty-four hours. "The magnets were likewise placed in different positions out of the planes of the balances: the results were very *similar* to those above, but differing in quantity, according to the distance of the magnets from the planes of the balances." Upon placing the magnets very near to the rim of the balances, a very rapid acceleration took place with both poles, and in every position; and upon too near an approach watch No. 1 and chronometer No. 3 were rendered useless, the former gaining 75<sup>m</sup> after the removal of the magnet, the latter losing 50<sup>s</sup> in twenty-four hours. Further experiments with the chronometers showed the following changes of rate, the figures given being "the difference of the rates when the magnets were applied, and a mean of the rates of the chronometers before and after the application of the magnets."

Figure of Dial.	North Pole.		South Pole.		North Pole.		South Pole.	
	No. 3.	No. 4.	No. 3.	No. 4.	No. 3.	No. 4.	No. 3.	No. 4.
3	+ 0 <sup>m</sup> 2 <sup>s</sup> ·7	+ 0 <sup>m</sup> 43 <sup>s</sup> ·5	+ 1 <sup>m</sup> 24 <sup>s</sup>	+ 0 <sup>m</sup> 46 <sup>s</sup>	+ 0 <sup>m</sup> 31 <sup>s</sup>	+ 1 <sup>m</sup> 14 <sup>s</sup>	+ 2 <sup>m</sup> 8 <sup>s</sup>	+ 0 <sup>m</sup> 43 <sup>s</sup>
6	- 5 32	- 1 40	+ 6 15	- 1 37	- 5 9	- 1 24	+ 4 25·7	- 0 59
9	+ 5 19	+ 1 18	- 1 53	+ 1 12	+ 5 25	+ 0 55	- 1 53	+ 0 42
12	+ 1 59	+ 1 11·7	+ 2 7·3	+ 1 29	+ 2 33	+ 1 5	- 2 23	+ 1 6

These Tables show plainly that No. 3 had been sensibly affected by the magnet, while No. 4 shows very nearly the same changes in all the three sets of experiments. Fisher draws from the above experiments, and from his observations made in Spitzbergen (p. 2, *seq.*) the conclusion "that chronometers will be generally accelerated (particularly if their balances have not received polarity by the too

near approach of anything magnetical) on ship-board.” And further, he thinks it probable that the balance-spring will be similarly affected, “since it is well known that chronometers having gold balance-springs, although more difficult to adjust, yet keep better rates at sea than the others.”

Fisher’s experiments are very defective in point of accuracy. There is, for instance, neither an account of the temperature, nor are the detached rates of the chronometers given—so that it is impossible to discuss the results thoroughly. It is, however, probable that a magnet at such a short distance will obscure all other disturbing influences; nevertheless I do not think that Fisher’s conclusion in favour of acceleration with magnetic action deserves much confidence, as the number of experiments is too limited, and as so strong a magnetism must necessarily have too strong an effect upon the whole work of a chronometer as to admit of any general deduction. One fact is, however, remarkable, and not the less so for the preceding notes, viz., that the effects of north and south poles upon No. 3 are nearly opposite each other, while they are very nearly the same in No. 4. This seems to involve that No. 3 had already, before the experiments began, acquired polarity, though it is difficult to say which of the steel parts had become magnetic. It is only made probable by Fisher’s remark about the effect of the magnet when out of the plane of the balance, that the balance is the chief part acted upon; and it is to be regretted that these latter observations have not been reproduced in full. As Fisher’s experiments stand, they are to be considered as preliminary ones only.

I may, perhaps, finish these remarks about Fisher’s observations by quoting a criticism of them by Barlow out of his Paper (No. 6), which will occupy us presently, and which is very much to the same effect as ours. He says: “The experiments and observations which Mr. Fisher describes as having been made with a strong bar magnet, brought within two inches of the balance, I consider to be perfectly distinct in their nature from those which were made by him on board and on shore at Spitzbergen; for a magnet of such power, brought within the distance of two inches of any small piece of steel, will, whether the latter be previously magnetic or not, impress upon it a strong temporary derangement of its latent magnetism, and give to the part nearest to the magnet a contrary pole to that by which it is opposed; and consequently there will exist between the balance and the magnet a strong power of attraction, sufficient to cause that acceleration so strongly indicated in Mr. Fisher’s experiments; and this will be the case whichever end of the magnet is opposed to the balance and to whatever part of the latter the application is made; because, in this instance, the effect does not depend upon the previous magnetic state of the balance, but upon that temporary state excited by the proximity of the magnetic bar, and which ceases when the bar is removed.”

## V.

[PETER BARLOW.—PETER LECOUNT.]

Fisher's observations at Spitzbergen (p. 2.) and his explanation of them by means of the action of the ship's iron, induced Barlow to make some experiments himself, in order to ascertain whether soft unmagnetized iron had actually any effect in changing a chronometer's rate. He assumed that such an effect would only take place if the spring or some part of the balance had previously become magnetic, and that "accordingly as the balance was placed in this or that direction with respect to any given mass of iron, the rate of the chronometer would be accelerated or retarded, and not uniformly accelerated." . . . "Or rather, perhaps, I ought to say," he continues, "that a different direction of the balance would alter the arc of its vibration from greater to less, or from less to greater; but it would still depend upon the original adjustment of the machine, whether the result would be to accelerate or to retard its action; that is to say, it would depend upon the contingency, whether the chronometer had a tendency to gain or lose in short arcs, which I am informed is nearly an equal chance, if it proceed from the hands of a scientific workman; but that in general cases the probability is that the watch will lose in large arcs and gain in small ones."

Before I begin to describe Barlow's experiments I reproduce the following ideas of Peter Lecount (No. 7) as to the influence of the ship's iron. He, too, thinks that this influence is caused by a quantity of fixed magnetism in the balance and its spring, and considers especially the magnetism lying entirely inside the chronometer to be the chief reason of the changes of rate in different parts of the world. These magnetic attractions will act in different ways; for instance, fixed magnetism in the balance and changeable magnetism in the steel spindles, the rate will be changed by any considerable alteration of the dip, as by that direction and power of the changeable magnetism will be altered. Fixed magnetism in the spindles and changeable magnetism in the steel of the balance will produce the same effect as before; and "the balance spring will likewise be acted on under similar circumstances."

These remarks of Barlow and Lecount are of very great importance. Barlow shows plainly the reason why a general rule holding good for all chronometers, as to whether magnetism must produce acceleration or retardation, cannot be given [cf. George Harvey (No. 12), on p. 30], and Lecount points out a source of magnetic disturbance of a chronometer which deserves very close attention. This remark of Lecount appears so much the more striking, when we take Harvey's instance of magnetic intensity (No. 9, p. 9) in a chronometer into account.

These observations tend to increase considerably the interest in Barlow's experiments, which, as mentioned before, are the only ones made with soft iron.

Barlow had six excellent chronometers at his disposal (two pocket and four box chronometers), which he observed in the proximity of an iron ball of 18 ins. diameter, weighing 496 lbs. Preliminary experiments with a small compass-needle having been made in order to determine the magnetic intensity in the neighbourhood of the ball, especially the zones of maximum and minimum intensity, the chronometers were put in different positions as to the iron ball, so as to vary the magnetic intensity, which was always previously ascertained by means of the above-mentioned small compass. This has only once been omitted (Tables IV. and V.), where the iron ball had been replaced by an iron plate, such as Barlow proposed elsewhere, for the compensation of the deviation of a compass [cf. p. 44]. His experiments are given extensively in six Tables, of which the following Tables form an abstract. The temperatures were read daily at 10 o'clock, A.M. The values I give are the means of the daily figures in Barlow's Tables. The other columns do not require further explanation: it is only to be added, that Barlow gives the results chronologically, while I arranged them according to the magnetic intensities, with the exception of Table II. The figures in the first column show how the experiments followed each other in time.

TABLE I.—*Pocket Chronometer (EARNSHAW), assumed Detached Rate - 3<sup>s</sup>.2 losing.*

Chronol. No.	No. of Days.	Temperature.	Intensity.	Position of XII.	Rate.	Difference from Detached Rate.	Remarks.
3	6	47	91	S.	- 5 <sup>s</sup> .6	- 2 <sup>s</sup> .5	S. of ball.
1	12	—	[100]	—	- 3·2	—	—
2	4	49	100	—	- 3·2	—	—

As the rate was very irregular, when the chronometer was again detached, the observations were discontinued after the above experiments were made.

[TABLE II.

TABLE II.—*Pocket Chronometer (ARNOLD), arranged as in the original; for the reason. see below.*

Chronol. No.	No. of Days.	Temperature.	Intensity.	Position of XII.	Rate.	Difference from Detached Rate.	Remarks.
1	11	—	—	—	+ 6 <sup>s</sup> .0	—	—
2	4	49	100	—	+ 5.0	0 <sup>s</sup> .0	—
3	6	47	117	N.	+ 6.5	+ 1.5	Above ball.
4	3	47	100	—	+ 5.8	+ 0.8	—
5	6	48	100	—	+ 5.2	+ 0.2	—
6	3	49	94	S.	+ 6.1	+ 0.9	N. of ball.
7	3	49	100	—	+ 4.7	- 0.5	—
8	5	53	162	S.	+ 5.0	- 0.2	Above ball.
9	2	56	117	S.	+ 4.0	- 1.2	„
10	7	51	100	—	+ 4.3	- 0.9	—

“The numbers in column 7 are drawn from comparison with each preceding detached rate (not done so in 8, 9, 10), and not from the mean one, as is done in the following Tables.”

“As this chronometer appeared to be increasing its rate, or rather decreasing its losing rate, independent of the action of the iron, . . . our observations with it [were] discontinued.” [Remark to 10].

TABLE III.—*Box Chronometer (BARRAUD, 749), assumed Mean Detached Rate + 0<sup>s</sup>.6 gaining.*

Chronol. No.	No. of Days.	Temperature.	Intensity.	Position of XII.	Rate.	Difference from Detached Rate.	Remarks.
6	3	48	84	S.	- 0 <sup>s</sup> .9	- 1 <sup>s</sup> .5	E. of ball.
1	11	—	100	—	+ 0.3	—	—
2	4	49	100	—	- 0.4	—	—
4	8	48	117	S.	- 0.9	- 1.5	Above ball.
3	7	47	126	S.	- 0.9	- 1.5	S. of ball.
5	4	50	162	S.	- 0.2	- 0.8	Above ball.

“This chronometer being so little affected by the action of the iron, our observations on it were discontinued after the 6th [of April], on which day it was returned to town; and by comparison with Greenwich time by Captain Lynn, on the 28th of April, its rate was found to have been 1<sup>s</sup>.0 per day, which makes the mean rate, as stated above, + 0.6.”

TABLE IV.—*Box Chronometer (PENNINGTON), assumed Detached Rate + 1<sup>s</sup>.5 gaining.*

Chronol. No.	No. of Days.	Temperature.	Intensity.	Position of XII.	Rate.	Difference from Detached Rate.	Remarks.
13	3	55	63	S.	+ 1 <sup>s</sup> .1	- 0 <sup>s</sup> .4	S. of ball.
14	4	51	63	N.	+ 1 <sup>s</sup> .3	- 0 <sup>s</sup> .2	S. „
3	3	48	94	S.	- 0 <sup>s</sup> .3	- 1 <sup>s</sup> .8	N. „
4	3	54	94	W.	+ 0 <sup>s</sup> .3	- 1 <sup>s</sup> .2	N. „
5	3	57	94	E.	+ 0 <sup>s</sup> .8	- 0 <sup>s</sup> .7	N. „
6	5	51	94	N.	+ 0 <sup>s</sup> .6	- 0 <sup>s</sup> .9	N. „
7	5	54	94	S.	- 0 <sup>s</sup> .6	- 2 <sup>s</sup> .1	N. „
11	9	59	97	S.	+ 0 <sup>s</sup> .2	- 1 <sup>s</sup> .3	E. „
2	4	50	100	—	+ 2 <sup>s</sup> .1	—	—
9	5	61	100	—	+ 1 <sup>s</sup> .3	—	—
10	7	—	100	—	+ 1 <sup>s</sup> .2	—	—
12	4	54	100	—	+ 1 <sup>s</sup> .5	—	—
1	7	48	126	S.	- 0 <sup>s</sup> .5	- 2 <sup>s</sup> .0	S. of ball.
8	3	60	—	S.	+ 0 <sup>s</sup> .2	- 1 <sup>s</sup> .3	S. of plate.

TABLE V.—*Box Chronometer (PARKINSON AND FRODSHAM), assumed Detached Rate + 0<sup>s</sup>.23 gaining.*

Chronol. No.	No. of Days.	Temperature.	Intensity.	Position of XII.	Rate.	Difference from Detached Rate.	Remarks.
1	6	48	100	—	+ 0 <sup>s</sup> .9	—	—
8	8	61	100	—	+ 0 <sup>s</sup> .4	—	—
9	7	—	100	—	- 0 <sup>s</sup> .6	—	—
11	5	57	117	S.	- 2 <sup>s</sup> .1	- 2 <sup>s</sup> .3	N. of ball.
2	4	50	143	S.	- 3 <sup>s</sup> .4	- 3 <sup>s</sup> .6	S. „
3	3	48	143	N.	- 3 <sup>s</sup> .3	- 3 <sup>s</sup> .5	S. „
4	3	54	143	W.	- 2 <sup>s</sup> .5	- 2 <sup>s</sup> .7	S. „
5	3	57	143	E.	+ 0 <sup>s</sup> .7	+ 0 <sup>s</sup> .5	S. „
6	5	51	143	S.	- 3 <sup>s</sup> .9	- 4 <sup>s</sup> .1	S. „
10	3	58	150	S.	- 1 <sup>s</sup> .4	- 1 <sup>s</sup> .6	N. „
12	3	54	199	S.	- 1 <sup>s</sup> .7	- 1 <sup>s</sup> .9	S. „
13	4	55	208	S.	- 2 <sup>s</sup> .3	- 2 <sup>s</sup> .5	S. „
14	4	51	208	E.	- 1 <sup>s</sup> .7	- 1 <sup>s</sup> .9	S. „
7	5	54	—	S.	- 3 <sup>s</sup> .2	- 3 <sup>s</sup> .4	S. of plate.

TABLE VI.—*Box Chronometer (PARKINSON AND FRODSHAM), assumed Detached Rate*  
— 0<sup>s</sup>.39 *losing.*

Chronol. No.	No. of Days.	Temperature.	Intensity.	Position of XII.	Rate.	Difference from Detached Rate.	Remarks.
10	4	55	33	S.	- 1 <sup>s</sup> .2	- 0 <sup>s</sup> .8	N. of ball.
11	4	51	33	N.	- 1.0	- 0.6	N. „
7	3	58	91	S.	- 1.9	- 1.5	S. „
2	5	51	97	S.	- 1.3	- 0.9	E. „
3	5	54	97	S.	- 1.5	- 1.1	W. „
1	4	57	100	—	+ 0.2	—	—
5	5	61	100	—	- 0.6	—	—
6	7	—	100	—	- 0.5	—	—
4	3	60	127	S.	- 1.6	- 1.2	N. of ball.
9	4	54	169	S.	- 1.4	- 1.0	N. „
8	4	58	183	S.	- 1.4	- 1.0	S. „

From these Tables Barlow draws the following “practical deductions” :—

1. The rate of a chronometer is undoubtedly altered by its proximity to iron bodies.

2. It does not appear to be by any means a general case that iron necessarily accelerates the rate, as five out of the six instruments used were obviously retarded, and only one showed indications of accelerations in one position (No. II.), and this case is more doubtful than the retardation in the other five.

3. It is very obvious (cf. Nos. IV. and V.) that much depends on the direction of the balance with respect to the iron.

4. Generally speaking, it appears that the greatest effect is produced in those instances where the change in the magnetic intensity is the greatest, but there does not seem to be that uniformity of relation that we should naturally have anticipated.

5. As a practical conclusion, it is obvious that a chronometer on board ship ought to be kept as carefully at a distance from any partial mass of iron as the compass itself, and that it should not be placed in a situation where experiments with a compass show any considerable degree of magnetic deviation.

6. Lastly, Barlow proposes a way of eliminating the influence of the ship's iron, which will be discussed later on, together with similar suggestions of other observers (cf. p. 44).



The above experiments are, certainly, a great deal more scientific and systematic than those by Fisher; in some respects, however, they are decidedly defective, and lose much of their value as a base of practical conclusions. The greatest difficulty in all chronometrical experiments is well known to be that of separating the great number of disturbing influences according to their sources. This has not been sufficiently attended to. Thus the temperature is read once a day only, and no statement is given as to the maximum and minimum values, so that the mean temperature remains unknown. It is, moreover, not mentioned how far the compensation of the chronometers for changes of temperature was perfect; consequently the mean detached rates, on which the whole result depends, are rather uncertain and doubtful. Moreover, although it is very interesting and important to observe the chronometers in different azimuths, as Barlow did, still his observations are of little value, since he did not vary the positions systematically, and especially since he did not observe the *detached rates* in different azimuths also. Scoresby (No. 8) thought apparently the same, when he says that in all the magnetical experiments made by others (which can only be those of Fisher and Barlow) some circumstances were neglected, "particularly the position of the watch or chronometer when its rate was determined." And finally, almost the greatest objection to Barlow's experiments is their want of uniformity: no two chronometers have been treated in the same way, so that the results obtained with the different time-pieces are only imperfectly, if at all, comparable with each other.

These objections affect Barlow's general deductions, in so far as they take a good deal of their evidence away. The fact, however, that iron affects a chronometer remains, and Barlow's experiments show how desirable and important further experiments with soft iron would be. These would have to be made on a larger scale, and with the most careful attention to every possible source of disturbance which might tend to obscure the result. Some suggestions as to the arrangement of such experiments will be made later on.

## VI.

[W. SCORESBY.]

W. Scoresby's (No. 8) general ideas about the effect of the ship's iron on a chronometer are not unlike those of Barlow and Lecount, but he thinks that the *terrestrial* magnetism has by far the greatest influence upon a chronometer's rate, or, as he expresses it later on (with reference to Fisher's observations in Spitzbergen), "the force of terrestrial magnetism acting upon a balance that is magnetic is fully sufficient to account for every change of rate observed." For in the same proportion as the magnetism of the earth (or the directive force of the compass-needle) exceeds the magnetism of the ship (or the deviating force), the

influence of terrestrial magnetism on the chronometer must exceed the influence of the ship's iron on it. And though a modified action takes place where these two forces do not act in the same direction, yet the influence of both these forces on the balance (which vibrates horizontally) must be similar to that on the equally horizontal compass-needle. And, moreover, as the medium effect of the attraction of the ship's iron on the compass within the parallels of Great Britain does not exceed  $5^\circ$  of deviation on each side of the meridian (and is, probably, a little less), the force of deviation is represented by  $\sin 5^\circ$ , the directive force by  $\sin 85^\circ$ , the relation of which number is 1 to 11.35. As, therefore, "the proportion of error due to the local attraction of the ship would appear not to exceed in these latitudes the eleventh or twelfth part of that resulting from the earth's magnetism (while nearer to the equator it must be still less)," it will be of little service to compensate for the error of local attraction so long as the action of terrestrial magnetism remains uncorrected. In the polar seas the force of local attraction approaches the directive force much nearer than in the British seas, and in some situations very near the magnetic poles exceeds it; but as it acts "without any increase of force," except what may arise from the little augmentation of the earth's magnetic intensity in those regions, the rate of a chronometer should be more equable in polar regions (could the effect of temperature be perfectly compensated), because the earth's magnetism acts nearly at right-angles to the plane of the balance. A corroboration of these opinions Scoresby finds in Barlow's experiments; and though he considers Varley's instance an extreme one, still he thinks "that the influence of magnetism in the balances most probably affects the rate, in some degree, of almost every watch and chronometer."

It appears doubtful whether the above conjectures as to the influence of the ship's iron would still hold good in the present time of iron steamers (cf. p. 42, Experiments of Delamarche and Ploix); and as observations in this respect are wanting, the following remarks of the Astronomer Royal (then Mr. Airy) may be of some importance. The first ones I find in Shadwell (No. 28), in two foot-notes on pp. 14 and 15:—"In a letter to the Hydrographer to the Admiralty on the liability of chronometers to be disturbed by the earth's magnetism (Nov. 1857), Mr. Airy has recently stated that 'of the hundreds of chronometers which have passed before us, and have been regularly put under magnetic trial, only one, viz. Buckland's (?) (No. 425) has been sensibly affected by the earth's magnetism.'" And: ". . . Mr. Airy, in the communication to the Hydrographer before referred to (Nov. 1857), 'On the magnitude of the magnetic forces in an iron ship,' observes—"I have never been in any part of a ship in which a chronometer would be placed in which the compass-needle was reversed, or in which it followed rudely the movements of the ship: there are places possessing this character, as very near the funnel, or very near some iron stanchions or knees, but nowhere where a chronometer would probably be placed. That is to say: the ship's magnetic force

(practically) is never equal to the earth's magnetic force, and the earth's magnetic force will never be doubled by the addition of the ship's force. Therefore if the earth alone will not sensibly affect a chronometer, the earth and ship together will scarcely disturb it sensibly." The other remark was made by the Astronomer Royal in 1859, and is to a similar effect (cf. Wackerbarth, No. 27), viz.: "that, with very rare exceptions, the effect of the earth's magnetism, which is much greater than that produced by local attraction, is wholly insensible." In spite of these remarks of the Astronomer Royal, the question of the ship's influence upon a chronometer cannot yet be considered to be solved, and further experiments seem to be highly desirable. These would most probably lead now to a final result, since the theory and practice of compass deviation have reached such a high degree of perfection in our days.

Scoresby made some experiments in order to see how far the magnetic influence might be general, and found that in three watches subjected to the action of magnetism a change of rate took place whenever a change was made in the relative position of the watch and the magnet. This leads him to the following consideration. Had any of the balances been free from magnetism, its rate (in all horizontal positions) would have been uniform, "whether under the action of terrestrial or of moderate artificial magnetism," for there would have been only induced "transient" magnetism in the balance, the poles of which change with every change of position of the watch, so that the rate would be unaffected by any slight magnetic influence. But in the case of a permanent magnetic quality of the balance, "there would be a repulsive action of the magnet in some positions and an attractive in others, which, affecting the vibrations of the balance in different ways, might be expected to produce a change in the rate of the watch." The only difference between these effects, whether produced by terrestrial magnetism only, or by artificial magnetism (directed in a similar way), was presumed to be in quantity.

The experiments with one watch only are communicated. A bar magnet, 12 ins. long, was placed in the magnetic meridian, and the watch (which was remarkable for the beauty of the movement and the uniformity of its rate) was placed in the same line at a distance of 4 ins. from the magnet. The following rates were then observed:—

When figure XII. was directed towards—

<i>North</i> ,	the chron. <i>lost</i>	13 <sup>s</sup> in 2 <sup>hrs</sup> 18 <sup>m</sup> ,	being at a daily rate of – 135 <sup>s</sup> losing;
<i>South</i> ,	„ „	<i>gained</i> 12 <sup>s</sup> in 2 <sup>hrs</sup> 12 <sup>m</sup> ,	„ „ „ „ „ „ + 131 gaining;
<i>North</i> ,	„ „	<i>lost</i>	as in the first instance, but at a rate somewhat less;
<i>South</i> ,	„ „	<i>gained</i> 56 <sup>s</sup>	in the course of the night, being at a daily rate of 156 <sup>s</sup> gaining. This acceleration above its former rate was probably owing to the diminution of temperature.

Scoresby concludes: "The regularity of a change of rate, from losing to gaining, with each reversion of position in the watch, everything else being the same, was a sufficient proof that some part of the watch was magnetic and that that part was acted upon by the influence of the magnet."

Scoresby's general considerations about the influence of terrestrial or artificial magnetism on an unmagnetic balance deserve some attention. For it does not appear to be so obvious, that a magnet should not have any influence upon an unmagnetic balance. This would be the case if the balance was a steel disc, for instance; but as the cross-bar will always exceed the other steel so considerably in quantity, it is very probable that a magnet would tend to alter the arc of vibration, and thus to affect the rate of the chronometer, especially when the cross-bar at rest was in a line with the magnet. How far this influence goes remains to be determined experimentally; it is probably very small, as it is certainly in the case of terrestrial magnetism, but it may become perceptible to careful observations. These observations would have to determine how strong a magnet must be in order to produce a sensible effect upon the rate of a chronometer, the steel parts of which have been *proved* to be free of magnetism. That an inversion of poles would—in such a case—not have any effect is obvious; and so Scoresby's experiment certainly proves some magnetic quality in the watch. Where it lies, however, is not to be ascertained. Hardly anything else can be deduced from his experiment, as it seems to be in every respect a rough and preliminary one only.

The means of counteracting the earth's magnetic influence on a watch will be discussed further on (cf. p. 45).

## VII.

[GEORGE HARVEY.]

The leading idea in all the experiments as yet mentioned was, that the balance and perhaps its spring were the chief bearers of any magnetic quality, and the chief medium through which external magnetic action affected the chronometer's rate. George Harvey (Nos. 10–13) is induced to make his experiments by the assumption that a change of rate takes place chiefly with changes in the position of the "main-spring" relative to the direction of the magnetic force. Notwithstanding this, he considers the balance to be the part of the chronometer chiefly acted upon by the magnet, as is seen from his attempt to explain the different effects of the same force upon different instruments. Leaving every discussion as to the correctness of this supposition till later on, I will proceed to describe his experiments, which possess some new, and for further experiments not quite worthless, features.

Harvey experimented at first with a bar magnet,  $13\frac{1}{2}$  inches long,  $1\frac{1}{4}$  inches broad, and  $\frac{1}{4}$  of an inch thick, which was of considerable power, and one pocket

chronometer A, and two box-chronometers, B and C. The rates of these time-pieces were observed in four different positions, which are represented in figures 1 to 4, Plate I. His description of these positions is:—

Fig. 1. Main-spring (S) nearly in contact with the magnet and the attractive power transmitted through its centre.

Fig. 2. Centre of the main-spring removed 90° from the preceding position, and the magnetic power transmitted nearly through the centre of the balance (B) and its spring. Balance at the least distance from the pole.

Fig. 3. Centre of the main-spring 180° from its first situation, and the magnetic power transmitted through its centre.

Fig. 4. As under fig. 2, balance at the greatest distance from the pole.

Chronometer A was thus exposed to the north pole only, while B and C were also brought under the influence of the south-pole. This was so arranged, that while B was exposed to the south pole, C stood at the same time before the north pole of the same magnet. Besides these experiments, A was observed also in the positions figs. 5 to 8, where the balance (instead of the main-spring) is brought into four different positions relative to the magnet. The time of exposure was four days in each situation. I reproduce the observed changes of rate as briefly as possible.

Situation of A.	Rate.	Situation of A.	Rate.
Detached.	+ 20·4	Detached.	+ 20·1
Fig. 1.*	+ 68·9	Fig. 5.*	+ 50·8
„ 2.	- 23·2	„ 6.	+ 29·1
„ 3.	+ 43·4	„ 7.	+ 33·7
„ 4.	- 2·6	„ 8.	+ 18·5

\* The values under figs. 1 and 5 are means of two observations, made respectively before and after figs. 2 and 4 and figs. 6 and 8, namely—

$$+ 68·9 = \frac{1}{2} (+ 65·1 + 72·7) \text{ fig. 1.}$$

$$+ 50·8 = \frac{1}{2} (+ 52·3 + 49·3) \text{ fig. 5.}$$

(There is on page 5 the misprint 52·3, instead of the second number 49·3.)

Situation.	CHRONOMETER B.			CHRONOMETER C.	
	North Pole.		South Pole.	North Pole.	South Pole.
	1.	2.			
Fig. 1.	+ 10 <sup>s</sup> .0	+ 11 <sup>s</sup> .7	+ 9 <sup>s</sup> .5	- 4 <sup>s</sup> .2	+ 3 <sup>s</sup> .2
„ 2.	+ 3.1	+ 3.4	- 4.2	+ 22.4	+ 18.6
„ 3.	+ 5.0	+ 7.0	+ 8.7	- 8.2	- 6.6
„ 4.	- 1.1	+ 1.4	- 0.8	+ 15.7	+ 12.0

The chronometers B and C had been taken out of their boxes during these experiments. The magnet lay horizontally, with its north end directed towards north.

From the north pole experiments with A and B, figs. 1 to 4, Harvey concludes: “An increase of rate resulted from the direct transmission of the magnetic influence through the centre of the main-spring; and a diminution thereof when the same power passed through nearly the middle of the balance and its spring.” And his deductions from a comparison of the two columns given in the first Table (chronometer A, figs. 1 to 4 and 5 to 8) are: Firstly, the position of the main-spring relative to the magnet has a very material effect upon the rate of the chronometer. Secondly, the removal of the centre of the main-spring from the magnetic axis by equal arcs seems to produce proportional changes of rate. Thus the rates 68<sup>s</sup>.9 (fig. 1), and 43<sup>s</sup>.4 (fig. 3) are very nearly proportional to 50<sup>s</sup>.8 (fig. 5), and 33<sup>s</sup>.7 (fig. 7). A foot-note says that this coincidence may be only accidental. But “it would seem as if the translation of the chronometer from the positions occupied in fig. 1, through a given arc, occasions a declension in the rate proportional to that which takes place when it is moved from the position denoted by fig. 3, through an equal arc in a contrary direction.” Thirdly, Harvey considers the differences in the changes of rate from figs. 1 to 2, and figs. 5 to 6, as well as from figs. 3 to 4, and figs. 7 to 8, very surprising; so much the more as the positions figs. 5 to 8 differ by 27° only from the situations figs. 1 to 4, respectively.

As I shall have to reproduce a longer discussion of these observations, which Harvey published somewhat later in the year (No. 13), I will reserve till then the remarks I have to make about the above experiments and deductions.

The observations of B and C show directly opposite results, the explanation of which “apparent anomalies” form the subject of a special Paper by Harvey (No. 12), which will be discussed presently (p. 30). A marked difference between north and south pole is perhaps perceptible in chronometer B only.

In order to compare the effect of the poles and of the equator of a magnetic disc of 8 ins. in diameter and  $\frac{1}{4}$  in. in thickness, Harvey proceeded to expose three chronometers, B, D, and E, to the influence of the disc in the way repre-

sented in his fig 13, which I reproduce on Plate I., Fig. 9. Two other chronometers, F and G, were also observed when standing on the disc, the figure XII pointing successively towards S., W., N., E. And, finally, chronometer F was exposed to the north pole, the figures X, VII, IV, being successively in contact with it. Chronometer B showed an increase of rate by  $10^s\cdot3$  before the north, and of  $1^s\cdot9$  before the south pole; chronometer E changed its detached rate of  $+8^s\cdot5$  into  $+27^s\cdot2$  before the south pole, after which the free rate became again  $+8^s\cdot3$ . This rate was then changed into  $-2^s\cdot6$ , when the chronometer was placed on the disc, so that its centre coincided with the centre of the plate, and the radius passing through the balance centre was at right angles to the magnetic axis. Harvey remarks:—"The great effect of the middle of the plate on the rates of the chronometer will not be regarded as remarkable when it is considered that only a single point of the chronometer could be applied to the equator of the magnet; and that both the balance and the main-spring were in each case beyond the centre of the plate, and consequently under the influence of an attractive force, less powerful than that developed by the poles of the magnet, but much superior to the effect of the actual equator of the plate." It is to be regretted that these observations did not induce Harvey to bring the centre of the balance into coincidence with the centre of the plate, nor to observe the rate of the chronometer when in the same position as to the equator, as the drawing shows it to be with reference to the poles.

The observations of the chronometers F and G led to the following daily rates, which are the results of six days' exposure on the average:—

Situation of Chronometer F.	Daily Rate.	Situation of Chronometer G.	Daily Rate.
Detached.	+ 2 <sup>s</sup> ·0	Detached.	- 4 <sup>s</sup> ·1
On the disc.	XII pointing S. + 7·3	XII pointing N. + 0·1	} On the disc,
	XII " W. - 3·6	XII " E. - 8·6	
	XII " N. + 24·8	XII " S. - 3·7	
	XII " E. + 5·0	XII " W. - 4·4	
X in contact with north pole. - 6·8	XII " N. + 2·2		
VII " " " " + 7·9	XII " W. - 4·7		
IV " " " " + 2·3			

which show that by turning the chronometer—

From N. to E. the alteration of rate was losing,  
 " E. " S. " " " " " " gaining,  
 " S. " W. " " " " " " losing,  
 " W. " N. " " " " " " gaining.

Finally, a chronometer, H, was observed on an irregular octagonal magnetic disc, in the same positions as F and G, and directly opposite results were arrived at. And further on it was seen that when the chronometer was moved only  $\frac{1}{8}$  of an inch towards the north pole, a very sensible change of rates was invariably observed. The rates observed in these two positions were:—

Situation of Chronometer H.	DAILY RATE.	
	First Position.	Second Position, $\frac{1}{8}$ in. further North.
XII pointing N.	+ 5 <sup>o</sup> .1	+ 6 <sup>o</sup> .7
XII „ E.	+ 20 <sup>o</sup> .4	+ 22 <sup>o</sup> .6
XII „ S.	+ 3 <sup>o</sup> .0	+ 3 <sup>o</sup> .5 (and + 4 <sup>o</sup> .1)
XII „ W.	+ 16 <sup>o</sup> .9	+ 23 <sup>o</sup> .7

We see from this that the displacement of the chronometer towards the north accelerated all the rates; and that the most considerable changes took place in the E. and W. positions, where the radius passing through the balance centre was at right angles to the magnetic axis; the least considerable changes in the N. and S. positions, where the balance centre was lying in the magnetic axis.

The above experiments are open to the same objections I had to make against the majority of the former ones. There is no account of the temperature, nor of the compensation of the time-pieces; the detached rates have not been taken in different positions, so that we do not know anything about eventual fixed magnetism in the chronometers. And then it is to be regretted that Harvey brought chiefly the main-spring into regular positions as to the magnet, and the more so as his third conclusion from the observations of A seems to show that it is the balance which is acted upon by the magnet.\* Any conclusive evidence as to which part is particularly influenced, however, Harvey's experiments do not afford. His observations with the magnetic disc are very interesting, and perhaps worth a repetition, when modified as suggested before, but it appears doubtful whether they will lead to any result of general value at present, where the whole question of magnetic influence on chronometers is still so far from being finally solved.

\* Horner's objection (No. 15), that Harvey's experiments did not admit of any deduction, since "the balance was affected by two magnetisms, changeable in position and proximity, viz., the direct one of the magnet, and the induced one of the main-spring," would of course apply to all magnetic experiments. But as we do not want to obtain anything but the *result* of all these combined magnetisms for practical application, Horner's objection ceases to have any weight.



One fact, however, of great interest, to which Harvey also directs special attention, is set forth by his experiments. It is the immediate effect of the magnetic influence—in many instances Harvey observed the changes of rate to take place suddenly from considerable acceleration to considerable retardation, and *vice versa*—and the “freedom” with which the influence was lost when the magnetic action was reduced or altogether removed. This is particularly striking in the case of chronometer A, where there is a remarkably small difference between the detached rates before and after the experiments, though the magnet was of considerable power and brought very near the time-piece. We conclude from this with Harvey, that the influence of a magnet is often only transient, and that a magnet does not easily impart its magnetism sensibly to the steel parts of a chronometer.

I have now briefly to consider Harvey’s discussion of the behaviour of chronometer A (No. 13).

In the figure we copy from Harvey (Plate I., Fig. 10), the lines OA, OB, OD, OE, OF, OH, OK, OL, denote the directions in which the magnet was applied to the chronometer A, as represented by the corresponding figures 1 to 8. Thus LO is the line of the greatest observed acceleration, as HO that of the greatest retardation of rate; and further on we have: rate KO : LO :: DO : EO, as remarked before. Now Harvey considers it probable that between BO and DO there should be one direction, where the magnetic influence would have produced a rate nearly equal to the detached rate of  $+20^{\text{s}}.4$ : similar directions are likely to exist between FO and HO, HO and KO, and finally LO and AO. These “lines of detached rate” he determines under the assumption that a proportionality such as that mentioned above might exist throughout, and finds thus the approximate positions of the lines of detached rate CO, GO, IO, and MO, as they are drawn in the figure.

He considers it rather remarkable, that there is very nearly rate KO + AO = LO; and further on, that CO and TO are very nearly a straight line, and that also GO and MO are very nearly a continuation of each other.

Harvey then proceeds to find out the rate of acceleration or retardation for each degree of each arc on the same hypothesis of proportionality as he used above. I do not think it necessary to reproduce his results.

The basis of this discussion, the proportionality of rates, is admittedly a very uncertain one. For it is by no means necessary, nor—considering the want of symmetry in the distribution of steel in a chronometer, and the excentric position of the balance—even probable, that such a proportionality, though observed in some directions, must exist throughout. The “lines of detached rate” are, therefore, equally uncertain. It is, however, very interesting to determine experimentally their position, which is probably peculiar to each individual chronometer. For these lines are those directions in which the united actions

of the magnet, the induced and permanent magnetisms of the steel parts, and the terrestrial magnetism are in equilibrium, so as to produce no change of rate at all: their position depends, therefore, upon the quantity and distribution of steel and its magnetic qualities, which are all different in different chronometers. It remains even to be proved if such lines exist for each chronometer, which at first sight does not appear to be necessary nor probable. The best arrangement of these experiments seems to be to change the magnet's position successively by  $10^\circ$  or  $5^\circ$  (or even less where considerable changes of rate take place), and to keep it at a fixed distance from the centre of the balance, and not from that of the chronometer—for the sudden changes from FO to HO, at which Harvey seems to be surprised, show clearly that the balance, or its spring (probably both), are chiefly acted upon by the magnet. The results thus obtained would be comparable with each other, and would most probably show a greater regularity than those arrived at by Harvey.

The last of Harvey's Papers to be quoted (No. 12) is called forth by the striking fact that the same magnetic influence produced directly opposite results in the two chronometers B and C (p. 26). He finds the explanation of it in "the varieties of imperfect isochronism existing among different chronometers."

The first part of the Paper contains some deductions, intended to show how fixed magnetism in the balance may be the reason why a magnet will produce either an increase or a decrease of the arc of vibration. Some instances will suffice to show his ideas. If the thermometer pieces of a balance be supposed to be in an active but opposite state of polarity, and if the magnetic force acts in the direction of the diameter joining both, with a pole opposite to the pole of the thermometer piece lying next, the moment the oscillations begin the arc of vibration will be decreased, "in consequence of the effort made by the thermometer piece on which the magnetic force acts to approach the attracting pole." And if the attractive power acts "on either side of the point of quiescence, within certain limits, the arc of vibration will still be diminished, but in a less ratio than before." And suppose, moreover, "the direction of the magnetic force to pass through the centre of the balance and the limit of the semi-arc of vibration, it is manifest, when motion is communicated to the balance, its effects will be to increase the arc of vibration, both from its attracting one of the thermometer pieces and repelling the other." If in addition to the thermometer pieces the arcs of compensation are magnetic also, it is obvious that the balance may be regarded as a "species of compound magnet," and every magnetic influence, as long as it does not act at a distance equally remote from both poles (in which case the two effects will neutralise each other) will create in the balance a tendency to occupy a special position as to the direction in which the magnet acts, and thus an alteration of rate must of necessity occur. It makes, obviously, no difference whether the magnetic action is that of an

artificial magnet or that of the earth; in the latter case the situation which the balance will try to regain will be that in which it would repose if detached and freely suspended.

In order to explain why “similar changes in the arc of vibration should be frequently attended in different chronometers with opposite alterations of rate,” Harvey says, “that it may be questioned, if ever a chronometer existed in which the vibrations of the balance were perfectly isochronous, or, in other words, in which the adjustments of the spiral spring were such as to admit of its elastic force varying precisely with the arcs of vibration.” And, according to a Paper of Atwood in the *Philosophical Transactions* for 1794, even the most minute and most imperceptible deviations from perfect isochronism may be sufficient to produce a sensible alteration of rate in twenty-four hours. Now it is obvious that “the elastic force of the spring may vary either in a *less* ratio than the angular distances from the point of quiescence, or in a *greater*,” and this accounts for the apparent anomalies alluded to.

This is made evident by a discussion of Atwood’s formula for the daily aberration of a time-keeper with changes of the arc of vibration—

$$24^b \left\{ \left( \frac{a}{a'} \right)^{\frac{1-n}{2}} - 1 \right\}$$

where  $a$  is the primitive arc of vibration,  $a'$  that produced by the disturbing force, and  $n$  the exponent dependent upon the peculiar ratio existing between the elastic force of the spring and the angular distances from the point of quiescence. Thus, if  $a = \text{const.}$ , and

1.  $n < 1$  (or the elastic force varying in a *less* ratio than the angular distances), the function will become *positive*, or the time-keeper will *gain*; if the arcs of vibration are shortened by external influence, or  $a'$  becomes less than  $a$ , the function will become *negative*, or the time-keeper will *lose*, if  $a'$  becomes *greater* than  $a$  (or the arcs are lengthened).

2.  $n > 1$  (or the elastic force varying in a *greater* ratio than the angular distances), we shall have in the corresponding cases—

$$\begin{aligned} a' < a, & \text{ a negative value, or retardation;} \\ a' > a, & \text{ a positive value, or acceleration.} \end{aligned}$$

Thus the “varieties of imperfect isochronism” account for the different effects of the same disturbing force upon different instruments.

The above deduction is a concise mathematical illustration of Barlow’s remark (p. 16): its value lies in its showing that and why it will be impossible to give a general law for the effects of magnetism upon a chronometer. For this reason it is to be regretted that this Paper of Harvey’s has completely escaped the attention of all the following experimentalists.

## VIII.

[ARNOLD AND DENT.]

The experiments made by Arnold and Dent (No. 17) have a special interest and importance, since they are the first attempt to separate the magnetic influence upon the balance from that upon the spiral spring. A further value lies in their being made by chronometer makers who had the advantage of a thorough knowledge of the construction of a chronometer. This value would, however, have been considerably increased if Arnold and Dent had been acquainted with the previous experiments, especially those of Barlow and Harvey.

They applied three bar-magnets, A, B, and C, each 16·12 ins. long, 1·68 in. broad, and 0·44 in. thick. They were lying in the meridian in the plane of the balance, and the chronometers alone were turned successively by 90°, or 180°, so that the figures XII, III, VI, and IX were exposed to the magnetic action. The distances were 7 and chiefly 3 inches; the time of exposure varied from 5 to 9 days. The temperature was read daily; but as the maxima and minima from the Royal Observatory Records are given, there is hardly any information to be got as to the changes of temperature to which the chronometers were actually subject.

The time-pieces made use of were:—

- |                                |   |
|--------------------------------|---|
| Chronometers Nos. 605 and 606, | with gold spirals, and balances of silver, platinum, and brass. |
| „                              | Nos. 615 and 657, with steel springs and steel balances.        |
| „                              | No. 600, with steel spring and platinum-silver balance.         |
| „                              | No. 274, with gold spring and steel balance.                    |

When the balance was at rest the cross-bar lay exactly in the line XII—VI; so that, as Arnold and Dent assume the poles of the balance to coincide with those of the cross-bar (which in the majority of instances seems to be the case), always either the north or the south pole of the balance must lie under the figure VI. Thus they state that the north end of the balance was lying under figure VI in the two chronometers Nos. 657 and 615. The same was apparently the case with No. 274.

The results I reproduce in a condensed form, as I give only the means of Arnold and Dent's figures. I remark that Nos. 605 and 615 were exposed simultaneously, the former to the north, the latter to the south pole of magnet

A; Nos. 606 and 657 in the same way to magnet B; Nos. 600 and 274 to magnet C.

Situation.	SOUTH POLE.		NORTH POLE.		No. of Days.
	No. 657.	No. 615.	No. 605.	No. 606.	
Detached.	- 0 <sup>m</sup> 8 <sup>s</sup> ·20	- 0 <sup>m</sup> 7 <sup>s</sup> ·41	+ 0 <sup>s</sup> ·09	- 3 <sup>s</sup> ·19	7
Magnet to VI at 7 in.	+ 0 16·38	+ 0 3·02	+ 0·14	- 3·16	5
„ VI	+ 37 31·47	+ 1 14·68*	+ 0·66	- 3·14	7
„ XII	- 5 30·00	- 0 4·43	- 1·23	- 4·47	7
„ IX	+ 6 38·90	+ 0 7·06	- 1·42	- 4·54	5
„ III	+ 5 51·34	+ 0 6·02	- 1·68	- 5·62	5
Detached.	- 0 6·86	- 0 6·04	- 1·08	- 5·03	9

Arnold and Dent conclude from these experiments that—

- (a) A chronometer's rate will be accelerated when the north end of the balance is exposed to the south pole of the magnet;
- (b) Its rate will be retarded when the south end of the balance is exposed to the south pole of the magnet.

If we consider, that in the case (a) the attraction of the magnet will tend to decrease, and that in case (b) the magnet's repulsion will tend to increase the arcs of vibration, we see that these two rules are virtually the same as those given by Barlow (cf. p. 16), and that, according to Harvey's Paper just discussed, they are by no means necessary ones. Since, Arnold and Dent continue, either the south or the north pole of the balance must lie under figure VI, the effects of the magnet's exposure to XII and to VI must be opposite each other; but by the excentric situation of the balance "the comparison of the effects is rendered uncertain." At III and IX values between those at XII and VI are obtained, which among themselves are "quite consistent." It is surprising, and to be regretted, that Arnold and Dent were not induced by these observations to regulate the positions and distances of the magnet with reference to the centre of the balance instead of that of the chronometer. They think also that Nos. 605 and 606 show traces of magnetic influence, but that in these chronometers the increase and decrease of rates are gradual, while they take place quite suddenly in the other chronometers. I do

\* Mean of four days only: during the first three days the axis of the magnet had been lying above the plane of the balance, which gave only - 13<sup>s</sup>·2 as daily rate.

not think that there is any magnetic influence perceptible, and if there be any, it is obvious that it is, compared to the effects in Nos. 657 and 615, exceedingly small, and practically of no account whatever. So we see that the balance and its spring are the chief, and most probably the only, parts of the chronometer through which a magnetic influence is imparted to the rate of the time-piece. A conclusion as to which of the two has the greatest effect may, perhaps, be drawn from the following observations of No. 600 (with a platinum silver balance) and No. 274 (with a gold spiral):—

Situation.	North Pole. No. 600.	South Pole. No. 274.	Number of Days.
Detached.	- 0 <sup>m</sup> 0 <sup>s</sup> ·36	+ 0 <sup>m</sup> 1 <sup>s</sup> ·32	13
Magnet to VI	+ 0 3·26	+ 2 51·50	5
„ XII	- 0 3·08	- 0 6·80	4
„ IX	+ 0 0·94	+ 0 12·14	8
„ III	- 0 1·16	+ 0 20·60*	9

This Table shows that the influence upon the balance is considerably greater than that upon the spring; and it would be very important to continue these observations, if possible, with spirals of known magnetic qualities, in order to see if the above result is a general one. But these experiments would be rather expensive ones, and could not be made without the continual assistance of a practical chronometer-maker.

Finally, Arnold and Dent observed chronometer No. 274 (and perhaps No. 600 also, though it is not especially stated) in two different positions as to the magnetic meridian after the removal of the bar, and found the following differences of rate:—

Direction of VI.	Rate. No. 274.	Rate. No. 600.	Number of Days.
N.	+ 2 <sup>s</sup> ·90	- 0 <sup>s</sup> ·47	3
S.	+ 1·50	- 0·84	5
N.	+ 2·73	- 0·50	3
S.	+ 1·67	- 0·97	3
N.	+ 2·93	- 0·70	3

\* The fifth of the original numbers, of which the above is the mean, is given + 12<sup>s</sup>·9 (February 20), which most probably is (and has been assumed to be) a misprint for + 21<sup>s</sup>·9.

The regularity of these differences is very striking, and causes one to regret much the absence of east and west observations. The corresponding rates of No. 600 in the third column make it probable that this chronometer's position has been equally changed, as differences of rate, though small, also occur with a considerable regularity.

IX.

[G. FISHER.—S. G. NORTHCOTE.]

The experiments of Arnold and Dent just detailed above, and especially the case of chronometer No. 274, whose rate underwent changes with a change of the chronometer's position, induced George Fisher (No. 19) to see whether observations of two of his chronometers might lead to similar results. Their rates were carefully determined with the figure XII successively directed towards N., S., W., and E. The cross-arm of the balance, when at rest, was lying in the line XII—VI: the mean temperatures were obtained for the single intervals of observation. The results arrived at with one chronometer only are published in three tables. It appears that this chronometer has a tendency to gain in higher and lose in lower temperatures. The observed changes of rate, with changes of position, contracted to means, are:—

I.—Jan. 20, 1836,	to March 10, 1836.—	Position N.,	Rate — 0 <sup>s</sup> .68	}	Diff. + 0.42.
"    "    "    "    "    "    "	"    "    "    "    "    "    "	"    "    "    "    "    "    "	"    "    "    "    "    "    "		
Mar. 15,	"    "    "    "    "    "    "	"    "    "    "    "    "    "	"    "    "    "    "    "    "	}	" + 0.35.
"    "    "    "    "    "    "	"    "    "    "    "    "    "	"    "    "    "    "    "    "	"    "    "    "    "    "    "		
May 25,	"    "    "    "    "    "    "	"    "    "    "    "    "    "	"    "    "    "    "    "    "	}	" + 0.35.
"    "    "    "    "    "    "	"    "    "    "    "    "    "	"    "    "    "    "    "    "	"    "    "    "    "    "    "		
II.—Dec. 3, 1835,	to Jan. 11, 1836.—	Position W.,	Rate — 1 <sup>s</sup> .18	}	" + 0.52.*
"    "    "    "    "    "    "	"    "    "    "    "    "    "	"    "    "    "    "    "    "	"    "    "    "    "    "    "		
Apr. 12, 1836,	"    "    "    "    "    "    "	"    "    "    "    "    "    "	"    "    "    "    "    "    "	}	" — 0.22.
"    "    "    "    "    "    "	"    "    "    "    "    "    "	"    "    "    "    "    "    "	"    "    "    "    "    "    "		

While Table I. shows a marked difference between the rates in the two positions N. and S., Table II. causes it to appear very doubtful if the differences observed in the W. and E. rates are in any way connected with the change of azimuth or with magnetic influence. The average values deduced from the third Table are:—

Position N.	<i>minus</i>	S.	+ 0.27
"    W.	"    "	E.	— 0.67
"    N.	"    "	S.	+ 0.44

\* In the original misprint:—

Position W.,	Rate — 0 <sup>s</sup> .90	} Difference + 0 <sup>s</sup> .28.
"    E.,	"    "    — 1.18	

Here is to be remarked, that in the single observations these differences are hardly conspicuous, as the rate of the chronometer is altogether not very regular, and the temperature not as equal as could be desired. A further objection to these experiments—which do not offer any new features—is their arrangement, since the position has not been changed in the succession N., E., S., W.; and finally, the intervals of observation in each position vary too considerably. They are, for instance, during the first set: *North* 4, 7, 5, 4, 8 days, and *South* 7, 4, 6, 4 days, and greater irregularities still take place during the east and west observations. In all these experiments it appears advisable not to make the intervals too long, for then the magnetic effect would be very easily obscured by other influences upon the rate; and, on the other hand, too short intervals are equally objectionable, since the changes may be gradual, and thus may not have reached their maximum values at the end of the interval. An interval of one or two days between two positions seems to be the best average, which, of course, is strictly to be adhered to in all the four positions. The temperature, of course, must be kept throughout at the same height as much as possible.

As an appendix to Fisher's Paper some observations of S. G. Northcote (No. 18) are given, made on H. M. S. "Jupiter," in 1835 and 1836, in order to ascertain if the chronometers showed any change of rate simultaneously with a change of the ship's course. These observations are too few, and too vague to admit of any conclusion as to the changes of rate; and it does not appear at all probable that the irregularities in the rates are due to magnetism, since temperature alone would be more than sufficient to produce them. Besides, of the three chronometers mentioned, one seems to have a tendency to gain and the two others an inclination to lose independently of the ship's course. I do not consider it necessary to reproduce Northcote's few observations in full; but I repeat, how much importance such observations, if made systematically, would have. They could be very easily made along with the necessary chronometer observations; or a simple comparison of the ship's journals alone would probably lead to some results.\*

## X.

[G. B. AIRY].

Airy's Paper (No. 22) is of special interest and importance, on account of the striking instance of changes of rate with changes of position which it contains, and on account of the rules for compensating these irregularities, which Airy bases upon his observations, and the efficiency of which he proves.

The chronometer was Brockbank's, No. 425, which was more subject to magnetic influence than any other chronometer tried at Greenwich. It had been sent

\* Similar remark by Dr. Carl Børgen on p. 300 in No. 29.



back to the Observatory in September 1839, because its rate underwent changes in the proximity of an iron door. It was compared daily, and after each comparison turned by 90° in azimuth. Since each cycle of observations is only four or five days, Airy considers it hardly probable that the comparison of rates is sensibly affected by the gradual changes of rate peculiar to all chronometers. The observed values which show, as Airy remarks, that the chronometer is, generally speaking, a good one, are contained in the following Table:—

Date.	POSITION OF FIGURE XII.			
	North.	East.	South.	West.
1839.				
October 4	- 4·7	—	—	—
„ 5	—	- 8·4	—	—
„ 6	—	—	- 8·3	—
„ 7	—	—	—	- 6·1
„ 8	- 4·1	—	—	—
„ 9	—	- 9·0	—	—
„ 10	—	—	- 9·6	—
„ 11	—	—	—	- 6·0
„ 12	- 5·0	—	—	—
„ 13	—	- 8·4	—	—
„ 14	—	—	- 11·3	—
„ 15	—	—	—	- 5·1
„ 16	- 4·1	—	—	—
„ 17	—	- 9·1	—	—
„ 18	—	—	- 9·3	—
„ 19	—	—	—	- 5·8
„ 20	- 3·9	—	—	—
„ 21	—	- 9·1	—	—
„ 22	—	—	- 9·4	—
„ 23	—	—	—	- 6·0
„ 24	- 4·9	—	—	—
„ 25	—	- 8·3	—	—
„ 26	—	—	- 9·5	—
„ 27	—	—	—	- 5·3
„ 28	- 5·2	—	—	—
„ 29	—	- 8·6	—	—
„ 30	—	—	- 9·9	—
„ 31	—	—	—	- 5·7
November 1	- 5·2	—	—	—
No. of Days	8	7	7	7

Hence follow the mean rates:—

Figure XII directed downwards	North	—	4 <sup>s</sup> ·64
”	”	”	East — 8·70
”	”	”	South — 9·61
”	”	”	West — 5·71.

We have therefore for the daily rate  $G$  with fig. XII in any azimuth  $A$ ,

$$G = -7^s\cdot16 + 2^s\cdot48 \cos A - 1^s\cdot50 \sin A,$$

where  $7^s\cdot16$  is the general mean,  $2^s\cdot48$  half the difference of the north and south, and  $1^s\cdot50$  half the difference of the east and west rates. It is further

$$\text{tang } 31 = \frac{1\cdot50}{2\cdot48} \text{ nearly, and } 5\cdot80 = 2\sqrt{2\cdot48^2 + 1\cdot50^2}.$$

This formula shows that the smallest losing rate is  $-4^s\cdot26$ , and takes place when the figure XII is directed N.  $31^\circ$  W. The largest losing rate is  $-10^s\cdot06$  when the figure XII lies in the direction S.  $31^\circ$  E. The largest difference of rate, dependent upon the chronometer's position is therefore  $5^s\cdot80$ .

Airy then proceeds to describe his way of compensating the influence of terrestrial magnetism, and gives his observations made in order to test its effect. We shall reproduce this part of his Paper later on, when dealing with all the different methods proposed for the same purpose (cf. p. 46).

The above formula is very interesting, since by it the points of maximum and minimum effect are to be ascertained. We see, for instance, that these two points lie in opposite directions. But assuming, as is generally the case, the balance to lie in the line XII—VI (cf. Harvey's figures on Plate I.), we remark, that the extreme effects do not take place with the balance in the magnetic meridian; we only perceive that the largest losing rate is reached when the balance is nearer to the north than it is when the smallest losing rate is observed. The reason of these peculiarities lies, most likely, in the special distribution of fixed magnetism in the balance, or, as the following observations of Airy make probable, in the spiral spring. Any detailed information as to this magnetic quality is, however, not to be derived from the observations. It would be very valuable to apply the formula to other chronometers and not only to experiments like Airy's, but to magnetic experiments also. This is, however, hardly to be done with the observations we have discussed till now, since on account of the excentricity of the balance the values are not quite comparable, if the distance of the influencing magnet is reckoned from the centre of the chronometer's box. It would further be of great interest to see, whether the observed rates follow throughout the same law as in Airy's instance or not. At first sight—if we especially compare Harvey's results on p. 26—this does not appear to be the case.

XI.

[ANSART-DEUSY.]

Ansart-Deusy's (No. 25) brochure is a striking instance of how considerably the value of speculations and experiments is reduced by a preoccupation of the observer's mind in some special direction. He not only tries to explain—as already remarked, p. 7—almost all changes of rate in a chronometer by magnetism, but he is also led in his experiments and speculations by one special idea about the action of magnetism, which we shall find to be, in all probability, entirely erroneous. And finally, we see from his investigation how seriously these experiments are injured by a want of knowledge of a chronometer's mechanism.

Ansart-Deusy considers the chronometer on board ship to be subject to the action of the variable magnetism, induced into the ship's iron by the earth, and which is the stronger the more the ship's course approaches the meridian, and its place generally the magnetic equator. This magnetism is chiefly to affect the free steel parts in the chronometer, especially the spiral spring, and its effect will generally be an acceleration of the rate. The passage deducing this fact I reproduce in full, since it is in more than one respect remarkable. Ansart-Deusy says on pp. 8 and 9:—"Considérons, en effet, la section d'un ressort spiral coupé par un plan perpendiculaire, cette section sera représentée par de petites lignes perpendiculaires à deux droites parallèles et comprises entre elles — —. Soumettons maintenant la montre à l'action d'un barreau aimanté placé au-dessus ou au-dessous; l'attraction exercée sur le spiral tend à le déformer et sa section prend autour des points d'attache du ressort une forme convexe ; il en résulte un accourcissement de la projection horizontale de ce ressort, et par suite une diminution dans l'amplitude et la durée des oscillations du balancier et une accélération dans la marche. Et cette déformation deviendra d'autant plus grande que la montre aura séjourné plus longtemps à bord du navire, fait confirmé par l'expérience qui constate une accélération dans les marches avec le temps.

"Il peut et il doit arriver que l'effet magnétique sur la montre tende au contraire à lui donner un retard, mais ce retard doit diminuer incessamment, et finalement se transformer en accélération. Admettons, en effet, que lors de la construction de la montre le spiral ne soit pas entièrement plan, c'est-à-dire que les faces de ses tranches ne soient pas contenues dans deux plans parallèles, elles présenteront nécessairement une surface courbée dans un sens ou dans l'autre, et de cette forme . Si l'action magnétique agit par dessus, c'est-à-dire si un des pôles du navire se trouve au-dessus de la montre, la courbure du spiral ne fera que s'accroître et l'accélération se mani-

festera; mais si ce pôle se trouve en dessous, c'est-à-dire vers la partie concave de la section du spiral, la force magnétique tendra au contraire à rapprocher cette section de la ligne droite: allongement dans la projection horizontale du ressort et retard dans la marche; mais l'action magnétique continuant, le spiral dépassera cette position normale et se déformera en sens contraire, et alors l'accélération se manifestera."

The above passage is not very intelligible, since the basis of Ansart-Deusy's deductions is not in accordance with the facts. For firstly, he obviously thinks throughout of a flat spiral only, while all the box, and almost all the pocket chronometers have, on account of the easier adjustment for isochronism, cylindrical spiral springs. And further, his considerations apply only to the ideal vertical section of the spiral, by which the single parts of the spring, though in reality curved in the plane of the spiral, appear as straight lines; and, naturally, the results obtained for the sections (or projection) do not necessarily hold good for the spring itself. And the action which he assumes to take place would only be possible if both ends of the sections of the spring (— —) were fixed, which is certainly not the case. But even if all these objections did not exist, a very strong magnet indeed would be required to produce any deformation of a spring, even when acting in the direction of the greatest elasticity, *i.e.* vertically to the flat side; and it is not probable that the rigidity of the spring would admit of any deformation when the magnet acted on its edge. We see, therefore, that the whole deduction of Ansart-Deusy is totally erroneous, and, since it forms the point of issue for all his speculations, it will hardly be necessary to reproduce them. Suffice it to say, that all cases of observed acceleration serve him as proofs of his theory, and that also the accidental variations, such as sudden changes of the chronometer's correction without a change of rate, are according to him due to magnetic action. Such irregularities, which generally will find their explanation in a fault of the mechanism,\* as perhaps in a weakness of the escapement spring, by which more teeth of the escapement wheel than one slip by at a time ("tripping"), are, for instance, observed by Mouchez (No. 24), and, significantly enough, in chronometers of one maker (Winnerln) only. And since Ansart-Deusy imagines by Mouchez's Tables, that these chronometers are less subject to the influence of temperature, and the reverse in the other instruments, he is led to the strange remark:—"Est ce que dans certains instruments le compensateur agirait à bord comme compensateur magnétique et que dans d'autres chronomètres il agirait comme compensateur thermométrique seulement?" which is hardly compatible with a thorough knowledge of a chronometer's mechanism. And further on, though he knows and criticises Fisher's (No. 5) and Barlow's (No. 6) Papers, still their results do not affect his theory at all.—The experiment which he communicates illustrates this

\* Similar remark by A. Lédieu (No. 30, on p. 70).

pre-occupation very well. He approached from above a magnet of moderate power to a chronometer of Jacob, which was not sensitive to temperature, and had a very uniform rate of + 15<sup>s</sup> to + 16<sup>s</sup> daily. The result was—

11th January, rate + 15<sup>s</sup>·5 gaining “marche ordinaire.”

12th „ „ + 36·2 „ under the influence of the magnet.

13th „ „ + 76·4 „ the first day after the removal of the magnet; and not until the 14th January did the rate again become + 15<sup>s</sup>·5, and remain so. The interesting fact in this experiment, which deserves further observation, viz., the continuation of acceleration after the removal of the magnet, Ansart-Deusy explains, according to his theory, by a repeated deformation of the spiral (once by the magnet and then by terrestrial magnetism). It is, of course, difficult to explain it satisfactorily from the few dates given; it is, however, probably an effect of the retentiveness of magnetization of the steel in balance and balance spring. Ansart-Deusy continues, that his not being acquainted with the position of the balance in the chronometer rendered it impossible to apply the magnet in the plane (!) of the spiral. He thinks, however, that there would have been no disturbance of rate, for then the deformation of the spiral would have taken place in its plane only, and, therefore, without any alteration of the length of its projection. This statement is the more extraordinary, as one look into the chronometer would have sufficed to show the situation of the balance; and since Ansart-Deusy ought to have known from Fisher's and Barlow's experiments that a most considerable effect would have taken place—in fact that in Fisher's experiments the effect of the magnet *decreased* when the magnet was *not* lying in the plane of the balance (page 14).

Finally, Ansart-Deusy suggests as the place where a chronometer ought to be kept on board ship the point of intersection of the two axes of the ship's induced magnetism, which are to be determined once with the vessel lying in the magnetic meridian and then at right angles to it. This rule, with which perhaps Givry's\* and Guépratte's\* are identical, does not take the ship's permanent magnetism into account; its idea, however, to place the chronometer in the point of magnetic equilibrium is certainly well worth an experimental investigation.

\* Givry's (No. 21) advice is to avoid the proximity of masses of iron, as well as too small a distance of the instruments *inter se*. This distance, he says, should not be less than two decimetres, “pour éviter les chocs et l'effet de l'attraction magnétique qu'elles pourraient exercer les unes sur les autres lorsqu'elles sont mises en mouvement.” Guépratte (quotation by Ansart-Deusy) says: “On les installera vers le milieu du bâtiment, où les mouvements sont moins sensibles, de manière de les garantir de l'influence magnétique des pièces de fer du bâtiment et des accidents imprévus.”

## XII.

[DELAMARCHE AND PLOIX.]

The experiments of Delamarche and Ploix, the last that came to my knowledge, were made with the practical view of ascertaining whether, and how far, the ship's iron could have any influence upon a chronometer, or whether the influence which a ship's magnetism is known to exercise upon a compass would be sufficient to produce any sensible irregularity in the rate of a chronometer.

Thus Delamarche and Ploix produced, by means of magnetic bars, a deviation of a compass-needle from  $15^{\circ}$  to  $40^{\circ}$ , which is the deviation observed in an iron vessel, and replaced afterwards the compass by a chronometer, in order to obtain in the changes of rate which might occur a measure for the action of the ship. These experiments were carried on during the time from June 1858 to January 1859. The number of chronometers experimented upon was nine; the periods of exposure (or non-exposure) to the magnetic action were from five to ten days. The results are given in a Table (*l. c.*, p. 264), which I reproduce. (*See* p. 43.)

The conclusions drawn from this Table by Delamarche and Ploix run literally as follows:—"La colonne 5 de ce tableau donne les différences entre la moyenne des marches avant et après l'épreuve et la moyenne des marches pendant l'épreuve. Ces différences, qui généralement ne sont que de quelques centièmes de seconde, quelles que soient les déviations produites, la position des barreaux, l'état des chronomètres et les circonstances extérieures de température ou autres, nous semblent indiquer que l'état magnétique des bâtiments n'a pas d'influence sensible sur les marches des chronomètres et qu'il faut attribuer à d'autres causes les perturbations qui se manifestent dans ces instruments lorsqu'on les a transportés de terre à bord et réciproquement.

"Les résultats de nos expériences sont donc contraires à l'opinion émise par quelques physiciens, opinion d'après laquelle le magnétisme pourrait déterminer des variations de marches s'élevant à plusieurs secondes."

Now it is true that the above experiments show but very little effect upon the chronometers' rates; it appears, however, probable that there is some—for instance in the first two experiments, where it is much to be regretted that the same arrangement of magnets (at first two, then a third compensating one) has not been applied alternately at different times. But it is very doubtful if Delamarche and Ploix's conclusion is to be admitted as a general one; since after all the preceding facts and observations, especially those of Barlow (p. 16 ff.), it is to be considered highly probable that other instruments (perhaps with some fixed magnetism) would have shown more conspicuous effects. This shows how desirable it would

Chronomètre.	Marche moyenne		Moyenne des Marches avant et après l'épreuve.	Marche pendant l'épreuve.	Différence	Déviation du Compas.	Remarques.
	avant l'épreuve.	après l'épreuve.					
Winnert, 227, sortant de réparat.	+ 1 <sup>m</sup> .68	+ 2 <sup>m</sup> .18	+ 1 <sup>m</sup> .93	+ 1 <sup>m</sup> .54	- 0 <sup>m</sup> .39	13°	Deux barreaux dans le plan du chron. à 1 <sup>m</sup> .40
—	—	—	—	+ 1 <sup>m</sup> .87	- 0 <sup>m</sup> .06	—	Ajouté un 3 <sup>e</sup> barreau qui compense l'effet des deux premiers.
—	+ 2 <sup>m</sup> .18	+ 1 <sup>m</sup> .98	+ 2 <sup>m</sup> .08	+ 2 <sup>m</sup> .28	+ 0 <sup>m</sup> .20	—	Un barr. horiz. à 1 <sup>m</sup> au-dessous du chron. direction N. et S.
—	+ 1 <sup>m</sup> .98	+ 2 <sup>m</sup> .00	+ 1 <sup>m</sup> .99	+ 1 <sup>m</sup> .93	- 0 <sup>m</sup> .06	—	Id.
—	—	—	—	+ 2 <sup>m</sup> .15	+ 0 <sup>m</sup> .16	20	Le même barreau direction E. et Ouest.
Breguet, 834, neuf, . . .	+ 2 <sup>m</sup> .10	+ 2 <sup>m</sup> .05	+ 2 <sup>m</sup> .07	+ 1 <sup>m</sup> .91	- 0 <sup>m</sup> .16	—	Barreau vertical; le pôle N. à 0 <sup>m</sup> .50 au-dessous du chron.
—	+ 2 <sup>m</sup> .05	+ 2 <sup>m</sup> .05	+ 2 <sup>m</sup> .05	+ 2 <sup>m</sup> .05	0	40	
Motel, 253, réparé, . . .	+ 1 <sup>m</sup> .17	+ 1 <sup>m</sup> .42	+ 1 <sup>m</sup> .30	+ 1 <sup>m</sup> .38	+ 0 <sup>m</sup> .08	—	
Berthoud, 303, réparé, . . .	+ 1 <sup>m</sup> .67	+ 1 <sup>m</sup> .63	+ 1 <sup>m</sup> .65	+ 1 <sup>m</sup> .71	+ 0 <sup>m</sup> .06	—	
Berthoud, 248, réparé, . . .	+ 0 <sup>m</sup> .75	+ 0 <sup>m</sup> .50	+ 0 <sup>m</sup> .62	+ 0 <sup>m</sup> .90	+ 0 <sup>m</sup> .28	45	
Motel, 261, réparé, . . .	- 2 <sup>m</sup> .22	- 2 <sup>m</sup> .18	- 2 <sup>m</sup> .20	- 2 <sup>m</sup> .22	- 0 <sup>m</sup> .02	—	
Winnert, 366, réparé, . . .	+ 0 <sup>m</sup> .02	+ 1 <sup>m</sup> .30	+ 0 <sup>m</sup> .66	+ 0 <sup>m</sup> .40	- 0 <sup>m</sup> .26	(a)	Tous ces chronomètres sont soumis à l'action d'un barreau aimanté placé à 0 <sup>m</sup> .50.
—	+ 1 <sup>m</sup> .30	+ 1 <sup>m</sup> .29	+ 1 <sup>m</sup> .29	+ 1 <sup>m</sup> .12	- 0 <sup>m</sup> .17	—	
Motel, 223, venant de campagne,	- 14 <sup>m</sup> .6	- 15 <sup>m</sup> .00	- 14 <sup>m</sup> .8	- 15 <sup>m</sup> .3	- 0 <sup>m</sup> .50	—	
Breguet, 4891, Id.	- 4 <sup>m</sup> .70	- 4 <sup>m</sup> .90	- 4 <sup>m</sup> .80	- 4 <sup>m</sup> .66	+ 0 <sup>m</sup> .14	—	

La moyenne des différences sans considération de signe est de 0<sup>m</sup>.14, et il y a lieu de remarquer que les deux derniers de ces chronomètres ayant trois ans d'huiles, ne doivent pas marcher régulièrement.  
 (a) Cette première expérience semblait indiquer un changement dans la marche du chronomètre; ce changement est probablement dû à des causes différentes de l'action magnétique.

be to carry on experiments like the above with chronometers of known magnetic qualities; but more will be said about this later on. Some features in the present experiments deserve attention, as the production of a special compass deviation, but otherwise they show a considerable want of systematic arrangement. And further, as the differences between the mean rates before and after the experiment are sometimes larger than the final values in the fifth column, the reliance to be put in the results becomes rather questionable. The following remark of Delamarche and Ploix shows, however, that this want of accuracy was not unintentional:—"Nous savons bien que ces expériences laissent à désirer sous le rapport de la précision, mais il nous a semblé que, pour le but que nous proposons, il était inutile de pousser plus loin l'exactitude. Nos recherches tendent seulement à indiquer de quel ordre sont les influences diverses auxquelles sont dues les variations de marche des chronomètres, afin d'attirer l'attention des horlogers en ce qui concerne la construction de ces instruments et celle des marins en ce qui concerne leur usage."

### XIII.

It remains now, before we proceed to discuss the best arrangement of chronometrical experiments, to review briefly the few suggestions made in order to avoid the magnetic influence upon a chronometer. As to the removal of iron out of the chronometer, and the destruction of magnetic intensity in the iron parts, we refer to the remarks on p. 11; and as to the proper placement of the chronometer on board ship, see p. 41. The rules of Shadwell (No. 28) are somewhat similar to Givry's; he only recommends, in addition, to keep the XII-VI lines, in all chronometers, always in the same direction relative to the "fore-and-aft" line of the vessel, in order to make an eventual magnetic influence affect all chronometers similarly. There are also to be considered the suggestions of Barlow, Scoresby, and Airy.

Barlow (No. 6) thinks it possible to determine, beforehand, a "ship's rate,"\* by observing the chronometer in the neighbourhood of a vertical iron disc, the influence of which is supposed to be equal to that of the ship's iron. This method of representing the ship's iron is now superseded; the idea of Barlow's suggestion, however, deserves attention and an experimental trial. This could, perhaps, be arranged, if a list of the rates was furnished (with the usual temperature list), which the chronometer would have for different degrees of deviation, produced in a compass standing in the place of the chronometer, and if the deviation of a

\* Peter Lecount (No. 7) (cf. p. 16) thinks it would be impossible to determine a sea-rate, on account of the considerable changes of the magnetic power and direction of the ship's iron in different dips.



compass in the chronometer's place on board ship was determined before the chronometer was installed on board (cf. p. 7). After the foregoing experiments of Delamarche and Ploix, it does not appear probable that, in the majority of cases, there would be very sensible differences of rate (cf. also pp. 22 and 23).

Scoresby (No. 8) tried to avoid the influence of terrestrial magnetism (or rather the changes of this influence) by keeping the chronometer always in the same situation relative to the magnetic meridian. His contrivance, which is intended to serve this purpose, consisted of a thin plate (a compass card without a needle) connected with a compass needle at a distance of 5 inches, and suspended horizontally upon a point (with an agate cap), so that it was freely carried round by the magnetic needle. Thus, when a pocket chronometer was laid on the plate, it was obviously kept in the same position as to the magnetic meridian as long as the needle continued to traverse. If then the precaution was used to take the rate on shore while the chronometer was fixed in a certain position on this apparatus, there would be every chance of its maintaining its rate at sea, while the *dip* was nearly the same; "for the action of terrestrial magnetism, combined with that of the local attraction of the ship, would produce a mean action on the bar carrying the chronometer, and a similar action on the chronometer." And further, he says:—"Under great changes, indeed, in the magnetic intensity or dip, a chronometer even thus situated might be liable to a small variation in its rate; but were the rate of the chronometer taken in various positions in the apparatus, and the position where its rate was nearest a mean given for its permanent position, then, I imagine, its rate would be uniform under all magnetic dips, and under all ordinary changes of intensity." This apparatus (a drawing of which is given by Scoresby on his plate xxiii.) was found to answer very well. Scoresby was at first doubtful "whether a plate, however light, when loaded with the weight of a pocket chronometer, could be made to traverse by the polarity of only a compass-needle; and whether, within a moderate compass, the magnet intended for directing the plate could be so far removed from the chronometer as to prevent all fear of additional mischief from its proximity." But on trial it was found that the plate for the chronometer traversed when loaded with a pound weight avoirdupois, and that at 5 inches distance the influence of the directing needle was only equal to the directing force of the earth on a horizontal needle in Britain. "Now," Scoresby continues, "such a degree of influence would probably be an advantage to the chronometer's going rather than otherwise; because the denomination of magnetism in either end of the needle, operating on the part of the chronometer to which it was most contiguous, would be of the opposite kind to that of the earth operating on the same part of the chronometer; hence the tendency of the magnetism of the needle on the chronometer (being the opposite of that of the earth, and nearly equivalent in intensity) would be to neutralize the effect of the magnetism of the earth on the chronometer." If this remark holds good, it would obviously make the above

apparatus of Scoresby—viz. for the turning of the chronometer—quite unnecessary; and that this idea of compensating the terrestrial magnetism is effective we see from Airy's compensation (No. 22), which is based upon exactly the same consideration, and perhaps suggested by the above remark of Scoresby.

Airy's rule is: "The action of terrestrial magnetism upon a magnetic chronometer may be annihilated by placing the chronometer upon the top of a compass-box, whose needle is perfectly free, provided that its elevation above the compass is properly adjusted." This elevation of the magnetic part of the chronometer is that, in which a small compass-needle, placed above the large compass, loses its directive power. When, accordingly, the chronometer Brockbanks (cf. p. 36, ff.) was placed above a large compass in such a way that its balance (where the magnetism was assumed to lie) was as nearly as possible at the same height with the small compass-needle, the result was (I reproduce only the mean rates):

	Free.	Placed on the Compass.
XII pointing N.	− 4 <sup>s</sup> ·64	− 6 <sup>s</sup> ·90
„ E.	− 8·70	− 8·10 (one day only.)
„ S.	− 9·61	− 8·17
„ W.	− 5·71	− 6·75;

the effect of the compass was therefore not sufficient. When it was raised by  $\frac{1}{4}$  of an inch, the rates became

XII pointing N.	− 7 <sup>s</sup> ·96
„ E.	− 9·20
„ S.	− 9·54
„ W.	− 8·41.

The error still lying in the same direction, the compass was again raised by  $\frac{1}{4}$  of an inch, and it was observed,

XII pointing N.	− 9 <sup>s</sup> ·24
„ E.	− 9·41
„ S.	− 9·75
„ W.	− 10·03,

or the chronometer is somewhat supercorrected. The small remaining discrepancy does not follow the same law as the original discordance, which Airy supposes to be due to the influence of the steel parts of the chronometer upon the compass, so that it did not entirely neutralize the terrestrial magnetism. It appears, therefore, to be advisable to make use of strong compasses which bear a greater distance from the chronometer. Airy is surprised at the necessity of bringing the large compass nearer to the chronometer than to the small compass-

needle; he thinks the most probable explanation would be the assumption that the magnetism was chiefly lying in the spiral spring instead of the balance. Finally, Airy condenses the above method of compensating the effect of terrestrial magnetism into six rules, of which the first four describe the way of adjusting the height of the chronometer above the compass. No. 5 points out that in different magnetic latitudes it will be necessary to repeat the experiment from time to time, and to alter the adjustment accordingly. And, lastly, No. 6 runs literally: "The amount of discordance depending on magnetic action is a matter of no consequence whatever, and needs not to be ascertained beforehand. The same arrangement of the compass which corrects a small discordance will correct a large one, and will do no harm to the chronometer if it have no discordance whatever."

#### XIV.

From the experiments and speculations, reproduced and discussed in the preceding pages, we perceive that experiments with single chronometers are not likely to lead to *general* results. But still it appears that such experiments would be exceedingly valuable and interesting, since they would always throw more light upon the peculiarities and complications which the disturbance of rate produced by magnetism may assume in different instruments. It is unnecessary to say that these experiments would increase in importance with the number of chronometers made use of. It is therefore highly desirable that the institutes for testing chronometers would take up these magnetic investigations.

The chronometers experimented upon should all be instruments whose compensation for the effects of temperature is known to be efficient within the usual limits, or has been sufficiently determined, so as to render the elimination of the errors arising from this source possible. Besides this, the precaution should always be used to keep the temperature—if necessary, by artificial means—as equal as possible throughout the duration of the experiments. As a further general rule, it is to be deduced from the preceding pages, that the most comparable and important results would be obtained if the different kinds of experiments described, viz., observations of chronometers in different azimuths, under the influence of soft iron, and of magnets; were all made, one after the other, upon one and the same chronometer. Thus a relation between the effects of terrestrial and artificial magnetism and of soft iron (or induced magnetism) might probably be arrived at. It is likely that a chronometer which is influenced by terrestrial magnetism will also (and only then) be affected by soft iron, and that, on the other hand, a magnet will disturb each chronometer, no matter whether it shows reaction to the earth and soft iron, or not.

The following remarks concern more the special arrangement of the experiments :—

The chronometers should always, whether under the influence of the earth, soft iron, or a magnet, be observed in at least four different azimuths; if possible, their rates should be determined in more positions (especially as to the magnet), but then it must be adhered to as a general rule, that the detached rate is always to be derived in the same position of the chronometer relative to the magnetic pole of the earth, as was done with reference to the artificial magnet. Thus only would strictly inter-comparable results be arrived at. The turning of the chronometer is not to take place round the centre of the dial or box, but round the centre (or rather vertical axis) of the balance and spring. It is not probable that this will have any sensible effect upon the results of the observations with varied azimuths; but the values obtained by experiments with magnets will undoubtedly become more regular and systematic, and probably admit of a mathematical treatment similar to that proposed by Airy (p. 38). Obviously, the proper centre round which the chronometer should be turned, so as to produce equal and opposite effects upon the balance and spring in opposite directions, need not necessarily coincide with the centre of the balance (on account of the other steel parts of the instrument), but it will not be very far from it. A determination of this proper centre would, however, be very interesting: some method by which perhaps it may be done will be pointed out afterwards. The primitive or starting direction, from which the azimuths are to be counted, should not be the XII–VI line of the dial, but the direction which the cross-bar of the balance (being the line of symmetry of the balance) assumes when the balance is at rest. This line will probably coincide with the XII–VI line in most instruments (cf. p. 32), but not necessarily, and should always be ascertained previously to the experiments. The turning should be done in the succession N., E., S., W. (cf. Airy, p. 38). The time during which the chronometer remains in each position should not be less than one day, nor exceed two (cf. p. 36): the most advisable time of exposure is probably one day, and the more so, as in magnetic experiments too long an exposure to the magnet in one direction should be avoided.

The above remarks contain everything necessary for the observation of rates in different magnetic azimuths; it is only to be added that, in case there should be a sensible difference between these rates, Airy's method of compensating the terrestrial influence — strictly arranged as described by him — should be applied (cf. p. 46).

Experiments with soft iron, which should succeed the "azimuth" observations, are highly desirable on account of their immediate practical applicability. It would further be important to decide whether an eventual effect of terrestrial magnetism is altered sensibly by the addition of soft iron. Their arrangement is, perhaps, best made after Barlow's plan (p. 17, *seq.*, p. 21): a ball (or bar or plate) of soft

iron is to be brought into the magnetic meridian ; the magnetic intensity to be determined in its vicinity by means of a compass, and the chronometer placed in such a way that the balance occupies the place of the compass-needle as nearly as possible. Then the chronometer is to be turned as before. Variations of interest and importance could be made by putting the chronometer into places of different intensities (which can be varied by changing the distance or the relative position as to the ball), and especially by placing the soft iron in succession N., E., S., W. of the balance, and turning the chronometer through the four azimuths once in each position.

The magnetic experiments which will have to follow those with soft iron will be similarly arranged: the soft iron is to be replaced by a magnet, and the chronometer under its influence turned through the different azimuths. The variations and complications desirable are naturally more numerous here, and may perhaps be classified under the following heads:—

1. Relative position of the magnet as to the chronometer.

*a.* The magnet is at first to be placed in the plane of the magnetic meridian and that of the balance.

*b.* The magnet is to remain parallel to the preceding position, but raised above or lowered beneath the plane of the balance. The results in these two positions as to the balance are likely to be different, since the spiral spring lies on one side of the balance (underneath). As the effects of the magnet upon the balance at equal distances above or below its plane would most probably be equal if there were no spiral spring, we have here, perhaps, a means of separating the influence upon the balance from that upon the spiral, inasmuch as an eventual difference between the effects in these two positions might be attributed to the spiral spring alone. This variation of the experiments appears, therefore, particularly important.

*c.* The magnet remaining in the magnetic meridian, but forming different angles with the balance plane. Here exist two specially prominent positions: one parallel to the needle of inclination, and the other vertical to the plane of the balance, above or below the centre or special points of its circumference. The differences of rate to be expected will be of considerable interest, being again partly due to the spiral spring.

*d.* The magnet is to be placed out of the plane of the magnetic meridian, but in the plane of the balance, forming different angles with the primary direction—or, which is the same, the chronometer is to be kept fixed, and the magnet is to be shifted round through different azimuths. It would be particularly valuable to ascertain if there is any sensible difference between the magnetic influence in this and in the arrangement described under *a*.

*e.* The distance of the magnet from the balance is rather a critical point; for though it is at least not very probable that a magnet will impart its magnetism

easily to the steel parts of the chronometer, still some caution ought to be used. Here lies a great advantage of the "azimuth" and "soft iron" experiments over the magnetic ones, since the former cannot possibly do any hurt to the chronometer, and may, therefore, be carried on safely with the best and most sensitive instruments. It is, however, not probable that a distance of the magnet corresponding to a compass deviation of  $45^\circ$  or even  $90^\circ$  will have any other than a transient effect upon the chronometer. It would be particularly interesting to investigate how far and in what proportion variations of the magnet's distance are accompanied by variations of rate. In order to ascertain this, the distance should be varied so as to alter the deviation of the needle successively by 5 degrees. This should at first be done with the magnet in position *a*; but it would obviously be also of great interest in the following arrangements (*b* to *d*).

*f.* Delamarche and Ploix's experiments with different magnets acting simultaneously (cf. pp. 42, 43) should be repeated. It should especially be ascertained whether the position of magnets, compensating each other's effect upon a compass, differs much from that of the same magnets when mutually neutralizing their influence upon a chronometer. This experiment would probably lead to a knowledge of the point of equilibrium, mentioned before (p. 48), round which, strictly speaking, the chronometer ought to be turned.

2. All the above experiments under 1 are, if possible, to be made with both poles of the magnet alternately, since we have seen that a difference between their actions frequently takes place, and is always to be presumed when the balance or the spiral have acquired fixed magnetism.

3. A question of special importance is, whether the effects of a magnet upon a chronometer, when applied in exactly the same way at *different* temperatures, would differ sensibly from each other. Generally speaking, some difference seems to be probable, since the actions of temperature and magnet upon balance and spring may lie either in the same or opposite directions.

4. Finally, we may repeat our remark, that all the above experiments would gain considerably in importance if they could be made upon chronometers, the steel parts (especially balance and spiral) of which have been separately tested as to fixed magnetic qualities, and are known to be either unmagnetic or to have permanent magnetism in a special distribution, which has been previously ascertained. In such a case the experiments should be arranged with reference to the magnetic axis of the balance instead of to its line of symmetry.

I do not dwell upon the variation that could be brought into these experiments by replacing the steel balance and spring by others of different metals, since this could not be done without considerable expense, nor without the assistance of an experienced chronometer-maker.

After the preceding suggestions, I should propose the following arrangement as an instance of a series of experiments upon a chronometer, which may form the

beginning of a longer and more thorough investigation, but which by itself would doubtless lead to remarkable results:—

1. "Azimuth" observations, 3 revolutions of chronometer, N., E., S., W., . . . . .	12 days.
2. Soft iron in the meridian, 3 revolutions, N., E., S., W., . . . . .	12 ,,
3. One revolution as under 1, . . . . .	4 ,,
4. Magnet in meridian at balance height, deviation 45°, 3 revolutions N., E., S., W., <i>north pole</i> , . . . . .	12 ,,
5. One revolution as under 1, . . . . .	4 ,,
6. Arrangement as under 4, chronometer fixed, magnet turned N., E., S., W. three times, . . . . .	12 ,,
7. One revolution as under 1, . . . . .	4 ,,
8. Experiments as under 4, <i>south pole</i> , . . . . .	12 ,,
9. One revolution as under 1, . . . . .	4 ,,
10. Experiments as under 6, <i>south pole</i> , . . . . .	12 ,,
11. One revolution as under 1, . . . . .	4 ,,
12. Repetition of experiments under 2, . . . . .	12 ,,
13. Repetition of experiments under 1, . . . . .	12 ,,

---

Total, 116 days.

The different desirable variations of the above series suggest themselves sufficiently after the preceding remarks, so as to render further comment upon them unnecessary. I only need point out in a general sketch what I consider to be an arrangement of magnetic experiments upon chronometers which would be least open to objections, and most likely to lead to a final solution of the question as far as its peculiar character admits.

## CHRONOLOGICAL LIST OF PAPERS QUOTED.

## 1.—S. VARLEY :

“On the Irregularity in the Rate of Going of Time-pieces, occasioned by the Influence of Magnetism.” [Dated, May 31, 1798.]—*The Philosophical Magazine*, by Alexander Tilloch, vol. i., pp. 16–21. London, 1798.

## 2.—LIEUTENANT MUDGE, R. N. :

“On the Difference between the Land and Sea Rates of Chronometers, deduced from the Register kept on board H. M. Ship ‘Leven,’ in two Voyages to the Cape de Verd Islands.”—*The Edinburgh Philosophical Journal*, conducted by Dr. Brewster and Professor Jameson, vol. v., pp. 378–380. Edinburgh, 1821.

## 3.—LIEUTENANT MUDGE, R. N. :

“On the Magnetic Influence of the Islands of S. Mayo and the Great Salvage.”—*Ibid.*, pp. 381–383.

## 4.—GEORGE COLEMAN :

Tables (Appendix to the following Paper of George Fisher). [Dated, June 5, 1820].—*Philosophical Transactions of the Royal Society of London* for 1820, p. 208, ff.

## 5.—GEORGE FISHER :

“On the Errors in Longitude as determined by Chronometers at Sea, arising from the Action of the Iron in the Ships upon the Chronometers.” [Dated, June 8, 1820].—*Ibid.*, pp. 196–207.

## 6.—PETER BARLOW :

“On the Effects produced in the Rates of Chronometers by the Proximity of Masses of Iron.” [Dated, June 28, 1821].—*Philosophical Transactions* for 1821, pp. 361–389. London, 1821.

This Paper has been frequently reprinted: for instance, in *The Edinburgh Philosophical Journal*, vol. v., 1821 (pp. 383–385). A further mention of it is made in the *Astronomische Nachrichten*, No. 2, p. 31, 1821, in a letter of Barlow to the editor. About this we find the following remark of F. W. Bessel in *Recensionen von F. W. Bessel*, Rudolf Engelmann, Leipzig, 1878, p. 256: — “Barlow zeigt an, dass das Eisen auf den Schiffen auch den Gang der Chronometer ändere; eine erhebliche Bemerkung, wenn sie sich bestätigt! Bei der jetzigen Vortrefflichkeit der Chronometer von Breguet, Jürgensen und Kessels könnte man leicht auf dem Lande entscheidende Versuche darüber anstellen.”



7.—PETER LECOUNT :

“On the Effect of Magnetism on Chronometers.” [Dated, November 10, 1821.]—*The Edinburgh Philosophical Journal, &c.*, vol. vi., pp. 238-239. Edinburgh, 1822.

8.—WILLIAM SCORESBY :

“Observations on the Errors in the Sea-Rates of Chronometers, arising from the Magnetism of their Balances; with Suggestions for Removing this Source of Error.” [Read to the Society, April 15, 1822.]—*Transactions of the Royal Society of Edinburgh*, vol. ix., pp. 353-364. 1823.

This Paper is mentioned in *Allgemeine Encyclopädie der Physik* von Gustav Karsten, 1. Band, Einleitung in die Physik von G. Karsten, F. Harms und G. Weyer, p. 638. § 187. Leipzig, 1869.

9.—GEORGE HARVEY :

“On a Remarkable Case of Magnetic Intensity of a Chronometer.” [Dated, August 12, 1823.]—*Transactions of the Royal Society of Edinburgh*, vol. x., pp. 117-126. 1824.

Briefly abstracted in *The Edinburgh Philosophical Journal, &c.*, vol. x., p. 349. 1824.

Abstracted in *Quarterly Journal of Science, Literature, and the Arts*, vol. xvii., p. 364. 1824.

10.—GEORGE HARVEY :

“Remarks on the Influence of Magnetism on the Rates of Chronometers.” [Dated, October 10, 1823.]—*The Edinburgh Philosophical Journal, &c.*, vol. x., pp. 1-11. 1824.

11.—GEORGE HARVEY :

“Appendix to the Essay on the Influence of Magnetism on the Rates of Chronometers,” published in No. 9. [Dated, February 16, 1824.]—*The Edinburgh Philosophical Journal, &c.*, vol. x., pp. 342-346. 1824. (An Appendix to No. 10.)

Abstract (together with No. 10) in *Quarterly Journal, &c.*, vol. xvii., p. 366. 1824.

12.—GEORGE HARVEY :

“On the Alteration of Rate produced in Chronometers by the Influence of Magnetism.” [Dated, May 20, 1824.]—*Quarterly Journal of Science, Literature, and the Arts*, vol. xvii., p. 197 (No. 34). London, 1824.

Abstract in *The Mechanics' Magazine*, vol. ii., p. 325. London, 1824.

13.—GEORGE HARVEY :

“Observations on the Rate of a Chronometer when under the Influence of Magnetism.” [Dated, June 26, 1824.]—*The Edinburgh Journal of Science*, conducted by David Brewster, LL.D., &c., vol. i., pp. 335-338. Edinburgh and London, 1824.

14.—PETER BARLOW :

“Conjectures as to the Cause of the High Degree of apparent Acceleration in the Rates of the Chronometers observed by Mr. Fisher, and reported by him in the *Philosophical Transactions*.” [Cf. No. 5.]—*The Edinburgh Journal of Science*, conducted by David Brewster, &c., vol. v., pp. 224-227. 1826.

15.—H(ORNER) :

“Einfluss des Magnetismus' auf den Gang der Chronometer.”—Johann Samuel Traugott Gehler's “*Physicalisches Wörterbuch*,” neu bearbeitet von Brandes, Gmelin, Horner, Muncke, Pfaff. Zweiter Band, C und D, p. 111. Leipzig, 1826.

16.—ABRAHAM :

[Moyen de neutraliser le magnétisme du balancier et des autres pièces d'acier des ouvrages d'horlogerie.]—*Society for the Encouragement of Arts*, vol. xlv., and *Technical Repository*, March, 1827, p. 140.

Abstract by Chev . . . t in *Bulletin des Sciences technologiques*, rédigé par M. Dubrunant, cinquième section du *Bulletin Universel des Sciences et de l'Industrie*, publié sous la direction de M. le B<sup>on</sup> De Férussac, tome huitième, p. 53. Paris, 1827.

17.—ARNOLD AND DENT :

“Magnetic Experiments on Chronometers.” [Dated, April 11, 1833.]—*The Nautical Magazine and Naval Chronicle*, vol. ii., p. 262, ff.

18.—S. G. NORTHCOTE :

(Table).—*Nautical Magazine*, 1837, pp. 164, 165.

An Appendix to the following No. 19.

19.—GEORGE FISHER :

“Effects of Magnetism on the Rates of Chronometers.” [Dated, July 10, 1836.]—*The Nautical Magazine*, 1837, p. 160.

Mentioned in Henry Raper, “The Practice of Navigation,” p. 174, 10th ed., 1870.

20.—ROBERT FITZ ROY :

“Narrative of the Surveying Voyages of His Majesty's Ships ‘Adventure’ and ‘Beagle’ between the years 1826 and 1830,” &c. Appendix to vol. ii., pp. 326, 327, 345, 346. London, 1839.

21.—A. GIVRY :

“Memoire sur les montres marines et sur les principales observations de l'astronomie nautique,” &c.—*Annales maritimes et coloniales*, &c., par M. Bajot et M. Poirrée. Vingt cinquième année, seconde série, partie non officielle, tome i., pp. 753, seq. 1840.

22.—G. B. AIRY :

“Magnetism of Chronometers.” [Dated, February 22, 1840.]—*The Nautical Magazine*, 1840, p. 231.

An Abstract is given by Ellis in *The Horological Journal*, &c., vol. viii., pp. 90, seq. April 1, 1866.

23.—POUILLET :

“Éléments de Physique expérimentale et de Météorologie,” vol. i., septième édition, p. 425. Paris, 1856.

Reproduced after the 6th edition by Ansart-Deusy (cf. No. 25).

24.—E. MOUCHEZ :

“Observations chronométriques faites pendant la Campagne de Circumnavigation de la Corvette ‘La Capricieuse,’” &c.—Publié sous le ministère de S. E. l'Amiral Hamelin, &c., p. 19. Paris, 1855.

In this brochure the criticism of Lesquen de la Menardais's Paper is given.

25.—ANSART-DEUSY :

“Étude sur les Causes Perturbatrices de la Marche des Chronomètres.” [Dated, February, 1858.]—Brest, 1858 (Lefournier Ainé, Grand rue 86). 8vo. 30 pp.

In this brochure a rule for the placement of the chronometer by Guépratte is given. The passage from Pouillet is also reprinted (cf. No. 23).

26.—DELAMARCHE ET PLOIX :

“Influence de l'état magnétique des bâtiments sur la marche des chronomètres.” [Read, March 7, 1859.]—*Comptes rendus hebdomadaires des Séances de l'Académie des Sciences*, tome quarante huitième, p. 462, seq. Paris, 1859.

27.—A. WACKERBARTH :

“On the Cause of Irregularity in the Rate of a Chronometer.” [Dated Upsala, March 20, 1859.]—*Monthly Notices of the Royal Astronomical Society*, vol. xix., pp. 222, 223. 1859. Additional Remark by the Astronomer Royal.

28.—CHARLES F. A. SHADWELL :

“Notes on the Management of Chronometers, and the Measurement of Meridian Distances,” new edition, chap. ii., p. 13. London, 1861.

Some remarks of the Astronomer Royal (out of a letter to the Hydrographer) reprinted.

29.—DR. CARL BÖRGEN :

“Längenbestimmungen auf See und die wissenschaftliche Behandlung der Chronometer-Beobachtungen.”—*Hydrographische Mittheilungen*, 1. Jahrgang, pp. 297, 300. Berlin, 1873.

30.—A. LEDIEU :

“Les Montres Marines, Description, Théorie et Perturbations.” (Extrait des “Nouvelles Méthodes de Navigation.”)—Opuscule rédigé pour la partie technique avec le concours de M. A. H. Rodanet, Constructeur de Chronomètres, pp. 67, 68, 70, 71, 73. Paris, 1877.

31.—EUGEN GELCICH :

“Chronometer-Studien und Anwendung der Wahrscheinlichkeits-Theorie auf die Chronometrie.”—*Mittheilungen aus dem Gebiete des Seewesens*, Band vi., p. 529. 1879.

In this Paper mention is made (partly with short abstracts) of Nos. 5, 6, 17, 21, 25, 26.

## CONTENTS.

	Page
I.—Introduction, . . . . .	1
II.—Changes of Rate with a Change of the Place of the Chronometer—Land and Sea Rates, . . . . .	2
III.—Magnetic State of Steel Parts in the Work of a Chronometer, and Suggestions for the Removal of it, . . . . .	8
IV.—Magnetic Experiments by S. Varley and G. Fisher—Criticism by P. Barlow, . . . . .	12
V.—Experiments with Soft Iron by P. Barlow—General Considerations by P. Lecount, . . . . .	16
VI.—General Considerations and Magnetic Experiments by W. Scoresby, . . . . .	21
VII.—Magnetic Experiments and General Discussions by G. Harvey, . . . . .	24
VIII.—Magnetic Experiments by Arnold and Dent, . . . . .	32
IX.—Observations of the Rates of a Chronometer in Different Azimuths by G. Fisher and S. G. Northcote, . . . . .	35
X.—Similar Observations by G. B. Airy, . . . . .	36
XI.—General Considerations and Magnetic Experiments by Ansart-Deusy, . . . . .	39
XII.—Magnetic Experiments by Delamarche and Ploix, . . . . .	42
XIII.—Suggestions, how to avoid the Magnetic Influence upon a Chronometer, by P. Barlow, W. Scoresby, and G. B. Airy, . . . . .	44
XIV.—Arrangement of further Experiments, . . . . .	47
Chronological List of Papers quoted, . . . . .	52

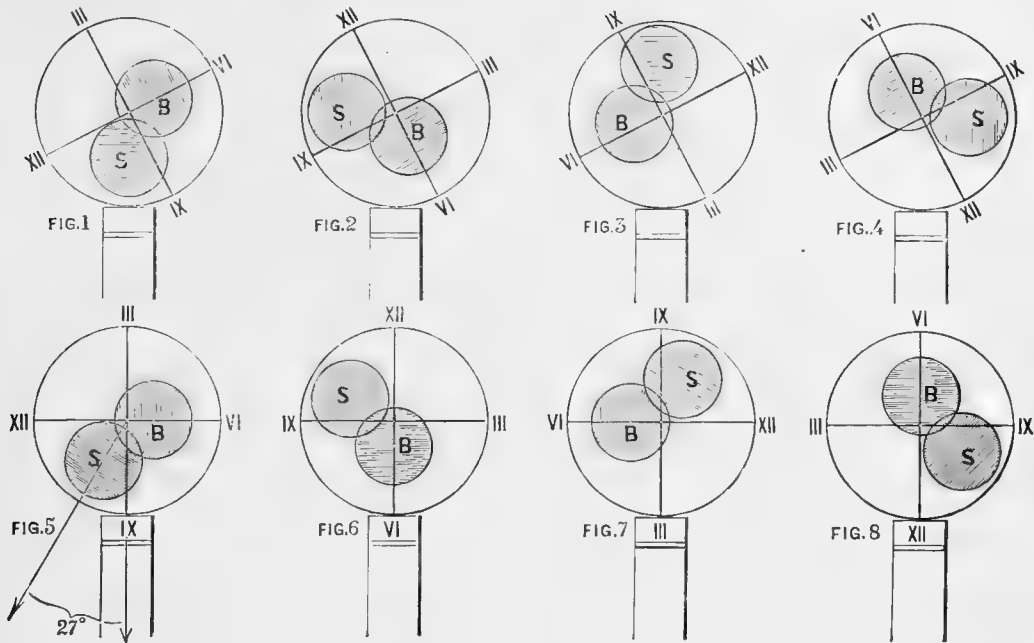

FIG. 9

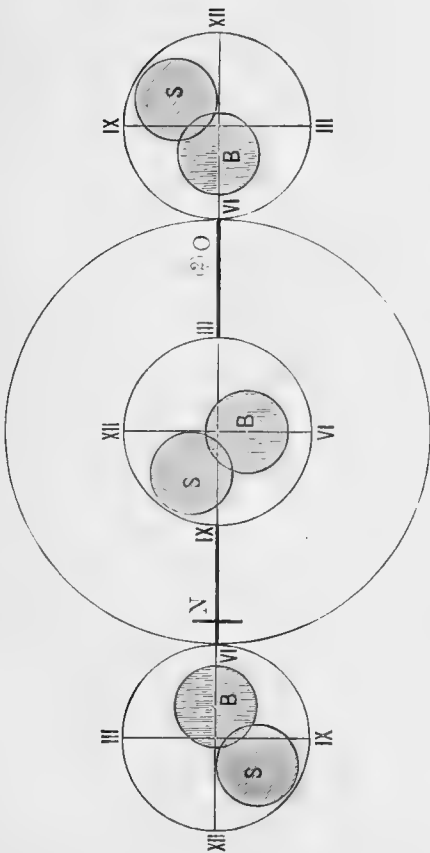
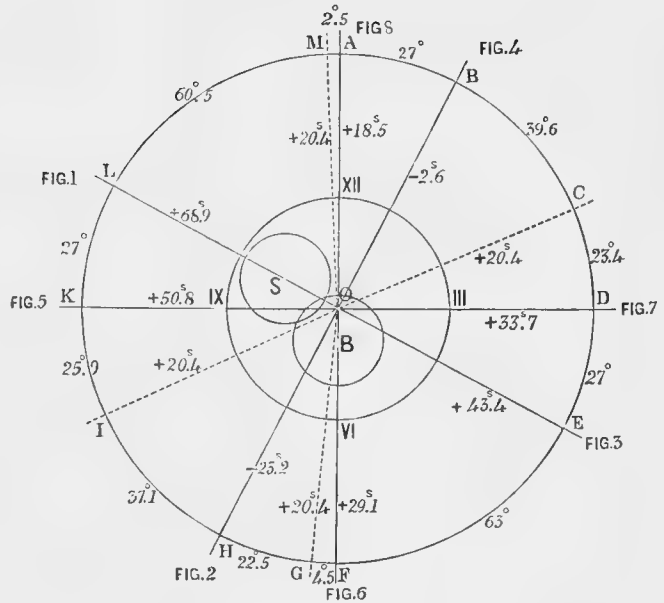

FIG. 10



100



# TRANSACTIONS (NEW SERIES).

(*Recently Published.*)

## VOLUME I.

PART

- 19.—Palæo-Geological and Geographical Maps of the British Islands and the adjoining parts of the Continent of Europe. By EDWARD HULL, LL.D., F.R.S., &c., Director of the Geological Survey of Ireland, and Professor of Geology in the Royal College of Science, Dublin. Plates XXII. to XXXV. (November, 1882.)
- 20.—Notes on the Physical Appearance of the Planet Mars during the Opposition in 1881. Accompanied by Sketches made at the Observatory, Birr Castle. By OTTO BOEDDICKER, PH.D. Plates XXXVI. and XXXVII. (December, 1882.)
- 21.—Notes on the Aspect of Mars in 1882. By C. E. BURTON, B.A., F.R.A.S., as seen with a Reflecting Telescope of 9-inch Aperture, and Powers of 270 and 600. Plate XXXVIII. (January, 1883.)
- 22.—On the Energy expended in Propelling a Bicycle. By G. JOHNSTONE STONEY, D.SC., F.R.S., a Vice-President of the Society; and G. GERALD STONEY. Plates XXXIX., XL., and XLI. (January, 1883.)
- 23.—On Electromagnetic Effects due to the Motion of the Earth. By GEORGE FRANCIS FITZGERALD, M.A., F.T.C.D., Erasmus Smith's Professor of Experimental Science in the University of Dublin. (January, 1883.)
- 24.—On the Possibility of Originating Wave Disturbances in the Ether by Means of Electric Forces:—Corrections and Additions. By GEORGE FRANCIS FITZGERALD, M.A., F.T.C.D. (January, 1883.)
- 25.—On the Fossil Fishes of the Carboniferous Limestone Series of Great Britain. By J. W. DAVIS. Plates XLII. to LXV. (September, 1883.) [*With Title-page to Volume.*]

## VOLUME II.

- 1.—Observations of Nebulæ and Clusters of Stars, made with the Six-foot and Three-foot Reflectors at Birr Castle, from the year 1848 up to the year 1878. Nos. 1 & 2. By the RIGHT HON. THE EARL OF ROSSE, LL.D., D.C.L., F.R.S. Plates I. to IV. (August, 1879.) No. 3. Plates V. and VI. (June, 1880.)
- 2.—On Aquatic Carnivorous Coleoptera or Dytiscidæ. By DR. SHARP. Plates VII. to XVIII. (April, 1882.) [*With Title-page to Volume.*]

## VOLUME III.

- 1.—On the Influence of Magnetism on the Rate of a Chronometer. By OTTO BOEDDICKER, PH.D. (September, 1883.) Plate I.



[MARCH, 1884.]

THE  
SCIENTIFIC TRANSACTIONS  
OF THE  
ROYAL DUBLIN SOCIETY.

VOLUME III. (SERIES II.)

---

II.—*On the Quantity of Energy transferred to the Ether by a Variable Current.*  
By GEORGE F. FITZGERALD, M.A., F.T.C.D., F.R.S.

---

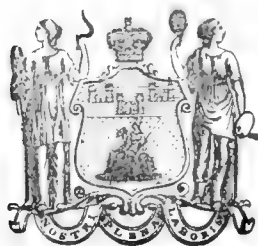

DUBLIN:  
PUBLISHED BY THE ROYAL DUBLIN SOCIETY.  
PRINTED AT THE UNIVERSITY PRESS, BY PONSONBY AND WELDRICK,  
PRINTERS TO THE SOCIETY.  
1884.

---

*Price One Shilling.*



II.—ON THE QUANTITY OF ENERGY TRANSFERRED TO THE ETHER BY A  
VARIABLE CURRENT. BY GEORGE F. FITZGERALD, M.A., F.R.S.

[Read, November 19, 1883.]

I TAKE the simple case of a small circular current varying according to the simple periodic pendulum law.

If the current be a small circle of radius  $a$  round the origin in the plane  $xy$ , then the direction of the electro-magnetic potential ( $\mathfrak{A}$ ) at any point is evidently in the circumference of a circle through the point parallel to the current, and whose centre is on the axis of  $z$ , and its amount is

$$\mathfrak{A} = \mu\alpha \int \frac{i \cos \theta d\theta}{r},$$

when  $\theta$  is the angle between the element of current  $ad\theta$  and the plane through the axis of  $z$  and the point, and  $i$  the intensity of the current.

This value is not the complete value when  $i$  varies, because there are then displacement currents due to the variations of electric displacement which produce electro-magnetic potentials of their own. The complete value of  $\mathfrak{A}$  must, however, be such as to satisfy the equation

$$\Delta^2 \mathfrak{A} + K\mu \mathfrak{A} = 0,$$

for all points outside the current, and must vanish at infinity.

Now, if  $i$  be simply periodic we may assume

$$i = i_0 \cos 2\pi \frac{t}{T},$$

and if we take

$$\mathfrak{A} = \mu\alpha i_0 \int \frac{\cos \frac{2\pi}{T} (t - \sqrt{K\mu} \cdot r)}{r} \cos \theta d\theta,$$

it, as a function of  $r$ , satisfies the required conditions, and for small values of  $r$  and large values of  $T$  is the same as if we neglected the displacement currents.

In order to get the energy of the ether due to the displacement currents in it we must calculate

$$T = \frac{1}{2} \iiint (Fu + Gv + Hw) dx dy dz = \frac{1}{2} \iiint S(\mathfrak{A}\mathfrak{C}) dx dy dz.$$

Now, as  $\mathfrak{C} = -\frac{K}{4\pi} \mathfrak{A}$  in this case, and as  $\mathfrak{A}$  is parallel to  $\mathfrak{a}$ , inasmuch as  $\mathfrak{A} = -\frac{4\pi^2}{T^2} \cdot \mathfrak{a}$ ,

$$T = -\frac{K}{8\pi} \iiint \mathfrak{a} \mathfrak{A} dx dy dz = \frac{K\pi}{2T^2} \cdot \iiint \mathfrak{a}^2 dx dy dz$$

$$= \frac{K \cdot \mu^2 \cdot \pi}{2T^2} (ai_0)^2 \iiint \cdot \left( \int \frac{\cos \frac{2\pi}{T} (t - \sqrt{K\mu}r)}{r} \cos \theta d\theta \right)^2 dx dy dz.$$

In order to calculate this we must calculate the value of

$$\left( \int \frac{\cos \frac{2\pi}{T} (t - \sqrt{K\mu}r)}{r} \cos \theta d\theta \right)^2$$

$$= \left( \cos \frac{2\pi}{T} t \int \frac{\cos \frac{2\pi}{T} \sqrt{K\mu}r}{r} \cos \theta d\theta + \sin \frac{2\pi t}{T} \int \frac{\sin \frac{2\pi \sqrt{K\mu}r}{T}}{r} \cos \theta d\theta \right)^2.$$

Now as all we require is the average energy of the vibration, it evidently depends on the part independent of the time in this, *i. e.* on

$$\left( \int \frac{\cos \frac{2\pi}{T} \sqrt{K\mu}r}{r} \cos \theta d\theta \right)^2 + \left( \int \frac{\sin \frac{2\pi}{T} \sqrt{K\mu}r}{r} \cos \theta d\theta \right)^2.$$

If we call  $\frac{2\pi\sqrt{K\mu}}{T} = l = \frac{2\pi}{\lambda}$ , when  $\lambda$  is the wave length, we require to calculate the values of

$$\int \frac{\cos lr}{r} \cos \theta d\theta, \quad \text{and of} \quad \int \frac{\sin lr}{r} \cos \theta d\theta.$$

In order to do this I shall assume  $a$  the radius of the current small, and take  $R$  the distance of the point from the centre of the current, and  $p$  its distance from the axis of  $z$ ; then

$$r = (R^2 - 2ap \cos \theta + a^2)^{\frac{1}{2}} = R \left( 1 - \frac{ap}{R^2} \cos \theta \right);$$

therefore  $\cos lr = \cos lR + \frac{lap}{R} \sin lR \cdot \cos \theta$ ;

and  $\frac{\cos lr}{r} = \frac{\cos lR}{R} + \frac{ap}{R^3} \cos \theta (\cos lR + lR \sin lR)$ .

Similarly,  $\frac{\sin lr}{r} = \frac{\sin lR}{R} + \frac{ap}{R^3} \cos \theta (\sin lR - lR \cos lR)$ .

therefore,  $\int_0^{2\pi} \frac{\cos lr}{r} \cos \theta d\theta = \pi \cdot \frac{ap}{R^3} \cdot (\cos lR + lR \sin lR)$

$$\int_0^{2\pi} \frac{\sin lr}{r} \cos \theta d\theta = \pi \cdot \frac{ap}{R^3} \cdot (\sin lR - lR \cos lR).$$

Hence the sum of the squares of these integrals is

$$= \pi^2 a^2 \cdot \frac{p^2}{R^6} (1 + l^2 R^2).$$

So that the average value of  $T$  is

$$T = (\pi a^2 i_0)^2 \frac{\pi K \mu^2}{2 T^2} \iiint (1 + l^2 R^2) \frac{p^2}{R^6} dx dy dz.$$

If this be integrated over the sphere of which  $R$  is a radius, it will give the average energy on that sphere.

Now,  $p = R \sin \phi$ ,  $dx dy dz = R^2 \sin \phi d\phi \cdot d\psi \cdot dR$ .

So that if we assume  $R$  constant, the average superficial energy is

$$\begin{aligned} &= (\pi a^2 i_0)^2 \cdot \frac{l^2 \mu}{8\pi} (1 + l^2 R^2) \frac{4\pi}{3R^2}, \\ &= (\pi a^2 i_0)^2 \frac{l^2 \mu}{6} \left( l^2 + \frac{1}{R^2} \right). \end{aligned}$$

Now, one part of this is independent of the size of the sphere, while the other part varies inversely as the square of the distance from the current. It is evidently only the first part of the energy that is really radiated; and if we assume that it moves with the same velocity as the waves,  $= \frac{1}{\sqrt{K\mu}}$ , we find that the energy radiated per second is

$$\begin{aligned} &= (\pi a^2 i_0)^2 \cdot \frac{l^4 \mu}{6 \sqrt{K\mu}}, \text{ or as } l = \frac{2\pi \sqrt{K\mu}}{T} \text{ if } V = \frac{1}{\sqrt{K\mu}} \\ &= (\pi a^2 i_0)^2 \frac{8\mu \pi^4}{3 T^4 V^3}. \end{aligned}$$

Except for the coefficient  $\frac{8}{3} \pi^4$ , this value can be got by considering the dimensions of the quantities involved, if we assume that the energy radiated is proportional to the square of the moment of magnetism of the radiating particle ( $\pi a^2 i_0$ ), which is evidently the case from the value of the energy in the form  $Fu + Gv + Hw$ , as  $F, G, H$  and  $u, v, w$  are all proportional to this moment.

If we calculate the amount of this energy we find that it is very small, except for very rapid vibrations indeed. For  $\frac{8\pi^4}{3} = 260 q.p.$ , while

$$V^3 = 26 \times 10^{30}; \text{ therefore } \frac{8\pi^4}{3 V^3} = 10^{-29} q.p.;$$

and as  $\mu$  generally equals unity in electro-magnetic measure, the energy radiated

$$= (\pi a^2 i_0)^2 \times N^4 \times 10^{-29},$$

where  $N$  is the number of vibrations per second, so that even if it were as many as ten million per second ( $10^7$ ), the energy radiated would still be only  $\frac{1}{16} (\pi a^2 i)^2$  ergs per second.

If we knew what the radiating power of a gas were, and assumed that its molecules gave their energy to the ether according to the same laws as varying electric currents do, we might estimate the magnetic moment of what correspond to electric currents in a molecule.

The energy in the neighbourhood of the radiating point that I rejected as varying with the distance from it, and consequently as unconnected with the radiation, is what would be got if we neglected the effects of induction of the displacement currents; *i. e.* it is the energy of the forced displacement currents produced directly by the variation of the primary current, and which start the radiating displacement currents. This part of the whole energy in the medium is but a small part of that at any point except within a few wave lengths of the origin.



## TRANSACTIONS (NEW SERIES).

### VOLUME I.

PART

- 21.—Notes on the Aspect of Mars in 1882. By C. E. BURTON, B.A., F.R.A.S., as seen with a Reflecting Telescope of 9-inch Aperture, and Powers of 270 and 600. Plate XXXVIII. (January, 1883.)
- 22.—On the Energy expended in Propelling a Bicycle. By G. JOHNSTONE STONEY, D.SC., F.R.S., a Vice-President of the Society; and G. GERALD STONEY. Plates XXXIX., XL., and XLI. (January, 1883.)
- 23.—On Electromagnetic Effects due to the Motion of the Earth. By GEORGE FRANCIS FITZGERALD, M.A., F.T.C.D., Erasmus Smith's Professor of Experimental Science in the University of Dublin. (January, 1883.)
- 24.—On the Possibility of Originating Wave Disturbances in the Ether by Means of Electric Forces:—Corrections and Additions. By GEORGE FRANCIS FITZGERALD, M.A., F.T.C.D. (January, 1883.)
- 25.—On the Fossil Fishes of the Carboniferous Limestone Series of Great Britain. By J. W. DAVIS. Plates XLII. to LXV. (September, 1883.) [*With Title-page to Volume.*]

### VOLUME II.

- 1.—Observations of Nebulæ and Clusters of Stars, made with the Six-foot and Three-foot Reflectors at Birr Castle, from the year 1848 up to the year 1878. Nos. 1 & 2. By the RIGHT HON. THE EARL OF ROSSE, LL.D., D.C.L., F.R.S. Plates I. to IV. (August, 1879.) No. 3. Plates V. and VI. (June, 1880.)
- 2.—On Aquatic Carnivorous Coleoptera or Dytiscidæ. By DR. SHARP. Plates VII. to XVIII. (April, 1882.) [*With Title-page to Volume.*]

---

### VOLUME III.

- 1.—On the Influence of Magnetism on the Rate of a Chronometer. By OTTO BOEDDICKER, PH.D. Plate I. (September, 1883.)
- 2.—On the Quantity of Energy transferred to the Ether by a Variable Current. By GEORGE F. FITZGERALD, M.A., F.R.S.



[MARCH, 1884.]

THE  
SCIENTIFIC TRANSACTIONS  
OF THE  
ROYAL DUBLIN SOCIETY.

VOLUME III. (SERIES II.)

---

III.—ON A NEW FORM OF EQUATORIAL TELESCOPE. BY  
HOWARD GRUBB, M.E., F.R.S. (PLATE II.)

---



DUBLIN:  
PUBLISHED BY THE ROYAL DUBLIN SOCIETY.  
PRINTED AT THE UNIVERSITY PRESS, BY PONSONBY AND WELDRICK,  
PRINTERS TO THE SOCIETY.

1884.

*Price One Shilling.*



III.—ON A NEW FORM OF EQUATORIAL TELESCOPE. BY HOWARD GRUBB, M. E., F. R. S. (PLATE II.)

[Read, January 21st, 1884.]

SOME years ago I devised an Equatorial which was intended to afford special facilities for spectroscopic observations. I here append a woodcut and description from the *Proceedings* of the Royal Dublin Society (Vol. II., N. S., page 362, April, 1880):

“This instrument, though obviously useful in many ways, is principally intended for solar spectroscopic investigation. It occurred to me that while in observing faint objects, such as nebulae, faint companion stars, &c., observers are always most careful to keep their eyes protected from even the faintest light; in observing the faint portion of the extreme ends of the solar spectrum, they are under the very worst possible conditions, for they must needs be in a room blazing with sunlight if they use a spectroscope attached to an ordinary equatorial mounting. I leave it to any observer to say what chance he would have of seeing faint objects in a telescope for ten minutes or a quarter of an hour after leaving a room in which he had been exposed to the electric or other bright light.

“Of course, when it is desired to concentrate on the slit the general light of the Sun for examination, a hole in a shutter can be used and a siderostat outside. But I refer to those observations where it is necessary to form an image of the Sun on the slit of the spectroscope, and examine each part *seriatim*, and this at present can only be done with an equatorially-mounted telescope and spectroscope attached thereto.

“The instrument consists of a cast-iron frame supporting a 4-inch achromatic telescope pointing directly at the south pole of the earth. Below the objective and in line with it is supported a mirror polished with the greatest care to an optically-plane surface, and silvered with a coating of chemically deposited silver.

“The telescope revolves on its own axis, either by hand or by clock work, as required, and this motion corresponds to the right ascension movement of an Equatorial. The mirror has a motion on its axis, and this corresponds to the declination movements of an Equatorial.

“The whole framing is carried, *when not in use*, on four rollers, rolling on a pair of iron rails let into the floor. When required for use the instrument is rolled over to a window specially prepared for it. The lower part of this window opens, and the instrument is rolled out until the mirror, objective, and a certain portion of the tube project outside the building, while the eye-piece remains in a convenient position inside. The wheel is now turned, and the whole frame is lowered down until three levelling screws bear on three cushions of iron specially prepared for them, and let into a solid stone pier just projecting

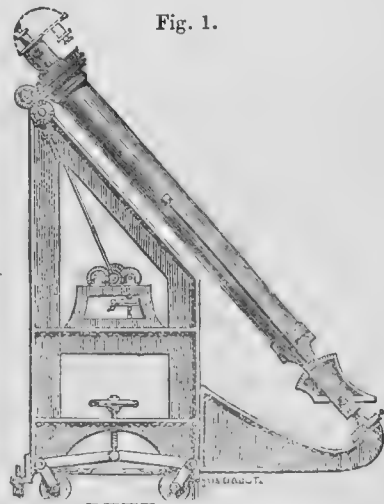

Fig. 1.

through, but quite disconnected from, the floor of the room. The instrument is now in a condition for observing, supported on a solid stone pier, and with its object glass in the open air under most favourable conditions for observation, while the observer is situated most comfortably, and perfectly sheltered, inside the observatory. It should be borne in mind that as there is in this case no open window, or, indeed, any opening in the wall (as the frame is so constructed as practically to keep out draughts), the telescope is not under the unfavourable condition that it would be if simply placed at an open window, where currents of air of differing temperatures just meet and mix. All objects from zenith to south horizon, and from E. to W., are now available for observation.

“For setting the instrument there is a right ascension circle divided to 2 m., and reading to 10 sec., at the upper end of the tube, and there is a declination arc on the mirror frame, read by the microscope from the eye-piece end, and by a peculiar arrangement this microscope also serves for illuminating the declination arc.

“The whole eye-piece also, with its rack and pinion, turns aside, the same motion bringing into the field a low-power lens, which virtually constitutes the telescope a finder with a field of 2°.

“The right ascension quick motion is obtained by drawing the right ascension screw out of gear by the handle, and turning the telescope on its own axis by hand.

“The right ascension slow motion is obtained by the milled head working into differential gearing.

“The declination movements are obtained by the button head (not visible in the figure), which is geared by a long rod and pinion to a toothed arc on the mirror frame.

“Now, this instrument being once got into adjustment, and set on (say) the Sun, the image will remain in the field for any length of time perfectly stationary. Obviously, the attachment of spectroscopes to such an instrument is an easy problem. It should be remembered that as the cushions into which the screws drop when placed in position have certain hollows in them, the instrument, if once adjusted, will always come into adjustment when again lowered into position.”

One of these instruments, of about 4 inches aperture, has been erected at the new Crawford Observatory in Cork, and has proved so useful and convenient, not only for such special work as originally intended, but also for general observations, as to create a general desire that the same principle could be applied to instruments of a large size. I did not see my way, however, to do so, as it involved the figuring of a mirror of at least 50 per cent. greater diameter than that of the objective; say, for such an objective as the Vienna (27 inch), 40 inches in diameter. Although I do not say that this would be impossible, there is no doubt that as no mirror of anything like this size has ever been attempted, success would be problematical, and, even if attained, the cost would be enormous. I therefore dismissed the idea, so far as very large instruments were concerned; but I did so with great regret, for it was in its application to them that I considered it would be most valuable. Afterwards it occurred to me that some advantage would be gained by placing the mirror behind the objective. This would render the construction of the mechanical part a little more complicated, but would reduce the necessary size of the mirror, and also reduce the effect on the image of any residual error of the mirror. I found, however, I gained very little advantage by this change, unless I placed the mirror a considerable distance from the objective, in which case the mechanical arrangements became cumbersome.

Lately, however, it has occurred to me that by using what is generally spoken

of as a "Dialyte" form of telescope I would gain a considerable advantage. To explain this: figure 2 represents a section of the cone of rays in the case of an ordinary achromatic telescope, and figure 3 that of the cone of rays in a dialyte, in which case the achromatism is corrected, not by a flint lens close to the crown, but by a flint, or combination of flint and crown, having a negative power, at a considerable distance from the crown.

Now if these two figures be examined, it will be at once seen that the section of the cone of rays at any given distance from the objective (say, one-third of the whole focus) is much smaller in the case of the dialyte than the ordinary form, and therefore a smaller mirror would suffice.

I have lately had an opportunity of examining one of those dialytes, made by Plössel, and presented by a late Emperor of Austria to the Vienna Observatory,

Fig. 2.

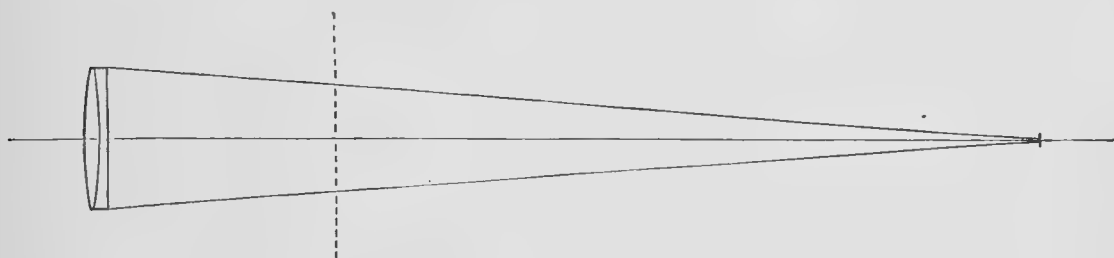
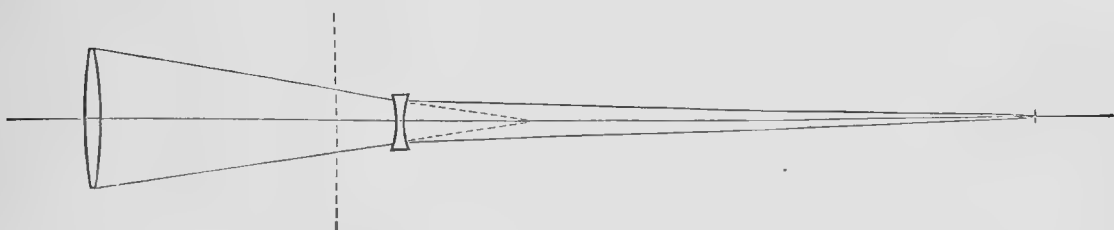

Fig. 3.



and it appears to me that the corrections can be made exceedingly perfect for the centre of the field.

The definition at the edge of the field, however, is not so good as in the ordinary form; but this would not be of so much consequence in large instruments, as the field in such cases is never of great extent.

The dialyte form of telescope was originally devised to meet the exigencies of a time when it was much easier to get large pieces of crown than of flint glass; but of late years it has been more patronized by amateurs than by professional opticians, and for this reason: in the ordinary forms of objectives the curves have to be very accurately calculated and figured, in order to correct both for chromatic and spherical aberration; but in the dialyte, given any three lenses, a large crown, and a small pair of crown and flint only very approximately right in foci and form, and a good dialyte can be made out of them by modifying the various *positions*

of the three components. A variation in distance between the large crown and the small compound corrector gives the correction for achromatism, and a variation in distance between the two components of the corrector gives a correction for spherical aberration.

It can be easily understood that this arrangement possesses special charms for amateurs whose stock of tools is limited.

The form of instrument I would propose for a large size is shown in the accompanying plate (Plate 2), which is drawn to represent one of about 27-inch aperture. The mechanical part consists simply of a polar axis working in a polar pillar *P*, through which at its upper end passes an axis on which swing a pair of light-framed girders, supporting at one end the light crown lens of the objective and at the other a counterpoise. *These girders we may call the tube.* At the intersection of the axes is placed the mirror, mounted on the same axes. By a simple mechanical arrangement this mirror is carried round simultaneously with the tube, but at half its angular velocity, *i.e.*, for every  $10^\circ$  the tube (or girders) carrying the objective swings, the mirror rotates  $5^\circ$ . The result is that the rays are always reflected in a direction towards the pole, *i.e.*, in a continuation of the polar axis; and this evidently is true no matter what the position of the telescope may be either in *A.R.* or declination. In the plate the rays are represented as passing through the walls of the observatory, where the eye-piece is arranged in an eminently comfortable position. The simultaneous motion of tube and mirror is effected, not by gearing, but by a system of steel bands, which work very smoothly and without loss. The correcting lens is placed at, or near, the cube.

*For the motions of the instrument,* steel bands pass round large pulleys, both on *A.R.* and declination axes; these are carried into the lower apartments of the observatory, and attached to the pistons of hydraulic cylinders, the taps of which are connected by long rods with handles in the observer's room, so that he has from his seat complete control over the instrument, without any more manual labour than is necessary to open a water tap.

*For the setting of the instrument.* There are no circles, but the steel bands which drive the instrument are connected to wires which pass to the upper storey of the building over pulleys, and are connected to indices which rise and fall on two scales attached to the wall, and these indicate to the observer the position of the instrument. It may be objected that this method would be open to inaccuracy from variation in temperature of the bands, &c.; but by setting once or twice each evening on some known object any zero error could be sufficiently eliminated.\*

*Clockwork* is shown, applied to drive the instrument; but I am inclined to hope that even this would be unnecessary, and that the water could be made to drive the instrument by a simple form of Clypsedra.

\* Since the above Paper was read, Dr. Huggins, F.R.S., has proposed to the author to have these scales painted with luminous paint, so as to be visible to the observer without the necessity of illumination.

*For protection against weather.* The instrument is shown erected between two walls sufficiently low to allow it to sweep E. and W.; on these walls a wooden framework or roof travels, which can be rolled over the instrument when the tube is placed in a horizontal position.

The instrument commands the heavens from E. to W., and from the south horizon to about  $20^\circ$  beyond the zenith.

In the plate no tube or connexion is shown between the equatorial and the eyepiece—probably in most cases it would be desirable to have a connecting tube; otherwise the images would revolve in the micrometer, and the zero of the position angle would be continually varying. This tube would preferably be made open-work or latticed, to avoid the currents of air which would be liable to be set up in a closed tube, the ends of which would be at different temperatures.

A form of instrument which partially fulfils the conditions I desired to attain to is figured in *Nature* of 8th November, 1883, and one of small size has already been erected in the Paris Observatory. As regards this instrument, I would observe that it possibly possesses an advantage over my form in being absolutely universal; it could, at least, be made so.

This I considered of little consequence, as almost the whole of the work suitable for such a large instrument can be commanded by the form above described. No doubt, universality, if it could be secured without corresponding disadvantages, would be a certain gain; but I believe that in the endeavour to obtain it, and at the same time to make the instrument one of precision, enormous sacrifices have been made; and I look upon the attempt to combine these two qualities in a single telescope as at once vain and unprofitable.

I think I may venture to say that it is the universal opinion of astronomers that no large instruments with two axes, one of which varies in its direction to the horizon, have ever been made instruments of precision. Nor even if they were would they be useful. Such instruments, so far as measuring is concerned, could only be used for measuring differences between the position of objects under examination and some known object close by, whose place has already been determined by instruments of precision, such as transit circles, &c.

In attempting to fulfil the two conditions of universality and precision, the French instrument is supplied with two reflectors, one half way in the tube (which would about correspond with the one in mine), and the other outside the objective.

Now the great difficulty about these instruments is, of course, the production of a perfectly plane surface on the mirror. If it were not for this, they would have been made and universally used long since. Some persons are at present even sceptical of the possibility of any optician producing a sufficiently accurate plane surface. No doubt, at all events, exists that there is no piece of work which calls into play more fully the skill of the mechanic than the production

of a perfect plane ; and, in fact, the skill of such might be estimated by the size of the plane surface which he could produce. For this reason, and keeping in view the fact that no perfect plane of a large size has ever yet been made, I have hesitated to recommend this form of instrument for large sizes until the idea occurred to me of reducing the necessary dimensions of the plane by the combination of the dialyte telescope and siderostatic mounting, as described above. The French, however, seem to have no such fears, for not only have they a mirror inside the tube, but another outside the objective, and the full size of same. A little reflection will show that, assuming any given degree of skill of the optician, the difficulties of construction of the French form are, at least, nine times that of the form above described ; or, putting it in another way, assuming a given degree of accuracy of the optician, the residual error and its effect on the image will be, at least, nine times as great ; for it must be acknowledged, I think, that the difficulties of producing an accurate plane surface vary, at least, as the area, *i.e.*, as the square of the aperture. (Probably nearer to the cube.) Therefore the difficulties in making the mirror outside the objective are four times that of the mirror inside, as it is about double the diameter : and again, as the rays have twice as far to travel from this to the focus as from the small mirror, the effect of any error will be again doubled, so that the difficulties of making the large mirror will be eight times that of the smaller, or, any given error will have eight times the effect on the image. Now the above form has only the inside mirror and none outside. So the effect of any given amount of error will be as 9 to 1.

This is what I meant when I said in an early part of the Paper that I believed enormous sacrifices have been made in the attempt to combine universality and precision in the French instrument. Again, it is clearly for very large instruments, in which the labour of working is great, that this form would be pre-eminently useful. In reading M. Loewy's Paper I imagined that the French instrument must have been of some great size, for speaking of working such telescopes he says :—

“ The rotatory movement of the earth changes at every instant the apparent position of the star which one observes. There follows from this a corresponding change of place for the observer : not a simple movement of his chair to right or left, but a further change of place in height. It is necessary, indeed, to elevate or depress his seat, according to the case. Further, since the telescope is enclosed under a dome which shelters it, and in which is provided a large slit from summit to base, in order to make observations possible, it is necessary to move this opening or slit, in front of the telescope. The dome can in reality turn upon itself. The observation then necessitates the movement of the telescope, that of the observer, and that of the dome, not to speak of the principal movements. If one adds to this that the observer is obliged to seat himself or to stretch himself in a horizontal position, sometimes in a most inconvenient manner, one understands that it may be truly laborious.



“The observing astronomer, whose attention has been divided and engrossed by a series of operations in reality foreign to these studies, may soon feel the approach of lassitude; his wearied eye no longer distinguishes with the same clearness stars of faint lustre; and from this result perceptible accidental errors and a notable loss of time. These inconveniences are so serious, that for certain studies, as the search for comets, when it is necessary to range over a great extent of space, one is obliged to renounce the use of Equatorials of large dimensions; one is reduced then to instruments smaller and less suitable for the exploration of the heavens.”

From this I imagined that the new telescope was to be of great size; but it appears to be only about  $10\frac{1}{2}$ -inch diameter, and I have never heard of any great difficulty in working such a comparatively small instrument as this.

It is, however, as I said, evidently in the case of very large instruments that this form would be most useful. Now, according to M. Loewy's own description, the French form is quite unsuited for such, for he insists that the mirrors must have a thickness of, at least, one-fifth of the diameter. This would make the outside mirror alone for such an instrument as I have sketched about half a ton weight, besides that of the objective, which would be about 200 lbs., and the mounting of the mirror!

Even if any glass manufacturer could be found to undertake the manufacture of such a mirror (which I believe would be impossible), the absurdity of having this three-quarter ton at the end of the cross tube, and yet calling the instrument one of precision, is too apparent to need demonstration.

In the case of the instrument described above, the total weight to be supported on the head of the tube need not be more than 80 lbs., or about  $\frac{1}{6}$  of that of the other form.

Again, it will be observed that, although in the French form the observer is as comfortably situated as in mine, still he has himself to exert all the energy necessary for working the instrument, while in my form this is applied by hydraulic means.

Finally, as to *cost*. It would appear that the French instrument has cost rather more than the same sized Equatorial of the usual form, with dome and equatorial room. I estimate that the form described above can be made for about one-fourth the cost of the usual form of Equatorial and equatorial room, dome, &c.

The necessity has lately become very fully recognized of having some form of Equatorial constructed, in observing with which the astronomer can be placed under the favourable conditions rendered possible by the above described instrument.

Professor Pickering, U. S., in a late address on astronomical subjects, makes special mention of a simple form of instrument with a mirror in front of the objective, as possessing great advantages, particularly for mountain observations and in exposed situations, where it would be practically impossible to work in the open

air with ordinary forms of Equatorials, and when the temporary nature of the observations does not warrant the expense of erecting domes.

The form he speaks of is not an Equatorial, and is very limited in its applications; but the fact that it has been largely adopted in the United States (possessing as it does all the disadvantages and only a few of the advantages of such an instrument as is above described) shows that the want of such a form of observing instrument has been already felt.

---

NOTE ADDED IN PRESS.

Since the above Paper was read, the Governors of the Armagh Observatory have decided on having an instrument made of the form described, and of about 18 inches aperture.

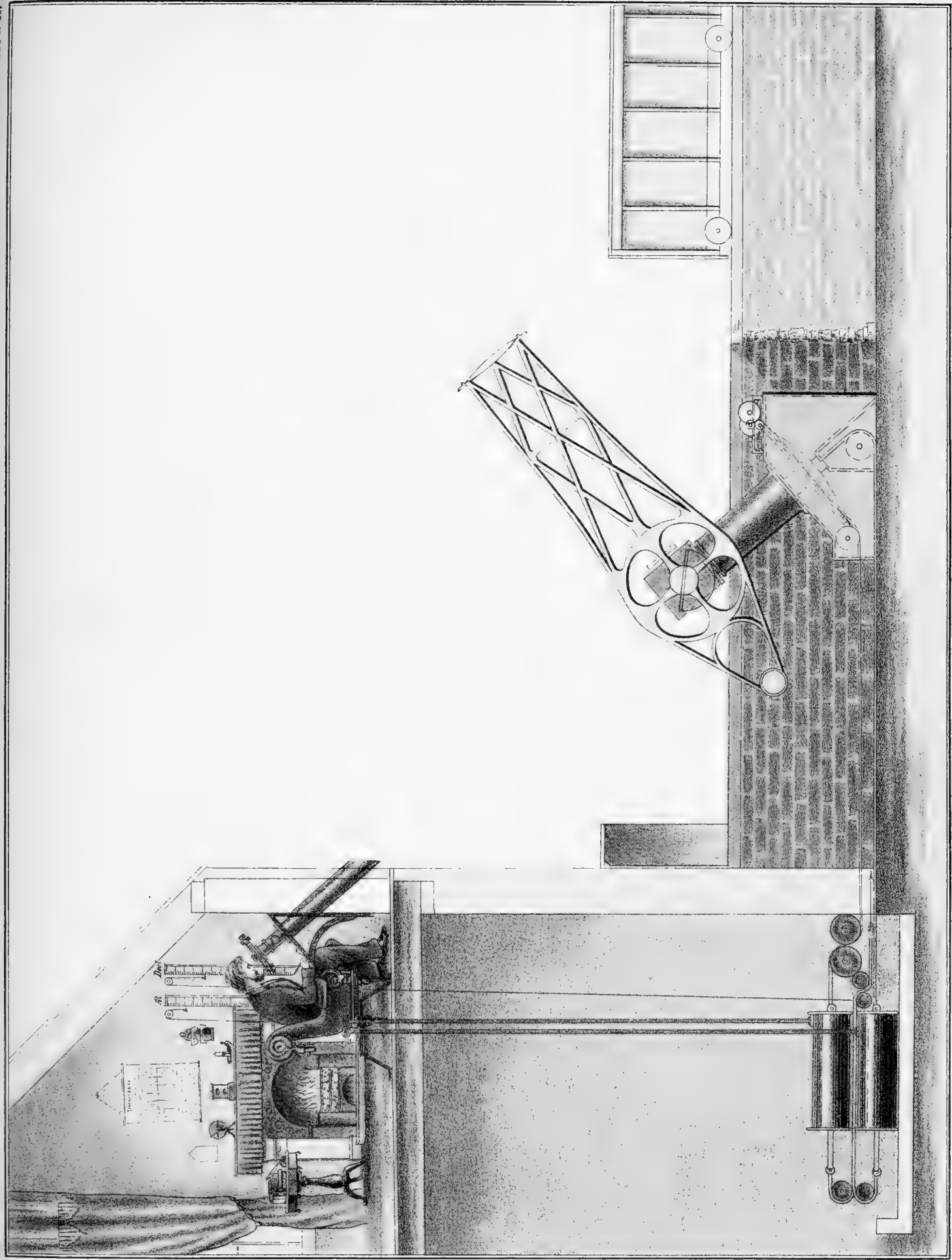





## TRANSACTIONS (NEW SERIES).

### VOLUME I.

#### PART

- 21.—Notes on the Aspect of Mars in 1882. By C. E. BURTON, B.A., F.R.A.S., as seen with a Reflecting Telescope of 9-inch Aperture, and Powers of 270 and 600. Plate XXXVIII. (January, 1883.)
- 22.—On the Energy expended in Propelling a Bicycle. By G. JOHNSTONE STONEY, D.SC., F.R.S., a Vice-President of the Society; and G. GERALD STONEY. Plates XXXIX., XL., and XLI. (January, 1883.)
- 23.—On Electromagnetic Effects due to the Motion of the Earth. By GEORGE FRANCIS FITZGERALD, M.A., F.T.C.D., Erasmus Smith's Professor of Experimental Science in the University of Dublin. (January, 1883.)
- 24.—On the Possibility of Originating Wave Disturbances in the Ether by Means of Electric Forces:—Corrections and Additions. By GEORGE FRANCIS FITZGERALD, M.A., F.T.C.D. (January, 1883.)
- 25.—On the Fossil Fishes of the Carboniferous Limestone Series of Great Britain. By J. W. DAVIS. Plates XLII. to LXV. (September, 1883.) [*With Title-page to Volume.*]

### VOLUME II.

- 1.—Observations of Nebulæ and Clusters of Stars, made with the Six-foot and Three-foot Reflectors at Birr Castle, from the year 1848 up to the year 1878. Nos. 1 & 2. By the RIGHT HON. THE EARL OF ROSSE, LL.D., D.C.L., F.R.S. Plates I. to IV. (August, 1879.) No. 3. Plates V. and VI. (June, 1880.)
- 2.—On Aquatic Carnivorous Coleoptera or Dytiscidæ. By DR. SHARP. Plates VII. to XVIII. (April, 1882.) [*With Title-page to Volume.*]

### VOLUME III.

- 1.—On the Influence of Magnetism on the Rate of a Chronometer. By OTTO BOEDDICKER, PH.D. Plate I. (September, 1883.)
- 2.—On the Quantity of Energy transferred to the Ether by a Variable Current. By GEORGE F. FITZGERALD, M.A., F.R.S. (March, 1884.)
- 3.—On a New Form of Equatorial Telescope. By HOWARD GRUBB, M.E., F.R.S. Plate II.

[JULY, 1884.]

THE  
SCIENTIFIC TRANSACTIONS  
OF THE  
ROYAL DUBLIN SOCIETY.

VOLUME III. (SERIES II.)

---

IV.—CATALOGUE OF VERTEBRATE FOSSILS FROM THE SIWALIKS OF  
INDIA, IN THE SCIENCE AND ART MUSEUM, DUBLIN. BY  
R. LYDEKKER, B.A., F.G.S., F.Z.S. (PLATE III. AND WOODCUTS.)

---



DUBLIN:  
PUBLISHED BY THE ROYAL DUBLIN SOCIETY.  
PRINTED AT THE UNIVERSITY PRESS, BY PONSONBY AND WELDRICK,  
PRINTERS TO THE SOCIETY.  
1884.

---

*Price One Shilling.*





IV.—CATALOGUE OF VERTEBRATE FOSSILS FROM THE SIWALIKS OF INDIA  
 IN THE SCIENCE AND ART MUSEUM, DUBLIN. BY R. LYDEKKER,  
 B.A., F.G.S., F.Z.S. (Plate III. and Woodcuts.)

[Read, March 17, 1884.]

HAVING been recently engaged in naming and cataloguing the valuable collection of Vertebrate Fossils from the Siwaliks\* of India which are contained in the Dublin Museum of Science and Art, I have thought it advisable to submit this Catalogue, with a few notes on the more important specimens, to the Royal Dublin Society, in the hope that they may deem it worthy of a place among their publications. I am induced to do this from the circumstance that the collection contains a considerable number of extremely rare and even unique specimens (many of which I have lately had an opportunity of figuring and describing in the "Palæontologia Indica"; and the figures of which, by the permission of the Superintendent of the Geological Survey of India, are here reproduced); whence it is extremely important that there should be a permanent and easily accessible record of the whole contents of the collection. It is only by the publication of catalogues like the present that collections of special interest and value contained in local museums can be made useful to students working on the subjects of such collections.

The present collection, as I am informed by the Director of the Museum, has been made by the fusion of five smaller collections; and in its present condition is probably second only to the collection of the British Museum, among the collections of the United Kingdom. The specimens from each of the five minor

\* It may be well to mention that the Siwaliks of India, Burma, and Perim Island, in the Gulf of Cambay, correspond in the main to the pliocene of Europe, but may possibly also contain some representations of the upper miocene. For the distribution of the formation the reader is referred to Medicott and Blanford's "Manual of the Geology of India" (Calcutta, 1879); and for the vertebrate fauna to Falconer and Cautley's "Fauna Antiqua Sivalensis" (London, 1846-49); to "The Palæontological Memoirs of the late Hugh Falconer," edited by Chas. Murchison (London, 1868); and to the works of the present writer in the Memoirs of the Geological Survey of India ("Palæontologia Indica," ser. x., vols. i., ii., iii.).

collections are indicated in this catalogue by a distinctive letter; the origin of the five collections being as follows:—

- A. Specimens from the Sub-Himalayan Siwaliks, presented by the Board of Trinity College.
- B. Specimens from the Sub-Himalayan Siwaliks, from the old collection of the Museum of Trinity College, presented by the Board.
- C. Specimens from the Sub-Himalayan Siwaliks, purchased from Dr. Beatty by the Royal Dublin Society.
- D. Specimens presented by Sir Proby T. Cautley to the Museum of the Royal Dublin Society.
- G. Specimens from the Siwaliks of Perim Island, Gulf of Cambay, presented by the Board of Trinity College.

The specimens in the series A, B, D, and G, although interesting, and affording a number of specimens of good typical value, are not of especial value; since they consist entirely of remains belonging to species abundantly represented in the British Museum and other large collections. The case is, however, very different with series C, which contains the above-mentioned rare or unique specimens. This series is especially rich in the remains of Carnivora, which are, comparatively speaking, of extremely rare occurrence in the Siwaliks; it also contains some valuable remains of *Rhinoceros* and *Sus*, and a few reptilian and fish remains, which are probably new. Apparently all the specimens in this series were collected by the late Generals Sir W. E. Baker and Sir H. M. Durand, who were among the earliest collectors of Siwalik fossils, and obtained a large series of very valuable specimens. A large number of the Dublin specimens, together with other specimens now in the British Museum, were described and figured by those palæontologists in the "Journal of the Asiatic Society of Bengal."\* How these valuable specimens came into the possession of Dr. Beatty is not recorded; and the present writer had long been fruitlessly endeavouring to discover what had become of them, until he was informed of their existence in Dublin, by the present Director of the Museum, when Professor of Geology at Trinity College.

In general the present catalogue merely records the name of each specimen, but in the case of some of the more important specimens in series C a brief *resumé* of some of the most striking specific characters is appended. The collection, like all collections of Siwalik bones, embraces a large number of the remains of bovoid, antelopoid, and cervoid ruminants, which it is in most cases impossible to determine even generically: these are, therefore, very generally entered in the catalogue merely as belonging to undetermined ruminants.

CLASS: MAMMALIA.

ORDER: CARNIVORA.

Family I.—*Mustelidæ*.

C. 45. *MELLIVORA SIVALENSIS* (Falc. and Caut.).—Nearly complete cranium and left ramus of the mandible. The palatal and mandibular dentition of this specimen is represented in the accompanying woodcut (figure 1); reproduced from “Pal. Ind.,” ser. x., vol. ii., p. 182. The only other known specimen of the remains of this species of ratel is a cranium in the British Museum, represented in plate xxvi. of the above-quoted volume. The species is closely allied to the existing ratels of India and Africa.

Family II.—*Canidæ*.

C. 42 b, 43, 44. *CANIS CAUTLEYI*, Bose.—Cranium, with two associated fragments of the mandible. The hinder palatal and mandibular dentition of this specimen is represented in woodcut, figure 2; reproduced from “Pal. Ind.,” ser. x. vol. ii.,

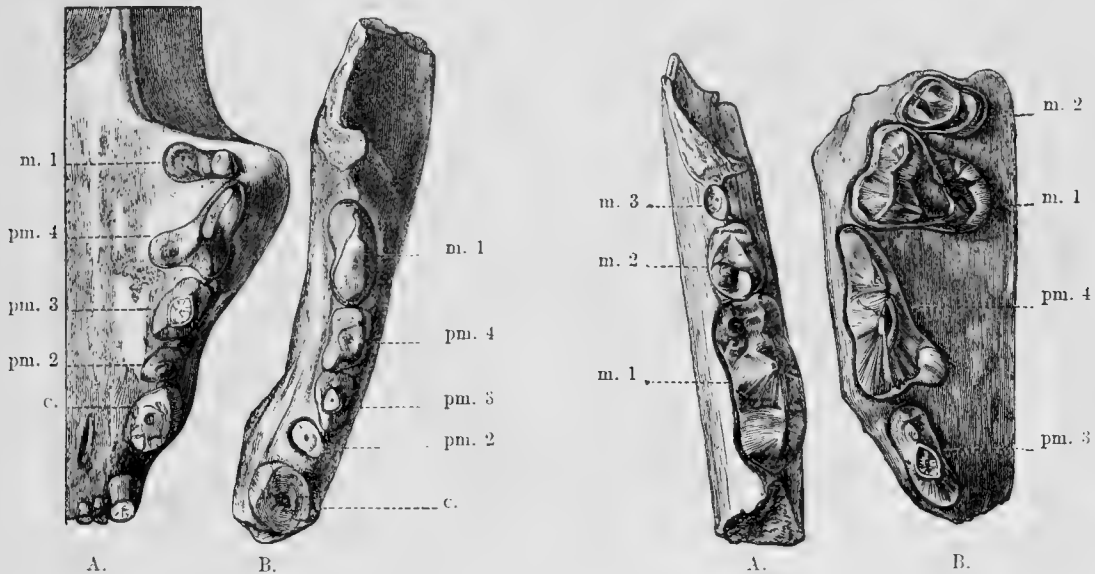

FAMILY I.  
Fig. 1. *Mellivora sivalensis* (F. and C.). The right half of the palate (A), and the left ramus of the mandible (B).

FAMILY II.  
Fig. 2. *Canis cautleyi*, Bose. Part of the left ramus of the mandible (A) and the left side of the palate (B).

p. 260. The present cranium is the only known example; this species of Siwalik wolf being represented in other collections only by a fragment of the maxilla in the Indian Museum, Calcutta, and two broken mandibles in the British Museum.\*

\* These specimens are figured in pl. xxxiii. of the volume quoted.

The Siwalik wolf cannot be certainly identified with any described form, although in many respects it was closely related to the existing wolves of the Old World. The occurrence of this fossil in the Siwaliks is one of extreme importance in regard to the pliocene age of at least a large portion of those deposits; since, in the tertiaries of Europe, with which the Siwaliks are in many respects closely allied, true wolves are unknown before the pliocene, though they are said to occur in the upper miocene of North America.

Family III.—*Hyænidæ.*

C. 42. *HYÆNA FELINA*, Bose.—Cranium, with the mandible attached; represented on a reduced scale in woodcut (figure 3); reproduced from "Pal. Ind.," ser. x., vol. ii., p. 283. This fine specimen is by far the most valuable one in the Society's collection: the only other known cranium, which is considerably damaged, is in

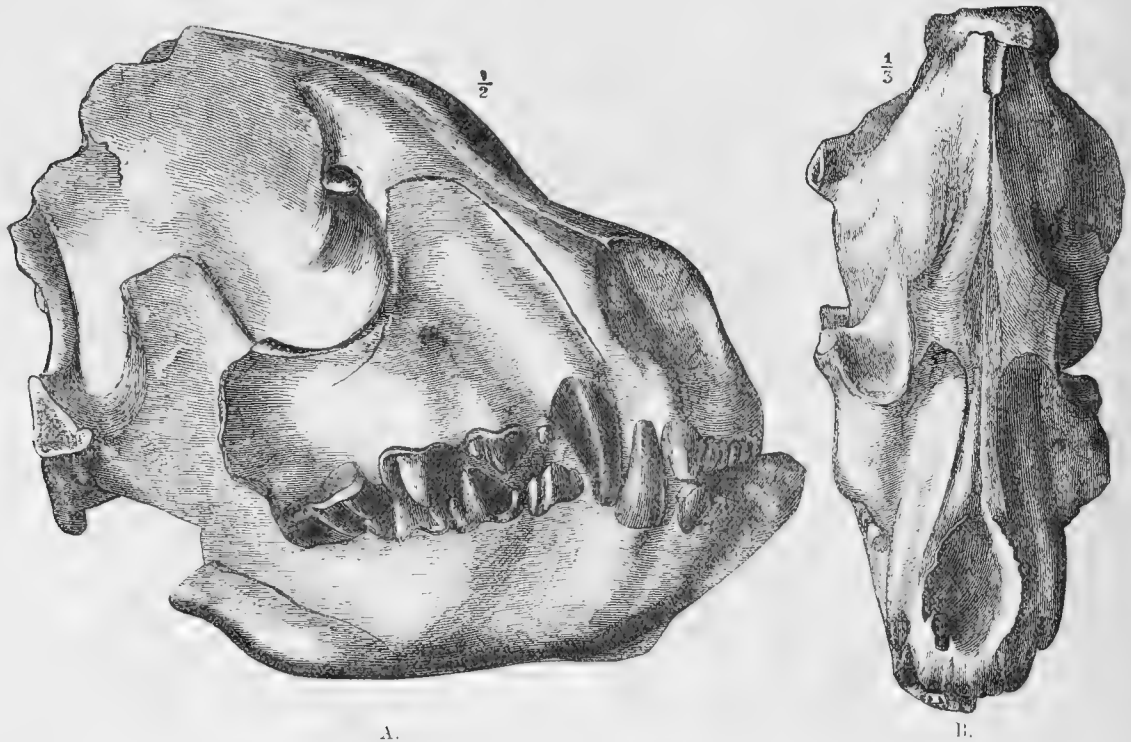

Fig. 3. *Hyæna felina*, Bose.—Cranium. A., oblique view of right side; B., front view.

the British Museum. The species (which is fully described in the above-mentioned volume) is more nearly related to the existing African *H. crocuta* (spotted hyæna) than to any other form, and presents no affinity to the existing Indian *H. striata* (striped hyæna).

C. 41. *HYÆNA COLVINI*, Lyd.—Fragment of left maxilla, containing pm. 3, pm. 4, and m. 1. This specimen is mentioned on page 294 of the above-quoted volume, and is believed to be the missing portion of a cranium in the Indian Museum,

Calcutta, figured in plate xxxv., figure 2 of the same volume. In that figure the hinder cheek-teeth of the left side are restored from those of the opposite side.

C. 39. *HYÆNA COLVINI*, Lyd.—Left ramus of the mandible, not improbably belonging to the same individual as the last. This specimen is alluded to on page 295 of the above-mentioned volume; and its hinder cheek-teeth are similar to those of the specimen represented in the woodcut on the opposite page of the same work. This species is in many respects allied to the preceding form, but is distinguished by its taller and more slender cheek-teeth, and by the generally larger size of the tubercular molar. It appears entirely to do away with the generic distinctness of *Crocuta*, since while its premolars and lower carnassial are of the type of the spotted hyæna (although pm. 4 indicates a tendency to a transition from the crocutine to the striatine type), its upper true molar, in its different variations, forms an almost complete transition from that of the striped to that of the spotted species, though generally of the type of the latter.

C. 40. *HYÆNA*, sp. non det.—Part of right ramus of mandible. It is possible that this specimen may belong to the same species as a specifically undetermined maxilla represented in plate xxxv. A of the above-mentioned volume, and described on page 309.

Family IV.—*Felidae*.

C. 47—8. *FELIS SUBHIMALAYANA*, Bronn.—Cranium, mandible, and bones of hind-limb. These specimens are unique, and are figured in “*Journ. Asiat. Soc., Bengal*,” vol. v., pl. xxvii., figs. 1, 2, and described on pages 330–1 of the above-quoted volume of the “*Pal. Ind.*” They indicate an animal of about the size of the existing Indian *F. bengalensis*, but of stouter build.

C. 49. *MACHÆRODUS SIVALENSIS* (Falc. and Caut.).—Left ramus of mandible of male. This specimen, which is figured in the accompanying woodcut (figure 4) (reproduced from p. 336 of the above-mentioned volume of the “*Pal. Ind.*”), is the most perfect known specimen of the mandible of this species. *Machærodus sivalensis* is a species coming nearer in its main cranial characters to the American *M. neogæus*, and *M. necator*, than to the European *M. meganthereon*, and (probably) *M. cultridens*. It apparently agrees with the two former in its relatively large canines; while in dental characters it presents a strong general resemblance to *M. necator*, although lacking the suppression of pm. 3; and in the structure of pm. 3 agreeing with *M. meganthereon*. In the small size of m. 1 the Siwalik species again comes nearest to *M. necator*. In the variation in size of pm. 3, and in the tendency to the disappearance of the second fang of this tooth, the species is evidently intermediate between the European and the American forms.

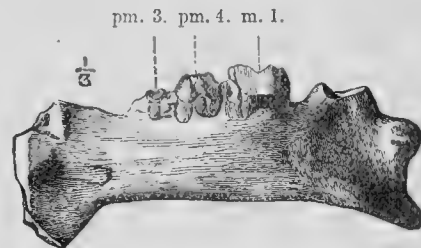

Fig. 4. *Machærodus sivalensis* (Falc. and Caut.). Outer view of left ramus of mandible of a male.

ORDER: UNGULATA.

SUB-ORDER, 1: PROBOSCIDEA.

Family.—*Elephantidae.*

- C-j. ELEPHAS (Stegodon) BOMBIFRONS, Falc. and Caut.  
 Last left upper true molar, wanting part of first and second ridges.  
 Fine specimen.
- C-k. ELEPHAS (S.) BOMBIFRONS.  
 Anterior part of last left lower molar.
- D. 1. ELEPHAS (S.) BOMBIFRONS.  
 Last right lower molar, imperfect anteriorly.
- C. 90. ELEPHAS (S.) BOMBIFRONS.  
 Section of part of last upper molar.
- A.  $\frac{3}{25}$ . ELEPHAS (S.) BOMBIFRONS (?).  
 Hinder part of unworn last upper molar.
- D. 2. ELEPHAS (S.) BOMBIFRONS (?).  
 Part of penultimate right lower molar.
- A.  $\frac{3}{26}$ . ELEPHAS (S.) BOMBIFRONS (?).  
 Anterior part of late molar.
- A.  $\frac{3}{26}$ . ELEPHAS (S.), sp.  
 Fragment of much-worn molar.
- C. 3. ELEPHAS (S.), sp.  
 Fragment of much-worn molar.
- A.  $\frac{3}{27}$ . ELEPHAS (S.) BOMBIFRONS (?).  
 Right ramus of mandible, with complete first true molar, containing  
 eight ridges. A valuable specimen.
- B. 2. ELEPHAS (S.) BOMBIFRONS.  
 Left ramus of mandible, with last molar, which has apparently nine  
 ridges. The hinder part of the crown is curiously bent.
- A. 2. ELEPHAS (S.) BOMBIFRONS.  
 Cranium, with much-worn last molar, which apparently had eight or  
 nine ridges.

- D. 7. ELEPHAS (Loxodon) PLANIFRONS, Falc. and Caut.  
Part of less-worn last upper molar.
- D. 4. ELEPHAS (L.) PLANIFRONS.  
Part of right ramus of mandible, containing well-worn last molar.
- D. 8. ELEPHAS (L.) PLANIFRONS.  
Last upper true molar in a middle stage of wear. Nearly complete.
- D. 5. ELEPHAS (L.) PLANIFRONS.  
Part of left ramus of mandible, containing greater part of last molar, in a middle stage of wear.
- A.  $\frac{3}{15}$ . ELEPHAS (L.) PLANIFRONS.  
Part of right ramus of mandible, containing hinder part of well-worn penultimate, and anterior part of little-worn last molar.
- D. 10. ELEPHAS (L.) PLANIFRONS.  
Fine specimen of palate, containing hinder part of penultimate, and complete last molars. Only the anterior ridges of the latter touched by wear.
- A.  $\frac{3}{24}$ . ELEPHAS (L.) PLANIFRONS.  
Fragments of molars.
- B. 1. ELEPHAS (L.) PLANIFRONS.  
Palate, with second and third molars, the latter very slightly worn. There are only nine ridges in last molar, which is one less than in normal specimens.
- A. 1. ELEPHAS (L.) PLANIFRONS.  
Cranium, with second and third molars; the latter very slightly worn. The ridges are closer together than in the last specimen. There are eleven ridges in the last molar.
- D. 6. ELEPHAS (L.) PLANIFRONS.  
Portion of well-worn last left upper molar.
- G. 19. ELEPHAS (Euelephas) HYSUDRICUS, Falc. and Caut.  
Greater part of last upper molar.
- D. 9. ELEPHAS (E.) HYSUDRICUS.  
Last right upper molar. This specimen is complete, and in an early stage of wear.

D. 3. ELEPHAS (E.) HYSUDRICUS.

Left ramus of mandible, with last true molar, in an early stage of wear.

C. 91. ELEPHAS (E.) HYSUDRICUS.

Section of last upper true molar.

A.  $\frac{3}{28}$ . ELEPHAS, sp.

Fragments of molars.

ELEPHAS or MASTODON.

C-6. Terminal part of tusk.

D-18. Part of tusk.

C 1. Part of tusk.

A  $\frac{3}{22}$ . Part of tusk.

C-m. Tip of tusk.

D-24. Dorsal vertebra.

D-25. Dorsal vertebra.

A- $\frac{3}{53}$ . Dorsal vertebra.

A- $\frac{3}{52}$ . Sacral vertebra.

G. 14. Glenoid end of left scapula.

A.  $\frac{3}{44}$ . Part of pelvis, with acetabulum.

A.  $\frac{3}{49}$ . Acetabulum.

D. 17. Distal end of humerus.

D. 16. Distal end of humerus.

D. 11. Proximal end of femur.

A.  $\frac{3}{48}$ . Distal end of femur.

D. 12. Distal end of femur.

A.  $\frac{3}{51}$ . Proximal end of tibia.

D. 19. Distal end of tibia.

G-6. Distal end of tibia.

D. 20. Part of calcaneum.

D. 27. Astragalus (two specimens).

A  $\frac{3}{50}$ . Cuneiform.

D-b. Cuboid.

D-a. Phalangeal.

D-27. Part of sternum.

D. 14. Distal end of femur.

D.14a. Distal end of femur.

D. 15. Proximal end of femur.



SUB-ORDER 2 : ARTIODACTYLA.

Section 1 : SUINA.

Family 1.—*Hippopotamidae.*

HIPPOTAMUS SIVALENSIS, Falc. and Caut.

- A.  $\frac{3}{4}$ . Cranium.
- D. 68. Half of cranium.
- C. 16a. Hinder part of cranium.
- D. 67. Palate, with teeth much worn.
- C. g. Mandible, with teeth complete.
- D. 66. Symphysis of mandible.
- A.  $\frac{3}{8}$ . Part of symphysis of mandible.
- A.  $\frac{3}{12}$ . Part of symphysis of mandible.
- D. 65. Mandible.
- A.  $\frac{3}{8}$ . Right ramus of mandible.
- D. 64. Left ramus of mandible, with teeth hammered off.
- C. h. Left ramus of mandible, with three last molars.
- D. 63. Right ramus of mandible, with two last molars.
- A.  $\frac{3}{15}$ . Fragment of mandible.
- A.  $\frac{3}{11}$ . Broken upper molar.
- A.  $\frac{3}{27}$ . Much-worn upper molar.
- A.  $\frac{3}{13}$ . Broken upper molars.
- C. i. Broken lower molars.
- A.  $\frac{3}{16}$ . Upper canine.
- C. 13. Upper canine.
- C. 14. Lower canine.
- C. 15. Lower canine, extremity.
- C. 28. Lower milk-canine.
- D. 75. Axis] vertebra.
- A.  $\frac{3}{4}$ . Acetabulum.
- D. 69. Femur, head of.
- D. 71. Femur, distal end.
- D. 70. Femur, distal end.
- A. 86. Femur, distal end.
- D. 73. Radius, distal end.
- D. 14. Radius, distal end.
- D. 72. Astragalus (two specimens).

## HIPPOPOTAMUS SIVALENSIS.

- B. 3. Nearly complete cranium—a fine and valuable specimen: the two molars are of the short square type; the last placed in advance of the posterior border of the palate. The specimen, therefore, like No. D. 67, belongs to the typical variety of the species.\*

Family 2.—*Suidæ.*

## SUS FALCONERI, Lyd.

- C. 27. Cranium of female. This fine specimen was originally figured in "Journ. Asiat. Soc., Bengal," vol. v., pl. xxxv., and its dentition in pl. xlv., fig. 3: it has been refigured in "Pal. Ind.," ser. x., vol. iii., pl. x., where it is fully described. The species is in some respects allied to the living *Sus barbatus* of Borneo.
- C. 31. Crushed specimen of anterior portion of cranium of a male. Figured in "Journ. Asiat. Soc., Bengal," vol. v., pl. xlv., fig. 5. The last molar is slightly smaller than in the last specimen.
- C. 30. Last right upper molar; shorter than in either of the previous specimens.
- C. 26. Mandible. The dentition of this specimen is figured in "Pal. Ind.," ser. x., vol. iii., pl. vii., fig. 1.

## Section 2: RUMINANTIA.

Family 1.—*Camelidæ.*

## CAMELUS SIVALENSIS, Falc. and Caut.

- A.  $\frac{3}{3\frac{1}{2}}$ . Fragment of left ramus of mandible, with last 2 molars.
- C. 72. Part of left ramus of mandible, with 2 molars.

## CAMELUS, sp.

- C. 73. Part of left maxilla, with three last molars, wanting the summits of their crowns. This specimen indicates an animal of gigantic size, which may possibly be distinct from *C. sivalensis*: the teeth require careful comparison with the types of that species in the British Museum.

Family 2.—*Giraffidæ.*

## SIVATHERIUM GIGANTEUM, Falc. and Caut.

- C. 78. Left upper premolar.
- C. 79. Two left upper premolars.

\* See "Pal. Ind.," ser. x., vol. iii., pt. 2.

SIVATHERIUM GIGANTEUM, Falc. and Caut.

- D. 37. Right lower molars, little worn.
- A.  $\frac{3}{17}$ . Part of right ramus of mandible, with two worn molars.
- C. n. Part of right ramus of mandible, with two little-worn molars.
- C. 74. Part of right ramus of mandible, with milk-dentition. This is a very rare and valuable specimen; the only other known example is in the Indian Museum, and is figured in "Pal. Ind.," ser. x., vol. ii., pl. xxi., fig. 3.
- C. 66. Centrum of axis vertebra.
- D. 33. Centrum of cervical vertebra.
- C. 60. Distal end of humerus.
- C. 59. Complete radius, associated with last specimen. These two bones are particularly fine and valuable; as indeed is the whole series of the remains of this remarkable 4-horned giraffoid ruminant.
- D. 57. Naviculo-cuboid (two specimens).
- D. 35. Part of proximal phalangeal.

BRAMATHERIUM PERIMENSE, Falc.

- G. 11. Glenoidal extremity of scapula.

Family 3.—*Bovidae*.

HEMIBOS OCCIPITALIS (Falc.)

- A.  $\frac{3}{3}$ . Cranium of male: similar to one figured in "Pal. Ind.," ser. x., vol. i., pl. A.

HEMIBOS ACUTICORNIS (Falc. and Caut.)

- D. 43. Hinder part of cranium: similar to one figured in "Pal. Ind.," ser. x., vol. i., pl. xxiii.A
- A.  $\frac{3}{7}$ . HEMIBOS, sp. (?) Occiput.
- C. 15. BOS, sp. (?) Part of frontals.
- C. o. HEMIBOS. (?) Palate.
- A.  $\frac{3}{14}$ . " (?) Part of palate.
- C. 94. BOS (?) Upper molar.
- A.  $\frac{3}{5}$ . " Upper molar (two specimens).
- C. 290. " Upper molar.
- C. 846. " Lower molar (four specimens).
- A.  $\frac{3}{6}$ . " Lower molar.
- C. 231. " Lower molar.
- C. 86. BOS or HEMIBOS (?) Part of mandible.
- C. p. " " Part of mandible.
- C. 88. " " Part of mandible (two specimens).

C. 83.	BOS or HEMIBOS. (?)	Part of mandible.
A. $\frac{3}{3}a$ .	„ „	Part of mandible.
C. 78.	„ „	Part of mandible.
A. $\frac{3}{2}9$ .	„ „	Part of mandible.
C. 69.	„ „	Part of mandible.
D. 44.	„ „	Part of mandible.
D. 45.	„ „	Part of mandible.
A. $\frac{3}{3}9$ .	„ „	Part of mandible.
C. 60.	ANTILOPE or CERVUS. (?)	Palate.
C. 86.	„ „	Upper molars.
C. 80.	„ „	Upper molars.
C. 85.	„ „	Upper molars.
C. 81.	„ „	Upper molars.
C. 87.	„ „	Upper molars.
C. q.	„ „	Mandible.
C. 70.	„ „	Mandible.
C. 71.	„ „	Mandible.
A. $\frac{3}{3}9$ .	„ „	Mandible.
A. $\frac{3}{4}9$ .	„ „	Mandible.
C. 75.	ANTILOPE, sp. nov. (?)	Frontlet.
A. 74.	„ (?)	Frontlet.
A. $\frac{3}{6}5$ .	BOVOID RUMINANT.	Horn-core.
A. 75.	„ „	Horn-core.
A. 67.	„ „	Horn-core.
A. 118.	„ „	Horn-core.
A. 66.	„ „	Horn-core.
A. 73.	„ „	Horn-core.
A. 72.	„ „	Horn-core.
A. 76.	„ „	Horn-core.
C. 62.	CERVUS, sp.	Hinder part of cranium.
C. 58.	„ „	Frontlet.
A. 70.	„ „	Fragment of antler.
C. 61.	„ „	Base of antler with brow-tine.
C. 76.	„ „	Base of antler with brow-tine.
D. 36.	„ „	Fragment of antler.
A. $\frac{3}{6}6$ .	RUMINANT.	Sixth cervical vertebra.
A. $\frac{3}{5}8$ .	„ „	Cervical vertebra.
D. 56.	„ „	Trunk vertebra.
A. $\frac{3}{4}6$ .	„ „	Innominate.

A. $\frac{3}{55}$ .	RUMINANT.	Trunk vertebra.
A. $\frac{3}{59}$ .	„	Trunk vertebra.
A. $\frac{3}{56}$ .	„	Trunk vertebra.
A. $\frac{3}{16}$ .	„	Trunk vertebra.
A. $\frac{3}{57}$ .	„	Trunk vertebra.
D. 46.	„	Scapula.
D. 53.	„	Distal end of humerus.
A. 90.	„	Distal end of humerus.
A. 107.	„	Distal end of humerus.
A. $\frac{3}{63}$ .	„	Anconeal joint.
D. 48.	„	Distal end of radius.
C. 55.	„	Femur and head of tibia (probably Bos).
D. 49.	„	Distal end of femur.
D. 50.	„	Distal end of femur.
D. 51.	„	Distal end of femur.
D. 47.	„	Distal end of femur.
D. 52.	„	Distal end of femur.
A. 87.	„	Distal end of femur.
G. 32.	„	Distal end of femur.
G. 29.	„	Distal end of femur.
A. 93.	„	Proximal end of tibia.
A. 97.	„	Distal end of tibia.
A. 101.	„	Distal end of tibia.
A. 105.	„	Distal end of tibia.
A. c.	„	Astragalus.
D. 55.	„	Astragalus (five specimens).
C. 37.	„	Calcaneum.
C. 55a.	„	Metatarsus and tarsus of same individual as C. 55.
A. 31.	„	Metacarpus.
A. 94.	„	Proximal end of metacarpus.
A. 106.	„	Proximal end of metacarpus.
A. 112.	„	Proximal end of metacarpus.
D. 54.	„	Distal end of cannon-bone.
A. 80.	„	Distal end of cannon-bone.
A. 82.	„	Distal end of cannon-bone.
A. 83.	„	Distal end of cannon-bone.
A. 88.	„	Distal end of cannon-bone.
A. 89.	„	Distal end of cannon-bone.
G. 33.	„	Terminal phalangeal.

## SUB-ORDER 3: PERISSODACTYLA.

Family I.—*Rhinocerotidæ*.

C. a. RHINOCEROS PLATYRHINUS, Falc. and Caut.—First or second left upper true molar, in a well-worn condition. This specimen is figured on a smaller scale in "Journ. Asiat. Soc., Bengal," vol. v., pl. xix., figure 6; and of the full size in figure 2, plate III., accompanying this catalogue. The teeth of the present species, which is a two-horned form, are of extremely rare occurrence; and the present specimen is the most perfect known example in this stage of wear. This specimen exhibits in great perfection the accessory fossette (*o*),\* formed by the union of the large crochet (*e*) and combing-plate (*n*), and thus differs from the corresponding tooth of the one-horned *R. palæindicus* (see "Pal. Ind.," vol. iii., p. 4, woodcut), which in the same state of wear has no fossette. The two teeth are, however, otherwise very similar, especially in the form of the two colles (*a*, *b*).

C. b. RHINOCEROS PALÆINDICUS, Falc. and Caut.—First or second left upper true molar, in an early stage of wear. This specimen is figured on a small scale in "Journ. Asiat. Soc. Bengal," vol. v., pl. xix., fig. 5; and of full size in figure 3, plate III., accompanying this catalogue. The teeth of this species are nearly as rare as those of the last, and the present tooth is the most perfect known specimen in an early stage of wear. It exhibits very clearly the characteristic points, viz., the apposition of the two colles (*a*, *b*); the large size of the anterior collis (*a*); the absence of a "buttress" at the antero-external angle of the crown, and the slight prominence of the costæ (*c*, *d*); the well-developed crochet (*e*); and the absence, in this stage of wear, of an accessory fossette at the extremity of the median valley (*g*).

C. c. RHINOCEROS PALÆINDICUS, Falc. and Caut.—Right upper milk-molars, partially worn. This specimen is figured on a small scale in "Journ. Asiat. Soc. Bengal," vol. v., pl. xix., figure 2, and of the full size in figure 1, plate III., accompanying this catalogue. The only other known example of the upper milk-dentition of this species is in the British Museum, and is figured in "Pal. Ind.," ser. x., vol. ii., pl. vii. fig. 3: it is contained in an immature skull, figured in plate lxxiv., figs. 1, 1 *a*, 1 *b*, 1 *c*, of the "Fauna Antiqua Sivalensis." The Dublin example is the more perfect of the two. The grounds for referring these specimens to

\* The letters employed in the figures are the same as those used in "Pal. Ind.," ser. x., vol. iii. pt. i., where the terms here used are explained.

*R. palæindicus* are—firstly, that the cranium in the British Museum indicates that the species to which it belonged was a one-horned form; and secondly, that the milk-molars are of too large a size to have belonged to *R. sivalensis*—the other one-horned form. The Dublin specimen shows that the structure of the milk-molars is rather more complex than that of the true molars of *R. palæindicus*.

C. d. RHINOCEROS, sp.—Left ramus of mandible of young individual. This specimen is figured in “*Journ. Asiat. Soc. Bengal*,” vol. v., pl. xvi., fig. 2, and may possibly belong to the same individual as the last.

A.  $\frac{3}{16}$ . RHINOCEROS, sp.—Part of mandible.

C. e. RHINOCEROS, sp.—Bones of fore-foot. This specimen is figured in “*Journ. Asiat. Soc. Bengal*,” vol. v., pl. xvii., fig. 14, and is one of the few Siwalik specimens that exhibit several bones in their original connexion.

A. 78. RHINOCEROS, sp.—Bones of foot.

C. 24. RHINOCEROS, sp.—Astragalus; figured in “*Journ. Asiat. Soc. Bengal*,” vol. v., pl. xvii., fig. 8.

A. 85. (?) RHINOCEROS, sp.—Astragalus. This bone is more elongated vertically than the last, and indicates a different species.

D. 61. RHINOCEROS, sp.—Head of femur.

G. 41. RHINOCEROS, or ACERATHERIUM, sp.—Lower canine.

A.  $\frac{3}{33}$ . RHINOCEROS, sp.—Fragment of mandible, without teeth.

D. 62. RHINOCEROS, sp.—Distal extremity of metacarpal or metatarsal.

C. 18. RHINOCEROS, sp.—Fragment of mandible, with two broken molars.

#### Family 2.—*Equidae*.

D. 28–9. EQUUS NAMADICUS, Falc. and Caut.—Anterior portion of maxillæ of both sides, similar to specimen figured in “*Pal. Ind.*,” ser. x., vol. ii., pl. xiv., fig. 3.

A. a. EQUUS, sp. Last right upper molars.

- C. 32. EQUUS SIVALENSIS, Falc. and Caut. (?)—Part of right ramus of mandible, not unlike specimen figured in "Pal. Ind." ser. x., vol. ii., pl. xii., fig. 5. Very large form.
- D. 30. EQUUS, sp.—Part of right ramus of mandible, smaller than last.
- C. 34. EQUUS, sp.—Left upper molar.
- C. 35. EQUUS, sp.—Two left upper molars.
- C. 36. EQUUS, sp.—Right upper molar.
- C. f. EQUUS, sp.—Metatarso-phalangeal joint, with enormously large sesamoids.
- A. 102. EQUUS, sp.—Distal end of cannon-bone.
- D. 23. EQUUS, sp.—Distal end of cannon-bone.
- D. 31. EQUUS, sp.—Head of femur.
- G. 86. EQUUS, sp.—Upper molar.
- G. 37. EQUUS, sp.—Phalangeal bones of fore-foot.
- A. 84. EQUUS, sp.—Limb-bones.

CLASS : *REPTILIA.*

ORDER 1<sup>o</sup>. CROCODILIA.

- A.  $\frac{3}{4}$ . GAVIALIS GANGETICUS (Gm.) Hinder part of cranium.
- G. 26. " " (?) Occiput.
- C. 50. " " Mandibular symphysis.
- D. 39. " " Mandibular symphysis.
- G. 26. " " Ramus of mandible.
- C. 71. " " Extremity of premaxilla.
- D. 37. " " Left ramus and part of symphysis of mandible.
- A.  $\frac{3}{4}$ . " " Middle portion of cranium.
- G. 58. " " Fragment of jaw.
- D. 38. GAVIALIS CRASSIDENS, Falc. and Caut. (?)—Hinder part of mandibular symphysis.



A. $\frac{3}{5}$ .	CROCODILUS PALUSTRIS, Less. (?)	—Large portion of cranium, much concealed matrix.
A. $\frac{3}{42}$ .	„ „	Articular portion of mandible.
C. 54.	CROCODILUS, or GAVIALIS.	Teeth (two).
D. 42.	„ „	Dermal scutes (four specimens).
C. 52.	„ „	Dermal scutes.
C. 59.	„ „	Dermal scutes.
A. 151.	„ „	Dermal scutes.
C. 27.	„ „	Cervical vertebra.
C. 2.	„ „	Trunk vertebra.
D. 40.	„ „	Trunk vertebra (very large).
A. $\frac{3}{62}$ .	„ „	Trunk vertebra.
A. 160.	„ „	Trunk vertebra.
D. 41.	„ „	Trunk vertebra.
G. 24.	„ „	Trunk vertebra.

#### ORDER 2: CHELONIA.

D. 59.	COLOSSOCHELYS (?), sp.	Fragment of carapace (three specimens).
A. 146.	„	Fragment of carapace.
A. 147.	„	Fragment of carapace.
A. 148.	„	Fragment of carapace.
A. 149.	„	Fragment of carapace.
A. 150.	„	Fragment of carapace.
A. 154.	„	Fragment of carapace.
A. 155.	„	Fragment of carapace.
A. 137.	„	Fragment of carapace.
A. 138.	BATAGUR (?), sp.	Fragment of carapace.
A. 140.	„	Fragment of carapace.
A. 141.	„	Fragment of carapace.
A. 153.	„	Fragment of carapace.
A. 156.	„	Fragment of carapace.
A. 159.	„	Fragment of carapace.
C-S.	EMYDINE, or TESTUDINE TORTOISE.	—Nearly complete carapace and plastron. This fine specimen probably indicates a species new to the Siwaliks.

- D. 58. TRIONYX, sp. Costal plate of a very large species.  
 D. 58a. „ Extremity of a costal plate of a still larger individual.  
 D. 58b. „ Costal plate.  
 A. 158. „ Extremity of costal plate of a young individual.  
 A. 158a. „ Part of costal plate.  
 A. 157. „ Part of costal plate.  
 D. 60. EMYDA, sp. Part of anterior costal plate.  
 C. t. „ Part of anterior costal plate.

CLASS: PISCES.

- C. 92. Head of undetermined teleostean fish. This specimen is unique.  
 A.  $\frac{3}{43}$ . Fragments of vertebræ and other bones of a fish.

---

For the dates of the publication of the names of the various species of mammalia mentioned in the foregoing catalogue, see "Palæontologia Indica," ser. x., vol. iii., p. 123, *et seq.* (1884).

---

EXPLANATION OF PLATE III.

- Fig. 1. *Rhinoceros palaindicus*, Falc. and Caut.—Fragment of right maxilla, containing three milk-molars (No. C. c.).  
 Fig. 2. *Rhinoceros platyrhinus*, Falc. and Caut.—First or second left upper true molar, in a well-worn condition (No. C. a.).  
 Fig. 3. *Rhinoceros palaindicus*, Falc. and Caut.—First or second left upper true molar, in an early stage of wear (No. C. b.).

All the figures natural size—*a*, anterior collis; *b*, posterior collis; *c*, second costa; *d*, first costa; *e*, crochet; *g*, median valley; *i*, posterior valley; *n*, combing-plate; *o*, accessory fossette.

o mlf r d um? mml

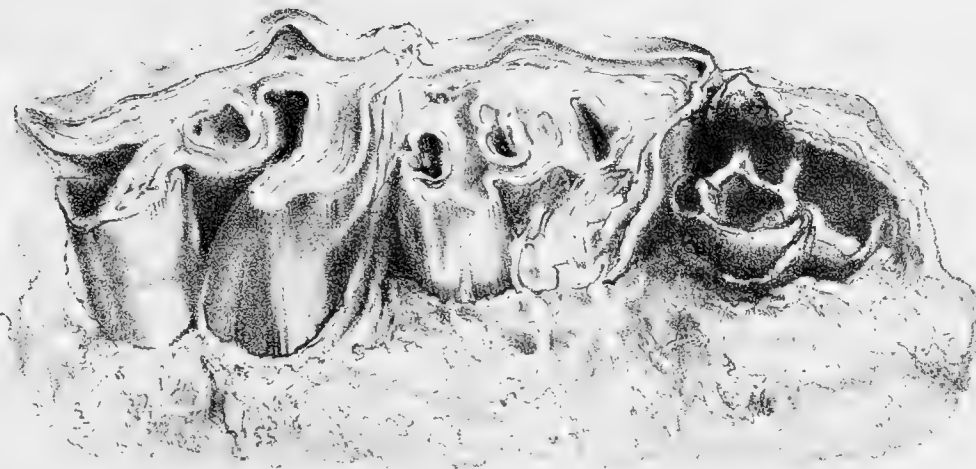

Fig. 1.



Fig. 2.



Fig. 3.





## TRANSACTIONS (NEW SERIES).

### VOLUME I.

PART

- 21.—Notes on the Aspect of Mars in 1882. By C. E. BURTON, B.A., F.R.A.S., as seen with Reflecting Telescope of 9-inch Aperture, and Powers of 270 and 600. Plate XXXVIII. (January, 1883.)
- 22.—On the Energy expended in Propelling a Bicycle. By G. JOHNSTONE STONEY, D.SC., F.R.S., a Vice-President of the Society; and G. GERALD STONEY. Plates XXXIX., XL., and XLI. (January, 1883.)
- 23.—On Electromagnetic Effects due to the Motion of the Earth. By GEORGE FRANCIS FITZGERALD, M.A., F.T.C.D., Erasmus Smith's Professor of Experimental Science in the University of Dublin. (January, 1883.)
- 24.—On the Possibility of Originating Wave Disturbances in the Ether by Means of Electric Forces:—Corrections and Additions. By GEORGE FRANCIS FITZGERALD, M.A., F.T.C.D. (January, 1883.)
- 25.—On the Fossil Fishes of the Carboniferous Limestone Series of Great Britain. By J. W. DAVIS. Plates XLII. to LXV. (September, 1883.) [*With Title-page to Volume.*]

### VOLUME II.

- 1.—Observations of Nebulæ and Clusters of Stars, made with the Six-foot and Three-foot Reflectors at Birr Castle, from the year 1848 up to the year 1878. Nos. 1 & 2. By the RIGHT HON. THE EARL OF ROSSE, LL.D., D.C.L., F.R.S. Plates I. to IV. (August, 1879.) No. 3. Plates V. and VI. (June, 1880.)
- 2.—On Aquatic Carnivorous Coleoptera or Dytiscidæ. By DR. SHARP. Plates VII. to XVIII. (April, 1882.) [*With Title-page to Volume.*]

---

### VOLUME III.

- 1.—On the Influence of Magnetism on the Rate of a Chronometer. By OTTO BOEDDICKER, PH.D. Plate I. (September, 1883.)
- 2.—On the Quantity of Energy transferred to the Ether by a Variable Current. By GEORGE F. FITZGERALD, M.A., F.R.S. (March, 1884.)
- 3.—On a New Form of Equatorial Telescope. By HOWARD GRUBB, M.E., F.R.S. Plate II. (March, 1884.)
- 4.—Catalogue of Vertebrate Fossils from the Siwaliks of India, in the Science and Art Museum, Dublin. By R. LYDEKKER, B.A., F.G.S., F.Z.S. Plate III. and Woodcuts. (July, 1884.)

[NOVEMBER, 1884.]

THE  
SCIENTIFIC TRANSACTIONS  
OF THE  
ROYAL DUBLIN SOCIETY.

VOLUME III. (SERIES II.)

---

V.—ON THE ORIGIN OF FRESHWATER FAUNAS: A STUDY IN EVOLUTION.

BY W. J. SOLLAS, M.A., Dublin; D.Sc., Cambridge; Fellow of St. John's College, Cambridge; Professor of Geology and Mineralogy in the University of Dublin.

---



DUBLIN:  
PUBLISHED BY THE ROYAL DUBLIN SOCIETY.  
PRINTED AT THE UNIVERSITY PRESS, BY PONSONBY AND WELDRICK,  
PRINTERS TO THE SOCIETY.  
1884.

---

*Price One Shilling and Sixpence.*





V.—ON THE ORIGIN OF FRESHWATER FAUNAS : A STUDY IN EVOLUTION. By W. J. SOLLAS, M. A., Dublin ; D. Sc., Cambridge ; Fellow of St. John's College, Cambridge ; Professor of Geology and Mineralogy in the University of Dublin.

[Read, May 19, 1884].

“ O ! what an endlesse worke have I in hand,  
 To count the seas abundant progeny,  
 Whose fruitfull seeds farre passeth those on land,  
 And also those which wonne in th' azure sky :  
 For much more eath to tell the starres on hy,  
 Albe they endlesse seeme in estimation,  
 Then to recount the Seas posterity :  
 So fertile be the flouds in generation,  
 So huge their numbers, and so numberlesse their nation.”

*Faërie Queene*, Canto xii. Bk. iv.

THE amazing fertility of the sea never fails to excite the wonder of the naturalist, and has often impressed the imagination of the poet. The comparative poverty of our freshwater fauna, though no less astonishing, is seldom remarked upon, and has not been made the subject of systematic investigation. A suggestive Paper\* by Von Martens, which appeared in 1857, and a chapter in Semper's thoughtful work, “The Natural Conditions of Existence as they affect Animal Life,” are the chief references bearing directly on the subject which I am able to cite.†

One reason for the barrenness of our literature on this subject is to be found in the too readily made assumption that the difference in composition of fresh and salt water is sufficient to account for all the facts. The susceptibility of marine animals to the influence of fresh water is supposed to be so great, that only under

\* “On the Occurrence of Marine Animal Forms in Fresh Water,” [by Dr. E. von Martens, *Ann. and Mag. Nat. Hist.*, 1858, ser. III., vol. i. p. 50 (translated by W. S. Dallas, F. L. S.).

† See incidental remarks on the origin of some freshwater species in Dr. P. M. Duncan's Presidential Address to the Geological Society of London, *Quart. Journ. Geol. Soc.*, 1878, and a chapter on distribution of the freshwater Crayfish, Prof. Huxley (*The Crayfish*, *International Science Series*).

very exceptional circumstances could they learn to accustom themselves to a freshwater mode of life; and no doubt we have here one cause, and that a potent one, for the exclusion of many marine organisms from our freshwater streams and lakes. But it is by no means the only cause, and probably not the chief; for Beudant, to whose observations Semper has recently called attention, has already shown that several species of marine molluscs can be brought to live in fresh water, if only the sea water in which they are at first placed be freshened with sufficient slowness. Thus in three months he was able to people a freshwater tank with limpets and mussels, which then might have been seen living in strange association with such true freshwater molluscs as *Limnea* and *Paludina* (*v. Semper, l. c., p. 153*).

While Beudant was thus successful in overcoming the repugnance of some marine forms to a change of medium, he failed with others: of fifteen marine species twelve bore the change of medium, and three perished. But it is very possible that, under more favourable conditions, these would have yielded to treatment like the rest. An unfailing supply of appropriate food and a secular slowness in change of medium would seem to be the two conditions essential to success. These given, it is quite possible that all marine animals are susceptible of a freshwater existence. A few considerations will serve to make the probability of this apparent. That the sea is the fertile mother of all life was a poetic fancy which has now become a fair deduction from admitted facts. Indeed, all naturalists are now agreed that all freshwater animals have descended, directly or indirectly, from marine ancestors; so that the adaptation in question must have occurred at some period in the past history of all freshwater races. But some of these are of such a character that it is difficult to admit adaptability for them and to deny it to others. If the freshwater *Hydra* and *Cordylophora* have survived a change of medium, it is difficult to see what reason can be adduced against this being possible in the case of other Hydroid polyps.

Again, so large a proportion of water enters into the composition of all "jelly-fish" that they might be regarded as singularly unlikely to survive a change of medium; and indeed some experiments of Mr. Romanes prove an extreme intolerance on the part of marine *Medusæ* in this respect. No one consequently would have expected to discover *Medusæ* living in fresh water in a state of nature, and yet the occurrence of *Limnocodium* in the tanks of the Botanical Society of London, associated with *Victoria regia*, proves that there is nothing in their nature absolutely incompatible with such a mode of existence. The change from one medium to another has here taken place, and so profoundly have the tissues of *Limnocodium* been modified in consequence, that it is now more susceptible to the fatal action of salt water than its marine relations are to fresh.

G. Romanes remarks, on closing his account of experiments on *Limnocodium*, as follows:—"If an animal so exceedingly intolerant of fresh water as is a marine jelly-fish may yet have all its tissues changed so as to adapt them to thrive in

fresh water, and even die after an exposure of one minute to their ancestral element, assuredly we can see no reason why any animal in earth or sea may not in time become fitted to change its element" (*Nature*, June 24, 1880).

Another cause which has been relied upon in explanation of the poverty of our freshwater faunas, and which no doubt is partially operative, lies in the greater severity of a freshwater climate as compared with a marine one. Von Martens, in his now well-known Paper already referred to, concludes his argument in the following words:—"The great richness of the sea is explained not only by its greater extent, but also by its more uniform temperature. The fresh waters stand in the same relation to it as a continental to an insular climate: their alternation of temperature is the principal hindrance to their becoming populous; and this attains its maximum by freezing in the colder zones; with the increase of temperature the populousness of the fresh waters increases, but is still limited in the sub-tropical zone by partial dessication. In the tropical zone the conditions of temperature of the fresh waters approach most nearly to those of the sea, and with them their populousness."

In support of his thesis Von Martens enumerates several families which, elsewhere exclusively marine, exhibit a mixed or entirely freshwater habit in tropical regions. He mentions *Arca scaphula*, Benson, as living in the Jumna, near Humerpoor, 1000 miles distant from the sea, and *Pholas rivicola*, Sow., which is found in floating timber on the river Pantai, twelve miles about its mouth. He also calls attention to the freshwater prawn of Jamaica, *Palaemon*\* *jamaicensis*, and to the Thelphusiadæ, a heterogeneous family of freshwater crabs, which occur in sub-tropical regions.

Active as this cause, brought to light by Von Martens, may be, it furnishes by no means a complete solution: the exceptional cases quoted by Von Martens are not numerous enough, and still leave the overwhelming preponderance of marine forms unexplained. If the Unionidæ and other freshwater molluscs have learnt to adapt themselves to a freshwater climate, one sees no good reason why other forms which endure the rigours of our winter along the coast, such as *Patella* and *Littorina*, should not have done so too.

Considering the merciless struggle for existence which the superabundance of marine life involves, sufficient, according to some writers, to drive the less successful competitors into the desolate depths of the abyssal sea, where the only remaining comfort lies in an unchanging uniformity of temperature of about 32° F.—considering the effects of this struggle, one would have expected to find numerous marine animals enterprisingly working their way along the shores of the abundant streams which open all along the coast, and every river characterized by a modified marine fauna derived from the neighbourhood of its mouth.

\* The genuine *Palaemon* is now recognized as a freshwater genus.

So far from this being the case, we find that the freshwater forms of Mollusca are remarkably well defined from the marine, and that they maintain their distinctive generic characters throughout a distribution generally world-wide in space, and extending far back into the Mesozoic period in time.

Some other efficient cause or causes must then be sought for in this inquiry, and one—and that a most important one—lies obviously on the surface. Perhaps one of the commonest ways by which marine animals obtain a distribution over extensive areas is by means of free-swimming larvæ. The peopling of the sea by slow-moving or attached forms has certainly been accomplished chiefly, if not almost wholly, in this manner. But obviously no new forms can have been introduced into existing river-systems through the agency of free-swimming larvæ, for these fragile and feeble forms can by no means make headway against the seaward current of a river: indeed, as a matter of observed fact, larvæ are never known to swim against any current, but always along with it. And thus the method which has been most potent in disseminating organisms through the sea must have been wholly inoperative in transferring them to a freshwater *habitat*.\*

Furthermore, if any slow-moving animal had managed, in the adult state, to penetrate some little distance up a stream, it could seldom succeed in permanently establishing itself so long as it passed through a free larval stage; for its larvæ would usually be carried away to the sea, where they would perish or resume the ancestral habits. Swift-moving animals, such as fish, would of course be more advantageously situated, since they could rapidly travel a long way up most streams, and might easily find at length some sheltered recess or quiet lagoon, wherein their young could come to maturity. The necessity for some such quiet spot is sufficiently indicated by the long and arduous journies which the freshwater Salmonidæ take to reach it. Excepting fish (and we only propose to discuss the Invertebrates in this Paper) and minute organisms, such as Protozoa, minute Crustacea, Rotifera, and Tardigrades, which are capable of transport in a desiccated

\* This has been hinted at by Semper, as I found subsequently; his words are:—"I have already indicated that very often the strength of the current in a river, or the surf at its mouth, its temperature, or the kind of food it affords, must cause quite as great a hindrance to the passage of a marine animal into the fresh water as the necessity for subsequently living in water devoid of salt. Thus, for instance, the remarkably tender bodies of the larva of the Echinodermata, Ascidia, Sea-anemones, Hydroid polypes, and others, are scarcely fitted to overcome such impediments; so that even under the assumption that they might be capable of living in water without salt, their transfer into fresh water seems to be almost impossible; and this is still more probably the case when the fully grown creatures—such as Ascidians, Corals, Polyps, and others—do not move freely on the sea bottom, but are permanently attached to it" (*Animal Life*, 1881, p. 149). I was quite under the impression that this idea was my exclusive property, and I have previously made use of it in explaining the exclusion of marine forms of Spongiæ from our rivers (*Cassell's Natural History*, article "Spongiæ," p. 328, Part LXX., 1882). But with such a mine of facts and wealth of ideas as occur in Semper's work, how shall one be sure that any idea on this subject is one's own?

state by winds, no inhabitant of freshwater streams ought to propagate, as a rule, or exclusively by means of free-swimming larvæ, for this would be inconsistent with its permanence as a freshwater form. I believe this deduction is capable of being verified by facts. Before proceeding further it will be well to provide ourselves with a list of known freshwater forms, and I have accordingly drawn up the following Table of the Invertebrate sub-kingdom, and marked the various groups *m.* or *f.*, according as they are freshwater or marine; an *o* after *f.* indicates that the group is exclusively freshwater; an *o* before *m.* that it is exclusively marine; *f.m.* indicates that it is both freshwater and marine. It will be observed that most of the great groups are marked *m.f.*; some, however, such as the Brachiopoda, Ascidia, Echinodermata, and other small outlying groups, Enteropneusta, Gephyrea, Chætognatha, are wholly marine\*. Those which are exclusively marine are not further analysed; but those which contain both freshwater and marine forms are resolved step by step into smaller and smaller groups, till a separation into exclusively marine or exclusively freshwater forms is reached; or in case this does not happen, till the families are divided into genera: beyond genera the subdivision has not been carried; but notes are added when a genus, otherwise exclusively marine, presents us with some exceptional freshwater species.

## PROTOZOA.

Monera,	<i>f. m.</i>	Radiolaria,	<i>o. m.</i> (Heliozoa, <i>f.</i> )
Protoplasta,	<i>f. m.</i>	Gregarinida,	<i>f. m.</i>
Foraminifera,	<i>o. m.</i> (Gromia, <i>f.</i> )	Infusoria,	<i>f. m.</i>

## METAZOA.

Spongiæ,	<i>f. m.</i>	Chætognatha,	<i>o. m.</i>
Cœlenterata,	<i>f. m.</i>	Nemathelminthia,	<i>f. m.</i>
Platyhelminthia,	<i>f. m.</i>	Mollusca,	<i>f. m.</i>
Rotifera,	<i>f. m.</i>	Crustacea,	<i>f. m.</i>
Brachiopoda,	<i>o. m.</i>	Tracheata,	<i>f. m.</i>
Polyzoa,	<i>f. m.</i>	Echinodermata,	<i>o. m.</i>
Chætopoda,	<i>f. m.</i>	Enteropneusta,	<i>o. m.</i>
Discophora,	<i>f. m.</i>	Ascidia,	<i>o. m.</i>
Gephyrea,	<i>o. m.</i>	Acraniota,	<i>o. m.</i>

\* It may be at once observed here that in all these groups propagation is accomplished by means of free-swimming larvæ. This fact sufficiently explains their entire absence from freshwater areas, and their wide distribution in the sea.

METAZOA— <i>continued.</i>		Coelenterata.	
<i>Spongiæ.</i>		Hydrozoa,	<i>f. m.</i>
Myxospongiæ,	<i>o. m.</i>	Actinozoa,	<i>o. m.</i>
Ceraospongiæ,	<i>o. m.</i>		
Monaxonidæ,	<i>f. m.</i>	<i>Hydrozoa.</i>	
Tetractinellidæ,	<i>o. m.</i>	Hydromedusa,	<i>f. m.</i>
Hexactinellidæ,	<i>o. m.</i>	Siphomedusæ,	<i>o. m.</i>
Calcispongiæ,	<i>o. m.</i>		
<i>Monaxonidæ.</i>		<i>Hydromedusæ.</i>	
Renieridæ,	<i>f. m.</i>	Gymnoblantica-anthomedusæ,	<i>f. m.</i>
Chalinopsidæ,	<i>o. m.</i>	(Hydra and Cordylo-	
Desmacidinæ,	<i>o. m.</i>	phora are the only fresh-	
Suberitidæ,	<i>o. m.</i>	water forms in this	
		group.)	
		Calyptoblastica-leptomedusa,	<i>o. m.</i>
		Trachomedusæ,	<i>f. m.</i>
		(Lymnocodium is the	
		only described freshwater	
		genus in this group.)	
		Narcomedusæ,	<i>o. m.</i>
		Hydrocorallinæ,	<i>o. m.</i>
		Siphonophora,	<i>o. m.</i>
		Polyzoa.	
		Ectoprocta, †	<i>o. m.</i>
		Entoprocta,	<i>f. m.</i>
		Gymnolæmata,	<i>f. m.</i>
		Phylactolæmata,	<i>f. o.</i>

\* This section was instituted by Dr. Wm. Marshall (*Ann. and Mag. Nat. Hist.* 1883, ser. v. vol. xii.) ; but with the exception of Lubomirskia, the alleged absence of statoblasts is asserted on negative evidence of an incomplete character. Lubomirskia lives in Lake Baikal. Potamolepis inhabits the Congo, occurring as far up as 150 miles by water from the sea, and over 100 metres above its level, with several cataracts intervening. Marshall also mentions *Spongilla stygia*, a transparent sponge, living in the Grotto of Gurk in Carniola, as being devoid of statoblasts.

Those freshwater sponges which do not form statoblasts are the exception: the vast majority of the Spongillinæ, world-wide in distribution, are characterized by the occurrence of these structures.

† The Ectoprocta are usually regarded as exclusively marine; but exceptions are recorded. Semper quotes the following:—*Membranipora bengalensis*, Stol.; *Victorella pavidæ*, Kent (*Animal Life*, p. 436).

The Gymnolæmata are almost exclusively marine. Paludicella is the only exception known in this country. Prof. Haddon regards it as a comparatively late immigrant.—Haddon, "On Budding in Polyzoa:" *Quart. Journ. Micro. Sci.*, vol. xxiii., N. S., p. 551.

## MOLLUSCA.

	<i>Glossophora.</i>				
Gastropoda,	<i>f. m.</i>		Pyramidellidæ,	<i>o. m.</i>	
Scaphopoda,	<i>o. m.</i>		Turritellidæ,	<i>o. m.</i>	
Cephalopoda,	<i>o. m.</i>		Xenophoridæ,	<i>o. m.</i>	
Lamellibranchiata,	<i>f. m.</i>		Naticidæ,	<i>o. m.</i>	
			Entoconchidæ,	<i>o. m.</i>	
	<i>Gastropoda.</i>		Marseniidæ,	<i>o. m.</i>	
Isopleura,	<i>o. m.</i>		Acmaeidæ,	<i>o. m.</i>	
Anisopleura,	<i>f. m.</i>		Capulida,	<i>o. m.</i>	
	<i>Anisopleura.</i>		Littorinidæ,	<i>f. m.</i>	
			Paludinidæ,	<i>f. o.</i>	
	<i>Streptoneura.</i>		Valvatidæ,	<i>f. o.</i>	
Zygobranchia,	<i>o. m.</i>		Ampullaridæ,	<i>f. o.</i>	
Azygobranchia,	<i>f. m.</i>				<i>Neritidæ.</i>
					Nerita,
	<i>Euthyneura.</i>				<i>o. m.</i>
Opistobranchia,	<i>o. m.</i>				Neritina,
Pulmonata,	<i>o. f. t.*</i>				<i>f. o.</i>
					Pileolus,
	<i>Azygobranchia.</i>				<i>o. m.</i>
Reptantia,	<i>f. m.</i>				Navicella,
Natantia,	<i>o. m.</i>				<i>f. o.</i>
	<i>Reptantia.</i>				<i>Littorinidæ.</i>
Holochlamyda,	<i>f. m.</i>				Littorina,
Pneumochlamyda,	<i>t.</i>				<i>f. m.</i>
Siphonochlamyda,	<i>o. m.</i>				Modulus,
					<i>o. m.</i>
	<i>Holochlamyda.</i>				Lacuna,
Rhipidoglossa.					<i>o. m.</i>
Trochidæ,	<i>o. m.</i>				Rissoa,
Neritidæ,	<i>f. m.</i>				<i>o. m.</i>
Pleurotomaridæ,	<i>o. m.</i>				Hydrobia,
Ptenoglossa.					<i>f. o.</i>
Scalaridæ,	<i>o. m.</i>				Assimineæ,
Janthinidæ,	<i>o. m.</i>				<i>brackish water.</i>
Tænioglossa.					
Cerithiadæ,	<i>o. m.</i>				<i>Pulmonata.</i>
Melaniidæ,	<i>f. o.</i>				<i>Basommatophora.</i>
					Limnæidæ,
					<i>f. o.</i>
					Auriculidæ,
					<i>f. o.</i>
					<i>Stylommatophora.</i>
					Helicidæ,
					<i>t.</i>
					Limacidæ,
					<i>t.</i>
					Oncidiadæ,
					<i>o. m.</i>
					<i>Lamellibranchiata.</i>
					<i>Isomya.</i>
					Integropalliata,
					Arcacea,
					<i>o. m.</i>
					Trigonacea,
					<i>o. m.</i>
					Unionacea,
					<i>f. o.</i>

\* *t* signifies land-dwellers

MOLLUSCA— <i>continued.</i>			
Lucinacea,	<i>o. m.</i>	Cumingia,	<i>o. m.</i>
Cyprinacea,	<i>f. m.</i>	Rangia,	<i>o. m.</i>
Sinupalliata.		Mactra, †	<i>f. m.</i>
Veneracea,	<i>f. m.</i>	Trigonella,	<i>o. m.</i>
Myacea,	<i>o. m.</i>	Vaganella,	<i>o. m.</i>
Pholadacea,	<i>o. m.</i>	Lutraria,	<i>o. m.</i>
	<i>Heteromya.</i>	Cyprinacea.	
Mytilacea,	<i>f. m.</i>	Tridacna,	<i>o. m.</i>
Mulleracea,	<i>f. o.</i>	Chama,	<i>o. m.</i>
	<i>Monomya.</i>	Dimya,	<i>o. m.</i>
Aviculacea,	<i>o. m.</i>	Diceras,	<i>o. m.</i>
Ostreacea,	<i>o. m.</i>	Isocardia,	<i>o. m.</i>
Veneracea,		Hippopodium,	<i>o. m.</i>
Cypricardia,	<i>o. m.</i>	Cardium,	<i>f. m.</i>
Tapes,	<i>o. m.</i>	Corbicula,	<i>f. æst.</i>
Cyclina,	<i>o. m.</i>	Cyrena,	<i>f. æst.</i>
Cytherea,	<i>o. m.</i>	Cyclas,	<i>f. o.</i>
Chione,	<i>o. m.</i>	Pisidium,	<i>f. o.</i>
Venus,	<i>o. m.</i>	Cyprina,	<i>o. m.</i>
Lucinopsis,	<i>o. m.</i>	Mytilacea.	
Sanguinolaria,	<i>o. m.</i>	Mytilus,	<i>o. m.</i>
Psammobia,	<i>o. m.</i>	Modiola,	<i>o. m.</i>
Tellina,*	<i>f. m.</i>	Crenella,	<i>o. m.</i>
Donax,	<i>o. m.</i>	Lithodomus,	<i>o. m.</i>
Scrobicularia,	<i>m. brackish.</i>	Dreissena,	<i>f. o.</i>
		Modiolarca,	<i>o. m.</i>
		CRUSTACEA.	
	<i>Branchiopoda.</i>	<i>Cirripedia,</i>	<i>o. m.</i>
Phyllopoda,	<i>o. m.</i>	<i>Ostracoda,</i>	<i>f. m.</i>
Cladocera,	<i>f. o.</i>		
	<i>Malacostraca.</i>	Chætopoda.	
Nebaliadæ,	<i>o. m.</i>	Achæta,	<i>f. o.</i>
Schizopoda,	<i>o. m.</i>	Polychæta, ‡	<i>o. m.</i>
Decapoda,	<i>f. m.</i>	Oligochæta,	<i>f. o. (a few exceptions).</i>
Stomapoda,	<i>o. m.</i>		
Cumacea,	<i>o. m.</i>	Platyhelminthia.	
Edriophthalmata,	<i>f. m.</i>	Turbellaria,	<i>f. m.</i>
	<i>Copepoda.</i>	Nemertina,	<i>o. m. (one exception).</i>
Eucopepoda.	<i>f. m.</i>	Trematoda,	<i>m. f.</i>
Branchiura.	<i>f.</i>	Cestoida,	

\* A sub-genus, *Galatea*, is found in rivers of Africa; otherwise marine.

† A sub-genus, *Gnathodon*, lives in fresh water, Gulf of Mexico.

‡ A single exception (*Lumbriconereis*) has been recorded by Dr. Kennel as living in fresh water in the river Ortoire, Trinidad.



It will be seen that, as the analysis proceeds, each group furnishes a large number of exclusively marine and a very small number of exclusively freshwater divisions; while the mixed freshwater and marine genera, omitting admittedly exceptional cases, are very few indeed. Thus, to take the Spongiæ as an example, it is divided into six orders, of which only one, the Monaxonidæ, is marked *m. f.*; all the rest are marine. Disregarding these, we find that the Monaxonidæ break up into five families, of which only one, the Renieridæ, is marked *f. m.* This, finally, is resolvable into several sub-families, all of which are marine, except one, the Spongillina, which is exclusively freshwater. When this Paper was first penned the Spongillina were regarded as a compact family, clearly distinguished from other Renieridæ by the possession of "statoblasts"; but recent discoveries have brought to light some ten species, belonging to four or five genera, which are said to be without this characteristic feature; and it is quite possible that some of these new forms may belong to genera otherwise known as marine.

We now approach the inquiry as to how far the exemption we have predicted of freshwater animals, from a free larval existence, is capable of verification. Commencing with the sponges, we find, in this country, the closely allied genera *Euspongilla* and *Ephydatia* or *Meyenia* (*Euspongilla fluviatilis* and *Ephydatia lucustris*). Elsewhere the rest of the world has furnished hitherto some additional seven or eight genera. Such of these (except *Lubomirskia*) as have been exhaustively studied have been found to propagate by means of so-called "winter-eggs" or statoblasts. These are modified internal buds or gemmules, which are provided with a protective horny envelope, and generally one or more layers of surrounding siliceous spicules. Within this protecting case the bud rests during the winter, and on the advent of spring emerges as a young sponge.

In tropical climates the statoblast is produced, not on the approach of winter, but just before the dry season; and it, no doubt, primarily serves, in this case, as a means of protection against the fatal effects of desiccation. Since, however, in the dry state, the envelope of these statoblasts contains a considerable volume of air, which materially diminishes their specific gravity, it is possible, as William Marshall has suggested, that their formation may serve a secondary purpose ensuring for the sponge a wide dispersion by the agency of the winds.

The pressing need for a rigid attachment of the reproductive gemmules, which exists in swift streams, or rivers liable to floods, is well illustrated by a case mentioned by Marshall; for he finds that in *Parmula brownii*, from the Rio Negro, the spicular layer of the statoblasts is continuous with that of the hard, dense skeleton of the parent sponge, thus protecting them against all chance of being washed away till they can crawl out as young sponges and shift for themselves. On the whole, so far as definitely ascertained facts go, they point unmistakably to the general, if not universal, occurrence of a peculiar mode of propagation in the case

of those sponges\* which are found inhabiting fresh water. In marine sponges, on the other hand, multiplication by free-swimming larvæ is the rule; and when, as in some cases, gemmules are produced as well as larvæ or in place of them, they are generally external; and if internal, never, so far as is known, remain within the parental tissues for any considerable time, but are set free as soon as produced as free-swimming organisms. Moreover, they are never provided with the characteristic protective envelopes which characterise the statoblast of the freshwater sponge.

Thus it appears that the evidence of the Spongillina may be claimed as substantiating, in a very high degree, the truth of our views.

We turn next to the Hydrozoa; and, as the development of the free-swimming Limnocoedium is unknown, we must restrict ourselves to the Hydroids, of which, as far as at present known, there are only two freshwater genera, Hydra and Cordylophora, both belonging to the same family, the Tubularidæ. In Hydra the egg is surrounded by a horny case, within which it undergoes its development. There is thus no free-swimming stage, and the young Hydra hatches out in the adult form. While Hydra, which is by far the commonest freshwater Hydroid, thus favours our view, the other genus, Cordylophora, presents us with what appears at first sight a most damaging exception, for the young of this Hydroid are liberated in great numbers as free-swimming planulæ, which persist in a state of great locomotive activity for some time before settling down to a sedentary existence. This exception is otherwise remarkable, as affording, according to Semper, the only known instance in which the progress of the colonization of freshwater streams by a semi-marine genus can be historically traced. The discovery of Cordylophora was made by Allman, who found it in the Grand Canal Docks of Dublin in 1854. Since then it has migrated into many rivers, and has already reached the Seine at Paris. One would like to be sure, however, as to how much of this history represents the progress of the discovery of the genus and how much its actual migrations. It is especially interesting as throwing light on the means by which Cordylophora has been enabled to carry on its migration, to find it frequently associated with *Dreissena polymorpha*, a mollusc which has, in recent times, colonised many rivers in England. Both *Dreissena* and *Cordylophora* are attached animals, frequently found growing together on floating timber; and it is probably owing to the occasional transport of this up stream by human agency that the introduction of both these forms into our rivers is due. It is also possible that the larvæ of *Cordylophora*, which is known to grow attached to buoys at the mouth of the Elbe, may attach themselves to boats at their moorings, and subsequently be transported by them up stream. Taking into account the

\* For much valuable information and suggestive remarks on this subject I would refer to Papers by Carter and Marshall, in the *Annals and Magazine of Natural History*, ser. v., vols. xii. and xiii.

comparative rarity of Cordylophora and its habit of growing attached to floating timber, we need not regard its propagation by free-swimming larva as fatal to our deduction.

The marine Polyzoa propagate exclusively by free-swimming larvæ; but in the freshwater division of the group, statoblasts, similar in essential characters to those of the sponges, are usually developed. A well-known exception is that of Paludicella, in which statoblasts have not been observed. The development of the ovum in this genus, however, has been watched by Professor Allman, who shows that it takes place within the perivisceral cavity of the parent, so that when it escapes, by rupture as he conjectures, of the parental body wall, it is in a condition to settle down at once as a fixed or attached form. This exception, therefore, may be said to prove the rule.

## LAMELLIBRANCHIATA.

ISOMYA.	<i>Cyprinacea.</i>
<i>Integropalliata.</i>	Cardium, <i>f. m.</i>
Unionacea, <i>f. o.</i>	Cyrena, <i>f. o.</i>
Cyprinacea, <i>f. m.</i>	Cyclas, <i>f. o.</i>
<i>Sinupalliata.</i>	Pisidium, <i>f. o.</i>
Veneracea, <i>f. m.</i>	<i>Veneracea.</i>
HETEROMYA.	Tellina ( <i>Galatea, f. o.</i> )
Mytilacea, <i>f. m.</i>	Scrobicularia.
Mulleracea, <i>f. o.</i>	Mactra ( <i>Gnathodon, f. o.</i> )
MONOMYA.	Donax ( <i>Fischeria, f. o.</i> )
Aviculacea, <i>o. m.</i>	<i>Mytilacea.</i>
Ostreacea, <i>o. m.</i>	Dreissena, <i>f. o.</i>

To give an account of the fresh-water Mollusca of the entire world would require a large monograph to itself; and this, when completed, would leave us in ignorance of many of those points relating to development which are essential to our inquiry. We cannot, therefore, discuss this group except in a very limited manner. Commencing with the Lammellibranchiata, and of these first the Unionacea, we meet in both genera of this family (*Unio* and *Anodon*) a most remarkable and well-known course of development, which furnishes a striking illustration of the necessity which exists in the case of slow-moving, freshwater forms of some means of dispersion not involving the production of a free-swimming embryo. The ova in these genera develop up to a certain stage within the gill-pouches of the parent, and remain there as "glochidia" till some passing fish or, it may be, a wading bird comes into their vicinity. The young glochidia then issue into the surrounding water, and, swimming like *Pectens* by the

flapping of their valves, attach themselves, like external parasites, to the animal whose presence has stimulated their efforts. Becoming encysted by an epidermic outgrowth of the host, they are carried about till they become metamorphosed into young Anodons or Unios; and then, escaping from the cyst, drop to the bottom of the stream, and assume a sedentary mode of life. In this way they become dispersed through the river they inhabit; and when transported by birds may be transferred from one river system to another.

Of the next family of Lammellibranchiata, the Cyprinacea, only three genera are river-dwellers, *Cyrena*, *Cyclas*, and *Pisidium*. In *Pisidium* the development of the embryo proceeds within the gill-plates of the mother; so that in this case also the young larvæ are secured from a seaward journey. The development of *Cyclas* is also intraparental; and no free larval stage exists.

With respect to the mode of development of the few forms which, among the Veneracea, are found inhabiting rivers, I can obtain no information.

Passing to the Mytilacea, we find the freshwater *Dreissena*, common in some English rivers and canals, into which it has been imported within recent times. Although I can find no details respecting its development,\* this need not trouble us, as its habit of attaching itself to floating objects will quite readily account for its introduction. I can find no reference to the development of the Mulleracea.

So far as our imperfect examination of the Lammellibranchs permits, we may claim this group as affording evidence in support of our hypothesis.

## GASTROPODA.

STREPTONEURA.		EUTHYNEURA.	
<i>Rhipidoglossa.</i>		<i>Pulmonata.</i>	
Neritidæ,	<i>f. m.</i>		
<i>Tænioglossa.</i>		<i>Basommatophora.</i>	
Melaniidæ,	<i>f. o.</i>	Limnæidæ,	<i>f. o.</i>
Entoconchidæ.	<i>o. m.</i>	Auriculidæ.	<i>brackish water.</i>
Littorinidæ,	<i>f. m.</i>		
Paludinidæ,	<i>f. o.</i>	<i>Stylommatophora.</i>	
Valvatidæ,	<i>f. o.</i>	Oncidiada.	<i>salt marshes, t.</i>
Ampullaridæ.	<i>f. o.</i>		

*Nerita* is a marine genus; but it contains species which dwell in freshwater streams. One species, in the Philippines, climbs trees.

*Neritina* is a freshwater genus; but *N. fluviatilis*, which is found in British rivers, also occurs in the brackish waters of the Baltic; while *N. viridis* and *N. meleagris* are Indian species which live in the sea.

\* Prof. Lankester thinks it probable that the larva of *Dreissena* is free-swimming, and that both it and *Cordylophora* are lacustrine rather than fluviatile forms.

Littorina is a marine genus; but it contains two sub-genera, Lithoglyphus (S. E. Europe, and Central Africa, *L. tanganyika*) and Limnotrochus (*L. tanganyika*), which inhabit fresh water.

Compared with the rich variety of forms which they present in other parts of the world, the freshwater Gasteropoda are but poorly represented in our British streams. The chief genera are Limnea, Ancyclus, Physa, Planorbis, and Valvata, belonging to the euthyneurous Gasteropoda, and Paludina and Bithynia, belonging to the Streptoneura.

Although not quite germane to our subject, we may stop to point out the remarkable thinness of the shell in these molluscs, and its frequent correlation with a thick epidermis (periostracum). The thinness of shell is suggestive at first sight either of a deficiency of carbonate of lime in fresh water, or of greater difficulty in extricating it from a solution in which sodium chloride is scarcely present. Analyses, however, show that fresh water is usually by no means deficient as compared with sea water in calcium carbonate; and the fact that the Unionidæ frequently secrete quite massive shells indicates that the absence of sodium chloride has no appreciable effect. The erosion of the umbones of Unio shells and earlier-formed whorls in Paludinæ seems to suggest an excess of free carbonic acid, and perhaps other acids which might tend to hinder the secretion of solid shell: and possibly the thick epidermis not only represents layers which in a marine shell would be calcified, but also functionally serves to protect the already formed shell from solution.\* On the whole it seems most probable that the thin shell has arisen by natural selection, and is correlated with the lower specific gravity of fresh water as compared to salt. This diminished density would render it needful for the free movements of the animal that it should be disburdened of all unnecessary weight. On the other hand, the thicker shells of marine mollusca, so often found broken, are probably correlated with the occurrence of powerful shifting currents and storm waves in the medium which they inhabit.†

Passing on to our main inquiry, we find that the euthyneurous Gasteropoda usually deposit their eggs in jelly, which is attached to some foreign object, and the young emerge in a fully formed state. In the streptoneurous division we have Bithynia and Paludina: the former attaches its eggs, but the latter—and this is a significant fact—is viviparous, the young molluscs leaving the mantle chamber of the parent as young adults.

The Crustacea furnish us with abundance of freshwater forms, Copepods, Branchiopods, and Ostrapods, Isopods and Amphipods; and Palæmoninæ, and Astacinæ among the Decapods. But the first three groups contain none but minute forms, which are capable of distribution by birds and probably winds. They

\* Semper has already suggested that the epidermis serves this purpose.

† Some interesting remarks bearing on this subject will be found in a Paper by Mr. A. R. Hunt, in the *Proceedings of the Royal Society*, London, 1882, p. 8 (reprint).

pass through a nauplius stage; but Nauplii are strong swimmers, and quite capable of maintaining their position amidst the slowly-moving water in which they teem.

The Amphipods carry their ova about with them, tucked under the abdomen; and the segments and limbs are all formed before hatching.

The marine forms of the Palæmonina usually leave the egg in the zoëa stage, but the freshwater in a stage more advanced than the Mysis, as Fritz Müller shows in his description of the development of a Palæmon living in brooks in Blumenau.

Astacus carries its eggs about, attached to the swimmerets of its abdomen, like the lobster. The young, however, unlike those of the lobster, are provided with sharply-hooked claws, by which they can maintain a hold of the parent after they have entered upon a free existence. Whether this contrivance is to prevent their being swept away by the river, or to afford them, when necessary, maternal protection, like that of a hen for her chickens, seems doubtful.

We have now passed in review many of the chief peculiarities in the mode of development of the members of our freshwater fauna, and find, with a few exceptional cases susceptible of ready explanation, everywhere consistent evidence in favour of our original proposition, that the invertebrate animals inhabiting fresh water might be expected not to propagate exclusively by means of free-swimming larvæ. The passage through a free larval stage in the course of development may be regarded as a real explanation of the exclusion of such marine forms as undergo it from a freshwater *habitat*.

Three causes are therefore admitted as leading to this exclusion: they are—(1) the difference in chemical composition of the medium; (2) the severe character of the freshwater climate; (3) the necessity for the suppression of a free larval existence. The number of animals which can satisfy all these three conditions might be expected to be few; and probably there are other quite as important deterrent causes to be revealed. The absence of suitable food in freshwater streams has been suggested by Semper as one of these, and does probably lead to the exclusion of many marine forms. Thus none of the Gastropods of our streams are carnivorous, in the sense of preying upon other animals of more than microscopic size,\* and yet many carnivorous Gastropods are actively locomotive, abound on our coasts between tide marks, endure a rigorous climate, and so dispose their eggs as to preserve them, during development, from destruction or transportation by currents. *Purpura* is a case in point, and *Nassa* another, yet these molluscs are not known to occur in a single freshwater stream. The *Murexes*, some of which are viviparous, and have no severe climate to contend against in the localities where they occur, are likewise exclusively marine. In another order of Mollusca, the Cephalopods, we find characters which one would expect to render

\* In rasping the leaves of freshwater plants the gastropods will necessarily devour hosts of Infusoria. Infusoria also help to furnish food for lammellibranchs.

them eminently adapted to a freshwater mode of existence, such as their firm and compact tissues, remarkable activity, and emergence from the egg in a complete state. Yet no such animal as a freshwater cuttlefish is known. In this case a deficiency of appropriate food is probably the efficient barrier, for these molluscs are exceedingly voracious, feeding largely on Crustacea—they have been known to overpower the lobster in fair fight—and the freshwater Crustacea of our streams are probably not numerous enough to furnish them with a dependable meat supply. Like the Murexes, they may also be regarded as amongst the dominant classes of the Mollusca, and, being pre-eminently successful in the struggle for existence, are not forcibly pushed into rivers for a means of subsistence, so that supposing immigration possible, no sufficiently strong reason for it exists. The habits of animals must also be taken into account, for these, in many cases, seem to be as characteristic of the species as are structural peculiarities, and a change from a marine to a freshwater life would therefore only take place under the action of some unusually powerful impelling cause.

Some other impediments to this transformation will be attended to in discussing the next part of our inquiry, *i. e.* as to the mode in which freshwater forms have originated, and the circumstances under which some of their chief peculiarities have been produced.

There are at least three conceivable ways by which freshwater animals may be derived from marine. The latter may—(1) directly migrate into rivers from the sea; (2) the area which they inhabit may be converted into a freshwater basin or lake; (3) they may acquire a terrestrial or marsh-loving *habitat*, and subsequently exchange this for a fluviatile or lacustrine one. Some of our freshwater Gastropods, *viz*: the freshwater Pulmonata, have most probably acquired their present *habitat* in this circuitous fashion, as also the freshwater Oligochaeta, as Professor Haddon has suggested to me. We shall now confine ourselves to a discussion of the first two alternatives.

With regard to direct emigration from the sea, we may safely dismiss it as an explanation in the case of fixed forms which are not parasitic nor attached to locomotive animals. Such forms as Sponges, Polyzoa, and Hydra, are not likely to have travelled direct from sea to rivers. Only one genus of locomotive Polyzoon is known; and though the Tubularidæ among the Hydrozoa pass through a freely-moving actinula stage; yet, as this is transitory, it is scarcely competent to explain the presence of Hydra in our ponds.\* Such locomotive Mollusca and Crustacea as fulfil the three conditions already laid down might, on the other hand, be fairly expected to furnish us with instances of direct colonization. Some such possibly exist, but

\* On the other hand, the actinula stage—or one not far removed from it—may, in very early geologic times, have persisted throughout life in the ancestral Tubularidæ, and thus have rendered direct immigration possible. Certain features in the development of Hydra have been regarded, however, as indicating that it is a degraded form of Tubularian, and not a persistent early type.

they are remarkably rare. The actively-moving Crustacea sometimes appear to push their way up stream, as is shown by the occurrence of two species of freshwater *Peneus*, one inhabiting the Sutlej, at the foot of the Himalayas, the other (*P. Braziliensis*) occurring far up the rivers of North America (Semper, p. 437). Some freshwater crabs also appear to be late immigrants into freshwater areas. Of freely-moving molluscs scarcely any good instances of direct immigration can be adduced.

Had our streams become populated by direct colonization from the sea, one might fairly expect to find more frequent cases of the process still in progress. Marine forms becoming estuarine, and estuarine passing into fluvial forms, should be processes of common occurrence; as a matter of fact, they are so rare that one is led to suspect that the *Peneus* of freshwater streams has been derived rather from descending lacustrine species than ascending marine ones. It would appear that some very serious obstacle besides those already suggested must exist about the debouchment of rivers to hinder the inland progress of marine animals: it is possible that in some cases this is of the nature of a thinly-peopled zone or desert margin, which none but swiftly-moving animals, such as fish or Crustacea, find it possible to traverse. Such a desert might well be produced by the commingling of the fresh and of the muddy water of a river with the sea. Such rivers as I am acquainted with are remarkably bare of vegetation along their seaward banks, and the fatal action of salt water on many of the minute organisms they bear to sea would probably produce unwholesome conditions extending over a considerable distance. Again, the percentage of salt may decrease too rapidly from sea to river to permit individual animals to cross from one to another in the course of a lifetime, though one would not rest much on this, as Semper mentions oysters which flourished at the mouth of a river where they were alternately bathed, according to the state of the tides, with fresh and salt water; and if oysters are capable of withstanding such rapid alternations of medium, no doubt other locomotive molluscs may be also. Direct immigration appears less probable than the second alternative already suggested; and I would rely for an explanation of the existence of freshwater animals on those wide changes in the distribution of land and sea, which we know to have taken place in the course of geological time. The conversion of continental seas swarming with various kinds of life into terrestrial areas, diversified by extensive systems of lakes, has occurred not once or twice only in the history of the earth. As lakes began to be produced by a rising of the sea-floor, they would probably remain in connexion at first with the open sea, and rivers discharging into them would only slightly sweeten their waters; but as elevation slowly continued, connexion with the sea would be severed at one point and another, till eventually it would cease altogether, except in so far as rivers might flow into the sea from the lake. The waters of a lake so formed would continually freshen at a rate depending on the size of the lake and the area and rainfall of its catchment basin.



Of the marine forms existing in this transformed area, few would probably migrate so long as the tidal waters of the ocean ebbed and flowed in it. As elevation progressed, many active locomotive forms, to whom the new conditions were distasteful, would escape seawards, and others less enterprising, in whom fixity of habit was a pronounced feature, would lag behind till escape became impossible. The attached forms would be unable to escape, and would therefore be entrapped. With complete isolation of the lake would commence a sorting out of the remaining fauna: some members would succumb, others would survive, and, adapting themselves to their altered circumstances, give rise to a freshwater fauna.

The Baltic has often been quoted as a marine area in which some such change as that described is in progress, and no doubt with truth, but one cannot but admit that the change is here taking place under somewhat unfavourable circumstances. The climate of the Baltic is severe, and a selection by means of climatal conditions proceeds apace with that due to freshening of the waters. The elevation is also proceeding with that slowness which characterises the terrestrial movements of the present day. Finally, the Baltic has only just emerged, geologically speaking, from a glacial episode which left its fauna poorer than it found it. In past times much more favourable transformations of marine into lacustrine areas must have occurred. To look no further back than the beginning of Tertiary times, we know that then there existed a far more uniform, which is the same as saying "less severe" climate than characterises the temperate regions of the existing period. We have reason to believe that the relative level of land and sea was subject to more rapid changes. Glacial epochs did not interfere, and the newly-raised rocks need not have always been schists and gneisses, but were sometimes probably composed of softer and more porous materials, which, retaining a certain quantity of salt water in their interstices, may have given a brackish character to the first-formed running streams. If the origin of our freshwater fauna dates back to a time when climatal conditions were more uniform or less severe, then the characters which freshwater animals now possess in adaptation to the existing climate would have been subsequently produced, and might have been acquired with secular slowness.

If now we turn to the evidences of geology, we find that the first recognized appearance of lakes is to be found in the Old Red Sandstone period. The previously existing Silurian marine areas became gradually differentiated into the Old Red Lakes and the Devonian Seas, and a freshwater fauna might very well have been contemporaneously developed. It is unfortunate that the explored Old Red Sandstone strata, like so many deposits of probably freshwater origin, should have proved so remarkably unfossiliferous; still we know of one fossil far from rare in the Kiltorcan beds of Kilkenny, which has been pronounced by no less an authority than Edward Forbes to be a genuine ancestor of existing pond mussels. This shell, known as *Anodonta Jukesii*, is altogether different in character from the

described lamellibranchs of the marine Devonian strata, and, from its large size, rivalling that of existing Anodons, appears to have flourished under remarkably favourable circumstances. If at this early period a glochidian stage was then characteristic of the Anodonta, it would have secured a wide distribution to the species by means of the contemporaneously existing fish. Although *Anodonta Jukesii* is the only fossil found in the Old Red Sandstone which has been referred to the freshwater Mollusca, others may undoubtedly have existed. Indeed the presence of numerous remains of fish which are supposed to have possessed the habits of the Salmonidæ directly suggests this, since, judging from their teeth, they must have required animals to feed upon during their sojourn in fresh water.

The world-wide distribution of the Unionidæ and their extraordinary richness in subgenera and species are quite in harmony with this early appearance of Anodonta; and I feel disposed to assign quite as early a date to the appearance of the Limnæidæ: their world-wide distribution, and the difficulty of assigning them any close alliance with marine forms, suggests a high antiquity for the family. The Valvatidæ, so curiously distinguished by the persistence of an archaic character in their gill plumes, might also have inhabited the Old Red Sandstone rivers and lakes. No one supposed that the terrestrial gasteropods had originated already in the Palæozoic period, yet the discovery of Pupa and Conulites (*Helix*) in the coal-measures leaves no doubt on this point.

The Helicidæ are amongst the nearest allies, and are possibly ancestors, of the Limnæidæ, and the latter may be fairly looked for in strata of corresponding age. It must here be added that the Helicidæ, though at least as old as the Carboniferous period, may be much older, and may have existed in the Devonian forests, so similar in the general character of their flora to those of the succeeding Carboniferous period.

The next great lacustrine epoch occurred in Permo-Triassic times, when extensive lakes covered a large part of the northern continental areas. Some of these were evidently inland salt seas, but probably not all: indeed Ramsay regards the Bunter beds of the Trias as in all probability the deposits of a freshwater lake, which subsequently became salt. In such freshwater lakes a part of the enclosed post-carboniferous fauna may have slowly become modified, and thus have contributed additional genera to our freshwater fauna. The Trias has not, however, as yet furnished us with any fossiliferous freshwater deposits, and consequently we must look to later Mesozoic strata for signs of the freshwater genera which had thus early come into existence. But scant evidence is however afforded until we reach the Purbeck and Neocomian strata: thus in the Lias we find *Cyrena*, *Neritina*, and, according to Moore, *Planorbis* (one species) and *Valvata* (two species). In the inferior Oolite we meet with *Corbula*, *Neritina*, *Planorbis*, *Paludina* (?), *Melania*, *Hydrobia*, and *Cyrena*. Of these genera, *Planorbis*, *Paludina*, and *Valvata* may be, and probably are, very ancient forms which originated in Devonian lakes; but with the other genera—*Cyrena*, *Neritina*, *Melania*, and *Hydrobia*—the case is different;

for we can easily find close alliances for them amongst marine molluscan families from which we may regard them as directly or collaterally descended. Further, as fossil remains of marine molluscs are comparatively abundant, we shall be able from the first appearance of these to gather some idea as to the probable date of the first appearance of their freshwater relations; always, however, bearing in mind that the determinations of many Palæozoic Mollusca are to a certain extent doubtful. Setting these aside, we find that the Cyprinidæ (*in sensu restricto*) date from the Trias, and thus *Cyrena*, which is allied to this family, in all probability may be regarded as post-Triassic in age. The *Neritina* are included in the family *Neritidæ*, which is also first found in the Trias, while *Hydrobia* belongs to the *Rissoidæ*, first met with in the Jura, though it may of course have made its appearance earlier, and probably did. Thus the genera *Cyrena*, *Neritina*, and *Hydrobia* cannot safely be pushed farther back than the Trias, but may very possibly have then originated in the lakes of that period.

Passing now to the Purbeck-Wealden deposits, we encounter the numerous freshwater genera detailed in the following list:—*Unio*, *Cyrena*, *Corbula*, *Cardium*, *Valvata*, *Hydrobia*, *Annicola*, *Neritina*, *Planorbis*, *Lioplax*, *Bithynia*, *Paludina* (?), *Physa*, *Limnæus*, *Gnathodon*, *Pleuroceras*, *Goniobasis*, *Leptoxis*, *Plychostylus*, *Carychium*, and *Auricula*. Of the genera which here appear for the first time, *Gnathodon*, a sub-genus of *Mactra*, may have become specially modified in Jurassic times, for the genus is not known earlier than the Coral-rag. *Unio*, however, may be regarded as a descendant of the Devonian *Anodonta*. The list is more especially interesting as affording evidence of the abundant development of the freshwater *Melaniina* in our own area during the Mesozoic period, from which, as well as from Northern Europe generally, they are now entirely absent, though widely spread in other regions, particularly the warmer zones of the earth. Considering the small part of the earth's crust that has been at all carefully studied, it is of the highest interest to find the same genera of freshwater shells occurring at widely-separated points in beds of approximately contemporaneous age, and so far remote from the present as Cretaceous times (Cenomanian or Senonian). Thus in North America, where the Cretaceous rocks have been grouped as follows:—Laramie, Fox Hill, Colorado, and Dakota groups, they have afforded *Unio* (one species), *Cyrena* (one species), *Neritina* (three species), *Physa*, and *Valvata*, from the Fox Hill beds; and *Unio*, *Corbicula*, *Acella*, *Leptolimnea*, *Limnophysa*, *Limnæa*, *Neritina*, *Melanopsis*, *Campelosis*, *Pyrgulifera*, and others, from the Laramie beds. With regard to the fauna of the Fox Hill beds, Clarence King well remarks that "the discovery of this singularly tertiary-like group deep in the Cretaceous should only open our eyes to the early specialisation of freshwater molluscan types." And Dr. White, referring to the Laramie fossils and their similarity to existing forms, speaks more strongly still, as when he says: "The lines of descent of the numerous types which have reached us unbroken seem to be almost parallel, so little

have they changed with the lapse of time. So slightly divergent are these lines, considered as lines of differentiation, that if we bound them all by two imaginary straight lines we should have an evolutional parallax that would carry back the origin of these types to a period inconceivably remote." \*

It is not only in North America that we find, however, the same freshwater genera as in Europe: India also furnishes us with an instructive list: thus from the lower Intertrappean freshwater beds (Cenomanian or Senonian in age) have been obtained—*Unio*, *Physa* (one sp.), *Paludina* (twelve sp.), *Valvata* (four sp.), *Limnæa* (six sp.), and *Pisidium* (one sp.)

Thus we find several freshwater genera of Mollusca already distributed in Cretaceous times over parts of the Palæarctic, Nearctic, and Oriental regions.

Proceeding in our review to the Tertiary period, we encounter an epoch of gigantic mountain building, and consequently of extensive lake formation. Many great mountain ranges now existing took their rise after the Eocene, Miocene, and Pliocene periods; and with them, I doubt not, several of our existing great lakes and inland seas, such as the Caspian, lake Baikal, and the lake system of Central Africa.

Some marine forms were probably enclosed in these basins, and became converted into freshwater genera; but the majority of the freshwater inhabitants of the Tertiary lakes and rivers were derived from previously-existing freshwater species, as is shown by the fact that they belong to genera already in existence in Mesozoic times. There are, however, some fresh acquisitions: thus the Littorinidæ, which might, from their hardy habits and universal distribution, have been expected to have furnished earlier some freshwater species, are now represented by the freshwater genus *Lithoglyphus*, which is found in Lower Pliocene strata (*i. e.* subsequent in time to the upheaval of the Siwalik hills, and previous to the upheaval of the Sub-Apennines). The Mytilidæ again, of which the absence of earlier freshwater modifications is equally remarkable, are now represented by numerous species of *Dreissena*, which first appears in the Upper Eocene.

Passing now to the existing lakes, which we regard as the modified descendants of Tertiary seas, we find that those of the northern hemisphere have been subjected to singularly unfavourable conditions: thus the lakes of North America, Europe, and Asia have endured all the rigours of a glacial climate, and in some cases have been submerged beneath a glacial sea; while the Caspian, in addition, suffers from an excessive concentration of its waters. Singularly unwholesome as it has thus become, it yet retains, however, a fragmentary relic of a Tertiary fauna. So much has been written on the subject of the Caspian and its fauna, that I make no excuse

\* Let us add, it by no means follows that we are bound to carry back their origin to a period so determined. The probabilities are that, if we could trace the lines of descent backwards, we should finally find them rapidly converging as they entered a region of geographical change—such, for instance, as that of the conversion of a continental sea into a system of freshwater lakes.

for here inserting the following list, compiled from a monograph on its Invertebrate fauna, by O. A. Grimm, which appeared in 1876 and 1877, with 273 pages of letterpress, nine plates, and a folding map. As, with the exception of the scientific names of species, it is written throughout in Russian, I have to regret that I am not able to extract any further information from a work\* which must be a veritable mine of interesting facts:—

RHIZOPODA.		Piscicola respirans	(Trosch.)
Heliozoa.		P. littoralis	(Johnst.)
Protastrum marina	(Grm.)	Clepsine cœcum	(Grm.)
Schulzia pelagica	(Grm.)	C. affinis	(Diesg.)
Radiolaria		PLATYHELMINTHES.	
Heliosphæra ? hæckeli	(Grm.)	Distomum tumidulum	(Rud.)
Foraminifera		Amphilina foliacea	(G. Wg.)
Rotia veneta	(M. Salch.)	Ligula monogramma	(Crepl.)
Textularia caspia	(Grm.)	L. digramma	(Crepl.)
INFUSORIA.		NEMATODES.	
Acineta tuberosa	(Ehb.)	Monhysteria bulbosa	(Grm.)
Lacrymaria caspia	(Grm.)	Eustrongylus tubifex	(Nitsch.)
Paramecium, sp.		Ascaris cuneiformis	(Rud.)
Colpoda pigerima	(Cohn.)	A. acus	(Bloch.)
Nassula flava	(Clp.)	A. constricta	(Rud.)
Pleuronema (?)		ACANTHOCEPHALA.	
Climacostomum longissimum	(Grm.)	Echinorhyncus strumosus	
Euplotes charon	(Ehb.) (?)	OLIGOCHATA.	
Stylonichia, sp.		Nais, sp.	
Tintinnus mitra	(Grm.)	Tubifex deserticola	(Grm.)
Carchesium, sp.		Limnodrilus bogdanowii	(Grm.)
SPONGIÆ.		Limnodrilus, (?) sp.	
Amorphina caspia	(Grm.)	Enchytræus, sp.	
Reniera flava	(Grm.)	Amphicteis invalida	(Gb.)
Metschnikowia tuberculata	(Grm.)	A. brevispina	(Gb.)
M. intermedia (Grm.) (larval form).		A. kowalewski	(Grm.)
TURBELLARIA.		POLYCHÆTA.	
Plagiostomum caspium	(Grm.)	Ampharete kowalewskii	(Grm.)
Polycelis schulmanii	(Grm.)		
HIRUDINEI.			
Archæobdella esmontii	(Grm.)		

\* *Fauna of the Caspian*, by O. A. Grimm, 1876 and 1877.

POLYZOA.			
Laguncula repens	(Farr.)	A. edentula	(Pall.)
Bowerbankia densa	(Farr.)	A. plicata	(Eich.)
Stichoporina ?		A. vitrea	(Eich.)
		Anadonta ponderosa	(Pfr.)
		Dreissena polymorpha	(Ben.)
		D. caspia	(Eich.)
		D. rostriformis	(Desh.)
		D. brardii, Brgn. var. caspia	(Grm.)
LAMELLIBRANCHIATA.		GASTROPODA.	
Corbicula fluminalis	(Müll.)	Neritina littorata	(Eich.)
Cardium edule	(Linn.)	N. schulzii	(Grm.)
C. edule, var. rusticum		Hydrobia caspia	(Eich.)
C. caspium	(Eich.)	H. dimidiata	(Eich.)
C. crassum	(Eich.)	H. spica	(Eich.)
C. trigonoides	(Pall.)	H. stagnalis	(Linn.)
C. trigonoides, var. crassum	(Grm.)	Eulima conus	(Eich.)?
C. pyramidatum	(Grm.)	Bithynia eichwaldi	(Krynicky.)
C. baeri	(Grm.)	Lithoglyphus ? caspius	(Krynicky.)
C. longipes	(Grm.)	Planorbis micromphalus	(Fuchs.)?
C. barbot-de-marnii	(Grm.)		
C. catillus	(Eich.)		
C. pseudocatillus	(Abich.)?		
Adacna læviuscula	(Eich.)		

Separating the Mollusca, we have the following list of genera, in which I have added the name of the group of beds in which each genus is first known to occur :

Corbicula,	1 sp.,	Lower Eocene.
Cardium,	12 sp.,	Upper Jura.
Adacna,	4 sp.,	Lower Pliocene.
Anodonta,	1 sp.,	Devonian.
Dreissena,	5 sp.,	Upper Eocene.
Neritina,	2 sp.,	Lias.
Hydrobia,	4 sp.,	Middle Jura.
Eulimus,	1 sp.,	Trias.
Bithynia,	1 sp.,	Middle Jura.
Lithoglypha,	1 sp.,	Lower Pliocene.
Planorbis,	1 sp.,	Lias.

It is generally admitted that this Molluscan fauna has its closest affinities with that of the "Congerien" strata of Upper Pliocene age, and I therefore add a list of the latter for comparison.

\* Fossils of "Congerien" Strata. Sandberger, p. 676, etc.

Dreissena subglobosa	(Partsch.)	P. loxostomia	(Sandb.)
D. triangularis	(Partsch.)	P. achatinoides	(Desh.)
D. subcarinata	(Desh.)	P. duboisi	(C. Mayer.)
D. simplex	(B. de Marny.)	Melantho sadleri	(Partsch.)
D. schrockingeri	(Fuchs.)	Tulotoma zelebori	(Hörnes.)
Didacna conjungens	(Partsch.)	T. rudis	(Neumayer.)
Unio vukotinovici	(Hörnes.)	T. avellana	(Neumayer.)
U. flabellatus	(Gdt.)	Bithynia verneulii	(C. Mayer.)
Pisidium priscum	(Eich.)	B. tentaculata	(Linn.)
Neritina, sp.		Valvata balatonica	(Rolle.)
Melanopsis martiniana	(Férussac)	V. piscinalis	(Müll.)
M. bouei	(Férussac)	Planorbis varians	(Fuchs.)
Melania escheri	(Brgn.)	Carinifer quadrangularis	
Goniochilus costulatum	(Fuchs.)		(Neumayer.)
Turbonella inaspecta	(Fuchs.)	Limnæus velutinus	(Desh.)
Paludina vukotinovici	(Frauenfeld)	Valenciennia annulata	(Rousseau.)

It will be seen that the Melaniina of the Congerian beds have disappeared from the Aralo-Caspian area, as indeed they have from all the northern Palæarctic zone, but Adacna and Dreissena are common in both the Caspian and Congerian faunæ. One species of the last-named genus (*Dreissena simplex*) is of particular interest, for it is stated by Sandberger to be closely allied to *D. Brardii*, a species which occurs in Lower Miocene deposits, and which is preceded by a very similar form, *D. unguiculus* of the Headon Hill strata (Upper Eocene). Since *Dreissena Brardii* (var. *caspius*) also occurs in the Caspian according to Grimm, we have in this species a series of forms which, commencing with *D. unguiculus* in the Upper Eocene, has persisted with scarcely more than varietal modification down to existing times.

If the genus *Dreissena* originated in Europe in Eocene times, it has acquired an extensive distribution since, for it is now found living in Eastern Europe, Asia, Africa, and America.

In the lakes of Central Africa, which have not experienced the severe climate and other trying conditions of the northern lakes, we find a remarkable assemblage of freshwater Mollusca. Those of Tanganyka and Nyassa, which are best known, are given in the following list, compiled from Mr. Edgar Smith's descriptions.\*

Some of these forms have a very marine aspect, particularly *Neothauma*, *Tiphobia*, *Paramelania*, *Limnotrochus*, and *Syrnolopsis*, so that at first sight one might be disposed to regard them as of comparatively very recent origin: further consideration, however, will render this view improbable. On the next page the molluscan genera of Lake Tanganyka are assigned to their respective families, and

\* *Proceedings, Zool. Soc.* 1880, p. 334; 1881, p. 276 and p. 558.

the date of their earliest known existence appended. It will be seen that *Neothauma* is a Paludinid, and consequently a modified freshwater genus—not marine.

Genera of Mollusca living in Lake Tanganyka.	Date of first known Appearance.	Families to which the Genera are assigned.	Date of first known Appearance of Families.
<i>Tiphobia</i> , . . . .	L. Eocene or Up. Cret.	} Melaniina, .	Mid. Jura (Inf. Oolite).
<i>Paramelania</i> , . . . . (= <i>Pyrgulifera</i> ?)	" "		
<i>Melania</i> , . . . .	Mid. Jura, (Inf. Oo.) .		
<i>Melanella</i> , . . . .	L. Pliocene, . . . .		
<i>Paludomus</i> , . . . .	Mid. Cret., . . . .		
<i>Paludina</i> , . . . .	Up. Cret., . . . .	Paludinidæ, .	Mid. Jura (Inf. Oolite).
<i>Unio</i> , . . . .	Up. Jura, . . . .	} Unionidæ, .	Devonian.
<i>Pleiodon</i> , . . . .	(?), . . . .		
<i>Ætheria</i> , . . . .	Recent, . . . .	} Mutelidæ, .	Up. Cret.
<i>Spatha</i> , . . . .	Up. Cret., . . . .		
<i>Mutela</i> , . . . .	L. Eocene, . . . .		
<i>Corbicula</i> , . . . .	L. Eocene, . . . .	} Cyrenidæ, .	Lias.
<i>Cyrena</i> , . . . .	Lias, . . . .		
<i>Planorbis</i> , . . . .	Lias, . . . .	} Planorbinae, .	Lias.
<i>Neothauma</i> , . . . .	Recent, . . . .		
<i>Segmentina</i> , . . . .	Up. Eocene, . . . .		
<i>Limnæa</i> , . . . .	Up. Jura, . . . .	} Limnæinae, .	Up. Jura.
<i>Physa</i> , . . . .	" . . . .		
<i>Limnotrochus</i> , . . . .	L. Pliocene, . . . .	} Littorinidæ, .	Silurian.
<i>Lithoglyphus</i> , . . . .	Recent, . . . .		
<i>Synolopsis</i> ,* . . . .	Recent, . . . .	Pyramidellidæ,	Cambrian.
<i>Lanistes</i> ,	Recent, . . . .	Ampullariidæ,	Up. Cret.

*Tiphobia*, which Mr. Smith regards as one of the most marine-looking of the whole fauna, is not only a Melanian, and therefore a genuine freshwater genus, but includes *Paramelania* as a sub-genus; and this is closely allied to, if not identical with, *Pyrgulifera*, which is known as a freshwater form so low down as the Laramie beds of North America. *Limnotrochus*, which Smith speaks of as exceedingly like a *Trochus*, both in general form and sculpture, is assigned by him to the Littorinidæ, a family which is already represented by one freshwater genus in the lower Pliocene beds of Europe; and since *Lithoglyphus* occurs together with *Limnotrochus* in the lake, it is quite possible that both have descended

\* This genus may belong to the Melaniinae.



from early Pliocene freshwater ancestors. It is, on the other hand, possible that the modification of some marine Littorinid into Limnotrochus, as well perhaps as *Syrnolis* into *Syrnolopsis*, may have taken place during the conversion of some part of the Tertiary sea into the African lakes; but whether these two genera are special modifications confined to the African area or not, future research alone can decide.

The lakes of the northern hemisphere must now be briefly referred to. Some of them, as those of Norway and the British Isles, were probably submerged beneath the sea during the middle of the glacial episode. The same is probably true of the North American lakes. This short, temporary submergence, while it must have destroyed the freshwater inhabitants of the lakes, probably introduced into them the marine and Arctic Crustacea, *Mysis relicta* and *Pontoporeia affinis*, which became isolated from the sea on the subsequent re-emergence of the land. The rest of the present inhabitants of these lakes must have been subsequently supplied by the rivers which discharge into them. It is probably owing to the severe climate which culminated in glacial conditions that the Melanidæ are no longer to be found in Northern Europe. The cold and the glaciers would, no doubt, have operated quite as effectually in North America; but in this case the structure of the country has made it possible for the Strepomatidæ to return from their southern exile, and once more to occupy their pre-glacial *habitat*. The great size also of the American lakes might have saved the Melanidæ from extinction during the first and most severe part of the glacial period; and during the great submergence, when the climate was warmer, they might have sought refuge from the sea-water in the freshly restored river-systems.

We have, finally, to consider the causes which have led to some of the more marked modifications which characterise freshwater genera. In the first place they are seldom shared by their nearest marine relations: no marine mollusc is known to pass through a glochidium stage; no marine Polyzoön nor sponge produces a winter bud or statoblast; no marine Phyllopod an ephippium; and no Tubularian an egg within a horny shell like that of *Hydra*. A large number of marine molluscs, however, lay their eggs in capsules, and some, such as *Cymba*, are viviparous.

The winter eggs of sponges and Polyzoa, since they appear in correspondence with a seasonal change, are probably, as Semper has suggested, produced as a protection against cold or drought. If they are adaptations to a freshwater climate they must have appeared subsequently to the isolation of the organism from the sea; and thus, though now available as a means of distribution, could not have been the means by which the organisms producing them exchanged a marine for a freshwater *habitat*. The ephippium of *Daphnia* and the incapsuled embryo of *Hydra* may also be regarded as modifications induced by the severity of a freshwater climate. The fact that the embryo of *Hydra* hatches out soon after it is laid in a freshwater tank

is not opposed to this view, as the water in such tanks is maintained at the temperature of the laboratory, and not at that proper to the season.

On the origin of the glochidium in the Unionidæ it is, in the absence of data, almost useless to speculate. One might suggest that it is the specialised descendant of a form of larvæ once of very general occurrence, and of which, as the development of the Mollusca becomes better known, some traces may still be found to exist. Its marked persistence in the Unionidæ would be clearly owing to modifications giving it a functional importance as a means of distribution.

The causes which have led to the viviparous character of Paludina and the attachment of the eggs of other freshwater Mollusca and Crustacea need special discussion, and we must now enter upon a somewhat lengthy argument, though I fear it will not appear so extensive and detailed as its importance demands.

I will begin by stating the following proposition:—The higher the position an animal occupies in the scale of organised beings, the higher, as a rule, the stage at which it assumes a free existence. Thus the lowest classes of animals, such as the sponges, cœlenterates, and echinoderms, almost invariably commence an independent existence as free-swimming larvæ, very unlike the parent in outward form and general structure. So do most of the Vermes, including the whole of the Brachiopoda and Polyzoa.

The Mollusca, Arthropoda, and Vertebrata, exhibit instructive gradations in this respect.

The young of all classes of the Vertebrata are always born in full possession of the characters distinguishing that sub-kingdom. (I here follow Balfour in regarding Amphioxus as a member of the Chordata, but not of the Vertebrata.) In the Icthyopsida, the lowest division of the Vertebrata, the young, however, frequently undergo a remarkable metamorphosis before assuming the adult state; at the same time they always enter upon existence as evident Icthyopsida. In the higher subdivisions Sauropsida and Mammalia, no considerable metamorphosis takes place, and the young are always born with the same generic or at least family characteristics as distinguish their parents. In the Mollusca we find the lower forms, such as the Chitons, commence life as free-swimming larvæ: so do some of the Gastropoda, but others do not. Thus the first hatched young of Murex, one of the culminating genera of the marine Gastropoda, are in all important respects similar to the parents. The case is similar with the Lammellibranchiata, the young being sometimes born as free larvæ; at others as young adults. But in the Cephalopoda, the crown of the molluscan sub-kingdom, the young animals never are hatched otherwise than as young cuttlefish. In the Arthropoda a similar gradation exists. The lower orders of Crustacea are characterised by passing through a free nauplius stage; the higher, such as the Decapoda (except in the case of Peneus), are not hatched until they have reached the zoëa stage, or it may be until they have completed their development, as in the case of the lobster.

The Tracheata furnish some interesting exceptions which, like most exceptions to a general rule, lend a helping hand to its interpretation. A young cockroach, for instance, is born with nearly all the parental characters, yet it is a less specialised form than a butterfly, which starts in life as an humble grub, and long remains so. Still, even in the Insecta, we find the highest forms, such as bees and ants, postponing a free existence till the larval state is passed. Taken broadly, then, the statement that the higher the organism the more advanced the stage at which it enters upon a free and independent existence, may be regarded as a sound generalization. We may next seek for an explanation of this rule, and we begin by the inquiry—What is the use of the more complex organization of a higher form to it, and how has it been produced? Its use, or one use, is to give an advantage in the struggle for existence; and it has been evolved by the constant superposition of successful inherited varietal modifications. This much being admitted—as it is universally admitted by modern naturalists—it is clearly a disadvantage for a highly organized animal to produce young which have to start afresh from the same level as the inferior competitors, which it has already distanced in the race, to repeatedly fight the same battle over again, or to run the gauntlet in its ontogenetic development of other competitors in each and every of the less highly organized states through which it has passed in its phylogenetic history. As a gastrula, it would have to compete with other gastrulæ, and not with gastrulæ only, but with older and more formidable competitors, more advanced in their development than itself. Not only would it be exposed to the dangers of direct competition, but also those of the inorganic world—to the violence of currents in particular. The very fact that the adult possesses a higher organization is a proof of the less efficiency of the lower organization which marks its earlier embryological stages. Thus it would be clearly of immense advantage to the race for the organism—(1) to abbreviate its larval history; (2) and to pass through that history in a state of seclusion—withdrawn, as far as possible, from the accidents and competition of the outer world.

On the higher forms these advantages are always conferred, so that a great part of their development takes place in concealment, and many larval stages are passed through with surprising rapidity, or even substantially curtailed.

But the more complete the seclusion of the developing animal, the less the possibility of its obtaining food by its own exertions, and hence food must be provided for it.\*

In the lower forms of life in which a free larval state is the rule, the resources of the parent are greatly taxed in producing a vast number of embryos, compara-

\* Probably the appearance of secondary nourishment in connexion with the ovum was the first variation to occur, and secluded development followed as an effect. The advantage which this conferred insured more certain survival and continued variation in the same direction.

tively few of which survive the chances of destruction which await them in the outer world.

In the higher animals the resources of the parent are less taxed in this direction, but more in another—that of providing food for the secluded embryos. The parent either contributes yolk to the essential part of the ovum, or in addition she lays up with it a store of additional food, such as honey, or a store of captured prey, or, as in the case of the Mammalia and some elasmobranch fishes, she nourishes it with her own blood. In some cases, when a number of ova are left to hatch in the same capsule, one of them having proved its superiority by outgrowing the rest, proceeds to devour them, and thus obtains the requisite additional nourishment by feeding on its brothers and sisters. A remarkable instance of this occurs in the freshwater genus *Hydra*—one ovum devouring the rest while still in its ovary; so that this *Hydrozoon* produces only one or two young, instead of the countless numbers which are born to its marine relations.\*

Cases of this class are of great interest, partly because they illustrate in a strikingly simple manner the supercession of “safety in numbers” by “safety in secluded development,” and partly since they seem to suggest a return on the part of the ova to “plasmoidal” formation, the stimulating effect of which is so well known amongst the Protozoa.

Thus by providing food for the ovum, the full inheritance of the adult organism is secured to the embryo. Herewith a secondary advantage of great importance follows to the race. Cells, like complexes of cells, have a life-history of their own, bounded on either hand by life and death. These machines for converting energy are liable to wear out, to become clogged by residual effete products, or perhaps to become converted into some metameric modification under the degrading action of constant molecular motion. However this may be, they have power to convert only a limited quantity of energy: when they have received and expended a definite but unknown amount they cease to work. Hence the necessity for the reproductive process. If this assumption be not capable of proof, it is at any rate extremely probable. Let us see what it involves. A free-swimming embryo which repeats the ancestry spends its time in swimming rapidly about by means of its vibratile cilia, in obtaining food and digesting it, and while performing these various functions it expends the balance of its resources in undergoing structural change. On exchanging the gastrula state for some other it has still to work for its own living, and when finally it reaches the adult state it has already to a considerable extent worn out its machinery, and expended its powers of converting energy.

In the lower classes of animals, such as the coelenterates and echinoderms, the larval state is not sufficiently prolonged, and the larval changes are not sufficiently

\* The same phenomenon is met with in other *Hydrozoa*, however, *ex. gr.* *Tubularia*.

numerous to make this result of a free larval existence clearly appear, so that the not very highly endowed animal may enjoy the adult state for a very considerable period. To rightly estimate the value of this hypothesis, we ought to know at least approximately the limits of age of various animals in the adult state, and the length of time they respectively pass in the larval state, as well as the changes which they pass through; and these data are almost wholly wanting, and not unnaturally, since no intelligent man, unprompted by some suggestions such as here made, would care to set about the laborious investigation which their ascertainment would involve, merely for the sake of tabular results. Something, however, may be learnt from various of the higher animals. Thus we may point to the Ephemeriidæ, which, after a prolonged larval existence, die soon after attaining maturity. So, too, the butterflies and moths, which do not live long after oviposition. A still more important consequence, however, would seem to follow from the premature ageing due to a free larval existence; and that is the comparatively early exhaustion of the power of undergoing transformational change; the adult or comparatively stable state is reached sooner than it otherwise would be, and the chances of further development are correspondingly diminished.

If we pass to the consideration of the opposite case, we find that the embryo within the egg is in a much superior position to the free larva. In most cases, all that it has to do, besides undergoing transformational changes, is to feed upon nourishment already prepared for it, needing scarcely any preliminary digestion, but capable of immediate absorption by the cells of the embryo. When the embryo is hatched, it enters upon the world with its cells scarcely used; their capacity for work has comparatively had small demands made upon it, and thus a longer life awaits them in the mature state, when the faculties of the organism are most highly endowed.

Thus, in contrast with the Ephemeriidæ, we may cite the ants and bees, which, while in the larval stage, are carefully nourished at the expense of the community, and some of which, after leading the life of grubs, enjoy an interesting and protracted existence. Further, the cells of a young animal just born would appear to be in a particularly plastic state, so that they are peculiarly ready to respond to the action of the environment. Many changes might be induced in the young animal at this critical period, the effects of which would be afterwards manifested as variations in its offspring.

Again, the longer life in the mature state, acquired by those forms which are saved from the drudgery of a larval existence, offers increased opportunities for evolution to the adult animals, so that a progressive development starting from higher and higher platforms is directly favoured.

But not only is a longer existence assured to the adult—existence in the embryonic state is shortened, and perhaps here the influence of seclusion is most

clearly exhibited; for the energy which would be expended by a free larva in activities other than those involved in producing structural change is here solely devoted to that end, and hence the embryonic stages are passed over by secluded forms with comparative rapidity. Thus, while it takes several days to produce no higher form than an *Echinus* from its larva, the chick repeats its enormously longer ancestral history in so short a time as three weeks! Thus we find an explanation for another generalization, viz., that the higher the organism the greater the tendency to pass rapidly through its embryological development, involving the abbreviation of one or more of its larval states, or it may even be their total suppression. That it should take nine months for the development of a man and only three weeks for that of a chick may seem strong adverse commentary upon this statement; but we have here to take into account not only the much higher state of organization in which the young child is born, but also its much greater relative size and the lower temperature at which the development is conducted. But it is in the Mammalia that the most perfect method is met with for insuring to the embryo immunity from all work but that of development. For here there is no useless expenditure of energy in maintaining temperature or carrying on respiration. Nourishment is obtained without the intervention of the stomach by direct absorption in the veins, and thus the ancestral history vastly longer in the Mammalia, especially in the higher orders of Mammalia, than in the other groups, is repeated in a conveniently short period.\*

With this kind of intra-uterine development is probably connected the development of mammæ, since the young embryo when born possesses an unused stomach, and must, consequently, if no other reason existed, be dependent for a while upon the mother for appropriate support. In some of the elasmobranch fishes, where intra-uterine development likewise occurs, nourishment is obtained at first from yelk, and subsequently from the vessels of the yelk-sac, and hence the stomachal parts being put to some use in the course of development, there is no need for a digestive education, and the young dog-fish may obtain food for itself as soon as born.

In the Sauropsida the embryos are nourished by the yelk of the yelk-sac, which, however, is partly employed in supplying blood to the blood-vessels, but it remains quite possible that some of it is directly absorbed by the walls of the alimentary canal. Thus it happens that many birds, as soon as hatched, fall to picking up grain and feed upon it; but certain exceptions even here seem to show the advantage of a gastric education, for some graminivorous birds, such as pigeons, do not take at once to a grain diet, but are fed by the mother bird with a kind of milk, which is secreted by her crop. So, too, the flamingo pours down

\* The earlier phases are passed through more rapidly than the later, probably owing to their having been far more frequently repeated.

the throat of her young a sanguineous fluid which is probably similarly derived. Even when the diet is so digestible as fish, the young bird is not put to feed upon it always in the unprepared state, but is allowed to take it from the crop of the parent where it has probably undergone a partial digestion.

The feeding of young pigeons with milk has been hitherto explained by the comparative helplessness of the young bird; but in that case what necessity is there for the special secretion of milk? One would have thought a grain diet could have been provided for it by the parent at a smaller expense to the parental resources.

We have now to end this digression by pointing to one further consequence which follows upon the comparatively late assumption of an independent existence in the case of the higher animals. It is that in seclusion, where the play of incident forces is as little varied as possible, variations from the usual course of development are unlikely to occur, and consequently the variations which so constantly appear in a species are, as a rule, to be traced to the action of incident forces on the adult animal. A form that passes through a free larval development is liable to modification at any point of its development: one that does not is chiefly susceptible of modification after birth. Hence, as no crustacean appears upon the world at an earlier stage than a nauplius, so no crustacean can diverge from the phylum at a point lower down than that of the nauplius; while the lobster, being born fully formed, cannot develop into fresh varietal modifications except as these are moulded on the lobster type. This helps us to understand the tree-like form of zoological classifications.

Returning now to the viviparous character of the development of *Paludina*, we find that it is not an isolated case amongst the Mollusca, for it occurs also among the *Murex*; and further, that it is an illustrative case of a general tendency towards development in seclusion, the advantages of which are in most cases great, but particularly so in relation to a freshwater mode of existence.

The views here advanced as to the origin of freshwater faunas may be briefly summarised as follows:—

1. The conversion of comparatively shallow continental seas into freshwater lakes has taken place on a large scale several times in the history of the earth; and has been accompanied by the transformation of some of the marine into freshwater species.

2. At their inception these species may have been phanero-genous; if so, they have since nearly all become crypto-genous. This change has been accomplished by the selective action of climate and river currents on varietal modifications induced by change of climate (*Hydra*, *Spongilla*), or of food (? *Paludina*, pseudoparasitic glochidium), or otherwise.

3. While apparently the only probable explanation of the origin of sedentary freshwater forms, the hypothesis will serve equally well to account for others which are locomotive; though in their case another explanation is possible, that of direct migration from the sea.

NOTE I.—Since this Paper was in type, Professor Ray Lankester has kindly called my attention to some observations by Dr. J. Von Kennel,\* who describes certain lagoons bordering the coast of Trinidad, which communicate at times with the sea, and so receive a number of marine inhabitants; and when subsequently the water of the lagoon becomes fresh, several of the marine forms, adapting themselves to the changed conditions, continue to live on, and amongst others thus persisting is a Medusa, which Dr. Kennel regards as different from *Limnoco-dium*, without, however, specifically determining it.

Besides this repetition by Nature of Beudant's experiments, Dr. Kennel gives a very clear instance of the direct introduction of marine forms into a river—due probably to the transportation of free-swimming larvæ by tidal agency—thus, he mentions Mytilaceæ, a small species of Pholæs, and Lumbriconereis, as existing in the freshwater of the river Ortoire, eight miles above its mouth.

NOTE II.—The occurrence as freshwater forms of marine animals which inhabit floating timber is very suggestive from two points of view, for first it leads one to infer that, in such cases, means of transport being afforded, adaptation to freshwater conditions follows readily; and next, since such instances are rare, that to inhabit freshwater is only the first step towards becoming a characteristic freshwater organism; till the developmental history also becomes modified a wide distribution is not probable. Hence I would call special attention to Prof. E. Perceval Wright's remarks on this subject in a Paper describing a freshwater *Teredo* (*Nausitora Dunlopei*) in the waters of the river Hurreegonga a tributary of the Ganges.†

\* Biologische u. faunistische Notizen aus Trinidad, Arb. d. Zool.-zoot. Instituts in Wurzburg; Bd. vi., 1883.

† On a new genus of Teredininæ, by E. Perceval Wright, M.D., *Transactions Linnæan Society*, Vol. xxvii., p. 451 (1864).





## TRANSACTIONS (NEW SERIES).

### VOLUME I.

PART

- 22.—On the Energy expended in Propelling a Bicycle. By G. JOHNSTONE STONEY, D.SC., F.R.S., a Vice-President of the Society; and G. GERALD STONEY. Plates XXXIX., XL., and XLI. (January, 1883.)
- 23.—On Electromagnetic Effects due to the Motion of the Earth. By GEORGE FRANCIS FITZGERALD, M.A., F.T.C.D., Erasmus Smith's Professor of Experimental Science in the University of Dublin. (January, 1883.)
- 24.—On the Possibility of Originating Wave Disturbances in the Ether by Means of Electric Forces:—Corrections and Additions. By GEORGE FRANCIS FITZGERALD, M.A., F.T.C.D. (January, 1883.)
- 25.—On the Fossil Fishes of the Carboniferous Limestone Series of Great Britain. By J. W. DAVIS. Plates XLII. to LXV. (September, 1883.) [*With Title-page to Volume.*]

### VOLUME II.

- 1.—Observations of Nebulæ and Clusters of Stars, made with the Six-foot and Three-foot Reflectors at Birr Castle, from the year 1848 up to the year 1878. Nos. 1 & 2. By the RIGHT HON. THE EARL OF ROSSE, LL.D., D.C.L., F.R.S. Plates I. to IV. (August, 1879.) No. 3. Plates V. and VI. (June, 1880.)
- 2.—On Aquatic Carnivorous Coleoptera or Dytiscidæ. By DR. SHARP. Plates VII. to XVIII. (April, 1882.) [*With Title-page to Volume.*]

### VOLUME III.

- 1.—On the Influence of Magnetism on the Rate of a Chronometer. By OTTO BOEDDICKER, PH.D. Plate I. (September, 1883.)
- 2.—On the Quantity of Energy transferred to the Ether by a Variable Current. By GEORGE F. FITZGERALD, M.A., F.R.S. (March, 1884.)
- 3.—On a New Form of Equatorial Telescope. By HOWARD GRUBB, M.E., F.R.S. Plate II. (March, 1884.)
- 4.—Catalogue of Vertebrate Fossils from the Siwaliks of India, in the Science and Art Museum, Dublin. By R. LYDEKKER, B.A., F.G.S., F.Z.S. Plate III. and Woodcuts. (July, 1884.)
- 5.—On the Origin of Freshwater Faunas: A Study in Evolution. By W. J. SOLLAS, M.A., Dublin; D.Sc., Cambridge; Fellow of St. John's College, Cambridge; Professor of Geology and Mineralogy in the University of Dublin.





VI.—MEMOIRS ON THE COLEOPTERA OF THE HAWAIIAN ISLANDS. BY  
THE REV. T. BLACKBURN, B. A., AND DR. D. SHARP. (Plates IV. and V.)

[Read, March 17th, 1884.]

INTRODUCTORY.

SEVEN years ago very little was known of the entomology of the Sandwich, or as they are now, perhaps more correctly, called the Hawaiian, Islands. About that time Mr. Blackburn commenced a residence in the archipelago, at Honolulu, and has since devoted as much time as the duties of his official position permitted to the subject of its entomological fauna. As the result of his activity, numerous Papers have been published in several scientific journals; and as Mr. Blackburn has now ceased to reside in the islands, we have thought it well to make what, so far as Mr. Blackburn's researches are concerned, may be called a final *resumé* of our present knowledge of the Coleoptera.

This object, it has appeared to us, might most satisfactorily be accomplished by Three Memoirs:—

- I. Descriptions of such genera and species as are hitherto undescribed.\*
- II. A Systematic Catalogue, with a brief statement as to the habits, habitat, &c., of each species.
- III. Topographical Table, accompanied by some generalizations, summaries, and comments on the Coleopterous fauna of the archipelago.

I.

ON SOME NEW SPECIES AND GENERA OF COLEOPTERA.

In this Memoir, some of the descriptions have been made by Mr. Blackburn, and some by myself; they are arranged in sequence, our individual responsibilities being indicated by appending to each description the initials of the describer, viz. T. B. for the Rev. Thomas Blackburn, and D. S. for David Sharp. The nomenclature and classification indicated is very little, because all that is necessary is given in the immediately following Systematic Catalogue of Hawaiian Coleoptera.

D. S.

\* A short account of the Islands and of Mr. Blackburn's collecting there is appended.

## Fam. DYTISCIDÆ.

## COPELATUS.

*Copelatus mauiensis*, n. sp.—Elongatus, subparallelus, subtilissime reticulatus, niger, capite prothorace antennis palpis, pedibusque rufescentibus; prothorace transverso, linea obscure punctata trans partem anteriorem et secus latera tracta et ad basin reflexa; elytris punctorum seriebus obscure notatis. Long.  $5\frac{1}{2}$  m.m.

Allied to *C. parvulus*, Boisd., but easily distinguished by its elongate, parallel, less convex form, and darker colour; by the more clearly-impressed line (containing some obscure punctures) surrounding the front and sides of the thorax a little within the margin; and the rather strong punctuation which forms a kind of reflexed continuation, within the basal angles, of the impressed line.

A single specimen occurred in a "water-hole" at an elevation of about 4500 feet above the sea, on Haleakala, Maui.

T. B.

## Fam. STAPHYLINIDÆ.

## BOLITOCCHARA.

*Bolitochara impacta*, n. sp.—Testacea; antennis incrassatis, nigro-brunneis, basi testaceo; prothorace quadrato; elytris brunneis trans basin testaceis; abdomine ante apicem infuscato. Long.  $2\frac{1}{3}$  m.m.

Probably allied to *B. insulana*, Fairm, from which it appears to differ in being considerably smaller, with the antennæ and elytra differently coloured.

As far as I have been able to examine this minute species, it possesses the tarsal characters of *Bolitochara*. The thorax resembles that of *Haploglossa*, but the head is constricted at the point of insertion in the thorax, though not as much as in the European species of *Bolitochara*. The shape of the thorax gives the insect a facies very different from that of *Aleochara*. The antennæ are scarcely so long as the head and thorax together, and are very strongly incrassate, resembling those of *Aleochara mycetophaga*, but are even still more thickened. The dissection of a specimen of *B. impacta* might probably lead to the establishment of a new genus to include its Tahitian ally with it; but as the species is unique in my collection, I am unwilling to dissect it, and it must stand for the present as a *Bolitochara*.

A single specimen occurred in marine rejectamenta on the beach near Honolulu. Repeated search in the same and similar localities failed to furnish a second specimen.

T. B.

DIESTOTA.

*Diestota montana*, n. sp.—Subdepressa, nigra, nitida, antennis palpis pedibusque rufescentibus; capite prothoraceque fortiter nec dense, elytris sparsim fortissime, punctatis; abdomine fere impunctato. Long. 3 m.m.

The coarse and sparing punctuation of the anterior parts and the shining impunctate hind body of this insect separate it widely from all its allies.

The middle coxæ are widely separated, and the mesosternum appears to be carinated, although, from the way in which my specimen is set, it is very difficult to be sure on the latter point.

Waimea, Hawaii, by beating flowers at an elevation of about 3000 feet.

T. B.

*Diestota incognita*, n. sp.—Subdepressa, subnitida, nigricans, palpis pedibusque rufescentibus; capite fortiter densius prothorace minus distincte, elytris confuse crebrius, abdomine distincte, punctatis. Long.  $2\frac{1}{2}$  m.m.

This species resembles *D. carinata*, but its different punctuation, &c., readily distinguish it.

The middle coxæ are widely separated, and the mesosternum is without any traces of a carina.

A single specimen was taken by beating flowers in a mountain forest on Hawaii, at an elevation of about 4000 feet.

T. B.

MYLLÆNA.

*Myllæna pacifica*, n. sp.—Nigra, creberrime subtiliter punctata, subnitida, antennis pedibusque fuscis, illis articulo ultimo flavo; elytris prothorace haud longioribus; antennis capite prothoraceque conjunctis longioribus. Long.  $3\frac{1}{4}$  m.m.

This insect resembles *M. familiaris*, Sh. The decidedly closer punctuation, however, the slightly longer antennæ with the apical joint of a clear yellow colour, and the distinctly though slightly shorter elytra, render it incapable of confusion with its ally. From *M. vicina* and *M. curtipes* the unicolorous hind body distinguishes it.

I may observe here that several of my specimens of *M. familiaris*, Sh., are not less than  $3\frac{1}{4}$  m.m. in length, and that (unless the size he gives is a misprint) I must, by some accident, have sent unusually small specimens to Dr. Sharp, as I have only one example as small as that from which his description seems to have been made.

A single specimen was taken on a flower of *Freycinetia* on Mauna Loa, Hawaii, at an elevation of nearly 4000 feet above the sea.

T. B.

*Myllæna oahuensis*, n. sp.—Nigro-fusca, creberrime subtilissime punctata, subopaca; pedibus fuscis; antennis gracilibus capite prothorace elytrisque conjunctis vix brevioribus; abdominis segmento ultimo fusco. Long.  $2\frac{3}{4}$  m.m.

The excessively fine and close punctuation of this insect, its long, almost unicolorous antennæ (which are considerably more slender than those of *M. vicina*), its elytra fully as long as the thorax and the fuscous apical segment of the hind body, are characters that in combination readily separate it from the other known Hawaiian species of the genus.

I may observe that I have two specimens of *Myllæna* from Maui, both very closely allied to *M. vicina*, Sh., but in my opinion distinct from it, and from each other. One of these is not in sufficiently good condition to be treated as a type of a new species; it appears to be larger than *M. vicina*, with the antennæ shorter and thicker, and the elytræ slightly longer. The other is so extremely close to *M. vicina*. Sh., that I hesitate to give it a name without having examined a number of specimens, though I have no doubt such examination would establish its distinctness; it is a smaller, narrower insect than *M. vicina*, with more slender antennæ. Both were obtained by beating flowers, one in the Wailuku Valley, the other at an elevation of some 5000 feet on Haleakala.

Several specimens have occurred on Oahu, but the record of the circumstances of capture has unfortunately been lost; probably, however, they were beaten from flowers in mountain forests near Honolulu.

T. B.

#### OLIGOTA.

*Oligota kauaiensis*, n. sp.—Parum elongata; subnitida; rufopicea; antennis, palpis, pedibus, abdominisque segmento apicali, testaceis; elytris parce punctatis. Long.  $1\frac{1}{2}$  m.m.

Antennæ pale-yellow, first and second joints elongate; third, fourth, and fifth scarcely differing *inter se*, all of them rather stout; sixth and seventh about as long as broad; eighth and ninth pretty strongly transverse; tenth large, as long as the two preceding together. Hind body slightly narrowed at base; tarsi short and stout.

Allied to *O. polita*, Sh., and *O. glabra*, Sh., but easily distinguishable from both by the much closer punctuation of the elytra. Its less elongate form, shorter tarsi, and more sparingly punctured elytra in combination separate it from *O. mutanda*, Sh., and from the species following in this paper.

I have a single specimen, differing as follows from the three allies—*O. glabra*, Sh.; *politata*, Sh.; and *kauaiensis*, mihi. It is about the same size as *O. glabra*, and is coloured as *O. polita*, save that the head and thorax are red. The punctuation agrees pretty closely with that of *O. polita*, of which species I



have no doubt it is a var. It was taken from a flower of *Freycinetia*, at an elevation of about 2500 feet, on Oahu.

A single specimen was taken by beating flowers on Waialeale, the highest mountain of Kauai, at an elevation of 2500 feet.

T. B.

*Oligota longipennis*, n. sp.—Sat elongata; nitida; rufopicea; antennarum basi pedibusque rufis; elytris elongatis rugatis; antennis brevibus incrassatis. Long.  $1\frac{3}{4}$  m.m.

Antennæ short; joints one and two rather elongate; three and four about as long as broad; five to nine transverse, increasing in size; tenth considerably longer than ninth.

The elongate elytra (a third longer than the thorax), wrinkled and devoid of distinct punctuation, readily separate this insect from *O. mutanda*, Sh., to which it is allied; the elongate tarsi separate it from *O. polita*, Sh., &c.

My specimen of *O. mutanda*, Sh., is fully 2 m.m. in length. The antennæ (reported as wanting in Dr. Sharp's specimen) are as follows:—joints one and two, elongate; three to seven, shorter, but all longer than broad, and increasing in size; eight and nine, about as broad as long; ten, scarcely broader than nine, but nearly twice as long. The basal two joints are testaceous, the rest pitchy. I have a single specimen of a small *Oligota* (long.  $1\frac{1}{4}$  m.m.), somewhat darker in colour than *O. mutanda*, Sh., and with the antennæ apparently a little more incrassated than in that species, but otherwise seeming to me identical with it. It was obtained by beating dead branches of trees, at an elevation of about 2500 feet, on the mountains of Lanai.

A single specimen was taken on Oahu, but exact particulars of capture are lost.

T. B.

*Oligota simulans*, n. sp.—Sub-ovata; distincte crebrius punctata; opaca; pubescens; nigro-fusca; antennis palpisque testaceis, pedibus abdominisque apice fuscis; antennis elongatis; elytris prothorace multo longioribus. Long.  $2\frac{1}{3}$  m.m.

Antennæ pale yellow; joints one and two very elongate; three elongate; four and five about as long as broad, six to nine increasing in size, but not transverse; ten longer than eight and nine together.

The ovate form (much narrowed in front and behind); the even, well-defined, and rather close punctuation, extending over the whole upper surface of the insect; together with its long, incrassated antennæ, long tarsi, and conspicuous pubescence, give this species a very distinctive appearance. In some respects it approximates to *Liophæna*, but certainly cannot be placed in that genus.

A single specimen was taken on Waialeale, Kauai, by beating dead branches of trees.

T. B.

*Oligota variegata*, n. sp.—Linearis; parum nitida testacea; capite prothorace-que rufis, abdominis segmentis 1–4 et antennarum apice infuscatis; elytris prothorace parum longioribus, obscure subtiliter punctatis. Long.  $1\frac{1}{2}$  m.m.

Antennæ short; joints one and two elongate; three to five about as long as broad, and nearly equal *inter se*; six to nine pretty strongly transverse, and increasing in size; ten twice as long as, but scarcely wider than, nine.

This minute species is allied, I think, to the European *O. pusillima*, Gr., but is even more linear than that insect. Its build, size, colour, and very fine punctuation of elytra (which under a microscope appear to be minutely wrinkled rather than punctate), combine to separate it from all other species of the genus that I can ascertain to have been described.

A single specimen occurred under the bark of a living tree, at an elevation of about 3000 feet, on Konahuanui, Oahu.

T. B.

*Oligota prolixa*, n. sp.—Elongata, parce punctata, nigra, antennis palpis, pedibusque fusco-testaceis, palpis elongatis; elytris prothoracis longitudine; abdomine parallelo, elongato. Long. 2 m.m.

Antennæ rather short, almost without club, a little thickened externally; second joint elongate; third, small; fourth, fifth, and sixth, each small; seventh, eighth, and ninth, each about as long as broad; tenth, rather large, a good deal longer than the ninth. Palpi very elongate, about half as long as the antennæ. Head narrow and elongate. Prothorax transverse, rather convex, sparingly punctate. Elytra about as long as, and rather narrower than, the thorax, rather coarsely and sparingly punctate. Hind body with the first four segments of one width, thence narrowed to the extremity, the two basal segments not closely punctate, but less sparingly than those following; the pubescence scanty, but rather elongate.

This insect, I should think, will form a distinct genus; but as I have before me only one individual, in a rather dirty state, I cannot investigate it thoroughly. Mr. Blackburn sent it as No. 245, and states that the species was beaten from dead branches of trees on Haleakala, in Maui, and Mauna Loa, in Hawaii, at elevations of about 4000 feet,

D. S.

#### LITHOCHARIS.

*Lithocharis incompta*, n. sp.—Depressa, ferruginea, abdomine fusco, antennis pedibusque testaceis, elytris in medio transversim obscuratis; crebrius punctata, subopaca. Long.  $3\frac{1}{4}$  m.m.

Antennæ rather short, the terminal joints evidently a little thicker than the others; ninth and tenth joints each rather shorter than broad. Head large, slightly broader than the thorax or elytra, densely punctate, vertex a little emarginate in the middle, the neck rather slender. Thorax rather broader than long, a

good deal narrowed behind, the front margin a good deal produced in the middle, densely punctate, excessively finely carinate along the middle, and with a rather large obscure depression in front of the base on each side of the middle. Elytra longer than the thorax, and of a paler and brighter red colour, but with a dark cloud across the middle, closely punctate. Hind body rather slender, blackish; the hind portion of the sixth segment yellowish.

Three specimens, found on the flowers of *Freycinetia*, at an elevation of about 1500 feet, near Hilo, Hawaii. The one described is a female; it is closely allied to the Amazonian *L. compressa*, Sh., and is probably a native of some part of the American continent.

D. S.

#### OXYTELUS.

*Oxytelus bledioides*, n. sp.—Rufescens; antennis piceis basi testaceis, pedibus testaceis; capite parce punctato, clypeo opaco subtilissime punctato; mandibulis sat brevibus; prothorace elytris que sat fortiter nec crebre punctatis; illo transverso, postice angustato, trisulcato; his prothorace parum longioribus, in longum rugatis; tibiis anterioribus intermediisque biseriatim spinulosis. Long. 4 m.m.

Antennæ moderately long; joint one long and slender, nearly equalling the following three in length; joints two and three elongate, pedunculated; three longer than two; four transverse, but not wider than three; five transverse, much larger than four; six to nine transverse, a little larger than five, about equal *inter se*; ten not narrower than nine, but as long as broad; eleven nearly twice as long as ten.

A careful examination of this distinct-looking insect has failed to reveal any other distinction from typical *Oxytelus* than the presence of the well-defined double fringe of spines on the anterior four tibiæ, and a slightly peculiar build of antenna. As I have in my own collection several *Oxyteli*, showing an indication of duality in the row of spines on some of the tibiæ, I see no sufficient reason for calling the species described above by a new generic name.

The antennæ (owing to the basal four joints being testaceous and very much narrower than the other joints, while the apical seven are of a pitchy colour and of nearly uniform width) present the appearance of being composed of a short slender stem and a long cylindrical club.

A single specimen occurred under the bark of a tree near Honolulu.

T. B.

#### LISPINODES.

*Lispinodes* (?) *quadratus*, n. sp.—Subdepressus; linearis; nitidus; rufopiceus; antennis palpis mandibulis pedibusque rufescentibus; antennis crassis, capite thoraceque conjunctis longioribus; capite glabro, bi-impresso, antice marginato; prothorace subquadrato, postice distincte punctato, basi utrinque impresso; elytris

prothorace sat longioribus, obscure nec crebre punctatis, stria suturali fortiter impressa, basi utrinque fossa profunde impressa; femoribus crassis, tibiis anterioribus curvatis. Long.  $3\frac{1}{2}$  m.m.

The antennæ are longer and thicker than those of *L. explicandus*, Sh., with joints seven to ten not so abruptly wider than the preceding joints. The slighter contraction of the thorax behind and the comparative shortness of the elytra also distinguish this insect.

This species does not present exactly the generic characters attributed by Dr. Sharp to *Lispinodes*, but, as it is undoubtedly allied to *L. explicandus*, I place it provisionally in its company. By the following characters it differs:—head moderate, margined in front, and with ill-defined antennal tubercles; parts of the mouth fairly well developed; maxillary palpi shortish and stout, with the apical joint acuminate, and about equal in length to the two preceding together; mandibles well developed and prominent; anterior coxæ almost contiguous, but a rather conspicuous process of the prosternum enters between them.

I unfortunately do not possess a type of *Lispinus* for comparison, but the well-defined separation of the anterior coxæ in it appears to bar it against this insect.

A single specimen occurred under the bark of a tree on the mountains near Honolulu.

T. B.

*Lispinodes*(?) *pallescens*, n. sp.—Glaber; subdepressus; linearis; nitidus; testaceus; antennis robustis, brevibus, prothorace vix longioribus, apice fortiter incrassato; capite magno, prothorace vix minore, antice utrinque impresso, postice nonnihil constricto; oculis parvis haud prominulis; prothorace obsolete canaliculato, postice angustato, utrinque foveolato; elytris prothorace parum longioribus, stria suturali et utrinque fossa basali profunde impressis; femoribus crassis. Long.  $2\frac{1}{2}$  m.m.

This species does not fit naturally into any genus known to me. It will be convenient to call it *Lispinodes* provisionally—noting, however, that it differs from that genus, as characterized by Dr. Sharp, as follows—*i. e.*, it is much less depressed, with the head almost quadrate, and deeply sunk in the thorax, the eyes very small and flat, the mandibles resembling those of *Prognatha* ♀, and the coxæ as in *L.* (?) *quadratus*, mihi.

The pale unicolorous tint and short antennæ of this insect prevent any possibility of confusing it with any of its Hawaiian allies.

A single specimen was taken under the bark of a tree near Honolulu.

T. B.

## Fam. CORYLOPHIDÆ.

## CORYLOPHUS.

*Corylophus rotundus*, n. sp.—Latus, subrotundus, piceus, prothorace margine dilutiore, antennis pedibusque testaceis, nitidulus, elytris crebre sat fortiter punctatis. Long  $1\frac{1}{8}$  m.m.

This species, on account of its broad, round form, resembles *C. tectiformis*, Woll., but the sculpture of the elytra is quite different in *C. rotundus*. The antennæ are stout; the thorax is shining, and is without sculpture, the pale explanate anterior margin conspicuous. The elytra have very distinct though not coarse punctuation, which is not aciculate, and their surface is quite shining.

Honolulu. Dr. Horn informs me that this is not like the North American species of the genus.

D. S.

*Corylophus suturalis*, n. sp.—Rotundato-ovalis, convexus, nitidus, piceus, prothorace elytrorumque sutura rufescente, illius margine anteriore albido, antennis pedibusque testaceis, illarum clava fusca; elytris subtilius obsoleteque punctatis. Long. vix 1 m.m.

Only half the size of *C. rotundus*, and of not quite so rotund form, and with the elytra obsolete punctured; their punctuation is, however, quite clear when a careful examination is made. Dr. Horn informs me the insect is of the size and appearance of the North American *C. truncatus*, but that species has the elytra almost absolutely smooth.

Found at the roots of grass, Nuuanu Pate, Oahu.

D. S.

## SERICODERUS.

*Sericoderus basalis*, n. sp.—Lator, testaceus, elytris fascia lata basali nigra, crebrius pubescens, subtiliter punctata, subopaca. Long.  $1\frac{1}{4}$  m.m.

Antennæ rather short, entirely pale yellow, club not stout. Thorax very broad, reddish yellow, very finely punctate, finely pubescent, the sides and front forming one quite continuous, regular curve. Elytra, densely punctate; pubescent, yellow, with a broad basal fascia occupying quite one-third of their area.

A species readily identified by the broad form and distinct basal fascia. Dr. Horn informs me it is not like any of the North American species.

Found in the salt marshes at Honolulu.

D. S.

*Sericoderus pubipennis*, n. sp.—Suboblongus, testaceo-ferrugineus, antennis pedibusque testaceis, illarum clava fusca; elytris subtiliter punctatis, longius conspicue pubescentibus. Long. 1 m.m.

Antennæ pale yellow, but with the rather large club abruptly infusate. Thorax sparingly pubescent. Elytra rather sparingly punctate, so that their surface is shining, but this is much concealed by their conspicuous comparatively elongate pubescence.

The species is very like *S. lateralis*, but the more sparing punctuation and more conspicuous pubescence leave no doubt it is distinct. Dr. Horn informs me that it differs also from the North American species.

The type was captured at an elevation of about 4000 feet on the mountains of Maui and sent me as No. 419. A second specimen, found on the mountains of Oahu, and sent as No. 365, appears to be immature, and has the antennal club scarcely infusate.

D. S.

#### ORTHOPERUS.

*Orthoperus æqualis*, n. sp.—Minutissimus, anguste ovalis, convexus, sat nitidus, fuscus, antennarum basi pedibusque testaceis, elytris crebre subtilissime punctulatis. Long.  $\frac{3}{4}$  m.m.

This atom is similar to *O. atomus*, Gyll., but is narrower and has a closer punctuation on the elytra, which are less shining. This character distinguishes it also, Dr. Horn informs me, from the North American species. The basal portion of the antenna is clear yellow, the club infusate.

Beaten from dead wood on Mauna Loa, Hawaii.

D. S.

---

#### Fam. HISTERIDÆ.

##### BACANIUS.

*Bacanius atomarius*, n. sp.—Breviter ovalis, convexus, ferrugineus, sat crebre et fortiter punctatus; mesosterno breve, punctato. Long. 1 m.m.

Thorax very distinctly though rather finely punctate, with basal transverse series of punctures. Elytra rather coarsely punctate, the punctures on the apical portion finer and very dense, some distance internal to the shoulder are the rudiments of two very indistinct short oblique striæ. Pygidium much inflexed, rather closely punctate. Under surface rather coarsely punctate, except on the middle of the breast.

This obscure little insect is very similar to *Acritus insularis*, but is readily distinguished by the broader tibiæ and invisible scutellum.

No. 344; found near Honolulu.

D. S.

*Bacanius confusus*, n. sp.—*Breviter ovalis*, convexus, ferrugineus, confuse nec fortiter punctato-rugatus. Long.  $\frac{2}{3}$  m.

Considerably smaller than *B. atomarius*, Sh., and having much less distinct punctuation. The punctures on the elytra, though not very fine, are obscure and confusedly mixed with indistinct wrinkles. On the under surface, the basal segment of the hind body is strongly, and the sides of the metasternum (also, so far as I can see, the mesosternum) are obscurely, punctured.

A single specimen occurred on Oahu, but the particulars of the capture have been lost.

T. B.

#### ACRITUS.

*Acritus insularis*, n. sp.—*Breviter ovalis*, sat convexus, nitidus, piceus, antennis pedibusque fuscis; crebre, æqualiter, sat fortiter punctatus. Long. 1 m.m.

Very similar to the European *A. minutus*, and about the same size but of broader form, darker colour, and with more punctate surface. The punctuation of the thorax is rather fine, and the transverse series of punctures in front of the base is very distinct; the elytra are more coarsely punctate, and the punctuation is evenly distributed over their surface, each puncture being round; there is a very obscure trace of a curved stria on the basal portion. Beneath, the body is impunctate in the middle, but rather coarsely punctate at the sides; the oblique stria on the front of the metasternum is obliquely directed outwards and is rather deep, but it is not looped upwards behind the coxa, and terminates some considerable distance inside of the epimeron.

Found near Honolulu. No. 425.

D. S.

#### ÆLETES.

*Æletes longipes*, n. sp.—*Oblongo-ovalis*, minus convexus, piceo-ferrugineus, nitidus, lævigatus; metasterno antèrius vage lateque impresso. Long.  $1\frac{1}{3}$  m.m. (Plate iv., f. 13.)

This insect is less convex than *Æ. facilis*, and is readily distinguished by its impunctate surface; it is probably allied to *Acritus politus*, Lec., but that species is described by Horn as possessing a longitudinal groove on the mesosternum, and is smaller; in *Æ. longipes* there is only to be seen a vague nearly round depression at the junction of the meso- and metasterna.

No. 252. Found at an elevation of 4000 feet, in Hawaii.

D. S.

*Æletes concentricus*, n. sp.—Ovalis, convexus, ferrugineus, nitidus, crebre obsoleteque curvatim strigosulus; subtus lævigatus, metasterno anterius plano. Long. 1 m.m.

Of rather narrow and convex form, and readily identified by the peculiar sculpture of the upper surface, which is without punctures, but bears extremely fine scratches; on the thorax these are so fine as to be with difficulty observed, but on the elytra they are more distinct, and have a peculiar arrangement, those near the suture about the scutellum being nearly longitudinal in their direction; those outside them are curved inwards towards the suture behind, while the scratches on the more posterior portion are nearly transverse in direction.

I have seen only one specimen, sent as No. 370 by Mr. Blackburn, and found in the mountains near Honolulu.

D. S.

*Æletes monticola*, n. sp.—Oblongus, convexus, piceo-niger, subtiliter nec inæqualiter punctulatus; elytris subtiliter rugatis. Long.  $1\frac{1}{3}$  m.m.

A decidedly narrower insect than *Æ. facilis*, Sh., and of darker colour; the elytra are very evenly and finely punctured, the punctures here and there running in irregular wrinkles. I cannot discover any punctuation on the metasternum.

A single specimen occurred on Haleakala, Maui, at an elevation of at least 5000 feet.

T. B.

*Æletes facilis*, n. sp.—Oblongo-ovalis, convexus, piceus, nitidus, crebre punctulatus, punctis ad elytrorum apicem densis et strigosis. Long.  $1\frac{1}{3}$  m.m.

The punctuation on the thorax is fine, but quite conspicuous, and there is no basal series; on the elytra it is coarser, and at the apex forms a transverse series of dense longitudinal strigosities; the basal ventral segment is strongly punctate, as is also the metasternum, but on this the punctuation becomes obsolete on the middle; the metasternal stria forms a curved margin to the middle coxa, and extends to the epipleura; the suture in the middle between the mesosternum and metasternum can scarcely be traced, but when seen it is found that the mesosternum is large.

Found near Honolulu. No. 426.

D. S.

---



## Fam. NITIDULIDÆ.

## GONIORYCTUS.

*Goniorcyctus fugitivus*, n. sp.—Haud latus; testaceo-ferrugineus, elytris abdomineque obscure infuscatis; prothorace minus transverso, margine posteriori quam anteriori vix latiori; elytris distincte sulcatis, marginibus pone humeros haud explanatis. Long. 8 m.m.

The antennæ are about as stout and well developed as those of *G. latus*, but with the fourth joint shorter in proportion to the third. This species can readily be identified by its thorax being only slightly transverse, scarcely wider at the base than in front, with scarcely explanate sides, and by its elytra being more definedly sulcate than in the other described species of the genus, with margins not at all explanate, and only very narrowly reflexed.

In the male the apical dorsal segment is much wider and less acuminate than in the other described species of the genus; the hind margin of this segment is convex, and formed by two slightly curved lines meeting in a well-defined but very obtuse angle, and the segment somewhat abruptly increases its downward slope in the apical third, so that the front and hind portions are in different planes. The small additional segment is ciliate. The apical ventral segment has a large depression (extending from the base, where the depression is narrow, to the apex, where it occupies nearly the whole width), and its hind margin is strongly and widely produced in the middle, and furnished with a fringe of hairs.

The female is unknown to me.

A single specimen was taken by me at an elevation of about 3500 feet, on the mountains near Waimea, Hawaii, on a flower.

T. B.

*Goniorcyctus similis*, n. sp.—Latus; testaceus confuse fusco-vittatus, antennis palpis pedibusque testaceis; prothorace transverso, angulis posticis acute rectis; elytris distincte sulcatis, marginibus pone humeros anguste explanatis. Long. 6 to 7 m.m.

Excessively close to *G. latus*, but differs in the shape of the thorax, which is not quite so strongly transverse, and has the hinder angles slightly sharper, in the less obsolete sulcation of the elytra, and in the sexual characters.

In the male the apical dorsal segment is formed as in *G. latus*, except that its hinder portion is slightly turned up, and the hind margin, instead of being simply rounded, is formed by two lines meeting in a well-defined angle. The apical ventral segment resembles that of *G. latus*.

In the female the apical dorsal segment is pointed as in the male, and has an elongate gently elevated, but well-defined, tubercle near the hind margin. The apical ventral segment has a small obscure depression close to the hind margin, which is rounded.

In all the females of this genus that I have examined, I observe a peculiar sculpture of the apical dorsal segment which has led me to record the presence of a tubercle. The fact is that, along its central line, the segment does not begin to be rounded off downwards so near its base as it does on either side of the central line, so that the central portion of the segment is (near its extremity) raised above the lateral portions, and then slopes off abruptly to the hind margin. In the females of *G. latus* this structure is much less clearly defined than in those of the other species, but I find no difficulty in discovering traces of it.

I may also observe that a short series of *G. latus*, recently captured, presents great variety of colour, the specimens varying from a nearly uniform pale testaceous hue, through diverse mixtures of testaceous and dark fuscous, to a nearly uniform blackish fuscous colour.

In the stems of a species of lily, growing near the summit of Konahuanui, Oahu. Apparently very rare.

T. B.

#### BRACHYPEPLUS.

*Brachypeplus olinda*, n. sp.—*Sat latus*; *convexiusculus*; ferrugineo-testaceus, supra obscure æneo-tinctus; *parcius pubescens*; *parum nitidus*; *capite prothoraceque sat crebre fortiter punctatis, hoc fortiter transverso*; *clytris obsolete punctato-striatis, interstitiis parce distincte punctatis, lateribus nullo modo explanatis*; *abdomine crebre nec fortiter punctato*. Long. 4 m.m.

This species is allied to *B. protinoides*, but differs from it as follows:—It is larger and less shining; the antennæ are a little stouter; the thorax is more strongly transverse, and its surface is even (in all my few specimens of *B. protinoides* there is a more or less defined transverse impression near the base of the thorax resembling that of various European *Halticidæ*). The rows of punctures on the elytra are in obscure striæ, with the interstices very finely and sparingly (but distinctly) punctured. The whole insect is more closely punctured, and the tarsi are of a uniform clear testaceous colour (in all my specimens of *B. protinoides* the claw joint is much darker than the rest).

In the male the hind margin of the apical dorsal segment forms a strong rounded emargination, the sides of which (as in *B. protinoides*) are only moderately produced). The apical ventral segment also is strongly emarginate at the apex.

The female is unknown to me.

A single specimen occurred on Haleakala, Maui, at an elevation of 4000 feet. Probably obtained by beating flowers.

T. B.

*Brachypeplus torvus*, n. sp.—Haud latus; convexiusculus; nigro-æneus, antennis pedibus prothoraceque lateribus rufescentibus, tarsis nigricantibus; pubescens, sat nitidus; capite prothoraceque obscure crebrius punctatis, hoc rotundato, fortius transverso; elytris subtiliter confuse nec seriatim punctatis, lateribus nullo modo explanatis, abdomine confuse crebrius punctato. Long.  $3\frac{2}{3}$  m.m.

Closely allied to *B. protinoides*, Sh. My specimen (which is a female) differs from the same sex of *B. protinoides* as follows:—It is a larger insect; the colour is much darker; the thorax is more transverse, with more strongly rounded sides, without the transverse impression near the base, with closer and confused punctuation (in *B. protinoides* it is very sparing and distinct; the sexes as in others of the genus being differently punctured), and the punctuation of the elytra does not run into lines. From *B. olindæ* it differs in colour, in the total absence of striæ from the elytra, and (probably) in respect of the sexual characters.

The male is unknown to me.

In the female the hind margin of the apical dorsal segment is rounded, and its extremity is narrowly reflexed. In the same sex of *B. protinoides*, the corresponding segment has an obscure depression just before the hind margin, which is truncate.

My single specimen of this insect was taken by beating flowers, at an elevation of about 8000 feet, on the Waianae Mountains, Oahu.

T. B.

*Brachypeplus koelensis*, n. sp.—Haud latus; convexiusculus; sat nitidus, parcius minus breviter pubescens; æneo-niger, antennis, pedibus prothoracis abdominisque lateribus et maculis nonnullis per elytra dispositis, testaceis; capite prothoraceque crebrius fortiter punctatis; hoc vix transverso, antice vix angustato; elytris elongatis, obscure seriatim punctatis, interstitiis vix conspicue punctatis. Long.  $3\frac{1}{2}$  m.m.

Rather closely allied to *B. protinoides*, Sh., but incapable of being treated as a variety of that species, being a narrower, more convex insect, with the thorax less strongly transverse, and scarcely at all narrowed in front. The elytra are longer and more finely punctured, and the sexual character of the only sex known to me is quite different. The narrow convex form and comparatively elongate thorax will separate this insect from all the other species described in the same section of the genus.

In the male the apical dorsal segment of the hind body is strongly, almost semicircularly, excavated behind, the sides of the excavation being produced in short, distinct, acute teeth (as in *B. bidens*, Sh.).

The female is unknown to me.

I am unable to understand Dr. Sharp's "vix transverso," as applied to the thorax of *B. protinoides*. In all my specimens the thorax is "fortius trans-

versus," although considerably less strongly transverse than that of several of the other species of the genus. A careful measurement of a number of specimens gives the width to the length as 1 to  $\frac{5}{8}$ , whereas in *B. koelensis* the width is to the length as 1 to  $\frac{3}{4}$ .

A single specimen was obtained by beating flowers at Koele, Lanai, at an elevation of about 2000 feet.

T. B.

*Brachypeplus floricola*, n. sp.—Latus; convexiusculus; subnitidus; parce pubescens; piceo-niger; antennarum articulus basalibus, pedibus, prothoracis abdominisque lateribus, et elytrorum disco, testaceis, prothoracis disco rufescente; capite prothoraceque crebre fortius punctatis; hoc rotundato, fortiter transverso, antice fortiter angustato; elytris crebre fortius (nullo modo seriatim) punctatis, lateribus haud explanatis; abdomine crebre nec fortiter punctato, prosterno rugose punctato. Long.  $4\frac{1}{3}$  m.m.

This very distinct insect differs so widely in system of coloration and shape from *B. protinoides*, Sh., that at the first sight it might appear out of place in being associated with it, but its proper position is undoubtedly in the *B. protinoides* group. The very broad build, the thorax almost twice as wide, as long, and with very strongly rounded sides, the coarse but faintly impressed punctures evenly distributed over the whole upper surface, and the rugosity of the prosternum render it impossible to confuse this with any other of the described species.

The male is unknown to me.

In the female the apex of the last dorsal segment of the hind body is simply rounded.

A single specimen occurred on a flower, at an elevation of about 2500 feet, on Waialeale, Kauai.

T. B.

*Brachypeplus celatus*, n. sp.—Sat latus, aureo-viridis, subopacus, tenuiter sed conspicue pubescens, fortiter punctatus, antennis pedibusque fusco-testaceis; prothorace transversim convexo, elytris angustiore, æquali, lateribus tantum prope angulos posteriores explanatis. Long.  $3\frac{1}{2}$ , lat.  $1\frac{2}{3}$  m.m.

Antennæ short, third joint but little longer than the second. Head coarsely punctate, with large eyes. Thorax very coarsely punctured, rather narrow and convex, with curved sides and obtuse angles, and very slightly narrowed in front. Elytra with quite distinct regular series of punctures, and with the interstices finely seriate-punctate. Hind body coarsely punctate. The specimen described has the apex of the last dorsal plate rather deeply notched; Mr. Blackburn informs me that the other sex has this part gently rounded, and the plate itself is a good deal curved longitudinally towards the extremity. This is a distinct species of the *B. tinctus* and *B. protinoides* group.

Found on Mauna Loa, Hawaii, at an elevation of 6000 feet.

D. S.

*Brachypeplus apertus*, n. sp.—*Angustior sat convexus, viridescens, parce pubescens nitidus, antennis rufescentibus, pedibus testaceis; fortiter punctatus, prothorace transversim convexo, æquali, lateribus tantum prope angulos posteriores explanatis. Long. 3½, lat. 1⅓ m.m.*

So far as I can judge from one specimen, much rubbed and in bad condition, this is a species closely allied to *B. celatus*, but narrower, more convex, and more shining, and with the dorsal segments of the hind body less punctate, and yellowish behind. This specimen has the apical dorsal plate a little sinuate at the side behind, so as to make the apex appear a little prolonged, the hind margin being gently rounded, nearly truncate. Mr. Blackburn informs me that the other sex has the hind margin semicircularly emarginate, so that it would seem the sexual characters are much the same as in *B. celatus*.

*B. apertus*, Sh., may be distinguished from all the four species preceding it above by its much coarser punctuation, especially by the greater coarseness of the punctures that form rows on the elytra. *B. celatus*, Sh., by its depressed form and less abrupt upward curve of the prosternal process.

Found in the same locality as *B. celatus*.

D. S.

*Brachypeplus quadraticollis*, n. sp.—*Haud latus, convexiusculus, nitidus; castaneus, supra æneo-micans; prothoracis lateribus, pedibus, antennarumque basi testaceis; capite prothoraceque crebre fortiter punctatis; hoc parum transverso, antice leviter angustato, ad angulos posteriores minus deplanato, lateribus parum rotundatis, angulis posticis subrectis; clytris longioribus, distincte striatis, postice confuse punctatis, striis obscure punctatis, interstitiis subconvexis seriatim punctatis abdomine crebrius fortiter punctato. Long. 4¼ m.m.*

This pretty little insect superficially resembles the species of the *B. protinoides* group, but the form of the prosternal process (which I quite agree with Dr. Sharp in considering a character of the first importance) would associate it with *B. discedens*, Sh. Its convex form, very evidently (almost deeply) striated elytra, and subquadrate thorax are quite sufficient to distinguish it from all its allies. It should be placed, I think, at the head of the *B. discedens* group.

In the male the apical dorsal segment has an obscure depression near the hind margin, and the additional segment is only slightly visible.

The female is unknown to me.

A single specimen occurred on a flower of *Freycinetia* on Mauna Loa, Hawaii, at an elevation of about 4000 feet.

T. B.

*Brachypeplus parallelus*, n. sp.—*Sub-parallelus, elongatus, subdepressus, pubescens; parum nitidus; obscure viridiæneus, antennis pedibus et prothoracis lateribus testaceis; capite prothoraceque crebre fortiter punctatis; illo sat magno;*

hoc transverso, antice parum angustato, lateribus parum rotundatis, angulis posticis obtusis; elytris sat elongatis, obscure striatis, striis distincte (interstitiis subtilius) punctatis; abdomine crebrius fortiter punctato. Long. 5 m.m.

Closely allied to *B. vestitus*, Sh., but easily separable by its elongate very parallel form and less strongly transverse thorax, different punctuation, greater size, &c.

In what I regard as the male the apical dorsal segment is truncate behind, a small additional segment being barely visible. The front tibiæ are very strongly curved.

The other sex is unknown to me.

A single specimen occurred on one of the mountains of Lanai, at an elevation of about 2000 feet. It was obtained by beating flowers.

T. B.

*Brachypeplus expers*, n. sp.—Brevis, latus, parum depressus, opacus, pubescens, rufopiceus; capite prothoraceque obscure crebre punctatis; hoc fortiter transverso, dorso tri-impreso; elytris inæqualibus, striatis, haud distincte punctatis; abdomine crasse obscure punctato. Long. 6 m.m., lat.  $2\frac{7}{8}$  m.m.

Rather closely allied to *B. sordidus*, Sh., but considerably wider; the width across the elytra, moreover, is distinctly greater than the length of the elytra (in *B. sordidus* it is about equal to it), and the lateral margins of the elytra, though not strongly explanate, are decidedly more so than in *B. sordidus*. The unevenness of the upper surface is sufficient to distinguish this species from *B. guttatus*, Sh., and *B. robustus*, Sh. (the only other described allies).

The prosternal process is somewhat curved upwards at the apex (less so than in *B. sordidus*, more than in *B. guttatus* or *B. robustus*), and very obscurely ciliated.

I regard my specimen as a male; the apical dorsal segment is rather short, is truncated (not very abruptly) behind, and leaves exposed a very short supplementary segment.

The other sex is unknown to me.

A single specimen occurred under the bark of a tree on Haleakala, Maui, at an elevation of about 4000 feet.

T. B.

*Brachypeplus spretus*, n. sp.—Sat latus, subdepressus, subnitidus, parce pubescens, nigrofuscus (feminis nonnullis omnino testaceis); antennarum basi, pedibus, thoracis elytrorum abdominisque marginibus lateralibus, et (nonnullis exemplis) maculis duabus prope scutellum positis, testaceis; prothorace transverso, antrorsum angustato, lateribus explanatis sat rotundatis, disco profunde tri vel quadri impresso; elytris inæqualibus, striatis, parum elongatis; abdomine parcius subtiliter punctato. Long.  $3\frac{3}{4}$ — $4\frac{3}{4}$  m.m.

Allied to *B. inæqualis* and *B. striatus*. From the former it is distinguished by its shorter (but scarcely narrower) elytra, which together form almost a square, its smaller thorax less strongly rounded on the sides, and the finer punctuation of the hind body. Compared with *B. striatus* it is a more shining insect, with shorter and less strongly striated elytra, and much finer and more sparing punctuation of hind body. Its broad build and sexual characters separate it from *B. bicolor* and *B. impressus*, and the uneven surface of the elytra and punctuation of hind body from *B. omalioides*.

In the male the apical dorsal segment is rather wide (as in *B. inæqualis*), and is abruptly truncate; there is a distinct, but not elongate, supplementary segment.

This species occurs at an elevation of about 4000 feet, on Haleakala, Maui, where it is procured by beating dead branches of trees. It probably represents (on Maui) *B. inæqualis* (from Oahu), and *B. striatus* (from Hawaii).

T. B.

*Brachypeplus bicolor*, n. sp.—Sat latus, nitidus, piceo-niger; pedibus, thoracis abdominisque lateribus, et gutta circa elytrorum suturam magna apicali, ferrugineis; prothorace transverso, lateribus sat rotundatis parum explanatis, disco tri-vel quadri-impresso; elytris inæqualibus obscure striatis striis sat fortiter punctatis; abdomine fortiter sat crebre punctato. Long.  $3\frac{1}{3}$ . m.m.

Allied to *B. inæqualis*, but slightly smaller and narrower; the thorax is not so strongly transverse; its hinder angles are less pronounced, and the margins of the elytra are straighter and only slightly explanate. The last named character, together with the dark antennæ and large, well-defined, rusty blotch on the nearly black elytra around the hind part of the suture, will readily distinguish this insect from all its described allies.

In the male the apical dorsal segment is truncate behind, leaving exposed a very distinct and rather elongate supplementary segment.

The female is unknown to me.

A single specimen was taken under the bark of a tree on Mauna Loa, Hawaii, at an elevation of nearly 5000 feet.

T. B.

[I may here call attention to the existence of the following:—

(a) An insect occurring on Kauai closely allied to *B. discedens*, Sh. (which I will call var. *Kauaiensis* of the same). It is probably entitled in reality to specific rank as representing a distinct local type, which circumstances are likely to render permanent or still farther differentiate; but it will perhaps for the present be more conveniently regarded as a variety. It is distinguished from its near ally as follows:—It is smaller (long.  $3\frac{3}{4}$ —4 m.m.), the colour is brighter—the antennæ

especially being entirely testaceous; the elytra are longer, and the apical dorsal segment in both sexes is wider and less narrowed behind. I have not taken typical *B. discedens* on Kauai.

(*b*) An insect occurring on Lanai closely allied to *B. blackburni*, Sh. (which I will call var. *Lanaiensis*). It differs from the type (which does not appear to occur on Lanai) in its greatly smaller size (Long.  $2\frac{2}{3}$  m.m.), more parallel form, and paler antennæ.

T. B.]

[As I was unable, when forwarding to Dr. Sharp the specimens on which he founded his descriptions of most of the species in this genus, to supply him with sufficient material for a satisfactory report on the sexual characters of many of the insects he described, I think it will be well for me to append some remarks on the subject, founded on the somewhat larger (but still scanty) material now in my own collection. A study of the sexual characters of the Hawaiian *Brachypepli* strikingly confirms Dr. Sharp's division of the species into groups; I will therefore put my remarks into the form of a brief statement of the sexual characters of the several groups, together with such additional notes as may seem desirable.

#### GROUP I.

*B. tinctus*, Sh.; *apertus*, Sh.; *protinoides*, Sh.; *torvus*, Bl.; *koelensis*, Bl.; *bidens*, Sh.; *olindæ*, Bl.; *floricola*, Bl.; *inauratus*, Sh.; *affinis*, Sh.; *celatus*, Sh.

This group is flower-frequenting in the strict sense, being found on fresh flowers.

Apical dorsal segment of male emarginate, with sides of emargination produced. Supplementary segment not well developed.

The sexes of *B. tinctus* have been well described by Dr. Sharp. I may add that in my male specimen the hind body is dark fuscous down the middle, while the hind body of the female is clear testaceous. The males of *B. protinoides* (*vide* Trans. Ent. Soc., 1881, part iv. p. 510), *B. bidens*, *inauratus*, and *affinis*, also have been well described by Dr. Sharp; and I have myself described those of the others, except *B. torvus* and *floricola*, of which I have seen only the female.

#### GROUP II.

*B. quadraticollis*, Bl.; *discedens*, Sh.; *metallescens*, Sh.; *parallelus*, Bl.; *vestitus*, Bl.; *varius*, Sh.

These species are not exclusively flower frequenting. Though generally obtained by beating flowers, they appear to be connected chiefly with the flower



stems, which in various species of lily and palm are enfolded by the bases of the leaves, and contain much moisture. When I have found the insects on flowers, it has usually been on large flowers with fleshy petals, some portion of which has been in a state of decay.

Apical dorsal segment of male, truncate or absolutely emarginate, with short supplementary segment. Tarsi of male thicker than of female. Head and thorax of male more closely punctured.

The whole of the above characters seem to be strongly marked only in *B. discedens* and *metallescens* (where the two sexes might pass for distinct species), but I can trace two or more of them in the others. The curvature of the front tibiæ in *B. vestitus* (and doubtless in *B. parallelus*) appears in both sexes.

The specimen of *B. vestitus* described by Dr. Sharp was, I think, a female; in the male there is a short supplementary segment.

#### GROUP III.

*B. blackburni*, Sh.

This insect seems to be connected with flowers and other vegetable matter when in a state of decay.

Sexual characters very slightly marked, the apical dorsal segment of male being truncate or obscurely emarginate behind, with a very indistinct supplementary segment.

#### GROUP IV.

*B. robustus*, Sh.; *guttatus*, Sh.; *sordidus*, Sh.; *expers*, Bl.

All the species have occurred on large solid trees, usually at exuding sap. Sexual characters slight. There is a more or less distinct supplementary segment in the male, and this sex is usually smaller and narrower than the female.

#### GROUPS V. AND VI.

*B. reitteri*, Sh.; *infimus*, Sh.

These insects are found in very wet vegetable matter; one of them between the layers of banana stems, the other under the thin bark or rind of what I believe to be a species of bamboo.

Sexual characters very well defined (see Dr. Sharp's descriptions). I may add that in *B. infimus* the supplementary segment of the male is of remarkable form, being abruptly vertical.

## GROUP VII.

*B. obsoletus*, Sh.; *omalioides*, Sh.; *aper*, Sh.; *explanatus*, Sh.; *brevis*, Sh.; *spretus*, Bl.; *inæqualis*, Sh.; *striatus*, Sh.; *bicolor*, Bl.; *impressus*, Sh.

These insects are usually found in decaying vegetable matter, especially on the *Freycinetia*, where the decay of the basal parts of the leaves and of the fleshy interior of the flowers furnishes them with sustenance; they also occur in decaying fern stalks, and occasionally under bark.

Hind body of male acuminate behind; supplementary segment generally well—sometimes very strongly—developed. Female usually coloured differently from the male.

The tendency to paleness of colour in the female is a very singular character. It is not absolutely invariable; that is to say, the lightest coloured males and darkest females (in my series of the two or three species of which I possess a fairly long series) are not much unlike each other; but the great majority of females are so much paler than the great majority of the males that at first sight one would take them to be different species.

The following notes on the sexual characters of some of the species supply information that the material in Dr. Sharp's hands has not enabled him to furnish:—

*B. obsoletus*. My material is insufficient for generalization regarding colour; the one female I possess is paler than my one male, however.

*B. omalioides*. Male almost always much clouded with fuscous, sometimes nearly black; its supplementary segment not large; female almost uniformly testaceous.

*B. aper*. My material is insufficient for generalization regarding colour.

*B. explanatus*. Female not known.

*B. brevis*. The average colour of the female is very decidedly paler than that of the male.

*B. spretus*. In my short series of this species two-thirds of the females are only a little paler than the lightest-coloured male, the remaining third are quite pale testaceous.

*B. inæqualis*. I have examined only one male specimen; it has the supplementary segment less distinct than usual in this group. It is very much darker in colour than the female, which is evidently the sex described by Dr. Sharp.

*B. striatus*. In this, and especially in the two species following it, the supplementary segment of the male is very strongly developed, appearing in *B. impressus* like a narrow more or less elongate plate, with almost parallel sides. The female of *striatus* (so far as my material furnishes evidence) is usually only a little paler than the male in colour. Of *B. impressus* one of my female specimens has the hind body bright clear yellow, while in the other it is of a similar tint, but slightly clouded with fuscous.

T. B.]

---

Fam. COLYDIIDÆ.

EULACHUS.

*Eulachus hispidus*, n. sp.—*Parum elongatus, angustulus, parallelus subconvexus, rufobrunneus; setis albidis vestitus; prothorace vix transverso, obscure punctato, lateribus obscure crenulatis, disco profunde impresso, basi utrinque acute producto, elytris obscure seriatim punctatis, interstitiis opacis, haud distincte punctatis.* Long. 3 m.m.

This peculiar little insect has much the appearance of a *Ditoma*. The sides of the thorax are crenulated, the basal crenulation being produced into an acute tooth. The details of form and sculpture, however, are hidden by rows (six on the thorax and the same number on each of the elytra), of white erect setæ, very similar to those of certain *Proterhini*.

I have attributed this insect to *Eulachus*; but, as I have not the opportunity of actual comparison with that genus, my reference must be partly conjectural, though it cannot be far wide of the mark.

It may be desirable to record the following characters of *E. hispidus*:—Eyes rather finely faceted, large, and very prominent; antennæ inserted under the margin of the forehead, thick, and longer than the thorax; joints one to four longer than broad, five to nine transverse, ten and eleven forming a well-defined club, of which the former joint is transverse, the latter elongate; front tibiæ finely spinous and enlarged at the apex, where there is a bent spine; the other tibiæ sparingly clothed with scales, but not spined, and only slightly enlarged towards the apex; joints one to three of the tarsi gradually decreasing in length; joint four about equal to the sum of the others; anterior coxæ contiguous. There is a large, profound, and nearly circular impression (possibly sexual) near the apex of the metasternum, and the basal segment of the hind body is considerably longer than the others.

A single specimen occurred near Honolulu under the bark of a tree, at an elevation of about 1000 feet, probably connected with the excavations of a species of *Bostrichidæ*.

T. B.

## Fam. CUCUJIDÆ.

## BRONTOLÆMUS (nov. gen.).

Antennæ corpore longiores, tenuissimæ, articulis, 3–11 inter se subæqualibus. Clypeus ante antennis productus, mandibulæ prorectæ, subrectæ, basi lato, apice acuminato, minute emarginato, vix incurvato. Palpi graciles. Pedes graciles, tibiis calcari minuto, recto: tarsi posteriores maris 4-articulati, sed articulo basali brevissimo ægre discernendo; feminae 5-articulati articulo basali fere nullo.

The elegant little insect, for which I propose this generic name, does not appear to be at all closely allied to any known genus, but may be best placed near *Læmophilæus*, with which it agrees in many characters, but differs in the form of the head, the slender legs, antennæ, and palpi, and the comparatively elongate little curved mandibles. The structure of the antennæ is peculiar: the basal joint is stout and elongate; the second is rather slender, shorter than any of the others, about half as long as the first; the third is subequal to the following joints, each of which is very slender, and is slightly swollen at the apex. Each of the three terminal joints is a little curved, more especially the last one.

D. S.

*Brontolæmus elegans*, n. sp.—Subdepressus, opacus, squamulis setiformibus depressis parce et irregulariter vestitus, fuscus, antennis pedibusque plus minusve dilutioribus; prothorace subcordato, basi elytris angustiore, intra latus linea recta subtili; elytris planatis, striatis, versus latera argute carinatis, lateribus perpendicularibus. Long. 3 m.m. (Plate IV., f. 16.)

Antennæ in the female rather longer than the body; in the male about twice as long; head rather narrower than the thorax, with an indistinct reticulate sculpture, and with fine depressed, pale setæ; eyes convex; thorax rounded at the sides and narrowed behind, so that it leaves the shoulders of the elytra free; hind angles nearly rectangular, the surface sculptured and clothed like the head, and with a fine straight line on each side; scutellum transverse, with declivous front; elytra truncate at the base, prolonged and subacuminate behind, bordered with a well-marked carina, extending from the shoulder to near the apex; within this carina quite flat, but external to it perpendicular, so that there is a rather large lateral portion placed at right angles to the rest of the surface; they are rather feebly striate, the striæ being evidently marked with punctures; they are quite dull, and obscurely maculate, the maculation being due to an irregular distribution of the pale scale-like hairs they bear. The slender legs are yellow, more or less infusate.

A pair of this species has been sent me by Mr. Blackburn as No. 335. He states that it is a very rare insect, but widely distributed, and occurs both in Oahu and Kauai; it occurs in crevices of the bark of living trees, and runs almost like a Longicorn.

D. S.

## LÆMOPHLEUS.

*Læmophleus æneus*, n. sp.—Depressus, latus, nitidus, niger, supra æneo-micans, antennis pedibusque fusco-rufis; clypeo anterie recte truncato; prothorace fortiter transverso, intra latus linea impressa; elytris profunde striatis, ecostatis, interstitiis fere lavigatis. Long.  $2\frac{1}{2}$  m.m.

I have seen only one specimen, but suppose from its large head it may be a male. The antennæ are not very elongate, and do not reach the extremity of the elytra; the third and following joints are conspicuously setose; the three terminal joints rather elongate, but scarcely as long as the five preceding together. Head as broad as the thorax, short; eyes very convex; rather coarsely punctate; clypeus quite straight in front; the angular transverse depression rather broad and deep, but indefinite; central channel obsolete; intra-ocular line fine but distinct. Thorax nearly twice as broad as long, a little narrowed behind, rather coarsely punctate, side without margin, but at a little distance within it there is a very fine line, and at a greater distance inwards from this a second line, continuous with the intra-ocular line. Scutellum large, with two or three punctures. Elytra shining brassy, without trace of pubescence, deeply striate, each with six rather deep striæ, but with no trace of any costæ, either submarginal or interstitial.

Sent as No. 394, and found by Mr. Blackburn, beaten from bark of large Koa tree, at an elevation of 4000 or 5000 feet, on Haleakala, Maui; much searching produced only two specimens. That retained by Mr. Blackburn attains  $3\frac{1}{2}$  m.m. in length, but in other respects, he tells me, does not differ from the one described.

D. S.

## MONANUS.

*Monanus brevicornis*, n. sp.—Ferrugineus, angustus, fortiter punctatus; antennis brevibus incrassatis; prothorace subelongato, postice parum angustato, fortiter punctato, lateribus crenulatis; elytris fortiter seriatim punctatis, pube vestitis. Long  $2\frac{1}{3}$  m.m.

Closely allied to *M. crenatus*, Sh., but much narrower and more parallel, with thicker antennæ, which are distinctly shorter than the head and thorax, the last three joints being distinctly larger than the rest, the ninth and tenth rather strongly transverse. The thorax is more elongate than that of *M. crenatus*, and very little contracted behind.

T. B.

## TELEPHANUS.

*Telephanus insularis*, n. sp.—Brevior, testaceus, parcius pubescens, elytris nigro-trimaculatis, antennis articulis tribus penultimis nigricantibus; prothorace fortiter transverso, lateribus parum perspicue denticulatis. Long.  $2\frac{2}{3}$  m.m.

Antennæ rather short, the tenth joint being only about as long as broad, terminal joint very pale. Thorax very strongly transverse, and much narrowed behind at each side, with three quite short teeth, and with two very obscure denticulations in front of these. Elytra on the middle of each, with a transverse spot, the two nearly or quite joining at the suture, and quite close to the apex, with a third common spot on the suture.

This is similar to several very closely allied species found in the Indo-Malasian regions, but does not seem to agree with any of them, although closely allied to *T. cruciger*, Wat., from New Guinea.

Found in Honolulu and Kauai; I have an individual before me from each locality, sent by Mr. Blackburn as Nos. 54 and 201 respectively. That from Kauai has the elytral spots rather larger, and connected together, a slender line of dark colour extending along the suture to connect the apical spot with the medial spots; in other respects they agree exactly.

D. S.

*Telephanus pallidipennis*, n. sp.—Elongatus, subnitidus; pube longa parcius vestitus, testaceus, antennarum articulis 8vo–10mo nigro-fuscis, elytrorum disco et apice transversim infuscatis; prothorace transverso, creberrime minus fortiter punctato, postice vix angustato, lateribus parum rotundatis irregulariter crenulatis, elytris oblongo-ovatis, fortiter seriatim punctatis, interstitiis subtiliter punctatis. Long.  $4\frac{1}{4}$  m.m.

This insect is closely allied to *T. insularis*, Sh., but differs as follows:—it is larger, differently shaped (the anterior half of the elytra being nearly parallel, but slightly increasing in width backwards, the posterior half gradually but rather strongly contracted), the thorax is much more closely and a little more finely punctured, less narrowed behind, and with the lateral teeth much less defined and differently placed (there are two obscure and blunt teeth close together near the anterior margin, then an interval, and then four teeth increasing in size backwards, the first being a little in front of the middle, and very minute, the last not at all large, and close to the base of the thorax). My specimen is nearly of a uniform testaceous colour, but may be abnormally pale, as there are faint indications of markings similar to those of *T. insularis*, Sh.

A single specimen was obtained by sifting dead leaves in a mountain forest near Honolulu.

T. B.

## Fam. CRYPTOPHAGIDÆ.

## TELMATOPHILUS.

*Telmatophilus debilis*, n. sp.—*Angustulus*, parum convexus, testaceus, evidenter pubescens, minus crebre sat fortiter punctatus; prothorace fortiter transverso; tarsis gracilibus. Long. 2 m.m.

Antennæ rather stout, third joint a little longer than any of the others, the three terminal joints a good deal broader, the ninth and tenth being evidently broader than long. Thorax twice as broad as long, the sides conspicuously margined, but without any teeth or prominences, only very slightly narrowed behind; rather coarsely, not densely punctate; the base with a small fovea on each side. Elytra not densely, rather coarsely, punctate at the base, but the punctuation becoming quite obsolete before the extremity.

I have only a single example at my disposal, and only refer it to the genus *Telmatophilus* with hesitation, the tarsi being more slender than they are in the known species of that genus. In the individual at my disposal the feet have been covered with gum tragacanth, and their structure is hence very obscure; but they are quite slender, not flattened out, and the basal joint of the hind tarsus is elongate, longer than the two following together; the second and third appear to be about equal, except that the third is produced beneath the following joint, so as to form a rather elongate lobe, the fourth joint is quite slender, and nearly as long as the three preceding together. I cannot see any evidence of a minute joint at its base, neither can I see any division on the basal joint, and if this be correct the tarsi are only four-jointed.

Found at an elevation of about 2000 feet, in the island of Oahu, and sent by Mr. Blackburn as No. 198.  
D. S.

## Fam. EROTYLIDÆ.

## EUXESTUS.

*Euxestus minor*, n. sp.—*Breviter ovalis*, convexus, glaber, nitidus, parce punctatus, piceus antennis pedibusque testaceis; illis clava magna, sub-circulari, uniarticulata. Long.  $1\frac{3}{4}$  m.m. (Plate IV., f. 14.)

Antennæ only seven or eight jointed, the fourth and fifth joints being coalesced with the elongate third joint, and even the sixth not sharply separated, the penultimate joint scarcely broader than that preceding it, and very abruptly contrasted with the large terminal joint. Thorax very convex transversely, distinctly lobed in the middle, finely and sparingly punctate; elytra finely and sparingly punctate. Among the punctures may be detected some very fine regular series.

Found in Oahu, and sent as No. 109 by Mr. Blackburn. I have specimens scarcely differing from Malacca.

D. S.

## EIDOREUS (nov. gen.).

This generic name is proposed for a very minute insect of rotund form, allied to *Hypodacne* and *Euxestus*. The head is broad and very short; and the small eyes, consisting of a few coarse facets, are placed as it were on a prominent free angle at the front of the side; the antennæ are short and apparently ten-jointed, the basal joint rather large, the second smaller, third not elongate, fourth to eighth small and short, ninth and tenth forming a large loosely articulated club. The middle and hind coxæ are very widely separated, the front ones only moderately; the metasternum is much produced in the middle between the coxæ, so that it touches the prosternum, and no portion of the mesosternum is visible. The tarsi are small, four-jointed, the three basal joints not differing much, the third simple, the fourth elongate; the hind tarsi are longer and more slender than the others, and their basal joint is more elongate.

D. S.

*Eidoreus minutus*, n. sp.—Rotundato-ovalis, sat convexus, nitidus, testaceus, glaber, fere impunctatus; antennis brevibus, clava laxè bi-articulata. Long. 1 m.m.

Antennæ about as long as the thorax; this strongly transverse, closely applied to and continuous with the elytra, truncate at the base, a little narrowed towards the front margin, shining and almost impunctate, as are also the elytra.

Two fragmentary specimens have been sent me as No. 336.

D. S.

## Fam. COCCINELLIDÆ.

## SCYMNUS.

*Scymnus vividus*, n. sp.—Læte rufus, pectore, abdomine, prothorace posterius in medio, elytrorumque plaga magna, communi, triangulari, nigris, femoribus posterioribus et intermediis fuscis; elytris fortiter punctatis, pubescentia pallida conspicua vestitis. Long. 2¼ m.m.

Antennæ and palpi yellow. Head and thorax yellowish-red; the latter in the middle, with a very large black mark extending nearly to the front margin; not closely and rather obsoletely punctured. Elytra bright red, with a large triangular mark black; the base of the triangle occupies the greater part of the width of the elytra at the base, and the apex is placed on the suture near the extremity; the punctuation is not dense, but is rather coarse, especially on the black portion. Beneath, the sides of the thorax are pale, the middle blackish, the breast and ventral segments black, the epipleuræ bright yellowish-red.



The black patch of the elytra sometimes extends to the sides, and covers all the basal portion. The species is allied to a Californian one returned to me from Dr. Leconte a few years ago without name, but is apparently distinct.

D. S.

*Scymnus ocellatus*, n. sp.—Parvus, rotundulus, obsolete punctatus, conspicue pubescens, testaceus, prothorace in medio elytrisque signaturis nigro-fuscis, corpore subtus exparte majore nigricante. Long.  $1\frac{1}{2}$  m.m.

This small insect has peculiar markings: there is a large triangular black mark round the scutellum, which is prolonged backwards along the suture, and just behind the middle is turned outwards on each side, so as to form a curved transverse prolongation, and just in front of the termination of this is a circular spot; the outer margin is also dark, the dark colour being, however, nearly divided on a line with the termination of the curved mark. The punctuation of the surface is very obsolete, though the pubescence is conspicuous. A second specimen has the under surface pale, and the dark thoracic mark nearly absent, perhaps indicating immaturity.

D. S.

*Scymnus discedens*, n. sp.—Minutus, valde convexus, testaceus, nitidus, obsolete punctatus, parum perspicue pubescens; metasterno anterius inter coxas intermedias linea abrupte curvata, longius producta. Long.  $1\frac{1}{4}$  m.m.

Thorax impunctate, with an extremely delicate pubescence easily removed, then appearing shining. Elytra more distinctly punctured than the thorax, but still only finely and obsolete; upper surface entirely yellow; the thorax scarcely darker; under surface more ferruginous.

This little insect, of which I have seen but a single specimen, will probably prove to be the type of a new genus, owing to the fact that the metasternum is distinguished from the mesosternum by a remarkably distinct raised line, which is greatly produced in front, so that the mesosternum is much reduced.

The species is rare; Mr. Blackburn has twice found it by sweeping, in Oahu. No. 337.

D. S.

---

## Fam. DERMESTIDÆ.

### ATTAGENUS.

*Attagenus plebeius*, n. sp.—Sat elongatus, opacus, dense pubescens, niger, antennis pedibusque rufis, capite, thorace, elytrorumque fascia angusta, angulata, subbasali pubescentiæ pallidæ. Long. 4– $4\frac{1}{2}$  m.m.

Similar in size, form, and appearance to the European *A. verbasci*, but with only one pale band on the elytra. The specimens described are probably of the

female sex, and have the antennæ short, the club three-jointed, and in length equal to the five or six preceding joints together; the apical joint but little longer than the tenth; thorax densely pubescent, so that its punctuation is concealed; the pubescence pale, but in certain lights appearing dark on the middle parts, owing apparently to an admixture of spots or patches of black pubescence; elytra not quite so densely pubescent as the thorax; the pubescence black, but there is a conspicuous band of cinereous pubescence near the base, which at the suture is strongly angulated in front, so as to approach rather near to the scutellum; legs entirely red.

Found in the houses of Honolulu. Sent as No. 427.

D. S.

#### LABROCERUS (nov. gen.).

Antennæ eleven-jointed; scarcely clavate, in the male with elongate terminal joint, hirsute, conspicuously and peculiarly so in the male; prosternum rather short, not at all directed upwards, but rather slightly deflexed in front in the middle, so as to form a protection for the parts of the mouth which are covered by it, except the labrum, which is completely exposed; antennal fossæ not present; prosternal process rather broad and flat, received into the mesosternum; middle coxæ but little separated; hind coxal lamina of moderate size.

This genus is allied to *Attagenus* and *Perimegatoma*, but with a quite different structure of prosternum from the former, and possessing probably a much shorter prosternum than the latter genus. It is possible, indeed, that *Perimegatoma* is but a synonym of *Megatoma*, this European genus having been stated by error in *Lacordaire* to possess antennal fossæ. From *Megatoma* *Labrocerus* is, I think, certainly distinct by its prosternal structure, the prosternum being but short and little rounded in front, the prosternal process more developed, and the mesosternal fossa extending quite to the metasternum: as in *Megatoma*, the sides of the prosternum are concave, but there is no true antennal fossa.

D. S.

*Labrocerus jaynei*, n. sp.—Suboblongus, parum convexus, niger, haud dense pubescens, antennarum basi sordide testaceo, elytris maculis quatuor fulvis, duabus anterioribus fere in fasciam curvatam conjunctis. Long.  $3\frac{1}{2}$  m.m.

Antennæ in the male as long as the head and thorax; second joint quite short, subglobular; third quite small and rather closely connected with the fourth; this latter and the two following joints somewhat short, and a little produced and acuminate inwardly; joints seven to ten rather broader, each very strongly transverse; terminal joint as long as the five preceding together. In the female the antennæ are about as long as the head; the third joint is slender and rather elongate,

being in fact slightly longer than the much broader subglobular second joint; of joints four to ten, each is a little broader than its predecessor, the tenth being strongly transverse; terminal joint rather large, longer than the two preceding together. The thorax is sinuate on each side, the hind angles being a little produced backwards and acute; its pubescence is rather long and scanty, but it is almost without punctuation. Elytra rather elongate, with pubescence and obscure punctuation similar to the thorax; from the shoulder of each there descends a yellowish fascia towards the suture, but the two do not quite meet, and behind the middle there is a large yellow spot.

I have named this species in honour of Dr. Horace F. Jayne, who has recently published a memoir on the North American allies, adding considerably to our knowledge of these neglected insects. I have received only one pair of *L. jaynei* from Mr. Blackburn as No. 392; they were beaten from dead wood on Haleakala, Maui, and I am told by Mr. Blackburn that the markings of the elytra are very variable.

D. S.

*Labrocercus concolor*, n. sp.—Minus elongatus, niger, nigro-pubescentis, antennis in medio tarsisque picescentibus; elytris subtiliter granulatis, granulis versus apicem obsoletis. Long. 3 m.m.

This species, so far as I can judge from a single male, is allied to *L. jaynei*, but is abundantly distinct by the shorter form and by the granulate sculpture of the elytra; the male antennæ are similarly formed, but are less elongate, and have a considerably shorter terminal joint.

Sent by Mr. Blackburn as No. 461, and found by beating dead branches of trees at an elevation of about 6000 feet on Mauna Loa, Hawaii.

D. S.

*Labrocercus obscurus*, n. sp.—Minus elongatus, haud dense pubescens, niger, antennis obscure testaceis; elytris obscure granulatis, maculis quatuor fulvis (duabus anterioribus fere in fasciam curvatam conjunctis) notatis. Long. 3 m.m.

This species is almost of the shape of *L. concolor*, Sh., with the markings of *L. jaynei*, Sh. The pubescence resembles that of *L. jaynei*; and the elytra are granulate as in *L. concolor*. My single specimen appears to be a female, and differs from the same sex in the other species of the genus in having considerably shorter and more slender antennæ.

I have a single female specimen of *Labrocercus* from the Waianae mountains, Oahu; apparently very close to *L. jaynei*, but narrower and more elongate, with more slender antennæ, and dark slender legs. Unfortunately, it is not in sufficiently good condition to serve as the type of a new species.

Taken by beating dead branches of trees on Mauna Loa, Hawaii, at an elevation of about 6000 feet.

T. B.

## CRYPTORHOPALUM.

*Cryptorhopalum brevicorne*, n. sp.—Sat convexum, nitidum, parce nigropubescent, parce subtiliter punctatum, nigrum, antennis pedibusque testaceis. Long.  $2-3\frac{1}{2}$  m.m.

This species is similar in appearance to *C. triste*, Lec., but has the legs and antennæ pale, and in the structure of the antennæ and prosternum is quite different, so that it is but doubtfully congeneric therewith, although in the present very unsatisfactory state of the arrangement of the exotic forms of these obscure Dermestidæ I think it best classed in *Cryptorhopalum*. The antennæ are very short and are pale yellow, their club is subcircular, larger in the male than in the female, and in the former sex is formed nearly entirely by the terminal joint, while in the female nearly one-third of it is formed by the penultimate joint. The hind angles of the thorax are nearly rectangular but slightly obtuse. The prosternum is more rounded and produced in front than it is in *C. triste*, and the antennal fossæ have a shining surface, are broad and short, and not very definitely limited. The under surface is clothed with a scanty cinereous pubescence, and the pale colour of the legs extends even to the coxæ.

Four specimens of this species have been sent me by Mr. Blackburn as Nos. 26 and 213; the species is found in the houses at Honolulu.

D. S.

*Cryptorhopalum terminale*, n. sp.—Breviter ovale, convexum parce griseopubescent, nigrum, elytris in medio et late ad apicem rufis, antennis, tibiisque testaceis. Long.  $2\frac{3}{4}$  m.m.

The female has the antennæ very short, with sub-circular two-jointed club, but the terminal joint much larger than the other joints; from the third to the club, very small and difficult to count. The upper surface is rather sparingly punctate, and has a rough but not dense pale pubescence, which does not form bands, except that on the dark fasciæ of the elytra it is less distinct and darker in colour; the hind angles of the thorax are nearly rectangular. The apical one-third or two-fifths of the wing cases is red; then in front of this there is across the middle a medial black band, and in front of this a red one, the base being black, these three basal bands of colour being about of one width.

I have received three specimens as No. 47; they are, no doubt, females; although probably a species introduced into the islands, it does not agree with any of the descriptions of the numerous New World species of this genus recently described by Reitter.

D. S.

## Fam. EUCNEMIDÆ.

## FORNAX.

*Fornax bonvouloiri*, n. sp.—Ferrugineus, subopacus, crebre punctatus, tenuiter fulvo-pubescentis; elytris posterius attenuatis, leviter striatis; prothoracis canaliculis lateralibus usque angulos posteriores haud productis; fronte ecarinata. Long.  $5\frac{1}{2}$  m.m. (Plate IV., f. 17.)

Antennæ slender and elongate, pale red, very broken at the insertion of the second joint; basal joint as long as the three following together; second joint twice as long as broad; third about one and a-half times the length of the second; fourth shorter than second; fifth longer than the fourth, but still shorter than the second; sixth quite as long as second; seven to ten subequal, each a little shorter than the third; terminal joint longer than the third, but not quite so long as the basal joint. Head rather finely punctate, without longitudinal or transverse carina. Thorax rather finely and closely punctate. Elytra finely striate, interstices closely punctate.

According to Comte de Bonvouloir's monograph, there are but two species of *Fornax* in which the prothoracic channels do not attain the hind angles; and one of these, *F. debilis*, has a longitudinal carina on the head. *F. bonvouloiri* can therefore only be confounded with the second species, *F. guineensis*, of which only a single example in the Stockholm Museum is known, and it is probable that the two are closely allied, but the details of Bonvouloir's description of *F. guineensis* do not apply satisfactorily to *F. bonvouloiri*, and moreover in the latter species the anterior tibiæ are broad. Though it is probable *F. bonvouloiri* will be found elsewhere than in the Sandwich Islands, I believe it to be an undescribed species, and have named it in honour of the author of the monograph of *Eucnemides*, which is certainly one of the most praiseworthy and useful entomological works of recent years.

Found, I believe, in Oahu; sent by Mr. Blackburn as No. 318.

D. S.

*Fornax sculpturatus*, n. sp.—Haud latus; postice angustatus; niger, antennis pedibusque rufopiceis; capite crebrius nec fortiter punctato; prothorace transverso, antice parum angustato, confuse nec crebre punctato; elytris fortiter striatis, interstitiis convexis, confuse nec distincte punctatis. Long.  $7\frac{1}{2}$  m.m.

This is a very distinct species; its black colour, longer thorax, less narrowed in front, obscure and comparatively sparing punctuation (which is difficult to discern at all on the elytra), and deeply striated elytra, distinguish it from *F. bonvouloiri*, Sh.; its shape, and the slightly produced hinder angles of the thorax, from *F. obtusus*; its much shorter antennæ, different shape, &c., from *F. longi-*

cornis, and the elytra uniformly narrowed behind from *F. parallelus*. My specimen has scarcely any trace of pubescence, but I think this may be due to its not being in fresh condition. There is an obscure longitudinal carina on the forehead.

A single specimen was taken under the bark of a tree on the Waianae Mountains, Oahu.

T. B.

*Fornax parallelus*, n. sp.—Angustus, parallelus, pubescens, castaneus; capite crebre fortiter punctato; prothorace leviter transverso antice parum angustato, trans basin elytris vix latiori, angulis posticis parum productis; elytris elongatis, parallelis, striatis, interstitiis subconvexis confuse nec crebre punctatis. Long. 7 m.m.

The extremely parallel form of this insect distinguishes it from all its described Hawaiian allies.

A single specimen was taken in damp moss near the summit of Konahuanui, Oahu.

T. B.

*Fornax longicornis*, n. sp.—Oblongus, apicem versus fortiter angustatus; obscure pubescens, fuscus, elytris nigrescentibus; antennis corporis dimidio longioribus; capite crebre fortiter punctato; prothorace transverso, antice angustato, trans basin elytris sat latiori, crebre subtilius punctato, angulis posticis fortiter productis; elytris striatis, interstitiis confuse punctatis. Long.  $4\frac{1}{2}$  m.m.

The great breadth of the thorax at the base (where it is considerably wider than the elytra), and the very strongly produced hinder angles of the same, the long antennæ, and the very strong narrowing of the elytra towards the apex, together with smallness of size, give this insect a perfectly distinct facies.

A single specimen occurred under bark of a tree on Haleakala, Maui, at an elevation of about 4000 feet; a second (severely mutilated, but probably identical) was taken afterwards within a mile of the same place, and at about the same elevation.

T. B.

*Fornax obtusus*, n. sp.—Latus; postice obtusus; pubescens; rufopiceus, antennis pedibusque dilutioribus; capite prothoraceque obsolete punctatis; hoc parum transverso, trans basin elytris latiori; elytris striatis, interstitiis crebre subtiliter punctatis. Long. 10 m.m.

Allied to *F. bonvouloiri*, Sh., but differently shaped, being much wider and less narrowed behind; the thorax is less transverse and more strongly produced backwards; the width across the lobes being considerably greater than the base of the elytra, which latter are scarcely at all contracted in their anterior half, their sides being slightly rounded, and their length decidedly less than three times that of the thorax; the head and thorax are very closely but excessively faintly punctured; the punctuation of the elytra is not so strong as in *F. bonvouloiri*, Sh.

Two specimens (one of them much mutilated) occurred under bark of trees on Haleakala, Maui, at an elevation of nearly 5000 feet.

T. B.

The last four species of *Fornax* described above have the following characters in common:—Head, vertical; clypeus, trapeziform; prosternal sutures uniting in front with the margins of the prothorax; margins of the prosternum furnished with antennal furrows; no lamellæ to the tarsi; antennæ simple; joints one, three, and eleven longer than the rest. In *F. obtusus* and *F. longicornis* (the two species from Maui) the basal lobes of the thorax are much longer and broader than in the other described Hawaiian species, and the thorax is much more convex longitudinally, and is very decidedly wider than the elytra.

---

Fam. ELATERIDÆ.

EOPENTHES (nov. gen.).

The structure in these insects is very similar to what exists in *Elater* and *Megapenthes*, but the head in front is broadly and gently rounded, not at all produced or angulated, and it is separated from the labrum by an extremely small but very abrupt interval; the prosternal sutures are nearly flat in front and not open; the posterior portion of the mesosternal cavity is subperpendicular; the legs and coxæ are formed much as in *Elater*; the tarsi are quite slender; the angle of the coxal lamina acute; second and third joints of the antennæ short.

D. S.

*Eopenthes basalis*, n. sp.—Niger, antennarum elytrorumque basibus pedibusque rufo-testaceis, tibiis in medio obscuris, tarsis nigricantibus; capite thoraceque dense fortiter punctatis, tenuiter pubescentibus, hoc angulis posterioribus acute carinatis; elytris profunde striatis, striis punctatis, interstitiis parce punctatis et tenuiter pubescentibus. Long. 11 m.m.

Antennæ not reaching so far back as the hind angles of the thorax, black; the three basal joints reddish yellow; second and third joints short, equal; thorax narrowed from the base to the front in nearly a straight line; the carina of the hind angle much raised above the lateral margin; punctuation dense, so that the surface is quite dull. The basal pale fascia of the wing-cases interrupted at the suture, and only occupying about one-sixth of their length; apices quite acuminate. Prosternal process not curved upwards behind the coxæ, and bearing a very abrupt angle.

*Elater humeralis* of Karsch, Berl. Ent. Zeit. xxv., p. 5, is no doubt congeneric with this insect, and probably closely allied to it.

The unique individual described was sent by Mr. Blackburn as No. 323, found in the mountains near Honolulu.

D. S.

*Eopenthes obscurus*, n. sp.—Fuscus, prothorace vix subænescente, antennis pedibusque sordide rufo-testaceis, illis basi rufo; capite thoraceque fortiter dense punctatis, tenuiter pubescentibus, hoc angulis posterioribus acute carinatis; elytris basi late vageque rufescente, interstitiis parce punctatis et tenuiter pubescentibus. Long. 10 m.m. (Plate iv., f. 19.)

In this species the sides of the thorax are slightly sinuate, and the prosternal process is bent upwards behind the coxæ, and is furnished with a small angular projection. This character will readily distinguish the insect from *E. basalis*, even if the difference in colour and other respects prove inconstant. In the only individual I have seen, the second and third joints of the antennæ are not quite so short as in *E. basalis*, and the apices of the elytra are not acuminate; but these may be sexual characters.

This species, like *E. basalis*, was sent me by Mr. Blackburn as No. 323. It was found in the mountains near Honolulu, but not in company with *E. basalis*.

D. S.

*Eopenthes debilis*, n. sp.—Rufus, capite nigro, antennis pedibus elytris testaceis; prothorace haud dense punctato; elytris tenuiter striatis, striis fortiter punctatis, interstitiis parce punctatis et pubescentibus. Long. 7 m.m.

Antennæ reaching as far back as the hind angles of the thorax, rather slender; second and third joints short; the latter of the two a little the longer, and very evidently longer than broad; striæ of elytra fine and very shallow, marked with conspicuous though rather distinct punctures; apices of elytra not acuminate. Prosternal process bent upwards a little behind the coxæ, its prominent angle but small.

I have two female individuals before me, sent as No. 322, and found rarely by sweeping ferns at an elevation of about 2500 feet on the Waianae mountains, Oahu.

D. S.

*Eopenthes konæ*, n. sp. — Subnitidus; niger, antennis pedibusque piceis, elytris (sutura excepta) castaneis; capite prothoraceque crebre subtilius punctatis tenuiter pubescentibus; hujus angulis posterioribus subtiliter carinatis; elytris fortiter striatis, striis fortiter seriatim, interstitiis confuse, punctatis; his tenuiter pubescentibus. Long. 9. m.m.

Antennæ reaching back by rather more than the length of the apical joint beyond the end of the hind angles of the thorax, pitchy, very little paler at the base; second and third joints short, equal. Thorax much more strongly widened towards the base in the basal third than in the front part, so that the lateral margin appears gently concave; the carina of the hind angle obscure; punctuation dense and fine, the surface being shining. The prosternal process resembles that of *E. obscurus*, Sh., but is not quite so strongly curved upwards behind the coxæ.

A single specimen was taken flying, near Kona, Hawaii, at an elevation of about 5000 feet.

T. B.



*Eopenthes ambiguus*, n. sp.—Subnitidus; castaneus, capite nigro, antennis (basi excepta) picescentibus, corporis dimidio longioribus; capite prothoraceque crebre subtilius punctatis, tenuiter pubescentibus; elytris striatis, striis fortiter seriatim, interstitiis vix distincte, punctatis; his tenuiter pubescentibus. Long. 7 m.m.

Antennæ reaching back by the length of the apical three or four joints beyond the end of the hind angles of the thorax; second and third joints short, equal. Thorax not much narrowed to the front, its sides being nearly straight, the carina of the hinder angles scarcely discernible. The prosternal process does not differ much from that of *E. konæ*.

A single specimen was taken by sweeping at the head of the Palolo Valley, Oahu, at an elevation of about 2000 feet.

T. B.

*Eopenthes satelles*, n. sp.—Elongatus, subparallelus, subnitidus, niger, antennis pedibus elytrisque testaceis, horum disco fusco; prothorace haud dense punctato; elytris fortiter striatis, striis fortiter interstitiis obscure punctatis; his pubescentibus. Long. 8 m.m.

Antennæ rather slender, just surpassing the end of hind angles of thorax; second and third joints short, equal.

This species is somewhat closely allied to *E. debilis*, Sh., from which it differs not only in colour and comparative length of second and third joints of antennæ, but also in the following respects:—the elytra are decidedly more elongate and parallel, being therefore much less acuminate behind; and they are much more deeply striated, with the interstices more distinctly punctured, and not so flat. The prosternal process is similar to that of *E. debilis*, Sh.

The single specimen retained by me, taken in company (*i. e.* at the same stroke of the beating stick), and believed to be conspecific with the specimen described by Dr. Sharp as *E. basalis*, presents some differences which I have regarded as probably sexual. It is slightly larger, and the antennæ reach back quite to the end of the hind angles of the thorax, having joints four to ten considerably widened and strongly compressed. Unfortunately I failed, before sending the specimen to Dr. Sharp, to notice the characters which he with his well-known acumen has observed in the prosternal process; but if I read his description aright, the specimen which forms the subject of this note agrees in that respect with that described by him as *E. basalis*; having the prosternal process abruptly and angularly perpendicular behind the front coxæ, and then again produced backwards on a lower plane.

A single specimen was obtained by sweeping ferns near a place called Koele, on Lanai, at an elevation of about 2000 feet.

D. S.

Besides the Elateridæ described above, I possess fragments of a robust-looking insect belonging to the family, of about the same size as *Itodacnus gracilis*, Sh., having black elytra, on each of which there are a number of small yellow spots, arranged in three irregular transverse fasciæ. These fragments were dug out of the trunk of a species of *Acacia*, at an elevation of about 2000 feet on the mountains of Oahu.

T. B.

## ITODACNUS (nov. gen.).

A new genus must be established for an insect allied to *Corymbites*, but with the lamina of the hind coxa strongly produced over the trochanter so as to form an angle, as in *Eopenthes*; from this later genus *Itodacnus* differs, by the front of the head being flat in the middle, so as to be continuous with the labrum, and by the elongate third joint of the antennæ. The facies is that of many species of *Athous*. The prosternal sutures are scarcely impressed in front, and the prosternal process is without an angle on its lower face; the posterior portion of the mesosternal cavity is a little oblique, but does not differ much in direction from the anterior portion. The tarsi are elongate and slender, and linear, with simple claws; the hind foot is quite as long as the tibia, and its basal joint is elongate, nearly as long as the three following joints together. *Corymbites corruscus*, Karsch, Berl. Ent. Zeit. xxv. p. 5, pl. i. f. 6, probably belongs to the genus.

D. S.

*Itodacnus gracilis*, n. sp.—Elongatus, parum convexus, fuscus, supra brunneus, prothorace obscuriore basi pallido, antennis pedibusque testaceis, tenuiter pubescens, sat nitidus; prothorace crebre sat fortiter punctato; elytris haud profunde striatis, striis punctatis; interstitiis crebre punctatis. Long. 12 m.m. (Plate iv., f. 18.)

Antennæ slender, reaching farther back than the hind angles of the thorax; second joint short, but not globular; third twice as long as second; fourth and following joints slender, not serrate internally; terminal joints simple; head and prothorax darker in colour than the elytra, but the base of the thorax is a good deal paler; its sides are not sinuate; the apices of the elytra are not acuminate.

I have a pair of this species before me; the antennæ and legs of the male appear to be more elongate than those of the female, but in other respects the two agree.

This species is found rarely by beating and sweeping on both the mountain ranges of Oahu, at an elevation of about 2000 feet. No. 321 of Mr. Blackburn.

D. S.

## Fam. MALACODERMIDÆ.

## HELCOGASTER.

*Helcogaster pectinatus*, n. sp.—Depressus, niger, nitidus, subglaber, antennis basi testaceo, articulis 5–10 breviter pectinatis. Long. 4 m.m. (Plate iv., f. 20.)

Antennæ longer than the head and thorax, the two or three basal joints yellow, the rest dark; second joint almost globular; third triangular; fourth somewhat produced inwardly; five to ten giving off each inwardly a well-marked, stout process acuminate at its extremity; terminal joint simple; head much narrower behind the prominent eyes; thorax black, smooth, and shining, about as long as broad; hind angles quite rounded, base strongly margined; elytra abbreviate, leaving exposed four of the segments of the hind body, and an emarginate terminal process, obsoletely punctate; exposed segments smooth and shining; black, with a narrow, white, membranous margin at the side.

This species differs from the recorded Australian species of *Helcogaster* by the pectinate antennæ, but this at present would scarcely justify its being treated as a distinct genus. Mr. Gorham has kindly looked at a specimen, and informs me it is unknown to him.

No. 324. Found in the town of Honolulu.

D. S.

## CACCODES (nov. gen.).

This genus is formed for a minute beetle having the appearance of our European *Malthodes*, but with the elytra very short, dehiscent, scarcely covering one-half of the hind body, and with the mandibles toothed internally near the extremity; in most other respects, so far as I can observe, the characters are but little different from those of *Malthodes*; the palpi are short, with acuminate extremity, the prosternum extremely short, the antennæ elongate and filiform, the hind wings ample and exerted.

D. S.

*Caccodes debilis*, n. sp.—Fusco-niger, capite pedibusque testaceis, antennarum basi tibiisque fuscis; antennis sat crassis, corpore longioribus; prothorace fortiter transverso; elytris abbreviatis, fortiter dehiscentibus, obsoletissime punctatis. Long.  $2\frac{1}{4}$  m.m.

Antennæ with the second and third joints rather shorter than the others, the third rather the longer, four to eleven differing little from one another in length; each slightly narrower than its predecessor, so that the acuminate terminal joint is evidently thinner than the fourth joint; head, thorax and elytra bearing an extremely short and fine, not dense, pubescence; eyes large and prominent, head

a little narrowed behind them; thorax quite twice as broad as long, slightly narrower than the elytra, very little narrowed behind; sides, base and front nearly straight, everywhere strongly margined, except that in the middle in front the margin becomes more indistinct; elytra short, but more than twice as long as the thorax, not coadapted at the suture, but becoming divergent from one another just behind the scutellum.

Found in Mr. Blackburn's house at Honolulu; single specimens at wide intervals of time. No. 351.

D. S.

---

Fam. PTINIDÆ.

Xyletobius.

*Xyletobius* (?) *insignis*, n. sp.—Angustus; dense subtilissime tomentosus; capite nigro, ore prothoraceque rufis; elytris piceis testaceo-variegatis subtiliter striatis, striis plus minusve sinuatis; antennis (toto corpore vix brevioribus), palpis, pedibusque rufis; oculis permagnis. Long. 5 m.m.

This insect so closely resembles *X. lineatus*, Sh., in some respects that I feel a slight misgiving as to whether the characters that seem to distinguish it may not be sexual; in which case, however, it would have to be considered probable that all the remainder of the specimens taken by me in the genus are of the same sex. If this be not the case it would appear doubtful whether the insect can be referred to this genus at all. It differs from *X. lineatus* as follows:—It is very much larger; the antennæ are very long (scarcely shorter than the whole body), are entirely of a pale red colour and hardly serrated, the joints being very slender and elongate; the eyes are very large and convex, extending the whole length of the head, and being together (viewed from the front) considerably wider than the space between them; the head is obscurely tricarinated longitudinally; the apical dilatation of the tarsi is less defined. I am not able to discover any other characters on which to separate this insect from *X. lineatus*, Sh.

A single specimen occurred near the crater "Kilauea," of the volcano Mauna Loa, Hawaii, but the exact particulars of its capture have unfortunately been lost. Most probably it was obtained by beating the branches of trees.

T. B.

*Xyletobius affinis*, n. sp. — Niger, pube subtilissima cinerescens, vestitus; antennis elongatis tenuibus, articulis 3<sup>o</sup>–6<sup>m</sup> intus serratis, 4<sup>o</sup> et 5<sup>o</sup> brevibus; elytris leviter striatis, parum inæqualibus. Long. 3, antenn. 1 $\frac{3}{4}$  m.m.

Antennæ black, as long as the elytra; from the fifth to the eleventh joint each is a little narrower and longer than its predecessor, so that only the third and three or four following joints can be said to be serrate; the third, fourth and

fifth joints are subequal, the former of them is, however, slightly longer than either of the other two, each of which is quite as broad as long. Thorax very short and broad, not produced in the middle in front, slightly broader in front than behind, the sides explanate.

Although I have seen only a single example of this species as well as of *X. oculatus*, I believe the two are distinct though very similar. *X. affinis* is rather broader, and has the antennæ a little shorter, and the fourth and fifth joints are shorter instead of longer than the third, and the thorax is less depressed at the sides.

Found at an elevation of about 6000 feet on Mauna Loa, Hawaii.

D. S.

*Xyletobius serricornis*, n. sp.—Angustus, dense subtilissime tomentosus, rufus, irregulariter infuscatus, pubescentia cinerea variegatus; palpis pedibusque et antennarum articulis 1–3 læte testaceis; antennarum articulis 4–11 nigris his (articulo ultimo excepto) transversis. Long.  $2\frac{1}{2}$  m.m.

This species bears a general resemblance to *X. marmoratus*, Sh., *X. lineatus*, Sh., and *X. insignis*, mihi, but can easily be distinguished from them all by the shortness of its antennæ, which are less than half as long as the body, and of which joints four to ten are decidedly transverse and rather strongly serrated internally.

A single specimen was obtained by beating dead branches of trees, at an elevation of about 2000 feet, on a mountain on Lanai.

I have a single specimen of *Xyletobius*, from Hawaii, which I refer to *X. oculatus*, although it differs from the type in having the legs reddish and the base of the antennæ testaceous.

T. B.

*Xyletobius lineatus*, n. sp.—Niger, pube variegata vestitus, antennarum basi pedibusque testaceis, elytris nigro-sanguineis; antennis tenuibus, parum elongatis, intus leviter serratis. Long.  $2\frac{1}{4}$  m.m.

Antennæ reaching but little farther back than the base of the thorax, slender; of joints five to ten each is slightly longer than its predecessor, but no one of them is elongate. Thorax very convex transversely in front, and with the front angles deflexed and hidden, clothed irregularly with a pale flavescent pubescence, which is absent altogether from the middle. Elytra finely striated, of a black colour tinged with red, the red being more distinct in places, so that they appear a little variegate, and this appearance of variegation is increased by some lines and patches of pale pubescence. Legs, clear yellow.

This distinct species may be placed in front of *X. marmoratus* as the first species of the genus, its antennæ showing a less remarkable development than do the others. It was found by beating dead branches of trees, at an elevation of about 6000 feet, on Mauna Loa, Hawaii.

D. S.

## CATORAMA.

*Catorama pusilla*, n. sp.—Brevis, rufo-ferruginea, antennis tibiisque pallidioribus; minus dense punctata et pubescens. Long. 2 m.m.

This obscure insect is readily distinguished from *C. mexicana* by its smaller size and brighter colour, and it also appears to have a less dense pubescence; the antennæ, with the exception of the basal joint, are quite pale yellow; the thorax is short and very transverse, without visible punctuation; the elytra are without striæ, and bear an almost invisible punctuation, and behind the base there are some fine but larger punctures that scarcely extend beyond the middle.

Mr. Blackburn found two individuals in the island of Maui.

D. S.

## MIROSTERNUS.

*Mirosternus acutus*, n. sp.—Piceus, antennis pedibusque rufescentibus; elytris ad basin apicemque crebre subtiliter punctatis; parte intermedia sparsim minus subtiliter punctata; metasterno fortiter carinato. Long. 3 m.m.

This species is allied to *M. muticus*, Sh., but has the metasternum differently sculptured, the hinder portion being profoundly channeled, and the front portion bearing a very strongly and sharply elevated carina. In the male (the only sex known to me) the densely punctured apical portion of the elytra appears to extend somewhat further forward than in *M. muticus*, and the apical three joints of the antennæ (especially the last) are wider than in the other known species of the genus.

A single specimen was obtained by beating dead branches of trees, at an elevation of about 2000 feet, on Kauai.

T. B.

## Fam. BOSTRICHIDÆ.

## BOSTRICHUS.

*Bostrichus migrator*, n. sp.—Cylindricus, niger, sat nitidus, antennis rufis, harum clavæ articulis suboblongis haud intus serratis; prothorace anterieus muricato, posterius dense sculpturato, margine anteriore in medio utrinque breviter producto; elytris dense sat fortiter punctatis. Long.  $9\frac{1}{2}$  m.m.

Var. major, elytris versus apicem utrinque biangulariter prominulis; an sexus alter? Long. 14 m.m.

Antennæ with the three terminal joints forming a lax elongate club, the first of them a little longer than broad, the two following nearly similar to it, and not at all triangular in shape; thorax a little produced in the middle in front; the produced portion a little emarginate, each side of the emargination terminating as a small hook, the tubercle forming the hook being the most anterior of a lateral series of five similar murications; there are besides these lateral series numerous other less sharply elevated murications; the posterior portion of the thorax bears a peculiar scale-like sculpture; the punctuation of the elytra is not very coarse, and is irregular, though of a somewhat serial character.

This species inhabits Nicaragua, as well as the Sandwich Islands; it is closely allied to *Amphicerus fortis*, Leconte, but it is comparatively narrower, and the punctures on the elytra are finer, and the prothoracic prolongations are very much shorter than in the North American insect. Although the insect belongs to the genus *Amphicerus* Leconte, yet it also belongs to *Bostrichus*, as now understood; Leconte, when dividing *Bostrichus*, having fallen into the error of giving the name of *Amphicerus* to the insects to which our well-known European *Bostrichus capucinus* belongs, whereas he should have retained the name *Bostrichus* for that division, and have conferred a new name on the cornuted forms to which he assigned the old Geoffroyan name of *Bostrichus*. In consequence of this error of Leconte's, the Munich Catalogue presents us with a complete confusion about the two genera.

D. S.

---

Fam. CIOIDÆ.

## Cis.

*Cis bimaculatus*, n. sp.—Niger, antennarum basi pedibus elytrisq[ue] testaceis, his in medio nigro-bimaculatis, glaber, nitidus, elytris basi parce, fortiter punctato, prothorace crebrius et subtilius punctato. Long. 3 m.m.

Antennæ small, with slender club, the two basal joints yellow, the rest dark; head small, only half as broad as the thorax; thorax curved at the sides, and rather narrowed in front, rather broader than long, black, but with a small paler mark in the middle of the base and at the front margin; very distinctly punctured; elytra pale, with a dark spot on the middle of each; the basal portion coarsely but sparingly punctate, the apical half impunctate.

Found very rarely, according to Mr. Blackburn, on the higher mountains of Maui and Hawaii. No. 271.

D. S.

*Cis nigrofasciatus*, n. sp.—Oblongus, sat elongatus, fortiter convexus; nitidus crebrius subtiliter punctatus; subtus nigricans, supra variegatus, antennis piceis basi testaceo, capite prothorace pedibusque flavo-testaceis, elytris fusco-testaceis; fascia nigra angulata transversa in medio notatis. Long. 3 m.m.

This species is somewhat allied to *C. bimaculatus*, Sh., but differs from it by the closer and finer punctuation of its elytra, and the much more strongly rounded sides of the thorax, of which the basal margin is very indistinct.

A single specimen was procured by beating dead wood, at an elevation of about 2000 feet, on Lanai.  
T. B.

*Cis longipennis*, n. sp.—Sub-oblongus; minime convexus; fortiter angustatus; nitidus; sublævigatus; fusco-brunneus, antennis pedibusque flavo-testaceis. Long.  $1\frac{1}{3}$  m.m., lat.  $\frac{2}{3}$  m.m.

This species is closely allied to *C. læticulus*, Sh., but differs from it not only by its colour, but by its distinctly less convex, narrower, and more elongate form, thorax less rounded at the sides, and more narrowed behind, and elytra more distinctly punctured.

A single specimen was found in dry wood on the mountains of Kauai.

D. S.

*Cis apicalis* (? = *C. setarius* var.), n. sp.—Parum elongatus, nitidus, niger, antennis pedibus elytrorumque apice testaceis, antennarum clava fusca; prothorace parce punctato, in margine anteriore testaceo-signato, elytris fere lævigatis. Long.  $1\frac{7}{8}$  m.m.

Thorax quite sparingly punctate, a little rounded at the sides, and with the hind angles indistinct and obtuse. Elytra black, with a large testaceous patch at the apex; at the base with a few punctures; elsewhere impunctate.

The unique individual described is in bad condition, but I can detect no trace of any elongate setæ on the elytra.

Hawaii.

D. S.

*Cis setarius*, n. sp.—Parum elongatus, niger, nitidus, prothorace elytrisque castaneis, his apicem versus dilutioribus, antennarum basi pedibusque testaceis; prothorace elytrisque parce, minus argute punctatis, his setis erectis, elongatis subtilissimis parce adspersis. Long.  $1\frac{7}{8}$  m.m.

Antennæ slender; thorax rather broader than long, not much rounded at the sides, and with the hind angles distinct though rather obtuse, sparingly and rather obsoletely, but not finely punctured; elytra on the basal portion, sparingly and obsoletely punctate, on the apical portion almost impunctate, bearing a very few excessively fine elongate setæ.



This, and *C. apicalis* and *C. concolor*, were sent me by Mr. Blackburn as No. 342, and were found in different localities (not specified) in Hawaii. Though I have seen only one individual of each, they appear to me to be distinct species; and I give the description of *C. apicalis*, though Mr. Blackburn may prove to be right in considering it a variety of *C. setarius*.

D. S.

*Cis concolor*, n. sp.—*Parum elongatus, angustulus, nitidus, niger, antennis pedibusque testaceis, femoribus nigris; elytris sublævigatis, setis elongatis, tenuissimis parcissime adspersis.* Long.  $1\frac{1}{2}$  m.m.

Antennæ yellow, slightly obscured towards the apex; thorax very sparingly punctate; elytra almost impunctate, with a few obscure inequalities on the basal portion. The setæ towards the sides are so few and fine, that they are not very easily observed. Although closely allied to *C. setarius* and *C. apicalis*, the specimen described is smaller, narrower, and less convex, and has the prosternum undoubtedly more elongate in front of the coxæ.

Hawaii.

D. S.

[I see Dr. Sharp regards the three specimens of *Cis*, sent to him by me under the number 342 (*vide supra*), as representing three distinct species. As regards *C. concolor*, I am disposed to accept the correction, and think that I had not attached sufficient importance to the difference in build, which certainly seems to distinguish that insect; but I am unable to acquiesce in the separation of the other two. I have specimens, coloured and punctured as *C. apicalis* is said to be, in which the elongate setæ are very well defined, and when the distinction of villosity is removed I see no other well-marked difference to separate *C. setarius* from it.

There exist in the Hawaiian islands a number of types of *Cis* closely allied to *C. bicolor*, Sh., and which I cannot satisfactorily distinguish from that insect. *C. bicolor*, Sh., therefore, I regard as a widely distributed and variable species, from which I do not see my way to separate *C. tabidus*, Sh. The following, therefore, would appear to me a desirable appendix to the description of *C. bicolor*, Sh., *Trans. Ent. Soc.*, 1879, Part i. p. 93:—

“This insect is extremely variable, and occurs throughout the Hawaiian Archipelago. Its size varies from  $1\frac{1}{2}$  m.m., to  $2\frac{1}{3}$  m.m. The specimens from Kauai (*C. tabidus*, Sh.) are a little shorter and broader than the type, and more obscurely coloured and punctured. Oahu specimens are usually of the form described, but vary in the direction of the punctuation, becoming faint, especially in the front of the thorax, and the markings being more or less obliterated or intensified—the extremes of marking, so far as known, being testaceous or fuscous, with obscure indications of some of the usual markings, and thorax and elytra almost entirely suffused with black.

“Specimens from Maui are slightly larger than from Oahu, and have, in well-marked specimens, the dark markings æneous, instead of black, and the punctuation tending to greater intensity.

“Specimens from Hawaii closely resemble those from Maui, but are a little smaller and more obscure.”

T. B.]

*Cis chloroticus*, n. sp.—Parum elongatus, convexus, nitidus, glaber, pallide fuscus, antennarum basi pedibusque testaceis, elytris prothoraceque anterieus pallidulis. Long.  $1\frac{7}{8}$  m.m.

This insect appears to be closely allied to *C. apicalis*, though differing from it remarkably in colour; the upper surface has no trace of clothing, and is very shining; the thoracic punctuation is distant, and is rather coarse, though indefinite; the elytra have very little sculpture; it consists of some distant, rather coarse but indefinite, punctures on the basal portion.

I have seen only one specimen, in very bad preservation. Mr. Blackburn found it on Haleakala, in the island of Maui, at an elevation of 4000 or 5000 feet, and sent it to me as No. 424.

D. S.

*Cis calidus*, n. sp.—Angustulus, nitidus, pube tenuissima, elongata sat dense vestitus, castanea, capite, thorace antennisque versus apicem fuscis, thorace in margine anteriore pallido; parce punctatus. Long.  $1\frac{1}{2}$  m.m.

This little insect will be readily recognized by the elongate, very fine, upright pubescence of its upper surface; if this pubescence were removed the surface would be seen to be quite shining; the punctuation of the thorax is rather obsolete and not coarse or close; that on the elytra is also indefinite, and is confined to the basal portion.

Mr. Blackburn has found this species in decaying wood on two occasions, in each case a single specimen, in the mountains of Oahu, but in localities twenty miles apart. No. 475.

D. S.

*Cis insularis*, n. sp.—Elongatus, parallelus, subglaber, nitidus, fusco-testaceus, antennarum basi pedibusque rufis, elytris pallidis; antennis apicem versus fuscis; prothorace dense fortiterque punctato; elytris crebrius inequaliter punctatis. Long.  $2\frac{1}{2}$  m.m.

Antennæ with rather elongate club; fuscous with the base pale; thorax elongate, quite as long as broad, a little curved at the sides and somewhat narrowed behind, coarsely and very densely punctate; lateral margin distinct, but basal margin very indistinct; elytra pale yellow, closely and rather coarsely punctate, and with the surface a little rugose; legs stout.

Oahu.

D. S.

*Cis roridus*, n. sp.—Parallelus, angustulus, sat elongatus, parum nitidus crebrius conspicueque setulosus, dense fortiter punctatus, fuscus, antennarum basi pedibusque rufis, prothorace anterieus testaceo, elytris maculis plurimis testaceis. Long.  $1\frac{3}{8}$  m.m.

Antennæ dark, with the two basal joints reddish; thorax about as broad as long, very densely punctate, finely and indistinctly margined; elytra coarsely and closely punctate, marked with conspicuous pale yellow spots, one on each side of the scutellum, and one more elongate between this and the shoulder, and nearly attaining a spot near the suture in front of the middle; beyond the middle an oblique transverse mark.

This species is another very distinct one; the peculiar clothing of the upper surface (which consists of a pale, rather rough setulosity, somewhat like what is frequent in the genus, but more elongate and finer) is of itself sufficient for its identification.

D. S.

*Cis attenuatus*, n. sp.—Oblongus, angustus, parum convexus, supra testaceus, elytris in medio nigro-signatis, opacus, dense punctatus, brevissime hispidulus. Long.  $1\frac{1}{2}$  m.m.

This species, by its very dense punctuation and other characters, is closely allied to *C. signatus*, of which I formerly treated it as a variety (Trans. Ent. Soc., 1879, p. 93); the thorax is, however, longer and less transverse, and its punctuation rather less dense; the general form is a little narrower and more cylindrical, and the eyes are a little smaller; the antennæ are entirely yellow, and the thorax is without the large black mark of *C. signatus*. I think, therefore, this will prove a distinct species, even should the colour distinctions, as is probable, prove inconstant.

Found on the mountains of Kauai, and formerly thought to be a variety of *C. signatus*.

D. S.

*Cis ephistemoides*, n. sp.—Ovalis, valde convexus, nitidus, glaber, impunctatus, subtus testaceus, supra nigricans vel piceus, antennis pedibusque testaceis, antennarum clava fusca. Long. 1 to  $1\frac{1}{2}$  m.m.

This insect differs so much in form and appearance from the other species of *Cis*, that I supposed it would prove to be a distinct genus, and allied probably to *Atomaria* or *Ephistemus*, of which it has much the facies, but on examination I am unable to find any good characters to distinguish it from *Cis*. The rather slender antennæ are of the form usual in the genus with three-jointed club. The thorax is extremely convex transversely and much longer in the middle than at

the sides, and is very closely applied to the elytra, the lateral margin is very fine, and the basal one obliterated. The elytra are even more convex than the thorax, and acuminate behind.

The species apparently varies in size, and in the depth of colour, and is, I believe, one of the commoner beetles of the archipelago.

D. S.

*Cis vagepunctatus*, n. sp.—Ovalis; valde convexus; nitidus; parcius fortiter punctatus; nigricans, pedibus et antennarum basi rufis; antennis brevibus, clava crassiuscula. Long.  $1\frac{1}{2}$  m.m.

This insect differs from *C. ephistemoides*, Sh., to which it is closely allied, in having shorter antennæ, which are more strongly clubbed; and in being strongly, though not at all closely, punctured throughout.

A single specimen was taken out of damp, rotten wood, on one of the mountains near Honolulu.

T. B.

---

## Fam. TENEBRIONIDÆ.

### PLATYDEMA.

*Platydema obscurum*, n. sp.—Oblongo-ovale, parum convexus, opacum, subtiliter punctatum, nigrum, antennis pedibusque testaceis, elytris testaceo-signatis. Long.  $2\frac{1}{2}$  m.m.

Antennæ short and stout, the third joint longer than any of the others, the seventh rather broader than the sixth, which itself is slightly broader than the fifth; seven to eleven subequal in length, each broader than long. Thorax very finely and rather closely punctured, dull, the base very distinctly sinuate on each side near the scutellum. Elytra with distinct and regular series of fine punctures, interstices impunctate, they bear elongate narrow yellow marks, which, however, are very variable, so that sometimes the elytra appear black with some small yellow marks, sometimes yellow with irregular fasciæ of black marks. The under-surface likewise varies in depth of colour, being sometimes quite black, while in other cases the prosternum is piceous; the femora are sometimes yellow, sometimes dark.

This species has allies widely distributed; and in the British Museum there is, without a name, a very closely allied species from Celebes.

D. S.

## SCIOPHAGUS (new generic name).

The insect for which I propose this generic name has the appearance of a small, shining *Alphitobius*, but its tarsi are densely pubescent beneath. The mentum is extremely small, reduced to a small carinate shield having only the size of the last joint of the maxillary palpus, and leaving all the parts of the mouth exposed; the maxillary palpi are short and thick, their terminal joint broader, subsecuriform. The antennæ are short and stout, with the basal joint concealed by the clypeus, and are incrassate from the middle to the extremity: eyes rather large, coarsely faceted; clypeus broad in front, and slightly emarginate, leaving exposed the broad labrum. Prosternum furnished with a well-marked, narrow, horizontal process, projecting into the impressed mesosternum. Metasternum of moderate length; tibiæ rather slender, not denticulate externally; spurs small; tarsi rather slender, clothed beneath with dense fine pubescence, penultimate joint simple; basal joint of the posterior elongate, about equal in length to the terminal joint.

The clothing of the tarsi renders the position of the genus somewhat dubious, otherwise it appears allied to *Alphitobius* and other of the genera placed by Lacordaire in the *Ulomides*. The insect for which it is proposed is the *Heterophaga pandanicola*, Esch. (Plate v., f. 27). It occurs in the Radack chain, and in New Zealand (Coll. Murray) as well as in the Sandwich Islands. The name appears to be omitted from the Munich Catalogue of Coleoptera. Mr. C. O. Waterhouse informs me that, in the British Museum collection, this insect is also extant under the name *Pachycerus domesticus*, Mont., from New Caledonia; but this does not affect the nomenclature, as *P. domesticus* is subsequent in date to *H. pandanicola*, and the name *Pachycerus* is in prior use for another genus of Coleoptera. In the Munich Catalogue *Pachycerus domesticus* is placed in the genus *Alphitobius*.

D. S.

## LABETIS.

*Labetis tibialis*, Wat.—As the description of *Labetis tibialis*, Waterh. (*Vide* E. M. M., vol. xv. p. 267), seems to be founded on a female—and I possess both sexes—it may be well for me to mention here the characters of the male. They are as follows:—The central portion of the apical ventral segment is occupied by a profound impression which is nearly as wide as long, and extends from near the base of the segment to its apex; there is a lamella underneath all the joints of the anterior, underneath the second, third, and fourth joints of the intermediate, and underneath the penultimate joint of the posterior tarsi; the antennæ are slender and rather more than three-fourths the length of the body; and the anterior tibiæ are wider than in the female, and have the external edge considerably more strongly produced at the apex. The length of the male specimen in my collection is 15 m.m., of the female 9½ m.m.

I obtained my pair of this insect by beating branches of trees on the mountains near Honolulu.

T. B.

## CISTELA.

*Cistela crassicornis*, n. sp.—Ovalis, angustulus, fusco-niger, antennis pedibusque testaceis, illis apicem versus obscuris, elytris bruneo-obscuris; capite thoraceque dentissime punctatis, opacis, elytris parcius punctatis, subnitidis. Long. 6 m.m (Plate IV., f. 25).

Antennæ 3 m.m. long, rather stout, the four or five terminal joints a little serrate internally; head narrow, coarsely and extremely densely punctate; thorax a good deal narrowed in front, and rounded at the front angles; the hind angles nearly rectangular; the basal margin fine but distinct; lateral margin scarcely to be detected in front, the surface coarsely and extremely densely punctate, finely and scantily pubescent; elytra of a dark, sordid brown colour, rather shining, moderately closely and not coarsely punctate, the punctures scarcely to be distinguished as impressions, with a depression along the suture, and with a very feeble appearance of being striate, owing to an arrangement of some of the punctures in a linear manner.

A pair of this species was taken from trees in the Palolo valley, Oahu. The male has the second, third, and fourth joints of the front tarsi, especially the two latter, considerably dilated. Mr. Blackburn states that the antennæ of the female are somewhat shorter, and paler in colour, than those of the male, and have the internal serration of the terminal four or five joints less evident.

D. S.

## ANTHICUS.

*Anthicus mundulus*, n. sp.—Gracilis, angustulus, parce pubescens, nitidus, ferrugineus, elytris plaga laterali variabili abdomineque fuscis; prothorace basi fortiter punctato, anterie fere impunctato; elytris parce punctatis, tenuiterque pubescentibus. Long. 3 m.m.

Antennæ reddish, rather elongate, slightly thickened at the extremity; head oval, narrow, the vertex greatly curved, and greatly elevated above the slender neck, sparingly and obsoletely punctate; thorax slender, greatly constricted behind, at the base coarsely and closely punctate, in front, almost impunctate, sparingly and finely pubescent; elytra elongate and narrow, rather curved at the sides, sparingly punctate and pubescent, with a large patch of darker colour at the side of each; legs yellow.

This species varies somewhat in colour, the dark marks of the elytra being sometimes more intense and extensive, and in such cases the head and thorax become deeply tinged with the dark colour; the punctuation of the elytra is sometimes coarser and more definite.

North American specimens, scarcely differing from this species, are extant in the British Museum, with the MS. name attached, *A. salinus*, Schaum; but this name is in use for another species.

D. S.

## ANANCA.

*Ananca collaris*, n. sp.—Rufo-testacea, capite supra elytrisq̄ue nigro-plumbeis, antennis pectore abdomineq̄ue fuscis; elytris opacis, minus argute sculpturatis, absque lineis elevatis. Long. 8–11 m.m.

Maxillary palpi, with their terminal joint slightly dilated internally; antennæ elongate, but not so long as the insect; thorax bright yellow, narrowed behind, and a good deal rounded at the sides in front, rather closely but indistinctly punctured, its surface slightly uneven; elytra of a dull leaden black, their surface sculptured rather closely, the sculpture not consisting of impressed punctures, without raised lines, though on careful inspection traces may be seen of the rudiments of two such lines, that near the suture being the more distinct.

Mr. Blackburn has sent me, as he believes, the sexes of this species, but they do not differ except that the antennæ are slightly longer in one. The colour of the metasternum and tarsi is a little variable, these parts being sometimes fuscous, sometimes yellow.

Single individuals of this species are occasionally found about Honolulu.

D. S.

## Fam. AGLYCYDERIDÆ.

## PROTERHINUS.

*Proterhinus linearis*, n. sp.—Angustus; subparallelus; crasse confuse punctatus; nigro-fuscus, antennarum basi, pedibus, prothorace et elytrorum basi rufis; prothorace elongato, lateribus leviter rotundatis; elytris subparallelis, humeris obscuris. Long.  $1\frac{3}{4}$  m.m.; lat.  $\frac{2}{3}$  m.m.

This very pretty little insect resembles *P. longulus*, Sh., in shape, but is even narrower and more parallel. It is quite distinct from everything else known to me. The basal two joints of the antennæ are rather large, the second especially being longer than is usual in the genus, and the remaining joints are stout. My specimen is somewhat abraded, but I can discover some traces of short setæ on the elytra.

A single female example occurred on Kauai, but the exact particulars of the capture have been lost.

T. B.

*Proterhinus scutatus*, n. sp.—Angustulus; rufescens, marginibus lateralibus plus minusve nigricantibus; obscure aureopilosus; setis erectis sparsim nec conspicue vestitus; fortiter punctatus; prothorace fortius rotundato; elytrorum parte anteriore angustata; humeris fortiter productis. Long.  $2\frac{1}{3}$ – $3\frac{3}{4}$  m.m.

This insect is allied to *P. simplex*, from which it differs in shape, the elytra being more elongate, much more narrowed towards the base than in *P. simplex*, and having the humeral angles more strongly produced, and the thorax being more regularly rounded laterally. It differs, moreover, from the insect on which the original description of *P. simplex* was founded in having unicolorous antennæ and tarsi, although in this respect it agrees with certain forms occurring on Oahu (which must at present be assigned with doubt to *P. simplex* as vars.). As in *P. simplex*, the basal joint of the antennæ is smaller in the male than in the female.

This species occurs in mountain forests on Kauai.

T. B.

*Proterhinus similis*, n. sp.—Sat *elongatus*; *rufescens*, plus minusve *aureo-tinctus*, elytris plus minusve *nigro-maculatis*; antennis sat *crassis*, *piceis*, *concoloribus*; prothorace leviter *transverso*, lateribus fortiter *regulariterque* *rotundatis*, antice posticeque fortius *angustato* nec *constricto*; elytris setis erectis *sparsius* *vestitis*; humeris parum *prominulis*. Long.  $2\frac{3}{4}$ – $3\frac{1}{2}$  m.m.

This is another ally of *P. simplex*, Sh. Its most conspicuous distinctive characters are that the lobes of the fourth joints of the tarsi are much smaller than in *P. simplex*, that the antennæ are of more uniform thickness (the intermediate joints being stouter in proportion to the basal and apical ones), and that there is no noticeable difference between the sexes in respect of the size of the first joint of the antennæ. The greater length of the second joint of the antennæ, together with the feeble development of the tarsal lobes, distinguishes the insect from *P. tarsalis*.

This species was obtained by beating branches of trees, at an elevation of about 4000 feet, on Mauna Loa, Hawaii, where it is not rare.

T. B.

*Proterhinus laticollis*, n. sp.—Sat *brevis*; *rufescens*, marginibus lateralibus plus minusve *nigricantibus*; obscure *aureo-pilosus*; setis erectis *sparsim* nec *conspicue* *vestitus*; obscure *punctatus*; prothorace fortiter *transverso*, elytris *nullo* *modo* *angustiore*, lateribus fortiter *rotundatis*; humeris parum *distinctis*. Long.  $2\frac{1}{2}$  m.m.

The extremely transverse thorax, which is wider instead of narrower than the elytra, renders this species (which belongs to the *P. simplex* group) very distinct. The colour of its whole surface, including legs and antennæ, is almost uniform, the only marking being some infuscation along the external margins of the elytra; the basal joint of the antennæ is scarcely longer than the second; the eyes are small and little prominent.

A single male specimen was obtained by beating branches of trees on the Waianae Mountains, Oahu.

T. B.



*Proterhinus tarsalis*, n. sp.—Sat elongatus; crebre punctatus; nigricans, albido-maculatus, tarsi rufis; prothorace transverso, rotundato; elytris setis longis vestitis, humeris vix acutis; antennarum articulo secundo vix elongato. Long.  $2\frac{3}{4}$ – $3\frac{1}{4}$  m.m.

The colouring of this species appears to be constant, and differs from that of every other known to me in the genus. The insect is entirely of a smoky black colour, except that there are a few golden brown scales on the thorax, and some (usually about eight) ill-defined round spots of a whitish colour, inclining to golden brown, on each of the elytra, and that the tarsi are clear red. It is allied to *P. simplex*, Sh., from which and other allied species it differs (apart from size, colour, and other respects) in having the second joint of the antennæ scarcely longer than wide, and the first joint scarcely shorter in the ♂ than in the ♀. From *C. debilis*, Sh., it differs in having larger eyes, more pronounced club of antennæ, &c., as well as in size and colour.

A short series of this insect was obtained by beating branches of trees on Mauna Loa, Hawaii, at an elevation of about 6000 feet.

T. B.

*Proterhinus robustus*, n. sp.—Rufo-brunneus; albido-squamulatus; setis erectis minus sparsim vestitus; prothorace vix transverso, antice posticeque parum angustato nec constricto, lateribus leviter rotundatis; angulis humeralibus haud prominulis; antennarum articulo primo quam secundo duplo majore, hujus longitudine latitudinem distincte superante. Long.  $3\frac{3}{4}$  m.m.

This species belongs, I think, to the *P. simplex* group; it is, however, a stouter-looking insect than the others. The elytra are broadest at the base, and not at all parallel, with indistinct humeral angles, and gently rounded sides. The elongation of the basal joint of the antennæ (in the female at least) is a conspicuous character.

A single specimen (female) was taken from the bark of a tree on the Waianae Mountains, Oahu.

T. B.

*Proterhinus ineptus*, n. sp.—Parum elongatus, nigricans, antennis tibiis tarsisque rufis, elytris ferrugineis, vage nigro-signatis; supra parum dense vestitus, setulisque erectis parum conspicuis; prothorace lateribus rotundatis, anterius parum constricto, dorso indistincte tri-impresso; elytris inæqualibus, humeris acutis. Long.  $2\frac{1}{2}$  m.m.

Closely allied to *P. vestitus*, but with the thorax more globose and less impressed, with the shoulders of the elytra more acute, and the setæ shorter. Also very similar to *P. integer*, but with smaller eyes, and shorter antennæ, and less

elongate thorax, and without the large black mark on the side of the elytra. The differences between the sexes are almost the same as in *P. vestitus*.

A pair of this species, found on the island of Lanai, has been received as No. 478.

D. S.

*Proterhinus integer*, n. sp.—Sat elongatus, nigricans, antennis, tibiis tarsis elytrisque rufis, his nigro-signatis; densius parum maculatim vestitus, setulis erectis sat conspicuis; prothorace lateribus rotundatis, anterioribus haud abrupte constricto, minus evidenter tri-impreso; elytris haud inæqualibus, humeris acutis. Long. 3 m.m.

This species appears about equally allied to *P. vestitus* and to *P. sternalis*; it is distinguished from the former by its more elongate form, more abrupt antennal club, considerably larger eyes, less abruptly constricted and less impressed thorax, more acute humeral angles, and rather larger tarsal lobes. It agrees with *P. sternalis* in the structure of the antennæ, and in the larger eyes, and also in that, on very careful examination, there may be detected traces of the curved elevation extending from the shoulder of the elytra, but it is of much less abbreviate form, has much smaller tarsal lobes, and more rounded sides to the thorax; the humeral angles of the elytra are much prolonged, as in *P. sternalis*.

The description is made from two males agreeing closely, except for a slight difference in size. Mr. Blackburn has sent as the female (or rather under the same number, a female) an insect differing in many particulars; the form is shorter and broader, the eyes smaller, the white ashy clothing is replaced by a scanty yellower setosity, and the erect setæ are shorter, the punctuation of the elytra is conspicuous, and they have no trace of the large lateral black mark. I think it more probably the female of another species.

Found on the mountains of Lanai.

D. S.

*Proterhinus detritus*, n. sp.—Elongatus, sub-parallelus, brevissime setulosus, parum squamosus, ferrugineo-obscurus, elytris nigro-maculatis; prothorace lateribus parum rotundatis, subrectis, anterioribus abrupte constricto, parum argute impreso, rugoso-punctato; elytris crebre fortiter punctatis. Long.  $3\frac{1}{4}$  m.m.

This appears to be a very distinct species, although I have only a single male individual to base this opinion on. The antennæ are entirely red, rather elongate and slender, with the two basal joints much incrassate, the second rather longer than broad, the third quite slender and elongate, three times as long as broad, the club very little marked, slightly longer (joints nine to eleven) than joints three to five. Rostrum short and broad, covered with depressed scale-like hairs quite to the front, head but little dilated over the insertion of the antennæ, eyes rather

large, moderately convex. Thorax just as long as broad, the lateral angle formed near the front by the anterior constriction, very abrupt, the surface but little impressed, the anterior impression forming a vague channel, deepest in front, the lateral ones slightly marked, without squamosity, but with depressed setæ, which somewhat obscure its rugose sculpture. Elytra elongate, but little dilated behind, humeral angles distinctly prolonged, the surface coarsely punctate, and bearing short setæ, which do not form patches; erect setæ scarcely evident; legs red.

Perhaps more allied to *P. vestitus* than to any other species, but readily distinguished by the numerous differences in all points.

Found on the mountains of Lanai.

D. S.

*Proterhinus longicornis*, n. sp.—Elongatus, angustulus, irregulariter squamosus, setulisque erectis conspicuis ornatus, nigricans, tarsis rufis, antennis versus basin rufescentibus, elytris rufo-variegatis; oculis sat magnis, a thorace remotis; hoc elongato, lateribus rotundatis, anterieus minus abrupte constricto, parum distincte tri-impreso; elytrorum humeris acutis. Long.  $2\frac{3}{4}$ –3 m.m.

Male; antennæ elongate three-fourths of the length of the body; second joint rather elongate, more than half as long as the third; eighth joint remarkably elongate; club very slender and elongate. Head elongate, much dilated above the insertion of the antennæ; eyes rather large, and very distant from the front margin of the thorax: this latter very coarsely and densely punctate, its impressions indistinct. Tarsal lobes not large. The female differs, by its shorter antennæ, the eighth joint of which is not elongate, but the club is comparatively abrupt; the eyes are rather smaller but more prominent and less remote from the thorax. The species is allied to *P. collaris* by the peculiar form of the male head and antennæ; but it is abundantly distinct by its narrower more elongate form, longer antennæ, and less globular thorax, and the squamosity of the surface is not so condensed into patches.

This is also from the mountains of Lanai.

D. S.

*Proterhinus insignis*, n. sp.—Major, piceus, supra fulvo-ferrugineus, fere equaliter tomentosus, setulisque erectis conspicue vestitus, elytris parum maculatis, antennis pedibusque rufis; antennis elongatis, gracilibus, articulo basali maxime elongato; oculis perprominulis; prothorace parum distincte trifoveolato, elytris parum inæqualibus. Long. ♂  $4\frac{1}{2}$ , ♀ cum rost. 4 m.m. (Plate v., f. f. 44, 45).

One of the most remarkable species, with excessive sexual disparity, but with the great elongation of the basal joint of the antennæ common to both sexes, and in both sexes the antennæ are much clothed with erect hair, which is longer and denser on the inner face of the joints in the male. In this latter sex the antennæ

are inserted far in front of the eyes, and in front of their insertion the head is narrowed so as to appear acuminate. In the male the basal joint of the antennæ is not only elongate but is greatly incrassate, the second joint is short and thick, subtriangular, about as long as broad; in the female these two joints are more slender, though the basal one is still stout as well as elongate, the club is very slightly marked in the male, but is more distinct in the female. The anterior thoracic impression is very vague, the lateral ones, though smaller, are more definite. The elytra are nearly parallel-sided, are coarsely punctate, and have the humeral angles prominent, and a slight basal elevation on each side of the scutellum, and in the male there is in addition an obscure longitudinal elevation on the side of each elytron.

In the male of this remarkable species the head is provided with true scrobes, visible from beneath as broad, deep depressions extending as far back as the under-surface of the eye.

This was also found in Lanai, at an elevation of about 2000 feet, near a place called Koele, and was beaten from dead branches of trees.

D. S.

---

SYNOPSIS OF THE HAWAIIAN PROTERHINI.

- |  |             |
|--|-------------|
| 1. Species having the surface of the elytra uneven,*   | 2.          |
| "    "    "    "    "    "    evenly convex, or nearly so,                                       | 10.         |
| 2. The unevenness of the elytra caused (at least partly) by the presence of longitudinal ridges, | 3.          |
| The unevenness of the elytra caused entirely by a transverse basal depression,                   | basalis.    |
| 3. The longitudinal ridges gently sloped off behind,   | 4.          |
| "    "    "    abruptly vertical behind,   | Lecontei.   |
| 4. First joint of antennæ shorter than second and third together,                                | 5.          |
| "    "    "    not shorter than second and third together,                                       | insignis.   |
| 5. Elytra without any trace of transverse unevenness,  | 6.          |
| "    more or less uneven, transversely as well as longitudinally,                                | 9.          |
| 6. The dorsal part of the elytra not conspicuously flattened,                                    | 7.          |
| The dorsal part of the elytra strongly flattened, and margined laterally by an elevated ridge,   | paradoxus.  |
| 7. The second joint of antennæ very much shorter than the third,                                 | 8.          |
| "    "    "    "    scarcely shorter than the third,   | Blackburni. |

---

\* In *P. integer*, Sh., and *P. dispar*, Sh., the unevenness of the surface of the elytra is not nearly so well defined as in some other species of the category.

8. Lobes of third joint of tarsi very large; oblique ridges on elytra well-defined and strong; a species of rather abbreviated form, . . . . . *sternalis*.  
 Lobes of third joint of tarsi only moderate; form rather elongate; oblique ridges almost obsolete, . . . . . *integer*.
9. The transverse as well as longitudinal ridges almost obsolete; antennæ slender, with a well-defined club of three joints, . . . . . *dispar*.  
 The transverse as well as longitudinal ridges well-defined; antennæ stout, only slightly thickened at apex, . . . . . *validus*.
10. The anterior portion of the thorax abruptly narrowed, so that the lateral outline does not form a continuous curve, . . . . . 11.  
 Thorax rounded regularly (or nearly so) on the sides, . . . . . 12.
11. Elytra considerably narrowed towards the base in their anterior third; legs and antennæ black, . . . . . *nigricans*.  
 Elytra but little (though quite evidently) narrowed towards the base in their anterior third; legs and antennæ testaceous, . . . . . *vestitus*.  
 Elytra parallel and somewhat elongate, . . . . . *detritus*.
12. Thorax not more than moderately transverse, and not wider than elytra, . . . 13.  
 Thorax extremely transverse, and slightly wider than the elytra, . . . . . *laticollis*.
13. Species of cylindric form (the length of thorax and elytra together being about three times the greatest width), . . . . . 14.  
 Species of shorter and broader form (the length of thorax and elytra together much less than three times the greatest width), . . . . . 15.
14. Shoulders not at all produced or angular. Species less than 2 m.m. in length, *linearis*.  
 Shoulders angular, prominent. Species more than 2 m.m. in length, . . . . . *longulus*.
15. Humeral angles prominent, . . . . . 16.  
 Humeral angles not prominent, . . . . . 22.
16. Second joint of antennæ not less than half as long as first, . . . . . 17.  
 Second joint of antennæ much less than half as long as first, . . . . . *collaris*.
17. Antennæ very little, if at all, longer than head (including rostrum) and thorax, . . . . . 18.  
 Antennæ considerably longer than head (including rostrum) and thorax, . . . . . *longicornis*.
18. Length of elytra along suture about one quarter longer than of head (including rostrum) and thorax, . . . . . 19.  
 Length of elytra along suture scarcely longer (especially in the female) than of head (including rostrum) and thorax, . . . . . *humeralis*.
19. Elytra across the base as, or nearly as, wide as in widest part. Tarsi unicolorous, . . . . . 20.  
 Elytra across the base much narrower than in the widest part. Lobes of the tarsi paler than claw joint, . . . . . 21.
20. A conspicuous patch of pale squamosity at the shoulder, . . . . . *angularis*.  
 Elytra without conspicuous markings, formed by patches of squamosity, . . . . . *ineptus*.

21. Thoracic impressions well defined, . . . . . gracilis.  
 Thoracic impressions almost obliterated, . . . . . scutatus.
22. First joint of the antennæ only moderately thicker than second, and much shorter than joints two and three together, . . . . . 23.  
 First joint of the antennæ quite double the thickness of the second, and scarcely shorter than joints two and three together, . . . . . robustus.\*
23. Humeral angles rectangular, or nearly so, and quite distinct, though not prominent, . . . . . 24.  
 Humeral angles so rounded off as to be quite effaced, . . . . . oscillans.
24. Intermediate joints of the antennæ comparatively slender, so that the club appears well defined, . . . . . 25.  
 Intermediate joints of the antennæ rather thick, so that the club does not appear very distinct, . . . . . 27.
25. Antennæ unicolorous, . . . . . 26.  
 Antennæ black, with the base red, . . . . . simplex.
26. Lobes of tarsi conspicuously pale in colour, . . . . . tarsalis.  
 Tarsi unicolorous, or nearly so, and not differing much in colour from the tibiæ, . . . . . pusillus.
27. Punctuation of elytra of the description usual in the genus; tarsal lobes small, . . . . . 28.  
 Punctuation of elytra much coarser than in most species of the genus; tarsal lobes of usual size, . . . . . punctipennis.
28. Second joint of antennæ longer than wide, . . . . . similis.  
 Second joint of antennæ very short and beadlike, . . . . . debilis.

T. B.

## Fam. CURCULIONIDÆ.

## RHYNCOGONUS (nov. gen.).

The insect for which I propose this generic name has the appearance of a large flat *Otiorhynchus*, with very elongate antennæ, and differs from that genus by the shorter rostrum, by the very elongate scape of the antennæ, by the less widely separated hind coxæ, and by the truncature of the hind tibiæ being broader and shorter, and not interrupted nor prolonged above. It would thus appear to be by no means really allied to any other described form, unless it be to *Psomeles*, which was unknown to Lacordaire, as it is to myself, and only imperfectly characterized. *Elytrogonus* and *Elytrurus* have not the otiorhynchoid form of the rostrum; and *Celeuthetes*, which resembles *Rhyncogonus* in this respect, has very large scrobes. The rostrum in *Rhyncogonus* is only as long as it is broad; the eyes are convex

\* Only the female of this species is known. It is possible that the first joint of the male antennæ may be less robust.

and outstanding, and the apex of the rostrum is considerably broader than the part above it; the scrobes are very short, confined in fact to the length of the outstanding pterygia: the mentum is broad and quite flat, and is separated from the sides of the head by a broad cleft, so that in one of the two individuals before me (the male) the maxillæ are concealed. I have associated with this remarkable species a second of very different appearance, resembling rather a *Peritelus* than an *Otiorhynchus*, and having much shorter antennæ and comparatively more widely separated hind coxæ, but which otherwise is not, so far as I can detect, distinguished by any important structural character, so that I have not thought it proper at present to treat it as a distinct genus.

D. S.

*Rhyncogonus blackburni*, n. sp.—*Nigrinus*, parum nitidus, subplanatus, supra fere sine pubescentia; capite strigoso, prothorace conico-cylindrico, dense punctato, elytris seriatim punctatis, apice acuminato. Long. ♂ inc. rostr.  $12\frac{1}{2}$ , ♀ 17 m.m. (Plate v., f. 28).

Antennæ slender and elongate; scape reaching as far back as half the length of the thorax; funiculus not so long as the scape; club very slender and elongate, very little thicker than the funiculus, conspicuously three-jointed. Eyes nearly as remote from the prothorax as from the insertion of the antennæ. Thorax about as long as broad, much narrower than the elytra, distinctly narrowed in front, densely and rather coarsely punctate. Elytra rather flat, broad, with sharply and abruptly inflexed pseud-epipleuræ, and internal to these, with about a dozen rather irregular series of punctures.

The sexual characters, if I interpret them correctly from the two individuals before me, are very remarkable: the male not half the bulk of the female, and the ridge near the side of the elytra, marking off the pseud-epipleuræ, is less definite, and is in fact quite wanting at the shoulders, while in the female it is definite and well-elevated from base to apex; the apical segments of the hind-body are scarcely so long, and the basal segments are a little impressed, and the maxillary palpi (and even the extremities of the labial) are exposed. In both sexes the apical ventral segments are densely pubescent, more especially the apical one.

Mr. Blackburn informs me that this species is found very rarely, by beating trees on the mountains near Honolulu.

D. S.

*Rhyncogonus vestitus*, n. sp.—*Fusco-niger*, griseo-squamosus, latusculus, parum convexus, prothorace elytris multo angustiore, his lateribus rotundatis, pseud-epipleuris latis, tantum ad humeros carinatis. Long. inc. rostr. 8–9 m.m.

Antennæ moderately long and stout; scape not extending so far back as half the length of thorax. Eyes very prominent. Thorax not quite so long as broad, rather rounded at the sides, and distinctly narrower in front than at the base; it as

well as the rostrum and elytra is covered with very fine depressed scales, concealing the sculpture. Elytra broad and rather flat, much curved at the sides, the apex a little acuminate, bearing numerous longitudinal series of fine punctures, the sides a good deal inflexed, but this broad lateral portion not marked off by any carination except for a short distance at the shoulder. On the under-surface the squamose covering does not cover the middle of the body, where there is only a fine pubescence; the apical ventral plates densely pubescent.

Maui. No. 110. Two specimens, differing very little from one another, except that one has a dark mark at the side of each wing case, owing to the absence of the scales at this point.\*

D. S.

#### ACALLES.

*Acalles lateralis*, n. sp.—*Latus, niger, supra piceus, tenuiter squamosus, elytris plaga magna laterali albida.* Long. exc. rostr. 4 m.m.

Thorax broad and somewhat flattened, so as to form an abrupt edge at the side, constricted in front and slightly narrowed behind, depressed in the middle in front of the scutellum, and with some black squamosity on the front margin in the middle arranged so as to give the appearance of two angular prominences. Elytra with very large punctures, and with the second and fourth interstices more raised, but in a broken manner, and bearing on the elevated portions a few erect scales; the general colour is dark, but there descends from each shoulder a broad and definite white patch which curves inwards and backwards, so as to nearly reach the suture about the middle.

Oahu. No. 37.

D. S.

*Acalles duplex*, n. sp.—*Valde convexus niger, pallide squamosus, rostro piceo, antennis rufis, clava crassa; prothorace in medio minus argute sulcato; elytris grosse punctatis.* Long. exc. rostr.  $3\frac{1}{4}$ –4 m.m.

♂, Rostrum broad, closely punctate. Thorax abruptly constricted in front, behind the constriction slightly narrowed towards the base, scarcely so long as broad; elytra rather broad at the base, with the humeral angles swollen, with very coarse punctures or pits, and with the second interstice more elevated than the others and rising behind the middle to an acute elevation. The female is a smaller and narrower insect, with the thorax much less broad, and the shoulders of the elytra undeveloped, and the elevation of the second interstice very slight.

This species is found by beating the Koa tree on the mountains near Honolulu; and Mr. Blackburn is sure the two forms are the sexes of one species. The species is, no doubt, quite distinct from *A. angusticollis*, by its form, sculpture, and clothing; the evident humeral angles of the elytra are of themselves sufficient to characterize *A. duplex*.

D. S.

---

\* This species is extant in the National Collection, where it is indicated as a new genus and species by Jekel.



*Acalles angusticollis*, n. sp.—*Angustus*, valde convexus, niger, grisco-squamosus, rostro piceo, antennis rufis; prothorace latitudine longiore, cum elytris minus argute longitudinaliter carinato, his basi angusto, lateribus rotundatis. Long. exc. rost.  $3\frac{1}{4}$  m.m.

Rostrum rather broad, closely punctate in front of the antennæ, behind them squamose; club of antennæ rather elongate, oval. Thorax much narrower than the elytra, a little constricted in front, and rather narrower in front than at the base, the sides a little rounded; it is closely covered with pallid depressed scales, and is indistinctly longitudinally costate, and the costæ bear a few erect setæ or scales, some of which are black in colour. Elytra covered with a pale squamosity like the thorax, and bearing each three or four rather indistinct costæ, none of which reach the apex, and of which only the second commences at the base; across the middle is a narrow indistinct black fascia, and the upright scales seen on the costæ are in front of this all pallid white, behind it some few of them are black.

The specimen described, No. 410, was beaten from Koa trees on Haleakala, island of Maui; two individuals, much rubbed and considerably smaller, found by beating in the mountain forests of Honolulu, seem to me to belong to the same species.

D. S.

*Acalles mauiensis*, n. sp.—*Minus brevis*; piceo-niger, setis nigris et cinereis intermixtis vestitus; elytris pone medium circum suturam bimaculatis; rostro tiliarum apice et tarsis rufescentibus; antennis testaceis; harum funiculi articulo secundo quam primo multo minore; prothorace vix transverso, antice constricto, postice parum angustato, 3-sulcato, interstitiis inter sulcas fortiter inæqualiter elevatis, lateribus parum rotundatis; elytris minus brevibus, a latere fortiter rotundatis, obscure striatis, striis obscure crasse punctatis, interstitiis 2° et 4° fortiter nec æqualiter elevatis.

This species bears a good deal of resemblance to *A. lateralis*, Sh., though very much smaller. It is sufficiently characterized, I think, by the comparative size of the first two joints of the funiculus, the two large whitish spots, one behind the other along the suture on the hinder half of the elytra, and the irregularity of the elevated ridges on the thorax and elytra (each of those on the former consisting in reality of three short ridges placed in a longitudinal line, and the second interstice of the elytra rising gradually to a strong elevation just before the middle, and then abruptly ceasing altogether).

A single specimen was beaten from *Aleurites triloba*, at an elevation of about 4000 feet, on Haleakala, Maui.

T. B.

*Acalles ignotus*, n. sp.—Brevis; nigro-cinereus, pedibus nigris, antennis, tarsis et tibiis apice rufescentibus; setis nigris et cinereis intermixtis vestitus; prothorace fortiter transverso, antice constricto, postice parum angustato, 5-sulcato, sulco medio carinam intrinsecus ferenti, lateribus postice fere rectis; elytris brevibus a latere fortiter rotundatis, obscure striatis, striis vix distincte punctatis, interstitiis 2°, 4°, et 6° fortiter regulariterque elevatis. Long. (rostr. inc.) 3½ m.m.

This insect is allied to *A. duplex*, Sh., but differs from it in being smaller, with the elytra very much more strongly and evenly rounded on the sides, and in the much less distinct striation and punctuation of the elytra, of which the elevated interstices, moreover, are not more elevated in one part than another (though they become less distinct at the apex).

A single specimen was taken on Oahu, but the particulars of the capture have not been preserved.

T. B.

*Acalles decoratus*, n. sp.—Sat elongatus; nigricans, setis nigris et cinereis intermixtis vestitus, prothoracis sulco-mediali squamis albidis dense vestito; elytrorum sutura, fascia lata ante medium, macula pone medium, et apice, cinereo-albidis; rostro, antennis, tarsis et tibiis apice rufis, femoribus cinereo-maculatis; antennis sat brevibus funiculi articulo secundo quam primo multo minore; prothorace vix transverso antice sat fortiter postice leviter contracto, a latere sat rotundato, obscurelongita dinaliter sulcato sulci lateribus leviter elevatis; elytris fortiter striatis, interstitiis rotundatim convexis. Long. 3 m.m.

Its diminutive size will distinguish this insect from most of its Hawaiian allies; moreover, from *A. ignotus* its much larger thorax, and from *A. mauianse* the regularity of its sculpture, will at once separate it.

A single specimen was obtained by beating branches of trees, at an elevation of about 2000 feet, on Lanai.

T. B.

The following observations are suggested by certain specimens of *Acalles* in my collection:—

1. *A. angusticollis*, Sh.—I hesitate a good deal to regard as incapable of distinction specifically the two forms which Dr. Sharp includes under this name; but, if they be identical, I think there will have to be included under the same name a specimen from Kauai, somewhat intermediate in size and having the ridge on the elytra less elevated; and also a specimen from Maui which (although it certainly appears to me narrower and more elongate, and has its entire upper surface densely and confusedly clothed with mingled ashy and black scales, and long setæ) I cannot distinguish from the Oahu specimens attributed to *A. angusticollis*—at any rate without removal of scales—by sufficiently strong characters to assure me that it is not merely a very fresh and brightly-coloured example of that insect.

2. *A. mauiensis*, Bl.—A single specimen, taken on Lanai at an elevation of about 2000 feet, is possibly referable to this species, though more probably only requiring the collection of more specimens to be proved distinct. The specimen is evidently much abraded, and therefore the proportions of the parts are difficult to compare with the same in a specimen pretty well clothed with setæ, but the thorax appears to be narrower, and the sculpture of the whole insect (though similar in plan to that of *A. mauiensis*) is much feebler; moreover, instead of the hinder part of the elytra bearing white spots, nearly the entire apical third is white.

T. B.

#### CHÆNOSTERNUM (nov. gen. Cryptorhynchidarum).

This new generic name I propose for an insignificant-looking insect, which bears a general resemblance to an *Omius*, but has the rostrum and sternum exaggeratedly cryptorhynchiform. The following are its characters:—

Rostrum and antennæ very much as in *Acalles*, the second joint of the funiculus in the latter being rather small; eyes coarsely faceted, rather depressed, and not visible from above. Thorax much like that of *Acalles*, but with the surface nearly free from inequalities; it is somewhat abruptly constricted a little in front of the middle, and has a short longitudinal fovea in the middle of the base, not extending so far as half way towards the front of the thorax; the anterior margin is strongly produced over the head. There is no scutellum visible. The elytra are exactly of the width of the thorax at their base, becoming very much wider in the anterior third of their length, then gradually but strongly acuminate to the apex; the sides very strongly rounded, the surface free from inequalities but deeply striated, the striæ coarsely punctured, the interstices regularly, strongly and roundly convex. The channel for the reception of the rostrum is very deep. The mesosternum is not at all emarginate, but abruptly truncate between the middle of the intermediate coxæ, and forms the posterior end of the rostral channel, but does not extend at all along its sides, the hind portion of its sides being limited by the extreme anterior part of the intermediate coxæ, in the same way that its sides on the prosternum are partly limited by the anterior coxæ, and there being between the anterior and intermediate coxæ a gap in the sides of the channel. The intercoxal process of the hind body is wide and quadrate, with its anterior margin squarely truncate. The metasternum is very narrow. The second segment of the hind body is nearly as wide as the third and fourth taken together, and is separated from the first by an arched suture. My specimen is perfectly glabrous, but may possibly be abraded. The tarsi are very decidedly more slender than in *Acalles*. The genus is near *Acalles*, *Tragopus*, and *Anaballus*. The form of the rostral channel strongly separates it from the latter two—the form of the intercoxal process of the hind body from *Acalles*, the coarsely faceted eyes and unarmed femora from *Tragopus*.

T. B.

*Chænosternum konanum*, n. sp.—Sat elongatum; brunneo-nigrum; pedibus nigris, antennis tarsis et rostri apice rufis; rostro parum robusto; prothorace vix transverso, fortiter crebrius punctato, antice fortiter contracto et super caput fortiter producto, a latere sat rotundato, postice parum contracto, ad basin in medio longitudinaliter sulcato; elytris sub-oblongis, a latere fortiter rotundatis, apice sat productis, fortiter striatis, striis crasse punctatis, interstitiis fortiter rotundatim elevatis. Long. (rostr. incl.)  $2\frac{3}{4}$  m.m.

A single specimen occurred in the Kona district of Oahu, but exact particulars of the capture are not forthcoming.

T. B.

#### HYPEROMORPHA (nov. gen. Cryptorhynchidarum).

The following are the characters of a small insect, for which it seems necessary to provide a new generic name, and which is evidently somewhat allied to *Acalles*, while in some respects resembling *Sympiezoscelus*—though a careful comparison with the latter has led me to the opinion that its relation to it is not close.

Rostrum rather short and wide as compared with *Acalles*, rather abruptly bent down close to the base, gradually narrowed from the base for about a third of its length, then suddenly widened, and continuing about the same width almost to the apex, where again it is a little widened; the whole of its upper surface clothed with short scaly setæ; its scrobes commencing about the middle, and running obliquely backwards to its base; antennæ inserted about the middle of the rostrum, short, and not at all robust; scape gently increasing in thickness, and not reaching the eyes when set back; funiculus seven-jointed, joints one and two about the same length, and longer than the rest, the other joints short (especially 5–7); club longer than wide, nearly as long as scape, not distinctly articulated; eyes coarsely faceted, depressed, acuminate at the lower end, not approximated above; prothorax considerably narrower than, and scarcely a third of the length of, the elytra—transverse, scarcely contracted at the base, but much contracted from the middle to the front, with gently rounded sides, its anterior border moderately produced over the head, its base truncated, the ocular lobes feeble; scutellum not visible; elytra about twice as long as together wide, very closely embracing the body, only moderately convex, and not abruptly sloped off behind, their sides nearly parallel (but slightly narrowed backwards) in the basal  $\frac{3}{4}$ , in the apical fourth more strongly contracted, but quite obtuse at the apex; the whole upper surface clothed evenly but not very densely with depressed scales, and quite devoid of inequalities; legs rather long and feeble, especially the femora, the lower side of which is rather deeply emarginate a little before the apex, the emargination being preceded by a small tooth; the tibiæ compressed, not very much enlarged towards the apex, where there is a small spine as in *Acalles*; the

tarsi not much different from those of *Acalles*; the legs clothed with short, scaly setæ; the second segment of the hind body is a little shorter than the third and fourth together, and the suture separating it from the first is straight; the process between the hind coxæ is broad and somewhat angular in front; the rostral canal is very broad and deep, but only impinges slightly on the mesosternum, the front margin of which is only gently emarginate; and there being quite a considerable portion of the mesosternum intact between the end of the rostral canal and the front of the metasternum, which latter is proportionally about as long as in *Cryptorhynchus*; the under-surface is excessively strongly and coarsely punctured, and is evidently clothed with scales (though in my specimen it is a good deal abraded); I observe that the mesothoracic epimera seem a little more directed upwards than in most of the allied genera; there is a considerable superficial resemblance in this insect to some species of *Hypera*.

T. B.

*Hyperomorpha squamosa*, n. sp.—*Sat elongata nigricans*, squamis cinereis vestita, elytris rufopiceis, antennis tarsisque testaceis; rostro robusto, basin prope contracto; prothorace transverso obscure crasse punctato, antice fortiter angustato; elytris subparallelis, obscure striatis, striis crasse punctatis, sculptura sub squamas abdita; subtus crasse profunde punctata. Long. (rostr. incl.) 4 m.m.

A single specimen was taken from very wet moss, on the edge of a mountain stream, near Honolulu.

T. B.

## CALANDRA.

*Calandra remota*, n. sp.—*Nigra*, nitida, fortiter punctata, rostro elongato, ad antennarum insertionem crassiore; prothorace elongato, anterius constricto. Long. (inc. rostr.) 5–6 m.m.

Rostrum nearly as long as the thorax, sparingly punctured and shining; eyes very near to prothorax; beak constricted in front of them; antennæ inserted at one-third or fourth of the length of the rostrum from the eyes; basal joint as long as the funiculus; club well marked; thorax very large, covered with distant, extremely large punctures; elytra deeply sulcate, and the grooves bearing large punctures, interstices narrower than the grooves, and remotely punctate, nearly covering the body, so that the pygidium is small.

This remarkable species has been found near Honolulu, and may be a native of some other country; but I have failed to identify it, and it does not exist in the British Museum collection. It occurs commonly in the stems of banana and the prickly pear, near Honolulu.

D. S.

## OODEMAS.

*Oodemias tardum*, n. sp.—Oblongo-ovatum; nitidum; nigro-æneum ad viridem accedens, antennis tibiis tarsisque plus minusve rufescentibus; oculis prominulis; rostro haud æqualiter arcuato, fortiter punctato rugatoque; antennis rostro capite prothoraceque conjunctis paulo brevioribus, scapo elongato, funiculi articulo primo brevi secundo elongato; prothorace transverso, antice angustato, distincte crebrius punctato; elytris thorace sat latioribus, antice vix, postice obsolete, striatis, parce fortiter seriatim punctatis, interstitiis confuse subtilius punctatis; subtus abdominis parte anteriori minus fortiter punctata. Long. 5–5½ m.m.

This insect resembles *O. infernum*, mihi, but is readily distinguished by the peculiar shape of the rostrum (which, instead of being slightly and quite regularly arched from base to apex, appears to be almost angularly bent downwards from the middle) by the much darker colour, and by the greater distance apart (in the rows) of the larger punctures on the elytra.

A few specimens were taken from the bark of a tree, at an elevation of about 4000 feet, on Haleakala, Maui.

T. B.

*Oodemias æquale*, n. sp.—Oblongum; nitidum; æneum, antennis pedibusque plus minusve rufescentibus vel testaceis; rostro brevi, distincte subtilius punctato; oculis vix convexis; antennis rostro capite prothoraceque conjunctis sat evidenter brevioribus, scapo brevi, funiculi articulis primo et secundo subæqualibus sat elongatis; prothorace leviter transverso, antice angustato, obscure subtilissime punctato; elytris prothorace latioribus, vix evidenter striatis, parce nec fortiter seriatim punctatis, interstitiis parce subtiliter punctatis; subtus abdominis parte anteriora parce subtiliter punctata. Long. 4–4½ m.m.

This species is remarkable for the exactness with which the base of the thorax is applied to the elytra, so that the curve formed by the side of the thorax and elytra (viewed from above) is almost perfectly continuous. This character readily distinguishes it from *O. obscurus*, mihi which in some respects it resembles. The apex of the last segment in the male is abruptly truncate, in the female is rounded.

A short series was obtained by beating branches of trees, at an elevation of about 2000 feet, on Lanai.

T. B.

*Oodemias crassicorne*, n. sp.—Oblongum; elongatum; nitidum; æneum, antennis pedibusque rufescentibus; oculis subprominulis; rostro brevi, obscure minus subtiliter punctato; antennis crassiusculis, rostro capite prothoraceque conjunctis sat evidenter brevioribus, scapo brevi, funiculi articulo primo brevi, secundo elongato; prothorace transverso antice angustato, obscure subtiliter punctato;

elytris prothorace evidentem latioribus, haud striatis, obscure subtilius seriatim punctatis, interstitiis parce subtiliter punctatis; subtus abdominis parte anteriore subtiliter punctata. Long.  $3\frac{1}{2}$ — $3\frac{3}{4}$  m.m.

This species is somewhat closely allied to the preceding, which it resembles in regularity of outline; but I am obliged to treat it as distinct, on account of the thickness of its antennæ and the relative length of the first two joints of the funiculus, together with the delicacy of the punctures which form rows on the elytra.

A few specimens occurred on Lanai, but the exact particulars of the capture escaped record.

T. B.

The inspection of recent captures in *Oodemas* has brought me to the conclusion that I was misled into regarding *O. substrictum*, mihi (E. M. M., vol. xvii., p. 200) as a distinct species by the occurrence of a certain amount of apparent variation in the relative length of the first and second joints in the funiculus of the antennæ of *O. obscurum*, mihi. I have now satisfied myself that this distinction cannot be maintained, the first joint in all my specimens of *O. substrictum* (so-called) being at any rate decidedly shorter than the second. The other differences mentioned in my description signify no more, I think, than that the insect varies somewhat in size and intensity of sculpture. The insect should stand therefore as follows:—

*O. obscurum*, Bln.

var. *O. substrictum*, Bln.

In my earlier descriptions of *Oodemas* I appear to have passed over, without sufficient notice, some characters that have since acquired a more evident importance through the discovery of additional allied species; and as, moreover, the descriptions appeared in various publications and at various times, I think it will be well here to pass briefly in review the distinguishing characters of the species described up to the present time:—

- |   |                      |
|---|----------------------|
| 1. First joint of funiculus of antennæ much shorter than the second, . . . . .  | 2.*                  |
| First joint of funiculus of antennæ not differing much from the second in length, . . . . .   | 9.†                  |
| First joint of funiculus of antennæ much longer than the second (a rather large species, oval in form, not very shining, its elytra absolutely without striation, but bearing rows of large punctures), . . . . . | <i>O. mauiense</i> . |

\* In *O. obscurum* the comparative elongation of the second joint is less marked than in the other species of this group.

† In *O. olindæ* the second joint is a little longer than the first, but the unusual elongation of the first joint seems to bar the species from being placed among those in which the first joint is very short.

2. Rostrum regularly arched, or almost straight, and not noticeably dilated at the apex, . . . . . 3.  
 Rostrum irregularly or angularly arched, . . . . . 8.\*  
 Rostrum strongly dilated at apex (a large species with long antennæ and legs, ovate in form, the elytra almost vertical behind, bearing rows of punctures, and obscurely striate near the apex), . . . . . *O. nivicola.*
3. Rostrum distinctly punctured, . . . . . 4.  
 Rostrum not distinctly punctured (a small, narrow, elongate insect, with the elytra scarcely striate, and the punctuation very confused), . . . . . *O. angustum.*
4. Elytra not distinctly striated (at least not in the anterior portion), . . . . . 5.  
 Elytra distinctly striated throughout (a species of medium size and oblong-ovate form, very shining, with stout legs and antennæ), . . . . . *O. robustum.*
5. Species of narrow, elongate form, with the elytra regularly curved on the sides, and not becoming, close to their base, abruptly wider than the thorax, . . . . . 6.  
 Form wide ovate, elytra bi-sinuate (*i. e.* with the sides much more strongly rounded in front than behind, and consequently abruptly dilated immediately behind the thorax). [A species of medium or small size, oval in form, very shining, elytra obscurely striated, the striæ strongly punctured], . . . . . *O. obscurum.*
6. Shining species, with eyes somewhat convex, . . . . . 7.  
 Surface much less shining than usual in the genus, with the eyes very depressed (a large, oblong-oval species, elytra very obscurely striated, with rows of strong punctures), . . . . . *O. borrei.*
7. The larger punctures on the elytra rather closely ranged in very distinct rows (a rather small, brilliantly-shining species; narrow, elongate; elytra hardly striated, interstices very distinctly punctured), . . . . . *O. halticoides.*  
 Rows of punctures on the elytra very obscure (a small, oblong species, with stout legs and antennæ), . . . . . *O. crassicorne.*
8. Elytra not shining, with no distinct punctuation, except rows of very large punctures (a large species of ovate, almost subquadrate, form), . . . . . *O. sculpturatum.*  
 Elytra very shining, with rows of moderately large punctures, and interstices more finely punctured (a rather large species of oblong-ovate form), . . . . . *O. tardum.*
9. Elytra gently sloped off behind; rostrum not abruptly bent near the middle, 10.  
 Elytra almost vertical behind; rostrum abruptly bent a little in front of the middle (a large, brilliantly-shining species of elongate-oval form, acuminate behind, with long rostrum, long, slender antennæ, very stout legs, and elytra margined along the base), . . . . . *O. olindæ.†*

\* In *O. sculpturatum* this character is less strongly developed than in *O. tardum*.

† This species might not unreasonably, I think, be regarded as the type of a new genus. In some respects it seems to approach *Heteramplus*.



10. Ovate species, . . . . . 11.  
 A narrow, elongate, rather small species; very shining, with indistinctly striated elytra, . . . . . *O. æquale.*
11. Antennæ rather elongate; elytra not distinctly striated (a rather large, shining species), . . . . . *O. infernum.*  
 Antennæ short; elytra in front strongly striated, with the striæ extremely strongly punctured, behind quite smooth (a species of medium size, and very shining, of brassy-green colour), . . . . . *O. ænescens.*  
 Antennæ short; elytra strongly punctate-striate, the punctate striæ not much fainter near the apex than in front (a species of medium size, shining, and of a black or reddish-black colour), . . . . . *O. insulare.*

T. B.

## HETERAMPHUS (nov. gen.).

This is a remarkable form of Cossonidæ, apparently without any ally, having all the coxæ widely separated, the metasternum very short, and the scutellum entirely concealed. In Mr. Wollaston's arrangement of the Cossonidæ, it would be placed near Styphloderes and Cotaster, from which, however, it greatly departs by the great distance between the front coxæ, as well as by the facies, which is nearer that of some of the Eriirhinida than to any Cossonidæ known to me. The rostrum is elongate, but not so long as the prothorax, curvate, subcylindrical, and quite as narrow immediately in front of the eyes as it is at the apex; the antennæ are rather long and slender, with elongate scape, seven-jointed funiculus, and rather elongate club, the apical half of which is evidently annulate; they are inserted at a distance from the apex, but conspicuously in front of the middle; and the scape is lodged in a deep, straight scrobe, which extends vaguely to the lower portion of the eye; this organ is rather elongate. The prothorax is large; the front coxæ are quite embedded, not at all prominent, widely separated; the prosternum is in no way impressed, is not at all emarginate in front, is quite flat between the coxæ, and has no rudiment of a prosternal process. The middle coxæ are widely separated; and the large mesosternum is quite flat, and throughout on the same plane as the metasternum; this latter is extremely short. The front tibiæ are armed with a well-developed hook; the middle and hind tibiæ with a rather smaller one; the tarsi are four-jointed, not largely developed, furnished with hairs beneath, the fourth joint broader, its hind edge emarginate, but not bi-lobed.

The species show so much difference, that they would, at first sight, scarcely be deemed all of one genus. In *H. cylindricus* the hind coxæ are not so extremely separated as they are in the other species; and *H. hirtellus* has the rostrum broader at the tip; but at present I do not think it desirable that they should be separated generically, as there are probably other species existing in the islands which might connect them more intricately.

Although, in Mr. Wollaston's arrangement, these insects would, on account of their concealed scutellum and very short metasternum, be placed far from the genus *Mesites*, yet in their general structure they appear more similar to that genus than to any other known to me.

D. S.

*Heteramphus wollastoni*, n. sp.—*Latus*, *subplanatus*, *niger*, *subopacus*, *antennis tarsisque piceis*; *thorace majore*, *anterius angustato et subconstricto*, *crebre punctato*, *basi marginato*, *dorso ante basin impresso*; *elytris seriatim punctatis*, *ad apicem attenuatis*, *in parte apicali plagis vagis setulosis*. Long. (inc. rostr.) 8–10; lat. 3 m.m.

The surface of the thorax is a little irregular, and its punctuation is moderately close and coarse; the sides are very slightly narrowed at the base; the basal margin thick; elytra very truncate at the base, angulate at a distance from the sides, so that there is a broad pseud-epipleura, furnished with seven series of punctures, and two others at the sides, that is on the pseud-epipleura; the rather distant punctures are placed on very obsolete striæ; the broad interstices are almost impunctate, and the third and fifth are much broader than the others; on the apical portion, there are some flavescent setæ, placed in an irregular or patchy manner.

The male has the rostrum broader and less cylindrical than it is in the female; and its anterior portion (commencing just behind the insertion of the antennæ) is just perceptibly dilated; it is also more closely punctate, and less shining than in the female.

This insect is found not very rarely in the stems of a plant called the "silver sword," in the mountains near Honolulu, at an elevation of 3000 feet, or more.

D. S.

*Heteramphus foveatus*, n. sp.—*Latus*, *niger*, *subopacus*, *antennis tarsisque piceis*; *thorace majore*, *anterius angustato*, *lateribus rotundatis*, *crebrius fortiter punctato*, *basi obsolete marginato*, *dorso ante basin rotundato-foveolato*; *elytris striatis*, *interstitiis ad latera et ad apicem parce setulosis*. Long. (inc. rostr.) 7; lat.  $2\frac{1}{2}$  m.m.

Similar to *H. wollastoni*, but abundantly distinct; rather smaller, with the thorax evidently rounded at the sides, and coarsely punctate, and only very indistinctly margined at the base. The elytra are somewhat deeply striate; and the striæ are marked, especially on the basal portion, with coarse but indefinite punctures; all the interstices are of nearly one width, and near the sides and apex are setulose.

The two individuals described are probably males: they have the rostrum broad and much punctate, and becoming just perceptibly broader from the base towards the apex, but without any dilatation near the insertion of the antennæ.

This species occurs in company with *H. wollastoni*.

D. S.

*Heteramphus hirtellus*, n. sp.—*Latusculus*, *piceus*, in thorace et in elytris crebre setosulus; thorace majore; anterieus angustato, crebrius fortiter punctato, dorso ante basin foveolato; elytris striatis, striis fortiter punctatis. Long. (inc. rost.) 5 m.m.

This is a very distinct species, similar in form to *H. wollastoni* and *H. foveolatus*; it is readily distinguished by the setulose surface and more pallid colour, and the smaller tarsi. The thorax is rounded at the sides, not margined at the base. The elytra are striate; and the striæ bear coarse punctures; the fourth and fifth striæ are much abbreviate behind, and are deeper than the others.

The unique individual is in bad condition, and has been covered with some dirt or exudation, the removal of which has been difficult and only partially effected. It is no doubt a male; the rostrum is densely and rugosely punctured, and quite evidently dilated at the insertion of the antennæ.

Very rare; found by sifting dead leaves, high up on the mountains. No. 377.

D. S.

*Heteramphus cylindricus*, n. sp.—*Angustulus*, *subopacus*, *niger*, *antennis*, *tarsisque piceis*; thorace elongato, minus crebre punctato; elytris leviter striatis, striis obsolete punctatis. Long. (inc. rost.)  $4\frac{1}{2}$ ; lat.  $1\frac{1}{4}$  m.m.

This species has somewhat the appearance and form of a narrow *Baridius* or of a *Mecinus*. The thorax is rather rounded at the sides, not margined at the base, rather sparingly, not finely, punctate; the punctures more obsolete on the disc. Elytra only as broad as the thorax, not shining, rather faintly striate; and the striæ bearing only very distant and indistinct punctures; but the sculpture is rather more accentuated near the apex; the pseud-epipleuræ not so definitely marked off as in the other species.

I have only a single individual of uncertain sex.

Two examples of this species have been found in company with *H. wollastoni* and *H. foveatus*.

D. S.

#### PHLEOPHAGOSOMA.

*Rhyncolus tenuis*, Germ.—The insect described by Boheman in the *Eug. Res.* under the name of *Rhyncolus tenuis* (changed by Gemminger to *tenuis*, on account of the prior *R. gracilis*, Rossi), cannot, adopting the views of Mr. Wollaston as to

genera near *Rhyncolus*, be correctly associated with what he considers to be the true *Rhyncoli*, but the species comes so near to the New Zealand *Phlæophagosoma* that I think it may be placed in that genus: it differs slightly from the New Zealand *P. dilutum* in that the third tarsal joint is not broader than the second, and that the front and middle coxæ are more widely distant.

PSEUDOLUS. (New generic name.)

The second species of *Rhyncolus* described by Boheman (under the name of *R. longulus*) is so distinct as to require a new generic name, for it apparently cannot be associated in any of the numerous genera recently proposed by Mr. Wollaston. It is of very elongate form; the eyes are remote from the margin of the thorax, and are coarsely faceted; the rostrum is largely developed, and its apical portion is evidently broader than the basal; the third joint of the tarsi is broad and deeply lobed, the fourth stout and parallel (that is, not at all more slender near the base), the front coxæ are widely separated, the middle and hind coxæ still more widely, the hind ones scarcely more distant than the middle ones. The male is of more elongate form than the female, and the apical portion of its rostrum is rather more dilated, the base of the ventral segments is rather more hollowed, and the apical segment longer, and with a patch of pubescence along its hind-margin on either side of the middle.

D. S.

DOLICHOTELUS (nov. gen.) *Cossonidarum* (?).

The affinities of the minute insect for which I propose this name are not quite clear to my mind, but I have concluded that it is most naturally placed among the anomalous genera that appear to be connecting links between the *Cossonidæ* and *Scolytidæ*. The following, as far as I can ascertain them without dissection, are its characters.

Head and rostrum not clearly distinguishable *inter se*, the latter being merely a very short and scarcely narrowed prolongation of the former. The head (including the pseudo-rostrum under the term) is not much less than twice as long as broad, and has parallel sides. The antennæ are inserted very little behind the front of the head (at a distance in front of the eyes nearly equal to the diameter of the eyes) in the sides of the pseudo-rostrum. The palpi are distinctly visible, but are very short, and I have not succeeded in making a satisfactory study of them; I can see, however, that they are somewhat cylindric in form, with the apex more acuminate. The antennal furrows are deep and oblique, passing below the eyes and underneath the head. The head does not appear to be at all retractile, neither is it vertical, but continues the plane of the thorax, to which it is closely applied at the base, and of about equal width; its central suture on the

under surface is strongly marked and deep. The eyes are rather large, nearly circular, coarsely faceted, little prominent, placed on the sides of the head in such a position that their hind margins are about intermediate between the back of the head and the front of the pseudo-rostrum, their diameter equalling about a quarter of the length of the head (including the pseudo-rostrum). The antennæ are short, and not particularly thick; the scape is slightly bent, of uniform thickness, and about as long as the diameter of the eye; in the funiculus the first joint is only a little more slender than (and not much less than half as long as) the scape; the next is shorter and more slender, but (under a good microscope) well-defined; then follow several minute joints (I am not sure whether three or four) very closely applied to each other and gradually increasing in stoutness, beyond which is a rather large and flattened club considerably longer than wide; the scape, funiculus and club do not differ very much in length; the funiculus being, however, somewhat shorter than the others. The thorax is a little longer than the head (inclusive of the pseudo-rostrum), and is quite twice as long as wide, and almost cylindric, the front margin being a little narrower than the base, and the sides nearly straight; the margins are not reflexed. The elytra are about half the length of the whole insect, nearly the same width as the thorax, quite parallel, and abruptly rounded off at the apex. The prosternum and metasternum are very elongate, the mesosternum narrow. The front coxæ are nearly circular, rather prominent, and not widely separated, the intermediate not much different, and the hind nearly contiguous. The thighs are oblong, oval, compressed; the tibiæ short, dilated from base to apex. Of the tarsi the apical joint is elongate, and the claws are larger and stout; the preceding joint is wide, bi-lobed, the first and second joints being short and rather broad. The hind body is very similar to that of *Pentarthrum*.

T. B.

*Dolichotelus apicalis*, n. sp.—*Linearis*; pallide testaceus, capite infuscato, elytrorum basi apiceque (hoc late illo angustissime) et abdomine nigricantibus; capite elongato; prothorace fortiter elongato, antice vix angustato, lateribus subparallelis; elytris parallelis obscure nec crebre seriatim punctatis. Long  $1\frac{3}{4}$  m.m. Lat.  $\frac{1}{3}$  m.

A single specimen was taken from a decaying trunk of a *Pandanus*, on the mountains near Honolulu. The species is probably rare, as frequent search failed to furnish a second example.

T. B.

## Fam. SCOLYTIDÆ.

## XYLEBORUS.

*Xyleborus obliquus*, n. sp.—Piceus, nitidus (? antennis pedibusque testaceis); thorace anterior crebre rugoso, posterior lævigato; elytris seriatim punctatis, apice longius oblique declivo fere mutico. Long.  $3\frac{3}{4}$  m.m.

This is very similar to *Xyleborus truncatus*, but the truncate portion of the elytra is still more prolonged, and is smooth and shining, so that two or three of the series of punctures mark its surface in a very conspicuous manner. At the commencement of the truncation, close to the suture, there is a very minute asperity.

Found very rarely near Honolulu; the only individual I have seen is deprived of all its limbs.

D. S.

*Xyleborus truncatus*, n. sp.—Fusco-niger, elytris picescentibus, antennis pedibusque testaceis; thorace anterior crebre rugoso, posterior lævigato; elytris seriatim punctatis, apice truncato fere mutico, tantum tuberculis omnium minutissimus quatuor munitis. Long.  $2\frac{1}{2}$  m.m.

Extremely similar to the European *Bostrichus saxesenii*, just perceptibly broader, and with the elytral apex a little more truncate, and broader. The punctures of the elytra on the basal portion are similar to those of *B. saxesenii*; but the apical truncation is excessively obscurely asperate, and there is a just perceptible tubercle close to the suture, at the commencement of the truncation, and another in a line with it near the apex.

Oahu.

D. S.

*Xyleborus rugatus*, n. sp.—Nitidus; subcylindricus; rufopiceus, antennis pedibusque testaceis; setis longis minus sparsim vestitus; prothorace antice asperato, postice obscure rugato, grosse confuse punctato; elytris subtilius subseriatim punctatis, postice obscure declivibus, parte declivi asperula minuta triseriatim ferenti. Long.  $3\frac{1}{4}$  m.m.

This species is allied to *X. immaturus*, *mihi*, and *X. truncatus*, Sh. It differs from the former in being clothed with longer and more numerous setæ, especially about the thorax, the hinder part of which is sub-opaque, with fine wrinkles, and bears numerous rather coarse but shallow and feeble punctures; also in having the punctuation of the elytra coarser, and the apical asperities of the same very minute. From the latter it differs in having the hinder part of the thorax less smooth, in being much less sparingly clothed with setæ, in having the hinder portion of the elytra

scarcely at all flattened, and the apical asperities (though not so large, yet) more numerous, and running in rows. From *X. frigidus*, mihi, it differs in form (being much wider), and in having the rows of punctures on the elytra (as in *X. truncatus* and *X. immaturus*) placed in evident though not well defined striæ.

A single specimen was taken on Oahu, but the exact particulars of the capture have been lost.

T. B.

*Xyleborus insularis*, n. sp.—Rufescens, elytris piceo-rufis, antennis pedibusque testaceis, thorace anterie crebre rugoso, posterius lævigato; elytris seriatim punctatis, apice oblique declivo tuberculis duobus conspicuis munito, ante eas tuberculis plurimis minoribus. Long. 3 m.m.

Closely allied to *X. truncatus*, but rather larger, and with the apex of the elytra less abruptly truncate, and more conspicuously armed. The retuse portion has its surface a little uneven; and near the suture, just before the middle, there is on each side a rather large tubercle. Just before, and at the commencement of, the truncation there are six or eight smaller tubercles, irregularly placed, and at the sides there are a few quite minute tubercles.

Oahu and Kauai.

D. S.

*Xyleborus immaturus*, n. sp.—Nitidus; subcylindricus; ferrugineus, ore nigricante; setulis sparsim vestitus; prothorace antice asperato, postice subnitido sparsim subtilissime punctato; elytris subtiliter subseriatim punctatis, postice obscure declivibus, parte declivi asperula parva triseriatim ferenti. Long.  $2\frac{3}{4}$ —3 m.m.

I have specimens of this insect from widely separated localities. They all have an immature appearance, but I think this is due only to the paleness of the colour. *X. immaturus* is allied to *X. truncatus*, Sh., but has the elytra much less abruptly sloped behind, with the apical portion hardly at all flattened. It is decidedly more setulose than *X. truncatus*, and the apical asperities are much more strongly developed, and are placed in three longitudinal series on each of the elytra. There are indications of some of the rows of punctures (which are very fine) being in obsolete striæ.

This species has occurred in dead branches of trees on the mountains of Oahu, at an elevation of about 2000 feet; also on Hawaii.

T. B.

*Xyleborus frigidus*, n. sp.—Angustus; cylindricus; piceo-niger, prothorace refuscente, antennis pedibusque testaceis; setulis brevibus sparsim vestitus; prothorace antice asperato, postice subnitido obsolete punctato; elytris subnitidis subtilissime seriatim punctatis, postice obscure declivibus, parte declivi asperula minuta subaqualia triseriatim ferenti. Long.  $2\frac{3}{4}$  m.m.

This insect resembles *X. immaturus*, mihi, in having on the hinder part of each of the elytra about three rows of nearly equal tubercles; but it differs in that the tubercles are conspicuously smaller than in *X. immaturus*, and also in being an extremely narrow, cylindrical, and less shining species, without any trace of striæ on the elytra where the punctures in the rows are excessively fine. My specimen shows only slight indications of being very sparingly furnished with a few short setæ, but may possibly be somewhat abraded.

A single specimen was taken out of a dry twig of *Acacia falcata*, on Haleakala, Maui, at an elevation of about 4000 feet.

T. B.

#### HYPOTHENEMUS.

*Hypothenus griseus*, n. sp.—Brevis; latior; opacus; pallide brunneus; antennis pedibusque flavis; setulis tenuibus nec brevibus vestitus; prothorace in parte anteriori fortiter sparsim rugoso, in parte posteriori subtilissime granulato; elytris creberrime subtiliter punctatis, distincte striatis, interstitiis leviter convexis. Long. 2 m.m.

This species is about the size of the largest *H. maculicollis*, Sh. Though I have carefully examined the antennæ under a compound microscope, I cannot feel sure whether there are three or four joints in the funiculus. The fine and rather long hairlike setæ with which it is (not very sparingly) clothed, and the sculpture of the elytra—which are rendered opaque by their extremely fine punctuation, and are quite deeply striated—separate the insect widely from every ally known to me. Its colour is a light umber brown, inclining to grey, which is somewhat darker on the thorax.

A single specimen was taken from the stem of a poppy on the plains near Honolulu, where (and elsewhere) the plant grows plentifully; frequent examination of the stems failed, however, to produce the insect again.

T. B.

---

#### Fam.† ANTHRIBIDÆ.

##### MAUIA (nov. gen.).

The following are the characters of the insect, apparently allied to *Ozotomerus*, for which I find it necessary to propose the above name:—Head much wider than long; rostrum about equal in length and width to the head (the two together being scarcely longer than wide), with its sides parallel, and apex very obscurely emarginate; rostral scrobes lateral, and consisting of a rounded cavity scarcely



smaller than the eye; antennæ about the length of the head and thorax together, rather slender, the first four joints all elongate, and not differing much among themselves, except that the basal joint is the stoutest, the following three being shorter, but still much longer than wide; the apical four (especially 9–11) somewhat thickened, though still considerably longer than wide, and forming a badly-defined club; eyes rather small (diameter not equalling the length of the basal two joints of the antennæ together), coarsely faceted, rounded behind, truncate in front; prothorax at base same width as base of elytra, slightly widened towards the front in the basal third, then contracted strongly to the anterior margin, which is scarcely half the width of the base, without any transverse carina in front of the base, having the lateral carina extending about half way to the front, the anterior margin strongly convex; scutellum extremely small, transverse; elytra not wider than the prothorax, cylindric, with the humeral angles ill-defined; legs stoutish and not particularly long, anterior coxæ feebly separated, the femora rather strongly fusiform, the posterior femora decidedly shorter than the hind body; first joint of the tarsi nearly twice as long as second, third moderately sunk in the second (the portion visible being distinctly bi-lobed); the tooth on the claws near the middle and not very large; pygidium rather narrow and elongate; metasternum short (scarcely longer than in *Brachytarsus*); mesosternal process vertical, bent backwards at its extremity.

T. B.

*Mauia satelles*, n. sp.—Cylindrata; rufa; pube cinerea confuse vestita; antennis capite prothoraceque conjunctis vix brevioribus; prothorace transverso; postice leviter antice fortiter angustato, margine anteriori rotundatim producto, angulis posticis leviter obtusis; elytris sat elongatis, prothorace haud latioribus, punctato-striatis, interstitiis crebrius punctatis convexis, humeris obscuris. Long. 4 m.m.

A single specimen (the sex of which I am unable to determine) was obtained by beating branches of trees near Wailuku, Maui, not very much above sea-level.

T. B.

---

## Fam. CERAMBYCIDÆ.

### CLYTARLUS.

*Clytarlus blackburni*, n. sp.—Capite, thoraceque nigris, hoc dorso, illo clypeo genisque sanguineis; elytris fulvis, pone scutellum plaga magna nigricante, et post hanc, plaga communi hastata albido-setulosa, circa basin dense punctatis, lateribus lævigatis; pectore coxisque rufo-testaceis, abdomine femoribusque nigris, his basi testaceo, antennis tibiisque rufescentibus, illis basi nigro-hirsuto, tarsis posterioribus magis dilutis, pallide hirtellis. Long. 8–18 m.m.

Thorax dark red on the middle, deep black at the sides, broadly cristate along the middle, less distinctly crested on each side, the spaces between the crests bearing each a longitudinal vitta of scanty white hair; elytra broadly tawny, yellow at the sides; this colour continued to the base along the shoulder, but the shoulder external to this colour is blackish, and the yellow colour also re-appears round the scutellum, behind which the surface is blackish. This colour extends backwards along the suture, reaching the apex, but is more dilute behind. A vitta of white hairs extends from the apex along the suture, and in front becomes broader, till near the scutellum it diverges laterally on either side, so as to be furcate. The middle and hind legs are extremely elongate, their femora intensely black, incrassate, but not clavate, although they have a slender basal portion, which is yellow in colour. The tibiæ and tarsi are hirsute, and the four or five basal joints of the antennæ are much clothed with hair; that on the legs is in greater part pale in colour, but on the antennæ is black. In the male, the antennæ reach about as far back as the extremity of the elytra, but in the female are considerably shorter. In the former sex the hind body is short and curvate, and composed of five segments; but in the female it extends as far as the apex of the elytra, is semimembranous in texture, and possesses six segments. The male apparently varies much in size. Mr. Blackburn has a specimen of this sex 18 m.m. in length. The largest of the two he has sent me is 13 m.m. long.

Found in Mauna Loa, Hawaii, on a species of Acacia, at an elevation of about 6000 feet.

D. S.

*Clytarlus filipes*, n. sp.—Minor, subdepressus, opacus, sordide niger, albido-setosus, in elytris subfasciatus, femoribus parte basali testacea, antennis tibiis tarsisque ex parte majore fuscis, antennarum articulis basalibus ad basin, geniculisque testaceis. Long.  $5\frac{1}{2}$ —7 m.m.

Thorax along the middle with some short transverse ridges, of which the most anterior is strongly elevated. Elytra very densely but not coarsely punctured, so as to be finely rugose; less attenuated behind than in the other species, clothed rather sparingly with pale setosity, which forms two or three broad, vague, transverse bands. Femora of hind and middle legs, with an elongate, very slender basal portion, which is pale yellow in colour; the tibiæ dark, but paler at the base, excessively slender; hind tarsi fuscous, slender, but little hirsute. The male has the antennæ considerably longer than the female, extending nearly to the apex of the elytra, and the apical part of the femora more swollen. The hind body is in each sex rather broad and flat, but is curved downwards at the extremity in the male. In the female it is rather longer. In the former sex it terminates as a large bi-lobed, or deeply-notched process, which appears to be retractile. The species is allied to *C. fragilis*.

Found in Hawaii on the same tree as *C. blackburni*; in fact, in company with it.

D. S.

## APPENDIX.

MR. BLACKBURN'S *RÉSUMÉ* OF HIS JOURNEYS AND COLLECTING IN THE  
ARCHIPELAGO.

The Hawaiian (sometimes called the "Sandwich") Islands form an archipelago lying between  $18^{\circ} 55'$  and  $22^{\circ} 15'$  of north latitude, and between  $154^{\circ} 42'$  and  $160^{\circ} 32'$  of longitude west from Greenwich. They are thus entirely within (but close to the northern limit of) the tropical portion of the earth's surface, and are in the "new world" or "western hemisphere." The continental land nearest to them is California—distant more than 2000 miles in a north-westerly direction—and that nearest to them between the same parallels of latitude is the central portion of Mexico—considerably more distant still. The Hawaiian Islands may, therefore, be considered as among the most isolated portions of land on the earth. The names of the islands, in order of size, and excluding those which are little more than small uninhabitable rocks, are as follows:—Hawaii, Maui, Oahu, Kauai, Molokai, Lanai, Niihau, Kahoolawe.

The climate of the archipelago is remarkably equable; during a residence of nearly six years I never saw the thermometer marking a shade temperature higher than  $90^{\circ}$  F. or lower than  $55^{\circ}$ ; and if the temperatures of the coldest and of the hottest week in the year were omitted the range would probably not be greater than from  $65^{\circ}$  to  $85^{\circ}$ . With the exception of a few days in the winter, of which the early mornings feel somewhat cold, the difference in temperature of the various seasons of the year is scarcely noticeable.

Concerning the rainfall it is difficult to say anything in general terms except that it is highly uncertain, varying with the locality and the character of the year. On most of the islands the eastern side has a very much larger rainfall than the western, owing, no doubt, to its receiving the trade winds from the sea and intercepting the moisture with which they are charged. I observe that in a recently published table of rainfalls at Honolulu (on the drier side of Oahu), the figures for the seven years 1874–81 are given as follows:—52·95, 39·04, 36·56, 32·30, 23·97, 51·92, 47·36 ins. On Oahu, however, the difference between the dry and wet regions is less marked than in other parts of the archipelago, owing doubtless to the less elevation of the mountains, so that the above figures would probably be roughly accurate if applied to all districts (not actually mountainous) of the island.

There is no strongly marked distinction between the dry and wet seasons of the year; certainly the rainfall during the four months, November to February,

is, on the average, about half the rainfall of the whole year,\* but this is caused by the much heavier downpour during that period. In my experience the clearest and most reliable weather of the year is almost always to be expected in the intervals, sometimes of several weeks, among the winter rains; and, on the other hand, it often happens that through month after month of the summer there is scarcely a day free (especially among the mountains) from frequent drenching showers. I remember reading in one of the Honolulu newspapers a statement, either in 1881 or 1882, that there had not been a single day during a continuous period of six weeks or more, in May and June of that year, on which it had not rained at an elevation of one thousand feet on the mountains behind Honolulu; and I remember also at the time I read it feeling well satisfied that the statement was correct. On and around some of the higher mountains of Hawaii the showers are almost constant. In a table of rainfalls at various places during twelve months, 1880–81, that of Hilo (at the foot of Mauna Loa) is given as 118·03 ins., and December and February figure as the driest months there. The dry portions of the island (*i. e.* the districts lying near the western foot of ranges of high mountains) are almost devoid of vegetation and of insect life.

I have dwelt at some length on the temperature and rainfall of the island, because doubtless to the equability of the former and the variability of the latter in combination must be attributed the fact that very few species of Hawaiian insects appear to reach maturity at one season of the year rather than another, the immense majority being found at all periods. The Longicornes, especially *Clytarlus*, furnish almost the only instances among the Coleoptera in which I have observed a decided tendency to favour one particular season; and yet of these—though the immense majority of my specimens were taken between April and August—there are species occurring usually through those months, but which I have met with occasionally, quite freshly developed, in November, December, and January.

All the islands of the Hawaiian group (exclusive of those which are mere rocks in the sea) deserve to be called mountainous, and they all consist of two very distinct regions, *viz.* a low-lying and flat fringe of some few miles in width, adjacent to the coast, and a central system of mountains, forming the largest proportion of the land. The fringe of plains is in general the only part of the island that is inhabited and cultivated. It produces here and there clusters of cocoa-nut palms (though they grow far less plentifully than in the groups of islands lying south of the equator), but is more frequently treeless, or nearly so, having no natural

\* This calculation is made from the few tables of rainfall available to me at the moment, and agrees with my own impression on the subject; but it must not be taken as more than an approximation, or as necessarily applicable to all parts of the islands, especially not as applicable to elevated places among the mountains, where the summer rainfall is often very large, as compared with that of the winter.

vegetation larger than cactus, a dwarf acacia, and a stunted hibiscus, of which the last-named occurs occasionally and singly (though plentiful enough on the mountains), and the former two occur singly or in combination, in patches rarely exceeding a few acres in extent. The main part of the plains between the sea and the mountains consists of an expanse of undulating grass-covered country, with a few flowering plants scattered at intervals among the grass, a species of poppy, a solanum, and a "burr," highly injurious to live stock, being the most conspicuous. These same plains, by means of irrigation from the mountains, are rapidly being brought under cultivation, and are found to yield exceedingly rich crops of sugar, rice, and other tropical products, but are almost devoid of interest to the coleopterist. They produce *Adelocera modesta*, M'L. (in stems of cactus), *Epitragus diremptus*, Karsch.; *Platydema obscurum*, Sh.; *Hopatrum seriatum*, Boisd.; and *Heterophaga pandanicola*, Esch. (the last four under stones), in some numbers; and there are certain additional species (*e. g.* *Cyllene crinicornis*, Chev.) apparently introduced with some of the numerous exotic trees and plants that are rapidly multiplying under the influence of irrigation. On the immediate fringe of the sea, and in salt-marshes, which extend here and there a mile or more inland, some half dozen other species are to be met with; and under various circumstances of a probably accidental character, I have found on the plains some few others still, of which I know some to occur ordinarily in the mountain districts, and I suspect some to be of only very rare occurrence anywhere.

The character and height of the mountain ranges varies greatly in different islands, though they all appear to agree in being of volcanic origin. On the islands forming the northern portion of the archipelago the ranges are from 3000 to 5000 feet in altitude, and are of a somewhat peculiar form, consisting generally of an elongate and very strongly serrated ridge, or backbone, from either side of which, and at right angles to the main-line of the hills, numerous shorter ridges run out towards the plains. Between these latter are extremely deep valleys, usually supplied with a stream descending from the high land towards the sea. Many of the mountain ridges that separate one valley from another are so narrow as almost to resemble a knife-edge. I remember on one occasion making an attempt to reach, by one of these "knife-edges," a particular summit that I wished to explore in the main south-eastern range of Oahu, and going on until the ridge became so narrow that trees growing upon it had to be climbed—up on one side and down on the other—because there was not room to go round them, I was at last stopped when very near the attainment of my purpose by a tree that I was unable to climb. At the northern end of each of the two southern islands—Maui and Hawaii—there is a single mountain range of the character just described, running more or less east and west, and with an altitude some 800 or 900 feet greater than that of the highest mountains in the northern part of the archipelago.

Mountains of an entirely different character are found in the southern islands, and consist of the four giants of the archipelago—Haleakala, in the south-east of Maui, with the largest summit crater in the world; Mauna Kea, near the centre of Hawaii, with an altitude of almost 14,000 feet; Hualalei, on the west coast of the same island, with an altitude somewhat about 8000 feet; and Mauna Loa, in the south of the same island, a constantly and violently active volcano, of an altitude considerably over 13,000 feet. These four differ from the other Hawaiian mountains, inasmuch as their outline is as notably rounded and their surface as gently inclined as that of the others is the reverse. The outline of Mauna Loa, viewed from a distance, is almost a perfect example of the curve called a hyperbola, and all the three highest summits can be reached on horseback. Indeed the only difficulty about ascending them is the great length of the journey from the nearest village or settlement, involving the necessity of passing at least one, two, or even more nights at a great elevation, where the air is cold and rare, and a considerable amount of *impedimenta*, involving almost a small caravan, is required. In this respect the four higher mountains differ widely from the lower ones, most of which are extremely steep. The highest point in the south-east range of Oahu (little more than 3000 feet in altitude) baffled several of my attempts to reach it, and eventually, when I had discovered the track by which it had previously been attained, ropes for scaling some of the precipices proved to be a necessary part of my equipment; and I found similar or greater difficulties in the case of every mountain between 3000 and 5000 feet in height that I attempted on the island.

The vegetation of the mountainous districts of the islands is extremely rich, though more or less confined to certain altitudes. Up to 2000 feet above sea-level the hills are usually very stony in character, and produce little more than a scanty turf, with cactus and occasional acacia bushes, the valleys of similar elevation being often filled with dense thickets of guava. At about 2000 feet commences the forest, in which, so far as my experience extends, nearly all the Hawaiian insects are found. This forest consists of a considerable variety of trees; but in the main its composition is as follows:—ohia lehua (of the natives; *Metrosideros*, botanically, I believe) is the most plentiful component, a grand forest tree, of which there are several species differing in colour of foliage, the most abundant being of a rich sombre green. The “koa” of the natives (*Acacia falcata* of science), with its vivid shade of green, follows close in order of abundance. Next comes what the natives call “kukui” (in English “candle-nut tree”; in science *Aleurites triloba*), with pale, silvery foliage, and, as the preceding, a very fine forest tree. The “hau” of the natives, a species of hibiscus, is something short of being a forest tree; it grows in an absolutely impenetrable, dense, woody jungle, from six to ten feet high, with dark, shining foliage, and large yellow or red flowers. The “hau” jungle, from a little distance, has much the appearance of a mangrove swamp. Other trees, occurring in plenty, but yet not forming a

staple of the forests, are:—The “ohia ai” of the natives (*Eugenia* of botany), which bears a pleasant fruit resembling an apple in appearance; the palm-like pandanus (sometimes attaining a very great size); an acacia, called by the natives *maumaina* (I am not sure of the spelling); a magnificent *dracæna* (which, however, is rather local), &c., &c. Besides the above, there are giant tree-ferns, often twenty feet high, bananas, and innumerable creepers, consisting of convolvuli, yams, and especially the *freycinetia* (called by the natives “ieie”). This superb plant, which creeps over the tallest forest trees, resembles a palm in the arrangement of its great clusters of ribbon-like leaves, and has stalks scarcely less thick than a man’s arm, with fleshy crimson flowers scarcely smaller than a man’s head. On nearly all the species of forest trees there are numerous parasites; and almost every fork in the branches, where a little collection of decayed vegetable matter has formed a soil, is a hanging garden of ferns. Undergrowth in the denser parts of the forest is almost non-existent, failing to hold its own in the struggle upwards for light and air; but wherever the forest is at all open, a considerable variety of low plants may be found, among which the most conspicuous and abundant are ferns, and what I take to be a large species of the nettle tribe. The forest extends from about 2000 feet above sea level to about 6000 feet, whence it begins to thin off, entirely disappearing at about 9000 feet. Above that elevation there are only stunted bushes (species unknown to me), tufts of coarse grass, and a few other small and scattered plants. The densest region of the forest is that between 2000 and 5000 feet above sea level; and it is the partially cleared portions of this part of the forest that I have found most prolific in insect life.

The scenery of the Hawaiian Islands is, as may be supposed, exceedingly fine. Perhaps there is no part of the world where lofty mountains can be seen to greater advantage, for the principal Hawaiian peaks rise so continuously from the sea that their summits are visible from the level of their base. Consequently the æsthetic effect of their altitude is much greater than in the case of many of the chief continental mountains of the world, which seem to be hemmed in by a surrounding multitude of rivals, and of which it is generally almost impossible to get a glimpse until one is half-way between sea level and their summit. Sometimes, when I have been sailing around the apparently endless base of Haleakala, and revelling in the luxury of its loveliness, carrying my gaze slowly upwards and ever upwards through the sunshine, from the white surf beating the foot of the mountain, past the villages scattered along the shore, past the lonely forests that creep aloft from the houses, past the banks of cloud that are almost always floating against the mountain’s breast, past the huge bare rocks piled up beneath the summit, and still upwards to the thin layer of snow silvering the topmost peak, and looking so unearthly cold and calm, I have compared the sight with my memory of loftier mountains still (say, *Mont Blanc*, as seen from *Chamounix*), and

felt inclined to give the palm for beauty to the Hawaiian scenery. In these landscapes, even where the higher mountains are not to be seen, there is a subtle and most fascinating charm, due I think to the peculiar brightness of the colours: the sea, often of a more vivid blue than a painter dare place upon his canvas, streaked with a broad, snow-white line of foam where the coral-reef disturbs it; the golden sand on the beach gilded with sunshine; the plains rolling backward from the shore, with their long, wind-waved grass beneath the feet and their feathery palm-branches far above the head; the many-tinted forest, spread like a glowing carpet to the topmost peak over all the hills; and the sky sometimes almost coppery in its splendour. It is perhaps an unjustifiable digression, in a memoir such as this, to wander into the subject of Hawaiian landscapes; but it may be excused for the possibility of its luring fresh explorers to the islands, who, I am sure, would carry away with them as strong an impression of the beauty of the scenery as of the interest of the fauna that finds a home in its midst.

One of the most remarkable features in Hawaiian entomology is the extreme rarity of *specimens*, in comparison of the number of *species*, the very common insects being few indeed, and the rather common ones almost none at all. As an instance of this I may mention, that all the specimens taken of that interesting brachelytron, *Pachycorynus discedens*, Sh., occurred in a single decaying stump near Honolulu, and that frequent search failed to produce the insect again. I could go on to mention many more similar cases of a species turning up once, and not again; not in remote localities, but in the very parts that formed my most frequent collecting ground. It is by no means an unusual thing to pass a morning collecting on the mountains (at any rate on those under 3000 feet high), and to return home with perhaps two or three specimens secured, and having seen literally nothing else except the few most abundant insects. I have frequently spent an hour or more sweeping flower-covered herbage, or beating branches of trees over an inverted white umbrella, without seeing the sign of a beetle of any kind. My experience in this matter agrees with that of previous explorers in the islands of the Pacific Ocean, many of whom allude to the extreme paucity of insect life there. In M. Fairmaire's *Essai sur les Coléoptères de la Polynésie* it is stated that M. Vesco had to devote several years to collecting in Tahite and the Marquesas Islands before he could amass a hundred species of coleoptera; and after remarking on the groups to which these hundred belong, the author adds the observation, that the Sandwich Islands produce nearly the same insects in very small quantities. Another of the explorers in the Pacific (I am unable this moment to verify the quotation) remarks that, in proceeding northwards from Australia, the islands become progressively more barren of insect life, those north of the equator being almost unworthy of the trouble of exploration. A residence of years on one of the most despised groups of islands in Polynesia has undoubtedly enabled me to show that such statements depreciate unduly the real state of the case; but it has also



satisfied me that a casual visitor might very easily spend a few days in energetic Hawaiian collecting, and have very little to show as the result.

During the period of nearly six years which I spent in the Hawaiian Islands, and in which I made the explorations that have resulted in this publication, I was able to devote but little time to the study of natural history. My duties, as chaplain to the bishop and as senior priest (and during the latter part of my residence as acting dean) of the cathedral, allowed me very little leisure for scientific pursuits; and, therefore, I think it well to complete these prefatory remarks by a sketch of the amount of exploration that I was able to make on each of the islands, in order that it may be seen how much probably remains to be discovered when an entomologist with more leisure than I enjoyed is able to take up the work of investigation. It must not be forgotten that I included in my scanty entomological labours some work on all the orders of insects, so that the coleoptera only received a share of my attention.

This account of what I did on the islands *seriatim* will give me the opportunity of a few remarks on the specialities of each, and I will take them in order of position from north to south, which is generally believed to be the order in which they enter upon their existence as separate portions of land.

#### KAUAI AND NIIHAU.

This, the northernmost island of the group, lies about 60 miles N.W. of Oahu, and has an area of 590 square miles. Its mountains are all grouped in the centre, the highest peak (Waialeale) having an altitude of about 5000 feet above sea level. As the island on which volcanic upheavals and disturbances have been longest unknown, and also as possessing the largest and most constantly flowing rivers, Kauai might, perhaps, be expected to have the richest coleopterous fauna. Whether such is the case, I can hardly express an opinion, as I have spent only four days there, and those in August, which I consider among the less favourable months for collecting coleoptera. I landed on the east coast, and spent two days in working southwards round the south coast, and northwards half way along the west coast, not strictly following the shore, but keeping on the plains. These plains are more thickly studded with trees than those of the other islands, but, as usual, yielded only the common and generally distributed species. From the west coast I attempted the ascent of Waialeale, an extremely steep mountain, but was stopped at about 3000 feet elevation by bad weather. Nearly all my Kauai specimens were obtained during this attempt at elevations varying from 2000 to 3000 feet above the sea. After a rapid return by the previous route to Nawiliwili (the spot where I landed on the island), I made a hurried trip northwards to some fine waterfalls on the Wailua river, but without much success in procuring coleoptera, after which I embarked for Oahu.

In the part of the forests of Kauai that I visited the ohia lehua appeared to be the strongly predominant tree. I have no doubt but that there are hundreds of species still to be discovered on this island, which, it may be remarked, was the residence of Mr. Harper Pease, who sent several fine things to the British Museum some years ago. A journey on land completely round Kauai is impracticable, owing to the rugged and precipitous nature of the north-west coast, where travellers cannot pass between the mountains and the sea.

The island Niihau, with an area of 97 square miles, lies west of Kauai, separated by a channel 15 miles wide. I obtained a fine view of it from Waialeale, though I did not land there. It has no very considerable hills, and is for the most part sandy, probably possessing a scanty fauna.

#### OAHU.

The area of this island is 600 square miles. It has two mountain ranges, both running more or less north and south, one of them on the southern portion of the east coast, the other on the northern portion of the west coast.

The eastern range of mountains was the scene of the greater part of my researches. The higher summits of this range have an elevation of about 3000 feet, and the vegetation of the forests is extremely varied, the ohia lehua being much less plentiful than the koa and the kukui, and, at least, five or six other trees occurring in large numbers. I find, on reference to my journal, that I spent some portion of time (varying from an hour to an occasional twelve hours) in collecting insects on the eastern side of Oahu, as nearly as possible once a fortnight on the average through the six years that I spent on the Hawaiian Islands.

The mountain range on the western side of Oahu rises to 4000 feet above the sea. I spent, in collecting there, four days in July, one day in December, one in April, and one in May, and came to the conclusion that each of the mountain ranges on Oahu has a considerable number of species peculiar to it. The western range bears the local name "Waianae Mountains."

#### MOLOKAI.

This island has an area of 270 square miles. It lies S.E. of Oahu, separated by a channel about 23 miles wide. I was able to pass only a few hours on it, during which I could not reach the forest; on the plains there appeared to be only the ordinary species. As Molokai is separated from Maui by a channel hardly nine miles wide, and is not much further from Lanai, it is probable that much of its insect fauna is identical with that of the neighbouring islands—though I feel no doubt as to the existence of many species peculiar to it.

## MAUI.

The area of this magnificent island is 760 square miles. It lies S.E. of Molokai (which, as already stated, lies S.E. of Oahu.) It is separated from Molokai by a narrow strait, and is distant nearly 80 miles from Oahu. It consists of two masses of mountain, connected by a sandy isthmus about eight miles wide. The western mountain district consists of an irregular and very precipitous range, attaining an elevation of a little less than 6000 feet above the sea. The summits are extremely serrated and picturesque, but highly dangerous to ascend, as there are no well-defined tracks; and such tracks as there are in many places pass along the foot of sheer precipices from which stones often fall under the influence of wind and rain. I have never reached one of the highest of these summits, but have ascended about 3000 feet on several occasions, though without much entomological result; but I have no doubt this was "bad luck," and that there are many interesting insects to be found here.

The central isthmus of Maui is the only tract of low-lying land on the Hawaiian Islands that I have found profitable to work. I have spent very little time on it, but obtained several new coleoptera there, and a good many hymenoptera and lepidoptera.

The eastern end of Maui is, in my opinion, the head-quarters of the insect fauna of the archipelago. It is formed entirely by that gigantic mountain Haleakala, with an elevation of 10,000 feet above the sea, the summit being occupied by the largest crater in the world. This mighty chasm is more than 2000 feet deep, and the distance around its margin is 29 miles. Volcanic action has long been extinct. As will appear on a reference to the catalogue of Hawaiian coleoptera, an enormous proportion of the most interesting insects occurred on the slopes of Haleakala. I only once visited the actual summit of the mountain, when I passed the night in a cave about 1000 feet below the highest point, and so devoted parts of two days to the exploration of the upper regions, which did not appear to be prolific of insect life. I found there, however, three species of carabidæ (two of them represented by single specimens—one, *Mauna frigida*, mihi, being of the highest interest) which I have not seen elsewhere.

The following is an account of the time I spent on Maui. In October I passed four days there, during which I had little leisure for entomology, and what leisure I had was in short intervals, that only enabled me to visit the sandy isthmus and the lower slopes of the western mountains. The next visit I paid to the island was in February, when I spent fifteen days there, but during that period I was for the most part "on duty," and then only able to make short excursions to the places I had visited before. I succeeded, however, in securing five days of leisure, which I devoted to Haleakala, during which I made the ascent (mentioned above) to the summit. My third visit to Maui was in April and May, when I passed a vacation

of eighteen days there. On that occasion I landed at the western extremity, and worked my way eastwards along the south coast to the isthmus, which I then crossed; I afterwards pushed on along the north coast to Haleakala, spending five days on the mountain (until famine drove me down), but not exploring much above 5000 feet of elevation, as the supply of insects evidently fell off above that region. My fourth, and last, visit to the island was in September, when I passed five days there, three of which I devoted to Haleakala.

#### LANAI.

This island lies due west of Maui, from which it is separated by a channel nine miles wide. It is one of the smaller islands, having an area of only about 150 square miles. Its highest summit has an elevation of about 3400 feet, and the mountains occupy an unusually small proportion of area to the plains; moreover, the forest is here less extensive and dense than in most parts of the archipelago. I am told, however, that it is very rich in species of plants.

I spent just a week on Lanai, in the month of September, and obtained several species of extreme interest, especially *Proterhinus insignis*, Sh., which must be considered, I think, the finest species yet discovered of its remarkable genus. As a rule the insect fauna of the island appears to be closely related to that of Maui, but only a few of its insects seem absolutely identical with those of its neighbour; I feel compelled to regard them in general as species in course of acquiring complete isolation, and therefore incapable of being treated as mere varieties. In the few patches of forest that I explored it appeared to me that insects were more plentiful than might have been expected.

#### HAWAII.

Hawaii is the largest island of the archipelago, having an area of 4210 square miles. It lies almost due south of Maui, from which a channel twenty-five miles wide divides it. It is almost entirely mountainous (save a narrow strip of land around the coast), and may be described as consisting of four great masses of mountain, surrounding a lofty and rugged table-land. In the north there is a very abrupt range running east and west, not far from the coast, with an elevation of about 5500 feet. The southern side of this range is occupied by a table-land ranging from 2000 to 3000 feet above the sea, from which, somewhat north of the centre of the island, the enormous mountain Mauna Kea rises to an altitude of nearly 14,000 feet. Near the middle of the western coast lies a mountain called Hualalei, with an elevation a little above 8000 feet; and the whole southern portion is occupied by Mauna Loa, a huge volcano exceeding 13,000 feet in altitude. The central table-land, into which each of these three mountains slope on one side, has an

average elevation of about 5000 feet, and is a barren waste of lava. Mauna Loa is a violently active volcano, at an elevation of about 4000 feet. There is a crater known as "Kilauea," which has been constantly raging with molten lava as far back as memory or tradition reaches; and it has been the immemorial custom of the mountain to break forth, at intervals of a few years, in unexpected places besides, from which it discharges vast streams of molten lava that roll downwards, sometimes for many months, and change the whole aspect of the country by their devastation.

To this island I have paid two visits. In the month of February I spent seventeen days there, travelling chiefly on foot. On that occasion I landed on the north-west coast, and proceeded inland, between the northern (or Kohala) range and Mauna Kea, to a place called Waimea. I then spent a day on the southern slopes of the northern range (where I found in the main the same insects as on the rest of Hawaii), and then crossed a spur of Mauna Kea to the central table-land. From this point I made a leisurely ascent of the great mountain, sleeping a night of ascent and descent, respectively, in a hut at an elevation of about 6500 feet. Owing to the exceptional depth of the snow, my guide showed the white feather, and refused to go on at an elevation a little over 10,000 feet; but my travelling companion (Mr. J. R. Watson, a botanist) and I were not willing to be baulked; so we left the guide, and completed the ascent without him, by the light of nature and of a little old-world experience in Switzerland, &c. We got through the expedition without much anxiety or mishap worse than a few tumbles into rather unpleasant snow-drifts, an inflamed nose to Mr. Watson, and a little snow-blindness to myself. During this trip I procured very few insects; but I attribute it chiefly to "bad luck," as I am satisfied that the fine forest clothing this mountain must be the home of many fine things. On the snow-covered portion I obtained nothing but a few torpid ichneumonida, though I must admit that the intense cold interfered with entomological activity on my part.

After returning to Waimea (as I could not find a guide who would undertake the difficult journey across the central table-land), we made our way to the coast, and proceeded by sea round the north of the island, to a place called Hilo, about the centre of the east coast, whence we proceeded on foot, devoting two days to the journey, to Kilauea (the active crater of Mauna Loa). This lies at a distance of thirty miles from the sea, the mountain rising so gradually that the ascent of 4000 feet accomplished in that distance seems imperceptible; and the crater, when it is reached, appears to be a chasm in the surface of a great plain. Portions of the forest that we passed through on this journey were the densest I have ever seen. On one occasion, when we were proceeding along a narrow path that is cut among the trees, we met a wild bull; and it seemed doubtful for a short time whether he or we would retrace our footsteps. At last, however, humanity prevailed; and our antagonist turned tail and fled; but he was compelled to

retreat ignominiously before us for more than two miles before he could find a place where he could force a passage off the path into the forest.

Three days were spent in the neighbourhood of the crater, during which we ascended a thousand feet, or more, higher up the mountain; after which we spent another couple of days in walking back to Hilo, and then devoted a few days to coast exploration. The expedition to Mauna Loa yielded a considerable number of new coleoptera, but not many species of extraordinary interest; most of those taken being more or less closely allied to forms already familiar on the other islands.

After an interval of a few years, I was able to make an expedition of six days to Hawaii, where I landed in May, on the south-west coast (at the scene of Captain Cook's massacre); and this was the last expedition I made on the archipelago. From Kealakekua, my landing-place, I worked gradually upward on the western slopes of Mauna Loa to an elevation of about 6000 feet, and was moderately successful, procuring a good many of the same species that I had obtained previously on the other side of the mountain, together with a fair percentage of new things; but again I was struck with the absence of coleoptera of highly specialized character as compared with those of other islands.

In concluding these general remarks on the Hawaiian Islands, I may state that all the evidence I have on the subject goes to show that I have collected probably less than half the species of the coleoptera that occur on the archipelago.

---

## II.

## SYSTEMATIC CATALOGUE OF THE COLEOPTERA OF THE HAWAIIAN ISLANDS.

BY THE REV. T. BLACKBURN AND D. SHARP.

This catalogue comprises the name of each species of the order Coleoptera that has been recorded, so far as Mr. Blackburn and myself have been able to discover, as occurring in the Hawaiian Islands; it also contains such information as Mr. Blackburn is able to give at present as to habits and habitat, and frequently as to the months of the year in which the species has been met with; as regards this latter point, Mr. Blackburn has not thought it necessary to give or even to preserve minute records, on the ground, as he informs me, "that in the uniform climate and temperature for which the Hawaiian Islands are remarkable, most of the species do not apparently occur with much regularity at any particular time of the year, but appear in successive broods at irregular intervals."

Each species is recorded under the name by which it was first described, and a reference is given to the work and page of the work where the description will be found. Only such synonymy is given as is specially connected with the Oceanic fauna.

A systematic arrangement is adopted nearly in conformity with that of the great *Munich Catalogue of Coleoptera*, and the reference appended to the generic name refers also to this catalogue; as this latter reference is in pursuance of a course not usually adopted by zoologists, it is only proper that I should make a brief statement on this point.

A considerable difference of opinion prevails at present as to what course should be pursued in citing a name and reference to the genus. Some prefer to refer to the author who first described or defined the genus; while others—looking to the fact that any genus in the lapse of time undergoes great changes—consider we should quote the author who defined the genus in the sense in which the individual now writing uses it. The first of these courses is, it must be admitted, practically of little value except to bibliographers; while the second is unfortunately to a considerable extent impracticable, for the reason that a genus is made what it is at any given moment, not by actual definition, but by definition plus addition and minus subtraction. A defines a genus, say, as "Chorazus," making it to consist of ten species; B adds another five species, still calling the aggregate Chorazus; C describes an allied new genus, say *Dyelomus*, which consists of certain insects, plus two of A's and one of B's Chorazi. E now coming to the subject finds that Chorazus, as in actual use, is not the same as it was to either A or B; while C, who

has been the last of the defining factors in its shaping, has not defined it in any way whatever. For these reasons, it has long appeared to me desirable that no rule should become fixed or conventional in reference to the use of references to generic names. In point of fact, four courses may be adopted: first, no author's name need be given when a generic name is used; and this, for many purposes, is the truest and most simple thing to do, though very unsatisfactory to amateurs of pedantry; second, the name and reference may be to the maker of the generic name—this may be used in bibliographic and synonymic works; third, the name of the last actual describer may be given: this is perhaps the best course for popular works, where brevity and utility are of predominant importance over consistency and completeness; fourth, a history of the genus and its changes may be given, and the course of events by which it has come to be what it is at the moment of writing may be sketched. This latter is the best course, but it involves more expenditure of time and labour than it is worth while to devote to the object in the present transitional state of zoological nomenclature. For the purpose of this Catalogue I have therefore adopted the method of referring to the *Munich Catalogue of Coleoptera*, which will give to the student the most accessible modern information as to the extent of the genus and such points; and when the generic name is not used in the *Munich Catalogue*, I have referred to some other work where information may be obtained.

D. S.

---

Fam. CARABIDÆ.

## Tribe LEBIINI.

Genus I.—*Plochionus*. Mun. Cat. i. p. 147.1. *Carabus pallens*, Fab. Syst. Ent. p. 244.

Ins. Maui. Imm. largely distributed in both hemispheres.

Two specimens were found by beating branches of trees on the sea-shore, near a place called Uluolu, in April.

Genus II.—*Saronychium*, Blackb. Ent. Mo. Mag. xiv. p. 142.2. *Saronychium inconspicuum*, Blackb. l. c.

Ins. Oahu. Imm. (?) not yet identified from elsewhere.

Found by sifting leaves at an elevation of about 2500 feet on Konahuanui; and also a specimen in Honolulu, probably accidentally brought down from the above locality. November and March.



## Tribe ANCHOMENINI.

Genus III.—*Metromenus*, Shp. Ent. Mo. Mag. xx. p. 217.

3. *Dyscolus palmæ*, Blackb. Ent. Mo. Mag. xiv. p. 147.

Ins. Oahu. Aut.

Not uncommon on the leaves of *Freycinetia* in this island; usually at an elevation of about 1500 feet.

4. *Dyscolus mutabilis*, Blackb. op. cit. p. 148.

Ins. Oahu. Aut.

Rather plentiful on the leaves of a species of the lily tribe (locally known as "silver sword"); also in stems of fern; at an elevation of 2000 feet and upwards.

5. *Dyscolus caliginosus*, Blackb. l. c.

Ins. Oahu. Aut.

Found occasionally in the stems of ferns and other plants, at an elevation of about 2000 feet.

6. *Anchomenus muscicola*, Blackb. op. cit. p. 144.

Ins. Oahu. Aut.

Common near a spring of water just below the Nouanu Pali.

7. *Anchomenus corruscus*, Er. Act. Ac. Cæs. Leop. xvi. 1834, supp. p. 223.

Ins. Oahu. Aut. (? extinct).

This species is said to have been found under bark in Oahu; but although this island has been the chief field of Mr. Blackburn's collecting, he has not found anything answering to the description during his six years' experience.

8. *Anchomenus epicurus*, Blackb. op. cit. p. 145.

Ins. Oahu. Aut.

Found at an elevation of about 2500 feet on Konahuanui on several occasions, but always in the one locality; usually rare, but once found in abundance in decaying vegetable matter.

9. *Anchomenus insociabilis*, Blackb. Ent. Mo. Mag. xv. p. 121.

Ins. Maui. Aut.

Unique; found on Haleakala, at an elevation of about 4000 feet, in the month of February.

10. *Anchomenus erro*, Blackb. l. c. (?) Syn. *Platynus planus*, Karsch, Berl. Ent. Zeit. xxv. p. 2.

Ins. Maui. Aut.

Rather common under stones, at an elevation of 4000 to 5000 feet, on Haleakala.

11. *Anchomenus protervus*, Blackb. Ent. Mo. Mag. xiv. p. 145.

Ins. Oahu. Aut.

Found in various localities on the mountains of Oahu, but not commonly, under the bark of trees.

12. *Anchomenus meticulousus*, Blackb. op. cit. p. 146.

Ins. Oahu. Aut.

Under the bark of trees on the mountains; not common.

13. *Anchomenus fossipennis*, Blackb. l. c.

Ins. Oahu. Aut.

Not rare; generally occurs in company with *Dyscolus mutabilis*.

14. *Anchomenus oceanicus*, Blackb. l. c.

Ins. Oahu. Aut.

Unique; among moss, Nuuanu Pali, November.

15. *Anchomenus bardus*, Blackb. l. c.

Ins. Oahu. Aut.

Rare; found on the mountains at an elevation of about 2000 feet.

16. *Anchomenus fugitivus*, Blackb. op. cit. p. 147.

Ins. Oahu. Aut.

Rare; found at an elevation of about 2000 feet on the mountains.

17. *Anchomenus cuneipennis*, Blackb. op. cit. p. 146.

Ins. Oahu. Aut.

Found running on marshy ground at an elevation of about 1000 feet; not very rare.

18. *Anchomenus scrupulosus*, Blackb. op. cit. p. 145.

Ins. Oahu. Aut.

Unique; found under bark at an elevation of about 1500 feet.

19. *Anchomenus fraternus*, Blackb. l. c.

Ins. Oahu. Aut.

Not rare; under bark of trees at an elevation of about 2000 feet.

20. *Anchomenus putealis*, Blackb. Ent. Mo. Mag. xvii. p. 227.

Ins. Maui. Aut.

Found in rotten leaves on the margin of a stagnant pool, at an elevation of about 4000 feet on Haleakala. May.

21. *Anchomenus mysticus*, Blackb. Ent. Mo. Mag. xiv. p. 147.

Ins. Oahu. Aut.

Under stones, &c., at an elevation of about 2000 feet on the Waianae mountains. July. Very local, but not rare.

Genus IV.—*Colpodiscus*, Shp. Ent. Mo. Mag. xx. p. 217.22. *Anchomenus lucipetens*, Blackb. op. cit. xvi. p. 105.

Ins. Hawaii. Aut.

In vegetable refuse; and also flying by night, at an elevation of about 2000 feet, on Oolaa.

23. *Dyscolus tantalus*, Blackb. op. cit. xiv. p. 147.

Ins. Oahu. Aut.

On the leaves of palm and other trees, on the mountains; not rare.

Genus V.—*Barypristus*, Shp. Op. cit. xx. p. 217.24. *Anchomenus incendiarius*, Blackb. op. cit. xvi. p. 105.

Ins. Hawaii. Aut.

A small colony of specimens occurred under bark of *Acacia falcata*, at an elevation of about 4000 feet, on Mauna Loa.

25. *Anchomenus rupicola*, Blackb. op. cit. xv. p. 122.

Ins. Maui. Aut.

A few examples were found under stones, at an elevation of about 9000 feet, on Haleakala, in February.

26. *Anchomenus sharpi*, Blackb. l. c. (?) Syn. *Colpodes octo-ocellatus* Karsch, Berl. Ent. Zeit. xxv. p. 3.

Ins. Maui. Aut.

Not very rare under stones, at an elevation of 4000 to 5000 feet, on Haleakala.

Genus VI.—*Blackburnia*, Shp. Ent. Mo. Mag. xiv. p. 179.27. *Blackburnia insignis*, Shp. l. c.

Ins. Oahu. Aut.

Under stones on the Waianae mountains, at an elevation of about 2500 feet; not rare, but very local. July.

28. *Blackburnia blaptoides*, Blackb. op. cit. xv. p. 157.

Ins. Oahu. Aut.

Unique; found under a stone at an elevation of about 1500 feet.

29. *Blackburnia frigida*, Blackb. l. c.

Ins. Maui. Aut.

Unique; found under a stone on Haleakala, at an elevation of about 10,000 feet, in the month of February.

Genus VII.—*Disenochus*, Blackb. Ent. Mo. Mag. xv. p. 121.30. *Disenochus anomalus*, Blackb. l. c.

Ins. Maui. Aut.

Two specimens, under stones on Haleakala, at an elevation of about 4000 feet, in February.

31. *Disenochus terebratus*, Blackb. Ent. Mo. Mag. xvii. p. 227 (1st March, 1881). (?) Syn. *Promecoderus fossulatus*, Karsch, Berl. Ent. Zeit. xxv. p. 4 (April or May, 1881).

Ins. Maui. Aut.

Several specimens occurred in the month of May, at an elevation of about 4000 feet, under stones on Haleakala.

Genus VIII.—*Atrachynemis*, Blackb. Ent. Mo. Mag. xv. p. 120.32. *Atrachynemis sharpi*, Blackb. l. c. p. 120. (?) Syn. *Anisodactylus cuneatus*, Karsch, Berl. Ent. Zeit. xxv. p. 3, pl. i. f. 4.

Ins. Maui. Aut.

Rare; under stones, at an elevation of about 4000 feet, on Haleakala. February, April, May.

Genus IX.—*Cyclothorax*, Macleay, Trans. Ent. Soc. N. S. W. II. 1873, p. 104.33. *Cyclothorax montivagus*, Blackb. op. cit. p. 122. (?) Syn. *Olisthopus insularis*, Karsch, Berl. Ent. Zeit. xxv. p. 1.

Ins. Maui, Hawaii. Aut.

One of the commoner species of the genus; found, at an elevation of about 4000 feet, under stones.

34. *Cyclothorax pele*, Blackb. op. cit. p. 107.

Ins. Hawaii. Aut.

Not common; occurs under stones near the crater called Kilauea of the active volcano Mauna Loa, at an elevation of about 4000 feet. February.

35. *Cyclothorax micans*, Blackb. op. cit. xv. p. 122.

Ins. Maui. Aut.

Two specimens were found in moss, at an elevation of 9000 feet, on Haleakala. February.

36. *Cyclothorax multipunctatus*, Blackb. l. c.

Ins. Maui. Aut.

Very rare; but has occurred several times, at an elevation of about 4000 feet, on Haleakala.

37. *Cyclothorax brevis*, Blackb. op. cit. p. 123.

Ins. Oahu. Aut.

Not very rare ; amongst decaying leaves at an elevation of about 2000 feet.

38. *Cyclothorax robustus*, Blackb. op. cit. xvii. p. 228.

Ins. Maui. Aut.

Unique ; found in moss at an elevation of about 4000 feet, on Haleakala, in the month of May.

39. *Cyclothorax oahuensis*, Blackb. op. cit. xv. p. 123.

Ins. Oahu. Aut.

In the mountains ; very rare.

40. *Cyclothorax simiolus*, Blackb. l. c.

Ins. Oahu. Aut.

This is, in Oahu, the most common of the species of *Cyclothorax*, and is found on the mountains.41. *Cyclothorax obscuricolor*, Blackb. l. c.

Ins. Maui. Aut.

Found on Haleakala, at an elevation of about 4000 feet, in February and May ; rare.

42. *Cyclothorax bembidioides*, Blackb. op. cit. xvi. p. 107.

Ins. Hawaii. Aut.

Unique ; the specimen was found near the crater "Kilauea" on Mauna Loa, at an elevation of about 4000 feet, in February.

43. *Cyclothorax paradoxus*, Blackb. op. cit. xvi. p. 108.

Ins. Hawaii. Aut.

Unique ; occurred on Mauna Kea, at an elevation of about 3000 feet, in February.

44. *Cyclothorax scaritoides*, Blackb. op. cit. xv. p. 156. (?) Syn. *Oopterus plicaticollis*, Karsch, Berl. Ent. Zeit. xxv. p. 1.

Ins. Maui. Aut.

Common on Haleakala, at an elevation between 4000 and 5000 feet.

45. *Cyclothorax cordaticollis*, Blackb. l. c. (?) Syn. *Acupalpus biseriatus*, Karsch, Berl. Ent. Zeit. xxv. p. 2.

Ins. Maui. Aut.

Not rare on Haleakala, at an elevation of about 4000 to 5000 feet.

46. *Cyclothorax deverilli*, Blackb. op. cit. xvi. p. 108.

Ins. Hawaii. Aut.

Found in various localities on this island, always singly, generally under bark of trees, at an elevation of 3000 to 4000 feet.

47. *Cyclothorax vulcanus*, Blackb. l. c.

Ins. Hawaii. Aut.

A few specimens occurred on Mauna Loa, at an elevation of 4000 feet, near the active crater Kilauea, under the bark of a tree, in February.

48. *Cyclothorax unctus*, Blackb. op. cit. xvii. p. 227.

Ins. Maui. Aut.

Found in rotten leaves on the margins of a stagnant pool, at an elevation of about 4000 feet, on Haleakala, in May.

49. *Cyclothorax lætus*, Blackb. op. cit. p. 228.

Ins. Maui. Aut.

Found on Haleakala, under stones, at an elevation of about 4000 feet, in May. Very rare.

50. *Cyclothorax angusticollis*, Blackb. op. cit. xv. p. 156.

Ins. Maui. Aut.

Rare; found on Haleakala, at an elevation of about 4000 feet.

51. *Cyclothorax rupicola*, Blackb. l. c.

Ins. Maui. Aut.

Unique; found under a stone, at an elevation of about 10,000 feet, on Haleakala, in February.

52. *Cyclothorax inæqualis*, Blackb. op. cit. p. 157.

Ins. Maui. Aut.

Found on Haleakala by sifting leaves, at an elevation of 4000 to 5000 feet, in February. Not very rare.

53. *Cyclothorax karschi*, Blackb. op. cit. xix. p. 62.

Ins. Hawaii. Aut.

Unique; found under a stone, on Mauna Loa, at an elevation of about 6000 feet, in May.

## Tribe BEMBIDIINI.

Genus X. *Tachys*. Mun. Cat. I. p. 401.54. *Tachys oahuensis*, Blackb. Ent. Mo. Mag. xv. p. 158.

Ins. Oahu. (?) Imm. or int.

Not uncommon on salt marshes near the sea.

55. *Tachys arcanicola*, Blackb. l. c.

Ins. Oahu. (?) Imm.]

Very local; but not rare, under bark in some mountain localities, at an elevation of about 1500 feet.

56. *Tachys atomus*, Blackb. l. c.

Ins. Oahu. (?) Imm. or aut.

Not rare; in moss in mountain localities, at an elevation of about 1500 feet.

57. *Tachys mucescens*, Blackb. l. c.

Ins. Oahu. (?) Int.

Unique; in decaying vegetable matter on the plains of Honolulu.

Genus XI.—*Bembidium*. Mun. Cat. I. p. 405 (*sub nom.* *Bembicidium*).58. *Bembidium teres*, Blackb. op. cit. xvii. p. 229.

Inns. Maui. (?) Imm.

Among decaying leaves, at an elevation of about 4000 feet, on Haleakala, in May. Rare.

59. *Bembidium pacificum*, Blackb. op. cit. xv. p. 157.

Ins. Oahu. (?) Imm.

Not rare, but very local, though found in several localities; it generally occurs running on damp ground.

60. *Bembidium ignicola*, Blackb. op. cit. xvi. p. 109.

Ins. Hawaii. (?) Imm.

Unique; found in a hot steam crack, beside the crater Kilauea on Mauna Loa, at an elevation of about 4000 feet, in February.

61. *Bembidium spurcum*, Blackb. op. cit. xvii. p. 228.

Ins. Maui. (?) Imm.

Unique; the specimen was found in decaying leaves, at an elevation of about 4000 feet, on Haleakala, in May.

## Fam. DYTISCIDÆ.

## Tribe COLYMBETINI.

Genus XII.—*Rhantus*, Mun. Cat. II. p. 448.62. *Colymbetes pacificus*, Boisd. Voy. Astr. Ent. II. p. 50.

Ins. Hawaii, Maui, Lanai, Oahu, Kauai. (?) Imm.

This insect occurs not rarely on all the islands visited, generally at an elevation of 1000 to 4000 feet.

Genus XIII.—*Copelatus*, Shp. Trans. Roy. Dub. Soc. Vol. II. 1882, p. 562.63. *Colymbetes parvulus*, Boisd. l. c.

Ins. Oahu, Maui. (?) Imm.

Not rare; probably occurs on the other islands; generally found in company with *Colymbetes pacificus*.64. *Copelatus mauiensis*, Blackb., *ante*, p. 120.

Ins. Maui. (?) Imm.

Unique; taken by sifting damp leaves round a small pool of water at an elevation of about 5000 feet, on Haleakala. May.

## Fam. HYDROPHILIDÆ.

Genus XIV.—*Hydrobius*. Mun. Cat. II. p. 479.65. *Hydrophilus semicylindricus*, Esch. Ent. p. 41.

Ins. Hawaii, Maui, Lanai, Oahu, Kauai. (?) Imm.

Plentiful on all the islands, at various elevations, in both stagnant and running waters.

Genus XV.—*Cyclonotum et Dactylosternum*. Mun. Cat. II. p. 495.66. *Cyclonotum subquadratum*, Fairm. Rev. Zool. 1849, p. 412.

Ins. Oahu. (?) Imm. or int. Tahiti.

In decaying vegetable matter, on the mountains; probably not confined to this island.

67. *Sphæridium abdominale*, Fab. Syst. El. I. p. 94.

Ins. Oahu, Maui. Int. Widely distributed.

Rather plentiful in decaying vegetable matter at various elevations, and probably occurs on the other islands.

Genus XVI.—*Omicrus*. Shp. Trans. Ent. Soc. Lond. 1879, p. 81.68. *Omicrus brevipes*, Shp. l. c.

Ins. Oahu. (?) Imm.

Occurs rarely at various elevations; generally in damp rotting wood.

## Fam. STAPHYLINIDÆ.

## Tribe ALEOCHARINI.

Genus XVII.—*Stenagria*. Shp. Biol. Cent. Am. Col. I. Pt. 2, p. 237.69. *Falagria currax*, Shp. Trans. Ent. Soc. Lond. 1880, p. 37.

Ins. Oahu. (?) Int.

Rare; only taken on one occasion. It was found under some logs of wood, at Honolulu.

Genus XVIII.—*Bolitochara*. Mun. Cat. II. p. 504.70. *Bolitochara impacta*, Blackb., *ante*, p. 120.

Ins. Oahu. (?) Int.

Unique: on the shore near Honolulu.

Genus XIX.—*Tachyusa*. Mun. Cat. II. p. 524.71. *Tachyusa pumila*, Shp. Trans. Ent. Soc. Lond. 1880, p. 38.

Ins. Maui. (?) Imm.

Two specimens were found on muddy sand, about high-water line, at Kahului bay, in February.



Genus XX.—*Homalota*. Mun. Cat. II. p. 530.72. *Homalota coriaria*, Kr. Ins. Deutsch. ii. p. 282.

Ins. Hawaii, Maui, Lanai, Oahu, Kauai. Int. Widely distributed out of the islands.  
Common in various localities on all the islands of the Hawaiian group.

Genus XXI.—*Diestota*. Muls. Rey. Op. Ent. xiv. p. 194.73. *Diestota plana*, Shp. Trans. Ent. Soc. Lond. 1880, p. 38.

Ins. Oahu. Aut.

Occurs rarely on *Freycinetia* flowers on the mountains near Honolulu.

The expression "in the flowers of palm trees" in my original notes on this species (quoted by Dr Sharp, loc. cit) must be corrected, as the *Freycinetia* is not a palm.

74. *Diestota parva*, Shp. op. cit. p. 39.

Ins. Oahu. Aut.

Mountains of Oahu. In decaying wood; not common.

75. *Diestota latifrons*, Shp. op. cit. p. 40.

Ins. Kauai. Aut.

On flowers of *Freycinetia*, about 3000 feet above sea level. August.

76. *Diestota rufescens*, Shp. op. cit. p. 42.

Ins. Kauai. Aut.

Found on *Freycinetia* in the mountain forests. August.

77. *Diestota palpilis*, Shp. op. cit. p. 40.

Ins. Hawaii. Aut.

Several specimens were taken in February at an elevation of about 4000 feet, near the active crater "Kilauea." Unfortunately the record of this species has been lost, but it is believed that it was found on flowers of *Freycinetia*.

78. *Diestota puncticeps*, Shp. op. cit. p. 41.

Ins. Oahu. Aut.

Found on *Freycinetia*, in the mountain forests.

79. *Diestota carinata*, Shp. l. c.

Ins. Oahu. Aut.

Taken by beating branches of trees, at an elevation of about 2000 feet.

80. *Diestota montana*, Blackb., *ante*, p. 121.

Ins. Hawaii. Aut.

Unique; occurred on the mountains at an elevation of about 3000 feet. February.

81. *Diestota incognita*, Blackb., *ante*, p. 121.

Ins. Hawaii. Aut.

Unique.

Genus XXII.—*Phlæopora*. Mun. Cat. II, p. 545.82. *Phlæopora cingulata*, Shp. Trans. Ent. Soc. Lond. 1880, p. 44.

Ins. Oahu. (?) Imm.

Under bark of a tree, near Honolulu.

83. *Phlæopora diluta*, Shp. l. c.

Ins. Kauai. (?) Imm.

In decaying wood on the mountains. August.

Genus XXIII.—*Oligota*. Mun. Cat. II, p. 547.84. *Oligota glabra*, Shp. Trans. Ent. Soc. Lond. 1880, p. 46.

Ins. Hawaii. Aut.

This insect occurs in various localities, apparently in dry dead wood. It has not been found at a lower elevation than 3000 feet above the sea.

85. *Oligota polita*, Shp. op. cit. p. 45.

Ins. Oahu. Aut.

This species was taken singly on several occasions on flowers (generally of *Freyinetia*), at elevations varying from 2000 to 3000 feet above the sea.

86. *Oligota mutanda*, Shp. op. cit. p. 46.

Ins. Hawaii. Aut.

Two specimens of this species were obtained by beating the branches of a tree on Mauna Loa, at an elevation of about 4000 feet. Although the tree from which they were beaten was living, it is probable that it contained dead twigs, which were the actual habitat.

87. *Oligota prolixa*, Shp., *ante*, p. 124.

Ins. Maui, Hawaii. Aut.

Rare; occurs in bark of trees on the islands Maui and Hawaii.

88. *Oligota kawaiiensis*, Blackb., *ante*, p. 122.

Ins. Kauai. Aut.

A single specimen was taken by beating dead branches of trees, at an elevation of about 2000 feet on Waialeale, Kauai. August.

89. *Oligota longipennis*, Blackb., *ante*, p. 123.

Ins. Oahu. Aut.

Unique.

90. *Oligota simulans*, Blackb., *ante*, p. 123.

Ins. Kauai. Aut.

A single specimen was taken by beating dead branches of trees, at an elevation of about 2000 feet on Waialeale, Kauai. August.

91. *Oligota variegata*, Blackb., *ante*, p. 124.

Ins. Oahu. Aut.

Unique.

92. *Oligota clavicornis*, Shp. Trans. Ent. Soc. Lond. 1880, i. p. 44.

Ins. Oahu. (?) Int.

Twice found in straw, in the city of Honolulu. In both cases the straw had been imported from England.

Genus XXIV.—*Liophæna*. Shp. Trans. Ent. Soc. Lond. 1880, p. 48.93. *Liophæna gracilipes*, Shp. op. cit. p. 47.

Ins. Hawaii. Aut.

This species is connected with dead branches of trees. It occurs on Mauna Loa, near the active crater "Kalauea;" elevation about 4000 feet.

94. *Liophæna flaviceps*, Shp. l. c.

Ins. Hawaii. Aut.

Occurs in the same locality as *L. gracilipes*, Shp.Genus XXV.—*Myllæna*. Mun. Cat. ii. p. 550.95. *Myllæna familiaris*, Shp. op. cit. p. 48.

Ins. Oahu. (?) Imm.

Not rare in the mountain forests around Honolulu. Generally obtained by beating miscellaneous trees and flowers.

96. *Myllæna curtipes*, Shp. op. cit. p. 49.

Ins. Oahu. (?) Imm.

This insect occurred, on a single occasion, in some numbers, in a heap of refuse at an elevation of about 3000 feet on Konahuanui.

97. *Myllæna vicina*, Shp. op. cit. p. 48.

Ins. Maui. (?) Imm.

The exact record of circumstances of capture has been lost, but the locality was certainly on Maui, and probably in the Wailuku valley.

98. *Myllæna discedens*, Shp. op. cit. p. 49.

Ins. Oahu. (?) Imm.

This species occurs very rarely (single specimens were taken twice, as the result of frequent search), under damp decaying logs of wood, on the low hills within a few miles of Honolulu.

99. *Myllæna pacifica*, Blackb., *ante*, p. 121.

Ins. Hawaii. (?) Imm.

Unique; occurred on Freycinetia, on Mauna Loa, at an elevation of about 4000 feet. February.

100. *Myllæna oahuensis*, Blackb., *ante*, p. 122.

Ins. Oahu. (?) Imm.

Probably beaten from flowers in the mountain forests near Honolulu.

## Tribe XANTHOLININI.

Genus XXVI.—*Pachycorynus*. Mun. Cat. II. p. 595.101. *Pachycorynus discedens*, Shp. Trans. Ent. Soc. Lond. 1880, I. p. 50.

Ins. Oahu. (?) Int. or imm.

Under bark, in a forest about three miles from Honolulu, at an elevation of about 2000 feet. A small series was taken once; all efforts to procure the species again were unavailing.

Genus XXVII.—*Leptacinus*. Mun. Cat. II. p. 605.102. *Leptacinus flavipennis*, Kr. Wieg. Arch. 1859, p. 111.

Ins. Oahu. Int. Ceylon.

Single specimens were taken on three separate occasions in the city of Honolulu. Probably widely distributed in Eastern Asia.

## Tribe STAPHYLININI.

Genus XXVIII.—*Crocophilus*. Mun. Cat. II. p. 575.103. *Staphylinus maxillosus*, L.

Ins. Hawaii, Maui, Lanai, Oahu, Kauai. Int. Widely distributed.

Plentiful in decaying carcasses all over the Hawaiian Islands.

Genus XXIX.—*Cafius*. Fauvel, Faune, Gal. rheu. III. p. 421.104. *Philonthus naticus*, Fairm. Rev. Zool. 1849, p. 288.

Ins. Maui. (?) Imm. Tahiti.

Two specimens occurred in decaying seaweed on the coast of Maui, near Haiku. March.

Genus XXX.—*Philonthus*. Mun. Cat. II. p. 584.105. *Philonthus scybalarius*, Nord. Symb. p. 94.

Ins. Hawaii, Maui, Lanai, Oahu, Kauai. Int. Widely distributed.

Plentiful on all the islands, but rarely occurring at a lower elevation than 1500 feet above the sea.

106. *Staphylinus discoideus*, Gr. Micr. p. 38.

Ins. Oahu. Int. Europe.

Common on Oahu (and probably on others of the Hawaiian Islands), generally in decaying vegetable matter.

107. *Philonthus turbidus*, Er. Gen. et Spec. p. 466.

Ins. Oahu. Int. Madagascar, Egypt, Natal, Canary Islands.

In Honolulu it has been found not uncommonly flying to a light in the evening.

108. *Staphylinus nigritulus*, Gr. Micr. p. 41.

Ins. Maui, Lanai, Hawaii. Int. Widely distributed.

Occasionally taken on Maui, Lanai, and Hawaii; generally under stones, on the mountains, at elevations varying from 2000 to 4000 feet above the sea.

## Tribe PÆDERINI.

Genus XXXI.—*Lithocharis*. Mun. Cat. II. p. 620.109. *Lithocharis debilicornis*, Woll. Cat. Col. Mad. p. 194.

Ins. Oahu. Int. Widely distributed.

A small batch of this species occurred in Honolulu.

110. *Lithocharis celebensis*, Fauvel, in litt.

Ins. Oahu. Int. Celebes.

In vegetable refuse near the beach, Honolulu.

111. *Lithocharis incompta*, Shp., *ante*, p. 124.

Ins. Hawaii. (?) Imm.

Rare. A few specimens occurred in Freycinetia flowers, at an elevation of about 4000 feet, on Mauna Loa. February.

112. *Lithocharis fuscipennis* (? Kr.) Fauv. Ann. Mus. Gen. XII. p. 229.

Ins. Oahu, (?) Int. Ceylon, Celebes, China.

Honolulu. This is, I believe, the same species as that recorded by Fauvel, l. c., as being the *L. fuscipennis*, Kr., but I think Mr. Fauvel's determination is clearly an erroneous one, and the species probably undescribed.

## Tribe OXYTELINI.

Genus XXXII.—*Oxytelus*. Mun. Cat. II. p. 648.113. *Oxytelus Blēdioides*, Blackb., *ante*, p. 125.

Ins. Oahu. (?) Int.

Unique. Honolulu. Occurred in September.

114. *Oxytelus advena*, Shp. Trans. Ent. Soc. Lond. 1880, p. 50.

Ins. Oahu. (?) Int.

In various localities on Oahu. Generally in decaying vegetable matter.

115. *Oxytelus pygmæus*, Kr. Wieg. Arch. 1859, p. 176.

Ins. Oahu. Int. Ceylon.

Honolulu. In decaying vegetable matter. Not common.

Genus XXXIII.—*Trogophlœus*. Mun. Cat. II. p. 652.116. *Trogophlœus senilis*, Shp. Trans. Ent. Soc. Lond. 1880, p. 51.

Ins. Oahu. (?) Imm.

Rather frequently to be met with on the margin of water, on Oahu; generally at a considerable elevation above the sea.

117. *Trogophlœus abdominalis*, Shp. op. cit. p. 52.

Ins. Oahu. (?) Imm.

Not uncommon in the salt marshes on the coasts of Oahu.

118. *Trogophlœus fontinalis*, Shp. l. c.

Ins. Oahu. (?) Imm.

Occurs on the margins of running water on the mountains.

## Tribe PIESTINI.

Genus XXXIV.—*Lispinodes*. Shp. Trans. Ent. Soc. Lond. 1880, p. 53.119. *Lispinodes explicandus*, Shp. l. c.

Ins. Oahu. (?) Imm.

Found rarely, under bark of trees, on the higher mountains.

120. *Lispinodes quadratus*, Blackb., *ante*, p. 125.

Ins. Oahu. (?) Imm. or int.

A single example was found under the bark of a tree near Honolulu.

121. *Lispinodes pallescens*, Blackb., *ante*, p. 126.

Ins. Oahu. (?) Imm. or int.

A single example was taken under bark of a tree near Honolulu.

Genus XXXV.—*Glyptoma*. Mun. Cat. II. p. 677.122. *Glyptoma blackburni*, Shp. Trans. Ent. Soc. Lond. 1880, p. 53.

Ins. Hawaii, Oahu, Kauai. (?) Imm.

Under bark of trees on the mountains of Kauai, Oahu, and Hawaii; probably occurs on all the islands of the group.

123. *Glyptoma brevipenne*, Shp. l. c.

Ins. Oahu. (?) Imm.

Occurs rarely, under bark of trees, on the mountains.

## Fam. TRICHOPTERYGIDÆ.

Genus XXXVI.—*Actidium*. Matth. Trichop. p. 86.124. *Actidium sharpianum*, Matt. Cist. Ent. II. p. 39.

Ins. Oahu. (?) Imm.

Under bark of trees in mountain forests.

Genus XXXVII.—*Ptiliodes*. Matth. Cist. Ent. III. p. 40.125. *Ptiliodes blackburni*, Matt. op. cit. p. 41.

Ins. Oahu. (?) Imm.

Under bark of trees in mountain forests.

Genus XXXVIII.—*Ptinella*. Mun. Cat. II. p. 745.126. *Ptinella pacifica*, Matt. Cist. Ent. III. p. 42.

Ins. Oahu. (?) Imm.

Under bark of trees in mountain forests.

## Fam. HISTERIDÆ.

Genus XXXIX.—*Carcinops*. Mun. Cat. III. p. 776.127. *Dendrophilus 14-striatus*, Steph. Ill. Brit. Ent. V. p. 412.

Ins. Oahu. Int. Widely distributed.

Not rare in the city of Honolulu, and probably elsewhere.

Genus XL.—*Saprinus*. Mun. Cat. III. p. 782.128. *Saprinus lugens*, Er. Jahr. 1834, p. 181.

Ins. Hawaii, Maui, Lanai, Oahu, Kauai. Int. Mexico, California.

Plentiful in decaying carcasses all over the Hawaiian islands.

129. *Saprinus oregonensis*, Lec. Mon. p. 45.

Ins. Oahu. (?) Hawaii, Maui, Lanai, Kauai. Int. California.

Generally found in company with *S. lugens*.

Genus XLI.—*Bacanius*. Mun. Cat. III. p. 796.130. *Bacanius atomarius*, Shp., *ante*, p. 128.

Ins. Oahu. (?) Int.  
Honolulu.

131. *Bacanius confusus*, Blackb., *ante*, p. 129.

Ins. Oahu. (?) Int.  
Unique; without special locality.

Genus XLII.—*Acritus*. Mun. Cat. III. p. 797.132. *Acritus insularis*, Shp., *ante*, p. 129.

Ins. Oahu. (?) Int.  
Mountains near Honolulu.

Genus XLIII.—*Aeletes*. Horn, Proc. Am. Phil. Soc. XIII. p. 312.133. *Acritus basalis*, Lec. Ann. Lyc. v. p. 170.

Ins. Oahu. (?) Imm.  
A few specimens have been taken in several mountain localities on Oahu.

134. *Aeletes facilis*, Shp., *ante*, p. 130.

Ins. Oahu. (?) Imm.

135. *Aeletes longipes*, Shp., *ante*, p. 129.

Ins. Oahu, Maui, Lanai. (?) Imm.

A few specimens occurred on Mauna Loa, Hawaii, in decaying wood, at an elevation of between 4000 and 5000 feet. In somewhat similar localities (though at a lower elevation) on Maui and Lana specimens have occurred somewhat smaller, but apparently referable to this species.

136. *Aeletes concentricus*, Shp., *ante*, p. 130.

Ins. Maui. (?) Imm.  
Rare; occurs in wood at an elevation of about 4000 feet on Haleakala, Maui.

137. *Aeletes monticola*, Blackb., *ante*, p. 130.

Ins. Maui. (?) Imm.  
Unique; occurred in decaying wood on Haleakala. April.

138. *Aeletes flavitarsis*, Lewis, Ent. Mo. Mag. XVI. p. 79.

Ins. Oahu. (?) Imm.  
Occasionally taken on the higher mountains of Oahu, generally in decaying wood.



## Fam. NITIDULIDÆ.

Genus XLIV.—*Carpophilus*. Mun. Cat. III. p. 810.139. *Carpophilus maculatus*, Mur. Mon. Nitid. p. 372.

Ins. Oahu, Kauai, Maui, Hawaii. (?) Int.

Occurs abundantly on various articles of food.

140. *Nitidula dimidiata*, Fab. Ent. Syst. I. p. 261.

Ins. Oahu, Maui. (?) Hawaii, (?) Lanai, (?) Kauai. Int. Widely distributed.

Taken on Oahu and Maui in the greatest abundance. It attacks almost all articles of food in houses; and doubtless occurs on all the islands.

141. *Dermestes hemipterus*, Lin. Syst. Nat. I. 2, p. 565.

Ins. Oahu, Maui. Int. Widely distributed.

Taken on Oahu and Maui, but not commonly.

Genus XLV.—*Gonioryctus*. Shp. Trans. Ent. Soc. Lond. 1878, p. 131.142. *Gonioryctus latus*, Shp. op. cit. p. 129.

Ins. Oahu. Aut.

Found on flowers (usually of the Freycinetia) in the mountain forests, at elevations of 2000 to 3000 feet above the sea; not rare.

143. *Gonioryctus blackburni*, Shp. op. cit. II. p. 130.

Ins. Oahu. Aut.

Taken singly on several occasions on flowers in the mountain forests.

144. *Gonioryctus monticola*, Shp. I. c.

Ins. Oahu. Aut.

A few specimens of this insect occurred in the decayed stems of a tree-fern, just below the summit of Konahuanui, in March.

145. *Gonioryctus fugitivus*, Blackb., *ante*, p. 131.

Ins. Hawaii. Aut.

Unique; taken by beating flowers near Waimea, at an elevation of about 3000 feet. February.

146. *Gonioryctus similis*, Blackb., *ante*, p. 131.

Ins. Oahu. Aut.

In the stems of a species of lily growing near the summit of Konahuanui.

Genus XLVI.—*Brachypeplus*. Mun. Cat. III. p. 807.147. *Brachypeplus tinctus*, Shp. Trans. Ent. Soc. Lond. 1879, p. 83.

Ins. Oahu. Aut.

Three specimens occurred on flowers at an elevation of about 1500 feet.

148. *Brachypeplus protinoides*, Shp. op. cit. p. 85.

Ins. Maui. Aut.

Occurs commonly on flowers at an elevation of about 4000 feet on Haleakala.

149. *Brachypeplus torvus*, Blackb., *ante*, p. 133.

Ins. Oahu. Aut.

Unique; occurred in flowers on the Waianae mountains.

150. *Brachypeplus koelensis*, Blackb., *ante*, p. 133.

Ins. Lanai. Aut.

Unique; occurred near a place called Koele, on the island Lanai. September.

151. *Brachypeplus bidens*, Shp. Trans. Ent. Soc. Lond. 1881, p. 510.

Ins. Hawaii. Aut.

Occurs on Mauna Loa, at elevations of 4000 to 5000 feet. On flowers.

152. *Brachypeplus floricola*, Blackb., *ante*, p. 134.

Ins. Kauai. Aut.

Unique; obtained by beating flowers on Waialeale, at an elevation of about 2000 feet. August.

153. *Brachypeplus olinda*, Blackb., *ante*, p. 132.

Ins. Maui. Aut.

Unique; taken by beating flowers, near Olinda on Haleakala, at an elevation of about 4000 feet. September.

154. *Brachypeplus celatus*, Shp., *ante*, p. 134.

Ins. Hawaii. Aut.

Four specimens were taken by beating flowers, at an elevation of about 6000 feet on Mauna Loa.

155. *Brachypeplus affinis*, Shp. Trans. Ent. Soc. Lond. 1881, p. 509.

Ins. Hawaii. Aut.

Not rare on flowers on Mauna Kea, at an elevation of about 3000 feet. February.

156. *Brachypeplus inauratus*, Shp. op. cit. p. 508.

Ins. Hawaii. Aut.

On flowers, at an elevation of about 7000 feet, on Mauna Kea, Hawaii. February.

157. *Brachypeplus apertus*, Shp.; *ante*, p. 135.

Ins. Hawaii. Aut.

A short series occurred on flowers, at an elevation of about 6000 feet, on Mauna Loa. May.

158. *Brachypeplus quadraticollis*, Blackb., *ante*, p. 135.

Ins. Hawaii. Aut.

A single specimen was taken by beating flowers, at an elevation of about 4000 feet, on Mauna Loa, Hawaii. February.

159. *Brachypeplus discedens*, Shp. Trans. Ent. Soc. Lond. 1878, II. p. 133.♂ *puncticeps*, Shp. l. c. Var. (?) *kauaiensis*, Blackb., *ante*, p. 137.

Ins. Oahu. Var. Ins. Kauai. Aut.

Occurs rather commonly on the flowers of various trees in the mountain forests near Honolulu—generally at an elevation above the sea of 1500 feet or more.

160. *Brachypeplus metallescens*, Shp. op. cit. 1881, p. 511.

Ins. Hawaii. Aut.

On flowers (especially of *Freycinetia*) on Mauna Kea and Mauna Loa, at elevations of 4000 to 5000 feet. February, May.

161. *Brachypeplus parallelus*, Blackb., *ante*, p. 135.

Ins. Lanai. Aut.

A single specimen was beaten from dead wood near a place called "Koek," at an elevation of about 2000 feet. September.

162. *Brachypeplus vestitus*, Shp. Trans. Ent. Soc. Lond. 1881, p. 511.

Ins. Oahu. Aut.

Occurs, not very rarely, on flowers in the forests near Honolulu, at an elevation of about 1500 feet.

163. *Brachypeplus varius*, Shp. op. cit. p. 512.

Ins. Hawaii. Aut.

Found on flowers, on Mauna Loa, at an elevation of about 4000 feet. February.

164. *Brachypeplus blackburni*, Shp. Trans. Ent. Soc. Lond. 1881, iv. p. 516.

(?) var. *lanaiensis*, Blackb., *ante*, p. 138.

Ins. Hawaii, Lanai (var.). Aut.

Taken by beating dead wood at an elevation of about 4000 feet on Mauna Loa, Hawaii. February. The var. (?) was taken under similar circumstances on Lanai, in September. From observation of the habits of the insect on Lanai I have little doubt that the specimens originally taken on Hawaii and recorded as occurring on flowers were in reality procured from unnoticed dead wood, around which the flowers were growing.

165. *Brachypeplus robustus*, Shp. Trans. Ent. Soc. Lond. 1878, p. 134.

Ins. Oahu. Aut.

Occurs near Honolulu rarely; once taken in some numbers in interstices on the bark of a tree. It has not been taken below 1500 feet above the sea.

\*166. *Brachypeplus guttatus*, Shp. Trans. Ent. Soc. Lond. 1881, p. 513.

Ins. Oahu. Aut.

Found near Honolulu, at an elevation of 1500 feet or more, and usually at exuding sap of the koa tree.

167. *Brachypeplus sordidus*, Shp. op. cit. p. 514.

Ins. Hawaii. Aut.

Two specimens occurred. They were taken at Kilauea, on Mauna Loa, by beating, at an elevation of about 4000 feet. February.

168. *Brachypeplus expers*, Blackb., *ante*, p. 136.

Ins. Maui. Aut.

A single specimen was taken on Haleakala, at an elevation of more than 4000 feet. May.

169. *Brachypeplus reitteri*, Shp. Trans. Ent. Soc. Lond. 1878, p. 134.

Ins. Oahu. Aut.

Frequents the stems of bananas on the mountains near Honolulu. Not at all common.

170. *Brachypeplus infimus*, Shp. op. cit. p. 135.

Ins. Oahu. (?) Imm.

Under the bark of trees on the mountains. Rare.

171. *Brachypeplus obsoletus*, Shp. op. cit. 1881, p. 515.

Ins. Hawaii. Aut.

Occurred in various mountain localities on Hawaii, but rarely, and at elevations higher than 3500 feet. Some (and probably all) of the specimens were taken in the stems of ferns. February.

172. *Brachypeplus omaloides*, Shp. op. cit. 1878, p. 136.

Ins. Hawaii, Oahu. Aut.

The commonest Hawaiian species of the genus. It occurs in considerable numbers on flowers in the mountain forests of Oahu, appearing to prefer the *Freycinetia*, on the stalks of which it may be found even when there are no flowers. It also occurs on Hawaii, and probably on other islands.

173. *Brachypeplus aper*, Shp. op. cit. p. 137.

Ins. Oahu. Aut.

Taken singly on several occasions under bark of trees on the mountains of Oahu.

174. *Brachypeplus explanatus*, Shp. op. cit. 1879, p. 84.

Ins. Oahu. Aut.

Two specimens only occurred. They were taken on the mountains near Honolulu, but the exact particulars of the capture have been lost.

175. *Brachypeplus brevis*, Shp. op. cit. 1878, p. 137.

Ins. Oahu. Aut.

Taken on several occasions, but only in very small numbers, by sifting dead leaves at the foot of a precipitous cliff in the mountains near Honolulu. The locality is about 1000 feet above the sea.

176. *Brachypeplus spretus*, Blackb., *ante*, p. 136.

Ins. Maui. Aut.

Occurs not uncommonly on dead branches of trees, at an elevation of about 4000 feet, on Haleakala.

177. *Brachypeplus inæqualis*, Shp. op. cit. p. 136.

Ins. Oahu. Aut.

Mountains of Oahu; generally on flowers of forest trees; rare.

178. *Brachypeplus striatus*, Shp. op. cit. 1881, p. 515.

Ins. Hawaii. Aut.

Occurs rather commonly in various mountain localities on Hawaii; generally at a considerable elevation (4000 feet or more). It is probably the representative on Hawaii of *B. spretus* on Maui, and *B. impressus* on Oahu.

179. *Brachypeplus bicolor*, Blackb., *ante*, p. 137.

Ins. Hawaii. Aut.

A single example was found under the bark of a tree on Mauna Loa, at an elevation of nearly 5000 feet.

180. *Brachypeplus impressus*, Shp. *op. cit.* 1878, p. 135.

Ins. Oahu. Aut.

Occasionally taken on flowers of trees in mountainous places near Honolulu.

Genus XLVII.—*Haptoncus*. Mun. Cat. III. p. 814.181. *Haptoncus tetragonus*, Murr. Mon. Nitid. p. 401. (?) Syn. *Epuræa* *ocularis*, Fairm. Essai sur les Col. de la Polynésie, p. 28.

Ins. Hawaii, Oahu, Kauai. (?) Maui, (?) Lanai. Int. Ceylon, Tahiti (?).

Occurred not rarely in decaying vegetable matter (especially fruit), at various elevations, on Kauai, Oahu, and Hawaii, and doubtless is found on all the other islands of the Hawaiian group.

182. *Haptoncus mundus*, Shp. Trans. Ent. Soc. Lond. 1878, II. p. 139.

Ins. Hawaii, Oahu, Kauai, var. (?) Imm.

Has been taken on Oahu and Hawaii, not very rarely, on flowers of forest trees on the mountains; generally occurs at an elevation of 1500 to 3000 feet above the sea.

Specimens which appear to be a small dark variety of this species occurred on Kauai under similar circumstances.

## Fam. MONOTOMIDÆ.

Genus XLVIII.—*Hesperobœnus*. Mun. Cat. III. p. 893.183. *Rhizophagus capito*, Fairm. Rev. Zool. 1850, p. 54.

Ins. Oahu, Kauai. (?) Hawaii, (?) Maui, (?) Lanai. Int. Tahiti.

Not common; occurs under bark in various localities on Kauai and Oahu, and is probably extant on the other islands.

## Fam. TROGOSITIDÆ.

Genus XLIX.—*Trogosita*. Mun. Cat. III. p. 841.184. *Tenebrio mauritanicus*, L. Syst. Nat. I. 2, p. 674.

Ins. Oahu. (?) Hawaii, (?) Maui, (?) Lanai, (?) Kauai. Int. Cosmopolite.

Common in Honolulu, and doubtless in other parts of the islands.

## Fam. COLYDIDÆ.

Genus L.—*Antilissus*. Shp. Trans. Ent. Soc. Lond. 1879, p. 87.

185. *Antilissus aper*, Shp. op. cit. p. 86.

Ins. Oahu. (?) Int. or imm.

Not rare; occurs under bark in various mountain localities on Oahu, but has not been found on the other islands.

Genus LI.—*Eulachus*. Mun. Cat. III. p. 860.

186. *Eulachus hispidus*, Blackb., *ante*, p. 141.

Ins. Oahu. (?) Int or imm.

A single example occurred near Honolulu, at an elevation of about 1000 feet.

## Fam. RHYSODIDÆ.

Genus LII.—*Clinidium*. Mun. Cat. III. p. 868.

187. *Rhyzodes liratus* (Newm.), Chev. Ann. Soc. Ent. Fr. 1873, p. 388.

Ins. Oahu. Int. Brazil.

"Honolulu" Chev.; unknown to us, and no doubt an accidental introduction which has not established itself.

## Fam. CUCUJIDÆ.

Genus LIII.—*Cryptamorpha*. Mun. Cat. III. p. 878.

188. *Psammæchus Desjardinsii*, Guer. Ic. Regn. An. Ins. p. 196.

Ins. Hawaii, Kauai, Oahu; (?) Maui, (?) Lanai. Imm. Widely distributed in islands.

Doubtless on all the islands; common in various kinds of localities. Usually appears to be connected with low herbage.

Genus LIV.—*Telephanus*. Mun. Cat. III. p. 874.

189. *Telephanus insularis*, Shp., *ante*, p. 143.

Ins. Oahu, Kauai. (?) Imm.

Rare; has been taken on three separate occasions, and appears to find its home at the roots of grass and other herbage, on the low ground not much above sea level.

190. *Telephanus pallidipennis*, Blackb., *ante*, p. 144.

Ins. Oahu. (?) Imm.

Unique; obtained by sweeping low herbage in the Pauoa valley, near Honolulu.

Genus LV.—*Læmophlœus*. Mun. Cat. III. p. 874.191. *Cucujus pusillus*, Schon. Syn. Ins. I. 3, p. 55.(?) Syn. *Læmophlœus brevis*, Fairm. Essai sur les Col. de la Polynesie, p. 83.

Ins. Oahu. (?) Int.

Not very uncommon near Honolulu. Its home appears to be in the burrows of *Apate castanoptera*, Fairm.192. *Læmophlœus æneus*, Shp., *ante*, p. 143.

Ins. Maui, Hawaii. (?) Imm.

Very rare. Has occurred several times, at an elevation of about 4000 to 5000 feet, on the higher mountains of Maui and Hawaii, in the crevices of bark. I rather suspect it of being connected with the burrows of *Clytarlus*, as I have always found them in the trees from which I have obtained this *Læmophlœus*.Genus LVI.—*Brontolæmus*. Shp., *ante*, p. 142.193. *Brontolæmus elegans*, Shp., *ante*, p. 142.

Ins. Oahu, Lanai, Kauai, (?) Hawaii (?) Maui (?) Imm.

Not at all common. Has been taken on Kauai, Oahu, and Lanai, running over the trunks of partially decayed trees like a longicorn. Probably occurs on all the islands.

Genus LVII.—*Monanus*. Shp. Trans Ent. Soc. Lond. 1879, p. 86.194. *Monanus crenatus*, Shp. op. cit. p. 85.

Ins. Oahu. (?) Imm.

Several specimens were taken on one occasion by beating the branches of a pandanus, near the Nuanu Pali.

195. *Monanus brevicornis*, Blackb., *ante*, p. 143.

Ins. Oahu. (?) Imm.

A batch of three specimens occurred in the decaying flowers of a banana, in the Pauoa valley.

Genus LVIII.—*Cathartus*. Mun. Cat. p. 880.196. *Cryptophagus advena*, Walt. Silb. Rev. Ent. II. p. 256.

Ins. Oahu. Int. Widely distributed.

Common in Honolulu. (?) Probably in other parts of the islands.

Genus LIX.—*Silvanus*. Mun. Cat. III. p. 878.197. *Dermestes surinamensis*, L. Syst. Nat. I. 2, p. 565.

Ins. Oahu, Lanai. Int. Widely distributed.

Common on Oahu, Lanai, and (probably) on the other islands.

198. *Dermestes unidentatus*, Fab. Syst. El. i. p. 317.

Ins. Oahu. Int. Europe.

Only once taken; on that occasion it occurred in some numbers under the bark of some native timber lying in Honolulu.

Genus LX.—*Nausibius*. Mun. Cat. iii. p. 880.199. *Corticaria dentata*, Marsh. Ent. Brit. p. 108.

Ins. Oahu. Int. Widely distributed.

Common in Honolulu, and widely distributed, doubtless over the whole group of islands wherever circumstances favour its introduction.

## Fam. CRYPTOPHAGIDÆ.

Genus LXI.—*Telmatophilus*. Mun. Cat. iii. p. 881.200. *Telmatophilus debilis*, Shp., *ante*, p. 145.

Ins. Oahu. (?) Imm.

At an elevation of about 2000 feet.

Genus LXII.—*Henoticus*. Th. Sk. Col. x. p. 67.201. *Cryptophagus serratus*, Gyll. Ins. Suec. i. p. 171.

Ins. Maui, Oahu. Int. Europe.

Rare; has occurred in small numbers on Maui and Hawaii, under bark, and flying in the evening. A single specimen, very pale in colour, taken on Oahu. May possibly be an extreme variety of this species.

## Fam. LATHRIDIIDÆ.

Genus LXIII.—*Lathridius*. Mun. Cat. iii. p. 896.202. *Lathridius nodifer*, Westw. Int. Class. Ins. i. p. 155.

Ins. Oahu, Hawaii. Int. Widely distributed.

Rare; has occurred under bark on Oahu and Hawaii, always at a considerable elevation above sea level.

## Fam. MYCETOPHAGIDÆ.

Genus LXIV.—*Litargus*. Mun. Cat. iii. p. 908.203. *Litargus vestitus*, Shp. Trans. Ent. Soc. Lond. 1879, p. 88.

Ins. Oahu, Lanai, Hawaii, (?) Maui, (?) Kanai. (?) Imm.

Doubtless occurs on all the islands. Appears to live in bark, at a considerable elevation above the sea.



Genus LXV.—*Typhæa*. Mun. Cat. III. p. 908.204.—*Dermestes fumatus*, Lin. Syst. Nat. I. 2, p. 564.

Ins. Oahu. Int.

Has occurred several times in dead wood in Honolulu.

Genus LXVI.—*Mycetæa*. Mun. Cat. III. p. 910.205. *Silpha hirta*, Marsh, Ent. Brit. I. p. 124.

Ins. Oahu. Int.

A single specimen was taken by beating branches of trees in the Pauoa valley, near Honolulu.

Genus LXVII.—*Propalticus*. Shp. Trans. Ent. Soc. Lond. 1879, p. 89.206. *Propalticus oculatus*, Shp. op. cit. p. 88.

Ins. Oahu, Maui. (?) Imm.

This probably occurs on all the other islands. In dead wood in all kinds of localities. Not rare but very difficult to capture, on account of its extremely agile saltatory powers.

## Fam. CORYLOPHIDÆ.

Genus LXVIII.—*Orthoperus*. Mun. Cat. XII. p. 3818.207. *Orthoperus æqualis*, Shp., *ante*, p. 128.

Ins. Hawaii. (?) Imm.

A single specimen occurred in the debris at the foot of a decaying stump of an *Acacia falcata*, at an elevation of about 4000 feet or more, on Mauna Loa.Genus LXIX.—*Sericoderus*. Mun. Cat. XII. p. 3819.208. *Sericoderus basalis*, Shp., *ante*, p. 127.

Ins. Oahu. (?) Imm.

Occurs in the salt marshes, on the plains of Oahu.

209. *Sericoderus pubipennis*, Shp., *ante*, p. 128.

Ins. Oahu, Maui. (?) Imm.

Various mountain localities, on Oahu and Maui.

Genus LXX.—*Corylophus*. Mun. Cat. XII. p. 3820.210. *Corylophus rotundus*, Shp., *ante*, p. 127.

Ins. Oahu. Imm. or int.

Honolulu.

211. *Corylophus suturalis*, Shp., *ante*, p. 127.

Ins. Oahu. (?) Imm.

Occurs at roots of grass on the Nuuanu Pali, at an elevation of about 2000 feet above the sea level

## Fam. EROTYLIDÆ.

Genus LXXI.—*Euxestus*. Mun. Cat. XII. p. 3686.212. *Euxestus minor*, Shp., *ante*, p. 145.

Ins. Oahu. (?) Imm.

In or under decaying wood (especially when it is attacked by mould or fungus), at various localities and various elevations above sea level, on Oahu.

Genus LXXII.—*Eidoreus*. Shp., *ante*, p. 146.213. *Eidoreus minutus*, Shp., *ante*, p. 146.

Ins. Oahu. (?) Imm.

## Fam. COCCINELLIDÆ.

Genus LXXIII.—*Neda*. Mun. Cat. III. p. 3769.214. *Coccinella abdominalis*, Say. Proc. Ac. Phil. IV. 1824, p. 95.Ins. Maui, Oahu, Kauai; (?) Hawaii, (?) Lanai. Int. North America, Mexico.  
Common in various localities.Genus LXXIV.—*Coccinella*. Mun. Cat. XII. p. 3748.

## 215. Sp. dub.

Ins. Oahu. Int.

N. B.—I have a single specimen of a *Coccinella* which I have not succeeded in identifying. It is considerably larger than *C. abdominalis*, and is black, with the antennæ, two small spots on the head, a large spot on the front of each side of the thorax, and a spot on the mesosternum on each side, yellow. The elytra are red, the suture and scutellum black, the space around the latter yellow. The probability of this specimen (which was taken in Honolulu) having been imported makes me hesitate to treat it as a previously undescribed species.—T. B.

Genus LXXV.—*Scymnus*. Mun. Cat. XII. p. 3791.216. *Scymnus vividus*, Shp., *ante*, p. 146.

Ins. Maui, Hawaii, Oahu. (?) Int.

Probably the rest of the islands. Generally found at the roots of herbage.

217. *Scymnus ocellatus*, Shp., *ante*, p. 147.

Ins. Maui, Oahu. (?) Int.  
Generally found on flowers.

218. *Scymnus discedens*, Shp., *ante*, p. 147.

Ins. Oahu. (?) Int.  
Twice found by sweeping.

## Fam. DERMESTIDÆ.

Genus LXXVI.—*Dermestes*. Mun. Cat. III. p. 913.219. *Dermestes cadaverinus*, Far. Schon. Syn. II. 85, 3.

Ins. Oahu, Maui, (?) Hawaii, (?) Lanai, (?) Kauai. Int. Widely distributed.  
Common in decaying animal matter on Oahu, Maui, and doubtless all the other islands, at various elevations.

220. *Dermestes vulpinus*, Fab. Sp. Ins. I. 64.

Ins. Hawaii, Oahu, Kauai. (?) Maui, (?) Lanai. Int. Widely distributed.  
Common on these islands, and doubtless all the other islands, in decaying animal matter at various elevations.

Genus LXXVII.—*Attagenus*. Mun. Cat. III. p. 915.221. *Attagenus plebius*, Shp., *ante*, p. 147.

Ins. Oahu. (?) Int.  
Not rare in houses in Honolulu.

Genus LXXVIII.—*Labrocerus*. Shp., *ante*, p. 148.222. *Labrocerus jaynei*, Shp., *ante*, p. 148.

Ins. Maui. (?) Imm.  
Taken by beating branches of trees on Haleakala, at an elevation of about 4000 feet. April and May.

223. *Labrocerus concolor*, Shp., *ante*, p. 149.

Ins. Hawaii. (?) Imm.  
Taken by beating branches of trees, at an elevation of about 6000 feet, on Mauna Loa.

224. *Labrocerus obscurus*, Blackb., *ante*, p. 149.

Ins. Hawaii. (?) Imm.  
Unique; Mauna Loa, at an elevation of about 6000 feet. May.

Genus LXXIX.—*Cryptorhopalum*. Mun. Cat. III. p. 919.

225. *Cryptorhopalum brevicorne*, Shp., *ante*, p. 150.

Ins. Oahu. (?) Int.

In houses, in the island of Oahu, and probably elsewhere.

226. *Cryptorhopalum terminale*, Shp., *ante*, p. 150.

Ins. Oahu, Kauai. (?) Int.

In houses, Kauai, Oahu, and probably elsewhere.

---

Fam. LUCANIDÆ.

Genus LXXX.—*Apteroicyclus*. Wat. Trans. Ent. Soc. Lond. 1871, p. 315.

227. *Apteroicyclus honoluluensis*, Wat. l. c.

Ins. Kauai. (?) Imm.

This insect was described on a specimen in the the British Museum from Mr. H. Harper Pease. It was taken on the mountains of Kauai, but I have not been able to find any trace of it there.

---

Fam. SCARABÆIDÆ.

Tribe COPRINI.

Genus LXXXI.—*Aphodius*. Mun. Cat. iv. p. 1042.

228. *Scarabeus lividus*, Ol. Ins. i. 3, 93, pl. 26, fig. 222.

Ins. Hawaii, Maui, Lanai, Oahu, Kauai. Int. Cosmopolite.

Common all over the islands.

Genus LXXXII.—*Atænius*. Mun. Cat. iv. p. 1066.

229. *Aphodius pacificus*, Shp. Trans. Ent. Ent. Soc. Lond. 1879, p. 90.

Ins. Oahu. (?) Int. (?) New Zealand.

Occurs in the neighbourhood of Honolulu, at various elevations.

230. *Atænius stercorator* (Fabr.), Horn, Tr. Am. Ent. Soc. III. p. 286.

Ins. Oahu. Int. Widely distributed.

Not rare in the neighbourhood of Honolulu; generally on the plains near sea level.

231. *Atænius peregrinator*, Har. Ann. Mus. Gen. x. p. 96.

Ins. Oahu. Int. Celebes, Borneo.

Four specimens occurred on the mountains, but at no great elevation, near Honolulu.

Genus LXXXIII.—*Saprosites*. Mun. Cat. iv. p. 1065.

232. *Saprosites pygmæus*, Har. op. cit. p. 91.

Ins. Oahu, Maui, (?) Hawaii, (?) Lanai, (?) Kauai. Int. or imm. Key Islands.

Probably on all the other islands. This species is seldom found at an elevation lower than 1500 feet. It has occurred on Maui, not much below 5000 feet.

Fam. EUCNEMIDÆ.

Genus LXXXIV.—*Fornax*. Mun. Cat. v. p. 1469.

233. *Fornax bonvouloiri*, Shp., *ante*, p. 151.

Ins. Oahu, Maui. (?) Imm.

Occurs in or on the bark of trees (usually *Acacia falcata*), at elevations varying from 1500 to 5000 feet. Probably occurs on other of the islands.

234. *Fornax sculpturatus*, Blackb., *ante*, p. 151.

Ins. Oahu. (?) Imm.

Unique; occurred on the Waianae Mountains, Oahu, under bark.

235. *Fornax obtusus*, Blackb., *ante*, p. 152.

Ins. Maui. (?) Imm.

Under bark on Haleakala, at an elevation of nearly 5000 feet. Two examples.

236. *Fornax longicornis*, Blackb., *ante*, p. 152.

Ins. Maui. (?) Imm.

Two examples, at an elevation of about 4000 feet, on Haleakala.

237. *Fornax parallelus*, Blackb., *ante*, p. 152.

Ins. Oahu. (?) Imm.

Unique; found in damp moss, near the summit of Konahuanui.

Fam. BUPRESTIDÆ.

Genus LXXXV.—*Buprestis*. Mun. Cat. v. p. 1377.

238. *Buprestis adjecta*, Lec. Proc. Ac. Phil. 1854, p. 17.

Ins. Oahu. Int. Oregon.

A single specimen occurred on a flower, near Honolulu.

## Fam. ELATERIDÆ.

## Tribe AGRYPNIDES.

Genus LXXXVI.—*Adelocera*. Mun. Cat. v. p. 1489.

239. *Agrypnus modestus*, Boisd. Voy. Astrol. Col. p. 108.

Ins. Oahu. Imm. Polynesia, &c. Widely distributed.

Common near Honolulu, and probably in other parts of the islands. It has been taken at various elevations and under different circumstances, but most frequently on the plains, and in or about decaying stems of cactus.

## Tribe CHALCOLEPIDIIDES.

Genus LXXXVII.—*Chalcolepidius*. Mun. Cat. v. p. 1502.

240. *Chalcolepidius erythroloma*, Cand. Mon. i. p. 282. Syn. *C. albertisi*  
Cand. Bull. Soc. Ent. Belg. 1878, p. 55.

Ins. Oahu. (?) Int. or imm. Chili. Ecuador.

Not common; occurs near Honolulu (generally on the mountains), and frequents the exuding sap of *Acacia falcata*.

## Tribe ELATERIDES VRAIS.

Genus LXXXVIII.—*Ischiodontus*. Mun. Cat. v. p. 1515.

241. *Ischiodontus hawaiiensis*, Cand. El. nouv: fasc. III. p. 42.

Int. (?)

“Sandwich Islands,” Cand. Unknown to us.

Genus LXXXIX.—*Simodactylus*. Mun. Cat. v. p. 1519.

242. *Æolus cinnamomeus*, Boisd. Voy. Astr. Col. p. 106.

Ins. Oahu. Imm. Polynesia.

Not uncommon on the mountains near Honolulu. Usually obtained by beating.

Genus XC.—*Melanoxanthus*. Mun. Cat. v. p. 1538.

243. *Elater melanocephalus*, Thunb. Nov. Ins. Spec. III. 1784, p. 63.

Ins. Oahu. Imm. Widely distributed.

Rather common in and around Honolulu; often taken flying; sometimes under bark of *acacia*.

Genus XCI.—*Eopenthes*. Shp., *ante*, p. 153.

244. *Eopenthes basalis*, Shp., *ante*, p. 153.

Ins. Oahu. Aut.

In the mountains near Honolulu.

245. *Elater humeralis*, Karsch. Berl. Ent. Zeit. xxv. p. 5, taf. i. f. 7.

Ins. Maui. Aut.

Stated to have been taken by Dr. Finsch on Maui, at a place called Olinda.

246. *Eopenthes obscurus*, Shp., *ante*, p. 154.

Ins. Oahu. Aut.

Also found in the mountains near Honolulu.

247. *Eopenthes konæ*, Blackb., *ante*, p. 154.

Ins. Hawaii. Aut.

A single example was taken on the wing, near Kona, at an elevation of about 5000 feet.

248. *Eopenthes satelles*, Blackb., *ante*, p. 155.

Ins. Lanai. Aut.

A single example taken by sweeping ferns, near Koele, at an elevation of about 2000 feet.

249. *Eopenthes debilis*, Shp., *ante*, p. 154.

Ins. Oahu. Aut.

Found by sweeping ferns, at an elevation of about 2500 feet, on the Waianae Mountains.

250. *Eopenthes ambiguus*, Blackb., *ante*, p. 155.

Ins. Oahu. Aut.

A single example was found by sweeping at the head of the Palolo valley, at an elevation of about 2000 feet.

Genus XCII.—*Itodacnus*. Shp., *ante*, p. 156.251. *Itodacnus gracilis*, Shp., *ante*, p. 156.

Ins. Oahu. (?) Imm. or aut.

Rare; obtained by beating branches of trees, at an elevation of 1500 to 2000 feet, at various places on the mountains of Oahu. July and September.

252. *Corymbites coruscus*, Karsch, Berl. Ent. Zeit. xxv. p. 5, taf. i. f. 6.

Ins. Maui. (?) Imm. or aut.

Olinda.

## Fam. MALACODERMIDÆ.

Genus XCIII.—*Helcogaster*. Mun. Cat. III. p. 1719.253. *Helcogaster pectinatus*, Shp., *ante*, p. 157.

Ins. Oahu. (?) Int.

Occasionally found in houses (generally crawling on the glass in the windows) in Honolulu.

Genus XCIV.—*Caccodes*. Shp., *ante*, p. 157.254. *Caccodes debilis*, Shp., *ante*, p. 157.

Ins. Oahu. (?) Int.

Usually found in houses in Honolulu; once crawling on a log of wood, close to a house.

## Fam. CLERIDÆ.

Genus XCV.—*Tarsostenus*. Mun. Cat. vi. p. 1740.255. *Clerus univittatus*, Rossi, Faun. Etr. i. p. 44.

Ins. Oahu. Int. Widely distributed.

Three specimens have occurred—all of them within a short distance of one spot in Honolulu, but at different times: two of them in spiders' webs; the other crawling on a window.

Genus XCVI.—*Necrobia*. Mun. Cat. vi. p. 1758.256. *Dermestes rufipes*. Fab. Syst. El. i. p. 286.

Ins. Hawaii, Maui, Lanai, Oahu, Kauai. Int. Widely distributed.

Plentiful in decaying animal matter all over the islands.

257. *Dermestes ruficollis*, Fab. Syst. Ent. p. 57.

Ins. Hawaii, Maui, Lanai, Oahu, Kauai. Int. Widely distributed.

Plentiful in decaying animal matter all over the islands.

## Fam. PTINIDÆ.

Genus XCVII.—*Holcobius*. Shp. Trans. Ent. Soc. Lond. 1881, p. 522.258. *Holcobius major*, Shp. op. cit. p. 521.

Ins. Maui. Aut.

Two specimens were taken from dead branches of trees, at an elevation of about 4000 feet, on Haleakala. April and May.

259. *Holcobius glabricollis*, Shp. op. cit. p. 520.

Ins. Oahu. Aut.

Two specimens were dug out of a koa tree in the Palolo valley, near Honolulu, at an elevation of about 1000 feet.

260. *Holcobius granulatus*, Shp. l. c.

Ins. Hawaii, Maui. Aut.

Not uncommonly to be met with by beating dead branches of trees, on the mountains of Maui and Hawaii, at elevations varying from 3500 to 6000 feet. April and May.

Genus XCVIII.—*Xyletobius*. Shp. op. cit. p. 519.261. *Xyletobius insignis*, Blackb., *ante*, p. 158.

Ins. Hawaii. Aut.

Unique; occurred at an elevation of about 4000 feet on Mauna Loa.



262. *Xyletobius oculatus*, Shp. Trans. Ent. Soc. Lond. 1881, p. 519.

Ins. Hawaii. Aut.

Obtained by beating dead branches of trees on Mauna Loa, at an elevation of 4000 feet. February.

263. *Xyletobius nigrinus*, Shp. op. cit. p. 518.

Ins. Maui. Aut.

Obtained by beating dead branches of trees, at an elevation of 4000 to 5000 feet, on Haleakala. February.

264. *Xyletobius marmoratus*, Shp. op. cit. p. 517.

Ins. Maui. Aut.

Not rare on Haleakala, at an elevation of 4000 to 5000 feet. Obtained by beating dead branches of trees. April and May.

265. *Xyletobius affinis*, Shp., *ante*, p. 158.

Ins. Hawaii. Aut.

A short series was taken from dead wood, at an elevation of about 6000 feet, on Mauna Loa. May.

266. *Xyletobius serricornis*, Blackb., *ante*, p. 159.

Ins. Lanai. Aut.

Unique; obtained by beating dead wood, at an elevation of about 2000 feet, near a place called Koele.

267. *Xyletobius lineatus*, Shp., *ante*, p. 159.

Ins. Hawaii. Aut.

Two specimens were obtained by beating dead wood, at an elevation of about 6000 feet, on Mauna Loa. May.

268. *Tripopitys capucinus*, Karsch, Berl. Ent. Zeit. xxv. p. 6, taf. i. f. 8.

Ins. Maui. Aut.

Olinda. The genus to which this should be ascribed is not quite certain, but if not *Xyletobius* it will be near to it.Genus XCIX.—*Anobium*. Mun. Cat. vi. p. 1771.269. *Dermestes paniceus*, L. Faun. Suec. p. 145.

Ins. Oahu. Int. Widely distributed.

Several specimens were taken in the city of Honolulu, in decaying timber. October.

Genus C.—*Lasioderma*. Mun. Cat. vi. p. 1781.270. *Ptinus serricornis*, Fab. Ent. Syst. i. p. 241.

Ins. Oahu, Kaai. Int. Widely distributed.

Plentiful in Honolulu; frequently found in cigars. A single example was found on Kauai in July.

Genus CI.—*Catorama*. Mun. Cat. vi. p. 1784.271. *Catorama mexicana*, Chev. in litt.

Ins. Maui. Int. Mexico.

Common on Maui, in houses and in decaying trees, near sea level.

272. *Catorama pusilla*, Shp., *ante*, p. 160.

Ins. Maui. (?) Int.

Two specimens occurred on Maui.

Genus CII.—*Mirosternus*. Shp. Trans. Ent. Soc. Lond. 1881, p. 526.273. *Mirosternus punctatus*, Shp. op. cit. p. 522.

Ins. Oahu. Aut.

Found by beating dead branches of trees on the Waianae mountains, at an elevation of 2000 or 3000 feet. July.

274. *Mirosternus obscurus*, Shp. op. cit. p. 523.

Ins. Oahu. Aut.

Found in company with *M. punctatus*.275. *Mirosternus muticus*, Shp. l. c.

Ins. Hawaii, Maui. Aut.

Occurs at elevations varying from 2000 to 6000 feet above sea level, and is taken by beating dead branches of trees on the mountains of Maui and Hawaii.

N. B. The original specimens occurred on Hawaii; more recently, however, a specimen was taken on Maui, which does not appear to differ from them sufficiently decisively (though it is evidently larger) to be treated as distinct.

276. *Mirosternus carinatus*, Sh. op. cit. p. 524.

Ins. Maui. Aut.

Not rare on Haleakala, where it is obtained by beating dead branches of trees, at an elevation of 4000 to 5000 feet.

277. *Mirosternus glabripennis*, Shp. l. c.

Ins. Oahu. Aut.

Obtained by beating dead branches of trees, at an elevation of about 1000 feet, on the Waianae mountains.

278. *Mirosternus debilis*, Shp. op. cit. p. 525.

Ins. Oahu. Aut.

In company with the preceding.

279. *Mirosternus bicolor*, Shp. l. c.

Ins. Oahu. Aut.

Also in company with *M. glabripennis*, Shp. Two specimens occurred.280. *Mirosternus acutus*, Blackb., *ante*, p. 160.

Ins. Kauai. Aut.

Unique; obtained by beating dead branches, at an elevation of about 2000 feet.

## Fam. BOSTRICHIDÆ.

Genus CIII.—*Bostrichus*. Mun. Cat. vi. p. 1791.281. *Bostrichus migrator*, Shp., *ante*, p. 160.

Ins. Oahu. Int. Nicaragua.

Not rare in various localities on Oahu; generally in houses or decaying trunks of trees. Probably occurs on other islands also.

Genus CIV.—*Apate*. Mun. Cat. vi. p. 1788.282. *Apate lifuana*, Mont. Ann. Soc. Ent. Fr. 1861, p. 267.

Ins. Oahu. Int. or imm. Ins. Lifu.

About equally common with the preceding, and like it found in various localities on Oahu. Once found rather commonly in burrows in acacia.

Genus CV.—*Xylopertha*. Mun. Cat. vi. p. 1790.283. *Apate castanoptera*, Fairm. Essai sur les Col. de la Polynesie, p. 77.

Ins. Oahu. Imm. or int. Widely distributed.

Generally found in burrows, or channels, in various species of acacia. Taken on Oahu only, but probably occurring on others of the islands. The Munich Catalogue records this insect under the name of *X. minuta*, Fab.Genus CVI.—*Rhyzopertha*. Mun. Cat. vi. p. 1792.284. *Rhyzopertha pusilla*, Steph. Ill. Brit. Ent. III. p. 354.

Ins. Oahu. Int. Widely distributed.

Two specimens occurred near Honolulu, but the exact particulars of the capture have been lost.

Genus CVII.—*Lyctus*. Mun. Cat. vi. 1793.285. *Xylotrogus brunneus*, Steph. Ill. Brit. Ent. III. p. 117.

Ins. Oahu. Int. Widely distributed. Rare.

## Fam. CIOIDÆ.

Genus CVIII.—*Cis*. Mun. Cat. vi. p. 1796.286. *Cis alienus*, Shp. Trans. Ent. Soc. Lond. 1879, p. 91.

Ins. Oahu. (?) Imm.

Two specimens occurred in decaying wood, on the mountains, near Honolulu.

287. *Cis pacificus*, Shp. l. c.

Ins. Oahu. Aut.

Not rare in fungi, on the trunks of trees, in mountain forests.

288. *Cis porcatus*, Shp. op. cit. p. 92.

Ins. Hawaii, Oahu, Kauai. (?) Maui (?) Lanai. Aut.  
Occurs in decaying wood, on the mountains.

289. *Cis bimaculatus*, Shp., *ante*, p. 161.

Ins. Hawaii, Maui. Aut.  
Found rarely on the higher mountains.

290. *Cis nigrofasciatus*, Blackb., *ante*, p. 162.

Ins. Lanai. Aut.  
Unique; beaten from dry wood, at an elevation of about 2000 feet, on the mountains of Lanai, near a place called Koele.

291. *Cis signatus*, Shp. Trans. Ent. Soc. Lond. 1879, p. 92.

Ins. Hawaii, Maui, Oahu. (?) Lanai (?) Kauai.  
Also probably others of the islands. Generally obtained by beating dry wood, at a considerable elevation, on the mountains.

292. *Cis attenuatus*, Shp., *ante*, p. 165.

Ins. Kauai. Aut.  
On the mountains.

293. *Cis bicolor*, Shp. Trans. Ent. Soc. Lond. 1879, p. 93. Var. (?) *C. tabidus*, Shp. l. c.

Ins. Hawaii, Maui, Oahu, Kauai. Aut.  
Not uncommon in decaying wood, on the mountains.

294. *Cis setarius*, Shp., *ante*, p. 162. Var. (?) *C. apicalis*, Shp. l. c.

Ins. Hawaii. Aut.  
Not rare in decayed wood, on the mountains of Hawaii, at an elevation of 4000 to 7000 feet.

295. *Cis concolor*, Shp., *ante*, p. 163.

Ins. Hawaii. Aut.  
Rare; occurs at an elevation of about 6000 feet, on Mauna Kea. May.

296. *Cis chloroticus*, Shp., *ante*, p. 164.

Ins. Maui. Aut.  
Rare; taken in dead wood, at an elevation of about 4000 feet, on Haleakala.

297. *Cis calidus*, Shp., *ante*, p. 164.

Ins. Oahu. Aut.  
Two specimens have been taken in dead wood in different localities, but both at an elevation of about 2000 feet, on the mountains.

298. *Cis insularis*, Shp., *ante*, p. 164.

Ins. Oahu. Aut.  
Three specimens have been taken at different times, in dead wood, on the mountains.

299. *Cis roridus*, Shp., *ante*, p. 165.

Ins. Hawaii. Aut.

Two specimens were taken from dead wood, at an elevation of about 3000 feet, on the mountains near Waimea.

300. *Cis diminutivus*, Shp. Trans. Ent. Soc. 1879, p. 94.

Ins. Oahu. Aut.

Two specimens were taken by beating dry branches of trees on Konahuanu

301. *Cis læticulus*, Shp. l. c.

Ins. Oahu. Aut.

Occurs near Honolulu, but the exact particulars of the capture have been lost.

302. *Cis longipennis*, Blackb., *ante*, p. 162.

Ins. Kauai. Aut.

Unique; found in decayed wood, on Waialeale, at an elevation of about 2000 feet.

303. *Cis evanescens*, Shp. Trans. Ent. Soc. Lond. 1179, p. 95.

Ins. Oahu, Kauai. Aut.

Found in decaying wood, in forests, on the mountains.

304. *Cis ephistemoides*, Shp., *ante*, p. 165.

Ins. Oahu, Kauai, Lanai, (?) Hawaii, (?) Maui.

Also probably the other islands. Occurs in decaying wood, at a considerable elevation, on the mountains. The specimen from Lanai is markedly larger than the others.

305. *Cis vagepunctatus*, Blackb., *ante*, p. 166.

Ins. Oahu. Aut.

Unique; a single specimen was obtained from decaying wood on the mountains, near Honolulu.

## Fam. TENEBRIONIDÆ.

## Tribe EPITRAGINI.

Genus CIX.—*Epitragus*. Mun. Cat. VII. p. 1840.306. *Epitragus diremptus*, Karsch, Berl. Ent. Zeit. xxv. p. 6.

Ins. Maui, Oahu, Kauai, (?) Hawaii, (?) Lanai. (?) Imm. (?) South America.

And probably all the rest of the islands. Common under stones near the sea level, and also various other kinds of places.

## Tribe OPATRINI.

Genus CX.—*Opatrum*. Mun. Cat. VII. p. 1930.307. *Opatrum seriatum*, Bois. Voy. Astr. Col. p. 252.

Ins. Kauai, Oahu, Molokai, Lanai, Maui, Hawaii. Imm. Radack Islands.

Generally found under stones, not much above sea level.

## Tribe DIAPERINI.

Genus CXI.—*Platydema*. Mun. Cat. vii. p. 1950.308. *Platydema obscurum*, Shp., *ante*, p. 166.

Ins. Oahu. (?) Imm.

At various elevations, and in various localities; generally under stones.

## Tribe ULOMINI.

Genus CXII.—*Gnathocerus*. Mun. Cat. vii. p. 1957.309. *Trogosita cornuta*, Fab. Ent. Syst. Supp. p. 51.

Ins. Oahu. Int. Widely distributed.

Common in Honolulu, in flour, &amp;c.

Genus CXIII.—*Tribolium*. Mun. Cat. vii. p. 1958.310. *Tenebrio ferrugineus*, Fab. Sp. Ins. i. p. 324.]

Ins. Oahu. Int. Widely distributed.

Common in Honolulu, in flour, &amp;c.

Genus CXIV.—*Alphitobius*. Mun. Cat. vii. p. 1962.311. *Tenebrio diaperinus*, Panz. Ins. Germ. 37, 16.

Ins. Maui, Oahu. (?) Hawaii, (?) Lanai, Kauai. Int. Widely distributed.

Also probably other islands. Frequently found in flour, &amp;c.; also under stones.

312. *Helops piceus*, Ol. Ent. iii. 58, p. 17. Syn. *Heterophaga mauritanica*, Fairm. Rev. Zool. 1849, p. 446.

Ins. Kauai, Oahu, Lanai. (?) Hawaii, (?) Maui. Int. Widely distributed.

Doubtless occurs on the other islands. Plentiful in all kinds of produce; also under stones.

Genus CXV.—*Sciophagus*. Shp., *ante*, p. 167.313. *Heterophaga pandanicola* (Esch.) Fairm. Rev. Zool. 1849, p. 446.

Ins. Oahu, Kauai. (?) Hawaii, (?) Maui, (?) Lanai. Int. Polynesia.

Also probably other islands; generally found under bark or in decaying wood, especially of the pandanus. Also found under stones. Has not occurred much above sea level.

## Fam. CISTELIDÆ.

Genus CXVI.—*Labetis*. Waterh. Ent. Mo. Mag. xv. p. 267.314. *Labetis tibialis*, Waterh. l. c. et *ante*, p. 167.

Ins. Oahu. (?) Imm.

A single pair occurred on the mountains of Oahu, at an elevation of about 1500 feet, in localities twenty miles apart. They were obtained by beating branches of trees.

Genus CXVII.—*Cistela*. Mun. Cat. VII. p. 2046.

315. *Cistela crassicornis*, Shp., *ante*, p. 168.

Ins. Oahu. (?) Imm.

A pair of this was taken, but in widely separated localities, on Oahu, by beating branches of trees, at an elevation of about 1500 feet.

Fam. ANTHICIDÆ.

Genus CXVIII.—*Anthicus*. Mun. Cat. VII. p. 2092.

316. *Anthicus oceanicus*, Laferté, Mon. Anth. p. 170.

Ins. Maui, Oahu, Kauai. (?) Hawaii, (?) Lanai. (?) Imm. Marquesas.

Probably also on the other islands. Common on the sea-shore, near high-water mark.

317. *Anthicus mundulus*, Shp., *ante*, p. 168.

Ins. Oahu, Kauai. (?) Hawaii, (?) Maui, (?) Lanai. (?) Imm.

Probably exists on the other islands. Usually found about salt marshes, near sea level.

Fam. CÆDEMERIDÆ.

Genus CXIX.—*Ananca*. Mun. Cat. VII. p. 2168.

318. *Ananca collaris*, Shp., *ante*, p. 169.

Ins. Oahu. (?) Int.

Common near Honolulu—usually taken at light—occasionally on flowers, especially of the exotic eucalypti.

Fam. AGLYCYDERIDÆ.

Genus CXX.—*Proterhinus*. Shp. Trans. Ent. Soc. Lond. 1878, p. 20.

319. *Proterhinus paradoxus*, Shp. op. cit. 1879, p. 100.

Ins. Oahu. Aut.

Two examples occurred in bark of a tree in a mountain forest, near Honolulu.

320. *Proterhinus longulus*, Shp. op. cit. p. 97.

Ins. Oahu. Aut.

Found in stems of fern growing on the mountains near Honolulu, at an elevation of about 1500 feet.

321. *Proterhinus linearis*, Blackb., *ante*, p. 169.

Ins. Kauai. Aut.

Unique.

322. *Proterhinus blackburni*, Shp. Trans. Ent. Soc. Lond. 1878, p. 17.

Ins. Oahu. (Var.) Oahu, Lanai. Aut.

The specimens first described were beaten from branches of trees near Honolulu, at an elevation between 1500 to 2000 feet. The examples subsequently obtained on the Waianae mountains, Oahu, and on Lanai, Mr. Blackburn thinks connect *P. hystrix* with this species.

323. *Proterhinus hystrix*, Shp. op. cit. 1881, p. 527.

Ins. Hawaii. Aut.

Found at an elevation of more than 4000 feet.

324. *Proterhinus pusillus*, Shp. op. cit. 1879, p. 97.

Ins. Oahu. Aut.

Several examples have been beaten from branches of trees, on the mountains near Honolulu, 1500 to 2000 feet. A single specimen taken on the Waianae mountains, Oahu, is possibly a variety, but more probably a new species.

325. *Proterhinus simplex*, Shp. op. cit. 1878, p. 17. Var. (?) *P. obscurus*, Shp. op. cit. p. 18.

Ins. Oahu. Aut.

Oahu; not uncommon on the mountains near Honolulu. Occurs in the bark of trees, at an elevation of about 1500 to 2000 feet. A very closely allied species, or constant variety, occurs on the Waianae mountains, Oahu, but there are not forthcoming sufficiently good specimens to enable it to be dealt with satisfactorily.

326. *Proterhinus scutatus*, Blackb., *ante*, p. 169.

Ins. Kauai. Aut.

Taken by beating branches of trees, at an elevation of about 4000 feet, near a place called Makawele.

327. *Proterhinus similis*, Blackb., *ante*, p. 170.

Ins. Hawaii. Aut.

Taken by beating branches of trees, at elevations of 3000 to 6000 feet, on the mountains of Hawaii.

328. *Proterhinus tarsalis*, Blackb., *ante*, p. 171.

Ins. Hawaii. Aut.]

A short series was taken by beating branches of trees, at an elevation of about 6000 feet, on Mauna Loa, Hawaii.

329. *Proterhinus gracilis*, Shp. Trans. Ent. Soc. Lond. 1881, p. 529.

Ins. Hawaii. Aut.

Occurs in bark of trees on Mauna Loa, at an elevation of about 4000 feet.



330. *Proterhinus debilis*, Shp. op. cit. 1878, p. 19.

Ins. Oahu, Hawaii. Aut.

The original specimens of this insect were taken on the Waianae mountains, Oahu; subsequently a series apparently identical, or nearly so, occurred at various elevations and in various localities, on the mountains of Hawaii.

331. *Proterhinus oscillans*, Shp. op. cit. p. 18.

Ins. Oahu. Aut.

Taken by beating branches of trees, at an elevation of about 2000 feet, on the mountains near Honolulu.

332. *Proterhinus punctipennis*, Shp. op. cit. 1881, p. 530.

Ins. Maui. Aut.

Four specimens of this insect were taken by beating branches of trees, at an elevation of about 4000 feet, on Haleakala.

333. *Proterhinus laticollis*, Blackb., *ante*, p. 170.

Ins. Oahu. Aut.

A single specimen of this insect was beaten from an acacia on the Waianae mountains.

334. *Proterhinus robustus*, Blackb., *ante*, p. 171.

Ins. Oahu. Aut.

A single specimen of this insect was taken on the Waianae mountains.

335. *Proterhinus integer*, Shp., *ante*, p. 172.

Ins. Lanai. Aut.

Taken by beating branches of trees near a place called Koele, at an elevation of about 2000 feet, on the mountains of Lanai.

336. *Proterhinus humeralis*, Shp. Trans. Ent. Soc. Lond. 1879, p. 96.

Ins. Maui. Aut.

Not rare on Haleakala, at an elevation of 4000 to 5000 feet, Obtained by beating branches of trees.

337. *Proterhinus ineptus*, Shp., *ante*, p. 171.

Ins. Lanai. Aut.

Occurs (not rarely) on the bark of trees, on the mountains of Lanai,

338. *Proterhinus angularis*, Shp. Trans. Ent. Soc. Lond. 1881, p. 530.

Ins. Oahu. Aut.

Taken by beating trees on the mountains, near Honolulu.

339. *Proterhinus nigricans*, Shp. op. cit. 1879, p. 95. Var. (?) *P. collaris*,  
Shp. op. cit. p. 96.

Ins. Kauai. Aut.

Taken by beating branches of trees in the forests, at an elevation of about 3000 feet, on Waialeale, Kauai.

340. *Proterhinus vestitus*, Shp. op. cit. 1878, p. 16.

Ins. Oahu. Aut.

Not uncommon on the mountains near Honolulu, at elevations varying from 1000 to 3000 feet. Generally obtained by beating branches of trees. Particularly common near the head of the Palolo valley.

341. *Proterhinus detritus*, Shp., *ante*, p. 172.

Ins. Lanai. Aut.

Taken by beating branches of trees on the mountains of Lanai. Not common.

342. *Proterhinus longicornis*, Shp., *ante*, p. 172.

Ins. Lanai. Aut.

Occurs on the mountains of Lanai, near Koele, at an elevation of about 2500 feet. Not common.

343. *Proterhinus sternalis*, Shp. Trans. Ent. Soc. Lond. 1879, p. 98.

Ins. Maui. Aut.

Occurs, not very rarely, in the bark of dead branches of trees, at an elevation of about 4000 feet, on Haleakala.

344. *Proterhinus basalis*, Shp. l. c.

Ins. Kauai. Aut.

Three specimens were taken by beating dead wood, at an elevation of about 3000 feet, on Waialeale.

345. *Proterhinus dispar*, Shp. op. cit. 1881, p. 528.

Ins. Oahu. Aut.

Not rare on the mountains above the head of the Palolo valley, Oahu. The tree on which it occurs is one unknown to me by name.

346. *Proterhinus validus*, Shp. op. cit. p. 531.

Ins. Maui. Aut.

Rare; occurs in the bark of *Acacia falcata*, at an elevation of about 4000 feet, on Haleakala.

347. *Proterhinus insignis*, Shp., *ante*, p. 172.

Ins. Lanai. Aut.

Occurs rarely in the bark of trees, on the mountains of Lanai, at an elevation of 2000 to 3000 feet.

348. *Proterhinus lecontei*, Shp. Trans. Ent. Soc. Lond. 1879, p. 99.

Ins. Maui. Aut.

Not rare in the bark of a tree (unknown to me by name) on Haleakala, at an elevation of about 4000 feet.

## Fam. CURCULIONIDÆ.

## Tribe OTIORHYNCHINI.

Genus CXXI.—*Rhyncogonus*. Shp., *ante*, p. 176.349. *Rhyncogonus blackburni*, Shp., *ante*, p. 177.

Ins. Oahu. (?) Imm.

Rare; six specimens in all have occurred in the Pauoa and Palolo valleys, at elevations of about 1500 feet above the sea. They were found on the branches of trees.

350. *Rhyncogonus vestitus*, Shp., *ante*, p. 177.

Ins. Maui. (?) Imm.

Not rare on a maritime plant growing on the sandhills, on the isthmus connecting East and West Maui. February.

## Tribe CYLADINI.

Genus CXXII.—*Cylas*. Mun. Cat. VIII. p. 2458.351. *Cylas turcipennis*, Boh. Sch. Gen. Curc. I. p. 369.

Ins. Maui, Oahu. (?) Hawaii, (?) Lanai, (?) Kauai. Imm. Widely distributed.

Probably to be found on all the other islands. Common in sandy places near the sea-shore.

## Tribe CRYPTORHYNCHINI.

Genus CXXIII.—*Acalles*. Mun. Cat. VIII. p. 2555.352. *Acalles lateralis*, Shp., *ante*, p. 178.

Ins. Oahu. (?) Imm. or aut.

Taken by beating branches of trees (generally *Aleurites triloba*), at an elevation of about 1500 feet, on the mountains.353. *Acalles duplex*, Shp., *ante*, p. 178.

Ins. Oahu. (?) Imm. or aut.

Not uncommon on trees in the mountain forests near Honolulu.

354. *Acalles angusticollis*, Shp., *ante*, p. 179.

Ins. Oahu, Maui, Kauai, Lanai. (?) Imm. or aut.

The original specimens were taken on Oahu. Examples, incapable of being satisfactorily distinguished, have since occurred on Kauai, Maui, and Lanai; it is very probable, however, that the examination of a long series from various localities, all in good condition, would lead to the distinction of several species now included under the name of *A. angusticollis*.355. *Acalles decoratus*, Blackb., *ante*, p. 180.

Ins. Lanai. (?) Imm. or aut.

Unique; taken by beating, at an elevation of about 2000 feet, on the mountains of Lanai.

356. *Acalles mauiensis*, Blackb., *ante*, p. 181.

Ins. Maui, Lanai (var.). Imm. or aut.

Taken by beating, at an elevation of about 4000 feet, on Haleakala, Maui. The specimen from Lanai mentioned in the "Descriptions" (vide *ante*, p. 180) as closely allied to it, is probably a distinct species.

357. *Acalles ignotus*, Blackb., *ante*, p. 180.

Ins. Oahu. (?) Imm. or aut.

Unique; taken on Oahu, but the account of the capture is not particularly recorded.

Genus CXXXIV.—*Chænosternum*. Blackb., *ante*, p. 181.358. *Chænosternum konanum*, Blackb., *ante*, p. 182.

Ins. Oahu. (?) Imm. or aut,

Unique; taken near Honolulu, Oahu.

Genus CXXXV.—*Hyperomorpha*. Blackb., *ante*, p. 182.359. *Hyperomorpha squamosa*, Blackb., *ante*, p. 183.

Ins. Oahu. (?) Imm. or aut,

Unique; occurred in very wet moss, on the margin of a mountain stream, in the Pauoa valley.

## Tribe CALANDRINI.

Genus CXXXVI.—*Sphenophorus*. Mun. Cat. VIII. p. 2646.360. *Calandra obscura*, Boisd. Voy. Astr. II. p. 448, Fairm. Rev. Zool. 1849, p. 474.

Ins. Oahu. Int. Tahiti, New Ireland.

In the stems of banana, on the mountains. This insect is apparently omitted in the Munich Catalogue of Coleoptera.

Genus CXXXVII.—*Calandra*. Mun. Cat. VIII. p. 2653.361. *Calandra remota*, Shp., *ante*, p. 183.

Ins. Oahu. (?) Imm.

Rather common in decaying wood, especially stems of cactus and banana, at various elevations.

362. *Calandra linearis*, var. *striata*, Thunb. Nov. Act. Ups. VII. p. 112.

Ins. Oahu. Int. Widely distributed.

Plentiful in decaying tamarinds, near Honolulu.

363. *Curculio oryzæ*, Linn. Amœn. Ac. VI. p. 395.

Ins. Oahu. Int. Cosmopolite.

Honolulu; excessively abundant in flour, sugar, and almost all other edibles.

## Tribe COSSONINI.

Genus CXXVIII.—*Heteramphus*. Shp., *ante*, p. 188.364. *Heteramphus wollastoni*, Shp., *ante*, p. 187.

Ins. Oahu. Aut.

Not rare in the stems of a species of lily growing at an elevation of about 2500 to 3000 feet, on some of the mountain ridges near Honolulu.

365. *Heteramphus foveatus*, Shp., *ante*, p. 188.

Ins. Oahu. Aut.

Occurs in company with the preceding.

366. *Heteramphus hirtellus*, Shp., *ante*, p. 189.

Ins. Oahu. Aut.

Unique; taken by sifting dead leaves and debris in the Pauoa Valley,

367. *Heteramphus cylindricus*, Shp., *ante*, p. 189.

Ins. Oahu. Aut.

Two specimens occurred in company with *H. wollastoni*.Genus CXXIX.—*Pentarthrum*. Mun. Cat. VIII. p. 2657.368. *Pentarthrum prolixum*, Shp. Trans. Ent. Soc. Lond, 1878, p. 25.

Ins. Hawaii, Oahu, (?) Maui, (?) Lanai, (?) Kauai. (?) Aut.

Rare; Oahu, Hawaii, and (probably) others of the islands. In the stems of ferns growing in the mountain forests.

369. *Pentarthrum obscurum*, Shp. l. c.

Ins. Oahu. (?) Aut.

Occurs in various mountain localities in decaying wood. Not very rare.

370. *Pentarthrum blackburni*, Shp. op. cit. p. 26.

Ins. Oahu. (?) Aut.

Rare; occurs in decaying wood on the plains near Honolulu.

Genus CXXX.—*Oodemas*. Mun. Cat. VIII. p. 2659.371. *Oodemas olindæ*, Blackb. Ent. Mo. Mag. XVII. p. 199.

Ins. Oahu. Aut.

Rare; occurs in dead branches of trees near Olinda, on Haleakala, Maui, at an elevation of about 4000 feet.

372. *Oodemas robustum*, Blackb. Ann. Soc. Ent. Belg. XXI. p. 75.

Ins. Oahu. Aut.

Rare; two specimens were taken out of dead wood on the Waianae Mountains, Oahu.

*N.B.*—In the original description of this insect (Annales de la Soc. Ent. de Belgique, 1878, p. 75), by some accidental error stated to have occurred in Maui; but there is no evidence of its having actually done so.

373. *Oodemias nivicola*, Blackb. op. cit. p. 74.

Ins. Oahu. Aut.

Has been taken at various elevations (from 4000 to 10,000 feet above the sea) on Haleakala. is usually found under stones, and probably feeds on the stems or roots of some small plant.

374. *Oodemias infernum*, Blackb. Ent. Mo. Mag. xvii. p. 199.

Ins. Hawaii. Aut.

A short series was taken from the trunk of an acacia, on Mauna Loa, Hawaii, at an elevation of about 4000 feet, and very near the crater "Kilauea."

375. *Oodemias insulare*, Blackb. Ann. Soc. Ent. Belg. xxi. p. 74.

Ins. Oahu. Aut.

Very rare. Has been taken singly three or four times on Oahu, generally in the Mauna Loa valley. It appears to be connected with a fruit-bearing tree known in the Hawaiian language as the "Ohia."

376. *Oodemias ænescens*, Boh. Eug. Res. p. 138, t. 2, f. 6.

Ins. Oahu. Aut.

Very plentiful in all kinds of localities above about 800 feet high, on Oahu. Generally found in decaying wood, under bark, or under stones. Has not been found on any other island.

377. *Oodemias sculpturatum*, Blackb. Ann. Soc. Ent. Belg. xxi. p. 74.

Ins. Maui. Aut.

Rather common in the decaying wood of acacia falcata on Haleakala, Maui, at an elevation of 4000 or 5000 feet.

378. *Oodemias obscurum*, Blackb. op. cit. p. 75. *O. substrictum*, Blackb. Ent. Mo. Mag. xvii. p. 200.

Ins. Maui. Aut.

Not rare on Haleakala, Maui, at an elevation of 2500 to 4000 feet. In dead wood.

379. *Oodemias tardum*, Blackb., *ante*, p. 184.

Ins. Maui. Aut.

Not common; occurs on Haleakala, Maui.

380. *Oodemias æquale*, Blackb., *ante*, p. 184.

Ins. Lanai. Aut.

Taken in dead wood, at an elevation of about 2500 feet.

381. *Oodemias crassicorne*, Blackb., *ante*, p. 184.

Ins. Lanai. Aut.

In similar localities to the preceding.

382. *Oodemias halticoides*, Blackb. Ent. Mo. Mag. xiv. p. 5.

Ins. Oahu. Aut.

Occurs in dead wood at elevations of 2000 to 3000 feet above the sea, but not commonly.

383. *Oodemias angustum*, Blackb. Ann. Soc. Ent. Belg. xxi. p. 75.

Ins. Oahu. Aut.

Unique; the single specimen was taken on the Waianae mountains.

384. *Oodemias borrei*, Blackb. l. c.

Ins. Maui. Aut.

A short series was taken from the stems of a low plant, to the best of my belief, growing at an elevation of about 4000 feet, on Haleakala; but, unfortunately, the capture is not recorded with greater detail than the mention of the locality.

385. *Oodemias mauicense*, Blackb. l. c.

Ins. Maui. Aut.

Haleakala, at an elevation of about 4000 to 5000 feet, February.

Genus CXXXI.—*Anotheorus*. Blackb. Ent. Mo. Mag. xiv. p. 5.

386. *Anotheorus montanus*, Blackb. op. cit. p. 5.

Ins. Oahu. Aut.

Occurs rarely in bark of trees in the mountain forests near Honolulu.

387. *Anotheorus ignavus*, Blackb. op. cit. xvii. p. 201.

Ins. Maui. Aut.

Rare; occurs in the bark of acacia at an elevation of 4000 feet or more on Haleakala, Maui.

Genus CXXXII.—*Pseudolus*. Shp., *ante*, p. 190.

388. *Rhyncolus longulus*, Boh. Eug. Res. p. 149.

Ins. Oahu, Maui, (?) Aut.

Oahu (various localities), Maui and (probably) others of the islands. This species is rather common in bark and decaying wood, especially of cactus.

Genus CXXXIII.—*Phlæophagosoma*. Woll. Trans. Ent. Soc. Lond. 1873, p. 23.

389. *Rhyncolus tenuis*, Gem. Mun. Cat. viii. p. 2667. Syn. *Rhyncolus gracilis*, Boh. Eug. Res. p. 149.

Ins. Oahu. Aut.

Rare.

Genus CXXXIV.—*Dolichotelus*. Blackb., *ante*, p. 190.

390. *Dolichotelus apicalis*, Blackb., *ante*, p. 191.

Ins. Oahu. (?) Aut.

A single specimen occurred in the Kalihi Valley, near Honolulu, in the trunk of a pandanus.

Genus CXXXV.—*Dryophthorus*. Mun. Cat. viii. p. 2657.

391. *Dryophthorus squalidus*, Shp. Trans. Ent. Soc. Lond. 1878, p. 22.

Ins. Maui, Oahu, Kauai. (?) Hawaii. (?) Lanai. (?) Aut.

Probably occurs in all the other islands. In decaying timber on the mountains at an elevation of 1000 to 4000 feet above the sea.

392. *Dryophthorus gravidus*, Shp. l. c.

Ins. Oahu. Aut.

Oahu; not rare; under logs of wood on the mountains.

393. *Dryophthorus crassus*, Shp. op. cit. p. 23. (?) Syn. *Rhyncolus opacus*, Karsch. Berl. Ent. Zeit. xxv. p. 7.

Ins. Oahu, Maui. (?) Aut.

Under logs of wood on the mountains, at elevations of 2000 to 4000 feet above the sea. Rare. The original specimens were from Oahu. Those from Maui appear indistinguishable; they were taken at Olinda.

394. *Dryophthorus declivis*, Shp. l. c.

Ins. Hawaii. Aut.

Not very rare under logs of wood on the mountains, about 2000 feet above the sea.

395. *Dryophthorus modestus*, Shp. l. c.

Ins. Hawaii, Maui, Oahu, (?) Lanai, (?) Kauai. (?) Aut.

Probably the other islands. Not very rare under logs of wood on the mountains, at various elevations, from 2000 to 6000 feet above the sea.

396. *Dryophthorus pusillus*, Shp. op. cit. p. 24.

Ins. Oahu. (?) Aut.

Rare; occurs in the decaying stems of ferns on the mountains near Honolulu.

397. *Dryophthorus insignis*, Shp. l. c.

Ins. Oahu. (?) Aut.

Not rare in and under decaying wood on the mountains, at an elevation of about 2000 feet.

N.B.—Fairmaire (*Essai sur les Coléoptères de la Polynésie*, p. 71) mentions having seen in the collection of M. Chevrolat a specimen of *Dryophthorus bituberculatus*, Fab., from the Hawaiian Islands. He quotes Olivier as stating that the specimen ticketed by Fabricius did not appear to be the real subject of that author's description, and as supplying a correct figure of the specimen in question. This same insect (*i. e.* the example from the Hawaiian Islands) has been described by Boisduval as *Dryophthorus crenatus*. In all probability the insect answering to the description of Fabricius was not a Hawaiian species; that which Olivier described, and which Fairmaire thinks identical with the Hawaiian specimen he mentions, may possibly have been the same as *D. squalidus*, Shp., but there does not appear good reason to consider decidedly that either of the names *D. bituberculatus* of Fab. or Ol., or *D. crenatus*, Boisd., can be identified with any insect occurring on the Hawaiian Islands.



## Fam. SCOLYTIDÆ.

## Tribe SCOLYTINI.

Genus CXXXVI.—*Xyleborus*. Mun. Cat. ix. p. 2684.398. *Xyleborus truncatus*, Shp., *ante*, p. 192.

Ins. Oahu. (?) Imm.  
In decaying wood.

399. *Xyleborus insularis*, Shp., *ante*, p. 193.

Ins. Oahu, Kauai. (?) Imm.  
Occurs in decaying wood on the Waianae mountains, Oahu, and also on Kauai.

400. *Xyleborus obliquus*, Shp., *ante*, p. 192.

Ins. Oahu, Hawaii. (?) Imm.  
This species has been taken from decaying wood on the mountains both of Oahu and Hawaii.

401. *Xyleborus rugatus*, Blackb., *ante*, p. 192.

Ins. Oahu. (?) Imm.  
Unique.

402. *Xyleborus immaturus*, Blackb., *ante*, p. 193.

Ins. Hawaii, Oahu. (?) Imm.  
This species has been taken from decaying wood on the mountains both of Oahu and Hawaii.

403. *Xyleborus frigidus*, Blackb., *ante*, p. 193.

Ins. Maui. (?) Imm.  
A single specimen was taken from decaying wood at an elevation of about 4000 feet, on Haleakala.

Genus CXXXVII.—*Hypothenemus*. Mun. Cat. ix. p. 2679.404. *Hypothenemus eruditus*, Westd. Trans. Ent. Soc. Lond. i. p. 34, pl. 7.

Ins. Oahu. (?) Int.  
In bark of acacia, on the plains near Honolulu.

405. *Hypothenemus maculicollis*, Shp. Trans. Ent. Soc. Lond. 1879, p. 101.

Ins. Oahu. (?) Int.  
Has occurred in bark of trees in several mountain localities near Honolulu.

406. *Hypothenemus griseus*, Blackb., *ante*, p. 194.

Ins. Oahu. (?) Imm.  
A single specimen occurred in the stem of a poppy, on the plains near Honolulu.

## Tribe PLATYPINI.

Genus CXXXVIII.—*Crossotarsus*. Mun. Cat. ix. p. 2696.

407. *Platypus externedentatus*, Fairm. Rev. Zool. 1850, p. 51.

Ins. Oahu. (?) Int. Tahiti.

A short series occurred in the trunk of an acacia in Honolulu.

## Fam. ANTHRIBIDÆ.

Genus CXXXIX.—*Mauia*. Blackb., *ante*, p. 194.

408. *Mauia satelles*, Blackb., *ante*, p. 195.

Ins. Maui. (?) Imm.

A single specimen occurred low down in the Wailuku Valley, Maui. It was beaten from a species of acacia.

Genus CXL.—*Aræocerus*. Mun. Cat. ix. p. 2749.

409. *Curculio fasciculatus*, De Geer. Ins. v. 276, t. 16, f. 2.

Ins. Hawaii, Maui, Lanai, Oahu, Kauai. Imm. Widely distributed.

Common in decaying leaves wherever they are heaped up from any cause, and occasionally beaten from fresh foliage. Very variable. This insect has no saltatory powers whatever.

## Fam. CERAMBYCIDÆ.

## Tribe PARANDRINI.

Genus CXLI.—*Parandra*. Mun. Cat. ix. p. 2751.

410. *Parandra puncticeps*, Shp. Trans. Ent. Soc. Lond. 1878, p. 202.

Ins. Oahu. (?) Imm. (?) Philippine Islands.

Under the bark and in the wood of acacia *falcata* on the mountains. This species or a closely allied one occurs in the Philippine Islands.

## Tribe PRIONINI.

Genus CXLII.—*Ægosoma*. Mun. Cat. ix. p. 2776.

411. *Ægosoma reflexum*, Karsch, Berl. Ent. Zeit. xxv. p. 7, taf. i. f. 11.

Ins. Hawaii. (?) Int.

Taken by me at a place called Oolaa on Hawaii, at an elevation of about 2000 feet above the sea, walking on the rafters of a native hut. February (T. B.) "Grove Ranche," Karsch.

## Tribe CERAMBYCINI.

Genus CXLIII.—*Astrimus*. Shp. Trans. Ent. Soc. Lond. 1878, p. 204.

412. *Astrimus obscurus*, Shp. op. cit.

Ins. Oahu. (?) Int.

Oahu. Taken usually at light, but occasionally under the bark of acacia, in the vicinity of Honolulu.

Genus CXLIV.—*Ceresium*. Mun. Cat. ix. p. 2837.

413. *Stenocorus simplex*, Gyll, Schön. Syn. Ins. App. i. 3, p. 178.

Ins. Oahu. Int. Widely distributed.

Rather common near Honolulu, at light; frequently found also under bark of acacia.

Genus CXLV.—*Sotenus*. Shp. Trans. Ent. Soc. Lond. 1878, p. 135.

414. *Sotenus setiger*, Shp. op. cit.

Ins. Oahu. (?) Int.

Not rare in Honolulu, at light, and under bark of acacias.

Genus CXLVI.—*Clytarlus*. Shp. op. cit. p. 137.

415. *Clytarlus microgaster*, Shp. op. cit. p. 103.

Ins. Oahu. Aut.

Rare; in decaying wood on the mountains near Honolulu, at an elevation of 2000 feet. June.

416. *Clytarlus robustus*, Shp. op. cit. p. 206.

Ins. Oahu. Aut.

On decaying trunks of acacia falcata. Has occurred in the Palolo and Mauna Loa valleys near Honolulu, and on the Waianae mountains.

417. *Clytarlus finschi*, Har. Mitt. Munch. Ent. Ver. 1880, p. 166. Karsch, Berl. Ent. Zeit. xxv. p. 8, taf. i. f. 13.

Ins. Maui. Aut.

This insect is found on decaying trunks of acacia falcata at an elevation of about 4000 feet above the sea. -Occurs in May, but not commonly.

418. *Clytarlus blackburni*, Shp., *ante*, p. 195.

Ins. Hawaii. Aut.

Found on decaying trunks and branches of a species of acacia growing at an elevation of about 6000 to 7000 feet on Mauna Loa. May.

419. *Clytarlus pulvillatus*, Karsch, Berl. Ent. Zeit. xxv. p. 9, taf. i. f. 14.

Ins. Maui. Aut.

"Grove Ranche." Unknown to us.

420. *Clytarlus pennatus*, Shp. Trans. Ent. Soc. Lond. 1881, p. 532.

Ins. Maui. Aut.

Rare; four specimens were taken at different times on Haleakala, at elevations between 4000 and 6000 feet, but it is not quite clear to what tree the insect is attached.

421. *Clytarlus cristatus*, Shp. op. cit. 1878. p. 207.

Ins. Oahu. Aut.

Not rare on *acacia falcata* at elevations of 2000 to 3000 feet, on the mountains near Honolulu.

422. *Clytarlus modestus*, Shp. op. cit. 1879, p. 104.

Ins. Maui. Int.

Occurs rather plentifully in April and May on *acacia falcata*, at an elevation of about 4000 to 5000 feet, on Haleakala. Two specimens were taken in February.

423. *Clytarlus filipes*, Shp. *ante*, p. 196.

Ins. Hawaii. Aut.

Found rather plentifully in company with *C. blackburni*, Shp.

424. *Clytarlus fragilis*, Shp. Trans. Ent. Soc. Lond. 1881, p. 534.

Ins. Oahu. Aut.

Three specimens were beaten from some dead sticks lying on the ground near the head of the Palolo valley, Oahu. November.

Genus CXLVII.—*Clytus*. Mun. Cat. ix. p. 2922.

425. *Clytus crinicornis*, Chev. Ann. Ent. Fr. 1860, p. 460.

Ins. Oahu. Int.

Very plentiful in and around Honolulu, on the trunks of a species of *acacia*.

#### Tribe LAMIINI.

Genus CXLVIII.—*Lagocheirus*. Mun. Cat. x. p. 3148.

426. *Cerambyx araneiformis*, L. Syst. Nat. ed. xii. p. 625.

Ins. Oahu. (?) Int. Brazil, St. Domingo.

Not uncommon on the mountains of Oahu. Generally beaten from *aleurites triloba*.

Genus CXLIX.—*Micracantha*. Mun. Cat. x. p. 3085.

427. *Micracantha nutans*, Shp. Trans. Ent. Soc. Lond. 1878, p. 209.

Ins. Oahu. (?) Int.

Not rare in Honolulu, where all the specimens taken have been found in houses. The species is probably introduced in timber.

Genus CL.—*Opsis*. Mun. Cat. x. p. 3106.

428. *Lamia nutator*, Fab. Mant. i. p. 142. (?) Syn. *Stasilea curvicornis*, Karsch, Berl. Ent. Zeit. xxv. p. 8, pl. f. 12.

Ins. Oahu. (?) Int. Tahiti, (?) Australia.

\* Common on *aleurites triloba* and other plants, at various elevations, but especially on the mountains.

## III.

## TOPOGRAPHICAL TABLE OF HAWAIIAN COLEOPTERA, WITH SUMMARY, GENERALIZATIONS, AND COMMENTS. BY D. SHARP.

The coleoptera of the Sandwich Islands are mostly small or very minute insects; and the few species whose individuals are of large size are either known to be non-endemic or will nearly certainly be found to be so: and of the endemic species there are few—probably it would be correct to say absolutely none—that would strike an ordinary observer as being beautiful; *Clytarlus microgaster* is indeed the only endemic species that has any special adornment appreciable by the human eye. But they are of great interest owing to the remote and isolated position of the group of islands they inhabit; and there can be no doubt that a thorough and accurate knowledge of them and their peculiarities would be important evidence as to the validity of the theory of organic evolution. If we understood thoroughly the structures of the inhabitants of the archipelago, and could make a valid estimate of the totality of peculiarity they possess, we should be in a position to discuss the question of how this peculiarity is to be accounted for. We do not, however, yet possess an accurate idea of the total peculiarity of the organisms of these islands, both because the creatures found there are only very imperfectly known, and also because our knowledge of the inhabitants of other places is in many respects only rudimentary, so that accurate comparison is not at present possible. Still, owing to the special interest attaching to this fauna, I have drawn up a table to illustrate the amount of its endemicity, and will briefly summarise the results of my examination.

There are in all 150 genera, comprising 428 species, found in the islands, and of this number 99 of the genera and 352 of the species are at present known only from the archipelago. This bare statement would convey, I believe, a far from correct impression, and I will briefly pass in review the components of the fauna, the object kept in view being to get a right impression of the amount of endemicity.

The family Cicindelidæ, universal on continental lands, is absent from the Sandwich Islands, as it is from all other remote island groups.

The family Carabidæ has, on the contrary, eleven genera and sixty-one species, of which seven genera, comprising thirty-three species, are peculiar to the islands; this statement, however, requires supplementing, for the genus *Saronychium*, belonging to the Lebiini, will probably be found elsewhere,\* while on the other hand the genus *Cyclothorax*, with twenty-one species in these islands, has only one species outside of them, it being found in Australia and New Zealand.

\* No exponent of this genus has reached Europe for comparison; only two individuals, indeed, of the *S. inconspicuum*, its only species, having been found.

We may treat *Cyclothorax*, therefore, as at present appearing to be characteristic of the archipelago, for we must remember that if species are occasionally immigrant to the islands from other parts of the world, the reverse is no doubt sometimes the case, and the productions of these or other remote islands may occasionally find their way to other regions of the earth and become established there. As regards the *Bembidiini*, we can at present form no accurate conception of whether they are endemic or not. They are very obscure small insects, and it is probable that some of them—possible that all of them—may have reached the islands from outside, some of the *Tachys* under bark of logs, some of the *Bembidia* with the earth attached to the roots of floating trees, or even with the ballast of ships. Leaving them out of the question, it appears that the islands have seven genera of peculiar *Anchomenini*, comprising no less than fifty-one species, while the non-endemic, or doubtfully endemic *Carabidæ* are none of them *Anchomenini*, and amount to ten species distributed in four genera, and two sub-families. This brings out a striking endemicity in the Hawaiian *Anchomenini*, which is much increased by a more detailed study of their peculiarities; and, in illustration of this, I may mention that Mr. H. W. Bates—undoubtedly at present the first of our authorities on this important family of beetles—when I had the pleasure of submitting to him a series of about half the species of Hawaiian *Anchomenini*, pronounced them, after a brief inspection, to be very peculiar and highly endemic. Indeed, so peculiar are some of these *Anchomenini* that they have been referred by authorities to other sub-families, Mr. Blackburn and Herr Karsch having considered one of the genera—*Atrachynemis*—as a member of the *Harpalini*, and Karsch having treated another genus—*Disenochus*—as a member of the *Broscini*, while Mr. Blackburn thought it rather to belong to *Pterostichini*. Although I have been able to examine each of these genera in a very imperfect manner, I believe, however, that both will prove to be aberrant *Anchomenini*.

The family *Dytiscidæ* has only two genera and three species, all of the latter but none of the former being peculiar. I think it probable, however, that all the species will be found elsewhere; one of them, indeed, has an allied species, formerly supposed to have been the same species, in Tahiti. The members of this family appear to be capable of greater migration than those of almost any other group of beetles.

The family *Hydrophilidæ* is poorly represented by four species in three genera; two of the species are peculiar, one of them, moreover, forming a peculiar genus, but it is a very small insect, and will probably be found elsewhere; and this will pretty certainly be also the case with the species of *Hydrobius*.

The *Staphylinidæ* are represented by fifty-five species, distributed in eighteen genera. Two of the genera are peculiar, as are forty-three of the species. This family is, however, so difficult to deal with, owing to our want of knowledge of the smaller exotic forms, and to the small amount of study that has been

given to its classification, that no importance can at present be attached to its consideration. The insects most likely ultimately to prove indigenous are the Diestotæ, nine in number, and the extremely peculiar Oligotæ and Liophænæ, eleven in number; the Oligotæ are very remarkable, and will no doubt ultimately form one or more distinct genera; *O. clavicornis*—which there is good reason to treat as introduced—being the only form that will probably remain as a genuine Oligota. A good many of the other Staphylinidæ are cosmopolitan or widely distributed species; and others—such as *Pachycorynus*, *Lispinodes*, and *Glyptoma*—live under bark, and may probably have been immigrant in dead trees and logs; while as regards the Myllenæ and Trogophlæi the same remark may be made as that above recorded concerning the Bembidiini.

The Trichopterygidæ have three peculiar species, each representing a distinct genus, and one of them peculiar. Mr. Matthews, the authority on this family, considers them highly interesting; but as they are the most minute of all beetles, and our ignorance of the exotic forms is nearly absolute, no importance can at present be attached to this.

The Histeridæ have five genera and twelve species. None of the genera are peculiar, but nine of the species are not known elsewhere. It is significant that all these nine species are excessively minute forms, and most, if not all, occur in dead wood, so that it is probable they will be found elsewhere, and are in part immigrants in floating wood.

The Nitidulidæ have no less than forty-three species, a very large number for a small family, of which only about 1000 species are known from all parts of the world. Putting aside the three Carpophili, of which two are known to be introduced species, and the two Haptonci, one of which is also in this category, we have remaining thirty-eight species assigned to two genera. One of these two has five species, and is peculiar; the other—*Brachypeplus*—with no less than thirty-three species, is a widely-distributed genus; but it should be remarked that *Brachypeplus* is not really at present a genus, but rather one of those composite magazines that abound in the present state of entomological knowledge—or rather ignorance, and that the Sandwich Island *Brachypepli* are themselves a very varied assemblage, and are not known to be at all closely allied to any of the forms found outside the islands. One of them, *B. infimus*, is very different from the others, and will, I believe, prove not endemic; it lives under the bark of trees. The other *Brachypepli* have varied habits; many are found in flowers, some on or under bark of trees, and at exuding sap, and in the stems of ferns and other plants. The species of *Gonioryctus*—the peculiar genus—occur in flowers, and the stems of lilies and tree-ferns.

The families Monotommidæ, Trogositidæ, and Rhyssodidæ are each represented in the fauna we are considering by a single species of foreign origin. And though Colydidæ have two species, one of them forming a peculiar genus, they probably

should be referred to the same category; they are wood-feeders, both confined to Oahu, one of them found only once near Honolulu.

The Cucujidæ are a more varied assemblage, consisting of eight genera and twelve species. Two of the genera are peculiar—*Brontolæmus* with one, *Monanus* with two species; six of the twelve species are known to occur elsewhere, and the only species that can have any claim at all to be considered autochthonous are the *Brontolæmus*, which is found running like a longicorn on partially decayed trees, and no doubt lives under the bark, and the *Monani* which are connected with *Pandanus*; but I have little doubt that these, like the other Cucujidæ, will prove to be of foreign origin.

The family Cryptophagidæ has two species of minute beetles, each representing a genus; one is certainly, the other probably, foreign. The Lathridiidæ have a single foreign species, *Latridius nodifer*, Westd., whose distribution over the world is apparently going on under the observation of our generation.

The Mycetophagidæ have four genera and four species. All the genera and two of the species are known outside the islands; the two peculiar species both live in bark or wood, and will probably prove to be foreign insects introduced naturally.

The Corylophidæ have three genera and five species. Though all the species are peculiar at present, none of the genera are so; and as they are excessively minute and nothing is known of the exotic forms, it is probable all may prove to be foreign.

The Erotylidæ are represented by two of the smallest and most obscure of the known members of the family. One of them forms at present a peculiar genus, but both may well prove to be introduced.

The Coccinellidæ have five species, two of them introduced, while the other three belong to *Scymnus*, an uninteresting genus, consisting of a large number of very small insects, very little collected or known. There is no direct evidence as to whether they may ultimately prove peculiar or not.

The Dermestidæ have eight species in four genera, one genus being doubtfully peculiar; the *Attagenus* and two *Cryptorhopala* may be looked on as certainly introduced, but the three species of *Labrocerus* are more probably immigrant by natural means. They are found by beating dead branches of trees.

The Lucanidæ are represented by a single species, only once found; it is a peculiar genus, said to be allied to Chilean forms, and is probably an immigrant with natural driftwood.

The great family Scarabæidæ has only three genera and five species, none of them peculiar.

The Eucnemidæ are represented by five species of the genus *Fornax*. This genus has a large number of obscure exotic species, all of them very little known, and this latter point also applies to the Hawaiian species. They are exclusively xylophagous, and will probably be found elsewhere.



The family Buprestidæ is represented by a single North American species, found at Honolulu.

The Elateridæ have seven genera and fourteen species. Five of these genera are known outside the islands, and have each only a single species, four of the species being also known as foreign. The two genera at present peculiar have nine species between them, and at present I can form no opinion whether they will prove autochthonous or not; possibly they may do so.

The Malacodermidæ have two genera and two species, one genus and both the species being peculiar. Both these insects are found only in Honolulu, and (as the peculiar genus is an extremely obscure and minute creature) are probably of foreign origin.

The Cleridæ consist only of three widely distributed species.

The Ptinidæ, on the other hand, comprise six genera and twenty-three species. Three of the genera, having between them four species, are of foreign origin, and three of their four species are known elsewhere. The other three genera have nineteen species between them, and there is no evidence to show that they are of foreign origin other than that they are pre-eminently wood feeders; the genus *Mirosternus* belongs to a different group to what the other two genera do; and it is my opinion that while these latter may probably prove autochthonous, *Mirosternus* may more probably be found elsewhere, it being a highly specialised—while *Holcobuis* and *Xyletobius* are generalised—forms.

The Bostrichidæ have five genera and five species. The members of this xylophagous family are widely distributed, even in remote parts of the earth, and all the Hawaiian species are foreign.

The Cioidæ are a small family of obscure beetles, living in boleti. From all parts of the world scarcely 200 species are known; it is, therefore, remarkable that there should be twenty already discovered in the islands whose fauna we are considering. Although these twenty species are referred all to one genus—*Cis*—they form really a most varied assemblage, exhibiting, I believe, a greater variety of forms than could be found in all the other members of the genus—and their number is more than one hundred—at present known from all parts of the earth. Some of the Hawaiian species, indeed, scarcely possess the facies of the family, so that they were not at first recognised either by Mr. Blackburn or myself as belonging to it; and as the family is, though much neglected, really an interesting one on account of its unspecialised (or, as some would say, “ancient”) character, these Hawaiian Cioidæ are really of great interest and importance.

The enormous family Tenebrionidæ has seven genera and eight species. The genera are all known from elsewhere, as are also six of the species, and the other two species, belonging to obscure and neglected genera, will pretty certainly also prove to be foreign.

The Cistelidæ have two genera and two species. This family is suffering from

complete neglect, so that although both of the Hawaiian species and one of the two genera are as yet peculiar, there is no reason for believing they will not be found elsewhere.

The Anthicidæ and Œdemeridæ are also families whose exotic members are very incompletely known, so that it is probable that their three members in the Hawaiian archipelago may be found elsewhere; one of them, indeed, is known to occur in the Marquesas, and another is found only near Honolulu, where it especially frequents the flowers of exotic eucalypti.

The family Aglycyderidæ may be looked on as peculiar to the Sandwich Islands. It is true that two members are known from other parts—one from the Canary Islands, the other from New Zealand—but these two are so different in certain important respects from the Hawaiian forms that the late Dr. Leconte considered them entitled to family distinction. Whether that be the case or not it is at least certain that the Aglycyderidæ form one of the most interesting of all the families of Coleoptera, and it appears to have claims to be considered absolutely the most primitive of all the known forms of Coleoptera, it being a synthetic form linking the isolated Rhyncophorous series of families with the Clavicorn series. About thirty species are known in the Hawaiian Islands, and they exhibit much difference *inter se*, but cannot at present be treated as forming more than one genus; many of the species are most difficult of study, owing to the great sexual disparities, and the apparently very close alliance between the various species in the most obscure part of the genus. Hence it is probable that accurate observation may show that the number of true species may prove considerably greater or considerably less than that I have mentioned.

The Curculionidæ are the most extensive of all the great families of Coleoptera, and there are at present known fifteen genera and forty-nine species in the Hawaiian Islands. This number, requires, however, analysis before we can comprehend its significance. The sub-family Otorhynchini has one genus and two species peculiar; the Cyladini have one widely-distributed species; the Cryptorhynchini are represented by *Acalles*, with five peculiar species, and two allied genera (whose members are so rare that I have not been able to get a sight of them from Mr. Blackburn), each with a single species; then we have the Calandrini, with two genera and four species, three of which are already known from elsewhere, while the other is a small insect with habits rendering it probable that it also is of foreign origin; then comes the sub-family Cossonini, having eight genera and thirty-four species—that is, more than two-thirds of the whole of the Curculionidæ of the islands. That the Cyladini and Calandrini are all foreign is certain; and I believe this will prove to be the case also with the Otorhynchini\* and the

\* Since this was written a species of the Otorhynchus genus, *Rhyncogonus*, has been detected in the Marquesas Islands by Mr. J. J. Walker.

Cryptorhynchini, though as regards these latter members it should be remarked that *Acalles* is one of the most frequent components of insular faunæ, being very richly represented in New Zealand, Polynesia, and the Atlantic islands. The *Cossonini* stand in a very different position; five of the eight genera, and all the species are peculiar, while the largest genus—*Oodemus*—has fifteen species, and is peculiar to the island; indeed, there is no near ally known to it. The endemic *Heteramphus*, too, displays a singularly large variety amongst its few species, so that though it is quite probable that a good many of the Hawaiian *Cossonini* may prove to be foreign forms, yet there remains a considerable proportion that we are justified in considering as probably thoroughly autochthonous.

The family *Scolytidæ* is represented by three widely-distributed genera, having between them ten species, of which eight are peculiar; they are xylophagous in habits, and very obscure forms; the exotic species have been very little collected, and it is very probable that all the Hawaiian *Scolytidæ* may prove to be foreign.

The *Anthribidæ* have one widely-distributed species, and in addition a genus supposed to be peculiar, but of which only one individual has been found, and is probably immigrant.

The *Cerambycidæ* have in all nineteen species, and of this number nine represent each a genus, while the remaining ten all belong to one peculiar genus. Of the nine scattered genera, each of which has but one species, seven are known elsewhere, one is doubtfully distinct from a foreign form, and the other is an obscure form, which may highly probably prove to be also foreign. Indeed I look upon it as pretty certain that all the Hawaiian Longicorns, except the genus *Clytarlus*, are of foreign origin. This latter genus has eight species, and they display so much difference that they might well form four genera. The only near ally of *Clytarlus* is the Haitian genus *Euryscelis*, of two species. It is worthy of note that only one of the foreign Longicorns has been found in any island except that of Oahu; in which island two of them, however—*Cerambyx araneiformis* and *Lamia nutator*—have become thoroughly naturalised. *Clytarlus* has been found on all the islands visited except Kauai, where probably one or more species remain to be found.

From the above brief revision of the Coleoptera of the archipelago it will be gathered that I am of opinion that a large portion of the fauna has been introduced from without. I think, indeed, that we may distinguish three elements in the fauna—First, species that have been introduced, in all probability comparatively recently, by artificial means, such as with provisions, stores, building timber, ballast, or growing plants; many of these species are nearly cosmopolitan. Second, species that have arrived in the islands, and have become more or less completely naturalized; they are most of them known to be wood- or bark-feeders, but some that are not so may have come with the earth adhering to the roots of floating trees; a few, such as the *Dytiscidæ*, or water beetles, may possibly have been introduced by violent winds. Third, after making every allowance for introduction

by these artificial and natural methods, there still remains a large portion standing out in striking contrast with the others, which we are justified in considering strictly endemic or autochthonous.

In the table of distribution I have endeavoured to distinguish these three components by adding "int." for introduced, to the names of those I believe to belong to the first category, and "imm." for immigrant to those I suppose to belong to the second, and "aut." for autochthonous, to the truly endemic species. Our knowledge is not yet sufficiently advanced to enable us to decide, in the case of many of these species, certainly to what category they should be referred, and I have intimated this doubt by a note of interrogation.

On looking over the table we find there are fifty-six species that we may feel certain are merely artificial introductions, and ten that are almost certainly natural immigrants, and also forty others that we may be sure belong to one or other of these two categories, though we cannot at present safely decide to which. It would, for instance, not be possible for us to decide, on the very small evidence we at present possess, whether certain of the foreign Longicorns have been introduced with trees for planting, or with building timber, in which cases they would be cited as introduced, or whether they may have arrived in more or less remote periods with trees or logs brought by natural currents. Still these forty species, being foreign, may with certainty be subtracted from the endemic or autochthonous fauna. There are also eighty-four species which, though they are not yet known outside the islands, I believe from various reasons and different kinds of evidence to be also immigrant species and not endemic; and there are, in addition, twenty-four others which I suspect to be immigrant, but which may really prove to be autochthonous. If we subtract all these, we find left a total of 214 species—curiously enough exactly one half of the total known fauna—that we must, in the present condition of the science of entomology, consider to be autochthonous.

Although the introduced and immigrant species play an important part in the extant fauna, yet the former are to the naturalist of little interest, and I shall not farther discuss them. The immigrant species are, however, of much greater importance to the biologist, and if it were certainly determined which of the species were natural introductions, or immigrants, as I prefer to term them, and what countries they have come from, it would throw a most important light on many of the obscure features of the geographical distribution of animals. At present entomological knowledge is not sufficiently advanced to enable us to do this. Most of these immigrants are small insects, that have not yet been collected or preserved, from tropical countries, or even in our own colonies; we must, therefore, wait for a further advance in Coleopterology before we can generalize with advantage on this subject. The only group where we can at present do this with any chance of approximation to exactness is in the case of the Longicorns, and here unfortunately the number of the species is but small; I may note, however,

that there are three species of Longicorns that I look on as probably immigrant, and six that I consider as introductions, and that the three immigrants have come, one from the Philippine Islands, one from tropical America, and one from some other of the Polynesian Islands. So far as we may generalise from these three cases it would appear that these immigrants have been derived from the nearest lands in various directions, and these conclusions will, I fancy, be farther supported by the immigrants belonging to less studied groups.

But the chief interest of the Sandwich Island fauna is attached to its endemic or autochthonous components, and these, on being separated from the foreign elements, will be found to contrast strongly with the latter in many respects. Thus, though there are members of thirty-eight families found in the islands, yet the autochthonous half of the fauna occurs only in nine of the families, while the foreign half of the fauna has its components scattered through the whole of the thirty-eight families, except only the Aglycyderidæ (which is nearly peculiarly Hawaiian). The autochthonous Coleopterous fauna is made up as follows:—The family Carabidæ has fifty-one species, distributed in seven genera, all peculiar to the islands; the family Staphylinidæ has nineteen species, distributed in three genera, only one of which is peculiar, though were not these insects so minute they would probably, if we were to judge from their strange appearance, form other distinct genera; the Nitidulidæ have thirty-eight species belonging to two genera, one of which is peculiar, while the other is composed by a large assemblage of very varied forms; the Elateridæ have seven species forming a peculiar genus; the Anobiini (Ptinidæ) have nineteen species in three peculiar genera; the Cioidæ nineteen species in one genus, not peculiar, but forming an assemblage of varied forms; Aglycyderidæ has the one genus with thirty species peculiar; the Curculionidæ are represented by three peculiar genera of Cossonini, with twenty-one species; and the Cerambycidæ by one peculiar genus of ten species.

Continuing our contrast of the autochthonous and foreign components of the fauna, we find that while the 214 foreign Coleoptera belong to 132 genera, giving an average of 1.62 in each genus; the 214 autochthonous species belong to only eighteen genera, giving an average of 11.9 in each genus.

Moreover, these truly native Hawaiian Coleoptera form a true micro-fauna—that is to say, they present us in miniature in each group with those numerous cross-affinities and complex repetitions of peculiarities that render the establishment of genera and larger groups of a really natural nature so very difficult.

My knowledge—and I think I may say our knowledge—of generalized Coleopterous structures is not sufficiently advanced to enable me to say with anything like authority whether these supposed autochthonous beetles are more or are less specialized in their structure than the average of beetles of other lands. I am inclined to the opinion, however, that there are in this respect two different elements among them—viz. one in which specialization is lower than the average,

and one in which it is, on the contrary, greater. Thus the Aglycyderidæ are related both to the Clavicorn and to the Rhyncophorous series of Coleoptera, and may thus be looked on as synthetic between two of what many would call the most ancient of the groups of Coleoptera. So too the Anchomenini may be classed as perhaps on the whole the least specialized of the normal Carabidæ; while the Cioidæ are a peculiarly unspecialized family, to such an extent indeed that, though they are usually classed near the Malacoderms in the Serricorn series, they would probably be better placed in the Clavicorn series. The Anobiid genera *Xyletobius* and *Holcobius* are of a type of low specialization.

On the other hand the Anobiid genus *Mirosternus* and the Cerambycide *Clytarlus* are certainly highly evolved forms. This latter fact makes me look on their claims to be truly autochthonous with some suspicion; but, as I have no other ground for excluding them from the list of autochthones, I have allowed them to remain there.

I think it may be looked on as certain that these islands are the home of a large number of peculiar species not at present existing elsewhere, and if so it follows that either they must have existed formerly elsewhere and migrated to the islands, and since have become extinct in their original homes, or that they must have been produced within the islands. This last seems the simpler and more probable supposition, and it appears highly probable that there has been a large amount of endemic evolution within the limits of these isolated islands. How far back in the life history of the species that evolution may have extended we cannot say; we are not at all in a position to decide whether the now peculiar species were formerly introduced into the islands, being at the time of their introduction of the same structure as individuals found elsewhere, and having become since different because they have been subject to different conditions from the other descendants of their common ancestors, or whether the evolution may not have been absolutely *ab initio*; the organisms having originated in these islands by processes and under laws such as must have originated organisms somewhere or other.

The data for the discussion of such problems as these are at present quite insufficient; but I cannot leave this subject without stating my opinion as to the extremely important nature of the knowledge we may ultimately derive from a careful, long-continued, conscientious study of the organisms of remote islands. Meanwhile it is only too probable that the evidence they may give us will be lost for ever to the human race if we do not obtain it speedily. It is known that a large number of these organic beings have become extinct in recent times, and it is also known that the process of extinction is going on in various spots with various degrees of rapidity. The organic beings found in lands widely separated from other lands offer most important evidence as to the nature of organic evolution in the past, and consequently in the future; and it is certainly the duty of this generation to preserve for its posterity all the evidence that can be obtained on

this important question. I am myself profoundly convinced that such knowledge will ultimately be found to be of extreme value, and its possession a great blessing to the human race. I agree with Mr. Wallace in thinking that it can be only obtained by resident naturalists (*vide* *Island Life*, p. 7, note); and I would respectfully urge on those who have the guidance and control of the small amount of funds devoted to the acquisition and preservation of organised knowledge, attention to the fact that such knowledge as that I am alluding to can be gained with greater completeness by us than it can be by any future generation.

Some of the largest and most important of the families of Coleoptera are quite unrepresented in the autochthonous fauna of the islands; there are no Cicindelidæ, no Buprestidæ, no Lamellicornis; and the enormous series of Phytophaga, with probably 50 or 100,000 species on the earth, is quite unrepresented at present in these islands either by autochthonous or foreign forms.

Although the number of species found in the islands is already considerable, yet it is still far from being anything like complete; some of the islands, indeed, have been comparatively little explored. Although it is clear that valuable results may be obtained by a comparison of the separate faunæ of each of the islands, yet at present it would not be justifiable to found any speculations on the facts we already know, because much more complete knowledge is attainable, and we may hope will ultimately be attained. As, however, there appears very little prospect of any fresh information being obtained for some time to come, I shall briefly summarise the facts under this heading as they at present appear.

In the island of Hawaii eighty-six species have been found; in Maui 107; in Lanai thirty-five; in Oahu 276; in Kauai fifty-one. Oahu thus stands far ahead of the others in the number of species it has produced, and there is much reason for believing that it is really the most productive of the islands; it has been well searched, and it is probable that the total number of species of Coleoptera at present to be found in it does not much exceed 300. On the other hand, the remaining islands are far less completely explored; and I estimate that when they have been better examined the total number of species of Coleoptera at present to be found in the islands may rise from 428 to somewhere between 550 and 600.\*

If we confine our attention to the endemic or autochthonous species (or rather to those considered such by me), we then find that the numbers found in the different islands stand as follows:—Hawaii, 55; Maui, 52; Lanai, 14; Oahu, 95; Kauai, 18.

Thus we see that of the Coleopterous fauna of Hawaii, .64 is autochthonous, .36 foreign; in Maui, .486 is autochthonous, .514 foreign; while in Lanai the proportions stand as .4 and .6; in Oahu, .344 and .656; and in Kauai, .35, .65.

\* Mr. Blackburn, *ante* p. 208, places the number very much higher—between 800 and 900—and I think his estimate likely to prove nearer the truth than mine.

Thus whereas two-thirds of the species in Hawaii are autochthonous, in Kauai, so far as we know at present, only one-third are autochthonous, two-thirds being foreigners. This conclusion, however, is not of importance, and will be subject, no doubt, to great alteration; but still it is possible that Oahu, when stripped of its foreign forms, will not have so great a predominance over the other islands in number of species as it possesses under a mere indiscriminating census enumeration.

Limiting our investigation to the autochthonous forms, it is interesting to ask how large a proportion of the species are confined to one island, and how many are more widely distributed in the archipelago, and on doing this we meet with a very striking result, viz. that out of the 214 autochthonous species, 200 are confined to a single island, only fourteen out of the whole number being found in more than one island. Of these fourteen species five are common to Hawaii and Maui; two to Hawaii and Oahu; one to Hawaii and Lanai; two to Oahu and Kauai; one to Hawaii, Oahu, and Kauai; one to Hawaii, Maui, and Oahu; one to Lanai, Oahu, and Kauai; and one to Hawaii, Maui, Oahu, and Kauai. That there is a striking endemicity as regards each separate island is therefore clear, although it is probable that future more exact and fuller knowledge will modify the above statement considerably. What are true species and what mere morphological forms is a study that has scarcely been commenced in Coleopterology, and one that in the Sandwich Islands will evidently be attended with peculiar difficulties. But there is perhaps no part of the world whose fauna could throw so much light on this difficult question—a question that I believe is destined to become of great importance in the future of Zoology—as that of this remote and isolated insular group.

There is some evidence of generic endemicity in the case of the separate islands. For example, we find that the genus *Metromenus* has in all nineteen species, and of these seventeen are found in Oahu and two in Maui, the other islands not having yet yielded any species of the genus. Maui has both the two species of the anomalous *Disenochus*, which is found nowhere else, and this same island the highly peculiar *Atrachyenemis*, which has as yet but one species. In the genus *Cyclothorax* we have twenty-one species in the archipelago, six peculiar to Hawaii, eleven peculiar to Maui, three to Oahu, while one is common to Hawaii and Maui. Thus Oahu possesses ninety per cent. of the whole *Metromeni*, but only about thirteen per cent. of the genus *Cyclothorax*. So too in the *Anobiini* we find that Oahu possesses five out of seven of the species of *Mirosternus*, while it has only one out of the eleven species of *Holcobius* and *Xyletobius*. *Heteramphus*, with four species, has been found only in Oahu. This part of the investigation is, however, in the present state of Zoology of little practical importance, owing to the indefinite, even mystical, nature of the zoological expression "genus."



[In this Table the Genera and Species that are at present not known to occur outside the Sandwich Islands are each preceded by an asterisk.]

GENERA AND SPECIES.						Hawaii.	Maui.	Lanai.	Oahu.	Kauai.
Fam. CARABIDÆ.										
Tribe LEBIINI.										
PLOCHIONUS.										
	1.	Carabus pallens, Fab.,	.	.	Imm.,	...	×	...	...	...
*SARONYCHIUM.										
	*2.	Saronychium inconspicuum, Blackb.	.	.	(?) Imm.,	...	...	...	×	...
Tribe ANCHOMENINI.										
*METROMENUS.										
	*3.	Dyscolus palmæ, Blackb.,	.	.	Aut.,	...	...	...	×	...
	*4.	Dyscolus mutabilis, Blackb.,	.	.	Aut.,	...	...	...	×	...
	*5.	Dyscolus caliginosus, Blackb.,	.	.	Aut.,	...	...	...	×	...
	*6.	Anchomenus muscicola, Blackb.,	.	.	Aut.,	...	...	...	×	...
	*7.	Anchomenus corruscus, Er.,	.	.	Aut. (? extinct)	...	...	...	×	...
	*8.	Anchomenus epicurus, Blackb.,	.	.	Aut.,	...	...	...	×	...
	*9.	Anchomenus insociabilis, Blackb.,	.	.	Aut.,	...	...	...	×	...
	*10.	Anchomenus erro, Blackb.,	.	.	Aut.,	...	×	...	...	...
	*11.	Anchomenus protervus, Blackb.,	.	.	Aut.,	...	...	...	×	...
	*12.	Anchomenus meticulosus, Blackb.,	.	.	Aut.,	...	...	...	×	...
	*13.	Anchomenus fossipennis, Blackb.,	.	.	Aut.,	...	...	...	×	...
	*14.	Anchomenus oceanicus, Blackb.,	.	.	Aut.,	...	...	...	×	...
	*15.	Anchomenus bardus, Blackb.,	.	.	Aut.,	...	...	...	×	...
	*16.	Anchomenus fugitivus, Blackb.,	.	.	Aut.,	...	...	...	×	...
	*17.	Anchomenus cuneipennis, Blackb.,	.	.	Aut.,	...	...	...	×	...
	*18.	Anchomenus scrupulosus, Blackb.,	.	.	Aut.,	...	...	...	×	...
	*19.	Anchomenus fraternus, Blackb.,	.	.	Aut.,	...	...	...	×	...
	*20.	Anchomenus putealis, Blackb.,	.	.	Aut.,	...	×	...	...	...
	*21.	Anchomenus mysticus, Blackb.,	.	.	Aut.,	...	...	...	×	...
*COLPODISCUS.										
	*22.	Anchomenus lucipetens, Blackb.,	.	.	Aut.,	×	...	...	...	...
	*23.	Dyscolus tantalus, Blackb.,	.	.	Aut.,	...	...	...	×	...
*BARYPRISTUS.										
	*24.	Anchomenus incendiarius, Blackb.,	.	.	Aut.,	×	...	...	...	...
	*25.	Anchomenus rupicola, Blackb.,	.	.	Aut.,	...	×	...	...	...
	*26.	Anchomenus sharpi, Blackb.,	.	.	Aut.,	...	×	...	...	...
*BLACKBURNIA.										
	*27.	Blackburnia insignis, Shp.,	.	.	Aut.,	...	...	...	×	...
	*28.	Blackburnia blaptoides, Blackb.,	.	.	Aut.,	...	...	...	×	...
	*29.	Blackburnia frigida, Blackb.,	.	.	Aut.,	...	×	...	...	...
*DISENOCHUS.										
	*30.	Disenochus anomalus, Blackb.,	.	.	Aut.,	...	×	...	...	...
	*31.	Disenochus terebratus, Blackb.,	.	.	Aut.,	...	×	...	...	...
*ATRACHYCNEMIS.										
	*32.	Atrachycnemis sharpi, Blackb.,	.	.	Aut.,	...	×	...	...	...
Carried forward,						2	9	...	21	...

GENERA AND SPECIES.		Hawaii.	Maui.	Lanai.	Oahu.	Kauai.
<i>Brought forward,</i>		2	9	...	21	...
<b>CYCLOTHORAX.</b>						
[This genus has outside the Hawaiian Islands at present only a single species, inhabiting Australia and New Zealand.]						
*33.	<i>Cyclothorax montivagus</i> , Blackb., . . . . . Aut., . . . . .	×	×	...	...	...
*34.	<i>Cyclothorax pele</i> , Blackb., . . . . . Aut., . . . . .	×	...	...	...	...
*35.	<i>Cyclothorax micans</i> , Blackb., . . . . . Aut., . . . . .	...	×	...	...	...
*36.	<i>Cyclothorax multipunctatus</i> , Blackb., . . . . . Aut., . . . . .	...	×	...	...	...
*37.	<i>Cyclothorax brevis</i> , Blackb., . . . . . Aut., . . . . .	...	...	...	×	...
*38.	<i>Cyclothorax robustus</i> , Blackb., . . . . . Aut., . . . . .	...	×	...	...	...
*39.	<i>Cyclothorax oahuensis</i> , Blackb., . . . . . Aut., . . . . .	...	...	...	×	...
*40.	<i>Cyclothorax simiolus</i> , Blackb., . . . . . Aut., . . . . .	...	...	...	×	...
*41.	<i>Cyclothorax obscuricolor</i> , Blackb., . . . . . Aut., . . . . .	...	×	...	...	...
*42.	<i>Cyclothorax bembidioides</i> , Blackb., . . . . . Aut., . . . . .	...	×	...	...	...
*43.	<i>Cyclothorax paradoxus</i> , Blackb., . . . . . Aut., . . . . .	...	×	...	...	...
*44.	<i>Cyclothorax scaritoides</i> , Blackb., . . . . . Aut., . . . . .	...	×	...	...	...
*45.	<i>Cyclothorax cordaticollis</i> , Blackb., . . . . . Aut., . . . . .	...	×	...	...	...
*46.	<i>Cyclothorax deverilli</i> , Blackb., . . . . . Aut., . . . . .	...	×	...	...	...
*47.	<i>Cyclothorax vulcanus</i> , Blackb., . . . . . Aut., . . . . .	...	×	...	...	...
*48.	<i>Cyclothorax unctus</i> , Blackb., . . . . . Aut., . . . . .	...	×	...	...	...
*49.	<i>Cyclothorax lætus</i> , Blackb., . . . . . Aut., . . . . .	...	×	...	...	...
*50.	<i>Cyclothorax angusticollis</i> , Blackb., . . . . . Aut., . . . . .	...	×	...	...	...
*51.	<i>Cyclothorax rupicola</i> , Blackb., . . . . . Aut., . . . . .	...	×	...	...	...
*52.	<i>Cyclothorax inæqualis</i> , Blackb., . . . . . Aut., . . . . .	...	×	...	...	...
*53.	<i>Cyclothorax Karschi</i> , Blackb., . . . . . Aut., . . . . .	×	...	...	...	...
Tribe BEMBIDINI.						
<b>TACHYS.</b>						
*54.	<i>Tachys oahuensis</i> , Blackb., . . . . . (?) Int., . . . . .	...	...	...	×	...
*55.	<i>Tachys arcanicola</i> , Blackb., . . . . . (?) Imm., . . . . .	...	...	...	×	...
*56.	<i>Tachys atomus</i> , Blackb., . . . . . (?) Imm. or aut., . . . . .	...	...	...	×	...
*57.	<i>Tachys mucescens</i> , Blackb., . . . . . (?) Int., . . . . .	...	...	...	×	...
<b>BEMBIDIUM.</b>						
*58.	<i>Bembidium teres</i> , Blackb., . . . . . (?) Imm., . . . . .	...	×	...	...	...
*59.	<i>Bembidium pacificum</i> , Blackb., . . . . . (?) Imm., . . . . .	...	...	...	×	...
*60.	<i>Bembidium ignicola</i> , Blackb., . . . . . (?) Imm., . . . . .	...	×	...	...	...
*61.	<i>Bembidium spurcum</i> , Blackb., . . . . . (?) Imm., . . . . .	...	×	...	...	...
Fam. DYTISCIDÆ.						
Tribe COLYMBETINI.						
<b>RHANTUS.</b>						
*62.	<i>Colymbetes pacificus</i> , Boisd., . . . . . (?) Imm., . . . . .	×	×	×	×	×
<b>COPELATUS.</b>						
*63.	<i>Colymbetes parvulus</i> , Boisd., . . . . . (?) Imm., . . . . .	...	×	...	×	...
*64.	<i>Copelatus mauiensis</i> , Blackb., . . . . . (?) Imm., . . . . .	...	×	...	...	...
Fam. HYDROPHILIDÆ.						
<b>HYDROBIUS.</b>						
*65.	<i>Hydrobius semicylindricus</i> , Esch., . . . . . (?) Imm., . . . . .	×	×	×	×	×
<i>Carried forward,</i>		12	27	2	32	2

GENERA AND SPECIES.					Hawaii.	Maui.	Lanai.	Oahu.	Kauai.
<i>Brought forward,</i>					12	27	2	32	2
<b>CYCLONOTUM.</b>									
*66. <i>Cyclonotum subquadratum</i> , Fairm., . . . (?) Int., . . .					...	...	...	×	...
*67. <i>Sphæridium abdominale</i> , Fab., . . . (?) Int., . . .					...	×	...	×	...
<b>*OMICRUS.</b>									
*68. <i>Omicrus brevipes</i> , Shp., . . . (?) Imm., . . .					...	...	...	×	...
<b>Fam. STAPHYLINIDÆ.</b>									
<b>Tribe ALEOCHARINI.</b>									
<b>STENAGRIA.</b>									
*69. <i>Falagria currax</i> , Shp., . . . (?) Int., . . .					...	...	...	×	...
<b>BOLITOCCHARA.</b>									
*70. <i>Bolitochara impacta</i> , Blackb., . . . (?) Int., . . .					...	...	...	×	...
<b>TACHYUSA.</b>									
*71. <i>Tachyusa pumila</i> , Shp., . . . (?) Imm., . . .					...	×	...	...	...
<b>HOMALOTA.</b>									
72. <i>Homalota coriaria</i> , Kr., . . . Int., . . .					×	×	×	×	×
<b>DIESTOTA.</b>									
*73. <i>Diestota plana</i> , Shp., . . . Aut., . . .					...	...	...	×	...
*74. <i>Diestota parva</i> , Shp., . . . Aut., . . .					...	...	...	×	...
*75. <i>Diestota latifrons</i> , Shp., . . . Aut., . . .					...	...	...	...	×
*76. <i>Diestota rufescens</i> , Shp., . . . Aut., . . .					...	...	...	...	×
*77. <i>Diestota palpalis</i> , Shp., . . . Aut., . . .					×	...	...	...	...
*78. <i>Diestota puncticeps</i> , Shp., . . . Aut., . . .					...	...	...	×	...
*79. <i>Diestota carinata</i> , Shp., . . . Aut., . . .					...	...	...	×	...
*80. <i>Diestota montana</i> , Blackb., . . . Aut., . . .					×	...	...	...	...
*81. <i>Diestota incognita</i> , Blackb., . . . Aut., . . .					×	...	...	...	...
<b>PHLÆOPORA.</b>									
*82. <i>Phlæopora cingulata</i> , Shp., . . . (?) Imm., . . .					...	...	...	×	...
*83. <i>Phlæopora diluta</i> , Shp., . . . (?) Imm., . . .					...	...	...	...	×
<b>OLIGOTA.</b>									
*84. <i>Oligota glabra</i> , Shp., . . . Aut., . . .					×	...	...	...	...
*85. <i>Oligota polita</i> , Shp., . . . Aut., . . .					...	...	...	×	...
*86. <i>Oligota mutanda</i> , Shp., . . . Aut., . . .					×	...	...	...	...
*87. <i>Oligota prolixa</i> , Shp., . . . Aut., . . .					×	×	...	...	...
*88. <i>Oligota kauiensis</i> , Blackb., . . . Aut., . . .					...	...	...	...	×
*89. <i>Oligota longipennis</i> , Blackb., . . . Aut., . . .					...	...	...	×	...
*90. <i>Oligota simulans</i> , Blackb., . . . Aut., . . .					...	...	...	...	×
*91. <i>Oligota variegata</i> , Blackb., . . . Aut., . . .					...	...	...	×	...
*92. <i>Oligota clavicornis</i> , Shp., . . . (?) Imm., . . .					...	...	...	...	×
<b>*LIOPHÆNA.</b>									
*93. <i>Liophæna gracilipes</i> , Shp., . . . Aut., . . .					×	...	...	...	...
*94. <i>Liophæna flaviceps</i> , Shp., . . . Aut., . . .					×	...	...	...	...
<b>MYLLÆNA.</b>									
*95. <i>Myllæna familiaris</i> , Shp., . . . (?) Imm., . . .					...	...	...	×	...
*96. <i>Myllæna curtipes</i> , Shp., . . . (?) Imm., . . .					...	...	...	×	...
<i>Carried forward,</i>					21	31	3	48	9

GENERA AND SPECIES.		Hawaii.	Maui.	Lanai.	Oahu.	Kauai.
<i>Brought forward,</i>		21	31	3	48	9
<i>MYLLÆNA—continued.</i>						
*97.	<i>Myllæna vicina</i> , Shp., . . . . . (?) Imm.,	...	...	...	×	...
*98.	<i>Myllæna discedens</i> , Shp., . . . . . (?) Imm.,	...	...	...	×	...
*99.	<i>Myllæna pacifica</i> , Blackb., . . . . . (?) Imm.,	×	...	...	...	...
*100.	<i>Myllæna oahuensis</i> , Blackb., . . . . . (?) Imm.,	...	...	...	×	...
Tribe XANTHOLINI.						
<i>PACHYCORYNUS.</i>						
*101.	<i>Pachycorynus discedens</i> , Shp., . . . . . (?) Int. or imm.	...	...	...	×	...
<i>LEPTACINUS.</i>						
102.	<i>Leptacinus flavipennis</i> , Kr., . . . . . (?) Int., . . .	...	...	...	×	...
Tribe STAPHYLININI.						
<i>CREOPHILUS.</i>						
103.	<i>Staphylinus maxillosus</i> , L., . . . . . (?) Int., . . .	×	×	×	×	×
<i>CAFIUS.</i>						
104.	<i>Philonthus nauticus</i> , Fairm., . . . . . (?) Imm. or int.	...	×	...	...	...
<i>PHILONTHUS.</i>						
105.	<i>Philonthus scybalarius</i> , Nord., . . . . . Int., . . .	×	×	×	×	×
106.	<i>Staphylinus discoideus</i> , Grav., . . . . . Int., . . .	?	?	?	×	?
107.	<i>Philonthus turbidus</i> , Er., . . . . . Int., . . .	...	...	...	×	...
108.	<i>Staphylinus nigrutilus</i> , Gr., . . . . . Int., . . .	×	×	×	...	...
Tribe PÆDERINI.						
<i>LITHOCHARIS.</i>						
109.	<i>Lithocharis debilicornis</i> , Woll., . . . . . Int., . . .	...	...	...	×	...
110.	<i>Lithocharis celebensis</i> , Fauv., . . . . . Int., . . .	...	...	...	×	...
*111.	<i>Lithocharis incompta</i> , Shp., . . . . . (?) Imm.,	×	...	...	...	...
112.	<i>Lithocharis fuscipennis</i> , Fauv., . . . . . (?) Int., . . .	...	...	...	×	...
Tribe OXYTELINI.						
<i>OXYTELUS.</i>						
*113.	<i>Oxytelus bledioides</i> , Blackb., . . . . . (?) Int., . . .	...	...	...	×	...
*114.	<i>Oxytelus advena</i> , Shp., . . . . . (?) Int., . . .	...	...	...	×	...
*115.	<i>Oxytelus pygmaeus</i> , Kr., . . . . . Int., . . .	...	...	...	×	...
<i>TROGOPHLCÆUS.</i>						
*116.	<i>Trogophlæus senilis</i> , Shp., . . . . . (?) Imm.	...	...	...	×	...
*117.	<i>Trogophlæus abdominalis</i> , Shp., . . . . . (?) Imm.	...	...	...	×	...
*118.	<i>Trogophlæus fontinalis</i> , Shp., . . . . . (?) Imm.	...	...	...	×	...
Tribe PIESTINI.						
<i>*LISPINODES.</i>						
*119.	<i>Lispinodes explicandus</i> , Shp., . . . . . (?) Imm.,	...	...	...	×	...
*120.	<i>Lispinodes quadratus</i> , Blackb., . . . . . (?) Int. or imm.	...	...	...	×	...
*121.	<i>Lispinodes pallescens</i> , Blackb., . . . . . (?) Int. or imm.	...	...	...	×	...
<i>GLYPTOMA.</i>						
*122.	<i>Glyptoma blackburni</i> , Shp., . . . . . (?) Imm.,	×	...	...	×	×
*123.	<i>Glyptoma brevipenne</i> , Shp., . . . . . (?) Imm.,	...	...	...	×	...
<i>Carried forward,</i>		27	35	6	71	12

GENERA AND SPECIES.		Hawaii.	Maui.	Lanai.	Oahu.	Kauai.
<i>Brought forward,</i>		27	35	6	71	12
Fam. TRICHOPTERYGIDÆ.						
ACTIDIUM.						
*124.	<i>Actidium sharpianum</i> , Matth., . . . . . (?) Imm.,	...	...	...	×	...
PTILIODES.						
*125.	<i>Ptiliodes blackburni</i> , Matth., . . . . . (?) Imm.,	...	...	...	×	...
PTINILLA.						
*126.	<i>Ptinella pacifica</i> , Matth., . . . . . (?) Imm.,	...	...	...	×	...
Fam. HISTERIDÆ.						
CARCINOPS.						
127.	<i>Dendrophilus 14-striatus</i> , Steph., . . . . . Int.,	...	...	...	×	...
SAPRINUS.						
128.	<i>Saprinus lugens</i> , Er., . . . . . Int.,	×	×	×	×	×
129.	<i>Saprinus oregonensis</i> , . . . . . Int.,	?	?	?	×	×
BACANIUS.						
*130.	<i>Bacanius atomarius</i> , Shp., . . . . . (?) Int.,	...	...	...	×	...
*131.	<i>Bacanius confusus</i> , Blackb., . . . . . (?) Int.,	...	...	...	×	...
ACRITUS.						
*132.	<i>Acritus insularis</i> , Shp., . . . . . (?) Int.,	...	...	...	×	...
ÆLETES.						
133.	<i>Acritus basalis</i> , Lec., . . . . . (?) Imm.,	...	...	...	×	...
*134.	<i>Æletes facilis</i> , Shp., . . . . . (?) Imm.,	...	...	...	×	...
*135.	<i>Æletes longipes</i> , Shp., . . . . . (?) Imm.,	...	×	×	×	...
*136.	<i>Æletes concentricus</i> , Shp., . . . . . (?) Imm.,	...	×	...	...	...
*137.	<i>Æletes monticola</i> , Blackb., . . . . . (?) Imm.,	...	×	...	...	...
*138.	<i>Æletes flavitarsis</i> , Lew., . . . . . (?) Imm.,	...	...	...	×	...
Fam. NITIDULIDÆ.						
CARPOPHILUS.						
139.	<i>Nitidula dimidiata</i> , Fab., . . . . . Int.,	?	×	?	×	?
140.	<i>Carpophilus maculatus</i> , Murr., . . . . . Int.,	×	×	×	?	×
141.	<i>Dermestes hemipterus</i> , Lin., . . . . . Int.,	...	×	...	×	...
*GONIORYCTUS.						
*142.	<i>Gonioryctus latus</i> , . . . . . Aut.,	...	...	...	×	...
*143.	<i>Gonioryctus blackburni</i> , Shp., . . . . . Aut.,	...	...	...	×	...
*144.	<i>Gonioryctus monticola</i> , Shp., . . . . . Aut.,	...	...	...	×	...
*145.	<i>Gonioryctus fugitivus</i> , Blackb., . . . . . Aut.,	×	...	...	...	...
*146.	<i>Gonioryctus similis</i> , Blackb., . . . . . Aut.,	...	...	...	×	...
BRACHYPEPLUS.						
*147.	<i>Brachypeplus tinctus</i> , Shp., . . . . . Aut.,	...	...	...	×	...
*148.	<i>Brachypeplus protinoides</i> , Shp., . . . . . Aut.,	...	×	...	...	...
*149.	<i>Brachypeplus torvus</i> , Blackb., . . . . . Aut.,	...	...	...	×	...
*150.	<i>Brachypeplus koelensis</i> , Blackb., . . . . . Aut.,	...	...	×	...	...
*151.	<i>Brachypeplus bidens</i> , Shp., . . . . . Aut.,	×	...	...	...	...
<i>Carried forward,</i>		31	43	10	92	15

GENERA AND SPECIES.			Hawaii.	Mau.	Lanai.	Oahu.	Kauai.
<i>Brought forward,</i>			31	43	10	92	15
<b>BRACHYPEPLUS—continued.</b>							
*152.	<i>Brachypeplus floricola</i> , Blackb.,	Aut.,	...	...	...	...	×
*153.	<i>Brachypeplus olindae</i> , Blackb.,	Aut.,	...	×	...	...	...
*154.	<i>Brachypeplus celatus</i> , Shp.,	Aut.,	×	...	...	...	...
*155.	<i>Brachypeplus affinis</i> , Shp.,	Aut.,	×	...	...	...	...
*156.	<i>Brachypeplus inauratus</i> , Shp.,	Aut.,	×	...	...	...	...
*157.	<i>Brachypeplus apertus</i> , Shp.,	Aut.,	×	...	...	...	...
*158.	<i>Brachypeplus quadraticollis</i> , Blackb.,	Aut.,	×	...	...	...	...
*159.	<i>Brachypeplus discedens</i> , Shp.,	Aut.,	...	...	...	×	...
	Var. (?) <i>B. kauaiensis</i> , Blackb.,		...	...	...	...	×
*160.	<i>Brachypeplus metallescens</i> , Shp.,	Aut.,	×	...	...	...	...
*161.	<i>Brachypeplus parallelus</i> , Blackb.,	Aut.,	...	...	×	...	...
*162.	<i>Brachypeplus vestitus</i> , Shp.,	Aut.,	...	...	...	×	...
*163.	<i>Brachypeplus varius</i> , Shp.,	Aut.,	×	...	...	...	...
*164.	<i>Brachypeplus blackburni</i> , Shp.,	Aut.,	×	...	...	...	...
	Var. <i>lanaiensis</i> , Blackb.,		...	...	×	...	...
*165.	<i>Brachypeplus robustus</i> , Shp.,	Aut.,	...	...	...	×	...
*166.	<i>Brachypeplus guttatus</i> , Shp.,	Aut.,	...	...	...	×	...
*167.	<i>Brachypeplus sordidus</i> , Shp.,	Aut.,	×	...	...	...	...
*168.	<i>Brachypeplus expers</i> , Blackb.,	Aut.,	...	×	...	...	...
*169.	<i>Brachypeplus reitteri</i> , Shp.,	Aut.,	...	...	...	×	...
*170.	<i>Brachypeplus infimus</i> , Shp.,	(?) Imm.,	...	...	...	×	...
*171.	<i>Brachypeplus obsoletus</i> , Shp.,	Aut.,	×	...	...	...	...
*172.	<i>Brachypeplus omalioides</i> , Shp.,	Aut.,	×	...	...	×	...
*173.	<i>Brachypeplus aper</i> , Shp.,	Aut.,	...	...	...	×	...
*174.	<i>Brachypeplus explanatus</i> , Shp.,	Aut.,	...	...	...	×	...
*175.	<i>Brachypeplus brevis</i> , Shp.,	Aut.,	...	...	...	×	...
*176.	<i>Brachypeplus spretus</i> , Blackb.,	Aut.,	...	×	...	...	...
*177.	<i>Brachypeplus inæqualis</i> , Shp.,	Aut.,	...	...	...	×	...
*178.	<i>Brachypeplus striatus</i> , Shp.,	Aut.,	×	...	...	...	...
*179.	<i>Brachypeplus bicolor</i> , Blackb.,	Aut.,	×	...	...	...	...
*180.	<i>Brachypeplus impressus</i> , Shp.,	Aut.,	...	...	...	×	...
<b>HAPTONCUS.</b>							
181.	<i>Haptoncus tetragonus</i> , Murr.,	Int.,	×	?	?	×	×
*182.	<i>Haptoncus mundus</i> , Shp.,	(?) Imm.,	×	...	...	×	...
	"    "    var.,		...	...	...	...	×
Fam. MONOTOMIDÆ.							
<b>HESPEROBÆNUS.</b>							
183.	<i>Rhizophagus capito</i> , Fairm.,	Imm.,	?	?	?	×	×
Fam. TROGOSITIDÆ.							
<b>TROGOSITA.</b>							
184.	<i>Tenebrio mauritanicus</i> , L.,	Int.,	?	?	?	×	?
Fam. COLYDIDÆ.							
<b>ANTILISSUS.</b>							
*185.	<i>Antilissus aper</i> , Shp.,	(?) Int. or imm.	...	...	...	×	...
<b>EULACHUS.</b>							
*186.	<i>Eulachus hispidus</i> , Blackb.,	(?) Int. or imm.	...	...	...	×	...
<i>Carried forward,</i>			46	46	12	110	20

GENERA AND SPECIES.				Hawaii.	Maui.	Lanai.	Oahu.	Kauai.
<i>Brought forward,</i>				46	46	12	110	20
Fam. RHYSSODIDÆ.								
CLINIDIUM.								
187.	<i>Rhyzodes liratus</i> , Newm.,	.	Int.,	...	...	...	×	...
Fam. CUCUJIDÆ.								
CRYPTAMORPHA.								
188.	<i>Psammæchus desjardinsii</i> , Guer.,	.	Imm.,	×	...	...	×	×
TELEPHANUS.								
*189.	<i>Telephanus insularis</i> , Shp.,	.	(?) Imm.,	...	...	...	×	×
*190.	<i>Telephanus pallidipennis</i> , Blackb.,	.	(?) Imm.,	...	...	...	×	...
LÆMOPHLEUS.								
191.	<i>Cucujus pusillus</i> , Schön.,	.	Int.,	...	...	...	×	...
*192.	<i>Læmophilæus æneus</i> , Shp.,	.	(?) Imm.,	×	×	...	...	...
*BRONTOLÆMUS.								
*193.	<i>Brontolæmus elegans</i> , Shp.,	.	(?) Imm.,	?	?	×	×	×
*MONANUS.								
*194.	<i>Monanus crenatus</i> , Shp.,	.	(?) Imm.,	...	...	...	×	...
*195.	<i>Monanus brevicornis</i> , Blackb.,	.	(?) Imm.,	...	...	...	×	...
CATHARTUS.								
196.	<i>Cryptophagus advena</i> , Walt.,	.	Int.,	...	...	...	×	...
SILVANUS.								
197.	<i>Dermestes surinamensis</i> , L.,	.	Int.,	?	?	×	×	?
198.	<i>Dermestes unidentatus</i> , Fab.,	.	Int.,	...	...	...	×	...
NAUSIBIUS.								
199.	<i>Corticaria dentata</i> ,	.	Int.,	?	?	?	×	?
Fam. CRYPTOPHAGIDÆ.								
TELMATOPHILUS.								
*200.	<i>Telmatophilus debilis</i> , Shp.,	.	(?) Imm.,	...	...	...	×	...
HENOTICUS.								
201.	<i>Cryptophagus serratus</i> , Gyll.,	.	Int.,	...	×	...	×	...
Fam. LATHRIDIIDÆ.								
LATHRIDIUS.								
202.	<i>Lathridius nodifer</i> , West.,	.	Int.,	×	...	...	×	...
Fam. MYCETOPHAGIDÆ.								
LITARGUS.								
*203.	<i>Litargus vestitus</i> , Shp.,	.	(?) Imm.,	×	?	×	×	?
<i>Carried forward,</i>				50	48	15	126	23

GENERA AND SPECIES.		Hawaii.	Maui.	Lanai.	Oahu.	Kauai.
<i>Brought forward,</i>		50	48	15	126	23
<b>TYPHLEA.</b>						
204.	<i>Dermestes fumatus</i> , Lin., . . . . . Int., . . . . .	...	...	...	×	...
<b>MYCETEA.</b>						
205.	<i>Silpha hirta</i> , Marsh, . . . . . Int., . . . . .	...	...	...	×	...
<b>PROPALTIUS.</b>						
*206.	<i>Propalticus oculatus</i> , . . . . . (?) Imm., . . . . .	?	×	?	×	?
<b>Fam. CORYLOPHIDÆ.</b>						
<b>ORTHOPEUS.</b>						
*207.	<i>Orthoperus æqualis</i> , Shp., . . . . . (?) Imm., . . . . .	×	...	...	...	...
<b>SERICODERUS.</b>						
*208.	<i>Sericoderus basalis</i> , Shp., . . . . . (?) Imm., . . . . .	...	...	...	×	...
*209.	<i>Sericoderus pubipennis</i> , Shp., . . . . . (?) Imm., . . . . .	...	×	...	×	...
<b>CORYLOPHUS.</b>						
*210.	<i>Corylophus rotundus</i> , Shp., . . . . . (?) Imm. or int.	...	...	...	×	...
*211.	<i>Corylophus suturalis</i> , Shp., . . . . . (?) Imm., . . . . .	...	...	...	×	...
<b>Fam. EROTYLIDÆ.</b>						
<b>EUXESTUS.</b>						
*212.	<i>Euxestus minor</i> , Shp., . . . . . (?) Imm., . . . . .	...	...	...	×	...
*EIDOREUS.						
*213.	<i>Eidoreus minutus</i> , Shp., . . . . . (?) Imm., . . . . .	...	...	...	×	...
<b>Fam. COCCINELLIDÆ.</b>						
<b>NEDA.</b>						
214.	<i>Coccinella abdominalis</i> , Say, . . . . . Int., . . . . .	?	×	?	×	×
(?) COCCINELLA.						
215.	Sp. (?), . . . . . Int., . . . . .	...	...	...	×	...
<b>SCYMNUS.</b>						
*216.	<i>Scymnus vividus</i> , Shp., . . . . . (?) Imm., . . . . .	×	×	?	×	?
*217.	<i>Scymnus ocellatus</i> , Shp., . . . . . (?) Imm., . . . . .	...	×	...	×	...
*218.	<i>Scymnus discedens</i> , Shp., . . . . . (?) Imm., . . . . .	...	...	...	×	...
<b>Fam. DERMESTIDÆ.</b>						
<b>DERMESTES.</b>						
219.	<i>Dermestes cadaverinus</i> , Fab., . . . . . Int., . . . . .	?	×	?	×	?
220.	<i>Dermestes vulpinus</i> , Fab., . . . . . Int., . . . . .	×	?	?	×	×
<b>ATTAGENUS.</b>						
*221.	<i>Attagenus plebeius</i> , Shp., . . . . . (?) Int., . . . . .	...	..	...	×	...
<b>*LABROCERUS.</b>						
*222.	<i>Labrocerus jaynei</i> , Shp., . . . . . (?) Imm., . . . . .	...	×	...	...	...
*223.	<i>Labrocerus concolor</i> , Shp., . . . . . (?) Imm., . . . . .	×	...	...	...	...
*224.	<i>Labrocerus obscurus</i> , Blackb., . . . . . (?) Imm., . . . . .	×	...	...	...	...
<i>Carried forward,</i>		55	55	15	143	25



GENERA AND SPECIES.					Hawaii.	Maui.	Lanai.	Oahu.	Kauai.
<i>Brought forward,</i>					55	55	15	143	25
CRYPTORHOPALUM.									
*225. <i>Cryptorhopalum brevicorne</i> , Shp., . . . (?) Int., . . .					...	...	...	×	...
*226. <i>Cryptorhopalum terminale</i> , Shp., . . . (?) Int., . . .					...	...	...	×	×
Fam. LUCANIDÆ.									
*APTEROCYCLUS.									
*227. <i>Apterocyclus honoluluensis</i> , Wat., . . . (?) Imm., . . .					...	...	...	...	×
Fam. SCARABÆIDÆ.									
Tribe COPRINI.									
APHODIUS.									
228. <i>Scarabeus lividus</i> , Ol., . . . Int., . . .					×	×	×	×	×
ATENIUS.									
229. <i>Aphodius pacificus</i> , Shp., . . . (?) Imm. or int.					...	...	...	×	...
230. <i>Atenius stercorator</i> , Horn., . . . Int., . . .					...	...	...	×	...
231. <i>Atenius peregrinator</i> , Horn., . . . Int., . . .					...	...	...	×	...
SAPROSITES.									
232. <i>Saprosites pygmaeus</i> , Har., . . . (?) Int. or imm.					?	×	?	×	?
Fam. EUCNEMIDÆ.									
FORNAX.									
*233. <i>Fornax bonvouloiri</i> , Shp., . . . (?) Imm., . . .					?	×	?	×	?
*234. <i>Fornax sculpturatus</i> , Blackb., . . . (?) Imm., . . .					...	...	...	×	...
*235. <i>Fornax obtusus</i> , Blackb., . . . (?) Imm., . . .					...	×	...	...	...
*236. <i>Fornax longicornis</i> , Blackb., . . . (?) Imm., . . .					...	×	...	...	...
*237. <i>Fornax parallelus</i> , Blackb., . . . (?) Imm., . . .					...	...	...	×	...
Fam. BUPRESTIDÆ.									
BUPRESTIS.									
238. <i>Buprestis adjecta</i> , Lec., . . . Int., . . .					...	...	...	×	...
Fam. ELATERIDÆ.									
Tribe AGRYPNINI.									
ADELOCERA.									
239. <i>Agrypnus modestus</i> , Boisd., . . . Imm., . . .					...	...	...	×	...
Tribe CHALCOLEPIDIDES.									
CHALCOLEPIDIUS.									
240. <i>Chalcolepidius erythroloma</i> , Cand., . . . (?) Imm. or int.					...	...	...	×	...
Tribe ELATERIDES.									
ISCHIODONTUS.									
*241. <i>Ischiodontus hawaiiensis</i> , Cand., . . . (?) Imm., . . .					?	?	?	?	?
SIMODACTYLUS.									
242. <i>Eolus cinnamomeus</i> , Boisd., . . . Imm., . . .					...	...	...	×	...
<i>Carried forward,</i>					56	60	16	157	28

GENERA AND SPECIES.				Hawaii.	Mau.	Lanai.	Oahu.	Kauai.
<i>Brought forward,</i>				56	60	16	157	28
<b>MELANOXANTHUS.</b>								
	243.	<i>Elater melanocephalus</i> , Thunb.,	Imm.,	...	...	...	×	...
<b>*EOPENTHES.</b>								
	*244.	<i>Eopenthes basalis</i> , Shp.,	Aut.,	...	...	...	×	...
	*245.	<i>Elater humeralis</i> , Karsch.,	Aut.,	...	×	...	...	...
	*246.	<i>Eopenthes obscurus</i> , Shp.,	Aut.,	...	...	...	×	...
	*247.	<i>Eopenthes konæ</i> , Blackb.,	Aut.,	...	×	...	...	...
	*248.	<i>Eopenthes satelles</i> , Blackb.,	Aut.,	...	...	×	...	...
	*249.	<i>Eopenthes debilis</i> , Shp.,	Aut.,	...	...	...	×	...
	*250.	<i>Eopenthes ambiguus</i> , Blackb.,	Aut.,	...	...	...	×	...
<b>*ITODACNUS.</b>								
	*251.	<i>Itodacnus gracilis</i> , Shp.,	(?) Imm. or aut.	...	...	...	×	...
	*252.	<i>Corymbites corruscus</i> , Karsch,	(?) Imm. or aut.	...	×	...	...	...
<b>Fam. MALACODERMIDÆ.</b>								
<b>HELCOGASTER.</b>								
	*253.	<i>Helcogaster pectinatus</i> ,	(?) Int.	...	...	...	×	...
<b>*CACCODES.</b>								
	*254.	<i>Caccodes debilis</i> , Shp.,	(?) Int.,	...	...	...	×	...
<b>Fam. CLERIDÆ.</b>								
<b>TARSOSTENUS.</b>								
	255.	<i>Clerus univittatus</i> , Rossi.,	Int.,	...	...	...	×	...
<b>NECROBIA.</b>								
	256.	<i>Dermestes rufipes</i> , Fab.,	Int.,	×	×	×	×	×
	257.	<i>Dermestes ruficollis</i> , Fab.,	Int.,	×	×	×	×	×
<b>Fam. PTINIDÆ.</b>								
<b>Tribe ANOBIINI.</b>								
<b>*HOLCOBIUS.</b>								
	*258.	<i>Holcobius major</i> , Shp.,	Aut.,	...	×	...	...	...
	*259.	<i>Holcobius glabricollis</i> , Shp.,	Aut.,	...	...	...	×	...
	*260.	<i>Holcobius granulatus</i> , Shp.,	Aut.,	×	×	...	...	...
<b>*XYLETObIUS.</b>								
	*261.	<i>Xyletobius insignis</i> , Blackb.,	Aut.,	×	...	...	...	...
	*262.	<i>Xyletobius oculatus</i> , Shp.,	Aut.,	×	...	...	...	...
	*263.	<i>Xyletobius nigrinus</i> , Shp.,	Aut.,	...	×	...	...	...
	*264.	<i>Xyletobius marmoratus</i> , Shp.,	Aut.,	...	×	...	...	...
	*265.	<i>Xyletobius affinis</i> , Shp.,	Aut.,	×	...	...	...	...
	*266.	<i>Xyletobius serricornis</i> , Shp.,	Aut.,	...	...	×	...	...
	*267.	<i>Xyletobius lineatus</i> , Blackb.,	Aut.,	×	...	...	...	...
	*268.	<i>Tripopitys capucinus</i> , Karsch.,	Aut.,	...	×	...	...	...
<b>ANOBIUM.</b>								
	269.	<i>Dermestes paniceus</i> , L.,	Int.,	...	...	...	×	...
<i>Carried forward,</i>				64	69	20	170	30

GENERA AND SPECIES.						Hawaii.	Maui.	Lanai.	Oahu.	Kauai.
<i>Brought forward,</i>						64	69	20	170	80
<b>LASIODERMA.</b>										
270. <i>Ptinus serricornis</i> , Fab., . . . . Int., . . . .						...	...	...	×	×
<b>CATORAMA.</b>										
271. <i>Catorama mexicana</i> , Chev., . . . . Int., . . . .						...	×	...	...	...
*272. <i>Catorama pusilla</i> , Shp., . . . . (?) Int., . . . .						...	×	...	...	...
<b>*MIROSTERNUS.</b>										
*273. <i>Mirosternus punctatus</i> , Shp., . . . . Aut., . . . .						...	...	...	×	...
*274. <i>Mirosternus obscurus</i> , Shp., . . . . Aut., . . . .						...	...	...	×	...
*275. <i>Mirosternus muticus</i> , Shp., . . . . Aut., . . . .						×	×	...	...	...
*276. <i>Mirosternus carinatus</i> , Shp., . . . . Aut., . . . .						...	...	...	...	...
*277. <i>Mirosternus glabripennis</i> , Shp., . . . . Aut., . . . .						...	...	...	×	...
*278. <i>Mirosternus debilis</i> , Shp., . . . . Aut., . . . .						...	...	...	×	...
*279. <i>Mirosternus bicolor</i> , Shp., . . . . Aut., . . . .						...	...	...	×	...
*280. <i>Mirosternus acutus</i> , Blackb., . . . . Aut., . . . .						...	...	...	...	×
<b>Fam. BOSTRICHIDÆ.</b>										
<b>BOSTRICHUS.</b>										
281. <i>Bostrichus migrator</i> , Shp., . . . . Int., . . . .						...	...	...	×	...
<b>APATE.</b>										
282. <i>Apate lifuana</i> , Mont., . . . . (?) Int. or imm.						...	...	...	×	...
<b>XYLOPERTHA.</b>										
283. <i>Apate castanoptera</i> , Fairm., . . . . (?) Int. or imm.						...	...	...	×	...
<b>RHYZOPERTHA.</b>										
284. <i>Rhyzopertha pusilla</i> , Steph., . . . . Int., . . . .						...	...	...	×	...
<b>LYCTUS.</b>										
285. <i>Xylotrogus brunneus</i> , Steph., . . . . Int., . . . .						...	...	...	×	...
<b>Fam. CIOIDÆ.</b>										
<b>Cis.</b>										
*286. <i>Cis alienus</i> , Shp., . . . . (?) Imm.						...	...	...	×	...
*287. <i>Cis pacificus</i> , Shp., . . . . Aut., . . . .						...	...	...	×	...
*288. <i>Cis porcatus</i> , Shp., . . . . Aut., . . . .						×	?	?	×	×
*289. <i>Cis bimaculatus</i> , Shp., . . . . Aut., . . . .						×	×	...	...	...
*290. <i>Cis nigro-fasciatus</i> , Blackb., . . . . Aut., . . . .						...	...	×	...	...
*291. <i>Cis signatus</i> , Shp., . . . . Aut., . . . .						×	×	?	×	?
*292. <i>Cis attenuatus</i> , Shp., . . . . Aut., . . . .						...	...	...	...	×
*293. <i>Cis bicolor</i> , Shp., . . . . Aut., . . . .						×	×	...	×	×
*294. <i>Cis setarius</i> , Shp., . . . . Aut., . . . .						×	...	...	...	...
*295. <i>Cis concolor</i> , Shp., . . . . Aut., . . . .						×	...	...	...	...
*296. <i>Cis chloroticus</i> , Shp., . . . . Aut., . . . .						...	×	...	...	...
*297. <i>Cis calidus</i> , Shp., . . . . Aut., . . . .						...	...	...	×	...
*298. <i>Cis insularis</i> , Shp., . . . . Aut., . . . .						...	...	...	×	...
*299. <i>Cis roridus</i> , Shp., . . . . Aut., . . . .						×	...	...	...	...
*300. <i>Cis diminutivus</i> , Shp., . . . . Aut., . . . .						...	...	...	×	...
*301. <i>Cis læticulus</i> , Shp., . . . . Aut., . . . .						...	...	...	×	...
*302. <i>Cis longipennis</i> , Blackb., . . . . Aut., . . . .						...	...	...	...	×
<i>Carried forward,</i>						72	76	21	190	86

GENERA AND SPECIES.		Hawaii.	Mau.	Lanai.	Oahu.	Kauai.
<i>Brought forward,</i>		72	76	21	190	36
<i>Cis</i> — <i>continued.</i>						
*303.	<i>Cis evanescens</i> , Shp., . . . . . Aut., . . . . .	...	...	...	×	×
*304.	<i>Cis ephistemoides</i> , Shp., . . . . . Aut., . . . . .	...	...	×	×	×
*305.	<i>Cis vagepunctatus</i> , Blackb., . . . . . Aut., . . . . .	...	...	...	×	...
Fam. TENEBRIONIDÆ.						
Tribe EPITRAGINI.						
<i>EPITRAGUS.</i>						
*306.	<i>Epitragus diremptus</i> , Karsch., . . . . . (?) Imm., . . . . .	?	×	?	×	×
Tribe OPATRINI.						
<i>OPATRUM.</i>						
307.	<i>Opatrum seriatum</i> , Boisd., . . . . . Imm., . . . . .	×	×	×	×	×
Tribe DIAPERINI.						
<i>PLATYDEMA.</i>						
*308.	<i>Platydema obscurum</i> , Shp., . . . . . (?) Imm., . . . . .	...	...	...	×	...
Tribe ULOMINI.						
<i>GNATHOCERUS.</i>						
309.	<i>Trogosita cornuta</i> , Fab., . . . . . Int., . . . . .	...	...	...	×	...
<i>TRIBOLIUM.</i>						
310.	<i>Tenebrio ferrugineus</i> , Fab., . . . . . Int., . . . . .	...	...	...	×	...
<i>ALPHITOBIUS.</i>						
311.	<i>Tenebrio diaperinus</i> , Panz., . . . . . Int., . . . . .	?	×	?	×	?
312.	<i>Helops piceus</i> , Ol., . . . . . Int., . . . . .	?	?	×	×	×
<i>SCIOPHAGUS.</i>						
313.	<i>Heterophaga pandanicola</i> , Esch., . . . . . Int., . . . . .	?	?	?	×	×
Fam. CISTELIDÆ.						
<i>*Labetis.</i>						
*314.	<i>Labetis tibialis</i> , Wat., . . . . . (?) Imm., . . . . .	...	...	...	×	...
<i>CISTELA.</i>						
*315.	<i>Cistela crassicornis</i> , Shp., . . . . . (?) Imm., . . . . .	...	...	...	×	...
Fam. ANTHICIDÆ.						
<i>ANTHICUS.</i>						
316.	<i>Anthicus oceanicus</i> , Laf., . . . . . Imm., . . . . .	?	×	?	×	×
*317.	<i>Anthicus mundulus</i> , Shp., . . . . . (?) Imm., . . . . .	?	?	?	×	×
Fam. ŒDEMERIDÆ.						
<i>ANANCA.</i>						
*318.	<i>Ananca collaris</i> , Shp., . . . . . (?) Int., . . . . .	...	...	...	×	...
<i>Carried forward,</i>		73	80	24	206	44

GENERA AND SPECIES.					Hawaii.	Mau.	Lanai.	Oahu.	Kauai.
<i>Brought forward,</i>					73	80	24	206	44
Fam. AGLYCYDERIDÆ.									
*PROTERHINUS.									
*319.	Proterhinus	paradoxus,	Shp.,	Aut.,	...	...	...	×	...
*320.	Proterhinus	longulus,	Shp.,	Aut.,	...	...	...	×	...
*321.	Proterhinus	linearis,	Blackb.,	Aut.,	...	...	...	×	...
*322.	Proterhinus	blackburni,	Shp.,	Aut.,	...	...	...	×	...
*323.	Proterhinus	hystrix,	Shp.,	Aut.,	×	...	...	...	...
*324.	Proterhinus	pusillus,	Shp.,	Aut.,	...	...	...	×	...
*325.	Proterhinus	simplex,	Shp.,	Aut.,	...	...	...	×	...
*326.	Proterhinus	scutatus,	Blackb.,	Aut.,	...	...	...	...	×
*327.	Proterhinus	similis,	Blackb.,	Aut.,	×	...	...	...	...
*328.	Proterhinus	tarsalis,	Blackb.,	Aut.,	×	...	...	...	...
*329.	Proterhinus	gracilis,	Shp.,	Aut.,	×	...	...	...	...
*330.	Proterhinus	debilis,	Shp.,	Aut.,	×	...	...	×	...
*331.	Proterhinus	oscillans,	Shp.,	Aut.,	...	...	...	×	...
*332.	Proterhinus	punctipennis,	Shp.,	Aut.,	...	×	...	...	...
*333.	Proterhinus	laticollis,	Blackb.,	Aut.,	...	...	...	×	...
*334.	Proterhinus	robustus,	Blackb.,	Aut.,	...	...	...	×	...
*335.	Proterhinus	integer,	Shp.,	Aut.,	...	...	×	...	...
*336.	Proterhinus	humeralis,	Shp.,	Aut.,	...	×	...	...	...
*337.	Proterhinus	ineptus,	Shp.,	Aut.,	...	...	×	...	...
*338.	Proterhinus	angularis,	Shp.,	Aut.,	...	...	...	×	...
*339.	Proterhinus	nigricans,	Shp.,	Aut.,	...	...	...	...	×
*340.	Proterhinus	vestitus,	Shp.,	Aut.,	...	...	...	×	...
*341.	Proterhinus	detritus,	Shp.,	Aut.,	...	...	×	...	...
*342.	Proterhinus	longicornis,	Shp.,	Aut.,	...	...	×	...	...
*343.	Proterhinus	sternalis,	Shp.,	Aut.,	...	×	...	...	...
*344.	Proterhinus	basalis,	Shp.,	Aut.,	...	...	...	...	×
*345.	Proterhinus	dispar,	Shp.,	Aut.,	...	...	...	×	...
*346.	Proterhinus	validus,	Shp.,	Aut.,	...	×	...	...	...
*347.	Proterhinus	insignis,	Shp.,	Aut.,	...	...	×	...	...
*348.	Proterhinus	lecontei,	Shp.,	Aut.,	...	×	...	...	...
Fam. CURCULIONIDÆ.									
Tribe OTIORHYNCHINI.									
*RHYNCOGONUS.									
*349.	Rhyncogonus	blackburni,	Shp.,	(?) Imm.,	...	..	...	×	...
*350.	Rhyncogonus	vestitus,	Shp.,	(?) Imm.,	...	×	...	...	...
Tribe CYLADINI.									
CYLAS.									
351.	Cylas	turcipennis,	Boh.,	(?) Imm.,	?	×	?	×	?
Tribe CRYPTORHYNCHINI.									
ACALLES.									
*352.	Acalles	lateralis,	Shp.,	(?) Imm. or aut.	...	...	...	×	...
*353.	Acalles	duplex,	Shp.,	(?) Imm. or aut.	...	...	...	×	...
*354.	Acalles	angusticollis,	Shp.,	(?) Imm. or aut.	...	×	×	×	×
*355.	Acalles	decoratus,	Blackb.,	(?) Imm. or aut.	...	...	×	...	...
*356.	Acalles	mauiensis (et varietates),		(?) Imm. or aut.	...	×	×	...	...
*357.	Acalles	ignotus,	Blackb.,	(?) Imm. or aut.	...	...	..	×	...
<i>Carried forward,</i>					78	89	32	224	49

GENERA AND SPECIES.		Hawaii.	Maui.	Lanai.	Oahu.	Kauai.
<i>Brought forward,</i>		78	89	32	224	49
*CHÆNOSTERNUM.						
*358.	<i>Chænosternum konanum</i> , Blackb., . . . (?) Imm. or aut.	...	...	...	×	...
*HYPEROMORPHA.						
*359.	<i>Hyperomorpha squamosa</i> , Blackb., . . . (?) Imm. or aut.	...	..	...	×	...
Tribe CALANDRINI.						
SPHENOPHORUS.						
360.	<i>Calandra obscura</i> , Boisd., . . . Int., . . .	...	...	...	×	...
CALANDRA.						
*361.	<i>Calandra remota</i> , Shp., . . . (?) Imm., . . .	...	...	...	×	...
362.	<i>Calandra linearis</i> (var. <i>striata</i> ), . . . Int., . . .	...	...	...	×	...
363.	<i>Curculio oryzæ</i> , Lin., . . . Int., . . .	...	...	...	×	...
Tribe COSSONINI.						
*HETERAMPHUS.						
*364.	<i>Heteramphus wollastoni</i> , Shp., . . . Aut., . . .	...	...	...	×	...
*365.	<i>Heteramphus foveatus</i> , Shp., . . . Aut., . . .	...	...	...	×	...
*366.	<i>Heteramphus hirtellus</i> , Shp., . . . Aut., . . .	...	...	...	×	...
*367.	<i>Heteramphus cylindricus</i> , Shp., . . . Aut., . . .	...	...	...	×	...
PENTARTHURUM.						
*368.	<i>Pentarthrum prolixum</i> , Shp., . . . (?) Aut., . . .	×	?	?	×	?
*369.	<i>Pentarthrum obscurum</i> , Shp., . . . (?) Aut., . . .	...	...	...	×	...
*370.	<i>Pentarthrum blackburni</i> , Shp., . . . (?) Aut., . . .	...	...	...	×	...
*ODEMAS.						
*371.	<i>Oodemas olindæ</i> , Blackb., . . . Aut., . . .	...	×	...	...	...
*372.	<i>Oodemas robustum</i> , Blackb., . . . Aut., . . .	...	...	...	×	...
*373.	<i>Oodemas nivicola</i> , Blackb., . . . Aut., . . .	...	×	...	...	...
*374.	<i>Oodemas infernum</i> , Blackb., . . . Aut., . . .	×	...	...	...	...
*375.	<i>Oodemas insulare</i> , Blackb., . . . Aut., . . .	...	...	...	×	...
*376.	<i>Oodemas ænescens</i> , Boh., . . . Aut., . . .	...	...	...	×	...
*377.	<i>Oodemas sculpturatum</i> , Blackb., . . . Aut., . . .	...	×	...	...	...
*378.	<i>Oodemas obscurum</i> , Blackb., . . . Aut., . . .	...	×	...	...	...
*379.	<i>Oodemas tardum</i> , Blackb., . . . Aut., . . .	...	×	...	...	...
*380.	<i>Oodemas æquale</i> , Blackb., . . . Aut., . . .	...	...	×	...	...
*381.	<i>Oodemas crassicorne</i> , Blackb., . . . Aut., . . .	...	...	×	...	...
*382.	<i>Oodemas halticoides</i> , Blackb., . . . Aut., . . .	...	...	...	×	...
*383.	<i>Oodemas angustum</i> , Blackb., . . . Aut., . . .	...	...	...	×	...
*384.	<i>Oodemas borrei</i> , Blackb., . . . Aut., . . .	...	×	...	...	...
*385.	<i>Oodemas mauiense</i> , Black., . . . Aut., . . .	...	×	...	...	...
*ANOTHEORUS.						
*386.	<i>Anotheorus montanus</i> , Blackb., . . . Aut., . . .	...	...	...	×	...
*387.	<i>Anotheorus ignavus</i> , Blackb., . . . Aut., . . .	...	×	...	...	...
*PSEUDOLUS.						
*388.	<i>Rhyncolus longulus</i> , Boh., . . . (?) Aut., . . .	...	×	...	×	...
PHLEOPHAGOSOMA.						
*389.	<i>Rhyncolus tenuis</i> , Gemm., . . . (?) Aut., . . .	...	...	...	×	...
<i>Carried forward,</i>		80	98	34	245	49

GENERA AND SPECIES.					Hawai.	Maui.	Lanai.	Oahu.	Kauai.
<i>Brought forward,</i>					80	98	34	245	49
*DOLICHOTELUS.									
	*390.	<i>Dolichotelus apicalis</i> , Blackb.,	(?)	Aut.,	...	...	...	×	...
DRYOPHTHORUS.									
	*391.	<i>Dryophthorus squalidus</i> , Shp.,	(?)	Aut.,	?	×	?	×	×
	*392.	<i>Dryophthorus gravidus</i> , Shp.,	(?)	Aut.,	...	...	...	×	...
	*393.	<i>Dryophthorus crassus</i> , Shp.,	(?)	Aut.,	...	×	...	×	...
	*394.	<i>Dryophthorus declivis</i> , Shp.,	(?)	Aut.,	...	...	...	×	...
	*395.	<i>Dryophthorus modestus</i> , Shp.,	(?)	Aut.,	×	×	?	×	?
	*396.	<i>Dryophthorus pusillus</i> , Shp.,	(?)	Aut.,	...	...	...	×	...
	*397.	<i>Dryophthorus insignis</i> , Shp.,	(?)	Aut.,	...	...	...	×	...
Fam. SCOLYTIDÆ.									
Tribe SCOLYTINI.									
XYLEBORUS.									
	*398.	<i>Xyleborus truncatus</i> , Shp.,	(?)	Imm.,	...	...	...	×	...
	*399.	<i>Xyleborus insularis</i> , Shp.,	(?)	Imm.,	...	...	...	×	×
	*400.	<i>Xyleborus obliquus</i> , Shp.,	(?)	Imm.,	×	...	...	×	...
	*401.	<i>Xyleborus rugatus</i> , Blackb.,	(?)	Imm.,	...	...	...	×	...
	*402.	<i>Xyleborus immaturus</i> , Blackb.,	(?)	Imm.,	×	...	...	×	...
	*403.	<i>Xyleborus frigidus</i> , Blackb.,	(?)	Imm.,	...	×	...	...	...
HYPOTHENEMUS.									
	404.	<i>Hypothenemus eruditus</i> , Westd.,		Int.,	...	...	...	×	...
	*405.	<i>Hypothenemus maculicollis</i> , Shp.,	(?)	Int.,	...	...	...	×	...
	*406.	<i>Hypothenemus griseus</i> , Blackb.,	(?)	Int.,	...	...	...	×	...
Tribe PLATYPINI.									
CROSSOTARSUS.									
	407.	<i>Platypus externedentatus</i> , Fairm.,	(?)	Int.,	...	...	...	×	...
Fam. ANTHRIBIDÆ.									
*MAUIA.									
	*408.	<i>Mauia satelles</i> , Blackb.,	(?)	Imm.,	...	×	...	...	...
ARÆOCERUS.									
	*409.	<i>Curculio fasciculatus</i> , de Geer.,		Int.,	×	×	×	×	×
Fam. CERAMBICIDÆ.									
Tribe PARANDRINI.									
PARANDRA.									
	*410.	<i>Parandra puncticeps</i> , Shp.,	(?)	Imm.,	...	...	...	×	...
Tribe PRIONINI.									
ÆGOSOMA.									
	*411.	<i>Ægosoma reflexum</i> , Karsch.,	(?)	Int.,	×	...	...	...	...
Tribe CERAMBYCINI.									
*ASTRIMUS.									
	*412.	<i>Astrimus obscurus</i> , Shp.,	(?)	Int.,	...	...	...	×	...
<i>Carried forward,</i>					85	104	35	265	52

GENERA AND SPECIES.		Hawaii.	Mau.	Lanai.	Oahu.	Kauai.
<i>Brought forward,</i>		85	104	35	265	52
CERESIUM.						
413.	<i>Stenocorus simplex</i> , Gyll., . . . . Int., . . . .	...	...	...	×	...
*SOTENUS.						
*414.	<i>Sotenus setiger</i> , Shp., . . . . (?) Int., . . . .	...	...	...	×	...
*CLYTARLUS.						
*415.	<i>Clytarlus microgaster</i> , Shp., . . . . Aut., . . . .	...	...	...	×	...
*416.	<i>Clytarlus robustus</i> , Shp., . . . . Aut., . . . .	...	...	...	×	...
*417.	<i>Clytarlus finschi</i> , Har., . . . . Aut., . . . .	...	×	...	...	...
*418.	<i>Clytarlus blackburni</i> , Shp., . . . . Aut., . . . .	×	...	...	...	...
*419.	<i>Clytarlus pulvillatus</i> , Karsch., . . . . Aut., . . . .	?	...	...	...	...
*420.	<i>Clytarlus pennatus</i> , Shp., . . . . Aut., . . . .	...	×	...	...	...
*421.	<i>Clytarlus cristatus</i> , Shp., . . . . Aut., . . . .	...	...	...	×	...
*422.	<i>Clytarlus modestus</i> , Shp., . . . . Aut., . . . .	...	×	...	...	...
*423.	<i>Clytarlus filipes</i> , Shp., . . . . Aut., . . . .	×	...	...	...	...
*424.	<i>Clytarlus fragilis</i> , Shp., . . . . Aut., . . . .	...	...	...	×	...
CLYTUS.						
425.	<i>Clytus crinicornis</i> , Chev., . . . . Int., . . . .	...	...	...	×	...
Tribe LAMINI.						
LAGOCHEIRUS.						
426.	<i>Cerambyx araneiformis</i> , L., . . . . Imm., . . . .	...	...	...	×	...
MICRACANTHA.						
427.	<i>Micracantha nutans</i> , Shp., . . . . (?) Int., . . . .	...	...	...	×	...
OOPSIS.						
428.	<i>Lamia nutator</i> , Fab., . . . . Imm., . . . .	...	...	...	×	...
TOTAL,		87	107	35	275	52

NOTE.—During the passage of these Memoirs through the press Mr. Blackburn has established a new genus, *Mauna* (Ent. Mo. Mag. xxi. p. 25), for *Blackburnia frigida*, No. 29 of the preceding Catalogue.



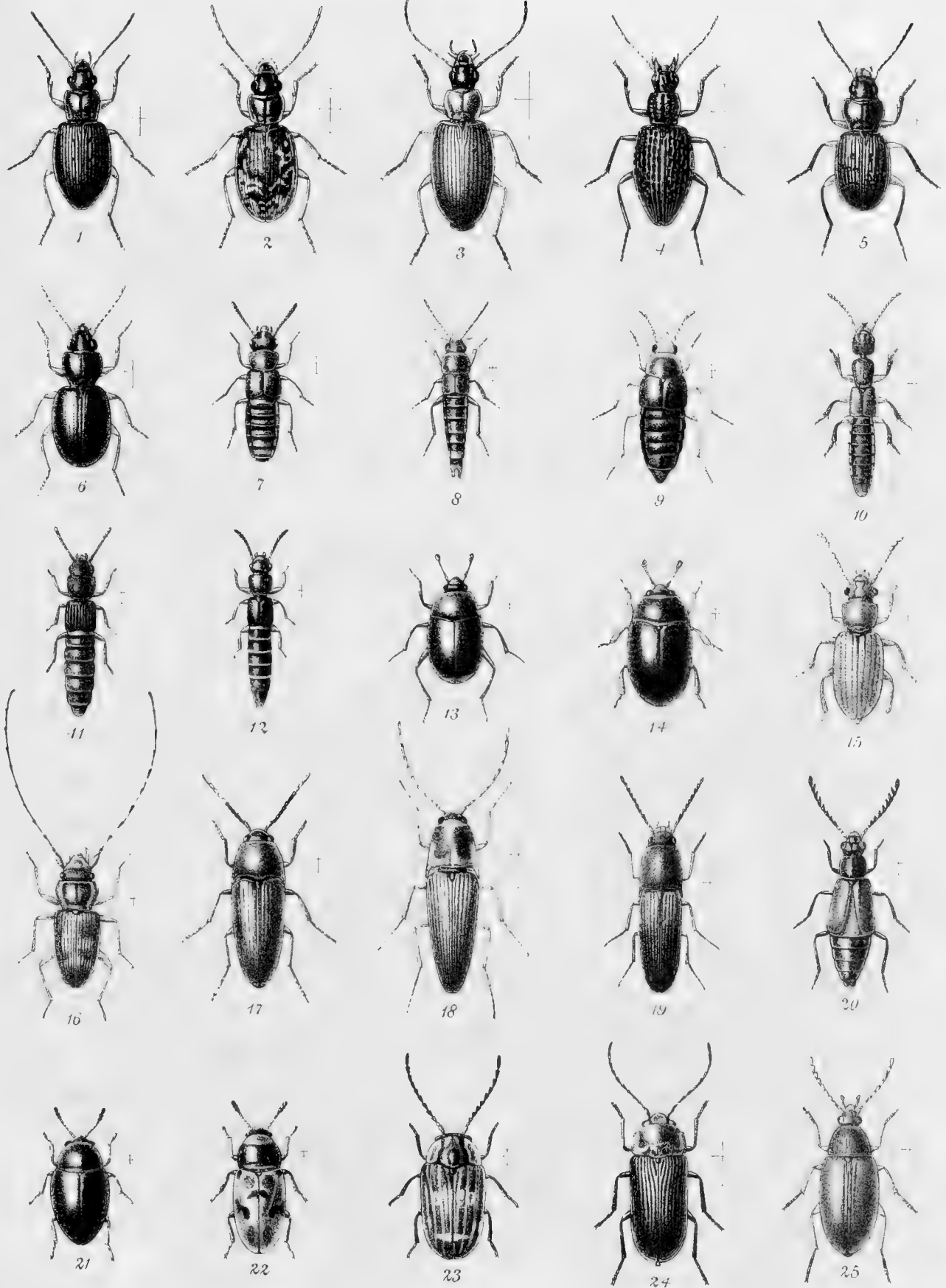

1 *Metromenus fossipennis.* 2 *Metromenus mysticus* 3 *Colpodiscus lucipetens.* 4 *Blackburnia insignis* 5 *Cylothorax scaritoides.* 6 *Cylothorax scaritoides.* 7 *Diestota rufescens* 8 *Myllæna discedens.* 9 *Liophœna flaviceps* 10 *Glyptoma Blackburni.* 11 *Glyptoma Blackburni.* 12 *Lispirodes explicandus* 13 *Æletes longipes.* 14 *Euxestus minor.* 15 *Monanus crenatus* 16 *Brontolæmus elegans.* 17 *Fornax Bonvouloiri.* 18 *Edacnus gracilis.* 19 *Eopenthes obscurus.* 20 *Helcogaster pectinatus* 21 *Cis ephistemoides.* 22 *Cis bicolor.* 23 *Xyletobius marmoratus.* 24 *Holcobius major.* 25 *Cistela crassicorni.*



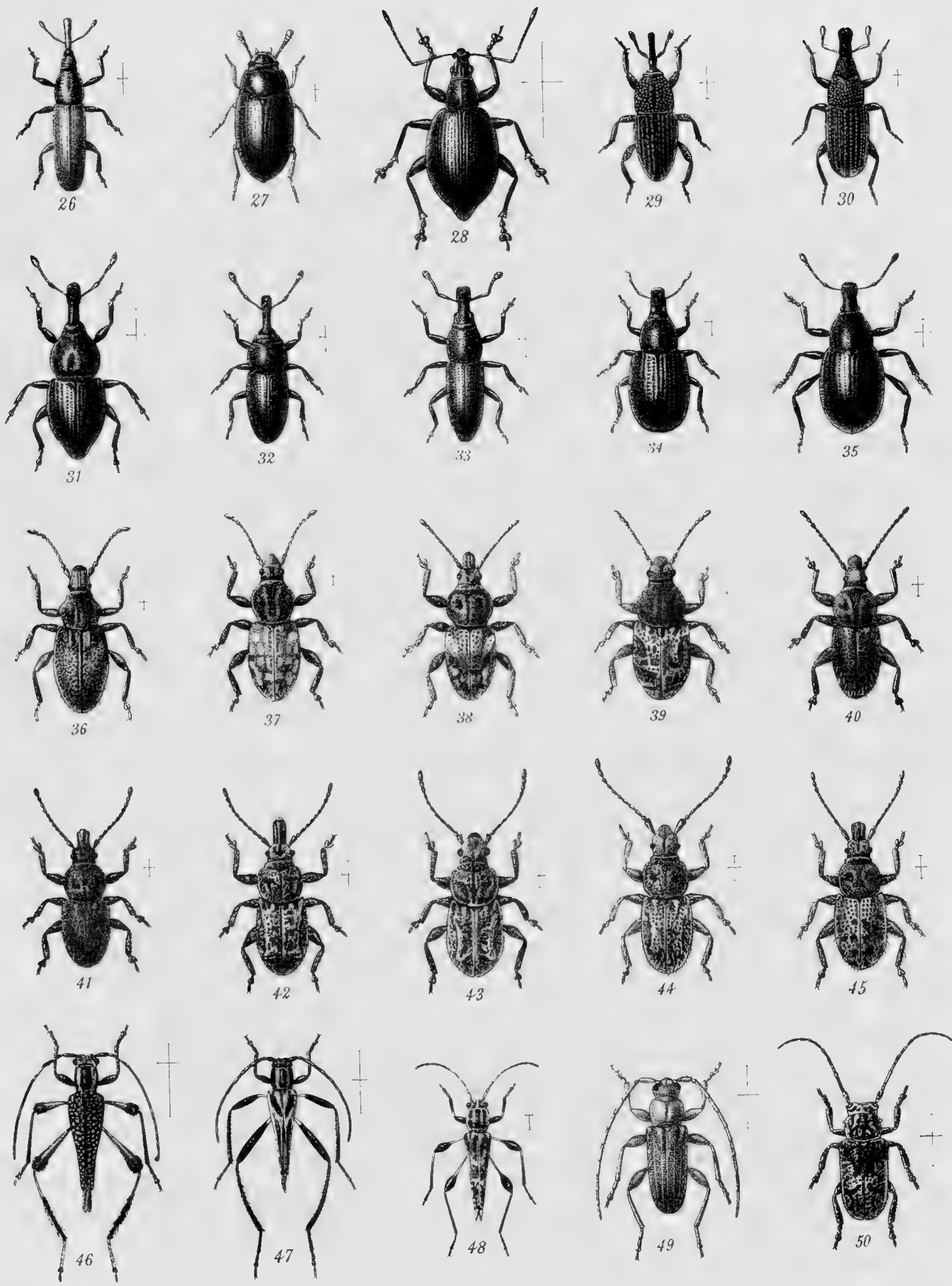

26 *Fontarthrum prolixum*. 27 *Sciophagus pandamcola*. 28 *Rhyncogonus* Blackburni. 29 *Calandra remota*. 30 *Dryophthorus modestus*.  
 31 *Heteramphus wollastoni*. 32 *Heteramphus cylindricus*. 33 *Pseudolus longulus*. 34 *Anotheorus montanus*. 35 *Oodemus nivalcola*.  
 36 *Proterhinus paradoxus*. 37 *Proterhinus vestitus* ♂. 38 *P. vestitus* ♀. 39 *P. sternalis* ♂. 40 *P. dispar* ♂.  
 41 *P. dispar* ♀. 42 *P. lecontei* ♀. 43 *P. lecontei* ♂. 44 *P. insignis* ♂. 45 *P. insignis* ♀.  
 46 *Clytarlus microgaster*. 47 *C. Blackburni*. 48 *C. fragilis*. 49 *Sotenus setiger*. 50 *Micracantha nutans*.







MARCH, 1885.]

THE  
SCIENTIFIC TRANSACTIONS  
OF THE  
ROYAL DUBLIN SOCIETY.

VOLUME III. (SERIES II.)

VII.—NOTES ON THE ASPECT OF THE PLANET MARS IN 1884. ACCOMPANIED BY SKETCHES MADE AT THE OBSERVATORY, BIRR CASTLE. BY OTTO BÄDDICKER, PH.D. (PLATE VI.)



DUBLIN:  
PUBLISHED BY THE ROYAL DUBLIN SOCIETY.  
PRINTED AT THE UNIVERSITY PRESS, BY PONSONBY AND WELDRICK,  
PRINTERS TO THE SOCIETY.  
1885.

*Price One Shilling.*





VII.—NOTES ON THE ASPECT OF THE PLANET MARS IN 1884. ACCOMPANIED BY SKETCHES MADE AT THE OBSERVATORY, BIRR CASTLE. BY OTTO BÖEDDICKER, PH.D. With Plate VI.

[Communicated by the Earl of Rosse. Read, June 16, 1884.]

OWING to unusually unfavourable weather, it was not until the 24th of February, or twenty-one days after the opposition, that some sketches of the planet Mars could be obtained; and only on six more nights—viz., March 10, 17, 22, 23, and April 1, 2—was the air steady and transparent enough to admit of further drawings. Thus altogether only thirteen sketches could be made, which are reproduced on Plate VI., arranged according to the longitudes of their central meridians. The instrument employed was the reflector of three feet aperture.

Below are given the notes made during observing, and a few remarks suggested by a comparison of my sketches with Signor Schiaparelli's charts of 1879 and 1882.

Plate VI., Fig. 1.—1884, *March 23—1*.  $L = 12^{\circ}6$ . Power, 144.

Clear, but exceedingly difficult. Sketch unfinished. Southern spots uncertain; northern ones better. The division in the northern spot at times very distinct.

Plate VI., Fig. 2.—1884, *March 22—1*.  $L = 24^{\circ}9$ . Power, 144.

Plate VI., Fig. 3.—1884, *March 22—2*.  $L = 28^{\circ}3$ . Power, 216.

Misty, but very steady; passing clouds. The dark spots blue; difficult. The round white spot immediately following the disc-centre on the first drawing very bright. The division in the southern spot very difficult. I considered, finally, the second drawing a better representation of it.

Plate VI., Fig. 4.—1884, *March 23—2*.  $L = 38^{\circ}0$ . Power, 144 and 216.

Clear, but exceedingly difficult. Southern spots only caught in glimpses, yet on the whole correct; northern spot surprisingly dark.

On the first of these four drawings—which represent very nearly the same hemisphere—there is faintly indicated the Sabaeus Sinus, Deucalionis Regio,

and the Margaritifer Sinus. The proper shape of the two Sinus was not recognised; neither was it in drawing fig. 2, which also shows Deucalionis Regio as a white division of the southern spot. In fig. 3 the division lies in an opposite direction, being probably Thymiamata, while only in fig. 4 the more exact angular shape was made out. It is obvious that, when these markings are visible near the central meridian, the sp. – nf. direction of the Deucalionis Regio must prevail; but when they are nearer to the preceding edge, the sf. – np. direction of Thymiamata must be more conspicuous. All the drawings, figs. 1–4, show an intensely dark marking in the north, Lacus Niliacus, in shape agreeing strikingly with my drawings of 1881–82 (see these *Transactions*, Vol. I., Ser. II., Part xx., figs. 1, 2, 17, 18, Plates 36 and 37). The interruption of this spot, visible on fig. 1, and slightly indicated on figs. 2 and 4, is perhaps visible on the two last quoted drawings of 1881 (figs. 17 and 18); it is probably identical with the interruption of Lacus Niliacus on Signor Schiaparelli's chart of 1882, where it seems to be brought about by the gemination of lines discovered by him.

On all the drawings, figs. 1–4, there is a dusky streak connecting Lacus Niliacus with the southern spots—the Indus of Schiaparelli's chart. It is not quite correctly delineated on fig. 2, while in the three other sketches (particularly on figs. 3 and 4) it terminates correctly in the following of the two southern spots, or Margaritifer Sinus. A trace of Gehon—the canal which connects Lacus Niliacus with Sinus Sabacus—I find unmistakably on figs. 3 and 4, perhaps also on fig. 2. The dusky shading which proceeds from Lacus Niliacus along the following limb of the planet is probably a trace of the Ganges-system of canals.

Plate VI., Fig. 5.—1884, *March* 17.  $L = 73^{\circ}0$ . Power, 216.

Very clear, but exceedingly difficult. The dark spots decidedly blue, except the one on the middle of the disc, which is reddish-brown. I could not make out what follows the dark southern spot.

The conspicuous dark southern spot is Aurorae Sinus; the following spot, which could not be discerned, must have been a trace of Lacus Solis. The dark northern spot near the preceding limb is again Lacus Niliacus; the dusky streak running from it towards the south along the preceding limb, the Indus. The whole sketch agrees remarkably well with my drawing of 1882, January 17 (*l. c.* fig. 4; Plate 36), a comparison with which makes it probable that the peculiar (forked) shape of Lacus Niliacus indicates a trace of the Hydaspes. The dark patch on the disc-middle, connected, as it appears, with Aurorae Sinus, is again the Ganges-system of canals; it occurs in very nearly the same shape on my drawings of 1882, January 17; 1881, December 14; and 1881, December 9 (*l. c.* figs. 3, 4, 5, 6, Plate 36), when I was equally unable to separate its detail.

Plate VI., Fig. 6.—1884, *March* 10.  $L = 137^{\circ}8$ . Power, 144.

Very clear. Exceedingly difficult, yet the spots on the whole correct. Particularly reliable is the white curve across the disc, which is very bright, and the white separation of the blue northern shading from the dark central spot. North pole very bright. The dusky cross-streak, south prec. very difficult.

I am unable to identify satisfactorily any of the markings on this drawing, except perhaps the south prec. streak, with the canal connecting Sinus Aonius with Mare Sirenum. Indeed, I should not consider this sketch worth publishing, if I was not convinced that at the time of drawing I thought it a pretty good representation of what I saw. A comparison with other drawings obtained about the same period must decide whether any and how much reliance may be put on my sketch.

Plate VI., Fig. 7.—1884, *April* 2—1.  $L = 261^{\circ}8$ . Power, 144.

Much wind (S. E., 3-4). Thickly hazy; but image very steady, and full of detail. The south prec. spot surprisingly dark, also the northern spot. Both are visible as sharp black points, when the whole planet is very dim. The following southern spot lighter.

Plate VI., Fig. 8.—1884, *April* 2—2.  $L = 267^{\circ}4$ . Power, 144.

Clearer at times. The following southern spot much darker, as dark as the south prec. and the northern ones. Syrtis Major not perceived during the first sketch.

The difference of longitude between these drawings is so small, that they ought to show very nearly the same features throughout. So we perceive on both Mare Cimmerium, the Peninsula Hesperia, and Syrtis Minor; and it is surprising that Syrtis Major is visible on the second sketch only, as it, doubtless, should be so on the first sketch also. Altogether it appears as if the following half of the planet's disc got clearer and more distinct during the time between the two sketches, as is particularly indicated by the darkening of Syrtis Minor. The dark northern spot appears on Schiaparelli's chart of 1879 as Aleyonius Sinus, but neither then nor during my observations in 1881 did it appear so dark. The preceding dark shading connecting Mare Cimmerium with the northern spot is the canal Cyclopus.

Plate VI., Fig. 9.—1884, *April* 1—1.  $L = 279^{\circ}4$ . Power, 144.

Clear, but exceedingly difficult. Interrupted by clouds. Sketch on the whole correct. North pole very bright indeed. Division in southern spot rather difficult, yet distinctly seen.

Plate VI., Fig 10.—1884, *February 24*—1.  $L = 286^{\circ}7$ . Power, 144.

Rather clear, and steady. Very difficult. The preceding continent reddish, more so than the following one.

Both drawings show Mare Cimmericum, Hesperia, and Syrtis Major. Syrtis Minor was not seen as a separate indentation. The north preceding spot is Alcyonius Sinus, together with Astapus, the north following one (especially on fig. 10), the Nilus. Along the preceding limb of the disc we have again a slight indication of the Cyclopus.

Plate VI., Fig. 11.—1884, *February 24*—2.  $L = 303^{\circ}2$ . Power, 144.

Clear, and steady. The preceding features not satisfactorily made out. Outline of the large following continent quite correct.

Plate VI., Fig. 12.—1884, *April 1*—2.  $L = 307^{\circ}6$ . Power, 144.

Clear, but the planet boiling very much. Exceedingly difficult. The preceding coast of the large following continent very bright, almost as if cut off by a dark canal. Northern spots not well discerned. North pole very bright.

Both drawings represent Syrtis Major; the former, however, with considerably more detail than the latter. Particularly the following coast and the Nilus are delineated with much more accuracy in fig. 11. In sketch, fig. 12, the brightness of the following coast is of a particular interest, as its cause lies probably in the planet's own atmosphere.

Plate VI., Fig. 13.—1884, *February 24*—3.  $L = 317^{\circ}4$ . Power, 144.

Very clear. The bright line from the corner of the following continent only with difficulty made out, but the drawing correct. The southern coast of this continent almost a perfectly straight line.

Syrtis Major is again near the preceding limb; the light streak in it is probably a trace of Oenotria, or of the semi-bright Japigia, lying off Hammonis Cornu in Schiaparelli's chart of 1879. It is very similarly delineated in my sketch of 1881, December 21 (*l. c.* fig. 15, Pl. 37). The shading on the middle of the disc is probably an indication of Euphrates and Phison. Nilus is shown unmistakably; its doubleness is in good agreement with Schiaparelli's chart of 1882.

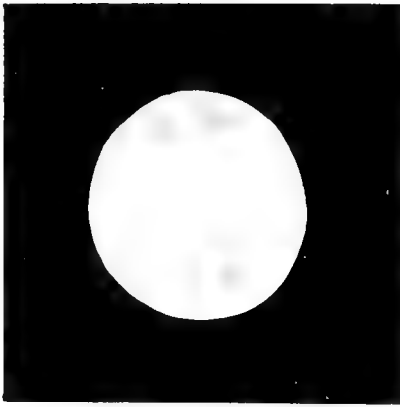

No. 1. L = 12° 6.



No. 2. L = 24° 9.



No. 3. L = 28° 5.

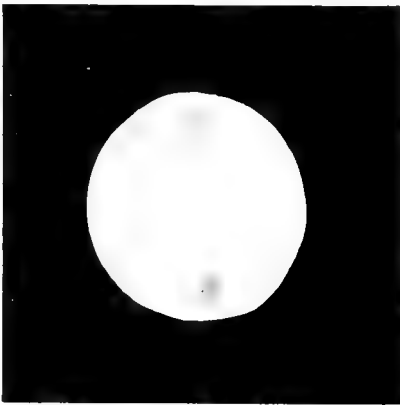

No. 4. L = 38° 0

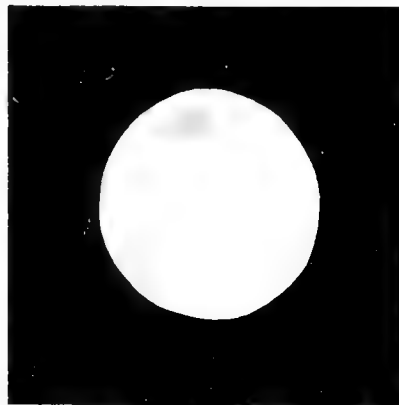

No. 5. L = 75° 0.

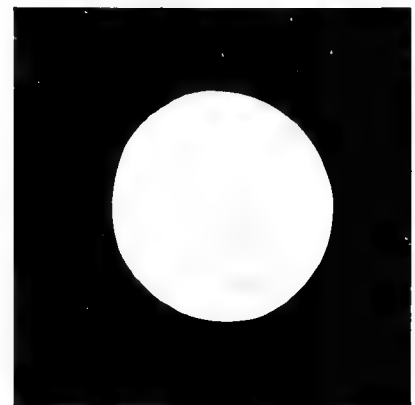

No. 6. L = 137° 8.

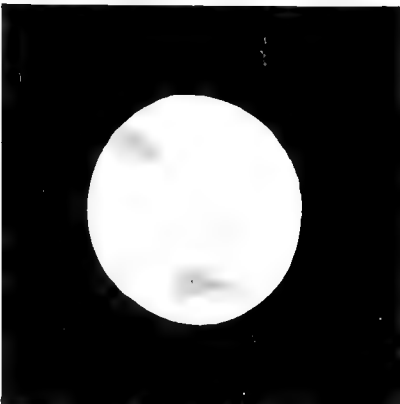

No. 7. L = 261° 8.

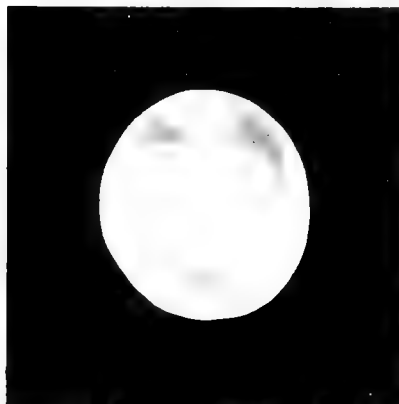

No. 8. L = 267° 4.

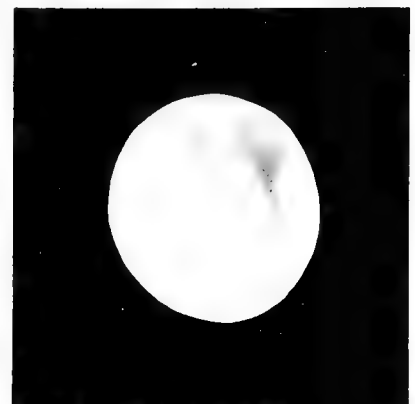

No. 9. L = 279° 4.

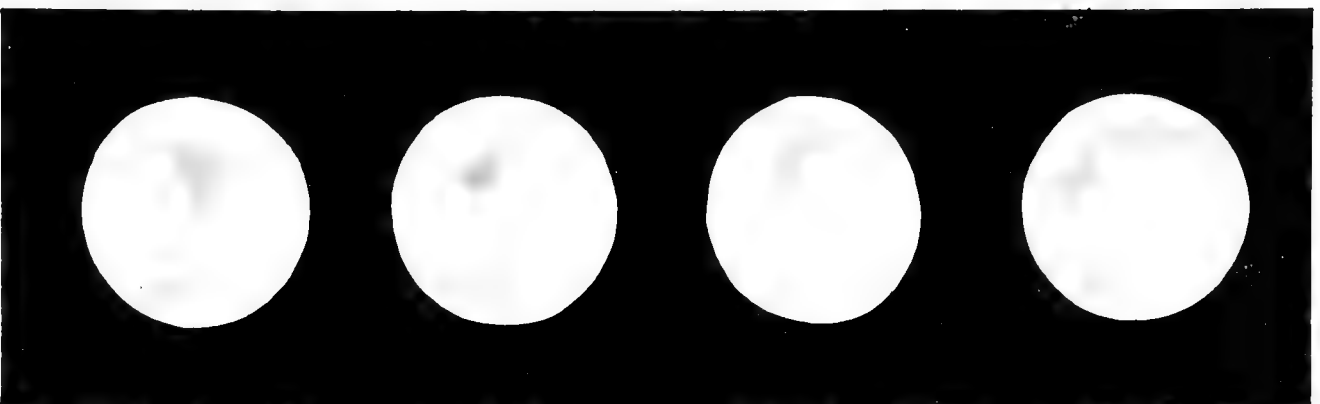

No. 10. L = 286° 7.

No. 11. L = 305° 2.

No. 12. L = 307° 6.

No. 13. L = 317° 4.



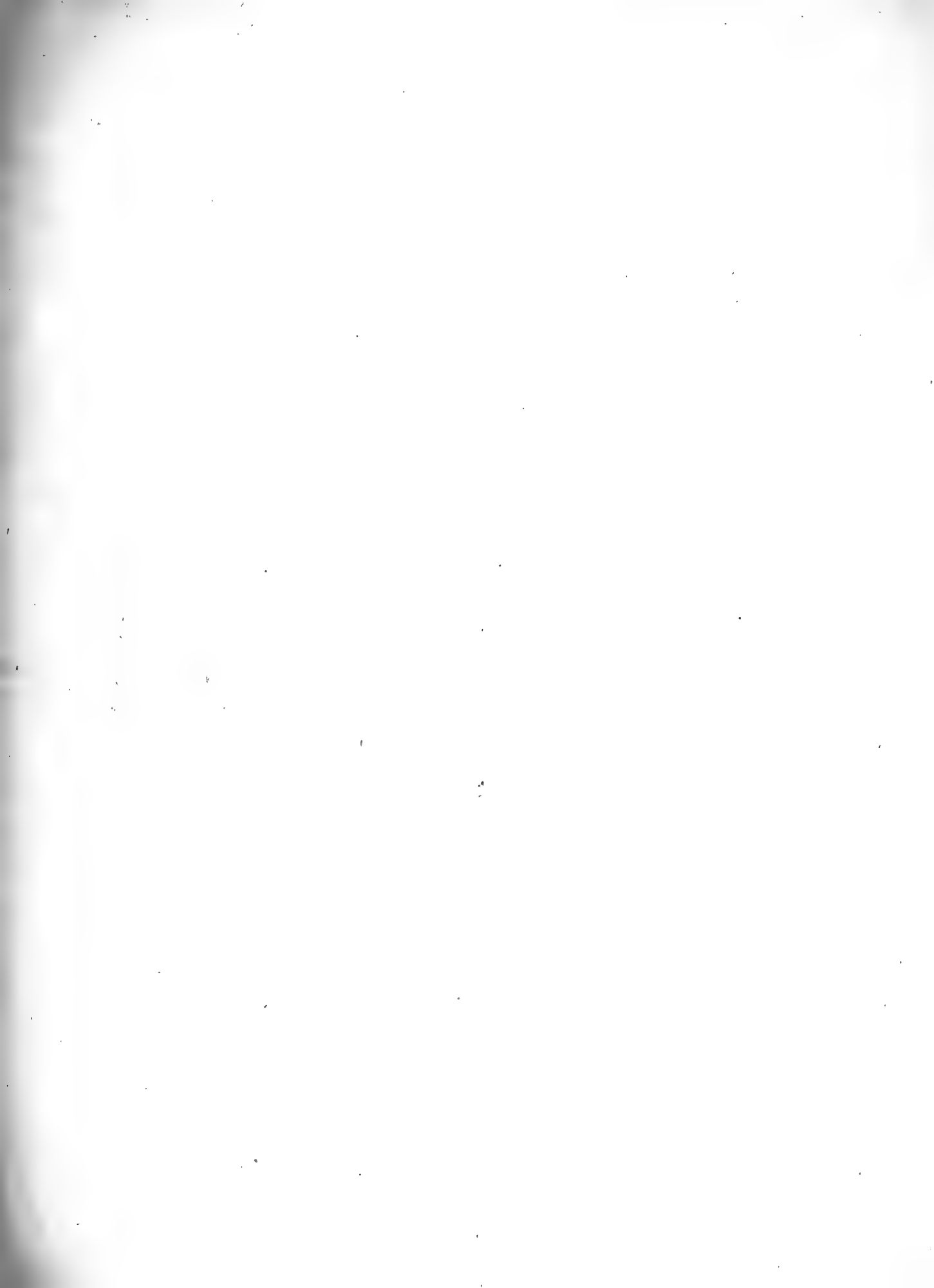

## TRANSACTIONS (NEW SERIES).

### VOLUME I.

#### PART

- 22.—On the Energy expended in Propelling a Bicycle. By G. JOHNSTONE STONEY, D.SC., F.R.S., a Vice-President of the Society; and G. GERALD STONEY. Plates XXXIX., XL., and XLI. (January, 1883.)
- 23.—On Electromagnetic Effects due to the Motion of the Earth. By GEORGE FRANCIS FITZGERALD, M.A., F.T.C.D., Erasmus Smith's Professor of Experimental Science in the University of Dublin. (January, 1883.)
- 24.—On the Possibility of Originating Wave Disturbances in the Ether by Means of Electric Forces:—Corrections and Additions. By GEORGE FRANCIS FITZGERALD, M.A., F.T.C.D. (January, 1883.)
- 25.—On the Fossil Fishes of the Carboniferous Limestone Series of Great Britain. By J. W. DAVIS. Plates XLII. to LXV. (September, 1883.) [*With Title-page to Volume.*]

### VOLUME II.

- 1.—Observations of Nebulae and Clusters of Stars, made with the Six-foot and Three-foot Reflectors at Birr Castle, from the year 1848 up to the year 1878. Nos. 1 & 2. By the RIGHT HON. THE EARL OF ROSSE, 1 L.D., D.C.L., F.R.S. Plates I. to IV. (August, 1879.) No. 3. Plates V. and VI. (June, 1880.)
- 2.—On Aquatic Carnivorous Coleoptera or Dytiscidæ. By DR. SHARP. Plates VII. to XVIII. (April, 1882.) [*With Title-page to Volume.*]

---

### VOLUME III.

- 1.—On the Influence of Magnetism on the Rate of a Chronometer. By OTTO BOEDDICKER, PH.D. Plate I. (September, 1883.)
- 2.—On the Quantity of Energy transferred to the Ether by a Variable Current. By GEORGE F. FITZGERALD, M.A., F.R.S. (March, 1884.)
- 3.—On a New Form of Equatorial Telescope. By HOWARD GRUBB, M.E., F.R.S. Plate II. (March, 1884.)
- 4.—Catalogue of Vertebrate Fossils from the Siwaliks of India, in the Science and Art Museum, Dublin. By R. LYDEKKER, B.A., F.G.S., F.Z.S. Plate III. and Woodcuts. (July, 1884.)
- 5.—On the Origin of Freshwater Faunas: A Study in Evolution. By W. J. SOLLAS, M.A., Dublin; D.Sc., Cambridge; Fellow of St. John's College, Cambridge; Professor of Geology and Mineralogy in the University of Dublin. (November, 1884.)
- 6.—Memoirs on the Coleoptera of the Hawaiian Islands. By THE REV. T. BLACKBURN, B.A., and DR. D. SHARP. Plates IV. and V. (February, 1885.)
- 7.—Notes on the Aspect of the Planet Mars in 1884. Accompanied by Sketches made at the Observatory, Birr Castle. By OTTO BOEDDICKER, Ph. D. Plate VI. [*Communicated by the Earl of Rosse.*] (March, 1885.)



APRIL, 1885.]

THE  
SCIENTIFIC TRANSACTIONS  
OF THE  
ROYAL DUBLIN SOCIETY.

VOLUME III. (SERIES II.)

VIII.—ON THE GEOLOGICAL AGE OF THE NORTH ATLANTIC OCEAN. BY  
EDWARD HULL, LL. D., F. R. S., F. G. S., DIRECTOR OF THE GEOLOGICAL SURVEY  
OF IRELAND. (PLATES VII. AND VIII.)

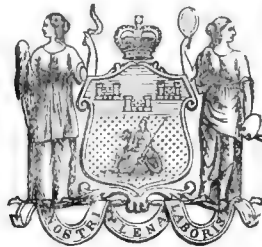

DUBLIN:  
PUBLISHED BY THE ROYAL DUBLIN SOCIETY.  
PRINTED AT THE UNIVERSITY PRESS, BY PONSONBY AND WELDRICK,  
PRINTERS TO THE SOCIETY.

1885.

*Price One Shilling and Sixpence.*



## VIII.—ON THE GEOLOGICAL AGE OF THE NORTH ATLANTIC OCEAN.

By EDWARD HULL, LL. D., F. R. S., F. G. S., Director of the Geological Survey of Ireland. (Plates VII. and VIII.)

[Read, June 16, 1884.]

## INTRODUCTORY.

THE determination of the age of our continents and oceans will ever be a problem of the highest interest in physical inquiry, and has recently occupied the attention of several eminent leaders in cosmical investigation, amongst whom may be specially named Professor Dana,\* Professor Le Conte,† and Dr. Wallace. The views of these observers are more or less in accord; and they agree in considering the continents on the one hand, and the oceans on the other, to be of immense antiquity—almost dating back to the original consolidation of the earth's crust. Stated in brief, these authorities hold the doctrine of “the permanency of oceans and continents.”‡ Against this may be placed the doctrine of “the repeated interchange of oceans and continents,” of which Lyell is the chief exponent.§ The differences between the views of these two schools are fundamental; for while those of the former maintain that the continents and oceans were marked out in their main features, and their geographical positions roughly determined, before the introduction of life on the globe, Lyell maintains on the other hand that “the configuration of the earth's surface has been remodelled again and again since it was the habitation of organised beings, and that the bed of the ocean has been lifted up to the height of some of the loftiest mountains.” Again, he says, “It is not too much to say that every spot which is now dry land, has been sea at some former period; and every part of the space now covered by the deepest ocean has been land.” This last paragraph especially shows how unreservedly Lyell held the doctrine of the “interchangeability of oceans and continents”: for myself, while I accept the former part of the thesis, I doubt much if the latter is true.

It cannot be said that the modern ideas of the permanency of oceans and continents have arisen in consequence of any recent discoveries regarding the

\* Silliman's “*Amer. Journ. Science*,” vol. v. p. 423, &c.

† “*Elements of Geology*,” and “*Amer. Journ. Science*,” vol. vi. p. 161, &c.

‡ An able review of these opinions and speculations, by Mr. W. O. Crosby, appears in the “*Geol. Magazine*,” June 1883. Dana says, “The above stated effects of contraction lead me to the conclusion that the oceanic and continental areas were defined when the earth's crust first began to form, if not still earlier, during the progress of its nucleal solidification.”

§ “*Principles of Geology*,” vol. i. chap. 12, edit. 1867.

distribution of animals and plants, either in geological or comparatively recent times; nor in consequence of new observations on the relations of stratified rocks in various parts of the globe;\* for unquestionably, as it seems to me, the facts recently brought to light tend rather to disprove than to confirm these views. Dr. Wallace's great work on "The Geographical Distribution of Animals," Professor Haeckel's "Schöpfungsgeschichte," and Darwin's work on Coral Reefs, all bristle with facts illustrating the changes in the distribution of animal and plant life, in consequence of the changes in position of land and sea. Lyell, however, was perfectly familiar with all the facts and arguments bearing on this great problem; and we may well pause before we accept views, from whatever quarter propounded, which appear to run counter to those unfolded, or amplified, by so able an exponent of the principles of geological science.†

The problem now under consideration has generally been treated on dynamical or purely physical grounds; but anyone who considers the amount of controversy to which this mode of treatment has given rise, and the opposite conclusions arrived at from the consideration of somewhat similar physical facts, will probably come to the conclusion, either that the problem itself does not admit of solution by this mode of treatment, or that we must wait till physicists are more in accord amongst themselves before we can accept their conclusions. I propose to treat the question of the geological age of one section of the aqueous envelope, namely, the North Atlantic, chiefly on stratigraphical grounds; and to point out how, ultimately, by the extension of our knowledge of the geological structure of the continents, we may hope to arrive at conclusions more or less definite regarding the geological age of other adjoining oceans.

In dealing with this problem I shall endeavour to ascertain how the characters and distribution of the strata of the lands bordering the Atlantic lend their aid towards its solution.

## I.

(a) *The Formations of chief import in the Problem.*—As prime factors in this problem, there are three great groups of strata of which we may make use, namely, the Archæan, the Silurian, and the Carboniferous: the intermediate groups—namely, the Cambrian and Devonian—being restricted in area, and more or less local, need not in this inquiry be considered.

\* The discovery recently made by the Danish Expedition, that the Island of South Georgia is made of slate rock, is one of great importance as bearing on this question. This island is a thousand geographical miles from any continental land, and rises from deep water. The significance of its position as bearing on this question has been ably pointed out by Mr. Mellard Reade in the "Geological Magazine," and in "Nature."

† When we find the table-land of Thibet—at an elevation of 20,000 feet—formed (as Mr. Blanford, F. R. S., has shown) largely of Cretaceous beds once deposited below the waters of the ocean, we have an illustration of the extent of the changes the earth's surface has undergone even in Tertiary times.

I select these three dominant groups for my purpose; first, because of their wide distribution over the land surface of the globe; second, because of the great vertical dimensions to which they attain; and thirdly, because (with the partial exception of the uppermost member of the Carboniferous system) of their marine origin, and as indicative of the former presence of oceanic waters wherever they are found within the limits to which these observations extend.

(*b*) *General Considerations regarding the Extent of Archæan and Palæozoic Land and Sea.*—Before proceeding, however, to localize my observations to the region of the North Atlantic and its bordering land, let me draw attention to one general result of far wider application.

In some investigations into the extent of the Archæan, Silurian, and Carboniferous formations over the land-surface of the globe, I have been strongly impressed with the belief that there has been a very general interchange of land and sea during these periods. The areas occupied by these formations—whether at the surface or as overlain by newer strata—form an exceedingly large proportion of the existing continents and islands; and if we include the inferential extent of the areas previous to denudation, these existing tracts, whether visible or concealed, would be largely extended. It would be impossible for me to enter into details in proof of this statement here; but it may be stated generally that the Archæan rocks, or their presumed representatives, are so widely extended that they may be supposed to form the floor of the larger portion of the continents of Europe, Asia, Africa, North and South America. Now, these rocks, although consisting of gneiss or granite, hornblendic and micaceous schists, quartzites, and crystalline limestones, were (it is generally admitted) originally marine sediments, deposited over the floor of the then ocean, and derived from the waste of continental *lands*, which could only have occupied the positions of *existing oceans*; and which, judging by the great vertical dimensions of the Archæan strata, must have been of proportionately vast horizontal extent.\*

It has, however, been argued by Dr. Wallace, that owing to the greater depth of the oceans as compared with the elevations of the land, and of the vastly greater volume of the ocean-water below the sea-level than of the land above that level (the proportion being as 1 to 36), whatever changes may have taken place in the relations of land and sea in past times were in the form rather of additions to, or modifications of, the pre-existing land, than by the upheaval of entirely new continents in mid-ocean;† and such would, I admit, be the conclusion to be derived from a contemplation of the *present* distribution of land and sea.

\* It is right to state that Sir J. W. Dawson, F. R. S. (as I understand), regards the Archæan rocks as formed of materials extruded out of the original crust in a molten condition, and afterwards metamorphosed. It is difficult, however, to understand how such strata as schist, quartzite, and occasionally bands of limestone, could have originated in this way.

† "Geographical Distribution of Animals," vol. i. p. 36.

But it may be replied, that *this* distribution cannot be taken as representative of very ancient geological epochs, inasmuch as the marine formations of Archæan and Palæozoic times must originally (*i. e.* before denudation and concealment by newer strata) have overspread the greater portion of the existing lands; and inasmuch as these formations represent the seas of those periods, the lands which yielded the sediments of which they are composed must have lain where now the ocean waters are spread.

So much, then, for the *general* question of the interchange of the present oceans and continents in early geological times. I must now pass on to the special consideration of the evidence afforded by the lands bordering the North Atlantic, with a view to ascertain to what extent it bears on the question of the age of this (to us) the most familiar and interesting of all the oceans of the world.

Continuing to use the three principal factors I have already mentioned, namely, the groups of strata known as the "Archæan," or "Laurentian," the "Silurian,"\* and the "Carboniferous," I shall call upon them in succession for the evidence they are capable of supplying.

(1) *The Archæan or Laurentian Group.*†—This great group of crystalline strata seems to form everywhere in Europe and the British Isles the floor of all more recent deposits, from the Cambrian and Lower Silurian upwards. In the British Isles the beds rise from beneath the representatives of the Cambrian and Silurian systems in the Northern Highlands of Scotland, and the Highlands of Donegal and Galway, besides occurring perhaps in other, more central, districts. They form a large portion of the Scandinavian promontory, and of Finland, passing beneath the Silurian beds of Russia and of Southern Sweden. They occur again in Normandy and Central France, in the north of Spain and Portugal, and they form the floor of the Silurian basin of Bohemia, and of the rocks of the Hercynian Forest, in the centre of Europe.

To sum up, then, we find over the British and European area metamorphic rocks, everywhere forming the floor upon which have been laid down, in highly discordant positions, the fossiliferous deposits of more recent times, ranging from the Lower Cambrian upwards. This series is of vast, but unknown, thickness, as *its base* nowhere appears over the surface; and consequently the strata stretch to unknown distances beneath the waters of the Atlantic Ocean. We are therefore unable anywhere to discover over the land-surface a trace of the pre-Archæan lands from which these strata were originally derived.

(a) *America.*—Turning our attention to the American side of this ocean, we find

\* The Lower Silurian is the division which is of most use in this inquiry, owing to its vastly greater extension: in some regions the upper and lower divisions are so greatly unconformable as to be stratigraphically distinct formations, as in the British Isles.

† In this inquiry I have to assume that the Archæan rocks of Europe and North America are representative in time, a view not capable of direct proof, but in the highest degree probable.

similar phenomena awaiting us. The Laurentian rocks stretch from Nova Scotia\* and the coast of Labrador to the shores of the Great Lakes, and thence in a north-westerly direction to Kent peninsula, north of the Arctic Circle.† On either side they throw off strata of Lower Silurian or Lower Cambrian (Huronian) age, so that their presence at the surface amongst the Laurentian mountains is partly, at least, due to denudation; but Professor Dana is of opinion that some of the central portions of the Laurentian area never have been covered by newer strata, as the Potsdam sandstone of New York, lying at the base of the Silurian series, affords evidence of marginal conditions of deposition.‡

These crystalline strata crop up in two places in Central America, in the Black Hills of Dakota, the Laramie range of Nebraska, and in the Middle Cordilleras, as shown by Mr. Clarence King.§ They also form a tract of country between the Alleghanies and the marginal oceanic region of the Atlantic. Thus it may be said that the whole of the fossiliferous strata of North America are set in a framework of Archæan bedded crystalline rocks; and we may consequently infer that these rocks underlie the newer formations, and stretch below the waters both of the Atlantic and Pacific Oceans for undefined distances (Plate VII., Fig. 1).

(*b*) *The Arctic Regions and Greenland.*—Gneissose rocks, presumably of Laurentian or Archæan age, occur at C. Isabella and C. Sabine, at the entrance to Smith Sound; and, on the opposite coast of Greenland at Foulke Head, where they form the cliffs at the edge of the great Humboldt glacier.|| These beds pass below conglomerates and limestones of Upper Silurian age, which occupy large districts north of the Arctic Circle. Of the rocks which enter into the structure of the interior of Greenland we know but little, except that they are crystalline and hornblendic; but whether of Laurentian or pre-Laurentian age is probably for ever to remain a mystery. But we have sufficient details to show that the region of Canada, Hudson's Bay, and northwards to beyond the Arctic Circle, are underlain by crystalline strata of this age, equally with the region of the United States to the southwards.

(*c*) *General Result.*—Having thus shown that the continent of Europe on the one hand, and of North America on the other, has a solid framework and floor of crystalline stratified rocks, of presumably the same age, or approximately so, being in both cases pre-Cambrian or pre-Silurian, and assuming that these rocks

\* Dawson, "Acadian Geology," p. 662.

† Logan, "Geol. of Canada," with Map. Dr. Selwyn estimates the area occupied by the beds forming the Archæan nucleus at 2,000,000 square miles, "Descriptive Sketch of the Geology of Canada," p. 23 (1884).

‡ "Manual of Geology," p. 177.

§ "U. S. Geol. Explor., 40th Parallel," vol. i. pp. 17 and 53, &c.

|| H. W. Fielden and C. E. De Rance, "Quart. Journ. Geol. Soc.," vol. xxxiv. p. 556.

are altered sediments laid down on the floor of the primæval ocean, I may be allowed to ask, where, if not in the region of the Atlantic Ocean itself, are we to look for the source of these sediments—the pre-Laurentian lands in fact—from the waste of which these great deposits were themselves constructed? and if this be a fair inference, it results that, since pre-Cambrian times, the present distribution of land and water, as far as these continents and the intermediate ocean are concerned, has been in the main reversed.\*

(2) *The Silurian Group.*—The Silurian rocks occupy large areas, both of the North American continent on the one hand, and of the British Isles and Western Europe on the other—areas which are largely concealed beneath newer formations, and which, previous to denudation, must have left but very small portions of the lands on either side of the North Atlantic uncovered (Plate VII., fig. 2).

The evidence for the position of the land-surfaces of the Silurian, and particularly the Lower Silurian, period may be thus stated:—

(a) *British and European Area.*—The Silurian areas, visible and concealed, occupy nearly the whole of the British Isles, with the exception of the North-western Highlands of Scotland and Ireland, and the granite tracts, which are due to subsequent igneous (or metamorphic) action and erosion. We are led also to infer, from the position of the strata towards the west of the existing areas, that originally no part of the British Isles was left uncovered by strata of the Lower Silurian period, and that the waters of the sea in which these beds were deposited occupied the whole region of these islands. (See note at end, p. 318.)

On the other hand, the predominance of quartzite and siliceous strata in the North-west Highlands of Scotland and Ireland points to the presence of granitic or gneissic lands in that part of the Atlantic lying to the west and north of the submerged tract.†

In the above observations I have assumed that the crystalline strata of the North Highlands of Scotland are of the geological age originally determined by Sir R. I. Murchison, of the truth of which conclusion I had satisfied myself not only by the study of his writings, and those of other geologists, but by personal examination of the Northern Highlands during the spring of 1880. Whatever modifications more recent researches may have required will not invalidate my argument. (See note at end, p. 318.)

\* The "Geological Magazine" for June, 1883, contains an interesting article by Mr. J. E. Marr, on the origin of the Archæan Rocks, in which he suggests their volcanic origin, with subsequent metamorphism. I doubt if he is likely to get many converts to this view. The Archæan or Laurentian strata differ very little from some of the more highly metamorphosed beds of Lower Silurian age. Another article, by Mr. W. O. Crosby, deals very ably with the views of Prof. Le Conte, Prof. Dana, and Mr. Wallace, regarding the origin of continents and oceans.

† The presumable position of land and sea during the Lower Silurian period is represented in Plate III. of "Physical History of the British Isles" (1883).



The Lower Silurian beds occupy large tracts of the Scandinavian promontory, resting unconformably on the Archæan metamorphic beds, or sometimes on representatives of the Cambrian deposits. From their position along the shores of the Gulf of Finland and the Baltic, on the north and west of European Russia,\* and again along the line of the Oural Mountains, it may be inferred that they underlie the whole of Central Russia. Here, however, the formation has become largely calcareous, and reduced in thickness to one-tenth of its volume in the British Isles. The formation occupies portions of the north of France, and has been proved by borings to underlie the Cretaceous strata of northern Belgium, as shown by Professor Gosselet. The great extent of beds of this age in Spain has been long known by the researches of both Spanish and other continental geologists. Very recently the work of M. Charles Barrois has put us in possession of the most recent results as regards the older rocks of the north of that country. From his observations it would appear that the three divisions of the Lower Silurian series attain a thickness of about 600 metres, or 2000 feet, at Cape Vidrias;† but in other districts the thickness is undoubtedly much greater. Comparing the thickness of the Silurian strata in Northern Russia, Scandinavia, and the British Isles, we cannot but be struck by their great vertical expansion in the direction of the latter country (from 1500 or 2000 feet in Russia to 20,000 or 25,000 in Britain)—a fact which Murchison has more than once directed attention to,‡ but without (as far as I can see) drawing the inference which, I think, is fairly deducible regarding the position of the originating land of the period.

In the north of France the Lower Silurian rocks attain to great vertical dimensions, probably not falling short of those in Wales and Ireland. The section of these rocks in the Department of the Sarthe, from Sillé le Guillaume to Chemiré, as given by MM. Triger and de Verneuil, shows a thickness of these beds amounting to nearly 20,000 feet.§ They consist, with one slight exception, of sedimentary strata (slates, sandstones, and conglomerates), surmounted by those of Devonian age.

From a general comparison of the development of these strata in various parts of the European and British area, there is evidently a great expansion in a westerly direction, indicating the position of the land from which the sediment was derived. This indication is also rendered more striking if we compare the composition of the strata of the west with those of the east. For along the borders of Russia and the Baltic provinces the strata consists largely of limestones, which, as we know, are but very sparingly represented amongst the Lower Silurian strata of Britain and France, and point to the Russian area as having been somewhat remote from land, while the waters which overspread it were generally free

\* Prof. F. Schmidt, "Quart. Journ. Geol. Soc.," vol. xxxviii. p. 515.

† "Recherches sur les Terrain anciens des Asturies et de la Galici," p. 451.

‡ "Siluria," 4th edit., ch. xiv.

§ "Bull. Soc. Geol. Fr.," vol. vii. ser. II., quoted by Murchison, "Siluria," 4th edit., p. 408.

from the presence of the sediments of sand, clay, &c., with which those over-spreading the regions lying on the borders of the Atlantic Ocean to the westward were beclouded.

(*b*) *North America.*—Turning now for evidence to the North American continent, we find the Lower Silurian beds giving unmistakable evidence of having had their origin in a region now submerged beneath the waters of the Atlantic. The base of this great group is the Potsdam sandstone,\* which has been traced in Canada, with an outcrop from the Straits of Belleisle to Bedford, a distance exceeding 1000 miles. The development and changes in mineral characters of the Potsdam group, at the base of the Silurian series of North America, point unmistakably to the originating lands as having lain eastwards of the Appalachians. According to Professor Dana the laminated sandstones of the State of New York and the Canadian borders—only a few hundred feet in thickness—are swollen out by the accession of “a vast thickness of slate or shale along the Appalachians.” In the same way the succeeding calcareous member, called in the Mississippi Valley the “Lower Magnesian Limestone,” passes into sandstone, with very thick shales, and some beds of limestone, along the course of the Appalachians; and, according to the same authority, the beds of “the Potsdam group” which, on the borders of Western Canada and along the Mississippi Valley, vary in thickness from 30 to 600 feet, assume along the line of the Appalachians a development estimated from 2000 to 7000 feet.†

It will thus be observed that the swelling out in this case is eastward towards the Atlantic border, and due to the accession of sedimentary materials in that direction. In the opposite direction, where the ocean of the period prevailed, calcareous rocks are developed, and the sedimentary deposits thin away proportionately.

During the “Trenton period” nearly the whole of the United States was the bed of the sea, over which marine limestones were being formed, while land lay over the Canadian area, the eastern border lands having probably retreated far into the Atlantic area; but in the succeeding “Hudson period” we again have the evidence of land towards the Atlantic borders, as the sedimentary strata—which in the districts of Lakes Huron and Iowa are of slight thickness (25 to 100, and 180 feet)—swell out to 1200 feet in Pennsylvania, and are of still greater thickness in Virginia and Eastern Tennessee‡ (Plate VIII., fig. 3).

It is unnecessary that I should pursue this portion of my subject further. From what has been said it will, I hope, be clear that the originating lands of the

\* Logan, “*Geol. of Canada*,” p. 87; Dana, “*Man. of Geol.*,” p. 172.

† It is scarcely necessary to remark that the source of this sediment could not have been in the Appalachian mountains themselves, which only came into existence after the Carboniferous epoch, as shown further on. (See p. 316.)

‡ Further west still, as shown by Mr. Clarence King, the Silurian rocks are composed in Wahsatch and Nevada almost entirely of limestone, from 1000 to 4000 feet, where the clear waters of the ocean prevailed.—“*U. S. Explor.*,” vol. i. p. 248.

great mass of the sedimentary materials of the Lower Silurian period lay over the region of the present Western Atlantic; just as, in the case of the Lower Silurian beds of Europe, the originating lands must have lain in the region of the Eastern Atlantic; and there is no reason to suppose that these two land areas were not connected, as the great extent of the deposits derived from them imply the existence of large rivers draining continental areas. Land also lay over the region of the Arctic regions during the earlier part of the Silurian epoch; but this was ultimately submerged in Upper Silurian times, as shown by the extensive deposits of strata of this period, from North Devon to Prince Albert Land.\*

(c) I pass over the evidence to be derived from the distribution of the Devonian strata of North America; but examples from it might be cited (as in the case of the "Hamilton group") of the swelling out in vertical dimensions towards the eastward, and attenuation, accompanied by the substitution of calcareous strata for sedimentary, towards the centre of that continent; all tending to show that, in Devonian as in Silurian times, the land areas lay in the region of the Atlantic, and the sea areas in that of Central and Western America.

Having thus endeavoured to point out the deductions to be derived from the position and extent of the Silurian beds on either side of the Atlantic, I pass on to consider what inferences may be drawn from the position of the Carboniferous strata in the same portions of the northern hemisphere.

(3) *Carboniferous Group.*—The evidence to be derived from the third factor—of which I am making use—in the elucidation of this question, viz., the Carboniferous group, is not less determinate than in the cases of those preceding.

(a) *British Isles.*—It is some years since I first drew attention to the fact of the remarkable swelling out in vertical thickness which the *sedimentary* strata of the Carboniferous epoch undergo within the region of the British Isles, when traced both towards the north-west and south-west coasts; and also how the Carboniferous limestone passes from its solid calcareous condition into such elastic beds as sandstone or shale, in similar directions. The details need scarcely be repeated here, and I content myself with the following summary, taken from the sources above referred to† (Plate VIII., figs. 1 and 2).

A general summary of the N. W. increments may here be given:—

	N.W. Lancashire.	S.E. Lancashire.	N. Staffordshire.	Leicestershire and Warwickshire.
Coal-measures, . . .	8460	7630	6000	3000
Millstone Grit Series, . .	5500	2500	500	100-300
Yoredale Series, . . .	4670	2000	2300	
Total in feet, . . .	18,630	12,130	8800	3100-3300

\* Both Upper and Lower Silurian beds occur in Grinnel Land.

† The reader is referred to the "Quart. Journ. Geol. Soc.," vol. xviii., p. 127, &c., for full details; also to "The Phys. Hist. Brit. Isles," p. 37; or, "The Coal Fields of Great Britain," 4th edit., p. 516.

The rapid attenuation of the strata towards the centre of England is in some degree due to the proximity of a ridge of older rocks which occupied that part of the sea-bed throughout nearly the whole Carboniferous period;\* but the evidence as to the westerly position of the originating lands, as regards that of the British Isles, is too obvious to require that I should further insist on it. Sir C. Lyell has, in a masterly manner, pointed out the conclusions to be deduced from the phenomena which the Carboniferous series present to us, and it is unnecessary for me to do more than recall this fact. I therefore pass on to consider the evidence to be derived from the distribution of the Carboniferous beds of America.

(*b*) *North America.*—Not less significant, as pointing towards a similar conclusion, is the distribution and changes in the characters of the Carboniferous strata of North America. The geologists of that country have supplied us with ample details for determining the directions in which the strata increase and decrease in thickness, and those in which calcareous and sedimentary strata predominate, or pass into one another.

In treating of these details I shall adopt Professor Dana's two divisions of "Sub-carboniferous" (corresponding to our Lower Carboniferous), and "Carboniferous" (embracing our Middle and Upper Carboniferous divisions). Taking the beds in the ascending series, we commence with those of the Sub-carboniferous series.

(*c*) *Sub-carboniferous Sedimentary Beds.*—The greatest development of these beds south of the River St. Lawrence is in Pennsylvania, where the sandstones and shales reach a combined thickness of 5000 feet. These beds thin northwards, westwards, and south-westwards; or pass into beds of limestone, as shown by Professor Rogers. Thus, in Michigan, the sandstones and shales have dwindled down to 480 feet, in Virginia to a few hundred, while over the region of Arkansas, Missouri, and Alabama, they are represented almost entirely by beds of marine limestone.

But, perhaps, the greatest development of the sedimentary materials over the North American continent occurs in New Brunswick, where the land projects more prominently than elsewhere into the Atlantic waters. The well-known section of South Joggins, on the coast of the Bay of Fundy, shows a vertical series of strata of 4515 feet, while the whole series is estimated at a thickness of 14,570 feet; of which, perhaps, one-half the amount may be considered as Lower Carboniferous. This enormous swelling out in a N. E. direction, and the truncation of so great a mass of strata near the Atlantic shores, points unmistakably to the position of the originating continental lands. While the attenuation of the Lower Carboniferous sedimentary strata towards the central continental area, and its

\* The position of this ridge is shown in Plates VI. and VII. of "The Phys. Hist. Brit. Isles." For fuller details the reader is referred to my Paper in the "Quart. Journ. Geol. Soc.," vol. xviii. p. 127.

replacement by limestones, shows that this region was submerged and remote from land.\*

(d) *Upper Carboniferous.*—The evidence derived from the distribution of the Upper Carboniferous strata tallies in the main with that from the lower division. The sedimentary strata increase in thickness towards the east or north-east, and thin out, or pass into limestone, in a westward direction, extending as far as the Rocky Mountains. Thus, in Pennsylvania the Upper Carboniferous beds reach a thickness of 3000 feet; in Western Kentucky 3300 feet. In Kansas, according to Mr. Broadhurst, the representative beds consist chiefly of limestone; while in Nevada they are represented by 2000 feet of limestone above the Weber Quartzite. In Missouri and Iowa, the strata (chiefly sediments) are only 600–1000 feet in thickness; and in Michigan they have thinned down to 123 feet. The great formation of Carboniferous limestone of the Rocky Mountains, described by Dr. Hector, probably represents an oceanic deposit of organic origin, representing the entire Carboniferous series of north-eastern America.

Combining the evidence from both the upper and lower divisions, we find the following suggestive results. If we take a section, drawn from New Brunswick on the extreme N. E., through Pennsylvania, Missouri, into Utah on the S. W., we shall find the following changes in the characters and thicknesses of the Carboniferous strata:—

*Comparative Carboniferous Sections of America.*

S.W. Utah.	Missouri and Iowa.	Pennsylvania.	N.E. New Brunswick.	
Upper Carbs. } Limestone	{ 600–1000 ft. (sediments),	3000 ft. (sediments),	} 14,570 (sediments mainly).	
Lower Carbs. } only.	{ 1000 ft. (limestone),	5000 ,, Do.		
Total of Sediments, .		600–1000 ft.	8000 ft.	14,570 ,,

The inference of an Atlantic continent in Carboniferous times, to be drawn from a consideration of the distribution of the Carboniferous strata, has been recognised by several geologists. Lyell dwelt upon this subject many years ago, even at a time when much of the evidence in its favour, now available, had not been obtained.† The more recent researches of American geologists in the regions lying to the south and west of the United States of America go to confirm the

\* In the Nevada territories (40th parallel) the Lower Carboniferous limestone attains a thickness of 7000 feet; according to Mr. Clarence King, and is succeeded by the Weber quartzites, or sandstone, 6000 feet, occupying the position of the “Millstone Grit;” and this again by the Upper Carboniferous limestone, 2000 feet.—“U. S. Exploration of the 40th parallel,” vol. i. The Weber quartzite is a local formation, originated during the temporary elevation of that region between the upper and lower oceanic epochs, represented by limestone.

† “Principles of Geology,” 10th edit., vol. i. p. 256, &c.

view that, while the originating lands of the Carboniferous sediments lay in the position of the Western Atlantic, the interior continental regions of North America, extending into the region of the Rocky Mountains, were occupied by the waters of the then ocean; so that it is not overstating the case to say that the relative positions of land and sea have been reversed since the Carboniferous period. (See diagram, Plate VIII., fig. 2.)

(4) *Later Conditions of the Atlantic and Bordering Areas.*—Having thus endeavoured to establish the proposition that, down to the close of the Carboniferous period at least, the area of the Atlantic was mainly in the condition of land, while the adjoining regions bordering it on either side were mainly in the condition of submerged areas, it may be asked—When did the oceanic condition of the North Atlantic area actually set in? When, in other words, was this part of the northern hemisphere first overspread by ocean water?

Replying to this question, it may be stated that in all probability the formation of the Atlantic Ocean, as we see it to-day, was the work, not of one, but of successive terrestrial movements. At the same time we have very clear evidence that, on the western side of the area here embraced, the formation of the Atlantic Ocean on the one hand, and of the American continent on the other, commenced immediately after the Carboniferous epoch itself.

The determination of the period of the uprise of the Alleghanies serves as the key to this problem. It must be obvious to everyone who considers the structure of the Alleghany range, and the relations of its flexures to the outline of the American continent, that there is a close relationship between the two. But, besides this, there is (to my mind) a very evident connexion between the position of the Alleghany axis and the line of the deep trough which runs along the eastern shore of North America, and which is overspread by the waters of the Gulf Stream. Were the bed of the North Atlantic Ocean laid dry it would be found to consist of three main features—as pointed out by the Rev. Dr. Haughton—a central ridge, bordered on either side by deep depressions. What, we may ask, do these features indicate in the history of its early formation? I need not here repeat the arguments which go to show that the uprise of the Alleghanies and of Central America dates from an epoch intermediate between the Carboniferous itself on the one hand and the Triassic on the other.\* Generally speaking, the great flexuring and uprising of this range of mountains, extending physically from Alabama to Newfoundland, marks the boundary in time between the Palæozoic and Mesozoic epochs. Previous to the commencement of these terrestrial movements the Carboniferous beds extended far beyond the present limits of the American continent, and out into the region now submerged beneath the Atlantic waters. *Beyond this*

\* This is proved by the position of the Triassic beds of Richmond, Virginia. See Dana, "Manual of Geology," p. 403.

*still* must have lain the lands formed of more ancient rocks (Archæan and others), which produced the sediments of which the Carboniferous formation is built up. This brings us towards the borders of the Central Atlantic plateau, or ridge; and here, as it seems to me, we have a clue to its origin and history.

Speaking with all due reserve on a subject, regarding which our means for observation are so restricted, may we not fairly surmise that the central plateau of the Atlantic has some connexion, at least, with that ancient continental land of which we have been speaking? It seems to occupy somewhat of the position which this continent must have occupied, stretching from the Arctic regions southwards, embracing Greenland of the present day, and lying in a position between the Carboniferous submerged tracts stretching into the American area on the one hand, and into those of the British Isles and Western Europe, on the other.

Again, let us inquire what would be the effect of the uprising of the Alleghanies on the parallel tract now under the waters of the Atlantic. It seems to me absolutely certain, on mechanical principles, that the uprising of the former must have been accompanied by a depression of the latter; in other words, that the formation of the ridge must have been accompanied by the formation of the furrow, complex though each may have been. The proverb, "every ridge has its furrow," holds good in terrestrial mechanics; and the furrow in this case corresponds with the oceanic valley eastward of the American coast.

The mode of formation of the eastern side of the North Atlantic is a question not so evident, or simple, as that of the western. Still I believe the same principles and course of reasoning are applicable to this case also. The originally horizontal sheets of Carboniferous strata of the British Isles, the north of France and Spain, which reach the Atlantic shores with a thickness of several thousand feet vertical, must have extended far away westwards into the region now covered by the Atlantic waters. I have already shown that in this direction also lay the originating lands; and here we catch a glimpse (as it were) of the eastern margin of the central continental area, the western margin of which we have already mentally visited. We know also, that at the close of the Palæozoic era terrestrial movements involving the flexuring and folding of the Carboniferous beds took place over Western Europe as over Eastern America, and the ultimate results would be somewhat of the same kind. Deep depressions, with corresponding elevations, were formed over the area once occupied by wide-spread tracts of horizontal Carboniferous strata. Thus we might infer that the depression of the Bay of Biscay was contemporaneous with the tilting of the Carboniferous beds of Asturias. But I desire to refrain from particulars in a question which can only be handled safely in a general manner. The general result of all these movements over the Atlantic area at the close of the Palæozoic era would, we may safely infer, have been to depress the central continental area, and to produce deep basins or

troughs on either side, with corresponding elevations over the European and American tracts. And thus, as it appears to me, we may refer the date of the oceanic condition of the Atlantic area, and of the continental condition of Eastern America and Western Europe (including the British Isles), to the close of the Palæozoic epoch.

(5) *Conclusion.*—It is not my intention in this place to attempt to trace the history of the North Atlantic down through succeeding geological epochs, tempting though the subject may be. I confine my observations to the limits of time above stated; and I trust I have adduced sufficient evidence to prove that, as far as the region of the Northern Atlantic, at least, is concerned, the doctrine of the permanency of oceans and continents does not hold good: on the contrary, do not the facts I have adduced go rather to support the views of those who, with Lyell, believe that where there is the land was once the sea, and where there is the sea was once the land?

If this line of reasoning be sound, then is this remarkable epoch of geological time (namely, the close of the Palæozoic) yet further signalled by one of the grandest events in the physical history of the world; for it would appear that it was at this epoch that Europe and America first emerged in a permanent form from beneath the waters of the ocean; and a new ocean was placed between them—a future highway for the nations of both hemispheres. Equally certain will it also be, that the doctrine of the permanency of oceans and continents derives no support from the phenomena presented by the region to which I have ventured to direct your attention.

---

NOTE ADDED IN THE PRESS.

(*March 20, 1885.*)

The above was written long before the recent determination of the structure of the North Highlands of Scotland, and is independent thereof.





Fig. 1. Sketch Map of visible and concealed Areas of Archaean Rocks.

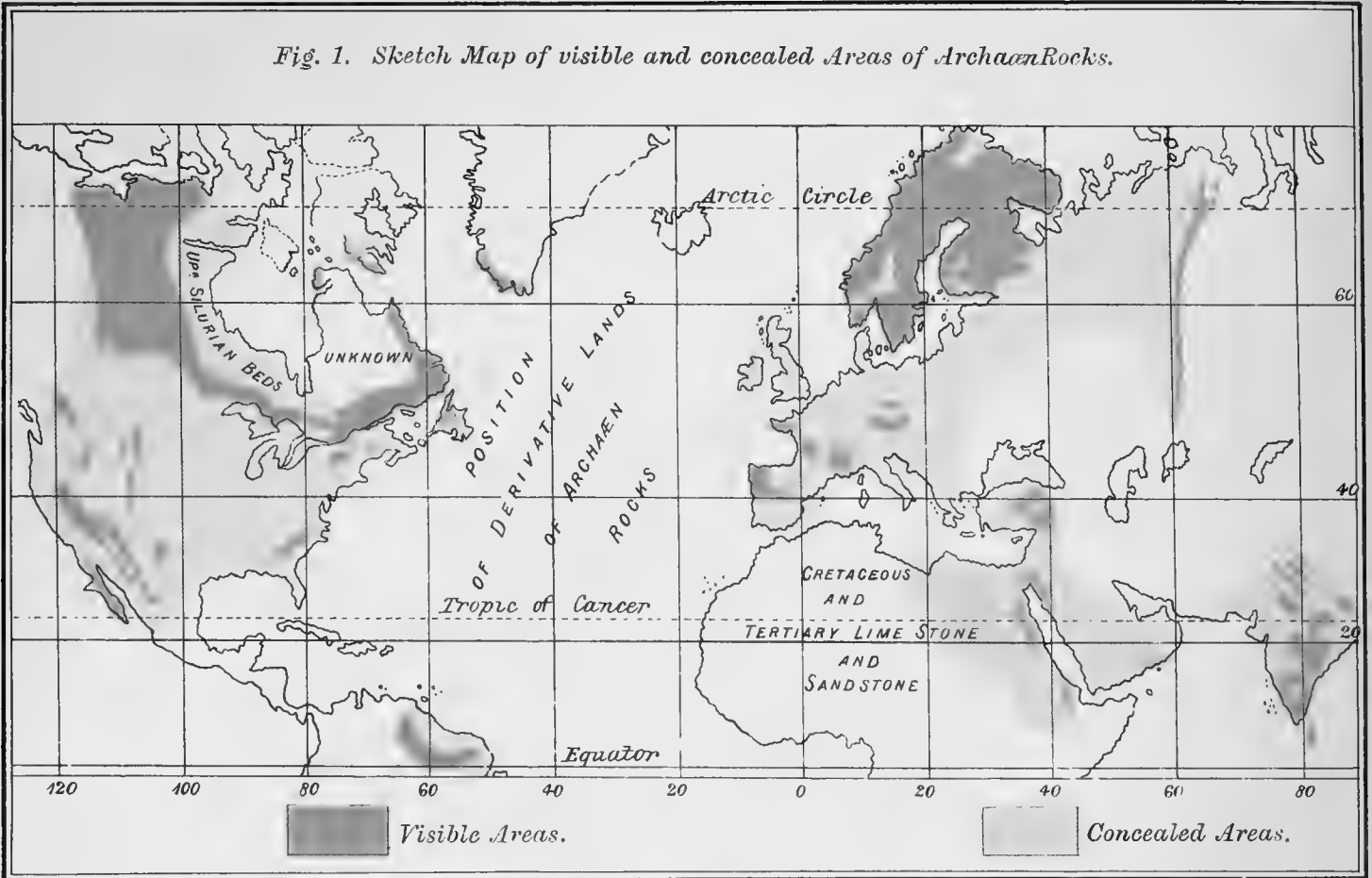
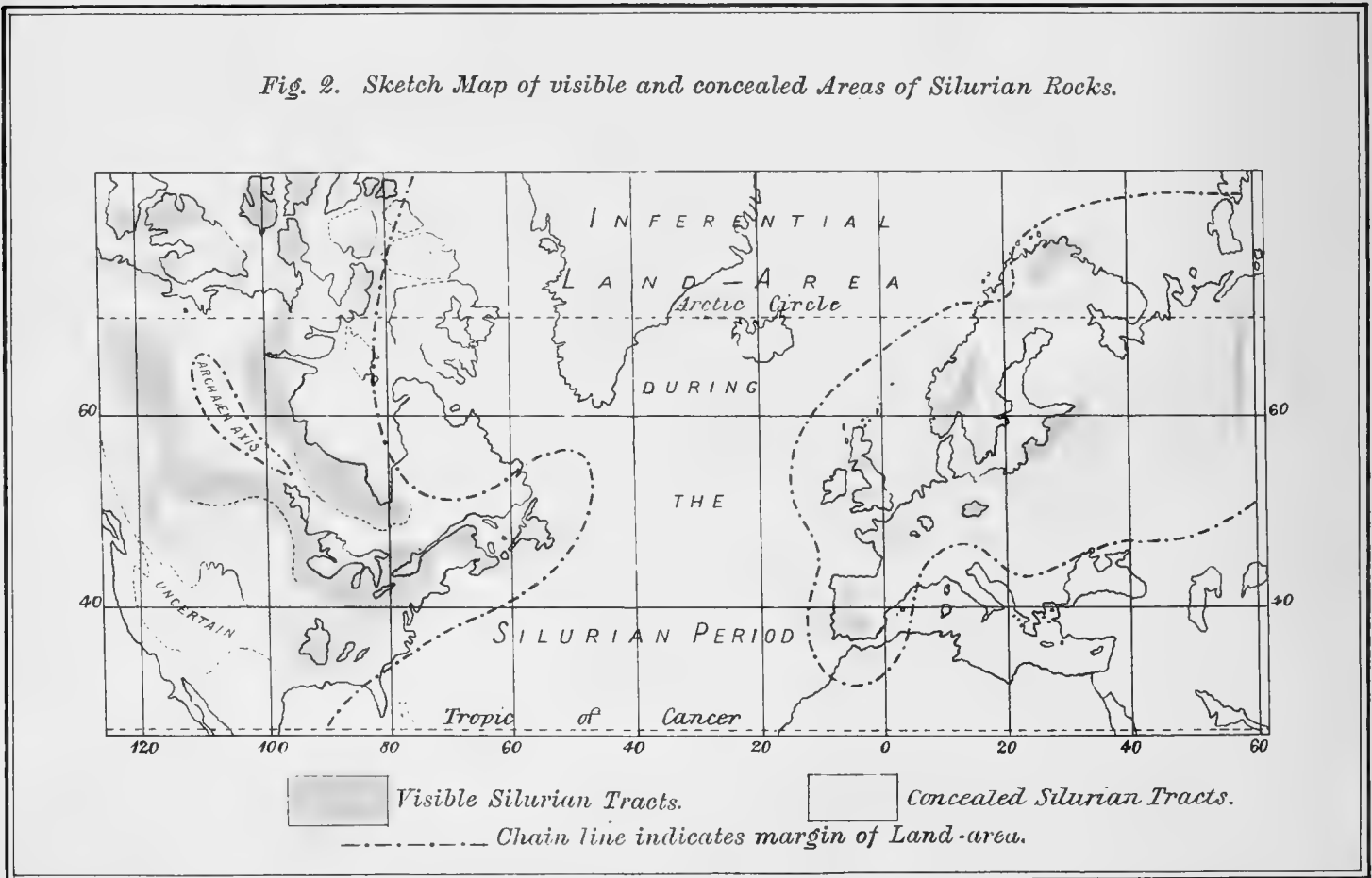

Fig. 2. Sketch Map of visible and concealed Areas of Silurian Rocks.



## EXPLANATION OF PLATE VII.

FIG. 1.—In this Map the areas of the Archæan rocks, where they occur at the surface, are shown by the darker tint; and where these rocks may be inferred to pass underneath, and form the floor of newer formations, by the lighter tint or shading. It will be observed how large an area of both continents is included.

FIG. 2.—In this Map the areas of the Silurian rocks, where they occur at the surface, is shown by the darker colouring, and where they pass underneath, and form the floor of newer formations by lighter shade. These areas having been under the waters of the ocean in Silurian times, the approximate line of separation between the land and the sea is shown by the chain line. It is needless to observe that this line must have been constantly changing during the period; but that indicated may be taken as the position towards the close of the Silurian epoch.

## EXPLANATION OF PLATE VIII.

FIG. 1.—This Map is intended to represent approximately the position of the land and submerged areas towards the close of the Carboniferous epoch, as based on observation and inference. The grounds on which it is constructed have been sufficiently indicated in the text.

FIG. 2.—These Diagrammatic Sections are an attempt to represent to the eye the manner in which the Carboniferous sedimentary strata swell out towards the centre of the North Atlantic on opposite sides of this ocean, and how the Calcareous strata are distributed on an opposite plan of formation. No attempt at scale is possible over so vast an area.

FIG. 3 represents the same phenomena in the case of the Lower Silurian beds. The grounds have already been sufficiently explained in the text.

*Fig. 1. SKETCH MAP,*  
 Showing position of the  
 DERIVATIVE LANDS AND AREAS OF DEPOSITION  
 at the close of the  
 CARBONIFEROUS EPOCH.

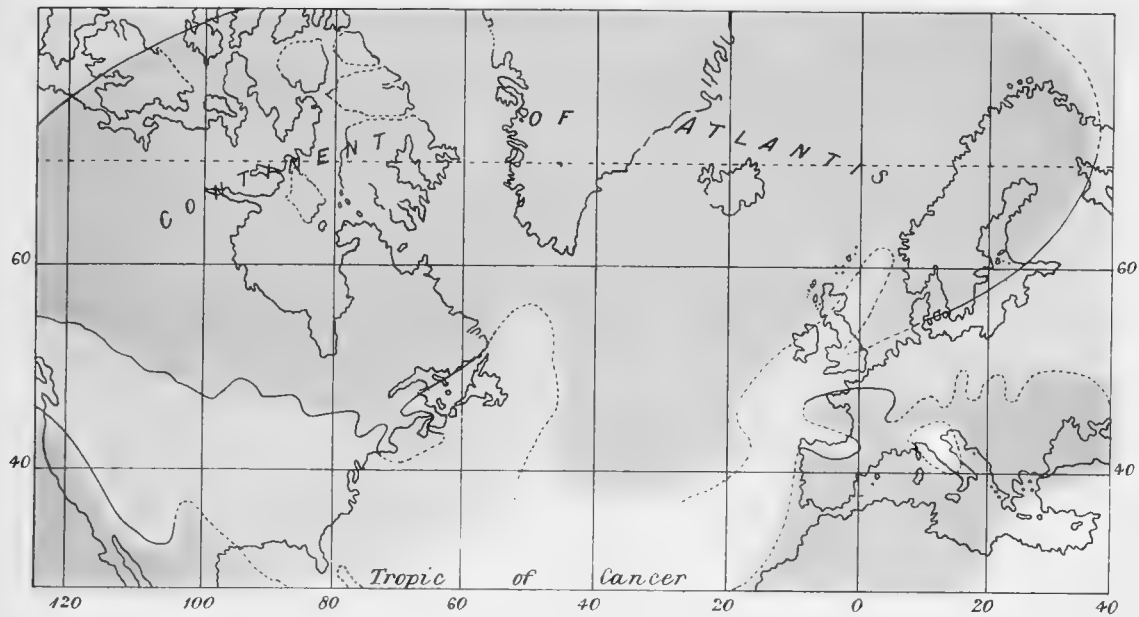

Land-areas.
  Submerged areas  
 Dotted boundaries uncertain.

*Diagrammatic Sections to illustrate the mode of Distribution  
 of the Carboniferous and Lower Silurian Strata on both  
 sides of the N. Atlantic Ocean.*

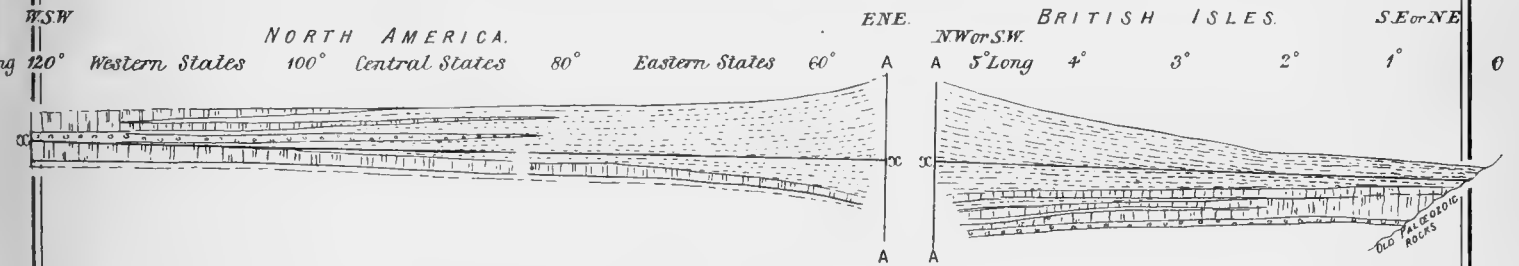

*Fig. 2. CARBONIFEROUS STRATA.*

*Fig. 3. LOWER SILURIAN STRATA.*

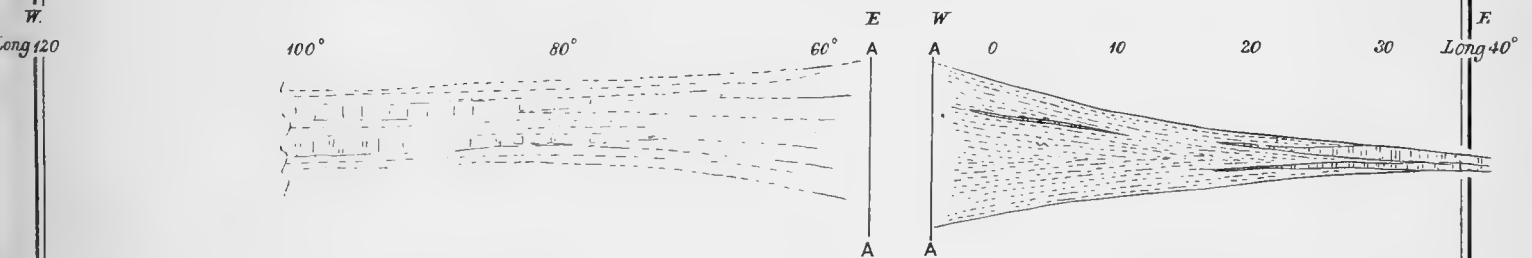

A.A. Atlantic Sea-board.
  Calcareous Strata.
  Sedimentary Strata.



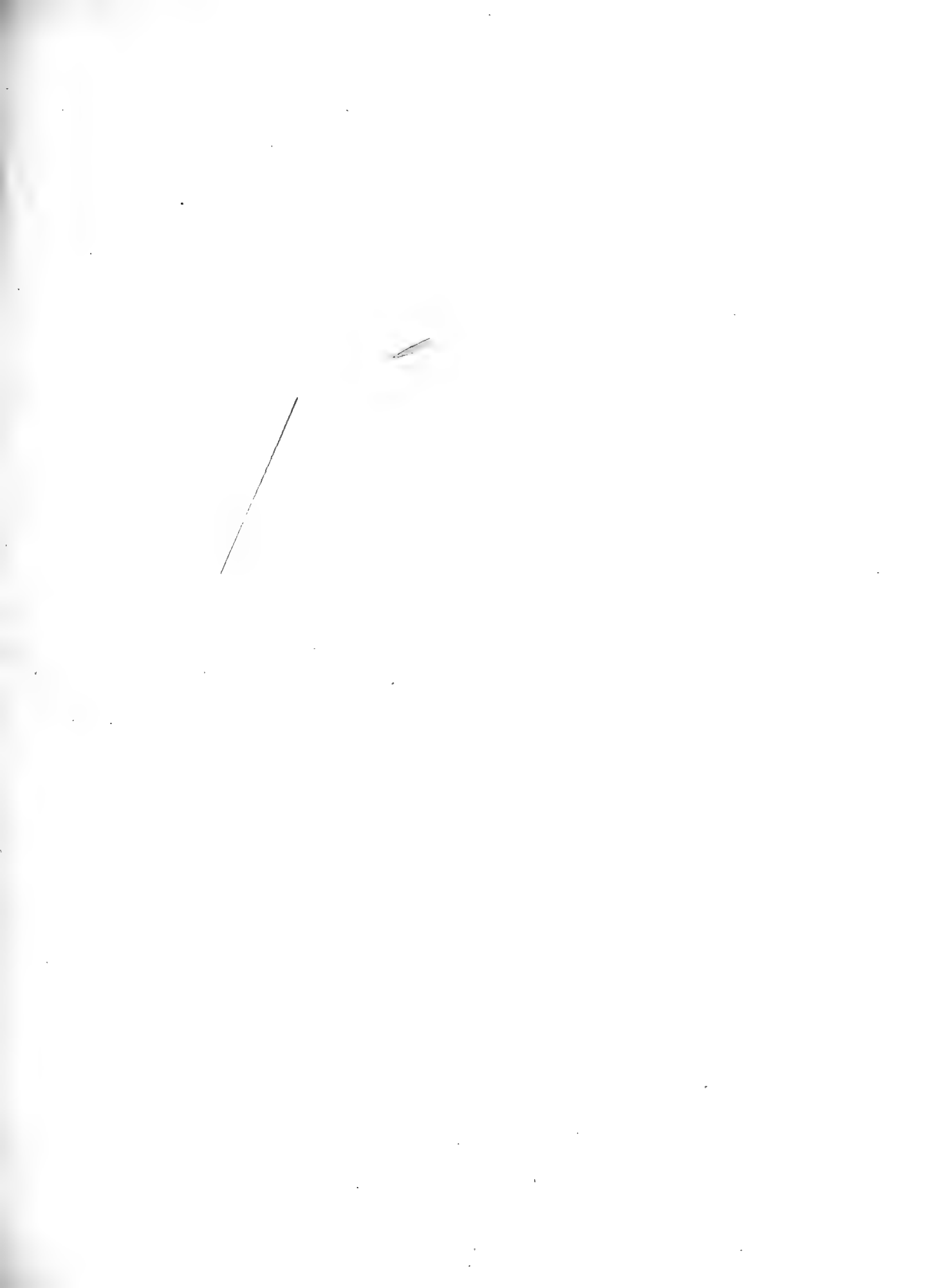

## TRANSACTIONS (NEW SERIES).

### VOLUME I.

PART

- 22.—On the Energy expended in Propelling a Bicycle. By G. JOHNSTONE STONEY, D.SC., F.R.S., a Vice-President of the Society; and G. GERALD STONEY. Plates XXXIX., XL., and XLI. (January, 1883.)
- 23.—On Electromagnetic Effects due to the Motion of the Earth. By GEORGE FRANCIS FITZGERALD, M.A., F.T.C.D., Erasmus Smith's Professor of Experimental Science in the University of Dublin. (January, 1883.)
- 24.—On the Possibility of Originating Wave Disturbances in the Ether by Means of Electric Forces:—Corrections and Additions. By GEORGE FRANCIS FITZGERALD, M.A., F.T.C.D. (January, 1883.)
- 25.—On the Fossil Fishes of the Carboniferous Limestone Series of Great Britain. By J. W. DAVIS. Plates XLII. to LXV. (September, 1883.) [*With Title-page to Volume.*]

### VOLUME II.

- 1.—Observations of Nebulæ and Clusters of Stars, made with the Six-foot and Three-foot Reflectors at Birr Castle, from the year 1848 up to the year 1878. Nos. 1 & 2. By the RIGHT HON. THE EARL OF ROSSE, I L.D., D.C.L., F.R.S. Plates I. to IV. (August, 1879.) No. 3. Plates V. and VI. (June, 1880.)
- 2.—On Aquatic Carnivorous Coleoptera or Dytiscidæ. By DR. SHARP. Plates VII. to XVIII. (April, 1882.) [*With Title-page to Volume.*]

### VOLUME III.

- 1.—On the Influence of Magnetism on the Rate of a Chronometer. By OTTO BOEDDICKER, PH.D. Plate I. (September, 1883.)
- 2.—On the Quantity of Energy transferred to the Ether by a Variable Current. By GEORGE F. FITZGERALD, M.A., F.R.S. (March, 1884.)
- 3.—On a New Form of Equatorial Telescope. By HOWARD GRUBB, M.E., F.R.S. Plate II. (March, 1884.)
- 4.—Catalogue of Vertebrate Fossils from the Siwaliks of India, in the Science and Art Museum, Dublin. By R. LYDEKKER, B.A., F.G.S., F.Z.S. Plate III. and Woodcuts. (July, 1884.)
- 5.—On the Origin of Freshwater Faunas: A Study in Evolution. By W. J. SOLLAS, M.A., Dublin; D.Sc., Cambridge; Fellow of St. John's College, Cambridge; Professor of Geology and Mineralogy in the University of Dublin. (November, 1884.)
- 6.—Memoirs on the Coleoptera of the Hawaiian Islands. By THE REV. T. BLACKBURN, B.A., and DR. D. SHARP. Plates IV. and V. (February, 1885.)
- 7.—Notes on the Aspect of the Planet Mars in 1884. Accompanied by Sketches made at the Observatory, Birr Castle. By OTTO BOEDDICKER, Ph. D. Plate VI. [*Communicated by the Earl of Rosse.*] (March, 1885.)
- 8.—On the Geological Age of the North Atlantic Ocean. By EDWARD HULL, LL.D., F.R.S., F.G.S., Director of the Geological Survey of Ireland. Plates VII. and VIII. (April, 1885.)



OCTOBER, 1885.]

THE  
SCIENTIFIC TRANSACTIONS  
OF THE  
ROYAL DUBLIN SOCIETY.

VOLUME III. (SERIES II.)

IX.—ON THE CHANGES OF THE RADIATION OF HEAT FROM THE MOON  
DURING THE TOTAL ECLIPSE OF 1884, OCTOBER 4, AS MEASURED  
AT THE OBSERVATORY, BIRR CASTLE. BY OTTO BÆDDICKER, Ph.D.  
(PLATES IX. AND X.) [Communicated, with a NOTE by the EARL OF ROSSE.]



DUBLIN:  
PUBLISHED BY THE ROYAL DUBLIN SOCIETY.  
PRINTED AT THE UNIVERSITY PRESS, BY PONSONBY AND WELDRICK,  
PRINTERS TO THE SOCIETY.  
1885.

*Price One Shilling.*



IX.—ON THE CHANGES OF THE RADIATION OF HEAT FROM THE MOON DURING THE TOTAL ECLIPSE OF 1884, OCTOBER 4, AS MEASURED AT THE OBSERVATORY, BIRR CASTLE. By OTTO BÆDDICKER, Ph.D. (PLATES IX. and X.). [Communicated with a NOTE by the EARL OF ROSSE.]

[Read, April 20, 1885.]

1. THE total eclipse of the moon on the 4th of October, 1884, afforded a welcome opportunity of testing the changes which the radiated lunar heat undergoes with the rapid change of the illuminated portion of the moon's surface. The interest attached to these observations was so much the greater, as no lunar eclipse had hitherto been sufficiently favoured by the weather as to admit of any decisive results. It was exceedingly fortunate, therefore, that thirty-two minutes before the beginning of the total phase the sky, till then thickly covered with Cirro-cumuli, cleared suddenly, and remained most perfectly and exceptionally transparent throughout the night. And, as also a perfect calmness prevailed all night, it may be said that the following eclipse-observations were made under the best attainable atmospheric conditions.

2. The apparatus used was the same as described by the Earl of Rosse in the Paper "On the Radiation of Heat from the Moon, the Law of its Absorption by our Atmosphere, and of its Variation in Amount with her Phases," published in the *Philosophical Transactions* of the Royal Society in the year 1873. The galvanometer-needle had, however, been taken out and repaired since that time, so that the figures given below are not directly comparable with those published in 1873. Another circumstance, which would also prevent this comparability, was discovered some time before the date of the eclipse. I had, namely, observed that the galvanometer indicated much slighter heat effects than it used to (*ceteris paribus*) during my observations of 1881, 1882, and 1883. As no reason for this could be found in spite of most careful and repeated examinations, and as the readings, *inter se*, were quite consistent, I raised the directing magnet from its usual distance of three inches to that of four inches, thus increasing the sensitiveness of the galvanometer to 2·24 as compared with unit in the former case.\*

\* This proportion is based upon a very extensive series of hot tin observations which I carried on in 1881, and have at present under discussion.

The sensitiveness attained by this appeared sufficient for the present purpose, though it did not come up to that of 1881. This alteration necessitated, obviously, lunar heat determinations before and after the eclipse, in order to enable me to see whether or not the apparatus underwent any change during the eclipse, and also to deduce a satisfactory value for the heat corresponding to full moon, which would be necessary for the discussion of the eclipse observations. Such additional observations were obtained on October 3, 5, 6; November 2, 28, 30, in 1884; and on March 24 and 29 in 1885, and are reproduced further on.

3. The mode of observing during the eclipse was the same as usual (*l. c.*, p. 588). As I had found, however, that when the illuminated phase of the moon was very small, the moon's image could not in the usual way be perceived on the small condensing mirrors, the late Mr. Butler, master at the Parsonstown Model School, remained in the observing gallery of the telescope, as near the thermopiles as could safely be, while the heat determinations were going on, directing the motion of the tube, so as to keep the moon's image constantly on the small condensers. This assistance proved exceedingly valuable, as it enabled me to observe till within a very few minutes of the total phase. The observations were carried on as much as possible uninterruptedly from 20<sup>h</sup> 27<sup>m</sup>, sidereal time, or 11<sup>m</sup> before the first contact with the shadow, till 1<sup>h</sup> 55<sup>m</sup>, sidereal time, or 45<sup>m</sup> after the last contact with the penumbra. The values up to 21<sup>h</sup> 11<sup>m</sup>, however, were obtained through a moderately dense covering of clouds, and are, therefore, of no value for our purpose. Besides this, four unavoidable interruptions took place. The first one from 21<sup>h</sup> 23<sup>m</sup> till 21<sup>h</sup> 27<sup>m</sup>, when a small, low, misty cloud—the last trace of the overcast sky—swept over the moon; the second one from 21<sup>h</sup> 38<sup>m</sup> till 23<sup>h</sup> 16<sup>m</sup>, or from two minutes before the beginning till three minutes after the end of the total phase, as during that time it was impossible to make sure that the moon's image was on the condensing mirrors. It is probable that this was to a considerable extent due to the unusual degree of darkness which the moon attained during this eclipse, and which has been remarked by numerous observers; but I do not think that the apparatus was sufficiently sensitive to show any effect, even if it had been possible to expose it properly to the moon's rays. The third interruption took place from 23<sup>h</sup> 26<sup>m</sup> till 23<sup>h</sup> 32<sup>m</sup>, during which time I examined the small condensers, to see whether they were covered with dew, which the exceedingly slow increase of the heat effect after the total phase had led me to suspect. My apprehension was, however, happily not verified. The last interruption, from 0<sup>h</sup> 40<sup>m</sup> till 0<sup>h</sup> 49<sup>m</sup> was owing to the rewinding of the driving clock of the telescope.

4. The following Table contains the eclipse observations only. The necessary explanations will be found after the Table:—

TABLE I.—LUNAR HEAT DURING THE TOTAL ECLIPSE ON OCTOBER 4, 1884.

I. Sidereal Time.	II. $G$	III. $P.E.$	IV. $z$	V. $G_z$	VI. $\log \rho^2$	VII. $\log R'^2$	VIII. Sidereal Time from Middle of Eclipse.	IX. $G_z^*$	X. $\epsilon$	XI. $G_z^*$ corrected for Phase.	XII. $G$ Curve.	XIII. Calc.-Obs.
II. M.							II. M.					
21 17	21.4	± 0.8	63.9	26.9	0.0006	0.0000	- 1 10	26.9	- 0 49	26.9		
25	14.3	± 1.4	62.9	18.2	.0006		- 1 2	18.2	- 0 47	18.2		
33	8.9	± 0.9	61.8	12.0	.0006		- 0 54	12.0	- 0 44	12.0		
23 21	3.3	± 2.1	51.0	3.7	9.9998		+ 0 54	3.7	+ 0 49	3.7	3.7	0.0
29	4.0	± 1.8	50.5	4.4	.9998		+ 1 2	4.4	+ 0 50	4.4	6.4	+ 2.0
37	11.6	± 2.9	50.0	12.8	.9998		+ 1 10	12.8	+ 0 51	12.8	14.0	+ 1.2
42	21.4	± 3.5	49.8	23.5	.9997		+ 1 15	23.5	+ 0 52	23.5	22.5	- 1.0
47	31.8	± 1.0	49.5	34.9	.9996		+ 1 20	34.9	+ 0 53	34.9	33.3	- 1.6
52	41.5	± 2.2	49.3	45.5	.9996		+ 1 25	45.4	+ 0 55	45.4	48.3	+ 2.9
57	58.9	± 3.0	49.0	64.5	.9996		+ 1 30	64.4	+ 0 56	64.4	67.3	+ 2.9
0 2	84.8	± 3.7	48.8	92.7	.9996		+ 1 35	92.6	+ 0 58	92.6	91.9	- 0.7
7	105.7	± 3.4	48.6	115.4	.9996		+ 1 40	115.4	+ 0 59	115.4	119.7	+ 4.3
12	137.7	± 7.4	48.4	149.7	.9996		+ 1 45	149.6	+ 1 1	149.6	148.3	- 1.3
17	168.7	± 3.6	48.3	183.8	.9996		+ 1 50	183.7	+ 1 2	184.9	179.1	- 5.8
22	188.5	± 4.7	48.2	205.2	.9995		+ 1 55	205.0	+ 1 4	206.4	209.2	+ 2.8
27	214.1	± 3.9	48.0	232.9	.9994		+ 2 0	232.6	+ 1 6	234.2	234.6	+ 0.4
32	233.1	± 3.2	48.0	253.5	.9994		+ 2 5	253.1	+ 1 8	254.9	255.8	+ 0.9
36	247.0	± 1.8	47.9	268.5	.9994		+ 2 9	268.1	+ 1 9	270.1	267.7	- 2.4
54	272.2	± 3.1	47.8	295.7	.9992		+ 2 27	295.1	+ 1 15	297.4	293.5	- 3.9
59	272.9	± 3.0	47.8	296.5	.9992		+ 2 32	295.9	+ 1 17	298.4	297.9	- 0.5
1 4	274.3	± 2.3	47.8	298.0	.9992		+ 2 37	297.5	+ 1 18	299.9	301.1	+ 1.2
9	277.1	± 1.7	47.9	301.1	.9991		+ 2 42	300.5	+ 1 20	303.0	304.0	+ 1.0
14	276.9	± 2.4	47.9	301.0	.9990		+ 2 47	300.3	+ 1 22	302.9	306.1	+ 3.2
19	284.4	± 2.3	48.0	309.4	.9990		+ 2 52	308.7	+ 1 24	311.4	307.9	- 3.5
24	285.8	± 1.4	48.1	311.1	.9990		+ 2 57	310.3	+ 1 26	313.1	309.2	- 3.9
29	280.1	± 1.9	48.3	305.2	.9990		+ 3 2	304.5	+ 1 28	307.3	310.0	+ 2.7
34	281.6	± 2.5	48.4	307.1	.9990		+ 3 7	306.3	+ 1 30	309.2	310.5	+ 1.3
39	283.9	± 3.7	48.6	309.9	.9990		+ 3 12	309.2	+ 1 32	312.2	311.0	- 1.2
44	281.0	± 3.4	48.8	307.1	.9990		+ 3 17	306.3	+ 1 33	309.3	311.1	+ 1.8
49	283.9	± 2.8	49.0	311.5	.9990		+ 3 22	310.0	+ 1 35	313.1	311.3	- 1.8
52	280.8	± 4.8	49.1	307.5	.9990		+ 3 25	306.8	+ 1 36	309.9	311.3	+ 1.4

- 21<sup>h</sup> 17<sup>m</sup>. Mean of twelve differences.
- 21 25. From 21<sup>h</sup> 23<sup>m</sup> till 27<sup>m</sup> a cloud swept over the moon. Mean of five differences before and five after the interruption.
- 21 40. Beginning of the Total Phase. 23<sup>h</sup> 13<sup>m</sup> end of the Total Phase.
- 23 29. No observations from 23<sup>h</sup> 26<sup>m</sup> till 32<sup>m</sup>. Mean of five differences before and five after the interruption.
- 0 12. Last contact with the shadow.
- 0 36. Mean of eight differences.
- 1 12. Last contact with the penumbra.
- 1 52. Mean of six differences. The condensers were again examined and found perfectly free from dew.

## 5. EXPLANATION OF THE PRECEDING TABLE.

COLUMNS I. AND II.—The observations were treated in the same way as in the publication referred to, viz., the arithmetical mean  $G$  of the ten differences, as given by eleven consecutive readings of the galvanometer, was put down as the heat effect corresponding to the sidereal time of the sixth of the galvanometer readings. This grouping of ten could be proceeded with by five differences each time, as all the readings form one uninterrupted series (or nearly so). Thus the interval between two successive values of  $G$  becomes five minutes on the average, and the number of points for the drawing of the final heat-curve is nearly doubled.

COLUMN III.—The probable errors in this column are based on the deviation from the mean. Their want of regularity is obviously owing to the rapid change of the moon's heat while the eclipse proceeded, together perhaps with the inequality of the moon's surface. The exceptionally large error at  $0^h 12^m$  may be due to the fact, that the corresponding  $G$  is the mean of five differences before and five differences after the last contact with the shadow. The increase again towards the end of the series is a little surprising, and I am unable to ascribe any reason to it besides the inequality of the moon's surface—unless it be connected with the unavoidable exhaustion of the observers.

COLUMNS IV. AND V.—By means of the moon's true zenith-distance,  $z$ , and the published table for the extinction of the lunar heat in our atmosphere (*l.c.*, p. 598), the values  $G_z$  were obtained, being the heat-effect which would have been recorded if the moon had been in the zenith at the time of observing.

COLUMNS VI. and VII.— $\rho$  is the moon's radius vector from the earth, the radius vector at the middle of the eclipse (or when the moon's horizontal equatorial parallax was  $59' 23''$ ) being taken as unity, and  $R'$  is the moon's distance from the sun, with her solar distance at the same epoch as unity.

COLUMN VIII. contains the sidereal times, counted from the middle of the eclipse (– before, + after).

COLUMN IX.—The values  $G_z^*$  are obtained by multiplying the figures  $G_z$  in Column V. with  $\rho^2$  and  $R'^2$ , and thus reducing them all to the same distances of the moon from earth and sun, to those, namely, which she held at the middle of the eclipse.

COLUMN X.— $\epsilon$  denotes the moon's apparent elongation from the point opposite the sun (– before, + after, full moon), calculated by the formula—

$$\cos (\pi - \epsilon) = \sin D \sin \delta' + \cos D \cos \delta' \cos (A - \alpha').$$

Where  $A$  = the sun's right ascension.

$D$  = the sun's declination.

$\alpha'$  = the moon's apparent right ascension.

$\delta'$  = the moon's apparent declination.

This formula, where  $(\pi - \epsilon)$  represents approximately the moon's apparent illuminated phase, is taken from the Paper of 1873, p. 593.

COLUMN XI.—The correction for phase has been applied to  $G_z^*$  in Column XI., after  $0^h 12^m$  (or the last contact with the shadow), by means of the Phase Table, *l. c.* p. 605, assuming simple proportionality. It appears somewhat doubtful whether this correction should be applied immediately after the last contact with the shadow: its effect on the heat curve is, however, but slight, in any case up to  $0^h 50^m$ , and after this time, the influence of the phase will doubtless become perceptible.

COLUMNS XII. AND XIII.—The values in Column XI. after the total] phase were now laid down as ordinates with the time as abscissæ, and a curve was carefully drawn and read off. These final values are given in Column XII., and their differences from the corresponding figures in Column XI. are to be found in Column XIII.

The heat curve is reproduced on Plate IX., which also contains the necessary explanations.

6. The observations of the moon's radiant heat, made in order to obtain a reliable value for full moon, are given in the following Table. Their number is rather limited, but no more opportunities offered themselves, and I did not consider it advisable, after having waited for so long, to delay still further the publication of this Paper. The necessary explanations will be found further on.

TABLE II.

I. DATE.	II. Sidereal Time.	III. $G$ as read.	IV. $P. E.$	V. True Zenith Distance.	VI. $G_z$ reduced to Zenith.	VII. $\log \rho^2$	VIII. $\log R'^2$	IX. $G_z$ reduced to same dist.	X. XI. XII. Adopted Mean			XIII. Weight.
									Sid. Time.	$G$	$\epsilon$	
1884. Oct. 3,	H. M. 0 30	263.0	$\pm 1.5$	$52.7^\circ$	295.1	0.0086	0.0004	301.2	H. M. 0 37	296.8	$- 12 20'$	1.5
	44	250.7	$\pm 1.9$	53.1	282.1	0.0084		287.8				
,, Oct. 5,	23 27	269.8	$\pm 1.5$	51.6	300.4	9.9932	9.9998	295.6	23 47	290.4	$+ 14 17'$	15
	37	270.8	$\pm 1.7$	50.6	299.5	9.9932		294.7				
	47	261.2	$\pm 1.7$	49.6	287.0	9.9932		282.4				
	57	265.1	$\pm 1.7$	48.7	289.5	9.9930		284.7				
,, Oct. 6,	0 7	275.3	$\pm 1.8$	47.9	299.2	9.9930		294.3				6
	23 54	203.8	$\pm 1.1$	52.0	227.5	9.9896	9.9994	221.8	0 4	221.9	$+ 28 10'$	
	0 4	207.2	$\pm 2.0$	50.7	229.3	9.9896		223.6				
,, Nov. 2,	14	205.8	$\pm 2.7$	49.6	226.2	9.9896		220.6				20
	23 41	349.5	$\pm 1.9$	51.5	388.9	9.9836	9.9932	368.6	0 1	368.2	$- 6 45'$	
	51	349.3	$\pm 3.7$	50.4	385.9	9.9836		365.9				
	0 1	354.1	$\pm 2.9$	49.3	388.4	9.9835		368.1				
	11	354.8	$\pm 3.2$	48.4	386.8	9.9834		366.5				
,, Nov. 28,	21	361.8	$\pm 1.9$	47.4	392.1	9.9834		371.5				15
	0 40	168.3	$\pm 2.7$	48.1	183.1	0.0074	9.9876	181.0	1 0	170.2	$- 54 13'$	
	50	157.1	$\pm 2.2$	48.0	170.9	0.0074		168.9				
	1 0	157.9	$\pm 3.6$	48.0	171.8	0.0072		169.7				
	10	153.1	$\pm 2.6$	48.1	166.6	0.0072		164.6				
	20	154.7	$\pm 1.0$	48.3	168.6	0.0070		166.5				
,, Nov. 30,	2 19	236.9	$\pm 1.1$	40.2	247.8	9.9814	9.9880	231.0	2 19	231.0	$- 26 51'$	1
1885. Mar. 24,	9 50	81.6	$\pm 1.1$	45.9	87.7	0.0026	9.9976	87.7	10 10	91.2	$- 74 20'$	20
	10 0	83.2	$\pm 2.3$	47.1	90.0	0.0026		90.0				
	10	81.4	$\pm 2.5$	48.3	88.7	0.0026		88.7				
	20	87.6	$\pm 3.6$	49.5	96.2	0.0026		96.2				
	30	84.5	$\pm 1.7$	50.7	93.5	0.0026		93.6				
,, Mar. 29,	12 8	274.8	$\pm 1.8$	53.8	311.0	0.0266	0.0150	342.2	12 28	336.1	$- 8 8'$	15
	18	269.1	$\pm 2.0$	54.0	304.9	0.0266		335.6				
	28	268.6	$\pm 0.9$	54.2	304.7	0.0266		335.3				
	38	269.1	$\pm 1.0$	54.4	305.8	0.0266		336.5				
	48	263.7	$\pm 1.3$	54.7	300.4	0.0268		330.8				

- Oct. 3. 0<sup>h</sup> 30<sup>m</sup> Mean of five differences; } Passing clouds.  
 0 44 Mean of nine differences. }  
 ,, 5. Very clear and calm. Slight fog on the grass, but not interfering.  
 ,, 6. Very clear and calm. Slight fog. Stopped by fog and clouds.  
 Nov. 2. All through absolutely and beautifully clear.  
 ,, 28. All through sky very clear. At 1<sup>h</sup> 1<sup>m</sup> and 1<sup>h</sup> 12<sup>m</sup> needle unsteady. Wind  
 at first S.W., Force 1; then shifting to N.W. and freshening slightly.  
 ,, 30. Passing clouds.  
 March 24. Very clear all through. Nearly calm.  
 ,, 29. Very clear. Wind N.N.W., Force 2-3, yet tube screened off.



7. COLUMNS I. to VI. do not call for any further remark after what has been said in explanation of Table I.

COLUMNS VII. and VIII. contain the factors necessary to reduce  $G_z$  in Column VII. to the distances from earth and sun which the moon occupied during the middle of the eclipse.

COLUMN IX. gives the value of  $G$ , reduced to zenith and to equal distances.

COLUMN XI.—The adopted mean values of  $G$  are deduced from those in Column IX. by assigning to each  $G$  a weight inversely proportional to the factor which reduces the readings to zenith (cf. *l. c.*, p. 599). Besides this, the former of the two observations of October 3 had double weight apportioned to it.

COLUMN XII.— $\pi - \epsilon$  is, as before, the angular amount of the moon's apparent illuminated phase.

COLUMN XIII.—The weights of the adopted mean values of  $G$  are apportioned after the following scale. They are firstly proportional to the number of sets which constitute the mean, bringing this number for Oct. 3 into account with  $1\frac{1}{2}$ . The weights are secondly proportional to a certain number—ranging from 1 to 4—denoting the state of sky and weather, as it, at the time of observing, was considered favourable or not for the determination of lunar heat. Thus the state of the atmosphere was—1, on Oct. 3 and Nov. 30; 2, on Oct. 5; 3, on Nov. 28 and March 29; 4, on Nov. 2 and March 24. This scale is necessarily somewhat arbitrary; yet some such plan must be adopted, as the readings may among themselves be quite consistent and very regular, and yet to a very considerable degree be affected by atmospheric influences. This is for instance nearly always the case in slight fog, when the galvanometer-needle may be very much steadier than during an ordinarily clear night, and yet the values recorded, *ceteris paribus*, very much smaller.

8. In order to deduce the most probable value of the galvanometer-reading at full moon, I have arranged the final values of  $G$  from Table II. according to  $\epsilon$  in the following small Table under  $G_B$ . In Column IV. are to be found the corresponding values ( $\Gamma$ ) taken from the Phase Table, *l. c.*, p. 605. Column V. contains the logarithms of the proportions of the corresponding figures in Columns II. and III.  $\left(\frac{G_B}{\Gamma}\right)$ .

TABLE III.

I. DATE.	II. $\epsilon$	III. $G_B$	IV. $\Gamma$	V. $\log \frac{G_B}{\Gamma}$	VI. Weight.
March 24 . .	$-74^{\circ} 20'$	91.2	104.7	9.9401	20
Nov. 28 . .	- 54 13	170.2	169.8	0.0006	15
Nov. 30 . .	- 26 51	231.0	293.0	9.8967	1
Oct. 3 . .	- 12 20	296.8	382.4	.8899	1.5
March 29 . .	- 8 8	336.1	401.0	.9233	15
Nov. 2 . .	- 6 45	368.2	404.6	.9590	20
Oct. 5 . .	+ 14 17	290.4	348.1	.9213	15
Oct. 6 . .	+ 28 10	221.9	286.5	.8888	6

9. By assigning the weights from Table II., which are here repeated in Column VI., to the numbers of which Column V. contains the logarithms, we obtain for the logarithm of the most probable factor for reducing the values for the lunar radiant heat of 1873 to those observed by me—9.94898, and have, therefore, by multiplying the number for full moon taken from the Phase Table, viz. 403.3, by the above factor, as the reading which I most probably should have observed during full moon.

$$G_{Full\ Moon} = 358.6 \pm 0.0000184.$$

10. Having regard to the full moon value thus obtained, the following points, which are brought out by the eclipse-observations, deserve special mention:—

*a.* After the last contact with the penumbra the heat-effect is only 85.3 per cent. of what it would have been without the eclipse, and thirty-eight minutes after the last contact with the penumbra it is still only 86.8 per cent. of the full moon value.

*b.* The decrease of heat before the total phase takes place much more rapidly in the same time than the increase after it. For from before the first contact with the penumbra till 54<sup>m</sup> before the beginning of the total phase the decrease amounts to 358.6–12.0 or 346.6 divisions of the scale; while during the same period after the eclipse the increase is only 306.1–3.7 = 302.4 divisions.

c. The minimum of the heat-effect falls decidedly later than the minimum of illumination, which may be supposed to coincide with the middle of the eclipse. This is obvious, as the values observed before the total phase are larger than those recorded at equal times after it.

These results are so much more remarkable, as they are opposed to the result of the eclipse observations of Nov. 14, 1872, which was, however, only obtained through clouds (*l. c.*, p. 619), and as my extra eclipse observations seem to confirm the fact found out in 1878, that the maximum of lunar radiant heat takes place before full moon (*l. c.*, p. 606).

---

NOTE BY THE EARL OF ROSSE, LL.D., F.R.S., &c.

In communicating the above to the Royal Dublin Society it may be as well to state shortly with what object the observations during the eclipse were undertaken, and to what point the investigation has been brought.

Having satisfied myself by the series of measurements of the Moon's Radiant Heat, published in the *Proc. Roy. Society*, 1869, No. 112, p. 437, that it was not only possible to perceive it by means of the thermopile, but even to determine its amount with tolerable accuracy; also by the series given in the *Proc. Roy. Society*, 1870, No. 123, p. 9, that, while from its varying largely with the phase of the moon, the heat had its origin rather from the sun than from the interior of the moon, and that from the much smaller percentage of it transmitted through a sheet of glass than of the sun's direct heat, it was in a large measure absorbed and then radiated, rather than instantaneously reflected or diffused, it became of interest not only to undertake a more careful and extended series of measurements and fully reduce the results, but also to try to obtain a little more information on the rate of heating and cooling of the moon's surface under the changing amount of the sun's rays. Accordingly the investigation published in the *Phil. Trans.* of 1873 was undertaken. So far from there being, as might have been expected, a greater lunar temperature after full moon than at a corresponding distance before opposition, if anything, the reverse appeared to be the case, perhaps from difference of average physical conditions between the two (preceding and following) visible portions of the surface. It then occurred that it would be important to seize the opportunity afforded by an eclipse of measuring the heat under changes of illumination far more rapid than those due to phase.

On May 22, 1872, clouds entirely prevented observations during the whole duration of the *partial* eclipse.

On Nov. 14, 1872, clouds interfered much ; but from simultaneous determinations of the heat and light at intervals when the sky was fairly clear, it appeared that during this *partial* eclipse the decline and subsequent increase of heat, as measured by the thermopile, took place about as rapidly as that of the light as measured by Zöllner's photometer.

On Aug. 23, 1877, some determinations of the heat during the *total* eclipse were made. Clouds again interfered, and the observations were very unsatisfactory, but after considerable delay were published in *Copernicus*, vol. i. p. 22.

No further opportunity for prosecuting the inquiry occurred until last October, when the above measurements were made under exceptionally favourable conditions in the opinion of Dr. Bæddicker (I was myself absent in America at the time). From theoretical considerations it seems difficult to reconcile the rapid fall from, probably, 359 divisions before the eclipse down to 4 only during totality, with so large a defect as 48 divisions (or 13 per cent.) after an interval as long as 38 minutes since the end of the eclipse. But as all attempts to find an explanation, where it might be natural to look for it, in the condition of the apparatus and the method of observation, have failed to afford a clue, it seems best to give the investigation to the world without further delay, reserving comment for a future time.

A total eclipse, where a sufficient altitude during the whole of its duration is attained, and where our climate allows of the phenomenon being taken advantage of, is so rare, that it may be some years before an opportunity for repeating the investigation may occur.

A sufficient explanation of the change of percentage of heat transmitted by glass with the change of phase still remains to be found. That suggested in *Phil. Trans.* 1873, pp. 626, 627, is probably quite inadequate ; and the assumption that it is due to a constant elevation of temperature, independent of that due immediately to the sun's action, would be quite inconsistent with the very rapid fall of temperature to about  $\frac{1}{10}$  of the full moon value in the short duration of the total eclipse, also with the fact that the observed heat falls away to an almost imperceptible amount even at some distance from conjunction (*Phil. Trans.*, 1873, p. 604).

BIRR CASTLE, *April* 17, 1885.

APPENDIX ADDED IN THE PRESS.

WITH PLATE X.

Since the above was written the variation of the total light from the moon, during her advance through the penumbra and the shadow, and her emergence therefrom, has been calculated approximately and compared with the heat observed by Dr. Bæddicker at the corresponding times.

The results are embodied in the Table below, and exhibited graphically in Plate X:—

Sid. Time.		☾'s Light.	☾'s Heat in % Full Moon = 358·9.	☾'s Heat in % Full Moon = 312.	Sid. Time.		☾'s Light.	☾'s Heat in % Full Moon = 358·9.	☾'s Heat in % Full Moon = 312.
H.	M.				H.	M.			
6*	21	17·5	4·83	6·8	8·0	13			
5*			2·96	5·7	6·7	14			
4*	21	25	1·63	4·7	5·5	15			
3*			0·75	4·0	4·7	16	0	13	
2*			0·26	3·4	3·8	17			
1*			0·05			18			
0*	21	40	0·00			19			
0	23	13	0·00			20	0	28	
1			0·05			21			
2			0·26	1·2	1·2	22			
3			0·75	1·5	1·5	23			
4	23	28	1·63	1·9	1·9	24	0	43	
5			2·96	2·6	2·7	25			
6			4·83	3·4	3·9	26			
7			7·27	4·9	5·6	27			
8	23	43	10·31	6·8	7·8	28	0	58	
9			13·96	9·1	10·6	29			
10			18·20	12·1	13·9	30			
11			23·03	15·6	18·1	31			
12	23	58	28·37	20·2	23·2	32	1	13	
							1	28	
							1	43	

The Table was obtained thus:—First, upon a sheet of paper circles were described, with radii proportional to the apparent semi-diameters of the sun and earth as seen from the moon, and by means of Amsler's planimeter the exposed

area of the solar surface was measured at sixteen equidistant positions, beginning with that where the solar surface is just wholly exposed, and ending with that where it just wholly covered. Thus sixteen points on a curve representing the law of increase of light between the edge of the shadow and that of the penumbra were obtained.

Secondly, circles were described on another sheet, with radii proportional to the apparent semi-diameters of the earth's shadow and penumbra and that of the moon as seen from the earth, and by means of the planimeter the area of sixteen zones of equal breadth and lying throughout their lengths in equal depths of penumbra were calculated. The moon's light at any time was approximately obtained by multiplying the area of each zone by the luminosity at the centre of its breadth, read off from the curve, and summing up these products. This was done for sixteen equidistant positions, and a curve representing very fairly the gradations of the moon's luminosity across the penumbra was obtained. This is represented in the diagram (Plate X.) by the strong full line. The observed heat is represented by the two other lines; the dotted one is based on the assumption that the heat of full moon was that towards which it seemed to approach on the night of the eclipse (*viz.* 312); the fine full line is based on the probable average full moon value deduced from observations previous and subsequent to the eclipse (*ante*, p. 328).

In determining the theoretic light-curve no allowance was made for the acknowledged decline of brilliancy of the sun's disc towards the limb, nor, of course, for any inequalities of brilliancy of the moon's disc. The moon's apparent diameter was assumed equal to the breadth of the penumbra from its exterior line to the edge of the shadow; the middle point of the curve is taken as that where one limb is as much (10'') inside of the shadow as the other is outside of the penumbra. The time when this occurred was carefully determined and the corresponding heat laid down. The rate of motion across the penumbra was assumed to be for our purpose constant. In obtaining the area of the zones of the lunar surface, they were assumed to be terminated on each side by circles of radius equal to that of the middle point of the penumbra and with centres along a radius, instead of by concentric circles of increasing and diminishing radii, as no appreciable error would result thereby.

We think there can be little or no doubt that an appreciable though small interval passes before the moon's surface acquires the temperature due to the light shining upon it at the moment, whichever of the two heat curves we take as based on the more probable value of the full moon's heat. From the character of the dotted curve, however, especially in the neighbourhood of 0<sup>h</sup> 28<sup>m</sup>, there seems hardly any doubt that 312 divisions is too small a figure to assume as a full moon value.

BIRR CASTLE, *August 26, 1885.*



LUNAR RADIANT HEAT CURVE, AS OBSERVED AT BIRR CASTLE OBSERVATORY  
 DURING THE TOTAL ECLIPSE OF 1884, OCTOBER 4.  
 By OTTO BOEDDICKER, Ph.D.





— Light Curve

— Heat Curve (Full Moon-358 & Divisions of the Galvanometer Scale.)

..... Heat Curve (Full Moon-392 Divisions of the Galvanometer Scale.)

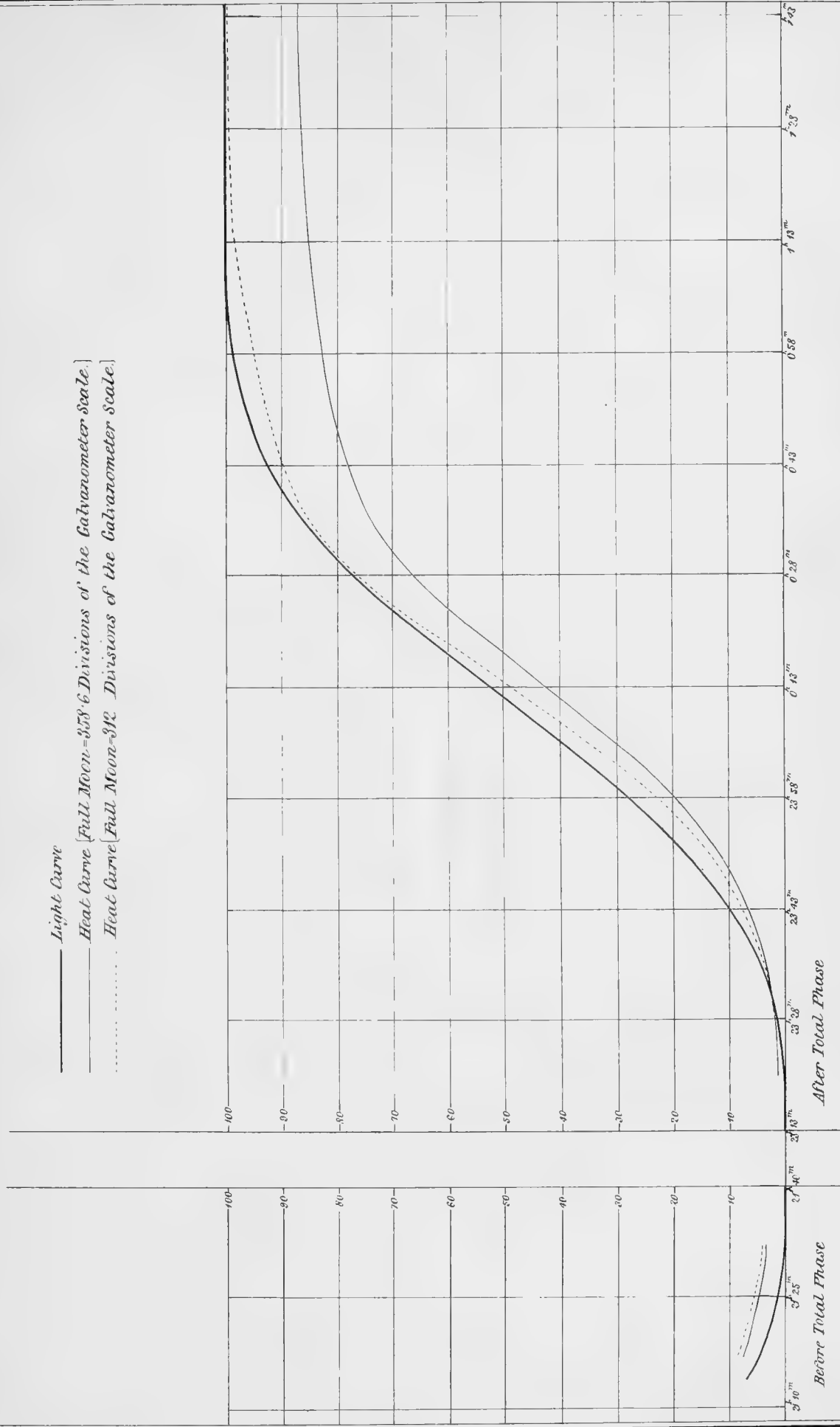

After Total Phase

Before Total Phase



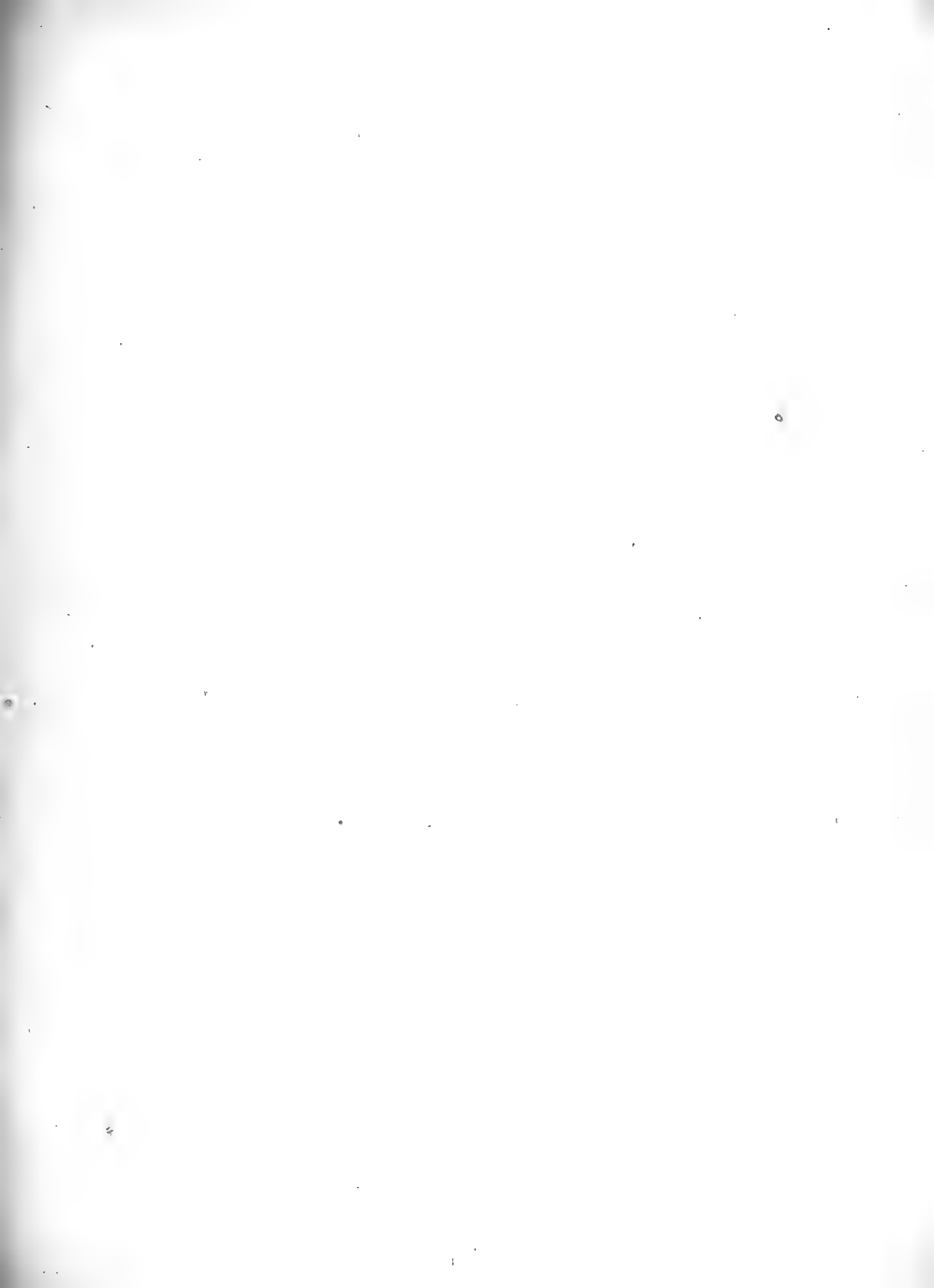

# TRANSACTIONS (NEW SERIES).

## VOLUME I.

PART

- 22.—On the Energy expended in Propelling a Bicycle. By G. JOHNSTONE STONEY, D.SC., F.R.S., a Vice-President of the Society; and G. GERALD STONEY. Plates XXXIX., XL., and XLI. (January, 1883.)
- 23.—On Electromagnetic Effects due to the Motion of the Earth. By GEORGE FRANCIS FITZGERALD, M.A., F.T.C.D., Erasmus Smith's Professor of Experimental Science in the University of Dublin. (January, 1883.)
- 24.—On the Possibility of Originating Wave Disturbances in the Ether by Means of Electric Forces:—Corrections and Additions. By GEORGE FRANCIS FITZGERALD, M.A., F.T.C.D. (January, 1883.)
- 25.—On the Fossil Fishes of the Carboniferous Limestone Series of Great Britain. By J. W. DAVIS. Plates XLII. to LXV. (September, 1883.) [*With Title-page to Volume.*]

## VOLUME II.

- 1.—Observations of Nebulæ and Clusters of Stars, made with the Six-foot and Three-foot Reflectors at Birr Castle, from the year 1848 up to the year 1878. Nos. 1 & 2. By the RIGHT HON. THE EARL OF ROSSE, I L.D., D.C.L., F.R.S. Plates I. to IV. (August, 1879.) No. 3. Plates V. and VI. (June, 1880.)
- 2.—On Aquatic Carnivorous Coleoptera or Dytiscidæ. By DR. SHARP. Plates VII. to XVIII. (April, 1882.) [*With Title-page to Volume.*]

## VOLUME III.

- 1.—On the Influence of Magnetism on the Rate of a Chronometer. By OTTO BOEDDICKER, PH.D. Plate I. (September, 1883.)
- 2.—On the Quantity of Energy transferred to the Ether by a Variable Current. By GEORGE F. FITZGERALD, M.A., F.R.S. (March, 1884.)
- 3.—On a New Form of Equatorial Telescope. By HOWARD GRUBB, M.E., F.R.S. Plate II. (March, 1884.)
- 4.—Catalogue of Vertebrate Fossils from the Siwaliks of India, in the Science and Art Museum, Dublin. By R. LYDEKKER, B.A., F.G.S., F.Z.S. Plate III. and Woodcuts. (July, 1884.)
- 5.—On the Origin of Freshwater Faunas: A Study in Evolution. By W. J. SOLLAS, M.A., Dublin; D.Sc., Cambridge; Fellow of St. John's College, Cambridge; Professor of Geology and Mineralogy in the University of Dublin. (November, 1884.)
- 6.—Memoirs on the Coleoptera of the Hawaiian Islands. By THE REV. T. BLACKBURN, B.A., and DR. D. SHARP. Plates IV. and V. (February, 1885.)
- 7.—Notes on the Aspect of the Planet Mars in 1884. Accompanied by Sketches made at the Observatory, Birr Castle. By OTTO BÆDDICKER, Ph. D. Plate VI. [*Communicated by the Earl of Rosse.*] (March, 1885.)
- 8.—On the Geological Age of the North Atlantic Ocean. By EDWARD HULL, LL.D., F.R.S., F.G.S., Director of the Geological Survey of Ireland. Plates VII. and VIII. (April, 1885.)
- 9.—On the Changes of the Radiation of Heat from the Moon during the Total Eclipse of 1884, October 4, as Measured at the Observatory, Birr Castle. By OTTO BÆDDICKER, Ph.D. Plates IX. and X. [*Communicated, with a NOTE by the EARL OF ROSSE.*] (October, 1885.)

NOVEMBER, 1885.]

THE  
SCIENTIFIC TRANSACTIONS  
OF THE  
ROYAL DUBLIN SOCIETY.

VOLUME III. (SERIES II.)

---

X.—ON THE COLLECTION OF THE FOSSIL MAMMALIA OF IRELAND IN  
THE SCIENCE AND ART MUSEUM, DUBLIN. BY V. BALL, M. A., F. R. S.,  
F. G. S., DIRECTOR OF THE MUSEUM. (PLATE XI.)

---



DUBLIN:  
PUBLISHED BY THE ROYAL DUBLIN SOCIETY.  
PRINTED AT THE UNIVERSITY PRESS, BY PONSONBY AND WELDRICK,  
PRINTERS TO THE SOCIETY.  
1885.

*Price One Shilling.*



X.—ON THE COLLECTION OF THE FOSSIL MAMMALIA OF IRELAND IN THE SCIENCE AND ART MUSEUM, DUBLIN. By V. BALL, M.A., F.R.S., F.G.S., Director of the Museum. (Plate XI.)

[Read, 18th May, 1885.]

As I have been long impressed with the desirability of conveying information to visitors to museums generally by means of specially prepared descriptive labels of more detailed character than those which are commonly used, no time has been lost in making a beginning in that direction, since the opportunity of doing so has been afforded by the establishment of a printing press in connexion with the Science and Art Museum.

So far as labels of this character have been prepared by the officers of the different departments in the Museum, the results have not only been satisfactory locally, but the form which has been adopted has received commendation from the officers of some of the principal museums in the kingdom, several of whom have expressed their intention of adopting similar labels for their own collections.

Our collection of the Irish Fossil Mammalia being the largest and most important one in existence, and having been recently re-arranged, afforded numerous suitable subjects for such labels, and the present Paper consists principally of a reprint of those already prepared. It will be observed that, being intended for popular usage and instruction, they are as far as possible free from technical language; at the same time they give a *resumé* to date of all that is most important in the history of the species to which they respectively refer.

The species are arranged under three headings, as follows:—

- I.—PREHISTORIC MAMMALS.—(WILD.)
- II.—PREHISTORIC MAMMALS.—(DOMESTIC.)
- III.—PLEISTOCENE MAMMALS.

Owing to the number of Dublin journals in which Papers on the Irish Mammalia have been published, authors have often confused the references. I have therefore prepared a complete bibliography of the subject as an Appendix to this Paper.

I would only add, that to the Papers by the late Drs. Leith Adams and Carte I am largely and more especially indebted for the information contained in the following pages.

## I.—PREHISTORIC MAMMALS OF IRELAND (WILD).

ALPINE HARE,	<i>Lepus variabilis.</i>
OTTER, . . .	<i>Lutra vulgaris.</i>
MARTEN, . . .	<i>Martes sylvestris.</i>
BADGER, . . .	<i>Meles taxus.</i>
THE BEAR, . . .	<i>Ursus (ferox) horribilis.*</i>
WOLF, . . .	<i>Canis lupus.</i>
FOX, . . .	<i>Canis vulpes.</i>
HORSE, . . .	<i>Equus caballus, ferus.</i>
RED DEER, . . .	<i>Cervus elaphus.</i>
IRISH ELK, . . .	<i>Cervus (Megaceros) hibernicus.</i>
REINDEER, . . .	<i>Cervus tarandus.</i>
WILD BOAR, . . .	<i>Sus scrofa, ferus ?</i>

## 1.—THE IRISH BEAR.

*Ursus (ferox) horribilis.\**

While the question may still be considered to be open as to the specific identity of the Great Cave Bear of Europe, *U. spelæus*, with the modern Grisly, or the Brown Bears, it is so far established that the bear's remains hitherto found in Ireland do not possess the characteristics which are distinctive of the former.

In the opinion of some of the most eminent zoologists of the present day, however, the difference between the Brown Bear of Europe, *U. arctos*, and the Grisly of North America, *U. (ferox) horribilis*, are attributable merely to geographical surroundings and diet, and do not amount to what would justify specific separation.

All the remains of Irish bears seem to have belonged to one and the same species, of which *Ursus arctos* and *U. ferox* (i.e. *horribilis*) are surviving varieties. This view may now be accepted as the verdict by most authorities—though formerly it was maintained that evidence had been found of the existence of four species, including the Polar Bear, in this country.

There is no certain evidence that the bear existed contemporaneously with man in Ireland. Mr. Thompson states that oral tradition asserts that it did, and the Celtic name for bear, *mathghamhain*, is often used in Irish literature, but the

\* According to the recently published *Catalogue of the Fossil Mammalia in the British Museum*, by Mr. R. Lydekker, the oldest title for this species is *U. horribilis*, Ord.; but *U. arctos* is regarded by him as a distinct species. The *Catalogue* was first seen by me after the above had been written.



testimony, both positive and negative, which is afforded by historians, is against its having survived into the historical period. St. Donatus, in A. D. 850, says it did not then exist, and other writers do not mention it.

The principal recorded cases of the discovery of bones belonging to the Irish Bear are the following.—I. At Ballinmore, in the county Leitrim, where a cranium was found in the excavation for the Shannon and Erne Canal. This specimen formerly in the Earl of Enniskillen's collection, is now in the British Museum (No. M. 230). II. Two crania were discovered in the year 1847 at a depth of seven feet in marl beneath peat, in a bog on the borders of Longford and Westmeath;\* they were deposited in the museum at Leeds by Mr. Denny, but we have casts of both of them in this Museum. III. A cranium was found in the year 1848 in an excavation at Clonbourne, near Parsonstown, at the depth of seven feet, under bog oak trees; it is now in the British Museum (No. 38906), and a cast of it is in this Museum. IV. A cranium was found in a cutting connected with the river Boyne, near Kilrathmurray, in the county Kildare; the specimen is now in this Museum. V. At the Shandon Cave, in county Waterford, the greater portion of the skeleton of one individual and a fragment of a mandible were discovered in the year 1859. They are now in this Museum. Remains of at least two individuals were found in the Ballynamindra Cave, in the county Waterford. They are also in this Museum. VI. Several bones were found in the year 1863 in a cutting which was made to lower the waters of Lough Gur, in the county Limerick. These were at one time supposed to have belonged to the Polar Bear, but Dr. Leith Adams has shown that they must be referred to the same species as the others. They are now in this Museum.

## 2.—THE WOLF.

### *Canis lupus.*

The earliest evidence of the existence of the wolf in Ireland is afforded by the discovery, as recorded by Dr. Leith Adams, of fragmentary bones belonging to several individuals, in association with bones of fox, horse, reindeer, red deer, bear, hare, and mammoth in the Shandon Cave, county Waterford; from which it may be concluded that it inhabited this country in pleistocene times. The specimens referred to are now in this Museum.

Bones not easily distinguishable from those of the dog, but considered to be wolf's, were found associated with Irish elk remains in the cave at Ballynamindra, near Cappagh, county Waterford. These are also preserved in this Museum.

Wolf bones were met with in prehistoric deposits in the Knockmore caves,

\* *Proc. Roy. Irish Acad.* (1849), vol. iv., pp. 416-420.

county Fermanagh; with these exceptions, and possibly also some of the bones from other localities which have been doubtfully referred to dogs, no discoveries of wolves' remains are recorded in Ireland. This is a most singular fact when we consider the historical facts. It serves to show how a large animal, at one time very abundant, may disappear, leaving but little trace behind it; for in each of these cases even the remains are few and fragmentary.

The following facts as to the extinction of the wolf are of interest. "In 1652 a council order of Cromwell's government prohibited the export of wolf dogs, and offered rewards of £5 and £6 respectively for male and female wolves." Smith, in his *History of Kerry*, p. 173, says the last was killed there in 1710. Mr. Hardiman, editor of O'Flaherty's *Description of H-Iar Connaught*, pp. 10 and 180, gives some information on the subject, and says that, so far as he could ascertain, the date of the last wolf being seen in that district was 1700.

### 3.—THE WILD HORSE.

#### *Equus caballus, ferus.*

There can be no doubt that the horse existed in Ireland during the pleistocene period as a contemporary of several animals which are now extinct. In the Shandon Cave at Dungarvan, on the authority of Dr. Leith Adams, the remains of six horses were found, together with those of mammoth, reindeer, red deer, bear, and wolf. So far as the evidence goes, these animals lived at a time anterior to the arrival of man in Ireland. In the Ballynamintra Cave horses' teeth were found, together with the bones of bear, Irish elk, and wolf, which were associated with human remains, and those of many still existing animals. It is possible that these horses had been used for food by the men of this period. It may be added that the characters of the associated remains and the circumstances of their position afford the principal evidence as to whether the bones should be referred to wild or domesticated varieties of the horse.

There are several more or less well-authenticated instances of horses' skulls having been taken from the drift and deposits of similar age; others have been found in caves at Ballintoy, county Antrim, and near the shores of Loch Erne.

It is not improbable that the wild horse may have survived up to about the time when the wolf became extinct, or at any rate till long after most of its above-mentioned earliest contemporaries had become extinct.

This Museum only possesses a few fragmentary equine remains at present, but there are two skulls in the Geological Museum of Trinity College.

## 4.—THE RED DEER.

*Cervus elaphus.*

As the sole survivor in Ireland of the large mammals of the pleistocene period, the red deer is of considerable interest. Although now restricted to a small area in Kerry, it appears, judging from the wide-spread abundance of its remains, to have been formerly plentifully distributed all over the island.

The cave of Shandon proves that it co-existed with the mammoth, and, as might be expected, its bones abound in the marls, underlying peat, where those of the Irish elk have been found.

Various attempts have been made to prove that the fossil red deer belonged to a species distinguishable from the existing one; but all that can safely be said on the subject simply amounts to this, as pointed out by Dr. Leith Adams, that the early race of Ireland, while larger than that which survives, was smaller than the early race of which the remains are found in the brick-earths of England. "But although the horns do not attain the massive proportions of many of the latter, the thistle-nest termination of the antler is often well developed." This fact will be amply apparent from an examination of several of the numerous specimens of antlers which are possessed by this Museum.

The following dimensions of a specimen found in mud, at a depth of 5 feet, at Killowford Bridge, near Dungarvan, are given by Dr. Leith Adams: cranium 17 inches, antler 31 inches, 14 tynes on each beam, expanse 35 inches, circumference of burr  $6\frac{1}{2}$  inches.

## 5.—THE IRISH ELK, OR GIGANTIC DEER.

*Cervus (Megaceros) hibernicus.*

This noble representative of the extinct mammalia of Ireland, judging from the number of specimens which have been discovered, must have been very abundant in later pleistocene and prehistoric times. The fact may perhaps be attributable to the comparative scarcity of its natural enemies, the larger carnivora, both as regards species and individuals. It was the sole survivor in Ireland, from pleistocene to prehistoric times, and has since become wholly extinct. The largest stags were probably 21 hands or 7 feet high, and the expanse of their antlers attained 9 to 10 feet, or even more.

The principal evidence in favour of the view that this animal was a contemporary of man has been afforded by the discovery by Mr. R. J. Ussher of its long

bones, split as though for the extraction of the marrow, in conjunction with stone implements, &c., in the caves of Ballynamindra, near Cappagh, county Waterford.\*

There are many examples in the Museum of Irish elk bones and antlers having been cut, worn, or polished by mutual attrition, when in contact with one another, and enveloped in the clay underlying peat. This fact might be adduced in favour of the existence of earth tremors.

The collection includes a large variety of skulls, numbering altogether about fifty. In one (plate xi., fig. i.) recently acquired, the palmate portion of the right antler and beam are bifurcate, showing possibly a tendency to approximate to the more branched forms of horns seen in other species of deer. Other pairs of horns, very much stunted, belonged to very old or perhaps emasculated individuals. From two skulls both antlers have been cast. The Museum possesses only two (hornless) skulls of hinds, one of which is mounted with a complete skeleton.

The rarity of the skulls of the hinds and the bones of the skeleton, when compared with the abundance of the skulls of stags with the antlers attached, is probably due to the latter having been anchored by entanglement in mud and stones, by means of which they were secured from removal by river currents.

In some cases the bones have been taken from clay or marl, underneath a covering of fifty feet of peat. When the peat is shallow, and search is regularly made, the position of the bones is generally ascertained by means of long probing-irons.

It would not be possible now to enumerate all the localities in Ireland where remains of this stag have been found, the records being incomplete. The following have proved specially prolific:—the plain of Limerick; Turloughmore, near Tuam, and the margin of Lough Derg, near Mountshannon, both in county Galway; Killowen, county Wexford; Ballybetagh bog, near Kiltiernan, county Dublin, where remains of upwards of 100 individuals were found by Mr. R. J. Moss and others.

In Great Britain, *Megaceros*, or Irish elk remains, are rare, but have been discovered in peaty mud near Newbury, in Berkshire, in the Isle of Man, and in mud below the peat in the parish of Maybole, Ayrshire. They have been found in Germany, and other parts of a central temperate zone in Europe. The caves of the Altai indicate the most eastern limit of the ascertained range of the animal.

## 6.—THE REINDEER.

### *Cervus tarandus.*

The only evidence that the reindeer was contemporary with man in Ireland is imperfect, being afforded by the discovery of what are supposed to be its bones in

\* See on this subject, however, *Jour. D. G. S.* 1862, vol. ix., p. 340; and *Edin. Jour. of Science*, N. S., 1830, vol. ii., p. 306, &c.

the Ballynamindra Cave, together with proofs of man's presence. Although it survived in Scotland up to the year 1159, neither history nor tradition record its former presence in Ireland; but judging from the remarkable condition of preservation in which some of the antlers have been found, it is difficult to attribute to them a very high antiquity.

From the discoveries made in the Shandon Caves, it has been concluded that the reindeer lived in pleistocene times, together with the mammoth and bear; possibly, however, the actual stratum containing its bones may have been more recent than those in which the mammoth and bear were found. No doubt whatever exists as to its having grazed together with the Irish elk on the margins of ancient lakes in which they both became entombed, as at Ballybetagh, near Kiltiernan, county Dublin, where very fine antlers were obtained; some of which are now preserved in this Museum.

Another fine specimen in this Museum was found in the year 1861, at Ashbourne, county Dublin, 5 feet from the surface, below peat and clay, and lying on blue marl and clay. Others have been obtained in Lough Gur, and on the banks of the Shannon, in the county of Limerick. Two perfect skulls, with antlers attached, were obtained as far back as the year 1741, in the bog of Ballyguiry, county Waterford. The remains found in the Shandon Cave, already referred to, belonged, according to Dr. Leith Adams, to between thirty and forty individuals. This is a small number when compared with that indicated by the discovery of a thousand antlers in a cave in Glamorganshire, as recorded by Sir Charles Lyell.

Of the several existing varieties of reindeer, the one to which all the Irish examples must be referred is the barren-ground or Arctic Caribou, in which the antlers are slender and rounded, as contrasted with the more massive and flattened beam of the horns of the Great or Wooland Caribou, which is found in eastern Canada and the Rocky Mountains.

As in most other species of deer, the left antlers, with the frontal snag, are more strongly developed than are the right.

The largest Irish antlers measure 3 feet 7 inches round the curve, and have a span of 3 feet at the tips.

## 7.—THE WILD BOAR.

*Sus scrofa, ferus* (?)

Owing to the absence of pig bones in the older deposits, it has been doubted whether this animal should be regarded as truly indigenous. In other words, it has been suggested that the herds of wild pigs which, according to ancient historians, formerly infested the woods and forests of Ireland, were all derived from an introduced stock.

The discovery of remains of the pig in Ballynamindra Cave, however, render it at least not improbable that there may have been a wild pig, despite the fact that all the skulls which are recorded belong to the same variety, namely, the greyhound, or long-faced Irish pig, which, even as a domesticated breed, is now nearly, if not altogether, extinct, its place having been taken by others which are better producers of bacon.

Many of the skulls obtained in Lough Gur show marks of the pole-axe, and cannot therefore be regarded as being of a very high antiquity, though possibly belonging to the prehistoric period.

---

The following animals, whose existence has been proved in Britain, are not known to have occurred in Ireland in prehistoric times, viz.—beaver, roe-buck, elk or moose, urus or wild ox (*Bos primigenius*):—

## II.—PREHISTORIC MAMMALS OF IRELAND (DOMESTIC.)

MAN, . . .	<i>Homo sapiens.</i>
DOG, . . .	<i>Canis domesticus.</i>
HORSE, . . .	<i>Equus caballus.</i>
SHEEP, . . .	<i>Ovis aries.</i>
GOAT, . . .	<i>Capra hircus.</i>
CATTLE, . . .	<i>Bos longifrons</i> and <i>B. frontosus.</i>
HOG, . . .	<i>Sus scrofa.</i>

### 8.—THE IRISH WOLF-DOG.

*Canis domesticus, var. Hibernicus.*

The formidable characteristics of the ancient Irish wolf-dog are, as is well known, both the subject of history and tradition. These records, it is moreover now fairly ascertained, do not exaggerate the power and strength of an animal which was the faithful companion not only of the hunter, but possibly also of the warrior, in far remote prehistoric as well as in more recent times.

It is considered by some authorities that the wolf-dog resembled in general aspect the modern rough-haired deerhound of Scotland; and of this race there is at present a reputed example still living in the gardens of the Royal Zoological Society of Ireland. But there is very positive evidence afforded by a Paper, by A. B. Lambert, F.R.S., and a letter to him from Lord Altamont, both of which are published in the *Linnean Transactions* for 1797, that there were in Ireland formerly two races of wolf-dogs, one of which was a greyhound and the other a mastiff,

somewhat resembling the great Dane. The figure given by Lambert (of which the woodcut is a copy, reduced to scale) represents, perhaps, a half-breed between the two, but with the mastiff characters predominating. For some years the late Dr. Robert Ball carried on, at the Zoological Gardens, a series of experiments in cross-breeding with the hope of recovering the lost type of dog indicated by this figure:—\*

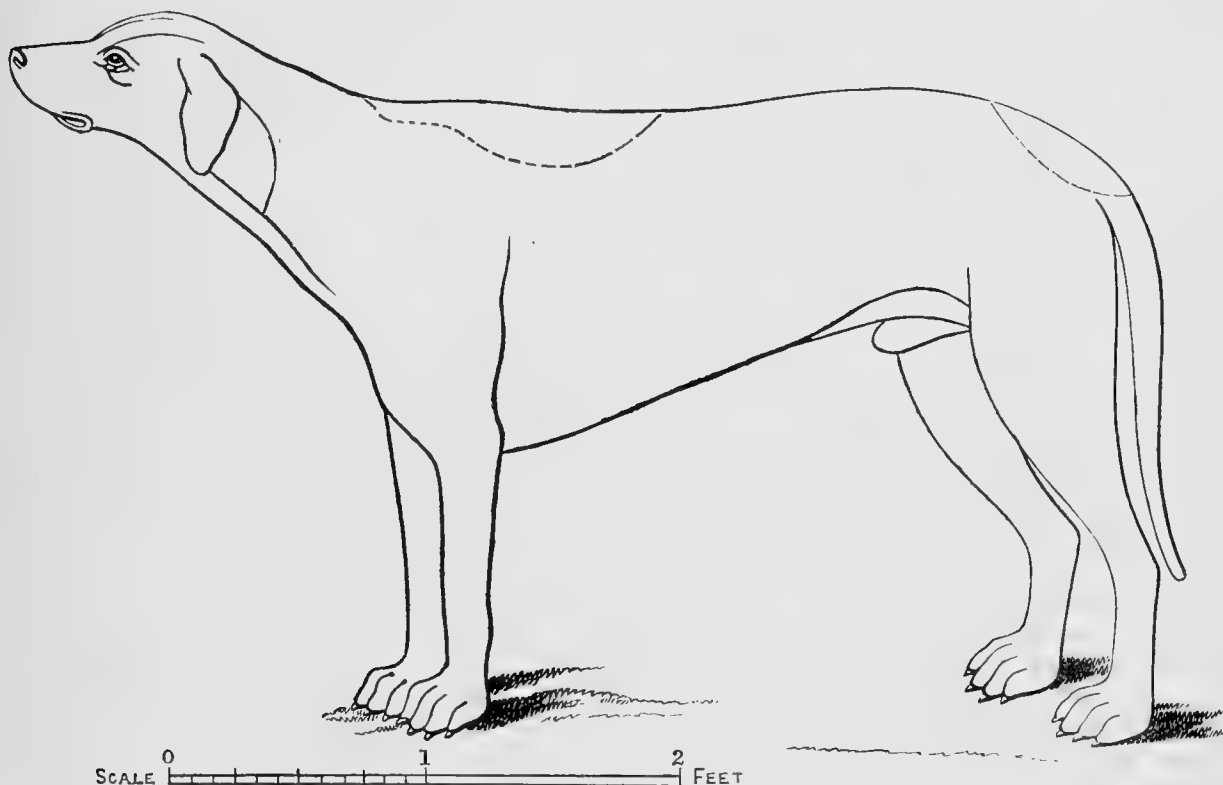

The discovery of several dogs' skulls in a crannoge at Dunshaughlin, county Meath, as recorded by Sir William Wilde, has afforded an opportunity of making a comparative examination, the result of which has been to establish the truth of the early statements above alluded to. Thus, Dr. Leith Adams has placed side by side the skull measurements of one of these dogs with those of a German boarhound, which at the age of three years measured 32½ inches at the shoulder.

	Irish.	German.
Length of skull . . . . .	10 inches	9 inches.
Breadth of forehead, . . . . .	3·3 ,,	3· ,,
Length of snout, . . . . .	4·5 ,,	4·3 ,,
Breadth of palate at first true molar,	2·8 ,,	2·6 ,,

\* Capt. Graham's important work on *The Irish Wolf-hound*, Dursley, 1885, has only just come to hand, too late for further reference here.

A larger skull, mentioned by Sir William Wilde, measured 11 inches in length. The muscular attachments on the Irish skulls indicate more powerful muscles than do those of the German skull. The canines in the Irish skulls are more like those of the wolf than are those in the German skulls. The former, indeed, are in many respects very wolf-like, and perhaps are not even certainly distinguishable. They are now preserved in this Museum.

In the Ballynamintra Cave, in addition to the bones referred to the wolf, as is mentioned elsewhere, Dr. Leith Adams has remarked upon specimens which he refers to a dog equal in size, and even taller than the wolf. This animal may have been domesticated by the hunters, who are believed to have split the Irish elk's bones for the extraction of the marrow, and who manufactured the stone implements, &c., which were found in the cave. These specimens are also now in this Museum.

#### 9.—SHEEP AND GOATS.

*Ovis aries et Capra hircus.*

Dr. Leith Adams has expressed a strong opinion that the remains of sheep and goats, which have hitherto been found in Ireland, have all belonged to races introduced and domesticated by man.

In the cave at Ballynamintra, county Waterford, numerous long bones, chiefly belonging to the feet, were plentiful; these were all referable either to a small sheep or goat; but some of the toe bones found with them were so slender and cervine in appearance as to suggest their having belonged to the roebuck. It is thought that these bones were not older than the human remains in the same cave, and indeed one implement had been fashioned from the metatarsal of a sheep or goat.

Bones of sheep and goats have been met with in crannoges and in the stone passages of ancient *raths*: although goats appear to have been the first to be introduced, there is evidence, according to Sir W. Wilde, that sheep reached Ireland before the Christian era.

Several of the specimens of crania of sheep from Dunshaughlin, now in the Museum, indicate the existence of four-horned varieties, and one has *five* well-preserved and distinct horn cores. Reports as to the existence of wild goats on the cliffs of the coast of Antrim in recent times appear to have originated from the fact that a few goats have been from time to time allowed to run wild on the Island of Rathlin. Such also is probably the origin of the small herds of wild goats now existing in parts of the west coast of Ireland and some of the islands off the mainland.



## 10.—CATTLE.

*Bos longifrons and B. frontosus.*

The mention of wild cattle by early Irish historians, though not unfrequent, does not tend to materially modify the conclusion arrived at from a full consideration of the evidence, which is, that the original stock from whence they were derived was first introduced from the continent of Europe to the British Isles by prehistoric, probably so-called neolithic man.

The skulls obtained in ancient Irish dwellings, as well as in caves, bogs, and river deposits, clearly indicate the existence of two well-marked races, namely, the Celtic shorthorn, *Bos longifrons*, with small drooping horns; and its ally, *B. frontosus*, which had a remarkable protuberance between the horn cores, and was sometimes altogether unprovided with horns, like the Angus and other modern "polled" breeds.

The Museum possesses a fine collection of skulls of the shorthorn, and a few of *B. frontosus* from the crannoge of Dunshaughlin, county Meath; some of them afford distinct evidence of the cattle having been slaughtered with the pole-axe.

No remains of either the urus (*Bos primigenius*) nor the bison (*Bison europæus*) have as yet been found in Ireland, though they both inhabited Britain.

## III.—THE PLEISTOCENE MAMMALS OF IRELAND.

BEAR, . . .	<i>Ursus (ferox) horribilis.</i>
WOLF, . . .	<i>Canis lupus.</i>
FOX, . . .	<i>Canis vulpes.</i>
HORSE, . . .	<i>Equus caballus.</i>
RED-DEER, . . .	<i>Cervus elaphus.</i>
IRISH ELK, . . .	<i>Cervus (Megaceros) hibernicus.</i>
MAMMOTH, . . .	<i>Elephas primigenius.</i>

With the exception of the mammoth, all the above survived into the prehistoric period of Ireland, and, among these, the Irish elk (see p. 337) is the only one which is now wholly extinct in all parts of the world.

## 11.—THE MAMMOTH.

*Elephas primigenius.*

The proofs of the existence of the Mammoth in Ireland in pleistocene, possibly in both pre- and post-glacial times, while most complete and satisfactory, point, so far as they go, to the presumption that it did not occur in great numbers. The evidence in favour of this conclusion is, however, only negative, and future exploration of caves which are yet untouched may modify it to some extent.

The mammoth is known to have had the Irish elk as its contemporary in England; but it can only be surmised that such was the case in Ireland, since positive evidence that they lived here side by side has not yet been obtained.

The most important and instructive discovery of mammoth remains in Ireland was made in the year 1859 by Mr. Brennan, who found its teeth and bones in a limestone breccia in the Shandon Cave, near Dungarvan, county Waterford. Associated with these there were the bones of the grisly bear, wolf, and reindeer. Subsequently this cave was more fully explored by Professors Harkness and Leith Adams, who have added to the above list, horse, fox, Alpine hare, and red deer. It is noteworthy that Dr. Leith Adams concludes, from the completeness of one of the mammoth skeletons which he found, that the animal must have made its way into the cave to die. These specimens are preserved in this Museum.

Besides these remains in Waterford, others have been found in the counties of Cavan, Galway, and Antrim.

The discovery in Cavan is recorded in the *Philosophical Transactions* for the year 1715, and is one of the first well-authenticated discoveries of elephant's remains in the British Isles. The bones were found in an apparently lacustrine stratum, during the sinking of a foundation for a mill at Maghery, on the lands of the Bishop of Kilmore, near the side of a small brook which parts the counties of Cavan and Monaghan. The teeth were figured and described by Dr. Thomas Molyneux, F.R.S.\*

The Galway specimen consists of a nearly perfect humerus, which was dredged up in Galway Bay; it was formerly in the possession of the Earl of Enniskillen, but is now in the British Museum.

The Antrim specimens consist of teeth, which are in the possession of Canon Grainger, D.D.; they were obtained at Ballyruder, half way between Larne and Glenarm, and also at Corncastle, in a stratum of stratified gravel, containing marine shells of post-tertiary species. No remains of either the ancient (*E. antiquus*), or the southern (*E. meridionalis*) elephants have as yet been discovered in Ireland.

\* The figures of some of the teeth seem to me to represent an arrangement of the layers of the enamel which approximates to that in the teeth of the group to which the African elephant belongs rather than to that in the teeth of the mammoth. However, Dr. Leith Adams has expressed his opinion that they all represent true mammoth teeth.

## APPENDIX.

## FOSSIL MAMMALIA OF IRELAND—BIBLIOGRAPHY.

In the following references, the first date in parentheses is that of the Paper; the second, that of the volume in which it appears:—

ADAMS, A. LEITH, M. D., F. R. S. :

- I.—*Transactions of the Royal Irish Academy* (1876), vol. xxvi., pt. v., p. 187.
- II.—*Journal Royal Geological Society of Ireland* (1877), (1877), vol. xiv. (N. S., iv.), p. 246.
- III.—*Proceedings of the Royal Dublin Society* (1878), (1878), vol. ii. (N. S.), pp. 45, 86, pl. i.-iv.
- IV.—*Journal Royal Geological Society of Ireland* (1879), (1879), vol. xv. (N. S., v.), p. 170.
- V.—*Scientific Transactions of the Royal Dublin Society* (1881), vol. i., ser. ii., p. 177.

ANONYMOUS :

- I.—*Irish Penny Journal* (1841), vol. i. p. 353.

BAILEY, WILLIAM H., F. G. S. :

- I.—*Journal of the Royal Geological Society of Ireland* (1878), (1878), vol. xv. (N. S., v.), p. 97.

BALL, R., LL. D. :

- I.—*Proceedings of the Royal Irish Academy* (1839), vol. i., p. 253.
- II.—*Idem.* (1844), vol. ii., 541.
- III.—*Journal of the Geological Society of Dublin* (1844), (1844), vol. iii., p. 50.
- IV.—*Proceedings of the Royal Irish Academy* (1849), (1849), vol. iv., pp. 214 and 416-420.
- V.—(Reprint of IV.)—*Annals of Natural History* (1850), vol. v., p. 234.

BLYTH, E. :

- I.—*Journal of the Geological Society of Dublin* (1864), (1864), vol. x., p. 173.
- II.—*Proceedings of the Royal Irish Academy* (1864), vol. viii., p. 472.

BRYCE, DR. JAMES :

- I.—*British Association Reports* (1834), p. 658. (Ballintoy Caves.)

BOYD-DAWKINS, PROF. W., F. R. S. :

- I.—*Early Man in Britain* (1880), p. 257, &c.

BRENAN, E. :

- I.—*Journal of the Royal Dublin Society* (1859), (1859), vol. ii., pp. 344-350, pl. x.-xii.
- II. (Reprint of I.)—*Natural History Review, Dublin* (1859), vol. vi., pp. 494-500.

CARTE, A., M. D. :

- I.—*Journal of the Royal Dublin Society* (1859), vol. ii., pp. 351-357, pl. x.-xiii.
- II.—*Journal of the Geological Society of Dublin* (1863), (1864), vol. x., pp. 103-107, and p. 166, pl. vii.
- III.—*Idem.*, pp. 114-119, and 173-4.
- IV.—*Journal of the Royal Geological Society of Ireland* (1866), (1866), vol. xi., p. 151

CLOSE, REV. M. H., M. A., F. G. S. :

I.—*Journal of the Royal Geological Society of Ireland* (1878), vol. xv. (N. S., v.), p. 74.

DENNY, HENRY :

I.—*Proceedings of the Geological and Polytech. Society, W. Riding of Yorkshire* (1855), (1849–59), vol. iii., pp. 400–439.

II.—*Idem.* (1864), (1864–69), iv., pp. 338–358. (Figures of bears' skulls.)

DU NOYER, G. V. :

I.—*Journal of the Royal Geological Society of Ireland* (1866), (1867), vol. xi. (N. S., vol. i.), pp. 247–248.

GEINITZ, PROF. H. B. :

I.—*Journal of the Geological Society of Dublin* (1863), (1863), vol. ix., p. 338.

GLENNON, R. :

I.—*Zoologist* (1847), vol. v., p. 1589. ("Lough Gur.")

GOING, W. Q. :

I.—Expl. to sheet No. 133 of Map by Geological Survey of Ireland (1862), p. 34.

HARKNESS, PROF. :

I.—*Geological Magazine* (1870), vol. vii., p. 253.

HART, DR. JOHN :

I.—*Proceedings of the Royal Dublin Society* (1824), vol. lx., p. 238.

II.—"On the Skeleton of the Fossil Deer of Ireland." Dublin (1830), pp. 1–36, plates i., ii.

III.—*Journal of the Geological Society of Dublin* (1833), (1833), vol. i., pp. 20–23.

HAUGHTON, REV. S., M. D., F. R. S. :

I.—*Journal of the Geological Society of Dublin* (1861), (1862), vol. ix., p. 340.

II.—*Idem.* (1863), (1864), vol. x., pp. 125–127.

HIBBERT, S., M. D. :

I.—*Edinburgh Journal of Science* (1825), vol. iii., pp. 15 and 129. ("Irish Elk in Isle of Man.")

II.—*Idem.*, N. S. (1830), vol. ii., p. 306. ("Historical Notices of Irish Elk.")

HULL, PROF. E., F. R. S. :

I.—*Journal of the Geological Society of Ireland* (1875), (1875), vol. xiv. (N. S., iv.), pp. 49–53.

II.—*Physical Geology of Ireland* (1878), pp. 267–272.

JUKES, PROF. J. B., F. R. S. :

I.—*Journal Geological Society of Dublin* (1863), (1864), vol. x., pp. 127–137, and pp. 168–171.

KINAHAN, G. H., M. R. I. A. :

I.—*Geology of Ireland* (1878), p. 293.

II.—*Scientific Transactions of the Royal Dublin Society* (1880), (1881), vol. i., ser. ii., p. 177.

III.—*Transactions of the Edinburgh Geological Society* (1883), vol. xvii.

KNOWLES, W. J. :

I. *Journal of the Anthropol. Institute* (1877), vol. vii., p. 202. ("Ballintoy.")

LENTAIGNE, SIR J., M. D. :

I.—*Journal of the Geological Society of Dublin* (1863), (1864), vol. x., p. 168.

MOLYNEUX, THOMAS, M. D. :

- I.—*Philosophical Transactions*, vol. xix. (1697), pp. 489–512. Pl. of the “ Irish Elk.”  
 II.— “ “ “ “ vol. xxix. (1717), p. 370. Pl. of mammoth teeth.

Both the above are reprinted in (Boates') *Natural History of Ireland* (1755).

MAUNSELL, ARCHDEACON :

- I.—*Proc. Royal Dublin Society* (1824), vol. lx., pp. 169 and 211 ; *idem.* (1825), vol. lxi., p. 93.  
 II.—*Annals of Philosophy* (1826), vol. xi., pp. 305–312.  
 III.—*Froriep Notizen* (1826), vol. xiv., col. 305–307.

MOSS, R. J., F. C. C. :

- I.—*Proceedings of the Royal Irish Academy* (1876), (1876), vol. ii., sec. 2, p. 547.

NEVIL, FRANCIS :

- (Boates') *Natural History of Ireland*, Dublin (1715), (1755), p. 128.

OLDHAM, T., LL. D., F. R. S. :

- I.—*Journal of the Geological Society of Dublin* (1844), (1844), vol. iii., p. 70.  
 II.—*Idem.* (1847), (1847), vol. iii., pt. iv., pp. 252–253.

OSWALD, H. R. :

- I.—*Edinburgh Journal of Science* (1825), vol. iii., pp. 28–31. (“ Fossil Elk of Isle of Man.”)

OWEN, SIR R., F. R. S. :

- I.—*Proceedings Royal Irish Academy* (1849), vol. iv., pp. 418–420 (a letter to R. Ball), (“ Bears' Skulls ”).  
 II. *Zoologist* (1847), p. 1620 (*Megaceros*).

RICHARDSON, H. M. :

- I.—*Zoologist* (1847), pp. 1623 and 1685.  
 II.—*The Irish Giant Deer*: M'Glashan, Dublin (1846).

SCOTT, R. H., F. R. S. :

- I.—*Journal of the Geological Society of Dublin* (1864), (1864), vol. x., p. 143.  
 II. (Reprint of No. I.)—*Geological Magazine* (1870), vol. vii., pp. 413–420.

SCOULER, DR. JOHN :

- I.—*Journal of the Geological Society of Dublin* (1836), (1838), vol. i., p. 197–210.  
 II.—*Idem.*, p. 224–231.  
 III.—*Idem.* (1844), vol. iii., p. 15.

SMITH, CHARLES, M. D. :

- I.—*Ancient and Present State of the County and City of Waterford* (1741), p. 58, pt. iv., fig. ii. mammoth's rib.  
 II.—*History of the County of Kerry* (1756), p. 173.

THOMPSON, WILLIAM :

- I.—*Proceedings of the Zoological Society of London* (1837), pt. v., p. 53.  
 II.—*Report of the British Association* (1840), p. 362.

## USSHER, R. J. :

- I.—*Journal of the Royal Geological Society of Ireland* (1879), (1879), vol. xv. (N. S., v.), p. 170.  
 II.—*Scientific Transactions of the Royal Dublin Society* (1880), (1881), vol. i., ser. ii., p. 177.

## WEAVER, THOMAS, M. R. I. A. :

- Annals of Philosophy*, London (1825), vol. ix., p. 468. (“Fossil Elk in Co. Down.”)

## WILDE, SIR WILLIAM :

- I.—*Proceedings of the Royal Irish Academy* (1840), (1840), vol. i., pp. 420–426.  
 II.—*Idem.* (1858), (1861), vol. vii., pp. 64–75.  
 III.—*Idem.* (1859), (1861), vol. vii., pp. 181–212.  
 IV.—*Natural History Review* (1858), vol. v., pp. 276–287.

## WILLIAMS, WILLIAM :

- I.—*Scientific Proceedings of the Royal Dublin Society* (1878), vol. ii., pt. 1, p. 105.  
 II.—*Geological Magazine* (1881), N. S., vol. vii., p. 354.

---

SUBJECT INDEX, WITH CROSS REFERENCES, TO THE PAPERS IN THE  
 PRECEDING LIST.

I.—*General Catalogues of the species of the Fossil Mammalia found in Ireland :*

Adams, Leith (ii., iii.);\* Boyd-Dawkins (i.); Hull (i., ii.); Kinahan (i.); Scott (i., ii.).

II.—*Papers descriptive of particular finds or species :*

*Alpine Hare*—Adams, Leith (i., v.); Brenan (i., ii.); Carte (i.).

*Bear*.—Adams, Leith (i., iv., v.); Ball (iv., v.); Blythe (i.); Brenan (i., ii.); Carte (i., iii.);  
 Denny (ii.); Going (i.); Owen (i.); Wilde, (iii., v.).

*Wolf*.—Adams, Leith (i., v.); Smith (ii.); Wilde (iii.).

*Dog*.—Adams, Leith (i., v.); Anonymous (i.); Knowles (i.); Scouler (ii.); Smith (i.); Wilde  
 (i., iii., iv.).

*Fox*.—Adams, Leith (i., v.).

*Horse*.—Adams, Leith (i., v.); Brenan (i., ii.); Bryce (i.); Carte (i.); Knowles (i.).

*Sheep and Goat*.—Adams, Leith (i.); Blyth (ii.); Bryce (i.); Wilde (i., iii.).

*Cattle*.—Adams, Leith (v.); Ball (i., iii.); Blyth (ii.); Bryce (i.); Knowles (i.); Thompson (ii.);  
 Ussher (i., ii.); Wilde (i., ii., iii.).

*Red Deer*.—Adams, Leith (i., v.); Bryce (i.); Haughton (ii.); Knowles (i.); Oldham (ii.);  
 Thompson (ii.); Wilde (iii.).

*Irish Elk*.—Adams, Leith (iv., v.); Bailey (i.); Blyth (ii.); Carte (iv.), (indented bones);  
 Close (i.); Denny (i.); Du Noyer (i.); Geinitz (i.), (measurements); Glennon (i.);  
 Going (i.); Hart (i., ii.); Haughton (i.), (contemporaneity with man); Hibbert (i., ii.);  
 Jukes (i.), (indented bones); Kinahan (ii., iii.); Lentaigne (i.); Maunsell (i., ii., iii.);  
 Molyneux (i.); Moss (i.); Oldham (i., ii.); Owen (ii.); Richardson (i., ii.); Scouler (i.,  
 ii., iii.); Smith (ii.); Ussher (i., ii.); Weaver (i.); Wilde (iii.); Williams (i., ii.).

*Reindeer*.—Adams, Leith (i.); Bailey (i.); Brenan (i., ii.); Carte (i., ii.); Close (i.); Moss (i.).

*Wild Boar*.—Adams, Leith (v.); Knowles (i.); Thompson (ii.); Ussher (i., ii.); Wilde (i., ii.).

*Mammoth*.—Adams, Leith (i.); Brenan (i., ii.); Carte (i.); Harkness (i.); Molyneux (ii.);  
 Nevil (i.).

---

\* The Roman numbers in parentheses refer to the numbers prefixed to the references in the preceding list.

DESCRIPTION OF PLATE XI.

PLATE XI.

CRANIA OF *CERVUS (MEGACEROS) HIBERNICUS*,

IN THE SCIENCE AND ART MUSEUM, DUBLIN.

FIGURE I.

Front of cranium and antlers, from Lough Gur, Co. Limerick. Right antler abnormally bifurcated. (See p. 338.) The right frontal tine was formerly present, as is proved by a scar, which is not distinctly represented in the figure.

FIGURE II.

Back view of cranium and antlers, from Limerick. Right antler with only rudimentary expansion of beam into palm. In almost all cases the left antler is larger than the right; in this one it is very notably so.

FIGURE III.

Front view of cranium and antlers, from Rathcannon, Co. Limerick. This remarkably fine head belongs to the complete skeleton which was presented to the Royal Dublin Society by Archdeacon Maunsell in the year 1824. Out of fifty, it is still the finest in the Museum; but owing to the peculiar form of the double-pointed *sur*-antlers, which spring from the beam, it cannot be regarded as typical, being indeed in this respect almost unique.





Fig. 1.



Fig. 2.



Fig. 3.





# TRANSACTIONS (NEW SERIES).

## VOLUME I.

PART

- 23.—On Electromagnetic Effects due to the Motion of the Earth. By GEORGE FRANCIS FITZGERALD, M.A., F.T.C.D., ERASMUS Smith's Professor of Experimental Science in the University of Dublin. (January, 1883.)
- 24.—On the Possibility of Originating Wave Disturbances in the Ether by Means of Electric Forces:—Corrections and Additions. By GEORGE FRANCIS FITZGERALD, M.A., F.T.C.D. (January, 1883.)
- 25.—On the Fossil Fishes of the Carboniferous Limestone Series of Great Britain. By J. W. DAVIS. Plates XLII. to LXV. (September, 1883.) [*With Title-page to Volume.*]

## VOLUME II.

- 1.—Observations of Nebulæ and Clusters of Stars, made with the Six-foot and Three-foot Reflectors at Birr Castle, from the year 1848 up to the year 1878. Nos. 1 & 2. By the RIGHT HON. THE EARL OF ROSSE, I.L.D., D.C.L., F.R.S. Plates I. to IV. (August, 1879.) No. 3. Plates V. and VI. (June, 1880.)
- 2.—On Aquatic Carnivorous Coleoptera or Dytiscidæ. By DR. SHARP. Plates VII. to XVIII. (April, 1882.) [*With Title-page to Volume.*]

## VOLUME III.

- 1.—On the Influence of Magnetism on the Rate of a Chronometer. By OTTO BOEDDICKER, PH.D. Plate I. (September, 1883.)
- 2.—On the Quantity of Energy transferred to the Ether by a Variable Current. By GEORGE F. FITZGERALD, M.A., F.R.S. (March, 1884.)
- 3.—On a New Form of Equatorial Telescope. By HOWARD GRUBB, M.E., F.R.S. Plate II. (March, 1884.)
- 4.—Catalogue of Vertebrate Fossils from the Siwaliks of India, in the Science and Art Museum, Dublin. By R. LYDEKKER, B.A., F.G.S., F.Z.S. Plate III. and Woodcuts. (July, 1884.)
- 5.—On the Origin of Freshwater Faunas: A Study in Evolution. By W. J. SOLLAS, M.A., Dublin; D.Sc., Cambridge; Fellow of St. John's College, Cambridge; Professor of Geology and Mineralogy in the University of Dublin. (November, 1884.)
- 6.—Memoirs on the Coleoptera of the Hawaiian Islands. By THE REV. T. BLACKBURN, B.A., and DR. D. SHARP. Plates IV. and V. (February, 1885.)
- 7.—Notes on the Aspect of the Planet Mars in 1884. Accompanied by Sketches made at the Observatory, Birr Castle. By OTTO BÆDDICKER, Ph.D. Plate VI. [*Communicated by the Earl of Rosse.*] (March, 1885.)
- 8.—On the Geological Age of the North Atlantic Ocean. By EDWARD HULL, LL.D., F.R.S., F.G.S., Director of the Geological Survey of Ireland. Plates VII. and VIII. (April, 1885.)
- 9.—On the Changes of the Radiation of Heat from the Moon during the Total Eclipse of 1884, October 4, as Measured at the Observatory, Birr Castle. By OTTO BÆDDICKER, Ph.D. Plates IX. and X. [*Communicated, with a NOTE by the EARL OF ROSSE.*] (October, 1885.)
- 10.—On the Collection of the Fossil Mammalia of Ireland in the Science and Art Museum, Dublin. By V. BALL, M.A., F.R.S., F.G.S., Director of the Museum. (Plate XI.)

NOVEMBER, 1886.]

THE  
SCIENTIFIC TRANSACTIONS  
OF THE  
ROYAL DUBLIN SOCIETY.

VOLUME III. (SERIES II.)

---

XI.—ON NEW ZEALAND COLEOPTERA. WITH DESCRIPTIONS OF NEW  
GENERA AND SPECIES. BY DAVID SHARP, M. B. (PLATES XII. AND  
XIII.)



DUBLIN:  
PUBLISHED BY THE ROYAL DUBLIN SOCIETY.  
PRINTED AT THE UNIVERSITY PRESS, BY PONSONBY AND WELDRICK,  
PRINTERS TO THE SOCIETY.  
1886.

---

*Price Five Shillings.*



XI.—ON NEW ZEALAND COLEOPTERA, WITH DESCRIPTIONS OF NEW GENERA AND SPECIES. BY DAVID SHARP, M.B. [Communicated by PROFESSOR W. R. M'NAB, Consulting Botanist and Entomologist to the Royal Dublin Society.] Plates XII. and XIII.

[Read, November 18, 1885.]

ALTHOUGH the entomology of New Zealand is of considerable interest, owing to the antipodean and isolated position of the islands, it is still very imperfectly known; indeed, for reasons which it is difficult to comprehend, it has, until recently, been supposed that this department of the New Zealand fauna was chiefly remarkable for its extreme poverty. Linneus was not acquainted with any beetles from there; but a small number were obtained by the naturalists of Captain Cook's voyage; and some of these were described by Fabricius about one hundred years ago, and are—in part at any rate—still preserved in the Banksian collection in our national museum at Kensington. After this very little was done at New Zealand entomology till 1846, when the zoology of the voyage of H. M. ships 'Erebus' and 'Terror' was, by authority of the Lords Commissioners of the Admiralty, in part published. The entomological portion was executed by Adam White, and the Coleoptera, so far as then known, were completely enumerated, other parts of the entomology remaining unpublished. This work included the specimens obtained during the voyage of the ships I have mentioned, and also a few collected by Charles Darwin on his voyage round the world, and some obtained from Dr. Sinclair, Mr. Earl, and others. About one hundred and fifty species were thus brought together. Very little was done from that time till the year 1867, when a new era, as regards the Coleoptera of New Zealand, may be said to have commenced, by the description by Bates of a small collection sent by Fereday to this country; and the result of the activity of several entomologists during this latter period is, that the catalogue of the New Zealand Coleoptera is increased from about one hundred and fifty to about one thousand five hundred species. Messrs. R. W. Fereday, and C. M. Wakefield of Christchurch, as well as Professor Hutton, were perhaps those who in the early part of this period contributed most to this great increase; and they were followed by Mr. T. Lawson, and Captain Thomas Broun of Auckland, and last, though not least, by Mr. R. Helms of Greymouth.

The successful collecting of beetles and other insects is by no means so easy a matter as those who have not tried it may be inclined to believe; and for the procuring of the rarer and more retiring species, experience, perseverance, skill, and even hard work, are required, so that it is only just that we should acknowledge the obligations of science to those who, by their labours in the field, render possible the investigations of the study and laboratory.

In the Paper I now lay before the Society about one hundred and forty additional species are described; and I have also proposed a considerable number of genera, and new generic names, as a preliminary considered essential to classification and investigation.

Although the catalogue of New Zealand Coleoptera is now of considerable extent, yet it is, even as regards number of species, still very incomplete; and on consideration of such data as I possess enabling me to form an opinion on the point, I estimate that New Zealand will be found to possess somewhere between three thousand and three thousand five hundred species of Coleoptera.

The study and classification of such a large number of organized beings of complex and minutely perfected structure, and often of very minute size, is, it will be admitted by all, by no means an easy matter, and must demand much time before anything like final results can be obtained. From this point of view the New Zealand catalogue is very far from being in a satisfactory state; a large number of species have been described and placed in genera to which they have no claim to belong, and hence a revision is urgently needed of the various families and groups, so as to bring order where at present disorder prevails. Of course this can only be done by examination of the creatures in question, and a very large number of those described are unknown in Europe, so that we cannot do very much at present to help the colonists in this respect. I have, however, previously revised—though in a very imperfect manner—a few of the groups, and in the present Paper I have given the results of a scrutiny I have made of such Pterostichini and Otiorhynchini as are at my disposal.

Under these circumstances, it is plain that anything that may be said as to the nature of the fauna and its affinities with those of other countries cannot be of much importance, and with this premise I will make a few remarks on these points.

It has now been ascertained that New Zealand possesses a coleopterous fauna analogous to that of Europe and other continental regions of the world in extent and complexness. The species when examined show similar structures exhibiting analogous gradations and cross affinities; but I think the New Zealand insects possess a larger proportion of forms in which the structures are—if I may be permitted the expression—comparatively little evolved, or less perfect. And in brilliancy of colour I think the New Zealand beetles are certainly very deficient. Cetoniadæ and Buprestidæ are the most brilliantly coloured of beetles, and of the



former family there is not one in New Zealand, and of the latter only two minute and comparatively obscure forms. Next to these two families in brilliancy of colour come the Phytophaga, which usually form a large proportion of the beetles of continental lands; but in New Zealand are few in numbers, small in size, and without any large and beautifully coloured representatives. In the weevils, too, there is nothing like the brilliant Phyllobii and Polydrusi which are amongst the most abundant of European Curculionidæ. So, too, in æsthetic and sexual ornamentation the New Zealand beetles are clearly deficient; no Longicorn has yet been obtained with tufted antennæ; there is not a horned Lamellicorn in the islands; and not one of the numerous Lucanidæ possesses a male with really large mandibles. The beetle in a New Zealand collection that would most strike an ordinary eye is, I think, *Lasiorhynchus barbicornis*, on which I shall make a remark below.

But if to the uneducated sense the New Zealand beetles are deficient, they amply compensate for this by some other peculiarities interesting to the trained intelligence. There are a considerable number of isolated forms having—it appears at present—little or no connexion with the ordinary coleopterous fauna of the islands. As instances I may mention *Amarotypus* (the sole representative of the first primary division of the Carabidæ,\* usually called Carabini, but for which I much prefer the appellation *Carabici fragmentati*), *Lenax*, *Rhyssodes*, *Diagrypnodes*, *Picrotus*, *Dendroblox*, *Saphobius*, *Brounia*, *Amplectopus*, *Rhinorhynchus*, *Rhadinomus*, *Clypeorhynchus*, *Paraphylax*, *Lasiorhynchus*, *Aglycyderes*, *Prionopus*. The study of these isolated forms will be an important feature in the New Zealand entomology of the future, with a view to ascertaining how much distinction they possess from the other creatures with whom they now live, and from those of other countries; an answer to this question being an essential preliminary to the inquiry whether these forms should be considered, notwithstanding their isolation, as really a part of the New Zealand endemic insects, or whether they have been more recently introduced. As in my opinion we do not know at present more than half of the New Zealand beetles, it is evidently possible that some of these isolated forms may prove to be connected with the more ordinary fauna by intermediates.

I have already alluded to the fact that in my opinion the New Zealand beetles will be found to exhibit a less evolution of their structural characters than their analogues in continental countries; but I offer this opinion with much diffidence, for really the data for its adequate discussion are not yet extant. Indeed, in the case of some of the structures of beetles, we have not sufficient knowledge of their functional importance to enable us to decide which is lower, which higher. Still

\* *Clivina rugithorax*, Putz, also belongs to this division, but is only, perhaps an Australian insect, for it is apparently confined to the neighbourhood of Auckland, and, if so, has probably been introduced by commerce.

we can even at present decide with approximate certainty, in the case of some organs, which is the more rudimentary of two forms under comparison.

When any attempt shall be made to ascertain what affinities the New Zealand beetles possess with those of other countries, it must, of course, if it is to be of value, deal with the mass of the fauna, and not be decided by the consideration of some of the exceptional or isolated forms I have previously mentioned; and as the majority of the New Zealand Coleoptera are insects of small size and unattractive appearance, belonging to groups whose congeners in foreign countries have been but little studied, or are even quite unknown, it is clear that no answer of importance can at present be given to the question where the nearest allies of the New Zealand beetles are to be found; but I entertain an impression that it will be in the Chilian and Patagonian fauna that the greatest amount of affinity will be found, and that while numerous points of propinquity with the Australian fauna undoubtedly exist, yet they are rather exceptions dealing with isolated forms, and but little affect the mass of the fauna; while if we recollect that many of the most striking, remarkable, and characteristic of the Australian groups of beetles are entirely unrepresented in New Zealand—the Pseudomorphini, the Schizorhinini, the Stigmoderas, and the Amycteridæ for instance—we must admit that the two faunæ cannot be considered as at all similar.

*Lasiorhynchus barbicornis* is the only member of the Brenthidæ found in New Zealand, and is, perhaps, the most remarkable beetle of the islands, and on the whole it must be considered a highly evolved form, there being great sexual differentiation, with remarkable male characters, large size, and considerable perfection of general structure. It would then appear to be quite foreign to the New Zealand fauna; and yet, so far as we know, it has not any really close ally in other countries. Another of the remarkable isolated forms is *Dendroblax*; it is of large size, and has been known for forty years (though still a great rarity in European collections). Its position has never been satisfactorily decided, and Parry considered it uncertain whether it should go in the Lucanidæ or not; that it has no ally at all in New Zealand, and no near ally out of it is clear therefore. And it appears very difficult to know how we are to explain such cases. My own idea is something of this sort: I imagine there has been going on in New Zealand, for an enormous period of time, the evolution of a fauna parallel with that of the continents of the world, and that during this enormous period it has occasionally received intrusions from the creatures of other countries, some of which may have continued to evolve since their introduction, while others have remained with little change. On such a view *Dendroblax* might be an ancient intrusion into New Zealand, which has become extinct elsewhere, and has evolved but little in New Zealand. *Lasiorhynchus* might be an intrusion into New Zealand that has evolved much since its introduction; while *Rhadinosomus* might be a comparatively recent intrusion from Australia.

## LIST OF SPECIES AND GENERA DESCRIBED OR NOTICED.

## Fam. CICINDELIDÆ.

Cicindela helmsi, n. sp.

## Fam. CARABIDÆ.

Mecodema ducale, n. sp.

,, rugiceps, n. sp.

,, metallicum, n. sp.

Diglymma, nov. gen.

,, ovipenne, n. sp.

,, dubium, n. sp.

Metaglymma sulcatum, n. sp.

Acallistus, nov. gen.

,, simplex, n. sp.

Ctenognathus, Fairm.

,, latipennis, n. sp.

,, pictonensis, n. sp.

Pterostichus compressus, n. sp.

,, calcaratus, n. sp.

,, achilles, n. sp.

,, brounianus, n. sp.

,, myrmidon, n. sp.

,, constrictellus, n. sp.

,, longiformis, n. sp.

,, oscillator, n. sp.

,, ovatellus, Chaud.

Zolus, nov. gen.

,, helmsi, n. sp.

Sympiestus, nov. gen.

,, syntheticus, n. sp.

Tarasthetus debilis, n. sp.

Tachys latipennis, n. sp.

Cillenum batesi, n. sp.

,, (?) subcæcum, n. sp.

## Fam. STAPHYLINIDÆ.

Aphytopus, nov. gen.

,, gracilis, n. sp.

Cafioquedus, nov. gen.

,, gularis, n. sp.

Quedius antipodum, n. sp.

,, edwardsi, n. sp.

,, insolitus, n. sp.

,, latifrons, n. sp.

Phanophilus, nov. gen.

Coprostygnus, nov. gen.

,, sculptipennis, n. sp.

Omalius sagoloide, n. sp.

## Fam. PSELAPHIDÆ.

Dalmisus, nov. gen.

,, batrisodes, n. sp.

## Fam. PARNIDÆ.

Protoparnus longulus, n. sp.

## Fam. SILPHIDÆ.

Catopsolius, nov. gen.

,, lævicollis, n. sp.

## Fam. COLYDIIDÆ.

Heterargus, nov. gen.

,, rudis, n. sp.

Bitoma sellata, n. sp.

,, auriculata, n. sp.

,, serraticula, n. sp.

,, mundula, n. sp.

Ulonotus dissimilis, n. sp.

Enarsus cucullatus, n. sp.

Pycnomerus, Auct.

,, longulus, n. sp.

,, helmsi, n. sp.

,, sulcatissimus, n. sp.

,, latitans, n. sp.

Bothrideres cognatus, n. sp.

## Fam. NITIDULIDÆ.

Ips minimus, n. sp.

## Fam. CUCUJIDÆ.

Brontopriscus, nov. gen.

,, sinuatus, n. sp.

Cathartocryptus, nov. gen.

,, obscurus, n. sp.

Saphophagus, nov. gen.

,, minutus, n. sp.

Picrotus, nov. gen.

,, thoracicus, n. sp.

## Fam. MYCETOPHAGIDÆ.

Triphyllus huttoni, n. sp.

,, zealandicus, n. sp.

,, maculosus, n. sp.

,, confertus, n. sp.

,, concolor, n. sp.

,, rubicundus, n. sp.

## Fam. LUCANIDÆ.

Lissotes rufipes, n. sp.

## Fam. SCARABÆIDÆ.

Saphobius setosus, n. sp.

Pyronota lugubris, n. sp.

## Fam. ELATERIDÆ.

Thoramus wakefieldi, Shp.

,, parryi, Cand.

,, huttoni, n. sp.

Cryptohypnus thoracicus, Shp.

,, pallipes, n. sp.

Corymbites irregularis, n. sp.

,, mundus, n. sp.

Asymphus, nov. gen.

,, insidiosus, n. sp.

Geranus crassus, Shp.

Protelater elongatus, Shp.

## Fam. DASCILLIDÆ.

Amplectopus, nov. gen.

,, ovalis, n. sp.

## Fam. PTINIDÆ.

Perplectrus, new name for Xenocera,  
Broun.

Perplectrus obscurus, n. sp.

## Fam. TENEBRIONIDÆ.

Pseudopatrum, nov. gen.

,, sordidum, n. sp.

Syrphetodes bullatus, n. sp.

Periatrum, nov. gen.

,, helmsi, n. sp.

Apthora glabritarsis, n. sp.

Adelium multistriatum, n. sp.

,, simplex, n. sp.

,, sericatum, n. sp.

,, intermedium, n. sp.

,, dunedinis, n. sp.

Cerodolus, nov. gen.

,, chrysomeloides, n. sp.

Artystona obscura, n. sp.

,, collaris, n. sp.

,, obsoleta, n. sp.

Malacodrya, nov. gen.

,, pictipes, n. sp.

## Fam. CURCULIONIDÆ.

Cecyropa, Pascoe.

,, albicans, n. sp.

Nonnotus, nov. gen.

,, griseolus, n. sp.

Protophormus, nov. gen.

,, gracilis, n. sp.

,, binodulus, n. sp.

,, robustus, n. sp.

Epitimetes, Pascoe.

,, wakefieldi, n. sp.

*Platyomida coronata*, n. sp.  
 „ *simulatrix*, n. sp.  
*Aporolobus*, nov. gen.  
*Protolobus*, nov. gen.  
 „ *obscurus*, n. sp.  
*Catoptes*, Schön.  
 „ *brevicornis*, n. sp.  
 „ *scutellaris*, n. sp.  
 „ *longulus*, n. sp.  
*Brachyolus*, White.  
 „ *inæqualis*, n. sp.  
 „ *punctipennis*, n. sp.  
 „ *bagooides*, n. sp.  
 „ *huttoni*, n. sp.  
 „ *longicollis*, n. sp.  
*Heterodiscus*, nov. gen.  
 „ *insolitus*, n. sp.  
 „ *horridus*, n. sp.  
*Cuneopterus*, nov. gen.  
 „ *conicus*, n. sp.  
*Dermotrichus*, nov. gen.  
 „ *mundulus*, n. sp.  
*Crisius obesulus*, n. sp.  
*Pentarthrum cephalotes*, n. sp.  
 „ *porcatum*, n. sp.  
 „ *confertum*, n. sp.  
 „ *constrictum*, n. sp.  
*Microtribus pictonensis*, n. sp.  
*Inosomus*, Broun.

## Fam. ANTHRIBIDÆ.

*Anthribus tuberosus*, n. sp.  
 „ *cucullatus*, n. sp.  
 „ *inornatus*, n. sp.  
 „ *concolor*, n. sp.  
 „ *obtusus*, n. sp.  
*Proscoporhinus albifrons*, n. sp.

## Fam. CERAMBYCIDÆ.

*Cemona*, Newm.  
 „ *humilis*, Newm.  
 „ *villosa*, n. sp.  
 „ *hirta*, Fab.  
 „ *plicicollis*, n. sp.  
 „ *inæqualis*, n. sp.  
 „ *simplicicollis* Broun.  
 „ *mutica*, n. sp.  
 „ *debilis*, n. sp.  
*Ophryops dispar*, n. sp.  
*Didymocantha quadriguttata*, n. sp.  
*Anencyrus*, nov. gen.  
 „ *discedens*, n. sp.  
*Ceralomus*, nov. gen.  
 „ *morosus*, n. sp.  
*Xylotoles germanus*, n. sp.  
 „ *fasciatus*, n. sp.  
*Stenellipsis cuneata*, n. sp.  
*Pœcilippe*, Bates.  
 „ *medialis*, n. sp.  
 „ *femoralis*, n. sp.  
*Tetrorea longipennis*, n. sp.

## Fam. CHRYSOMELIDÆ.

*Eucolaspis*, nov. gen.  
*Atrichatus*, nov. gen.  
*Pilacolaspis*, nov. gen.  
 „ *wakefieldi*, n. sp.  
*Cacomolpus*, nov. gen.  
 „ *globosus*, n. sp.  
 „ *plagiatus*, n. sp.  
*Trachytreta*, nov. gen.  
*Pleuraltica*, nov. gen.  
*Luperus*, Auct.  
 „ *nigricornis*, n. sp.  
 „ *cenescens*, n. sp.  
 „ *puncticollis*, n. sp.

## Fam. CICINDELIDÆ.

## CICINDELA.

*Cicindela helmsi*, n. sp.—Nigra, parum metallescente, labro elytrorumque margine albidis; hoc haud lato, post humerum interrupto, post medium fasciam sat elongatam emittente; pronoti margine laterale simplice. Long. 8 mm.

Antennæ entirely dull black, rather elongate; head small; labrum large, pallid yellow, slightly oblique on each side (in the male), and with a short tooth in the middle; sculpture of head and thorax very fine; elytra moderately broad, of a dull slate colour, with a few indistinct green spots scattered over them; the cream-coloured margin is narrow, and is interrupted, so that the basal portion forms a slender lunule; the postmedian fascia is slender and irregular; the legs are elongate, the femora green, the tibiæ dark, slightly fuscous at the knees.

This insect is allied to *C. feredayi*, Bates, from which it differs by the surface of the elytra being smooth, the very numerous blue specks seen in *C. feredayi* being here very obsolete and very few, while on the other hand there are some larger, round, green spots scattered over the surface, not arranged in a series; the humeral lunule is small and isolated, and the post-median fascia short and irregular. It more resembles *C. austro-montana*, Bates, but that species is remarkable by the large development and duplication of the side margin of the pronotum.

The only specimen\* I have seen of this species was sent me some years ago from Texas, North America, by Mr. Belfrage, who also informed me that it came from Greymouth. It was probably found there by the naturalist who has been so persevering and successful in collecting the invertebrates of New Zealand, and after whom I have, with much pleasure, named it.

## Fam. CARABIDÆ.

## MECODEMA.

*Mecodema ducale*, n. sp.—Major, elongatum nigrum, haud nitidum; prothorace basi fortiter coarctato, lateribus crenatis, dorso, presertim versus latera, transversim strigoso; elytris interne lævigatis, externe rugulose foveolatis. Long. 30 mm. (Plate XII., fig. 1.)

Length of thorax rather more than three-fourths of the greatest width, the sides strongly rounded, abruptly contracted behind, the hind angles rectangular, the lateral margin much interrupted, so as to be conspicuously crenate; along the middle is a very definite longitudinal channel, and the surface has distinct, rather distant transverse wrinkles, which are only very slightly impressed or obsolete over a great part of the surface, being a little more distinct near the sides and the

\* See notes added during press, No. 1.

median channel; touching the lateral margin at its point of constriction there is a small deep fovea not extending to the base, the hind margin distinctly emarginate in the middle; elytra elongate, near the sides with deep, coarse, regular foveæ, but more than half the surface is smooth.

A single female was sent by Helms as No. 383; it was captured at Ahoura, near Greymouth, in 1884.

This is probably the most remarkable Carabideous insect yet discovered in New Zealand, and will be readily distinguished by the peculiar sculpture of the wing cases.

*Mecodema rugiceps*, n. sp.—Parum latum, nigrum, capite thoraceque profunde rugosis, hoc lateribus crenatis, elytris ubique subequaliter variolosis. Long. 21 m.m. (Plate XII, fig. 2.)

Head with very prominent eyes, which are placed rather nearer to the thoracic margin than they are in *M. sculpturatum*, the surface bearing deep, coarse rugæ, which are distant on the disc, denser on the vertex, where also they are chiefly transverse in their direction, and appear to a certain extent to consist of enlarged punctures; thorax rather flat, the length nearly seven-eighths of the greatest width, the sides rounded, much constricted behind, the hind angles rectangular, the base truncate, the lateral margin numerously interrupted, with about eight intramarginal tactile setæ on each side, the surface evenly covered with deep, quite uninterrupted transverse lines, and bearing a longitudinal channel which does not quite attain the front or the hind margin; close to both these margins there are short, longitudinal plicæ; there is a small impression at the point of constriction on each side, not attaining the base. Elytra regularly covered with impressions placed in series, deep at the sides, more shallow towards the suture; legs black; middle tibiæ very asperate externally.

\* None of the descriptions of other species at all accord with the sculpture of this insect, of which three examples were found by Helms near Bealey, in 1884.

*Mecodema metallicum*, n. sp.—Angustulum, nigro-piceum, supra æneum, antennis pedibusque piceis, femoribus rufis; capite subrugoso, vertice latius punctato; prothorace elongato, lateribus obsolete crenatis, dorso parum profunde transversim rugoso; elytris ubique subequaliter variolosis. Long. 18 m.m.

Antennæ and palpi dark red; head very irregularly rugose, the rugæ not elongate or very definite, the vertex coarsely punctate. Thorax elongate, very nearly as long as broad, with a channel on the middle becoming obsolete before attaining the front margin, the surface with rather distant coarse, but not deeply impressed, transverse rugæ; the base has distinct longitudinal plicæ; the sides are but little rounded, but are narrowed behind, and sinuate so as to form a rather well-marked contraction close to the base; the base is a little emarginate in the middle, and the hind angles rather obtuse; at the point of contraction there is a

depression not reaching the base; the lateral margin is not truly crenate, though it has the appearance of being broken owing to its being impinged on by the punctures in which the intra-marginal tactile setæ are placed; these latter are nine or ten in number on each side, the three or four anterior being placed rather near one another. The elytra are narrow, the shoulders being excessively diminished, and they bear series of impressions or large punctures, the external ones being deep, those near the suture rather smaller and less deep.

Greymouth. I received my example of this species from Mr. Helms four or five years ago, but have not described it hitherto, hoping I might be able to compare it with *M. crenicolle* Cast., to which it is probably allied. Although I have not been able to make the acquaintance of Castlenau's species, I feel little doubt the two are distinct, though Castlenau's description is very brief and imperfect.

#### DIGLYMMA (nov. gen. Broscinorum).

Ex affinitate generis *Mecodemæ*. Antennæ breves, moniliformes, articulis 5–11 ubique pubescentibus. Palpi graciles, articulo ultimo tenue, præcedente vix crassiore. Tibiæ anteriores sat latæ, extus rectæ, angulo apicale externo haud producto. Tarsi breves.

The two species for which I propose this name are allied to *Metaglymma*, from which they differ by the unproduced angle of the front tibiæ, and by the strongly pubescent antennæ, as well as by the mandibles which in *Metaglymma* are elongate, and have no seta in the scrobe, whereas in *Diglymma* the scrobe is setigerous.

They have the terminal joint of the palpi more slender than in any of the other yet described New Zealand Broscini, and in this respect differ strongly from *Oregus*, which also has front tibiæ simple at the apex. *Diglymma* differs from *Mecodema* by the tibial structure, and by the shorter tarsi and more slender palpi. The only other New Zealand genus of the Broscini is *Brullea*, and although I am not acquainted with it, except by description, it is evident that it is very different from *Diglymma*. According to Putzeys (*Ann. Mus. Gen.* 1873, p. 318) it has the palpi slender like *Diglymma*, but the structure of the tibiæ must be remarkably different. *Metaglymma clivinoides* Cast., redescribed at length by Putzeys in his revision of the Australian and New Zealand Broscides (op. sup. cit. p. 314) is, I think, probably a species of *Diglymma*, though it is strange that Putzeys should have placed it in *Metaglymma* if it has pubescent antennæ, as he makes the bare condition of those organs one of the most prominent characters of *Metaglymma*; he indicates, however, that *M. clivinoides* should probably form a new genus without mentioning the grounds for his opinion. His words are, "ces deux derniers insectes (*i. e.* *M. clivinoides*, and *M. dyschirioides*) appartiennent à peine au genre dans lequel je les laisse provisoirement."



*Diglymma ovipenne*, n. sp.—Nigrum, antennis pedibusque piceis; prothorace nitido, elongato, profunde canaliculato, utrinque ad basin foveolato, basi apiceque crebre punctatis; elytris regulariter profunde striatis, striis crebre punctatis. Long. 12–14 m.m. (Plate XII, fig. 3.)

Antennæ short, not reaching so far back as the base of the thorax. Head small, not much more than half as broad as the thorax, with a series of punctures extending across the vertex at the point in a line with the back of the eyes, where it is depressed, and also with a feeble punctuation on each side of the front. Thorax elongate, just as long as it is broad; the sides rounded, contracted behind and sinuate; the hind angles almost rectangular, but slightly obtuse; the lateral margin is entire; the surface is shining black; there is a very deep channel along the middle which does not reach the base or apex, parallel with the front and also with the base there are numerous rather deep punctures, and across the middle a few extremely fine and obsolete transverse undulatory lines, and at each side at the point of constriction an elongate sinuous fovea reaching the base. The elytra are curved at the sides, and deeply striate, so that the interstices are a little converse; the striæ numerous and distinctly punctured.

Greymouth. Helms, No. 13.

*Diglymma dubium*, n. sp.—Nigrum, antennis pedibusque piceis; prothorace nitido, elongato, profunde canaliculato, utrinque ad basin foveolato, basi apiceque punctatis; elytris regulariter striatis, striis punctatis versus apicem obsoletis. Long. 11 m.m.

This is very closely allied to *D. ovipenne*, but is rather less elongate, and has the elytra more lightly striate, so that at the sides and extremity the striation becomes obsolete.

Mr. Bates, who kindly allowed me to examine his rich collection, and aided me with his stores of knowledge, thought this might be the *Metaglymma clivinoides* Cast.; but after carefully reading Putzeys' redescription of the species made from Castlenau's type, I do not think this can be the case, there being several discrepancies, especially the omission of any reference to the punctuation of the base and front of the thorax; the thoracic base, indeed, of *M. clivinoides* is said to be slightly rugose.

Bealey. Helms, two examples.

#### METAGLYMMA.

*Metaglymma sulcatum*, n. sp.—Nigrum, antennis pedibusque piceis; prothorace impunctato, canalicula longitudinali impresso; elytris fortiter profundeque punctato-sulcatis. Long. 18 m.m. (Plate XII, fig. 4.)

Head without punctures or wrinkles; with prominent eyes, and very indistinct post-ocular constriction. Thorax, with a length nearly seven-eighths of the width, a little rounded at the sides, considerably narrowed behind, and with a gentle, not abrupt, basal sinuation; the surface without sculpture, transversely convex; the side margin not crenate, but infringed on by the punctures bearing the intra-marginal tactile setæ, of which there are six on each side; hind angles rather obtuse, the lateral fovea indistinct. Elytra large, parallel-sided, with regular, very broad, deep striæ, bearing coarse punctures. Front tibiæ with moderately long apical prolongation; middle tibiæ a little, hind tibiæ scarcely at all, incrassate at tip.

This bears a considerable resemblance to *M. monilifer*, Bates, the typical species of the genus, but is distinct by some important characters; the antennæ are shorter, and the pubescent areæ on their upper and lower margins are greater; the thorax has a basal prolongation; the elytra are deeply sulcate, and the tibiæ much less dilated at the extremity.

Picton. Helms, three examples, in bad condition.

#### ACALLISTUS (nov. gen. Broscinorum).

Ex affinitate generis *Promecoderi*, sed corpus superne subplanatum, et tarsi intermedii maris simplices, anteriores subtus imperfecte spongiosi.

The insect for which I establish this genus is very different from the other New Zealand Broscidæ, the thorax being finely margined at the sides, and furnished with only two tactile setæ, one some distance behind the front angle, and the other about equally as much in front of the hind angle. The antennæ are slender, pubescent from the fourth joint onwards; the front tibiæ are not at all prolonged externally; there is a seta in the scrobe of the mandible; the labrum is large, feebly emarginate—almost truncate in fact—in front, and its setigerous punctures are minute. The palpi are all slender, with slightly truncate apex; the lobes of the mentum rather short, and its excision has a small triangular tooth in the middle. The front tarsi of the male are but little dilated; the basal joint is rather elongate, and is furnished with a transverse patch of spongy clothing at its extremity; the second and third joints are nearly entirely covered beneath, but the small fourth joint appears to have no sexual clothing, though that projecting from the third joint somewhat covers its base. The intermediate tarsi in this sex are not dilated, and are without clothing.

The characters bring this genus very close to the well-known Australian genus *Promecoderus*, but the appearance is very different, owing to the comparatively flat upper surface of the body; and as the male feet present apparently well-marked differences from those of *Promecoderus*, it would not be proper to place the New Zealand insect in that genus.

*Acallistus simplex*, n. sp.—Niger, supra subviridescens, subopacus, antennis tarsisque piceo-rufis; prothorace posterius angustato, transversim subtiliter strioso; elytris striatis, striis punctatis. Long.  $10\frac{1}{2}$  m.m.

Head dull black, without sculpture. Thorax just as long as broad, truncate in front, curved at the sides, considerably more narrowed behind than in front; hind angles extremely obtuse; the surface dull, without any punctuation; channelled along the middle, the channel equal abbreviate in front and behind, with a few fine, but distinct, transverse wrinkles. Elytra much curved at the sides, with distinct, but quite shallow, striæ, which are somewhat coarsely, but obsoletely, punctate, and are obsolete at the sides and apex. The legs are black, the tarsi pitchy red.

New Zealand. Castlenau, a single example. This insect has, perhaps, more the facies of *Adelium aucklandicum*, Broun—one of the *Heteromera*—than of any New Zealand *Carabidæ*.

#### CTENOGNATHUS (Fairm.)

This name was proposed by Fairmaire (Ann. Soc. Ent. France, 1843) for a New Zealand *Carabid*, but was afterwards treated as a synonym of *Anchomenus* or *Colpodes*, because the character relied on by Fairmaire for its differentiation proved to be unsatisfactory. On examining for the purposes of this paper the New Zealand *Anchomeni* and *Colpodes* in my collection, I have discovered that a character hitherto neglected divides them very satisfactorily into two groups. In certain species there is only one tactile seta on each side of the thorax, placed in front of the middle, while in others there is a second seta placed at, or on, the posterior angle. This latter is the normal condition in the group of *Carabidæ* to which these insects belong; and in fact I have not\* been able to find amongst the exotic *Colpodes* at my disposal any species similar to the New Zealand species above alluded to, and as it was for one of these that Fairmaire proposed the name *Ctenognathus*, I propose to restore it to these forms. *Ctenognathus* then will include such of the New Zealand *Carabidæ* hitherto placed in *Colpodes* or *Anchomenus* as possess only a single lateral seta on each side of the thorax, placed in front of the middle. In addition to the two species I here describe, the genus will include *Colpodes bidens*, Chaud. and pretty certainly also some of the other species of *Colpodes* and *Anchomenus* described by Chaudoir and Broun, but not known to me as yet.

*Ctenognathus latipennis* (new name).—*Anchomenus elevatus*, Bates, Ann. Nat. Hist. XIII, p. 10 (reprint) nec White. Robustus, latior, niger, antennis palpisque rufis, pedibus piceis; prothorace lato angulis posterioribus perobtusis; elytris profunde striatis, striis haud punctatis, interstitio secundo puncto unico versus apicem sito. Long.  $13\frac{1}{2}$  m.m.

The salient characters of this species have been mentioned by Mr. Bates as

\* See notes added during press, No. 2.

above. The thorax is very broad, the length however being more than three-fourths of the width, without sculpture, with the lateral margin rather broadly and evenly reflexed from base to apex, the base a little narrower than the front, the hind angles unusually obtuse. The elytra are very broad, rather short, very deeply and evenly striate, with a single puncture placed near the extremity of the second interstice. The grooving of the tarsi is variable in its development; it may be, and usually is, nearly entirely absent, but in other examples there is a distinct groove on each side of the middle of the basal joints, extending sometimes as far as the fourth. The male has three, the female five setigerous punctures on each side of the hind margin of the last ventral segment. The only examples I possess of this species were found at Auckland by Lawson, as recorded by Bates. It is allied by the single puncture on the second interstice to *Colpodes neozealandicus*, Chaud. Whether this latter species be *C. novæzealandiæ*, Fairm. or not I cannot say; Fairmaire's species is not alluded to by Chaudoir.

It may here be useful to state, for the information of New Zealand naturalists, that in the *Annales de la Société entomologique de France*, 1878, Chaudoir has described five species from New Zealand purporting to be new, viz., *Colpodes neo-zealandicus*, p. 294, *bidens*, p. 303, *crenatus*, p. 304, *cardiophorus*, p. 305, *macropterus*, p. 370. These are not alluded to by Broun, so that it is probable that some of his numerous species may be synonymous with those of Chaudoir.

*Ctenognathus pictonensis*, n. sp.—Niger antennis pedibusque læte rufis; prothorace cordato, secundum latera fortiter depresso, angulis posterioribus argute rectis; elytris fortiter profundeque punctatis, apicibus prolongatis, interstitio secundo ante apicem puncto unico notato. Long. 11 m.m. (Plate XII, fig. 5.)

This species is distinguishable by the bright-coloured legs and antennæ, the deep striation of the elytra, and the very cordate thorax, whose hind angles are sharply rectangular; the lateral margin of the thorax appears much elevated, owing to a depression extending parallel to it, and within this there is a second curvate feeble impression; the surface near the hind angles is greatly depressed, the median channel and the anterior transverse impression very deep; there is no distinct punctuation or rugosity. The very deep elytral striæ are, when strongly magnified, seen to be only very indistinctly punctured; their apices are gently sinuate and a good deal prolonged. The tooth of the mentum is entire, but broad and truncate at the apex: the fourth joint of the hind tarsus feebly emarginate, the surface of the tarsus deeply grooved on each side of the middle, and with a less distinct lateral groove.

This is readily distinguished from *A. helmsi*, which has similarly coloured legs and antennæ, by the remarkably deep striation of the elytra, and by there being only one tactile seta on each side of the thorax.

Picton, Helms, a good series.

## PTEROSTICHINI.

Having made a short study of such New Zealand members of this group as are at my command, I subjoin a table of their genera or sub-genera which I hope may be found to facilitate future research.

Metathoracic episterna elongate, . . . . .	Rhytisternus Chaud.
Metathoracic episterna short.	
1. Prosternum with setæ at tip, . . . . .	Trichosternus Auct.
1A. Prosternum without setæ at tip, . . . . .	2.
2. Basal joint of antenna impressed and subcarinate, . . . . .	Zeopœcilus (sub. gen. nov.)
2A. Basal joint of antenna simple, . . . . .	3.
3. Scutellum striate at base, . . . . .	4.
3A. Scutellum not striate, . . . . .	5.
4. { A Thorax with four lateral setæ, . . . . .	Pterostichus subæneus group.
{ B    "    "    three   "   " . . . . .	"    elongellus.
{ C    "    "    two    "   " . . . . .	"    longiformis group.
5. Elytra with two or three punctures on third interstice, . . . . .	Haptoderus Bates (auct. ?).
5A. Elytra without interstitial punctures, . . . . .	Pterostichus helmsi.

The above scheme brings into moderately good order the New Zealand forms at present known to me, but as it is sure to require modification in the future—the species at my disposal being certainly only a minority of those existing—I have not thought it desirable to give special names to the groups except in the case of *Zeopœcilus*; especially, too, as a great deal remains to be done in correlating these insects with their allies in other countries, the Pterostichini being one of the most widely distributed and complex of all the groups of Carabidæ. As regards this part of the question, it may be remarked that *Rhytisternus* and *Trichosternus* are Australian forms, while the other sections have apparently affinities with the Pterostichi of the Northern hemisphere. For instance, group 5a—of which *Pterostichus helmsi* is at present the sole representative—has no salient character to distinguish it from the European insects now ranged under *Pterostichus*, but at the same time it does not recall to the eye any of the groups of that genus except it be *Steropus*, and of this it wants precisely the distinctive character, viz., the short (in the transverse direction), thick basal margin to the wing-case; on the other hand, *Pterostichus brounianus*, belonging to the group or groups hitherto called *Holcaspis* (and differing therefore from *Steropus* which has the scutellum estriate) has the *Steropus* facies as well as the characteristic *Steropus*-structure of the shoulder. It will be observed that I have not used the name of *Holcaspis* in the table; this is because I have satisfied myself that the scutellar character has only been very imperfectly studied, and species differing much in other respects possess this in common. I have introduced the thoracic lateral setæ as a means of classification, and as regards this I should remark that though apparently but little variable within specific limits, yet when the normal number of setæ is departed from by

increase it occasionally occurs that one or even two of the additional setæ may be duplicate on one of the sides of the thorax, though rarely or never on both sides; thus though the character appears to be really an important one, it must be used with some caution as to this point.

#### PTEROSTICHUS.

*Pterostichus* (*Trichosternus*) *compressus*, n. sp.—Niger, supra fusco-æneus, limbo anguste viridescente, antennis pedibusque piceis; prothorace anteriorius minus lato, prope angulos anteriores depresso, angulis posterioribus rectis; elytris sat profunde striatis, striis impunctatis. Long. 21–23 m.m. (Plate XII, fig. 6.)

This is one of the allies of *P. sylvius*, Bates, a group of species, or perhaps varieties, very difficult at present to distinguish; it is, however, not so green in colour as *P. sylvius*; the striæ of the elytra are almost impunctate, and the thorax is rather longer, the basal portion, as shown by the sinuation at the sides, being longer, and the male front tarsi considerably less dilated. The hind angles of the thorax are not at all directed outwards, and are nearly rectangular, very slightly obtuse; the tooth formed by the basal margin of the wing-case is very distinct. *P. rectangulus*, Chaud., and *P. capito*, White, have the thorax broader at the front margin, and this is also the case with *P. aucklandicus*.

Picton. Helms, a series of ten individuals, showing but little variation.

*Pterostichus* (*Zeopœcilus*) *calcaratus*, n. sp.—Niger, supra fusco-æneus, prothorace cupreo-aurato, antennis pedibusque piceis; elytris profunde striatis, striis subtiliter punctatis. Long. 20–22 m.m. (Plate XII, fig. 7.)

Mas., elytris nitidis interstitiis convexis; tibiis posterioribus apice intus calcare acuminato-hamato armatis.

Fem., elytris opacis, interstitiis haud convexis.

Antennæ with a depression on the upper face of the basal joint. Thorax strongly transverse, with much rounded sides; these sinuate behind, so as to give rise to a well-marked basal constriction; hind angles rectangular; surface coppery, more golden about the foveæ; these broad, quite impunctate, not touching the lateral margin. Elytra with rounded sides, strong humeral denticulation, and very regular striæ; the interstices of these a little transversely waved on the apical portion. The male has one, the female two, setæ on each side of the hind margin of the last ventral segment. The sexes differ a good deal in the elytral sculpture, as mentioned above.

Picton. Helms, a good series of nearly twenty examples.

N.B.—This, and the allied species, *P. achilles*, *putus* and *combesi*, form a distinct sub-genus, distinguished from *Trichosternus* by the absence of setæ on

the prosternum, and by the peculiar structure of the basal joint of the antennæ; this latter character is a very interesting one, and is analogous to our European *Pœcilus*, to which sub-genus these New Zealand insects are most nearly allied. Although Brown failed to observe the absence of the prosternal setæ in the species he described, yet his acute eye detected the antennal structure; so I have little doubt his two (? are they not the sexes of one) species really belong to this group.

*Pterostichus* (*Zeopœcilus*) *achilles*, n. sp.—Niger, supra fusco-æneus, prothorace cupreo-aurato, antennis pedibusque piceis; elytris elongatis, sat profunde striatis, striis vix perspicue punctatis, interstitiis convexis, postice transversim subimpressis. Long. 21–23 m.m.

Mas, tibiis posterioribus apice calcare robusto apice rotundato-hamato armatis; tarsis articulo basale intus dilatato.

Thorax strongly transverse, the sides rounded, a good deal narrowed behind; the basal impressions large; the hind angles rectangular, slightly obtuse; the surface coppery, about the foveæ more golden.

This species is closely allied to *P. calcaratus*; but so far as the male is concerned can be readily distinguished by the form of the basal joint of the hind tarsus, and by the broader less acuminate prolongation of the tibia; it has, too, the basal portion of the thorax shorter, and the elytra more elongate and oblong, and these two latter characters will probably permit the discrimination of the females. The latter sex I do not know, but probably it will be extremely similar to *P. calcaratus* ♀.

This insect almost agrees with Brown's description of *Trichosternus putus* (*New Zealand Journal of Science*, Sept., 1882), but there are no setæ on the prosternal process, so that it is not a *Trichosternus*; and although it will probably be found that Brown overlooked this fact when describing *T. putus*, yet I can scarcely think the two identical, as *P. achilles* is not tinged with green, and the elytral striæ are only extremely feebly punctulate.

Picton. Helms, two male examples.

*Pterostichus brounianus*, n. sp.—(Scutello basi minus argute plicato). Robustus, niger, antennis pedibusque piceis; prothoracis lateribus rotundatis, angulis posterioribus valde obtusis; elytris profunde striatis, striis vix punctatis hic inde parum conspicue interruptis. Long. 19–20 m.m.

This species, belonging to the group with four setæ on each side of the thorax, is distinguished by the unusually great curvature of the sides of the thorax, and the very obtuse hind angles, as well as by the large size. There is no denticulation of the humeral angles, and the striation of the elytra is deep, so that the interstices are distinctly convex; the indistinct punctures of the striæ are less close than usual, and the striæ are only vaguely and indistinctly interrupted.

There is a simple deep fovea on each side of the thorax at the base, distant from the lateral margin. The male has the hind femora angularly dilated in the middle, and only a single seta on each side of the hind margin of the last segment, whereas in the female there are two setæ on each side.

I have named this species in honour of Captain Thomas Broun, who has rendered great service to entomology by the discovery of a great number of New Zealand insects whose existence was previously unsuspected.

Picton. Helms, a good series.

*Pterostichus myrmidon*, n. sp.—(Scutello basi striato). Elongatus, supra subplanatus niger, antennis tarsisque piccis; prothorace vix transverso, angulis posterioribus argutis fere rectis; elytris striatis, striis ubique a basi ad apicem interruptis. Long 16–17 m.m. (Plate XII, fig. 8.)

This species is very different from the others of the group with four thoracic setæ, the thorax being more quadrate, and the general outline more parallel. The thorax is but little curvate, and is slightly narrowed behind, but its outline is only very slightly sinuous. There is an extremely minute projection outwards of the hind-angle itself, so that the angles which, except for this, would be slightly obtuse, are almost rectangular. The surface is feebly transversely rugose; the basal foveæ are large and deep, distant from the sides; and between each and the outside there is at the base a distinct plication. The striation of the elytra is interrupted throughout in a very distinct and almost regular manner. The hind femora of the male are much swollen in the middle, so as to form an angular prominence; they are also very broad in the female, but in this sex the prominence does not form an angle. In each sex there are two punctures on each side of the middle of the hind margin of the last ventral plate.

I have little doubt that *Holcaspis cribratus* Brown is allied to this species, but it is described as possessing a rugose head, and a more remarkable development of the peculiar sculpture of the elytra. *P. myrmidon* bears a considerable resemblance in size, form, and sculpture to *P. cribratus* Dej., found on Monte Rosa in Europe. *Holcaspis hispidulus* Brown no doubt pertains also to this group, as shown by the number of thoracic setæ mentioned in his description. It has apparently a very different sculpture of feeble abbreviate striæ.

Picton. Helms, a good series.

*Pterostichus constrictellus*, n. sp.—(Scutello basi striato). Angustulus, niger, antennis tarsisque piccis; prothorace posterius angustato, angulis posterioribus obtusis; elytris striatis, striis punctatis. Long. 11–12 m.m.

Thorax a good deal broader than long, the sides a little curved, considerably narrowed behind, so that the base is evidently a little narrower than the front



margin, without the least sinuation at the sides, so that the hind angles are obtuse; the basal foveæ deep, distant from the sides. Elytra narrow, without humeral denticle, the striæ regular, rather deep, closely and regularly punctate, not interrupted; the interstices in the male rather more convex than in the female. In the male the hind femora are a little dilated in the middle, so as to form an obtuse prominence, not an angle; in each sex there are two punctures on each side of the hind margin of the last ventral ring.

The individuals of this species are the smallest I am acquainted with of the group having four lateral tactile setæ to the thorax. *P. subænea* Guer., Bates, is very similar, but has the sides of the thorax sinuate behind, and the striation coarser and less regular. This is the species treated by Bates as the *F. elongella* White, and it is indeed so similar thereto, that I also myself, previously to noting the difference in the thoracic setæ, considered it a small variety thereof; hence my remarks in New Zealand Journal of Science, 1884, p. 298, on White's *Feronia elongella*, require correction as regards the occurrence of *F. elongella* at Christ Church; it being *P. constrictellus* that has been found there. *F. elongella* has the peculiarity—unique, so far as I know, among the New Zealand species—of possessing three lateral thoracic setæ, one at the hind angle, one a little behind the front angle, and one just about the middle.

Christ Church, Wakefield, Helms. Greymouth, Helms. One example from each source.

*Pterostichus longiformis*, n. sp.—(Scutello basi striato). Minor, angustulus subparallelus nigro-piceus, nitidus, antennis pedibusque piceo-rufis; prothorace elongato, basi utrinque bifoveolato, angulis posterioribus rectis; elytris oblongis, regulariter profunde striatis, striis impunctatis. Long. 11 m.m.

A distinct species belonging to the group with only two lateral thoracic setæ, and probably allied to *P. sylvaticus*. The thorax is elongate, the length being five-sixths of the width. The sides are very gently sinuate behind, the external angles being rectangular, quite minutely prominent externally. The two basal foveæ on each side are shallow and indefinite, the outer one small. The striæ on the base of the scutellum are deep and definite; the elytra are narrow, parallel, flat, with slight humeral denticle, and very regular, deep striation, the striæ being simple. In the male the hind femora are much swollen, and are angular in the middle. There is only one puncture on each side of the last ventral segment. The female is unknown.

This appears to be allied to *P. angustulus* Chaud. (*elongatus* Blanchd.), as well as to *P. sylvaticus* Chaud., but does not sufficiently agree with either description.

Christ Church, Wakefield. A single example.

*Pterostichus oscillator*, n. sp.—(Scutello lævigato). Nigerrimus, antennis extrorsum tarsisque piceis; antennis gracilibus, oculis convexis; prothorace basi

utrinque fovea elongata lineare, angulis posterioribus exacte rectis; elytris regulariter sat profunde striatis, striis fere impunctatis, interstitio tertio bi vel tripunctato. Long. 13 m.m.

Antennæ slender, with the fourth joint rather longer than the third. Head short, with prominent eyes, and with two foveæ near the front. Thorax flat, about one-fourth broader than long, the sides a little narrowed, and slightly sinuate behind; the central channel deep, extending from base to the front margin, half-way between it and the side with an elongate channel-like fovea. Elytra with slightly rounded shoulders, destitute of denticle, the striation regular and rather deep, with two or three large punctures placed on the third interstice touching the third stria. The male has the hind femora simple, and one seta on each side of the last ventral segment.

This is, no doubt, allied to *Haptoderus maorinus* Bates, which, however, is only 7 or 8 m.m. long, and is almost destitute of frontal impressions. Although no doubt the type of a distinct group, or sub-genus of New Zealand *Pterostichi*, I somewhat doubt the propriety of associating this insect with the European *Haptoderi*, though no doubt the structural characters of the New Zealand and European species, so far as yet observed, are very similar. The labrum in the New Zealand insects is very short and broad, the mandibles short and stout, smooth, not striate above, the left one with slender and elongate incurved apex, the fourth joint of antennæ longer than the third, the thorax with a front margin, two lateral setæ, and the scutellum estriate.

Dunedin and Otago. Sent by Professor Hutton in 1876 and 1877, two male examples.

*Pterostichus ovatellus* Chaud.—(Scutello basi striato). Nigerrimus, femoribus piecis; prothorace evidentè transverso, basi utrinque unifoveolato, angulis posterioribus subrotundatis; elytris profunde fortiterque striatis, striis punctatis, interstitio tertio bi vel tripunctato. Long. 17 m.m.

This is a peculiar species, with thorax only three-fourths of its width in length; a single deep fovea on each side the thorax, without any trace of external plication; only two lateral setæ on the thorax. The elytral striæ very deep, and with two or three punctures (placed variably and irregularly) on the third interstice, and the shoulder and basal margin of the elytra formed as in *P. constrictellus* and *elongellus*. It quite agrees with those two species in appearance, but departs greatly from them by the number of the thoracic setæ, and by the interstitial punctures on the wing-case. The male has the front tarsi much dilated, the hind femora a little thickened in the middle, but not angular, and two punctures on each side of the hind margin of the last ventral segment.

New Zealand; Castlenau. Chaudoir was not acquainted with the male, and I have not seen the female. Chaudoir's examples, like my own, came from Castlenau, and I feel little doubt of the correct identification.

## ZOLUS (nov. gen. Zolinorum).

The insect for which this generic name is proposed has peculiar characters, so that its position and affinities cannot be determined with precision at present, and must be a subject for future discussion; meanwhile it may be treated as forming a distinct group, which perhaps will be best placed near the Zabryni, and will be called Zolini.

The size is rather small, and the appearance somewhat that of the smaller Pterostichi, such as Haptoderus or Argutor; the base of the thorax is very closely adapted to the base of the elytra, which it overlaps. The basal joint of the front tarsus in the male is large, and its front side is produced so as to form an angle and make the joint unsymmetrical in form; the second joint is much smaller than the first, but is similarly formed; the third and fourth joints being small and symmetrical in form. The undersurface of the two dilated joints bears fine elongate hairs, and the anterior side (*i.e.* the side most produced) bears also papery-like squamæ; the middle tarsi are simple, as also are the claws. There is only one orbital seta. The mentum and ligula are of ordinary Pterostichoid form, the former with a strong tooth in the middle, the latter slightly acuminate in the middle, with small paraglossa projecting beyond it on each side. The second joint of the labial palpus is very feebly bisetose, the terminal joint about as long as the second; rather slender acuminate. The maxillary lobes are not very long, and are of very ordinary form; the corresponding palpi are not stout; the second and third joints subequal in length; the third broadest at its apex, where it is rather closely connected with the terminal joint, which is slender and acuminate, scarcely so long as the third joint. The mandibles are short, and the right one is very obsolete armed with a single tooth in the middle, and there is a feeble external seta. The labrum is transverse, with straight front margin, bearing six setæ. The thorax is well margined at the sides, and is destitute of tactile setæ. The scutellum is visible, and its broad short extremity penetrates between the basal margins of the wing-cases. The elytra have no erect setæ, and no larger lateral punctures, except that near the base there are close to the side margin three or four feeble punctures bearing very feeble setæ. The elytra are not in the least truncate, only feebly sinuate near the extremity, and at the point of sinuation the thin edge is traversed by an oblique groove. There are no wings, but the elytra are not soldered. The prosternal process is short and bent upwards. The mesosternal epimera are quite slender, well separated from the coxal cavities; the metasternum small, with short broad episterna; the hind coxæ contiguous; the ambulatorial setæ of the ventral segments feeble.

It will be seen from the above characters that this insect departs from the Pterostichini by the important characters of the form and condition of the male

tarsi, and by there being but one orbital seta. I have not yet alluded to the condition of the antennæ, because these are in a singularly doubtful condition as to the pubescence of the basal joints; the first is free from pubescence; the rather elongate second joint is scantily pubescent on the apical part; the third joint is very elongate, and is glabrous at the base, pubescent elsewhere, the following joints being closely pubescent; thus the second and third joints show a gradual transition from the glabrous to the pubescent condition. The form of the male tarsus is an affinity with *Pogonus*. The position in the New Zealand Catalogue will be between the *Pterostichini* and *Harpalini*. It should be remarked that in this genus the mandibular seta is of little importance; always very feeble, it appears to be occasionally entirely absent from one or the other mandible.

*Zolus helmsi*, n. sp.—Piceo-castaneus, antennis rufis pedibus castaneis; prothorace anteriorius fortiter rotundato, basi truncato, ante basin punctato, utrinque prope latus argute plicato; elytris profunde striatis, utrinque versus apicem plica elevata, interstitio tertio obsolete tripunctato. Long 8 m.m. (Plate XII, fig. 11.)

The head is quite short, deeply impressed on each side between the eyes, which are rather large. The antennæ are slender and rather long, each joint being much longer than broad, and the second joint about as long as the basal. The thorax is not much broader than long, with rectangular hind angles, and broader at the base than at the front margin. Very near the lateral margin at the base there is a very distinct straight plica, and within this plica the surface is depressed, uneven, and punctate, the punctuation not quite reaching the plica itself. The median channel does not reach the front, but extends to the base, though indistinct behind, owing to the sculpture there. The striation of the elytra is regular, and there is a striole near the scutellum. The striae are not punctate, the interstices are flat, the plication behind very distinct. The first of the three punctures on the third interstice is placed as far forward as the termination of the scutellar stria, the second as far behind it as it is from the base, while the third is remote, placed at about two-thirds of the length.

Greymouth. Helms, No. 276. I have much pleasure in connecting Mr. Helms' name with this interesting form. Some years ago I received a specimen from him which I could do nothing with as it was a female; after waiting a long time he has been able to send me the male.

#### SYMPIESTUS (nov. gen. *Pterostichinorum*).

Labrum very short, deeply emarginate, so that its angles are prominent. Mandibles rather elongate, little curved, with external seta. Palpi with the terminal joint a little incrassate, oval and acuminate, that of the maxillary palpi twice or three times as long as the penultimate joint, which is much abbreviated;

excision of the mentum shallow, not toothed. Antennæ with the three basal joints glabrous, the third joint being, however, feebly pubescent above. Head with two orbital setæ. Thorax margined laterally, with two lateral setæ, normally placed; closely applied to the base of the elytra. Epipleura oblique, grooved near the apex. Metasternum very small. Male anterior tarsi with three joints feebly dilated and furnished beneath with squamæ.

The insect for which this genus is established has quite the appearance of a small *Pterostichus*, but will be very readily identified by the peculiar palpi and labrum. It should, I think, be placed near *Cyclothorax* and *Tarastethus*. The former genus is at present placed by systematists in the *Anchomenini*, but it must be removed from thence, as the epipleuræ are traversed near the apex by a slender deep groove, as in the present genus. *Tropopterus* should be removed from the New Zealand list, and its species placed in *Tarastethus*. These obscure New Zealand genera are of rather difficult classification, and will perhaps ultimately form a distinct tribe near the *Pterostichini* and *Trechini*.

*Sympiestus syntheticus*, n. sp.—Subparallelus, niger, antennis rufis, articulo basali pedibusque piceis; prothorace subquadrato, basi utrinque fovea elongata sulciforme; elytris parum profunde striatis, striis conspicue punctatis. Long.  $6\frac{1}{2}$  m.m. (Plate XII, fig. 10.)

Antennæ rather short; basal joint stout, darker than the others; second joint short, not half the length of the first; third greatly longer than the second, equal to the fourth. Head narrow, with small but convex eyes, and two large depressions in front. Thorax elongate, but a good deal shorter than broad; the sides finely marginate, a little narrowed and sinuate behind; hind angles nearly rectangular, a little obtuse, the base slightly broader than the front margin; the surface very shining, with a median channel starting from the base, but not reaching the front; base impunctate, with a rather elongate canalicular fovea half-way between the channel and the side. Exposed portion of scutellum broad, extremely short. Elytra with the posterior line of basal margin reaching only as far inwards as the fourth stria. Their surface is rather dull, and the two or three striæ towards the side are almost obliterated. There is no raised apical plica.

Bealey. Helms, three examples.

#### TARASTETHUS.

*Tarastethus debilis*, n. sp.—Piccus, antennis pedibusque testaceis; prothorace basi punctato, angulis posterioribus minute prominulis, subobtusis; elytris sat profunde striatis, striis subcrenato-punctatis. Long.  $4\frac{3}{4}$  m.m.

Antennæ rather feeble. Head rather narrow; eyes small and not prominent. Thorax finely and very evenly margined at the sides; the sides much curved,

scarcely at all sinuate behind; the base a little rounded on each side, so that the hind angles would be quite obtuse except that they are a little prominent externally, finely punctate across the basal portion, with fine median channel, but without lateral impression. Elytra with the sutural striæ rather deep, the external finer; their punctuation of a rather peculiar nature, so that it is intermediate between crenation and punctuation.

This species has a very Trechoid appearance, and will be distinguished by its small, smooth eyes. Although I have seen only two females, I do not detect anything to distinguish it from this genus.

Bealey. Helms, two examples.

#### TACHYS.

*Tachys latipennis*, n. sp.—Testaceus, plus minus ve picescens, nitidus, antennis palpis pedibusque testaceis; prothorace cordato, angulis posterioribus rectis; elytris striis duabus ad suturam sat profundis, striaque tertia minus distincta. Long.  $2-2\frac{1}{2}$  m.m.

Antennæ feeble, second joint elongate, longer than third. Eyes small, head biimpressed between them, the impressions rather widely separated. Thorax a little curved at the sides, narrowed and sinuate behind, the hind angles sharply defined, exactly rectangular. There is a rather fine channel along the middle, and a fovea at the base on each side. The elytra are broad and short, with the shoulders perfectly rounded. The sutural stria is deep, and extends to the apex. The second stria is also rather deep, but does not extend on to the apical portion; and there is a third indistinct stria. The striæ external to these are almost entirely obliterated. The apical plica is very distinct, and there are two obsolete setigerous punctures on the third interstice. The oblique truncation of the anterior tibia is excessively slight.

Greymouth and Kumara. Helms, No. 275.

#### CILLENUM.

*Cillenum batesi*, n. sp.—Oblongo-ellipticum, convexum, politum, pallido-testaceum, capitis vertice elytrorumque disco vix infuscatis; thorace cordato, basi depresso, subplicato; elytris substriatis, margine laterali crassiusculo, interstitio tertio tripunctato. Long.  $4\frac{1}{4}$  m.m.

This is very closely allied to *C. albescens*, though easily distinguished by the almost complete absence of the dark variegation of the upper surface. The margin of the elytra also is less prominent at the extremity.

Mr. Bates has discussed at some length the points of resemblance and contrast between the New Zealand and European *Cillenum*, deciding on considering them

at any rate provisionally as congeneric. I fancy, however, that when we can obtain specimens for an exhaustive examination, that they will have to be generically separated.

Otago. Sent by Professor Hutton in the year 1878, but only one example.

*Cillenum* (?) *subcæcum*, n. sp.—*Minutissimum*, *testaceum*, *impunctatum*, *brevis-  
sissime setigerum*; *oculis minimis*. Long.  $1\frac{1}{2}$  m.m.

Antennæ very feeble, almost white; second joint elongate, longer than the third. Head narrow, eyes very minute, interocular grooves shallow. Thorax transverse, sides curved, narrowed but not sinuate behind; hind angles extremely obtuse, median channel subobsolete, basal impressions very obscure. Elytra narrow, humeral angles rounded, lateral margin well marked, apices subtruncate, without punctuation, but under a half-inch power appearing finely reticulate, studded with minute setæ, especially on the lateral margins. Front tibiæ stout.

This is one of the most minute of the *Carabidæ*, and its almost blind condition renders it possible that it may be one of a group of species with subterranean habits, analogous to the minute European *Scotodipni* and *Anilli*. I obtained it some years ago from Herr Reitter, and I expect that when specimens come to hand to enable it to be thoroughly investigated, it will prove to be sufficiently generically distinct. I cannot place it in *Scotodipnus* nor *Anillus*, though it is apparently nearer to the former than to the latter of these two genera; and as it has somewhat the form of the New Zealand *Cillena*, I associate it provisionally with them. The robust front legs are rather remarkable in so minute and fragile an insect, but do not indicate any real affinity with the *Dyschirioid* genus *Reicheia*, which consists also of minute blind species.

Greymouth. Helms, ex Reitter.

---

### Fam. STAPHYLINIDÆ.

#### APHYTOPUS (nov. gen. *Aleocharinorum*).

Tarsi omnes quinque articulati, articulis quatuor primis subequalibus, articulo ultimo inflato, unguiculis magnis.

The minute insect for which I propose the above generic name can scarcely fail to be distinguished from all the known genera of *Aleocharini* by the very peculiar structure of the tarsi, the terminal joint being not only incrassate, but of peculiar shape, looking in fact as if it were a bilobed joint, and the lobes were folded along the middle, and their underfaces applied to one another. The large

unguiculi are but little curved, and as they project considerably beyond the joint itself, the foot has at first sight the appearance of being like that of the *Phytophaga*. The basal joint of the maxillary palpi is minute, the second elongate and slender, the third oval, the fourth very minute; the other parts of the mouth I cannot see sufficiently for description. The antennæ are inserted near the front of the head, and there is no trace of any tubercle at their point of insertion; they are eleven-jointed. The genæ are strongly margined. The side-piece of the thorax is large, almost triangular in form, and projects downwards and inwards, so that in its form and position it much resembles that of the *Pæderini*. The front coxæ are very exerted, and of the ordinary *Aleocharoid* form. The middle coxæ are contiguous, the metasternum rather elongate.

This peculiar little form is, I have little doubt, correctly placed in the *Aleocharini*, though the thoracic structure is a little like that of the *Pæderini*. The number of joints in the tarsi range it in the *Aleocharates*, but I do not know of any near ally to it.

*Aphytopus gracilis*, n. sp.—*Angustulus*, rufotestaceus, elytris versus apicem, abdomine ante apicem antennisque extrorsum fusciscentibus; prothorace subquadrato dense fortiterque punctato, dorso vix perspicue longitudinaliter biimpresso. Long. 3 m.m.

Antennæ slender, but distinctly thicker from the third joint to the apex, second remarkably elongate, equal to the first, and twice as long as the slender third joint; the two penultimate joints transverse; terminal joint rather elongate, acuminate. Head narrow, narrower than the thorax, and only about half as broad as the elytra, gradually narrowed behind the eyes, rather closely punctate, and bearing a fine erect pubescence. Thorax much narrower than the elytra, broader than long; the base and the sides nearly straight, the latter rounded at the front angles; the surface dull, unusually densely and distinctly punctate. Elytra a good deal longer than the thorax, rather coarsely, not densely punctate. Hind body with the basal segments densely, the apical obsoletely punctate. Legs pale yellow.

The only example I have seen was sent to me many years ago by Mr. Lawson from Auckland.

#### CAFIOQUEDUS (nov. gen. *Quediinarum*).

Prothorax lateribus ad basin mediocriter inflexis, antice haud inflexis, lineis marginalibus tantum ad angulos anteriores conjunctis, his valde deflexis, rotundatis, breviter liberis. Genæ immarginatæ. Tarsi anteriores in utroque sexu modice dilatati.



This curious insect may, I believe, be considered as an aberrant member of the Quediina. It has, perhaps, more the aspect of a Cafius than of any other known genus, but it differs totally therefrom by the structure of the side-piece of the prothorax. I have pointed out elsewhere that the essential character by which the Quediina are distinguished is that the prosternum is not placed quite at the front of the thorax, but leaves the anterior angles free and projecting. This is the case in Cafioquedus, though to a slighter extent than in the other genera of the group. Looking on the genus as a member of the Quediina, the very peculiar form of the prothoracic side-piece, which in front is scarcely at all inflexed, is diagnostic: both marginal lines are quite distinct till the front angles are reached, and exactly at this point they are joined. The other characters throw but little light on the affinities, though the general structure is apparently much that of Philonthus. The antennæ are similar to those of the larger Philonthi; the labrum very short, quite divided; the mandibles long and slender, dentate in the middle. The ligula is apparently bilobed, but of this I am not quite sure. The labial palpi are rather slender, with the terminal joint quite slender, sublinear, a good deal longer than the penultimate joint. The penultimate joint of the maxillary palpi is broader at the apex than at the base; the terminal joint of very slender oval form, slightly shorter than the penultimate. The middle coxæ are slightly separated.

*Cafioquedus gularis*, n. sp.—Elongatus, subcylindricus, niger, parce albido-pruinosis, capite subtus gula sanguinea; prothorace transversim fortiter convexo angulis anterioribus per-deflexis; elytris thorace longioribus, obsolete sculpturatis, opacis. Long. 15 m.m. (Plate XII, fig. 13.)

Antennæ black, moderately slender; third joint longer than second; joints 4–10 each minutely red at the base, the penultimate 3 or 4 joints each slender at the base, the penultimate not so long as its greatest width; terminal joint short, strongly obliquely sinuate. Head rather elongate, eyes rather large, sides for some distance behind them almost straight, then distinctly narrowed to the broad neck; along the inner margin of the eyes is a series of coarse punctures, and between this series and the neck are some other coarse punctures, marking off a rather large space about the hind angles on each side, which is finely punctate, and bears a scanty white pubescence. Thorax rather long, black, shining, and impunctate, except that there is a space along each side dull, obsoletely punctate, and bearing some white pubescence. Scutellum elongate. Hind body rather closely and finely punctate, with scanty white pubescence. Underside of head and neck red; at each side behind the eye there is a dull punctate space bearing white hairs. Legs black, griseo-pubescent. Underside of hind body rather obsoletely punctate, with some coarse numerous punctures irregularly placed on each segment. The male has a deep incision on the last ventral plate, and an

emargination of the hind margin of that preceding it. The tarsi are moderately dilated in each sex.

North Island (Castlenau). Bealey (Helms).

#### QUEDIUS.

*Quedius antipodum*, n. sp.—Major, latus, nigerrimus; clypeo membranaceo, flavo; prothorace amplo, elytris latiore. Long. 15–21 m.m.

Antennæ entirely black, rather stout, penultimate joint scarcely so long as broad. Head short and broad, with large yellow membranous clypeus, to which is attached the large labrum; this is broadly emarginate in the middle, armed with very long black setæ, and increased by a large membranous border. An irregular series of large punctures extends from front to back, along the inner margin of the eye, and there are some fine punctures on the side behind the eye. Thorax more than one and a-half times as broad as long, with excessively broadly rounded hind angles, the front margin sinuate on each side. Scutellum and elytra closely punctate, dull. Hind body broad, closely punctate, black, with some iridescent reflections. Male with a broad shallow emargination on the last ventral ring, and the front tarsi rather strongly dilated. Female with the tarsi rather less dilated.

This is another species, very distinct from its New Zealand congeners, and suggesting by its form, size, and colours, an affinity with the European genus *Velleius*. I sent it some years ago, under the above name, to M. Fauvel, and he intended to describe it under the name of *Q. flavilabris*. As this is not a very good name, the labrum not being yellow, I have preserved the name I first suggested.

Dunedin (G. M. Thomson). Greymouth (Helms).

*Quedius edwardsi*, n. sp.—Elongatus, angustus, piceus, nitidus; elytris prothoracis longitudine, fortiter punctatis; abdomine elongato, fortiter punctato. Long. 13 m.m.

Antennæ slender, obscure red, tenth joint much longer than broad. Head short, clypeus distinctly marked off by a suture, but quite horny, the surface sparingly and finely punctate, eyes occupying rather more than half the length of the side, genæ not margined. Thorax transverse, a little rounded at the sides in front; the surface sparingly punctate, and with a large puncture on each side of the middle distant from the front margin, in addition to the marginal punctures. Scutellum large, coarsely punctate, like the elytra. Hind body coarsely punctate, rather shining, with iridescent reflections; terminal styles very long. Male with a small excision on the hind margin of the last ventral plate.

This is a very different species from any others known from New Zealand. I received an example of it from Mr. Henry Edwards about twenty years ago, and have named it after him. It has now been found by Helms at Picton.

*Quedius insolitus*, n. sp.—*Elongatus*, *angustulus*, *niger*, *antennis palpis tarsisque piceis*; *prothorace antrorsum fortiter angustato*, *angulis anterioribus valde depressis*, *disco utrinque punctis quatuor impressis*; *elytris elongatis, dense subtiliter punctatis*. Long. 13 m.m. (Plate XII, fig. 12.)

Antennæ long and slender, basal joint rather darker than the rest. Head oblong, eyes rather small, not occupying one-half the length; clypeus extremely short, horny, vertex over a large extent closely punctate, anterior portion of the surface quite smooth; genal sutures quite obliterated. Thorax quite as long as broad, of the usual form at the base, but much narrowed towards the front, and at the front margin with the angles so greatly deflexed, that the sides appear sinuate; the surface is shining black, with some sericeous reflections, and is remarkable by the four punctures placed near one another on each side of the middle. Scutellum elongate, densely and finely punctate. Elytra longer than the thorax, closely and finely punctate, dull. Hind body black, with some iridescent reflections, densely and rather finely punctate. Male unknown; female with the front tarsi a little dilated.

This peculiar insect will no doubt form the type of a distinct genus, though at present I cannot point to any character that appears to be of generic importance to distinguish it, except it be the comparatively short and stout basal joint on the hind feet.

New Zealand (Henry Edwards). Dunedin (Hutton, 1878).

*Quedius latifrons*, n. sp.—*Subdepressus*, *niger*, *capite thoraceque subæneis*, *elytris guttulis minutis obscure testaceis*; *abdomine iridescente, segmentis ad basin elytris ad latera setulis flavis parce variegatis*. Long. 10 m.m.

Antennæ rather slender, fuscous, the basal joints rufo-fuscous or piceous. Head broad and short, eyes large and prominent; a series of punctures along the margin of the eye, and two large impressions on the front; clypeus very short and broad, membranaceous, dusky; labrum rounded in middle, but increased by a pallid membranæ, which is emarginate in the middle. Thorax short and broad, shining brassy, with two deep punctures in front of the middle. Elytra slightly longer than the thorax, slightly shining, rather finely, moderately closely punctate, blackish, with two or three minute and obscure flavescent dots on their apical portion, with a few flavescent hairs across the middle, most distinct at the sides. Hind body beautifully iridescent, rather closely punctate, with some flavescent hairs at the base of each segment, arranged so as to form two indistinct spots, terminal styles lurid red; tarsi obscure red.

This species is one of a group found in New Zealand. Its nearest ally is *Quedius wakefieldi* Fauv. in litt., but the two differ in almost all their details.

Bealey. Helms, one female.

PHANOPHILUS (nov. gen. Pæderinorum).

Labrum magnum, medio emarginatum; caput rotundatum, collo sat lato; antennæ graciles laud fractæ. Tarsi anteriores late dilatati; tibiæ anteriores intus subsimplices: tarsi posteriores sat graciles articulo basale quam secundo vix longiore. Generis typus *Lithocharis comptus* Broun.

This genus, though without any very salient characters, is evidently abundantly distinct from any known, and should be placed near *Lathrobium* and *Domene*, and this also is M. Fauvel's opinion. It has not the facies of any of these forms, and is, I think, more like *Pæderus* in this respect. From *Lithocharis* it is abundantly distinct by the form of the labrum, by the strongly dilated front tarsi, and the proportions of the joints of the hind feet. From *Lathrobium* and *Domene* it is distinguished by the almost simple front tibiæ, which are nearly straight externally, and have their lower portion only very slightly flattened or shaved off, as well as by the suborbicular thorax. The mandibles are elongate, strongly bidentate towards the base. The head is large, suborbicular, and the slender antennæ are very widely separated; the clypeus is apparent as a strip of white membrane behind the labrum. The basal ventral segment is strongly carinate at the base. I am acquainted with only a single female; it has the last ventral plate angular in the middle like many *Lathrobia*.

COPROSTYGNUS (nov. gen. Oxytelinorum).

Generis *Coprophili* facie et affinitate. Clypeus sat magnus, sutura profunda, arcuata delimitatus; mentum in medio obtuse acuminatum fere rotundatum; palpi breves, maxillarium articulo penultimo brevissimo, quam ultimo triplo brevior. Tarsi quinque articulati, articulis quatuor basalibus per brevibus; tibiæ anteriores extus versus apicem parce breviterque spinulosæ.

The insect for which this genus is established is closely allied to the European *Coprophilus*, but the numerous differences in some points of detail, which are mentioned above, render it a proper course, I think, to separate it. The species has the slender build of the neighbouring genus *Acrognathus*.

*Coprostygnus sculptipennis*, n. sp.—Elongatus, niger, nitidus, antennis pedibusque rufo-piceis; prothorace fortiter punctato, inæquali; elytris lineis elevatis exaratis. Long 6–6½ m.m. (Plate XII, fig. 14.)

Antennæ stout, very loosely articulated, penultimate joint scarcely so long as

broad. Head narrower than the thorax, with prominent eyes, coarsely and closely sculptured, the clypeus with only a few punctures. Thorax much narrower than the elytra, nearly as long as broad; front and hind margins straight; sides curved, slightly sinuate behind; hind angles rectangular, sharply marked; the surface is closely, deeply, and coarsely punctate, has a large impression on each side, two indistinct impressions at the base, and another on the middle. The elytra are much longer than the thorax, each traversed by about eight raised lines, those near the suture coarser than those external; the intervals between the lines sculptured in a rather indefinite, elongate manner. The male has the fourth and fifth joints of the antennæ dilated; an elevated tubercle at the sutural and apical angles of the wing-cases, a depression on each of the three basal dorsal segments, and a sharply elevated sub-hamate carina on the penultimate segment.

Greymouth. Helms, one pair.

#### OMALIUM.

*Omalium sagoloide*, n. sp.—Haud latum, anterius angustior, rufo-testaceum, capite thoraceque fusciscentibus, minus breviter pubescens; capite thoraceque inæqualibus, profundius impressis, hoc minus fortiter transverso, posterius fortiter constricto; elytris minus punctatis, basi inæquale. Long.  $2\frac{1}{2}$  m.m. (Plate XII, fig. 15.)

Antennæ longer than head and thorax, strongly pubescent; joints 6–10 evidently broader than those preceding; penultimate slightly transverse. Head with the two frontal impressions deep and large. Thorax rather coarsely punctured, with two very deep impressions on the middle, and another at each side. Elytra about twice as long as the thorax, rather sparingly punctate, the punctures towards the apex obsolete, shining, strongly pubescent, with a transverse depression near the base, giving rise to the appearance of a slight callosity on each side of the scutellum.

This species is remarkable from its great resemblance to the more elongate of the species of the genus *Sagola*. It is allied to *O. hirtellum* Fauv. in litt., but is readily distinguished by the more elongate form, less transverse thorax, and more uneven surface of the head and thorax.

Picton. Helms.

---

#### Fam. PSELAPHIDÆ.

##### DALMISUS (nov. gen.).

Antennæ rectæ, undecimarticulatæ. Palpi maxillares breves, simplices, articulo ultimo ovale. Caput superne subproductum, supra antennas fortiter tuberculato-elevatum, his sat approximatis. Tarsi unguiculo unico. Abdomen e segmentis ventralibus sex, dorsalibus quinque, compositum.

The insect for which I establish this genus is not all closely allied to any other European or exotic form known to me. It has the aspect of a *Batrisus*, but in Reitter's arrangement of the family would apparently be placed in the *Pselaphini*. The first ventral segment behind the coxæ is quite short, and is strongly carinate-elevate between the coxæ which are approximate, the following segments are short, the second being, however, as long as the third and fourth together, the fifth short and transverse, the sixth in the male (from which this description is taken) is large at the side, but in the middle is cut away nearly to the base. The first visible dorsal segment is rather short, but longer than the second; this, as well as the third and fourth, are subequal, the apex much deflexed, the two or three basal segments obscurely margined at the sides, with greater inequality in the lengths of the segments. The palpi are similar to those of *Batrisus*. The front coxæ are exerted, and rather elongate. The tarsi consisting apparently of two elongate joints, but there is also really a minute basal joint; the single claw is elongate.

The genus in the New Zealand list should be placed before *Dalma*, from which it is distinguished by the shorter hind body, and the produced front of the head.

In the *Verh. Ver. Brunn*, xx. p. 197, Reitter has briefly indicated a New Zealand genus which he calls *Adalmus* (hitherto without described species), but which, from the brief characters given, evidently cannot be the present genus.

*Dalmisus batrisodes*, n. s.p.—*Subgracilis*, rufus, tenuiter pubescens, antennis pedibusque gracilibus; prothorace elongato, tricanaliculato, canaliculis ad basin foveolatis, impressione basale transverso profundo. Elytris elongatis, basi intra humeros profunde impresso. Long.  $2\frac{1}{4}$  m.m.

Antennæ with the basal joint thicker than those following, and about as long as the second, third, and fourth together; the three terminal joints slender, though stouter than the others. Head with small eyes, which are prominent only in front; in front of them a good deal produced, the genæ delicately, but elongately setose. Thorax as long as broad, much narrowed in front and behind. Elytra without punctuation, but with a sutural stria, and a large deep intra-humeral impression. The male has a very small spine on the intermediate trochanters.

This species was sent me from Greymouth by Mr. Helms some time ago. Though it is probably known to Herr Reitter, as Mr. Helms has been in the habit of transmitting his *Pselaphidæ* to him, it does not appear to have been yet described.

## Fam. PARNIDÆ.

## PROTOPARNUS.

*Protoparnus longulus*, n. sp.—Oblongo-ovalis, fusco-niger, nitidus, longius pilosus, antennis pedibusque rufis; sat crebre et sat fortiter punctatus, elytris obsolete striatis, striis internis omnino deletis, externis ad humeros profunde impressis. Long.  $4\frac{1}{4}$  m.m.

This is closely allied to *P. vestitus*, but is readily distinguished by the more elongate form, and the elongate pilosity of the surface; the punctuation, too, is coarser and more distant.

Picton. Helms, one example.

Mr. Helms informs me that these insects, as I suspected, are not aquatic in their habits, but occur under logs in damp places. *P. vestitus* apparently is not very rare about Greymouth, as Mr. Helms has recently been so kind as to send me several other examples, which agree exactly with the type.

## Fam. SILPHIDÆ.

## CATOPSOLIUS (nov. gen.).

Corpus subdepressum, nitidum absque pubescentia. Pedes graciles, tarsi 5-articulati. Antennæ graciles, articulo octavo quam contiguis angustiore, clava gracile, triarticulata. Palpi maxillares articulo ultimo acuminato, precedente paulo latiore, multo longiore. Prosternum ante coxas sat magnum.

Although very different in appearance therefrom this genus is undoubtedly allied to *Catops*, but the head is not capable of the great inflexion it possesses in that genus, and as a correlative fact the front of the prosternum is comparatively large. The proportions of the joints of the maxillary palpi are very different from those of *Catops*. From *Camarius* the genus is distinguished by the different maxillary palpi, and by the fact that the epipleuræ—very broad at the base, continue to the end of the wing cases, becoming gradually narrower behind. The legs are remarkably slender, the tibiæ quite straight, extremely feebly spinulose externally; the basal joints on the middle and hind feet are much longer than the seconds. The front coxæ are rather small, not very prominent, and have but little extension in the transverse direction, their cavities closed behind and similar to those of *Catops*. The middle coxæ are separated only by an excessively narrow process, and the mesosternum is not in the least carinate. The hind coxæ are very long in the transverse, very short in the longitudinal directions.

*Catopsolius lævicollis*, n. sp.—Ovalis, latus, subdepressus, niger, nitidus, antennis pedibusque rufis; prothorace amplo, lævissimo; elytris fortiter regulariterque seriatim punctatis. Long. 4 m.m. (Plate XII., fig. 16.)

Antennæ longer than head and thorax; very slender; joints 3–6 very slender and elongate, almost similar in length and breadth; seventh joint perceptibly broader, and a little shorter, much longer than broad, eighth joint longer than broad, about as broad as the sixth; ninth, tenth, and terminal joints each longer than broad. Head smooth, shining, and impunctate. Thorax strongly transverse, a good deal narrowed in front, the front angles obtuse, the hind slightly acute owing to a slight sinuation of the base on each side. Scutellum rather large, triangular, impunctate. Elytra, each with nine very regular series of coarse punctures, the external of which touches the lateral margin. Legs very slender.

Greymouth. Helms, No. 158. I have seen only two examples, and regret that I do not know the male.

---

Fam. COLYDIIDÆ.

HETERARGUS (nov. gen.)

Oculi minuti; antennarum clava abrupte biarticulata; canalicula subocularis lata et profunda; pedes omnes sat distantes.

The little insect for which this new generic name is proposed is more nearly allied to *Coxelus* than to any other New Zealand form. The eyes, however, are quite rudimentary, and the minute ciliated prominence existing behind the eye in *Coxelus* is quite absent; the mentum is larger, and the front and middle coxæ are slightly more distant; the last joint of the maxillary palpus is more acuminate, and the basal joint of the antenna is not concealed, as it is in *Coxelus*. The metasternum, ventral segments, and legs are but little different from those of *Coxelus*. The only species yet discovered has the prosternum between the front coxæ traversed by two deep depressions.

*Heterargus rudis*, n. sp.—Fuscus, antennis pedibusque rufis; fere nudus prothorace fortiter transverso, inæquali; elytris obsolete tuberculatis. Long.  $2\frac{3}{4}$  m.m. (Plate XII., fig. 17.)

Antennæ small, with short two-jointed club. Head with clypeus distinctly marked off and scarcely sculptured, with a small elevation over the insertion of each antenna. Thorax broad, the front angles but little prominent, the surface uneven, but very indefinitely sculptured, the lateral margins thick, obsoletely tuberculate seriate. Elytra rather short, with an obscure sculpture arranged longitudinally, consisting of series of very minute elevations, and with two or three interrupted series of larger, but still small, elevations.



This species is very difficult to describe, owing to the undecided character of the sculpture; but the minute eyes, and the two peculiar depressions between the front coxæ will render its recognition easy.

Greymouth. Helms.

#### BITOMA.

*Bitoma sellata*, n. sp.—*Angusta, oblonga, subdepressa, fusco-rufa, supra fusco-ochracea, elytris plaga commune post scutellum nigro-fusca, antennis pedibusque testaceis; prothorace lateribus profunde excisis, lobis angustis longe separatis; elytris tuberculis parum elevatis subseriatim dispositis. Long.  $3\frac{1}{4}$  m.m. (Plate XII., fig. 20.)*

Antennæ red, club not darker; third joint much more slender than second, and a little shorter than it, but little longer than broad; 4–9 small, similar to one another; the two terminal joints forming an abrupt, rather broad club. Thorax with uneven surface, and explanate sides, the explanate portion divided by very large excisions into three elongate slender lobes, one of which projects much forwards and forms the produced very acute front angles, the two others project outwards, and the hind angles form a fourth but very minute prominence. Elytra not at all explanate at sides, bearing numerous blunt slight tubercles. The upper surface is obscurely squamulose and setulose, and there are some minute dark marks, in addition to the common dark mark placed some distance behind the scutellum and by which the species may be readily recognized.

This little insect is very strange in *Bitoma* owing to the deeply rugged sides of the thorax, which are like those of *Tarphiominus* and some of the small *Ulonoti*; but the two-jointed club of the antenna makes its position at present to be more correct in *Bitoma*, to which genus it is connected, as regards the sides of the thorax, by the two species next described. Broun has proposed to separate, under the name of *Ablabus*, those forms allied to *Ulonotus* by the explanate and indented sides of the thorax, but having, like *Bitoma*, only a two-jointed club: as no character is mentioned by which his genus can be separated from *Bitoma* other than the shape of the thorax, and as this in the New Zealand species is too variable to serve when used alone as a generic character, I do not adopt the genus at present, though I do not think the species here described as *Bitoma*, or indeed any of the New Zealand species, will ultimately prove congeneric with the European type of the genus.

Greymouth. Helms, No. 289.

*Bitoma auriculata*, n. sp.—*Oblonga, angustula, ferruginea; capite supra antennis fortiter elevato; prothorace lateribus anterieus lobato-prominulis, posterius longius denticulatis; elytris tuberculis fasciculatis, parum elevatis, seriatim dispositis. Long.  $3\frac{3}{4}$  m.m.*

This species is very like a small *Endophlœus*; but, though there is a very slight enlargement of the ninth joint of the antennæ and the club itself is rather slender, yet it is very evidently only two-jointed. The head is remarkably strongly elevated at each side over the antennal cavity, and the first joint of the antenna is concealed; the sides of the submentum are quite prominent, and there is thus formed a well-marked antennal fovea adjacent to the eye; the legs are short, and there is a very slight incrassation of, and prolongation of, the under-surface of the basal joint of the tarsus. The form of the thorax is remarkable, the front half having the sides dilated as an explanate projection, as in *Tarphiominus*, while the posterior half is not explanate, but merely armed with some elongate denticles or serrations; the surfaces of the head and thorax are rather closely granulate, and the latter is a little uneven; the elytra have regular series of punctures, which, however, only look like punctures when viewed from one direction, and each also has three series of three or four small tubercles, which are a little hispid at the summit; near the scutellum at the base is a longer elevation, and the lateral margins are minutely serrate and hispid. The tibiæ are destitute of any but very fine clothing.

New Zealand; a single example from Murray's collection.

*Bitoma serraticula*, n. sp.—Oblonga, angustula, fusco-ferruginea, antennis pedibusque rufis; prothorace lateribus minus explanatis, serrato-dentatis; elytris regulariter seriatim sculpturatis, hispidulis, guttulis minutis ferrugineis, griseo fasciculatis. Long.  $3\frac{1}{2}$  m.m.

This is allied to *B. auriculata*, having a similar structure of the head and legs, though the elevations over the antennæ are not so large; the sides of the thorax, however, are different, owing to the anterior explanation or lobe being here less developed. The thorax is rather strongly transverse, the surface a little uneven, like the head, closely granulose. The elytra have a very regular serial sculpture, consisting of about nine rows of punctures, the punctures being connected by a series of five crenate elevations; they are also regularly hispid, and have each three series of distinct pallid red, minute spots, the fasciculation of these spots being pallid. The legs are short and stout.

New Zealand; a single example from Murray's collection.

*Bitoma mundula*, n. sp.—Oblonga, angustula, subdepressa, fusco-ferruginea, subtiliter squamosa haud hispida, antennis pedibusque rufis; prothorace lateribus anterius lobato-explanatis, posterius constrictis; elytris tantum ante apicem tuberculatis, apice abruptius declivo. Long. 3 m.m.

Antennæ short, with rather large two-jointed club. Head but little elevated at sides over the antennæ. Thorax with numerous slight depressions, rendering the

surface even, not hispid, and only with very obsolete sculpture, bearing a scanty, extremely fine squamosity, which is more condensed near the sides, so that the surface appears there griseous; the explanate lateral margin is yellowish; it forms a rather large lobe, extending back more than half the length of the thorax, and has a distinct notch before its termination, leaving behind it a slender, rather short, lobe or projection; the hind angle is also slightly prominent. The elytra have no distinct sculpture, but are dull; a little before the apex there are some slight tubercular prominences, the projection being rather backwards than upwards, so that the apex appears rather abruptly declivous, and this part is of rather darker colour, the lateral margins only very obsoletely serrate.

Picton. Helms, one example. Distinguished from *B. auriculata* by the different sides of the thorax and sculpture, and the slighter elevations over the antennæ.

#### ULONOTUS.

*Ulonotus dissimilis*, n. sp.—Oblongus, angustulus, subdepressus, fuscus, supra sordide fusco-rufus, antennis pedibusque rufis, illis clava, his tibiis externe in medio fuscis; prothorace subæquali, lateribus anguste explanatis, integris, elytris brevissime setulosis, tuberculis parum elevatis seriatim dispositis. Long.  $4\frac{1}{2}$ –5 m.m. (Plate XII., fig. 18.)

Third joint of antennæ slender and elongate, nearly twice as long as the third; club large, the ninth and tenth joints darker than the others, the ninth three times as broad as the eighth. Head elongate, without any elevations over the insertion of the antennæ, the surface opaque, densely sculptured; but the sculpture is very obscure, owing to depressed minute squamæ concolorous with the surface. Thorax strongly transverse, the sides nearly straight, but with a very slight emargination in the middle, the anterior angles rather strongly prominent, the posterior nearly rectangular; the surface is covered with granules, the disc very slightly depressed, and, though the surface is slightly uneven, there are no definite elevations. Elytra rather elongate and narrow, with three series of very slightly elevated tubercles, and with very indistinct series of small punctures. The legs are rather slender.

Though this is, apparently, a not uncommon insect in New Zealand, and I some years ago received an example from Captain Broun (with the No. 109 attached), I cannot find any description in his Manual, or the supplements, to agree with it. It was found in numbers at Bealey and Picton by Helms. Reitter sent me an example some time ago from Greymouth, and it was represented in Murray's New Zealand collection. There seems to be little to distinguish it from the type of *Ulonotus*, except the longer head, without elevations over the antennæ.

#### ENARSUS.

*Enarsus cucullatus*, n. sp.—Oblongus, inæqualis, indumento fusco obtectus, prothorace anteriori in medio in lobum longiorem producto, basi utrinque excisione lata sat profunda. Long. 10–12 m.m. (Plate XII., fig. 19.)

This is the largest of the New Zealand Colydiidæ, and though similar to *E. bakewelli* and *E. wakefieldi*, is readily distinguishable by the peculiar thoracic lobe over the head, this being remarkably elongate, not deflexed, and with its sides much raised; these raised sides, moreover, curve round at the front of the lobe and nearly meet one another, being separated only by a slight fissure. The inequalities of the surface are greater than in the other species, and the disc of the elytra flatter, the tubercles behind more prominent, so that the apical portion is more abruptly declivous; the joints of the antennæ, too, are longer than in any of the other species.

Greymouth. Helms, No. 280. Mr. Helms sent me, some time ago, two individuals of this species, but I feared to describe it, thinking it might just possibly prove to be a large variation

*E. bakewelli* or *E. wakefieldi*; he has recently, however, been able to accede to my request for further examples, and I have no doubt it is a quite distinct species.

#### PYCNOMERUS.

As the New Zealand species of the genus *Pycnomerus* are now rather numerous, the following note may facilitate their study:—The genus *Penthelispa* cannot now be maintained, because the New Zealand species supply a transition between those with antennæ of ten joints and those with eleven. The majority of the New Zealand species belong to the ordinary form of the genus, as found in various parts of the world, having large eyes and an elongate metasternum; to this group belong *P. sophoræ*, *simulans*, *minor*, *longulus*, Shp. and *Penthelispa acutangulum*, Reitt. At Greymouth Mr. Helms has met with two very interesting species, nearly or quite blind, and with a short metasternum; these species, *P. sulcatissimus* and *P. latitans*, form a group peculiar to New Zealand, but are connected to the normal type of the genus by an intermediate form, *P. helmsi*. The most abundant and variable of the species is *P. sophoræ*, of which I have seen a large number of examples from each of the two islands. When its variations are understood the other species are very easily determined; *P. sophoræ* varies remarkably in the punctuation, so that the surface is sometimes quite dull, while in other varieties it is nitid, on account of the punctuation being much scantier; it is distinguished by the prominent anterior angles of the thorax, and the shape of the discoidal impression on this part, which assumes the form of a rather deep quadrate depression in front, with a slight prolongation backwards, this posterior part being obscurely divided by a very slight, broad elevation. *P. simulans* greatly resembles *P. sophoræ*, but the discoidal impression extends nearer to the base of the thorax, and is divided by an elongate smooth carina; this species also occurs in both the main islands. *P. longulus* is readily distinguished by its elongate form, less deeply sculptured elytra, with broader, flat interstices; this I have seen only from the southern island. *P. minor* is like a small *P. longulus*, but less elongate, with very indistinct thoracic impression, and antennal club only indistinctly divided. *P. acutangulum*, Reitter I have not been able to recognize, and do not feel sure that

it may not be a variety of *P. sophoræ*. The same remark applies to *P. rufescens*, Broun. The other species described by Broun, *P. simplex*, *ellipticus*, and *basalis*, are, I am pretty sure, unknown to me, and distinct from any I have described.

*Pycnomerus longulus*, n. sp.—*Elongatus*, *angustulus*, *nitidus*, *piceus*, *antennis pedibusque rufis*; interdum *rufescens*; *antennarum clava evidenter divisa*; *prothorace angustulo*, *angulis anterioribus nullo modo prominulis*, *disco vage impresso*; *elytris striatis*, *striis fortiter punctatis*, *interstitiis planis*. Long.  $3\frac{1}{2}$  m.m. (Plate XII., fig. 21.)

Antennæ moderately stout; thorax narrowed behind, slightly longer than broad, closely and coarsely punctate, the disc vaguely depressed, the depression duplicate behind, single in front. Shoulders of elytra free, not at all prominent.

This is closely allied to *P. minor*, though very distinct by reason of the evidently divided club of the antenna. It is also more elongate, and the thoracic impression is a little less obsolete. I do not think the rufescent form is distinct from the dark one.

Greymouth. No. 206; Kumara, and Picton. Helms.

*Pycnomerus helmsi*, n. sp.—*Parum elongatus*, *nitidus*, *piceus*; *capite elongato*, *oculis minoribus*; *prothorace oblongo*, *disco impressione oblonga magna et profunda anguste divisa*; *elytris sulcatis*, *sulcis leviter flexuosis*, *haud punctatis*, *post scutellum transversim depressis*. Long.  $3\frac{1}{2}$  m.m.

Antennæ stout, with club large and only very indistinctly divided, the terminal or pubescent portion small; head densely punctate; thorax scarcely perceptibly narrowed behind the sides, a little contracted near the front angles, which are not prominent, the surface shining but rather closely and coarsely punctate, the disc occupied by a large and deep oblong depression, which is only divided by a slight carina along the middle; elytra with very deep striæ, which are not sculptured, though their edges are a little flexuose, the base is emarginate but the humeral angles are not acute, and immediately behind the scutellum the surface is depressed; metasternum rather short.

This interesting species is an intermediate form between the normal and ordinary New Zealand *Pycnomeri* as represented by *P. sophoræ*, and the blind forms of which *P. sulcatissimus* may be taken as the type. The only examples I have seen are the three sent by Mr. Helms, after whom I have consequently named it.

Greymouth. Helms, No. 291.

*Pycnomerus sulcatissimus*, n. sp.—*Nigerrimus*, *nitidus*, *oculis minutis*, *antennis pedibusque rufis*; *prothorace oblongo*, *fortius punctato*, *disco profunde impresso*, *impressione anguste divisa*; *elytris profunde sulcatis*, *sulcis leviter flexuosis*. Long.  $3\frac{1}{2}$  m.m. (Plate XII., fig. 22.)

This is distinguished amongst the allies by the very deep oblong impression on the middle of the thorax, which is divided only by a narrow carina, extending all along the depression, but less distinct in its anterior part. The eyes are very minute, but still are very easily detected. The eleventh joint of the antenna appears merely as a pubescent apex to the tenth. The thorax has the anterior part of the sides slightly narrowed, the front angles slightly prominent, and the hind angles also distinct. The striation of the elytra is very strong, even the sutural stria being broad and deep, and the striæ not irregular. The metasternum is very short.

I am not sure but that there may still be two species mixed under this name; some of the individuals are only  $2\frac{1}{4}$  m.m. long, and are piceous in colour, the thoracic depression less, and more distinctly separated into two by a broader space; I have not, however, seen enough examples of the two forms to enable me to come to a decision, and prefer treating these smaller specimens merely as a variety.

Greymouth. I have retained for this species the trivial name under which it has been distributed by Herr Reitter.

*Pycnomerus latitans*, n. sp.—*Nigerrimus*, nitidus, oculis minutissimis, antennis pedibusque rufis; prothorace oblongo, fortius punctato, disco leviter biimpresso; elytris profunde sulcatis, sulcis flexuosis. Long.  $3\frac{1}{4}$  m.m.

This is very similar to *P. sulcatissimus*, but is distinguished by some good characters; the lateral margin of the thorax just before the front border becomes thinner, and thus the thorax has an appearance of being suddenly though slightly narrowed in front, and there is no prominence of the front angle; the disc has only two slight impressions, separated by a rather broad space; there is no transverse depression on the wing cases behind the scutellum, whereas in *P. sulcatissimus* the second stria on each elytron is connected by a transverse depression extending behind the scutellum, so that its hind margin is raised; and in *P. latitans* the sculpture of the grooves or striæ is not so effaced as it is in *P. sulcatissimus*, and the eyes are even more minute.

Greymouth. Helms, No. 205.

#### BOTHRIDERES.

*Bothrideres cognatus*, n. sp.—Niger, antennis elytris pedibusque ferrugineis, prothorace subquadrato, fortiter punctato, dorso foveolato, angulis posterioribus argute rectis; elytris apicem versus subcostatis. Long.  $4\frac{1}{4}$  m.m.

Very closely allied to *B. mœstus*, though readily distinguished by the colour of the legs and elytra; the sculpture is almost identical in the two species, except that it is a little more obsolete on the elytra in *B. cognatus*; the latter is, however,

of rather less elongate form, and the thorax is a little shorter, with the hind angles more prominent, and there is no trace of any tubercle on the middle of the prosternum behind.

Bealey, Helms, one example.

---

Fam. NITIDULIDÆ.

Ips.

*Ips minimus*, n. sp.—Brunneo-castaneus, nitidulus, supra subænescens, elytris fusciscentibus, basin versus externe vage testaceo-signatis, obsoletissime striatis. Long. 3 m.m.

Antennæ red with large three-jointed club, which is dusky; head very broad, narrowed and prolonged in front of the insertion of the antennæ, labrum connate with front, but the suture still perceptible; thorax large, just as broad as the elytra, and closely applied to them, rather strongly transverse, nearly straight at the sides, which are evenly and finely margined, base not margined, surface, like that of the head, evenly and finely punctate; elytra rather darker in colour than the other parts, with a large mark of irregular form, and more pallid colour near the base externally; they are finely punctulate and indistinctly striate, the sutural and external striæ being, however, quite distinguishable.

This little creature marks the existence of a quite unsuspected element in the New Zealand Coleopterous fauna. Though from its small size it is very different to the other species of the genus known to me, I am scarcely inclined to separate it generically at present; but it presents the following differential characters:—the thorax has no trace of basal margin, the antennal sulci are directed less inwards, and the prosternal process is remarkably elongate and prominent, so that it attains the front of the metasternum, the mesosternum in the middle being quite smooth for its accommodation. The front coxal cavities are broadly open behind.

Kumara, Helms, a single example.

---

Fam. CUCUJIDÆ.

BRONTOPRISCUS (nov. gen.).

Antennæ fractæ articulo basali elongato. Elytrorum epipleura lata. Tarsi sat elongati, articulo basale brevissimo (interdum fere omnino nullo).

When I described *Brontes pleuralis* I stated that it might be made the type of a new genus, and the discovery of a second species with the peculiarities still more

exaggerated renders it advisable that this should now be done. The remarkably broad epipleuræ separate the New Zealand genus from the Brontes, both of Europe and Australia, and the tarsi are also much different from the former, though similar to those of the Australian species. The tarsal peculiarities are very interesting, as they differ a little in the two species, and show, as it were, the basal joint in the process of disappearing, so as to allow us to understand the occurrence of four-jointed feet in a few of the genera of the family. The basal joint of the foot is very short, while the second is elongate, twice or three times as long as the third, the fourth being very short, and the fifth very elongate; the articulation between the first and second joints is very oblique, especially on the hind feet, so that the second joint lies on the upper surface of the first, and nearly touches the apex of the tibia; this peculiarity is very distinct in *B. pleuralis*, but in *B. sinuatus* it has gone still farther: not only is the basal joint still more reduced in size, but the connexion between the two is so extremely close that the suture can scarcely be detected, and the tarsi appear to be tetramerous with an elongate basal joint.

*Brontopriscus sinuatus*, n. sp.—Depressus, castaneo-testaceus, opacus, prothorace ubique crebre punctato, lateribus profunde serratis; elytris ovalibus, humeris sinuatis; profunde seriatim punctatis, secundum marginem punctis majoribus impressis. Long. 8 m.m. (Plate XII., fig. 23.)

This is similar to *B. pleuralis*, but has important points of difference, the head and thorax, instead of being shining and nearly impunctate are dull, and covered with a coarse, shallow punctuation. The elytra are less elongate, and have a peculiar sinuation at the shoulders, so that the humeral angles are rectangular instead of obtuse. The male has the base of the front tarsi thicker, of the middle and hind more slender, than the female.

#### CATHARTOCRYPTUS (nov. gen.).

Corpus subdepressum, parum elongatum. Antennæ crassiusculæ clava triarticulata. Thorax transversus lateribus muticis. Coxæ anteriores et intermediæ fortiter distantes.

This insect resembles *Cathartus*, and is allied thereto, but has the front and middle coxæ widely separated, the genæ without tooth, and the sides of the thorax without sinuation. The three joints of the antennæ forming the club are all broad; the tarsi are five-jointed, all the joints simple, the three basal on the hind foot all rather small, about equal to one another, fourth rather smaller, fifth as long as the four preceding together. The wide separation of the front coxæ is remarkable, the hind ones being about as approximate as they are in *Cathartus*.



*Cathartocryptus obscurus*, n. sp.—Oblongus, subdepressus, sordide ferrugineus, elytris pedibusque testaceis, prothorace elytrisque plus minusve argute nigro quadrimaculatis; thorace crebre sat subtiliter punctato, elytris subtiliter seriatim punctatis, seriebus apicem versus deletis, interstitiis subtilissime punctulatis. Long.  $2\frac{1}{8}$  m.m. (Plate XII., fig. 24.)

Antennæ short and stout, club large, about as long as the six joints preceding it. Head short, very finely punctulate, nearly dull. Thorax strongly transverse, about twice as broad as long, the surface rather closely and finely punctate, with a more or less distinct black spot on the middle, the sides distinctly narrowed behind, hind angles very minutely prominent. Scutellum transverse. Elytra, with series of fine punctures, which disappear before the apex, with two black spots just before the middle, and a common spot in front of the apex.

Picton, Helms, three examples. *Cathartus advena* and *Silvanus bidentatus* are representatives of other genera near this, and have been found in New Zealand.

#### SAPHOPHAGUS (nov. gen.).

Corpus minutum, depressum, nudum. Antennæ crassiusculæ undecim articulatae, articulis tribus ultimis paulo majoribus. Prosternum magnum; coxæ anteriores globosæ, acetabulis clausis, parum distantes, processu post his sat elongato. Coxæ intermediae minutæ; metasternum longissimum. Coxæ posteriores parum distantes. Abdomen e segmentis ventralibus quinque parum elongatis compositum. Tarsi quinque articulati, articulis quatuor basalibus brevissimis, quinto elongato.

This very minute creature is not at all closely allied to any other form known to me, and from its appearance as well as from the characters I can observe pretty certainly belongs to the Clavicorn series; and the only families in this series its facies suggests that it may possibly be a member of are the Colydiidæ, Cucujidæ, or Cryptophagidæ. I think I have seen with certainty that the tarsi are five-jointed, and the former of these three families may therefore be left out of consideration; while the latter two are so feebly differentiated that, as this genus has no special ally in either, it is a matter of little importance in which it is placed provisionally. As the coxal cavities are nearly always open behind in *Cryptophagidæ*, whereas in the genus I am at present considering they appear to me closed, I decide on placing it in *Cucujidæ*. Only two examples of the insect having been found, I do not think it desirable at present to break one of them up, and the structure must therefore be left largely undescribed. But the remarkable elongation of the metasternum, which is considerably longer than all the ventral segments together, will greatly facilitate the recognition of the form. The antennæ are inserted quite close

to the rather prominent eyes, and these are well separated from the front of the thorax. This latter is by no means closely articulated with the after body. The ventral sutures are deep, and the first segment measured along the middle is longer than the second, but the length behind the coxæ is rather less than that of the second.

*Saphophagus minutus*, n. sp.—Oblongus, depressus, angustulus, brunneo-castaneus, nitidulus, fortiter punctatus; prothorace cordato, dorso obsolete bi-impresso. Long.  $1\frac{3}{4}$  m.m. (Plate XII., fig. 25.)

Antennæ with the exposed portion of the basal joint short, second joint short, stouter than the following: joints 3–8 small, subequal, 9, 10, and 11 forming a very loose club, the 10th scarcely transverse. Head small, rather rounded in front, surface nearly even, rather closely punctate. Thorax about as long as broad, truncate in front, with the front angles depressed and rounded, much narrowed behind, not margined at the sides, constricted in front of the base, hind angles rectangular and with a fovea quite at the angle, the surface very shining, rather coarsely punctate, the two impressions on the middle nearly confluent, and varying somewhat in their outline according to the point of sight (as in some *Pycnomeri*). Scutellum very minute. Elytra with series of coarse punctures, and with a short series interposed at the base between the sutural and the next series, so that there is a slight convergence of the second and third series towards the suture behind the supplementary series; they are rather elongate and completely cover the hind body. The legs are short.

Picton, Helms, two examples.

#### PICROTUS (nov. gen.)

Corpus minutum, glabrum, nitidum, capite angusto, exserto, nullo modo deflexo; antennæ undecimarticulatæ, clava abrupta biarticulata; prothorax grandis, ad elytra arctissime applicatus, margine laterali latissimo, angulis posterioribus productis, supra humeros receptis. Coxæ anteriores et intermediæ minutæ, globosæ, late distantes; acetabula anteriora aperta; prosternum processu magno posterius producto; coxæ posteriores sat magnæ, transversæ, distantes; abdomen e segmentis quinque ventralibus compositum quorum primo ultimoque ceteris longioribus. Tarsi omnes quinque articulati, articulis quatuor basalibus parvis, subequalibus, simplicibus, ultimo elongato.

This genus is established for a minute and very anomalous beetle; the characters permit its location at present among the Cucujidæ, though it has an appearance entirely foreign to that family, suggesting an affinity with Thoricidæ, to which, however, it has apparently but little affinity. The front, the

middle, and the hind body are so closely united together that it is not easy to disarticulate them; and the union between the prothorax and the after-body is so perfect that I could only sever them by taking off the abdomen, and then thrusting them apart by a needle placed in the interior; on the other hand, the head is exerted and possesses much mobility. The small eyes are very convex and contiguous with the front of the thorax; the antennæ are inserted a considerable distance in front of the eyes in large cavities, quite exposed in front and only moderately separated. The antennæ themselves are stout, the first joint is globular, rather larger than the second; this is of similar form; joints 3–9 are all short, and the tenth is abruptly broader, strongly transverse, rather larger than the terminal joint; the labrum is exposed, horny, almost transverse-oblong. The mandibles are corneous, thick at base, strongly curved, acuminate, simple. The palpi are all short and very broad, the maxillary four-jointed, basal-joint small and slender, second closely connected with it by an oblique suture, so that the two look like one elbowed joint, it is about as long as broad; third joint strongly transverse; fourth longer and narrower towards the apex, which however is truncate. Maxillary lobes both distinct, the inner slender, the outer robust, both of them pubescent. Ligula exposed, broad, corneous, simple, labial palpi shaped like the maxillary, except that they are only three-jointed; the genæ form a short obtuse angular prominence on each side at the base of the maxilla. The prosternum in front of the coxæ is rather large, and arches over the small coxæ to project backwards as a broad grooved process attaining the metasternum; there is no projection of the side piece behind the coxa, the cavity consequently being quite open behind. The mesosternum is rather large, is occupied in the middle by a deep groove, with raised edges for the support of the prosternal process, and on either side of this with a curved ridge to complete the enclosure of the front coxæ. The metasternum is rather short, and its side pieces are scarcely visible; the hind coxæ are about as widely separated as those of the front and middle legs, they are transversely conical; the legs are small, the tibiæ feeble, unarmed, without apical spurs. The tarsi are terminated by two rather large simple claws; there is very little difference between the front and hind feet. The ventral sutures are all deep, and the basal segment along the middle is nearly as long as the three following together, these being quite short.

*Picrotus thoracicus*, n. sp.—Brevissime ovalis, testaceo-ferrugineus, politus, glaber, capite porrecto transversim post antennas subrugoso; prothorace magno, omnium latissime marginato, angulis posterioribus prolongatis. Long.  $1\frac{1}{3}$  m.m. (Plate XII., fig. 9.)

The peculiar thorax, with its remarkable broad flat margin, will at a glance permit the identification of this species. The elytra are convex, very short in

proportion to the thorax, very completely covering the undersurface; the scutellum is scarcely visible, the base of the thorax being transversely depressed, and a little prolonged, so that only a very minute tip of the scutellum is exposed; there are no wings.

Bealey, Helms, half a dozen examples. Though amongst the most minute of the New Zealand Coleoptera it is certainly one of the most peculiar.

---

Fam. MYCETOPHAGIDÆ.

TRIPHYLLUS.

*Triphyllus huttoni*, n. sp.—Ovalis, convexus, minus nitidus, nigricans, antennis (clava excepta) pedibusque testaceis, elytrorum humeris rufis; prothorace densissime fortiter, elytris parcius subtiliter, punctatis. Long.  $2\frac{1}{2}$  m.m.

Antennæ with large stout club, which is dark in colour. Thorax strongly transverse, the sides curvate, a good deal narrowed in front, the surface coarsely and very densely punctate, the front angles extremely deflexed, the sides finely margined. Elytra with very indistinct punctuation, covered like the rest of the surface with a very short depressed pubescence, with a well-marked humeral spot.

This was sent from Otago some years ago by Professor Hutton. It is well distinguished by the absence of any serial punctuation or thoracic fovea.

*Triphyllus zealandicus*, n. sp.—Ovalis, convexus, sat nitidus, niger, antennis (clava excepta) pedibusque testaceis, elytris basi summo rufo, prothorace basi apiceque elytrorumque apice sæpius plus minusve rufescentibus; thorace crebre fortiter punctato, basi utrinque foveola rotundata minuta; elytris parce punctatis, ad basin punctis majoribus seriatis impressis. Long.  $2\frac{1}{4}$  m.m. (Plate XIII., fig. 1.)

Although similar to *T. huttoni* this is of smaller size, and can be very readily identified by the serial punctuation and the thoracic fovea.

Sent in numbers from Otago by Professor Hutton at the same time as *T. huttoni*.

*Triphyllus maculosus*, n. sp.—Ovalis, niger, pubescentia grisea tenuiter maculatus. Long.  $1\frac{7}{8}$  m.m.

Thorax only very indistinctly punctured, without basal fovea, but with a slight depression of the surface at the base near each side. Elytra rather more distinctly punctured than the thorax, sparingly pubescent, but with the pubescence a little concentrated here and there, forming delicate small spots, and at the apex a figure 8 on each; there is a slight depression of the surface behind the scutellum, and the suture towards the extremity is very finely elevated, though a sutural stria can scarcely be said to exist.

Greymouth, Helms, No. 59; Auckland, Lawson.

*Triphyllus confertus*, n. sp.—Oblongo-ovalis, convexus, fusco-ferrugineus, prothorace omnium densissime punctato; elytris sparse punctatis, ad basin punctis seriatis magnis impressis, ferrugineis irregulariter nigro-tinctis, pubescentia flava maculatim vestitis. Long.  $2\frac{1}{4}$  m.m.

Readily distinguished from the other species by the dense punctuation, this on the head and thorax is coarse and rugose, there is no basal fovea on the latter. The yellow pubescence on the elytra appears to be confined to the red marks, these form no definite pattern, but are mixed with the black colour in a very irregular and indefinite manner.

Auckland, Lawson; Picton, Helms. One example from each locality.

*Triphyllus concolor*, n. sp.—Ovalis, testaceo-ferrugineus, antennarum clava fusca, prothorace sat crebre et fortiter punctato, basi utrinque foveola rotundata parvula; elytris parce subtiliter punctatis, ad basin punctis impressis majoribus parum conspicuis. Long.  $1\frac{7}{8}$ - $2\frac{1}{8}$  m.m.

In this species the serial punctures at the base of the elytra, though present, are sub-obsolete. It is remarkable from its resemblance to the European *T. suturalis*, Auct., but it is less convex, much more finely punctate, and the thoracic lateral margin is entire, or rather the few serrations present on it are so minute that they can only be distinguished with a strong magnifier.

Auckland, Lawson; Tairua, Broun; Picton and Greymouth, Helms.

*Triphyllus rubicundus*, n. sp.—Breviter ovalis, convexus, ferrugineus, nitidus; prothorace crebrius fortiter profundeque punctato; basi utrinque foveola parvula; elytris parce subtiliter punctatis, ad basin punctis majoribus impressis seriatis; metasterno fortiter punctato. Long.  $1\frac{1}{2}$  m.m.

Although similar to the smaller examples of *T. concolor* this is readily distinguished by the much less elongate form, and the coarse punctuation of the thorax, and still more emphatically by that of the metasternum.

NOTE.—The genus *Triphyllus* has not yet been noted as occurring in New Zealand; Broun's Handbook gives a description of two species of the neighbouring genus, *Typhæa*, which, however, probably do not belong to *Typhæa*, though I doubt whether they will prove to be *Triphylli*. The New Zealand species of the genus have perfectly the facies of the European *T. suturalis*, Auct., for which Reitter has recently proposed a separate generic name, *Pseudotriphyllus* (Verh. Ver. Brunn, 1879, p. 89). Reitter's paper is, however, merely a systematic analytical table of the European species, and can scarcely be considered a serious attempt to set on a satisfactory basis the genera of these small and neglected insects, and the characters he gives to distinguish *Triphyllus* and *Pseudotriphyllus* can scarcely prove to have generic importance, and I therefore treat the New Zealand species as members of the old genus *Triphyllus*. The neighbouring genus, *Typhæa*, likewise occurs in New Zealand, *T. fumata*, introduced no doubt by commerce, having been sent from Auckland by Lawson.

Auckland, Lawson.

## Fam. LUCANIDÆ.

## LISSTOES.

*Lisstotes rufipes*, n. sp.—Piceo-niger, femoribus rufis, supra hic inde dense fortiterque punctato, punctis squamigeris, areis inter puncta politis. Long. 13 m.m.

This is quite similar to *L. reticulatus*, but is of rather narrower form, and is distinguished by the more definite contrast between the punctate and smooth portions of the upper surface. The thorax is quite smooth between the punctate spaces; these, in addition to those at the side and front, consist of four discoidal, nearly circular depressions, the anterior one on each side being separated from that behind it by only a small space; the punctuation along the anterior margin extends nearly all across; the disposition of the punctured and smooth areas on the wing-cases is the same as in *L. reticulatus*, but the latter are proportionally larger. The sides of the thorax are rather strongly bisinuate; the prosternal process is more dilated and prominent behind the front coxæ than it is in *L. reticulatus*.

Picton, Helms, two examples.

## Fam. SCARABÆIDÆ.

## SAPHOBIUS.

*Saphobius setosus*, n. sp.—Breviter ovalis, latus, fusco-niger, opacus, supra breviter setosus, pedibus piceis, antennis pallide flavis; tibiis anterioribus extus ante apicem angulatis, intus valde curvatis, apice obliquo, dilatato. Long.  $4\frac{1}{2}$  m.m.

This is readily distinguished from the other species by the setose surface, and the peculiar shape of the front tibiæ; the latter of these characters may prove to be found in the male only. The broad head is densely punctate, bidenticulate in front. The thorax is moderately closely punctured, indistinctly depressed along the middle behind. The elytra are only obsoletely striate, but the striæ can be well distinguished, owing to the setæ being absent, or nearly so, along their course.

Greymouth, Helms, two examples in bad preservation.

## PYRONOTA.

*Pyronota lugubris*, n. sp.—Ovalis, supra niger, limbo flavescente, subtus flavescente abdomine plus minusve nigricante, antennarum basi pedibusque flavis. Long. 8 m.m.

This is easily recognized by the black colour of the upper surface, the outer margin of the thorax and elytra being yellow, this colour on the wing-cases becoming broader behind, and sometimes extending a little forwards from the apex along the suture. The front tibiæ of the male are slender, but shaped much as in *P. festiva*, and the basal joint of the front tarsus in this sex is longer and more slender than in the other species; the club of the antennæ is elongate.

Greymouth, Helms.

NOTE.—Mr. Helms has been so kind as to capture and forward to me a considerable number of specimens of this genus, so as to enable me to form an opinion about the species. I also received a good many examples from Professor Hutton, and am thus able to form an opinion as to the variation, at any rate, in the centre of the south island. Three species seem to occur there in plenty. 1. *P. festiva* may be recognized by the fuscous stripe extending from the front of the thorax to the extremity of the elytra; there is also usually a fuscous stripe near the side of the wing-case, but this is occasionally absent; the ground colour is usually pallid metallic green, but this varies a good deal, though the surface is never of a fulgid, coppery, or sanguineous hue. 2. A species recognizable by its green colour, without stripes; the green colour is frequently more or less shot with copper or sanguineous red, and this colour occasionally gains predominance, so that the upper surface may be entirely fulgid red, or the thorax and scutellum may be of this colour, the elytra remaining green. *Melolontha læta*, Fab. appears to be a rare variety of this species, in which the fulgid, coppery colour is confined to the middle of the thorax and to the scutellum. I have seen no other examples of *P. munda* than the three I originally described from the north island, but think it will prove to be a variety of this species, which will take the name of *P. læta*, as Fabricius expressly mentioned its most constant character, viz. the concolorous suture. 3. *P. edwardsi*, Sharp: this is apparently rarer than the two preceding; the colour is usually darker, and the suture is golden or metallic, there being sometimes outside this metallic stripe a contiguous line of dull purple or fuscous colour. All these three occur at Greymouth and Otago. I have seen no fresh examples of *P. sobrina*.

---

## Fam. ELATERIDÆ.

### THORAMUS.

*Thoramus wakefieldi*, Shp.—Mr. Helms has met with this insect and *T. obscurus* in some numbers near Picton; both run through similar variations in size and some of the smaller details, and I now feel pretty certain that the suspicion I expressed as to the two being sexes of one species was correct, and propose that they should be united, the trivial name of *wakefieldi* being retained for the species. The variation in size of the individuals is remarkable, some of the females being about 30 m.m. long, while other examples of the same sex scarcely attain 15 m.m. The largest male I have seen is about 21 m.m. long.

*Thoramus parryi*, Cand.—I have made acquaintance with the male of this species by means of an example from the late Andrew Murray's collection. It is

extremely similar to the corresponding sex of *T. feredayi*, but has the meso- and metasterna between the middle coxæ more consolidated, the produced angles of the antennæ less elongate, the sides of the thorax without constriction, and the punctuation of the interstices rather more obsolete. Thus, the four species, *T. wakefieldi*, *T. parryi*, *T. feredayi*, and *T. lævithorax* appear to be valid, though the female of *T. feredayi* is still unknown, and, no doubt, will prove to be difficult to distinguish from the smaller individuals of the corresponding sex of *T. wakefieldi*.

*Thoramus huttoni*, n. sp.—Nigricans, parum nitidus; prothorace elongato, antèrius angustato, crebre subtiliter irregulariter punctato, dorso utrinque area impunctata; elytris subtiliter striatis, interstitiis crebre obsolete punctatis. Long. 19 m.m.

Mas., antennis articulis secundo, tertioque brevissimis, 4-10 angulo apicale interno sat producto.

This species is readily distinguished from others of the genus by the fine prothoracic punctuation; it also possesses an important structural peculiarity; the sides of the mesosternal cavity being very much shorter in front; this character is so striking that it may prove to be of generic importance; the metasternum between the middle coxæ is not very well co-adapted with the mesosternal cavity at the sides, but in the middle the two are consolidated.

Dunedin, Professor Hutton; a single example was sent me from this locality in 1879 by the eminent naturalist in whose honour I have named it.

#### CRYPTOHYPNUS.

*Cryptohypnus thoracicus*, Shp.—Mr. Helms has sent me from Greymouth a series of this species; some of the examples are only half the size of the typical example, and are besides narrower and more parallel, with straighter sides to the thorax; these individuals represent, I have little doubt, the male sex, and they come so near to *C. frontalis* that I feel doubtful whether this latter may not prove to be only a very sparingly punctate variety of *C. thoracicus*: it may, however, be retained as distinct till further evidence can be obtained to settle the point decisively.

*Cryptohypnus pallipes*, n. sp.—Niger, antennis fusco-testaceis, basi, palpis pedibusque pallide flavis; prothorace magno, convexo, nitido, angulis posterioribus elongatis, sat divergentibus, crebrius fere subtiliter punctato, medio canaliculato; elytris subtiliter striatis, interstitiis subtiliter punctulatis. Long. 11 m.m.

This is allied to *C. thoracicus*, but is readily distinguished by the very fine sculpture, and the quite pallid femora and base of the antennæ; the pubescence is short and extremely fine; the thorax is elongate, the length along the middle being just equal to the greatest breadth; the sides are a good deal rounded, and there



is a very distinct constriction in front of the angles; these latter are rather divergent, there is a rather long basal plica on each side in addition to the carina on the angle.

Greymouth, Helms, No. 27; two examples, probably female.

#### CORYMBITES.

*Corymbites irregularis*, n. sp.—Fusco-niger, densius pubescens, opacus, elytris fuscis, antennis pedibusque testaceis; elytris subobsolete striatis, striis irregulariter subinterruptis. Long. 17 m.m. (Plate XIII, fig. 2.)

Antennæ rather long, reaching back a good deal behind the thorax, third joint elongate, fully as long as the fourth. Eyes of moderate size. Thorax elongate, the sides a little rounded and very slightly contracted before the hind angles, densely and finely punctate, canaliculate. Elytra slightly dilated from the shoulders to beyond the middle, thence much narrowed to the apex, so as to be subacuminate, densely and finely punctulate, and with fine striæ, which are irregularly interrupted so as to give somewhat the appearance of a seriate punctuation. Legs yellow, stout; tarsi elongate, stout.

This species is readily identified by its peculiar form, and the conspicuous pubescence, as well as by the peculiar striation of the wing-cases; it is also peculiar structurally, the saltatorial mucro of the prosternal process being only a little prolonged beyond the lower face of the process, and only distinguished from the latter by this possessing an extremely slight tuberculation at its termination. The borders of the mesosternal cavity are not elevated, and the cavity is but little distant from the metasternum; the femoral portion of the coxal lamina is very slender, and the suture or chink between the labrum and clypeus is deep.

Greymouth, Helms, No. 131.

*Corymbites mundus*, n. sp.—Elongatus, parallelus, rufescens, elytris brunescens, antennis pedibusque testaceis; thorace longiore, crebrius fortiter punctato, lateribus rectis; elytris subtiliter striatis, densius subtiliusque punctulatis et pubescentibus. Long. 14 m.m.

Antennæ reaching back a good deal beyond the thorax, third joint scarcely so long as the fourth, but fully twice as long as the short second joint. Thorax shining of a rather bright reddish hue, evidently longer than broad, the sides straight, rather coarsely and regularly punctate, canaliculate at the base only. Elytra slender, very closely and finely punctate, and very minutely pubescent, finely striate. Trochanteral portion of coxal lamina scarcely distinct from the femoral.

New Zealand, Candèze. This should be placed near *C. myops* and *C. strangulatus*. I am indebted to M. Candèze for the only example I have seen; he obtained it, I believe, from Castlenau's collection.

## ASYMPHUS (nov. gen.).

Frons antèrius rotundato-truncata, haud marginata; clypeus brevis perpendicularis; coxæ posticæ lamina exterius perbreve.

The insect for which I establish this genus has quite the aspect of a *Corymbites*: indeed, I at first thought it would prove to be the female of *C. mundus*; but as the front of the head shows a well-marked abrupt inflection of the clypeus, the species cannot be placed in *Corymbites*. This character brings it nearer to *Thoramus*, but it does not resemble any of the species of that genus, and has the mesosternal cavity destitute of elevated margins, and the coxal lamina is very much smaller than in *Thoramus*. The other characters are apparently the same as in the two genera mentioned. The meso- and metasterna are not at all consolidated at their point of contact between the coxæ; the prosternal process is nearly straight, and shows no division into two parts. The genus is not only allied to *Corymbites* and *Thoramus*, but comes very close to *Cryptohypnus* (as illustrated by *C. thoracicus*), from which it is distinguished chiefly by the shape of the front of the head, the deflexed part of the front not being completely unfolded, and by the greater elongation of the basal joint of the tarsi.

*Asymphus insidiosus*, n. sp.—Rufescens, antennis pedibusque testaceis, elytris pallide brunneis; prothorace subquadrato, crebrius subtiliter punctato, angulis posterioribus parum prolongatis, apicibus quasi-obtusis; elytris striatis, obsolete punctulatis, striis ad apicem profundis, apicibus obtusis. Long. 13 m.m.

Antennæ yellow, reaching back slightly beyond the thorax, basal joint stout, second and third short, subequal, fourth twice as long as second. Thorax straight at the sides, and only very slightly narrowed at the front angles, slightly longer than broad, the hind angles but little prolonged, and slightly twisted or uplifted, their apices viewed laterally appearing rounded, the surface is rather closely and finely punctured, extremely feebly pubescent. Elytra rather distinctly striate, the striæ continued without any obliteration to the apex, this not at all acuminate; the interstitial punctuation is very indistinct, and the pubescence very feeble.

Bealey, Helms, one example. I suppose the individual to be a male, it is remarkable inasmuch as the front leg on the right side is aborted, and only one-third the natural size; but the development of the example does not appear to have been in any way affected by this.

## GERANUS.

*Geranus crassus*, Shp.—Mr. Helms has sent me from Greymouth, Picton and Bealey, specimens of *Elater lineicollis*, White, accompanied in each case by one or more examples of *Geranus crassus* from each locality, so that I now entertain no doubt that the two are the sexes of one species, *G. crassus* being the female.

I have seen no other examples agreeing with the unique types of *G. fulvus* and *G. similis*.

#### PROTELATER.

*Protelater elongatus*, Shp.—I have received also a nice series of this insect from Mr. Helms; amongst them is a well-marked variety, represented by a small number of examples, in which the black marks of the elytra are not present, or rather are indefinite and diffused over nearly the whole surface of the wing-cases, so that these become of a dark-brown colour, with one or two small paler spaces over which the dark colour is not diffused. This variety is not connected with the type by intermediate examples, and may be styled var. d. (Plate XIII., fig. 3); it much resembles *P. huttoni*, but has the wing-cases darker in colour, and with the alternate interstices more elevated behind, the sides of the body beneath infuscate, and the process of the metasternum between the middle coxæ broader.

---

#### Fam. DASCILLIDÆ.

##### AMPECTOPUS (nov. gen.).

Corpus parvum, ovale; caput subtus inflexum; antennæ parvæ, undecim articulata, articulis quatuor basalibus majoribus, laxè articulatis, articulis 5–10 per brevibus. Prosternum nullum; mesosternum grande, coxis intermediis sat distantibus; metasternum sat grande, utrinque antè ad pedorum intermediorum receptionem profunde impressum. Coxæ posteriores intus magnæ, a sutura recta arcte conjunctis.

The minute insect forming this very distinct genus will be readily recognized by the peculiar antennæ, and the fact that the inflexed and retracted head is in contact with the mesosternum, which as thus exposed bears a remarkable resemblance in form and position to the prosternum, as seen in many coleoptera. I have only a smashed example at my disposal for ascertaining the characters, and am unable to see the parts of the mouth; the small anterior part of the head is prominent, but the mandibles are apparently covered by the labrum, and no palpi are visible; the eyes are of moderate size, and the antennæ are inserted between the eyes; the space between the eye and the base of the mandible forming a deep depression for the reception of the base of the antennæ in repose. The anterior coxæ are transverse, and are attached by the base to the infolded side of the pronotum, but I cannot detect any prosternum either in front of them or between the tips; the femur is rather widely separated from the coxa by the interposed trochanter, and the tibia is dilated externally near the tip, the minute tarsus being protected by being folded backwards and

placed in close apposition with the tibial dilatation. The mesosternum is placed on the same plane as the metasternum, and extends, in an example in the position of contraction, quite visibly on either side in front of the middle coxa: this is rather large and has a visible trochanter. The front outer angle of the metasternum is occupied by a deep depression for the contracted middle leg, and there is a minute appendage to the larger depression for the accommodation of the tarsus. The hind coxæ are transverse, their inner margins are closely interconnected, and their outer portion is deeply impressed, as in the Elateridæ, for the accommodation of the femur; there are five ventral segments, the basal one showing a deep depression on either side for the reception of the contracted tibia. The hind tarsi are small, five-jointed, the four basal joints small, but the first of them rather larger than the following, the fourth is emarginate above for the reception of the small terminal joint. I do not detect any tibial spurs.

There can be no doubt that this little insect should be placed amongst the Dascillidæ, though it does not appear to be allied to any of the known forms of that family; it has, however, considerable affinity with *Chelonarium*; and though this genus is at present located by systematists in the Byrrhidæ, it certainly should be transferred to the Dascillidæ, so that this affinity does not, in my opinion, invalidate the position I propose for *Amplectopus*.

*Amplectopus ovalis*, n. sp.—*Ovalis*, sat convexus, pallide brunneus, pubescentia depressa, pallida, minus dense vestita, antennis articulis 4-11 nigris; haud dense, fere obsolete punctatus. Long. 2 m.m.

Antennæ with stout first and second joints; third joint also stout, but articulated to the second joint by an extremely slender base; fourth joint larger than those following, which are very minute, the 9th and 10th being however broader than the others, and strongly transverse; terminal joint rather short and broad, nearly as long as the two preceding together. Thorax twice as broad as long, base very closely connected with the elytra. Scutellum triangular, rather large. Elytra almost without sculpture, closely embracing the hind body, their hind margin obliquely subtruncate, a little incrassate, and minutely directed upwards.

This very obscure, but very interesting little beetle, was detected at Greymouth, by Mr. Helms some years ago, but only in a single example, which I sent back to him after examination, and I have now received two other examples from him.

---

## Fam. PTINIDÆ:

PERPLECTRUS (new name for *Xenocera*, Broun).

Corpus subcylindricum, brevissime pubescens. Antennæ undecim articulatæ, articulis 3°, 4°, 6° et 8° minutis, articulis 5°, 7° et tribus ultimis magnis. Prothorax ad latera immarginatus, angulis anterioribus ad coxas sitis, prosternum et mesosternum inter coxas sulcata. Coxæ posteriores quoad longitudinem brevissimæ. Abdomen suturis ventralibus profundis.

The above will be found sufficient characters for the identification of an insect allied to the European genera, *Gastrallus* and *Anobium*, but different by the peculiar enlargement of the fifth and seventh joints of the antennæ; in the European genera just mentioned the three terminal joints are elongate, while all the intermediate joints remain small; these three joints of the club have a similar form in *Perplectrus* to that seen in the European genera. Apart from these characters the genus differs from *Anobium* by the absence of a raised lateral margin on the thorax, and from *Gastrallus* by the number of joints in the antennæ. In form and facies *Perplectrus* is remarkably similar to *Gastrallus*.

This is no doubt the genus Broun intended to establish under the name of *Xenocera*, and I should have been glad to have adopted the name he proposed; but, unfortunately, *Xenocerus* has been in use for a long period for a well-known genus of Coleoptera.

*Perplectrus obscurus*, n. sp.—Subcylindricus, sat elongatus, ferrugineo-brunneus, brevissime pubescens, elytris ad latera vage fusco-plagiatis. Long. 3 m.m. (Plate XIII., fig. 4.)

Covered with a dense, excessively minute pubescence of a pallid fuscous tint, not variegate, though a darker patch appears vaguely defined on each wing-case; this is probably due to some arrangement of the pubescence, as the position and shape of the darker patch varies according to the light and point of view. The antennæ and legs are ferruginous, the former largely developed, the fifth joint being broad as well as long, its width at the apex being, in fact, but little less than its length; the other enlarged joints progressively diminish in width, the terminal joint being very slender and elongate. The prothorax is not quite so long as broad, slightly broader in front than at the base, the surface excessively finely sculptured, without elevations, and with only a slight simulation of conical elevation of the disc. Elytra with quite regular, close striæ, which are distinctly punctate.

Though Broun has described numerous species of *Xenocera*, I cannot make this accord with any of his descriptions.

Bealey, Helms, four examples.

## Fam. TENEBRIONIDÆ.

## PSEUDOPATRUM (nov. gen. Helopinorum).

Antennæ subclavatæ articulo 3<sup>o</sup> elongato, ad basin tectæ; oculi transversim margine anteriore curvato. Pseudepipluræ latissimæ acute inflexæ ad ventri marginem grosse profundeque foveolatæ. Tarsi graciles, subtus satis pubescentes; tibiæ calcaribus brevibus; coxæ posteriores valde distantes, extus brevissimæ.

This genus is proposed for *Opatrum tuberculicostatum*, White (and a very closely allied species), and is of an anomalous character, so that its true position is very doubtful. The clypeus is emarginate in front, and the much-exposed labrum has its front margin of similar shape; the antennary orbit is rather strongly elevated, and is laterally more prominent than the eye. The last joint of the maxillary palpus is securiform. The mentum is moderately large, and the ligula visible at its extremity. The sides of the thorax are dilated and explanate. The front coxæ are small, globular, moderately distant, the process separating them flat, not prominent. The posterior portion of the mesosternum is more prominent (i.e. on a different plane) than the anterior, but not at all impressed, the middle coxæ are moderately distant, globular, their trochanter rather small. The metasternum is short, and the hind coxæ so widely separated that they are very abbreviated in their transverse dimension. The most remarkable character is the great development of the pseudopipleuræ, which, moreover, are so acutely inflexed that their existence would not be suspected from an inspection of the upper surface, and along the sides of the ventral segments they bear a series of extremely remarkable foveæ. The legs are elongate and slender, the tibiæ quite slender, and with two short but distinct spurs. The tarsi are all slender, the pubescence is on the basal joint divided by an impressed line, the penultimate is a little prolonged beneath the terminal joint.

The most natural position for this genus is, in my opinion, near *Adelium* and *Cilibe*; the form of the eyes and the concealed insertion of the antennæ remove it considerably from Pascoe's *Syrphetodes*, and from the extremely curious genus *Paraphylax* Broun, which is remarkable on account of the neck of the mesothorax being greatly and abruptly below the level of the base of the elytra.

*Pseudopatrum sordidum*, n. sp.—Fuscum, opacum, depressum, prothoracis lateribus explanato-elevatis; elytris per paria striatim minute asperato-punctatis, inter paria hic inde vix tuberculatis, ante apicem tuberculis parum elevatis. Long. 12 m.m.

This is extremely similar to White's *O. tuberculicostatum*, but the remarkable sculpture of that insect is present here in a rather more rudimentary condition, the head is not so broad and the antennæ are not so elongate. The surface is sparsely

studded with depressed flavescent setæ. The anterior angles of the thorax are much produced, and the disc is rendered uneven by some indistinct depressions. The scutellum is remarkably small. Along each wing-case there are three or four irregular stripes formed by minute asperities and punctures placed in pairs; the surface between these is scarcely at all elevated, but here and there is slightly swollen laterally; just before the declivous apex there are three slight tubercles on each elytron, the margin is elevated, and within it are coarse, indefinite depressions.

Picton. Helms; one example.

#### SYRPHETODES.

*Syrphetodes bullatus*, n. sp.—Fuscus, indumento ochraceo-brunneo vestitus; prothorace angulis anterioribus per-productis, margine anteriore medio tuberculato-emarginato; elytris convexis dorso tuberculis quatuor grossis instructis. Long. 9 m.m.

Antennæ blackish; thorax with the anterior angles very long, very acute, widely separated from the eyes; the sides bisinuate; the hind-angles free, rectangular, very sharply defined. Elytra nearly twice as broad at the base as the base of the thorax, just behind the shoulder with a sharp tubercle directed outwards, causing the shoulders to look hamate; the disc provided with four very large elevations, and a pair of smaller acute tubercles between them and the base; the sides but little explanate; the lateral outline undulate near the outer margin, with seven or eight foveæ; tibiæ and tarsi blackish, the former spotted with pallid scales.

Greymouth. Helms, No. 31. I received my example of this remarkable insect from Mr. Helms some years ago; it was the first example of the genus I had seen, and I thought it might be *S. marginatus*, Pascoe. Mr. Helms has, however, found recently a small series of a species at Picton, which agrees much better with Pascoe's figure, and I have no doubt the Greymouth insect is new.

#### PERIATRUM (nov. gen. Helopinorum).

*Pseudopatri* affine. Caput utrinque supra oculos fere planum, his subtransversis vix sinuatis. Antennæ articulo tertio sat elongato.

Although this insect is closely allied to *Pseudopatrum*, the differences in the head and eyes, accompanied by other less important peculiarities, warrant its generic differentiation, though the important points of structure are similar. Neither the clypeus nor the labrum is emarginate. The tibial spurs are extremely obscure, and the tarsi are quite slender. The pseudepipleuræ are extremely broad at the base, and there are well defined and acutely inflexed; they are not marked off from the upper surface by a margin, but by a sort of tuberculation; this becomes coarser behind, so that towards the extremity the pseudepipleuræ have ceased to exist; there is no trace of the extraordinary fossæ that exist on them in *Pseudop-*

patrum. This interesting form may, if an intermediate should be discovered, prove to connect the genus *Syrphetodes* with *Pseudopatrum*; though one or two intermediate links as regards the antennary orbits and eyes are required before we are warranted in considering this affinity as established.

*Periatrum helmsi*, n. sp.—Oblongum, haud depressum, supra planulatum, fuscum, opacum, tenuiter setosum; elytris ad latera et apicem irregulariter tuberculatis; antennis pedibusque testaceis. Long. 7 m.m. (Plate XIII., fig. 5.)

Antennæ with third joint one and a-half times as long as the second, a little thickened from the fifth joint to the extremity, the terminal joint being the largest. The upper surface is obscurely sculptured in the form of very minute asperities, quite irregularly placed; there is an irregular longitudinal depression along the middle of the thorax more free from sculpture than the rest of the surface. The thorax is rather broader than long, moderately emarginate in front, the sides a little narrowed behind, the outline irregular, the hind angles nearly rectangular. The scutellum can scarcely be distinguished. The wing-cases are parallel-sided, and their outline behind becomes quite irregular on account of the nodules; there are also two irregular transverse series of nodules extending across the declivous apex. The very broad basal portion of the pseudopipluræ bears large shallow punctures.

Greymouth. Helms, No. 376.

#### APTнора.

*Apthora glabritarsis*, n. sp.—Oblonga, parallela, nigerrima, nitida; prothorace fere impunctato, margine laterale posterius crasso; elytris seriatim subtiliter punctatis. Long. 12 m.m.

Antennæ short, black; each joint from the third to the tenth a little shorter and broader than its predecessor; the penultimate joints strongly transverse; terminal joints large, obtuse; epistome very deeply notched in front, so as to be quite bilobed; thorax about one-third broader than long, its surface with distant, excessively minute punctures. The serial punctures of the elytra are fine, but distinct and very regular; there is a short series on the sutural interval near the scutellum; the interstices impunctate. The tarsi are short and thick, and remarkable on account of their freedom from pubescence or setæ, all that can be detected being a very few placed on the inner face of the tarsus, not on the sole. The only example found is no doubt a male; it has the hind tibiæ denticulate internally below the knee, and the hind margin of the posterior femora and trochanters set with flavescent pubescence.

Picton. Helms. This is an interesting insect on account of the peculiar tarsi: the only other species of the genus has much more slender feet, with a little pubescence beneath.



## ADELIUM.

*Adelium multistriatum*, n. sp.—Oblongum, parallelum, æneum, pedibus piceis, antennis tarsisque rufescentibus, prothorace subquadrato, crebrius fortiter punctato elytris regulariter fortiterque striatis, striis crebrius punctatis, interstitiis angustis. Long. 12 m.m.

This is closely allied to *A. thoracicum*, and has a similar sculpture; the thorax, however, is not conspicuously narrowed behind, and the elytra are remarkable by their deep, regular striation, the striæ being very closely punctured, and the interstices narrow and rather convex. The punctuation of the thorax is similar to that of *A. thoracicum*, but rather more dense, and the sculpture of the vertex is decidedly rugose.

Picton. Helms, one mutilated example.

*Adelium simplex*, n. sp.—Æneo-nigrum, nitidum, pedibus piceis, antennis tarsisque rufis, prothorace subquadrato, lateribus subrectis, postice tantum lenissime angustato, crebre subtiliter punctato, intra latera depressiusculo; elytris multistriatis, sat fortiter punctatis. Long. 9 m.m.

Head closely, moderately finely punctate. Thorax about one-fourth broader than long, rather closely and moderately finely punctured, the sides a little depressed close to the lateral margin, this latter rather broad, the hind angles rectangular. Elytra with series of punctures placed in striæ, the punctures coarse, so that the striation is not very distinct; with one or two spots on the disc where the striæ become disorganized; the interstices almost impunctate. In addition to the punctuation the head and thorax have a few vague larger impressions irregularly placed, and, perhaps, abnormal.

Christchurch. Wakefield, one example. I sent this to Mr. F. Bates some years ago, and he returned it as unknown to him. It should be placed near *A. thoracicum*. *A. æratum* Broun appears from the description to be a closely allied species with differently sculptured elytra.

*Adelium sericatum*, n. sp.—Oblongum, subdepressum, subnitidum, æneum, pedibus piceis, antennis tarsisque rufis; prothorace subquadrato, crebre subtiliter punctato, elytris seriatim punctatis, interstitiis latis sparsim minus subtiliter punctatis. Long. 9–10 m.m.

This is closely allied to *A. simplex*, though readily distinguished by the less shining surface, and by the much finer punctuation of the wing-cases, which are only very feebly striate, the outer series being very obsolete; when compared with *A. simplex*, the striæ are really as numerous (about fifteen) as they are in *A. simplex*, though owing to their greater fineness, and to the broader interstices, and

to the fact that the sides of the elytra are more deflexed, they appear at first to be fewer. There is but little difference in the front tarsi of the two sexes.

Dunedin. Professor Hutton.

*Adelium intermedium*, n. sp.—Oblongum, subdepressum, nigro-æneum, parum nitidum, antennis fuscis, tarsis rufis; prothorace subquadrato, subtiliter marginato, crebre subtiliter punctato; elytris crebre punctatis, obsolete striatis. Long. 8 m.m.

This greatly resembles *A. zealandicum*, but is much less densely punctate, and the fine depressed pubescence of that species is represented in *A. intermedium* by a setosity that is so extremely minute that it can be only detected with a high power, the striæ are quite as obsolete as they are in *A. zealandicum*.

Bealey. Helms; a series of six examples.

*Adelium dunedinis*, n. sp.—Oblongum, convexum, parum nitidum, æneum, antennis pedibusque rufis, femoribus picescentibus; prothorace subquadrato, crebrius subtiliter punctato; elytris subobsolete punctatis, ad basin seriebus minus regularibus punctorum paulo majorum. Long. 8 m.m.

This has most affinity with *A. simulans* Redt., from which, however, it is readily distinguished by the much longer thorax, and by the fact that the serial sculpture of the elytra is confined to their basal half, and is even there more or less irregular. The thorax is fully one-fourth broader than long, the surface very closely and regularly punctate, with a definite punctiform basal fovea on either side, the lateral margin rather fine, the hind angles rectangular, but not sharply marked, the surface convexly transverse, especially in front, so that the front angles are much depressed, and the anterior margin seems comparatively less emarginate than in *A. zealandicum*, and many others.

Dunedin. Another species we owe to Professor Hutton.

#### CERODOLUS (nov. gen. Helopinorum).

Corpus ovale, convexum, absque pubescentia. Pedes graciles, tarsi subtus sat longe pubescentes, articulo penultimo simplice precedente fere angustiore. Prosterni processus latus, inter pedes impressus, apice libero; mesosternum declive.

Antennæ slender, the apical joints scarcely thicker, the third joint a little longer than the fourth; antennary orbits a little elevated; basal joint of antenna partly covered above; terminal joints of palpi securiform; mentum rather broader than long; a little narrowed towards the base; the front oblique on each side, so as to form an angle in the middle; the surface not flat, the prominent antero-medial part being bulged: this apparently accommodates the ligula behind it, for this part is but little exposed; front coxæ rather small, rather widely separated;

the prosternal process impressed between the legs, and behind them not bent up; its extremity capable of close apposition with the vertical front of the posterior part of the mesosternum; metasternum very short; hind coxæ broadly separated; the process between them neither truncate nor acuminate in front, but intermediate in shape between these two forms; ventral segments as in *Adelium*; epipleuræ moderate, gradually narrowed from the base to the apex; legs slender; tibiæ cylindric, smooth; tarsi quite slender, not densely pubescent beneath.

This is another genus of Tenebrionides, not closely allied to any other; but will probably be found allied to some of the little-known forms of the family from New Caledonia, such as *Isopus*. In the New Zealand list it will take its place next to *Adelium*.

*Cerodolus chrysomeloides*, n. sp.—Ovalis, niger, supra æneus, antennis pedibusque rufis; capite thoraceque subtiliter punctatis, elytris subopacis, seriatim foveolato-punctatis. Long. 7 m.m. (Plate XIII., fig. 6.)

Antennæ longer than head and thorax; penultimate joint about as long as broad; head scarcely half as broad as the elytra; thorax a little narrowed from the base to the front, with a very slight sinuation of the sides in the front of the hind angles; these about rectangular, but minutely rounded; the lateral margin very fine; the front not emarginate; the base a little sinuate on either side; the surface finely and not densely punctate, with a minute depression on the base on either side of the middle; scutellum transverse; elytra convex, each with eight series of foveiform punctures, somewhere about twelve punctures in each series; those near the suture and base finer, and those at the apex irregular, so that the surface there is quite uneven. Legs, glabrous unicolorous red.

Greymouth. Helms, No. 377. I first received this insect from Herr Reitter; and, as he wished a name proposed for it, I labelled it "*Adelium? variolosum*;" on investigation it proves, however, to be abundantly different from *Adelium*.

#### ARTYSTONA.

*Artystona obscura*, n. sp.—Elongata, convexa, nigricans, antennis pedibusque rufis; capite thoraceque crebre subtiliter punctatis, subopacis; elytris subtiliter striato-punctatis, interstitiis versus apicem vix tuberculato-elevatis. Long. 12 m.m.

The species of this genus are apparently very close to one another in their external characters, but appear to be subject to very little variation. *A. obscura* is about as large as *A. wakefieldi*, but broader and less linear, and is readily distinguished by the more opaque and less punctate head and thorax, and the very slight development of the elytral tuberculation.

Bealey. Helms. *A. wakefieldi* occurs at Christchurch (Wakefield), Dunedin (Hutton), and Picton (Helms).

*Artystona collaris*, n. sp.—Elongata, nigricans, vix nitida antennis tarsisque rufescentibus, capite thoraceque subtiliter minus crebre punctatis, subopacis, hoc ante basin in medio transversim depresso, clytris striato-punctatis, interstitiis apicem versus parum tuberculato-elevatis. Long. 13 m.m.

This is readily distinguished from *A. wakefieldi* by the more obsolete sculpture and the less shining surface. In these respects it is nearer to *A. obscura*; but that is more convex and less elongate, and has no trace of the depression at the base of the thorax.

Dunedin. G. Copland; sent by G. M. Thomson, Esq.

*Artystona obsoleta*, n. sp.—Elongata, nigricans, pedibus piceis antennis tarsisque rufis; capite thoraceque subtiliter minus crebre punctatis, subopacis; clytris obsolete striato-punctatis vix nitidis, vix tuberculato-elevatis. Long. 12 m.m.

This is distinguished from all the other species by the comparatively obsolete sculpture.

Castle Hill. Enys. I owe my example to the kindness of C. M. Wakefield, Esq.

#### MALACODRYA (nov. gen. Helopinorum).

Corpus subdepressum, dense punctatum, antennis pedibusque gracilibus, elongatis; caput parvum, oculis magnis anterieus emarginatis, antennarum basi exposito. Palpi maxillares articulo ultimo subsecuriforme. Coxæ anteriores leviter prominulæ, haud late distantes, acetabulis oclusis; prothorax marginatus. Pedes ubique pubescentes, tarsi linearibus.

This is another anomalous genus of Heteromera; as it has the anterior coxal cavities closed, the prothorax margined, and the claws simple, the only families of Heteromera where it can be located are the Tenebrionides and the Lagriides of Lacordaire. These two families are, however, separated by a character of only minor importance, viz. the greater prominence and contiguity of the front coxæ in the latter, and in this respect the present genus is intermediate between them; as it does not possess sufficiently the characters of the Lagriides it should be placed in the Tenebrionides, as at present understood, though I must admit that it is entirely different in its facies to the typical components of the family. Its structure, however, is not very different from *Artystona*, the most important differences being that in *Malacodrya* the antennæ are quite exposed at their point of insertion, and that all the coxæ are less widely separated, the prosternum between the front coxæ being, moreover, a little less prominent than the tips of the coxæ.

The mandibles of *Malacodrya* are small, and bidentate at the apex; the mentum is small, broader than long, and the ligula quite exposed at its extremity. The

antennæ are inserted quite close to the rather large and prominent eye, which is sinuate in front; the thorax is small, much narrower than the after body; the middle coxæ are but little separated, their trochantins distinct; the metasternum elongate, its episterna moderately broad; the hind coxæ are separated by an angular process, and are strongly transverse; the ventral segments are five in number, and apparently all mobile; the basal three are of similar lengths, the fourth shorter, the fifth small; the epipleuræ are rather narrow, but become a little broader near the hind coxæ, and cease at the margin of the fourth ventral plate; the legs are remarkably elongate and slender, with minute spurs to the tibiæ, and quite simple penultimate joint to the tarsi; the pubescence on the undersurface of the tarsi is but little dissimilar to that of the rest of the surface.

The genus *Chalcodrya*, Redtenbacher should be located close to the present genus; it has the anterior acetabula closed, and it was owing to some error of observation that Redtenbacher stated the anterior coxæ to be contiguous; they are, in point of fact, separated by a well-marked process of the prosternum, and are only moderately prominent, the process being a little immersed between them.

*Malacodrya pictipes*, n. sp. — Testacea, capite abdomineque fuscescentibus, elytris plus minusve viridi-tinctis, corpore superne pedibus antennisque fuscomaculatis; elytris ante apicem tuberculatis, lateribus post medium undulatis. Long. 6–7 m.m. (Plate XIII., fig. 7.)

Antennæ nearly twice as long as head and thorax; second joint but little shorter than the first, all the others elongate; the terminal three a little thicker than the others; the apices of the joints are infusate to a variable extent; thorax much narrower than the elytra, slightly narrowed behind; the hind angles very obtuse; the front ones quite rounded, the surface densely punctate, a little uneven, the sides finely, the base more distinctly margined, the latter a little notched in front of the scutellum; scutellum transversely triangular, punctate; elytra rather closely punctate, with some dark marks on the sutural region; with lateral prominences close to or on the epipleuræ, causing the outline to be undulate, and with a tubercular elevation on each in front of the apex; the tibiæ and tarsi are pallid, but there is a large very definite dark mark on the middle of the former.

Picton, Greymouth. No. 322, Helms. The only example I have seen from Greymouth differs in having the dark marks on the elytra a little elevated and polished, but can scarcely be more than a variety. The natural colour of this elegant insect is, no doubt, delicate and difficult to preserve after death.

---

## Fam. CURCULIONIDÆ.

## OTIORHYNCHINI.

The classification of this difficult group of weevils has been much improved during the last few years; it is considered by Leconte and Horn as a separate family of Rhynchophora. It is, however, still very difficult to determine in the case of certain weevils whether they belong to this group or not; it is defined as consisting of such Rhynchophora as possess in the pupal condition and immediately on emerging therefrom, supplementary mandibles affixed to the true mandibles, deciduous and usually leaving a scar on the spot from which they were detached. This scar is very conspicuous in the case of the large majority of the genera of Otiorynchini, but in some it can scarcely be detected, and then it can only be by inference that the genus can be determined as belonging to the family, it being rarely possible to observe the creature immediately on its emerging from the pupal condition; fortunately it frequently happens that one or both of the deciduous mandibles are preserved rather longer than usual, and this is of great assistance in these difficult cases. The New Zealand genus *Rhadinosomus* is one of the uncertain forms; it was placed by Lacordaire in the Otiorynchidæ, but I am not able to find any trace of the mandibular scar, and I have not, therefore, included it in the following table of the New Zealand genera of Otiorynchini, though it is quite probable that observation may show that it ought to be so included. In the table the primary division adopted is that of Lacordaire, according to the presence or absence of an ocular lobe; only one of the New Zealand genera was known to Lacordaire, viz. *Catoptes*, and this he placed in the wrong division. *Catoptes* possesses an ocular lobe, though in only a rudimentary state; indeed Mr. Pascoe has re-characterized the genus, under the name of *Irenimus*, and correctly stated that it possesses an ocular lobe. For the information of New Zealand entomologists I may say that the ocular lobe, when rudimentary, consists merely of a slight projection of the side of the thorax towards the eye; but it is nearly always accompanied by two correlative marks, viz. an emargination of the front of the prosternum, and a change in the form of the eye, the rule being, that in species with an ocular lobe the eye is increased in diameter from above to below, whereas, when there is no ocular lobe, the tendency is for the eye to increase in the transverse diameter that is to extend towards the tip of the rostrum. It is especially necessary to remember this in examining these New Zealand insects, because in them the ocular lobe itself is never extremely developed, and is frequently quite rudimentary. The opening of the corbels or tips of the hind tibiæ is also a very important character in the present classification of the family, and this also in the case of the New Zealand insects is frequently exhibited in only a rudimentary form. White's genus, *Platyomida*,

can scarcely be considered to have been properly described; but as the type exists in the British Museum, and shows it to be the same as *Empæotes*, Pascoe, I have adopted the older name, though with much hesitation and regret. Broun's *Eurynotia pulcherrima* is a synonym of *Ancistropterus hochstetteri* Redt. The insect was ascribed quite erroneously by Redtenbacher to *Ancistropterus*; and as I am not able to see any character to separate it from *Empæotes*, I have not included *Eurynotia* as a genus in the table:—

Thorax without ocular lobes,	
Corbels closed,	
Scrobes minute, . . . . .	<i>Nicæana</i> .
Scrobes distinct, rostrum pterygiate, . . . . .	<i>Otiorhynchus</i> .
Corbels cavernous,	
Front tibiæ dilated externally at tip, . . . . .	<i>Cecyropa</i> .
Front tibiæ normal at tip,	
Scrobes short,	
Tip of rostrum not dilated, scrobes cavernous, . . . . .	<i>Nonnotus</i> .
Tip of rostrum dilated, hind coxæ moderately distant, . . . . .	<i>Protophormus</i> .
Tip of rostrum dilated, hind coxæ very widely distant, . . . . .	<i>Epitimetes</i> .
Scrobes elongate, . . . . .	<i>Platyomida</i> .
Thorax provided with ocular lobes,	
Front coxæ separated, . . . . .	<i>Aporolobus</i> .
Front coxæ contiguous,	
Corbels closed,	
Rostrum short, scrobes abbreviate,	
Ocular lobes very feeble, scape short and stout, . . . . .	<i>Protolobus</i> .
Ocular lobes definite, scape elongate,	<i>Catoptes</i> and <i>Brachyolus</i> .
Rostrum and scrobes elongate, . . . . .	<i>Heterodiscus</i> .
Corbels cavernous, . . . . .	<i>Inophlæus</i> .

#### CECYROPA, Pascoe.

Rostrum breve, crassum; scrobes brevissimæ, profundæ; antennarum clava breviter ovalis. Tibiæ anteriores apice extus dilatato.

This is a very interesting form, reproducing in several respects the characters of one of our most familiar European weevils formerly assigned to *Cneorhinus*, but now correctly separated as the genus *Philopedon*. It differs, however, in some very important particulars: *Philopedon* is one of the genera where the mandibular scar is present, but only in a rudimentary condition; whereas, in the New

Zealand insect it is apparently quite absent; so that this genus cannot be assigned to the Otorhynchidæ with certainty at present.

The rostrum is very short and thick, and the short scrobes are very deep; they possess, however, at their upper and posterior part, a slight prolongation directed towards the under-surface of the rostrum, not towards the eye; the mentum is rather small, but the maxillæ are not exposed; the scape of the antennæ is elongate, reaching back behind the front margin of the thorax; the eyes are round, but little convex; the thorax is without the slightest trace of ocular lobes, but vibrissæ are present in a rudimentary state; the prosternum is not emarginate in front, and is of moderate length; the front coxæ are rather small, and are contiguous, though their cavities are very nearly separated; middle coxæ a good deal, hind very widely separated; first ventral segment moderate, separated from the second by a strongly arcuated suture, which is obliterated in the middle; tarsi with the third joint bilobed; the first joint of the front feet entirely concealed (viewed in front) by a prolongation of the tibiæ; truncature of hind tibia uniform (= "corbilles cavernuses," Lacordaire), and surrounded by short thick transparent setæ, which are almost spines; the hind tibia is much dilated at the apex; the claws of the tarsi are small.

The above characters are taken from *Cecyropa albicans*. *C. tychioides*, Pascoe, has the front coxæ just perceptibly more separated, the thorax is provided with well-developed vibrissæ (but, independent of these, is quite destitute of ocular lobes), and the corbels are studded with peculiar squamæ or tubercles. Thus, it exhibits the characters of *C. albicans* in a more perfected degree.

*Cecyropa albicans*, n. sp.—Rufa, fere ubique albido-squamosa, prothorace transversim subgloboso, antice angustiore; elytris subtiliter seriatim punctatis, lateribus post humeros dilatatis. Long. 5 m.m.

Antennæ with the scape covered with white scales, and bearing numerous erect setæ, the third joint rather shorter than the second, the penultimate joints transverse, the club short-ovate; eyes very widely separated; thorax broad, very much rounded at the sides, more narrowed in front than behind, and with a faint constriction behind the front; the base obsoletely margined, without channel or other impressions, uniformly covered with fine white scales, and also with minute distant setæ; elytra clothed like the thorax, but the setæ are even more minute; they bear regular series of fine distant punctures, and they have a lateral dilatation behind the shoulders; a minute scutellum is visible.

Otago. Professor Hutton; one example.

#### PROTOPHORMUS (nov. gen. Otorhynchinorum).

Rostrum breve, crassum, pterygiatum, scrobes brevissimæ. Oculi subconvexi, a prothorace remoti; antennæ elongatæ, scapo oculos superante, prothoracis marginem attingente. Prothorax subcylindricus, lobis ocularibus nullis.



This insect is very similar in facies to the European genus *Phyllobius*, from which it differs by the development of the pterygia, and also by the fact that whereas in *Phyllobius* the tip of the hind tibia is edge-like and bears only one series of setæ, it is here minutely truncate and bears two closely approximated series of ciliæ, so that the "corbeilles cavernouses" of Lacordaire are here present in a rudimentary\* state, though this structure is so minute that the corbeilles would be said to be open by Lacordaire had he known the insect. There are also other important differences from *Phyllobius*, such as that in *Protophormus* the hind coxæ are widely separated; the mentum is small but fills the buccal cavity; the mandibular scar is present; the front coxæ are small and contiguous, and placed not very far from the front margin of the prosternum, which is not all emarginate; the metasternum is rather short, about as long as the first ventral segment in the middle, the second ventral segment is rather short.

Although the insect does not much resemble *Otiorhynchus* in appearance, yet it appears very closely allied thereto, the only character in fact which distinguishes, so far as I see, the two with certainty being the slightly cavernous corbeilles of *Protophormus*.

*Protophormus gracilis*, n. sp.—*Angustior, fusco griseoque squamosus, plus minusve variegatus, antennis rufis; thorace subcylindrico, medio vix dilatato, longitudine vix latiore.* Long. 5 m.m. (Plate XIII., fig. 9.)

Antennæ elongate, second joint longer and stouter than the third, eighth joint about as long as broad, club large, very elongate oval; rostrum not grooved, the front of the eye placed about half the distance between the front of the thorax and the insertion of the antennæ; thorax much narrower than the elytra, only very slightly broader in the middle, and minutely narrowed in front, the surface densely squamose, not at all uneven or rugose; scutellum small; elytra variable in the colour of their clothing, usually brown, mottled with gray, but sometimes nearly concolorous, there remaining always a more or less distinct pallid mark at each side near the hind femur; they bear striæ of fine punctures and a few fine setæ, and the fifth interstice is a little raised or subnodulose in front of the apex: this is acuminate; the front tibiæ are flexuose inwardly, and mucronate at the apex.

Greymouth. Helms, No. 23. Prof. Hutton found a closely allied species in Otago, and sent me a good series of the sexes in 1879, this is, I have no doubt, the insect described by Broun as *Catoptes cuspidatus*; the female is well distinguished from *P. gracilis* by the produced apices of the elytra, and by the bare tubercle on the thorax; these characters, however, are not present in the male, and this sex can only be distinguished from *P. gracilis* by the thorax being rather less cylindric, and having the sides a little more dilated in the middle.

---

\* I do not mean by this phrase to imply that this is a primitive condition, on the contrary, I think it probable that the cavernous apex is a lower form than the laminate.

*Protophormus binodulus*, n. sp.—Fusco vel griseo-squamosus, vix variegatus, antennis rufis; thorace subcylindrico antrorsum paululum angustato; clytris minus elongatis ante apicem binodulosis. Long. 6 m.m.

Slightly larger and more robust than *P. gracilis*, and readily distinguished by the existence of a longitudinal nodule or elevation on the third interstice, just at the commencement of the apical declivity. The surface is densely covered with scales varying in colour according to the example, but scarcely at all variegate; the prothorax is elongate, and its surface bears some very obsolete rugæ; the elytra possess regular series of rather large punctures, and, in addition to the nodule on the third interstice, there is a very slight elevation of the fifth interstice, a little more to the front than the other elevation.

Greymouth. Helms, No. 95. Mr. Helms identified the sexes of this species for me by observation of the living insects, the male appears to be rather more slender than the female.

*Protophormus robustus*, n. sp.—Latiior, griseo-squamosus, antennis pedibusque piceis; prothorace rugoso; elytris ante apicem nodulosis, apicibus productis acuminatis (an feminae tantum?) medio ante apicem pallido-squamoso. Long. 8 m.m.

This is distinguished from the other species not only by its larger size, but also by the more uneven surface and broader scutellum. The rostrum is carinate along the middle and minutely foveate between the eyes; the surface of the thorax has numerous coarse rugæ; the broad elytra also have the surface uneven, and bearing series of rather coarse distant punctures, each of which is occupied by a more pallid scale, the interstices present here and there slight longitudinal elevations, the third, fifth, and seventh have each a more distinct elevation at the commencement of the declivity, that nearest the suture being much the larger; behind these two larger elevations the surface extending to the apex is densely clothed with more pallid scales, and on either side there is a large patch of darker—nearly black—scales; the apices are prolonged.

Otago. Professor Hutton; one example. This is probably a female, and from analogy with *P. cuspidatus* it is possible the male may have the apices less produced. The species bears a superficial resemblance to *Catoptes*, from which the form of the head and anterior parts of the thorax readily distinguish it. The tips of the posterior tibiæ are even less cavernous than they are in *P. gracilis*; so that, had it not been for my previous knowledge of that insect, I should have considered the corbels as open in the present insect, yet a really careful inspection shows that they are truly cavernous in a rudimentary manner. The sculpture and form of the insect are very similar to those of *Empæotes censorius*, Pascoe; but that has a less pterygiate rostrum, with definite scrobes directed towards the front of the eye.

#### NONNOTUS (nov. gen. Otiornychinorum).

Rostrum breve, crassiusculum, subcylindricum, scrobes brevissimæ. Oculi magni haud convexi superne minus distantes.

This is closely allied to *Protophormus*, from which it differs in the form of the

head and rostrum, this latter being destitute of pterygia, while the head is much narrowed, and the eyes placed more on its upper face. The truncature of the posterior tibiæ is much the same as in *Protophormus*, though the truncate surface is scarcely so minute. It should be remarked that, though the rostrum is not expanded at the apex, yet the scrobes are quite visible from the front; they are very deep at the insertion of the antennæ, but very short and very indefinite behind. The structure of the antennæ, and indeed all the other characters, seem nearly the same as in *Protophormus*.

*Nonnotus griseolus*, n. sp.—*Angustulus*, squamulis pallide griseis vestitus, antennis tarsisque rufis, tibiis rufo-obscuris; prothorace subtransverso lateribus rotundatis. Long. 5 m.m. (Plate XIII., fig. 8.)

Antennæ rather long, second joint longer than the third, eighth hardly so long as broad, club large, elongate oval; rostrum punctate, the squamosity not so dense as on the elytra; eyes large, but not at all convex; thorax evidently broader than long, even, without impressions or rugosities, the sides a good deal rounded, more narrowed in front than behind, the surface rather closely punctate, but the punctuation almost concealed by the pallid squamosity; scutellum rather small; elytra rather densely and uniformly covered with very pallid scales, and bearing minute pallid hairs, very finely striate.

Otago. Professor Hutton; a single example.

#### EPITIMETES, Pascoe.

Corpus robustum, dense squamosum, setosum. Rostrum breve crassum; scrobes perbreves. Antennæ elongatæ scapo gracile, prothoracis marginem attingente. Prothorax latiusculus, lobis ocularibus nullis. Corbellis posterioribus leviter cavernosis.

There can be no doubt as to the position of this genus, which should be between *Protophormus* and *Platyomida*: it is very different from the former genus in appearance, and differs in numerous details, the eyes are more pointed below, the rostrum thicker and more quadrate, and the hind coxæ extremely widely separated; the scrobes are very short and their posterior part excessively vague, as in *Protophormus*, but nevertheless taking a different direction, being, in fact, directed towards the lower part of the front of the eye, not to the under-surface of the head; the posterior corbels are very evidently, though not broadly, cavernous; the short rostrum and obsolete scrobes readily distinguish the genus from *Platyomida*; there is no trace of ocular lobes, and the short prosternum is but little emarginate in front; the metasternum is excessively short, and the intercoxal process of the first ventral segment extremely broad, quite truncate in front; the second ventral segment much shorter than the first; the facies is quite similar to that of *Brachyolus*, which, however, has a well-marked ocular lobe.

*Epitimetes wakefieldi*, n. sp.—Niger, indumento sordido fusco-squamoso; prothorace latiusculo antennis angustato ante medium foveolato; elytris apicem versus obsolete tuberculatis. Long. 8 m.m.

The whole surface is covered by a mixture of exudation and scales, giving it an uniform dark colour, the setæ projecting through this clothing; the second and third joints of the antennæ are slender and elongate, subequal in length; the very short thick rostrum is a little depressed between the eyes and carinate along the middle; the thorax is broad, not narrowed at the base, but rather abruptly narrowed in front: it is rugose, and has a vague depression along the middle, which near the front becomes conspicuous, it is also a little depressed on either side; the elytra are broader than the thorax, and have the third, fifth, and seventh interstices a little raised; this elevation terminates as a slight tubercle on the third and fifth interstices in front of the declivous apex; and, on the fifth, there is another small tubercle behind the front one; the seventh interstice has no tubercle behind, but, at the shoulder becomes so strongly raised as to form a lateral margin: the serial punctuation is obscured by the clothing.

Christchurch. C. M. Wakefield, Esq. Though very different in form from *E. lutosus*, Pascoe, this species seems quite to agree with it structurally.

#### PLATYOMIDA, White.

*Platyomida coronata*, n. sp.—Convexa, nigra, dense griseo-squamosa, interdum subolivaceo-tincta; prothorace rugoso; elytris tuberculis prominulis sex ornatis. Long. 6–8 m.m. (Plate XIII., fig. 12.)

Antennæ elongate and slender, scape squamose and setose, second and third joints elongate, the former rather the longer, club very elongate oval, rostrum carinate on middle, eyes sub-convex; thorax much narrower than the elytra, surface rugose, densely squamose; elytra convex, obliquely narrowed at the shoulders to the base of the thorax, the surface a little uneven, in addition to the circle of tubercles there being a slight elevation of the third interstice at the base, and also one or two other less distinct elevations, the third interstice bears on the middle a rather small tubercle, and behind it a much more elongate one, while the fifth interstice bears another tubercle, the surface is densely squamose, and also bears coarse setæ, which are more concentrated on the tubercles; the rows of punctures are rather coarse, but are rendered indistinct by the squamosity; the anterior tibiæ are slender and flexuose.

Greymouth. Helms, No. 31. This has been sent in considerable number; and, according to a pair sent separately by Mr. Helms as representing the sexes the female has the elytra more inflated, and the tubercles rather less prominent; but this may not be constant, as I find the two characters do not always go together.

The scrobe in this species is not so elongate as in the typical species of the genus; but I do not think this sufficient for generic differentiation.

*Platyomida simulatrix*, n. sp.—Minor, griseo-squamosa, haud variegata; prothorace cylindrico, rugoso; elytris interstitio tertio longitudinaliter ante declivitatem magis elevato. Long. 6 m.m.

This is extremely similar to *Protophormus binodulus*, but the surface is more uneven, though the apical nodules are less developed; the scape of the antenna is rather short, the apical portion much incrassate, the short broad rostrum has on the middle two very short feeble grooves, separated by a slight carina; the thorax is remarkably cylindric, and its surface coarsely rugose; the elytra bear regular series of rather coarse punctures, and the third interstice has an elongate, slight elevation at the commencement of the apical declivity; only a very slight elevation of the fifth interstice can be detected, and this is elongate, not in the least nodular.

Greymouth. Helms, No. 96; a single example. Though so similar to *Protophormus binodulus*, the species will be readily separated therefrom by the deep elongate scrobe attaining very nearly the front margin of the eye. It is very closely allied to *P. (Empæotes) censoria*, Pascoe, but scarcely attains the size of the smallest examples of that species, and is readily distinguished by the absence of the nodules seen in *P. censoria*.

#### APOROLOBUS (nov. gen. Otiorrhynchinorum).

Corpus parvum, indumento obscuratum, setosum; antennæ scapo crasso; rostrum breve, scrobes profundæ, foveiformes; coxæ anteriores sat distantes; loba ocularia obsoleta. (Plate XIII., fig. 10, *A. irritus*.)

This genus cannot be associated with *Trachyphlœus* on account of the separated anterior coxæ; and, moreover, though the ocular lobes are excessively rudimentary, yet it is clear the genus is correctly placed in the group characterised by the possession of the lobes in question. In *Aporolobus* the prosternum is markedly emarginate, the eyes are placed near the thoracic margin, and extend slightly downwards rather than forwards; these characters being usually correlative with the ocular lobes, and the lobes themselves being faintly indicated, there can be, I think, no real doubt as to the position of the genus. The separation of the front coxæ is exhibited by only a few genera of Otiorrhynchidæ, though it is here conspicuous. The coxæ are small and very little prominent; the metasternum is excessively short, the second ventral segment is of moderate length, and the posterior corbels are not cavernous; the mandibular scar is quite perceptible; the tarsi are quite of the *Trachyphlœus* type, very short, with very broad third joint, the lobes of which, however, are short. The only species known to me is *Trachyphlœus irritus*, Pascoe.

The presence or absence of ocular lobes is at present considered of primary importance in the classification of the Otiorrhynchidæ, but if there should prove to be many genera in which it is as vague a character as it here is, it will be impossible to treat it as a character of primary importance.

## PROTOLOBUS (nov. gen. Otorhynchinorum).

Corpus parvum, indumento obscuratum, setosum; antennæ scapo crasso; rostrum breve crassum, scrobes modice elongatæ parum distinctæ; coxæ anteriores contiguæ; loba ocularia parum distincta.

This is undoubtedly closely allied to the preceding genus, though the front coxæ are in the normal condition as to contiguity; the scrobes, too, are differently constructed, instead of being broad and deep cavities tending directly upwards towards the front and anterior part of the eye, they are here finer, and their terminal portion, though not very distinct, is directed towards the undersurface of the head; the metasternum is short, but not so extremely short as it is in *Aporolobus*; the other characters seem to be much the same as in that genus. I refer two species to the genus. Of the three individuals I have seen, two show the minute palpi visible at the front of the mentum; I am not sure whether this may not be abnormal.

*Protolobus obscurus*, n. sp.—Longulus, indumento grisescente vestitus, parcius albido-setosus; prothorace elongato, subcylindrico. Long. 3 m.m.

Antennæ with the third joint only half as long as the second, club elongate oval, acuminate; eyes widely separated, and very little visible from the front; thorax elongate, subcylindric being nearly straight at the sides; elytra rather narrow and elongate. No sculpture can be seen owing to the dense exudation with which the surface is covered; but the setæ project through this, and on the elytra form regular series. There is a slight appearance of nodulosity on the commencement of the declivity of the wing-cases.

Otago. Professor Hutton. The second species of the genus is from the same source, and may perhaps be *Trachyphloeus parvulus*, Pasc.

CATOPTES, Schönherr. (*Irenimus*, Pascoe).

Although placed by Lacordaire in his division without ocular lobes, this genus really belongs to the other division. It is true the ocular lobes are but slightly defined, still they are clearly present, and the correlative position and form of the eyes leave no doubt as to the true place of *Catoptes*: when Lacordaire's error is corrected and his description amended it will be seen that there is nothing to distinguish Pascoe's genus *Irenimus* from *Catoptes*. *Brachyolus punctipennis* assigned by me provisionally to that genus approaches closely in the systematic characters to *Catoptes*, but has the ocular lobes well marked, and the emargination of the prosternum abrupt; also the buccal cavity is more open at the base.

*Catoptes brevicornis*, n. sp.—Dense pallide griseo-squamosus, fusco-varie-

gatus; prothorace minus elongato lateribus æqualiter rotundatis; elytris apicem versus fere enodulosis, apice oblique albido. Long.  $4\frac{1}{2}$  m.m.

Rostrum densely squamose, not visibly carinate. Thorax rather short and small; strongly transverse; much narrower than the elytra; the sides rounded, the greatest width near the middle; the front margin a little constricted, and rather narrower than the base; the surface densely squamose, a little variegate, there being a vague abbreviated lateral white vitta, and within this at the base a dark fuscous spot. Elytra also variegate, the sutural region being in greater part fuscous, and the lateral pallid grey, nearly white; the third interstice has a very minute obsolete nodosity in front of the declivity, but there is none at all on the fifth; the setosity is well marked. The antennæ are dark-red, the third joint shorter than the second; the eighth not so long as broad. Allied to *C. obliquesignatus*, but much smaller, with shorter thorax and antennæ.

Otago, Professor Hutton; Auckland, Lawson.

*C. obliquesignatus*, Schon., is evidently a variable species; it has an elongate thorax and antennæ, the greatest width of the former in front of the middle: I have the species from Auckland and Christchurch, as well as intermediate localities: a variety, or possibly a distinct species, has shorter antennæ and thorax; this I have from Auckland and Otago. The type form of *C. brevicornis*, as above described, is from Otago; the specimen from Auckland is a variety with still shorter and thicker antennæ, so as to make a considerable approach to *Protolobus*; the example is apparently dirty, and it may possibly be a distinct species; an example from Otago agrees with it. Broun gives a description of a *C. obliquis*, Schon. (*Man. N. Z. Col.*, p. 428); but Schonherr described only one species, *C. obliquesignatus*, which is given by Broun on p. 693. Some years ago I received examples of *C. obliquesignatus* from Broun, with the information that they were found on the ngaeho-tree.

*Catoptes scutellaris*, n. sp. — Minus gracilis, pallide fusco-squamosus apice pallidiore; prothorace subrugoso; elytris thorace latioribus, disco minus convexo, seriatim remote punctatis, ante apicem nodulis parvis quatuor munitis. Long. 6 m.m.

Antennæ rather elongate, second joint longer than the third, eighth nearly as long as broad. Thorax nearly one-fourth broader than long; the sides a good deal rounded and much narrowed in front, less so behind. Elytra broad, distinctly flat on the disc; scutellum rather broad, and touched on each side by a minute swelling of the wing-case, furnished with distinct rows of rather distant punctures, and with two quite distinct distant small tubercles on each placed on the same level, and forming only a slight curve transversely; setosity of the surface indistinct.

Though similar to the Auckland form of *C. obliquesignatus* in colour, this is a very distinct species, approximating in form to *Brachyolus punctipennis*: the more rugose thorax, and larger scutellum are easy and certain marks for distinguishing it from *C. obliquesignatus*.

Otago, Professor Hutton; a single example.

*Catoptes longulus*, n. sp.—*Angustior*, *elongatus*, *pallide griseo-squamosus*; *prothorace elongato*, *obsolete rugoso*; *elytris thorace latoribus*, *seriatim remote punctatis*, *ante apicem nodulis parvis quatuor munitis*. Long.  $6\frac{1}{2}$  m.m.

Closely allied to *C. scutellaris*, but of much narrower form, and pallid griseous colour. The rostrum is rather longer and more slender; the thorax is a little broader than long, and has a slight oblique broad depression on each side near the front; the scutellum is quite distinct, and there is not the slightest swelling at its sides. The elytra are minutely uneven, and the rows of distant punctures they bear are quite distinct, those on the deflexed sides being even more distinct. The setosity of the surface is very slight. The example is, no doubt, a male, and has the basal and apical ventral segments longitudinally depressed along the middle.

Dunedin, Professor Hutton; a single example sent in 1879.

#### BRACHYOLUS, White.

The species for which this genus was established was found in plenty by Mr. Helms near Picton. It has well-marked ocular lobes, and a deeply-emarginate prosternum; the front coxæ are contiguous; the short thick rostrum has short, very deep scrobes, almost as in *Aporolobus*; and the corbels of the hind tibiæ are quite open; this latter character will not permit its association with *Inoplœus*. It is totally dissimilar from *Heterodiscus* in appearance; and the short rostrum, with different scrobes, quite separate it from that genus. I now associate with White's typical species some others differing from it in certain points, as will be noticed in the descriptions, and for which it is possible two other genera may be required; but as I wish to restrict the number of these as much as possible at present, I shall not adopt this course; but I may state that *B. punctipennis* and *longicollis* approximate to *Catoptes* in their characters, though not much in appearance, while *B. bagoooides* approaches *Inoplœus*. I do not suppress the genus; for though it apparently grades into *Catoptes*, yet the typical species of the two look so different that I can well believe that future more careful examination may detect a better means of distinguishing these genera than I can point out at present.

*Brachyolus inæqualis*, n. sp.—*Niger*, *pallide griseo-squamosus*; *prothorace angustulo*, *rugoso*; *elytris brevibus convexis*, *apice abrupte declivo*, *ante declivitatem grosse nodulosis*. Long.  $4\frac{1}{2}$  m.m.

Antennæ dark-red; slender and elongate; second and third joints subequal. Eyes contiguous with front margin of thorax: this latter is about as long as broad, a little rounded in front, and narrowed behind; coarsely rugose. Elytra short,



broad, and convex; obliquely narrowed at the shoulders, so that the base is the same width as the base of the thorax; the surface uneven, the punctures being irregular, and taking the form of large but subobsolete depressions; in front of the apical declivity the third and fifth interstices are united to project as a triangular nodulosity, the inner angle of this nodulosity being the largest and thickest; between the nodulosity and the apex the suture is a little raised.

This differs from the *B. punctatus*—the typical species—by the large nodules placed higher up, and by the longer, more slender antennæ. The three examples found are not in good condition; but I am pretty sure that even fresh examples would not present the elegant appearance of *B. punctatus*. The elytral projections are somewhat similar to those of *Heterodiscus*.

Picton. Helms.

*Brachyolus punctipennis*, n. sp.—Fusco-brunneus, minute squamulosus; prothorace rugoso sed haud inæquali, antè rotundato, postè angustato; elytris seriebus punctorum magnorum conspicuis, interstitio tertio ad basin et quinto apicem versus, magis elevatis. Long. 6 m.m.

This differs from *B. punctatus* by the scrobes being broader and more indefinite behind, and has also a much longer second ventral segment. The upper surface of the rostrum is tricarinate, the eyes contiguous with the thoracic margin; the second and third joints of the antennæ are elongate. The thorax is much narrower than the elytra; the anterior half of the sides gently rounded; the posterior a good deal narrowed to the base; the surface is coarsely rugose, but the rugæ are not sharply defined, and there are no larger depressions or elevations. There is no scutellum visible. The elytra are oblong; gently narrowed at the shoulders, which are wider than the base of the thorax; they bear regular series of large punctures; the third interstice is a little elevated at the base, and the fifth strongly elevated behind; the seventh is also a little elevated, so as to render the outline rather sharply defined; the third interstice has a slight tubercle on the apical declivity, and the suture has a more obscure tubercle still farther down.

Christchurch. Wakefield.

*Brachyolus bagoooides*, n. sp.—Sat angustus indumento griseo dense vestitus; supra subinæqualis elytris basi utrinque supra thoracem leviter producto. Long. 4 m.m.

Densely covered with a pallid incrustation, concealing the sculpture. Rostrum rather more long and slender than in the typical species; the scrobes less visible from above; deep and very short. Eyes moderately distant from the thoracic margin. Thorax not so long as broad; the sides a good deal rounded, and narrowed behind; the surface is apparently uneven, but the sculpture is quite

obscured by the clothing; there appears, however, to be a slight depression of the surface on each side behind the front margin, and another in front of the middle. Elytra clothed, like the thorax and rostrum, with a dense indumentum, through which the setæ protrude, the third interstice, projects distinctly forwards over the base of the thorax; and the scutellar region is apparently depressed; and the third and fifth interstices project very slightly in front of the apical declivity.

Otago, Professor Hutton; three examples agreeing exactly.

*Brachyolus huttoni*, n. sp.—Latiior, indumento griseo-vestitus, supra inæqualis, elytris basi utrinque supra thoracem producto. Long. 5 m.m. (Plate XIII., fig. 11.)

This is very closely allied to *B. bagooides*, but is larger and notably broader, and has the inequalities of the surface more conspicuous, the third interstice being remarkably prominent and prolonged at the base, and the apical nodosities more conspicuous; moreover, the suture between these latter is very prominent; the surface bears both pallid and fuscous setæ, while in *B. bagooides* I see only the former.

Otago, Professor Hutton; one example.

*Brachyolus longicollis*, n. sp.—Niger, sat elongatus, tenuiter griseo-squamosus, antennis tarsisque piceis; prothorace elongato, lateribus basin versus quasi marginatis; elytris æqualibus seriebus punctorum ad basin majorum ad apicem obsoletis. Long. 6 m.m.

Antennæ with third joint shorter than the second. Rostrum short and stout; only feebly carinate. Eyes small; separated by a considerable space from the thoracic margin; very widely separated from one another. Thorax quite as long as broad; the sides rounded in front, and a good deal narrowed behind; the surface not rugose, but finely sculptured, and in front almost smooth; at each side behind with the margin distinctly plicate, so as to make the posterior part flat. Elytra rather elongate; without nodulosities; the third interstice slightly raised, and incrassate at the base.

Bealey, Helms; one example. This is a very peculiar species, and might, so far as the systematic characters go, be almost as well placed in *Catoptes* as in *Brachyolus*. The only example shows the strange peculiarity of possessing an elongate narrow excision on the last ventral plate. Possibly the specimen is abraded, but the squamosity is probably always obscure.

#### HETERODISCUS (nov. gen. Otiiorhynchinorum).

Rostrum modice elongatum, crassum, apice manifeste crassiore superne ad apicem plaga triangulare munitum; scrobes terminales, elongati, subrecti, oculos haud attingentes; antennæ modice elongatæ, scapo oculorum marginem anteriorem attingente. Prothorax lobis ocularibus tantum modice prominulis munitus; coxæ anteriores magnæ prominulæ, contiguæ; metasternum brevissimum; tarsi articulo tertio bilobato.

This genus is closely allied to several others already found in New Zealand: the mentum fills the buccal cavity about as completely as it does in *Catoptes*, and the peduncle is excessively short—almost, in fact, wanting—so that the genus should clearly be placed in Lacordaire's "*Adelognathes*:" it differs from *Catoptes*, however, by the elongate rostrum and the distinct ocular lobes, as well as by the definite elongate scrobes; from *Platyomida* it departs by the ocular lobes, by the mentum more completely filling the buccal cavity, and by the less elongate scape of the antenna; and from *Inophlœus* by the rather more definite scrobes and shorter scape, and the much more filled buccal cavity; the basal portion of the mentum bears a rather deep semicircular impression, the anterior part being smooth and shining; the first ventral segment is moderately long, separated from the second by a suture which departs comparatively little from the rectilinear form; the second is not large, only equal to the two following together; the terminal segment is only moderately large; the legs are elongate and stout, with the tarsi spongy-pubescent; the lobes of the third joint perfectly developed; the form of the wing-cases in the only species known is very curious: they have a flat disc, becoming broader behind, and terminating as two obliquely truncate prominences, the apex being so abruptly declivous that it projects scarcely so far backwards as the angles of the dorsal prominences do. The genus is allied to the Chilian *Megalometis* and *Strangaliodes*.

*Heterodiscus insolitus*, n. sp.—Niger, squamulis et indumento sordide griseo-cens, rugosus, elytris apicem versus latioribus, disco pone medium quadrangulariter prominulo, quasi truncato. Long. 8 m.m.; rostr. incl. 11 m.m. (Plate XIII., fig. 13.)

Upper surface of rostrum with four grooves, the lateral being less distinct than the two median; second and third joints of antennæ moderately long, subequal; thorax subcylindric, nearly as long as broad, slightly narrowed towards the front on the anterior third, longitudinally depressed along the middle, and with the surface coarsely rugose; elytra with slight elevations not sufficiently marked to be termed nodules, and also with regular series of impressed rather distant punctures; apparently truncate behind, the disc forming two slight angles near the suture, and also an external angle on each side, the apical declivous part large; the width of the wing-cases at the base is the same as the base of the thorax, and there is a very minute scutellum; the legs are thick, the front tibiæ mucronate, the claws short and thick: in addition to the squamosity of the surface there are also a few pallid setæ, which become numerous on the legs.

Picton, Helms; a good series.

*Heterodiscus horridus*, n. sp.—Niger, tuberculato-rugosus, indumento sordido plus minusve obscuratus, elytris apicem versus latioribus, disco pone medium quadrangulariter prominulo, quasi truncato. Long. 7 m.m.

This differs from *H. insolitus* by the very rough surface; it is also of less elongate form, with a shorter rostrum, which also has less definite scrobes; the thorax is broader than long, slightly narrowed behind, more narrowed in front, its surface coarsely and deeply rugose; elytra without punctuation, but with a large number of small tubercles irregularly placed, they become broader behind, and are abruptly declivous at the extremity, the dorsal portion projecting backwards as four short obtuse angles, the lateral prominence on each side not reaching so far back as those near the suture; legs rather short. As in *H. insolitus*, the corbels are not in the least cavernous.

Otago, Bakewell; Dunedin, Professor Hutton: one example from each.

CUNEOPTERUS (nov. gen. Rhyparisominorum).

Rostrum elongatum, capite thoraceque paulo longius, sat tenue, valde arcuatum; antennæ paulo ante medium rostri insertæ, graciles scapo apice clavato, scrobes vagæ, oculis haud attingentibus, his a thorace sat remotis; prothorax elongatus, conico-oblongus; elytra elongata, basi emarginato, apice truncato, lateribus late valdeque deflexis; scutellum nullum; prosternum quam pronoto multo brevius, lobis ocularibus nullis. Metasternum haud brevissimum; abdomen segmentis duobus basalibus valde elongatis, secundo quam tertio quartoque simul sumptis fere duplo longiore, segmento ultimo sat elongato; pedes sat tenues, tibiæ muticæ; tarsi parum elongati, articulo tertio haud lobato.

This is in its appearance amongst the most remarkable of the New Zealand weevils, and should be placed near *Phrynixus Pascoc*, from which it differs by the elongate rostrum with less effaced scrobes, the less abbreviate metasternum and third and fourth ventral segments, and still more importantly in the parts of the mouth, the buccal cavity being larger, the peduncle rather elongate, the mentum apparently quite absent, and all the stout rigid palpi quite exposed; the mandibles have no scar, the third tarsal joint is deeply excavate above for the reception of the terminal joint, and its hind margin is feebly emarginate; there is no dilatation of the apices of the tibiæ, and the tarsi are densely pubescent beneath.

*Cuneopterus conicus*, n. sp.—Elongatus, antè angustatus, postè truncatus, indumento fusco obtectus, supra sub-nodosus. Long. absque rostro 11 m.m.; rostr. incl. 14 m.m. (Plate XIII., fig. 14.)

Antennæ slender, second and third joints very elongate, club slender, acuminate oval; rostrum glabrous in front, and very finely punctate; eyes small; on either side of the upper face of the rostrum at the base is a broad vague groove, which causes the middle to appear vaguely broadly costate; thorax longer than broad, the surface and sides uneven, a deep depression at the base in the middle, and a ridge on the front part, besides less distinct inequalities; elytra broader from the base backwards, the apex remarkably abruptly truncate, with some slightly elevated nodules, the most distinct of which are lateral, and two immediately in

front of the terminal truncation; the pseud-epipleuræ are remarkable for their excessive size, and bear distant large, though rather obsolete, serial punctures.

Greymouth. Mr. Helms has obtained two examples of this remarkable weevil; the first was found in a spider's web some years ago, and the second under a piece of wood in a wet place.

#### DERMOTRICHUS (nov. gen. Rhyparisominorum).

Corpus irregulariter setosum. Rostrum gracile, arcuatum prothorace paulo longius, scrobes laterales oculos attingentes. Oculi parvi subrotundati a thorace sat distantes; antennæ scapo apice clavato.

This genus is closely allied to *Phrynixus* Pascoe, but possesses elongate though rather vague scrobes reaching to the small eyes. The antennæ, too, are inserted evidently in front of the middle of the rostrum. The other characters, so far as I can see, are similar to those of *Phrynixus*. The tarsi are small, with the third joint short, not bilobed but deeply depressed above for the insertion of the terminal joint. The thorax is quite destitute of ocular lobes; the metasternum very short, the second ventral segment excessively large, the third and fourth extremely short.

*Dermotrichus mundulus*, n. sp.—Piceus, haud nitidus, setulositate crispata irregulariter vestitus. Long.  $3\frac{1}{2}$  m.m. (Plate XIII., fig. 15.)

Rostrum slightly broader in front of the antennæ, and there almost smooth and shining, behind sulcate and minutely setulose, with two minute tufts between the eyes; antennæ rather short, the scape gently clavate at the apex; second joint longer and thicker than the third, the funiculus only indistinctly articulated; the club elongate, obtuse, its first joint extremely long, the others quite short. Thorax slightly longer than broad, its greatest width in the middle, gently and equally narrowed to the front and the base, its surface not convex, but somewhat uneven and bearing ochraceous (or fuscous) thick setæ, which are here and there more condensed and elevated. Elytra of peculiar form, being much narrowed to the base, which is of the same width as the thorax, becoming broader behind in a long slope, covered with angulate transverse fasciæ of condensed setæ, two of these, one on the middle and one behind it, being very distinct; scutellum invisible; legs only feebly setose.

Greymouth. Helms, No. 316. The three examples exhibit a good deal of difference in the clothing of the wing-cases, which may be due partly to variation, partly to abrasion.

#### STEPHANORHYNCHUS.

*Stephanorhynchus aper*, n. sp.—*S. curvipedi* similis sed latior; rugosus, indumento plus minusve variegato vestitus, elytris dorso sellato-tuberculato. Long.  $3\frac{1}{2}$  to  $6\frac{1}{2}$  m.m.

Antennæ with rather elongate slender club, the second joint of which is subquadrate, and about as long as the first; rostrum keeled along the middle, a

depression between the eyes, vertex bicristate. Thorax as broad at the base as it is long, much narrowed in front, and constricted behind the front margin, obscurely tuberculate. Elytra uneven, shoulders a little prominent, the middle with two flattened elevated spaces, forming together a kind of saddle, each being abruptly defined externally, but only sloping gently towards the other. Femora triangularly toothed, the tooth on the posterior extremely large. This is closely allied to *S. curvipes*, but is readily distinguished by the club of the antenna, which has not the abnormal form it has in the species named. *S. aper* is a broader insect, with a comparatively shorter and broader thorax, and more prominent shoulders to the elytra. Like *S. curvipes*, it varies greatly in size and colour.

Picton. Helms.

#### CRISIUS.

*Crisius obesulus*, n. sp.—Brevior, dense squamosus, rufo-tinctus, elytris in partem anteriorem minute fasciculatis. Long. 5, lat.  $3\frac{1}{4}$  m.m. (Plate XIII., fig. 16.)

Of very short form, densely covered with scales, which are in large part of a reddish colour, with here and there ochraceous patches. Rostrum scarcely so long as the head and thorax, its upper part squamose, the lower two-thirds bare, punctate. Antennæ red, rather short. Thorax irregular, the anterior two-fifths constricted, the middle with two conical tufts; two smaller tufts on the front margin. Scutellum very short, transverse. Elytra very short, broad at the base, shoulders prominent, the basal regions with small elevations, some of which bear a few scales, and on the basal and external portion rows of punctures may be seen, much interrupted by the inequalities of the surface. Legs squamose.

This is of much shorter form than *C. binotatus*, the typical species of the genus, and is very distinct by the small scutellum, shorter rostrum, &c.

Greymouth. Helms.

#### PENTARTHURUM.

*Pentarthrum cephalotes*, n. sp.—Subcylindricum, piceum, nitidum, rostro breve, vertice globoso-inflato, oculis a thorace remotis; prothorace crebre subtiliter punctato; elytris profunde striatis, apice declivo marginato. Long.  $3-3\frac{1}{2}$  m.m.

This species is remarkable by its large globose head, so that the rostrum is only as long as it; the rostrum and the head behind the eyes are finely punctate, the inflated vertex impunctate. The thorax behind is almost broader than the elytra, greatly narrowed in front, there constricted, smooth in front of the constriction; elsewhere closely and finely punctate, with more or less abbreviate smooth line on the disc. Elytra very deeply striated, the striæ coarsely and densely punctured, so that the punctures are confluent, the interstices narrow, indistinctly seriately punctate; the apex rather abruptly declivous and distinctly marginate. Legs red.

Picton, Helms; three examples, all I think of the female sex.

*Pentarthrum porcatum*, n. sp.—Subcylindricum, piceum, nitidum; capite pone oculos strangulato, his prominulis; prothorace dense fortissime punctato; elytris profunde striatis, apice marginato. Long. rostr. incl.  $3\frac{1}{2}$ –4 m.m.

This is readily distinguished by the extremely coarse thoracic punctuation, which extends much in front of the anterior constriction. Rostrum moderately stout, cylindric, more than half as long as the thorax, punctate, rugose between the eyes, these abruptly prominent, vertex perfectly smooth, quite as long as the length of the eye; antennal insertion considerably behind the middle. Thorax very elongate, very much narrowed to the front, very coarsely and densely punctate, with a strong constriction a considerable distance behind the front margin. Elytra parallel-sided, at the apex distinctly but not broadly margined, deeply striate, the striæ bearing very coarse punctures, which are only imperfectly separated from one another; interstices narrow, not punctate; underside very coarsely punctate. The male has the rostrum in front of the antennæ rather shorter and broader, the base of the abdomen and apical portion of the sternum much depressed.

Dunedin, Hutton; Greymouth, Reitter; Picton, Helms. This is no doubt allied to *P. sculpturatum*, Broun, but differs from the description by the differently sculptured less rugose rostrum, the absence of any hairs, and other particulars. I have seen only one male, the example from Dunedin, but I have no doubt it is the same species as the Greymouth female; the two examples from Picton are a smaller variety of the female, having shorter elytra and more densely-placed smaller punctures in the striæ, but are, I think, really the same species.

*Pentarthrum confertum*, n. sp.—Angustulum, subdepressum, nigricans, capite, rostro, antennis pedibusque rufis, elytris circa humeros fusco-rufis; rostro elongato, cylindrico; elytris profunde striatis, striis densissime punctatis. Long. rostr. incl.  $2\frac{3}{4}$  m.m.

Rostrum about as long as the thorax, cylindric, shining, impunctate. Antennæ slender, their insertion slightly behind the middle; eyes but little separated, vertex small, foveolate. Thorax rounded at the sides and much narrowed in front, where it is distinctly constricted, it is densely, moderately coarsely punctate, the disc flattened. Elytra but little shining, with striæ, in which are placed punctures so densely that the intervals have become much obliterated; the longitudinal interstices are finely rugulose.

This is a very distinct species, somewhat similar to *P. parvicorne*, but readily distinguished by the slender antennæ. The example described is no doubt a female.

Picton. Helms; one example.

*Pentarthrum constrictum*, n. sp.—Angustum, subdepressum, fulvo-rufum; prothorace elytris angustiore, anterior fortiter constricto, disco subimpresso. Long. rostr. incl.  $2\frac{1}{4}$ –3 m.m. (Plate XIII., fig. 17.)

Rostrum finely sculptured, dull, eyes moderately large; antennæ small and stout, inserted at the middle of the rostrum. Thorax elongate and narrow, evidently

narrower than the elytra, rounded at the sides, and with a strongly constricted anterior part, flat, longitudinally depressed on the middle, rather closely but somewhat indefinitely punctured, a little rough, with an obscure smooth space in the middle of the depression. Elytra elongate, shining, flat, with regular series of coarse punctures, the interstices not raised, impunctate. The female has the rostrum more cylindric in front, and shining.

Greymouth. Helms, No. 76. This distinct little species may be placed next *P. parvicorne*.

#### MICROTRIBUS.

*Microtribus pictonensis*, n. sp.—*Parum elongatus*, fusco-piceus, subcylindricus, rostrum breve, crassiusculum, punctatum, antennis brevibus, crassiusculis; prothorace crebrius fortiter punctato; elytris parum profunde striatis, striis fortiter punctatis. Long. rostr. incl. 3 m.m.

Rostrum closely punctulate, dull; antennæ inserted behind the middle, very short, with small slender club; eyes prominent; thorax rounded at the sides, and much narrowed in front, where it is only very obscurely constricted; coarsely punctate; scutellum minute; elytra with series of punctures becoming more obsolete towards the extremity, but quite coarse at the base; interstices sparingly seriatly punctate.

Picton, Helms; one example. This differs from its only congener—*M. huttoni*—by its thicker rostrum and differently formed antennæ, which are more like those of *Pentarthrum*: the insect, indeed, has much more the appearance of an obscure *Pentarthrum* than of its congener, but it is abruptly differentiated from the genus named by its approximate front coxæ.

#### INOSOMUS, Broun.

Corpus breve, crassum, setosum; antennæ breves, funiculo septem articulado; rostrum breve, a capite sat abrupte discretum, oculis subinferioribus.

This is a remarkably distinct genus, having the appearance of a Scolytid, but with a true rostrum and slender anterior tibiæ not denticulate externally; owing to the peculiar position of the eyes, which are not at all visible from the front, it would, perhaps, be placed in Wollaston's arrangement of the *Cossonidæ*, near to *Himatium* and *Coptorhamphus*, though it has really little connexion therewith, and is a great deal more like *Stenoscelis*. In the New Zealand list it may be placed before *Xenocnema*. The rostrum is rather longer than broad, furnished with true longitudinal scrobes, in which the scape is received; this attains the anterior margin of the eye; joints 2–7 of the funiculus are very short and difficult to count; the club is rather short and stout, obtusely acuminate, distinctly ringed, the larger basal joint being glabrous; on a slight inspection the insect appears blind, but the eyes are of moderate size, and are placed quite laterally, extending more to the under surface than the upper. The prosternum is emarginate, and the front coxæ are minutely separated; the middle coxæ more



distinctly so; the metasternum is not elongate, but is longer than the first ventral segment; this is rather more prominent than the other segments, which are very short, with the exception of the last. The front tibiæ are slender, armed at the apex externally with a curved mucro, internally with a sharp denticle; the middle tibiæ are armed externally with an emarginate prolongation, the lower angle of which is quite spinose, and the hind tibiæ have a similar termination. All the tarsi are very slender, the third joint being not thicker than the others, and not bilobed.

I have little doubt the insect thus characterized is the genus described under the name of *Stenopus* by Broun, *Man. New Zealand Coleoptera*, Pt. II., p. 739, and afterwards re-named *Inosomus*. Broun placed the genus in *Scolytidæ*, alluding to its resemblance with *Cossonidæ*, however; but the possession of a true rostrum and slender anterior tibiæ, not denticulate externally, are characters that require it to be placed at present among the *Cossonidæ*. In Broun's description of the species *Stenopus rufo-piceus* an unfortunate error occurs; the first line on p. 740, instead of "seven interstices are a little elevated behind, are merged," should read, "seventh interstice is a little elevated behind and merged." This insect was found by Helms at Picton.

---

### Fam. ANTHRIBIDÆ.

#### ANTHRIBUS.

*Anthribus tuberosus*, n. sp.—Nigricans, dense vestitus, rostro elytrorumque lateribus griseo-ochraceis, antennis pedibusque testaceis, his conspicue maculatis; elytris tuberculis grossis ornatis. Long.  $4\frac{1}{4}$  m.m. (Plate XIII., fig. 18.)

This species does not appear to be very closely allied to any other, but may be placed near *A. discedens*. It can be readily distinguished by the very large basal tubercles of the elytra, and the fact that the sides of the wing-cases are covered by pallid, the middle by dark, pubescence. Antennæ not so long as the body, yellow; first joint covered in front by white pubescence; second joint very feebly pubescent, oval; third much longer than the following, swollen at tip, 6–8 sub-equal, each slightly swollen at the tip; ninth as long as the eighth, equal to the two following together, and forming with them a well-marked club. Rostrum short and broad, densely covered with very pallid griseo-ochraceous pubescence. Eyes convex, only moderately large, rather deeply emarginate. Thorax much broader than long, with well-marked carina distant from the base, and a little angulate in the middle, bent forward at the sides, forming an obtuse angle, and extending one-third of the length to the front; the outline of the sides is uneven, and a little narrowed towards the front; the surface is black variegate on the middle, with pallid pubescence. Elytra with two extremely large centro-basal tubercles, with two smaller, but yet large post-median tubercles, and just before the declivity with

four small prominences in a transverse straight line; the pallid pubescence covers the sides of the basal tubercles, their front being black; there is also much dark colour at the apex, and it extends along the suture, though more contracted in the middle part. Legs pallid, with the femora and tibiæ largely marked with fuscous on the middle.

Greymouth. Helms, No. 64.

*Anthribus cucullatus*, n. sp.—Nigricans, pube fusco-griseaque vestitus, rostro dense sub-albido pubescente, antennis pedibusque testaceis, his fusco-variegatis; thorace margine anteriore in medio bicristato, elytris tuberculis parum elevatis munitis. Long. 4 m.m.

Allied to *A. tuberosus*, but abundantly distinct. Antennæ formed as in that species, but with less elongate third joint, and the first and second joints densely covered in front with white pubescence like that of the rostrum. This latter is short and broad. The thorax is rather strongly transverse, covered with variegate pubescence, which is condensed in front, forming two small tufts projecting over the front; the carina is remote from the base, sub-obsolete in the middle, only a little deflected to the front at the sides, and forming a very rounded angle; the elytra have broad but slightly elevated centro-basal and post-median tubercles, and four indistinct nodosities, before the declivity; they are densely covered with mottled pubescence, which does not form any distinct pattern; the legs are variegate.

Although the form and the structural characters bring this very near to *A. tuberosus*, it is quite different, on account of the small tubercles of the elytra, and the colour of the sides.

Otago. Professor Hutton; one example.

*Anthribus inornatus*, n. sp.—Niger, opacus, haud variegatus, pubescentia concolore vestitus, antennis corporis dimidio longioribus. Long.  $4\frac{1}{2}$  m.m.

Rostrum about as long as broad. Eyes large and prominent, short, oval, truncate rather than emarginate in front. Antennæ with the intermediate joints more or less pubescent; second joint pyriform, rather slender, but a good deal stouter than the third, the three terminal joints forming a well-marked rather large club; the ninth longer than broad, gradually broader from base to apex; tenth not quite so long as broad; terminal joint longer than tenth, but not so long as ninth. Thorax about as long as broad, much narrower from the base to the front. Carina well separated from the base, gently curved, turned forwards at the sides, forming an obtuse angle; the surface densely, evenly, and finely rugose. Elytra substriate, the striae consisting of regular series of very distinct punctures. Legs and tarsi black, more or less pubescent at the knees.

Although closely allied to *A. incertus* and *A. vates*, this is distinguishable at a glance by the uniform black colour.

Greymouth, Kumara, Helms.

*Anthribus concolor*, n. sp.—Piceus, fusco-pubescent, antennis pedibusque rufis, illis corporis dimidii longitudine, clava obscura. Long. 4 m.m.

This agrees in most particulars with *A. inornatus*, but differs in the more pallid colour, and has also shorter, more slender antennæ; the thorax, too, is a little less elongate. In sculpture and all other characters the two species are very similar.

Picton. Helms.

*Anthribus obtusus*, n. sp.—Subcylindricus, nigro-fuscus, squamulis variegatis vestitus; antennis pedibusque fusco-rufis, illis corpore brevioribus; prothorace carina transversa ad basin per-propinqua, angulis posterioribus haud acutis. Long. 4 m.m.

This is remarkably similar to *Etnalis spinicollis* in appearance, but differs in important structural characters, so as to stand systematically intermediate between the species named and *A. huttoni*. The antennæ are slender, a good deal shorter than the body, the basal joint much exposed; third joint very slender, elongate, not at all clubbed at the apex; 4–8 each infusate at the apex; ninth broader from base to apex, slightly longer than broad; tenth shorter, terminal joint obtuse, about as long as broad. Rostrum short and broad. Eyes moderately large, emarginate, but not deeply so in front; the surface very densely and minutely sculptured, feebly pubescent. Thorax not so long as broad, only a little narrower in front, the sides scarcely sinuate in front of the base; the carina straight, extremely near the base; it is not continued upwards along the sides, but is scarcely prominent at the angles; the surface is covered with fuscous scales or hairs, and has a large patch of white, or pallid ochreous colour, on the basal portion of each side. Elytra not elongate, behind the base a little transversely depressed, with series of punctures, which are quite obsolete on the apical portion, the external ones being more distinct; they are covered with griseous, fuscous, and nearly black hairs or pubescence in an irregular spotted manner; legs red; femora more or less dark across the middle; the tarsi with the apices of the joints infusate.

Picton. Helms; two examples. This is distinguished from *Etnalis spinicollis* by the simple angles of the thorax, and the much less deeply divided eyes; the thoracic carina, too, is not absolutely contiguous with the base of the elytra.

#### PROSCOPORHINUS.

*Proscoporhinus albifrons*, n. sp.—♂ Fusco-viridescens, hic inde rufescens, capite antierius albido-piloso, clytris inæqualibus, antennis corpore fere triplo longioribus, testaceis. Long. 5 m.m. (Plate XIII., fig. 19.)

The prevalent colour is a pallid fuscous, passing in places to a greenish tinge, and in other spots to a reddish. The front of the head, and also the basal joint of the antenna, presents a vertical face, covered with a white pubescence, which is denser and more patchy on the middle of the head; in front of the insertion of each antenna there is a small pointed projection or tuft. The thorax is without punctuation, and has a fine white pubescence on the middle; the transverse line in front of the base strongly angulated on either side. The elytra have a very large prominence on either side of the suture behind the scutellum, and the third interstice from the suture projects at the hinder part so as to form a sort of bulla, the fifth interstice projecting in a similar though slighter manner; the striæ are rather deep, but irregular, and consist of series of rather coarse punctures; the interstices bear a few small fuscous spots or tufts.

A specimen of this species was sent by Mr. Helms as No. 389, and was found on the racecourse, 12th Nov., 1880. The female is, I believe, unknown. *Anthrribus meinertzhageni*, Broun, is no doubt a *Proscoporphinus*. This genus was founded on a rare New Caledonian insect, and its discovery in New Zealand is of some interest on this account. The entomology of New Caledonia is only very imperfectly known, and we may anticipate that a greater affinity will be found to exist between it and that of New Zealand than is at present suspected.

---

### Fam. CERAMBYCIDÆ.

#### CEMONA, Newman.

Though this is one of the oldest and best known of the New Zealand Longicorns, until recently only one species was recognised. I have for some years been aware that there are several species, though I have not previously been able to understand them; but as I have now recognised that the peculiar sexual differences in the sculpture of the thorax seen in other genera of the sub-family Cerambycides exist in a marked form in this genus, I am able to arrange satisfactorily the specimens at my disposal. According to this character there are two groups, distinguished by the prosternal sculpture in the male sex; and I may mention that it appears that this is correlative with a well-marked difference in the concealed internal supplementary abdominal segment of this sex. In all the species yet discovered the females have the flanks of the prothorax impunctate, while in the other sex they are punctate.

Sect. 1. Prosternum without true punctuation in the male and female.

*Cemona humilis*, Newm.—This species is of slender form, with the elytra a little attenuate behind, the thorax deeply furrowed by transverse rugæ, and, when the pubescence is removed, quite shining; the femora and the scape of the antennæ are infuscate externally. The two sexes are extremely similar, but the male has the

flanks of the thorax punctate, and the antennæ slightly longer than those of the female. The dorsal plate of the supplementary internal segment is in the former sex infuscate at the tip and emarginate; the female has this supplementary segment replaced by a very short, quadrate, transparent semimembranous ovipositor. The length attained is 15 to 18 m.m.

I have several males of this species found at Auckland by Lawson, and two females from old collections, one of the latter accompanied by a male agreeing with the Auckland males. It is the only species known to me with the femora fuscous at the tip; and though it is apparently the common species in collections and is usually named *Æmona hirta*, Fab., yet I cannot consider it to be the Fabrician insect, as that author says, specially "pedes grisei." I therefore retain for the species the trivial name proposed by Newman.

*Æmona villosa*, n. sp.—The individuals of this are much larger than those of *Æ. hirta*, and it is a broader insect, not attenuate behind; the thorax is not in the least rounded at the sides, but is straight, or becomes just perceptibly broader behind; it is very deeply furrowed transversely, and the femora are red, without infuscation; the length is as much as 27 or 28 m.m.

I have seen only two examples, one sent from Greymouth some time since, and then supposed to be a large example of the preceding species, and an old individual obtained from Murray's collection. These accord with the size and form represented by White as *Isodera villosa*; and there can, I think, be no harm in my retaining the trivial name, though it would only confuse the student if the older authors were cited as the authority for it.

Notwithstanding the great discrepancy from the following, I have a suspicion this may be only the female thereof, in which case the trivial name will be abandoned altogether.

*Æmona hirta*, Fab.—I have one male of this. Compared with *Æ. humilis*, it is a larger and broader insect, with the elytra not attenuate behind, the femora and scape of the antennæ entirely pallid. The sides of the thorax are a little rounded, the transverse furrows are not quite so deep, and the flanks are opaque, not shining as in *Æ. humilis*, and more finely punctured than in that species. The abdominal structure is the same as in the corresponding sex of *Æ. humilis*; the length is 20 m.m.

This example was sent me several years ago by Mr. Helms, and considered to be the common species; probably it may be so in the South island; and it is possible, as already remarked, that *Æ. villosa* may be its female.

Sect 2. Prosternum punctate in the male sex, impunctate in the female.

*Æmona plicicollis*, n. sp.—Pallide ferruginea, griseo-vestita, antennis pedibusque

cum tarsis concoloribus; prothorace sat profunde transversim ruguloso. Long. 13 m.m.

Mas: prosterno fere undique profunde arguteque punctato.

This species, of which I am acquainted with only a single male, is very distinct, though looking at first sight like a small *Æ. hirta*. The prosternal structure and sculpture is, however, markedly different; in the male sex of *Æ. humilis* and of *Æ. hirta*, the prosternum in front of the coxæ is divided by a transverse depression into two parts, the anterior of which is polished, and the posterior traversed by some obsolete wrinkles, the sides of the prothorax being punctate; in the present species the anterior part is very much reduced in size, and the posterior part is entirely covered, like the sides of the thorax, by a coarse deep punctuation. The supplementary concealed anal segment is very different in its form from that of the two species mentioned, the dorsal plate being broad and short, gently rounded behind, not emarginate in the middle. As other characters, it may be mentioned that the thoracic rugæ are not so deep and regular as in the other species of this group, that the sides of the thorax are rounded, and that the legs, including the tarsi, are entirely pale.

Greymouth, Belfrage. I have two female examples from Picton, which I have little doubt pertain to this species, but as they were not found in the same district, and present some differences, it is advisable to consider the species as established on the male only. These examples are 17 or 18 m.m. long, darker in colour, with the thorax straight at the sides; the prosternum and sides of the thorax without true punctuation.

*Æmona inæqualis*, n. sp.—Ferruginea, griseo-vestita, antennis pedibusque cum tarsis concoloribus; prothorace cylindrico, parum profunde rugoso, nec tuberculato neque transversim plicato. Long. 13 m.m.

Comparing the male of this species with that sex of *Æ. plicicollis*, it will be found that though exceedingly similar, the present species has the sculpture of the pronotum obsolete, while the sexual punctuation on the sides of the thorax is a little coarser and denser. The other characters are the same as in *Æ. plicicollis*, the prosternal punctuation being equally very strongly developed, and the supplementary apical segment of the males similar.

Picton. Helms; two examples.

*Æmona simplicicollis*, Broun.—Ferruginea, griseo-vestita, antennis pedibusque cum tarsis concoloribus; prothorace minus cylindrico, subquadrato, haud plicato, versus angulos obsolete tuberculato. Long. 12–14 m.m.

The thorax is just about as broad as it is long; it has no transverse grooves, but at each side near the front there is a slightly raised shining tubercular space, and nearer the middle, nearly in a line with it a larger rugose elevation; on the middle

there is another feeble elevation becoming linear in front, and on the basal portion some obsolete inequalities. I am acquainted only with the female.

Christchurch, Wakefield; Picton, Helms; one example from each source.

*Æmona mutica*, n. sp.—Angustior, ferruginea, griseo-vestita, antennis pedibusque cum tarsis concoloribus; prothorace cylindrico, fere esculpturato, opaco, tenuiter pubescens. Long. 11 m.m.

This is the most slender of the species, and may be readily known by the almost complete absence of thoracic sculpture, the surface being feebly uneven, with an obscure slight carination of the disc. The male has the sides of the thorax a little rounded, but in the female they are straight; the former sex has the flanks of the pronotum punctate, and all the prosternum, except the front, similarly punctate; the supplementary segment is like that of *Æ. plicicollis*.

Picton, Helms; one pair.

*Æmona debilis*, n. sp.—Minor, angusta, ferruginea, griseo-vestita, antennis pedibusque cum tarsis concoloribus; prothorace angusto, subcylindrico, lateribus leniter curvatis, parce obsoleteque sculpturato, crebrius pubescente. Long. 10 m.m.

Rather less elongate than *Æ. mutica*, with a less cylindrical thorax, which is more pubescent and has some feeble asperities on the middle; in the male sex the prosternum and the sides of the prothorax are punctate, but less definitely than in the other species of this group, and the punctuation is rendered still more indistinct by the pubescence. Without a careful examination these parts appear impunctate as in the female, but the species cannot be mistaken as belonging to the first group, in consequence of the small size and absence of plication on the thorax.

Picton, Helms; one pair.

#### OPHRYOPS, White.

*Ophryops dispar*, n. sp.—Elongatus, angustulus, testaceus, capite antennarum basi, thorace pedibusque ferrugineo-testaceis, antennis articulis tertio quarto quintoque plus minusve fuscis; thorace dense subtilissime punctato punctisque majoribus sparsis parum conspicuis, subopaco utrinque longitudinaliter impresso, medio area angusta antice tenuissima polita; elytris, punctis majoribus impressis profundis. Long. 18 m.m. Fem.(?) eadem species; prothorace nitido fortiter inæqualiter punctato, hic inde subtuberculato. (Plate XIII., fig. 20.)

The thorax of the male is very broad, abruptly constricted behind, covered with a dense porous-like punctation, here and there with larger punctures; on each side there is a peculiar polished space, somewhat depressed, but terminating in front considerably behind the front margin in a very feeble elevation placed somewhat more towards the middle; the medial smooth space extends from front

to base, being very slender in front, but dilated on each side at the basal margin. The scutellum is impunctate; the elytra are equally covered with large punctures, the colour of the punctures being chocolate-red, and along each wing-case there are two or three feeble longitudinal pallid veins.

Greymouth, Helms, No. 127. *O. pallidus*, Broun, Man., p. 576, is, I have little doubt, this species. This insect was sent me some years ago, having been captured, I believe, at Maori Creek, by Mr. Lins: and the two examples were sent as being one species, though there appears to be no direct evidence of this beyond the general resemblance between the two: I myself likewise think them one species, though the prothoracic differences are so marked and extreme that they are almost what would be considered of generic importance amongst the allies; and also in the supposed female the longitudinal veins on the wing-cases are not present; it is therefore possible that the supposititious female may not really belong to the species. The genus was established by White, on a single male, closely allied to that which I have described, but considerably larger, and with differences in the prothoracic sculpture; it has since remained unknown to entomologists, its position being somewhat uncertain. Lacordaire is quite in error in supposing (*Gen. Col.* VIII., p. 378) that the eyes present the remarkable form they do in the genus *Bardistus*: that he should have made this mistake is curious, as White gives a figure of the side of the head and eye, which is approximately correct. This at present is all the information I can give about the genus, as the condition of the two examples I have received does not warrant a prolonged examination; but I think there is little doubt it will prove to be closely allied to the New Zealand *Didymocanthæ*.

#### DIDYMOCANTHA.

*Didymocantha quadriguttata*, n. sp.—Capite thoraceque rufis, antennis pedibusque testaceis, elytris pallide testaceis vitta laterale guttulisque quatuor discoidalibus nigris; corpore subtus plus minusve infuscato. Long. corp. 11–12 m.m.

Head and thorax castaneous or rufescent, with many white hairs, the latter with coarse punctuation along the middle, and just behind the middle, with a slight tuberculation, which is prolonged backwards as a smooth, not raised space not quite reaching the basal margin; on each side of the disc, near the front, there is a more distinct tubercle, the sides behind the middle with an acute tooth. Scutellum clothed with pallid scales or hairs. Elytra with rather coarse, definite punctuation, becoming a little finer at the apex, and with a scanty pallid pubescence, in front of the middle with two very minute black dots, and behind the middle with a pair of slightly larger dots. The male has the antennæ much longer than the body, but in the female they extend only slightly beyond the extremity of the elytra.

This is very closely allied to *D. sublineata*, but is a rather larger insect, with not quite so coarse punctuation on the wing-cases, and with the dark lines reduced to small dots. *D. sublineata* I have not seen from the South Island.

Picton, two males; Greymouth, one female. No. 379. Helms.



## ANENCYRUS (nov. gen. Cerambyciorum).

Corpus parum elongatum, minus pubescens, thorace elytrisque inæqualibus, illo lateribus haud spinosis, his abdomine paulo brevioribus: antennæ (feminæ?) corpore breviores, filiformes. Caput breve, frons verticalis sat elongata. Oculi laterales, supra distantes, magni, subtiliter granulati. Coxæ anteriores globosæ, acetabulis a prosterno bene separatis, posterius apertis, externe parum prolongatis, trochantinis conspicuis. Elytra apicem versus angustata, apicibus oblique truncatis. Metasternum convexum, sat elongatum, episternis latis. Abdomen normale, segmento basale secundo longiore, sequentibus inter se subæqualibus. Pedes modice elongati, femora basi tenue; tarsi posteriores articulo basale sequentibus duobus simul sumptis æquale, vix longiore.

This is another genus which seems to have no near ally, and which it would be very difficult to place in Lacordaire's arrangement. In the New Zealand list it will go next to *Gastrosarus*, to which, however, it is by no means closely allied, being different in form and sculpture, having the front coxal cavities with a broad aperture, externally displaying the trochantin, while internally they are separated by a well-marked convex process of the prosternum; the front of the head, too, is elongated, instead of displaying the remarkable abbreviation of *Gastrosarus*.

*Anencyrus discedens*, n. sp.—Rufus, femorum basi, elytrorumque costis abbreviatis ad basin et ad latera pallide flavis; thorace impunctato, brevissime flavo-pubescente, disco obtuse trinodoso; elytris fortiter irregulariter punctatis. Long. 11 m.m.

Antennæ slender, not quite reaching extremity of body; 3rd, 4th, and 5th joints with a few rather long hairs beneath; the 4th rather shorter than the 3rd or 5th, which are about equal; eyes convex, but little distant from the thorax. This latter is rather broader than long, with a very large but obtuse prominence on each side of the middle, and between them, just behind the middle, with a smaller prominence: these protuberances are polished and shining, the rest of the surface being covered with a very delicate minute pubescence; this is of a pallid colour, the thorax itself being of a darker, more vinous red, than the rest of the surface. The elytra are peculiar both in form and sculpture; their basal portion is flattened, but bears a short longitudinal elevation near the suture, and from near the shoulder there extends backwards a fold or plication, which, on the middle of the length, is very abruptly defined and costiform, and then ceases, there being external to it at the middle of the elytra, close to the side, a shorter abrupt costa; these costæ are pallidly flavescent, the rest of the surface being of a tawny-red colour; the elytra are evidently narrowed behind and leave the terminal segment exposed; the apices not at all spinose; they have a peculiar rough irregular

sculpture, which is not true punctuation, and is not present on the costæ; they have a few short feeble hairs, most distinct at the apex.

Picton, Helms; one mutilated example of quite uncertain sex.

CERALOMUS (nov. gen. Cerambycorum).

Corpus parvum, tomento subtilissime vestitum. Caput exsertum, fronte minus elongato, abrupte perpendiculare; oculi omnino divisi, supra valde distantes, a thorace remotis. Antennæ corpore longiores, sat tenues, simplices, articulis 3-6 apicibus subnodosis. Thorax lateribus obtuse angulatis. Coxæ anteriores haud prominulæ, parum transversæ, acetabulæ extus latissime apertæ, trochantinis maximis; inter se parum distantes. Acetabula intermedia extus late apertæ; metasternum elongatum, episternis modice latis.

This is another genus, apparently without any ally, to be placed in the New Zealand list near Calliprason, to which, however, it is only very distantly allied; the facies is rather that of the Lamiadæ, such as *Hybolasius* or *Tetrorea sellata*, and I had no idea until I investigated it that it would prove a Cerambycid, though really its structures are quite normally Cerambycid; the antennæ are inserted on the summit of the depressed head, far from the mandibles; the eyes are so deeply emarginate that they are practically divided into two parts, of which the superior is much smaller than the inferior; they are placed far from the front margin of the thorax, and are finely faceted; the front coxal cavities are open behind, the mesosternum being very approximate to them; a short process, broad in front, imperfectly divides them, and they project only slightly beyond it; the middle coxæ are widely separated; the femora have the basal half much more slender than the outer, the division between the two parts not abrupt; the tibiæ are very slender, and the basal joint of the hind tarsus is elongate, longer than the two following together; the hind body is normal, its five segments sub-equal in length.

*Ceralomus morosus*, n. sp.—Niger, sub-olivescens, opacus, pube argentea subvariegatus, pedibus fuscis, tarsis antennisque testaceis, his articulis versus apices nigricantibus; elytris haud punctatis, omnium subtilissime rugulosis. Long.  $7\frac{1}{2}$  m.m.

Antennæ with the first six joints sparingly armed with erect hairs beneath, scape rather long, but little thicker at the apex than at the base, each of these joints (except the basal and second) swollen at the apex, and with the incrassate part black; thorax as long as broad, each side with a large angular prominence, and the disc between these with two large obsolete elevations, the surface only minutely sculptured, with a small spot on the middle; between the prominences smooth; elytra slender, even, dull olivaceous black, marbled with a minute silvery

pubescence, which itself is encroached on by small bare spaces; apices singly rounded; femora piceous, but little paler at the base; tibiæ sordid testaceous, with a few long erect hairs; tarsi rather more dilute.

Greymouth, Helms; a single example, in very bad preservation. No. 128.

#### XYLOTOLES.

*Xylotoles germanus*, n. sp.—*X. nano* proxime affinis, sed antennis tenuioribus articulo tertio quarto evidenter longiore facile distinguendus. Parvus, fusco-testaceo-cupreus, pube grisea vestitus, elytris plus minusve fusco-variegatis; pedibus antennisque testaceis, his articulis apice fusciscentis, illis femoribus extrorsum fuscis. Long  $3\frac{1}{2}$ – $4\frac{1}{2}$  m.m.

Though very similar to the smaller examples of *X. nanus*, I have no doubt this is distinct, as, in addition to the structure of the antennæ mentioned above, it exhibits other differences, being of shorter form, with shorter thorax and metasternum. Like *X. nanus*, it varies a good deal in colour.

Dunedin, Professor Hutton; a small series of examples.

*Xylotoles fasciatus*, n. sp.—*Minimus*, niger, subænescens, pube grisea variegatus, elytris post medium fascia conspicua pallida, tibiis testaceo-annulatis, antennis fuscis, articulis basi testaceo. Long. 3 m.m.

This, the smallest species of the genus, is very distinct from *X. germanus*, the elytra having the minute punctuation more sparing and distinct. The antennæ are slender, with the third joint much longer than the fourth. The thorax is cylindrical, elongate. The elytra are very slender, with curved sides, a fine sutural stria, a few coarse punctures at the base, with a well-marked pallid fascia some distance before the apex, and a very minute pallid pubescence irregularly distributed on the basal part.

Bealey, Helms; a single example.

#### STENELLIPSIS.

*Stenellipsis cuneata*, n. sp.—*Minus* elongata, elytris ad apicem attenuatis; nigricans, supra fusco-rufa, tenuiter griseo-vestita, elytris ad latera ante medium vage ochraceo-plagiatis, ultra medium vage angulariter griseo-fasciatis. Long. 7 m.m. (Plate XIII., fig. 21.)

Antennæ reaching to the extremity of the body, the joints a little infusate towards their apices, from the base to the sixth joint feebly ciliate beneath. Thorax with the sides rounded, feebly constricted in front and behind, densely and finely punctate, obscure reddish in colour, evenly covered with fine griseous pubescence. Elytra only a little broader than the thorax, but with prominent shoulders, similar in colour to the thorax, but unevenly pubescent, there being a nearly denuded

space in front of the middle, so as to cause an angular faint fascia, limited in front at the sides by pubescence of a more ochraceous colour, the posterior angular fascia still more faint; there is a sutural stria not reaching the front, and numerous coarse punctures on the basal portion. Femora much inflated.

This species, on account of its shorter legs and antennæ and acuminate elytra, approaches rather closely to *Xylotoles*; but the sculpture and facies are more those of the genus in which I place it.

Picton, Helms; a small series of examples.

#### PŒCILIPPE, Bates.

This genus has not yet been distinguished in a very satisfactory manner from *Hybolasius*, but I find a character which appears sufficient to warrant its retention, viz. that the scape of the antennæ is cicatrized in front towards the apex by numerous scars. This character exists also in *Hybolasius simplex*, though not in so marked a degree, and it will be necessary, therefore, to treat that species as belonging to *Pœcilippe*. The two following new species also are quite similar to *Hybolasius*, except in the above character.

*Pœcilippe medialis*, n. sp.—Nigro-fusca, antennis tibiisque testaceo-variegatis; pubescens, elytris ante medium fascia lata ad latera antrorsum curvata albida, post hac fascia nigro-fusca, apice minus argute pallido; prothorace ad latera minus acute tuberculato, elytris ad basin tuberculis sat elevatis haud cristatis. Long.  $5\frac{1}{2}$ –8 m.m.

Scape of antennæ dark, the following joints testaceous at base, fuscous at extremity. Thorax strongly transverse, furnished at each side with an angular prominence, and on the middle with two transverse elevations; it is sparingly covered with griseous pubescence, which is more concentrated at each side behind the lateral tubercle. Elytra broad, not narrowed till near the extremity, near the suture at the base, with two broad, not tufted, elevations, and behind each a little obliquely depressed, clothed with whitish pubescence, which forms a broad band just about the middle, and is sharply limited behind by black, in front quite vaguely limited; behind the broad dark fascia the pubescence is again more pallid, though more scanty. Tibiæ black at the apex; pallid above this.

This species is excessively similar to *Hybolasius pedator*, but the central pallid fascia is more distinct and curvate in the opposite direction.

Picton, Helms; a small series exhibiting little variation except in size.

*Pœcilippe femoralis*, n. sp.—Nigricans, griseo-vestita, subvariegata, pedibus plus minusve rufo-variegatis femoribus semper superne rufis, antennis pedibusque longius albido-setosellis, illis ex parte majore testaceis. Long.  $5\frac{1}{2}$ –7 m.m.

Thorax rather elongate, with moderate lateral prominence, and two slight elevations in front of the middle, the pubescence more concentrated at the side behind the lateral tubercle. Elytra depressed, narrowed behind, the centro-basal tubercles moderately conspicuous, but not tufted, the surface behind them a little obliquely depressed, and also near the suture behind the middle longitudinally a little depressed; they are more or less obscurely rufescent, exhibit a punctuation like the species of *Hybolasius*, and are clothed with griseous pubescence in a somewhat spotty or irregular manner.

Although very similar to *P. medialis*, this is readily distinguished by the longer thorax, and the absence of a definite medial fascia on the wing-cases.

Picton; Helms; a series of twelve examples, unfortunately much abraded, varying a good deal in size and in the colour of the derma, which is sometimes more rufescent than black.

#### TETROREA.

*Tetrorea longipennis*, n. sp.—*Angustula*, nigra, supra olivaceo-nigra, elytris pube pallida ornatis, pedibus antennisque rufescentibus, griseo-vestitis, fusco-maculatis; thorace ad latera obtuse tuberculato, disco fortiter punctato, obsolete bi-tuberculato. Long. 10 m.m. (Plate XIII., fig. 22.)

I have seen only a single example of this insect; though similar to *T. sellata* it is much smaller, and is readily distinguished by the large extent of the pale patch of the wing-cases; this extends backwards beyond the middle, becoming attenuate behind, and then expanding again, and ceasing a little before the apex. The thorax has but little pubescence, and is armed at the side with only a short obtuse angular prominence, and there are numerous coarse, deep punctures on the middle, and two slight prominences. The elytra have a very obscure elevation of the surface on each side near the base; they possess numerous deep punctures on the basal portion; these extend backwards along the sides nearly to the extremity; behind the termination of the pale portion there is a minute elevation, covered with dense black velvety pile; the posterior part of the pale colour is defined in front by a minute line of black pile, and there is an obscure obtuse elevation behind the middle, near the suture. The slender basal portion of the femur, unlike the other parts, is not maculate.

Greymouth. Helms, No. 196.

---

#### Fam. CHRYSOMELIDÆ.

##### EUCOLASPIS (nov. gen. Eumolpinorum).

Coxæ omnes parum distantes; corpus absque pubescentia; coxæ anteriores ad marginem anteriorem prosterni sitæ.

The form is rather short, convex. The head is deflexed, the eyes moderately convex. The pronotum is margined at the base, sides, and front, but has no denticles or sinuation on the lateral margin. The front coxæ are situated as near as possible to the front margin of the prosternum, which is not at all deflexed; they are moderately separated, the prosternum arched upwards behind them. The middle coxæ also are moderately separated; the metasternum is short: the hind coxæ are not more widely separated than the others. The femora are rather slender, unarmed; the tibiæ are simple, straight externally, not mucronate at the apex; the third joint of the tarsus is bilobed, but it is short, and fitted rather closely to the preceding joint; the claws are appendiculate.

The genus is established for the insects placed by White and Broun in *Colaspis*; but, according to the classification of Chapuis, they must not only be removed from *Colaspis*, but also from the group *Colaspites*, and their position would appear to be in the group *Iphimaites*. *Peniticus* is clearly an allied form, and as a genus is distinguished by the short convex form, the greater separation of the coxæ, the excessively short metasternum, and the position of the front coxæ, which is not quite so close to the front margin.

#### ATRICHATUS (nov. gen. Eumolpinorum).

Corpus oblongum absque pubescentia; prothoracis anguli posteriores liberi; coxæ posteriores magis quam anteriores et intermediae distantes.

This is another form closely allied to *Eucolaspis*, but appearing to me entitled to generic distinction. The anterior and middle coxæ are but little more separated than they are in *Eucolaspis*, but the posterior are more widely distant. Although very different in form to *Peniticus*, *Atrichatus* is as near to it as to *Eucolaspis*, but the front coxæ are not so widely separated, and the metasternum is not so extremely abbreviated. *Atrichatus* has the antennæ very widely separated, and the tibiæ broader at the extremity, and excavate externally; the front coxæ are very near the margin of the prosternum, though not so excessively close as they are in *Eucolaspis*. The claws are appendiculate.

The insect which I take for the type of this genus was found at Christchurch by Wakefield. I do not describe it, as I think it may probably be the *Colaspis ochraceus* of Broun, but figure it. (Plate XIII., fig. 24.)

#### PILACOLASPIS (nov. gen. Eumolpinorum).

Corpus oblongum, subtiliter pubescens; coxæ anteriores et intermediae satis, posteriores magis, distantes, anteriores bene pone prosterni marginem anteriorem sitæ.

This is allied to *Eucolaspis*, but presents too many points of distinction to be treated as a mere extension thereof. The hind coxæ considerably more widely

separated, and the position of the front coxæ, added to the pubescent surface, being the most important points of distinction. The other characters are apparently similar to those of *Eucolaspis*, except that I cannot detect any lobes or appendage on the claws: it is just possible, however, that I may be in error on this point, as the only example I have seen is in bad condition, and much mutilated.

*Pilacolaspis wakefieldi*, n. sp.—Sordide testaceus, supra ænescens, tenuiter albido-pubescent, crebre punctatus, antennis pedibusque elongatis, crassiusculis. Long. 5 m.m.

Antennæ elongate; second joint subglobose; third elongate, a little shorter than the fourth; tenth twice as long as broad (terminal joint mutilated); the colour is uniform dusky yellow. Head rather closely punctate, with a fovea on the middle. Thorax strongly transverse, with the sides rounded, and more narrowed behind than in front; a little sinuate at the posterior angles, which are by this made rectangular; the surface is uniformly densely and moderately coarsely punctured. Elytra with diffuse moderately coarse punctuation, not so dense as that of the thorax and more effaced on the apical portion. Undersurface yellow, sparsely pubescent. Legs stout, yellow.

Christchurch, C. M. Wakefield, Esq.

#### CACCOMOLPUS (nov. gen. Chrysomelinorum).

Antennæ graciles, apicem versus paulo latiores. Palpi maxillares articulo ultimo apice truncato. Coxæ omnes distantes. Tibiæ extus ultra medium latiores basi et apice tenuioribus.

This genus is closely allied to *Aphilon*, but it is comparatively of ordinary facies, resembling in form and appearance the hemispherical *Phytophaga*, such as *Phædon* and *Apteropeda*. It differs from *Aphilon* by the almost filiform antennæ, and truncate apex of maxillary palpi, by the less widely distant front coxæ, and the fact that all the coxæ are larger and less globose.

The position of these two genera should be in the Chapuis group *Chrysomélites*, where they will be exceptional on account of the bilobed tarsi. One Eastern genus—*Agasta*—is already known to possess this peculiarity, but the New Zealand genera do not appear to be in the least allied to it.

*Cacomolpus globosus*, n. sp.—Rotundatus, convexus, æneo-niger, nitidus, antennis, pedibus, abdomine, capite subtus sternique lateribus flavis; elytris seriatim punctatis, interstitiis parce punctatis. Long. 3 m.m. (Plate XIII., fig. 23).

Antennæ elongate; third joint longer than second; tenth much longer than broad; terminal joint still more elongate. Head very sparingly punctate; the clypeus more closely. Thorax about three times as broad as long; sparingly punctate. Scutellum moderately large and elongate, impunctate. Elytra each with nine series of punctures, the external indistinct, and all becoming quite obsolete behind; between the suture and the first stria there are three or four punctures interpolated near the base; legs pale yellow, coxæ brownish; middle of the body beneath æneous. The male has the basal joint of all the tarsi much larger than it is in the female.

Greymouth, Helms.

*Caccamolpus plagiatus*, n. sp.—Rotundato-ovalis, convexus, nitidus, testaceus, elytris basin versus plaga magna transversa nigro-fusca, obsolete seriatim punctatis. Long. 4 m.m.

Antennæ pale yellow, elongate, slender; third joint a good deal longer than second. Head impunctate, bi-impressed between the eyes. Thorax with numerous rather large punctures irregularly distributed. Elytra near the base with a very large patch of dark colour extending nearly but not quite to the side margin; near the outside this patch is prolonged in front so as to touch the base, and behind it is also longer externally than it is at the suture, being externally about half the length of the elytra; the scanty serial punctuation is very much effaced; the legs are rather long; the external sinuosity of the tibiæ very pronounced: on the under-surface the middle of the breast is dark, the rest pale.

Greymouth, Helms: I am indebted to Herr Reitter, of Vienna, for the only example I have seen of this distinct species.

#### TRACHYTETRA (nov. gen. Halticinorum).

Acetabulæ anteriores apertæ; pronotum absque sulca transversa; tibiæ posteriores apice breviter calcarato; metasternum brevissimum.

Antennæ moderately long and stout, 11-jointed; anterior coxæ only slightly separated; mesosternum not in the least impressed; metasternum so short that the hind coxæ are only slightly separated from the middle; hind coxæ moderately separated; femora strongly dilated; hind tibia slender, armed at the apex with a short mucro directed outwards; tarsi rather short, their basal joint one-third of the length of the tibia; claw joint small; claws minute: the other tibiæ without mucro; epipleura rather narrow, completely disappearing some distance before the extremity.

The type of this genus is a remarkable little Halticid with very coarse punctuation, and the shoulders of the elytra very rounded; it was found at Auckland by Lawson, and is, I believe, the



*Phyllotreta rugulosa*, Broun. The genus may be placed near *Phyllotreta*, from which it is distinguished by the very abbreviate metasternum.

PLEURALTICA (nov. gen Halticinarum).

Acetabulæ anteriores apertæ; pronotum absque sulca transversa; tibiæ posteriores ecalcaratæ; metasternum sat elongatum.

This genus I propose for the reception of *Phyllotreta cyaneum*, Broun. It is not much allied to *Phyllotreta*, nor apparently to any known form. It has very long antennæ, 11-jointed, with elongate basal joint; the front coxæ are moderately separated, and the mesosternum is very slightly impressed in the middle for the reception of the prosternal process; the metasternum is of normal length, and the hind coxæ rather widely separated; the hind femora are moderately broad, rather flat; the tibiæ are not grooved at the extremity, but their superior external aspect is flat, and polished nearly up to the knee, and its outer edge is finely and densely minutely ciliate near the extremity; the epipleuræ are broad, and do not disappear till near the extremity. The female has a raised plica on the elytra extending backwards from the shoulder; and in the male the epipleuræ are broader and more deeply sulcate. (Plate XIII., fig. 25.)

LUPERUS, Auct.

Broun, in his "Manual of New Zealand Coleoptera," has described, p. 631, as a new genus, under the name of *Adoxia*, some insects which he says differ from *Luperus* in the form of the head and structure of the palpi and antennæ. *Luperus* is a cosmopolitan genus already recorded from Polynesia and New Caledonia; and after a prolonged comparison of the New Zealand species at my disposition, I have quite failed to find any character to distinguish them generically from those of other countries. One species indeed I can separate only by slight specific characters from a Brazilian species of the genus.

*Luperus nigricornis*, n. sp.—Niger, vertice fusco, thorace testaceo, elytris albido-testaceis, dense punctatis, sutura margineque externo omnium angustissime nigris. Long.  $4\frac{1}{2}$ –5 m.m.

Antennæ black, basal joint but little swollen, third joint longer than second, fourth much longer than third; each of the joints towards the extremity three or four times longer than broad. Head black in front, the vertex brown. Thorax yellow, nearly twice as broad as long, much narrower than the elytra; its sides nearly straight, simply margined, without denticle at anterior angle; the surface appears smooth, but is really rather closely punctate, though the punctuation is quite obsolete. Scutellum black. Elytra very pallid, but with the suture as well as the outer margin just visibly marked with black; they are finely but extremely

densely punctate, almost rugulose, the apex broadly rounded. The legs and undersurface are black; the hind body sometimes fuscous towards extremity.

Greymouth, Helms, No. 51. One of the sexes appears to be rather larger, with the antennæ slightly more elongate.

*Luperus ænescens*, n. sp.—Elongatus, depressus, æneus, antennis pedibusque fusco-testaceis; prothorace fere impunctato, elytris crebre minus subtiliter punctatis. Long. 4 m.m.

Antennæ very slender, elongate, joints 4-11 sub-equal to one another, the former slightly the longer; basal joints not much swollen. Thorax twice as broad as it is long, only very indistinctly and sparingly punctate, the punctuation a little more distinct on the basal portion, the sides slightly narrowed behind, the front angle a little thickened and prominent. Elytra parallel, closely and not finely punctured, with a slight depression at the base within the shoulder; the apices broadly rounded; the long narrow pygidium projects horizontally beyond the elytra, and is impunctate. Legs infusate yellow, the base of the femora clear yellow. This is excessively similar to the numerous European species of the *L. rufipes* group, but has a much more elongate basal joint to the antennæ.

Bealey, Helms.

*Luperus puncticollis*, n. sp.—Minus gracilis, nigricans, supra cum antennis pedibusque testaceis; prothorace elytris que fortiter punctatis. Long.  $4\frac{1}{2}$  m.m.

Antennæ rather short and stout, sordid yellow. Thorax transverse, the sides rounded, the anterior angles not prominent, the base oblique on either side near the very obtuse posterior angles, the surface shining, coarsely and moderately closely punctate. Elytra coarsely and closely punctate; apices rounded, leaving extremity of body exposed. Legs yellow; hind tibiæ not curvate.

This is very different from the other species.

Otira, Wakefield.

## NOTES ADDED DURING PRESS.

Since this Paper was submitted to the Society I have received from Mr. Helms a small consignment of Coleoptera from Greymouth, containing some interesting species, and giving rise to the following descriptions and most of the remarks:—

*Cicindela helmsi* (*ante*, p. 358).—Both sexes of this species have now been received; and although the examples are in bad preservation, they are sufficient to confirm the species as a very distinct one; the surface of the wing-cases is much marked by large but extremely obsolete pits; the pallid lateral margin has some brown specks in its apical portion; the female is rather larger and broader than the male, and has, at the extremity of the suture, a deep, remarkably definite, narrow, common excision. The interruption near the base of the pallid lateral margin is constant.

Genus *Ctenognathus* (*ante*, p. 363).—Since this was written I have examined some of the very numerous Central American species of *Colpodes* recently described by Bates in *Biologia Centrali-Americana*, vol. i., pt. 1, and I find that some of them are, so far as the thoracic setæ are concerned, *Ctenognathi*: the genus, therefore, is not peculiar to New Zealand.

*Pterostichus rugifrons*, n. sp.—*Elongatus*, *subparallelus*, *nitidus*, *niger* *antennis palpis pedibusque piceis*; *capite thoraceque transversim rugosis*; *elytris foveolato-striatis*. Long. 18 m.m.

This species belongs to the group 4A, as defined by me on p. 365 *ante*, and is allied to *P. myrmidon*, but has the sculpture much more remarkably developed, suggesting at first that the insect is a *Mecodema* rather than a *Pterostichus*. *Holcaspis cribrale*, Broun (*sic*) is, I expect, nearer to the species I am considering, but the description indicates that it must possess a still more remarkable sculpture. In *P. rugifrons* the thorax is almost longer than broad, but little curved at the sides, and slightly broader at the base than it is at the very depressed obscure front angles; the surface is traversed by numerous distinct, but not deep, transverse rugae; the hind angles are decidedly obtuse, owing rather to the curvation of the base than to the rather small obliquity of the lateral margin. The sculpture of the elytra consists of striae interrupted in some places, and in others augmented by oblong depressions, which are more conspicuous and punctiform on the lateral regions than on the sutural.

*Soronia oculata*, Reitter (Fam. Nitidulidæ).—This species has been received by me, for the first time, from Mr. Helms (as No. 418). It is exceedingly similar to *S. grisea*, so much so, that unless the two are actually placed side by side they might well be considered as one species. It is certainly a very remarkable fact

that one of our commonest European insects should be so very similar in appearance to a New Zealand species, and this is still more the case, as the superficial resemblances are accompanied, I find, by some structural dissimilarities, so that I doubt whether the two will ultimately remain in one genus. The sexual characters are very different, the front and middle tibiæ in the male of *S. oculata* being simple, and the hind tibia excised at the base internally. The New Zealand species, too, is remarkable on account of the very wide separation of the hind legs, the wide abdominal process between them being only very obtusely angulate in the middle. In the New Zealand insect the antennal grooves are much less convergent behind, and the epipleuræ entirely disappear at the sutural tip of the wing-cases.

*Picrotus* (*ante*, p. 394).—This insect has been recently examined by some skilful entomologists, who concluded they could only find four joints to the tarsi. I may therefore state that the description given by me of the trophi and feet of *P. thoracicus* was made from a dissection mounted in Canada balsam, and is undoubtedly correct, as a fresh examination of the preparation, so far as regards the feet, has been made by myself and the Rev. H. S. Gorham.

The following interesting weevil of the group *Eugnomides* has been received with some other insects during the printing of this memoir:—

*Ancistropterus helmsi*, n. sp.—Major, fusco-piceus, elytris æneo-rufis, tibiis rufis; oculis parum prominulis; elytris humeris extus vix prolongatis, dorso obtuse binodosis, nodulis penicillatis. Long. rostr. incl. 8 m.m.

Antennæ blackish, terminal joint of club rather longer than the two preceding joints together. Rostrum stout, closely punctulate; eyes not convex, though, as the head is abruptly narrowed in front of them, their anterior aspect is convex. Thorax truncate-conical, coarsely punctate, indistinctly transversely plicate. Elytra elongate, much narrowed behind, shoulders forming an obtuse angle: viewed laterally it is seen that the surface rises much from the scutellum backwards, and at the summit, much behind the middle, is crowned with two obtuse elevations, having much longitudinal extension, and being surrounded by a longitudinally long tuft of hairs; the regular series of punctures are rather fine.

This more resembles *A. browni* than it does any other species, but is very distinct therefrom by the less convex eyes. This character renders the generic position somewhat doubtful, suggesting that the insect would be as naturally placed in *Scolopterus*. Moreover, the two examples received have the pygidium and propygidium exposed, but this may be the result of the decayed state in which I received them. It is not advisable to add to the New Zealand genera of this group a new one until a thorough revision be made of them. This is much needed.

Greymouth, Helms; two examples, No. 436.

EXPLANATION OF PLATE XII.

## PLATE XII.

- |  |   |
|--|---|
| Fig. 1. <i>Mecodema ducale.</i>                      | Fig. 14. <i>Coprostygnus sculptipennis.</i> |
| „ 2. „ <i>rugiceps.</i>                              | „ 15. <i>Omalius sagoloide.</i>             |
| „ 3. <i>Diglymma ovipenne.</i>                       | „ 16. <i>Catopsolius lævicollis.</i>        |
| „ 4. <i>Metaglymma sulcatum.</i>                     | „ 17. <i>Heterargus rudis.</i>              |
| „ 5. <i>Anchomenus pictonensis.</i>                  | „ 18. <i>Ulonotus dissimilis.</i>           |
| „ 6. <i>Pterostichus (Trichosternus) compressus.</i> | „ 19. <i>Enarsus eucullatus.</i>            |
| „ 7. „ <i>(Zeopœcilus) calcaratus.</i>               | „ 20. <i>Bitoma sellata.</i>                |
| „ 8. „ <i>myrmidon.</i>                              | „ 21. <i>Pycnomerus longulus.</i>           |
| „ 9. <i>Picrotus thoracicus.</i>                     | „ 22. „ <i>sulcatissimus.</i>               |
| „ 10. <i>Sympiestus syntheticus.</i>                 | „ 23. <i>Brontopriscus sinuatus.</i>        |
| „ 11. <i>Zolus helmsi.</i>                           | „ 24. <i>Cathartocryptus obscurus.</i>      |
| „ 12. <i>Quedius insolitus.</i>                      | „ 25. <i>Saphophagus minutus.</i>           |
| „ 13. <i>Cafioquedus gularis.</i>                    |   |

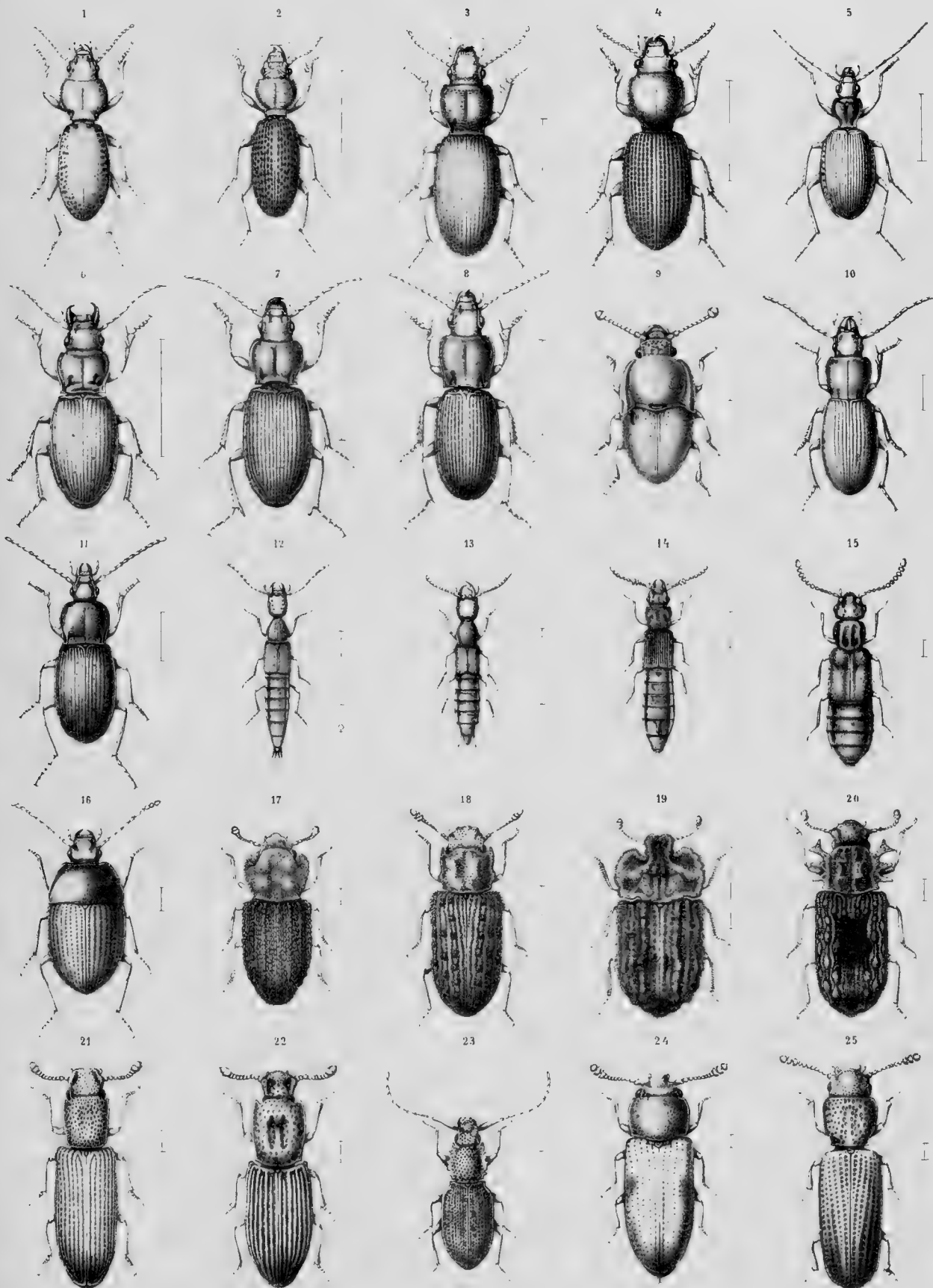





EXPLANATION OF PLATE XIII.

## PLATE XIII.

- |  |  |
|--|--|
| Fig. 1. <i>Triphyllus zealandicus.</i>                   | Fig. 14. <i>Cuneopterus conicus.</i>                 |
| „ 2. <i>Corymbites irregularis.</i>                      | „ 15. <i>Dermotrichus mundulus.</i>                  |
| „ 3. <i>Protelater elongatus</i> var. d.                 | „ 16. <i>Crisius obesulus.</i>                       |
| „ 4. <i>Perpectus obscurus.</i>                          | „ 17. <i>Pentarthrum constrictum.</i>                |
| „ 5. <i>Periatrum helmsi.</i>                            | „ 18. <i>Anthribus tuberosus.</i>                    |
| „ 6. <i>Cerodolus chrysomeloides.</i>                    | „ 19. <i>Proscoporphinus albifrons.</i>              |
| „ 7. <i>Malacodrya pictipes.</i>                         | „ 20. <i>Ophryops dispar</i> ♀.                      |
| „ 8. <i>Nonnotus griseolus.</i>                          | „ 21. <i>Stenellipsis cuneata.</i>                   |
| „ 9. <i>Protophormus gracilis.</i>                       | „ 22. <i>Tetrorea longipennis.</i>                   |
| „ 10. <i>Aporolobus (Trachyphlæus) irritus</i> , Pascoe. | „ 23. <i>Caccamolpus globosus.</i>                   |
| „ 11. <i>Brachyolus huttoni.</i>                         | „ 24. <i>Atrichatus (Colaspis) ochraceus</i> Broun.  |
| „ 12. <i>Platyomida coronata.</i>                        | „ 25. <i>Pleuraltica (Phyllotreta) cyanea</i> Broun. |
| „ 13. <i>Heterodiscus insolitus.</i>                     |  |

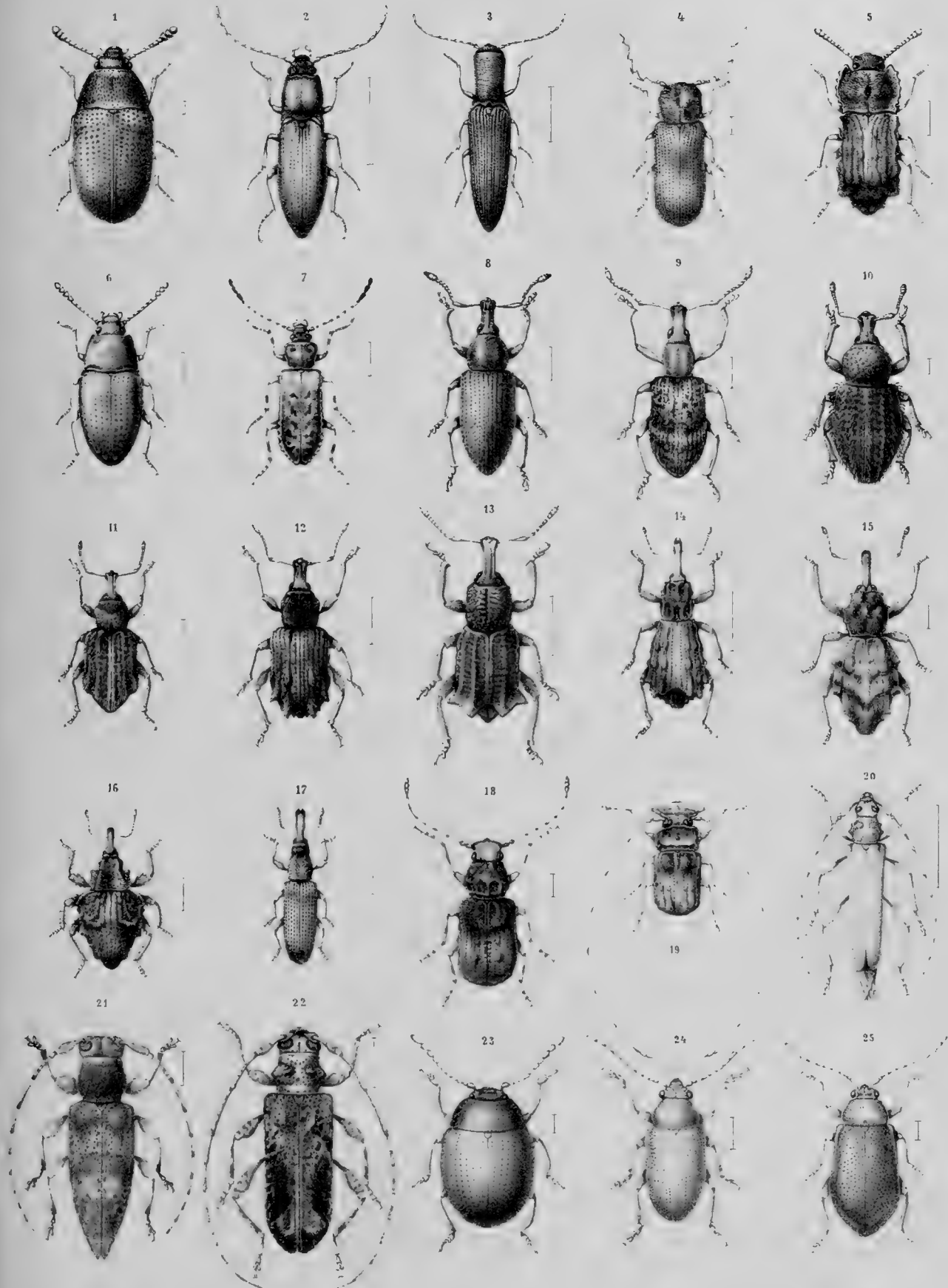





## TRANSACTIONS (NEW SERIES).

### VOLUME I.

Parts 1-25.—November, 1877, to September, 1883. (*Part 25 contains Title-page to Volume.*)

### VOLUME II.

PART

- 1.—Observations of Nebulæ and Clusters of Stars, made with the Six-foot and Three-foot Reflectors at Birr Castle, from the year 1848 up to the year 1878. Nos. 1 & 2. By the RIGHT HON. THE EARL OF ROSSE, LL.D., D.C.L., F.R.S. Plates I. to IV. (August, 1879.) No. 3. Plates V. and VI. (June, 1880.)
- 2.—On Aquatic Carnivorous Coleoptera or Dytiscidæ. By DR. SHARP. Plates VII. to XVIII. (April, 1882.) [*With Title-page to Volume.*]

---

### VOLUME III.

- 1.—On the Influence of Magnetism on the Rate of a Chronometer. By OTTO BÆDDICKER, PH.D. Plate I. (September, 1883.)
- 2.—On the Quantity of Energy transferred to the Ether by a Variable Current. By GEORGE F. FITZGERALD, M.A., F.R.S. (March, 1884.)
- 3.—On a New Form of Equatorial Telescope. By HOWARD GRUBB, M.E., F.R.S. Plate II. (March, 1884.)
- 4.—Catalogue of Vertebrate Fossils from the Siwaliks of India, in the Science and Art Museum, Dublin. By R. LYDEKKER, B.A., F.G.S., F.Z.S. Plate III. and Woodcuts. (July, 1884.)
- 5.—On the Origin of Freshwater Faunas: A Study in Evolution. By W. J. SOLLAS, M.A., Dublin; D.Sc., Cambridge; Fellow of St. John's College, Cambridge; Professor of Geology and Mineralogy in the University of Dublin. (November, 1884.)
- 6.—Memoirs on the Coleoptera of the Hawaiian Islands. By THE REV. T. BLACKBURN, B.A., and DR. D. SHARP. Plates IV. and V. (February, 1885.)
- 7.—Notes on the Aspect of the Planet Mars in 1884. Accompanied by Sketches made at the Observatory, Birr Castle. By OTTO BÆDDICKER, PH.D. Plate VI. (March, 1885.)
- 8.—On the Geological Age of the North Atlantic Ocean. By EDWARD HULL, LL.D., F.R.S., F.G.S., Director, Geological Survey of Ireland. Plates VII. and VIII. (April, 1885.)
- 9.—On the Changes of the Radiation of Heat from the Moon during the Total Eclipse of 1884, October 4, as Measured at the Observatory, Birr Castle. By OTTO BÆDDICKER, PH.D. Plates IX. and X. (October, 1885.)
- 10.—On the Collection of the Fossil Mammalia of Ireland in the Science and Art Museum, Dublin. By V. BALL, M.A., F.R.S., F.G.S., Director of the Museum. (Plate XI.)
- 11.—On New Zealand Coleoptera, with Descriptions of New Genera and Species. By DAVID SHARP, M.B. Plates XII. and XIII.

THE  
SCIENTIFIC TRANSACTIONS  
OF THE  
ROYAL DUBLIN SOCIETY.

VOLUME III. (SERIES II.)

---

XII.—THE FOSSIL FISHES OF THE CHALK OF MOUNT LEBANON, IN  
SYRIA. BY JAMES W. DAVIS, F. G. S., F. L. S., ETC.

(PLATES XIV. TO XXXVIII.)



DUBLIN:  
PUBLISHED BY THE ROYAL DUBLIN SOCIETY.  
PRINTED AT THE UNIVERSITY PRESS, BY PONSONBY AND WELDRICK,  
PRINTERS TO THE SOCIETY.  
1887.





## XII.—THE FOSSIL FISHES OF THE CHALK OF MOUNT LEBANON, IN SYRIA.

By JAMES W. DAVIS, F.G.S., F.L.S., &amp;c. Plates XIV. to XXXVIII.

[Read, March 16, 1885.]

[COMMUNICATED BY THE EARL OF ENNISKILLEN, F.R.S.]

## CONTENTS.

	PAGE
I.—EXPLANATORY PREFACE, ... ..	457
II.—HISTORICAL AND BIBLIOGRAPHICAL RESUMÉ, WITH GEOLOGICAL DESCRIPTION OF LOCALITIES, ... ..	458
III.—CLASSIFIED DESCRIPTION OF FOSSIL FISHES, ... ..	467
INDEX TO GENERA AND SPECIES, ... ..	629
DESCRIPTION OF PLATES, ... ..	633

## I.—EXPLANATORY PREFACE.

I AM principally indebted for the material on which the descriptions of the Fossil Fishes, contained in the following pages, have been based to the enlightened and energetic action of Professor E. R. Lewis, who, during his residence as a professor in the American College at Beyrout, seized every available opportunity to study the natural history of the district, and accumulated a magnificent collection of the fossil fishes from the classic localities in the mountains of Lebanon. On the retirement of Professor Lewis from the college at Beyrout the collection was transferred to the museum of Mr. Robert Damon, at Weymouth, and many of the specimens have since been acquired for, and added to, the national collection. These are now placed in the new Natural History Department of the British Museum at South Kensington. A considerable portion of the collection still remains at the museum at Weymouth; and, as will be observed by a reference to the pages following, specimens from it have served to indicate the types of several new forms. In addition to the sources already specified, there exists in the National Museum a large mass of material derived, to a great extent, from the collections of the Earl of Enniskillen and the late Sir Philip de M. Grey Egerton, Bart., which has been most freely and with great kindness placed at my disposal for observation and description.

It is with unfeigned pleasure that I take this opportunity to express my indebtedness to those friends who, in many ways, have assisted my researches, and more especially to Dr. Henry Woodward, F.R.S., Director of the Geological Department of the British Museum; to Mr. William Davies, F.G.S., whose great practical knowledge is an invaluable aid to the student in this branch of palæontology; to the Earl of Enniskillen, and Dr. E. Perceval Wright; and to Mr. Robert Damon, F.G.S., who has generously placed his rich private collection freely at my service.

## II.—DESCRIPTION OF LOCALITIES AND BIBLIOGRAPHY.

The existence of fossil fishes in the chalk-beds of Mount Lebanon has been known from remote antiquity. They were found and their nature discussed by Herodotus about the year 450 B.C. In 1248, it is related in the History of Saint Louis by De Joinville (reprinted in the *Le Temps* newspaper on May 11th, 1865), that whilst he was travelling in the neighbourhood of Sidon, at the present time called Saïda, a stone was brought to him which, being split in two, exposed the form of a fossil fish. The circumstance is related in the following words: "On apporta au roi une pierre qui se levait par écailles, le plus merveilleuse du monde; car, quand on levait une écaille, on trouvait entre les deux pierres la forme d'un poisson de mer. Le poisson était de pierre, mais il ne manquait rien à sa forme: ni yeux, ni arêtes, ni couleur, ni autre chose qui empêchât qu'il ne fût tel que s'il fût vivant. Le roi demanda une pierre et trouva une Tanche dedans, de couleur brune et de telle façon qu'une Tanche doit être."

In a note to the translation of the works of de Blainville into German it is stated that Jonas Korte, during his travels in the Holy Land, found a white slate, between the layers of which were reddish skeletons of fishes.

M. Maraldi communicated a paper, printed in the "Histoire de l'Académie des Sciences," 1703, in which he describes certain dried-up fishes in stones which had been taken to Phœnecia, in the territory of the city of Biblis, now named Gibeal, over mountains almost inaccessible and distant fifteen miles from the sea. The author attempts to account for their presence by supposing that as there are subterranean waters, so there must be subterranean fishes; and as the waters are carried up, according to the system of M. de la Hire, as vapour, the latter, perhaps, carries with it the eggs and small seeds, after which, when the vapour condenses and becomes again water, the eggs can hatch and become fishes and shells. He then conceives it quite possible that by some accident the water may become diverted or evaporated, and the fishes which it nourished, left high and dry, became enveloped in the earth, which, as it became petrified, petrified also the remains of the fishes.

Some particulars are given by Corneille Lebrun ("Voyage au Levant," 1714, chap. 58, p. 309) of the discovery of fossil fishes in the neighbourhood of Tripoli, the locality referred to being probably that of Hakel. He describes "certaines pierres où l'on voit la ressemblance de diverses sortes de poissons, mais si naturelle qu'on ni aurait regarder cela sans admiration." These stones were found in a high mountain some hours distance from Tripoli. The stones are described as exhibiting no peculiarity until they are broken or divided, when each of the two pieces exhibits the resemblance of a fish. M. Lebrun made a collection of these objects which so interested him, and in his work gives an engraving of one of the specimens.

M. C. F. Volney also refers to the imprints of fishes, shells, and plants on the stony schists between Batroun and Djebail au Kesraonau, which he found during his travels in Syria and Egypt during the years 1783 to 1785.

M. Guettard, in his "Nouvelle Collection de Mémoires sur différentes parties des Sciences et des Arts," vol. iii., p. 429, 1768, has some observations on the fossil fishes of Lebanon, specimens of which he has figured.

M. de Blainville was the first author who appears to have studied the Lebanon fossils from a zoological point of view. He determined the genera of two species, which he described without figuring, namely, *Clupea brevissima* and *Clupea beurardi*; these names the fossils still retain (Sur les Ichthyolithes ou les Poissons fossiles; Nouveau Dictionnaire d'Histoire Naturelle, tome xxvii. 1818. The work was translated into German, in 1823, by Krüger).

M. Louis Agassiz, when preparing his great work on "Recherches sur les Poissons Fossiles," 1833-43, had seen only a comparatively small number of specimens from the chalk of Lebanon. Four new species are described: *Clupea lata*, *C. minima*, *Rhinellus furcatus* and *Sphyræna amici*; two others are named, but not described, *Pagellus leptosteus*, and *Vomer parvulus*; and further details are given with respect to the two species described by de Blainville. Professor Agassiz states that M. Jules Amic communicated to him the figures of a fine collection of fishes from Lebanon, for the most part new, which would enable him to determine the relationships of the fishes of that locality with those of other strata already well known. MM. Alexandre Brogniart and St. Moricaud are also indicated as being the possessors of fossil fishes from Lebanon. The examples possessed by the latter were not utilized by Agassiz, but M. Pictet afterwards described some of them under the generic name of *Spaniodon* ("Desc. de quelque poissons fossiles du Mont Liban, 1850"). The collection of M. Amic, at Geneva, was seen by Messrs. Pictet and Humbert, who state that the description of it by Agassiz was exaggerated, and that it served to constitute only a very small number of new species.

In 1833, the memoir of M. Botta on the Lebanon and Anti-Lebanon was published. ("Memoirs Soc. Geol. de France," vol. i., p. 135.) In it the two best

known fossil fish localities are described, but no further descriptions of fossil fishes are given. Sir Philip de Grey Egerton described the fossil Ray, *Cyclobatis oligodactylus*, in the Quarterly Journal of the Geological Society, vol. i., p. 225, Pl. V., 1845; and in 1849, M. Heckel had the opportunity to study specimens collected by M. Th. Kotschy (*Abbildungen und Beschreibungen neuer und seltener Thiere und Pflanzen in Syrien, etc., versammelt von Th. Kotschy, herausgegeben von D.D. Fruzl. Heckel und Redtembacher, 1843-9*). Two new species of *Clupea* are described, viz. *C. macrophthalma* and *C. gigantea*; the latter from a very imperfect and doubtful specimen. He established the genus *Pycnosterinx*, and described two new species pertaining to it, viz. *P. discoides* and *P. russeggerii*, and a specimen, afterwards identified by M. Pictet as a jaw of the genus *Eurypholis*, was described and figured under the name *Isodus sulcatus*.

In 1836, M. Russeger, travelling under the protection of Ibrahim Pascha, visited the Kloster of Sahel Alma, and induced the people there to collect the fish remains for him, by paying them a piaster for each specimen. This peculiar freak attracted the attention of the people in the neighbourhood, who communicated with the Prior, who in great wrath threatened to beat Russeger if he did not give up all the fishes he had collected. The position might have been a serious one had not Russeger taken out his pistols, on seeing which the Prior suppressed his wrath, and finally agreed for a further sum of money to allow the fossils to be retained. (Russeger, *Reisen. B. III.*)

A most important and valuable contribution to the knowledge of the fossil Ichthyology of the Lebanon district is contained in the memoir by M. F. J. Pictet, Professor of Zoology and Comparative Anatomy at the Academy of Geneva, entitled "Description de quelques poissons fossiles du Mont Liban, 1850." After briefly reviewing the observations contributed by previous authors on the subject, this learned ichthyologist proceeds to describe a collection of fossil fishes sent to the Museum at Geneva by M. Edmond Boissier. The specimens were collected from the two localities of Hakel and Sahel Alma.

Previous authors expressed diverging opinions as to the geological age of the fish-beds of Lebanon. M. Agassiz hesitated as to whether they should be considered as pertaining to the jurassic epoch or to that of the chalk; whilst M. Heckel was doubtful between the chalk and the tertiary formations. Pictet considered that the great number of extinct forms and the great difference between the fauna of the fish-beds and that existing in the sea at the present time made it impossible to attribute the remains to a tertiary epoch; on the other side, the entire absence of ganoid fishes appeared to indicate that they are of a period anterior to the jurassic, and must consequently have belonged to that of the cretaceous period. He further confirmed this opinion by the presence of fossil fishes of the genus *Beryx* and the remarkable *Dercetis*, which had been found only in the white chalk. This opinion has since been proved to be the

correct one, though the three species of *Dercetis*, described from very imperfect specimens, have all been found to belong to other genera. As already stated, Blainville described two species from the Lebanon fish-beds, Agassiz six, Egerton one, and Heckel five; to this number Pictet added twenty. The following synopsis of these species may be useful; the locality in each instance is appended:—

BLAINVILLE, . . .	<i>Clupea brevissima</i> : Hakel.	<i>C. beurardi</i> : Sahel Alma.
AGASSIZ, . . .	<i>Clupea lata</i> : Sahel Alma.	<i>C. minima</i> : „
„	<i>Rhinellus furcatus</i> : Sahel Alma.	<i>Sphyræna amici</i> : „
„	<i>Pagellus lepidosteus</i> : „	<i>Vomer parvulus</i> : „
EGERTON, . . .	<i>Cyclobatis oligodactylus</i> : Hakel.	
HECKEL, . . .	<i>Clupea macrophthalma</i> : „	<i>C. gigantea</i> : Hakel.
„ . . .	<i>Pycnosterinx discoides</i> : Sahel Alma.	<i>P. russeggerii</i> : Sahel Alma.
„ . . .	<i>Isodus sulcatus</i> (= <i>Eurypholis</i> ): Sahel Alma.	
PICTET, . . .	<i>Pagellus libanicus</i> (= <i>P. ovalis</i> ): Sahel Alma.	<i>Pycnosterinx dorsalis</i> : Sahel Alma.
„ . . .	<i>Pycnosterinx heckelii</i> : Sahel Alma.	<i>Osmeroides megapterus</i> : Sahel Alma.
„ . . .	<i>Mesogaster gracilis</i> : Sahel Alma.	<i>Spaniodon blondelli</i> : Sahel Alma.
„ . . .	<i>Eurypholis longidens</i> : Sahel Alma.	<i>Dercetis tenuis</i> : Sahel Alma.
„ . . .	<i>Spaniodon elongatus</i> : Sahel Alma.	<i>D. linguifer</i> : Sahel Alma.
„ . . .	<i>Dercetis triqueter</i> : „	<i>Platax minor</i> : Hakel.
„ . . .	<i>Spinax primævus</i> : „	<i>Coccodus armatus</i> : Hakel.
„ . . .	<i>Beryx vexillifer</i> : Hakel.	<i>Eurypholis boissieri</i> : „
„ . . .	<i>Petalopteryx syriacus</i> : Hakel.	<i>Clupea laticauda</i> : „
„ . . .	<i>Eurypholis sulcidens</i> : „	
„ . . .	<i>Clupea sardinioides</i> : „	

Included in the above list are four new genera, viz., *Petalopteryx*, *Eurypholis*, *Spaniodon*, and *Coccodus*, which M. Pictet found it necessary to establish for the more peculiar and aberrant forms of the fishes he described.

In 1855, M. O. G. Costa, Professor at the University at Naples (“*Descrizione de alcuni Pesci fossile del Libano. Mem. della R. Acad. d. sc. di Napoli*,” vol. ii., pp. 97–112, with two plates), made an addition of four new species to those

mentioned above. They are—

- Beryx niger: Sahel Alma.  
 Omosoma sahel-almæ: Sahel Alma.  
 Imogaster auratus: Sahel Alma.  
 Rhamphornimia rhinelloides.

The last-named genus was probably an aggregate of fragments, not necessarily of fishes, because Messrs. Pictet and Humbert had reason to believe that they could distinguish the carapace of a crustacean in the specimen figured by M. Costa.

In 1866, M. F. J. Pictet, in conjunction with M. Aloïs Humbert, published "Nouvelles recherches sur les poissons fossiles du Mont Liban." The work was undertaken in consequence of the acquisition of a number of fossil fishes by M. Humbert during a visit to the two fish-bearing localities of Mount Lebanon. Many of these M. Pictet found to be new species, and some of them afforded information on undetermined characters in the species already described. He had also the opportunity to include in his description the examples deposited in the Museum of Natural History at Paris by M. Gaudry, as well as those preserved in the Palæontological Museum of the Academy of Sciences at Munich in the charge of Dr. Oppel. The work of Messrs. Pictet and Humbert, at the time it was written, was thoroughly comprehensive, and has to some extent served as the basis on which the superstructure of the present memoir is erected. It will be often necessary in the following pages to refer to it, and it is consequently not proposed to enter into a detailed analysis of the work at the present moment. The stratigraphical and palæontological relationship of the two fish-bearing beds of Hakel and Sahel Alma are discussed, and nine new species are added from the former locality and eight from the latter, besides transferring *Mesogaster gracilis*, Pictet, to *Opistopteryx gracilis* P. and H., and *Beryx niger*, Costa, to *Pycnosterinx niger* P. and H.

The following is a tabulated list of the new species described by MM. Pictet and Humbert:—

<i>Beryx syriacus</i> :	Sahel Alma.	<i>Pseudoberyx syriacus</i> :	Hakel.
<i>Cheirothrix libanicus</i> :	„	<i>P. bottæ</i> :	„
<i>Solenognathus lineolatus</i> :	„	<i>Clupea gaudryi</i> :	„
<i>Leptosomus macrourus</i> :	„	<i>C. bottæ</i> :	„
<i>L. crassicostatus</i> :	„	<i>Scombroclupea macrophthalma</i> :	„
<i>Spaniodon brevis</i> :	„	<i>Cheirocentrites libanicus</i> :	„
<i>Scyllium sahel-almæ</i> :	„	<i>Leptotrachelus hakelensis</i> :	„
<i>Pycnosterinx elongatus</i> :	„	<i>Aspidopleurus cataphractus</i> :	„
		<i>Rhinobatus maronita</i> :	„

Including the species given above, the total number described was fifty-one;

about three-fifths of the number were obtained from the soft chalk of Sahel Alma and the remaining two-fifths from the hard chalk at Hakel.

The earliest available description of the districts in Mount Lebanon from which the fossil fishes have been obtained is given by M. P. E. Botta in his "Observations sur le Liban et l'anti-Liban," in the "Mémoires de la Société Géologique de France," tome 1., part 1., 1833. He divides the strata of the district into three groups. The lowest is the Upper Jurassic, on which rests the green sand, and above that the inferior chalk. The latter is formed of alternations of chalk and chalky marl. It is in one of the middle beds of the inferior chalk that the fishes from Hakel are obtained. As to those of Sahel Alma, continues M. Botta, they appear to be in the same group, but are a little lower in the series.

In order to reach Hakel, it is necessary to go to Djebail, the ancient Byblos, a small village situated on the sea-coast, about 17 miles north of Beyrout. Hakel is about  $6\frac{1}{4}$  miles E.N.E. from Djebail. M. Botta describes the locality as being in a deep valley, situated at a great height above the sea level. The beds containing the fish remains are upon the slope of the hill on the right in ascending towards the village of Hakel. The beds are considerably displaced and vary much in their direction and inclination; the sides of the mountain are covered with *débris*, and it is in this *débris* that the fishes are found. The *débris* is in the form of thin foliated slabs, exhaling, when struck, a strong odour of sulphuretted hydrogen; these contain irregular beds of flint, or more properly of siliceous limestone, which enclose the fish. Aggregations of carbonate of lime are also found. The locality of these fishes differs in all its characters from that of Sahel Alma, and appears to be superior to it, the latter being found nearer to the sandy rocks; the species of fishes are quite different in the two localities.

M. Humbert, who visited the locality in 1860, states that the strata in which the Hakel fish-beds occur are in a deep ravine, at the bottom of which is a small rivulet. A short distance below the fish-bearing locality the valley becomes wider, the slopes are somewhat less abrupt, and evidences of cultivation appear. The village of Hakel is situated on the left flank of the valley, a few hundred paces below the wider part referred to above. A series of alternating beds of chalk and marl, which extend up the valley from the village, serve as a datum line for the determination of the relative ages of the fish-beds. At the place where the valley becomes wider, chalk strata, resting on a bed of marl, extend horizontally round the upper part of the valley and form a series of steps, over which the water of the rivulet falls in a cascade. These beds furnished a few fossils characteristic of the Cenomanian formation, amongst others *Arca tailleburgensis*, *Cardium hillanum*, *Natica difficilis*, and *Ostrea flabella* are found in the chalk, and *Hemiaster saulcyanus*, d'Orb. and *Psuedodiadema sinaica*, Cotteau, in the marl. M. Humbert's investigations led him to believe that the fish-bed

was immediately above or closely contiguous to that one containing *Cardium hillanum*; but the slopes of the hill-side being covered with the *débris* of the fallen cliff rendered the operation of tracing the fish-bed very difficult.

The fish-beds of Hakel appear to extend to a considerable distance. Specimens exist in the collection at the British Museum, South Kensington, which were found at Djebail, and M. Agassiz studied specimens of *Clupea* which were brought from Mount Carmel and St. Jean d'Acre. M. de Tchihatcheff discovered a number of fossil fishes at Makrikoï, near Constantinople, which were considered by Valenciennes to be the same species as *Eurypholis boissieri* and *sulcidens*, of Pietet, *Clupea brevissima*, Blainville, and *Cyclobatis oligodactylus*, Egerton, found at Hakel. In 1840, Professor W. C. Williamson described, in the Proceedings of the Geological Society of London (vol. iii. p. 291), certain districts in the vicinity of Beyrout, especially Mount Gebeel Suneen, which forms part of the Lebanon range immediately above Beyrout. The town is built on a triangular tongue of land, with undulating surface, about four miles in extent from the coast to the mountain. It is composed of a hard cream-coloured limestone, which exhibits in the cliffs or the sea-shore numerous veins of flints; this is on some parts of the coast overlaid by a soft calcareous rock a hundred feet in thickness, easily wrought, and frequently employed as a building stone. The stratigraphical arrangement of the rocks on Mount Gebeel Suneen is as follows:—

Compact limestone forming the summit of the mountain, ...	100 feet.
A seam of oysters, which may be traced completely round the mountain.	
A furruginous rock, ... ..	50 ,,
Compact limestone, ... ..	2000 ,,
Coarse siliceous conglomerate, containing three seams of lignite, and fragments of siliceous wood, ... ..	800 ,,
Compact limestone, ... ..	2000 ,,

The section is taken from the flat plain at the base of the mountain, four hundred feet above the sea level. Amongst numerous fossil mollusca specimens of *Clupea brevissima* were found. The latter occurs in great numbers a little above Tripoli, on the way to the Cedars, and about thirty miles north of Beyrout.

The Sahel Alma locality is described by M. Botta as follows:—The fish-beds of Sahel Alma are found beneath the convent of that name, at three hundred feet above the level of the sea. It is an argilo-calcareous stone, sometimes laminated, soft, and without appreciable odour. There are parts of a deep gray colour, almost resembling a plastic clay. The stratification cannot be identified, because the rock appears very little at the surface, which is all cultivated. The impressions of fish remains occur in considerable numbers, both of individuals and



species. Some species of crustaceans are also met with. This fish-bed differs from that of Hakel by its inferior position, the nature of the species, the quality of the chalk, the absence of silex, &c.

The convent of Sahel Alma is situated a little over one and a-half miles E.N.E. of Djouni, the latter about nine and a-half miles north of Beyrout. The convent is built on ground sloping rapidly towards the sea, covered with soil growing mulberry trees, beneath which is the marly chalk containing the fishes.

Dr. Oscar Fraas, in 1878, published the second part of his valuable memoir, "Aus dem Orient," which is, perhaps, the most useful work existing on the geological and stratigraphical constitution of that portion of Syria comprised in the district around the mountains of Lebanon. It is intitled "Geologische Beobachtungen am Libanon," and, in addition to an exhaustive description of the strata, the author gives a brief but comprehensive delineation of the fossil remains found in, and characteristic of, the several formations. The arrangement of the beds in the Lebanon district is somewhat complex, and not easily defined and correlated. Dr. Fraas recognizes the representatives of several European divisions, which are comprised in the following series, commencing from those uppermost in the series:—

<i>Fraas.</i>	<i>D'Orbigny.</i>	<i>Lyell.</i>
Senonbildung.	Danian and Senonian.	Maestricht beds. White chalk, and part of chalk marl.
Turonbildung.	Turonian.	Chalk marl.
Cenomanbildung.	Cénomanian.	Upper Greensand.
Gault.	Albien and Aptien.	Gault and part of Lr. Greensand.
Neokom.	Neocomian.	Part of Lr. Greensand and the Wealden.

The divisions are further subdivided into horizons, based on their palæontological contents, the characteristic fossils in most instances serving to indicate the bed by its name. The three uppermost divisions, with which we are more especially concerned in this work, constitute the following horizons:—

#### I. Senonbildung.

1. Senonmergel or white chalk, with nummulitic beds.

#### II. Turonbildung.

2. Marl or soft chalk, with the fishes of Sahel Alma.
3. Slatey or hard chalk, with fish remains of Hakel.
4. Radiolitenzone.

5. Zone of *Ammonites syriacus*.
6. Cardium beds.
7. Zone of Gasteropods of Abieh.

### III. Cenomanbildung.

8. Sandstone-formation with beds of coal and bitumen.
9. Glandarien-zone. (*Cidarites glandarius*.)

The Senonmergel, in addition to the nummulites and some species of molluscs, contains the remains of fishes. Dr. Fraas enumerates several species, of which the following is a list. They are all from the hill, Abu Tor, on the road between Hinnom and Bethlehem.

1. *Otodus lanceolatus*, Agass. (Poiss. foss. vol. iii., plate 37, fig. 20.)
2. *O. appendiculatus*, Agass. ( „ „ „ „ 32, fig. 15.)
3. *Oxyrhina mantelli*, Agass. ( „ „ „ „ 33, figs. 3–9.)
4. *Lamna compressa*, Agass. ( „ „ „ „ 37, fig. 33.)
5. *L. acuminata*, Agass. ( „ „ „ „ 37, fig. 54.)
6. *Enchodus halocyon*, Agass. ( „ „ vol. v., „ 25, figs. 1–7.)
7. *Ptychodus polygyrus*, Agass. ( „ „ vol. iii., „ 23.)
8. *Corax heterodon*, Reuss. (Böhm. Kreid., plate 3, figs. 49–71.)  
= *C. falcatus*, Agass.)
9. *Lamna subulata*, Agass. (Poiss. foss. vol. iii. p. 296, pl. 37*a*, figs. 5–7).
10. *L. elegans*, Agass. ( „ „ „ p. 289, pl. 35, figs. 1–7).

The species numbered 1–6 are given in “Aus dem Orient,” pt. II., pp. 100, 101. Those numbered 7–10 are from the same locality, and are described by the author in “Aus dem Orient,” pt. I., p. 109. I have had no opportunity of confirming the above identifications; their English equivalents range from the Lower Neocomian (*O. appendiculatus*, Ag.), through the chalk series, to the London clay (*Lamna compressa*, Ag., and *L. elegans*, Ag.), and, taken together with the invertebrate fauna, appear to indicate that the Senonmergel, or white chalk of Palestine and Syria is either a tertiary deposit, or that the fossils may have been collected from several horizons, and that there has been a gradual and continuous process of deposition from the chalk to the tertiary epochs.

The upper beds of the Turonian group contain the fish remains which have made the locality famous in Ichthyological annals. The Sahel Alma marls are replete with the fossil mollusc, *Pholadomya fabrina*, d'Orb., from which Dr. Fraas suggests the name *Pholadomyenmergel*, to distinguish them from the several divisions into which the group is divided. Besides the *Pholadomya fabrina* several others are found, and along with them two or three species of

ammonites. The fish remains described by MM. Pictet and Humbert are enumerated, and the author states that others are in the possession of the Rev. Mr. Lewis, and at the college at Beyrout, which will probably considerably increase the number of known species when they are described.

The hard chalk of Hakel is principally remarkable for the immense numbers of fishes found between some of the layers composing it. Hundreds of the small *Leptosomus macrourus* are preserved on slates occupying only a few square feet, and some other species are proportionately numerous. Several species of comatula and of echinoderms, cuttlefishes and crustaceans (*Pseudastacus*) are more or less common. Dr. Fraas cites the several species of fossil fishes hitherto described as found at Hakel, and which have been already mentioned in the previous pages of this memoir. Dr. Fraas describes and figures an example of the genus *Gyrodus*, consisting of the teeth and jaws (“*Aus dem Orient.*,” pt. II., p. 92, plate 4, figs. 5, 6), which is named *G. syriacus*, Fr.

As the special characteristics of the lithology and palæontology of the remaining strata of the Turonbildung and those of the Cenomanbildung do not influence the consideration of the present subject, the reader desirous of further information may be referred to the pages of Dr. Fraas’ most interesting work.

### III.—CLASSIFIED DESCRIPTION OF THE FOSSIL FISH REMAINS.

The classification of the fossil fish remains described in the following pages is based, so far as has been practicable, on that of Dr. Albert C. L. G. Günther, Keeper of the Zoological Department of the British Museum. The great and comprehensive summary of ichthyological knowledge contained in the “*Catalogue of Fishes*” (1859–1870), and epitomized in his “*Introduction to the Study of Fishes*” (1880), will justly constitute the foundation on which future ichthyologists will base their researches and deductions in this branch of Zoology. Founded to a large extent on the classical researches of Dr. Johannes Müller, and embracing the most recent work of modern embryologists and anatomists; combined with the experience obtained by constant association with the large and unrivalled collections in the British Museum, Dr. Günther’s work will always remain as a fitting monument of his intellectual energy in the systematic arrangement of fishes.

The Class PISCES is divided into four sub-classes:—

- I. PALÆICHTHYES = Elasmobranchii, Ganoidei, and Dipnoi (Huxley).
- II. TELEOSTEI = Teleostei (Huxley).
- III. CYCLOSTOMATA = Marsipobranchii (Huxley).
- IV. LEPTOCARDII = Pharyngobranchii (Huxley).

The fish remains from the cretaceous formation of Mount Lebanon are comprised in the two first classes. The sharks and rays are represented by several species in each group, and the Teleosteans are numerous and varied. There is a marked absence of Ganoids. The large number of fishes of the latter order, which formed so important a part of the Fauna of the Oolite and Liassic formations, have disappeared, and it is doubtful whether a single example has been found in the chalk of the Lebanon district. In accordance with the general character of the evidence afforded by the chalk strata, there is a decided advance towards the present existing Fauna. Some of the sharks have certainly a generic relationship with those now living, and the same observation may be applied to the rays. The Holocephala (Chimæroids) are not represented. The Teleosteans are for the most part, if not entirely, comprehended in the orders Acanthopterygii and Physostomi, and, as will be found hereafter, embrace many very peculiar forms. These groups appear to have taken the place of the Ganoids of the older formations, and although no direct proof of any process of evolution has hitherto been traced, there is strong presumptive evidence that some such process may have been in operation.

#### Sub-class I.—PALÆICHTHYES.

Heart, with a contractile conus arteriosus; intestine with a spiral valve; optic nerves non-decussating, or only partially decussating; skeleton cartilaginous or osseous.

This sub-class is divided into two orders: the Chondropterygii, and the Ganoidei: of the latter, as already observed, there are no representatives in the chalk of Lebanon. The former, comprising the sharks, rays, and chimæras, is thus defined by Dr. Günther:—

#### Order 1.—CHONDROPTERYGII.

“Skeleton cartilaginous. Body with medial and paired fins, the hinder pair abdominal. Vertebral column generally heterocercal; the upper lobe of the caudal fin produced. Gills attached to the skin by the outer margin, with several intervening gill-openings: rarely one external gill-opening only. No gill-cover. No air-bladder. Two, three, or more series of valves in the conus arteriosus. Ova large and few in number; impregnated, and in some species developed within the uterine cavity. Embryo with deciduous external gills. Males with intromittent organs attached to the ventral fins.”

This order is divided into two sub-orders: the Plagiostomata and the Holocephala, the latter containing the chimæroid fishes.

## Sub-order 1.—PLAGIOSTOMATA.

“From five to seven gill-openings. Skull with a suspensorium and the palatal apparatus detached; teeth numerous.”

The Plagiostomata may be divided into two groups—the (A) Selachoidei, or sharks, whose body is elongate, more or less cylindrical, gradually passing into the tail; gill-openings lateral.

The (B) Batoidei, or rays, in which the body is depressed, and surrounded by immensely developed pectoral fins, forming a broad flat disc. Caudal portion more or less rapidly contracted to form the tail. Gill-openings, five in number, are always placed on the abdominal surface of the fish.

The sharks are all of a small size, rarely, if ever, exceeding two feet in length: in this respect they differ very materially from the great Selachians of the earlier formations: they exhibit still greater divergence in the state of their preservation; for whilst the earlier fishes are represented in the fossil state, only in the most fragmentary form, those of the Lebanon are beautifully preserved, and exhibit considerable details of structure. The state of their preservation, considering the cartilaginous nature of the skeleton, apparently points to the extremely quiet and unruffled period during which the chalk was deposited. Had the fish been subjected to the action of the tides only, they must have been dismembered by the decomposition of the connecting cartilages; and had such been the case, there would have remained only a mass of indeterminate fragments, consisting of vertebræ and teeth, with occasionally a small spine. The special characteristics of the several members of this group will be enumerated in the detailed descriptions further on: at present it will be sufficient to observe that *Notidanus gracilis* is somewhat nearly related to some species of the same genus from the chalk of Sussex. *Spinax primævus* appears to be an intermediate form between the *Spinax* of the Lias and the Dog-fishes now existing, and *Scyllium Sahel Almæ*, a diminutive form, bearing a close resemblance to the smooth hound, also common in the waters on our own coast.

The number of genera and species of the Selachoidei has been largely increased during the past few years by the careful efforts of the Rev. E. R. Lewis, for some time at the Protestant Syrian College at Beyrout, who neglected no opportunity to collect every new example brought to light. The same observation applies with equal force to the second group of the Plagiostomata; and the knowledge of the fossil rays of the Lebanon chalk has been greatly extended by his well-directed energy. The sharks, with the exception of the genus *Spinax*, have been obtained from the soft chalk of Sahel Alma: *Spinax* is found both in that locality and at Hakel. The rays are more equally divided between the two localities; five species have been discovered in the hard

chalk of Hakel, and four from the soft chalk. *Cyclobatis oligodactylus*, described by Sir P. Egerton, was from the hard chalk of Djebail: it has since been found at Hakel.

(A)—SELACHOIDEI—SHARKS.

Family. **NOTIDANIDÆ.**

Genus. **Notidanus.** CUVIER.

Dentition unequal in the jaws. In the upper jaw one or two pairs of awl-shaped teeth, the following six being broader, and provided with several cusps, one of which is much the strongest. Lower jaw with six large comb-like teeth on each side, beside the smaller posterior teeth. Spiracles small on the side of the neck; no pit at the root of the caudal fin; gill-openings wide, six or seven in number (Günther); one dorsal fin opposite to the space between the ventral and anal fins.

*Notidanus gracilis*, DAVIS.

(Pl. xiv., figs. 1, 1a.)

Ventral surface exposed; head with mouth; under surface of pectorals and ventrals; anal and caudal fins. Body and fins covered with a thick skin, coated with minute, rounded tubercles: the skin more or less wrinkled and furrowed. Length, 13 inches; diameter behind pectorals, 1·6 inches, diminishing posteriorly to ·6 at the base of the tail. Head, 2·5 inches; tail, 3·5 inches in length; anal 2 inches in front of caudal. The ventrals nearer to the anal than to the pectorals.

Head, only under surface exposed; snout extends 0·7 in. beyond the mouth.

Mouth, large; deeply arched. The jaws extend a further distance backwards than the diameter at their base; strong and robust. Teeth, lower jaw, 0·3 inches long; strong flat base, from which rise a series of five denticles, anterior one largest, having a length of 0·1 inch, succeeding ones diminishing posteriorly, as in the recent *Notidanus*; the edges sharp and free from serration. Teeth, apparently from the upper jaws, lie scattered about; they are conical, compressed antero-posteriorly, with sharp edges, and a somewhat broad base, either without lateral denticles, or in some instances apparently possessing one on each side. The median cusp is slightly, if at all, longer than the anterior one of the teeth of the lower jaw.

Vertebral column consists of about 145 vertebræ, of which 115 are preserved in the specimen, and the remainder it is calculated would be required to complete the part of the tail which is missing. The vertebræ are largest near the head,

where they are round,  $\cdot 25$  of an inch in diameter, and  $\cdot 1$  inch in length: they are apparently thin bony plates, joined together by cartilage.

The paired fins are well preserved; the pectorals are situated immediately behind the head; the left fin extends from the body a distance of 2 inches; its base is about 1 inch in diameter; its surface is covered with the characteristic dermal skin; the fin was probably thin and entirely cartilaginous, because its substance is folded, and apparently twisted towards its extremity; the right pectoral is imperfect; the right ventral is absent; the left ventral is well preserved; it is situated 2·4 inches behind the anterior insertion of the pectoral fins, and is fully 1 inch across the base; it extends from the body  $\cdot 8$  inch.

Of the vertical or unpaired fins the dorsal is absent; the anal and caudal present. The anal fin is situated about midway between the ventral and the caudal; it extends 1 inch along the ventral surface of the body; anteriorly it is  $\cdot 6$  of an inch in depth, diminishing gradually backwards. The caudal fin is 4 inches in length, and embraces about seventy vertebræ, which extend to the extremity of the upper lobe. The base of the tail is  $\cdot 6$  inch in diameter. From this springs the lower lobe, increasing in 1·4 of an inch backwards to a depth of 1·1 inch: it is entirely cartilaginous. After the termination of the lower lobe the upper one is  $\cdot 7$  in depth, and gradually diminishes posteriorly, and ends in a somewhat rounded extremity.

This specimen differs so completely in its dental armature from the forms described by Pictet, that there can be no hesitation in separating it from them: the teeth correspond closely with those of the existing *Notidanus*, and it is therefore placed in that genus with the nomen triviale *gracilis*. Its nearest fossil relationship is with *Notidanus microdon*, Agass. (*Poiss. foss.* vol. iii., p. 221, pl. xxvii., fig. 1, and Pl. xxxvi., figs. 1, 2). It is distinguished by having only five denticles, the largest of which is not serrated, whilst those of *N. microdon* are six in number, and the anterior denticle is serrated along the anterior border. The latter is found in the white chalk of Sussex. The specimen of *Notidanus münsteri*, Agass. (*op. cit.*, p. 222, pl. xxvii., figs. 2, 3), found by Count Münster in the Jurassic rocks of Streitberg, in Franconia, differs from *N. gracilis* by the rapid diminution in size of the smaller denticles, the fifth being very short; and by the shortness of its base as compared with the height of the denticles.

*Formation and Locality.*—Upper Cretaceous: Sahel Alma, Mount Lebanon.

*Ex coll.*—Lewis Collection, R. Damon, Esq., Weymouth.

Family. **SCYLLIIDÆ.**Genus. **Thyellina.** MÜNSTER.

Thyellina; Münster. L. AGASSIZ, 1836. "Rech. sur les Poissons Fossiles," vol. iii., p. 378.

The type specimen of this genus was named by Count Münster, but not described. It is from the cretaceous formation of Baumberge, near Münster, and was sent to the late Professor L. Agassiz when he was preparing his great work on fossil fishes. The latter states that "Ce fossile a la forme ordinaire des vrais Scyllium, seulement la première dorsal est peu en arrière des ventrales, tandis que la seconde dorsale, qui est plus grande que l'anale est apposée à cette dernière nageoire, comme dans le genre Ginglymostoma, mais un peu plus reculée. Toutes ces nageoires ont leur angle antérieur arrondi; les pectorales sont également très-arrondies. La caudale est courte et son lobe antérieur faiblement échancré. L'espèce type du genre est le *Thyellina angusta*, Münst. (*op. cit.*, Tab. xxxix., fig. 3). Sa forme est cylindracée et va en s'atténuant insensiblement jusqu' à la base de la caudale, dont l'extrémité postérieure est arrondie. Ses vertèbres sont un peu plus courtes que hautes et déprimées sur le milieu de leur longueur."

Professor Agassiz also described a second species from the Lias of Lyme Regis under the specific name *Thyellina prisca*. The specimen consisted of a series of vertebræ resembling those of *T. angusta*, Münst., and was placed in the genus with considerable hesitation. Subsequent discoveries of better preserved specimens enabled the late Sir Philip Egerton (*Memoirs of the Geological Survey, Decade XIII.*, pl. vii.,) to detect that the first and second dorsal fins carried spines similar to those of the Spinacidæ, and that consequently the fish could not belong to the genus *Thyellina*, which has no dorsal spines. He therefore instituted a new genus for its reception, *Palæospinax*.

The genus *Palæoscyllium* was formed for the reception of a fossil fish from the chalk formation of Arenfeldes, in Westphalia, by Dr. W. von der Marck, and is described in "*Palæontographica*," vol. xi. (1863-4), p. 66, plate viii., figs. 6-9. The ventral surface of the specimen is exposed; it is about 16.5 inches in length, and nearly 2 inches in height. The pectoral fins, a part of a ventral fin, and the second dorsal fin are exposed; a long fin at the root of the tail is considered as the anal. The first dorsal fin is not visible, and its position relative to the ventral fins cannot therefore be ascertained. The posterior margin of the second dorsal overlaps, to some extent, the anterior portion of the anal. The vertebræ, 120 in number, are longer than high. The snout is broadly rounded, the mouth situated an inch behind its extremity. The teeth are similar in form to those



of the existing Scyllium, the apex of the denticles being inclined at a sharp angle to the base of the teeth.

The genus Thyellina, Munst., differs from Palæoscyllium in the following particulars, some of which have been pointed out by Dr. von der Marck. The body is not so high, but presents a more slim appearance; the head is smaller; the teeth are longer, straighter, and more sharply pointed; the vertebræ of the spinal column are higher than broad; the pectoral fins are smaller in proportion to the size of the body; and the anal fin, which, in Palæoscyllium, is closely contiguous to the caudal, is placed in Thyellina, midway between the tail and the ventral fins, and, instead of being quite behind the posterior dorsal fin it is slightly in front of it; the last may, perhaps, be considered the most important difference.

Thyellina is readily distinguished from Rhinognathus by the tenuity of its body and the small size of the head, as compared with the large head and long snout of the latter. The teeth of Notidanus gracilis are sufficiently characteristic to separate it from that genus in addition to its altogether different external appearance.

The species now to be described from the soft chalk of Sahel Alma appear to be more closely related to the genus Thyellina; the long, slender body, the form of the teeth, and the position of the fins in the one, and the finely-pointed teeth, and the advanced position of the anal fin in the other, are, without doubt, indicative of such relationship, though it is only after some hesitation that this determination has been reached.

*Thyellina elongata*, DAVIS.

(Pl. xiv., figs. 2, 3.)

Left side of the body exposed, outline complete, with the exception of the anal fin, which has either been removed, or more probably is of small size, and folded beneath the body of the fish. The total length of the specimen is 9·7 inches. The depth of the body is greatest behind the pectoral fins, being 0·5 of an inch, and it becomes smaller towards the tail, the pedicle of the latter being only 0·25 of an inch. Of the entire length, the head, exclusive of the branchial apparatus, occupies only one-twelfth; the first dorsal fin is 3·2 inches behind the head, midway between the extremity of the snout and that of the tail. The second dorsal fin is 1·75 inches behind the first. The pectoral and ventral fins are well defined; the latter is situated considerably in advance of the first dorsal. The body was enveloped by a thick skin, covered with dermal ossifications, arranged in definite order, presenting something of the appearance of an imbricated tessellated pavement.

The vertebral column can be readily distinguished, and is well ossified; its component vertebræ in the region between the pectoral and ventral fins are less than 0·1 of an inch in length; the diameter is slightly smaller than the length. There are 29 vertebræ between the head and the ventral fins; an additional 14 to the anterior insertion of the first dorsal fin, thence to the root of the tail there are 50, and in the portion of the tail preserved there are 16, and about the same number is required to complete the axis to the end of the tail, giving a total of 125 vertebræ.

The head is remarkably small: from the tip of the snout to the occiput is 0·8 of an inch; the depth of the cranium 0·45 inch. The mouth is hidden. The elevation of the head above the matrix appears to indicate that its component parts—the jaws and cranial members—were of dense cartilage, if not osseous. Between the head and the pectoral arch a number of small bones, somewhat displaced, appear to indicate the branchial arches.

The pectoral fins are 0·8 of an inch in length. The pectoral arch is well developed and the fins supported by 16 to 18 osseous rays. The second specimen (Pl. xiv., fig. 3) exhibits the pectoral fins in greater perfection, as well as the bones of the pectoral arch. The osseous fin rays are 0·2 of an inch in length. The ventral fins are similarly constituted, smaller than the pectorals, and two inches behind them.

The first or anterior dorsal fin is located 1·2 inches behind the ventrals, its anterior insertion being slightly behind the termination of the ventrals. It is 0·7 of an inch in length, posterior margin rounded, and does not possess a spine. The second dorsal fin is slightly larger than the first, but in other respects similar. Both are covered with dermal ossicles like the body. The anal fin, as already observed, cannot be seen. The caudal fin is not large, nor apparently so powerful as is usually found in sharks. It is 1·7 inches in length. The vertebræ are prolonged to the upper lobe, which terminates in a somewhat peculiar manner, as though the end had been removed, leaving a square termination. The lower lobe of the tail is formed of a membranous extension of the upper, supported by a series of osseous or semi-osseous spinous processes from the vertebral column. The lower lobe has its origin two inches from the posterior caudal extremity, extends 0·15 of an inch from the body-line, and gradually tapers off backwards.

The second specimen already referred to (Pl. xiv., fig. 3) exhibits the under surface of the body. It is not perfect, but the head and pectoral fins are well exposed. The specimen was as nearly as possible the same size as the one already described; the diameter between the expanded pectoral fins is 2·2 inches. The under surface of the head is 0·8 of an inch in breadth, equal to nearly double the height of the lateral exposure of the specimen described already. The mouth is moderately large; the snout extends 0·25 of an inch beyond the anterior extremity of the mouth; it is obtusely rounded. The teeth, which are

very small, are more or less conical and acutely pointed. The lower jaws were deep and strong.

This species appears to fall naturally into the Family Scylliidæ of Günther. The discovery of these specimens adds a second member of the family to the one in the Museum at Geneva, already described by Messrs. Pictet and Humbert ("Nouvelles Recherches sur les Poissons fossiles du Mont Liban., 1866," p. 111, pl. xviii., figs. 2-4) as *Scyllium Sahel Almæ*. The total length of this specimen was estimated at 10 centimetres (4 inches); the mouth and teeth were similar to the species now described. The two fishes differ essentially in the position of the fins and the proportionate number of vertebræ. In this species the first dorsal fin is situated above the forty-second and forty-third vertebræ, whilst in *Scyllium Sahel Almæ* it is over the twenty-seventh; the commencement of the ventral fins in the latter is opposite to the twentieth vertebra, in the former they are opposite to the twenty-ninth. The specimens now described are much longer, in proportion to their size in other respects, than those of MM. Pictet and Humbert.

*Locality and Formation.*—Upper Cretaceous: Sahel Alma, Mount Lebanon.

*Ex coll.*—Robert Damon, Esq., Weymouth.

*Thyellina curtirostris*, DAVIS.

(Pl. xv., fig. 1.)

The specimen which serves for the following description is well preserved, and exhibits the ventral surface of the fish. The head is characterized by its short rounded snout, somewhat similar to *Spinax primævus*; but, unlike that genus, it has no spines attached to the dorsal fins. The length of the fish preserved is 11·5 inches; some portion of the extremity of the tail is missing. The head to the base of the pectoral fins occupies 2·4 inches.

The spinal column consists of more than a hundred vertebræ; those of the extremity of the tail, being somewhat displaced, cannot be exactly identified. They are 0·1 of an inch in length, and about the same height anteriorly; on the median part of the column the vertebræ are 0·15 of an inch in length; towards the caudal extremity they become gradually smaller and narrow in proportion to the height.

The head is large; the snout extends 0·6 inch beyond the mouth; it is rounded, and probably flattened. The jaws extend 1·1 inches backwards, and are 0·8 of an inch wide posteriorly; they are furnished with a large number of small sub-conical teeth, longer and more attenuated in the anterior part of the mouth. Between the posterior extremity of the jaws and the pectoral fins there is a series of five branchiostegal rays.

The pectoral and ventral fins are exposed: the former are situated 2·5 inches from the snout, and extend 1·3 inches along the base; the external margin is 1·5 inches in length. The basal part of the fins is supported by about ten cartilaginous rods, each 0·3 of an inch in length. An apparently dense and strong cartilaginous pectoral arch supported the fins, and to this the cartilaginous rods are attached. The ventral fins are much smaller than the pectorals, and situated 3 inches behind their anterior basal margin.

The dorsal fins cannot be seen. The anal fin is about 1·5 inches behind the ventrals: its base is 0·8 of an inch in length, and it extends 0·5 of an inch along the anterior margin. The caudal fin is not satisfactorily preserved.

The whole of the body, head, and fins are enveloped in a covering of minute dermal ossicles, larger on the abdominal surface of the body, but smaller on the fins, and very minute towards their extremities. The larger ossicles are striated on the surface, the striæ being produced along the anterior margin so as to give it a dactylous appearance; the median striation is longest, and extends to the point of the rhomboidally-shaped scale.

*Formation and Locality.*—Upper Cretaceous: Sahel Alma, Mount Lebanon.

*Ex coll.*—Tristram Collection, British Museum, South Kensington.

#### Family. SCYLLIIDÆ.

#### Genus. Scyllium.

#### *Scyllium Sahel Almæ*, PICTET and HUMBERT.

(Pl. xv., fig. 3.)

[“Nouv. Recher. sur les Poiss. foss. du Mt. Liban.,” p. 11, pl. xviii., figs. 2–4.]

A specimen of this fish in the National Collection exhibits some of the characters wanting in those figured by the authors cited above. Its total length is 7 inches; of this the head, including the branchiostegal rays to the base of the pectoral arch, is 1·4 inches, to the ventral arch is an additional 1·2 inches. The anal fin is 1·5 inches behind the ventral arch. It consists of nine short rays; the outline of the fin is not preserved. The number of vertebræ is 125; the pectoral arch is attached to the fourth, and the ventral to the twenty-second; anteriorly the vertebræ are as long as high, posteriorly the height is much less than the length. The vertebræ behind the ventral arch have attached to them neural and hæmal apophyses, the terminations of which are connected longitudinally.

## Family. SPINACIDÆ.

## Genus. Spinax.

Each dorsal fin with a spine. Teeth of the lower jaw with the teeth so much turned aside that the inner margin of the tooth forms the cutting edge. Upper teeth erect, each with a long-pointed cusp and one or two small ones on each side. Spiracles wide, superior behind the eye. (Günther.)

*Spinax primævus*, PICTET.

[“Desc. de quelques Poiss. foss. du Mont. Liban.” (1850), p. 53, pl. x., figs. 1–3.]

(Pl. XVI., fig. 2.)

M. Pictet described and figured three fragments which he attributed, with some hesitation, to the above species. Figure 3 (*op. cit.*) is a fragment of a fish exhibiting the second dorsal fin, and is without spine. The head (figure 2, *op. cit.*) may or may not belong to a fish of this species; it is sufficiently indefinite to render the question doubtful. A comparatively perfect specimen, collected by Mr. Lewis, and now in the Natural History Museum at South Kensington, exhibits the true characters of the fish. It is 11 inches in length from the tip of the snout to the extremity of the tail. The greatest height is 1·2 inches behind the head; the peduncle of the tail is 0·4 of an inch.

The spinal column is well ossified; the vertebræ in the anterior part of the body are 0·125 of an inch in length, and their height is equal to two-thirds their length; they gradually diminish in size backwards, and at the extremity of the caudal series they are quite minute. The articulating surfaces are expanded, the intermediate median portion much contracted. The number of vertebræ is 96.

The head is 1·5 inches in length. The snout, prolonged nearly 0·5 of an inch beyond the buccal orifice, is more or less depressed, wide, and rounded. The mouth is large, extending 0·8 of an inch backwards, and armed with teeth whose base is rather less than 0·1 of an inch in breadth; a central cusp is prominent, half the basal breadth in height, and leaning backwards in the form of a flattened cone; on each side the central cone there are two or three minor cusps or denticles. The only teeth exposed are situated on the posterior portion of the jaws. The whole of the head, as well as the remaining portions of the body, are covered with dermal tubercles. Position of the orbit not defined.

There are two dorsal fins, each supported by a spine. The spine of the first dorsal is 3·5 inches behind the snout; the base of the fin extends 1 inch,

and it rises in a more or less triangular form to a height of 0.4 of an inch. The spine is 0.7 of an inch in length, 0.15 of an inch wide at the base, and tapers to a point; it is smooth, slightly curved backwards, is somewhat acutely angular along the anterior margin, and has a groove posteriorly for the attachment of the fin. The anterior spine is placed immediately above the twentieth vertebra from the occiput. The spine of the posterior fin is over the fifty-first vertebra, and 3.3 inches behind the anterior one; it is 1.1 inches in length, similar in form to the anterior spine, except that it is considerably more curved, and, in proportion to its length, more slender. The second fin is larger than the first in proportion to the length of the spine. Anal fin not exposed. The caudal fin is large, the upper lobe supported by the vertebral column; it is 2.5 inches in length. The lower lobe is 1.1 inches in length, and its greatest diameter is 1.0 inch.

The pectoral fins are large and powerful. The anterior margin is 2.5 inches behind the snout; it is 1.3 inches in length, and extends 1.2 along the abdominal surface; like the remainder of the body and other fins, they are thickly coated with dermal ossicles. The ventral fins are situated 2.8 inches behind the anterior base of the pectorals; the base extends 0.9 of an inch along the surface, and the anterior margin is 0.8 of an inch in length.

*Formation and Locality.*—Upper Cretaceous: Sahel Alma, Mount Lebanon.

*Ex coll.*—Lewis Collection, British Museum.

#### Genus. *Centrophoroides*. DAVIS.

Body elongated; dorsal fins armed with short spines, deeply embedded; vertebræ equal in height and length; mouth inferior. Teeth unicuspidate, different in the two jaws, maxillary teeth lanceolate and sharply pointed; mandibular teeth broader, somewhat obtusely pointed. Skin covered with minute ossicles.

#### *Centrophoroides latidens*, DAVIS.

(Pl. xv., figs. 2, 2a.)

This specimen is imperfect: the snout and the caudal extremity are wanting. The part preserved exhibits the buccal orifice, the pectoral fins, and the length of the body as far as the second dorsal fin. It is 14 inches in length. The fish, when perfect, would probably be 18–20 inches in length; it is 2 inches in diameter between the pectoral fins. The head to the occiput occupies 2.8 inches; to the pectoral arch 4 inches. The body is covered with dermal tubercles; they are triangular in outline, with striated surface, producing a serrated edge.

The spinal column comprises fifty vertebræ to the base of the second dorsal fin, and beyond this ten or twelve others are preserved. The vertebræ are 0·2 to 0·25 of an inch in length; the diameter of the articulating surfaces being equal to the length; the central portion is extremely contracted, the osseous matter being small, whilst the cartilaginous greatly preponderated.

The head, as already observed, is not well preserved anteriorly, and it cannot be exactly stated how far the snout extended beyond the mouth. The part preserved is 1·4 inches. The mouth extends 1·1 inch posteriorly, and the proximal termination of the jaws is 1 inch wide. The teeth vary in size: those of the lower jaw are broad at the base, culminating in a somewhat obtuse point; those of the upper jaw are narrower, with longer and more lanceolate points; only one cusp extends from the base of each tooth.

Of the unpaired fins the only one present is the second dorsal. Its base is 11 inches behind the anterior portion of the buccal orifice. Its anterior margin is armed with a spine 0·6 of an inch in length, of which 0·4 of an inch is enveloped in the integument of the fin, the remaining 0·2 of an inch is compressed laterally with a blunt and rounded extremity. The margin of the fin extends beyond the termination of the spine.

The pectoral fins are large; the anterior margin is 3·5 inches behind the mouth, and extends 2·8 inches from the body; its base is 2·2 inches in length; the whole thickly coated with dermal ossicles, large and thick anteriorly, but smaller near the distal margin of the fin and posteriorly.

It is probable that if the anterior dorsal fin had been exposed it would have had a similar spine attached as that of the posterior one which is exhibited. I am indebted to Mr. Wm. Davies, of the British Museum, for directing my attention to a paper by Herr. C. Hassé ("Einige seltene palæontologische Funde," 1884), in which it is pointed out that the microscopical structure of the vertebræ separates this fish from the genus *Spinax* and its closely related allies, *Centrosyllium* and *Centrina*, and shows its relationship to *Centrophorus* and *Acanthias*; from the latter it is separated by the character of its teeth, which much resemble those of some of the former genus; the embedded character of its short spine also closely resembles that of the existing *Centrophorus*. I therefore propose to indicate its relationship to that genus with the distinctive appellation, *Centrophoroides latidens*.

*Formation and Locality.*—Upper Cretaceous: Sahel Alma, Mount Lebanon.

*Ex coll.*—Enniskillen Collection, British Museum.

Genus. *Rhinognathus*.\* DAVIS.

Body fusiform; snout much prolonged and spatulate. Head occupies one-fourth the entire length. Buccal orifice large. Teeth of anterior portion of each jaw long and pointed; posterior teeth, broader and shorter central cusp, with a smaller one on each side. Vertebræ numerous; pectoral and ventral fins well developed. Anal fin nearer to the ventrals than to the caudal

*Rhinognathus lewisii*, DAVIS.

(Pl. xiv., figs. 4, 4a.)

Length, 16 inches; largest diameter between the pectoral fins 1·5 inches, tapering backwards to the tail and forwards to the snout, which is prolonged considerably beyond the mouth and terminates more or less pointedly. The ventral aspect of the fish is uppermost, exposing the pectorals, ventrals, anal and caudal fins; the mouth, with teeth, is exhibited, and the branchial apparatus can be distinguished. The surface of the body was enveloped in a cuticular covering, with minute tubercular dermal ossifications.

The head occupies more than one-fourth the entire length of the fish, and is 4·5 inches from the tip of the snout to the posterior portion of the branchial apparatus. The anterior portion of the mouth is situated 2·2 inches behind the extremity of the snout, and it extends backwards with a somewhat acute curvature a distance of 1 inch. The teeth vary in form: those occupying the anterior surface of the jaws are long, round, acutely conical and sharply pointed, slightly expanded towards the base, without lateral denticles. Posteriorly the teeth gradually become less acutely pointed, shorter, and more widely expanded at the base. Those furthest back have an obtusely triangular apex and broad base, more or less striated. The majority of the teeth are without lateral cusps, but the smallest teeth are possessed of a minute lateral cusp on each side. The mandibles are well developed, and are represented in the figure extending to the branchial apparatus. The latter extends from the vertebra on either side, consisting of five branchiostegal rays, apparently with serrated margins for the attachment of the gills.

The vertebral column is not so distinctly preserved as might be desired. The thoracic vertebræ are 0·15 of an inch in length and about the same in diameter. They gradually decrease in size towards the caudal fin. There are about 130 vertebræ in all, and of these 67 are included in the tail. Some

\* ῥιν, a snout; γνάθος, a jaw.



of the thoracic vertebræ afford evidence of the attachment of short rudimentary osseous ribs or spinous processes.

The pectoral fins are moderately large but not very well preserved; they are 15 inches in length. The basal portion of both the pectoral and ventral fins was supported by a series of elongated ossicles 0·2 of an inch in length, from which the cartilaginous portion of the fin extended. The anterior insertion of the pectoral fin is 4·7 inches behind the snout; the ventral fins 2·5 inches behind the pectorals.

The unpaired fins are represented only by the anal and caudal. From the circumstance of the ventral surface of the fish being exposed the dorsal fins are hidden from view. The caudal fin is 4·2 inches in length; the vertebræ extend to the extremity of the upper lobe, which is 0·6 of an inch in depth, gradually tapering backwards. The lower part of the tail is comparatively small, extending only 1 inch along its base and 0·2 beyond the line of the superior lobe. The anal fin is placed 1 inch behind the termination of the ventrals; its base extends 1·3 inches in length, apparently without any ossified supports. It is small, depending 0·3 of an inch from the ventral surface of the body; a space of 1·2 inches separates it from the caudal fin.

*Formation and Locality.*—Upper Cretaceous: Sahel Alma, Mount Lebanon.

*Ex coll.*—Lewis Collection, Mr. Damon, Weymouth.

The head and portion of the body of a Selachian, from the Lewis Collection, now in the British Museum, possesses peculiarities with regard to its dentition which closely resemble those described above, and, though from a larger fish, appear to be the same species. The fragment is 7·5 inches in length, and of this 5·0 inches is included in the head. The snout is not complete, a portion of the extremity being absent. The part preserved extends 2·0 inches beyond the mouth, and gradually diminishes in height. The mouth is large, the upper jaw is 3·0 inches in length; it is replete with conical sharply-pointed teeth, slightly curved inwards on the anterior portion of the jaw, with smaller base than those behind. The latter are 0·16 inches across the base, with a large central cone 0·13 in height, and one lateral cone on each side. The teeth of the lower jaw are longer than those of the upper and are narrower at the base; the larger on the anterior surface of the jaw are 0·2 inches in length. The posterior portion of the head and the part of the body shown are badly preserved, and do not afford any details for description. This fish is readily distinguished from *Notidanus lewisii* by the great length of the snout, the sharply-pointed and long teeth, and the smaller size of its fins.

## (B)—BATOIDEI—RAYS.

Family. **RHINOBATIDÆ.**Genus. **Rhinobatus.** BLOCH.

Cranial cartilage produced into a long rostral process, the space between the process and the pectoral fins being filled by a membrane. Teeth obtuse, with an indistinct transverse ridge. Dorsal fins, two in number, without spines, both at a distance behind the ventrals. Caudal fin without lower lobe. Disk dilated, the rayed portion of the pectoral fins not continued to the snout.

*Rhinobatus maronita*, PICTET and HUMBERT.

*Rhinobatus maronita*, P. and H., 1866. "Nouv. Rech. s. les Poissons foss. du Mt. Liban.," p. 113, pl. XIX.

*Rhinobatus maronita*, Fraas, Oscar, 1878. "Aus dem Orient. II. Theil. Geologische beobachtungen am Libanon," p. 92.

*Rhinobatus grandis*, DAVIS.

(Pl. XVI., fig. 1.)

The specimen of which the following description is given is large; the ventral surface is exposed; the head and one side of the body are well preserved, the opposite side and the tail are wanting. The part of the specimen preserved is 21 inches in length; the head, between the snout and the pectoral arch, occupies 8.5 inches; from the pectoral to the pelvic arch is 5 inches, and the pelvic arch to its posterior termination takes 4 inches; the remaining 3.5 inches are not very well defined, but may be the base of the tail. The vertebral column extends along the central axis of the fish. From the vertebræ to the outer margin of the head is 4.25 inches, giving a total breadth of 8.50 inches. Midway between the pectoral and pelvic arches the body is 10 inches across, 5 inches on each side the vertebral axis. The fins are, unfortunately, to a great extent hidden beneath the matrix, but sufficient is exposed of the basal portions of them to indicate their nature. The whole surface of the fish was protected by innumerable minute dermal ossicles, flat and enamelled on the surface; beneath these was extended a thick layer of chondroid cartilage, filled with distinctly perceptible rounded ossifications, largest and thickest in the region of the head.

The vertebral column is well preserved; the vertebræ consisted, when living, of an ossified centrum, the anterior and posterior surfaces of which are round and prominent, the median portion contracted and rugose; anteriorly to the scapular or pectoral arch the branchiæ are attached; behind the arch are a series of twenty to twenty-two ribs on each side, their bases connected with the spinal column by ligaments. So far as can be distinguished there are no spinous processes from the vertebræ. In the figure of *Rhinobatus maronita* (*loc. cit.*) the ribs are seen extending beyond the pelvic arch, and the total number is less than those which are in front of it in the present specimen. The number of vertebræ preserved or indicated in this specimen is probably seventy: of these there are twenty-four between the scapular and pelvic arches. In front of the scapular arch twelve or fourteen vertebræ give support to the skull, and the remainder, not so well defined as those already named, extend beyond the pelvic girdle. The ribs average 2·5 inches in length, and extend from the spinal column with a considerable curvature backwards.

The head, as already stated, is 8·5 inches in length and the same in breadth. A number of teeth indicate the position of the mouth (Pl. xvi.): it was 3 inches wide, and extended in an almost straight line transversely across the head at a distance of 4·5 inches from the termination of the snout. The teeth are small, not more than 0·5 of an inch across, somewhat flattened antero-posteriorly, and rounded laterally, with an obtuse edge; they are apparently much better adapted for crushing invertebrate food than for seizing and masticating other fishes. The teeth are coated with a white dentine or enamel, smooth and highly polished. The snout is circular in outline; on the line of the mouth it is 5 inches across, from thence it is gradually rounded off to the anterior extremity, as represented in the drawing (Pl. xvi., fig. 1). The cranial cartilage forming the anterior rostral process was supported by a large more or less osseous plate); this commences immediately in front of the upper jaw, where it is 1·5 inches wide, and extends to a point 0·6 of an inch behind the extremity of the rostral process. The under surface of the plate, which is the one exposed, is convex laterally, and slightly so antero-posteriorly. It consisted of a chondroid substance closely packed with rounded ossifications.

A second plate extended in the opposite direction from the neighbourhood of the lower jaw to the scapular arch; it is nearly 3 inches in length, and anteriorly 1·4 inches in breadth, diminishing to 1·2 inches posteriorly. To this plate the branchiostegal rays appear to have been attached; the method, however, is not well defined. The rays were large and strong, separated from each other by intervals of 0·5 of an inch: five on each side can be distinguished, and dependent from them there were numerous secondary supports for the gills.

The scapular arch is formed by large and flattened bones attached to the vertebral column. At a distance of 2·3 inches from the vertebræ the bone

contracts in width and divides into two branches; one of these ascends and protects the gills, the other is bent over towards the abdominal region. From these bones spring the pectoral fins. The latter contain numerous rays, most of which are unfortunately hidden from view under the matrix, and their size and characters cannot be ascertained in consequence. The pelvic arch, which supports the ventral fins, extends from the vertebral column with a graceful curve towards the posterior portion of the body (Pl. XVI.); from this there was evidently a considerable expansion of the dermal covering of the body; but the construction of the fins is not shown with sufficient clearness to render accurate description possible.

A second specimen in the collection at the British Museum exhibits some of the features wanting in the one described above. The specimen is one-fifth smaller, and is preserved caudally so far as the extremity of the ventral fins. The pectoral fins extend from a point 1·5 inches anterior to the line of the buccal orifice, a distance along the base of the fin equal to 10·5 inches, which is 1 inch posterior of the pelvic arch. There are fifty rays to each fin, and of these twenty-eight are placed anterior to the largest median ray opposite the scapular arch, and twenty-two are extended along the posterior surface. The longest median ray is 3 inches, and from this the external outline of the fin becomes gradually attenuated, with a graceful curvature in each direction. The rays, averaging 0·1 of an inch at the base, expand slightly with the expansion of the fin; they are divided by six or seven articulations, and at the joints divide so that a basal ray will, in the succeeding part, support two rays. The ventral fins extend backwards from the pelvic arch to a distance of 4 inches; there are about twenty-four rays, each 0·8 of an inch in length in the anterior part, but increasing in length and decreasing in diameter towards the posterior extremity of the fin.

The posterior part of the body, including the tail, is wanting in this specimen also.

Several points of divergence from the species described by MM. Pictet and Humbert have been indicated in the foregoing description, and there can be no doubt that this specimen must be regarded as a new species which it is proposed to distinguish by the name *Rhinobatus grandis*.

*Formation and Locality.*—Upper Cretaceous: Hakel, Mount Lebanon.

*Ex coll.*—Lewis Collection; Robert Damon, Esq.

*Rhinobatus latus*, DAVIS.

(Pl. xvii.)

The central portions of the body of this specimen are admirably preserved, but, unfortunately, the anterior portion of the head and the tail are wanting. The whole of the body and fins are covered with minute dermal ossicles, closely impacted, more or less rectangular in form, smooth and shining. The entire length preserved is 10·5 inches: of this from the pectoral arch the head takes 3·5 inches; between the pectoral and ventral arches 2 inches, the remainder behind the ventral arch. The head, exclusive of the fins, is 4 inches across; the thoracic cavity 3 inches. The distance between the two extremities of the pectoral fins 7·8 inches, between those of the ventral fins 4 inches, and the diameter of the base of the tail is 2 inches, gradually diminishing backwards.

The spinal column is well indicated, forming the median axis of the body. The total number of the vertebræ preserved is seventy-five: of these twenty-two connect the pectoral with the pubic arch and the remainder behind; in the posterior part there are twelve vertebræ in the distance of 1 inch; their diameter across the articulating surface is 0·17 of an inch. There are twenty-five ribs on each side, of which about one-third extend behind the ventral arch. The caudal vertebræ support lateral spines, which are longitudinally connected by bony or cartilaginous processes.

In addition to the number of vertebræ already given it is probable that a continuation of the column, about three-quarters of an inch in length, extended to the head, but it is covered by the support of the branchial apparatus.

The head is large: its structure cannot be easily identified. The snout probably extended about 1·5 inches beyond the part preserved, and by continuing the marginal lines of the head forward the form indicated appears to have been nearly a right-angled triangle, the extremity more or less pointed. The mouth is not exposed; the surface exposed appears to be the upper one, so that the mouth is hidden beneath. The branchiostegal rays, five in number on each side, were strong and thick, about an inch in length, their form being impressed on the supervening cuticular covering; a largely expanded mass of bone or ossified cartilage is exhibited between the branchiostegal rays on the median line.

The scapular or pectoral arch is formed by divaricating osseous plates, supported by strong bones connected with the vertebral column. The pectoral fin is supported by sixty rays: the median ones being 2·8 inches in length, frequently jointed, and increasing in number towards their distal extremities. The length of the base of the fin is 5 inches; the fin has a somewhat triangular

outline, much less rounded or semicircular than in the preceding species. The ventral fin is supported by the pubic bones connected with the vertebral column at a distance of 2 inches behind the pectoral arch; it is 2 inches along the base, and extends 1 inch laterally from the body of the fish. The number of rays supporting the fin are not well defined, but the impressions produced by eighteen can be identified on the dermal covering. The unpaired fins are not present.

This species differs from those previously described in the widely expanded body, the broad triangular outline of the pectoral fins as compared with the elongated and circular form of *R. grandis*.

*Formation and Locality.*—Upper Cretaceous, Sahel Alma, Mount Lebanon.

*Ex coll.*—Lewis Collection, British Museum.

*Rhinobatus expansus*, DAVIS.

(Pl. XVIII.)

The beautiful specimen which forms the subject of the following description, as well as the type of the species last described, *R. latus*, were collected by Mr. Lewis during his sojourn at Beyrout. This specimen is distinguished by the immense expansion of the pectoral fins, comparatively small ventrals, and attenuated tail. The fish is not quite perfect, as a portion of the snout and the extremity of the tail are wanting. The length preserved is 9·5 inches. The width across the pectoral fins is 10 inches. The dorsal surface of the fish is exposed. The dermal covering is in part preserved: it is thinner, but otherwise similar to that of *R. latus*. The width at the base of the tail is 0·9 of an inch.

The spinal column exhibits seventy-three vertebræ, but is imperfect at the caudal extremity. The vertebræ are higher than long, the median portion much contracted. The thoracic vertebræ support twenty-four ribs on each side; the thoracic cavity is comparatively small and narrow.

The head occupies a length of 3 inches from the snout to the pectoral arch, and is 2·5 inches across. The orbits are large and round, 0·5 of an inch in diameter; they are situated 1 inch behind the snout, and are separated by a distance of 0·4 of an inch. The post-orbital region is not preserved, and the form of the snout, which was more or less pointed, can only be ascertained by inference. The buccal armature, by reason of the position of the fish, is not exposed.

The pectoral fins are widely expanded: they extend from a position 0·5 of an inch anterior to the eyes backwards for 5·5 inches, and from the body to the lateral extremity of the fin is 4·5 inches. The outline of the fin is triangular, culminating laterally in a somewhat acute point; from the head to this point the outline is slightly convex, thence posteriorly it forms a gracefully

flowing sigmoidal curvature. The scapular bones connecting the vertebræ to the divaricating bones supporting the fins extend on each side only 0·5 of an inch, and thence the scapular bones extend forwards and encircle the head, and backwards encircling the thoracic cavity. From these extend sixty rays, repeatedly jointed, and occasionally dividing at the joints into two smaller rays. The ventral fins are small: they are supported by a pelvic arch, which is attached to the vertebræ at a distance 2·2 inches behind the pectoral one; from this arch the fin extends backwards 1·2 inch; it is supported by 10–12 rays 0·8 of an inch in length.

At the extremity of that portion of the caudal region preserved there remains the base of the first dorsal fin. It was cartilaginous, without osseous support; there is not a sufficient portion preserved to indicate its size or form.

The example now described approaches nearer in its peculiar characteristics to *Rhinobatus latus*, but it differs in several material and important respects. In *R. latus* the thoracic cavity is large and wide, the head also is widely expanded, and the pectoral fins are obtusely triangular in outline. In this species the body cavity and head are comparatively small in proportion to the size of the fish, whilst the pectoral fins are greatly expanded and have a triangular outline with quite an acutely pointed apex. Beyond the ventral fins the caudal region of the body is very small and attenuated as compared with that of *R. latus*.

In consideration of the wide extent of the fins of this species it is proposed to distinguish it by the nomen triviale *expansus*, *Rhinobatus expansus*.

*Formation and Locality.*—Upper Cretaceous: Hakel, Mount Lebanon.

*Ex coll.*—Lewis Collection, British Museum.

*Rhinobatus tenuirostris*, DAVIS.

(Pl. XIX, fig. 1.)

A remarkable specimen, collected by Mr. Lewis, and now in the national collection at the British Museum, is characterized by the possession of an extremely long and pointed snout. The anterior portion of the body is well preserved, and exhibits the relative proportions accurately. The caudal extremity is absent. The portion preserved is 18 inches in length: of this length the snout and head takes 11 inches, the remaining 7 inches being posterior to the pectoral arch. The greatest width across the pectoral fins is about 8 inches, the base of the tail 2 inches. The width of the head at the termination of the pectoral fin and 8 inches behind the tip of the snout is 3·5 inches, and from this point the margins of the snout gradually converges and terminates in a prolonged and attenuated extremity. The pectoral fins have a greater resemblance to the prolonged and rounded form of *Rhinobatus grandis* than

any other hitherto described. The body, head, and fins are covered with dermal ossicles, more or less triangular and pointed.

The head is of an oval form, 3·5 inches in length and 3 inches in breadth. The mouth is 8·2 inches behind the end of the snout, has the usual form, and is 1·3 inch in width posteriorly. It contains a very large number of minute, conical, and sharply-pointed teeth. Extending along the base of the nasal prominence there is a strong chondroid bone; beginning immediately behind the buccal orifice, it is 0·5 of an inch in width; in a distance of 0·8 of an inch it expands to a diameter of 0·9 of an inch and becomes divided into two long rods: these run parallel for 5 inches and gradually coalesce again and thence continue to the termination of the snout. From each side the widest part of this cartilaginous rod there extends a horn-shaped process which, ending in a point anteriorly, expands posteriorly, and forms a broad plate reaching to the upper jaw, apparently to support the wide lateral expanse of the snout. The posterior part of the head is not very well defined, the matrix being slightly displaced; a strong chondroid bone extends backwards from the mouth towards the pectoral arch, and on each side of it a series of branchiostegal rays can be distinguished occupying the space, bounded on each side by the pectoral arch.

The spinal column consists of vertebræ well ossified; they are 0·15 inches in length and 0·1 of an inch in transverse diameter; from the pectoral arch backwards as far as the fish is preserved there are fifty-five vertebræ, of which fourteen appear to be comprised between the pectoral and ventral arches. Ribs, bifurcating at the base, are attached to the vertebral column.

The pectoral arch is strong, the posterior flexion forming a thoracic cavity 2·6 inches in diameter. The pectoral fins extend from a point 7·4 inches behind the termination of the snout for a distance of 7·2 inches backwards. They are widest at a distance of 5 inches from the anterior termination, where they are 2·7 inches; from this point anteriorly the margin is deeply concave, posteriorly the fin is expanded and the margin convex. The fin is supported by forty-eight rays attached at their basal extremity to the pectoral arch, and repeatedly jointed and divided towards their distal extremity. The ventral fin is large, and supported by sixteen or eighteen rays. Its length along the basis is 3 inches, the anterior margin 2 inches, and it extends from the body a little more than 1 inch. Its form is the same as that of the pectoral fin in miniature.

This species is unlike any previously described specimen from Mount Lebanon. Its prolonged and attenuated snout, the minute and closely aggregated teeth, the pendant, posteriorly-expanded form of the pectoral fin, and the elongated vertebræ readily distinguish it from any other species.

*Formation and Locality.*—Upper Cretaceous: Sahel Alma, Mount Lebanon.

*Ex coll.*—Lewis Collection, British Museum.



*Rhinobatus intermedius*, DAVIS.

(Pl. xx, fig. 1.)

One side of the body of this specimen is very well preserved, the other is considerably displaced. The presence of a clasper attached with the ventral fin indicates that the fish was a male, and it is exhibited with the abdominal surface upwards. The form of the fish is similar in some respects to that of *Rhinobatus tenuirostris*, but, as will be seen hereafter, it differs in many details. The anterior extremity of the head is wanting, so is the tail. The part preserved is 14 inches in length: of this 4·5 inches are comprised in the portion of the head still attached; the width of the fish across the pectoral fins was about 8 inches, across the ventral fins 4 inches, and at the base of the tail 2 inches. The body is covered with closely set minute dermal tubercles.

The head is more or less disturbed and the separate parts displaced. The posterior portions of the left rami of the upper and lower jaws are preserved; they are large and strong (Pl. xx, fig. 1), and composed of cartilage, with numerous round ossifications intermixed with the substance of the cartilage. Between the rami is a large aggregation of teeth; they are small, with a broad base, from which rises a central cusp, with, in some cases, a lateral cusp on each side, in others only the one median denticle. The posterior portion of the head is occupied by a large median ossification, 2 inches in length and 0·8 of an inch in breadth, from which depend the branchiostegal rays, five in number, 2 inches in length, and 0·2 of an inch in thickness. In front of the buccal orifice the base of a large chondroid bone of similar shape and structure to that giving support to the snout of *Rhinobatus tenuirostris* is exhibited. From the presence of this bone there can be little doubt that the form of the anterior portion of the head was much the same as in *R. tenuirostris*; but as the basal portion exhibited in this specimen is shorter and wider than the one already described, it may be inferred that the snout was also shorter.

The vertebral column in the extent preserved exhibits eighty vertebræ, and of these eighteen are comprised between the pectoral and ventral arches. A number of ribs, apparently twenty-four, extend from the pectoral some distance beyond the ventral arch; they are small and slender anteriorly, but the posterior ribs are considerably thicker and longer. A number of processes extend from the caudal vertebræ; they are not sufficiently exposed to be clearly identified. The diameter of the vertebræ is 0·3 inches, their length is 0·15 of an inch, decreasing backwards.

The paired fins are large and well developed. The pectorals extend from a position opposite the extremity of the mouth for a distance of 7 inches backwards; the longest central rays are 3·5 inches in length. The basal portion

of the fin is composed of fifty-five rays; these are articulated, and towards their distal extremities have increased by subdivision to a much larger number. The external outline of the fin is similar to that of *R. tenuirostris*, attenuated and narrow anteriorly, but widely expanded and rounded posteriorly. The ventral fin has a basal length of 3·5 inches. Its anterior extremity commences 2·6 inches behind the scapular arch. The fin is supported by a strong pelvic bone, which has attached to it twenty-eight long and somewhat slender rays, of which the anterior ones are the strongest. Attached to the pubic bones is a long clasper-like appendage (Pl. xx., fig. 1*b*) extending 2·5 inches beyond the fin: its posterior extremity is expanded and presents the appearance of having had sucker-like capabilities; the stern of the appendage and its external coat are covered with the same dermal appendages, which envelope the whole of the surface of the fish. The dorsal and other unpaired fins are not visible.

This species presents several features allying it very closely with the one previously described, *R. tenuirostris*. The form of the head, pectoral, and ventral fins is similar; the number of rays constituting the two fins in this species, however, are in excess of those of the previous one. The base of the rostral bone here preserved shows affinity with *R. tenuirostris*, but, as already observed, the snout of this specimen was probably shorter. The head is also considerably wider in proportion to its length, and the teeth differ from those of the previously described species. An important distinction between the two is exhibited in the spinal column. In *R. tenuirostris* the vertebræ are longer than high; in this species the reverse exists; the height is double the length.

*Formation and Locality.*—Upper Cretaceous: Sahel Alma, Mount Lebanon.

*Ex coll.*—British Museum.

#### Family. TORPEDINIDÆ.

#### Genus. *Cyclobatis*. EGERTON.

*Cyclobatis*. EGERTON, Sir P., 1845. "Quart. Journ. Geol. Soc. London,"  
vol. 1, p. 225, pl. v.

Head with circular anterior termination. Teeth small and discoidal. Pectoral fins large, encircling the head and extending backwards beyond the ventral fins, producing an ovoid disk. The rays of the pectorals are less numerous than are the torpedos at present existing. The ventral fins small size, with six or eight rays. Claspers present in the male. Caudal vertebræ prolonged about one-third the length of the body beyond the ventral arch.

The specimen described by Sir Philip Egerton was collected by Captain

Graves from the quarries at Mount Lebanon. It is a small fish, with undoubted affinities with the existing rays. The circular form of the head indicates a relationship with the torpedos, and the genus is here provisionally regarded as a member of that family. In the type specimen of the genus described by Sir P. Egerton there are forty-seven rays to each pectoral fin, a smaller number than either the torpedo or the existing ray, the latter averaging eighty to one hundred and the former sixty rays each. The rays dichotomize in the fossil at the sixth articulation, whilst in the recent species it is the tenth that divides. The ventral fins are small and have six rays. The claspers are large and have a somewhat complicated structure. The greatest peculiarity of the fish, however, lies in the large anterior and lateral extension of the pectoral fins, which completely surround the region of the cephalo-thorax. Egerton argues from the resemblance of the fish to the torpedos now existing, from its apparently sluggish constitution, and its being destitute of the means of defence, that it possessed an electric apparatus of a similar kind to the torpedo.

In addition to the species *Cyclobatis oligodactylus*, described by Egerton, a second and larger species has been discovered by the Rev. Prof. E. R. Lewis.

*Cyclobatis oligodactylus*, EGERTON.

(Pl. XXI, fig. 3.)

EGERTON, Sir P., 1845. "Quart. Journ. Geol. Soc. London," vol. I, p. 225, pl. v.

PICTET, F. J., 1850. "Description de quelques Poissons fossiles du Mont Liban.,"  
p. 55, pl. x, fig. 4.

FRAAS, OSCAR, 1878. "Aus dem Orient. II. Theil. Geolog. beobacht.," p. 91.

The specimen from which this species is described was obtained from the hard limestone at Djebail, Mount Lebanon.

*Ex coll.*—Egerton Collection, British Museum.

*Cyclobatis major*, DAVIS.

(Pl. XXI, fig. 1.)

This species is represented in the museum by the two halves representing the same fish. The anterior portion is well preserved; the posterior behind the ventral arch is lost. The length of the specimen is 8 inches, and the breadth to the exterior of the pectoral fins is 6·5 inches. The cavity of the head occupies 1·7 inches in length and 1·8 inches in width; the pectoral or thoracic cavity is 1·5 inches by 1·7 inches in breadth. The surface is covered with small hexagonal shining dermal ossicles.

The head is divided into two almost equal parts, the anterior containing the organs for mastication, sight, &c.; unfortunately they are not in such a state of preservation as to enable a description to be given of them. The posterior half is occupied by the branchiostegal apparatus; a large median bone extends along the centre from which the branchiostegal rays are suspended, apparently five in number.

The vertebral column is composed of 17 vertebræ between the pectoral and ventral arches: they are short, averaging 0·5 inch in length and 0·2 of an inch in height. The caudal extremity of the vertebral column is altogether wanting.

The pectoral fins are remarkably extended. The scapular arch is very strong. The median bones connected with the vertebral column are 0·35 of an inch in diameter, and extend from the centre 0·9 of an inch from their distal termination; large curved bones divaricate, enclosing the circular cavities of the head and thorax; these in turn afford attachment to the rays supporting the great pectoral fins, numbering on each side fifty-four. The rays from the two fins meet anteriorly and extend in a straight line from the anterior extremity of the head a distance of at least 2 inches. From this point they radiate laterally, resolving the form of the anterior portion of the body to a slightly elongated oval. The posterior rays are 2·5 inches in length and stronger than those anteriorly; each ray is about 0·1 of an inch in diameter, depressed, jointed, and distally bifurcated. Their surface is covered by rows of dermal ossicles of a similar character to those on the surface of the body. The ventral arch is 1·5 inches behind the pectoral. The median transverse osseous support of the fin at a distance 0·2 of an inch from the centre of the vertebral column branches in three parts: the first and strongest backwards to support the ventral fin; the second tends diagonally backwards about 0·8 of an inch, and may have been the basal portion of a clasper; the third part extends anteriorly one inch in length in the pectoral cavity, from a diameter of 0·1 of an inch it tapers evenly to a fine point. The ventral fins are not well preserved, but sufficient remains to show that the fin was comparatively small, with eight to ten rays.

This species differs from *Cyclobatis oligodactylus*, Egerton (Proc. Geol. Soc. Lond., 1844, vol. iv, p. 442, pl. v.), in the larger number of the pectoral rays, and in their broadly expanded, depressed character. The number of vertebræ in this species is greater than in *C. oligodactylus*, and they are characterized by having a much greater diameter and consequent strength.

*Formation and Locality.*—Upper Cretaceous: Hakel, Mount Lebanon.

*Ex coll.*—Tristram Collection, British Museum.

Family. **RAJIDÆ.**Genus. **Raja.**

Disk broad, rhombic, generally with asperities. Two dorsal fins on the tail, without spine. Tail with a rudimentary caudal fin, or without caudal. Each ventral fin divided by a deep notch. Teeth small, obtuse, or pointed. Pectoral fins not extending forwards to the extremity of the snout. Nasal valves separated in the middle, where they are without a free margin. (Günther.)

*Raja minor*, DAVIS.

(Pl. XXI., fig. 2.)

An exquisite little specimen, collected by Mr. Lewis, and now in the British Museum, is from the soft cretaceous beds of Sahel Alma. The length of the fish from the tip of the snout to that of the tail is 2·6 inches; its breadth across the pectoral fins is 2·2 inches. The pectoral fins are large, extending anteriorly beyond the orifice of the mouth, but not encircling the head. The whole of the dermal covering has disappeared, leaving the internal framework of the fish fully exposed.

The cavity of the head is nearly circular and 0·9 of an inch in diameter. The mouth is placed 0·4 of an inch from the end of the snout and 0·5 in front of the pectoral arch. It is large, 0·6 of an inch across, and is armed with a series of minute teeth, conical and acuminate in front, and somewhat flattened and expanded laterally. A broad flat bone extends between the buccal region and the pectoral arch; there is no evidence preserved of the branchiostegal rays. Anteriorly to the upper jaw there is a cartilaginous extension, broad at its base, but dividing into filamentous prolongations.

The thoracic cavity extends 0·35 of an inch backwards and is 0·6 of an inch across. Anteriorly it is bounded by the scapular bones, which are large and strong. At a distance of 0·3 of an inch from the vertebral column a very strong branch extends anteriorly and encircles the cavity of the head; a second and smaller one extends posteriorly, enveloping the thoracic cavity. From these bones the pectoral rays, fifty-eight in number, on each side are radiated. The rays are fine and slender, and dichotomize towards their distal extremity. The base of the pectoral fin extends forwards to a position in front of the mouth and backwards to the pubic bones a distance of 1·1 inch. The longest central rays are 0·7 of an inch in length; the external margin of the fin is circular.

The ventral arch is 0·35 of an inch behind the pectoral; the central bone extends from the vertebral column 0·2 of an inch on each side: from this a branch is given off backwards for the support of the ventral fin, and a second forms a spinous anterior ray to the fin. In addition to the spine there are eighteen rays to support the fin, the longest 0·3 of an inch in length, and diminishing posteriorly. The rays do not present any appearance of jointing or division.

The spinal column is composed of vertebræ whose length and height are as nearly as possible equal in the thoracic region of the body, but which increase in height towards the caudal extremity. The number of vertebræ contained in the distance between the pectoral and ventral arches is thirteen, and thence to the posterior extremity of the ventral arch about ten more. Beyond the ventral area the caudal vertebræ extend 1·1 inch. The number of vertebræ cannot be distinguished; the intermediate portion of the caudal appendage is imperfect. The forty-eighth and adjacent vertebræ, counted from the pectoral arch, support a strong recurved spine less than 0·1 of an inch in length, stout and broad at the base, rapidly contracting to an acute point. At the termination of the tail there is evidence of a second hook or spine similar to the one described, and it is probable that others occupied intermediate positions.

The strong spines attached to the anterior rays of the ventral fins, and the long caudal appendage with the recurved spinous bodies attached to it, separate this fish from both the genera of rays hitherto described from the upper cretaceous rocks of Sahel Alma or Hakel. It is more closely related with *Rhinobatus* than *Cyclobatus*. The non-extension of the pectoral fins to the anterior portion of the head readily distinguishes it from the latter. And whilst the pectoral fins resemble, to a large degree, those of *Rhinobatus*, the presence of spines attached to the ventral fins separates it from that genus.

Its closest relationship appears to be with the genus *Raja*, and provisionally it is placed in that genus with the specific appellation, in reference to its small size, of *Raja minor*.

*Formation and Locality.*—Upper Cretaceous: Sahel Alma, Mount Lebanon.

*Ex coll.*—Lewis Collection, British Museum.

Order.—GANOIDEI. AGASSIZ.

“Skeleton cartilaginous or ossified. Body with medial and paired fins, the hinder pair abdominal. Gills free, rarely partially attached to the walls of the gill cavity; one external gill opening only on each side; a gill cover. Air bladder with a pneumatic duct. Ova small, impregnated after exclusion. Embryo sometimes with external gills.” (Günther.)

## Sub-order.—PYCNODONTOIDEI.

“Body compressed, high and short, or oval, covered with rhombic scales arranged in decussating pleurolepidal lines. Notochord persistent. Paired fins without axial skeleton. Teeth on the palate and hinder part of the lower jaw molar-like. Branchiostegals, but no gular plates.” (Günther.)

This sub-order comprises two families, the Pleurolepidæ, in which the body is not high and the fins have fulera, and includes two species from the Lias; and the Pycnodontidæ, which is more or less rotund in form, and is especially distinguished by the peculiar form of its teeth.

Family. **PYCNODONTIDÆ.** AGASSIZ.

“Homocercal. The neural arches and ribs are ossified; the roots of the ribs are but little expanded in the older genera, but enlarged in the tertiary forms so as to simulate vertebræ. Paired fins not lobate. Obtuse teeth on the palate and the sides of the mandible; maxilla toothless (rows of teeth on the vomer); incisor-like teeth in the intermaxillary and front of the mandible. Fulera absent in all the fins.” (Günther.)

The Pycnodontidæ were recognized by Professor Agassiz and formed into a family, which was distinguished by the arrangement and form of the teeth. (“*Rech. sur les Poissons Fossiles*,” vol. II., part 2, p. 184.) Three genera were placed by Agassiz in the family, Pycnodus, Microdon, and Gyrodus, and to these must be added, amongst others, that of Palæobalistum, de Blainville. They are abundant in the secondary rocks, and extend upwards to those of the tertiary period, but are now extinct. The teeth of Pycnodus vary in form and size, from small circular teeth on the rami of the jaws, to large, oval, or elongated forms on the palate; those of Gyrodus have a circular groove parallel with the margin of the tooth, whilst the teeth of Microdon are small, subcircular or oval, and do not vary in size as those of the other genera do. In the upper jaw there is a row of teeth on each of the maxillariës, with five rows on the vomer. On the lower jaw there are four rows on each side. The anatomical structure of Microdon is, perhaps, best known; specimens of this genus have been found well preserved, whilst those of Pycnodus and Gyrodus are often represented only by their teeth. Sir Philip Egerton indicated a peculiar feature in the structure of the scales of the Pycnodonts (“*Quart. Journ. Geol. Society*,” vol. v., p. 331): “Each scale bears upon its inner anterior margin a thick solid bony rib, extending upwards beyond the margin of the scale, and sliced off obliquely above and below, on opposite sides, for forming splices with the corresponding processes of the adjoining scales. These splices are so closely adjusted that, without a magnifying power or an accidental dislocation, they are not perceptible. When *in situ* and

seen internally, these continuous lines decussate with the true vertebral apophyses, and cause the regular lozenge-shaped pattern so characteristic of the Pycnodont family." In the fossil remains of this group it not unfrequently happens that the skeleton of the fish is preserved, whilst the scales have been removed or are not preserved, though the "thick solid bony ribs," described by Sir P. Egerton, still remain, or have left a very distinct impression on the matrix, crossing the spinous apophyses diagonally (see Pl. xxii., fig. 1). This serves to explain the difficulty experienced by Agassiz, who states (*op. cit.*, p. 185 and p. 204) that the singular bones prolonged obliquely across the apophyses and sometimes also across the ribs are the most remarkable feature in the skeleton of these fishes, of which there is no representative in living fishes. There can be no doubt the cross pieces are the thick ribs detached from the under surface of the scales.

Hitherto no fossil fish remains of the order Ganoidei have been with certainty identified from Mount Lebanon. Considerable uncertainty exists as to the true position of the genus *Leptotrachelus*; it is the more satisfactory, therefore, to find the following representative of the Ganoidei in the hard chalk of Hakel, and to express the indebtedness of ichthyologists to the Rev. J. E. Lewis for his valuable service in collecting the specimens.

Genus. **Palæobalistum.** DE BLAINVILLE.

Body more or less circular, adpressed. Head large, profile, almost vertical. Orbit large, very high. Mouth placed near the base of the head, slightly prominent; teeth situated on the vomer and on each of the maxillaries: there are rows on each mandible, all nearly equal in size, circular or crescentic. Dorsal and anal fins, commencing near the middle of the body, extend to the base of the caudal, the latter short, but widely expanded. Paired fins small.

*Palæobalistum gædelli*, HECKEL.

(Pl. xxii., figs. 1, 1a.)

Specimens vary from 9 inches to a foot in length. The one now described is 9 inches from the snout to the base of the tail. The latter is 1·3 inches in addition; its form is ovoid, tending to rotundity; the greatest height is 7 inches, exclusive of the fins, midway between the head and tail. Posteriorly the height is rapidly diminished to the peduncle of the tail, which is 0·5 inch. The anterior margin is rounded, with a slight prominence of the buccal orifice. The head is large, and occupies one-third of the length of the fish. Dorsal and anal fins of considerable extent envelop the posterior margin of the body to the



base of the tail; the latter is short, but its lobes are widely expanded to a diameter of 4 or 5 inches. The internal anatomy of the fish is well preserved, and patches of scales remain, principally on the ventral surface.

The head has a height of 5 inches, and from the snout to the posterior margin of the operculum it is 3 inches. The orbit is large: it is situated in the superior portion of the head. The post-orbital region is occupied by large, elongated, enamelled opercular plates; their anterior margin is concave, posterior one convex; the plates are not sufficiently well preserved to determine their number or exact relative position. Below the operculum there is a number of branchiostegal rays. The mouth is placed on the inferior part of the head, separated by nearly 2 inches from the orbit; the lower jaws are 0·7 of an inch in length, broad behind, but narrowing forwards after the manner of the Pycnodonts; five rows of teeth are spread over the rami of the jaws and the palate. The teeth are small, with rounded, flat apex, supported by a contracted peduncle, the whole teeth being raised from the jaw one-twentieth of an inch, the height being slightly greater than the breadth of the surface. The upper jaw is large and massive. The frontal bones are large, and extend with a bold curvature to a position above the eye. The surface of the head bones, where exposed, is covered with raised tubercles of a round shape.

The vertebral column is large and massive, and extends with a slight curvature from the head to the tail. That it was notochordal, without bony centres, is proved by the entire absence of osseous remains. The column consisted of about thirty-eight vertebræ, of which twenty-three are caudal. The vertebræ towards the occiput are somewhat hidden by a patch of matrix, and, in consequence, the number of abdominal vertebræ cannot be given except approximately; they are 0·4 inch in height and 0·25 inch broad; near the tail the vertebræ are somewhat smaller. The terminal eight of the caudal series support the tail; they exhibit a decided flexure towards the superior lobe of the tail; the last three radiate from a common centre (Pl. xxii., fig. 1), and expand with a spatulate extremity exposed towards the caudal fin-rays, the median portion of which they support. The five succeeding vertebræ are much narrower and closely impacted; they afford a basis for the attachment of the long rays of the upper and lower lobes of the tail. The remaining fifteen of the caudal vertebræ each support a neural and hæmal spine. The spines are strong, and nearly or quite straight; they extend backwards in a diagonal direction and support a series of interneural and interhæmal bones, to which, in their turn, the fin-rays were attached. Each neural spine was spliced with at least two interneurals, and the fin-rays correspond in number with those of the latter. The interneural spines, varying from 0·9 inch in length, where they support the anterior rays of the fin, to 0·3 near the base of the tail, are more or less pointed at each extremity; a ridge extends along the median surface, and from this there extends

a flattened wing-like expansion on each side. The interhæmal spines are similar to the interneural, excepting those placed most anteriorly, which are much more numerous in proportion to the hæmal spines. The caudal portion of the body is separated from the abdominal by a strong rounded bone, with the concave surface towards the abdominal cavity, and extending to and supporting the long anterior rays of the anal fin. The ribs are strong, and extend to the abdominal surface of the body.

The dorsal fin extends from the base of the tail to the highest point of the back, and increases in size anteriorly. The length of the rays and their precise character is not apparent, but they were probably 1·5 inches in length at least, and gradually decreased nearer the tail. The anal fin is similar to the dorsal, but does not extend so far forwards. The caudal fin, as already observed, is short, but the two lobes are widely expanded. The upper lobe consists primarily of nine rays; these dichotomize and towards the extremity are again divided and are jointed transversely. The lobe of the tail is not all exposed, but it is at least 2 inches in length. The median rays of the tail, eighteen in number, are supported from the inferior surface of the concluding caudal vertebræ; they are 0·5 inches or more in length. The lower lobe is composed of eight fin-rays, the longest of which are slightly more than 2 inches in length. The anterior rays of both the upper and lower lobes are supported by a series of imbricating rudimentary rays.

Of the paired fins only the pectoral is visible. It is situated immediately behind the opercular apparatus, and is attached to a large pectoral arch. It is about one-third the height of the fish above the abdominal margin. The fin consists of a large number of small fin-rays, the longest about an inch in length.

The body and head of the fish appear to have been covered by thick plates and scales. Patches still remain, but the greater part has been removed. The scales have already been mentioned on a previous page, along with Sir P. Egerton's description of the peculiar articulation of the scales, one with another, in the Pycnodontidæ. On the ventral surface beneath the pectoral fin the scales are 0·4 inch in length and 0·2 inch in breadth. A thick rib extends longitudinally across the scale and splices with similar ribs on the scales above and below. In the specimen figured (Pl. xxii., fig. 1) a number of the thickened portions of the scales remain, whilst the thinner portion has disappeared; the result is that a series of lines of bony substance is preserved, extending from the dorsal surface diagonally backwards across the apophyses of the vertebræ, the vertebral column, and towards the abdominal surface.

This species may be readily distinguished from those described by Agassiz from the Solenhofen beds, by the rounded and slightly elongated form of its body. It approaches most closely to *Microdon elegans*, Agassiz; but the size

of the head, in proportion to that of the body, is much smaller in *M. elegans* than in the species now described. In the latter the orbit, though high, is situated at a greater distance from the anterior margin of the head.

*Formation and Locality.*—Hard limestone: Hakel, Mount Lebanon.

*Ex coll.*—Lewis Collection, R. Damon, Esq.

*Palæobalistum ventralis*, DAVIS.

(Pl. XXIII., figs. 1, 1a.)

A specimen in the Natural History Museum, London, from the hard chalk, possesses characters which distinguish it from the more common species, *Palæobalistum goedelli*, Heckel, and appears to render necessary the following description. The fish approaches an oblong form, the anterior portion somewhat thicker and more rounded than the other. The body is 10·0 inches in length; the tail, which is widely spread in this specimen, adds 3·0 inches to the length. It measures 6·0 inches across the outstretched extremities of the lobes.

The head is large, 5·5 inches in height and 3·5 inches from the snout backwards. The bones are split, a portion having adhered to the opposite matrix, which renders their determination difficult. The orbit is large; it is above the median line, 1·0 inch from the anterior margin of the head. The opercular bones are long and narrow. The jaws are obscure; the dentition not present. The teeth are exhibited in another example; they are round, with flat surface, 0·1 of an inch in diameter. Their arrangement on the jaw is not shown.

The vertebral column is large and massive, consisting of thirty-nine vertebræ; of this number eighteen are caudal. The vertebræ are 0·4 inch in height, and 0·2 in width. Those towards the termination at the caudal end are much smaller. The ribs are long, extending nearly to the abdominal margin. The neurapophyses are strong, straight, and long. Supporting the dorsal fin are interneural spines, about twice the number of the neural, longest anteriorly, and diminishing backwards. The hæmal and interhæmal spines are similar to those above. The anterior interhæmal spine is large, and extends considerably upwards, affording a firm support to the long anterior rays of the anal fin.

The dorsal fin extends from the summit of the back to the base of the tail. The anterior ray is 6·0 inches from the snout and 7·0 inches from the base of the tail. The fifth ray is the longest, attaining 1·7 inch. The succeeding rays gradually diminish in length towards the tail. The first four are fulcral, and diminish in length anteriorly. One-third the length of each ray is solid; the remaining divided. The anal fin is 4·0 inches in length. The anterior rays are probably 2·0 inches in length. The succeeding ones rapidly shorten to the sixteenth, and thence to the base of the caudal fin they gradually decrease in length. The

construction of the rays is similar to that of the dorsal fin. The caudal fin is deeply forked, the extremities of the two lobes being 6·0 inches apart. The outer rays of each lobe are thick and strong; they are supported by a number of rudimentary imbricating rays.

The pectoral fin is large, consisting of more than thirty rays. It is attached at a distance of 1·5 inch from the abdominal margin on the lateral surface of the body. Ventral fins not present. The scales are imperfectly preserved; they were large. A number of ridges extend diagonally from left to right across the specimen, which probably mark the impress left by the internal surface of the scales, as in the genus *Microdon*.

This species differs from *Palæobalistum goedelii*, Heckel, in the form of the body and the teeth. In the latter the teeth are small and have a notch on the upper surface. The teeth of this species are much larger, and have a flat, smooth surface. The form of the posterior part of the body in *P. goedelii* is more regular than in this: taking the vertebral axis as a base, the dorsal and ventral outlines form equal or nearly equal angles with it above and below. In the species now described, the angle formed by the spinal column and the dorsal margin is very acute, whilst that of the ventral surface descends almost perpendicularly at right angles with the vertebral column.

A second specimen of this species is imperfect, only the posterior portion of the body, part of the dorsal and anal fins, and the caudal being preserved. A small portion of the head, sufficiently to indicate its position, and of the pectoral fin, are preserved. The vertebral column consists of about the same number of vertebrae as does that of *Palæobalistum goedelii*, Heckel. Its size is also about the same; the neural and interneural spines are shorter than in the species already described; but the hæmal and the interhæmal spines are very much longer, with the result that the portion of the body below the vertebral column is greatly extended. Both the interneural and the interhæmal spines possess broad wing-like processes on the anterior margin similar to those of *Microdon elegans*, Agassiz. The abdominal margin of the fish descends almost vertically, with a slightly rounded flexure from the short peduncle of the tail; and with the line of the vertebral column forms an obtuse angle, whilst that of *P. goedelii* is decidedly acute. The tail, from the part preserved, is much shorter.

The evidence left by the pleurolepidal character of the scales, in the form of impressions of the solid bony ribs, extending transversely over the apophysial elements as well as the vertebral column, indicate that the scales were much smaller than those of the species described above; they are less than 0·1 of an inch across. The rays of the dorsal and anal fins are broadly expanded at the base where attached to the interhæmal spines; for a short distance they are simple, but speedily dichotomize.

The great depth of the abdominal portion of this specimen distinguishes it

from every other species hitherto described; and, whilst its general resemblance to the members of the genus *Palæobalistum* leaves no room to doubt its relationship with that genus, there is every probability that it is a separate species, and the name *Palæobalistum ventralis* is suggested to distinguish it.

*Formation and Locality.*—Hard chalk: Hakel.

*Ex coll.*—Natural History Department, British Museum.

#### **Incerta sedis.**

##### *Chondrosteus?*

(Pl. xxiv., fig. 1.)

A single specimen, consisting of only a portion of the tail, of a large chondrosteian fish has been found by Mr. Lewis. It consists of the posterior portion of the upper and lower lobes; the former is 6·0 inches and the latter 7·0 inches in length. The distance between the extremity of the two lobes is 9·0 inches. There are twelve rays, with a total diameter of 1·2 inch in the upper lobe. The external ones are somewhat shorter and smaller than the median ones. Along the whole of the inner margin of the fin a large number of fine rays extend obliquely from the large ones already mentioned. The large fins are much subdivided towards their extremities. The lower lobe is similarly forward to the upper one. There are only eight large rays, with rudimentary rays supporting, and filamentary rays on the posterior surface.

*Formation and Locality.*—Hard chalk: Sahel Alma, Mount Lebanon.

*Ex coll.*—Lewis Collection, Natural History Department, British Museum.

##### *Microdon? pulchellus*, DAVIS.

(Pl. xxiv., fig. 3.)

A small fish, of a rounded form, 1·3 inch in length, exclusive of the tail, and 1 inch in height. The tail is nearly half an inch additional. The fish is well preserved, and exhibits the anatomical structure as well as a considerable portion of the scaly covering.

The head extends backwards from the snout 0·45 of an inch, about one-third the entire length of the body. The orbit is superior and large. The supra-orbital bones are not well preserved; the region is small. The operculi are elongated and narrow, smooth on the surface, and apparently without serrations on the margin. The mouth is placed obliquely. The mandible is 0·3 inch in length; its dentition is not exposed. The snout is obtusely pointed; the profile ascending with a gracefully-rounded curvature to the base of the dorsal fin.

The spinal column consisted of thirty vertebræ, and of these seventeen are caudal; they are slightly higher than broad. The column extends with a graceful curvature from the head to the tail. From each vertebra in the caudal region there extends a strong hæmal and neural spine, gently curved backwards. The neural spines extend forward to the occipital region of the head; the neural ones are replaced by a series of ribs; the latter extend from the vertebræ 0·4 of an inch, or two-thirds the depth of the abdominal cavity. Interspinous bones connect the hæmal and neural spines with the base of the dorsal and anal fins. They are thin and slender, and twice the number of the spinous processes.

The dorsal fin extends from a point midway between the snout and the tail, along the dorsal surface quite to the base of the tail. It is supported by numerous short rays, which become smaller posteriorly. The anal fin commences opposite the anterior rays of the dorsal one, and extends to the base of the caudal. As with the dorsal, the anterior rays are the stronger, and they decrease in size backwards. The caudal fin is supported by strong rays; it is moderately forked, and the external rays of the two lobes are supported by a series of rudimentary rays, firmly imbricated along its base.

The pectoral fin is situated on the side of the fish, but low down towards the median line of the abdomen. It is composed of six or seven small rays, and was apparently of comparatively feeble dimensions. The fin is connected with a long and comparatively small series of bones, forming the pectoral arch. The ventral fins are located on the abdominal surface, at a distance of 0·1 of an inch from and immediately below the pectorals. They are larger and stronger than the pectoral fins; the number of rays cannot be distinguished.

The scales are thick, circular behind, with smooth margin and surface. Those on the dorsal surface are large, elongate, rugose, and have a pointed and imbricated appearance; they extend over the head to a position immediately above the orbit. The scales on the ventral surface are also much elongated; the surface is rudely striated, and the abdominal extremity of the scale is quite pointed, producing a serrated appearance.

*Formation and Locality.*—Soft chalk: Sahel Alma.

*Ex coll.*—Lewis Collection, Mr. Robert Damon, Weymouth.

#### Genus. *Spathiurus*.\* DAVIS.

Posterior part of fish only is preserved. The vertebral column is thick and strong; its caudal extremity is diverted upwards in a marked degree. The caudal fin is attached to the lower convex surface of the vertebræ by a series of long hæmapophyses, rod-like at the base, but expanding to a spatulate form near

\* σπαθη, a paddle; οὔρα, a tail.

their point of attachment with the caudal rays. A long series of spinous and interspinous bones support the dorsal fin; and anteriorly the two are connected by free rods of bone, the latter overwrapping the free ends of the spinous and interspinous processes. Dorsal fin very large. Anal about half the length of the dorsal.

The heterocercal arrangement of the termination of the spinal column and the hæmapophyses supporting the caudal fin greatly resemble those of the ganoid *Lepidosteus*. The constitution of the dorsal and anal fins do not share the resemblance. There is no evidence of scales. It is considered advisable to place the genus provisionally amongst the Ganoids, and await the advent of more perfect specimens to prove whether the determination is the correct one.

*Spathiurus dorsalis*, DAVIS.

(Pl. xxxvi., fig. 1.)

The specimen, which is unique, exhibits only the caudal portion of the fish. The slab is broken diagonally across the body. The entire length preserved is 9 inches; from the base of the tail 7·0 inches of the dorsal surface is preserved, but only 2·5 inches of the ventral. The part of the spinal column which remains is 5 inches in length, comprising thirty-three vertebræ. The vertebræ are 0·3 inch in height and 0·2 inch in length. They decrease in size towards the caudal extremity. The latter is very decidedly heterocercal. The neurapophyses are strongly attached, one to each vertebra, curve gently backwards, and extend midway towards the dorsal margin of the fish. Interneural spines, interlocking with the apophyses, extend to and support the rays of the dorsal fin; they are straight and widely expanded for attachment. Commencing at about the twenty-fourth vertebra from the tail, a series of slightly-bent, rod-like bones extend intermediately between the spinous and interspinous bones, serving to support and combine the action of the two. The hæmal and interhæmal bones are similar to the neural.

The dorsal fin extends from the base of the tail 6·0 inches in length; it is large, supported by strong rays, expanded at the base where connected with the interspinous processes; the basal portion forms a solid hollow tube, averaging about 0·5 inch in length; beyond it becomes articulated, and by dichotomization is much divided at the distal extremity. The fin comprises forty-four rays. The anterior ones are apparently of the same character as those behind, but may have been spinous. It has unfortunately happened that all except a short piece of the base has been lost. The rays near the middle of the length of the fin are 1·0 inch in length. The anal fin is not preserved. The base of the anterior rays and their connection with the interspinous processes is exhibited; they are strong and bent

backwards. The anterior ray is opposite to the twenty-sixth of the dorsal fin. The caudal fin is not perfectly preserved. The caudal vertebræ are turned upwards, so that the terminal vertebræ approach very nearly to the dorsal margin of the fish. From the convex, under side of the column, a series of apophyses extend and support the rays of the tail; they are sixteen to twenty in number, strong and cylindrical at the base, expanded and spatulate at the distal end. The anterior one is an inch in length, succeeding ones gradually diminish. The rays of the tail are large and strong, solid for a short distance, then articulated and divided; only about an inch of the basal portion is preserved.

The peculiar heterocercal form of the tail, combined with a strong osseous framework, appears to separate this fish from other genera previously described either from Lebanon or other localities. As previously stated, the resemblance of the caudal extremity to that of *Lepidosteus* indicates an affinity with the Ganoids; at the same time, it cannot be denied that the arrangement of the fins points more in the direction of some of the Teleostean groups; and it may be possible that the discovery of specimens which exhibit the complete anatomy of the fish may serve to indicate more closely some of the characters which appear to connect the Teleosteans with the Ganoids.

*Formation and Locality.*—Hard chalk: Hakel.

*Ex coll.*—Lewis Collection, Natural History Department, British Museum, South Kensington.

Genus. ***Amphilaphurus***.\* DAVIS.

Fish, only caudal portion preserved. Vertebral column thick and strong, terminating heterocercally. Caudal fin supported from the lower convex surface of the vertebræ by hæmapophyses; peduncle of tail and the tail very thick. Anal fin small, remote from the caudal. Posterior part of dorsal fin situated at half the distance from the caudal, which separates the latter from the anal.

This genus approaches nearer to that of *Spathiurus* than any other found in the hard or soft chalk of Mount Lebanon. But, whilst *Spathiurus* is apparently a more or less flat-bodied fish, with well-developed and extended dorsal and anal fins, this one has a long and rounded body, and the anal fin, at any rate, is small and remote.

*Amphilaphurus major*, DAVIS.

(Pl. xxiv., fig. 2.)

The caudal extremity of a large fish. The remaining part is broken away at the anterior extremity of the ventral fin; a small part of a dorsal remains, and

\* ἀμφίλαφης, massive; οὐρα, a tail.



the tail is perfect. The greatest length on the ventral surface is 7·5 inches; the extremities of the two lobes of the tail are 4·0 inches apart, the peduncle of the tail 2·0 inches in height, which increases anteriorly. The caudal portion of the vertebral column is preserved, and numbers thirty-two vertebræ; the extremity heterocercal. The vertebræ are large, higher than broad. Neural and hæmal spines extend from each vertebræ. A number of interneural spines support the dorsal fin, of which fifteen can be distinguished. Interhæmal spines, eight in number, support the anal fin.

The anal fin is situated 2·8 inches from the caudal. It comprises eight rays, portions of which are now in fragments; the rays were probably 1·5 inch in length, and are articulated and branching. The dorsal fin is broken away; only three posterior rays remain, similar to the anal. The caudal fin is strongly supported by processes extending from the vertebral column to the rays of the fin, decreasing in length near the end of the spine. The rays composing the fin are twenty-one in number, and are all supported from the lower convex surface of the spinal column; they are thick near the base, but rapidly bifurcate and become divided into numerous filamentous rays, whose posterior margin forms a slightly concave outline to the fin. Numerous rudimentary rays extend from the upper concave surface of the vertebræ and form a strong support to the upper lobe of the fin; a number of rudimentary rays also support the lower lobe.

The ventral fin is 2·0 inches in advance of the anal; it is supported by a horseshoe-shaped bone, a portion of which only is preserved. The fin is 1·6 inch in length, and consists of fourteen rays, which become rapidly divided into several times that number.

*Formation and Locality.*—Hard chalk: Hakel.

*Ex coll.*—Lewis Collection, Natural History Museum, South Kensington.

### Sub-class II.—TELEOSTEI.

“Heart with a non-contractile bulbus arteriosus; intestine without spiral valve; optic nerves decussating; skeleton ossified, with completely formed vertebræ; vertebral column diphyccercal or homocercal; branchiæ free.” (Günther.)

The Teleostei are divided by Dr. Günther into six orders, as follows:—

- I. Acanthopterygii.
- II. Acanthopterygii pharyngognathi.
- III. Anacanthini.
- IV. Physostomi.
- V. Lophobranchii.
- VI. Plectognathi.

The larger proportion of the Teleostean fishes of the chalk of Lebanon are comprised in the first and fourth groups; others, like *Pycnosterinx*, probably find their nearest relationship with the Chromides in the second group. Many of the genera exhibit peculiar and aberrant features, which do not appear to be possessed by any living representatives; it is proposed to consider these in more or less detail under their more immediate or individual relationships.

#### Order 1.—ACANTHOPTERYGII.

“Part of the rays of the dorsal, anal, and ventral fins are not articulated, more or less pungent spines. The lower pharyngeals are generally separate. Air-bladder, if present, without pneumatic duct in the adult.” (Günther.)

#### *Acanthopterygii perciformes*, GÜNTHER.

“Body more or less compressed, elevated or oblong, but not elongate; the vent is remote from the extremity of the tail, behind the ventral fins, if they are present. No prominent anal papillæ; no superbranchial organ. Dorsal fin or fins occupying the greater portion of the back; spinous dorsal well-developed, generally with stiff spines of moderate extent, rather longer than, or as long as, the soft; the soft anal similar to the soft dorsal, of moderate extent, or rather short. Ventrals thoracic, with one spine and four or five rays.”

This division is represented by only one genus, that of *Pagellus*. It includes two species, both somewhat doubtfully referred to this genus by Pictet.

#### Family. SPARIDÆ.

#### Genus. *Pagellus*, CUVIER.

#### *Pagellus leptosteus*, AGASSIZ.

*P. leptosteus*. AGASSIZ, L., 1844. “Rech. sur les poiss. foss.,” vol. iv., p. 10 and p. 154.

*P. leptosteus*. PICTET and HUMBERT, 1866. “Nouv. rech. s. l. poiss. foss. du Mont. Liban.,” p. 50.

This species was described by Professor Agassiz; the original specimen he stated to be in the Museum at Zurich. Its origin was doubtful, but he had every reason to believe that it had come from Lebanon. Professor Pictet remarks, in the work cited above, that with the assistance of the administrators of the Museum at Zurich he sought for the specimen, but did not succeed in

finding it. As Agassiz has not given a figure of the species, and all trace of the original has disappeared, it is, perhaps, questionable whether it should still be considered as a species from Lebanon.

*Pagellus libanicus*, PICTET.

*P. libanicus*. PICTET, J. F., 1850. "Desc. de quelques poissons fossiles du Mont Liban.," p. 11, pl. I., figs. 2, 3.

*P. libanicus*. PICTET and HUMBERT, 1866. "Nouv. desc. sur les poiss. fossiles du M. Liban.," p. 50.

Two specimens are represented in plate I. of Pictet's work: they are both imperfect. M. Pictet observes that "the form of the skeleton, the number of the vertebræ, the disposition of the fins, and the absence of denticulations on the opercular bones appears to prove that this species belongs to the family of the Sparides. I am less certain that it ought to be placed in the genus *Pagellus*. I have been induced to place it in this group, because one of the specimens, I have observed, contains in the region of the mouth, but separated from the jaws, some teeth in pavement, too small to belong to the genus *Sparoides* or that of *Dorades*."

This species differs from the one described by Agassiz in the greater robustness of the skeleton, and the structure of the dorsal fin, which in this species has the soft rays longer than the spinous ones, whilst in *Pagellus leptosteus*, Agassiz, the hard rays are longer than the soft ones.

*Formation and Locality.*—Soft chalk of Sahel Alma, Mount Lebanon.

*Acanthopterygii beryciformes*, GÜNTHER.

Body compressed, oblong, or elevated; head with large muciform cavities, which are covered with a thin skin. Ventral fins thoracic, with one spine and more than five soft rays.

This division is distinguished by Dr. Günther from the Perciform acanthopterygians by the ventral fins, which in the latter have not more than five soft rays in addition to the spinous one, whilst the members of the Beryciform acanthopterygians have more than five soft rays. The fossil fishes comprised in this division exhibit great diversity of form and constitute some of the earliest types of Teleostean fishes. They are represented in the chalk of Lebanon by several genera, the most prominent being *Beryx*, *Pseudoberyx*, *Hoplopteryx*, and *Homonotus*.

Genus. **Beryx.***Beryx vexillifer*, PICTET.

*B. vexillifer*. PICTET, J. F., 1850. "Desc. des quelques poiss. foss. du M. Liban.," p. 8, pl. I., fig. 1.

*B. vexillifer*. PICTET and HUMBERT, 1866. "Nouv. rech. sur les poiss. foss. du Mont Liban.," p. 30, pl. II., figs. 1–3.

The admirable description and illustration of this species, in the "Nouvelles recherches," by MM. Pictet and Humbert, leaves nothing further to be desired.

*Formation and Locality.*—Hard chalk: Hakel, Mount Lebanon.

*Ex coll.*—Common.

*Beryx ovalis*, DAVIS.

(Pl. XXVII., fig. 4.)

The body has an oval form, much shorter in proportion to its height than that of *Beryx vexillifer*, Pictet; its length is 2·8 inches, of which the tail occupies 0·6 inch; its height, between the anterior part of the dorsal and the ventral fins is 1·3 inch.

The head is less than one-fourth the length of the body. The impression of the bones is well indicated, but a large portion of the actual bones have been removed by the opposing matrix. The orbit is high and moderately large. The supra-occipital region of the head is depressed and concave, the snout prominent and rounded. The maxilla is 0·4 inch in length, and, compared with *B. vexillifer*, is nearly straight; the intermaxillary is moderately large. The mandible is longer than the maxilla, angular behind and diminishing in strength and thickness anteriorly. Teeth cannot be distinguished. A large sub-triangular temporal bone fills the space between the orbit, jaws, and operculum. The latter is higher than broad, the inferior extremity curving forwards towards the posterior extremity of the lower jaw. The branchiostegal rays are not exposed.

The vertebral column consists of thirty-four vertebræ, of which seventeen are caudal. They are small, as high as long. The ribs are moderately long, fine, and curved backwards; the hæmapophyses are extended, one from each vertebra, two-thirds the distance to the anal fin, with which they are connected by interhæmal spines. The neurapophyses and interneural spines are similarly arranged.

The dorsal fin is situated 0·3 of an inch behind the head; its base extends 0·75 inch, and it is separated from the peduncle of the tail by 0·6 inch. It is

composed of sixteen rays, of which the anterior two are short and spinous; the remainder are soft, divided, and articulated. The fifth or sixth ray, which is the longest, attains a length of half an inch. The anal fin is situated posteriorly, and extends 0·6 inch from the base of the tail, to which the posterior rays extend. The anterior rays are 0·45 inch in length; with the exception, perhaps, of the first they are not spinous, but similar to those of the dorsal fin. The fins are supported by strong interspinous bones. The caudal fin is moderately large, bilobate, each lobe supported by a series of imbricating rudimentary rays. The tail is connected with the vertebral column by a series of broad, flat plates. Each lobe is composed of ten strong articulated dichotomizing rays, those of the upper one attaining 0·65 inch, and of the lower one 0·8 inch in length.

Of the paired fins the pectorals are comparatively feeble; they are attached to the pectoral arch 0·25 inch above the abdominal line. The ventrals are immediately under the pectorals; they are large, 0·8 inch in length, consisting of ten or twelve rays, strong at the base, but divided to a filamentous condition at their extremities.

A patch of scales is preserved on the antero-superior portion of the body; they are large, 0·15 inch in length and one-third that in breadth. The free posterior margin of the scales is slightly circular and minutely pectinated.

This species may be distinguished from *Beryx vexillifer* by the oval form of its body, by the larger number of vertebræ, and the position of, and the number of rays constituting the fins. The position of the mouth in this species is lower than in *B. vexillifer*, and the jaws, especially the upper one, are consequently straighter and more symmetrical than those of the species last named.

*Formation and Locality.*—Upper chalk: Hakel, Mount Lebanon.

*Ex coll.*—Lewis Collection, Natural History Museum, South Kensington.

Genus. **Pseudoberyx.** PICTET and HUMBERT.

*Pseudoberyx syriacus*, PICTET and HUMBERT.

*P. syriacus.* P. and H., 1866. "Nouv. rech. s. l. Poiss. foss.," p. 33, pl. II., figs. 4–6.

*Formation and Locality.*—Hard chalk: Hakel.

*Ex coll.*—Museum, Geneva (type), not rare.

*Pseudoberyx bottæ*, PICTET and HUMBERT.

*P. bottæ*. P. and H., 1866. "Nouv. rech. sur les poissons fossiles," p. 34, pl. II., fig. 7.

In addition to the details of the description of this species given by Pictet and Humbert, examples from the collection made by Professor Lewis afford evidence of spinous rays, two in number, attached to the dorsal fin, and a single strong spine in front of the ventral fin. The pectoral fins are medium size, attached slightly below the median line of the body, and consisting of ten to twelve rays.

The scales are large, posterior margin circular and minutely denticulated. There are eight in a transverse row in front of the dorsal fin, and on the lateral line, between the head and tail, twenty-eight scales. In proportion to those of *Pseudoberyx syriacus* the scales are considerably larger and fewer in number, confirming the determination of the authors cited above that the species were not the same.

*Formation and Locality*.—Hard chalk: Hakel, Mount Lebanon.

*Ex coll.*—Museum at Geneva (type), not rare.

*Pseudoberyx grandis*, DAVIS.

(Pl. XXVIII., fig. 4.)

Compared with the species of this genus previously described from Mount Lebanon, viz. *P. syriacus*, Pictet and Humbert, and *P. bottæ*, P. and H., this one is large. Its form is an elongated oval, somewhat attenuated towards the tail. The snout and anterior portion of the head are not well preserved, and their position relatively to the body is somewhat displaced, so that the orbit has been pressed under the surface exposed. The length of the fish, as preserved, is 6.5 inches, and of this the tail absorbs 1.5 inch and the head 1.8 inch. The greatest height is in front of the dorsal fin, 2.2 inches, diminishing backwards to the peduncle of the tail, which is 0.8 inch in height. The opercular bones are high and narrow. The operculum is triangular; the anterior exposed margin is nearly straight, with the infero-posterior margin it forms an obtuse angle; its surface is vertically striated on the lower portion, radiating to a horizontal direction on the upper. The pre-operculum is long, with a slight concave curvature of the anterior surface, and increasing in width downwards.

The vertebral column is massive, composed of twenty-nine vertebræ, fourteen of which are caudal. The ribs and apophyses are strong, and extend with backward curvature nearly to the margin of the body. The interspinous bones supporting the dorsal and anal fins are strong, and overlap the apophyses to a considerable extent. The terminal caudal vertebra is widely expanded and flat; radiating from it are the primary rays of the caudal fin.

The dorsal fin is large, situated on the median portion of the back between the occiput and the tail; the number of its rays is considerable, probably fifteen or sixteen, but they cannot be counted with exactitude; they are 1·8 inch in length, the basal part undivided; distally they are both divided and articulated. The first ray appears to have been short and spinous. The anal fin is not present; its position is indicated by the interhæmal spines; it had a basal extent of 1·0 inch, and was separated from the tail by about 0·3 inch. The caudal fin is large and deeply lobed. The length of the upper lobe is 1·5 inch; the extremity of the lower has become detached. The upper lobe consists of twelve rays, the outer ones thick and strong; the lower one possesses ten rays: each is strengthened by six or seven imbricating rudimentary rays.

No trace of the pectoral fin remains. The ventral is abdominal, about 1·0 inch behind the head or midway in the length of the body without the tail. It is composed of ten or twelve rays, the anterior one strong and curved backwards. The scales are large, 0·2 inch in height and rather less than 0·1 inch of the width is exposed. The free posterior margin is circular and minutely denticulated. The scales are only preserved in small patches, not sufficiently to ascertain the number. The lateral line can be distinguished: it is straighter than the spinal column and mostly slightly above it.

The character of the scales, the form and arrangement of the fins and the opercular bones clearly indicate the Berycoid affinities of this species. The abdominal position of the ventral fin removes it from the genus *Beryx*, Cuvier, whilst it points with equal clearness to that of *Pseudoberyx*, Pictet and Humbert, with which it also agrees naturally in other respects. Its large size and more robust anatomy, the length of the rays of the dorsal fin, and the height of the peduncle of the tail distinguish this species from those already described.

*Formation and Locality.*—Hard chalk: Hakel.

*Ex coll.*—Lewis Collection, Natural History Museum, South Kensington.

*Pseudoberyx longispina*, DAVIS.

(Pl. xxv., fig. 2.)

The unique specimen which forms the type of this species formed a part of the magnificent collection made by Professor Lewis. It is 2·5 inches in length, including the head, which is 0·9 inch; the tail, from its base to the tip of its upper lobe, is 1·0 inch; the lower lobe is shorter. The height in front of the dorsal fin is 1·0 inch: it diminishes rapidly towards the snout, and in the opposite direction to the tail; the height of the peduncle of the latter is 0·4 inch. The great development of the dorsal fin, extending to nearly 2 inches in length, forms a peculiar and striking feature of the fish.

The bones of the head are not sufficiently well preserved to render their identification very certain. The opercular bones are large, rounded on their posterior margin and smooth. The jaws are displaced; no teeth are visible.

The spinal column consists of twenty-eight vertebræ, of which thirteen are caudal. The vertebræ are longer than high towards the caudal fin, but near the head the height equals or slightly exceeds the length. The ribs are long and slender, the posterior ones with branching epipleural spines. The neural and hæmal spines are stronger than the ribs, and extend with a slightly sygmoidal curvature backwards. A series of strong interneural spines support the rays of the dorsal fin, and smaller interhæmal spines those of the anal. The posterior termination of the vertebral column gives rise to a large triangular hypural bone, from which extends the rays of the caudal fin.

The vertical fins are represented only by the dorsal and caudal. The anal fin, placed 1 inch behind the ventral, and 0·2 inch before the caudal, is only represented by the bases of a few of the rays. The dorsal fin is abnormally developed. The anterior rays extend to a length of 1·9 inch. They are strong at the base, and taper to a point. The posterior rays are shorter. There are nine rays in the fin; and besides these there are a number of fin rays extending some distance towards the tail. They are short, not exceeding 0·2 inch in length anteriorly, and diminishing to 0·1 posteriorly. The caudal fin is bilobate and deeply cleft. The upper lobe is longer than the lower. Each consists of about twelve rays, dichotomizing and forming a filamentous extremity. They are articulated.

The pectoral and ventral fins are not well preserved. The position of each can be traced. The pectoral fin is situated immediately behind the operculum; the ventral, 0·6 inch behind the pectorals. The ventral fins are opposite to the dorsal.

The scales are small, smooth on the surface, and minutely serrated on the posterior margin.

The general characters of this specimen appear to associate it with *Pseudoberyx*. The form of the body is similar to that of *P. syriacus*, *P.* and *H.*, and the number of vertebræ and their division into caudal and abdominal is the same. The arrangement of the fins agrees in each as to their relative position; though the ventral and anal fins are not preserved in the specimen now described, their position is clearly indicated. Whilst the generic relationship is thus clearly defined, the great length of the rays of the dorsal fin readily distinguish it specifically, and the specific name (*longispina*) has been given to it as indicating this peculiarity.

*Formation and Locality.*—Upper Cretaceous: Hakel, Mount Lebanon.

*Ex coll.*—Prof. Lewis, in the possession of R. Damon, Esq., Weymouth.



Genus. **Hoplopteryx.** AGASSIZ.

Body compressed, more or less oval in outline. Abdominal cavity deep. Head large in proportion to the size of the body. Orbit large. Opercular bones serrated. Vertebral column strong. Dorsal fin with five or six spinous rays, strong and widely separated. Anal fin has three spinous rays, supported by a strong interspinous process, which reaches nearly to the vertebral column. Scales large, strongly connected, but not coarsely punctured. Lateral line begins on abdominal surface, near the tail, and passes over the vertebral column forwards; it consists of arrow-shaped scales." (V. d. Marck.)

The genus *Hoplopteryx* approaches those of *Holocentrum* and *Myripristis* in form and general configuration, and also in the possession of seven or more branchiostegal rays; but it is distinctly separated by the spinous and soft rays of the dorsal fin being continuous, and forming only one fin, whilst those of *Holocentrum* and *Myripristis* constitute two separate dorsal fins. From *Platycormus* (*Beryx germanus*, Agassiz), established by Von der Marck ("Palæontographica," vol. xi., p. 19), this genus is distinguished by the scales of the former not being denticulated along the posterior margin, but only granulose; and the spinous rays of the dorsal fin forming an imbricating series considerably smaller than the succeeding soft rays. *Hoplopteryx* is perhaps more nearly related to *Beryx* than to any other genus. It agrees with the latter in the form of the head and the denticulation of its bones as well as the scales of the body. It is distinguished by Agassiz ("Poissons Fossiles," vol. iv., p. 131) by the larger development of the spinous portion of the dorsal fin, which exceeds in length and size the articulated portion. The spinous rays are more widely separated from each other, and do not appear to have the same close connexion with the fin rays behind as those of *Beryx*. It is necessary to consider the variety of fishes which have been included in the genus *Beryx*. Agassiz described five species; and of these, *Beryx germanus* has served Von der Marck as the type of the genus *Platycormus*, as already stated. The three species, *Beryx ornatus*, *radians*, and *microcephalus*, from the chalk of the South of England, agree with the existing members of the genus in the formation of the dorsal fin, whilst *B. zippei*, from Bohemia, is possessed of a number of dorsal spinous rays, which very closely approximate to those of *Hoplopteryx*. The same observation applies to the species *B. superbus*, a figure of which is given by Mr. Dixon in the "Geology of Sussex" (pl. xxxvi., fig. 5). From the Lebanon, Pictet and Humbert have described two species of fish remains as *Beryx vexillifer* and *Beryx syriacus*. The former is aptly spoken of by the authors as, under every point of view, a true *Beryx*; the other, as belonging to an intermediate group. *Beryx syriacus* is, in fact, closely related with *B. zippei*, Ag., and *B. superbus*, Dixon, and with them to the genus *Hoplopteryx*. After a

careful comparison of all the forms named, it is impossible to ignore the marked approximation in the characters of the three last-named species of *Beryx* with those of *Hoplopteryx*, as instituted by Agassiz and defined by Von der Marek, and at the same time not to mark their divergence from the type of the genus, viz. *Beryx ornatus*, described in the "Poissons Fossiles" by Agassiz, as well as from those at present existing in tropical seas. It therefore becomes necessary either to broaden the definition of the genus *Beryx*, so as to embrace that of *Hoplopteryx*, as was suggested by Pictet and Humbert, or to transfer some of the aberrant forms from *Beryx* to that of *Hoplopteryx*. Considering that there is the advantage of living specimens of *Beryx* to compare with those found fossil, and that they form a natural group, evidently closely related, whilst *Hoplopteryx* forms a centre round which the species *Beryx zippei*, *B. superbus*, and *B. syriacus* appear to naturally arrange themselves, there can be no hesitation in transferring these species to the genus *Hoplopteryx*, which will also include the following new species from the collection of Prof. Lewis.

It may be worth while to direct attention to the evident resemblance of the species of *Hoplopteryx* from the chalk of Lebanon to the genus *Priscacara* described by Prof. E. D. Cope, obtained from the Eocene formation at Wyoming ("United States Geol. Surv. of the Terr.: the Vertebrata of the Tertiary Formations of the West," 1884, book i., p. 92). The genus *Priscacara* is characterized as belonging to the Pharyngognathi, with ctenoid scales and well-developed spinous rays; it bears a close relationship with the Pomacentridæ, differing, however, in the possession of vomerine teeth, and apparently in having eight branchiostegal rays. The form of the body and the arrangement of the fins approach closely to *Hoplopteryx*. The dorsal fin consists of ten to twelve spinous rays, succeeded by soft rays. The anal has three spinous rays in front, and the ventral fin is preceded by a single spinous ray. The spinous and soft rays of the dorsal fin are continuous, as in *Hoplopteryx*. The latter appears to be distinguished by the larger number of its vertebræ and its jaws being furnished with teeth; in *Priscacara* the jaws are toothless, only the pharyngeal bones are studded with minute conical teeth.

*Hoplopteryx syriacus*, PICTET and HUMBERT.

*Beryx syriacus*. P. and H., 1866. "Nouv. rech. sur les Poissons fossiles,"  
p. 28, pl. 1.

This species, for the reasons already stated in discussing the characteristics of the genus, it is now proposed to transfer from *Beryx* to *Hoplopteryx*.

*Formation and Locality*.—Upper Cretaceous: Sahel Alma, Mount Lebanon.

*Ex coll.*—Museum at Geneva (type), common.

*Hoplopteryx oblongus*, DAVIS.

(Pl. xxv., fig. 1.)

The specimen represented on the plate indicated above is well preserved for the most part, though it is unfortunate that, whilst the outline of the head is clearly shown, the bones themselves have been removed. The body of the fish, from the snout to the base of the tail, is 6·0 inches; including the tail, it is 7·5 inches in length. The greatest height is in front of the dorsal fin, 2·7 inches; from thence, with well-rounded outline, the height diminishes to the peduncle of the tail, which is 0·7 inch in height.

The head is large, 2·5 inches in height posteriorly, diminishing towards the snout. The orbit is situated medially. The gape wide, and the jaws equal in length, and strong. Unfortunately the bones of the anterior portion of the head are absent, and the dentition cannot be seen, except two or three scattered teeth, which are small, conical, and pointed. The opercular bones were rounded on their posterior surface, and considerably higher than broad; they appear to have covered a considerable area on the lower posterior portion of the head. The upper cranial surface is covered with scales, smaller than those on the body, but imbricated in the same way. The branchiostegal rays are only represented by fragments.

The spinal column consists of thirty-two vertebræ; of these fourteen are caudal. Large and robust spinous processes extend from the hæmal and neural surfaces of the vertebræ, and interspinous bones support the dorsal and anal fins. The ribs were probably small; they are hidden by the covering of scales and matrix. The vertebræ are strong, 0·2 inches in height and 0·15 in length, becoming slightly shorter towards the occiput.

The dorsal fin commences immediately behind the head, and probably extends 2·5 inches along the dorsal surface. The length of its base cannot be exactly determined, the posterior portion of the fin not being preserved, but the distal extremities of the fin-rays are shown. The anterior part of the fin consists of six or seven spinous rays, thick and strong, tapering to a point; they are a little over 1·0 inch in length. In front of these are other rays, shorter, similar in form, and curved slightly backwards. Beyond the spinous rays there was a number of soft jointed rays, of which the only part preserved is the distal extremities. The anal fin, like the dorsal, is strongly supported by interspinous bones. Its anterior ray is 1·5 inch from the base of the caudal, and its posterior rays extend to within a quarter of an inch of it. A series of spinous rays precede the soft rays of the fin behind. The latter are numerous, divided, and jointed, decreasing in size backwards. The caudal fin is deeply bifurcated. Each lobe consists of nine principal rays, about 1·5 inch in length; a number of shorter rays fill up the intermediate

space between the two lobes. The rays dichotomize repeatedly, and they are jointed at short intervals. A series of imbricating rudimentary rays support each lobe of the fin.

The pectoral fin is situated midway between the line of the vertebral column and the abdominal surface. It consists of about fourteen small rays, 0·7 inch in length, and is supported from the median portion of the pectoral arch. The ventral fin is attached to a process from the pectoral arch, and is inserted immediately under the base of the pectoral fin, on the abdominal surface. The ventral is much larger than the pectoral, its rays extending more than an inch in length. Like the rays of the unpaired fins, those of the ventral and pectoral fins are divided by dichotomization and are jointed.

The scales are large; the exposed surface is 0·25 inch in height; the posterior margin circular and deeply denticulated. In the highest part of the body there are twelve scales in a vertical series; nearer the tail the number is reduced to eight. Along the lateral line the number is twenty-five, between the posterior margin of the operculum and the tail. On the dorsal surface of the body the number will be greater, on account of the extension of the scaly covering to the upper surface of the cranium.

This species is distinguished from *Hoplopteryx* (*Beryx*) *syriacus*, P. and H., by its graceful outline and more elongated form. The number of vertebrae constituting the spinal column is larger. Its principal characteristic is in the relative position of the several fins. In *H. syriacus* the dorsal and anal fins are opposed, the ventrals considerably in advance of either. In the species now described, the anterior rays of the dorsal fin extend further forwards than those of the ventral, and the anal fin commences opposite to the posterior rays of the dorsal.

*Formation and Locality.*—Upper Cretaceous: Sahel Alma, Mount Lebanon.

*Ex coll.*—Lewis Collection; Robert Damon, Esq., Weymouth.

*Hoplopteryx spinosus*, DAVIS.

(Pl. XXVIII., fig. 1.)

The body of this peculiar fish is 5 inches in length and 1·7 inch in height. The tail is 1·5 inch in length, making a total length of 6·5 inches. The form of the body is an elongated and flattened oval, or an oblong with rounded corners. The peduncle of the tail is small, 0·3 inch across. The anterior portion of the head is badly preserved; otherwise the example is in fine state.

The jaws and snout of the head are absent. The orbit occupied a median position, apparently between the extremity of the gill covers and the snout, and

0·3 inch from the superior margin; it is of a moderate size. The opercular bones are imperfect; the lower posterior margin extends backwards in an obtusely triangular form; its inferior margin is rounded, and is prolonged forwards to a considerable extent.

The spinal column consists of twenty-seven vertebræ, of which number thirteen are caudal. They are of moderate size, slightly longer than high. The ribs are hidden beneath scales. The neural and hæmal apophyses are short but strong. The interneural spines are slightly thicker and longer than the neural, and extend along the dorsal surface from a position immediately behind the occipital portion of the head to the peduncle of the tail. The interhæmal spines can only be seen by the impression beneath the scales which cover them. The anterior ones supporting the spines of the anal fin are large and powerful. The termination of the spinal column is without any upward curvature, and numerous small rays support the caudal appendage.

The dorsal fin consists of fourteen large spinous rays 0·6 or 0·7 inch in length; the diameter at the base is 0·13 inch, which gradually becomes smaller and ends in a finely-pointed apex. The rays are hollow for a considerable portion of their length; they are separate and extend a length of 2·2 inches on the dorsal surface, commencing immediately behind the head; in addition there are eight articulated rays which are immediately contiguous to the last spinous ray and extend to the peduncle of the tail. The anal fin is situated posteriorly: it consists of seven spinous rays and ten articulated ones, without division into two portions or fins. The anterior spinous ray is short, strong, and pointed; it is 1·2 inch in front of the tail. The succeeding rays are longer, attaining 0·7 of an inch; they are similar in form and structure to those of the dorsal fin. The articulated rays extend to the base of the caudal fin and are repeatedly dichotomized. The caudal fin is deeply bilobed, composed of numerous fine rays, articulated and bifurcating. A considerable number of rudimentary rays form an imbricated support to the outer rays of each lobe.

The pectoral fin was attached to the bones of the scapular arch at one-third the height of the body above the ventral surface. The fin is absent, but an impression of the basal portion of its rays remain. The ventral fin is abdominal; it is 2·2 inches in front of the tail, and 1·0 inch behind the inferior margin of the operculum. It is closely folded and compressed against the ventral surface of the body, so that its character, or the number of rays constituting it, cannot be seen.

The scales are moderately large, less than 0·1 inch in height; the posterior margin is circular, with a slight median point, which, however, cannot be in all cases detected. The edge of the scale is otherwise smooth; the surface is slightly pitted. There are about twenty-five scales in a transverse row running diagonally between the dorsal and ventral surface. The width of each scale on

the exposed part is 0·05 inch, and the number in a row along the lateral line must be large; the series is not sufficiently well preserved to ascertain the exact number.

A second specimen exhibits the anterior portion of the head. The orbit in this is somewhat higher than in the one already described. Its anterior margin is 0·8 inch from the tip of the snout. The latter forms a somewhat acute angle with the upper jaw. The maxilla is 0·7 inch in length, expanded posteriorly for attachment. It is furnished with numerous small-pointed teeth. The pre-maxillary portion of the jaw must have been small, but is not shown on this specimen. The lower jaw was strong, only the posterior part is preserved; its dentition is the same as that of the upper jaw. The branchiostegal rays, of which five are exposed, are curved backwards, 0·5 inch in length and moderately thick. The pectoral fin is lateral, and attached to the scapular arch opposite to the pointed posterior extremity of the operculum. Its rays are small and moderate in number.

This species agrees with the characters of the genus *Hoplopteryx*, as defined by Agassiz ("Rech. sur les Poiss. foss.," vol. iv., p. 131), in having the spinous and soft rays of both dorsal and anal fins combined, and generally in the form and character of the paired fins. It differs from *Hoplopteryx antiquus*, Agassiz (*op. cit.*, pl. xvii., fig. 6–8), in possessing fourteen spinous and eight articulated rays in the dorsal fin, and seven spinous and ten articulated rays in the anal fin, as against six spinous and eleven articulated rays in the dorsal, and four spinous and eight articulated rays in the anal fin of the species described by Agassiz.

This species may be similarly and readily distinguished from *Hoplopteryx oblongus*, Davis. It is also separated from it by the smaller size of the scales.

*Formation and Locality.*—Soft chalk: Sahel Alma.

*Ex coll.*—Lewis Collection, Natural History Museum, South Kensington.

#### Genus. **Homonotus.** AGASSIZ. Indet.

Body small, elongate, oval; head more or less triangular, flat on superior surface; mouth median size; teeth small; orbit large, the median line towards the superior surface; opercular bones and scales with slightly serrated margins; dorsal fin large and long; anal opposite or behind the dorsal, both with anterior spinous rays; pectoral and ventral fins small; spinal column small and slender.

This genus appears to occupy a position intermediate between *Beryx* and *Pycnosterinx*. The type of the genus is *Homonotus dorsalis*, Dixon ("Geology and Fossils of Sussex," p. 372). Professor Agassiz regarded it as a member

of the family of the Percoides, nearly related to the genus *Beryx*, but separated from it by the character of the vertebræ, the dorsal fin, delicate scales, and the more attenuated head. The species of *Pycnosterinx*, named by Pictet and Humbert *P. elongatus*, appears to be also very nearly associated in generic characteristics with *Homonotus*, and it is possible that it may be found necessary to remove it to that genus. M. Pictet states ("Nouv. Rech. sur les Poissons Fossiles du Mont Liban," 1866, p. 43) that it was not without hesitation that he placed this species in the genus *Pycnosterinx*, on account of its elongated form differing from any other species before known; he also states on a previous page, that although the Percoides, the Chromides, and the Squammipennes are sufficiently distinct from each other at the present day, they were represented by types during the Cretaceous Epoch, which were evidently more nearly related to each other.

*Homonotus pulcher*, DAVIS.

(Pl. xxv., fig. 3.)

This beautiful little specimen measures 2·2 inches in length, exclusive of the tail, the latter being 0·7 of an inch. The head occupies 0·9 of an inch. The height immediately behind the occipital region is 0·9 of an inch; the peduncle of the tail is 0·25 of an inch. Its form is somewhat oblong, the head flattened on the top and more or less pointed at the snout. The several parts are well preserved; the dorsal fin is situated on the posterior part of the fish, the anal one opposite to it.

The head is more or less triangular in outline. The orbit is large, and situated on the upper part; the bones of the infra-orbital ring are strong, large, and enamelled. The maxillaries are extended backwards under the centre of the orbit; the mandibles are longer and thicker than the maxillaries; no teeth can be distinguished. An interval between the jaws and the operculi is occupied by scales. The opercular bones are long and narrow; in this specimen they do not exhibit any serrations on their posterior margins; the superior post-orbital region is covered with scales.

The spinal column is composed of twenty-eight vertebræ, sixteen of which are caudal. The vertebræ are small, higher than long. The ribs cannot be distinguished. The neural and hæmal spines appear to have been comparatively strong, and the dorsal and anal fins are supported by interspinous bones.

The dorsal fin is large; its base extends 0·8 of an inch along the dorsal surface, and it is 0·8 of an inch behind the occipital portion of the head; it is nearly, if not quite, connected with the caudal fin. The longest anterior rays are spinous, 0·5 of an inch in length; several smaller closely-set spinous rays support the longer ones anteriorly; posteriorly the rays, numbering in all about

twenty-five, gradually diminish in size and thickness. The anal fin is long, extending 0.6 of an inch, and separated by 0.2 of an inch from the caudal; it contains sixteen rays, of which those anterior are opposite to the first rays of the dorsal fin; they are strong, spinous, and close together; their length cannot be ascertained, the extremities having all disappeared. The caudal fin is moderate-sized and deeply cleft. There are twenty-two rays in the two lobes, frequently articulated and dichotomizing. The external rays of each lobe are strengthened by rudimentary imbricating caudal rays.

The paired fins are not so well defined as the vertical ones; the pectoral fin is situated on the side of the body about one-third of the height of the fish above the abdominal line. The fin is not large; nine rays can be distinguished. The ventral fins are situated on the abdominal surface immediately beneath the pectorals; they are larger and stronger than the pectoral fins, and supported by long pubic bones.

The scales are small, circular, thick, and smooth, very slightly crenulated on the posterior margin. They extend over the whole of the body to the root of the tail and envelop the base of the dorsal and anal fins; they are also found on the upper surface of the head, on the temporal region, and in front of the opercular bones. The number of scales in each longitudinal row cannot be ascertained, but there are about twenty in a vertical row, extending between the anterior rays of the dorsal and anal fins.

This specimen offers peculiar features which render its association with others hitherto described somewhat problematical. Its nearest relationship with any species which have been described from the chalk of the Lebanon district appears to be with *Beryx vexillifer*, Pictet, but it differs from that species in several important particulars. *B. vexillifer* is a fish of about similar size, whose dorsal fin is situated a little in advance of the middle of the body, and consists of nineteen to twenty rays. The anal fin is considerably behind the dorsal and consists of thirteen to fourteen rays; in the dorsal there are two spinous rays in front of the softer posterior rays, and in the anal fin three to five, which, however, can with difficulty be distinguished from those which follow. The dorsal fin in this specimen is situated on the posterior dorsal surface; it consists of twenty-five rays, of which the anterior six are spinous, and its posterior rays extend to the base of the caudal fin. The anal fin is supported by sixteen rays, of which the anterior seven are very strong spines. The scales of the specimen now described are smaller than *B. vexillifer*. In the latter M. Pictet counted ten scales in a vertical row; in this one there are at least twenty scales in a line between the dorsal and anal fins. The pectoral fins of this specimen are much smaller than those of *B. vexillifer*.

Compared with the several species of the genus *Beryx*, from the chalk, which have been described by the late Professor Agassiz ("Poiss. Foss.," vol. iv.), or



with *Hoplopteryx syriacus* of Pictet and Humbert ("Nouv. Rech. sur les Poiss. foss. du Mont Liban.," p. 28, pl. 1.), this specimen has a more elongated form; the vertebral column is comparatively slender; the head is smaller and more attenuated anteriorly; the dorsal and anal fins are opposite, and the scales are serrated on the margin only to a small extent. Some of these characters are comprised in the genus named, but not described by Professor L. Agassiz, *Homonotus*. Mr. F. Dixon ("Geology and Fossils of Sussex," 1850, p. 372, pl. xxxv., fig. 2) has very briefly and inadequately referred to the specimen named by Agassiz. He says: "The vertebræ are more slender, the head smaller, and it has a longer and stronger dorsal fin; the scales are very delicate and rarely seen perfect." A good illustration of the specimen is given, and it appears to possess characters very nearly approaching to the one now described. The body is thicker, but the arrangement of the fins and the form of the head is similar. The pectoral and ventral fins are not present, and the caudal is also absent, so that complete characters cannot be stated; nevertheless, those that are exhibited more closely approach those of the specimen now described than do those of *Beryx* or *Pycnosterinx*, and I therefore venture to include this latter in the genus *Homonotus*.

*Formation and Locality.*—Upper Cretaceous: Sahel Alma, Mount Lebanon.

*Ex coll.*—R. Damon, Esq., Weymouth.

*Acanthopterygii trichiuriformes*, GÜNTHER.

Body elongate, compressed or band-like; cleft of the mouth wide, with several strong teeth in the jaws or on the palate. The spinous and soft portions of the dorsal fin and the anal are of nearly equal extent, long, many-rayed, sometimes terminating in finlets; caudal fin forked if present. Günther.

Family. **TRICHIURIDÆ.**

Genus. **Enchodus.** AGASSIZ.

*Enchodus.* AGASSIZ, L., 1833-43. "Rech. sur les Poiss. foss.," vol. v., p. 64.

*Isodus.* Heckel, J. J., 1843. "Abbildungen und Beschreibungen der Fische Syriens," p. 241.

This genus was instituted by Professor Agassiz, and embraced two species, viz. *Enchodus halocyon*, from the chalk of Lewes, and *E. faujasii*, from the chalk of Maëstricht. Only fragments of the head and jaws had been found; they were placed in the family Scomberid, Cuvier, from the close relationship

evidently existing between the dentition of this family and the genera *Thyrsites* and *Lepidopus*. Professor Agassiz remarks: "It is probable that the fossil genus differs from the living *Scomberoids* in that the large teeth are not limited to the anterior border of the jaw, but extend along its entire length. Small teeth exist in the spaces between the larger teeth; the latter vary considerably in dimensions and are very irregularly disposed. The extremity of the jaws are furnished with several small teeth between the larger ones. The external surface of the large teeth is flatter than the internal surface, which is more or less circular; the edges are sharp.

MM. Pictet and Humbert include the genus *Isodus*, Heckel, in that of *Eurypholis* ("Poissons foss. du M. Liban.," 1866, p. 105), under the impression that the fragment of a jaw named by Professor Heckel was the jaw of *Eurypholis*. This has been proved by more recently acquired and more perfect specimens to have been an error. It also appears probable that the genus *Isodus* is the same as *Enchodus*. The description of the former by Heckel is identical with that of the latter, so far as the types served; that of *Isodus* consisted of the anterior part of a lower jaw, with only three teeth preserved. Both were published in the same year, but that of Agassiz had been for some time previously identified by the name he gave it; for that reason the priority should rest with Agassiz, and the name *Enchodus* be retained.

As already stated, Professor Agassiz identified the relationship of this genus with *Lepidopus* and *Thyrsites* from the Miocene of Licata in Sicily, and with *Anenchelum*, from the Eocene of Glaris, and placed them amongst the *Scomberidæ*. Dr. Günther ("Study of Fishes," p. 433) has placed them in the family *Trichiuridæ* along with the recent genera *Trichiurus*, *Lepidopus*, *Thyrsites*, and others, characterized by a long compressed body and wide mouth, armed with strong teeth in the jaws.

*Enchodus recurvus*, DAVIS.

(Pl. xxv., fig. 6.)

Lower jaw 3·3 inches in length, 0·5 in depth, at a distance of one and a-half inches from the anterior extremity. The anterior portion of the jaw narrows towards its termination, on which are several small teeth. From the alveolar surface rise eight teeth, separated by varying distances. The teeth are irregular in size and shape. The anterior one is the largest; only the base is preserved; it is 0·13 inch in diameter, double that of any other. The second laniary tooth is comparatively small, next four larger, and the two posterior ones again smaller. The internal surface of the jaw is exposed. The teeth from the base upwards bend outwards; they recurve, almost with a sigmoidal curvature, towards the point. The teeth are not so compressed as those of *Enchodus halocyon*, Agass.,

on the internal surface, but are oval, with sharp posterior and anterior edges. An excrescence extends in a ring round the base of the tooth, just above the alveolar surface; and from this the teeth are striated upwards nearly to the apex, which is a sharp point.

This species may be readily distinguished from *Enchodus faujasii*, Agass., by the great size and robustness of the mandible and the teeth, and by the round form and blunt apex of the latter. *Enchodus halocyon*, Ag., in addition to the flattened character of the teeth already named, does not exhibit the recurved character which has furnished the specific name.

The example of *Isodus* (*Enchodus*) *sulcatus*, Heckel, is described as having erect, long, sharp teeth, with the outer surfaces convex and both edges slightly concave. These characters do not agree with those of the species described; and though it may eventually be found that Heckel's and this species are more nearly related than at present appears, they must now be considered as distinct.

*Formation and Locality.*—Soft chalk: Sahel Alma, Mount Lebanon.

*Ex coll.*—R. Damon, Esq., Weymouth.

*Enchodus* (*Isodus*) *sulcatus*, HECKEL.

Heckel, J. J., 1843. "Abbildungen und Beschreibungen der Fische Syriens,"  
p. 241, pl. xxiii., fig. 4.

*Formation and Locality.*—Soft Chalk: Sahel Alma, Lebanon.

*Acanthopterygii cotto-scombriformes.* GÜNTHER.

Spines developed in one of the fins at least. Dorsal fins either continuous or close together; the spinous dorsal, if present, always short; sometimes modified into tentacles or into a suction disk; soft dorsal always long, if the spinous is absent; anal similarly developed as the soft dorsal, and both generally much longer than the spinous, sometimes terminating in finlets. Ventrals, thoracic or jugular, if present, never modified into an adhesive apparatus. No prominent anal papilla. (Günther.)

Family. **CARANGIDÆ.**

Genus. **Platax.** CUVIER.

"Body much compressed and elevated; snout very short. One dorsal, with the spinous portion almost entirely hidden, and formed by from three to seven

spines; anal with three. Ventrals well developed, with one spine and five rays. Teeth setiform, with an outer series of rather larger teeth, notched at the top; palate toothless. Scales of moderate size or rather small." (Günther.)

Attention is drawn by M. Pictet ("Nouv. rech. sur les Poiss. foss. du M. Liban.," p. 46) to the comparatively short anal and dorsal fins of the fossil species as compared with those of the species still existing, and also those of the fossil forms of the more recent strata at Monte Bolca. A resemblance in this respect to the genus *Pycnosterinx* is pointed out, but, excepting in the comparative smallness of the vertical fins, the fossil from Lebanon accords well with the characteristics of the genus. The specimen of which a description is here given is much deeper between the extremities of the vertical fins in proportion to its length than *Platax minor*, described by Pictet.

*Platax minor*, PICTET.

*Platax minor*. J. F. PICTET, 1850. "Poissons Fossiles du Liban.," p. 19, pl. II., fig. 1.

*Platax minor*. PICTET and HUMBERT, 1866. "Nouv. rech. sur les Poiss. foss.," p. 48, pl. IV., figs. 1-3.

*Formation and Locality*.—Hard chalk: Hakel, Mount Lebanon.

*Ex coll.*—Museum at Geneva.

*Platax brevis*, DAVIS.

(Pl. XXV., fig. 4.)

The form of the body without the fins is oval, much compressed antero-posteriorly. Its length from the snout to the base of the caudal fin is 1.1 inch; its height, exclusive of the dorsal and anal fins, is 1.7 inch. The caudal fin is not perfect, neither is the anal. The dorsal fin adds 0.7 inch to the height of the fish. The anterior outline of the body, including that of the head, is rounded; and to the base of the dorsal and anal fins, which occupy the highest and lowest points of the body, the profile occupies about one-third the entire length of the body. The vertical fins extend to the base of the tail in more or less straight lines.

The head is very short in proportion to its height, the latter being 1.3 inch; the length, 0.5 inch, or nearly one-half the length of the entire body without the tail. It is bounded posteriorly by the opercular bones. They are long and narrow, rounded towards their lower extremity, and tapering upwards. Between the operculum and the lower jaw a few short and slender bones appear to indicate branchiostegal rays; their number or exact form cannot be distinguished. The

mouth is small, apparently less than one-tenth of an inch aperture. A number of minute teeth, round at the base, with a pointed apex, extend around the orifice, and others, rounded and flat, may be distinguished on the posterior surface of the jaws. From the maxilla upwards, the anterior cranial surface is depressed; it, however, resumes its convex form, and the bones coalesce, forming a prominent and elevated mass, triangular at its base, tapering rapidly, and terminating at its superior extremity in a sharp point, like a spine. The orbit is comparatively small, and is situated immediately below the triangular part of the bone forming the upper portion of the skull.

The spinal column extends with a somewhat sygmoidal curvature, first upwards from the head, thence ventrally, and again it ascends with a decided inclination towards the upper lobe of the tail. The number of vertebræ is indefinite, but there are probably between twenty and twenty-four; they were osseous and deeply bi-concave, very high in proportion to their length. Neural spines are connected with each vertebra; they are strong, and of considerable length. Connected with these are interneural spines, usually double the number of the neural spines, but occasionally three branch from one of them. The interneural spines expand towards the surface, and afford a strong basal support to the rays of the dorsal fin. The hæmal and interhæmal spines supporting the anal fin are arranged symmetrically with the neural. The ribs are small, slender, and not very numerous, decreasing in length as they approach the occiput.

The dorsal fin extends from the highest point above the head to the base of the tail; it is supported by thirty-five rays, expanded at the base for attachment to the interspinous bones, and divided and subdivided towards the opposite extremity. The anterior rays are the longest, the length rapidly decreasing towards the tail; the longest ray is at least 0·7 inch in length; it is supported in front by two or three shorter imbricating spinous rays. The anal fin has twenty-two rays; the anterior ones are thick and strong, not so long as those which immediately follow, but sharply pointed. The fin is not perfectly preserved, and the length of the rays cannot be ascertained. They diminish posteriorly. The caudal fin is deeply cleft, forming two lobes, each 0·25 inch in length; each lobe contains twelve to fourteen rays.

The pectoral fins are small, with eight short rays, supported by the pectoral arch. The latter extends parallel with and immediately behind the opercular apparatus. The fin is situated midway between the axis of the vertebral column and the abdominal surface. From the pectoral arch a strong bony process descends to support the ventral fins. The latter, in this specimen, are not preserved.

The body of the fish was covered with thin scales, which are preserved in small patches, but not sufficiently well to afford any information as to their form or characters.

This species differs from *Platax minor*, Pictet, in the great height of its body as compared with the length, in the length of the head in proportion to that of the body, and in its obtusely-rounded facial contour as compared with the somewhat pointed or aquiline outline of *P. minor*. M. Pictet and Humbert refer, in the description of *Platax minor* (*op. cit.*, p. 48), to a pointed hook extending forwards at the base of the dorsal fin, at right angles to the rays of the fin. From a careful examination of several specimens, it appears very probable that the bone, mistaken by M. Pictet for an external hook or spine, is really the expanded surface of the large interspinous bone which serves to support the long anterior ray of the dorsal fin.

The species of *Platax* described by Agassiz ("Poiss. Foss.," vol. iv., p. 244, *et seq.*), from Monte Bolca, are sufficiently distinct from this one. *P. papilio*, Agass., which most nearly resembles *P. brevis*, is readily distinguished by its round body and the short, weak anterior rays of the anal fin.

*Formation and Locality.*—Upper Cretaceous: Hakel.

*Ex coll.*—R. Damon, Esq., Weymouth.

Genus. **Vomer.** CUVIER.

*Vomer parvulus*, AGASS.

*V. parvulus.* AGASSIZ, 1840. "Rech. sur les Poiss. Foss.," vol. v., pp. 4 and 31.

*V. parvulus.* PICTET and HUMBERT, 1866. "Nouv. Rech. sur les Poiss. foss. du M. Liban.," p. 50.

Agassiz simply refers to this species as having been found at Lebanon, but gives no description of it.

MM. Pictet and Humbert refer to the species as having been indicated by Agassiz; but not having any knowledge of the specimen, they can give no further information.

Genus. **Petalopteryx.** PICTET.

*Petalopteryx syriacus*, PICTET.

*P. syriacus.* PICTET, F. J., 1850. "Description de quelques Poissons fossiles du Mont Liban.," p. 22, pl. III., fig. 1.

*P. syriacus.* PICTET and HUMBERT, 1866. "Nouv. Rech. sur les Poissons fossiles du M. Liban.," p. 54.

I have not been able to identify a second specimen of this species amongst the many fossil fishes which I have had the pleasure to examine. Pictet does not state where the type specimen is located.

*Formation and Locality.*—Upper Cretaceous, Hakel, Mount Lebanon.

Genus. **Cheirothrix.** PICTET and HUMBERT.

Cheirothrix. PICTET and HUMBERT, 1866. "Nouv. Rech. sur les Poissons fossiles du Mont Liban.," p. 51.

This genus was founded by Messrs. Pictet and Humbert, and its general characters stated in terms, of which the following is a translation:—"Body narrow and long; skeleton slender; head attenuated anteriorly; jaws small, straight, armed with small conical teeth; dorsal fin commences immediately behind the head, composed of long filiform rays; pectoral fins also composed of very long and small articulated rays; ventral fins inserted in the vicinity of the pectorals, and composed in part of long rays and in part of short ones." To this may be added that the anal fin is of medium size and extends to the base of the caudal; the latter is large and deeply lobate.

The genus was founded by the learned authors on a single specimen of fossil fish from the soft chalk of Sahel Alma, which is imperfect and somewhat disturbed from its natural position. The authors state that they had great difficulty in recognizing its several parts, and they place it provisionally and with diffidence in the family of the Gobioids. The discovery of other specimens has rendered possible the elucidation of several of the characters of the genus, more especially with regard to the pectoral and ventral fins. The difficulty experienced by Prof. Pictet in deciding which were the pectoral and ventral fins immediately disappears on referring to the examples figured on Plate xxvi., in which it is clearly shown that the pectoral fin was attached to the lateral surface of the body, whilst the ventral is situated on the lower median line, beneath the pectoral. Both are large fins, and capable of great expansion. The ventrals are the larger, and furnished with the strongest rays.

In addition to the species described by MM. Pictet and Humbert, a second one, from the same locality, will be added.

*Cheirothrix libanicus*, PICTET and HUMBERT.

(Pl. xxvi., figs. 3, 4.)

*C. libanicus.* PICTET and HUMBERT, 1866. "Nouv. rech. sur les poissons fossiles du Mont Liban.," p. 52, pl. II., fig. 1.

The description of this species, though founded on a single specimen, renders a further description for the most part unnecessary. The anterior part of the body was well preserved, the posterior was absent. Other and more perfect specimens have been discovered, and have proved that the species was not an

uncommon one during the deposition of the Sahel Alma chalk beds. The length of the body is about 4.0 inches; of this the head occupies one-fourth. The height of the latter is little more than half its length; attenuated in front. The jaws are straight, and are furnished with small, conical, pointed teeth, more or less arched and unequal, and not very numerous. The orbit is large, and superior in position. The operculum slightly pointed behind, and longer than broad. The branchiostegal rays are long and arched, and apparently five in number.

The spinal column is somewhat feeble, the vertebræ short and contracted medially. M. Pictet estimates the number at sixty, but this is probably too large. Neurapophyses extend from the dorsal surface of each vertebræ, and they in turn support interneural spines, to which are attached the rays of the dorsal fin. Hæmapophyses are attached to the lower surface of the vertebræ and support the interhæmal spines. The ribs are fine and slender.

The dorsal fins are large, with a basal extent of about 1.0 inch. The anterior rays are inserted immediately behind the occiput; they are eighteen in number, long, and more or less slender. M. Pictet states the number of rays in the dorsal fin are fifteen, attaining a length of 1.7 inch; this was, no doubt, due to the imperfection of his specimen. The anal fin extends forwards from the base of the tail to a distance of 1.1 inch; its rays are short, but numerous, and, as already stated, are supported by interhæmal spines. The caudal fin is moderately large, about an inch in length, and deeply lobate.

The pectoral fins are attached to the side of the body; they are large, but not so large as the ventrals. In all the specimens examined the rays are more or less aggregated into a close mass, so that their number cannot be ascertained. The ventral fins are attached to the abdominal surface, beneath the position of the pectorals. Seventeen long and bifurcating rays 2.0 inches in length form the posterior and principal part of the fin; in addition there are five or six short rays attached to and constituting the anterior part of the fin. There is no evidence of scales.

*Formation and Locality.*—Upper Cretaceous: Sahel Alma, Mount Lebanon.

*Ex coll.*—Lewis Collection and Enniskillen Collection, British Museum (Natural History Department), London.

*Cheirothrix lewisii*, DAVIS.

(Pl. xxvi., fig. 2.)

This magnificent example, which I have selected from a number of others in the National Collection, was obtained by Professor Lewis during his residence at Beyrout. For the most part it is wonderfully well preserved; a portion of the dorsal fin and the base of the tail have been carried away by the opposing



matrix. The length of the fish is 5·2 inches from the snout to the tip of the tail: the latter occupies 0·8 inch.

The head is 1·5 inch<sup>1</sup> in length from the snout to the free margin of the operculum; the height of the posterior part of the head is 1·0 inch. The orbit is moderate in size, occupying a medium position near the superior margin of the head. The operculum is not well preserved, but appears to have been moderately large, with circular posterior margin, the anterior one concave; the height is greater than the breadth. The supra-orbital area is small, and occupied by one or more somewhat straight and long bones reaching to the tip of the snout. The mouth, shown in a second specimen, is large and capable of considerable distension. The pre-maxillas encircle the anterior part of the upper jaw, and are 0·3 inch in length on each side; the maxillas are slightly longer than the pre-maxillas. The maxillas extend backwards 0·5 inch, rounded, and rather thin and delicate. There is no evidence of teeth on any of the jaws I have examined. The branchiostegal rays are very large and strong, nearly an inch in length, and curved almost to a semicircle; they are seven in number.

The vertebral column consists of fifty vertebræ: of these twenty-two are caudal. The vertebræ are 0·12 inch in height, their width about half the height, diminishing in size towards the tail. The ribs are numerous and long. The neural and hæmal apophyses are short and slender. The interneural spines supporting the large dorsal fin are short and stiff in the upper part; at half their length they are bifurcated and descend so far that the anterior spines embrace the vertebral column; those situated more posteriorly and supporting shorter fin-rays do not descend to the vertebræ. The interhæmal spines are single, short, and strong.

The dorsal fin consists of seventeen rays, the anterior ones 1·3 inch long, decreasing backwards; they are strong at the base, divided towards the distal extremity. The fin has its origin near the base of the skull, and extends 1·2 inch backwards. The anal fin is large, its base extending 0·8 inch; the anterior ray is 1·0 inch from the base of the caudal fin; it contains thirteen rays, of which the anterior one is 0·9 of an inch in length. The rays are similar, but somewhat stronger than those of the dorsal fin. The caudal is fairly large and powerful; it is moderately lobate; each lobe is supported by twelve strong articulated and dichotomizing rays. The outer rays of each lobe are supported by ten or twelve strong imbricating rudimentary rays.

The pectoral and ventral fins are extremely large. The former are attached to the side of the body, slightly lower than the median line, immediately behind the opercular apparatus. The pectoral arch is very strong, and descends to the abdominal surface, where it affords a base of attachment to the ventral fin, immediately below that of the pectoral. The pectoral fin comprises sixteen

rays, apparently about the same length of 2·3 inches; the rays are fine, articulated at short intervals, and dichotomize three or four times, so that the distal extremity of the fin is furnished with numerous small rays capable of very wide expansion; the pectoral fin in the figure is closed together. The ventral fin has its origin immediately behind the head on the abdominal surface; it has eighteen rays, 2·5 inches in length, strong at the base, but repeatedly dividing. The anterior ray is rather thicker than the succeeding ones, and it and the second one do not apparently become divided, as the remainder do. In front of the large ventral fin there are short subsidiary fins, consisting of six or eight rays 0·5 inch in length; it may be a part of the ventral fin, if not it is difficult to understand its position and meaning. There is no evidence preserved on any of the specimens that the members of this species were possessed of scales; from the thin film which marks the surface of the fish it is very probable that the scales were, if present, very thin and delicate.

This species may be distinguished from *Cheirothrix libanicus*, P. and H., by its more robust form and larger size; the head, in proportion to its length, is considerably higher than in *C. libanicus*, and the vertebræ are fewer in number, and, at the same time, thicker and stronger in this species. I propose to distinguish it specifically by appending the name of *Lewisii* to that of the genus in honour of Professor Lewis, who, as already stated, was its discoverer.

*Formation and Locality.*—Soft chalk: Sahel Alma, Mount Lebanon.

*Ex coll.*—Lewis Collection, British Museum (Natural History Department), London.

#### Genus. *Sphyræna*. BLOCH.

##### *Sphyræna amici*, AGASSIZ.

*S. amici*. AGASSIZ, L., 1844. "Rech. sur les poiss. foss.," vol. v., pp. 8 and 97, pl. x., fig. 3.

*S. amici*. PICTET and HUMBERT, 1866. "Nouv. rech. sur les poiss. foss. du Mont Liban," p. 51.

This species was established by Agassiz upon a fragmentary specimen of the jaws of a fish in the collection of M. Amici, which recalled to some extent the dentition of *Sphyræna*, but differed in the teeth being much larger and having a pyramidal form. The representation of the head, given in the figure in "Poissons fossiles," may be that of one of the species of the genus *Eurypholis*, since founded by Pictet.

*Acanthopterygii gastrosteiformes*, GÜNTHER.

“The spinous dorsal is composed of isolated spines, if present; the ventrals are either thoracic or have an abdominal position in consequence of the prolongation of the pubic bones which are attached to the humeral arch. Mouth small at the end of the snout, which is generally more or less produced.”

Family. **FISTULARIIDÆ.** GÜNTHER.Genus. **Solenognathus.** PICTET and HUMBERT.*Solenognathus lineolatus*, P. and H.

(Pl. xxvi., fig. 6.)

*S. lineolatus.* PICTET and HUMBERT, 1866. “Nouvelles recherches sur les Poissons fossiles du Mont Liban,” p. 56, pl. iv., figs. 4–7.

The admirable description of this species leaves nothing to be added. A figure is given here which is more perfect than either of the three given in the “Nouvelles recherches” of MM. Pictet and Humbert.

*Formation and Locality.*—Soft chalk: Sahel Alma, Mount Lebanon.

*Ex coll.*—Museum at Geneva.

## Second Order.—ACANTHOPTERYGII PHARYNGOGNATHI.

“Part of the rays of the dorsal, anal, and ventral fins are non-articulated spines. The lower pharyngeals coalesced. Air bladder without pneumatic duct.” (Günther.)

Family. **CHROMIDES.**Genus. **Pycnosterinx.** HECKEL.

“Abbildungen und Beschreibungen der Fische Syriens,” p. 235, pl. xxiii., 1843.

This genus was established by J. J. Heckel for the reception of fossil fishes from Mount Lebanon. The following is a translation from the description of Dr. Heckel:—

“Gape moderately wide; each jaw furnished with a number of straight, short, closely-set teeth, of which those in the rear become gradually stronger and more conical. Operculum rounded; pre-operculum denticulated on its border. External branchial arches provided on their anterior border with large cultriform osseous apophyses, on the midst of which is a re-curved hook. There

are five branchiostegal rays. Body compressed and elevated. Dorsal and anal fins simple and long, commencing near the middle of the body, exclusive of the tail, consisting of spinous rays, close to each other, and becoming longer by degrees. Ventral fins in a sloping position. Scales closely set, covering the occiput, operculum, cheeks, the trunk, and a part of the vertical fins: they are small, round, and thick, with smooth concentric circles, of which the central point is in the posterior half; border simple, but carrying sharp denticles. Vertebrae short, nine to eleven abdominal, seventeen to eighteen caudal. Ribs short and slender, the posterior ones supporting long transverse apophyses."

*Pycnosterinx discoides*, HECKEL.

(Pl. XXVII., fig. 3.)

- P. discoides. HECKEL, 1843. "Abbildungen und Beschreibungen der Fische Syriens," p. 238 (340), pl. XXIII., fig. 3.  
 P. discoides. PICTET, F. J., 1850. "Desc. de quelques poiss. foss. du Mont Liban.," p. 57.  
 P. discoides. PICTET and HUMBERT, 1866. "Nouv. recher. sur les Poiss. foss. du Mont Liban.," p. 38, pl. III., figs. 1, 2.

A figure of a beautiful example of this species is here given, as it exhibits the natural form of the head, which is not so well preserved in the specimen figured by MM. Pictet and Humbert.

*Formation and Locality.*—Soft chalk: Sahel Alma, Mount Lebanon.

*Ex coll.*—Museum at Geneva (type); not rare.

*Pycnosterinx heckelii*, PICTET.

(Pl. XXVII., fig. 1.)

- P. heckelii. PICTET, F. J., 1850. "Desc. de quel. poiss. foss. du M. Liban.," p. 15, pl. II., figs. 1, 2.  
 P. heckelii. PICTET and HUMBERT, 1866. "Nouv. rech. sur les poiss. foss. du Mont Liban.," p. 40, pl. III., figs. 3, 4.

The specimens obtained by Prof. Lewis are, in several respects, more perfect than those figured by Pictet, and enable me to furnish the following addition to the description given. The natural form of the fish is an oval, exclusive of the tail. The length is equal to double the height. The head is triangular in outline, the mandible forming a broad base, and the facial line and that of the

posterior margin of the operculum, converging to a more or less pointed apex. The pectoral fin is situated on the lateral surface of the body, and is one-fourth the height of the body from its abdominal margin. The ventral fin is abdominal, situated immediately behind the head; it consists of six rays, dichotomized and articulated.

This species is distinguished from *P. discoides* principally by the rays of the dorsal and ventral fins being much less numerous, and having sixteen caudal vertebræ instead of eighteen, as in *P. discoides*.

*Formation and Locality.*—Upper Cretaceous: Sahel Alma, Mount Lebanon.

*Ex coll.*—Museum at Geneva; not uncommon.

*Pycnosterinx russeggerii*, HECKEL.

*P. russeggerii.* HECKEL, J. J., 1843. "Abbildungen und Beschreibungen der Fische Syriens," p. 236, pl. XXIII., fig. 1a.

*P. russeggerii.* PICTET, F. J., 1850. "Desc. de quel. poiss. foss. du M. Liban.," p. 57.

*P. russeggerii.* PICTET et HUMBERT, 1866. "Nouv. rech. sur les poiss. foss. du M. Liban.," p. 41.

This species, described by Professor Heckel, was not seen by MM. Pictet and Humbert. Neither has the writer had any opportunity to identify the species.

*Formation and Locality.*—Soft chalk: Sahel Alma, Mount Lebanon.

*Pycnosterinx dorsalis*, PICTET.

(Pl. XXVIII., fig. 2.)

*P. dorsalis.* PICTET, J. F., 1850. "Desc. de quelques poiss. foss. du M. Liban.," p. 17, pl. II., fig. 3.

*P. dorsalis.* PICTET et HUMBERT, 1866. "Nouv. rech. sur les poiss. foss. du M. Liban.," p. 41.

This species is distinguished from the two preceding ones by the greater elongation of its body and the greater height of the dorsal fin. It is probably more closely related with *P. russeggerii*, Heckel, than with other species of the genus. It may be distinguished from the latter by the length of the rays of the dorsal fin; by the number of caudal vertebræ, which is at least twenty in place of seventeen or eighteen; and by the anal fin, which is supported in front by very strong spinous rays.

*Formation and Locality.*—Upper Cretaceous: Sahel Alma, Mount Lebanon.

*Ex coll.*—Museum at Geneva (type); rare.

*Pycnosterinx niger*, PICTET et HUMBERT.

*Beryx niger*. COSTA, O. G., 1855. "Descrizione di alcuni pesci fossili del Libano," p. 4, pl. II., fig. 1.

*Pycnosterinx niger*. PICTET et HUMBERT, 1866. "Nouv. rech. sur les poiss. foss. du M. Liban.," p. 43.

MM. Pictet and Humbert observe that there can be no doubt that the fossil fish figured by M. Costa, under the name of *Beryx niger*, belongs to the genus *Pycnosterinx*. It is related to *P. dorsalis*, Pictet, from which it differs by the dorsal fin being smaller and shorter. It approaches still more to *P. russeggerii*, Heckel, and it may be not impossible that it will be found necessary to unite the two.

*Formation and Locality.*—Soft chalk: Sahel Alma, Mount Lebanon.

*Pycnosterinx latus*, DAVIS.

(Pl. XXVII., fig. 2.)

This specimen differs from those already described in the peculiar height of the body as compared with its length. The specimen is the largest I have seen of the genus. Its head has been disturbed and the component bones displaced; but the remainder of the body appears to be in its normal position. The length of the body between the posterior margin of the operculum and the base of the tail is 1·8 inches, and the height of the body, exclusive of the dorsal and anal fins, is 3·2 inches; the height of the peduncle of the tail is 0·8 inch, and the length of the tail at least an inch.

The head was probably an inch and a quarter to an inch and a half in length. The orbit was large, and situated near the superior margin of the head; the jaws and teeth cannot be separately distinguished; the opercular bones moderate in size. The operculum is 1·0 inch in length and 0·5 inch broad, strong and straight or slightly concave in front, convex behind; the sub-operculum is similar in form but more elongated. The tympanic or pterygoid bones are largely developed and occupy a large area between the orbit and the maxillary bones.

The spinal column is straight, except a distinct curvature upwards of the terminal three or four vertebræ supporting the caudal fin. It is composed of twenty-eight vertebræ, of which eighteen are caudal. The vertebræ are 0·15 inch in height, and their length is equal to half the height. The hæmal and neural apophyses are long and slender. The interhæmal and interneural spines are more numerous than the hæmal and neural spines which support them, and are attached to the rays of the dorsal and anal fins by a broad expansion of their extremities. The ribs are about an inch in length, small, slender, and curved backwards.

The dorsal fin in this specimen is not perfect, the anterior rays have disappeared, and the number of spinous rays cannot be ascertained; there are eighteen or twenty soft rays partially preserved. The anal fin occupies a more posterior position than the dorsal, the insertion of its anterior rays being half an inch behind that of the dorsal; it is composed of four spinous rays and twenty articulated ones; the latter dichotomize. The spinous rays increase rapidly in length from the first to the fourth, the latter being 0·8 inch in length; the remainder of the fin-rays decreases in length backwards. The caudal fin is moderately large, with a broad base. The upper lobe is supported by ten and the lower one by thirteen rays; the basal portion, about one-fourth of an inch in length, is simple and undivided, beyond the rays are articulated and bifurcate. The external rays of each lobe are supported by rudimentary rays.

The pectoral fin is small, separated 0·5 of an inch from the abdominal margin of the body; it is attached to the bones of the pectoral arch, the latter elongated and slender. It is composed of fourteen rays, which are only partially preserved; the distal extremities are broken off. The ventral fins are imperfectly preserved; the rays are strong, the anterior one or two spinous; the full number is not apparent; they are attached to pubic bones immediately below the pectoral fins on the abdominal surface. The scales are small, circular, smooth on the surface, thick, with the posterior margin denticulated; they extend to and cover the base of each of the unpaired fins.

It is proposed to designate this species by the name *Pycnosterinx latus*, indicating its great depth in proportion to its length. Its nearest relationship is with *P. discoides*, Heckel, and *P. heckelii*, Pictet; it differs from both in the greater depth of its body, in the number of its vertebræ, and the character of its fins. The posterior position of the anal fin, as compared with the dorsal, distinguishes it from *P. discoides*, and the proportion and size of those fins separate it from *P. heckelii*; the latter is stated by Pictet and Humbert to possess eighteen rays in the dorsal fin and twelve in the anal; but in a very well-preserved specimen before me there are only sixteen rays observable in the dorsal and eleven in the anal. The caudal fin also distinguishes this species, consisting of thirteen rays; that of *P. discoides* has eighteen, whilst *P. heckelii* has sixteen rays.

*Formation and Locality.*—Upper Cretaceous: Sahel Alma, Mount Lebanon.

*Ex coll.*—R. Damon, Esq., Weymouth.

*Pycnosterinx lewisii*, DAVIS.

(Pl. xxvii., fig. 5.)

This unique specimen is unfortunately slightly imperfect; the greater part of the head is wanting. The part preserved is 3·6 inches in length, the tail absorbing

0·6 of the total. The height of the body is 1·7 inch; its form a compressed spheroid.

The only part of the head preserved consists of the lower part of the operculum and the check plates, and traces of the branchiostegal rays. The operculum is rounded posteriorly, somewhat thickly enamelled; where the enamel has been removed the impression of the under surface of the plate exhibits radiating lines, with forking branches. The branchiostegals are comparatively small.

The vertebral column consists of twenty-five vertebræ; of these twelve are caudal. They are fully 0·1 inch in height; the length is a little less than the height; the central part of each vertebra is contracted. The ribs are short, but strong. The neural apophyses are short, straight, and strong. The interneural spines are longer than the apophyses, and afford a firm support to the spinous and soft rays of the large dorsal fin. The hæmal and interhæmal spines are similar to the neural, excepting that the four anterior interhæmal spines coalesce and form a large and thick bony mass, extending from the ventral surface far towards the vertebral axis of the body, and affording a firm base of attachment to the anterior spinous rays of the anal fin. The caudal termination of the vertebral column is slightly turned upwards, and affords a point of attachment for a radiating series of strong processes, which support the caudal fin.

The unpaired or vertical fins are all strong, and well protected by spinous rays. The dorsal fin may not be entirely preserved (see Pl. xxvii., fig. 5); there are six anterior spinous rays, curved backwards and slightly pointed, and ten soft articulated rays. The fin extends from a point which cannot be far removed from the occipital region of the head almost to the base of the tail. The longest rays are 0·8 inch in length near the middle of the fin, where the spinous and soft rays join. The anterior rays of the anal fin are beneath and opposite to the middle of the dorsal fin; they are separated by a distance of 1·1 inch from the ventrals. The first four rays are spinous; the fourth is the longest, 0·65 inch, the three in front diminishing in length to the first; the four form a closely imbricating triangular mass, with a sharp point and curving slightly backwards, which would serve as a powerful weapon of offence or defence. In addition to the spinous rays there are eight articulated ones, thick and strong at the base, but subdivided towards the distal extremity, and diminishing in size backwards. The anal reaches to the base of the caudal fin. The latter is large, deeply bilobate, twelve rays forming the upper lobe, and thirteen the lower; they are close, thick, divided by short transverse articulations, and dichotomizing. The entire length of the fin is hidden in the matrix; it was probably quite 0·8 inch. A number of rudimentary rays support each lobe of the fin, the first of which is a thick spine, sharply pointed, and separate from the succeeding ones.

The pectoral fin is only indicated by an impression; it is situated midway



between the dorsal and ventral surface, and is attached to a powerful scapular arch, which also descends and affords support to the ventral fins. The latter is slightly in advance of the pectoral fin, and consists of a number of rays, six of which can be determined, strong, and, so far as preserved, undivided by articulations. The anterior ray is a pointed spine, 0·6 inch in length, and slightly curved.

The scales are not well preserved; they were moderate in size, with rounded posterior margin. The lateral line is marked by a series of pointed scales, thicker than the others, about 0·1 inch higher than the line of the vertebral column near the head, and approaching and extending over it on the caudal extremity of the body.

This beautiful species, which I have taken the liberty of naming after its discoverer, Prof. Lewis, may be readily distinguished from those already described by the number and size of the spinous rays of the dorsal and anal fins. In this respect it approaches the genus *Hoplopteryx*, and it is not without some doubt that the species is placed with *Pycnosterinx*; but the position of the ventral fins almost in advance of the pectorals appears to indicate its relationship with this genus rather than with *Hoplopteryx*, in which the ventral fins are situated abdominally, and much farther back.

*Formation and Locality.*—Hard chalk: Hakel, Mount Lebanon.

*Ex coll.*—Lewis Collection, Natural History Department, British Museum.

*Pycnosterinx elongatus*, PICTET et HUMBERT.

*P. elongatus.* PICTET et HUMBERT, 1866. “Nouv. rech. sur les poiss. foss. du Mont Liban,” p. 42, pl. III., figs. 5, 6.

This species is somewhat doubtfully placed in the genus *Pycnosterinx* because of its elongated form; but, apart from this circumstance, its characters agree in general with those of the genus, and it is considered advisable to retain it in its present position. The description of the specimens figured by the authors named above renders any further comment unnecessary.

*Formation and Locality.*—Upper Cretaceous: Sahel Alma, Mount Lebanon.

*Ex coll.*—Museum at Geneva; common.

*Pycnosterinx daviesii*, DAVIS.

(Pl. XXIX., fig. 2.)

Length of the body, exclusive of the tail, 2·7 inches; of this the head occupies one-third. The greatest height is behind the head, 1·5 inch; thence

the dorsal and abdominal surfaces gradually converge towards the tail; the peduncle of the latter is 0·3 inch in height. The anterior margin is more or less circular, and the general outline of the body ovoid. The tail is 1·3 inch in length.

The head, rounded in outline anteriorly, is slightly convex posteriorly. The orbit is large and high; the opercular bones are higher than broad, but in this specimen are not very well preserved. The supra-orbital region is small; the plates enveloping the cranium, as well as others, are comparatively strong and are enamelled. The infra-orbital region is occupied by bony plates of considerable extent, and the maxillary, conterminous with the lower margin of them, is well developed, and extends a length of 0·8 inch. The anterior part of the upper jaw is imperfect. The mandible is large and strong; on its anterior extremity there are indications of a number of minute teeth. Branchiostegal rays are exposed, but not sufficiently well to ascertain their number.

The spinal column consists of twenty-eight vertebræ; of these eighteen are caudal. They are strong, slightly higher than broad. The neural and hæmal spines are strong, comparatively straight, and extend from the spinal column two-thirds the distance towards the surface of the body. There are eighteen interneural spines, to support the dorsal fin, and twelve interhæmal, to support the anal fin. The posterior termination of the vertebral column is slightly turned up.

The dorsal fin extends from the base of the tail 1·2 inch towards the head. It is composed of eighteen rays, the anterior ones 0·6 inch in length, diminishing slightly backwards. The first two or three rays are shorter and spinous; the remainder bifurcate, and are articulated. The anal fin is shorter than the dorsal; its base is 0·8 inch in length; it has three strong, pointed rays in front; the remaining nine are similar to those of the dorsal fin. The caudal fin is large and deeply forked; the upper lobe consists of twelve rays, and the lower of nine, strong and undivided at the base, but bifurcated and articulated towards the distal extremity. In addition there are five or six short, imbricating spinous rays at the base of both the upper and lower lobes.

The pectoral fin is on the side of the body, at one-fourth the height of the fish above the abdominal margin. It consists of fourteen or fifteen rays, 0·6 inch in length; distal margin rounded. The ventral fins are on the abdominal surface, in advance of the pectorals. Its rays are 0·7 inch in length; they are closed against the surface of the body, so that their number cannot be seen.

Patches of scales extend over the surface of the body, but are not very well preserved; they were thin and apparently small. The plates enveloping the head were thicker, and in some fragments an imbricated margin is exhibited.

This species approaches most nearly to that of *Pycnosterinx heckelii*, Pictet. It may be distinguished by its slightly more elongated form, the narrowness

of the peduncle of the tail, and the relative position of the dorsal and anal fin. In this species the anterior rays of the dorsal fin are inserted further behind the head than in *Pycnosterinx heckelii*. These characters will also distinguish it from *P. dorsalis*, Pictet. I have much pleasure in dedicating this species to my friend Mr. William Davies, of the British Museum, to whom I have repeatedly been indebted both for the benefit of his ripe experience, and to his knowledge of the magnificent collection in which he takes so great an interest.

*Formation and Locality.*—Upper Cretaceous: Sahel Alma, Mount Lebanon.

*Ex coll.*—British Museum, Natural History Department.

*Pycnosterinx gracilis*, DAVIS.

(Pl. XXIX., fig. 1.)

Body elongated oval. Length, with the exception of the tail, 3·8 inches, including the head, 1·8 inch; the tail is an additional 1·5 inch. Its greatest height is 1·7 inch, at the base of the dorsal fin, midway between the two extremities. The body is well preserved, except the anterior portion. The cranial surface is absent, and the lower posterior part of the head is much disturbed. The orbit is large, placed rather forwards. The jaws are strong, capable of considerable expansion, and in both the upper and lower there are minute, pointed teeth, scarcely visible without the aid of a lens. The preoperculum is broad in the median part, diminishing in width slightly towards the occipital region, and much more so in the lower part; it is larger than the operculum, which is displaced and pushed backwards.

The vertebral column comprises twenty-eight vertebræ, of which fifteen are caudal. They are not so high as long, and contracted medially. The neural spines are comparatively short, extending about half the distance between the vertebræ and the dorsal fin. The interneurals are proportionately large, and their exposed base forms a broad articular surface for the rays of the fin. The hæmal spines are longer than the neurals, and thicker; they are less numerous than the interhæmal spines, as are also those on the neural side than the interneurals. The ribs are short and, so far as can be distinguished, feeble.

The dorsal fin extends from the peduncle of the tail 1·5 inch; its anterior rays are 2·5 inches behind the snout. The first six rays are spinous and imbricating; those succeeding, twenty-six in number, are articulated. The first of the soft rays is 1·3 inches in length; from this they gradually diminish, the posterior being 0·15 inch. The anal fin has a basal length of 1·3 inch: its anterior rays, 2·5 inches from the snout, exactly the same as the dorsal. Three or four of the anterior rays appear to be spinous, but the whole fin is so much broken that it is difficult to make out its several parts. The caudal fin is deeply

bifurcated; there are eleven or twelve rays in each lobe; they are articulated, and divided towards their extremity; a number of rudimentary rays also support each of the two lobes.

The pectoral fins are indicated by an impression only on the lateral surface of the body, and the ventrals are altogether absent. The scales are less than the tenth of an inch in height; the surface is minutely striated, and the posterior margin circular, with very small crenulations.

This species is distinguished by its gracefully proportioned form, by the opposition of the dorsal and anal fins, and by the large number of the rays supporting the dorsal fin, and probably that of the anal also. It differs from *Pycnosterinx davisii*, by the greater length of the neural and hæmal spines, and the proportionately shorter interspinous processes. The length of the anterior articulated ray of the dorsal fin, and rapid diminution in the length of the succeeding rays, gives the fin a very triangular form—a feature which does not prevail to the same extent in any other species. In allusion to its graceful outline, I have appended the *nomen triviale* *gracilis* to this species of *Pycnosterinx*.

*Formation and Locality.*—Upper Cretaceous: Sahel Alma, Mount Lebanon.

*Ex coll.*—Lewis Collection, British Museum, Natural History Department.

*Pycnosterinx dubius*, DAVIS.

(Pl. XXIX., fig. 3.)

Specimen imperfect; the anterior part of the head and the caudal fin are absent; the distal extremities of both the dorsal and anal fins are also wanting. The body of the fish is 3·0 inches in length from the anterior part of the head preserved to the base of the tail; the head occupies of this 1·3 inch. The height at the base of the anterior ray of the dorsal fin is 1·5 inch; the outline of the body is oval, slightly more attenuated towards the snout than the tail. The head is not well preserved; the orbit is high, large, and round; the jaws are not preserved; the operculum is large, and its posterior margin is circular.

The spinal column comprises twenty-eight vertebræ, of which seventeen are caudal; they are as high as long, deeply contracted medially. It is possible that one or two additional vertebræ would be present if the caudal extremity were complete. The ribs are short and not very strong. The neural spines are short and thick; the interspinous bones are numerous, strong, and proportionately long as the spinous are short; the hæmal spinous and interspinous bones are similar to those supporting the dorsal fin; a large anterior spinous bone supports a spatulate bone of more or less triangular form, to which are attached the anterior spinous rays of the anal fin.

The dorsal fin comprises twenty-nine rays, the anterior ones spinous. The base of the fin extends from the base of the tail 1·2 inches. The distal extremities of the rays are absent, so that their length cannot be given; for the same reason it is not easy to distinguish how many of the rays are spinous, because the proximal portion of many of the articulated rays are also solid. The anal fin is similarly imperfect with the dorsal. The three anterior rays are spinous, and these are followed by twenty articulated rays. The caudal fin is absent.

The pectoral fin cannot be distinguished; there appears to be, however, a slight impression on the lateral surface indicating its position. The ventral fins are both exposed, closely impinging on the median abdominal line; nine or ten rays can be distinguished, the anterior ones strong and robust. The scales are small; patches are preserved, but their form is not distinguishable.

*Formation and Locality.*—Upper Cretaceous: Hakel.

*Ex coll.*—British Museum, Natural History Department.

#### Genus. **Imogaster.** COSTA.

I have had no opportunity of seeing the type of this genus. MM. Pictet and Humbert remark that this genus is placed with some doubt with the family Chromides. It possesses some relationship with *Beryx* and *Pycnosterinx*. Its body is, as in those genera, oval and short; its scales are strongly denticulated; and its anal fin is sustained in front by a strong spine. It differs from both in the dorsal fin extending the whole length of the back from the occiput to the tail, supported in front by fine and serrated rays. M. Costa states that the ventral fins are abdominal. Though I have not seen the original type of this genus, described by Professor Costa, there can be little doubt that the specimen here described and represented is the same species.

*Imogaster auratus*, COSTA.

(Pl. xxviii., fig. 3.)

*I. auratus.* COSTA, O. G., 1855. "Descrizione di alcuni pesci fossili del Libano," p. 6, pl. I., fig. 2.

*I. auratus.* PICTET and HUMBERT, 1866. "Nouv. rech. sur les poiss. fossiles du Mont. Liban.," p. 44.

Length of the body, exclusive of the tail, 2·7 inches; height 2·2 inches, immediately behind the head, is maintained to the base of the anal fin. The tail, widely expanded in this specimen, will add about 0·5 inch to the length.

The fish is very rare; it was described by Costa in 1855, and, so far as I am aware, this is the only specimen since found; it forms a part of the collection made by Professor Lewis, and is in good preservation.

The head is 1.0 inch in length from the snout to the posterior margin of the gill cover. The orbit is advanced and superior. The mouth is small, the jaws straight, and armed with short conical teeth, of which a few may be seen in proximity to the jaws. The opercular bones are longer than broad, convex posteriorly, and concave in front.

The spinal column is slender, the vertebræ rather longer than they are deep. The vertebræ are twenty-eight in number, of which sixteen are caudal. The ribs are fine and short; the neural and hæmal apophyses are stronger, slightly curved, and extend three-fourths the distance between the spinal column and the outer margin of the body. Interspinous bones support the dorsal fin the whole length of the back, and also the anal fin so far as it extends. The interspinous bones are quite double the number of the spinous. A strong internal bone extends from the anterior rays of the anal fin to the vertebræ; it is straight except the lower extremity, which is expanded forwards in a triangular form, ending in a point on the median abdominal line.

The dorsal fin extends the whole length of the back, from the occipital region of the head to the base of the tail; it is composed of numerous uniform branching rays, supported by an equal number of interspinous bones. The first three rays are spinous; the third, the longest, is 0.35 inch in length, acuminate, and directed backwards; the second and first rays are smaller and relatively shorter. The anal fin extends from the base of the tail forwards 1.0 inch; it is composed in a similar manner to the dorsal, and also has three spines in front of the fin; they are stronger than the dorsal spines, and are supported, as stated above, by a strong internal bone. The caudal fin, judging from the basal portions of the rays which are preserved, was tolerably strong; a small number of rays are preserved, but in a crushed condition. The peduncle of the tail is 2.6 inches in height.

The pectoral fin is 0.4 inches in length, comprising a considerable number of fine rays. It is situated at one-third the height of the body above the ventral margin, on the side immediately behind the opercular apparatus. A strong straight process descends diagonally from the base of the pectoral fin to the anterior margin, and probably indicates the position, or was the point of attachment, of the ventral fin; it is midway between the anterior rays of the anal fin and the head.

As already observed, this genus was instituted by Professor Costa. When MM. Pictet and Humbert published their "Nouvelles recherches," in 1866, they remark, in writing of this genus: "Nous plaçons avec doute a la fin de la famille des Chromides ce genre que nous n'avons vu en nature, et dont nous

avons quelque peine a bien apprécier les véritables rapports." They continue: "It bears some little resemblance to *Beryx* and to *Pycnosterinx*. Its body is, as in those two genera, oval and short; its scales are strongly denticulated, and its anal fin is supported in front by strong spines. It differs from both in the dorsal fin, which occupies the whole length of the back from the occiput to the tail; it is supported in front by fine and closely-set rays." M. Costa states that the ventral fins are abdominal, but his plate leaves us in some doubt in this respect.

M. Costa does not indicate the locality from whence this fossil was obtained. MM. Pictet and Humbert consider that the specimen had been obtained from Sahel Alma, but they had no opportunity of examining it. The example now described is from Sahel Alma.

*Formation and Locality.*—Soft chalk: Sahel Alma, Mount Lebanon.

*Ex coll.*—Lewis Collection, British Museum (Natural History Department), London.

#### Family. **STROMATEIDÆ.**

##### Genus. **Omosoma.** COSTA.

The genus *Omosoma* was established by Professor O. G. Costa, in 1855, for a fossil fish from Mount Lebanon. It was placed in the Scomberoid family, approaching *Centralophus*, from which he considered it was distinguished only by characters of minor importance. It is represented as an oval fish, with a long dorsal fin, and an anal fin almost as long, pectoral rays small, ventrals thoracic, and covered with small smooth scales striated concentrically.

##### *Omosoma sah-el-almæ*, COSTA.

(Pl. xxv., fig. 5.)

*O. sah-el-almæ.* COSTA, O. G., 1855. "Descrizione di alcuni pesci fossili del Libano," p. 10, pl. I., fig. 1.

*O. sah-el-almæ.* PICTET and HUMBERT, 1866. "Nouvelles recherches sur les poissons fossiles du M. Liban.," p. 45.

The body is oval; 2·1 inches in length from the tip of the snout to the peduncle of the tail; of this length the head occupies 0·9 of an inch. The tail is 0·8 of an inch additional. The greatest height, 0·9 of an inch, is midway between the head and the tail, and from this point the diameter diminishes gradually, and at about the same rate, in each direction. A long dorsal fin extends from a point immediately behind the head to the base of the tail, and an anal fin from the middle of the ventral surface to the tail. The fish is in

all respects well preserved, except the ventral fins, of which only the base remains.

The head is large; orbit superior and moderately large; cranial bones well developed; mouth small, and jaws short, but thick and strong, furnished with villiform teeth. Operculum large, anterior surface concave, posterior one convex. Preoperculum, in the form of an elongated triangle, is longer than the operculum; attached to its lower extremity there is an interoperculum, extending forwards to the posterior extremity of the lower jaw; and a suboperculum completes the series, the latter is attached to the lower extremity of the operculum, its height equal to about half its length. A series of branchiostegal rays is present, but the exact number cannot be stated, a portion of them being hidden under the opercular apparatus.

The vertebral column extends in a straight line; it is composed of thirty-three vertebræ, of which eighteen are caudal. The vertebræ are, on an average, equal in height to their length. Neural apophyses extend from the upper surface of the vertebræ; they are strong, and more or less straight; to their distal extremities is attached a series of interneural spines, which in turn support the numerous rays of the dorsal fin. A similar arrangement exists on the hæmal surface of the caudal portion of the body supporting the long anal fin. A series of ribs, short, strong, and nearly straight, may be distinguished in the abdominal cavity. Three or four vertebræ at the caudal extremity turn up towards the upper lobe of the tail.

The dorsal fin extends from a point 1.0 inch behind the snout to the base of the tail. It is stated by M. Costa to be composed of forty-five rays. In this specimen the number cannot easily be distinguished, but there are more than forty interneural rays, and each one appears to support or be attached to a ray of the fin; the anterior rays are strong and spinous, 0.5 of an inch in length; the anterior ray is supported by four imbricating shorter spines. The soft rays are divided, and decrease in length backwards. The anal fin is 0.9 of an inch in length. Its anterior rays are spinous, and are supported, like the dorsal, by four or five imbricating short rays; the soft rays of the fin diminish in length backwards. The anterior spinous rays are supported by a strong triangular bone or plate, in addition to the strong interspinous rays. The caudal fin is large, deeply bilobate, and the outer rays of each lobe, which are the longest, are supported by a number of imbricating rudimentary rays.

The pectoral fin is broad, but short, consisting of about twelve rays. It is attached to the pectoral girdle at one-third the height of the body from the abdominal surface. A process from the pectoral arch descends obliquely backwards, and supports the ventral fin midway between the head and the anterior rays of the anal fin. A second horizontal pubic bone extends from the fin to the abdominal extremity of the pectoral arch. The ventral fins are not preserved.



They were situated 0·1 of an inch in advance of the middle of body, not including the tail.

The scales are small, thin, apparently smooth and without marginal serration their outline is not distinguishable, except in small portions, and the number of scales cannot be identified.

Though I have had no opportunity of seeing the type specimen described by Prof. Costa, this one appears to be the same species. It is very rare, and the difficulty of becoming acquainted with the original type has led me to redescribe and figure this specimen.

*Formation and Locality.*—Upper Cretaceous: Sahel Alma, Mount Lebanon.

*Ex coll.*—Lewis Collection, Robert Damon, Esq., Weymouth.

#### Order IV.—PHYSOSTOMI.

“All the fin-rays articulated, only the first of the dorsal and pectoral fins is sometimes ossified. Ventral fins, if present, abdominal, without spine. Air-bladder, if present, with a pneumatic duct (except in Scombresocidæ).” (Günther.)

Dr. Günther includes in this order the great families of the Siluroids, the Cyprinoids, the Salmoids, and the Clupeoids. The two latter families were comprised by Prof. Agassiz in the Halecoidei; they are largely represented in the fossil fish remains of both the Hard and Soft Chalk of Lebanon. The Siluroids appear to be represented by the single genus *Coccodus*, and *Istius* is the single representative of the *Esocidæ*.

#### Family. **SILURIDÆ.**

#### Genus. **Coccodus.**

M. Pictet described a peculiar genus of fossil fishes with the above name (“Description d. quelques poiss. foss. du M. Liban.,” 1850, p. 51, pl. ix., fig. 9) from Hakel. The specimens present anomalous features, and it is difficult to determine their precise relationship with either the Ganoids or Teleosteans. Its skeleton is described as possessing rather a fibrous than a bony consistence; the vertebræ have been displaced, and the ribs and apophyses present a compressed and somewhat irregular appearance; large bony spines are attached to the pectoral arch, and appear to have supported the fins; whilst the massive form of the arch recalls that of some of the rays. One of the principal characters consists in the dentition of the mouth; four regular rows of teeth cover the palate similarly to those of the *Pycnodonts*. In the lower jaw the teeth are similar, but smaller.

These characters do not clearly associate the genus with any existing fish, but present a modification of several. M. Pictet considers that the form of the pectoral arch and the feebleness of the skeleton appear to approach the Chondropterygians, but the ribs and apophyses are better developed than in fishes of that class; the nature of the teeth are entirely different to those of the rays. The teeth, as already observed, would indicate its relationship to the Pycnodonts, but the form of its body and the character of the pectoral arch and spines are quite different from those of the fishes of that group. The latter features are very similar to those of some of the Siluroids, and bear a close resemblance to the form and structure of the pectoral arch of *Pimelodus clarias*, Geof., of the Nile. The spines are similarly striated, and denticulated along the margin, of the same form, and are attached in the same way to the pectoral arch.

I have not seen the specimen figured by M. Pictet, but the description and figure appear to indicate a peculiar combination of the characters possessed by the Pycnodonts and the Siluroids, and thus to connect the Ganoids with the Teleostean Siluroids.

*Coccodus armatus*, PICTET.

(Pl. xxx., fig. 1.)

*C. armatus*. PICTET, J. F., 1850. "Desc. de quelques poiss. foss. du Mont Liban.," p. 51, pl. ix., fig. 9.

*C. armatus*. PICTET and HUMBERT, 1866. "Nouv. rech. sur les poissons fossiles du Mont Liban.," p. 90.

This species was named and the dentition described by Prof. Pictet ("Desc. de quelques poissons fossiles du Mont Liban.," p. 51, pl. ix., fig. 9). An additional specimen is now figured, which has the advantage of exhibiting the head from a different point of view, and also connected with it a considerable portion of the vertebral column, the base of the dorsal fin and the ventral.

The head has a total length, from the snout to the posterior point of the spinous process emanating from the cranial covering, of 3·6 inches; its height is 1·8 inch. The whole of the superior portion of the head is covered with strong enamelled plates, pitted or grooved on the external surface. The orbit is small, situated midway between the snout and the posterior outline of the head, and 0·3 of an inch below the upper margin of the head. A strong shield-like plate extends from a position behind the orbit over the forehead to the snout, and extends latero-posteriorly so as to encircle the lower part of the orbit; from the centre of the upper surface of this plate, 2·0 inches behind the snout, there ascends a large recurved spinous process, of which only the base is preserved. The latter is 0·35 inch in diameter, finely striated, and denticulated on the

anterior and posterior margin. The latter curves gently backwards, and forms a short, acutely-pointed spinous process, extending over and protecting the occipital region of the skull. The opercular region is covered by thick plates, extending in an almost straight line from a position behind the orbit to the lower margin of the head; they are 0·8 inch in breadth; the posterior margin circular. A plate extends between the opercular bones and the occipital spine already mentioned. The posterior portion of the armature of the head consists of an expansion of the pectoral arch into three prominent pointed spinous processes. The first has its origin behind the median portion of the operculum, and from a broad base extends backwards, with a downward curvature, to a more or less pointed apex. The spine is hollow; its external surface is striated, and the convex margin denticulated. A second and smaller spinous process is developed near the base of the first, and extends in an outwardly diagonal direction from the body. The third extends from a base, parallel with the abdominal surface of the body of the fish, horizontally backwards, its point passing behind the second process. It is striated, and has denticles similar to the first one. The upper jaws are preserved, and the teeth are attached. The jaws have been pressed backwards, and expose more of the under surface than they would in a natural position. There are two rows of palatal teeth, with flattened crowns, on each ramus of the jaw, which completely cover the palatal surface; they are large posteriorly, and diminish in size as the front of the mouth is approached. In addition to the four rows mentioned by Prof. Pictet, there are a considerable number of small teeth occupying the extremity of the jaws. A portion of the lower jaw is exposed; it extends 1·8 inch backwards; it is strong, pustulate on the outer surface, and furnished with similar teeth to those of the upper jaw.

The vertebral column is exposed to the length of 3·5 inches; the osseous centres, if any existed, have disappeared, leaving only the external coating of the column preserved. The vertebræ are 0·2 inch in height and 1·5 in length; a number of ribs may be discovered. Neural apophyses, straight and strong, are attached to the dorsal aspect of the vertebræ. Two inches behind the head the anterior rays of the dorsal fin are supported by interspinous bones. The extent of the fin is not shown. At a distance of 1·5 inch behind the anterior rays of the dorsal fin the commencement of the ventral fin exists; but this also is imperfect.

*Formation and Locality.*—Hard chalk: Hakel.

*Ex coll.*—Lewis Collection, British Museum (Natural History Department), London.

*Gyrodus (Coccodus ?) syriacus*, FRAAS.

*G. syriacus*. FRAAS, O., 1878. "Aus dem Orient. II. Theil. Geolog. beobach. am Libanon," p. 92, pl. iv., figs. 5, 6.

The figure given by Dr. Fraas appears to indicate that the specimen named by him *Gyrodus syriacus* is closely related to *Coccodus armatus*, Pictet; and, until more perfect examples shall have been examined, it may be advisable to consider the question an open one as to whether the one described belongs to the genus *Gyrodus*. Taken simply as a group of teeth, the likeness is sufficiently striking; but, in conjunction with the specimen described by Pictet, there is reason to doubt whether it may not be more closely related with it; and, if such be the case, then, as already stated with respect to *Coccodus*, its affinities and relationship appears to be rather with the Siluroids than the Ganoids.

Genus. **Xenopholis**.\* DAVIS.

Fish, moderate size; head enveloped in strong dermal plates; operculum large; spinal column cartilaginous; ribs spinous apophyses, and fin-rays osseous. Dorsal and anal fins large, extending from the base of the tail; ventral fins midway between the anal and the posterior part of the head. Scales large and thick; median lateral line of both upper and under surface is raised in the form of a ridge, from which striations branch backwards on each side.

This fossil fish exhibits several peculiarities which distinguish it from any other form discovered in the Lebanon strata. The apparent absence of ossified vertebræ, combined with the presence of spinous and interspinous bones supporting dorsal and anal fins, comprised of simple articulated rays, resembles the Ganoids, and recalls the *Caturi* of the lithographic stone of Sohnhofen; the posterior position and extended base of the dorsal and anal fins, however, readily distinguish this species from those of *Caturus*. The large size of the strong plates enveloping the head resemble those of the Siluroids; and the scales have more than a passing similarity to those of the genus *Scopelus*; but the unpaired fins in this species are again sufficiently characteristic to readily separate it from the latter. It is unfortunate that the specimen is not in a better state of preservation, so that the character of the head could have been ascertained; it would be unsafe to express a very decided opinion as to its relationship until more perfect specimens shall have been obtained; but the parts preserved probably indicate a closer connection with the Siluroids than with any other group.

\* ξένος, strange; φολις, a scale.

*Xenopholis carinatus*, DAVIS.

(Pl. XXIX., fig. 4.)

A peculiar specimen of very great interest, but, unfortunately, very imperfect: the whole of the head, with the exception of some of the opercular and cranial bones, is absent; a large portion of the back and a part of the tail has shared the same fate. The length of the part of the specimen preserved is 5·5 inches, of which the tail occupies 0·7 inch.

The spinal column cannot be distinguished. The neural and hæmal spines in the posterior part of the body are clearly seen: they are strong, and support interneural and interhæmal spines attached to the dorsal and anal fins. The vertebræ in this part of the body may be enveloped by the scales, but neither in the posterior nor the anterior portions do the vertebræ make any impression, as they naturally would if osseous; and it is probable that the entire vertebral column was cartilaginous. The base of a portion of the caudal fin is preserved, and, though the rays are in natural position, there is no evidence of bony vertebræ, a vacant space remaining where they once were.

A portion of the dorsal fin is preserved; twenty-six rays can be counted, though in the same length only eighteen interneural spines seem to be preserved. The rays are simple and undivided, but are articulated, and nearly an inch in length. The anal fin is situated opposite to the dorsal, and near the base of the caudal; its base is 1·2 inch in length; the two anterior rays are strong; spines 0·2 and 0·25 inch in length respectively. The succeeding rays are similar to those of the dorsal fin, twenty-one in number, supported by fifteen interspinous hæmal rays. Of the caudal rays fifteen can be distinguished pertaining to the lower lobe, but the greater part of the fin is absent.

The ventral fin is 1·1 inch in advance of the anterior rays of the anal; it consists of twelve or thirteen articulated rays nearly 1·0 inch in length; it is situated on the abdominal surface. At the base of the anterior ray an external bony plate extends forwards 0·35 inch; its external surface is produced so as to form two acute points or denticles 0·1 inch in height. The pectoral fin cannot be distinguished.

The scales of the head and body are large, solid, bony plates. At a distance of 2 inches from the tail there are eight scales in a transverse line, and from the tail in the same distance there are ten scales along the lateral line. The scales are more or less angular in form; their greatest diameter at right angles to the vertebral axis is 0·35 inch; the opposite diameter parallel with the lateral line is 0·3 inch. The median surface of the scale is raised in the form of a ridge, extending to the posterior part of the scale, which is produced so as to form an obtuse angularity; from this the margin recedes, forming concave outlines; the posterior margin, which is not exposed, is triangular, with straight

lines. The surface of each scale is also covered with striæ, branching on each side from the central ridge and extending backwards; the under surface of the scale, in addition to being striated, is also punctured, and has a corresponding central ridge, which may serve, in some way not very clearly defined, to interlock one scale with another.

Immediately in front of the ventral fin there is a large ovoid plate 0·7 inch in length and 0·4 in greatest diameter; the median surface is raised along the longitudinal axis: its surface is covered with pustulate corrugations; the under surface is also pustulate. The plate appears to have occupied a median position on the abdominal surface; other large plates, similarly ornamented, are scattered about the anterior portion of the specimen, but their exact position or relationship is difficult to determine. One plate, probably the operculum, is an inch in diameter; it is produced, like the scales, posteriorly so as to form a point.

*Formation and Locality.*—Hard chalk: Hakel, Mount Lebanon.

*Ex coll.*—Tristram Collection, Natural History Department, British Museum, London.

#### Family. **SCOMBRESOCIDÆ.**

##### Genus. **Exocœtoides.** DAVIS.

Body small and attenuated; skeleton slender; head large and broad between the orbits; intermaxillary present. Pectoral fins very large, attached laterally to a strong process of the pectoral arch; ventral fins abdominal, much smaller than the pectoral; dorsal fin small, situated posteriorly; caudal soft and filamentous; anal not seen.

Two species of the genus *Cheirothrix* have been previously described, both from the soft chalk of Sahel Alma. The specimens constituting this genus are from Hakel. They differ in most important respects from *Cheirothrix*, and these differences will, perhaps, be more easily understood by referring to the plate. The pectoral fins in *Cheirothrix* are lateral, but smaller than the ventrals. In this genus they are similarly attached to the lateral surface of the body, but they are very much larger than the ventrals. The latter are comparatively small, and are attached to the abdominal surface considerably behind the pectorals; in this respect it differs from *Cheirothrix*, as it does also in the position, character, and size of the dorsal fin. In proportion as it differs from *Cheirothrix*, it approaches *Exocœtus*, and there can be little doubt that there is in this genus a prototype of the flying fishes of the present day. In the latter the large pectoral fins are placed on the side of the body; the ventral fins are small and abdominal; the dorsal situated posteriorly, and near the tail. It will be seen from the description following that the fossil approaches very closely to the

existing flying fishes in all these particulars, and consequently *Exocœtoides*, by which name it is proposed that this genus shall be distinguished, may be regarded as more or less closely related to the genus *Exocœtus*, one of the family *Scombresocidæ*.

*Exocœtoides minor*, DAVIS.

(Pl. XXVI., figs. 1 and 5.)

The fish is preserved with the dorsal surface exposed. The cranial portion of the head, the vertebral column, the pectoral and ventral fins, are exhibited; but the unpaired fins, except a few rays of the dorsal, are wanting. The portion preserved is 1·8 inch in length. The head occupies nearly one-fourth of this length. The entire length of the body cannot be easily estimated, on account of the absence of the tail and the posterior part of the body.

The head is 0·4 of an inch in length from the snout to the anterior margin of the pectoral arch. Its greatest width is 0·35 inch across the occipital region, and it diminishes rapidly to the snout, which is small, apparently flattened, and with a triangular outline. The head was covered with thin enamelled plates, the greater portion of which have disappeared, and only the impression of them is left. A somewhat prominent ridge extends along the median line of the head, formed by the parietal and frontal bones; the anterior portion is depressed. The orbits are median or slightly posterior, separated by 0·15 of an inch, moderately large and circular. The maxillaries, which extend in this specimen from the anterior margin of the orbit to the end of the depressed ethmoid bones, are 0·2 inch in length. Premaxillary bones are spread on each side of the snout, displaced, no doubt, by pressure during deposition; they are 0·15 inch in length on each side. Teeth are not visible. Opercular bones can be distinguished, but not with sufficient clearness for detailed description.

The spinal column, so far as preserved, consists of about forty vertebræ; nine, larger and longer than the remainder, extend between the head and the base of attachment of the ventral fins. The vertebræ are small, slightly longer than broad, and contracted in the middle. Towards the posterior extremity a few short and fine spinous processes are preserved, and near them are four rays, which have belonged to the dorsal fin; they are 1·1 inch behind the occipital region.

Of the paired fins, the pectorals are very large, and situated laterally, immediately behind the head; the ventrals are 0·35 inch farther back, and are much smaller. The pectoral fins are supported by a strong scapular arch, and the fin-rays are attached to a broadly-expanded scapular bone, connected by the coracoid with the base of the skull. The rays of the pectoral fin are sixteen in number, and about 1 inch in length; the proximal end is expanded for attachment; for a distance of half their length the rays are simple, beyond they

dichotomize. The rays extend from the body with a gentle curvature outwards and backwards. The ventral fins are connected together by a pair of pubic bones joining on the abdominal surface, the fins being 0·2 inch apart. Each contains seven rays, of about the same length, 0·3 inch. The rays are comparatively strong, and the fin was capable of wide expansion.

There is no trace of scales.

A second specimen exhibits the caudal portion of the fish. The tail is separated by 0·3 inch from the dorsal fin; it consists of a number of fine, filamentous rays, 0·2 inch in length, and repeatedly divided.

*Formation and Locality.*—Hard chalk: Hakel, Mount Lebanon.

*Ex coll.*—Lewis Collection, Natural History Department, British Museum (fig. 1); Robert Damon, Esq., Weymouth (fig. 5).

#### Family. **ESOCIDÆ.**

##### Genus. **Istieus.** AGASS.

*Istieus.* L. AGASSIZ, 1834. “Rech. sur les Poissons fossiles,” vol. v., pt. II., p. 91.

The genus *Istieus* was formed by Prof. L. Agassiz to embrace a number of fossil fishes restricted to the chalk, and only found in the *grès-vert* of Westphalia. Prof. Agassiz at first considered that the relationship of the genus was with the Scomberoids, from its external resemblance to *Elacates*. He failed, however, to discover distinct traces of spines in the rays of the dorsal fin, and a more detailed study of the specimens led him to doubt their existence. On the other side, the presence of large scales, the abdominal position of the ventral fins, the posterior position of the anal fins, and the form of the caudal fin, bear evident resemblance to the family of the *Esocides*, and this induced Prof. Agassiz to consider *Istieus* nearly related to that family.

The characters which served to distinguish this genus from all other fossil fishes are enumerated as follows:—The vertebræ are excessively short, and proportionately more numerous than in the most of the *Cycloids*; the interapophysial bones are less numerous than the apophyses, which is not the case in any other fish. The dorsal fin extends nearly the whole length of the back; the anal is placed far backwards, so that its posterior extremity touches the base of the tail. The head is well developed, longer than high; the mouth small, and the jaws armed with small, hooked teeth.

M. Agassiz described four species from the chalk of Baumberge, near Münster, viz. *Istieus grandis*, *I. macrocephalus*, *I. microcephalus*, and *I. gracilis*. Twenty years later, Dr. W. von der Marck, in his elaborate and scholarly work on the “Fossile Fische, Krebse, und Pflanzen aus dem Plattenkalk der jüngsten Kreide



in Westphalen," p. 37, pl. iv., figs. 1-5 ("Palæontographica," vol. xi., 1863), combined the two species *Istius grandis* and *I. microcephalus* of Agassiz under the new specific name *I. macrocoelius*, the acquisition of a large series of examples having demonstrated the identity of the two species. The remaining species described by M. Agassiz are corroborated by additional specimens, and Dr. von der Marck institutes the new species *Istius mesospondylus* from the Plattenkalke of Sendenhorst, in Westphalia. The species now described from the chalk of Sahel Alma will, consequently, be the fifth belonging to this genus. It is extremely interesting in affording evidence of the close relationship of the fauna of the chalk of Westphalia with that of Mount Lebanon—a matter which will be treated at greater length in another part of this memoir.

*Istius lebanonensis*, DAVIS.

(Pl. xxx., fig. 3.)

This ichthyolite is sufficiently well preserved to show the form of the body, the character of the scales, and the arrangement of the fins; the vertebral column is well preserved, but the anatomy of the head and the spinous processes are defective. One of the most important characters consists in the extremely long dorsal fin. The fish is 5 inches in length from the snout to the base of the tail. The latter adds 1.5 inch to the length. The head occupies rather more than one-third of the length: it is 1.8 inch. The greatest height of the body is 1.4 inch, immediately in front of the dorsal fin. The height gradually diminishes to the peduncle of the tail, where it is 0.45 of an inch.

The head is large, but, unfortunately, not easily defined. The snout is somewhat obtuse. The orbit high and well advanced. The gape was probably fairly wide, the mandible of the lower jaw being fully 1 inch in length. The operculum was large, rounded, and extended from the cranium with an oblique posterior curvature to the pectoral fin. Branchiostegal rays not exhibited.

The vertebral column consists of a large number of closely-impacted vertebræ, 0.125 of an inch in diameter across the circumference, and half the diameter in length. Seventy vertebræ can be counted from the tail to the base of the anterior ray of the dorsal fin, and, allowing for the additional length to the occipital condyle, the total number of vertebræ was probably eighty-five; of these, thirty-four were caudal. The neural and hæmal spines are only exhibited near the tail, where they are the length of the vertebræ apart, and tend obliquely towards the caudal fin. The ribs cannot be distinguished.

The dorsal fin commences 0.5 of an inch behind the head, and extends 2 inches along the dorsal surface. Its posterior rays are separated by a space of 1 inch from the caudal fin. It contains thirty-nine rays, supported by inter-

spinous bones. The rays are strong; anteriorly they are 0·45 of an inch in length, and decrease backwards to half that length; the rays were probably longer than the part preserved, the basal portions only, which are not divided by articulation, remaining, whilst the distal extremities, which were probably articulated, have been separated and lost. The anal fin is 1·5 inch behind the ventrals, and its base extends 0·5 of an inch, approaching to 0·3 of an inch, to the caudal; it is composed of ten rays; the anterior one is 0·8 of an inch in length, the others decreasing in length backwards. The distal half of each is divided by a number of articulations, the proximal one, like those of the dorsal fin, being unbroken by articulations.

Only the external rays of the lower lobe of the caudal fin are preserved; they are 1·5 inch in length, strong, and articulated at short intervals. A number of rudimentary caudal rays support the fin.

The pectoral fin, consisting of ten rays, the longest of which is 1·0 inch in length, is situated immediately behind the gill cover, opposite to the anterior rays of the dorsal, and about 0·3 of an inch above the abdominal margin of the body. The ventral fins are placed 1·1 inch behind the pectoral, joining at the abdominal line; they are 0·9 of an inch in length, and consist of eight rays each; the fins are attached to a triangular pair of bones, meeting internally in the axis of the fins. The ventral fins are opposite the median portion of the dorsal fin. The rays of both the paired fins are simple for half their length; the remaining portion is divided by joints.

The scales are large, 0·2 of an inch in height, with semicircular posterior outline; they are thick and, where well preserved, appear to be coated with ganoine; this is more especially so with the external bones of the head, which have a decidedly enamelled and glistening surface.

This species is apparently most nearly related to *Istieus macrocephalus*, Agass. It may be distinguished by its greater height as compared with the length, and the larger size of the head; the head of *I. macrocephalus* occupies a quarter of the length of the fish, in this species it is little more than one-third. The dorsal fin in the example now described commences at a point considerably nearer the head than in *I. macrocephalus*, and it also terminates posteriorly at a greater distance from the tail. The anal fin of *I. macrocephalus* is supported by twelve rays; in this one there are only ten.

*Formation and Locality.*—Upper Cretaceous: Sahel Alma, Mount Lebanon.

*Ex coll.*—Robert Damon, Esq., Weymouth.

Family. **HALECIDÆ.** AGASSIZ.

= SALMONIDÆ + CLUPEIDÆ.

Genus. **Osmeroides.** AGASSIZ.

*Osmeroides.* L. AGASSIZ, 1834. "Rech. sur les Poissons Fossiles," vol. v., pt. II., p. 103.

Body more or less ovate, thick and depressed; head large, flat on the upper surface; mouth large, with wide gape; teeth small and pointed; branchiostegal rays, eight on each side. Dorsal fin in advance of middle of the back, the base of the fin more or less elongated; pectoral and ventral fins large; anal moderate or small; caudal fin cleft, the two lobes equal in length. Scales medium or large, thin, rounded, more or less ridged on the surface, with serrated posterior margin.

The genus *Osmeroides* was formed by M. Agassiz, and embraced three species of fishes from the chalk related to the sprats (*Osmerus*) which, with the latter, evidently belonged to the family of the *Salmonidæ*. In some examples traces of the adipose fins have been preserved; but they differ from *Osmerus* in being shorter and the peduncle of the tail being less contracted. There is also a difference in the positions of the fins: the dorsal is more advanced, and, instead of being in the middle of the back, its insertion corresponds to the anterior third of the back. The caudal is well developed, as are also the ventrals and the pectorals; but the anal is small. The skeleton much resembles that of the *Clupea*, except that it has no sternal ribs. The head is flat, as in *Osmerus*, but the mouth is smaller, and it appears that the teeth were small and closely set. M. Agassiz described three species, two communicated by Count Münster, viz., *O. monasteri* and *O. microcephalus*, from the cretaceous formation of Westphalia, and one from the chalk of Lewes, *O. lewesiensis*; a fourth specimen from Lewes is referred to as *O. granulatus*, but not described.

In 1850, Professor F. J. Pictet described an additional species of *Osmeroides* from Mount Lebanon ("Description de quelques Poissons Fossiles du Mont Liban.," p. 27). He states that *Osmeroides* is characterized by having eight branchiostegal rays, which distinguish it from the *Salmonidæ*, and that the wide extension of the gape removes it from *Coregonus*. The species described by M. Pictet is *O. megapterus*.

M. von der Marck ("Palæontographica," 1863, vol. i., p. 41), in a description of the fossil fishes of the chalk of Westphalia, disputes the existence of the adipose fin, which M. Agassiz stated he had observed on some of the Westphalian specimens. M. von der Marck examined more than eighty examples and could find no trace of an adipose fin, and this notwithstanding that some other genera

from the same locality have the adipose fin preserved. He therefore considered that the genus was not a good one, and, along with Osmerus, he rejected them, replacing the genera by those of Sardinus and Sardinoides, and placing them in the section of the family of the Clupeidæ, which is characterized by the absence of sternal ribs.

MM. Pictet and Humbert ("Nouvelles recherches sur les Poissons Fossiles du Mont Liban," 1866, p. 77) are not sufficiently clear as to the value of the new genus of M. von der Marck, and consider that by the law of priority the names applied by M. Agassiz ought to be retained.

From a consideration of the statement of M. von der Marck, that he failed to find an adipose dorsal fin, and the fact that no evidence of such a fin can be traced in the specimens from Mount Lebanon, it may be reasonably inferred that M. Agassiz was mistaken when stating that traces of this fin had been found, and as it was principally on its presence that he relied in placing the genus Osmeroides amongst the Salmonidæ, it will be necessary to reconsider its relationship. The anatomical structure in most respects is closely assimilated with that of the Clupeidæ so far as the trunk is concerned, but the form of the head is different; the number of interneural spines and the extent of the dorsal fin in Osmeroides is much larger and more extensive than in the Clupeidæ; and the absence of sternal ribs in the former also serves to distinguish the two.

The spinal column in the species of Osmeroides, which are described in the succeeding pages of this work, consists of a considerably larger number of vertebræ than the spinal column of the species described by Professor Agassiz from Westphalia. The latter possess, according to the author named, Osmeroides microcephalus, thirty-two, and O. monasterii, at least twenty-six.

M. von der Marck, in a description of the same fishes, but, as before stated, placed in a new genus (Sardinoides), states that Sardinoides microcephalus has twenty-seven to thirty vertebræ, whilst S. monasterii possesses thirty; and two new species named S. crassicaudatus and S. tenuicaudatus have respectively, the former twenty-seven, and the latter thirty vertebræ. The species, Osmeroides megapterus, described by M. Pictet, is designated as possessing thirty-four vertebræ; but the example figured is a very imperfect one, and in several specimens which are now before me there are fifty-seven to sixty vertebræ visible. Other species described further on possess an average of sixty; and in one species there are eighty-five vertebræ included in the spinal column. This great difference, along with those previously named, appears to indicate that the species obtained from the chalk of Westphalia ought to be removed from the genus Osmeroides, and the determination of M. von der Marck confirmed. At the same time there appears every probability that the third species, described by Professor Agassiz as Osmeroides lewesiensis (Salmo lewesiensis, Mantell., "Geology of Sussex"), forms the type of the genus Osmeroides. Its head is

broad and flat; the scales are thick and strong; and though, unfortunately, the spinal column is not known in its entirety, detached vertebræ have been identified, and indicate by their great height as compared with the length, that they were more numerous than those of the other species described by Agassiz, and probably numbered as many as those found in the chalk of Mount Lebanon.

Thus, whilst *Osmeroides* is, without doubt, closely related to both the Clupeidæ and the Salmonidæ, it possesses several features which separate it from these families, and necessitate its being considered as occupying an independent position.

*Osmeroides megapterus*, PICTET.

(Pl. xxxii., figs. 4–6.)

- Osmeroides megapterus*. PICTET, 1850. "Desc. de quelques poissons fossiles du Mont Liban.," p. 27, pl. iii., fig. 3.
- Osmeroides megapterus*. PICTET et HUMBERT, 1866. "Nouv. rech. sur les poissons foss. du Mt. Liban.," p. 78.
- Osmeroides megapterus*. FRAAS, O., 1878. "Aus dem Orient. II. Theil. Geologische beobachtungen am Libanon," p. 98.

The specimen described and figured by M. Pictet is imperfect; the acquisition of more perfect specimens, since the publication of his work, enables me to supplement the description there given as follows:—The length of the body, exclusive of the tail, varies from 4 to 7 inches, of which the head occupies 1·8 inch in the larger size; the tail is 1·5 inch in length. The height of the body at its junction with the head is 1·8 inch, and the peduncle of the tail is about half that height. The dorsal fin commences 1·0 inch behind the head, and its base extends 0·8 inch. The pectoral fins are inserted immediately behind the gill covers, and separated from the ventrals by a distance of 2·0 inches. The anal fin is 1·5 inches behind the ventrals, and has a basal length of 0·7 inch, and is about half an inch in front of the caudal fin. The caudal is moderately cleft and widely expanded.

The head is as high posteriorly as its length; the snout is wide and large, flattened on the upper surface, with a proportionately wide gape; teeth small, closely set, and finely pointed. The operculum is 0·8 inch in diameter, with well-rounded posterior margin, the anterior one straight on the lower portion, but rounding off towards the upper one. The under surface of the head between the operculi is occupied by branchiostegal rays, eight in number on each side (not seven, as stated by M. Pictet, *Op. cit.*, p. 28), curved, and about 0·7 of an inch in length; the upper surface of the head, above and behind the orbit, is covered with thickly enamelled plates. The orbit is not well defined. The jaws are long and somewhat slender.

The spinal column consists of fifty-eight to sixty vertebræ, of which about twenty are caudal. M. Pictet only observed thirty-four vertebræ, but that was, no doubt, owing to the imperfect preservation of the specimen he described. The vertebræ of the anterior part of the body are 0·15 inch in height, and less than half that in breadth; they are closely connected, and only slightly contracted in the middle; towards the tail the vertebræ are longer, not so high, and considerably contracted medially. The ribs are long and slender; the hæmal and neural spines are stronger; they are numerous, and attached to the apophyses of each vertebræ.

The dorsal fin is seen in the specimen figured (Pl. xxxii., fig. 4). It is one inch behind the head, and its posterior rays about the same distance from the tail; it consisted of thirteen rays in the specimen described by M. Pictet, with which this agrees. The anal fin in this specimen exhibits twelve rays: they are shorter than those of the dorsal fin, the anterior rays of which are 0·8 inch in length; those of the anal fin are about 0·6 inch. The pectoral and ventral fins are similar in construction, the latter slightly larger than the former. The pectorals are supported by nine or ten rays, and measure 0·6 of an inch in length; they are separated from each other on the abdominal surface by a space of 0·6 of an inch across. The ventral fins are quite 1·0 inch in length, composed of twelve rays; the outer ones are longest; they are thick, and only divided towards their distal extremities. The bases of the two fins are 0·4 inch apart; the space between them is occupied by a single large plate, somewhat angular behind, but rounded in front; this is succeeded by others in the posterior direction, which are smaller, but still considerably larger than the ordinary scales. The caudal fin is strongly supported by rays not only from the hypural bone, but also from several of the terminal vertebræ. There are twenty-four rays, and several rudimentary ones support both the upper and lower lobes; the rays are jointed and repeatedly bifurcate.

The scales on the sides between the pectoral and ventral fins are 0·2 inch in height; the width of the exposed surface is equal to half the height. The surface is ornamented by a series of radiating ridges, which terminate on the exposed margin in folds, which give it a serrated appearance. The larger scales on the abdominal surface, already alluded to, as well as the median plate between the ventral fins, are similarly ridged. The scales on the posterior portion of the body are slightly smaller than those in front.

*Formation and Locality.*—Upper Cretaceous: Sahel Alma, Mount Lebanon.

*Ex coll.*—E. R. Lewis; R. Damon, Esq., Weymouth.

*Osmeroides gracilis*, DAVIS.

(Pl. xxxi., figs. 2, 3.)

Several specimens of this graceful fish have been discovered in the cretaceous beds at Sahel Alma. The example figured exhibits many of the details of the structure and characters of the fish. From the snout to the base of the tail the length is 8·5 inches, of which the head occupies 2·7 inches; the caudal fin adds 2·0 inches to the length. The height of the body in front of the dorsal fin is 1·6 inch; the peduncle of the tail is 0·6 of an inch.

The head is half as high as its length. The orbit is situated anteriorly, rather high, 1·2 inch from the snout; it is small, the cranial bones and infra-orbital ring are well developed. The operculi are large, and extend with a well-rounded and prominent posterior margin towards the abdominal surface of the fish. The jaws were long, and apparently capable of wide expansion; the teeth cannot be distinguished. The snout is not well preserved in this specimen; but another (Pl. xxxi., fig. 3) exhibits the structure of the under surface of the head remarkably well. The lateral margins of the mandibles converge anteriorly in a more or less triangular form; between the jaws there is one or more plates, and behind these the branchiostegal rays: the latter average one inch in length, and number eight on each side; those on the right side overwrap the opposite ones to a slight extent, the breadth of the whole being slightly more than an inch. The posterior extremities of the branchiostegal rays extend to the scapular arch, which, on the abdominal surface, curves considerably forward. In a third specimen the alveolar surface of the jaws exhibit the orifices, where teeth, apparently of considerable size, but deciduous, have been implanted. The opercular and other bones of the head are coated with a thick enamel, on which there are raised lines radiating from the upper anterior margin.

The vertebral column is composed of sixty-three vertebræ, of which twenty are caudal and the remaining forty-three abdominal. In the abdominal region the vertebræ are longer than deep; those of the caudal are deeper than long, these are also larger and stronger than those of the anterior part of the body. The ribs are fine, and extend backwards a considerable distance beyond the ventral fins. The hæmal spines are strong, and especially well developed from the four or five vertebræ nearest the tail; the neural spines are similarly strong for the support of the caudal fin; anteriorly they are long, divided at the base, and slender; the interneurals, supporting the long dorsal fin, are thick and strong, but short and tapering, apparently less numerous than the rays of the fin. Inter-hæmal spines support the anal fin.

The dorsal fin is placed on the anterior portion of the body, separated from the head by a distance of 1·7 inch, and from the tail by 3·2 inches; its base

occupies 1·8 inch; it consists of thirty-two rays. The anal fin is 1·5 inch in front of the caudal; its base occupies half an inch, and consists of about a dozen rays, strong at the base, but imperfectly preserved towards the extremity. The caudal fin is well developed: there are twenty rays in each lobe; two or three short rays support those following, which are articulated at short intervals and frequently bifurcate; a number of rudimentary rays also support the external rays of each lobe.

The pectoral fin is attached to the scapular arch immediately behind the operculum; it is of moderate size, 1·1 inch in length, and composed of fourteen rays, which dichotomize at least three times, giving the extremity of the fin a finely divided filamentous appearance. The rays are only jointed near their extremities. The two pectoral fins, like the ventrals, are joined on the inferior margin of the body. The ventral fins are 2·7 inches behind the pectorals, and opposite to the posterior rays of the dorsal fin; they are smaller than the pectoral, and contain about eight rays. The ventral fin is separated by a distance of 2·3 inches from the anal.

The scales are ovoid in outline, with radiating ridges; they are broader on the anterior part of the body, more elongated towards the caudal extremity.

There are large masses of rounded granular substance spread over the abdominal region of the body; they do not extend beyond the outline of the fish. The granules average ·05, or less, in diameter; the number is very great; they extend from the pectoral fins backwards to an inch beyond the ventral fins, and from the vertebral column to the lower margin of the body.

*Formation and Locality.*—Upper Cretaceous: Sahel Alma, Mount Lebanon.

*Ex coll.*—R. Damon, Esq., Weymouth.

*Osmeroides brevis*, DAVIS.

(Pl. xxxii., fig. 1.)

The body, with its scaly covering, is well preserved in this specimen; the head is defective. The length of the body to the base of the caudal fin is 3·5 inches; that of the head cannot be ascertained from this specimen; the tail is 1·8 inch from the peduncle to the extremity of the lower lobe. The greatest height of the body at the commencement of the dorsal fin is 1·5 inch; it gradually decreases to the tail, the height of the base being 0·6 of an inch. The species is remarkable for its short, stout, oval-shaped body.

The head is crushed; the external bones are thickly enamelled. The posterior margin of the operculum forms a semicircle.

The vertebral column comprises fifty-three vertebræ, and of these sixteen are caudal; their diameter is greater than the length; the articular surfaces, being



0·1 of an inch across, the middle of the vertebra is contracted. The body being closely covered with scales, the characters of its skeleton are not well defined. The neural and hæmal spines are especially well developed near the tail, and indicate that this fin was strong and calculated for rapid progression.

The dorsal fin is 0·8 of an inch behind the occipital region of the head; its base extends 1·6 inch along the dorsal margin of the body, and it terminates 1·4 inch from the caudal. The fin is supported by about thirty rays; the anterior rays are little short of an inch in length; they are strong, and for half an inch undivided; beyond this they are articulated and dichotomize; the posterior rays are shorter. The anal fin is 0·4 of an inch from the base of the caudal, and its base extends 0·5 of an inch; it comprises eight strong rays; the longest anterior one is 0·6 of an inch in length, and similar in construction to the rays of the dorsal. The caudal fin is large and powerful, deeply forked, and composed of thirty rays, fifteen in each lobe; the external rays of each lobe are supported by a number of imbricating rudimentary rays. The base of the fin-rays is connected with the last caudal vertebra by strong radiating bony plates. The rays are articulated and divide repeatedly into eight or more filamentous branches. Of the paired fins the pectorals are absent. The ventrals are 1·3 inch in advance of the anal; the rays are eight in number, and 0·35 of an inch in length.

The scales are arranged with a sigmoidal curvature of the transverse series, seventeen scales extending from the dorsal to the ventral surface. A line of scales from head to tail, parallel with the lateral line, which cannot be distinguished, numbers forty-six to forty-eight. The scales are more or less rounded on the exposed margin; they are 0·1 of an inch in length, and about half that in width. The surface is raised into six to eight ridges, which terminate on the margin in a serrated edge. The dorsal scales behind the dorsal fin are compressed, so as to form a serrated ridge; the abdominal scales are likewise elongated and angular, and present an appearance similar to that characteristic of the genus *Clupea*.

*Formation and Locality.*—Upper Cretaceous: Sahel Alma, Mount Lebanon.

*Ex coll.*—Lewis Collection; R. Damon, Esq., Weymouth.

*Osmeroides latus*, DAVIS.

(Pl. xxxi., fig. 1.)

The specimen of which the following is a description is in two parts, exhibiting the left side of the anterior part of the body and the right side of the posterior; placed on the opposite halves of the matrix. The length of the fish is 8·0 inches from the snout to the base of the tail; of this the head occupies 2·0 inches. The length of the tail, in addition to the above, is 2·0 inches. The

greatest height, in front of the dorsal fin, is 1·8 inch; thence the body and head gradually contract, the latter terminating in a broadly-expanded snout. The peduncle of the tail is 0·8 of an inch in height. The height is greater in proportion to the length than in any other species.

The vertebral column consists of fifty-eight vertebræ: the articulating surfaces are expanded; the intermediate portion is contracted and fibrous. Twenty of the vertebræ are caudal. The ribs are not well defined, but were long and fine. The hæmal and neural spines are short and strong, those supporting the caudal rays more especially so. Interneural and interhæmal spines support the dorsal and anal fins.

The head, during the deposition of the fish, has been turned over, so that the upper surface of the cranium is exposed. The width of skull between the orbits is 0·4 of an inch; the orbit is 0·5 of an inch behind the extremity of the snout; it is large, and surrounded by bones of considerable strength. The opercular apparatus is fully developed, about an inch in diameter, with convex external margin, and the anterior one concave. The gape was wide, extending backwards beyond the orbit. The alveolar margin of the lower jaw is exhibited; it contains the bases of a number of teeth. The external bones of the head were enveloped in a thick coating of shining enamel.

The dorsal fin is 2·1 inches behind the head; it extends 1·2 inch along the back. The number of rays cannot be determined, but they are strong near the base, and supported by interspinous bones. The anal fin numbers seven rays, divided towards their extremity; it is situated 1·3 inch in front of the caudal, and is separated by 2·3 inches from the ventral. The caudal fin is large and powerful; it consists of about thirty-two rays, divided between the two lobes. Extending from the end of the vertebral column there are strong bony rays, branching to each lobe of the tail, and from these spring others diagonally; the rays dichotomize, and are articulated at short intervals. Short fulcral rays support the external rays of the upper and lower lobes of the tail.

The paired fins are comparatively small and feeble. The pectorals are situated on the lower lateral surface, immediately behind the opercular bones. Each consists of fourteen rays, at first undivided, but more distally, articulated at short intervals, and frequently dichotomizing; the longest rays are 1·1 inch in length. The ventral fins are placed nearer the median abdominal surface than the pectorals; they contain eight rays each, and are smaller; otherwise the two pairs of fins are similar. The ventrals are rather in advance of the dorsal fin; they are midway between the pectorals and the anal fins, being separated from each by 2·3 inches.

The scales are elongated, and oval in outline, the greater axis being 0·2 of an inch in diameter. The surface is covered with radiating ridges, which, produced, form a crenulated margin; the middle ridges are somewhat longer than the others, and their extension induces an acuminate projection of the median

anterior outline of the scale; in the latter respect they differ from the scales of *O. gracilis*, which have a rounded external border. The scales of the abdomen are long and angular, and present an imbricated or serrated border to that region.

This species approaches most nearly to *Osmeroides gracilis* in size and form, though the latter is longer and more slender and graceful. The relative position and size of the fins of the two species varies considerably. In this one the dorsal fin is one-third shorter than in *O. gracilis*, and is situated at a greater distance from the head; the ventral fin, on the contrary, occupies a more anterior position, and the consequence is, that in this species the ventral fin is 0.1 of an inch in front of the dorsal, whilst that of *O. gracilis* is opposite the posterior portion of its long dorsal fin, or about an inch behind its anterior rays.

*Formation and Locality.*—Upper Cretaceous: Sahel Alma, Mount Lebanon.

*Ex coll.*—Prof. Lewis; R. Damon, Esq., Weymouth.

*Osmeroides minor*, DAVIS.

(Pl. xxxii., fig. 2.)

The small specimen now to be described appears to possess sufficiently distinctive features to render the institution of a separate species necessary. The length of the fish, from the snout to the base of the tail, is 2.3 inches, and of this length the head occupies 0.9 inch. The greatest height is immediately behind the operculum, where it is 0.7 inch, and thence gradually diminishes to the peduncle of the tail, which is 0.3 inch. The body is well preserved, as are also the fins, with the exception of the anal.

The head is comparatively large and angular, the frontal bones being produced forward; the facial angle is acute. The post-orbital region of the head is 0.6 inch in height; this height is maintained for 0.5 inch forwards, and thence it becomes rapidly less to the termination of the snout. The jaws are long and straight; the anterior extremity is unfortunately absent. A number of small, straight, sharp teeth are visible, separated by small intervals from each other. Eight fine branchiostegal rays, sharply curved backwards, are exposed below the jaws. The operculi are not well preserved; parts of the enamelled surface have broken away, leaving the remainder somewhat fragmentary. They extended nearly the whole height of the head, and were narrow in proportion to the height; the number or form of the several components of the opercular apparatus cannot be identified. The orbit is small, and elevated in position, apparently surrounded by a series of large tympanic bones; others, which are probably the turbinals, are well-developed and large.

The spinal column consists of forty-two vertebræ, of which nineteen or twenty are caudal, higher than long on the anterior portion of the body, but posteriorly

lengthened and less in diameter; the extremity of the vertebral column is turned towards the upper lobe of the tail. The ribs are long and slim. The neural and hæmal spines are thicker than the ribs, and extend obliquely backwards. Interneural spines support the rays of the dorsal fin, and interhæmal ones those of the anal fin; of the former there are about fifteen, and of the latter fourteen; they are very fine and, the body being covered with scales, can only be observed after careful examination.

The dorsal fin was large, and situated behind the ventrals; its anterior rays are midway between the ventral and anal fins, and, estimating from the number of interneural spines, it would contain about fifteen rays; of these, the anterior ones only are shown in the specimen. They are 0·6 of an inch in length, and the first ray is supported by a few short imbricating rays. The anal fin is not preserved, but its position is indicated by the interhæmal rays. It was 0·4 of an inch in length, and its posterior extremity 0·4 inch in advance of the tail. The caudal fin is forked; the lobes are of equal length. The fin consists of twenty-three rays; they are jointed, and bifurcate towards their extremities.

The pectoral fins are situated on the abdominal surface of the body. The rays of the one exposed are closed, so that their number cannot be ascertained; the fins were large, and quite half an inch in length. The ventral fins are also attached to the abdominal surface; they are considerably in advance of the dorsal fin.

The scales are large; the outer margin is more or less semicircular; the median portion of the margin is produced, so as to form a small point. The scales are enamelled and smooth. Their number is not easy to count, but there were probably twelve in a transverse line on the anterior part of the body.

This species may be readily distinguished from others previously described by its small size, the small number of the vertebræ in the spinal column, the relative position of the dorsal to the ventral and anal fins, and the character of its scales. The latter, though of the same outline as those of *O. lata*, in this species are smooth, whilst those of *O. lata* are ridged; other species are ridged, or have a serrated outline. The first characteristic named, that of its small size, if unaccompanied by others, might be simply taken as indicating immature growth, but taken in conjunction with the fewness of its vertebræ, which only number about two-thirds those of some other species, and the short dorsal fin placed posteriorly, and the general aspect the fish presents of maturity, leads to the conclusion that it forms the type of a distinct species.

*Formation and Locality.*—Upper Cretaceous: Sahel Alma, Mount Lebanon.

*Ex coll.*—R. Damon, Esq., Weymouth.

*Osmeroides dubius*, DAVIS.

(Pl. xxxi., fig. 4.)

The body of this fish is short and stout. The length, from the snout to the base of the tail, is 2·6 inches, of which the head occupies 0·7 of an inch. The tail is also 0·7 of an inch in length. The height immediately behind the head is 0·8 of an inch; at the base of the tail it is 0·45 of an inch. The dorsal fin occupies a position slightly anterior to that of the ventrals.

The head occupies rather less than one-fourth the length of the body. Post-orbitally the height is equal to the length. The orbit occupies a superior position about midway in the length of the head; the infra-orbital bones are strong and well developed. The maxilla extends behind the orbit, 0·45 of an inch in length; it is 0·05 of an inch deep at its articulating extremity, and becomes thinner towards the snout; the pre-maxillary is unfortunately displaced. The mandible is strong, and also converges anteriorly. No trace of teeth can be distinguished. The branchiostegal rays, eight in number, are fine and small, 0·2 of an inch in length, and curved backwards. The opercular plates are large, smooth, and enamelled.

The spinal column is formed of sixty vertebræ, seventeen of which are included in the caudal region. They are much higher than long, especially those situated near the caudal extremity. The ribs and anterior neural spines are not defined, being hidden by the scales. The neural and hæmal spinous processes of the posterior vertebræ are short and thick. Interspinous bones, seven of which are visible, support the dorsal fin; others are also indicated in connexion with the anal.

The dorsal fin is situated on the anterior portion of the body; it is 0·65 of an inch behind the head, and 1 inch in advance of the caudal fin; its base occupies 0·4 of an inch, and it consists of twelve rays, the anterior ones 0·8 of an inch in length. The anal fin is 0·2 of an inch in advance of the caudal; in the specimen described it unfortunately happens that the opposite matrix has carried away a portion of the fin, and only a fragment remains. The caudal fin is broad at the base, and short; the outer rays are 0·7 of an inch in length, the median ones not more than half that length, so that the tail is forked; the outer rays are supported by ten to twelve rudimentary imbricating rays.

Of the paired fins, the pectorals are not represented; the ventrals are midway betwixt the head and the anal fin; they occupy a more posterior position than the dorsal fin. Each ventral fin is supported by seven rays, the length of which cannot be accurately determined.

The body is enveloped in closely imbricating scales; the exposed surface is circular and smooth, covered with brown enamel. The lateral surface of the

body exhibits a series of indented lines, extending from the head to the tail, and converging in their passage backwards; between the raised impression of the vertebral column and the dorsal surface there are seven, and on the abdominal half there are five of these lines. Their special significance cannot be easily understood; they are not caused by the scales; they may possibly indicate some internal muscular character.

This species has been placed in the genus *Osmeroides* with some doubt. The number of its vertebræ and the position of the fins, and the branchiostegal rays, eight in number, are characters which ally it with other members of the genus already described.

*Formation and Locality.*—Upper Cretaceous: Sahel Alma, Mount Lebanon.

*Ex coll.*—Lewis Collection; R. Damon, Esq., Weymouth.

*Osmeroides maximus*, DAVIS.

A large example of this genus in the Natural History Museum appears to offer some peculiarities which distinguish it from other species already described. It is imperfect; the caudal extremity is broken off. The fins, except the ventral and anal, are not distinguishable. The head, however, is fairly well preserved, and the body, thickly coated with scales, shows a good impression of the vertebral column. The length of the specimen preserved is 12·5 inches from the tip of the snout to the base of the tail. The head occupies 3·6 inches. The height of the body behind the head is 2·2 inches. The peduncle of the tail is 1·0 inch.

The head, 2·0 inches in height in the region of the occiput, diminishes forwards to the end of the snout, which forms an obtuse point. The jaws attain a length of 1·8 inch, but no teeth are distinguishable. The head is covered with thickly-enamelled plates, the surface of which is rugose, the rugosity occasionally arranged in lines of greater or less extent. The orbit is not well defined, and the head, apparently twisted over, exposing the under surface, is considerably deranged. The opercular bones were large, rounded posteriorly, and a number of branchiostegal rays are exposed.

The vertebral column is large and strong. The vertebræ are sixty-seven in number, of which twenty are caudal. The anterior ones are shorter and higher than those farther back, varying from 0·25 inch in height and 0·15 inch in length anteriorly to 0·18 inch in height and 0·2 inch in length posteriorly. The ribs and spinous processes can be distinguished beneath the scales, but not with sufficient clearness to give a description of them.

The pectoral fins are not present. The ventrals are situated 6·8 inches behind the snout. The rays are 2·0 inches in length, strong, articulated, and bifurcating. These fins are laid close to the body, and consequently the number of rays cannot

be counted. The anal fin has its origin 3·5 inches behind the anterior rays of the ventrals, and its base extends about an inch along the surface, being separated by only 0·6 inch from the base of the tail. It probably consisted of about eighteen rays, but its badly preserved condition renders an exact description impossible.

This specimen is unique. It most nearly approaches *Osmeroides gracilis* in size and form, but differs from it in the position and size of the anal fin; in *O. gracilis* it is separated from the caudal by 1·5 inch, its base occupies 0·5 inch, and it is composed of twelve rays. In the species now described the anal fin is only 0·6 inch in front of the caudal; its base occupies 1·0 inch, and it comprises eighteen rays.

*Formation and Locality.*—Soft Chalk: Sahel Alma, Mount Lebanon.

*Ex coll.*—Lewis Collection, Natural History Department, British Museum.

#### Genus. *Sardinius*. VON DER MARCK.

Slenderly built fish, with fins large in proportion to the size of the body; tail deeply forked. The dorsal fin occupies middle portion of the back, and consists of five undivided and thirteen to fourteen branching rays. The pectoral and ventral fins are well developed; mandible and intermaxillary bones are provided with numerous fine setiform teeth. The scales are circular, with concentric circles and radial furrows.

In some of the examples described by Von der Marck the intestines are preserved by phosphate of lime, and small crabs and other animal substances which are present indicate the character of their food. It has already been stated, when considering the relationship of the genus *Osmeroides* on a previous page, that the genera *Sardinoides* and *Sardinius* were instituted on a sound basis, and, notwithstanding the objection of Professor Pictet, ought to be retained. No evidence can be traced, in the species it is now proposed to include in this genus, of an adipose dorsal fin, and its generic characters agree with those of the species described from the chalk of Westphalia, whilst specific differences readily separate it from the species already included in the genus.

*Sardinius crassapinna*, DAVIS.

(Pl. XXXII., fig. 5.)

The body and fins of this specimen are remarkably well preserved; the head is somewhat disjointed, but can be fairly determined. The length of the fish, exclusive of the tail, is 3 inches, and of this the head occupies one-third; the tail, from the termination of the spinal column, is 1·0 inch in length; the height

in front of the dorsal fin is 1·0 inch; at the peduncle of the tail it has diminished to 0·4 of an inch. The body is short and proportionately deep and strong. The pectoral fins are peculiar from their length and evident capability for expansion.

The head is nearly as high at the posterior part as it is long, and rapidly diminishes forwards, assuming a triangular form; as already observed, it has not been well preserved. The gape is very wide; the mandible 0·7 of an inch in length, and the maxillary bones about the same; teeth cannot be distinguished. The orbit is about 0·4 of an inch behind the snout. The opercular bones appear to have been large, and are coated with enamel. There are ten branchiostegal rays on the side exposed, the longest 0·3 of an inch in length, fine, and gracefully curved backwards.

The spinal column is composed of thirty-four vertebræ, of which the caudal region of the fish comprises sixteen; they are not preserved, but their form and number is sufficiently well indicated by the impression they have left; the vertebræ were small, and equal in length to their height. The ribs are long and fine. The neural spines connected with the vertebræ by neurapophyses are long, and curve considerably backwards. Attached to the hæmal spines in the caudal region are interhæmal spines which support the anal fin. The interneural spines are short, broad, and strong.

The dorsal fin is large; the anterior rays are 0·75 of an inch in length; the succeeding posterior rays diminish gradually in length to 0·15 of an inch. The rays are fourteen in number, and the distal extremities of the rays are subdivided, but not articulated. The base of the fin extends 0·6 of an inch; it is 0·7 of an inch behind the head, and is separated from the caudal fin by 1·0 inch. The anal fin is composed of fourteen rays; its base extends 0·6 of an inch, the posterior rays being separated from the tail by 0·2 of an inch. The caudal fin is 1·0 inch in length, deeply forked, and composed of twenty-two rays, eleven in each lobe; the rays are bifurcated and articulated; the external rays of each lobe are supported by rudimentary rays. The last vertebra of the spinal column is expanded to a rounded, flattened hypural plate, which gives support to the caudal rays.

The paired fins are large and important. The pectorals are fixed immediately behind the gill covers on the abdominal surface of the body; they are supported by thirteen or fourteen rays, which repeatedly dichotomize, but are not jointed, producing a filamentous arrangement at the margin. These fins are more than 1·0 inch in length, and were evidently capable of great expansion. The ventral fins are similar to, but smaller than, the pectorals; each contains eight rays, and is supported by a large triangular internal bone; its position is opposite to the posterior rays of the dorsal fin. The body is covered with elongated scales, somewhat dense in structure, with smooth surfaces.



This species most nearly resembles *Sardinius cordieri* (*Osmerus cordieri*, Agassiz), but may be distinguished therefrom by its more robust form; the latter has a vertebral column consisting of thirty-eight to forty vertebræ, twenty-five of which are caudal. In this species the total number is thirty-four, of which only sixteen are caudal. The pectoral fin in this species appears to be more strongly developed than in *S. cordieri*.

*Formation and Locality.*—Upper Cretaceous: Sahel Alma, Mount Lebanon.

*Ex coll.*—Lewis Collection; R. Damon, Esq., Weymouth.

Genus. **Opistopteryx.** PICTET and HUMBERT.

“Nouv. Rech. sur les poissons fossiles du Mont. Liban.,” 1866, p. 78.

“Body elongated, mouth largely extended; intermaxillaries straight, attaining nearly half the length of the maxillaries, which are the more robust; dorsal fin short, situated behind the middle of the body, and nearly opposite to the anal; ventral fins situated towards the middle of the distance, which separates the pectorals from the anal fin.” (P. and H.)

*Opistopteryx gracilis*, P. and H.

*O. gracilis.* PICTET et HUMBERT, 1866. “Nouv. rech. s. l. poiss. foss. du Mont Liban.,” p. 80, pl. XI., figs. 1–4.

*Mesogaster gracilis.* J. F. PICTET, 1850. “Poiss. foss. du Liban.,” p. 21, pl. III., fig. 2.

*Mesogaster gracilis.* FRAAS, OSCAR, 1878. “Aus dem Orient. II. Theil. Geol. beobach. am Libanon,” p. 98.

*Formation and Locality.*—Soft chalk: Sahel Alma.

*Ex coll.*—Musée de Genève.

*Opistopteryx curtus*, DAVIS.

(Pl. XXXII., fig. 3.)

This beautiful little specimen exhibits the whole anatomy of the body, the head, and the fins. The length of the body, exclusive of the tail, is 2·1 inches; to this must be added 0·4 inch, the length of the tail. The depth of the body is 0·45 of an inch, and proportionately to the length it is as one to four and a-half; in this it differs from *O. gracilis*, Pictet and Humbert (“Nouv. Rech. sur les poissons fossiles du M. Liban.,” p. 80, pl. XI., figs. 1–4), in which the depth is one-eighth the length of the body, in each case not including the tail.

The head, from the tip of the snout to the pectoral arch, equals two-sevenths

of the length of the fish, that is 0·6 of an inch; the height is 0·5 of an inch; it is triangular in outline, with a rounded posterior margin formed by the gill covers. The operculi are convex behind, and have a corresponding concave margin in front; they are elongated, but do not exhibit the constituent parts with sufficient clearness for identification. The orbit is placed anteriorly, and of small size; the maxillary and intermaxillary bones exhibit no traces of teeth; they form an acute angle with the line of the cranium. The mandibles are 0·45 of an inch in length, and extend slightly beyond the intermaxillary bones, giving prominence to the lower jaw, but not nearly to the same extent as depicted in the elongated head of *O. gracilis* (*op. cit.*, see also “*Poissons fossiles du M. Liban.*,” by Pictet, 1850, pl. III., fig. 2, where the fish is named *Mesogaster gracilis*).

The spinal column consists of fifty-eight vertebræ; they are short, but deep; of this number twenty-six are caudal. The ribs are numerous, curved, and excessively fine; the neural and hæmal spines have triangular apophyses attached to the vertebræ; they extend at a corresponding angle diagonally towards the dorsal and ventral surfaces. The posterior termination of the tail is turned up towards the upper lobe of the tail; this may, however, be an accidental circumstance.

The dorsal fin is supported by ten interneural spines; there is about an equal number of rays to the fin, the longest being 0·3 of an inch in length. The anal fin has its origin slightly in the rear of the dorsal, at a distance of 0·7 of an inch from the caudal; it is supported by a number (about eight) of interhæmal rays; the anterior rays of the fin are long, and, compared with the remainder, they are very strong.

The caudal fin is deeply cleft; the termination of the vertebræ is prolonged to the upper lobe; the fin-rays are strong and extend 0·5 of an inch; the lobes of the tail are 0·6 of an inch apart.

The pectoral fins are attached to the scapular arch at a point apparently very near the ventral surface of the body; the rays extend 0·2 of an inch; their number is not determinable. The ventral fins are situated almost midway between the pectorals and the anal fin, but they are slightly nearer the pectorals; the one exposed contains fourteen or fifteen fin-rays, 0·15 of an inch in length; they are supported by pelvic bones, having the form of an elongated triangle.

Some of the characters which distinguish this species from the type species of Pictet and Humbert have been already pointed out. It is shorter and thicker; its head, in proportion to its height, is only half the length of *O. gracilis*, and the lower jaw is not so prominent. The fins also are considerably modified, and the anal occupies a position further behind the anterior rays of the dorsal in this species.

*Formation and Locality.*—Upper Cretaceous: Sahel Alma, Mount Lebanon.

*Ex coll.*—R. Damon, Esq., Weymouth.

Genus. *Clupea*. LINNEUS.

Body compressed, with the abdomen serrated, the serrature extending forwards to the thorax. Scales of moderate or large, rarely of small size; upper jaw not projecting beyond the lower; cleft of the mouth of moderate width; teeth, if present, rudimentary and deciduous. Anal fin of moderate extent, with less than thirty rays; dorsal fin opposite to the ventrals; caudal forked. (Günther.)

*Clupea lewisii*, DAVIS.

(Pl. XXXIII., fig. 1.)

The fish is 13 inches in length; its greatest depth is 2.75 inches between the pectoral and ventral fins; from this position the depth decreases anteriorly and posteriorly. The head occupies 3.5 inches, being one-fourth the entire length. The whole of the fish is well preserved; the scales, except on the ventral surface, have disappeared, exposing the osseous structure.

The head is large in proportion to the size of the fish. The height of the post-orbital region is 2.2 inches; the orbit is large, situated anteriorly; the mouth is large, with a wide gape. The intermaxillary bone is straight, and extend 0.5 of an inch beyond the maxillary; the maxillary is a larger bone, with a slightly downward curvature. The mandible is 2.2 inches in length, 0.4 of an inch in depth, and tapering towards the front; the jaws appear to be edentulous; no teeth are discernible. Beneath the posterior portion of the mandible there are a number of branchiostegal rays, apparently long and somewhat slender bones. The operculi consist of an operculum, with a well-rounded posterior margin, the anterior one concave with the overwrapping edge of the pre-operculum; a sub-operculum and inter-operculum bound the lower margin of the series. The tympanic area appears to have been more than usually ossified, and the bones of the cranium are also substantial. The parasphenoid is exposed crossing the orbit. The bones of the infra-orbital ring are well developed.

The spinal column is composed of forty-nine vertebræ: between the head and the insertion of the dorsal fin there are twenty vertebræ; between the dorsal and the anal, fifteen; and thence to the caudal, fourteen. The vertebræ immediately behind the gill-covers are the greatest in height, but are shorter than those which occur behind; the centre of the vertebræ are deeply bi-concave. The neural spines are connected with the vertebræ by neurapophyses; in the anterior region they are arranged very obliquely; opposite the dorsal fin and towards the caudal they are much nearer upright. The hæmal spines and ribs correspond in arrangement with those on the neural side of the vertebræ; the ribs are long and slender; the spines supporting the anal fin are much stronger.

The vertebræ supporting the caudal fin are closely aggregated, and form a support for an imbricated series of fulcral rays at the base of each lobe.

The dorsal and anal fins are comparatively small; the caudal large. The dorsal fin occupies a position somewhat nearer the head than to the tail; its base extends 1 inch along the dorsal surface, and contains eighteen fin-rays; the longest fin-rays are the anterior ones, being 1·2 inch in length; those behind rapidly diminish in length. Their distal terminations are branched, and divided by transverse joints. The fin is supported by interneural spines, fine, rather short, and divided at the end in conjunction with the fin. The anal fin occupies a position 2 inches in front of the caudal; it is composed and supported in a similar manner to the dorsal, except that the hæmal spines and interhæmal bones are much more oblique than those supporting the dorsal fin. The anal fin is small, having only ten rays; its base is 0·8 of an inch, and the anterior or longest fin-ray barely an inch in length. The caudal fin is large and powerful; its peduncle is 1·2 inch in height, and the tail expands to a diameter of 3·4 inches at the termination of the lobes, which are 3·0 inches in length. The hypural bone is surrounded by a series of strong ossicles, about 0·2 of an inch in length, from which spring the fin-rays, about thirty in number; these become rapidly divided, and branch into innumerable jointed filaments. The tail is deeply forked, the central portion extending only 1·3 inch beyond the hypural bone.

The paired fins are of small size. The pectoral fin takes its position immediately behind the gill-covers. The pectoral arch is well developed, and the fin attached thereto in a position considerably higher and nearer to the lateral line than is the case with any previously described specimen from Lebanon. About fifteen rays are distinguishable, the longest 1·3 inch in length. The ventral fin was about 1 inch in length; the number of rays cannot be traced. The fin was supported by a somewhat triangular, long, and slender bone. The ventrals occupy a position immediately under the dorsal fin, exactly intermediate between the pectorals and the anal.

The specimen now described, though very much larger in size than any of the species hitherto described from the Lebanon district, without doubt possesses many of the characteristics of the genus *Clupea*: the position, size, and arrangement of the fins, the form of the head, and the apparently edentulous jaws, and the internal anatomical structure, are all of a Clupean nature. There are one or two features which appear to connect it with the genus *Salmo*; for instance, the great thickness of the peduncle of the tail, and the size and extent of the branchiostegal rays, which are much more prominent and extend posteriorly to a greater extent than in *Clupea*.

This species resembles the species *Clupea sardinoides*, Pictet, *C. lata*, Agassiz, and *C. laticaudata*, Pictet, in the number of its vertebræ. From each of them it differs in the greater breadth of the peduncle of the caudal fin, and in the large

number of fin-rays composing that fin; it may be readily distinguished from *C. sardinoides* by the position of the dorsal fin, which in the latter species is considerably nearer the head than in the specimen now described. The greater number of rays composing the anal fin distinguishes it from *Clupea lata*. From the description given by M. Pictet of the specimen called *C. laticaudata* ("Desc. de quelques poissons fossiles du Mont Liban.," p. 39, pl. VII., fig. 3), it appears doubtful whether it should remain in this genus; at any rate, it differs very much from the type of the genus in the form of its tail, and in the relative positions of the dorsal and anal fins, the anterior rays of the latter being immediately under the posterior rays of the former; in these respects it is also quite distinct from the present species.

*Clupea macropoma*, Ag. ("Poiss. foss.," vol. v., pt. 2, p. 115, pl. 37*b*, figs. 3, 4), from Monte Bolca, resembles the species now described in some respects, but differs from it in the size of the dorsal and anal fins, the former being much larger, and the latter, though smaller, contains twenty rays, very fine and short. It may also be distinguished by the number of vertebræ composing the spinal column. This feature also applies to *Cl. dentex*, De Blainv. (*op. cit.*, p. 116, pl. LXI., fig. 5).

I propose to discriminate this species by appending to it the name of Mr. Lewis, to whose careful labours palæontologists will be long indebted.

*Formation and Locality.*—The hard gray chalk: Hakel, Mount Lebanon.

*Ex coll.*—Lewis Collection; R. Damon, Esq., Weymouth. (Counterpart in the British Museum, Natural History Department.)

*Clupea brevissima*, BLAINVILLE.

- C. brevissima.* BLAINVILLE, 1818. "Ichthyologie," p. 60, "Extrait du Nouveau Dict. d'hist. nat.," vol. xxvii.
- C. brevissima.* BLAINVILLE, 1823. Id. trad. allem., p. 149.
- C. brevissima.* KRUGER, 1823. "Geschichte der Urwelt," vol. ii., p. 657.
- C. brevissima.* AGASSIZ, L., 1833-43. "Rech. sur les poiss. foss., vol. v., p. 117, pl. LXI., figs. 6-9.
- C. brevissima.* GIEBEL, 1848. "Fauna der Vorwelt," vol. i., part 3, p. 126.
- C. brevissima.* PICTET, J. F., 1850. "Desc. de quel. poiss. foss. du Mt. Liban.," p. 41, pl. VIII., figs. 1, 2.
- C. brevissima.* PICTET et HUMBERT, 1866. "Nouv. rech. sur les poiss. foss. du Mont Liban.," p. 61, pl. VI., figs. 1-4.
- C. brevissima.* FRAAS, OSCAR, 1878. "Aus dem Orient. II. Theil. Geolog. beobach. am Liban.," p. 91.

*Formation and Locality.*—Hard chalk: Hakel, Mount Lebanon.

*Ex coll.*—Museum, Geneva (type). The most abundant species found at

Hakel. It occurs in all sizes, from the young, about an inch in length, to the full-grown adult.

*Clupea minima*, AGASS.

- Clupea minima*. AGASSIZ, L., 1833-43. "Rech. sur les poiss. foss.," vol. v., pt. 2, p. 120, pl. LXI., fig. 1.
- Clupea minima*. PICTET, J. F., 1850. "Desc. de quel. poiss. foss. du Mt. Liban.," p. 41, pl. VII., fig. 4.
- Clupea minima*. PICTET et HUMBERT, 1866. "Nouv. rech. sur les poiss. foss. du Mt. Liban.," p. 65.
- Clupea minima*. FRAAS, OSCAR, 1878. "Aus dem Orient. II. Theil. Geolog. beobachtungen am Libanon," p. 91.

This species was described by Agassiz as not only the smallest of the genus, but probably of the whole family. The head has the ordinary proportions, and is about one-fifth of the entire length of the fish. The dorsal fin is described as rather long; it is exactly median, and contains at least twelve rays. The vertebral column contains twenty-nine vertebræ, of which fourteen are caudal. The ribs are more slender than the apophyses.

Pictet expressed much doubt as to whether this species should be retained in the genus *Clupea*, and considered the incomplete description of Agassiz insufficient to justify its being so. This author afterwards describes a series of *C. minima* as *Leptosomus crassicosatus* ("Nouv. rech. sur les poissons fossiles du M. Liban.," p. 74).

*Formation and Locality*.—Schistes Calcaires du Liban.

*Ex coll.*—Mons. Amic, Paris.

*Clupea lata*, AGASS.

- Clupea lata*. AGASSIZ, L., 1833-43. "Rech. sur les poiss. foss.," vol. v., pt. 2, p. 118, pl. LXI., fig. 10.
- Clupea lata* (non), PICTET, J. F., 1850. "Desc. de quel. poiss. foss. du Mt. Liban.," p. 37, pl. VII., fig. 1.
- Clupea lata*. PICTET et HUMBERT, 1866. "Nouv. rech. sur les poiss. foss. du Mont Liban.," p. 68, pl. VII., fig. 6.
- Clupea lata*. FRAAS, OSCAR, 1878. "Aus dem Orient. II. Theil. Geolog. beobach. am Libanon," p. 91.

*Clupea lata* was described by M. Agassiz from a specimen in the cabinet of M. Alex. Brogniart; it is distinguished principally from the great depth of the body immediately behind the head, instead, as is generally the case, its greatest

depth being in front of the dorsal fin. A second distinguishing feature is the backward position of the dorsal fin.

In 1850, Pictet gave a figure of a second specimen of *C. lata*, Ag., which shows the pectoral fins ("Desc. de quelques poiss. foss. du Mont Liban.," pl. vii., fig. 1); but in the second work on the fishes of Lebanon, by MM. Pictet and Humbert, this specimen is transferred to *Spaniodon brevis*, P. and H., and another (pl. vii., fig. 6) is figured and described as *Clupea lata*, Ag. It is nearly related to *C. sardinoides* by the large number of its vertebræ, but differs in having twenty-one caudal vertebræ in place of fifteen, and by the posterior position of the dorsal fin. It is distinguished from *C. dentex*, Blainv., and *C. beurardi*, Blainv., by the greater number of its vertebræ. The shortness of its anal fin also serves to distinguish it from *C. beurardi*, Blainv.

*Formation and Locality.*—Upper Cretaceous: probably Hakel, Mount Lebanon.

*Ex coll.*—Alexander Brogniart.

*Clupea gaudryi*, PICTET and HUMBERT.

*C. gaudryi.* PICTET et HUMBERT, 1866. "Nouv. rech. sur les poiss. foss. du Mont Liban.," p. 60, pl. v., figs. 2-5.

*C. gaudryi.* FRAAS, OSCAR, 1878. "Aus dem Orient. II. Theil. Geolog. beobach. am Libanon," p. 91.

*Formation and Locality.*—Hard chalk: Upper Cretaceous beds, Hakel, Mount Lebanon.

*Ex coll.*—Museum at Geneva.

*Clupea bottæ*, PICTET and HUMBERT.

*C. bottæ.* PICTET et HUMBERT, 1866. "Nouv. rech. sur les poiss. foss. du Mont Liban.," p. 64, pl. vii., figs. 1-5.

*C. bottæ.* FRAAS, OSCAR, 1878. "Aus dem Orient. II. Theil. Geolog. beobach. am Libanon," p. 91.

MM. Pictet and Humbert's description covers everything that may be seen in the several specimens recently obtained. The scales, which were absent on their examples, are large, thin, with rounded posterior margins; on the dorsal surface they envelop the base of the dorsal fin, and are arranged in imbricating order, with an angular margin. The ventral scales are similar, but more oblong, and the posterior extremity is drawn out to a point.

*Formation and Locality.*—Upper Cretaceous: Hakel, Mount Lebanon.

*Ex coll.*—Museum at Geneva; not uncommon.

*Clupea sardinoides*, PICTET.

- C. sardinoides*. PICTET, J. F., 1850. "Desc. de quel. poiss. foss. du Mt. Liban.," p. 38, pl. VII., fig. 2.
- C. sardinoides*. PICTET et HUMBERT. "Nouv. rech. sur les poiss. foss. du Mt. Liban.," p. 66, pl. VIII., figs. 1-4.
- C. sardinoides*. FRAAS, OSCAR, 1878. "Aus dem Orient. II. Theil. Geolog. beobach. am Libanon," p. 91.

The admirable description and observations of MM. Pictet and Humbert render any further remarks unnecessary.

*Formation and Locality*.—Hard chalk: Hakel, Mount Lebanon.

*Ex coll.*—Museum at Geneva, &c.; common.

*Clupea laticauda*, PICTET.

- C. laticauda*. PICTET, F. J., 1850. "Desc. de quel. poiss. foss. du Mt. Liban.," p. 39, pl. VII., fig. 3.
- C. laticauda*. PICTET et HUMBERT, 1866. "Nouv. rech. sur les poiss. foss. du Mt. Liban.," p. 69.
- C. laticauda*. FRAAS, OSCAR, 1878. "Aus dem Orient. II. Theil. Geolog. beobach. am Libanon," p. 91.

This species approaches nearest to *C. sardinoides* and *C. lata*, but may be distinguished by its anal fin, which is supported by fourteen interspinous bones in place of seven or eight, and by the rays of the base of the caudal, which are smaller and more numerous.

*Formation and Locality*.—Upper Cretaceous: Hakel, Mount Lebanon.

*Clupea beurardi*, BLAINVILLE.

- C. beurardi*. BLAINVILLE, 1818. "Ichthyologie," p. 61.
- C. beurardi*. AGASSIZ, L. 1833-43. "Rech. sur les Poiss. foss.," vol. v., p. 117, pl. LXI., figs. 6-9.
- C. beurardi*. PICTET et HUMBERT, 1866. "Nouv. rech. sur les poiss. foss. du Mont Liban.," p. 70.
- C. beurardi*. FRAAS, OSCAR, 1878. "Aus dem Orient. II. Theil. Geolog. beobach. am Libanon," p. 91.

The original type of this species is now with the Enniskillen Collection at the new Natural History Museum, London. It has the following inscription, in the



writing of Mons. de Beurard:—"Ichthyolite ou poisson fossile d'une espèce peu commune, que M. de Blainville a décrit sous le nom de Beurardi, dans le nouveau dictionnaire d'histoire naturelle et dans son 'Memoire sur les Ichthyolites,' p. 61; sans doute parce qu'il ne l'a vue que dans ma collection, où elle a été placée par un de mes neveux, officier de marine, qui l'a rapportée du Mont-Liban, près de Gibel en Syrie, en 1817."

The species is described by Agassiz as having the closest relationship with *Clupea dentex*, de Blainville, from Murazzo-Strutiano; it may be distinguished by the comparatively larger size of the head. The vertebral column is small, composed of forty vertebræ, of which twenty are caudal; the ribs are large relatively to the vertebræ. The insertion of the dorsal fin is exactly in the middle of the body, without the tail. The rays of the dorsal as well as the other fins are fine; the anal is very long and extends to the caudal; the pectoral fins are moderate in size; the caudal is distinctly forked.

*Formation and Locality.*—Hard chalk: Gibel. (The specimen figured by Agassiz is from St. Jean d'Acre.)

*Ex coll.*—Enniskillen Collection, British Museum.

*Clupea gigantea*, HECKEL.

- C. gigantea.* HECKEL, J. J., 1843. "Abbildungen und Beschreibungen des Fische Syriens," p. 243.
- C. gigantea.* PICTET et HUMBERT, 1866. "Nouv. rech. sur les poiss. foss. du Mont Liban.," p. 70.
- C. gigantea.* FRAAS, OSCAR, 1878. "Aus dem Orient. II. Theil. Geolog. beobach. am Libanon," p. 91.

The only information respecting this species is the following sentence inserted by Heckel in his article on *Clupea macrophthalma*:—"Une autre plaque, provenant de la même localité (Hakel) contient une portion de la région antérieure du tronc d'un gros poisson haut d'au moins 6 pouces, sur laquelle on ne peut reconnaître rien autre que 18 vertèbres abdominales à demi brisées, qui sont plus hautes que longues, de côtes longues, grêles, sillonnées d'apophyses dorsales assez fortes recouvertes d'une forêt d'arêtes musculaires. Nous lui donnons provisoirement le nom de *Clupea gigantea*." (P. and H.)

*Formation and Locality.*—Upper Cretaceous: Hakel, Mount Lebanon.

*Clupea pulchra*, DAVIS.

(Pl. XXXIII., fig. 3.)

This exquisite little specimen is almost perfect in all its parts. From the tip of the snout to the base of the tail it is 2·0 inches in length; the tail adds 0·4 of an inch to this length; the height is 0·5 of an inch. The bones of the head are preserved. The head is 0·6 of an inch in length; the fins and tail are present; the scales on the upper surface have been removed. The outline of the fish is gracefully fusiform.

The head is 0·6 of an inch in length and 0·45 of an inch in height, tapering anteriorly to the snout; the orbit is large, and situated anteriorly and high; the pre-maxillary and maxillary are slightly arched downwards. The mandible is 0·4 of an inch in length. The gape is wide; there is no evidence of teeth. The operculum is large and posteriorly rounded; the upper surface of the cranium is slightly rounded.

The spinal column bends with a gentle sigmoidal curvature from the head to the tail; it comprises fifty-five vertebræ, of which only sixteen are caudal. The vertebræ are small; ribs numerous and very fine; neural and hæmal spines are straight and long: they are about double the distance apart which separates the ribs; interneural and interhæmal spines support the dorsal and anal fin-rays.

The dorsal fin is situated considerably behind the middle of the length of the fish; from the snout to the anterior ray of the fin is 1·5 inch, or from the occiput 0·9 of an inch; from the anterior ray of the dorsal to the base of the caudal is 0·6 of an inch. This fin has sixteen rays; the longest rays are 0·2 of an inch in length, and the base of the fin extends the same distance along the dorsal surface.

The anal fin is midway between the dorsal and caudal on the opposite surface of the body; it is considerably smaller than the dorsal, and appears to consist of ten rays; but its structure is a little indeterminate.

The abdominal surface of the body exhibits the serrated edge, which Dr. Günther regards as one of the characters of *Clupea*. The serrations are very small, and can only be seen with a magnifying glass, after carefully arranging the light.

The caudal fin is composed of a number of strong rays supporting the outer margins of the two lobes; the tail is forked, and the rays become gradually finer as they approach the median part of the fin. A series of short rays support the dorsal and abdominal margins of the fin.

The pectoral fins are attached immediately behind the head to the scapular arch; the fins are large, the number of rays not well defined; they extended 0·3 of an

inch in length. The ventral fins are opposite the anterior portion of the dorsal fin: they are a moderate size and consist of eight fin-rays.

This species appears to be most closely related with *Clupea elongata*, Davis. The small proportion of caudal vertebræ and the posterior position of the dorsal, ventral, and anal fins are similar in both specimens. In this one, however, the proportion of caudal vertebræ is smaller than in *C. elongata*. The fish is much shorter in proportion to its height—a character in which the head shares equally with the body. In *C. elongata* the dorsal fin is supported by twelve fin-rays; in the species now described there are sixteen fin-rays; whilst in the anal fin of the latter there are ten rays, in the former the fin is much longer, and contains eighteen fin-rays.

*Formation and Locality.*—Upper Cretaceous: Sahel Alma, Mount Lebanon.

*Ex coll.*—Professor Lewis's Collection; R. Damon, Esq., Weymouth.

*Clupea curta*, DAVIS.

(Pl. xxxiii., fig. 5.)

A fragment only, comprising the post-orbital region of the head and the anterior portion of the body. The dorsal, pectoral, and ventral fins are present; the ventrals are opposite to the dorsal; the latter are less than the height of the fish behind the occiput, from which it may be inferred that the fish was a short one. The length preserved is about six inches; the height of the body in front of the dorsal fin is 3 inches; of the length 2·5 inches are comprised in the head, the remainder in the body. The scales are of moderate size, imbricating, rounded, with smooth edges. The lateral line is high, considerably above that of the vertebral column.

The head is imperfectly represented. The operculum, sub-operculum, and inter-operculum are preserved: they are large and strong, well rounded posteriorly.

The spinal column consists of forty-eight vertebræ in the portion preserved; there were probably eighty to ninety in the complete fish. The vertebræ are 0·25 of an inch in diameter, and their length is equal to one-third the diameter; those situated behind the dorsal fin are longer and of less diameter. The neural spines are supported by long and fine neurapophyses, and interneural spines support the dorsal fin. The ribs are long, well curved, and tolerably strong.

The dorsal fin is placed 2·0 inches behind the head, and extends along the dorsal surface of the fish 1·5 inch. The fin-rays are strong, divided deeply at the base where attached to the interneural rays. The third or fourth rays are longest, being about 1·3 inch when perfect; 1 inch only is preserved; the distal extremity is articulated. There are eighteen rays; anal and caudal fins absent.

The pectoral fins are attached to the scapular arches, and are abdominally situated; they are not well preserved. The rays are strong, and of considerable length. The ventral fins are situated immediately beneath the anterior portion of the dorsal. The fin-rays are strong, and are attached to a moderately large pelvic bone.

This specimen, in its general features, appears to be closely related to the genus *Clupea*; the arrangement of the fins and the internal anatomy is similar; it is peculiar in the great number of the vertebræ, and in this respect differs from any other species previously described. It is proposed to distinguish this species by the name *curta*, indicating its short though high and somewhat bulky form.

*Formation and Locality.*—Upper Cretaceous: Hakel, Mount Lebanon.

*Ex coll.*—Professor Lewis; in the cabinet of R. Damon, Esq., Weymouth.

*Clupea attenuata*, DAVIS.

(Pl. XXXIII., fig. 4.)

This fish presents a peculiarly elongated form; the whole length is equal to seven times the height. The body and head are well preserved. The caudal, a pectoral, and a portion of the dorsal fins are present, and sufficient remains to indicate the position and character of the ventral and anal fins; it is 3·6 inches in length without the tail, and that fin adds 0·9 of an inch; the head is 1·0 inch in length; the greatest height is 0·9 of an inch before the dorsal fin; the peduncle of the tail is 0·3 of an inch. The body is covered with scales; they were probably thin, and now present a more or less homogeneous mass; the form of individual scales, with the exception of those on the abdominal surface, cannot be distinguished; the abdominal ones are elongated, with an obliquely imbricating arrangement towards the caudal extremity.

The post-orbital region of the head is 0·6 of an inch in height, the length being 1·0 inch. The lower jaw is long, armed with minute teeth, *en velours*, at its anterior extremity; the under surface of the jaw is pitted; the orbit is situated on the anterior portion of the head; it is large. The operculi are large, and consist of four bones, the pre-operculum, the operculum, the sub-operculum, and the inter-operculum, the two latter forming the lower portion of the gill cover. Branchiostegal rays were present.

The spinal column is composed of fifty-eight vertebræ; they are ·05 of an inch in diameter, and the same length; the ribs are thin and fine, with branching epiplural bones. The neural and hæmal spines are numerous as the vertebræ. Ten interneural spines support the dorsal fin, the two anterior ones being both longer and stronger than the others.

The dorsal fin extends 0·5 of an inch along the surface of the back; it is 1·0 inch from the head and 1·5 inch from the tail; it is composed of ten rays, the longest 0·8 of an inch in length. The anal fin is 0·4 of an inch in front of the caudal; it is very imperfectly preserved. The caudal is composed of eighteen branching rays, the two lobes separated by a deep cleft; the longer rays are 0·9 of an inch in length; both lobes are supported by a long series of imbricating rudimentary caudal rays, which, on the peduncle of the tail, merge to the long imbricating scales already referred to.

The paired fins are barely indicated by a slight impression of their rays. The pectoral fins are small, and at least nine rays entered into the composition of each. The ventrals are midway between the pectorals and the anal, exactly opposite to the anterior rays of the dorsal.

The peculiarly long and slender form of this species readily distinguishes it from others previously described. The position of the ventral fins, indicated by the broken base, is opposite to the anterior rays of the dorsal; and this feature, combined with the form of the abdominal scales, leaves no room for doubt that the species belongs to the genus *Clupea*. I have appended the specific name *C. attenuata*, which points out its peculiarity of form.

*Formation and Locality.*—Upper Cretaceous: Sahel Alma, Mount Lebanon.

*Ex coll.*—R. Damon, Esq., Weymouth.

*Clupea elongata*, DAVIS.

(Pl. xxxiii., fig. 2.)

This fish is chiefly peculiar from the position of the dorsal and ventral fins, which are situated far back towards the region of the tail. The fish is small, but well preserved. The head, which has been somewhat displaced, is rather less than one-third the length of the body, the latter being 3 inches, exclusive of the tail. All the fins are preserved; patches of scales remain; they were thin and small, but are not sufficiently well preserved to exhibit more special characters. The bony framework of the fish is exposed.

The head is 0·9 of an inch in length, and 0·5 of an inch in height post-orbitally; it has been pressed over so as to exhibit the under surface of the jaws and branchiostegal apparatus. The snout is prominent and semi-rotund; the upper jaw has been pressed forward and is displaced to that extent; the mandibles are 0·55 of an inch in length, joined together in front, and separating backwards with an outwardly sigmoidal curvature. The alveolar surfaces of the upper jaws are shown encircling the lower; they exhibit the minute orifices, where numerous teeth have been attached. The space between the jaws is filled

with a series of more or less parallel plates, probably the anterior portion of the branchiostegal rays. The upper part of the head is badly preserved.

The spinal column is composed of forty-eight to fifty vertebræ, of which nineteen are caudal; they are small, as broad as high anteriorly; posteriorly the vertebræ are broader in proportion to their height. The hypural bone is long and pointed posteriorly; it ascends to the upper lobe of the tail. The vertebræ are much contracted in the middle. The neural and hæmal spines are numerous, long, and fine; the ribs similarly so. Interhæmal and interneural spines support the anal and dorsal fins.

The dorsal fin is situated 1·4 inch behind the occiput, and 0·8 of an inch before the caudal fin; it consists of twelve fin-rays, of which the anterior one is longest, extending 0·45 inch; they possess the ordinary characteristics of the genus, and are branched and articulated towards the extremity of the fin.

The anterior ray of the anal fin is 0·55 of an inch from the base of the caudal; its base extends 0·35 of an inch; it is composed of eighteen rays, about half the length of those of the dorsal. The caudal fin is large, consisting of numerous rays, subdivided, and forming a filamentous margin; the rays are articulated quite to the base. The fin is supported dorsally and ventrally by a number of rudimentary caudal rays.

The pectoral fins are imperfectly exposed; the left fin is broken away with the matrix near its base; sufficient remains attached to the bones of the scapular arch to indicate the number of rays, which was fifteen. The right fin is also exposed behind the ribs, but the rays are closely aggregated together; it has a length of 0·6 of an inch. The ventral fins are laid closely along the side; they are half the size of the pectorals, and were each supported by a long, somewhat triangular bone.

This specimen, whilst it agrees in the generic characters of the genus *Clupea* in the arrangement of the fins, the deciduous character of its small teeth, and its internal anatomy, differs from any of the species hitherto described, more especially in the posterior position of its dorsal, ventral, and anal fins. The number of caudal vertebræ, as compared with the abdominal, also corresponds with the brevity of the external caudal region.

This species and the one previously described (*Clupea pulchra*, Davis) are peculiar in having the dorsal, anal, and ventral fins situated quite on the posterior portion of the body of the fish. In no other Clupeoid from the chalk of Lebanon or elsewhere does this occur to anything like a similar extent.

*Formation and Locality.*—Upper Cretaceous: Sahel Alma, Mount Lebanon.

*Ex coll.*—Lewis Collection; R. Damon, Esq., Weymouth.

Genus. **Engraulis.** AGASSIZ.

“Scales large, or of moderate size. Snout more or less conical, projecting beyond the lower jaw. Teeth small or rudimentary. Inter-maxillaries very small, hidden; maxillary long, attached to the cheek by a scarcely distensible membrane. Anal fin of moderate or great length. Branchiostegals short, from nine to fourteen in number.” (Günther.)

*Engraulis* (?) *tenuis*, DAVIS.

(Pl. xxx., figs. 4, 5.)

The body is long, tapering towards the tail. In this specimen the back of the fish is exposed, the head is partially turned over, and some of the bones displaced. From the snout to the base of the tail the length is 3·5 inches; the tail adds 0·5 inch; the diameter of the body between the pectoral and ventral fins is about 0·5 inch. The pectoral, ventral, and dorsal fins are all situated near the head. The fins towards the tail, if the fish were possessed of any, are not preserved.

The head is 0·9 of an inch in length; the operculi are large, and rounded posteriorly; the bones are displaced, and not easily identified. The snout appears to have been rounded and somewhat prominent.

The vertebral column consists of forty-seven vertebræ; they are as high as long; twelve connect the ventral arch with the head; the remainder extend to the tail; the hypural bone is expanded and flat. A number of small and delicate ribs may be observed extending some distance beyond the ventral fins. Strong neural spines support the rays of the dorsal fin, and short but strong neural and hæmal spines branch from the vertebræ near the tail.

The dorsal fin is situated 0·3 inch behind the head; it is composed of twelve rays, strongly attached to interneural apophyses, single and transversely articulated for half their length, and afterwards dichotomizing. The anterior rays are longest, 1·1 inch in length; the posterior rays become gradually shorter. Anal fin absent. Caudal fin supported by a broad hypural bone; lobes 0·5 inch in length, with about twenty-four rays divided between the two.

The pectoral fins are large, consisting of sixteen rays each. The third, fourth, and fifth rays are longest, exceeding 1·0 inch in length; succeeding ones shorter; the posterior margin of the fin has an oval form. The rays dichotomize. They are attached to the pectoral arch on the side of the body of the fish, and in this specimen are separated by a distance of 0·4 of an inch. The ventral fins are also rather widely separated from the abdominal surface; they consist of seven rays, radiating at a considerable angle from the pubic bones, indicating that the fins were capable of wide expansion. The ventral fins are half an inch from the pectorals, the latter being in close proximity to the head.

The scales were thin; a very slight film over the surface where the body of the fish was laid, probably indicates their presence, but affords no information as to their character.

*Formation and Locality.*—Hard chalk: Hakel, Mount Lebanon.

*Ex coll.*—Robert Damon, Esq., Weymouth.

Genus. **Scombroclupea.** KNER.

*Scombroclupea macrophthalma*, PICTET and HUMBERT.

*Clupea macrophthalma.* HECKEL, 1843. "Fische Syriens," p. 242 (344), pl. xxiii., fig. 2.

*Scombroclupea macrophthalma.* PICTET et HUMBERT, 1866. "Nouv. rech. s. l. Poissons fossiles du Mont Liban.," p. 71, pl. ix.

Many examples of this species have been discovered since Messieurs Pictet and Humbert described those referred to above, but they afford no additional information to the comprehensive description of those learned savants.

*Formation and Locality.*—Hard Chalk: Hakel, Mount Lebanon.

*Ex coll.*—Museum at Geneva (type); common.

Genus. **Leptosomus.** VON DER MARCK.

*Leptosomus macrourus*, PICTET and HUMBERT.

*L. macrourus.* PICTET et HUMBERT, 1866. "Nouv. rech. sur les poissons fossiles du Mont Liban.," p. 75, pl. x., figs. 1-4.

*Formation and Locality.*—Soft chalk: Sahel Alma, Mount Lebanon.

*Ex coll.*—Museum at Geneva (type).

*Leptosomus crassicostratus*, P. & H.

*L. crassicostratus.* PICTET et HUMBERT, 1866. "Nouv. rech. sur les poissons fossiles du Mont Liban.," p. 76, pl. x., figs. 5-7.

*Formation and Locality.*—Soft chalk: Sahel Alma, Mount Lebanon.

*Ex coll.*—Museum at Geneva (type).

Genus. **Chirocentrites.** HECKEL.

"Beiträge zur Kenntniss der fossilen Fische Oesterreichs," p. 3.

This genus was established, in 1849, by Heckel for the reception of fossil fishes from the chalk of Westphalia, which resembled the living genus *Chirocentrus* and the



*Threissops formosus* of Agassiz. In 1866, Pictet included in this genus a specimen obtained from the hard chalk of Hakel. The fish was imperfectly preserved, so that the characters of the genus could not be completely identified; but so far as could be observed, it agreed in all points with the description given by Heckel. The characters which justified the relationship were the form of the pectoral fins, composed of very large rays; the operculum was probably denticulated; the disposition of the vertebræ and their apophyses were similar, as were also the large scales, with rounded posterior margin. The author further remarks that the only genus which could cause any hesitation is that of *Spathodactylus*, established by Pictet for a fish from the Neocomian ("Materiaux pour la Paléontologie Suisse," 2nd series; "Description des poissons des Voirons," Part III., p. 2, pl. 1.). The Lebanon fish, tolerably well preserved in the dorsal region, presented no trace of the large isolated ray which exists in *Spathodactylus*.

*Chirocentrites libanicus*, PICTET and HUMBERT.

PICTET et HUMBERT, 1866. "Nouv. rech. sur les poissons fossiles du Mont Liban.," p. 88, pl. XIII.

The fish is large; the example described by the authors cited above was imperfect; the anterior portion of the body only being preserved. The head was badly preserved; the remaining part of the body, from the occiput backwards, comprising twenty-four vertebræ, was 6.5 inches in length; and the total length of the fish, if it were complete, is estimated at about 24 inches, that is on the supposition that the body was similar in form to that of *Chirocentrites coroninii*, Heckel.

The vertebræ are nearly as high as long; attached to them are neurapophyses, the latter robust, oblique, and apparently exhibiting traces of branching apophyses. The ribs are preserved only in the upper part; the bones of the trunk are considered to resemble in their arrangement and complication the living Halecoids.

The pectoral fins are well preserved, and form the most important feature of the specimen described by MM. Pictet and Humbert. The rays of the right fin are preserved, and there is also the base of the rays of the left fin. The rays of the right fin are very large, more so probably than in any other known species. The first ray has been in part covered by the second, and it is difficult to say which is the one and which the other. What appears to be the second is longest, attaining 2.2 inches; it expands uniformly from the base to the extremity, where its width is 0.3 inch. A longitudinal striation divides its surface into two unequal parts; the anterior part, which is the straighter one, presents fine oblique striæ; the posterior part is ornamented by longitudinal striæ, three or four in number, near the base, but branching into a larger number towards the distal extremity.

On the anterior margins of the first and second rays there are traces of transverse striations, which are characteristic of this genus. The third, fourth, and fifth rays are similar to the posterior area of the second; they enlarge towards the extremity in a similar manner, but diminish gradually in length, the latter being only 0·8 inch in length; they are striated in the same way as those already described. There are additional rays, but their arrangement is somewhat confused; there were probably not more than a total of eight.

Since the description was written by Pictet many examples of *Chirocentrites* have been discovered, and several are comprised in the collection made by Professor Lewis. Unfortunately no single specimen has been found which is perfect, or even exhibits the whole length of the fish. An example 14·5 inches in length, and extending forwards from what has apparently been the peduncle of the tail, is at its anterior extremity 4·0 inches in height; this diminishes gradually to 1·5 inch at the point nearest the caudal extremity, which is preserved. The vertebral column comprises, in this example, fifty-six vertebræ; those near the tail are considerably longer than high, but they become gradually higher than long further forwards. The whole specimen is covered with scales, and, in consequence, the arrangement of the spinous processes cannot be easily identified. The neural and hæmal spines attached to the caudal vertebræ are regular and simple; the neural spines and the ribs situated further forwards have a more complicated arrangement, and, as was remarked by Professor Pictet, they appear to be as numerous as, and similarly arranged to, those of the recent herrings.

The scales are large and thin, with a convex posterior margin; their exposed surface is 0·5 inch in height and 0·3 inch in width; the posterior margin is smooth and rounded, and the surface is devoid of striæ. Along the lateral line, on the anterior part of the body, there are seven scales in a length of 2 inches; a transverse line in the same region embraces ten to twelve scales.

The evidence of fins is very incomplete. A series of fragmentary rays, which may with probability be taken as the base of a dorsal fin, extend backwards from a distance of 6·0 inches from the caudal extremity here preserved, but its extent or size cannot be ascertained.

*Formation and Locality.*—Hard Chalk: Hakel.

*Ex coll.*—Museum at Geneva (type).

#### Genus. *Spaniodon*. PICTET.

PICTET, J. F., 1850. "Desc. des quelques poissons fossiles du M. Liban.," p. 33.

PICTET et HUMBERT, 1866. "Nouv. rech. sur les poiss. foss. du M. Liban.," p. 84.

This genus was established for the reception of some fossil fishes from the soft chalk of Sahel Alma. They are nearly related to members of the family

Halecoides. The genus is described by MM. Pictet and Humbert in terms of which the following is a translation:—The skeleton is slender; the ribs are fine and numerous; the upper jaw is formed by short and strong intermaxillaries, bearing a small number of long hooked teeth, and by long maxillary bones with few or no teeth; the lower jaw is similarly armed to the intermaxillaries; the branchiostegal rays are numerous, and the fins are disposed more or less as in the salmon and herring.

M. Pictet described two species of the genus, *S. blondelii* and *S. elongatus*; and a third was added in the “*Nouvelles recherches*,” namely, *S. brevis*.

*Spaniodon blondelii*, PICTET.

(Pl. xxxiv., fig. 3.)

*Spaniodon blondelii*. PICTET, F. J., 1850. “Description de quelques poiss. foss. du Mont Liban.,” p. 34, pl. 5., figs. 2, 3, 4.

*Spaniodon blondelii*. PICTET et HUMBERT, 1866. “Nouv. rech. sur les poissons fossiles du Mont Liban.,” p. 84.

The specimens described by M. Pictet were all imperfect; one represented by him (fig. 3) is without tail, and another (fig. 4) is headless. Since 1850 several specimens have been found, and notably in the collection gathered by Professor Lewis there are very perfect specimens. It is of one of the latter that the following description is given.

The specimen is in good preservation. The body of the fish, exclusive of the tail, is 5·0 inches in length; the longest lobe of the tail adds 1·4 inch to the length. The greatest height in front of the dorsal fin is 1·1 inch, whence it tapers backwards to the base of the caudal fin, which is 0·4 inch; anteriorly the body maintains its height; the head is large, and the snout thick and strong. From the snout to the posterior margin of the operculum measures 1·9 inch; the jaws are large and powerful, only the pre-maxillary and the anterior portion of the mandible are furnished with teeth, and the gape was not in proportion to the size of the jaws. The mandible is 1·1 inch in length; the teeth, three in number in each ramus of the jaw, are long and pointed; they occupy a length of 0·35 inch from the snout backwards; there is some evidence also of a few small teeth occupying the spaces between the large ones. Beyond the teeth a strong angular process rises from the mandible, and was apparently connected with the maxilla; the posterior half of the mandible is comparatively slender. The branchiostegal rays, long and slender, are numerous, fifteen or sixteen in number on each side. The orbit is situated very high, slightly in advance of the middle of the head. The opercular bones are large, higher than broad,

sub-triangular in outline, with the apex upwards; their constituent elements cannot be easily recognized in this specimen. The tympanic area is large.

Of the spinal column Professor Pictet states that he counted about forty-seven vertebræ, of which twenty were caudal. In the specimen now described there are fifty-seven vertebræ, and of these twenty are caudal. The discrepancy, no doubt, arises from the imperfection of the examples which served as types to Professor Pictet. The vertebræ are slightly broader than high, small, and contracted in the middle; the hæmal and neural apophyses are deeply forked, numerous, long, and slender. Sixteen interneural apophyses support the dorsal fin, and an equal number of interhæmals that of the anal. The ribs are numerous, long, and slender; attached to them are branching ribs, or pleurapophyses, extending more or less horizontally backwards.

The dorsal fin is supported by sixteen rays, is moderate in size, its base extending 0·7 inch; it is equidistant between the posterior margin of the head and the base of the tail. The anal fin is also composed of sixteen rays, shorter and less robust than those of the dorsal; it is situated almost in contact with the caudal, the anterior ray only 0·7 inch from its base. The caudal fin is deeply bilobate, the lower lobe the larger; the outer rays of each are strong, jointed, and towards the distal extremity dichotomized; they are supported by rudimentary rays. The bases of the short median rays are expanded and simple, attached to the rather widely expanded hypural bones.

The pectoral fins are situated near the abdominal surface; they are strong, especially the anterior rays, and about 0·8 inch in length. The number of rays in this specimen is not shown. The ventral fins are considerably smaller than the pectorals; they are placed in arrear of the posterior rays of the dorsal, and supported by a pair of pubic bones, joined together on the median abdominal line.

Small patches of the scales are preserved, but they are too fragmentary to afford information even as to their size or form.

*Formation and Locality.*—Soft chalk: Sahel Alma, Mount Lebanon.

*Ex coll.*—Lewis Collection; R. Damon, Esq., Weymouth.

*Spaniodon elongatus*, PICTET.

*Spaniodon elongatus*, PICTET, 1850. "Desc. de quelques poiss. foss. du M. Liban.," p. 35, pl. XII., figs. 1, 2.

*Spaniodon elongatus*. PICTET et HUMBERT, 1866. "Nouv. rech. s. l. poiss. foss. du M. Liban.," p. 85, pl. VI., figs. 1, 2.

This species is distinguished by its great length in proportion to its height, the former being ten to one of the latter. The number of the constituent

elements of the spinal column is greater than that of any other species of the genus.

*Formation and Locality.*—Upper Cretaceous, soft chalk: Sahel Alma, Mount Lebanon.

*Ex coll.*—Museum at Geneva.

*Spaniodon electus*, DAVIS.

(Pl. xxxiv., fig. 2.)

The specimen which serves for the type of this species is well preserved from the nape backwards; the head is somewhat displaced and difficult to discriminate. The length of the fish, from the snout to the peduncle of the tail, is 7·0 inches; the tail to the extremity of the lower lobe occupies an additional 1·5 inch. The height of the body is 1·35 inch midway between the head and the anterior rays of the dorsal fin, equal to one-fifth the total length; the body gradually diminishes in height to the peduncle of the tail, where it is 0·45 inch.

The head is 2·3 inches in length. The gape is wide. Each pre-maxillary bone is furnished with two large teeth, which appear to be the only large ones in the upper jaw; they are more or less curved inwards; the surface striated, pointed. The lower jaws are armed with two or three teeth on each ramus; the orbit is high, elongated anteriorly, forming an acute angle, situated midway between the tip of the snout and the posterior margin of the operculum. The opercular bones are circular posteriorly, long as high, and 0·8 inch in diameter; their constitution cannot be ascertained. Nine branchiostegal rays exist on each side; they are 0·8 inch in length, curved, and slender.

The vertebral column is composed of forty-eight to fifty vertebræ, 0·1 inch in length anteriorly, and gradually diminishing towards the tail; they are as high as long; twenty-one are caudal. A large number of neural spines extend from vertebral axis, and interneural spines support the dorsal fin. The hæmal spines, equal in number to the vertebræ of the caudal region, support the interhæmal spines, to which are attached the fin-rays of the anal fin. The abdominal cavity is large, long, straight; divaricating ribs extend from the vertebral column to the inferior margin of the abdominal cavity. The position of the stomach is indicated by the preserved remains of a semi-absorbed fish, extending from the pectoral to the ventral fins.

The dorsal fin is small, composed of twenty-one fin-rays, the longest an inch in length; the base of the fin extends 0·8 inch; the base of the anterior ray is 4·5 inches from the snout and 2·5 inches from the base of the caudal fin. The anal fin is situated in immediate proximity to the caudal, and extends 0·8 inch along the abdominal surface; it has twenty-two rays, the anterior ones 0·3 inch

in length. The caudal is deeply forked; the rays are transversely jointed and subdivided towards their extremities; the outer longest rays are supported by shorter imbricating rays.

The pectoral fins are situated on the ventral surface immediately behind the operculum; only the base of the fin is preserved in this example, and the size of the fin or the number of rays cannot be identified. The ventral fins are supported each by a small triangular bone; they are situated 3.0 inches behind the insertion of the pectoral fins, and 0.7 inch in front of the anterior ray of the anal. Each fin is composed of eight rays, the anterior one strong and undivided, ending in an acute point; the succeeding rays diminish in size; they repeatedly dichotomize, and distally are quite filamentous.

The scales are in good preservation. Those of the upper surface of the fish have been removed by the opposing matrix, leaving the internal surface of the underlying scales exposed beneath the bony skeleton of the fish. The scales covering the anterior portion of the fish are larger than those situated posteriorly, and the ventral are considerably larger than the dorsal ones. Fifty-six scales are arranged along the lateral line; a transverse series, from the dorsal to the ventral surface at the highest part of the body, comprises fifteen scales; but in a parallel line behind the dorsal fin there are only eleven. The surface of the plates protecting the head are covered with small pustulations.

This species most nearly approaches to that of *S. elongatus* (Pictet), but differs from it in the greater depth of the body in proportion to its length. In *Spaniodon elongatus* the height is included about ten times in the length; in this it is five, or, including the tail, six. The vertebral column is composed of a smaller number of vertebræ; whilst the dorsal fin has a larger number of rays in this species than in *S. elongatus*. The dorsal and ventral fins are situated in a position relatively to the length of the fish, much farther back in this species. To the other species described by M. Pictet, viz. *S. blondelii* and *S. brevis*, the relationship of this is not so close; they are very clearly distinguished by the difference in the number and comparatively large size of the vertebræ, the former having fifty-seven and the latter forty-four, whilst this species has forty-eight vertebræ. The dorsal fin of *S. blondelii* occupies a more advanced position than that now described.

The presence, in a fossil state, of a small fish in the abdominal region of the body indicates the carnivorous character of the genus *Spaniodon*, the partially digested fish having the appearance of being a member of the genus *Leptosomus*; the position of the enclosed little fish may also point out the position and extent of the stomach of *Spaniodon*. I name it *Spaniodon electus*, having reference to the excellent arrangement and preservation of its parts.

*Formation and Locality.*—Upper Cretaceous: Sahel Alma, Mount Lebanon.

*Ex coll.*—Lewis Collection; R. Damon, Esq., Weymouth.

*Spaniodon hakeleensis*, DAVIS.

(Pl. xxxiv., fig. 4.)

The specimen is well preserved, except the anterior portion of the head. It has a long and slim body, with strong dorsal and caudal fins; it is 5 inches in length, exclusive of the tail, and of this length the head takes up one-fourth. The height at the base of the anterior rays of the dorsal fin is 0·5 of an inch, and this is maintained anteriorly to the head and posteriorly to the base of the anal fin; thence it contracts to the peduncle of the tail, which is 0·3 of an inch. The scales are not well defined, but appear to have been small and thin.

The bones of the head are partially displaced; the orbit is medium-sized, situated rather high, otherwise centrally; it is surrounded by strong infra-orbital bones; the post-orbital area is large, the operculum somewhat angular on its posterior margin. The mandible is not shown, but the displaced quadrate indicates a strongly articulated bone; the snout extends 0·5 of an inch beyond the orbit.

The spinal column is composed of forty-four vertebræ, of which thirteen are caudal; the vertebræ are large and strong, deeply bi-concave, and about as broad as high. The ribs are short and slender; the abdominal cavity enclosed by them is long, but shallow. The neural and hæmal spines are much thicker than the ribs; they are strongly attached to the spinal column by apophyses, especially towards the tail. Eleven interneural spines give support to the dorsal fin, and a supplementary plate extends horizontally from the most anterior one; the anal fin is similarly supported by seven interhæmal spines.

The dorsal fin is 1·3 inch behind the head; its base extends 0·75 of an inch along the ridge of the back; it has twelve rays, of which the anterior ones are longest 0·7 of an inch. The anal fin has nine rays, smaller and shorter than the dorsal; its anterior ray is midway between the ventral and caudal. The caudal fin is large; its base is formed by a series of radiating hypural plates, connecting the caudal rays with the vertebral column; the caudal rays are jointed and bifurcate towards the distal extremity; the external ones are longest and thickest, being at least an inch in length. The tail is forked, but not very deeply. Both the superior and inferior margins are supported by a series of imbricating rudimentary caudal rays; those at the base of the upper lobe are twelve in number.

Of the paired fins, the pectorals are supported by a strong scapular arch, forming an angular series of bones encircling the posterior outline of the operculi. The pectoral fins consist of eight or ten fin-rays, 0·4 of an inch in length. The ventral fins are 1·5 inch behind the base of the pectorals; each is supported by a

triangular bone, and consists of eight rays, which dichotomize repeatedly; they are 0·5 of an inch in length.

It is unfortunate that the anterior portion of the head should be wanting; but though the characteristic teeth are not present, there appears to be little doubt that the parts preserved clearly indicate that the species should be located in the genus *Spaniodon*.

This specimen is from the hard limestone of Hakel. All the species of *Spaniodon* hitherto described have been found at Sahel Alma, so that with this specimen the horizon for the genus is extended to both localities. It is remarkable for its elongated form, and in this respect much resembles *Spaniodon elongatus*, Pictet. This resemblance, however, is only superficial; the two may be readily distinguished by the vertebral column of the latter, consisting of fifty-eight vertebrae, whilst the specimen now described has only forty-four vertebrae. It is proposed to distinguish this species as *Spaniodon hakelensis*.

*Formation and Locality.*—Hard chalk: Hakel, Mount Lebanon.

*Ex coll.*—Professor Lewis Collection; R. Damon, Esq., Weymouth.

*Spaniodon brevis*, PICTET and HUMBERT.

(Pl. xxxiv., fig. 1.)

*Clupea lata*. PICTET, F. J., 1850. "Desc. des quelques poiss. fossiles du Mt. Liban," p. 37, pl. vii., fig. 1. (Non *Clupea lata*, AGASSIZ.)

*Spaniodon brevis*. PICTET et HUMBERT, 1866. "Nouv. rech. s. les poissons fossiles du M. Liban.," p. 86, pl. xii., figs. 3, 4.

The examples of this species, described by MM. Pictet and Humbert, are somewhat imperfect, part of both head and tail being absent; for this reason it appears to be desirable that a more perfect specimen should be figured. The description of the vertebral column and its apophyses, and the dorsal, anal, and paired fins are well given by the authors cited above. The caudal fin is deeply cleft, and the lower lobe considerably longer than the upper one; the outer and longer rays of each are strong, and are also supported by imbricating rudimentary rays; they are transversely jointed and dichotomize; the median rays are short, and divided towards their extremity.

The entire length of the body to the base of the tail is 4·1 inches; to this must be added 1·3 for the tail; the greatest height in front of the dorsal fin is 1·1 inch; the head, from the tip of the snout to the posterior margin of the gill-cover, is 1·7 inch; its height 1·1 inch. The head is slightly twisted so as to expose the under surface; the orbit is high, and well advanced towards the snout; the opercular bones are large and rounded; about a dozen branchiostegal rays are



visible, apparently all attached to one side. The maxillæ are large, and the gape somewhat extended. The under surface of the lower jaw is exposed; teeth, about 1·5 inch in length, pointed, and slightly curved, are exposed in connexion with the lower jaw, but cannot be distinguished in the upper one.

This species is distinguished from the others of the same genus by its body being much shorter. The large and powerful pectoral fins, the form of the head, and character of the teeth, render its transference from the genus *Clupea* to that of *Spaniodon*, without doubt, correct.

*Formation and Locality.*—Upper Cretaceous: Sahel Alma, Mount Lebanon.

*Ex coll.*—James W. Davis, Chevinedge, Halifax.

#### Genus. *Lewisia*. DAVIS.

Head moderately large; orbit superior, median; gape wide; maxilla and mandible long, armed with large, conical, curved teeth; operculum large; vertebral column somewhat slender, furnished with numerous spinous apophyses and ribs. Dorsal fins small, situated on the posterior portion of the dorsal surface; anal also small and very near caudal; caudal large, deeply bilobate; pectoral fins abdominal immediately behind the opercula; ventrals abdominal, behind the dorsal, and little removed from the anal.

The fishes from which it is proposed to form the genus *Lewisia* combine several of the characters of the Halecoidei, but appear to be distinguished by peculiarities in structure which removes them from each of the already constituted genera. The form of the head bears some resemblance to that of *Eurypholis*; the gape is very wide; the jaws are long, and armed with large teeth, probably larger but less numerous than those of *Eurypholis*. The vertebral column, ribs, and apophyses closely resemble those of *Clupea* or *Spaniodon*, but the position of the dorsal, ventral, and anal fins are quite unlike those genera; they are small and striated quite on the caudal part of the body. The caudal fin is very large, and compensates to some extent for the sparcity of the others.

The name of the genus is chosen to express, in some slight degree, the indebtedness of palæontologists to the persistent and painstaking labours of Professor Lewis, whilst resident at Beyrout, in collecting, at no small sacrifice, so many of the beautiful and rare specimens figured in this memoir.

*Lewisia ovalis*, DAVIS.

(Pl. xxxiii., fig. 6.)

The outline of *Lewisia ovalis* forms a tolerably perfect oval, the length of the body, exclusive of the tail, being 5·0 inches, and the height 2·0 inches, the least

diameter thus equalling two-fifths of the greatest. The specimen is in good preservation. The anatomy of the head and body, and the position and constitution of the fins are displayed to advantage. The body is highest 0·6 of an inch in front of the dorsal fin, and from thence it gradually narrows to the peduncle of the tail, which is 0·5 of an inch anteriorly; it also converges to the snout. The fins, except the pectorals, are all situated far backwards; the caudal deeply cleft, the extremities of the two lobes being 2·5 inches apart.

The height of the head posteriorly is 0·7 of an inch, and its length is the same; it is subtriangular in outline, the snout bluntly rounded. The orbit is placed midway between the occiput and the snout, and very high; the bones of the infra-orbital ring are well defined; the parasphenoid, which crosses its lower part, is strong, and connected with it anteriorly, the vomer is exhibited. The maxillary is 0·8 of an inch in length; the pre-maxillary is short and strong; it is slightly displaced in this specimen. The mandible extends 1·2 inch; it is a narrow bone, slightly expanded posteriorly, and forms the lower margin of the head; the branchial apparatus is not exhibited. Attached to the mandible is a bone diverging upwards in a triangular form, which is probably the quadrate or hypotympanic bone; attached to the posterior limb of this a long bone (hyomandibular) connects it with the cranium; other bones, not well defined, occupy the tympanic area. The post-orbital bones are elongated and narrow; the pre-operculum, as well as the inter-operculum, have been to a large extent removed with the opposite matrix; the operculum is twice as high as broad, convex posteriorly, but concave in front; the sub-operculum is comparatively small and subtriangular in outline; the inter-orbital space is narrow, the frontal bones well developed and strong; midway between the orbit and the snout there is a tooth 0·15 of an inch in length, conical, and sharply-pointed; it is dissociated from the jaws, but has the appearance of having formerly been connected with them; there is also evidence of two or three small teeth attached to the lower jaw.

The spinal column consists of forty-nine vertebræ, of which fifteen are included in the caudal region. The anterior portion of the column has been somewhat displaced, as indicated in the figure. The vertebræ are broad as long, the median portion deeply contracted. The neural and hæmal spines in the caudal region are short and fine; the interhæmal spines supporting the anal fin form almost a right angle with them; the interneural spines supporting the dorsal fin are laid more nearly parallel. The ribs are numerous, long, and fairly strong; they extend to the ventral surface of the abdomen; the stylets or epipleural spines extend diagonally from the ribs. The neural apophyses and spines in the abdominal region are also numerous and strong, especially near the head the neural spines are very thick and strong.

The dorsal fin is very posteriorly placed; its anterior ray is 3·3 inches behind the snout and 2 inches before the caudal fin; it is 0·8 of an inch in length, and

its seventeen rays, supported by the same number of interneural rays, have a base extending 0.6 of an inch along the dorsal surface. The fin-rays are strong, and are articulated in the distal half of their length.

The anal fin is very near the caudal, its posterior extremity being removed only 0.2 of an inch; its base extends 0.8 of an inch. The fin-rays are short and stout, sixteen in number, and are supported by an equal number of inter-hæmal spines. In the caudal fin the rays of both superior and inferior lobes are closely aggregated, and extend almost at right angles to the body of the fish. The arrangement is probably accidental. The rays are thick near the base, but dichotomize repeatedly, and assume a filamentous appearance at the margin of the fin. All the rays are articulated.

Of the paired fins the pectorals are the larger; they are attached to the scapular arch very near to the ventral margin. The scapular arch is strong, and encircles the convex margins of the opercula. The pectoral fins are 1.0 inch each in length, though slightly imperfect, the rays are aggregated, and the number cannot be ascertained with exactitude, but there are at least fifteen. The ventral fins are each situated 0.6 of an inch before the anterior ray of the anal and opposite to the posterior portion of the dorsal fin; each is supported by a strong triangular pubic bone; the fin-rays are 0.6 of an inch in length and are not numerous. The scales on the under surface of the body, beneath the skeleton, are preserved; they were thin, circular, and a medium size.

An interesting fact in connexion with this specimen is that the nature of its food is indicated by the presence of a small fish, probably a *Leptosomus*, fossilized in the abdominal cavity. The included fish is 1.5 inch in length; its vertebral column and fins are distinctly discernible; the head occupies its proper relative position, but is somewhat crushed, or may have been disturbed by the process of digestion. The stomach appears to have extended to a considerable distance behind the ventral fins; the body of the included fish reaches 0.5 of an inch behind them.

This specimen possesses several peculiar features which render its allocation to any of the genera hitherto described somewhat problematical. The arrangement of the fins correspond in number with those of *Clupea*; they are situated near the caudal extremity of the fish, and in this resemble the species already described in this memoir, *C. pulchra* and *C. elongata*; it differs from these, and from all other species of *Clupea*, in the position of the ventral fins relatively to the dorsal; instead of being opposite or slightly in advance of the dorsal fin, they are behind it, and the somewhat extended anal is forced almost to the base of the caudal. The genus *Spaniodon* presents features similar to this specimen, though the dorsal is in each species of that genus placed midway along the body. Of the three species of *Spaniodon* described by Pictet (*Op. cit.*), *S. brevis* most nearly resembles this; but its large head, slender body, and

generally rapacious appearance form a striking contrast to the thick, short, oval body of the specimen now delineated. The contour of the head has a much closer resemblance to that of *Eurypholis* than to *Spaniodon*; but the presence of long, sharply-pointed teeth, though there is no evidence of the great lanian teeth possessed by the latter genus, indicates some relationship. This character separates it from *Clupea*, which, if possessed of teeth, are rudimentary and deciduous.

*Formation and Locality.*—Upper Cretaceous: Sahel Alma, Mount Lebanon.

*Ex coll.*—Lewis Collection; R. Damon, Esq., Weymouth.

#### Genus. *Eurypholis*. PICTET.

The characters of this genus are indicated in terms of which the following is a translation:—"Body probably as broad as high, much attenuated towards the posterior extremity; head large, the surface of the bones ornamented with granules. Mouth occupies half the length of the head; gape wide; teeth numerous, pointed, unequal in size. Spinal column composed of osseous vertebræ, all the anterior vertebræ bearing obliquely radiating apophyses. Dorsal fin median, short; anal fin about same length as dorsal, situated posteriorly; caudal fin homocercal, and remarkable for the large rays of the outer extremities of the two lobes. Scales bony, apparently disposed in three rows, of which one is dorsal and two are lateral extending from the head to the tail. The scales of the dorsal row are oval, very granulose, the most anterior being the largest; the scales of the lateral rows are more or less pointed and angular." (Pictet, "Nouv. rech. sur les poissons fossiles du Mont Liban.," p. 99.)

#### *Eurypholis boissieri*, PICTET.

*E. boissieri*. PICTET, J. F., 1850. "Desc. de quelques poissons fossiles du Mont Liban.," p. 30, pl. iv., figs. 2, 3, 4.

*E. sulcidens*. PICTET, J. F., 1850. *Ibid.*, p. 31, pl. iv., fig. 1.

*E. boissieri*. PICTET et HUMBERT, 1866. "Nouv. rech. sur les poissons fossiles du Mont Liban.," p. 102, pls. xv. and xvi.

An admirable and exhaustive description of this species is given by the authors cited above. The species is abundant, and large numbers of specimens have been found in the hard chalk. The second species of the genus described by Pictet from Sahel Alma is, for reasons to be stated hereafter, transferred wholly or in part to another genus.

*Formation and Locality.*—Hard chalk: Hakel, Mount Lebanon.

*Ex coll.*—Museum at Geneva; abundant.

*Eurypholis longidens*, PICTET.

- Isodus sulcatus*. HECKEL, 1843. "Fische Syriens," p. 241 (343), pl. XXIII., fig. 4.  
*E. longidens*. PICTET, F. J., 1850. "Desc. de quelques poissons fossiles du M. Liban.," p. 31, pl. v., fig. 1.  
*E. longidens*. PICTET et HUMBERT, 1866. "Nouv. rech. sur les poissons fossiles du M. Liban.," p. 105, pl. XVII.

It is probable that a portion at least of the fish remains ascribed by Professor Pictet to this species must be transferred to the genus *Eurygnathus*. The reasons for this are given with the necessary detail in the description of the latter genus on page 601.

*Formation and Locality*.—Soft chalk: Sahel Alma, Mount Lebanon.

*Ex coll.*—Museum at Geneva.

*Eurypholis major*, DAVIS.

(Pl. xxx., fig. 2.)

A very fine example of this genus is included in the collection made by the Rev. Professor Lewis, and now in the National Collection at South Kensington. Its length is 11·5 inches; of this the head occupies 3·3 inches and the tail 2·2 inches. The greatest depth of the body is immediately behind the head, 1·7 inch; it gradually diminishes towards the base of the tail, which is less than 0·5 inch in height. The lobes of the tail are deeply cleft and widely expanded, the extremities being 3·0 inches apart. The fins are well preserved, and differ considerably from those of *Eurypholis boissieri* of Pictet.

The head is large, fully as high as the anterior part of the body, its length nearly double the height. The upper surface of the snout is depressed and the bones of the mouth prominent. The jaws are 2·3 inches in length, the gape wide; both the mandible and maxillary are nearly straight, strongly osseous, and armed with a number of sharp, conically elongated teeth. The pre-maxillary is apparently short, and affords support to the teeth, few in number, but longer and thicker than those of the maxillary bones. The bones of the upper part of the head, including the orbit, are for the most part absent. The operculum was large, extending backwards with a gentle curvature, its inferior posterior margin somewhat angular. The branchiostegal rays, apparently short and thick, are preserved.

The vertebral column is composed of forty vertebræ, 0·2 inch in length and about the same height; they are constricted in the middle, and somewhat longer

in proportion to the height towards the tail. One half the vertebræ are caudal. The ribs are long, extending quite to the ventral aspect of the body; they are strong, tapering towards the distal extremity. Neural spines are attached to each vertebra. The anterior ones are shorter than those attached to the caudal vertebræ; both are supported and strengthened by small bones, extending at right angles to the neural spines, midway between the spinal column and the dorsal surface. Interneural spines, seventeen or eighteen in number, support the dorsal fin; the anterior ones are large and thick, the others diminish in size backwards; the interneural spines are widely expanded at the upper extremity, and afford a firm base of attachment to the rays of the fin, which are likewise adapted to the surface of the spines. The hæmal spines supporting the anal fin are longer and stronger than those extending from the superior surface of the vertebræ; they are expanded at the base and firmly attached. A number of small thin bones are laid across the hæmal spines parallel with the vertebral column similar to those of the neural arrangement already referred to. Twenty inter-hæmal spines support the anal fin; the anterior ones extend obliquely forward; they are 0·7 inch in length, thick and strong; those succeeding diminish in size and length.

The unpaired fins are all large and well developed. The dorsal consists of fifteen or sixteen rays; the two anterior ones are spinous, undivided, and shorter than the soft rays following. The latter are fully 1·5 inch in length, articulated, and repeatedly divided. The anterior ray is inserted midway between the tip of the snout and the base of the tail, and the base of the fin extends backwards on the dorsal surface 1·7 inch. The anal fin comprises eighteen to twenty rays, the longest anterior ones being 1·2 inch in length. The base of the anterior ray is 2·3 inches in advance of the caudal, and the base of the fin extends a length of 1·6 inch. The rays are articulated and divided, but apparently not to the same extent as those of the dorsal fin. The caudal fin is deeply bilobate. The longest ray of each lobe is about the eighth; that of the upper lobe is 2·0 inches, and that of the lower 2·3 inches in length; they are thick and strong, tapering towards the distal extremities, articulated at short intervals, but undivided. The rays preceding the eighth are shorter and rudimentary; intermediate between them there are about twenty articulated rays, which rapidly subdivide and assume a filamentous condition.

The paired fins differ very materially from those ascribed to *E. boissieri* by Pictet and Humbert ("Nouv. rech. sur les poiss. foss. du M. Liban.," p. 104). The pectoral fins are attached to the pectoral arch at a point on or very near to the median abdominal line. The rays are about 1·0 inch in length, and perhaps twelve in number. The ventral fins are separated from the pectorals by a distance of 2·0 inches, and from the anal by 1·8 inch; they are attached to a large flat pubic bone on the abdominal surface, and are similar in size to those of the

pectorals; the rays are articulated and bifurcate. Their attachment is under and opposite to the eighth ray of the dorsal fin.

The presence of scales is indicated in some places, but they are unfortunately not well preserved. There is a cast of the third large scale, which extends backwards from the occipital region of the head; it is semi-oval, 0.3 inch in diameter, and indicates a radiating structure of the under surface. The two anterior scales or plates are absent, the matrix being broken. There are also fragments of dermal scutes on the lateral surface of the body; they are there, but not sufficiently well preserved to afford matter for description. The upper margin of the row of scutes extended in a line above the vertebral column in the anterior part of the body, gradually converging to it midway to the tail, and thence all trace is lost.

This species differs from those previously described from the chalk of Lebanon most especially in the position of the paired fins. The description of *Eurypholis longidens* from Sahel Alma was made from imperfect specimens, the remains of the paired fins affording little information as to their character. The fins of *E. boissieri* were, however, well preserved, and described and figured by M. Pictet with considerable detail. The pectorals are attached midway between the ventral line and the row of lateral scutes; they were small. The ventral fins are attached to an osseous piece, triangular in form, which extended to a point just behind the posterior termination of the opercular apparatus, at no great distance behind the pectoral fins. In this species the pectoral fins are attached to the under surface of the body instead of the sides, and the ventral fins are situated far back beneath the dorsal.

*Formation and Locality.*—Soft chalk: Sahel Alma.

*Ex coll.*—Lewis Collection, Natural History Department, British Museum.

#### Genus. *Pantopholis*.\* DAVIS.

Fish moderate size; head with strong jaws armed with conical pointed teeth; gape wide; branchiostegal rays numerous; vertebral column large and strong; hæmal processes and ribs attached to each vertebra; pectoral fins equal in length to the height of the body. A series of plates extend along the dorsal surface of the body, from the head backwards, apparently the whole length of the body.

The principal distinguishing characteristic of this genus consists in the long series of dorsal plates. To some extent it resembles *Eurypholis*, Pictet, which has three plates immediately behind the occiput; the two genera differ not only in the number of the plates, but those of *Eurypholis* are proportionately very much larger than, and differ in form from, those of the genus now described.

\* παντοιος, manifold; φολις, a scute.

M. von der Marck ("Fische, Krebse und Pflanzen aus dem Kreide in Westphalen," p. 28) instituted the genus *Ischyrocephalus*, which is distinguished, amongst other things, by the fish possessing four dorsal plates extending backwards from the head; the plates are elongated and pointed at each end, and, unlike those of *Eurypholis*, are not imbricated. The series of lateral plates or scutes, which MM. Pictet and Humbert describe in *Eurypholis*, are entirely absent in this genus.

*Pantopholis dorsalis*, DAVIS.

(Pl. xxxvi., fig. 2.)

The specimen is imperfect, and is the only one I have seen possessing the same characters; it, however, offers several peculiarities which are considered of sufficient importance to render necessary the institution of a new genus for its accommodation. The part of the fish preserved is 7·5 inches in length; of this the head comprises 3·2 inches, the remainder being the anterior portion of the body. The head is displaced, so that the cranium is at the base, and the jaws occupy the superior position; it has evidently by some means become twisted; only one fin is exposed, a large pectoral; the caudal, anal, ventral, and dorsal fins are absent. Along the whole length of that part of the back which is preserved there is a row of elongated oval plates, irregular in size, varying from 0·2 to 0·4 inch in length, and averaging 0·13 inch in width. Twelve plates can be counted, and there were probably six or eight others between the anterior one preserved and the head, this part of the specimen being defective. Posteriorly the fish is entirely gone, so that it is impossible to say whether the plates extended to the tail. The posterior portion of each plate is rounded and depressed; the anterior part, being slightly elongated, extends over the flattened posterior portion of the preceding scale.

The fish, when perfect, was probably 13 or 14 inches in length. Its ravenous nature is indicated by the presence of the bodies of two fishes in the abdominal cavity. The enclosed skeletons are those of young specimens of *Osmeroides*; the head of each is about an inch in length, and the entire fish 4 or 5 inches.

On account of the peculiar position of the head its size and proportionate measurements can only be given approximately. From the tip of the snout to the posterior margin of the opercular plates, in their present position, is 3·2 inches, and the posterior portion of the head is 1·8 inch; from that width the outline rapidly converges to a point at the snout. The maxillæ are strong, 2·0 inches in length, and armed with a series of conical pointed teeth 0·2 inch in length. The branchiostegal rays are twelve in number on each side, long, curved posteriorly, and separated by about 0·1 of an inch from each other. The opercular bones, somewhat crushed, are large and thickly enamelled; where the latter has



been removed numerous radiating lines are exposed; they converge towards the antero-superior part of the operculum and expand towards its posterior outer margins. The orbit, maxillæ, and other parts cannot be identified.

The spinal column consists of thirty-three vertebræ in the part preserved, the whole of which appear to be abdominal. Ribs, long and strong, are attached to each vertebra and extend with a sigmoidal curvature to the ventral surface of the body. Hæmal spines extend from the vertebræ on the dorsal surface; they are short and strong, and proceed to the under surface of the dorsal plates; the vertebræ are longer than high, with well ossified centres, the body of the vertebræ contracted. The spinal column is situated very high in the body, but this may to some extent be displaced, though it has not the appearance of being removed from its normal situation.

There is only one fin exhibited; it is 2·2 inches in length and is folded close. The rays at the basal part are strong and undivided; ten can be distinguished; midway they bifurcate, and the distal extremity of the fin is much divided. The scales are medium size, 0·15 inch in length, with rounded posterior margin. The dorsal plates have been already referred to.

*Formation and Locality.*—Soft chalk: Sahel Alma, Mount Lebanon.

*Ex coll.*—Lewis Collection, Robert Damon, Esq., Weymouth.

#### Genus. **Eurygnathus**.\* DAVIS.

Fish of moderate size; head large, broad, depressed, with wide gape and formidable dentary apparatus; branchiostegal rays present; vertebral column strong and straight. Unpaired fins large, similar in form and construction. Outer rays of each lobe of the tail expanded and spinous. Paired fins medium size, abdominal. Scales thin, small.

This genus approaches in several respects that of *Ischyrocephalus*, Von der Marck (“*Fossile Fische, Krebse und Pflanzen aus dem Plattenkalk der jüngsten Kreide in Westphalen*,” p. 28), the latter is distinguished by the possession of an adipose dorsal fin and a series of four bony plates extending in a line along the median dorsal surface, of which there is no evidence in the genus now described.

M. Pictet instituted the genus *Eurypholis* for a group of fossil fishes from Mount Lebanon, which, he states, were evidently comprised in the family Halecoides, but which were apparently not represented by any living genera (“*Description des poissons fossiles du Mont Liban*., 1850,” p. 28). The genus is distinguished by the ventral fins being supported by a strong bone attached to the scapular cincture which makes the fishes thoracic. “*Ce caractère exceptionnel, très-rare dans les Cycloides malacopterygiens, et qu’on ne retrouve que dans une petit*

\* εὐρύς, latus; γνάθος, maxilla.

nombre de poissons vivants, tels que les Aulopes, est une de ceux qui les distinguent le plus clairement et qui montrent le mieux qu'ils ne peuvent être confondus avec aucune des genres connus."

The genus is again referred to in the second work on the Lebanon fishes by the same author, published in 1866, and additional characters, derived from a more extensive series of specimens, are described, the most important being that osseous scales, disposed in three rows, of which one is dorsal and the other two lateral, extend from the head to the tail. The dorsal series are oval, very granulose; the anterior ones are largest; the lateral rows are angular and smaller. In the first work three species are described, of which two, viz. *Eurypholis boissieri* and *E. sulcidens* are combined under the former name in the second work. The third species, *Eurypholis longidens*, is described, with some doubt as to its identity in the first work, and confirmed in the second in 1866. The additional specimens, however, throw an additional light only on the construction of the head. The spinal column, the paired fins, and the scales are very slightly represented; of the specimens figured five are of the head and one of the tail; the latter, probably, belongs to *E. boissieri*; and of the anterior portion of the body represented in the figs. 1-4 (Plate xvii.) only fig. 2 exhibits any portion of the spinal column, and that in so fragmentary a condition that the small scaly portions may or may not be derived either from the head or the anterior portion of the body. The small specimen, fig. 5, which exhibits also the anterior portion of the body, is seen from the ventral aspect, and does not exhibit any trace of the dorsal plates, so conspicuous in the specimens of *E. boissieri*.

The specimens now to be described as *Eurygnathus ferox* possess some characters in common with the *Eurypholis longidens* of Pictet. They have, however, no lateral or dorsal series of scales; but the structure of the head and the formidable character of the teeth are very similar in the two species. It is possible that the two series may belong to the same species; but as I have had no opportunity of inspecting the types of M. Pictet, no definite opinion can be offered on the subject. Should it be expedient to unite them, there can be no doubt that it will be found necessary to remove the specimens, described by the learned author so often referred to, from *Eurypholis* to the genus now described.

*Eurygnathus ferox*, DAVIS.

(Pl. xxxvi., figs. 1, 1 a.)

A considerable number of specimens of this ichthyolite have been discovered since the publication of MM. Pictet and Humbert's classical work in 1866, and it is possible, in consequence, to give a more detailed description of some of the

parts in which the examples at the disposal of those authors were defective. The average length is about 9 inches from the snout to the peduncle of the tail, the latter adding 2 inches. The height of the body, slightly in advance of the dorsal fin, is 2 inches, diminishing evenly backwards to the tail, the base of which is little more than 0.5 inch. The tail is widely expanded and deeply cleft. The dorsal and anal fins are large and powerful; the paired fins are also well developed. The head is large, and has the appearance, probably due to pressure in expanding its bony structure, of being deeper than the body.

The head in profile is somewhat triangular; the snout obtuse, the lower margin, formed principally by the mandible, large and powerful, and the lower portion of the opercular bones extends from the snout 3 inches; the profile to the posterior portion of the skull 2.5 inches, and the line dividing the head from the body 2.5 inches. Seen from above, the head is broad, the snout obtusely circular. The bones covering the head are externally coated with a thick layer of enamel; the operculum is ornamented by radiating ridges, and other bones exhibit a similar character. Where the enamel has been removed and the under surface exposed, it is pitted in more or less parallel lines. The orbits are situated slightly in advance of the middle of the head, and the two are separated by only a small distance on the median line. The opercular bones are large, rounded, and extend far towards the abdominal surface. The upper jaw is composed of a pair of maxillaries, straight, and a considerable length; the intermaxillaries are short, but powerful, and are armed with long-pointed teeth; the lower jaws are long and very robust; their posterior extremity is attached to a large quadrate bone, affording a powerful leverage. The gape is very wide; the dentition of the jaws is their most striking feature. A large tooth 0.7 of an inch in length occupies the anterior extremities of the upper jaw; it is sharply pointed, laterally compressed, with a sharp cutting edge extending down each side; it is probably ankylosed to the bone of the jaw. A number of teeth occupy both the upper and lower jaws; they increase in size backwards to the median portion of the jaws, and further back again decrease in size. The teeth are separated by considerable spaces in transverse section; they are a flattened oval; on each side a longitudinal cutting edge extends from the point downwards, as in the large anterior teeth.

The spinal column consists of thirty-eight vertebræ, and of these fifteen are abdominal and twenty-three caudal. The vertebræ in the anterior portion of the body are 0.25 inch in height and 0.2 in length; the length remains the same nearer the tail, but the height gradually decreases to 0.15 inch. The anterior and posterior surfaces of each centrum are deeply concave, and the median portion considerably contracted. Neural apophyses are attached to each vertebra; the spines posterior to the dorsal fin curve slightly backwards and extend to the dorsal surface of the body; those opposite to or in front of the dorsal fin are curved

backwards at a much more acute angle. A series of epipleural spines extend transversely from the neural spines as well as from the hæmal spines presently to be mentioned. Interneural spines, eighteen in number, support the rays of the dorsal fin; they are stronger than the neural spines, and their upper extremities are expanded for attachment to the rays of the fin. The hæmal spines are similar to those of the posterior neural ones, except that their extremities are curved backwards to a larger extent. Interhæmal spines support the anal fin; they are eighteen in number, and similar to those supporting the dorsal fin. The ribs are strong, simple, an inch to an inch and a-half in length, and extending apparently to the abdominal surface of the body.

The anterior rays of the dorsal fin are 2 inches behind the head; the base of the fin extends 1·7 inch, and its posterior ray is separated by about 3 inches from the base of the tail; it is composed of fifteen strong rays; the anterior one is longest, being for a length of 1 inch undivided; beyond it branches into smaller rays; the succeeding rays are gradually reduced in length.

The anal fin is, like the dorsal, large and powerful; its base is 1·75 inch in length, and is separated from the caudal fin by a space of 0·75 of an inch. The fin-rays are shorter but somewhat more robust than those of the dorsal fin; towards the extremities they are subdivided to a considerable extent.

The caudal fin is large, each lobe 2 inches in length and deeply forked, the whole consisting of twenty rays, with rudimentary rays supporting both the upper and lower lobes, eight in number, attached to the former, and seven to the latter. The external ray of each lobe is remarkably thick and strong, 0·12 inch in diameter in the central portion, but tapering slightly towards the extremity; the succeeding rays are thinner, and diminish in length rapidly towards the median portion of the fin. The rays, except the large external ones, repeatedly dichotomize, assuming a filamentous character at their extremities; the external rays are enveloped in a series of imbricating sigmoidally-shaped plates, represented on Pl. xxxvi., fig. 1a.

The pectoral fins are situated immediately behind the opercular apparatus on the abdominal surface of the body, and are attached to a strong series of bones forming the scapular arch, but which cannot, in the specimens available, be separately identified. Each fin is composed of twelve rays, and is 1·6 inch in length; the basal half of the rays is simple, beyond they are divided. The distal extremity of the fin is rounded, the fourth and fifth rays being the longest.

The ventral fins are 1·5 inch behind the pectorals, and are separated by a distance of 2·5 inches from the anterior ray of the anal; they are on the abdominal surface 0·2 of an inch apart, and are connected by transverse osseous processes which, as well as the pubic bones, 0·5 of an inch in length, meet triangularly on the median line. The ventral fins apparently contain about the same number of

rays as the pectorals; the exact number is, however, not determinable. The fins are 1.0 inch in length, and the constitution of the fin-rays is similar to those of the pectoral fins.

The scales are not well preserved on most of the specimens; they were thin and comparatively small in size. There is no evidence of the large dorsal plates characteristic of the genus *Eurypholis*; neither is there any evidence of the lateral rows of plates extending on each side of the body from the head to the tail, as in that genus.

The relationship of this species has already been referred to under its generic appellation.

*Formation and Locality.*—Upper Cretaceous: Sahel Alma, Mount Lebanon.

*Ex coll.*—Lewis Collection; R. Damon, Esq., Weymouth.

#### Genus. *Phylactocephalus*.\* DAVIS.

Body elongated, oval, robust; head large, protected by thickly enamelled plates; mouth large; jaws strong, and provided with numerous small, conical, acutely-pointed teeth. Spinal column strong; vertebræ not numerous; ribs many, and fine. Dorsal fin near the head; anal close to the caudal, which is deeply bifurcate; pectoral fins attached to the side of the body; ventrals abdominal. Scales very small, free posterior margin pointed.

This genus, whilst possessing many peculiar characters, appears to be most nearly related to *Eurypholis* and *Eurygnathus*. The very strongly plated head and jaws, the latter provided with numerous sharp teeth, associate it with these genera; but the absence of the long teeth, which characterize these genera, will readily distinguish this one. The arrangement of the fins is similar to *Eurypholis* so far as the paired fins are concerned; but the dorsal of *Phylactocephalus* is nearer the head and the anal is nearer the tail. In *Eurygnathus* the dorsal fin is remote, whilst the anal occupies a similar position to that of the genus now described. It is separated from *Ischyrocephalus*, V. der Marck, by the absence of the long anterior teeth characteristic of that genus.

#### *Phylactocephalus microlepis*, DAVIS.

(Pl. xxxv., fig. 2.)

This specimen, which serves as the type of this species, is unique, and possesses several peculiar features which dissociate it from all its piscine congeners of the chalk of Lebanon. It possesses a strong osseous framework; its head is

φύλακος, a guard; κεφαλη, head.

encased in thick plates of enamel, and the jaws are remarkably strong and powerful, and armed with numerous teeth; the body is covered with minute scales, pointed at the free extremity, and reminding one forcibly of the shagreen of a selachian. The body, including the head, is 6·5 inches in length; the head occupies one-third of this length, and 1·5 inch must be added for the tail, to give a total length of 8 inches. Its height, in front of the dorsal fin, is 2 inches; the height diminishes to the base of the caudal fin, which is 0·4 inch. The whole of the body is well preserved. The pectoral and ventral fins are unfortunately in a rather fragmentary condition.

The head is slightly less in height than its length; the supra-occipital area is large and prominent, with a well-rounded margin. The distance between the orbits is large, and is occupied by a strong external osseous plate. The orbit is round and small, 0·6 inch from the snout and 1·5 inch in front of the posterior margin of the operculum. Of the opercular apparatus the pre-operculum occupies the largest space; it is 1·5 inch in height and half that in breadth, sub-angular at the top, with anterior concave margin and convex posterior one; the lower portion curved forwards towards the jaws. The operculum is a long and narrow bone extending parallel with the pre-operculum, but expanding somewhat in breadth towards its lower extremity; its free posterior margin is more or less sinuous. An inter-operculum extends at the base of the pre-operculum; it is a small bone: the sub-operculum was probably present, but is not well preserved. The lower jaw is strong, 1·4 inch in length, broadest at the back, and tapering towards the snout. The alveolar surface is straight, and provided with numerous small, closely-set, slightly curved, sharply-pointed teeth. The upper jaw is provided with a similar dental arrangement. The exposed surface of the bones of the head is smooth; the under surface, where exposed, is covered with minute pittings, sometimes without any apparent arrangement, at others, as in the opercular bones, exhibiting a series of lines of pittings radiating towards the free margin of the bone.

The spinal column is composed of thirty vertebræ, of which eleven are caudal; they are large; anteriorly the height is equal to the length, but towards the caudal extremity the height diminishes. The ribs are numerous, fine, and tolerably long. The neural spines are comparatively short and strong. A series of sixteen interneural spines support the dorsal fin. The hæmal spines are similar to the neural, but are curved backwards. A series of interhæmal spines, short and weak, support the anal fin.

The dorsal fin is situated midway between the snout and the base of the tail; it comprises fourteen rays, the anterior one 1·0 inch in length; the succeeding rays gradually diminish in length, and the fin, when expanded, as in the specimen, has a triangular form, the base slightly longer than the two sides; the rays of the fin are strong, and divide only towards the extremity.

The anal fin is situated on the posterior part of the body, the anterior fin-ray 1.0 inch in advance of the tail. Its rays are short and fine, dividing filamentously very near to their base.

The caudal fin is deeply forked, the lobes expanding to a diameter of about 3.0 inches. The two lobes comprise thirty rays, about equally divided between the two. The rays are articulated and divided by dichotomizing. The lower lobe is connected with the vertebral column by five or six strong processes expanding towards the fin to afford attachment to the fin-rays.

The pectoral and ventral fins are badly preserved. The former are attached to the pectoral arch, somewhat in advance of the posterior margin of the operculum, half an inch above the ventral margin of the body; fragments of rays are scattered about; they are stout bones, and appear to indicate a fin of considerable power. The ventral fins are 1.0 inch behind the pectorals; they were probably strong fins; a firm support was afforded by large pubic bones, in form an elongated oval, extending forwards from the base of the fins.

The scales are very small, extending in parallel horizontal lines containing seventy scales in the length of 1 inch; their height is equal to the length. The posterior margin is round, with the centre drawn out in the form of a point or tooth-like prominence, giving the scales very much the appearance of the shagreen of a dog-fish.

*Formation and Locality.*—Hard chalk: Hakel.

*Ex coll.*—Lewis Collection, Natural History Department, British Museum.

#### Genus. **Rhinellus.** AGASSIZ.

“Body elongate, covered with small imbricating, rounded scales: head long, prolonged into a beak, occasionally equal to the length of the body. Skeleton bony and complex. Dorsal fin short, slightly behind the middle of the body, and opposite to or a short distance behind the ventrals; anal fin short and near the tail; caudal divided into two deeply-cleft lobes; pectoral fins moderately large; ventrals small.” (Pictet and Humbert in part.)

The genus *Rhinellus* was established by M. Agassiz (“*Poiss. foss.*,” vol. ii., pt. II., p. 260), and embraced a small fish from Mount Lebanon, characterized principally by the excessive length of its jaws. Two specimens, both imperfect, are figured (*Op. cit.*, pl. 58*b*, figs. 5, 6); the first, the anterior part of the body, is still the type of the genus; the second is now known to be the tail of a fish, quite distinct from *Rhinellus*, and included in the genus named by Agassiz, *Dercetis*. By reason of this error Professor Agassiz considered that it was probable that the fish had two dorsal fins, and its dermal covering allied it to the *Scleroderms*, though he states that the two specimens may not belong to the same species.

M. Pictet ("Poiss. foss. du M. Liban.," 1850, p. 43) points out the error fallen into by M. Agassiz, and considers that *Rhinellus* should be removed from the Scleroderms and placed with the Esocides; the long beak, single dorsal situated behind the middle of the body, the abdominal position of the ventral fins all point to its relationship with *Belone*. Dr. Günther ("Geol. Magazine," 1864, vol. i., p. 114), whilst describing the genus *Plinthophorus*, falls into the error of supposing that *Rhinellus* had three rows of lateral external scutes, and differed in this respect from his new genus. Dr. Günther states that the position of the dorsal fin in the middle of the body removes it most clearly from any relationship with *Belone*, which Cuvier has associated with *Esox*.

MM. Pictet and Humbert, in their new researches ("N. rech. sur les poiss. foss. du M. Liban.," 1866, p. 81), indicate the error of Dr. Günther in regard to the external scutes of *Rhinellus*, but accept the correction with regard to its relationship with *Belone*, stating that new specimens have shown that the dorsal fin is not so far back as was formerly supposed, and that they present an incontestable analogy with *Opistopteryx*; they are therefore considered as a member of the numerous family of the Halecoides.

The only member of the genus hitherto described from Mount Lebanon is *R. furcatus*, Agassiz, from Sahel Alma; two new species from the same deposits will now be added from the admirable collection made by Mr. Lewis, and also three species from the hard chalk of Hakel.

*Rhinellus furcatus*, AGASSIZ.

- R. furcatus*. AGASSIZ, L., 1834. "Rech. sur les poissons fossiles," vol. ii., pt. II., p. 260, pl. LVIIIb., fig. 5, non fig. 6.
- R. furcatus*. HECKEL, 1843. "Fische Syriens," p. 238, pl. XXIII., fig. 1, which represents *Pycnosterinx russeggerii*, contains also a head of *R. furcatus*.
- R. furcatus*. PICTET, J. F., 1850. "Desc. de quelques poissons fossiles du Mont Liban.," p. 44, pl. VIII., figs. 3, 4.
- R. furcatus*. PICTET and HUMBERT, 1866. "Nouv. rech. sur les poissons fossiles du Mont Liban.," p. 82, pl. XI., figs. 5-8.

*Formation and Locality*.—Soft chalk: Sahel Alma.

*Ex coll.*—Museum at Geneva (type).

*Rhinellus robustus*, DAVIS.

(Pl. XXXVII., fig. 5.)

Several specimens of this species have been found in the soft chalk of Sahel Alma, but have not hitherto been discovered in the hard chalk of Hakel. Their



length, exclusive of the tail, is 4 inches; of this 1·8 inch is included in the length of the body from the base of the caudal fin to the occiput; the head and the beak-like snout is 2·2 inches. The greatest height is immediately before the dorsal fin, where it is 0·85 of an inch. From this point the height diminishes posteriorly; the peduncle of the tail is 0·35 of an inch; anteriorly the height remains nearly the same to the occipital region, which is 0·8 inch; the head is triangular, the jaws being continued almost straight to the end, and when closed, 0·2 of an inch across. The fins are well preserved; a distance of 0·8 of an inch separates the anterior ray of the dorsal from the head, and from the first ray of the dorsal to the base of the caudal is 1·1 inch. The pectorals are 0·8 of an inch in advance of the ventrals, which are immediately under the anterior rays of the dorsal. The anal fin is 0·7 of an inch behind the ventrals, and extends nearly to the base of the caudal. The caudal fin adds 0·5 of an inch to the length of the fish.

Head.—The orbit is large, and situated above the posterior part of the jaws; the post-orbital region is large. The operculi, rounded posteriorly, are well developed, but the constituent parts cannot be thoroughly identified in these specimens. The mandible is long and straight, equal in length to that of the body; the bone is strong and slightly thicker than that of the upper jaw; the latter equals the lower one in length; both are armed with small, straight, sharply-pointed teeth, with larger ones at intervals of about 0·2 of an inch. There are twelve to fourteen of the smaller between each of the larger. The dentition of both jaws is similar, differing in this respect from *R. furcatus*, Agassiz. There are a number of branchiostegal rays, which are long and slender.

The spinal column consists of thirty-six to thirty-eight vertebræ; they are small, about as long as broad; the articulating surfaces are deeply concave, and the central part much contracted. The neural and hæmal spines correspond posteriorly; interneural spines support the dorsal; and interhæmal the anal fin. The ribs are slender and long, with numerous apophyses.

The dorsal fin is placed midway between the head and the caudal fin; its base extends 0·3 of an inch along the dorsal surface; it is composed of fourteen rays, the three anterior ones not so long as those following. The anal fin occupies a position immediately in front of the caudal, and is supported by sixteen rays, which are articulated to a corresponding number of interhæmal spines. The caudal fin is deeply cleft, with about twenty-six rays divided between the two lobes. The rays are articulated and dichotomize.

The pectoral fins are large, supported by fourteen to fifteen rays, 0·8 of an inch in length; they divide and become filamentous at their distal extremity. The fins are low down on the abdominal surface of the body, the inferior rays of the two being joined on the median line of the abdomen; they are

supported by a series of strong scapular bones. The distance between the base of the pectorals and that of the ventrals is 0·8 of an inch. The ventral fin is composed of ten rays, shorter than those of the pectorals; their position on the abdominal surface is similar to the pectorals. The ventrals are supported by strong pubic bones, which branch into two parts, one horizontally along the abdomen of the fish, the second diagonally upwards.

The scales are not particularly well defined; they are more or less rounded, and small in size.

This species differs from *Rhinellus furcatus*, Agassiz, in many respects. The form of the body is very much thicker and stronger; the length of the body in proportion to its height is as 5 is to 1, whilst that of *R. furcatus* is as 18 to 1. The number of vertebræ in *R. furcatus* is about forty-five, in this thirty-six. The dentition is different, as mentioned above; and the relative position of the fins diverges considerably in the two species. Indicating its strong form, the name *Rhinellus robustus* is given.

In one of the specimens a small fish is preserved in the abdomen, apparently unmastered, which appears to indicate that the long jaws of the fish, well armed with teeth, were used for prehensile purposes, as well as the predatory character of the fish.

*Formation and Locality.*—Upper Cretaceous: Sahel Alma, Mount Lebanon.

*Ex coll.*—R. Damon, Esq., Weymouth (Lewis Collection).

*Rhinellus curtirostris*, DAVIS.

(Pl. XXXVII., fig. 2.)

The specimen which forms the type of this species is unique. The head and the whole of the vertebral column is preserved. All the fins, excepting the dorsal, have disappeared, including the caudal. The posterior half of the fish is laid on its side; the anterior half has the dorsal surface uppermost.

The head is small, 1·1 inch in length; of this the cranial portion occupies 0·6 of an inch, and the beak 0·5 of an inch. The upper surface of the cranium is seen; it was covered with bony plates. An operculum, dislodged from its proper position, lies near; it is comparatively large and rhomboidal in outline. Detached scales occur here and there over the specimen; they are of medium size, more or less square, and smooth.

The spinal column consists of forty-five vertebræ; they are longer than their diameter; the articulating surfaces are prominent, and the central portion contracted. The caudal vertebræ number twenty, the remainder are abdominal. The neural and hæmal spines are tolerably wide apart; the ribs are long, very

slender, and extend backwards; their whole length cannot be clearly discerned because they are doubled by the position of the fish.

The dorsal fin is 0·7 of an inch behind the occiput; it is supported by ten rays, the longest 0·7 of an inch in length. The rostral portion of the head or beak is 0·5 of an inch in length and 0·15 of an inch across the proximal portion, diminishing to 0·1 inch a short distance from the end. The termination of the beak is peculiar; at 0·1 inch from the end the bony framework suddenly expands and forms a process on each side which resembles a hammer; the termination of the beak is obtusely pointed. The right and left ramus of the jaw are separate until the end is nearly reached, when they gradually meet and coalesce.

*Rhinellus curtirostris* is remarkable for its long body, small head, and short jaws; the most peculiar feature consists in the hammer-like enlargement of the distal end of the jaws. The position of the dorsal fin is more advanced than in either of the two specimens from the soft chalk at Sahel Alma. It is possible that the peculiar form of the termination of the jaws may be found to be of generic importance. This specimen is, however, imperfect, and for the present it will be retained in the genus *Rhinellus*.

*Formation and Locality.*—Cretaceous: Hakel, Mount Lebanon.

*Ex coll.*—Lewis Collection; R. Damon, Esq., Weymouth.

*Rhinellus longirostris*, DAVIS.

(Pl. xxxvii., fig. 3.)

This beautiful little fish, like the preceding one, is from the hard gray chalk; it differs from all others hitherto described in the large size of the head and immensely long jaws in proportion to the other parts of the body. The length of the fish, from the tip of the snout to the peduncle of the tail is 3·4 inches; of this length the head and jaws comprise nearly two-thirds, or 2·2 inches, the length of the body being 1·2 inch. The greatest height of the body is 0·55 inch immediately in front of the dorsal fin, and posteriorly the body tapers to the base of the caudal, where its height is 0·2 of an inch.

The post-orbital region of the head is 0·65 of an inch; from this point the head and snout extend forward with a concave flexure on the upper surface, and with a straight horizontal base. The terminations of the jaws are pointed, the lower one turning upwards very slightly at the tip. The mandible is 1·9 inch in length, 0·15 in height near the articular base, and thence gradually diminishes to an acute point. The pre-maxillary forms the terminal part of the upper jaw, and is 1·3 inch in length, the maxilla occupying the remaining portion. The jaws are armed with a long series of sub-conical teeth, very minute, only to be distinguished when magnified. The orbit is less than in *R. furcatus* or

*R. robustus*; it is situated one-third of the height of the head below the cranial surface, and 0.25 inch in front of the occiput. The opercular bones are narrow antero-posteriorly, but extend to a considerable height. The impression on the matrix show a number of branchiostegal rays to have been present, which have disappeared probably on the opposite matrix; the rays are shorter and stiffer than those of *Rhinellus robustus*.

The spinal column consists of the small number of twenty-four to twenty-six vertebræ; the articulatory surfaces are expanded, the central portion contracted; the length of each vertebra is equal to its diameter. Neural and hæmal spines spring from each vertebræ in the caudal region. The ribs are long and slender, extending diagonally backwards.

The dorsal fin is large, having about a dozen rays 0.3 of an inch in length; its base extends 0.4 of an inch, and it is separated by 0.2 of an inch from the head. The anal fin is midway between the ventrals and the caudal; its size or extent is not well defined. The caudal fin is large; the diameter between the outstretched lobes is 1.1 inch, each being 0.5 of an inch in length; the fin is deeply cleft, the rays strong, closely articulated, and, so far as can be observed, they are only once divided.

The pectoral and ventral fins are small; they are both low down on the abdominal region. The pectorals are immediately behind the operculi; they are separated by a distance of 0.35 of an inch from the ventral fins. The anterior ray of each ventral fin is opposite the median portion of the dorsal; it is more posteriorly placed than in either of the preceding species. The scales are not preserved.

The distinguishing characters of this species have to some extent been already indicated in its excessively long beak-like snout and short body. The minute, sub-conical teeth, the small number of its vertebræ, and the backward position of the ventral fins also serve to separate it from preceding species.

*Formation and Locality.*—Hard gray chalk: Hakel, Mount Lebanon.

*Ex coll.*—Lewis Collection; R. Damon, Esq., Weymouth.

*Rhinellus laniatus*, DAVIS.

(Pl. XXXVII., figs. 6, 7.)

The specimen exhibits the form of the body, the relative position of the fins, and the internal arrangement of the bones. The extremity of the jaws are broken off and a part of the fins hidden in the matrix. The part preserved is 10.0 inches in length from the snout to the peduncle of the tail; of this length the head occupies 4.0 inches. The greatest depth of the body is 1.5 inch.

The head is large and the jaws powerful. The occipital region is 1.5 inch

in height; it diminishes anteriorly to the termination of the jaws. The orbit is situated very high: it is large, and little more than half an inch in front of the posterior margin of the operculum. The opercular bones are large, and rounded posteriorly. The upper jaw expands backwards beyond the orbit, and descends so as to envelop the posterior portion of the lower jaw. Only a slight trace of teeth can be distinguished: they are small, conical, and pointed; others of larger size may be hidden by the matrix.

The vertebral column is composed of thirty-nine or forty vertebræ, of which sixteen are caudal. The anterior vertebræ are larger than those behind; the larger are 0·2 inch long and 0·15 inch high. Strong ribs, with branching apophyses, with a slight curvature backwards, are attached to each abdominal vertebræ. Similar spinous processes extend from the neural and hæmal surface of the posterior vertebræ; hæmal spines are also attached to the anterior vertebræ. Interhæmal bones support the anal fin, and interneural the dorsal.

The dorsal fin extends 2·0 inches along the surface of the back; it is 2·5 inches behind the head, and its posterior rays 1·5 inch before the tail; it has twenty rays; the basal portion of these is preserved; they are strong, with articular base for attachment to the interspinous bones. So far as preserved they are undivided. The anterior rays are thicker than those following.

The anal fin consists of seventeen rays, each attached to an interhæmal spine; it is much smaller than the dorsal, the rays thin and apparently short; its anterior rays are 2·0 inches before the caudal, and it has a basal extension of 1·5 inch.

The caudal fin is not well preserved; its lobes are widely expanded and short. It consists of twenty-four rays attached to a somewhat expanded hypural bone; the rays are jointed at short intervals. A series of rudimentary rays support both the upper and lower lobe of the tail.

The pectoral and ventral fins are not well preserved. The former are located on the ventral surface immediately behind the head; only a remnant of a base is preserved. The ventral fins are 3 inches behind the pectorals; they appear to be comparatively small; they are separated by a distance of 1·0 inch from the anal fin, and are opposite to the middle portion of the dorsal.

The evidence of scales is slight, and no estimate of their form or size can be made. The bones of the head are enveloped in thin brown enamel, which also extends over the surface of the jaws.

A large jaw of this species of *Rhinellus* is represented on Plate xxxvii., fig. 7; it is the mandible, or lower jaw, measuring 5 inches in length; at its base it is 0·35 inch broad; it is straight, and contracts in breadth towards the anterior extremity, which terminates in a point. The surface of the jaw is raised into a series of converging ridges, which coalesce towards the point; one or two of the larger ridges are broken so as to form a serrated line. The anterior

portion of the alveolar surface is armed with teeth of two kinds, a series of large, recurved, pointed teeth placed at intervals, and separated by six smaller ones between each. The posterior part of the jaw, reaching from an inch behind the point, is closely set with minute, conical, pointed teeth.

The jaw appears to be somewhat similar to the lower jaw of *R. longirostris*, Davis, but it is very much larger, and the teeth are different, the presence of the large laniary teeth in this specimen readily distinguishing it. It is distinguished from *R. ferox* by the character of its teeth; the smaller ones are more numerous and are conical.

Another specimen from the collection of Mr. Lewis, at the British Museum, exhibits a portion of the head, but the snout and the whole of the body is absent. Its height immediately behind the orbit is 1·2 inch, and the length preserved is 3·0 inches. The orbit is situated high in the head; it is not so broad as in *R. ferox* from Sahel Alma. The anterior part of the operculum is preserved, and the posterior terminations of some of the branchiostegal rays may be observed: they are long and slender. A series of ridges radiate from the central part of the anterior surfaces of the operculum towards its inferior and posterior margins. The proximal portions of the maxilla and mandible only are preserved; they possess the characters already described. The superior margin of the snout is minutely serrated along the entire length of the snout preserved.

*Formation and Locality.*—Hard chalk: Hakel, Mount Lebanon.

*Ex coll.*—Lewis Collection, Natural History Department, British Museum.

*Rhinellus ferox*, DAVIS.

(Pl. xxxvii., fig. 1.)

The specimens from which the description of this species is taken are in the Natural History Museum at South Kensington. The most perfect, represented on the plate indicated above, is from the collection of Mr. Lewis. The head, body, and tail are preserved; the dorsal and mid-ventral surfaces are imperfect, a portion of each having apparently been lost during the extraction of the fossil from the matrix. Fortunately other specimens occur from which the characters of the missing parts can be deduced.

The total length of the body, from the snout to the tip of the tail is 16 inches. The head occupies 6·8 inches of this length, and the tail 2·5 inches; the body, from the base of the tail to the posterior margin of the operculum, is 6·8 inches, exactly equal to the length of the head. The greatest height is 1·4 of an inch immediately behind the pectoral fins; it changes little for 4 or 5 inches, but beyond that distance diminishes rapidly to the base of the tail, which is 0·8 of an inch in height.

The dorsal fin is not clearly preserved, only the posterior portion of rays remain; this, combined with the evidence of another specimen about the same size, shows that its posterior was about 4 inches behind the head. The pectoral fins are situated abdominally immediately behind or under the operculum; the ventrals are 2·6 inches behind the pectorals; the distance between the insertion of the ventral fins and the anterior ray of the anal is 3 inches, and thence to the base of the tail 1·5 inch.

The head is equal in length to the body. The orbit is large; it is 4·5 inches behind the tip of the snout, 0·8 of an inch in diameter, situated high in the head, leaving a very small inter-orbital space. The post-orbital area extends 1·5 inch between the orbit and the posterior margin of the operculum, and its height is 1·2 inch. Nearly the whole of this space is occupied by the operculi. They are not sufficiently well preserved to be distinctly identified, but they are rounded posteriorly, and were encased in a smooth coating of enamel. The branchiostegal apparatus is not exposed. The jaws are long and slender, in the specimen of which a figure is given (Pl. xxxvii.), the rami of the jaws have become separated; those of the lower jaw are longer than those of the upper one; it is doubtful, however, whether this may not be simply due to want of care on the part of the person who has prepared the specimen. The articulating extremity of the mandible is strong, rounded, and prominent, and is attached to the skull 0·2 inch behind the orbit. The dentition of the upper and lower jaws is dissimilar. The teeth of the upper jaws are longer than those of the lower one; they consist of laniary teeth, 0·15 of an inch in length near the base of the jaw, but becoming gradually shorter towards the extremity; they are small in diameter and acutely pointed, very slightly curved inwards; between the larger teeth are others much smaller, but similar in form, and averaging three in number. The teeth of the lower jaw are smaller than those of the upper; the small teeth between the laniaries are very small; whilst the latter are not so much as half the length of those of the upper jaw.

The vertebral column consists of forty-eight vertebræ; those situated anteriorly are 0·2 inch in length; the articulating surfaces are equal in diameter to three-fourths the length; the vertebræ decrease in size towards the caudal extremity. The neural spines are bifurcated at their base, long, and slender, numerous, with branching apophysial bones. Strong interneural bones, with broadly-expanded base, support the dorsal fin. The ribs are less numerous and stronger. The hæmal spines partake of the character of the ribs, and a series of small inter-hæmal spines support the rays of the anal fin.

The dorsal fin, in the specimen drawn on Pl. xxxvii., is absent; it is preserved on a second specimen in the National Collection; it was large, supported by strong fin-rays; their entire length is not shown; they probably numbered

fourteen or fifteen. The anterior rays are strongest, and supported by proportionately large interneural spines.

The anal fin is comparatively small, its base extending 1·0 inch; it consisted of about twenty short and fine fin-rays. The caudal fin is of moderate size and forked; each lobe is supported by nine or ten strong articulated rays, which become subdivided by repeated bifurcation towards their distal extremities. The outer rays of both the upper and lower lobes are supported by short imbricating rudimentary rays.

The pectoral fins are large and well developed. The number of rays in each is ten to twelve, the anterior ones 1·25 inch in length; they are situated in close apposition on the abdominal surface of the body. The ventral fins are not well defined on any of the specimens; they appear to have been comparatively small, supported by a triangular and flattened internal bone.

The scales are thin; the exposed posterior surface is circular and smooth in outline; their diameter is 0·1 inch on the dorsal portion of the fish. The scales on the ventral surface are slightly smaller and more or less elongated, parallel with the lateral line. Between the head and the peduncle of the tail there are about seventy rows of scales, and the transverse series numbers twenty-four.

This species presents several features which distinguish it from others already described. Its large size cannot of itself be considered of much importance; its most peculiar characters are those of the teeth, the vertebral column, and the position of the fins. The large laniary teeth, with intermediate small ones, few in number, and separated by rather wide intervals, distinguish this species from *R. robustus*, in which the larger teeth are more widely separated, and have twelve or fourteen small ones between each. *R. robustus* also differs in possessing only thirty-six to thirty-eight vertebræ, whilst this species has forty-eight.

From *Rhinellus curtirostris* this species is readily distinguished by the length of its jaws and the character of its dentition, though they resemble each other in the number of the vertebræ.

From *R. longirostris* it is readily distinguished by the spinal column, which in *R. longirostris* consists of only twenty-six to twenty-eight vertebræ, and the comparative length of the head and body. The anterior position of the ventral fins, as compared with the dorsal, serves to distinguish this species from any other, in addition to the differences already enumerated.

In allusion to its formidable appearance, I have given it the specific name of *ferox*.

*Formation and Locality.*—Upper Cretaceous: Sahel Alma, Mount Lebanon.

*Ex coll.*—Lewis Collection, Natural History Department, British Museum.



*Rhinellus damoni*, DAVIS.

(Pl. XXXVII., fig. 4.)

Several specimens of a species of *Rhinellus*, which appear to be different from those hitherto described, have been found at Sahel Alma, and are now in the British Museum. They have a comparatively short fusiform body, and a very long snout; they vary from 6 to 7 inches in length. The one taken as a type is a beautifully preserved specimen from the Lewis Collection; it is 5·7 inches in length from the tip of the snout to the peduncle of the tail; the latter adds 1 inch to the length. The head and snout occupy 3·5 inches, the remaining 2·2 inches constituting the length of the body. In other specimens the length of the body more nearly approaches that of the head and snout. The greatest height in this specimen is 1·1 inch between the pectoral and ventral fins; from this point the height rapidly diminishes both anteriorly and posteriorly, the base of the tail being 0·5 of an inch. The dorsal fin is 1 inch behind the head to its anterior ray, the latter being also 1·4 of an inch from the base of the tail. The first rays of the pectoral and ventral fins are separated by 0·7 of an inch. The anal is 1·0 inch behind the ventral and 0·6 from the caudal.

The head is comparatively small, the length of the jaws great; behind the orbit it is 0·8 inch in height; the height rapidly decreases anteriorly, the continuation of the jaws being long and slender. The orbit is small and circular, situated lower in the infra-orbital region than in the other species described. Between the orbit and the outer margin of the operculum is 0·7 inch. The latter occupies 0·4 inch of this space; it is much higher than broad. The constituent parts of the operculum are not sufficiently well preserved for identification. The mandibles extend backwards 0·25 inch beyond the orbit; they are armed with a long series of minute, recurved, sharply-pointed teeth; there are no large laniary teeth, as in *R. ferox* or *R. laniatus*.

The vertebral column is comparatively small in diameter. There are forty-five vertebræ. The neural and hæmal spines are long and slender, bifurcated at the base, and with branching apophyses; the ribs slightly stronger and longer. Interneural spines support the dorsal fin, and fine short interhæmal spines support the anal fin.

The unpaired fins are larger than those of some of the species of *Rhinellus*. The base of the dorsal fin extends 0·6 of an inch; it is composed of fourteen rays, the anterior ones reaching a length of 0·8 inch; they are strong and undivided at the base, but assume the usual form of subdivision towards their extremities.

The anterior rays of the anal fin are situated 0·6 of an inch from the base of the tail; they are 0·3 inch in length; the succeeding ones, sixteen in number,

diminish gradually in size, and the base of the fin extends backwards, so that it is separated by a short interval only from the base of the tail.

The caudal fin consists of twenty-one rays; it is deeply cleft into two lobes; the external rays of each lobe are about 1·0 inch in length. The base of each ray is pointed and attached to the hypural bone as a common centre; the latter is a triangularly expanded and flattened plate, with its broad extremity extending from the vertebral column towards the tail. The caudal rays rapidly increase in size with the expansion of the fin and become subdivided towards their extremities. The rays are jointed throughout their entire length; the outer rays of each lobe are supported by a series of imbricating rudimentary rays.

The pectoral fins are large, consisting of thirteen or fourteen rays, the anterior ones 1·0 inch in length. The bones of the scapular arch are proportionately strong and indicate considerable power. The articulating surface of the base of the fin-rays is produced, rounded, and curved towards the point of attachment. The distal half of each ray is divided by bifurcation.

The ventral fins are similar to the pectorals, except that they are smaller; they are attached to pubic bones, which converge and meet on the ventral surface. Both fins are exposed in the specimen figured. The scales have a rounded posterior outline similar, but somewhat larger and more elongated vertically, than those of *Rhinellus ferox*.

This short and somewhat ovoid-bodied example is distinguished by the great proportionate length of the head, combined with the small size and position of the orbit, and the dentition of the jaws; these combined characters separate it from species hitherto described. The ventral fins are slightly in advance of the dorsal, and in this respect it is separated from *R. ferox*, in which the dorsal fin is much further back; the dentition of the two is also unlike.

*Formation and Locality.*—Upper Cretaceous: Sahel Alma, Mount Lebanon.

*Ex coll.*—Lewis Collection, Natural History Department, British Museum.

Family. **HOPLOPLEURIDÆ.** PICTET.

“*Traité de Paléontologie*,” 2nd edition, vol. ii., p. 213.

“Body generally with four series of sub-triangular scutes, and with intermediate scale-like smaller ones. One (?) dorsal only; head long, with the jaws produced.”

Genus. **Leptotrachelus.** VON DER MARCK.

“Fossile Fische, Krebse und Pflanzen aus dem Plattenkalk du jungsten Kreide in Westphalen,” *Palæontographica*, vol. xi., p. 59, 1863–64.

Body long, narrower anteriorly than behind. Dorsal fin short, sub-median; anal short, probably midway between the dorsal fin and the caudal; ventral fins situated under the dorsal. Five series of scales (three according to M. von der Marck), of which one is dorsal, and two on each flank; the scales are, in most cases, tricuspid, but occasionally heart-shaped (Pictet and Humbert, “*Nouv. rech. s. les poiss. foss.*,” p. 93). The above diagnosis will require further modification, so that the sixth row of scales extending along the abdominal surface may be included.

This genus was instituted by Dr. W. von der Marck, and included one species, *L. armatus*, from the chalk formation of Westphalia. He regarded the genus as nearly related to *Dercetis*, Ag., and it was considered as a Ganoid along with the genus *Pelargorhynchus*, which, in addition to the dermal scutes of *Leptotrachelus*, possessed small scales and a well-developed dorsal fin.

MM. Pictet and Humbert discuss the zoological position of the genus at considerable length, and arrive at the conclusion that it is closely related to the genus *Eurypholis*, Pictet, which has undoubted affinities with the Teleosteans. They therefore consider these genera along with *Sauroramphus*, Heckel,\* *Dercetis*, Agassiz; *Ischyrocephalus*,† Von der Marck; and *Plinthophorus*,‡ Günther, as forming a natural group, which they are convinced should be considered as a sub-class of the Teleosteans, and for which M. Pictet has established the family *Hoplopleuridæ*.

In 1850, M. Pictet described three species of *Dercetis* from the soft chalk of Sahel Alma. The examples described were in a more or less fragmentary condition. During the interval intervening between the publication of the memoir in 1850 and the “*Nouvelles recherches*” in 1866, it was found that two of the species, viz. *Dercetis triqueter* and *tenuis*, were portions of fishes of the same species, and that combined they belonged to the genus *Leptotrachelus*, and are described as *L. triqueter*. The remaining species, *Dercetis linguifer*, Pictet, was retained by MM. Pictet and Humbert. The example on which it was established is a small fragment about 2 inches in length from the body of the fish, and exhibits a portion of the spinal column and a few of the dorsal scutes.

Since the year 1866 a considerable number of specimens have been obtained, and, as will be seen from the following observations on the species, they differ

\* Heckel, “*Beiträge zur Kenntniss der Fossilien Fische (Esterreichs)*,” 1849, p. 17.

† *Op. cit.*, p. 60.

‡ Günther, “*Geological Magazine*,” 1864, vol. I., p. 114, pl. vi.

much in size as well as in the details of the form of the scutes; and there can be no doubt that the figure given by M. Pictet (*op. cit.*, pl. IX., figs. 7 and 8) is that of a portion of the body of a large fish of the genus *Leptotrachelus*, and that it is the same species as those already included in the species *L. triqueter*, P. and H.

*Leptotrachelus triqueter*, PICTET and HUMBERT.

(Pl. XXXVIII., fig. 1.)

*Leptotrachelus triqueter*. PICTET et HUMBERT, 1866. "Nouvelles recherches sur les poissons foss. du Mont Liban.," p. 95, pl. xiv., figs. 1, 2.

*Dercetis triqueter*. PICTET, F. J., 1850.

FRAAS, OSCAR, 1878. "Aus dem Orient. II. Theil. Geolog. beobach. am Libanon," p. 98.

MM. Pictet and Humbert described the fish remains thus named from very imperfect specimens. Since the publication of their memoir others, with much better preserved characters, have been discovered, and, whilst confirming the observations of MM. Pictet and Humbert, afford considerable additional information as to the characteristics of this peculiar fish. The length of the specimens varies considerably: an average is about 9 to 12 inches. The specimen represented on Pl. xxxviii., fig. 1, is 9 inches in length from the tip of the snout to the base of the tail; the head occupies 1.5 inch, and 1.0 inch must be added for the tail. The body of the fish is long and slim; it is highest at a distance of 3.0 inches behind the head, where it is 0.6 inch; from this point it becomes smaller towards the tail, which is one-third the greatest diameter of the body. Anteriorly the trunk becomes rapidly smaller, and a long and slim neck connects it with the head; the height of the latter is 0.7 of an inch behind the orbit, rapidly converging to the snout. The position and character of the fins is shown in the specimen represented.

The dorsal fin extends 2.4 inches along the back (the length of the fish being 10 inches); it is 3 inches behind the occipital portion of the head, and is 2.8 inches in advance of the tail; the median dorsal surface in front and behind the fin is occupied by a series of the tri-pointed scutes characteristic of the genus.

The anal fin is 1 inch in length, and is separated by a space of 0.6 of an inch from the caudal. The ventral fins are 3 inches in front of the anal, and opposite to the anterior rays of the dorsal. The pectoral fins are suspended from the pectoral arch immediately behind the gill-covers. The body is protected by lateral series of tricuspidate dermal scutes, which vary considerably in form, as may be seen by reference to the examples figured from several parts of the body.

The head, which has been selected for description, is 2·7 inches in length, and the posterior part is 0·9 inch in height. The orbit is 1·3 inch behind the anterior extremity of the maxillæ; it is 0·4 inch across, and is situated 0·1 inch from the superior outline of the skull. The operculi are large; the anterior margins of each are straight, the posterior ones rounded and arched towards the abdominal surface of the fish; the pre-operculi occupy the largest area, each operculum being a long and narrow bone attached to its posterior margin. The branchiostegal rays are small and slender, but long; the actual number does not appear, but there were probably eight or ten on each side. The superior surface of the skull was protected by strong plates or bones covered thickly with enamel, as were also those of the other parts of the head. The mandible is 2·1 inches in length, and is articulated to the bones of the skull at a point considerably behind the orbit. The mandible is a strong and comparatively thick bone, expanding widely towards the median line between the jaws, the lower surface bending slightly upwards towards the anterior extremity, whilst the upper or alveolar surface is straight. The maxillæ are slightly longer, and overlap the mandibular bones; the posterior portion is thicker than the mandible. A peculiar depression of the anterior extremity of each maxillary appears to be a natural one, other specimens indicating the same peculiarity; both are furnished with a large number of moderately-sized, recurved, sharply-pointed teeth.

The spinal column consists of seventy-two vertebræ: of these fifty-two are thoracic, twenty-eight extending from the head to the anterior ray of the dorsal fin; the remaining twenty are abdominal. The anterior vertebræ are twice as long as high, the articulatory surfaces well ossified, but the intermediate central part contracted and small. Opposite the commencement of the dorsal fin the vertebræ become thicker and shorter; this character is maintained to the base of the tail; but the vertebræ decrease in size backwards. The ribs are slender, and bent considerably backwards. Neural spines extend from the upper surfaces of the vertebræ and beyond the abdominal cavity; stronger hæmal as well as neural spines support the posterior portion of the body of the fish. A number of closely impacted strong interneural spines support the dorsal fin.

The dorsal fin is composed of thirty-eight rays; the anterior ones are strongly jointed and curve slightly backwards; they are 0·5 inch in length. The rays gradually diminish in strength backwards, those near the posterior termination being not only more slender, but considerably shorter than the anterior ones; the basal part of the rays is not jointed, but towards the distal extremity they are, and the rays also bifurcate.

The anal fin consists of fourteen rays and possesses similar characters to those of the dorsal fin.

The caudal fin is moderately expanded and deeply cleft. It is supported by twenty-two principal rays; those on the external margins of the two lobes are

strongest and longest, diminishing towards the centre; the rays are jointed and repeatedly dichotomize. The superior and inferior ray of each lobe is supported by a series of imbricating rudimentary caudal rays.

The pectoral fins are widely separated from the median abdominal line and strongly supported by the pectoral arch; there are ten to twelve rays in each. Their whole length is not preserved in this specimen, but another shows them to have been 0·8 of an inch in length, the outer rays largest and diminishing towards the axis of the body. The ventral fins are slightly larger and stronger than the pectorals, otherwise they are similar.

The scales are admirably described by M. Pictet in terms of which the following is a translation:—"The scales form at least five series in certain parts of the body, one medial dorsal and two lateral on each side. The dorsal series has only been observed on the anterior part of the neck, upon a length less than that of the head. The scales of this series are in the form of an arrow-head, with the point directed forwards; the sides of the scale are rounded, with the greatest diameter a little behind the middle; their posterior extremity is included at a sharp angle, the two posterior lobes terminating in points. The scales best preserved are those which . . . probably occupied the middle of the flank. . . . They present the form of a tricuspid arrow-head, of which one point is directed forwards, the other two diverging so as to form an obtuse angle; in the scales occupying the region between the head and the ventral fins the anterior point is a little longer than the other two; but in the region behind this the lateral points tend to predominate over the anterior one. Between this series and the dorsal one may be seen on each side another, composed of smaller scales, probably more delicate, because they are not so well preserved. These scales are similar in form to those already described with the point directed forwards, and furnished at their base with two diverging prolongations, shorter and less important than in the series preceding." ("Nouv. rech. s. les poiss. foss. du Mt. Liban.," p. 96.)

In addition to the five series of scales described above there is a sixth extending along the abdominal median line; the scales are very similar to those already described as situated on the median dorsal surface.

*Formation and Locality.*—Upper Cretaceous: Sahel Alma, Mount Lebanon.

*Ex coll.*—Natural History Department, British Museum.

*Leptotrachelus triqueter*, var. *a.*, DAVIS.

(Pl. xxxviii., fig. 2.)

A large specimen of a *Leptotrachelus*, collected by Mr. Lewis, and now in the New Natural History Museum, South Kensington, is worthy of note. It is probable that it may belong to a distinct species, but until other and more

perfect specimens have been discovered, it will be well to regard it as a variety of the species already described. The part preserved is 12·5 inches in length; of this the head occupies 5 inches, the remainder consisting of the anterior portion of the vertebral column; the latter does not materially differ from that of *L. triquetus*, except in size. The head is not well preserved, the termination of the snout is broken away. The lower jaw is 3·5 inches in length, the upper one being proportionately large; both are filled with a large number of teeth similarly recurved and pointed to those of the species already described. The upper part of the head is not well preserved.

*Formation and Locality.*—Soft chalk: Sahel Alma, Mount Lebanon.

*Ex coll.*—Lewis Collection; Natural History Department, British Museum.

*Leptotrachelus gracilis*, DAVIS.

(Pl. xxxviii., fig. 3.)

In the collection at the new Natural History Museum there are examples of a *Leptotrachelus* which are extremely long and slender as compared with the type specimens already described. They are 9 inches in length; the greatest depth of the body is 0·3 of an inch. The head is 1·3 inch in length, and its greatest depth behind the orbit is 0·35 of an inch. The dorsal fin is not well preserved, but its anterior rays are 4 inches in front of the base of the tail. The ventral fins are 3·3 inches from the tail. The anal fin is 1·1 inch before the caudal; its rays are longer, but the fin has not quite the same basal length as in the type. The head is triangular and terminates with an acutely-pointed snout; the jaws are furnished with teeth, recurved, acutely-pointed, and larger in proportion to the size of the head than in the types. The dermal scutes are somewhat more angular and more acutely-pointed than in the larger specimens.

*Formation and Locality.*—Soft chalk: Sahel Alma, Mount Lebanon.

*Ex coll.*—Natural History Department, British Museum.

*Leptotrachelus hakelensis*, PICTET and HUMBERT.

*L. hakelensis.* PICTET and HUMBERT, 1866. "Nouv. rech. s. les poiss. foss. du Mt. Liban.," p. 98, pl. xiv., fig. 3.

*L. hakelensis.* FRAAS, OSCAR, 1878. "Aus dem Orient. II. Theil. Geolog. beobachtungen am Libanon," p. 92.

Several examples of this small species have been added to the National and

other collections, but, whilst confirming the diagnosis, they do not add materially to the particulars already given by MM. Pictet and Humbert.

*Formation and Locality.*—Hard chalk: Hakel, Mount Lebanon.

*Ex coll.*—Museum at Geneva (type).

Genus. **Dercetis.** AGASSIZ.

*Dercetis linguifer*, PICTET.

D. linguifer. PICTET, J. F., 1850. "Description de quelques poissons fossiles du M. Liban.," p. 47, pl. ix., figs. 7, 8.

D. linguifer. PICTET and HUMBERT, 1866. "Nouv. recherches s. l. poissons fossiles du Mont Liban.," p. 35.

It is highly improbable that the fragmentary remains on which Professor Pictet founded this species belong to the genus *Dercetis*. I have stated that they much resemble those of *Leptotrachelus*, and have given the reasons for doing so on a previous page. It is unfortunate that I have not had an opportunity of examining the specimens themselves, and until this has been done it may be advisable to retain the name given by Professor Pictet.

*Formation and Locality.*—Soft Chalk, Upper Cretaceous: Sahel Alma.

*Ex coll.*—Museum at Geneva.

Genus. **Aspidopleurus.** PICTET and HUMBERT.

*Aspidopleurus cataphractus*, P. and H.

(Pl. xxxviii., fig. 4.)

A. cataphractus. PICTET and HUMBERT, 1866. "Nouv. rech. s. les poissons fossiles du Mont Liban.," p. 109, pl. xviii., fig. 1.

Family. **MURÆNIDÆ.**

Genus. **Anguilla.**

Small scales embedded in the skin; upper jaw not projecting beyond the lower; teeth small, forming bands; gill-openings narrow at the base of the pectoral fins. The dorsal fin commences at a considerable distance from the occiput. (Günther.)



*Anguilla sahel-almæ*, DAVIS.

(Pl. xx., fig. 2.)

A number of examples of fishes from the soft chalk of Sahel Alma are referred to this genus. The average length is about 7 inches, and the height 0·5 inch. The head occupies 1·2 inch; an extremely fine dorsal fin appears to have extended from a point immediately behind the occipital region of the head, the whole length of the back, and to have completely encircled the tail, which is diphyccercal and undivided, and thence extended 1·5 inch forwards along the median ventral surface. There are a pair of pectoral fins and also ventrals.

The head is elongated and flattened towards the snout; the jaws well rounded anteriorly and somewhat widely expanded posteriorly; gape wide, extending backwards to the centre of the orbit. The maxilla was armed with a series of comparatively long, slightly curved, sharply-pointed teeth; the mandibles were, in all probability, similarly armed, but the teeth are not exposed on any of the specimens. The orbit is moderately large, situated midway between the snout and the posterior margin of the opercular bones; it is very high, leaving a narrow space to be occupied by the cranial bones. The opercular bones are large, their components are not clearly shown; there is a large plate, well rounded posteriorly, extending high towards the occipital region, and with a concave anterior margin, probably the operculum; a triangular plate of smaller dimensions is attached to the lower margin of the operculum, and apparently extends slightly beyond it posteriorly. The infra-orbital region is large; the branchiostegal rays are exposed, apparently twelve to fifteen in number, long, slender, and curved backwards.

The vertebral column is composed of about seventy-six vertebræ, each vertebræ somewhat longer than high, with bi-concave centres widely expanded, whilst the median portion is much constricted. The vertebræ occupying a position one-third the length of the fish from the caudal extremity are strongest and largest, and appear to indicate the extent of the caudal portion of the vertebral column. Numerous ribs are attached to the anterior vertebræ; they are long and slender, extending quite to the ventral surface, and are further supported by false ribs, extending backwards with a sharp curvature, bringing them parallel for some distance with the vertebral column. The extent of the œsophageal cavity is indicated by the presence of smaller fishes which have been devoured. In one specimen two, if not three, fishes are thus entombed, and occupy nearly one-half the length of the body. Numerous hæmal apophyses extend from the vertebral column beyond the region occupied by the ribs and support the anal and caudal fins. Neural spines ascend from the upper surface of the column, and interneural spines connect them with the rays of the long dorsal fins.

The pectoral fins are situated immediately behind the opercular apparatus, one-third the height of the fish above the ventral line; each consists of nine rays, the anterior of which is 0·5 inch in length, thick and strong; each succeeding one diminishes in size as well as length.

The ventral fins are not well defined, but appear to be present on one specimen; they are smaller than the pectorals, from which they are separated by a distance of about 3 inches, and are attached at a point nearer the median ventral line than are the pectorals.

A slight discolouration of the stone is the only indication of the external covering of the fish. If scales were present it is probable that they were very minute.

*Formation and Locality.*—Soft chalk: Sahel Alma.

*Ex coll.*—Natural History Department, British Museum.

*Anguilla hakelensis*, DAVIS.

(Pl. xx., fig. 3.)

A second species of this genus, considerably smaller than the one already described, occurs in the hard chalk of Hakel. Two specimens are in the National Collection. The larger one is 3·7 inches in length, of this the head occupies 0·5 inch. The greatest height of the fish is not more than 0·3 inch. The number of vertebræ in this specimen is 107, one-third in excess of that of *Anguilla sahel-almæ*.

The head is broadest and highest posteriorly, tapering forwards; the jaws are longer, in proportion to the size of the fish than those of the species from Sahel Alma, and the orbit is situated lower. The components of the head are displaced and not well preserved; the operculum probably extended further backwards, and was not so high in proportion to the breadth. Branchiostegal rays are exposed; they are long and slender.

The vertebral column is composed of vertebræ of which the length is equal to the height; the median part is not so much constricted as in those of *A. sahel-almæ*. The anterior portion of the spinal apophyses is not preserved; neural and hæmal spines are attached to the remainder; they are shorter and thicker, as well as less curved backwards than those of the species previously described. Fragments of a dorsal fin remain, which extended apparently the entire length of the back to the tip of the tail, and thence recurved on the ventral surface, in combination with the anal fin. The fin-rays are short and very fine; the tail is undivided.

Of the paired fins the pectorals were situated immediately behind the operculum on the thorax; they were small and fine, apparently devoid of the strong anterior spinous ray found in *A. sahel-almæ*.

*Formation and Locality.*—Hard chalk: Hakel.

*Ex coll.*—Natural History Department, British Museum.

## NOTES ADDED IN PRESS.

---

*Petalopteryx dorsalis*, DAVIS.

(Pl. xx., fig. 4.)

A small fish, elongated in form; greatest height behind the pectoral fins and gradually diminishing towards the tail. The vertebral column extends to the upper lobe of the tail. The length of the fish is 2·7 inches: of this the head occupies 0·35 inch; the height of the posterior part of the head is equal to the length; the snout is obtuse and rounded. The orbit lies above the median line, large and well defined; the supra-orbital area small. The anterior parts of the jaws are displaced; the operculum high and rounded posteriorly immediately beneath the mandible. The anterior termination of the left mandible is exposed, and is full of minute, closely-set, erect teeth, sharply pointed and elongated. Branchiostegal rays are present; seven are visible, and are comparatively thick and strong.

The vertebral column is osseous and well defined, the thick and well-preserved coating of scales prevents its exact description; its direction can be distinguished, and the extension of its caudal extremity to the upper lobe of the tail is very marked.

The dorsal fin extends apparently from the occipital part of the head to the base of the tail. The fin-rays are hidden by the matrix, 0·2 inch at the anterior extremity of the fin, the remaining part is exposed; the rays are widely separated, strong, and straight, diminishing in size as the posterior end of the fin is approached.

The anal fin cannot be distinguished. The caudal has a few short rays on the upper surface of the upper lobe, and from the under there extends twelve strong rays; they are articulated; but so far as this specimen exhibits them they are undivided.

The pectoral fins are situated on the side of the body, supported by a strong pectoral arch, to which they are attached. The number of rays cannot be distinguished; the anterior rays are the strongest, diminishing in size backwards. The ventral fins are 0·8 inch behind the pectorals; they were small, and in this specimen are not well preserved.

The scales are well preserved, rhomboidal in form, thick, and covered with smooth, glistening enamel, thinning towards the posterior margin, which presents a jagged outline. Along the lateral line the scales are in fifty-two rows; transversely there are across the thorax twenty-eight rows; towards the tail this number diminishes to one-half. The scales diminish in size and are narrow on the abdominal surface. At the base of the pectoral fins and of the caudal the scales are small, closely aggregated, and more or less rounded.

This species is much smaller than *Petalopteryx syriacus*, Pictet ("Poissons fossiles du Mont Liban.," 1850, p. 22, pl. III., fig. 1), which was obtained from the soft chalk of Sahel Alma, but it possesses the characters as defined by M. Pictet; the tapering form, long dorsal fin, strong angular scales, and teeth of the anterior parts of the jaws long and pointed. The two species are readily distinguished.

This description was omitted from its proper place before the reference to *P. syriacus*, Pictet (see p. 526), the fossil being then not available.

*Formation and Locality.*—Upper Cretaceous: Hakel, Mount Lebanon.

*Ex coll.*—Lewis Collection, Natural History Department, British Museum.

#### REMAINS OF A VERTEBRAL COLUMN.

A portion of a vertebral column, found in the hard chalk of Hakel, is remarkable for the size and characters of its constituent elements. Remains of seven vertebræ are preserved; they are all disconnected, but retain their relative positions. The exposed part of each vertebra is 0·8 inch in diameter; the entire diameter would be somewhat larger. The length cannot be exactly determined; the pressure which displaced them, being applied diagonally, has laid the vertebræ one on the edge of the other, and they have been to some extent crushed; but a little under half an inch is probably correct. The centrum was concave; the median part of the vertebræ constricted to half the diameter of the ends; the whole strongly osseous, and supported by osseous bars extending between the two ends, and enclosing lacunæ somewhat similar to those in the vertebra of some sharks.

It is not proposed to designate this fragment; but as it indicates a fish of much larger size than any hitherto described, it appears desirable to record its occurrence.

*Formation and Locality.*—Hakel, Mount Lebanon.

*Ex coll.*—Natural History Department, British Museum.

## INDEX TO GENERA AND SPECIES.

\* \* \* The Genera are printed in CAPITALS, the Species in Roman, the Groups and Families in Roman, and the Species not described in this Memoir and Synonyms in *Italics*.

- ACANTHIAS, 479.  
 Acanthopterygii, 505, 506.  
*A. beryciformes*, 507.  
*A. cotto-scombriformes*, 523.  
*A. gastrosteiformes*, 531.  
*A. perciformes*, 506, 507.  
*A. pharyngognathi*, 505, 531.  
*A. trichiuriformes*, 521.  
 AMPHILAPHURUS, 504.  
*A. major*, 504.  
*Anacanthini*, 505.  
 ANGUILLA, 624.  
*A. hakelensis*, 626.  
*A. sahel-almæ*, 625, 626.  
 ASPIDOPLEURUS, 624.  
*A. cataphractus*, 462, 624.  
 AULOPES, 602.
- Batoidei, 469, 482.  
 BELONE, 608.  
 BERYX, 460, 507, 511, 513, 514, 518, 519, 520, 521, 541, 542.  
*B. germanus*, 513.  
*B. microcephalus*, 513.  
*B. niger*, 462, 534.  
*B. ornatus*, 513, 514.  
*B. ovalis*, 508.  
*B. radicans*, 513.  
*B. syriacus*, 462, 513, 514, 516.  
*B. superbus*, 513, 514.  
*B. vexillifer*, 461, 508, 509, 513, 520.  
*B. zippei*, 513, 514.
- Carangidæ, 523.  
 CATURUS, 548.  
 CENTRINA, 479.  
 CENTROLOPHUS, 543.  
 CENTROPHOROIDES, 478.  
*C. latidens*, 478.  
 CENTROPHORUS, 479.  
 CENTROSCYLLIUM, 479.
- CHEIROTHRIX, 527, 550.  
*C. lewisii*, 528.  
*C. libanicus*, 462, 527, 530.  
 CHIMERIDS, 468.  
 CHIROCENTRITES, 584, 586.  
*C. coroninii*, 585.  
*C. libanicus*, 462, 585.  
 Chondropterygii, 468.  
 CHONDROSTEUS, 499.  
 CHROMIDES, 519, 531, 541, 542.  
 CLUPEA, 555, 556, 561, 570, 593, 595, 596.  
*C. attenuatus*, 580, 581.  
*C. beurardi*, 459, 461, 575, 576.  
*C. botta*, 462, 575.  
*C. brevissima*, 459, 461, 464, 573.  
*C. curtus*, 579, 580.  
*C. dentex*, 573, 575, 577.  
*C. elongatus*, 579, 581, 595.  
*C. gaudryi*, 462, 575.  
*C. gigantea*, 460, 461, 577.  
*C. lata*, 459, 461, 572, 573, 574, 575, 576, 592.  
*C. laticauda*, 461, 572, 573, 576.  
*C. lewisii*, 570.  
*C. macrophthalma*, 460, 461, 577, 584.  
*C. macropoma*, 573.  
*C. minima*, 459, 461, 574.  
*C. pulcher*, 578, 582, 595.  
*C. sardinoides*, 461, 572, 573, 576.  
 Clupeidæ, 553, 556, 557.  
 COCCODUS, 461, 545.  
*C. armatus*, 461, 546, 548.  
*C. syriacus*, 548.  
*Corax falcatus*, 466.  
*C. heterodon*, 466.  
 CORREGONES, 555.  
 CYCLOBATIS, 490, 494.  
*C. major*, 491.  
*C. oligodactylus*, 460, 461, 464, 470, 491, 492.  
*Cycloides malacopterygiens*, 601.  
 Cycloids, 552.  
 Cyclostomata, 467.

DERCETIS, 460, 607, 619, 624.

*D. linguifer*, 461, 619, 624.

*D. tenuis*, 461, 619.

*D. triqueter*, 461, 619, 620.

Dipnoi, 467.

DORADES, 507.

ELACATES, 552.

Elasmobranchii, 467.

ENCHODUS, 521, 522.

*E. faujasii*, 521, 523.

*E. halocyon*, 466, 521, 522.

*E. recurvus*, 522.

*E. sulcatus*, 523.

ENGRAULIS, 583.

*E. tenuis*, 583.

ESOCIDÆ, 552, 608.

ESOX, 608.

EURYGNATHUS, 597, 605.

*E. ferox*, 602.

EURYPHOLIS, 460, 461, 522, 530, 593, 596, 599, 600,  
601, 605, 619.

*E. boissieri*, 464, 596, 597, 598, 599, 602.

*E. longidens*, 461, 597, 599, 602.

*E. major*, 597.

*E. sulcidens*, 461, 464, 596, 602.

EXOCETOIDES, 550.

*E. minor*, 550.

EXOCETUS, 550, 551.

Fistulariidae, 531.

Ganoidei, 467, 468, 494, 496.

Ganoids, 504, 545, 548, 619.

GINGLYMOSTOMA, 472.

Gobioides, 527.

GYRODUS, 467, 495.

*G. syriacus*, 467, 548.

Halecidae, 555.

HALECOIDES, 585, 587, 593, 601.

HOLOCENTRUM, 513.

Holocephala, 468.

HOMONOTUS, 507, 518, 521.

*H. dorsalis*, 518.

*H. pulcher*, 519, 521.

Hoplopleuridae, 618, 619.

HOPLOPTERYX, 507, 513, 514, 518, 537.

*H. antiquus*, 518.

*H. oblongus*, 515, 518.

*H. spinosus*, 516.

*H. syriacus*, 514, 516, 521.

IMOASTER, 541.

*I. auratus*, 462, 541.

ISCHYROCEPHALUS, 600, 601, 605, 619.

ISODUS, 521, 522.

*I. sulcatus*, 460, 461, 523, 597.

ISTEUS, 552.

*I. gracilis*, 552.

*I. grandis*, 552, 553.

*I. lebanonensis*, 553.

*I. macrocelius*, 553.

*I. macrocephalus*, 552, 554.

*I. mesospondylus*, 553.

*I. microcephalus*, 552.

*Lamna acuminata*, 466.

*L. compressa*, 466.

*L. elegans*, 466.

*L. subulata*, 466.

LEPIDOPUS, 552.

LEPIDOSTEUS, 503, 504.

Leptocardii, 467.

LEPTOSOMUS, 584, 590, 595.

*L. crassicostatus*, 462, 574, 584.

*L. macrourus*, 462, 467, 584.

LEPTOTRACHELUS, 496, 619, 620, 622, 623, 624

*L. armatus*, 619.

*L. gracilis*, 623.

*L. hakelensis*, 462, 623.

*L. triqueter*, 619, 620.

*L. triqueter*, var. a., 622.

LEWISIA, 593.

*L. ovalis*, 593.

Lophobranchii, 505.

Marsipobranchii, 467.

*Mesogaster gracilis*, 461, 462, 569.

MICRODON, 495.

*M. elegans*, 498, 499, 501.

*M. pulchellus*, 501.

Muraenidae, 624.

MYRIPRISTIS, 513.

Notidanidae, 470.

NOTIDANUS, 470.

*N. gracilis*, 469, 470, 473.

*N. lewisii*, 481.

*N. microdon*, 471.

*N. münsteri*, 471.

OMOSOMA, 543.

*O. sach-el-alma*, 462, 543.

OPISTOPTERYX, 569, 608.

- O. curtus*, 569.  
*O. gracilis*, 462, 569, 570.  
 OPLOCEPHALUS, 605.  
*Osmeroides*, 555, 556, 557, 566, 600.  
*O. brevis*, 560.  
*O. cordieri*, 569.  
*O. dubius*, 565.  
*O. gracilis*, 559, 563, 567.  
*O. granulatus*, 555.  
*O. latus*, 561, 563.  
*O. lewesiensis*, 555, 556.  
*O. maximus*, 566.  
*O. megapterus*, 461, 555, 556, 557.  
*O. microcephalus*, 555, 556.  
*O. minor*, 563.  
*O. monasteri*, 555, 556.  
 OSMERUS, 555.  
*Otodus appendiculatus*, 466.  
*O. lanceolatus*, 466.  
*Oxyrhina mantelli*, 466.
- PAGELLUS, 506, 507.  
*P. leptosteus*, 459, 461, 506, 507.  
*P. libanicus*, 461, 507.  
*P. ovalis*, 461.  
 Palæichthytes, 468.  
 PALEOBALISTUM, 495, 496, 501.  
*P. gædelli*, 496, 501.  
*P. ventralis*, 499, 501.  
 PALEOSCYLLIUM, 472, 473.  
 PALEOSPINAX, 472.  
 PANTOPHOLIS, 599.  
*P. dorsalis*, 600.  
 PELARGORHYNCHUS, 619.  
 PERCOIDES, 519.  
 PETALOPTERYX, 461, 526.  
*P. dorsalis*, 627.  
*P. syriacus*, 461, 526, 627, 628.  
 Pharyngobranchii, 467.  
 Pharyngognathi, 514.  
 PHYLACTOCEPHALUS, 605.  
*P. microlepis*, 605.  
 Physostomi, 505, 545.  
*Pimelodus clarias*, 546.  
 Plagiostomata, 468, 469.  
 PLATAX, 523.  
*P. brevis*, 524.  
*P. minor*, 461, 524, 526.  
*P. papillio*, 526.  
 PLATYCORMUS, 513.  
 Plectognathi, 505.  
 PLINTOPHORUS, 608, 619.
- Pomacentridæ, 514.  
 PRISCACARA, 514.  
 PSEUDOBERYX, 507, 509, 511.  
*P. bottæ*, 462, 510.  
*P. grandis*, 510.  
*P. longispina*, 511, 512.  
*P. syriacus*, 462, 509, 510, 512.  
*Ptychodus polygyrus*, 466.  
 Pycnodontidæ, 495.  
 Pycnodontoidei, 495.  
 Pycnodonts, 545, 546.  
 PYCNODUS, 495.  
 PYCNOSTERINX, 460, 518, 519, 521, 524, 531, 537,  
     541, 542.  
*P. daviesii*, 537.  
*P. discoides*, 460, 461, 532, 533, 534.  
*P. dorsalis*, 461, 533, 534, 539.  
*P. dubius*, 540.  
*P. elongatus*, 462, 519, 537.  
*P. gracilis*, 539, 540.  
*P. heckelii*, 461, 532, 534, 538.  
*P. latus*, 534, 535.  
*P. lewisii*, 535.  
*P. niger*, 462, 534.  
*P. russeggerii*, 460, 461, 533, 534, 608.
- RAJA, 493.  
*R. minor*, 493, 494.  
 Rajidæ, 493.  
*Rhampornimia rhinelloides*, 462.  
 RHINELLUS, 607, 608, 611, 613.  
*R. curtirostris*, 610, 611, 616.  
*R. damoni*, 617.  
*R. ferox*, 614, 616, 617, 618.  
*R. furcatus*, 459, 461, 608, 609, 610, 611.  
*R. laniatus*, 612, 617.  
*R. longirostris*, 611, 614, 616.  
*R. robustus*, 608, 610, 612, 616.  
 Rhinobatidæ, 482.  
 RHINOBATUS, 482, 494.  
*R. expansus*, 486, 487.  
*R. grandis*, 482, 486, 487.  
*R. intermedius*, 489.  
*R. latus*, 485, 487.  
*R. maronita*, 462, 482.  
*R. tenuirostris*, 487, 489, 490.  
 RHINOGNATHUS, 473, 480.  
*R. lewisii*, 480.
- Salmo lewisiensis*, 556.  
 Salmonidæ, 555, 566, 567.  
 SARDINIUS, 556, 567.

- S. cordieri*, 569.  
*S. crassapinna*, 567.  
 SARDINOIDES, 556, 566.  
*S. crassicaudatus*, 556.  
*S. microcephalus*, 556.  
*S. monasterii*, 556.  
*S. tenuicaudatus*, 556.  
 SAURORAMPHUS, 619.  
 Scleroderms, 607, 608.  
 SCOMBEROIDES, 521, 522.  
 Scombrocoidæ, 550, 551.  
 SCOMBROCLUPEA, 584.  
*S. macrophthalma*, 462, 584.  
 SCOPELUS, 548.  
 Scylliidae, 472, 475, 476.  
 SCYLLIUM, 472, 476.  
*S. sahel-almæ*, 462, 469, 475, 476.  
 Selachoidei, 469, 470.  
 Siluridae, 545.  
 Siluroids, 546, 548.  
 SOLENOGNATHUS, 531.  
*S. lineolatus*, 462, 531.  
 SPANIODON, 459, 461, 586, 592, 593, 595, 596.  
*S. blondelli*, 461, 587, 590.  
*S. brevis*, 462, 575, 590, 592, 595.  
*S. electus*, 589, 590.  
*S. elongatus*, 461, 587, 588, 590, 592.  
*S. hakelensis*, 591, 592.  
 Sparidae, 506.  
 Sparoides, 507.  
 SPATHIURUS, 502, 505.  
*S. dorsalis*, 503.  
 SPATHODACTYLUS, 585.  
 SPHYRENA, 530.  
*S. amici*, 461, 530.  
 Spinacidae, 472, 477.  
 SPINAX, 469, 477, 479.  
*S. primævus*, 461, 469, 475, 477.  
 Squammipennes, 519.  
 Stromateidae, 543.  
 Teleosteans, 504, 545, 619.  
 Teleostei, 467, 505.  
 THRISSOPS, 585.  
 THYELLINA, 472, 473.  
*T. angusta*, 472.  
*T. curtirostris*, 475.  
*T. elongata*, 473.  
*T. prisca*, 472.  
 THYRSITES, 522.  
 Torpedinidae, 490.  
 Trichiuridae, 521, 522.  
 TRICHIURUS, 522.  
 VOMER, 526.  
*V. parvulus*, 459, 461, 526.  
 XENOPHOLIS, 548.  
*X. carinatus*, 549.



## DESCRIPTION OF PLATES.

## PLATE XIV.

	PAGE
Fig. 1. <i>Notidanus gracilis</i> , Davis, .. ..	464
Fig. 1a. Tooth from lower jaw, enlarged.	
Fig. 2. <i>Thyellina elongatus</i> , Davis, .. ..	467
Fig. 3. Another specimen, showing the under surface.	
Fig. 4. <i>Rhinognathus lewisii</i> , Davis, .. ..	474
Fig. 4a. Tooth, enlarged.	

## PLATE XV.

Fig. 1. <i>Thyellina curtirostris</i> , Davis, .. ..	469
Fig. 1a. Tooth, enlarged.	
Fig. 2. <i>Centrophoroides latidens</i> , Davis, .. ..	472
Fig. 2a. Teeth, enlarged.	
Fig. 3. <i>Scyllium sahel-almæ</i> , Pictet and Humbert, ..	476

## PLATE XVI.

Fig. 1. <i>Rhinobatus grandis</i> , Davis, .. .. (Reduced to $\frac{1}{2}$ natural size.)	482
Fig. 2. <i>Spinax primævus</i> , Pictet, .. .. (Reduced to $\frac{2}{3}$ natural size.)	471

## PLATE XVII.

<i>Rhinobatus latus</i> , Davis, .. .. (Reduced to $\frac{2}{3}$ natural size.)	485
--	-----

## PLATE XVIII.

<i>Rhinobatus expansus</i> , Davis, .. .. (Reduced to $\frac{1}{10}$ natural size.)	486
--	-----

## PLATE XIX.

Fig. 1. <i>Rhinobatus tenuirostris</i> , Davis, .. .. (Reduced to $\frac{1}{2}$ natural size.)	487
Fig. 2. <i>Beryx vexillifer</i> , Pictet, .. ..	508
Fig. 3. <i>Pseudoberyx syriacus</i> , Pictet and Humbert, ..	509
Fig. 4. <i>Pseudoberyx bottæ</i> , Pictet and Humbert, ..	510

## PLATE XX.

			PAGE
Fig. 1.	<i>Rhinobatus intermedius</i> , Davis,	..	489
	(Reduced to $\frac{2}{3}$ natural size.)		
Fig. 2.	<i>Anguilla sahel-almæ</i> , Davis,	..	625
Fig. 3.	<i>Anguilla hakelensis</i> , Davis,	..	626
Fig. 4.	<i>Petalopteryx dorsalis</i> , Davis,	..	627

## PLATE XXI.

Fig. 1.	<i>Cyclobatis major</i> , Davis,	..	491
Fig. 2.	<i>Raja minor</i> , Davis,	..	493
Fig. 3.	<i>Cyclobatis oligodactylus</i> , Egerton,	..	491

## PLATE XXII.

Fig. 1.	<i>Palæobalistum gœdelli</i> , Heckel,	..	496
Fig. 1 $\alpha$ .	Tooth of same, enlarged.		

## PLATE XXIII.

Fig. 1.	<i>Palæobalistum ventralis</i> , Davis,	..	499
	(Reduced to $\frac{2}{3}$ natural size.)		
Fig. 1 $\alpha$ .	Teeth of same, enlarged.		

## PLATE XXIV.

Fig. 1.	<i>Chondrosteus</i> sp.?	..	501
	(Reduced to $\frac{2}{3}$ natural size.)		
Fig. 2.	<i>Amphilaphurus major</i> , Davis,	..	504
	(Natural size.)		
Fig. 3.	<i>Microdon pulchellus</i> , Davis,	..	501

## PLATE XXV.

Fig. 1.	<i>Hoplopteryx oblongus</i> , Davis,	..	515
Fig. 2.	<i>Pseudoberyx longispina</i> , Davis,	..	511
Fig. 3.	<i>Homonotus pulcher</i> , Davis,	..	519
Fig. 4.	<i>Platax brevis</i> , Davis,	..	524
Fig. 5.	<i>Omosoma sach-el-almæ</i> , Costa,	..	543
Fig. 6.	<i>Enchodus recurvus</i> , Davis,	..	522
Fig. 7.	<i>Platax minor</i> , Pictet,	..	524

## PLATE XXVI.

Fig. 1.	<i>Exocœtoides minor</i> , Davis,	..	550
Fig. 2.	<i>Cheirothrix lewisii</i> , Davis,	..	528
Fig. 3.	<i>Cheirothrix libanicus</i> , Pictet,	..	527
Fig. 4.	<i>Cheirothrix libanicus</i> , Pictet,	..	527
Fig. 5.	<i>Exocœtoides minor</i> , Davis,	..	550
Fig. 6.	<i>Solenognathus lineolatus</i> , Pictet,	..	531

## PLATE XXVII.

			PAGE
Fig. 1.	<i>Pycnosterinx heckelii</i> , Pictet, ..	..	532
Fig. 2.	<i>Pycnosterinx latus</i> , Davis, ..	..	534
Fig. 3.	<i>Pycnosterinx discoides</i> , Heckel, ..	..	532
Fig. 4.	<i>Beryx ovalis</i> , Davis, ..	..	508
Fig. 5.	<i>Pycnosterinx lewisii</i> , Davis, ..	..	535
Fig. 6.	<i>Pycnosterinx elongatus</i> , Pictet and Humbert, ..	..	537

## PLATE XXVIII.

Fig. 1.	<i>Hoplopteryx spinosus</i> , Davis, ..	..	516
Fig. 2.	<i>Pycnosterinx dorsalis</i> , Pictet, ..	..	533
Fig. 2a.	<i>P. dorsalis</i> = <i>russeggerii</i> , Heckel, ..	..	533
Fig. 3.	<i>Imogaster auratus</i> , Costa, ..	..	541
Fig. 4.	<i>Pseudoberyx grandis</i> , Davis, ..	..	510

## PLATE XXIX.

Fig. 1.	<i>Pycnosterinx gracilis</i> , Davis, ..	..	539
Fig. 2.	<i>Pycnosterinx daviesii</i> , Davis, ..	..	537
Fig. 3.	<i>Pycnosterinx dubius</i> , Davis, ..	..	540
Fig. 4.	<i>Xenopholis carinatus</i> , Davis, ..	..	549

## PLATE XXX.

Fig. 1.	<i>Coccodus armatus</i> , Pictet, ..	..	546
Fig. 2.	<i>Eurypholis major</i> , Davis, ..	..	597
	(Reduced to $\frac{1}{4}$ natural size.)		
Fig. 3.	<i>Isteus lebanonensis</i> , Davis, ..	..	553
Fig. 4.	<i>Engraulis tenuis</i> , Davis, ..	..	583
Fig. 5.	<i>Engraulis tenuis</i> , Davis, ..	..	583

## PLATE XXXI.

Fig. 1.	<i>Osmeroides latus</i> , Davis, ..	..	561
Fig. 2.	<i>Osmeroides gracilis</i> , Davis, ..	..	559
Fig. 3.	<i>Osmeroides gracilis</i> , Davis, ..	..	559
Fig. 4.	<i>Osmeroides dubius</i> , Davis, ..	..	565

## PLATE XXXII.

Fig. 1.	<i>Osmeroides brevis</i> , Davis, ..	..	560
Fig. 2.	<i>Osmeroides minor</i> , Davis, ..	..	563
Fig. 3.	<i>Opistopteryx curtus</i> , Davis, ..	..	569
Fig. 4.	<i>Osmeroides megapterus</i> , Pictet, ..	..	557
Fig. 5.	<i>Sardinus crassipinna</i> , Davis, ..	..	566
Fig. 6.	<i>Osmeroides megapterus</i> , Pictet, ..	..	557

## PLATE XXXIII.

	PAGE
Fig. 1. <i>Clupea lewisii</i> , Davis, .. ..	570
Fig. 2. <i>Clupea elongatus</i> , Davis, .. ..	581
Fig. 3. <i>Clupea pulcher</i> , Davis, .. ..	578
Fig. 4. <i>Clupea attenuatis</i> , Davis, .. ..	580
Fig. 5. <i>Clupea curtus</i> , Davis .. ..	579
Fig. 6. <i>Lewisia ovalis</i> , Davis, .. ..	593

## PLATE XXXIV.

Fig. 1. <i>Spaniodon brevis</i> , Pictet et Humbert, .. ..	592
Fig. 2. <i>Spaniodon electus</i> , Davis, .. ..	589
Fig. 3. <i>Spaniodon blondelli</i> , Pictet, .. ..	587
Fig. 4. <i>Spaniodon hakelensis</i> , Davis, .. ..	591
Fig. 5. <i>Leptosomus macrourus</i> , Pictet and Humbert, ..	584

## PLATE XXXV.

Fig. 1. <i>Spathiurus dorsalis</i> , Davis, .. ..	503
Fig. 2. <i>Phylactocephalus microlepis</i> , Davis, .. ..	605

## PLATE XXXVI.

Fig. 1. <i>Eurygnathus ferox</i> , Davis, .. ..	602
(Reduced to $\frac{2}{3}$ natural size.)	
Fig. 1a. Fragment of scales, showing arrangement on tail.	
Fig. 2. <i>Pantopholis dorsalis</i> , Davis, .. ..	600

## PLATE XXXVII.

Fig. 1. <i>Rhinellus ferox</i> , Davis, .. ..	614
Fig. 2. <i>Rhinellus curtirostris</i> , Davis, .. ..	610
Fig. 3. <i>Rhinellus longirostris</i> , Davis .. ..	611
Fig. 4. <i>Rhinellus damoni</i> , Davis, .. ..	617
Fig. 5. <i>Rhinellus robustus</i> , Davis, .. ..	608
Fig. 6. <i>Rhinellus laniatus</i> , Davis, .. ..	612
Fig. 7.     "     "     "     "	

## PLATE XXXVIII.

Fig. 1. <i>Leptotrachelus triqueter</i> , Pictet and Humbert, ..	620
Fig. 2. <i>Leptotrachelus triqueter</i> , var. a., Davis, .. ..	622
Fig. 3. <i>Leptotrachelus gracilis</i> , Davis, .. ..	623
Fig. 4. <i>Aspidopleurus cataphractus</i> , Pictet and Humbert, ..	624

Fig 1

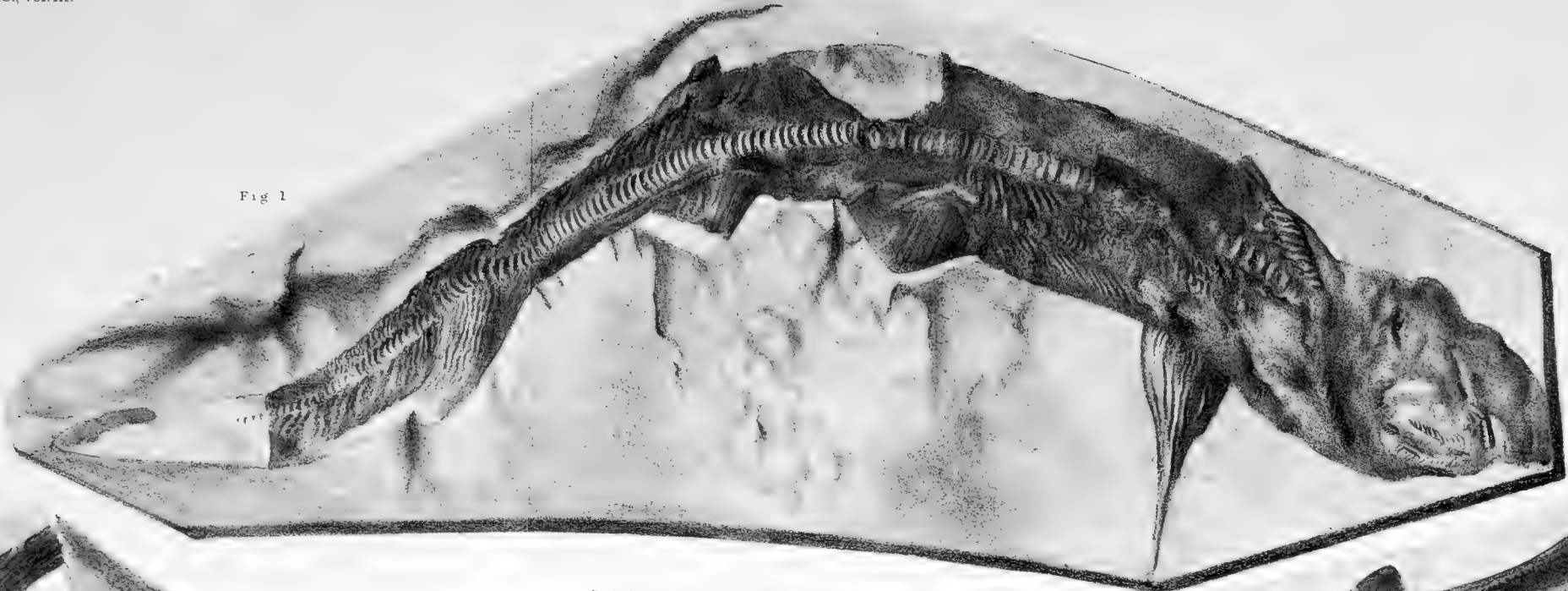

Fig 1a



Fig 2



Fig 4



Fig 4a

Fig. 3.







Fig. 1.

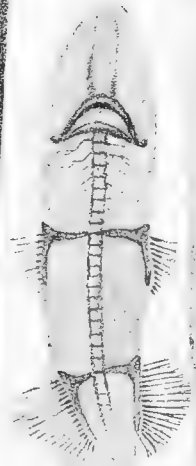

Fig. 3.



Fig. 2.a.



Fig. 1a

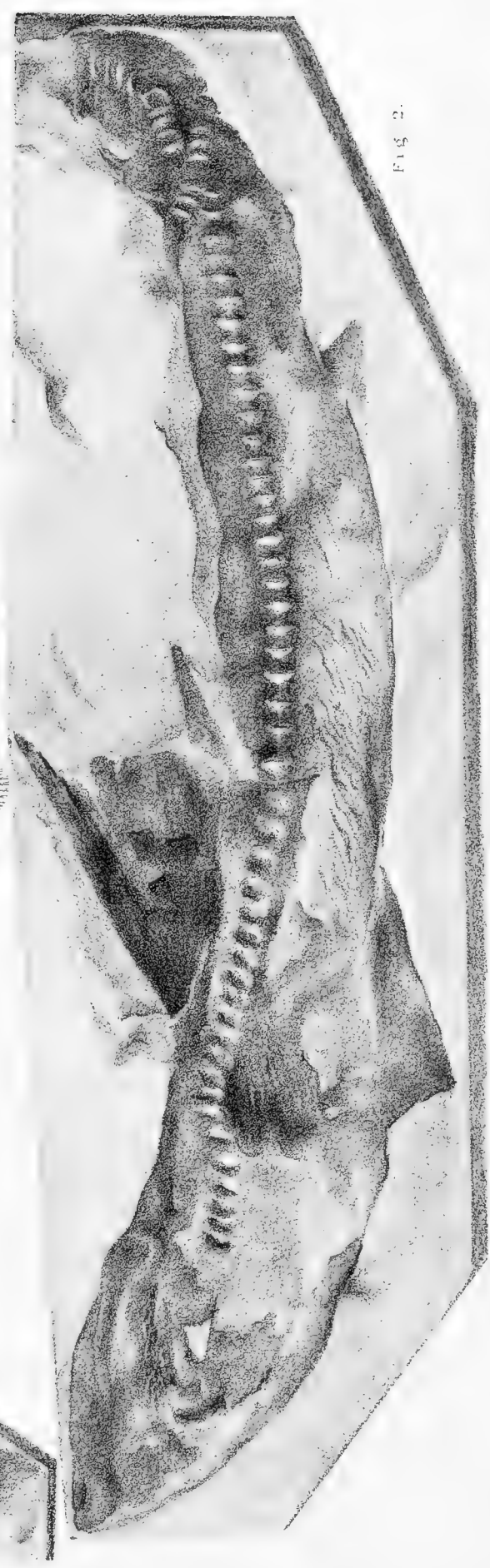

Fig. 2.







FIG. 2.









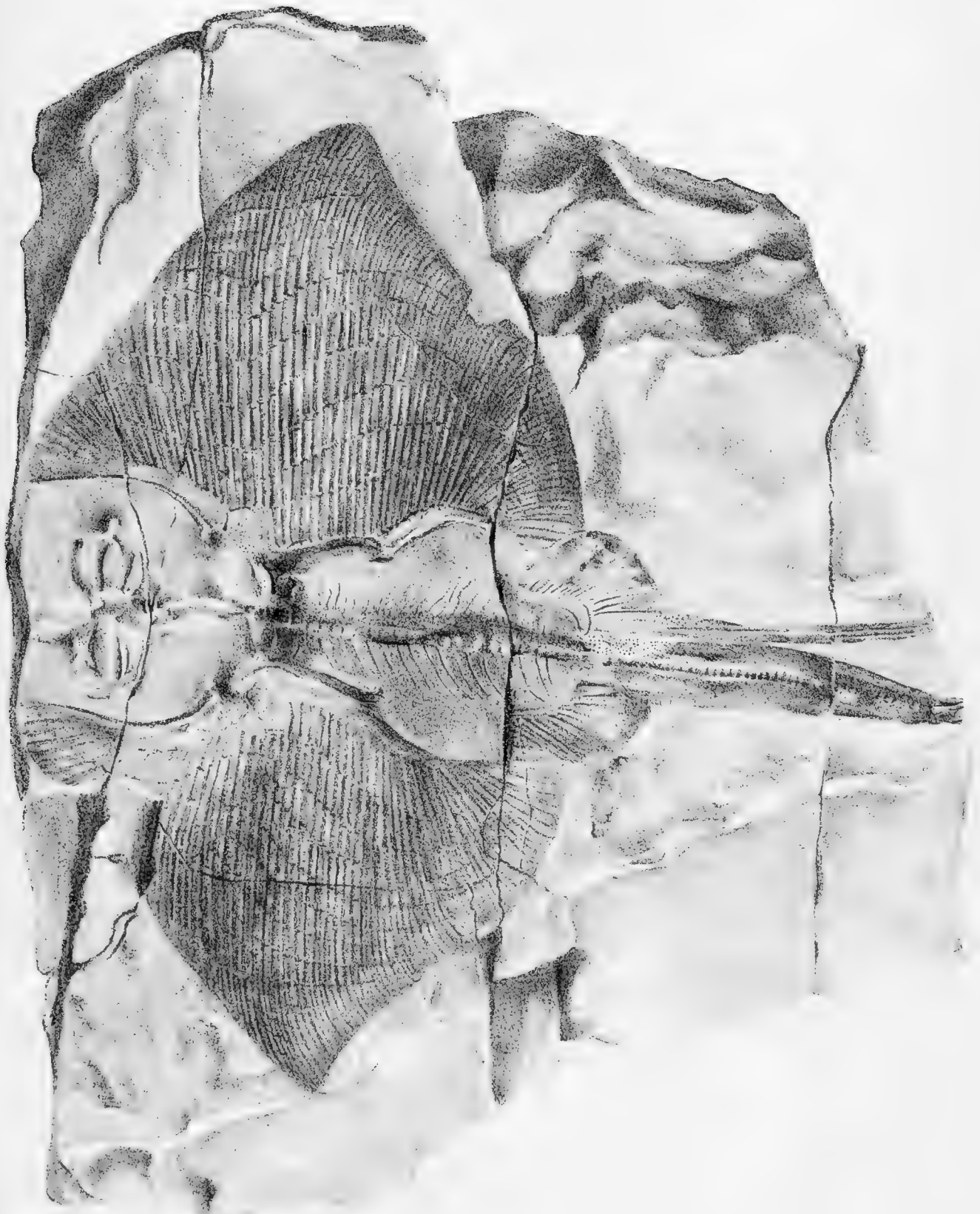



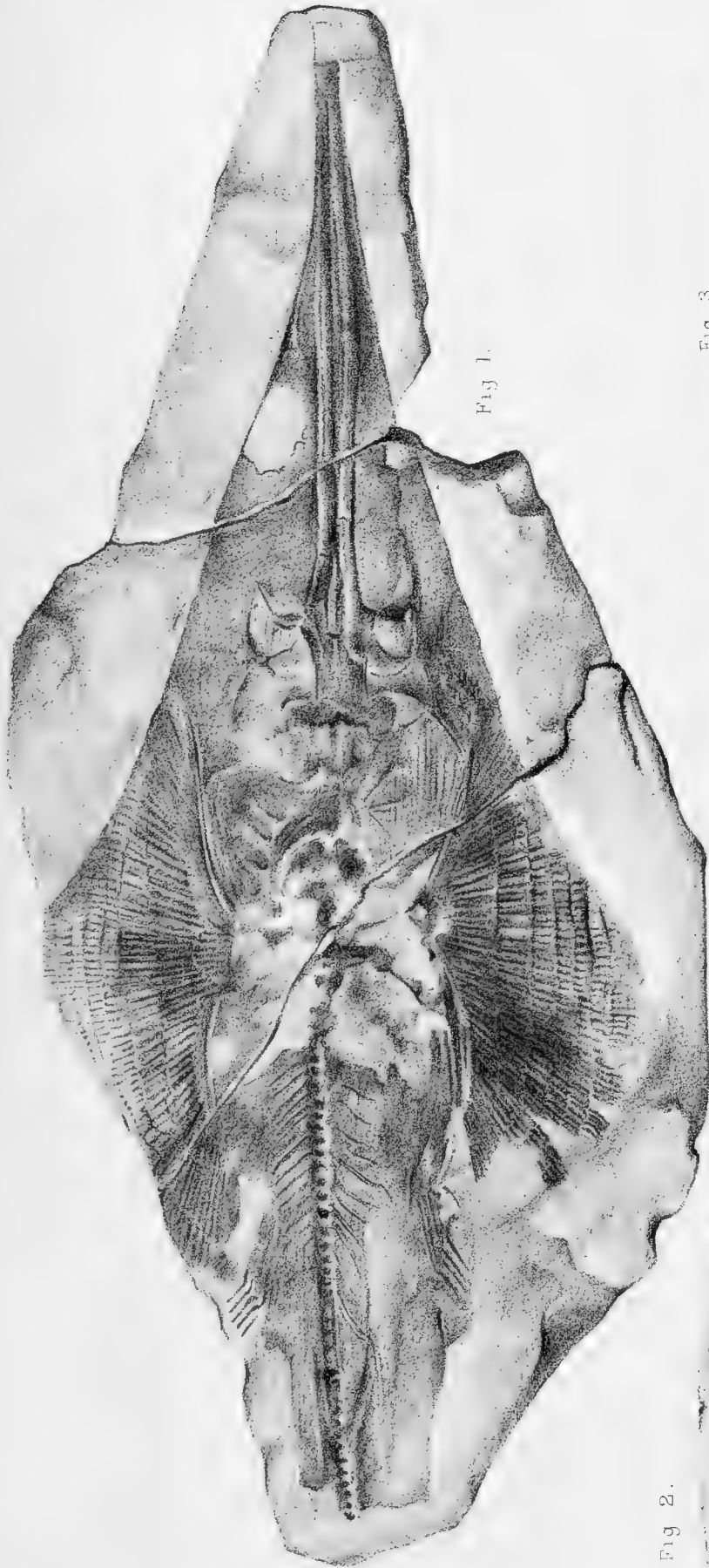

Fig 1.



Fig 3



Fig 4.



Fig 2.





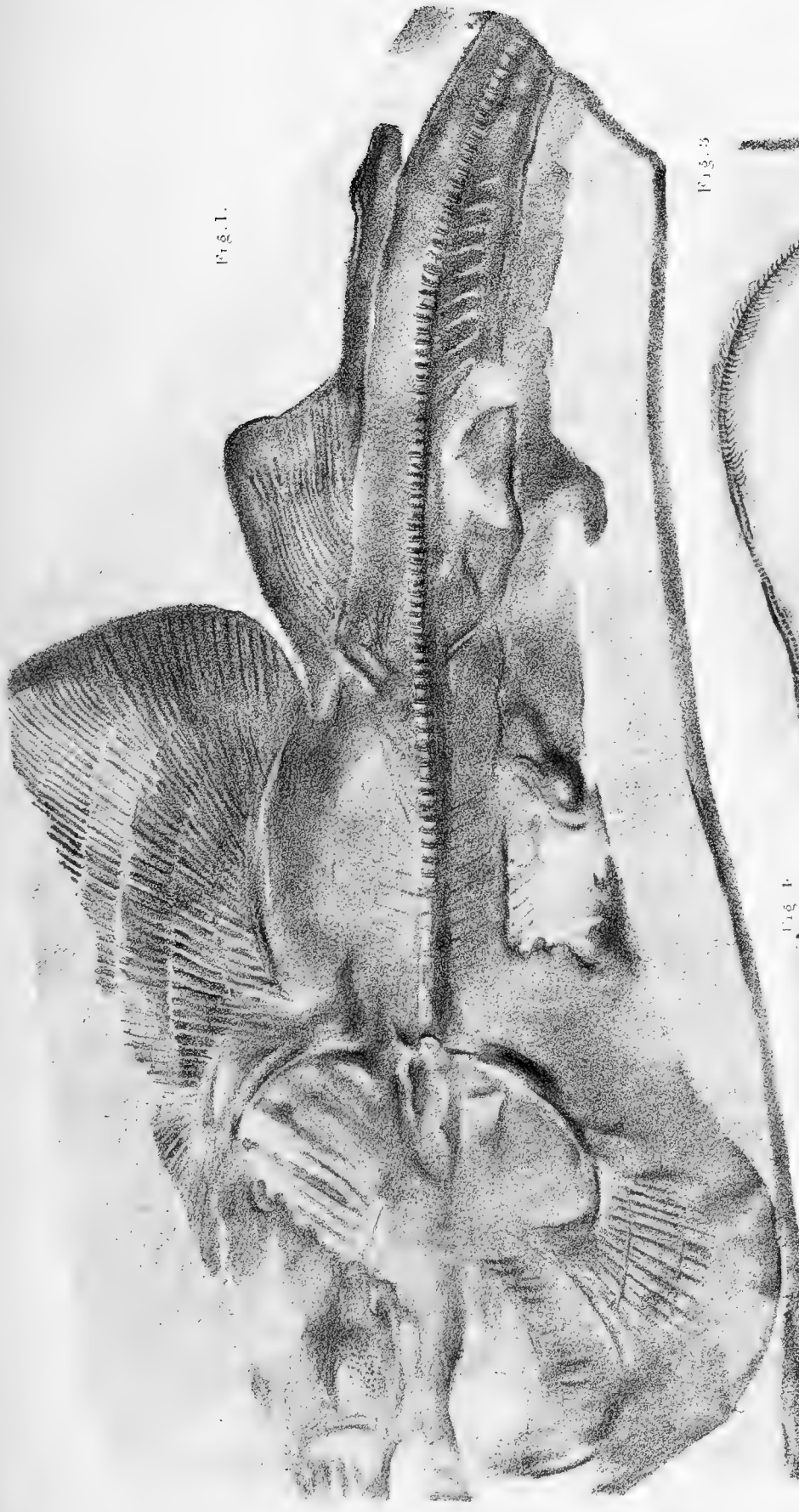

Fig. 1.

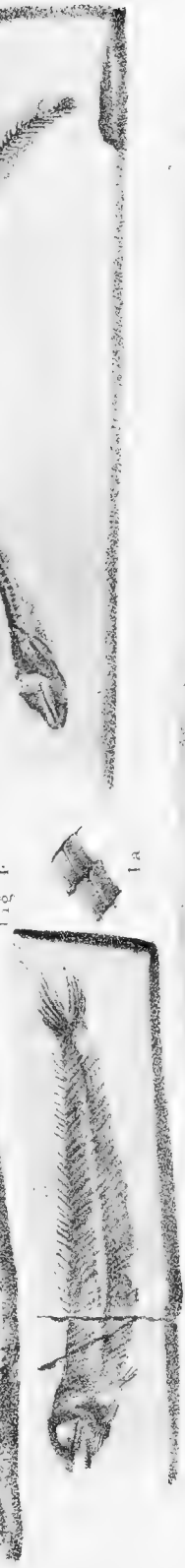

Fig. 2.

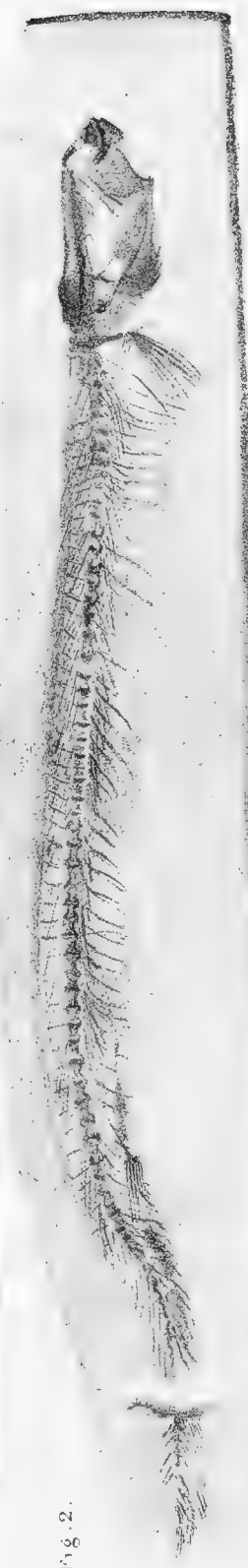

Fig. 3.



Fig 1

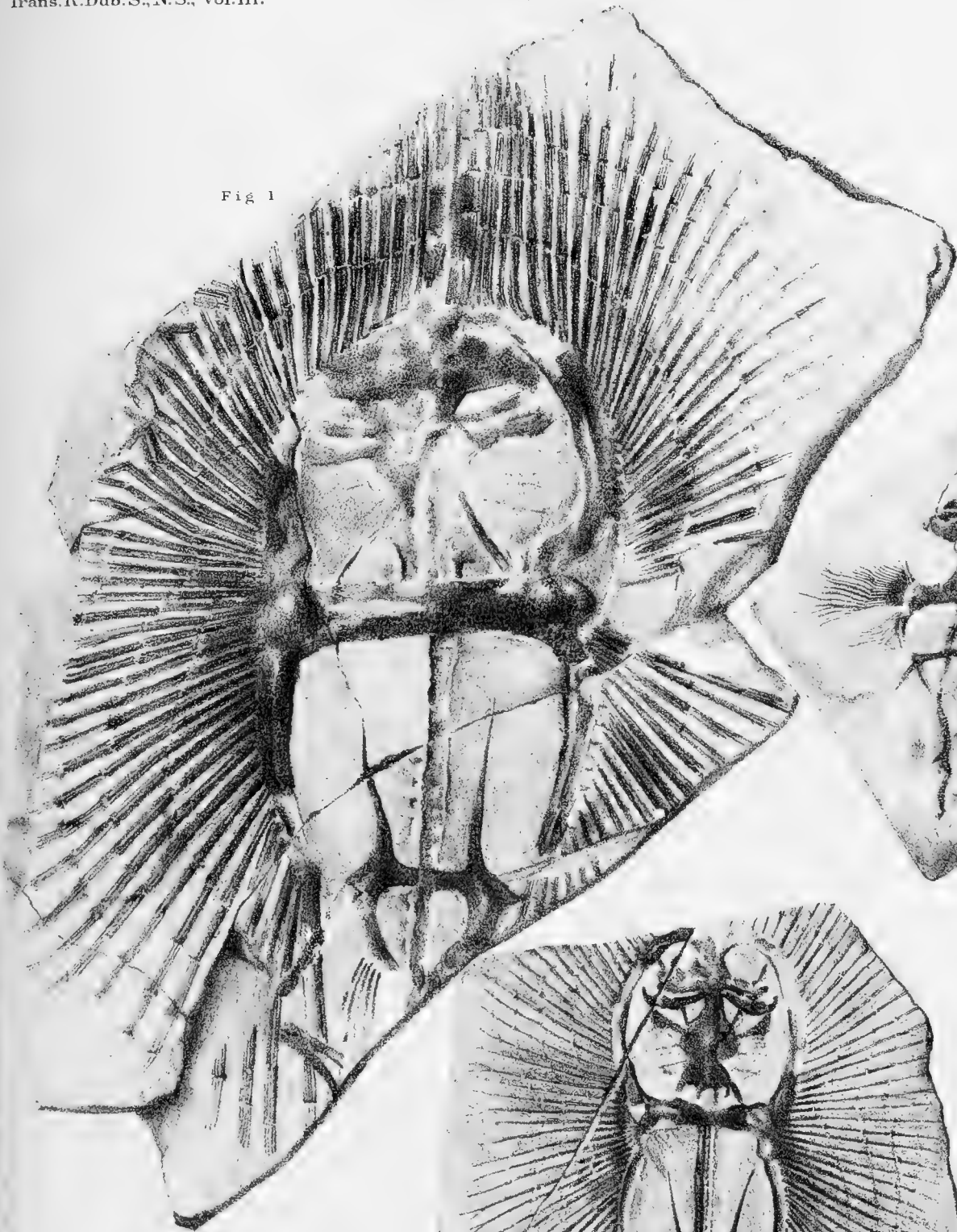

Fig 2

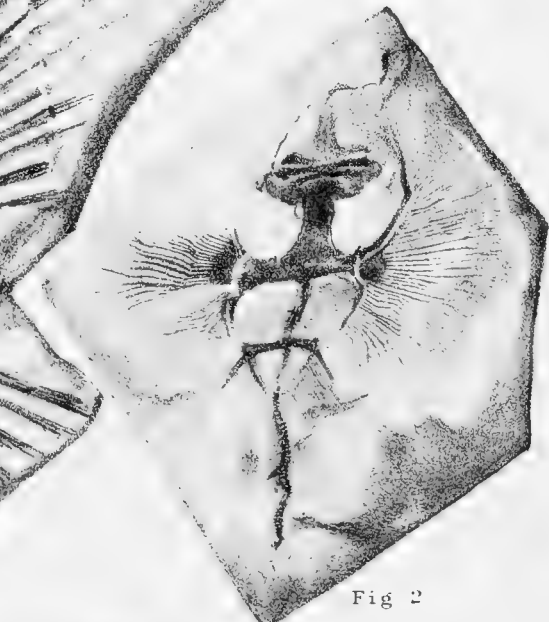
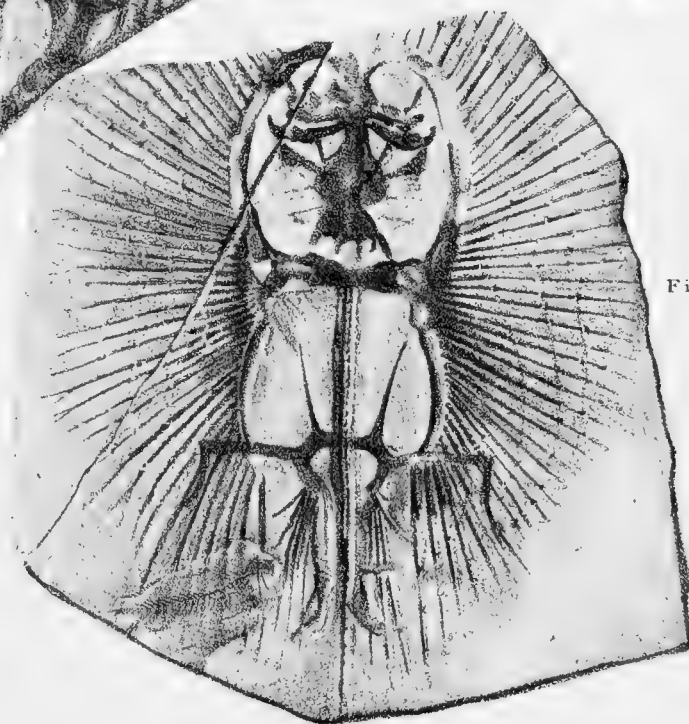

Fig. 3.





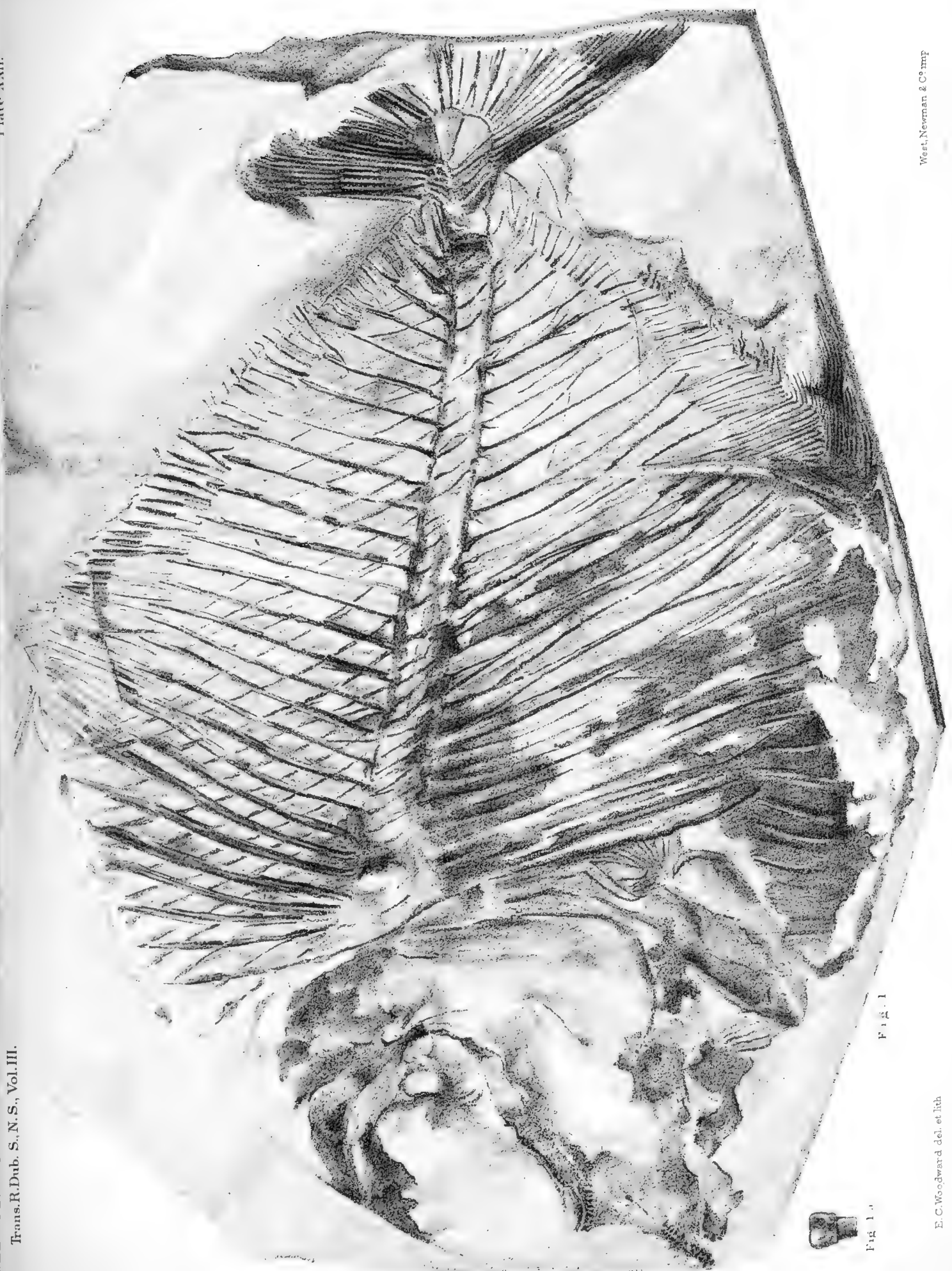

Fig. 1.

FIG. 1

E. C. Woodward del. et lith

West, Newman & Co. imp.



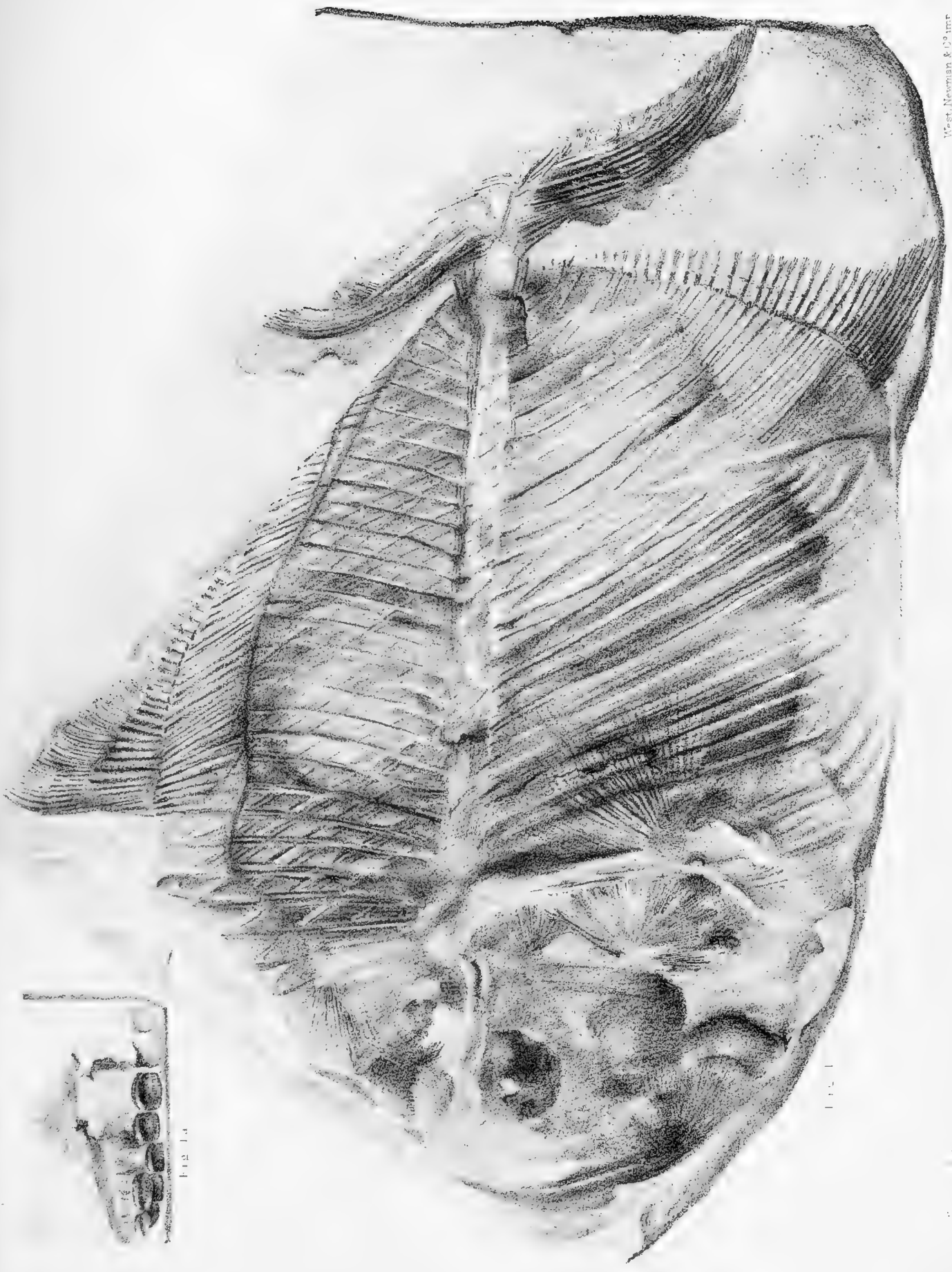

FIG. 1.

FIG. 1.

West, Newman & D'Imr





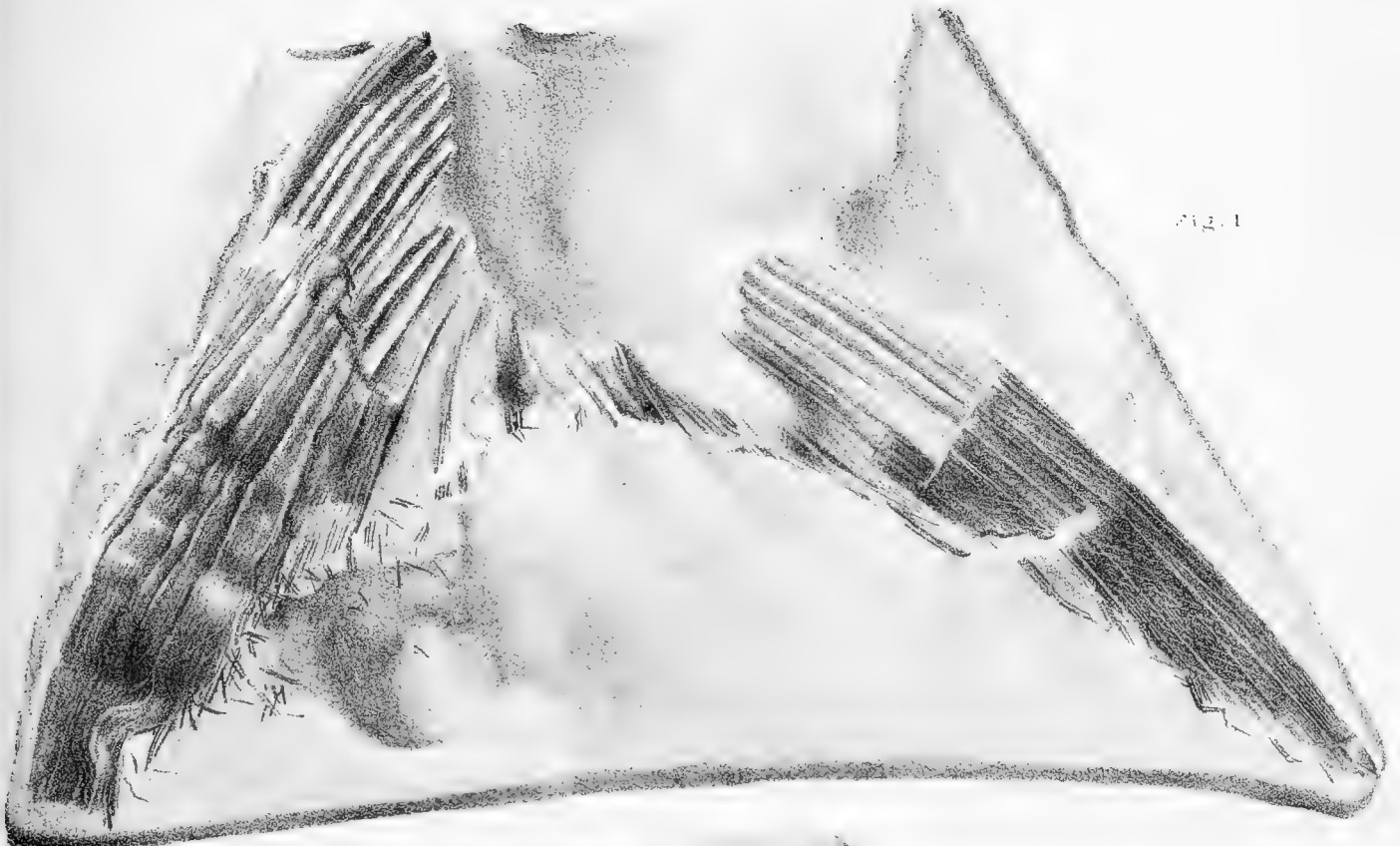
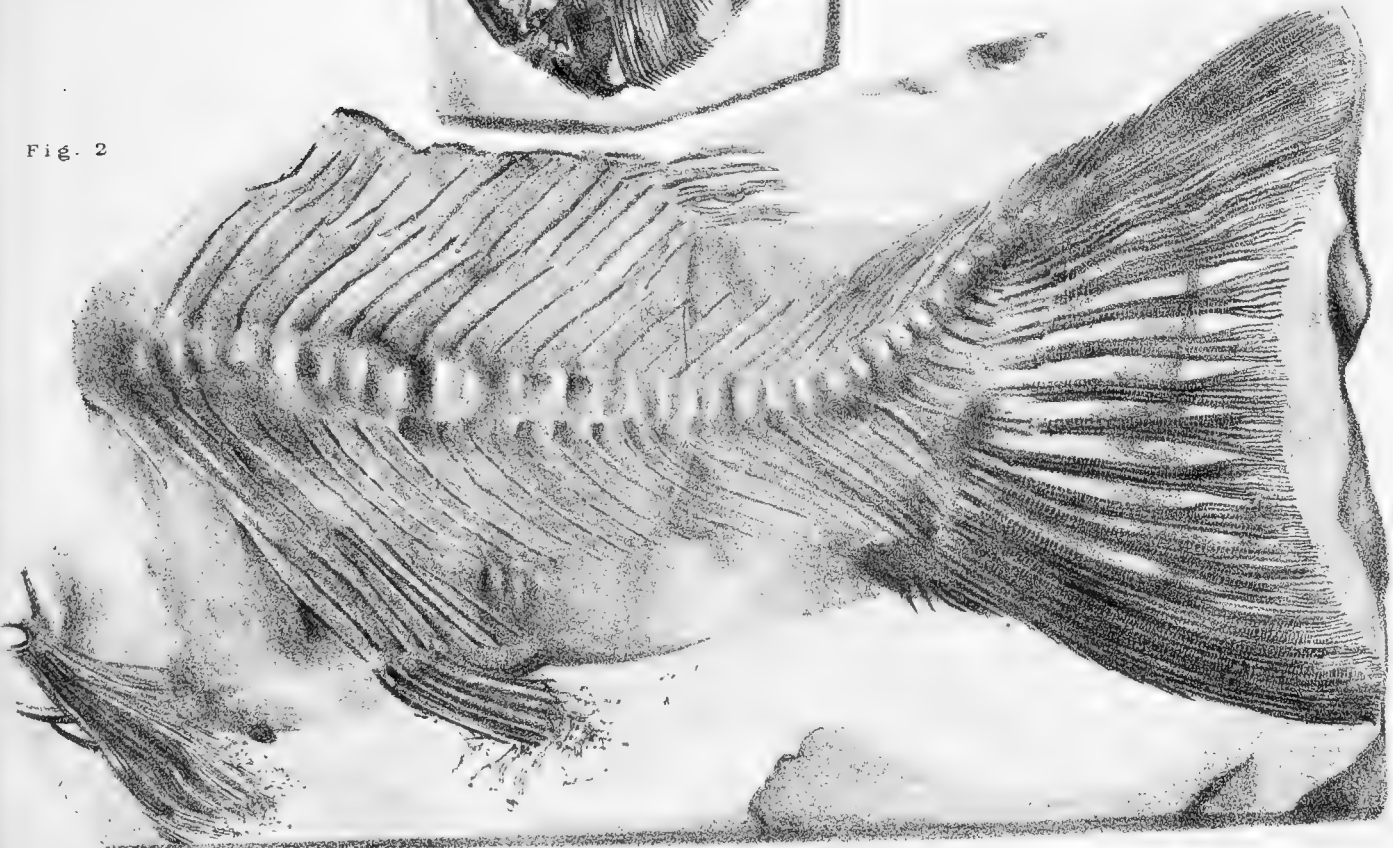

Fig. 1



Fig. 3

Fig. 2





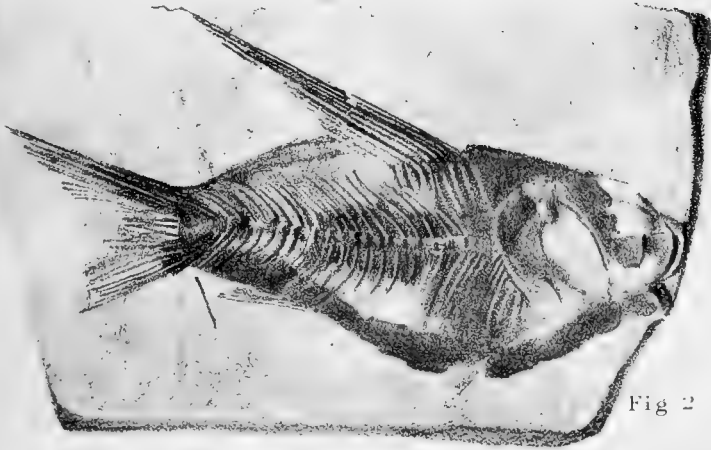

Fig. 2.

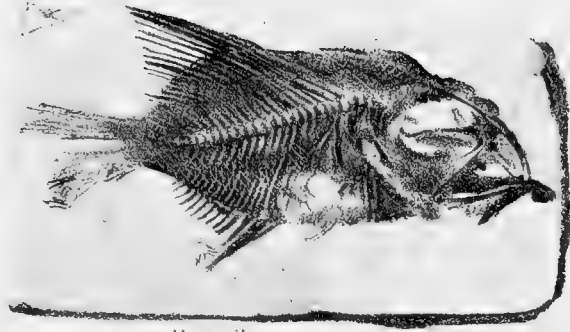

Fig. 3.

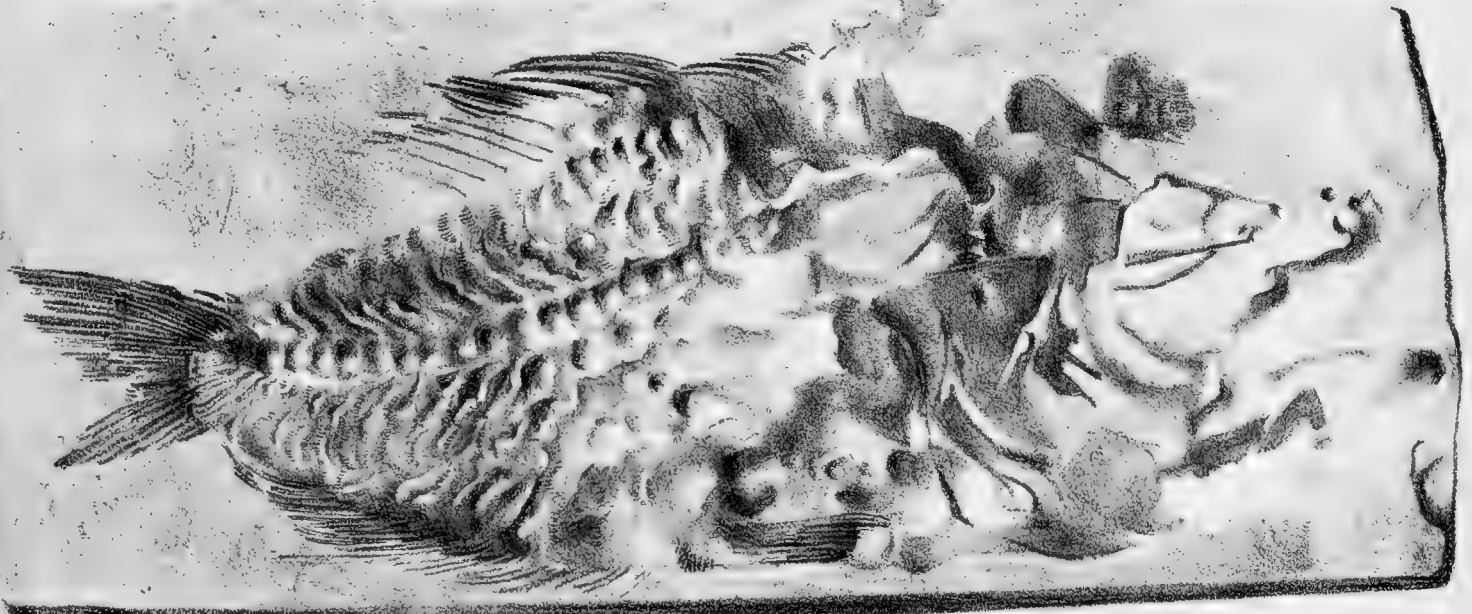

Fig. 1.

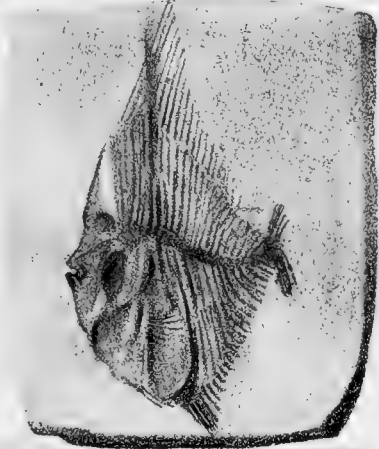

Fig. 4.

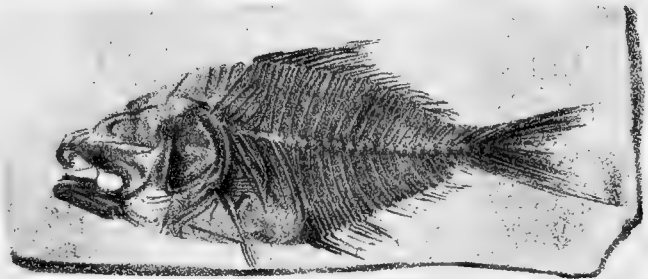

Fig. 5.

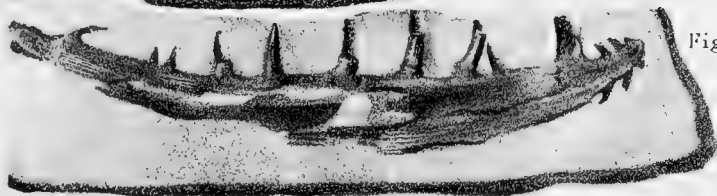

Fig. 6.

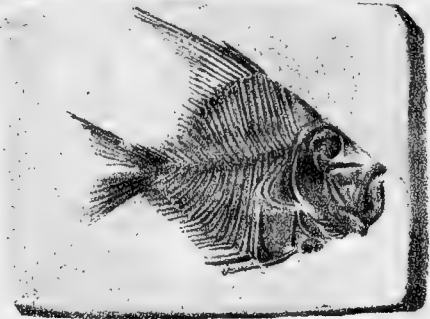

Fig. 7.



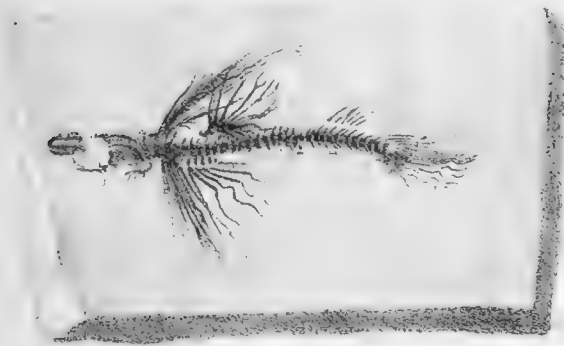

Fig 1

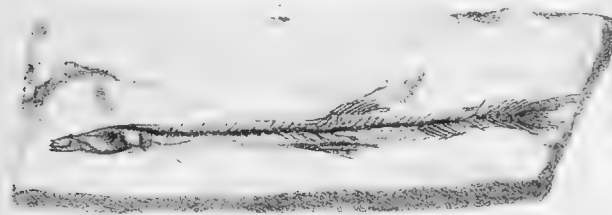

Fig 6

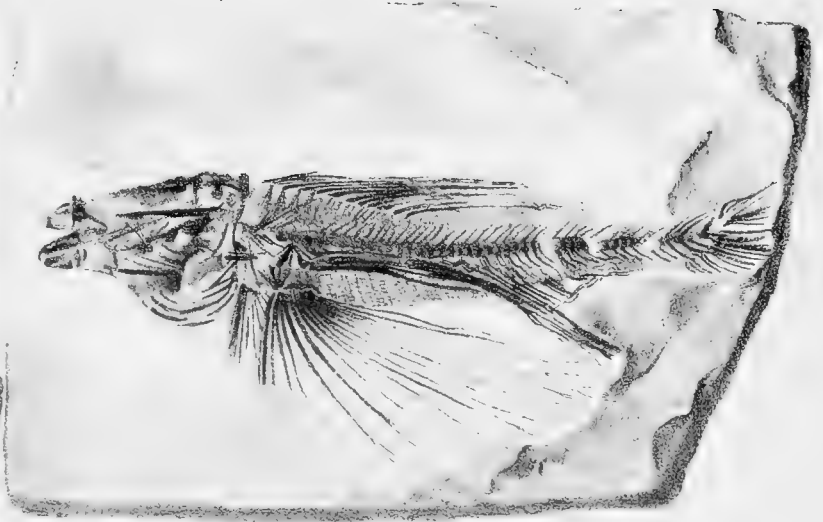

Fig 4

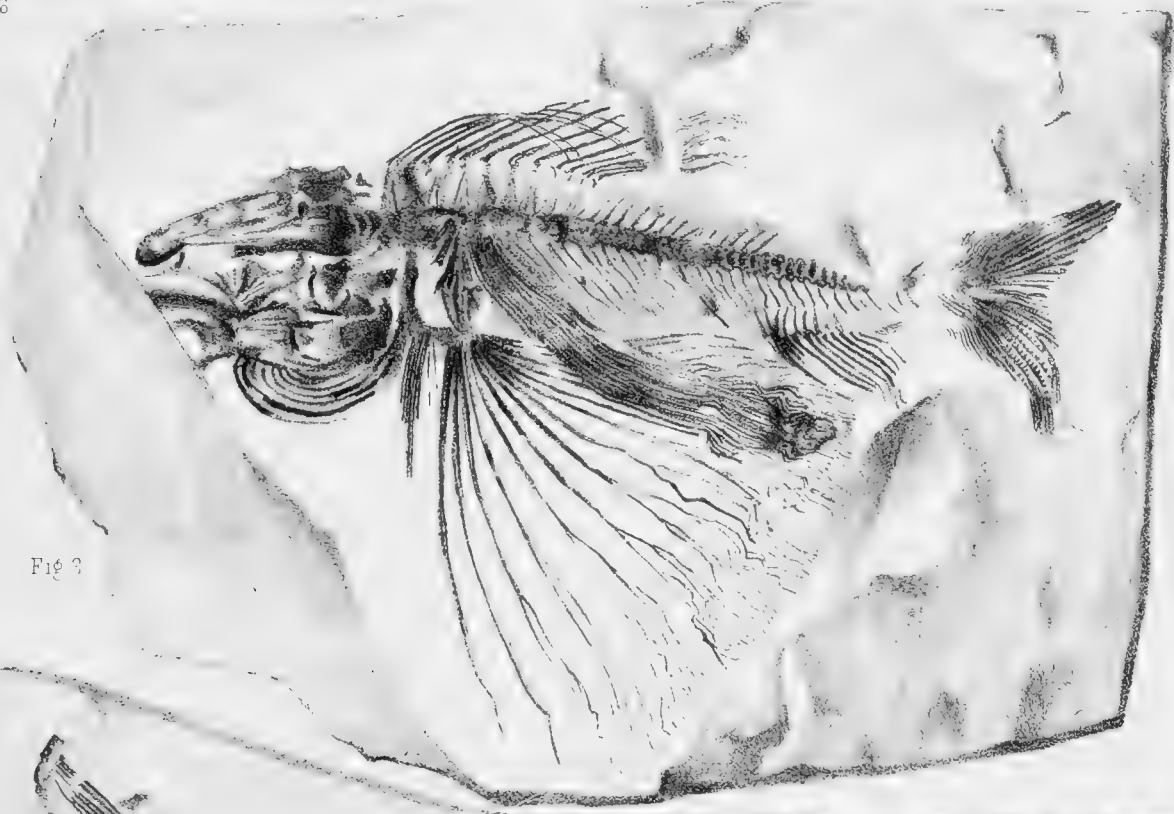

Fig 3



Fig 3.

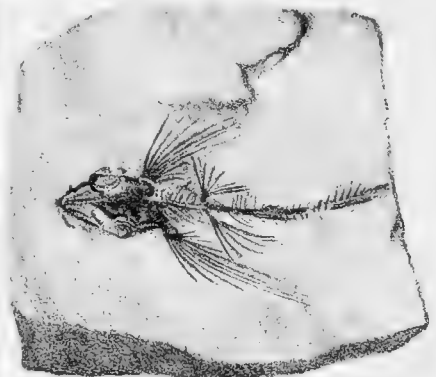

Fig 5



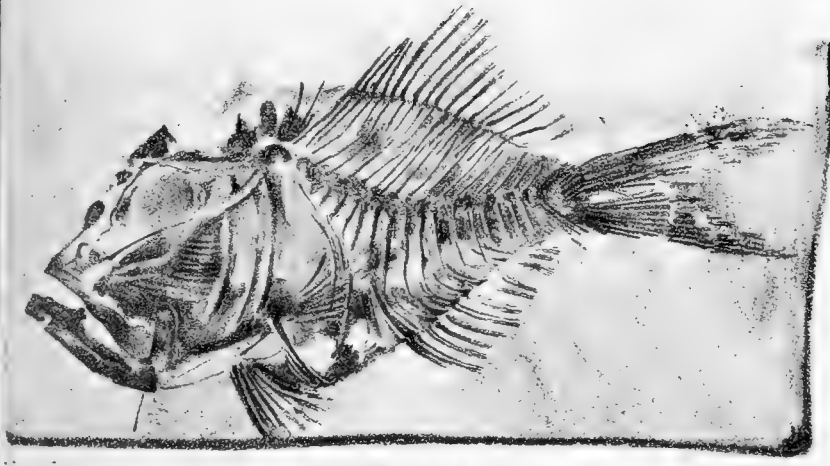

Fig. 1.

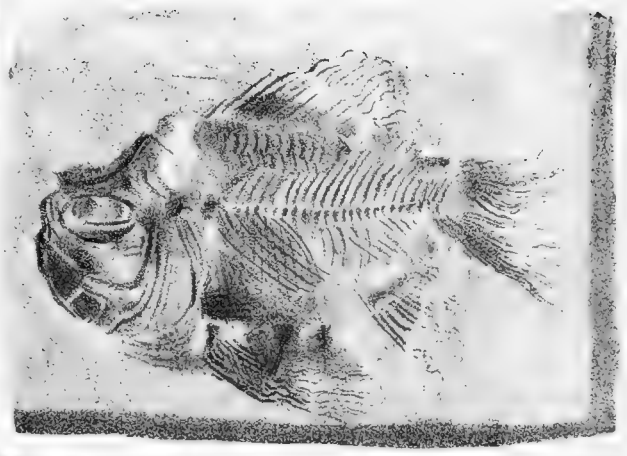

Fig. 2.

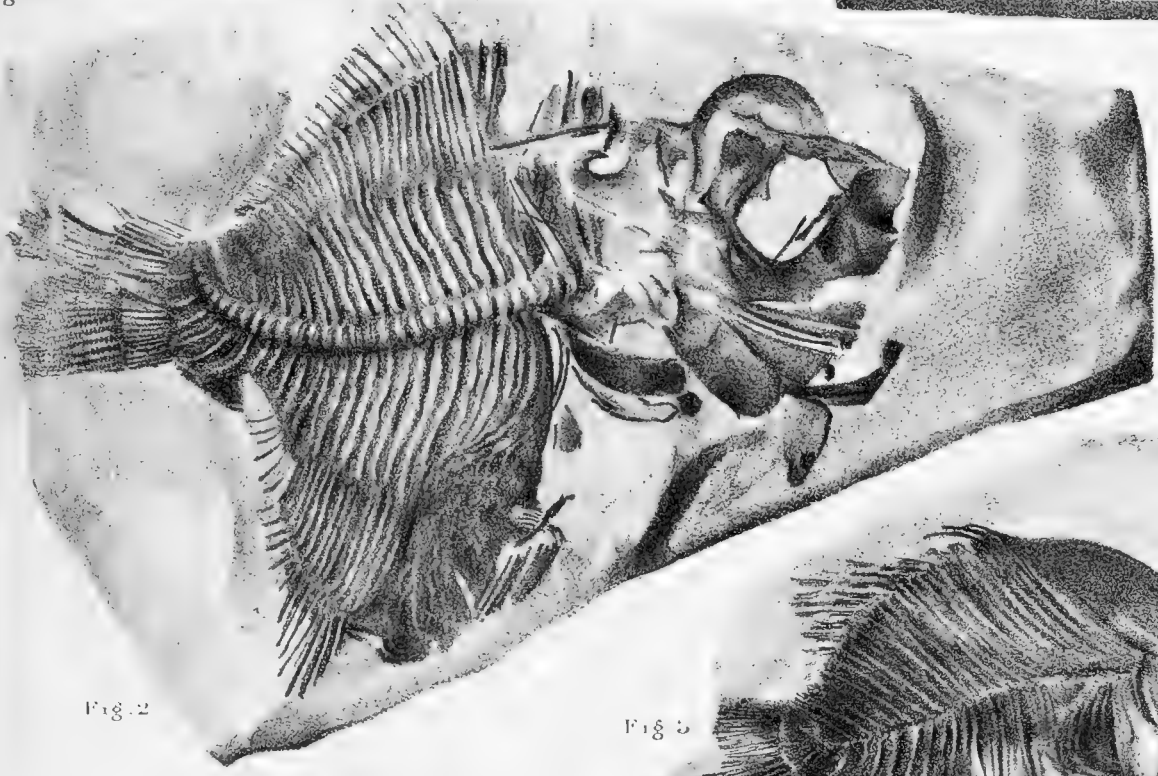

Fig. 3.

Fig. 4.



Fig. 5.

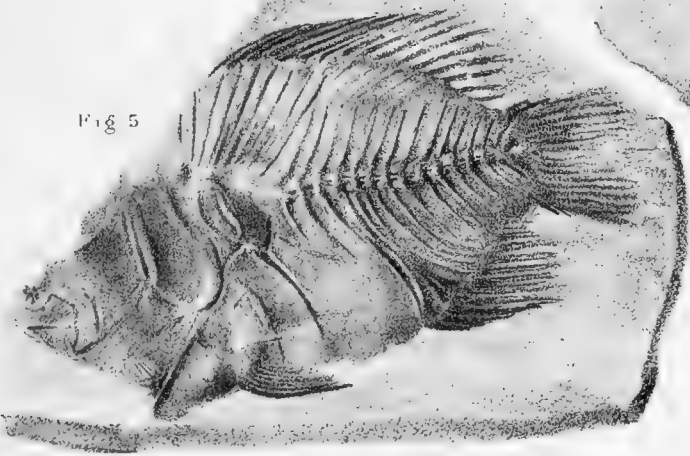
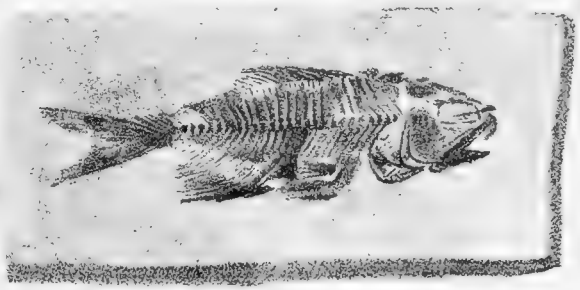

Fig. 6.







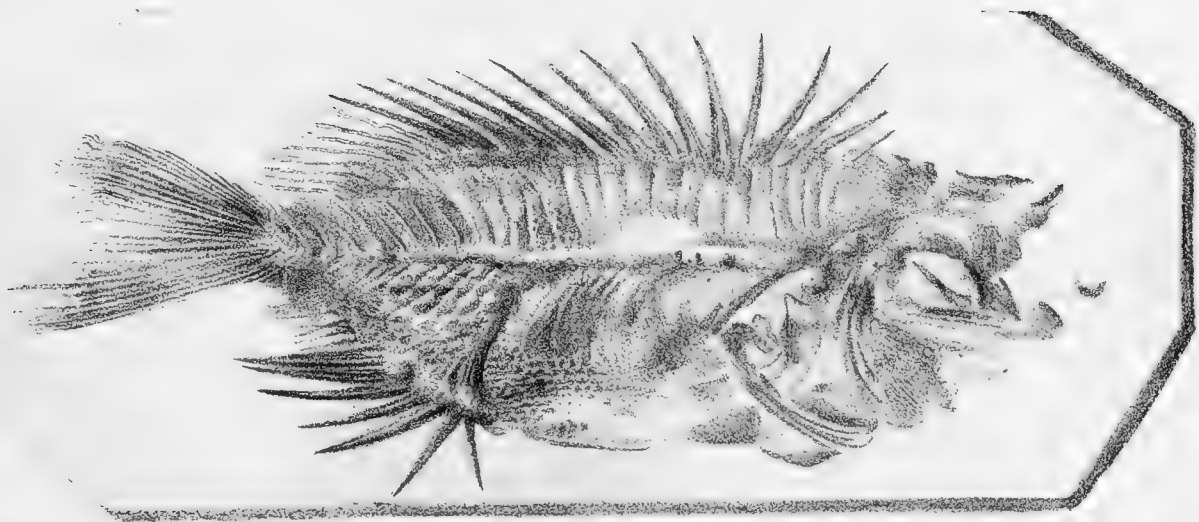

Fig 1

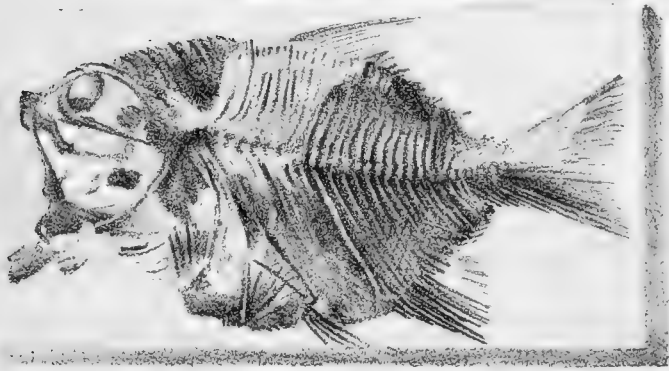

Fig 2



Fig 3

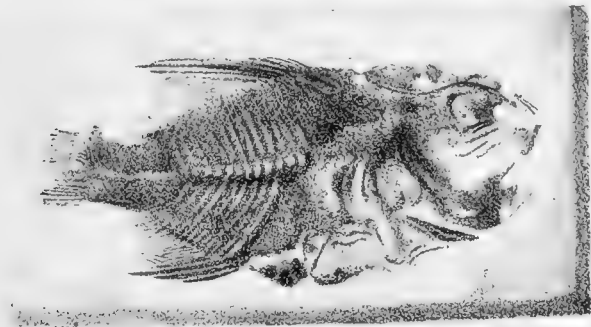

Fig 2a



Fig 4





Fig. 1.

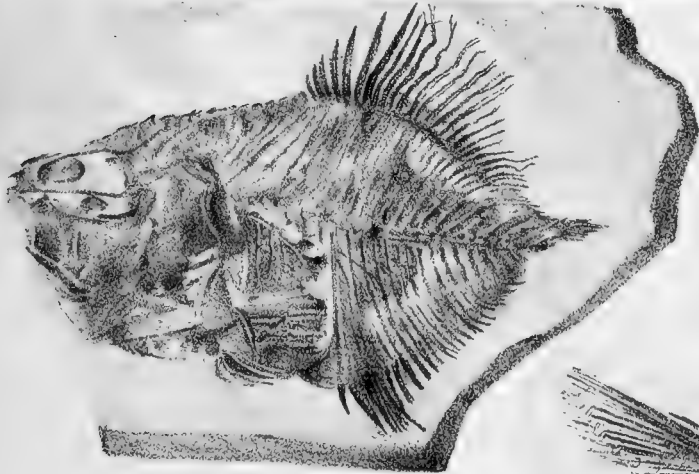

Fig. 3.

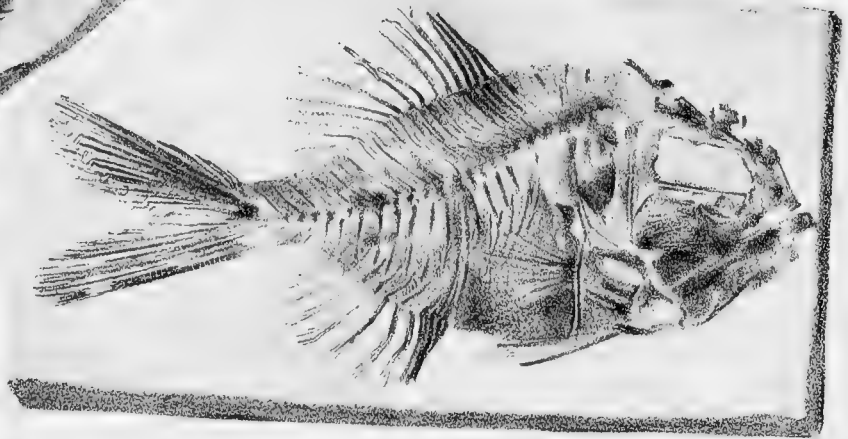

Fig. 2.

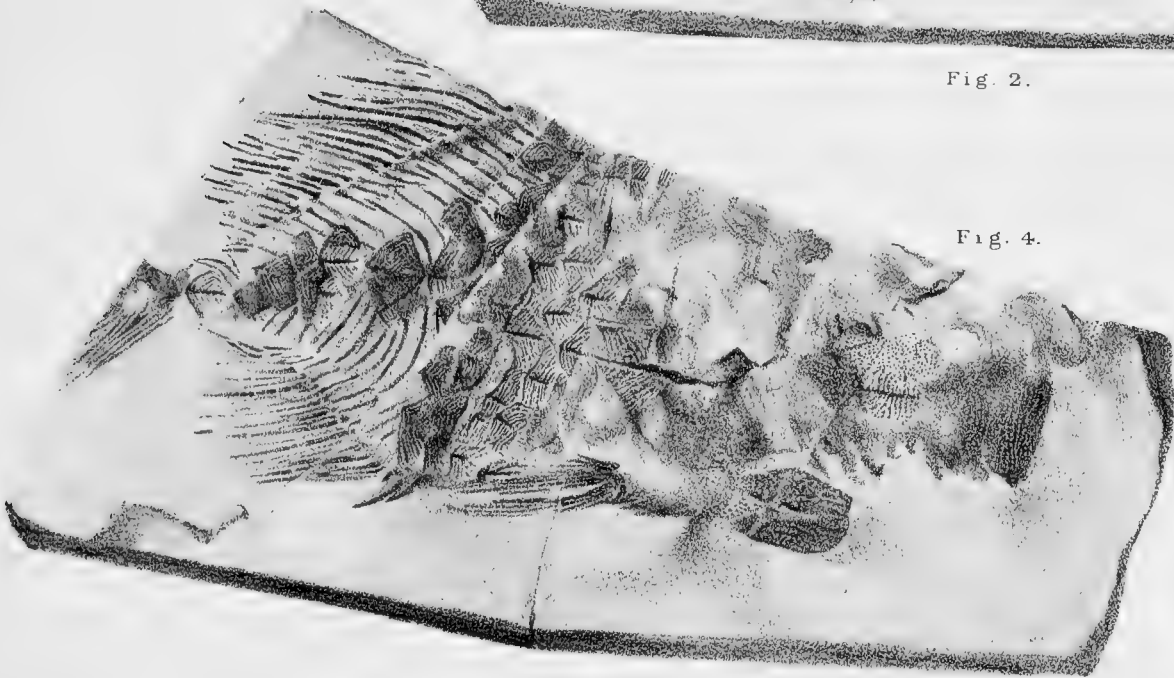

Fig. 4.



Fig. 1.

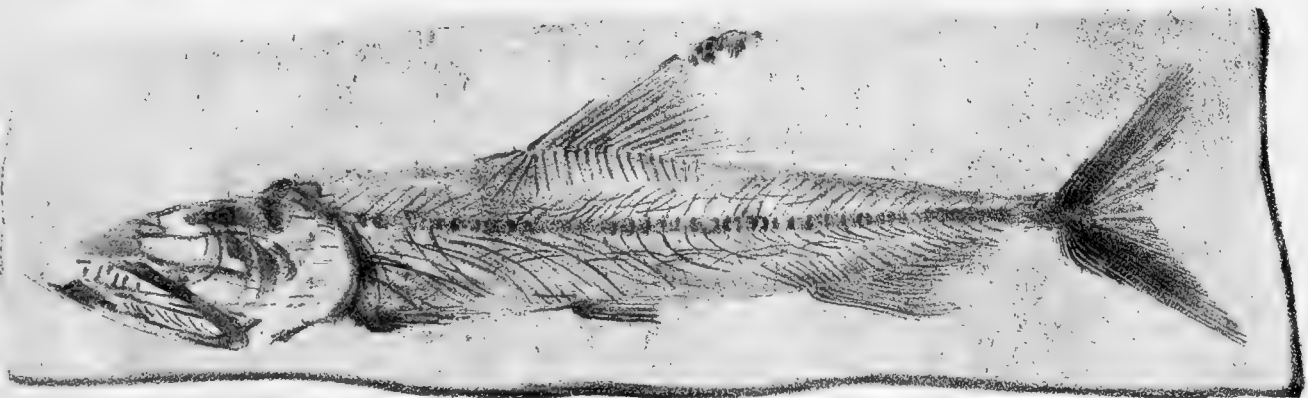
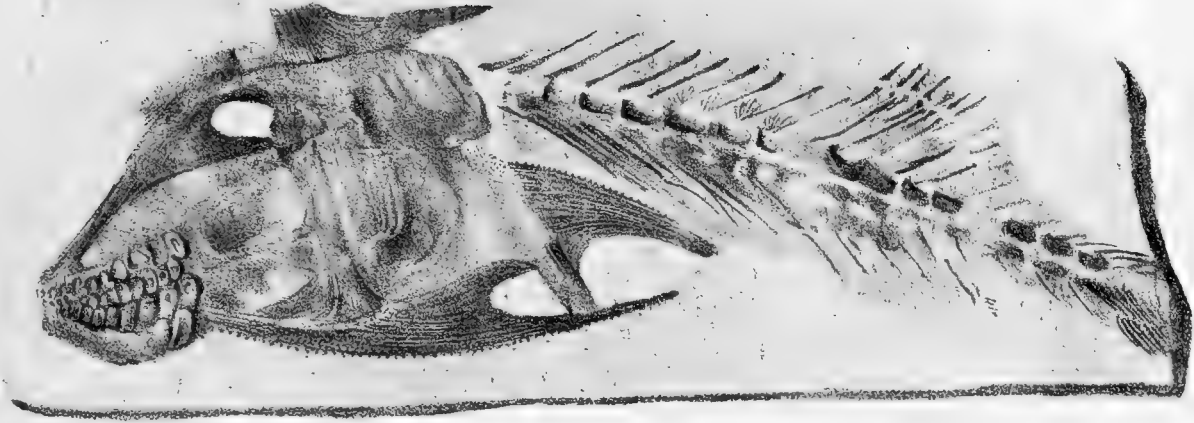

Fig. 2.

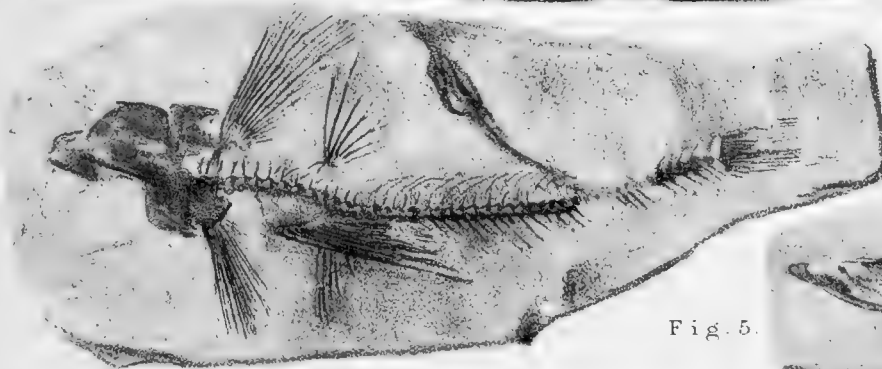

Fig. 3.

Fig. 4.



Fig. 5.

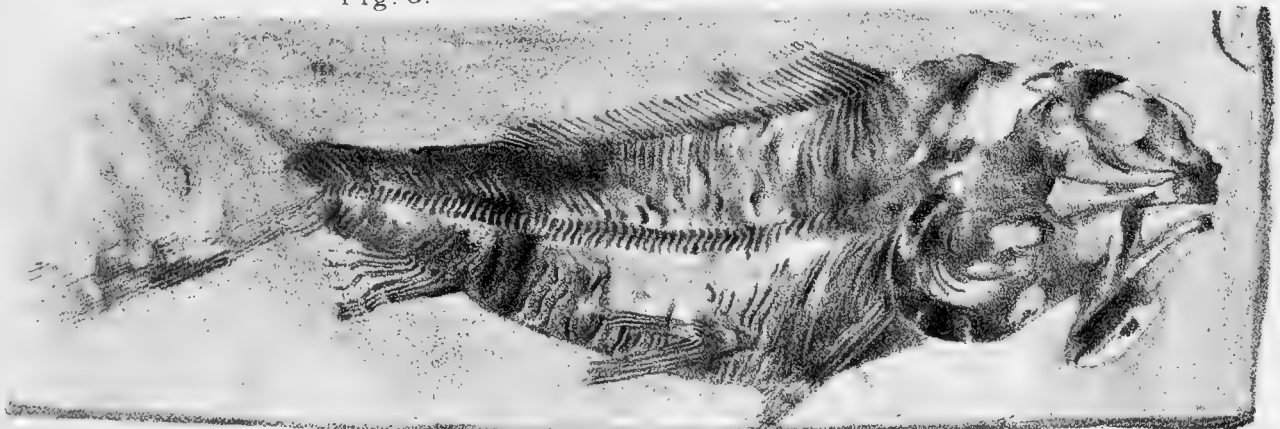





Fig. 1.



Fig. 3.



Fig. 4.

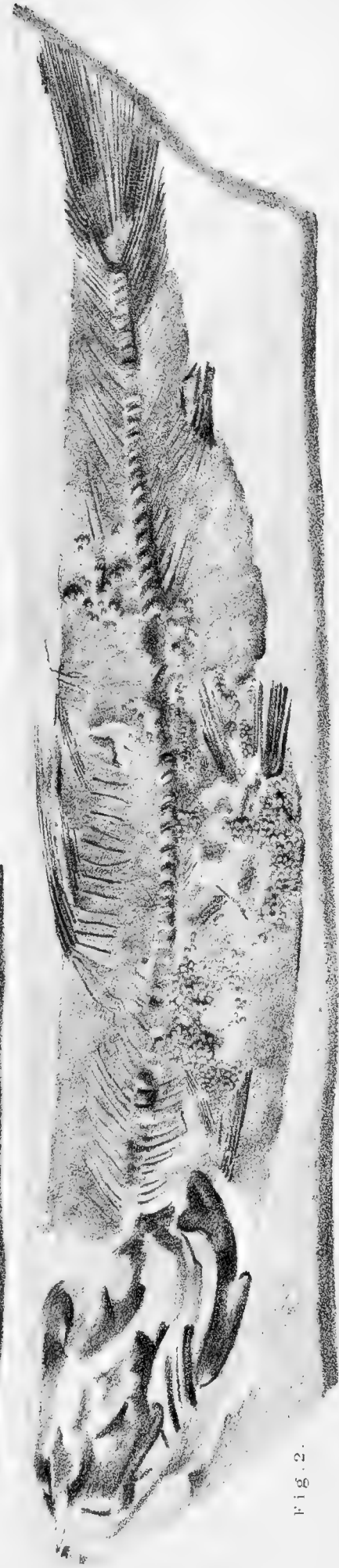

Fig. 2.





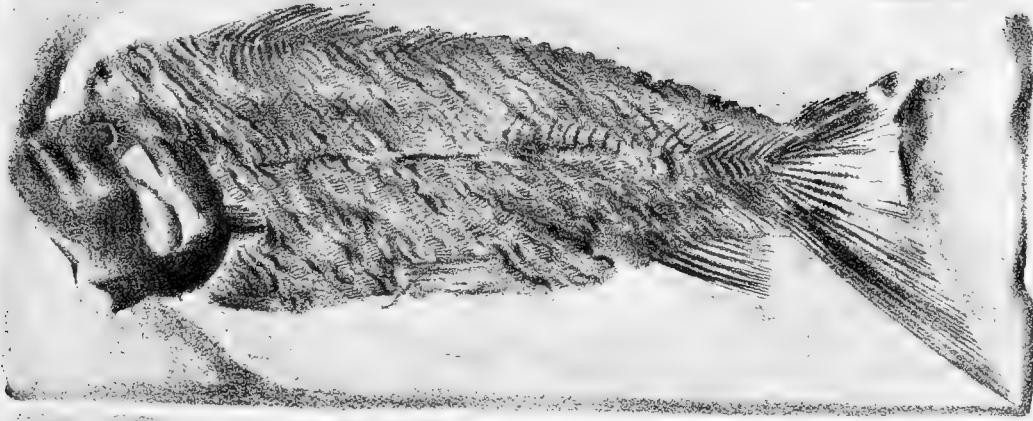

Fig. 1.



Fig. 2.

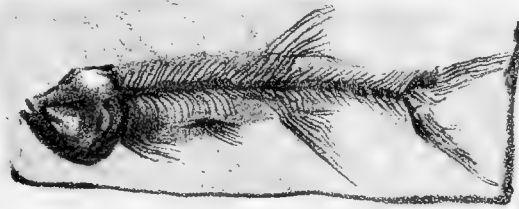

Fig. 3.

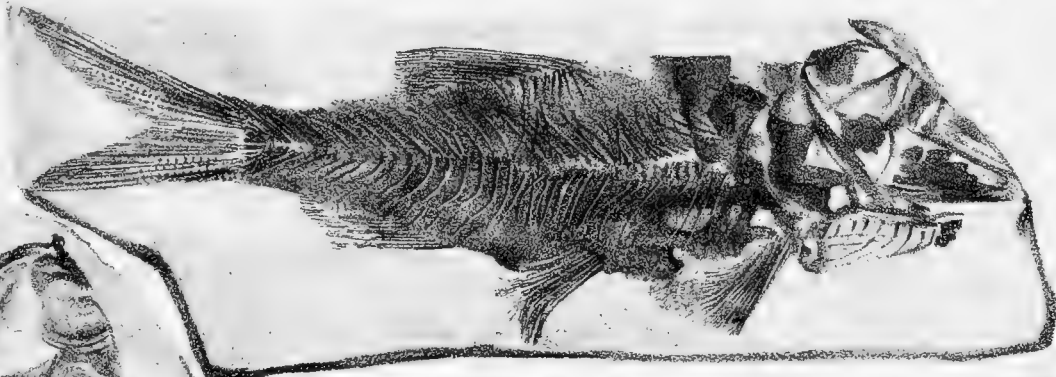

Fig. 4.

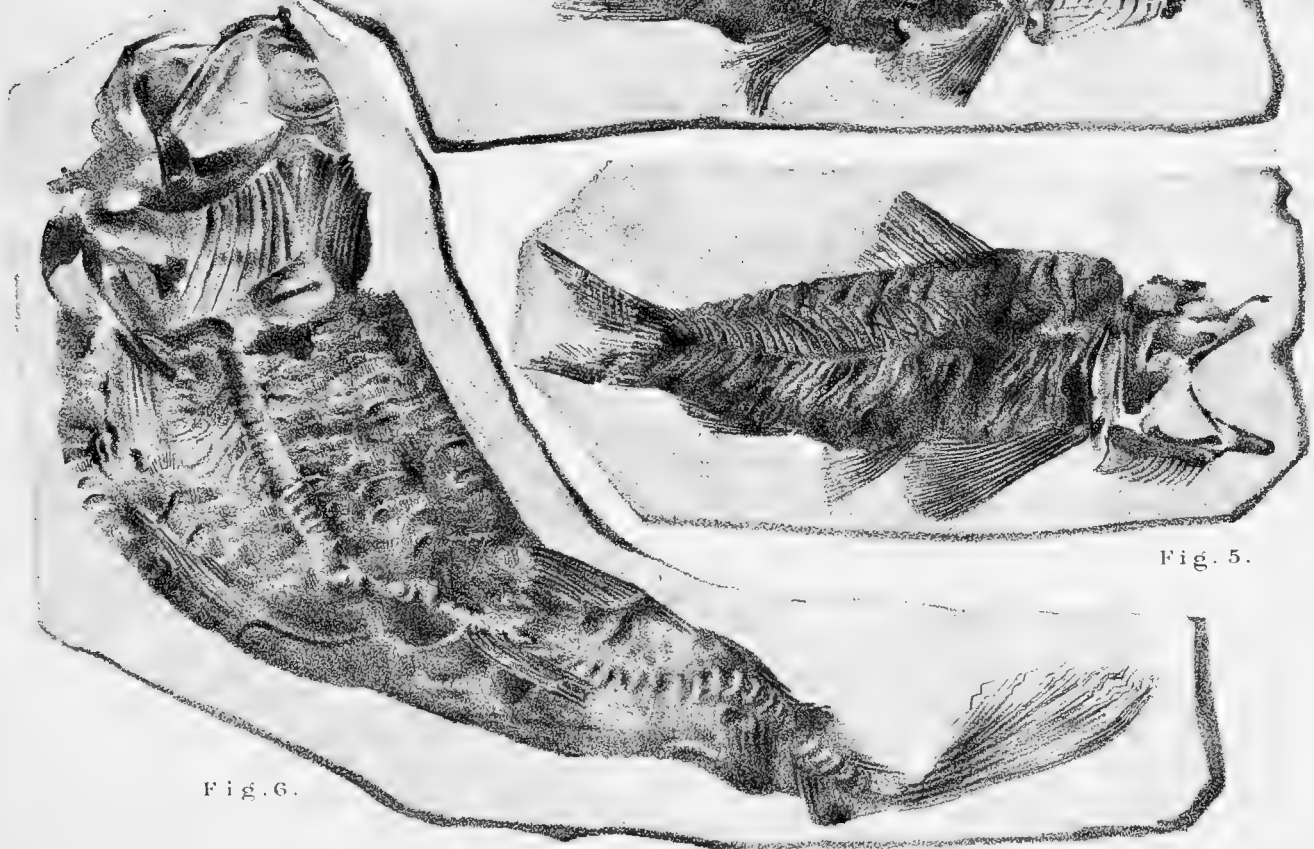

Fig. 5.

Fig. 6.



Fig 2

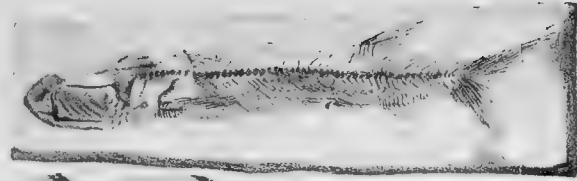

Fig 3.

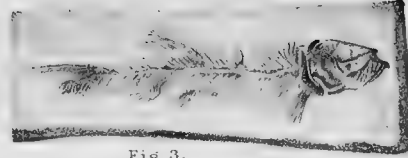

Fig 4.

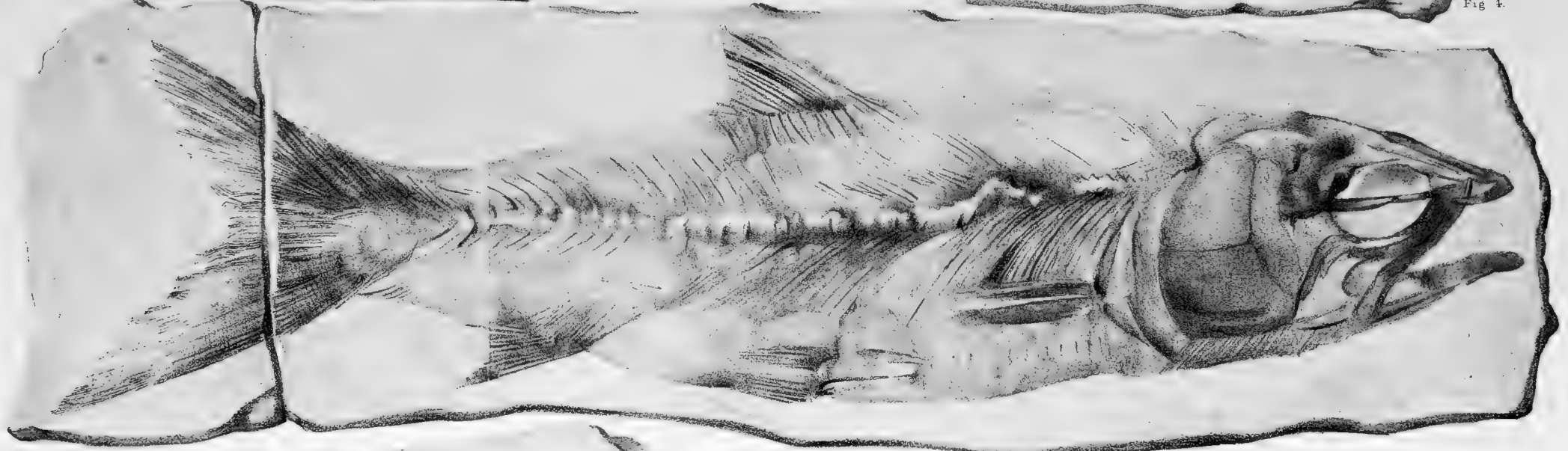

Fig 1



Fig 5

Fig 6







Fig. 3.



Fig. 4.



Fig. 1.



Fig. 5.

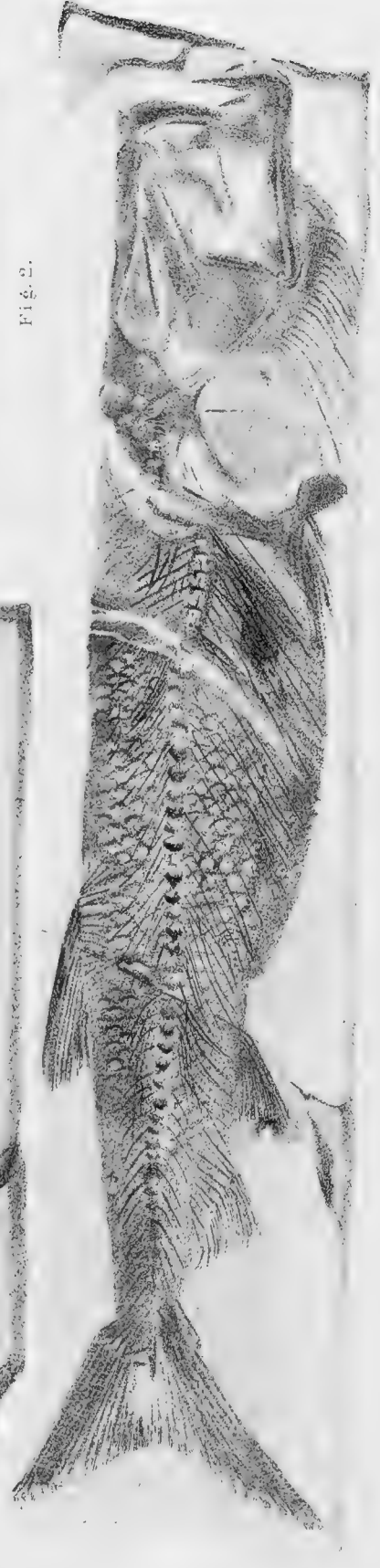

Fig. 2.



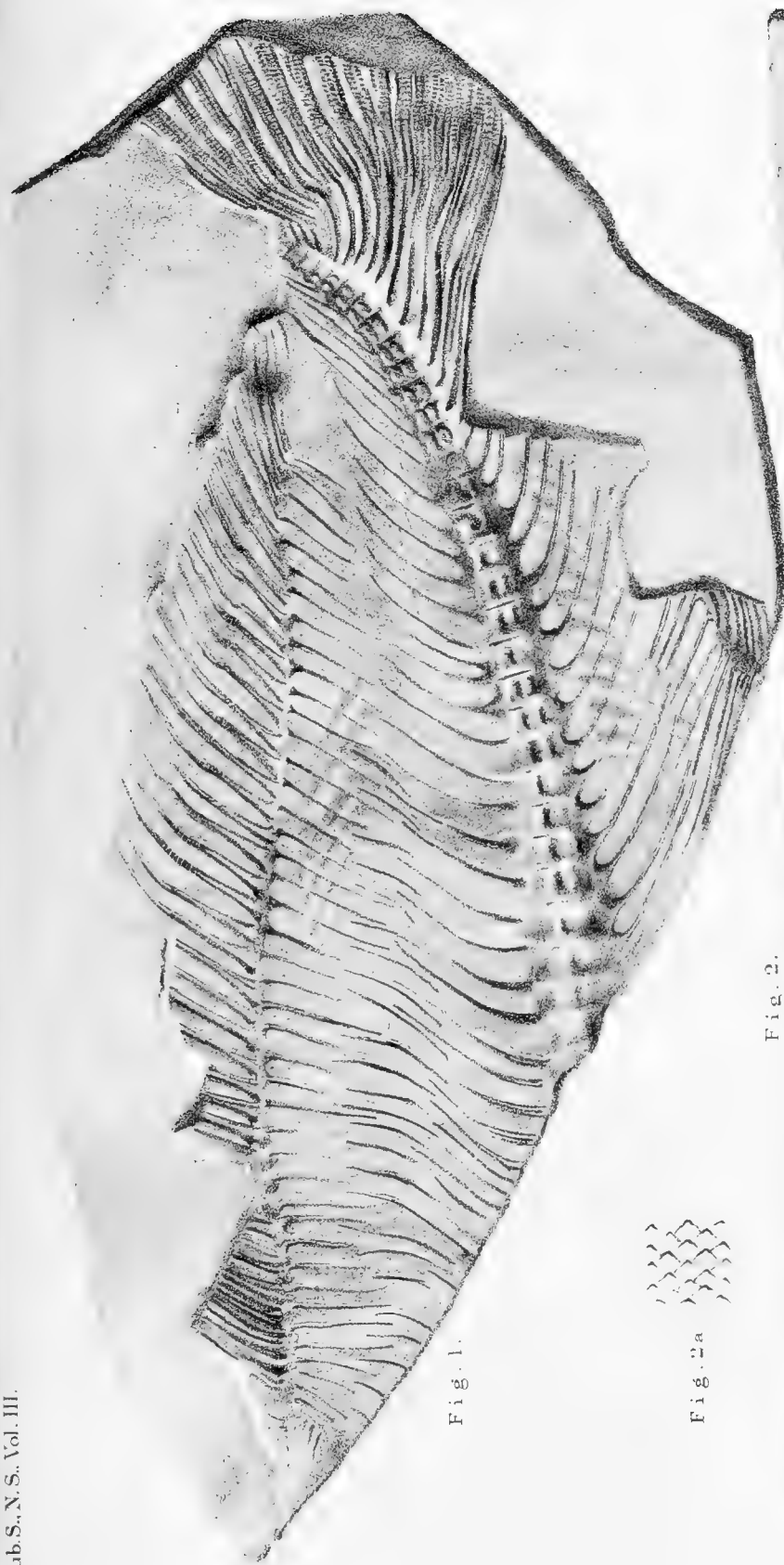

Fig. 1.



Fig. 2a

Fig. 2.









FIG. 2.



FIG. 1.

FIG. 1.



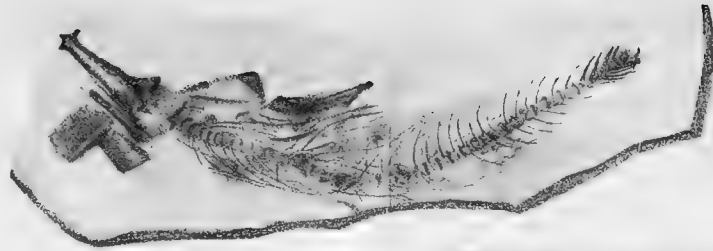

Fig. 2.



Fig. 3.



Fig. 7.

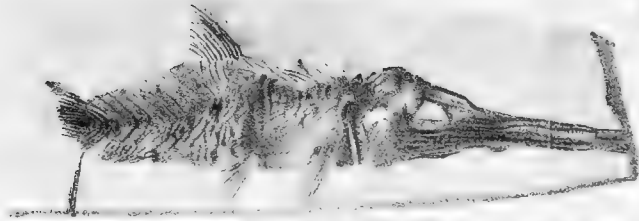

Fig. 5.

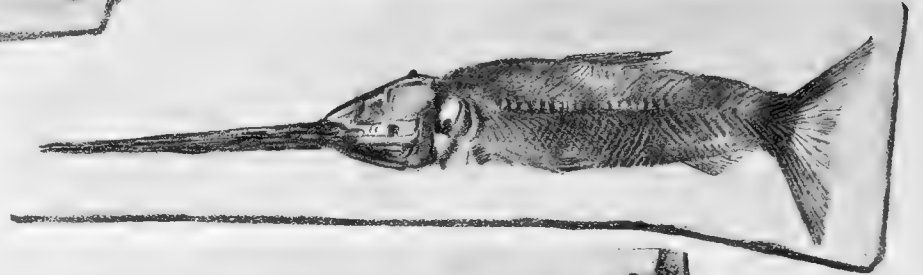

Fig. 4.



Fig. 1.



Fig. 6.





Fig. 1.

Fig. 3a. (Restored.)



Fig. 2.

Fig. 3.

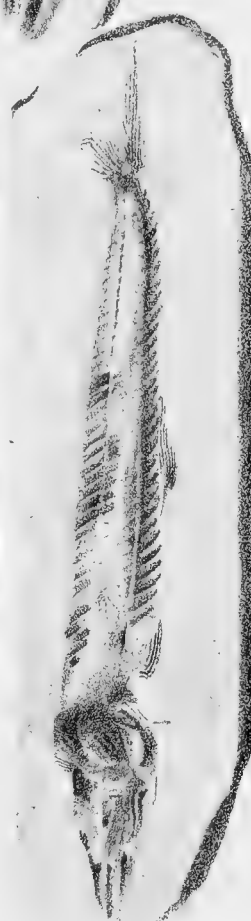
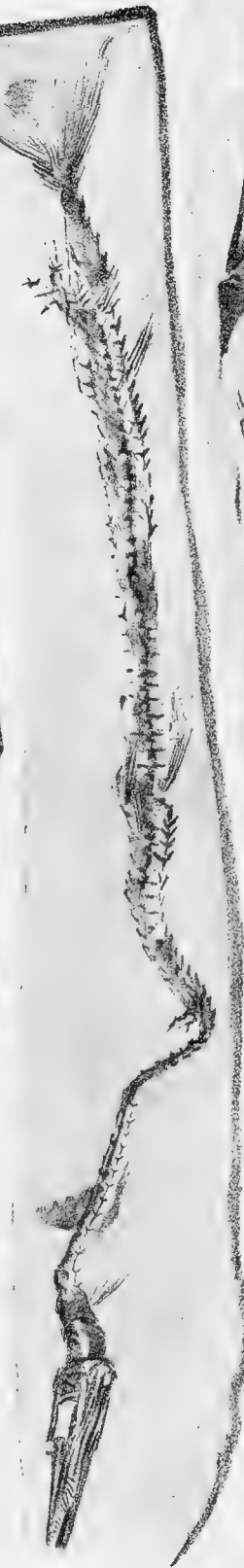

Fig. 4.



MAY, 1887.]

THE  
SCIENTIFIC TRANSACTIONS  
OF THE  
ROYAL DUBLIN SOCIETY.

VOLUME III. (SERIES II.)

---

XIII.—ON THE CAUSE OF IRIDESCENCE IN CLOUDS. BY G. JOHNSTONE  
STONEY, M.A., D.Sc., F.R.S., A VICE-PRESIDENT R.D.S.

---

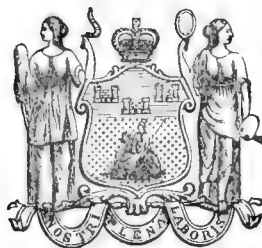

DUBLIN:  
PUBLISHED BY THE ROYAL DUBLIN SOCIETY.  
PRINTED AT THE UNIVERSITY PRESS, BY PONSONBY AND WELDRICK,  
PRINTERS TO THE SOCIETY.  
1887.

---

*Price One Shilling.*





THE  
SCIENTIFIC TRANSACTIONS  
OF THE  
ROYAL DUBLIN SOCIETY.

VOLUME III. (SERIES II.)

XIII.—ON THE CAUSE OF IRIDESCENCE IN CLOUDS. BY G. JOHNSTONE  
STONEY, M.A., D.Sc., F.R.S., A VICE-PRESIDENT, R.D.S.



DUBLIN:  
PUBLISHED BY THE ROYAL DUBLIN SOCIETY.  
PRINTED AT THE UNIVERSITY PRESS, BY PONSONBY AND WELDRICK,  
PRINTERS TO THE SOCIETY.  
1887.



XIII.—ON THE CAUSE OF IRIDESCENCE IN CLOUDS. BY G. JOHNSTONE STONEY, M.A., D.Sc., F.R.S.; a VICE-PRESIDENT, R.D.S.

[Read, February 16, 1887, except the last four paragraphs, which were read March 23, 1887.]

WHEN the sky is occupied by light cirro-cumulus cloud, an optical phenomenon of the most delicate beauty sometimes presents itself, in which the borders of the clouds and their lighter portions are suffused with soft shades of colour like those of mother-of-pearl, among which lovely pinks and greens are the most conspicuous. Usually these colours are distributed in irregular patches, just as in mother-of-pearl; but occasionally they are seen to form round the denser patches of cloud a regular coloured fringe, in which the several tints are arranged in stripes following the sinuosities of the outline of the cloud.

I cannot find in any of the books an explanation of this beautiful spectacle, all the more pleasing because it generally presents itself in delightful summer weather. It is not mentioned in the part of Moigno's great "Répertoire d'Optique," which treats of meteorological optics, nor in any other work which I have consulted. It seemed desirable, therefore, to make an attempt to search out what appears to be its explanation.

At the elevation in our atmosphere at which these delicate clouds are formed, the temperature is too low, even in midsummer, for water to exist in the liquid state; and, accordingly, the attenuated vapour from which they were condensed passed at once into a solid form. They consist, in fact, of tiny crystals of ice, not of little drops of water. If the precipitation has been hasty, the crystals will, though all small, be of many sizes jumbled together, and in that case the beautiful optical phenomenon with which we are now dealing will not occur. But if the opposite conditions prevail—which they do on rare occasions—if the vapour had been evenly distributed, and if the precipitation took place slowly, then will the crystals in any one neighbourhood be little ice crystals of nearly the same form and size, and from one neighbourhood to another they will differ chiefly in number and size, owing to the process having gone on longer or taken place somewhat faster, or through a greater depth, in some neighbourhoods than others. This will give rise to the patched appearance of the clouds which prevails when this phenomenon presents itself. It also causes the tiny crystals, of which the cloud consists, to grow larger in some places than others.

Captain Scoresby in his *Account of the Arctic Regions* gives the best description of snow crystals formed at low temperatures with which I am acquainted. From

his observations it appears (*a*) that when formed at temperatures several degrees below the freezing-point, the crystals, whether simple or compound, are nearly all of symmetrical forms; (*b*) that thin tabular crystals are extremely numerous, consisting either of simple transverse slices of the fundamental hexagon, or, more frequently, of aggregations of these attached edgewise and lying in one plane; and (*c*) that, according as atmospheric conditions vary, one form of crystal or another largely preponderates. A fuller account of these most significant observations is given in the Appendix to this Paper.

Let us then consider the crystals in any one neighbourhood in the sky, where the conditions that prevail are such as to produce lamellar crystals of nearly the same thickness. The tabular plates are subsiding through the atmosphere—in fact falling towards the earth. And although their descent is very slow, owing to their minute size, the resistance of the air will act upon them as it does upon a falling feather: it will cause them, if disturbed, to oscillate before they settle into that horizontal position which flat plates finally assume when falling through quiescent air. We shall presently consider what the conditions must be, in order that the crystals may be liable to be now and then disturbed from the horizontal position. If this occasionally happens, the crystals will keep fluttering, and at any one moment some of them will be turned so as to reflect a ray from the sun to the eye of the observer from the flat surface of the crystal which is next him. Now, if the conditions are such as to produce crystals which are plates with parallel faces, and as they are also transparent, part only of the sun's ray that reaches the front face of the crystal will be reflected from it: the rest will enter the crystal, and, falling on the parallel surface behind, a portion will be there reflected, and, passing out through the front face, will also reach the eye of the observer. These two portions of the ray—that reflected from the front face and that reflected from the back—are precisely in the condition in which they can interfere with one another, so as to produce the splendid colours with which we are familiar in soap bubbles. If the crystals are of diverse thicknesses the colours from the individual crystals will be different, and the mixture of them all will produce merely white light; but if all are nearly of the same thickness, they will transmit the same colour towards the observer, who will accordingly see this colour in the part of the cloud occupied by these crystals. The colour will, of course, not be undiluted; for other crystals will send forward white light, and this, blended with the coloured light, will produce delicate shades in cases where the corresponding colours of a soap bubble would be vivid.

We have now only to explain how it happens that on very rare occasions the colours, instead of lying in irregular patches, form definite fringes round the borders of the cloudlets. The circumstances that give rise to this special form of the phenomenon appear to be the following. While the cloud is in the process of growth, that is, so long as the precipitation of vapour into the crystalline state

continues to take place, so long will the crystals keep augmenting. If then a cloudlet is in the process of formation, not only by the springing up of fresh crystals around, but also by the continued growth of the crystals within it, then will that patch of cloud consist of crystals which are largest in its central part and gradually smaller as their situation approaches the outside. Here, then, are conditions which will produce one colour round the margin of the cloud, and that colour mixed with others, and so giving rise to other tints, farther in. In this way there comes into existence that iris-like border which is now and then seen.

The occasional upsetting of the crystals, which is required to keep them fluttering, may be produced in any of three ways. The cloudlets may have been formed from the blending together of two layers of air saturated at different temperatures, and moving with different velocities or in different directions. Where these currents intermix a certain amount of disturbance will prevail, which, if sufficiently slight, would not much interfere with the regularity of the crystals, and might yet be sufficient to occasion little draughts, which would blow them about when formed. Or, if the colder layer is above, and if it is in a sufficient degree colder, there need not be any previous relative motion of the two layers; the inevitable convection currents will suffice. Another, and probably the most frequent, cause for little breezes in the neighbourhood of the cloudlets is, that when the cloudlets are formed they immediately absorb the heat of the sun in a way that the previously clear air had not done. If they absorb enough they will rise like feeble balloons, and slight return currents will travel downwards round their margins, throwing all crystals in that situation into disorder.

I do not include among the causes which may agitate the crystals another cause which must produce excessively slight currents of air, namely, that arising from the subsidence of the cloudlets owing to their weight. The crystals will fall faster where in cloud masses than in the intervening portions where the cloud is thinner. But the subsidence itself is so slow, that any relative motions to which differences in the rate of subsidence can give rise are probably too feeble to produce an appreciable effect. Of course, in general, more than one of the above causes will concur, and it is the resultant of the effects which they would have separately that will be felt by the crystals.

If the precipitation had taken place so very evenly over the sky that there were no cloudlets formed, but only one uniform veil of haze, then the currents which would flutter the crystals may be so entirely absent that the little plates of crystal can fixedly assume the horizontal position which is natural to them. In this event the cloud will exhibit no iridescence, but instead of it a vertical circle through the sun will present itself. This on some rare occasions is a feature of the phenomenon of parhelia.

It thus appears that the occasional iridescence of cirrus clouds is satisfactorily accounted for by the concurrence of conditions, each of which is known to have a

real existence in Nature. We may, in fact, recapitulate our knowledge on the subject as follows:—Captain Scoresby's observations show that the crystals of ice formed in the atmosphere do not agglutinate into snow-flakes, except at temperatures bordering on the freezing-point. At temperatures even a few degrees lower, the crystals remain distinct from one another, and at low temperatures are for the most part unmutilated and perfect geometrical figures. He has also shown that all the forms which crystals of ice can assume do not present themselves together, but that some one or two forms generally preponderate over the others, the preponderating form varying according to atmospheric conditions, which he does not seem to have fully traced out. Thin tabular crystals are frequently the preponderating form, and become more delicate and thin and diminish in size as the cold increases. Hence it is to be presumed that the state of the atmosphere in the region of the cirrus clouds will sometimes be such as to produce crystalline plates of a tolerably uniform thickness. When the atmosphere has been in this state at the formation of the cloud, we shall accordingly have either the phenomenon of iridescence, or the twin phenomenon of a vertical column of reflected light passing through the sun. This latter meteor will present itself but seldom, as it requires unusual quietude in the region of the cloud to allow the crystals to settle down sufficiently into the horizontal position. And, accordingly, on the rare occasions when the vertical column is seen, the cloud has been observed to present a gauze-like uniformity of appearance, which is an independent evidence of the calmness which is essential. But it much more frequently happens that the cloud is flocculent in its structure, and exposed to little breezes blowing in various directions, excited by one or more of the causes that have been indicated above. Whenever draughts of this kind intervene, the little tabular crystals are every now and then tossed about, and will then flutter; since being flat plates, subsiding through a resisting fluid, they will oscillate after each such disturbance in their progress towards the horizontal position. Whenever these events happen, we have conditions which must result in that iridescent phenomenon which is the subject of our inquiry.

---

#### APPENDIX.

Extracts from Captain Scoresby's record of his Observations on Snow Crystals formed at low temperatures, in his *Account of the Arctic Regions*, Vol. I., from p. 425 to p. 433, and Plates VIII., IX., X., and XI., in Vol. II.

“When the temperature of the air is within a degree or two of the freezing-point, and much snow falls, it frequently consists of large irregular flakes, such as are common in Britain.” “But in severe

frosts, though the sky appears perfectly clear, lamellar flakes of snow, of the most regular and beautiful forms, are always seen floating in the air and sparkling in the sunbeams, and the snow which falls, in general, is of the most elegant texture and appearance." "The various modifications of crystals may be classed under five general kinds or genera:—1. Lamellar. 2. A lamellar, or spherical nucleus, with spinous ramifications in different planes. 3. Fine spiculæ, or six-sided prisms. 4. Hexagonal pyramids. 5. Spiculæ, having one or both extremities affixed to the centre of a lamellar crystal."

We are more particularly concerned with the first and the last of these genera. About the first, Captain Scoresby says:—

"1. *Lamellar Crystals.*—The varieties of this kind are almost infinite. They occur at all temperatures, and in the greatest abundance, and most of the specimens are extremely thin, transparent, and of an exquisitely delicate structure. They may be subdivided into several distinct species:—

- (a) Stelliform; having six points radiating from a centre, with parallel collateral ramifications in the same plane. This species is the most general form met with." "It occurs in greatest profusion when the temperature approaches the freezing-point.
- (b) Regular hexagon. This occurs in moderate, as well as in the lowest temperature; but it becomes more delicate and thin, and diminishes in size as the cold increases. Some specimens consist of simple transparent plates, others are beautifully variegated within the perimeter by white lines, forming smaller hexagons or other regular figures in immense variety."
- (c) "Aggregations of hexagons. This beautiful species admits of immense variety. It occurs chiefly at low temperatures."
- (d) "Combinations of hexagons, with radii or spines and projecting angles. This constitutes the most extensive species in the arrangement."

About the last, or fifth, genus, Captain Scoresby says:—

"5. *Spiculæ or prisms having one or both extremities inserted in the centre of a Lamellar Crystal.*—This is the most singular genus I have ever seen, and has been observed but twice. It resembles a pair of wheels, united by an axle-tree; the wheels consisting of hexagonal or other lamellar crystals, and the axle of a slender crystal." "Some of this extraordinary figure occurred along with the last-described genus [Hexagonal pyramids]. Of which kinds, principally, a quantity of snow, three or four inches in depth, once fell on the deck of the ship in which I sailed, in the course of a few hours. The temperature when this kind of crystal fell was in one instance 22°, and in the other 20°" [Fahrenheit].

In four engraved plates Captain Scoresby delineates ninety-six different forms, magnified from three to seven times. And he attaches a letter to most of them referring to an annexed Table, in which the state of the atmosphere and weather, when each form was observed, stand recorded. In what he further adds to his record, he says:—

"Many instances, it may be observed, occur of mutilated and irregular specimens, some wanting two or three radii, and others having radii of different shapes. But in low temperatures the greatest proportion of crystals that fall are probably perfect geometrical figures."

The foregoing are the parts of Captain Scoresby's record of his invaluable observations upon ice crystals, which more particularly throw light on the cause

why cirrus clouds are occasionally iridescent; but the rest of the account of this accurate observer, and the admirable drawings which he made of the crystals, will also well repay careful study. Thus, if the cloud consist of crystals of Scoresby's fifth genus, or if crystals of the first and third genera are both present, and if the air is so calm that the crystals can remain in the terminal position into which they would come in falling through still air, then we shall have the phenomenon of both a horizontal and a vertical circle through the sun making a cross. Whereas, if the crystals are of the first genus only, the vertical circle will present itself without the horizontal. I have myself seen the phenomenon in this latter form. Crystals of either the first or the fifth genus, if occasionally agitated so that they will keep fluttering, would give rise to iridescence if of sufficiently uniform thickness.

Captain Scoresby describes lamellar flakes of snow floating in the air and sparkling in the sunbeams, as always present during severe frosts, when the sky is clear. The beautiful appearance they would have is a familiar one in chemical laboratories, when a glass vessel, in which precipitated tabular crystals are subsiding through the mother liquid, is placed in the direct light of the sun. The whole liquid then seems alive with minute specks flashing with the brilliant colours of thin plates.

---





# TRANSACTIONS (NEW SERIES).

## VOLUME I.

Parts 1-25.—November, 1877, to September, 1883. (*Part 25 contains Title-page to Volume.*)

---

## VOLUME II.

PART

- 1.—Observations of Nebulæ and Clusters of Stars, made with the Six-foot and Three-foot Reflectors at Birr Castle, from the year 1848 up to the year 1878. Nos. 1 & 2. By the RIGHT HON. THE EARL OF ROSSE, LL.D., D.C.L., F.R.S. Plates I. to IV. (August, 1879.)  
No. 3. Plates V. and VI. (June, 1880.)
  - 2.—On Aquatic Carnivorous Coleoptera or Dytiscidæ. By DR. SHARP. Plates VII. to XVIII. (April, 1882.) [*With Title-page to Volume.*]
- 

## VOLUME III.

- 1.—On the Influence of Magnetism on the Rate of a Chronometer. By OTTO BÆDDICKER, PH.D. Plate I. (September, 1883.)
- 2.—On the Quantity of Energy transferred to the Ether by a Variable Current. By GEORGE F. FITZGERALD, M.A., F.R.S. (March, 1884.)
- 3.—On a New Form of Equatorial Telescope. By HOWARD GRUBB, M.E., F.R.S. Plate II. (March, 1884.)
- 4.—Catalogue of Vertebrate Fossils from the Siwaliks of India, in the Science and Art Museum, Dublin. By R. LYDEKKER, B.A., F.G.S., F.Z.S. Plate III. and Woodcuts. (July, 1884.)
- 5.—On the Origin of Freshwater Faunas: A Study in Evolution. By W. J. SOLLAS, M.A., Dublin; D.SC., Cambridge; Fellow of St. John's College, Cambridge; Professor of Geology and Mineralogy in the University of Dublin. (November, 1884.)
- 6.—Memoirs on the Coleoptera of the Hawaiian Islands. By THE REV. T. BLACKBURN, B.A., and DR. D. SHARP. Plates IV. and V. (February, 1885.)
- 7.—Notes on the Aspect of the Planet Mars in 1884. Accompanied by Sketches made at the Observatory, Birr Castle. By OTTO BÆDDICKER, PH.D. Plate VI. (March, 1885.)
- 8.—On the Geological Age of the North Atlantic Ocean. By EDWARD HULL, LL.D., F.R.S., F.G.S., Director, Geological Survey of Ireland. Plates VII. and VIII. (April, 1885.)
- 9.—On the Changes of the Radiation of Heat from the Moon during the Total Eclipse of 1884, October 4, as Measured at the Observatory, Birr Castle. By OTTO BÆDDICKER, PH.D. Plates IX. and X. (October, 1885.)
- 10.—On the Collection of the Fossil Mammalia of Ireland in the Science and Art Museum, Dublin. By V. BALL, M.A., F.R.S., F.G.S. Plate XI. (November, 1885.)
- 11.—On New Zealand Coleoptera, with Descriptions of New Genera and Species. By DAVID SHARP, M.B. Plates XII. and XIII. (November, 1886.)
- 12.—The Fossil Fishes of the Chalk of Mount Lebanon, in Syria. By JAMES W. DAVIS, F.G.S., F.L.S., &c. Plates XIV. to XXXVIII. (April, 1887.)
- 13.—On the Cause of Iridescence in Clouds. By G. JOHNSTONE STONEY, M.A., D.SC., F.R.S., a Vice-President R.D.S. (May, 1887.)

DECEMBER, 1887.]

[TITLE-PAGE TO VOL. III.]

THE

SCIENTIFIC TRANSACTIONS

OF THE

ROYAL DUBLIN SOCIETY.

VOLUME III. (SERIES II.)

XIV.—THE ECHINODERM FAUNA OF THE ISLAND OF CEYLON. BY F. JEFFREY BELL, M.A., SEC. R.M.S., PROFESSOR OF COMPARATIVE ANATOMY AND ZOOLOGY IN KING'S COLLEGE, LONDON; COR. MEM. LINN. SOC., N.S. WALES.

(PLATES XXXIX. AND XL.)

[COMMUNICATED BY PROFESSOR HADDON, JULY, 1887.]



DUBLIN:

PUBLISHED BY THE ROYAL DUBLIN SOCIETY.

PRINTED AT THE UNIVERSITY PRESS, BY PONSONBY AND WELDRICK,

PRINTERS TO THE SOCIETY.

1887.

*Price Two Shillings and Sixpence.*



THE  
SCIENTIFIC TRANSACTIONS  
OF THE  
ROYAL DUBLIN SOCIETY.

VOLUME III. (SERIES II.)

XIV.—THE ECHINODERM FAUNA OF THE ISLAND OF CEYLON. BY F.  
JEFFREY BELL, M.A., SEC. R.M.S., PROFESSOR OF COMPARATIVE ANATOMY  
AND ZOOLOGY IN KING'S COLLEGE, LONDON; COR. MEM. LINN. SOC., N.S. WALES.

(PLATES XXXIX. AND XL.)

[COMMUNICATED BY PROFESSOR HADDON, JULY, 1887.]



DUBLIN:  
PUBLISHED BY THE ROYAL DUBLIN SOCIETY.  
PRINTED AT THE UNIVERSITY PRESS, BY PONSONBY AND WELDRICK,  
PRINTERS TO THE SOCIETY.  
1887.



XIV.—THE ECHINODERM FAUNA OF THE ISLAND OF CEYLON. BY F. JEFFREY BELL, M.A., SEC. R. M. S., PROFESSOR OF COMPARATIVE ANATOMY AND ZOOLOGY IN KING'S COLLEGE, LONDON; COR. MEM. LINN. SOC., N. S. WALES. Plates XXXIX. AND XL.

[COMMUNICATED BY PROFESSOR HADDON, JULY, 1887.]

A FEW years ago we had no exact knowledge of the Echinoderm Fauna of the island of Ceylon; and though it has been a British possession since 1815—and stands, as it were, invitingly in the midst of the Indian Ocean—much still remains to be done before we can hope to have a satisfactory knowledge of its extensive Fauna.

In the year 1882, when only four species of Echinoderms were known from the island, Dr. Ondaatje, a Colonial Surgeon in Ceylon, arrived in England with a collection of no less than nineteen species of the group, many of which were most admirably preserved. These specimens, with others, Dr. Ondaatje was good enough to present to the Trustees of the British Museum, and they formed the subject of a short Paper by myself.\* With the possible exception of a single Crinoid, none of the species were new to science, and they led rather to the belief that further investigation would reveal the presence at Ceylon of forms already known from some other part of the Great Ocean, as Mr. Theodore Lyman† calls the Indian Ocean and the warmer part of the Pacific.

This belief has been shown to be well founded; but it does not, on that account, seem to me to diminish the interest which attaches to collections from Ceylon. For a long term of years naturalists have been unceasingly adding to the catalogue of the faunal wealth of the world, and the labour of description has often been found to be so great as to leave no time or opportunity for revision or comparison; it is, to some minds, a relief to turn from the extension to the consolidation of our knowledge, and to prepare the way for comprehensive monographs.

Just before Dr. Ondaatje left Ceylon, Professor Haeckel reached that fertile island; he entrusted the description of his collection of Echinoderms to Dr. Alfred Walter, for some time an assistant in the Zoological Institute at Jena.

\* Ann. & Mag., N. H. (5), x., pp. 218-225.

† Preliminary List of Living Ophiuridæ, &c., Cambridge, [U.S.A.], 1880, p. 2.

This collection contained sixteen species, ten or eleven\* of which were not found by Dr. Ondaatje.†

Adding to these the species enumerated by earlier writers and by myself, the total number came to the sum of thirty-two species.

On returning to Ceylon, in 1883, Dr. Ondaatje set zealously to work, and especially did he direct his attention to the two groups of Echinoderms, as to which we still remained in almost complete ignorance—the Holothurians and the Crinoids. From time to time consignments have reached me of specimens of these two orders, which have most welcomingly been, in very many cases, accompanied by coloured drawings made during life of these creatures, which, when preserved for some time in alcohol, lose both their original colouration and their ordinary form.

It is with the object of making public some of the admirable representations prepared under Dr. Ondaatje's direction that I offer the list, and the remarks that follow, for the consideration of the Society. Coloured drawings such as these awaken an interest in Natural History of a kind which is often keener than that produced by anatomical sketches.

By adding to the species collected by the naturalists just mentioned those found by Mr. E. W. H. Holdsworth, and others, I am able now to give a list of more than fifty species of Echinoderms known from Ceylon.

I have refrained from burdening the text with lengthy references to the literature, but I have given enough to enable the student to extend his researches, and I have in the case of all the groups of Echinoderms made a reference to a work in which the full synonyms will be found cited; Professor Perrier,‡ Mr. Lyman,§ Mr. Alexander Agassiz,|| and Drs. Lampert¶ and Théel\*\* being the authors so quoted.

\* There is a species of *Linckia* which Dr. Walter thinks may be identical with *Scytaster nova-caledonia*, which was collected by Dr. Ondaatje. Dr. Walter promised to me his kind offices to get me one of the specimens from Jena, but it has never reached me.

† Ceylon Echinodermen. *Jenaische Zeitschrift*, xviii., pp. 365-384.

‡ Révision de la Collection de Stellérides du Muséum d'histoire naturelle de Paris. Paris, 1875 (also in *Archives de Zoologie expérimentale*, vol. v.)

§ Report of the Ophiuroidea, dredged by H. M. S. Challenger, 1882.

|| Agassiz, Alex. Revision of the Echini. Cambridge [U.S.A.], 1872-74.

¶ Lampert K.—Die Seewalzen—Holothurioidea. In *Reisen im Archipel der Philippinen*, II., iv. 3. Wiesbaden, 1885.

\*\* Report on the Holothurioidea dredged by H. M. S. Challenger, Part 2, 1886.



## A.—PELMATOZOA.

## I. CRINOIDEA.

## 1. ANTEDON CARINATA.

*Comatula carinata.* Lamarck, Hist. Anim. sans Vertebr., ii., p. 534.

*Antedon carinata.* Carpenter\*, Chall. Rep., p. 199.

## 2. ANTEDON ADEONAE.

*Comatula adeonae.* Lamarck, Anim. s. Vert., ii., p. 535.

*Alecto adeonae.* Müller, Arch. f. Nat., 1843, p. 135.

*Antedon adeonae.* Bell, Rep. Voy. Alert, p. 156.

As I have already pointed out, there is a curious error in connexion with this species. Although Lamarck describes it as "*C. radiis pinnatis densis*," de Blainville refers to a twenty-armed species in his Atlas (Manuel d'Actinologie, pl. xxvi.); and in this error the latter has been followed by succeeding naturalists.

## 3. ANTEDON REYNAUDI.

*Comatula (Alecto) reynaudii.* Müller, MB Acad., Berlin, 1846, p. 178.

This twenty-armed form has never, to my knowledge, been found again since the expedition of the Chevette.

## 4. ACTINOMETRA CUMINGII.

*Comatula cumingii.* Müller, Die Gattung Comatula, p. 19.

*Actinometra cumingii.* Bell, Rep. Voy. Alert, p. 167.

This is, typically, a ten-armed species, but injury and subsequent repair frequently lead to the development of a larger number of arms.

## 5. ACTINOMETRA PARVICIRRA.

*Alecto parvicirra.* Müller, MB Acad., Berlin, 1841, p. 185.

*Alecto timorensis.* Müller, t. c., p. 186.

*Actinometra annotea.* P. H. Carpenter, Journ. Anat. and Physiology, xi., p. 91.

*Actinometra polymorpha.* P. H. Carpenter, Trans. Linn. Soc., ii., p. 51.

*Actinometra parvicirra.* P. H. Carpenter, Notes, Leyd. Mus., iii., p. 204; Chall. Rep.

\* Dr. Carpenter has been so kind as to allow me to see such advance sheets of his forthcoming Report on the Comatulæ of the Challenger Expedition as are yet printed.

## B.—ECHINOZOA.

## II. ASTEROIDEA.

## 6. LINCKIA LÆVIGATA.

*Asterias lævigata.* Gmelin, Syst. Nat., p. 3164.

*Ophidiaster miliaris.* Müller and Troschel, System der Asteriden, p. 30 ; Perrier, Rév. Stellér., p. 137.

*Linckia lævigata.* Lütken, Videnskab. Meddel, p. 47 ; Bell, Rep. Voy. Alert, p. 124 ; Proc. Zool. Soc., 1887, p. 139.

This species is often distinguished by its blue colouration, and, contrary to what ordinarily happens with the colouring matter of starfishes, this blue colour is often well preserved in dried specimens; it would be interesting to make a chemical and spectroscopic investigation of this body. The museum examples from Ceylon were obtained by Mr. E. W. H. Holdsworth.

## 7. LINCKIA, sp.

*Linckia*, sp. Walter, Jenaische Zeitschrift, xviii., p. 366.

Dr. Walter thinks this may be the same as the succeeding species. He was kind enough to promise to use his best efforts with the authorities of the Jena Museum, in order that I might be allowed to examine one of the specimens myself ; but the starfish has never reached me.

## 8. SCYTASTER NOVAE-CALEDONIAE.

*Scytaster novae-caledoniae.* Perrier, Rév. Stellér., p. 162.

In my earlier essay I used this species as the text for insisting that an injury to an arm might be accidental—that is, that it might be due to external forces depending on the will of another animal. Put in less general terms, one means here that a starfish may lose an arm by having it bitten off. The differences between a loss by external means and the so-called voluntary process are obvious enough. In the latter case the arm is marked by a longitudinal constriction, which, becoming deeper and deeper, finally separates the distal from the proximal or basal portion. In a specimen of *Scytaster* now before me, two of the arms are cut across *obliquely*, and the freshly-grown portion of one of them has its long axis a little oblique to the original long axis of the arm ; these characters combined

indicate that the injury is directly due to an external enemy. It was to me a matter of peculiar satisfaction—having, in 1882, written, “It is not difficult to see that the result of such an injury might, of itself and by itself, be the production of two rays where one had previously existed, owing to increased activity, due to inflammatory action. A further result might well be a tendency, in a race of individuals of a certain species, to produce an irregular number of rays: occasionally, as in the case of *Asterias polaris*, this would be advantageous, and would become a constant arrangement”—to read in 1885 the following words of an accomplished pathologist:—“In many cases where organs or sets of organs have undergone hypertrophy to such a degree that pathologists would regard them as abnormal, these exceptional conditions have been inherited, and in this sense pathology may be assumed to have played a part among the ordinary processes of evolution in producing rare peculiarities.” Cf. Mr. J. Bland Sutton, on “Hypertrophy and its Value in Evolution,” P. Z. S., 1885, pp. 432–445.

#### 9. SCYTASTER VARIOLATUS.

*Asterias variolata*. Retzius, Diss. sist. spec. Asteriar., p. 19.

*Scytaster variolatus*. Müller and Troschel, Syst. der Aster., p. 34; Perrier, Rév. Stellér., p. 159.

#### 10. FROMIA MILLEPORELLA.

*Asterias milleporella*. Lamarck, Anim. s. Vertebr., ii., p. 565.

*Fromia milleporella*. Gray, Ann. Mag. Nat. Hist., vi., p. 286; Perrier, Rév. Stellér., p. 173.

#### 11. FROMIA TUMIDA.

*Fromia tumida*. Bell, P. Z. S., 1882, p. 124.

This species, which was described by me in 1882, is not included in Dr. Walter's later enumeration; but as he makes no reference to it, nor to the Paper in which it was published, I presume it escaped his notice. The Museum owes its specimens to M. Kelaart.

#### 12. OREASTER LINCKI.

*Asterias lincki*. De Blainville, Dict. Sci. Nat., lx., p. 219.

*Pentaceros muricatus*. Perrier, Rév. Stellér., p. 239.

*Oreaster lincki*. Bell, P. Z. S., 1884, p. 72.

I think it is very probable that further search will be rewarded by the discovery of other species of *Oreaster* on the shores of Ceylon.

## 13. ASTROPECTEN POLYACANTHUS.

*Astropecten polyacanthus.* Müller and Troschel, Syst. der Ast., p. 69; Perrier, Rév. Stellér., p. 355.

*Astropecten hystrix.* Müller and Troschel, t. c., p. 70.

*Astropecten armatus.* Müller and Troschel, t. c., p. 71. Walter, Jen. Zeitsch., xviii., p. 368.

I cannot imagine why Dr. Walter uses the specific name of *armatus* in preference to the familiar *polyacanthus*.

## 14. ASTROPECTEN, sp.

## 15. LUIDIA MACULATA.

*Luidia maculata.* Müller and Troschel, Syst. der Ast., p. 77; Perrier, Rév. Stellér., p. 338; Walter, Jen. Zeitsch., xviii., p. 368.

## III. OPHIUROIDEA.

## 16. OPHIOPLOCUS IMBRICATUS.

*Ophiolepis imbricata.* Müller and Troschel, Syst. der Ast., p. 93.

*Ophioplocus imbricatus.* Lyman, Illustr. Catal. Mus. Comp. Zool., p. 69; Chall. Rep., p. 20.

## 17. OPHIOCOMA ERINACEUS.

*Ophiocoma erinaceus.* Müller and Troschel, Syst. der Ast., p. 98; Lyman, Chall. Rep., p. 170.

## 18. OPHIOCOMA SCOLOPENDRINA.

*Ophiocoma scolopendrina.* Agassiz, Mem. Soc. Sci. Nat., Neuchâtel, i., p. 192; Lyman, Chall. Rep., p. 170.

It is almost certain that in a short time systematists will be agreed as to the necessity of uniting these two species of *Ophiocoma*.

## 19. OPHIOCOMA BREVIPES.

*Ophiocoma brevipes.* Peters, Archiv f. Naturg., xviii. (1852), p. 85; Lyman, Chall. Rep., p. 172.

## 20. OPHIOCOMA PICA.

*Ophiocoma pica.* Müller and Troschel, Syst. der Ast., p. 101; Lyman, Chall. Rep., p. 171.

*Ophiocoma lineolata.* Müller and Troschel, t. c., p. 102. Walter, Jen. Zeitsch., xviii., p. 370.

I do not know why Dr. Walter prefers to use the term *lineolata*, in favour of which neither usage nor priority can be cited.

## 21. OPHIOMASTIX ANNULOSA.

*Ophiomastix annulosa*. Müller and Troschel, Syst. der Ast., p. 107; Lyman, Chall. Rep., p. 175.

This species was brought home by Dr. Ondaatje in the most excellent condition.

## 22. OPHIACTIS SAVIGNII.

Savigny, Descrip. de l'Egypte, Echinod., pl. ii., figs. 4 and 5.

*Ophiolepis savignii*. Müller and Troschel, Syst. der Ast., p. 95.

*Ophiactis savignii*. Lyman, Chall. Rep., p. 115.

## 23. OPHIOTHRIX NEREIDINA.

*Ophiura nereidina*. Lamarck, Anim. s. Vert., ii., p. 544.

*Ophiothrix nereidina*. Müller and Troschel, Syst. der Ast., p. 115; Lyman, Chall. Rep., p. 221.

## 24. OPHIOTHRIX PUNCTOLIMBATA.

*Ophiothrix punctolimbata*. Martens, Arch. f. Nat., 1870, p. 257; Bell, Rep. Voy. Alert, p. 143; Lyman, Chall. Rep., p. 227.

## 25. OPHIOCNEMIS MARMORATA.

*Ophiocnemis marmorata*. Müller and Troschel, Syst. der Ast., p. 87.

Mr. Lyman (Illustr. Cat. Mus. Comp. Zool., i., p. 152) is the authority for this species having been found at Ceylon; it was not collected either by Dr. Ondaatje or Professor Haeckel.

## 26. OPHIOTHELA HOLDSWORTHI.

*Ophiothela holdsworthi*. E. A. Smith, Ann. & Mag. Nat. Hist. (5), i., p. 463.

This species, collected by Mr. E. W. H. Holdsworth, and described by Mr. Edgar Smith, is not mentioned either by Mr. Lyman in the enumeration of species given in his Challenger Report, or by Dr. Walter in his account of what preceding workers have done for the Fauna of Ceylon.

## 27. ASTROPHYTON CLAVATUM.

*Astrophyton clavatum*. Lyman, Proc. Boston Soc., I. H., viii., p. 85; Chall. Rep., p. 258.

It is to be hoped that future collectors of this beautiful form will, while their specimens are fresh and capable of being moulded into shape, extend the many branched arms, and not allow the specimens to dry or harden with the arms twisted up.

## IV. ECHINOIDEA.

## 28. PHYLLACANTHUS IMPERIALIS.

*Cidarites imperialis*. Lamarck, Anim. s. Vert., iii., p. 54.

*Phyllacanthus imperialis*. Brandt, Prod. descr. Anim., p. 68; Agassiz, Rev. Ech., p. 151.

Mr. Alex. Agassiz, on whose authority this species is included among those of Ceylon, does not cite the collector by whom it was obtained or collection in which it is to be found, but in giving his list of littoral species found in "Indian Ocean to Philippine Islands" (l. c., p. 235), he gives its distribution as "Ceylon: Aru Islands." Neither Dr. Ondaatje nor Prof. Haeckel collected the species.

## 29. DIADEMA SETOSUM.

*Cidarites diadema*. Lamarck, Anim. s. Vert., iii., p. 58.

*Diadema setosa*. Gray, Annals Philosophy, xxvi. (n. s. x.), p. 426.

*Diadema setosum*. A. Agassiz, Rev. Ech., p. 103.

Great interest attaches to this well-known and widely distributed form, now that Herren Sarasin has discovered eye-spots on the integument, a full and well-illustrated account of which is to be found in Part I. of their just published "Ergebnisse naturwissenschaftlichen Forschungen auf Ceylon" (Wiesbaden, 1887). There is, apparently, a second species of *Diadema* at Ceylon, for the authors observed a form in which the eye-spots were not separated but formed continuous rows.

## 30. ASTROPYGA FREUDENBERGI.

*Astropyga freudenbergi*. P. & F. Sarasin, Ergebnisse naturw. Forschungen auf Ceylon, I., i., p. 16, pl. i.

Herren Sarasin, during their recent fruitful journey to, and stay in, Ceylon, acquired only one example of this remarkably fine form. As it was obtained after a high sea, it is possible that it comes from somewhat greater depths than most of the species. Its brilliant red colour, with its blue eye-spots, its large size, and the division of the naked interambulacral area into three bands, must make it an object which, if it be littoral in habit, will surely reward a careful search.

## 31. CYANOSOMA URENS.

*Cyanosoma urens*. C. F. and P. B. Sarasin, Zoolog. Anzeiger, ix., p. 80.

From the short account given by Herren Sarasin this appears to be an Echinothurid; they direct especial attention to the poison apparatus formed by some of the spines.

## 32. TOXOPNEUSTES PILEOLUS.

*Echinus pileolus*. Lamarck, Anim. s. Vert., iii., p. 45.

*Toxopneustes* for *E. pileolus*. Agassiz, Observ. sur les progrès récents de l'hist. nat. des Echinodermes, p. 7; A. Agassiz, Rev. Ech., p. 167.

## 33. TRIPNEUSTES ANGULOSUS.

*Cidaris angulosa*. Leske, Addit., p. 92.

*Tripneustes sardicus*. Agassiz and Desor, Ann. Sci. Nat. (3), vi., p. 363.

*Tripneustes angulosus*. Dujardin and Hupé, Echinodermes, p. 533; Bell, P. Z. S., 1879, pp. 657 and 661.

*Hipponoe variegata*. A. Agassiz, Rev. Ech., p. 135; Walter, Jen. Zeitsch., p. 375.

## 34. TEMNOPLEURUS TOREUMATICUS.

*Cidaris toreumatica*. Leske, Addit., p. 155.

*Temnopleurus toreumaticus*. Agassiz, in Valentin's Anat. du genre *Echinus*, p. vii.; A. Agassiz, Rev. Ech., p. 166; Bell, P. Z. S., 1880, p. 424.

This species was collected by Mr. E. W. H. Holdsworth.

## 35. SALMACIS BICOLOR.

*Salmacis bicolor*. Agassiz, in Valentin's Anat. du genre *Echinus*, p. viii (not 8); A. Agassiz, Rev. Ech., p. 156; Bell, P. Z. S., 1880, p. 428.

## 36. SALMACIS SULCATA.

*Salmacis sulcatus*. Agassiz and Desor, Ann. Sci. Nat. (3), vi., p. 359.

*Salmacis sulcata*. A. Agassiz, Rev. Ech., p. 156.

This species is inserted on the authority of Mr. Alex. Agassiz.

## 37. ECHINOMETRA LUCUNTER.

*Cidaris lucunter*. Leske, Addit., p. 109.

*Echinometra lucunter*. De Blainville, Actinologie, p. 225; A. Agassiz, Rev. Ech., p. 115; Bell, P. Z. S., 1881, p. 423.

## 38. ECHINOMETRA OBLONGA.

*Echinus oblongus*. De Blainville, Dict. Sci. Nat., s. v. Oursin, vol. xxxvii., p. 95.

*Echinometra oblonga*. Id., Actinol., p. 225; A. Agassiz, Rev. Ech., p. 116.

## 39. ECHINODISCUS BIFORIS.

*Echinodiscus bisperforatus.* Leske, Addit., p. 132.

*Echinus biforis.* Gmelin, Syst. Nat., xiii., p. 3188.

The term *biforis* can only be preferred to Leske's clumsy epithet on the ground of long and general usage.

## 40. ECHINONEUS CYCLOSTOMUS.

*Echinoneus cyclostomus.* Leske, Addit., p. 173 ; Agassiz, Rev. Ech., p. 117.

## 41. ECHINOLAMPAS OVIFORMIS.

*Echinus oviformis.* Gmelin, p. 3187.

*Echinolampas oviformis.* Gray, Annals Philos., xxvi. (n. s. x.), p. 429.

I include this species in the list of Echinoderms on the strength of M. de Loriol's determination (Mem. Soc. Phys. Genève, xxiv., p. 665) of a specimen collected by M. Humbert in Ceylon, and now in the Geneva Museum; there is no specimen from Ceylon in the British Museum, and Mr. A. Agassiz's statement to that effect must be based on some misunderstanding.

## 42. MARETIA ALTA.

*Maretia alta.* A. Agassiz, Proc. Acad. Nat. Hist., Philadelphia, 1863, p. 360; Rev. Ech., p. 139.

## V. HOLOTHURIOIDEA.

## 43. SYNAPTA BESELII.

*Synapta beselii.* Jaeger, De Holothuriis, p. 15, pl. i.; Semper, Holothurien, p. 11, pl. i.; Lampert, p. 223; Théel, p. 19.

This must be one of the most conspicuous members of the littoral Fauna of Ceylon. Dr. Ondaatje has forwarded to me two beautiful figures of the species; but as it has been already well figured by Semper, there is no need to repeat it here. Of great size, as much as seven feet in length, with its fifteen bright yellow tentacles, and its regular rows of prominent wart-like tubercles, it must frequently attract the eye.

## 44. SYNAPTA GRISEA.

*Synapta grisea.* Semper, Holothurien, p. 11; Lampert, p. 219; Théel, p. 21.

Of this smaller species there is, unfortunately, no figure.



## 45. CHIRODOTA RUFESCENS.

*Chirodota rufescens*. Brandt, Prodr. descr. Animal., p. 59; Ludwig, Zeitschr. f. wiss. Zool., xxxv., p. 578; Lampert, p. 230.

*Chirodota variabilis*. Semper, Holothurien, p. 21; Théel, p. 36 (where correct the misprint *refuscens*).

This species, with eighteen tentacles, appears to be widely distributed in the Indian Ocean.

## 46. HAPLODACTYLA MOLPADOIDES.

*Haplodactyla molpadoides*. Semper, Holothurien, p. 41, pl. ix.; Lampert, p. 205; Théel, p. 50.

Owing to the absence of suckers, the thick bodywall and the fifteen tentacles of this species should be easily recognised by the collector. The specimens in the British Museum were presented to the Trustees by E. W. H. Holdsworth, Esq., by whom they were collected. (See note A.)

## 47. ACTINOPYGA\* MAURITIANA (Pl. xxxix., fig. 1).

*Holothuria mauritiana*. Quoy and Gaimard, Voy. de l'Astrolabe, iv., p. 138.

*Muelleria mauritiana*. Brandt, Prodr. descr. Animal., p. 74; Semper, Holothurien, p. 76; Lampert, p. 98; Théel, p. 201.

The figure which is given does not represent a large specimen; this species is known to attain to a length of as much as 200 mm.

## 48. ACTINOPYGA MILIARIS (Pl. xl., fig. 1).

*Holothuria miliaris*. Quoy and Gaimard, Voy. de l'Astrolabe, iv., p. 137.

*Muelleria miliaris*. Brandt, Prodr. descr. Animal., p. 74; Lampert, p. 99; Théel, p. 200.

The fine figure illustration of the appearance of this species is one of the best of the drawings sent by Dr. Ondaatje, and warrants us in speaking with reserve, at any rate, as to the hideousness of Holothurians.

## 49. HOLOTHURIA ARGUS.

*Bohadschia argus*. Jaeger, De Holothur., p. 19, pl. ii., fig. 1; Semper, Holothur., p. 80; Lampert, p. 87; Théel, p. 203.

The eye-like spots on the integument, to the possession of which this creature owes its specific name, will allow it to be easily detected by the collector.

\* On the name to be applied to the genus, which is ordinarily called *Muelleria*, see Bell, Ann. & Mag. Nat. Hist. (5), xix., p. 392, and xx., p. 148.

## 50. HOLOTHURIA ATRA.

*Holothuria atra*. Jaeger, De Holothur., p. 22; Semper, Holothur., p. 88; Lampert, p. 85; Théel, pp. 181 and 213.

This is one of the most widely distributed of Echinoderms.

## 51. HOLOTHURIA CÆSAREA (Pl. XXXIX., fig. 2).

*Holothuria caesarea*. Ludwig, Arbeit. Zool. Institut, Würzburg, ii., p. 37; Lampert, p. 61; Théel, p. 227.

This must be a particularly fine form when alive. Dr. Théel thinks that this species is synonymous with *Holothuria discrepans* and *H. immobilis* of Semper. So far as any argument can be drawn from geographical distribution, the presence of *H. caesarea* at Ceylon would support the views of that distinguished naturalist; for, while *H. discrepans* and *H. caesarea* have only been reported from the Navigator's Islands, *H. immobilis* (under the title of *H. collaris*, Haacke) has been found at Mauritius.

## 52. HOLOTHURIA CINERASCENS (Pl. XL., fig. 2).

*Stichopus cinerascens*. Brandt, Prodr. descr. Animal., p. 51.

*Holothuria pulchella*. Selenka, Zeitschr. f. wiss. Zool., xvii., p. 329; Semper, Holothur., p. 89; Théel, p. 212.

*Holothuria cinerascens*. Lampert, p. 82.

Dr. Lampert appears to be right in restoring Brandt's specific name for this species; Dr. Théel recognises the synonyms of *H. pulchella* with *H. cinerascens*, but retains the more frequently used specific name.

## 53. HOLOTHURIA IMPATIENS.

*Fistularia impatiens*. Förskal, Descr. Animal., p. 121.

*Holothuria impatiens*. Gmelin, Syst. Nat., p. 3142, pl. xxxix., fig. B; Semper, pp. 82 and 248, pl. xxii.; Lampert, p. 65; Théel, p. 233.

It would have been astonishing, indeed, if this well-known and widely distributed form had not been found on the shores of Ceylon.

## 54. HOLOTHURIA ONDAATJEI, n. sp. (Pl. XXXIX., fig. 3).

No calcareous spicules in bodywall.

Twenty tentacles; body elongated; suckers confined to trivium, where they are irregularly and rather thickly distributed; integument soft, rather thick; cesophageal ring delicate; Polian vesicle not long; no Cuvierian organs; genital tubes elongated, extending far back.

Colour—chocolate brown bivium, rather lighter on the trivium and tentacles.

The larger specimen is 100 mm. long, and its greatest diameter is 18 mm.

## GEOGRAPHICAL RELATIONS OF THE ECHINODERM FAUNA OF CEYLON.

As, in the Report of the Voyage of the Alert,\* I have comparatively recently discussed the general aspects of the Echinoderm Fauna of the inter-tropical areas of the Indian and Pacific Oceans, it will be convenient here to limit oneself to the geographical relations of the Echinoderm Fauna of Ceylon.

Of the 55 species now known to dwell on the shores of that island, 26 are inhabitants of what may be called the Great Ocean; they extend from the eastern shores of Africa, across the Indian Ocean, through Torres Straits, to the more northern parts of East Australia and to the scattered islands of the Pacific; 13 which were [known east of Singapore have now had their extension to the central part of the Indian Ocean demonstrated; 2, on the other hand, have been reported from a more eastern locality than has yet been assigned them; 2 are known from the Atlantic, as well as from the Indian or Pacific Oceans; 7 are, so far as our knowledge at present extends, confined to the neighbourhood of Ceylon; but it is remarkable that while in other faunal regions we have been accustomed to find the Crinoids exhibiting a much more restricted area of distribution than other Echinoderms, of the five certainly known Crinoids from Ceylon only one seems indigenous to that island.

---

NOTE A.—[46A.]

Since this Paper was presented, I have recognised in a specimen from Ceylon, collected by Mr. Holdsworth, an example of *Colochirus armatus*, lately described by Dr. von Marenzeller (Verh. Zool. Bot. Ges. zu Wien, 1881, p. 132).

\* Report on the Zoological Collections made in the Indo-Pacific Ocean during the Voyage of H. M. S. Alert, 1881-82, 1884. (Echinodermata. By F. J. Bell.)

## TABLE OF GEOGRAPHICAL RANGE OF ECHINODERMS OF CEYLON.

## I. CRINOIDEA.

- |                                    |       |  |
|------------------------------------|-------|--|
| 1. <i>Antedon carinata</i> ,       | . . . | Mauritius, Java, Brazil.                                       |
| 2. <i>Antedon adeonae</i> ,        | . . . | East Australia (Port Curtis and Port Denison), New<br>Holland. |
| 3. <i>Antedon reynaudi</i> ,       |       |  |
| 4. <i>Actinometra cumingii</i> ,   | . . . | Malacca, East Australia (Port Molle).                          |
| 5. <i>Actinometra parvicirra</i> , | . . . | Malaysian Archipelago.   |

## II. ASTEROIDEA.

- |  |       |                                   |
|--|-------|-----------------------------------|
| 6. <i>Linckia laevigata</i> ,          | . . . | Great Ocean.                      |
| 7. <i>Linckia</i> , sp.                |       |                                   |
| 8. <i>Scytaster novae-caledoniae</i> , | . . . | New Caledonia.                    |
| 9. <i>Scytaster variolatus</i> ,       | . . . | Mauritius, Mozambique, Rodriguez. |
| 10. <i>Fromia milleporella</i> ,       | . . . | Indian Ocean.                     |
| 11. <i>Fromia tumida</i> ,             |       |                                   |
| 12. <i>Oreaster lincki</i> ,           | . . . | Indian Ocean.                     |
| 13. <i>Astropecten polyacanthus</i> ,  | . . . | Great Ocean.                      |
| 14. <i>Astropecten</i> , sp.           |       |                                   |
| 15. <i>Luidia maculata</i> ,           | . . . | Great Ocean.                      |

## III. OPHIUROIDEA.

- |  |       |  |
|--|-------|--|
| 16. <i>Ophioplocus imbricatus</i> ,    | . . . | Great Ocean.                                       |
| 17. <i>Ophiocoma erinaceus</i> ,       | . . . | Great Ocean.                                       |
| 18. <i>Ophiocoma scolopendrina</i> ,   | . . . | Great Ocean.                                       |
| 19. <i>Ophiocoma brevipes</i> ,        | . . . | Great Ocean.                                       |
| 20. <i>Ophiocoma pica</i> ,            | . . . | Great Ocean.                                       |
| 21. <i>Ophiomastix annulosa</i> ,      | . . . | Java, Pelews.                                      |
| 22. <i>Ophiactis savignii</i> ,        | . . . | Great Ocean.                                       |
| 23. <i>Ophiothrix nereidina</i> ,      | . . . | Philippines.                                       |
| 24. <i>Ophiothrix puncto-limbata</i> , | . . . | Java, Torres Straits, East Australia (Port Molle). |
| 25. <i>Ophiocnemis marmorata</i> ,     | . . . | Great Ocean.                                       |
| 26. <i>Ophiothela holdsworthii</i> ,   |       |  |
| 27. <i>Astrophyton clavatum</i> ,      | . . . | Zanzibar.  |

## IV. ECHINOIDEA.

28. *Phyllacanthus imperialis*, . . . Indian Ocean.  
 29. *Diadema setosum*, . . . Great Ocean.  
 30. *Astropyga freudenbergi*.  
 31. *Cyanosoma urens*.  
 32. *Toxopneustes pileolus*, . . . Great Ocean.  
 33. *Tripneustes angulosus*, . . . Great Ocean.  
 34. *Temnopleurus toreumaticus*, . . . Great Ocean.  
 35. *Salmacis bicolor*, . . . Great Ocean.  
 36. *Salmacis sulcata*, . . . Great Ocean.  
 37. *Echinometra lucunter*, . . . Great Ocean.  
 38. *Echinometra oblonga*, . . . Great Ocean.  
 39. *Echinodiscus biforis*, . . . Indian Ocean.  
 40. *Echinoneus cyclostomus*, . . . Great Ocean.  
 41. *Echinolampas oviformis*, . . . Red Sea, Mauritius, Cape of Good Hope.  
 42. *Maretia alta*, . . . Japan.

## V. HOLOTHURIOIDEA.

43. *Synapta beselii*, . . . Great Ocean.  
 44. *Synapta grisea*, . . . Philippines, Queensland.  
 45. *Chirodota rufescens*, . . . Philippines.  
 46. *Haplodactyla molpadoides*, . . . Philippines.  
 46A. *Colochirus armatus*, . . . Japan.  
 47. *Actinopyga mauritiana*, . . . Great Ocean.  
 48. *Actinopyga miliaris*, . . . Great Ocean.  
 49. *Holothuria argus*, . . . Great Ocean.  
 50. *Holothuria atra*, . . . Great Ocean.  
 51. *Holothuria cæsarea*, . . . Samoa.  
 52. *Holothuria cinerascens*, . . . Great Ocean.  
 53. *Holothuria impatiens*, . . . Great Ocean, Mediterranean, Atlantic.  
 54. *Holothuria ondatjei*.
-

## DESCRIPTION OF PLATES XXXIX. AND XL.

[The figures here given are illustrations merely of the external form of certain Holothurians; but, as these creatures are greatly deformed by preservation in spirit, and speedily become deprived of all, or much of their colour, the drawings taken on the spot, and from living specimens, are of especial interest and value; they are here reproduced exactly as they left the hands of the Cingalese Artist.]

## PLATE XXXIX.

1. *Actinopyga mauritiana*.—One-half the natural size.
2. *Holothuria casarea*.                    "                    "
3. *Holothuria ondatjei*.

## PLATE XL.

1. *Actinopyga miliaris*.
2. *Holothuria cinerascens*.

END OF VOLUME III., NEW SERIES.



Fig. 3.

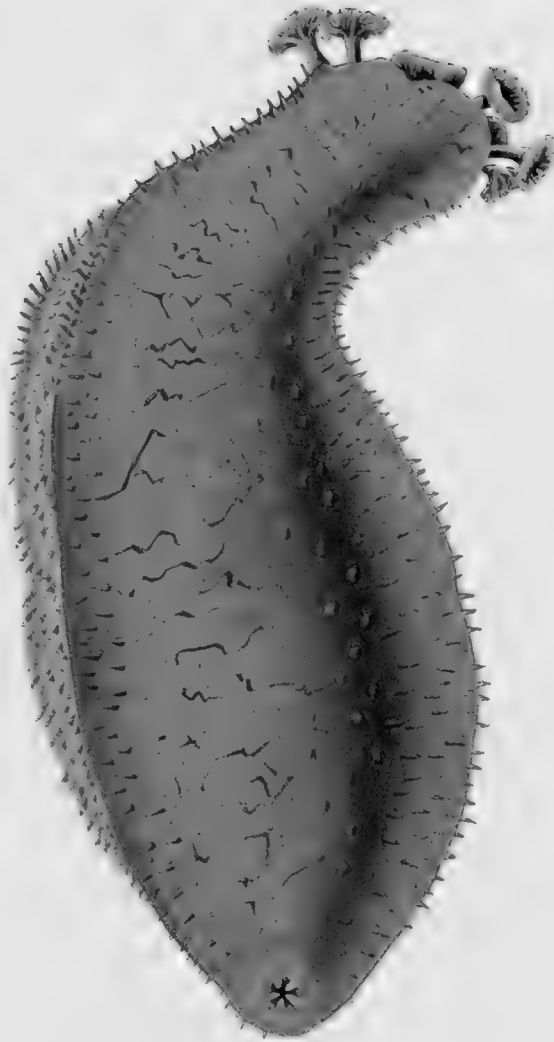

Fig. 1.



Fig. 2.







Fig. 1.



Fig. 2.



**DIRECTION TO BINDER.**

—  
VOLUME III.—PART XIII.  
—

Cancel pp. 641, 642, and substitute accompanying  
leaf instead.



frosts, though the sky appears perfectly clear, lamellar flakes of snow, of the most regular and beautiful forms, are always seen floating in the air and sparkling in the sunbeams, and the snow which falls, in general, is of the most elegant texture and appearance." "The various modifications of crystals may be classed under five general kinds or genera:—1. Lamellar. 2. A lamellar, or spherical nucleus, with spinous ramifications in different planes. 3. Fine spiculæ, or six-sided prisms. 4. Hexagonal pyramids. 5. Spiculæ, having one or both extremities affixed to the centre of a lamellar crystal."

We are more particularly concerned with the first and the last of these genera. About the first, Captain Scoresby says:—

"1. *Lamellar Crystals.*—The varieties of this kind are almost infinite. They occur at all temperatures, and in the greatest abundance, and most of the specimens are extremely thin, transparent, and of an exquisitely delicate structure. They may be subdivided into several distinct species:—

"(a) Stelliform; having six points radiating from a centre, with parallel collateral ramifications in the same plane. This species is the most general form met with. It occurs in greatest profusion when the temperature approaches the freezing-point.

"(b) Regular hexagon. This occurs in moderate, as well as in the lowest temperature; but it becomes more delicate and thin, and diminishes in size as the cold increases. Some specimens consist of simple transparent plates, others are beautifully variegated within the perimeter by white lines, forming smaller hexagons or other regular figures in immense variety.

"(c) Aggregations of hexagons. This beautiful species admits of immense variety. It occurs chiefly at low temperatures.

"(d) Combinations of hexagons, with radii or spines and projecting angles. This constitutes the most extensive species in the arrangement."

About the last, or fifth, genus, Captain Scoresby says:—

"5. *Spiculæ or prisms having one or both extremities inserted in the centre of a Lamellar Crystal.*—This is the most singular genus I have ever seen, and has been observed but twice. It resembles a pair of wheels, united by an axle-tree; the wheels consisting of hexagonal or other lamellar crystals, and the axle of a slender crystal. Some of this extraordinary figure occurred along with the last-described genus [Hexagonal pyramids]. Of which kinds, principally, a quantity of snow, three or four inches in depth, once fell on the deck of the ship in which I sailed, in the course of a few hours. The temperature when this kind of crystal fell was in one instance 22°, and in the other 20° [Fahrenheit].

In four engraved plates Captain Scoresby delineates ninety-six different forms, magnified from three to seven times. And he attaches a letter to most of them, referring to an annexed Table, in which the state of the atmosphere and weather, when each form was observed, stand recorded. In what he further adds to his record, he says:—

"Many instances, it may be observed, occur of mutilated and irregular specimens, some wanting two or three radii, and others having radii of different shapes. But in low temperatures the greatest proportion of crystals that fall are probably perfect geometrical figures."

The foregoing are the parts of Captain Scoresby's record of his invaluable observations upon ice crystals, which more particularly throw light on the cause

why cirrus clouds are occasionally iridescent ; but the rest of the account of this accurate observer, and the admirable drawings which he made of the crystals, will also well repay careful study. Thus, if the cloud consist of crystals of Scoresby's fifth genus, or if crystals of the first and third genera are both present, and if the air is so calm that the crystals can remain in the terminal position into which they would come in falling through still air, then we shall have the phenomenon of both a horizontal and a vertical circle through the sun making a cross. Whereas, if the crystals are of the first genus only, the vertical circle will present itself without the horizontal. I have myself seen the phenomenon in this latter form. Crystals of either the first or the fifth genus, if occasionally agitated so that they will keep fluttering, would give rise to iridescence if of sufficiently uniform thickness.

Captain Scoresby describes lamellar flakes of snow floating in the air and sparkling in the sunbeams, as always present during severe frosts, when the sky is clear. The beautiful appearance they would have is a familiar one in chemical laboratories, when a glass vessel, in which precipitated tabular crystals are subsiding through the mother liquid, is placed in the direct light of the sun. The whole liquid then seems alive with minute specks flashing with the brilliant colours of thin plates.

ADDENDUM.—*JUNE 16, 1887.*

When the fluttering of the lamellar crystals which form an iridescent cloud is gentle, the crystals will not incline much from a horizontal position ; and as this is the case which most frequently occurs, it is desirable fully to consider the consequences of it. With clouds of this kind the iridescent colours will be seen only when the sun is low in the sky, and only in parts of the cloud that are at no great distance from him, and that are rather above or below the sun than sideways. In more distant clouds, when the sun is low—and in all the clouds when the sun is high in the sky—the flat surfaces of the crystals do not become sufficiently inclined to reflect the sun's rays to the spectator, and accordingly all the light which reaches the eye from the clouds that are so situated has been reflected by edges of crystals, or scattered in irregular ways, and is mere white light. This is the case that is oftenest seen : only a few clouds near the setting or rising sun exhibit their soft iridescence. But some few times in one's life the display may be seen in all quarters of the sky, and with the sun well up in the heavens, and the phenomenon is then one of the most enchanting presented to us by nature. This exquisite spectacle can only present itself on those rare occasions when the crystals are tossed about in an unusual degree.



# TRANSACTIONS (NEW SERIES).

## VOLUME I.

Parts 1-25.—November, 1877, to September, 1883. (*Part 25 contains Title-page to Volume.*)

## VOLUME II.

PART

- 1.—Observations of Nebulæ and Clusters of Stars, made with the Six-foot and Three-foot Reflectors at Birr Castle, from the year 1848 up to the year 1878. Nos. 1 & 2. By the RIGHT HON. THE EARL OF ROSSE, LL.D., D.C.L., F.R.S. Plates I. to IV. (August, 1879.) No. 3. Plates V. and VI. (June, 1880.)
- 2.—On Aquatic Carnivorous Coleoptera or Dytiscidæ. By DR. SHARP. Plates VII. to XVIII. (April, 1882.) [*With Title-page to Volume.*]

## VOLUME III.

- 1.—On the Influence of Magnetism on the Rate of a Chronometer. By OTTO BÆDDICKER, PH.D. Plate I. (September, 1883.)
- 2.—On the Quantity of Energy transferred to the Ether by a Variable Current. By GEORGE F. FITZGERALD, M.A., F.R.S. (March, 1884.)
- 3.—On a New Form of Equatorial Telescope. By HOWARD GRUBB, M.E., F.R.S. Plate II. (March, 1884.)
- 4.—Catalogue of Vertebrate Fossils from the Siwaliks of India, in the Science and Art Museum, Dublin. By R. LYDEKKER, B.A., F.G.S., F.Z.S. Plate III. and Woodcuts. (July, 1884.)
- 5.—On the Origin of Freshwater Faunas: A Study in Evolution. By W. J. SOLLAS, M.A., Dublin; D.Sc., Cambridge; Fellow of St. John's College, Cambridge; Professor of Geology and Mineralogy in the University of Dublin. (November, 1884.)
- 6.—Memoirs on the Coleoptera of the Hawaiian Islands. By THE REV. T. BLACKBURN, B.A., and DR. D. SHARP. Plates IV. and V. (February, 1885.)
- 7.—Notes on the Aspect of the Planet Mars in 1884. Accompanied by Sketches made at the Observatory, Birr Castle. By OTTO BÆDDICKER, PH.D. Plate VI. (March, 1885.)
- 8.—On the Geological Age of the North Atlantic Ocean. By EDWARD HULL, LL.D., F.R.S., F.G.S., Director, Geological Survey of Ireland. Plates VII. and VIII. (April, 1885.)
- 9.—On the Changes of the Radiation of Heat from the Moon during the Total Eclipse of 1884, October 4, as Measured at the Observatory, Birr Castle. By OTTO BÆDDICKER, PH.D. Plates IX. and X. (October, 1885.)
- 10.—On the Collection of the Fossil Mammalia of Ireland in the Science and Art Museum, Dublin. By V. BALL, M.A., F.R.S., F.G.S. Plate XI. (November, 1885.)
- 11.—On New Zealand Coleoptera, with Descriptions of New Genera and Species. By DAVID SHARP, M.B. Plates XII. and XIII. (November, 1886.)
- 12.—The Fossil Fishes of the Chalk of Mount Lebanon, in Syria. By JAMES W. DAVIS, F.G.S., F.L.S., &c. Plates XIV. to XXXVIII. (April, 1887.)
- 13.—On the Cause of Iridescence in Clouds. By G. JOHNSTONE STONEY, M.A., D.Sc., F.R.S., a Vice-President, R.D.S. (May 1887.)
- 14.—The Echinoderm Fauna of the Island of Ceylon. By F. JEFFREY BELL, M.A., Sec. R.M.S., Professor of Comparative Anatomy and Zoology in King's College, London; Cor. Mem. Linn. Soc., N. S. Wales. Plates XXXIX. and XL. (November, 1887.) [*With Title-page and Contents to Volume, also Cancel Page to Part 13.*]







1915  
1916  
1917  
1918  
1919  
1920  
1921  
1922  
1923  
1924  
1925  
1926  
1927  
1928  
1929  
1930  
1931  
1932  
1933  
1934  
1935  
1936  
1937  
1938  
1939  
1940  
1941  
1942  
1943  
1944  
1945  
1946  
1947  
1948  
1949  
1950  
1951  
1952  
1953  
1954  
1955  
1956  
1957  
1958  
1959  
1960  
1961  
1962  
1963  
1964  
1965  
1966  
1967  
1968  
1969  
1970  
1971  
1972  
1973  
1974  
1975  
1976  
1977  
1978  
1979  
1980  
1981  
1982  
1983  
1984  
1985  
1986  
1987  
1988  
1989  
1990  
1991  
1992  
1993  
1994  
1995  
1996  
1997  
1998  
1999  
2000  
2001  
2002  
2003  
2004  
2005  
2006  
2007  
2008  
2009  
2010  
2011  
2012  
2013  
2014  
2015  
2016  
2017  
2018  
2019  
2020  
2021  
2022  
2023  
2024  
2025

ACME  
CORP., INC.

AUG 20 1984

100 CAMBRIDGE STREET  
CHARLESTOWN, MASS.



3 2044 093 401 495

